

Radio— Electronics

**COAX VS. TWIN-LEAD
FOR YOUR TV ANTENNA**

\$1.25 JULY 1980

48783

Build an all-master home intercom system
VMOS—is it the ideal transistor?
Expand your μ P with a D/A converter

Designing small hi-fi speakers
All-in-one communications analyzer
Build a PLL function generator



**BUILD THIS
ENERGY-SAVING
HOME THERMOSTAT**



The Thinking Cap.



Now you can check, sort and measure capacitance in less time, with more accuracy.

Forget what you know about cap meters. Our new Model 3001 Digital Capacitance Meter offers advantages worth thinking about.

It's more accurate. More rugged. With more features, more accessories. All in the first cap meter specifically designed for professional lab, test and production benches. All for just \$275.*

As usual, we started where everyone else left off. Behind our 3½-digit LED display, you'll find a unique *Dual Threshold* circuit that boasts 0.1% accuracy** (that's 0.1% of the *reading*—not of full scale). Nine overlapping ranges, up to .1999 Farad, with down to 1 pF resolution. Auto over- and under-

range indications. And the 3001 isn't fooled by dielectric absorption.

Our back panel is more intelligent, too. With an easy interface for remote display, sorting and control accessories. And a clever way of eliminating battery problems—an AC cord.

We've put a lot of thought into our accessories, of course. With a production test fixture, a Tri-Mode Comparator and a variety of test cables. Plus one of the best manuals in the business.

We can't tell you the whole story here. Call or write for details. Or better yet, order your Thinking Cap today.

Smarter tools for testing and design.

70 Fulton Terr., New Haven, CT 06509 (203) 624-3103, TWX 710-465-1227
OTHER OFFICES: San Francisco (415) 421-8872, TWX 910-372-7992
Europe: Phone Saffron-Walden 0799-21682, TLX 817477
Canada: Len Finkler Ltd., Downsview, Ontario

**GLOBAL
SPECIALTIES
CORPORATION**

Call toll-free for details
1-800-243-6077
During business hours

*Suggested U.S. resale. Prices, specifications subject to change without notice. © Copyright 1980 Global Specialties Corporation.

CIRCLE 5 ON FREE INFORMATION CARD

www.americanradiohistory.com

Heart Computer

Your heart can tell you three things that can help you live longer and stay healthier. The rest is up to you.

JS&A has never offered a pulse meter. And for good reason.

If you've ever used one, you'll quickly discover that your heart does not beat like a clock. It's irregular. It might beat at 40 beats per minute for one instant and at 120 the next. Since most pulse meters measure each beat as it occurs, you never feel confident that you're getting a very good reading.

We also considered size. Each pulse meter we examined was large or cumbersome and awkward to carry or store.

WE WAITED

We waited a few years. In the meantime, we discovered three ways your heart (through your pulse) helps you monitor your health.

Pulse Rate Your pulse rate can tell you if you are getting enough oxygen throughout your body. A high pulse rate indicates that your heart must pump faster to supply that oxygen and may indicate poor physical condition.

Target Zone Your pulse can tell you if your heart is beating fast enough during exercise. There's an area called the "Target Zone." Below this level, you're not exercising hard enough to do your heart or respiratory system any good. Above this level, you can be dangerously over-exercising yourself.

Cardiac Recovery Time The time it takes for your pulse rate to return to normal after you've exercised is the real measure of whether or not your exercise program is doing you any good. This time can be as healthy as one minute or as poor as several minutes.

The three things we learned convinced us that the ideal pulse meter must have the following features:

1. It must measure a series of heart beats and simultaneously compute the average to avoid the strange readings from irregular heart beats.

2. It must be small enough to use while exercising.

3. It should have a timing capability to determine the Cardiac Recovery Time.

It wasn't until a small Utah medical electronic instrument company created what we feel not only provides the capabilities listed above, but excels in other areas too.

FITS ON FINGER

The unit is called the Pulsetach, and it fits right over your finger. It weighs less than an ounce and can be worn easily during most exercise programs.

The large liquid crystal display can easily be seen in normal room lighting or in bright sunlight, and because liquid crystal displays consume very little power, the readily-available watch batteries will last for years. The Pulsetach automatically turns itself off in five minutes if you forget.

The heart of the system is a powerful micro-

computer CMOS semi-conductor integrated circuit that will take up to 4 pulse beats, compute an average pulse rate, and then flash that rate on the liquid crystal display.

FINGERTIP SCANNER

The sensor consists of a Gallium Arsenide infrared light-emitting diode which scans your fingertip hundreds of times a second to determine your pulse rate. This new system is one of the most accurate and is also used in sophisticated hospital systems.

The unit also contains a quartz-controlled timing circuit which will accurately time either your exercise period or your Cardiac Recovery Time. And you can switch back and forth between the pulse and chronograph mode while you are exercising.

We realize that the Pulsetach sounds like a very sophisticated unit. And it is. But as sophisticated as it is internally, it's an extremely easy unit to operate. There are just two buttons to press which operate the pulse reading and the chronograph timing circuit. A third button engages the audio circuit.

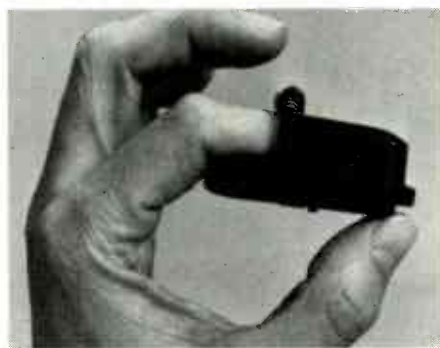

The Pulsetach system fits comfortably on your finger while it monitors your heart and determines your Cardiac Recovery Time.

HEAR YOUR PULSE

The audio circuit simply beeps every time your pulse beeps. This feature lets you monitor your pulse by hearing it as you run or exercise and it can be shut off by pressing the button a second time. The timing circuit is quartz-controlled and extremely accurate.

The Pulsetach not only has combined all of the most advanced technology in an extremely small size, but it costs less than many other systems lacking its advanced features.

The Pulsetach can be used for joggers, athletes, all forms of exercise and even cardiac recovery patients, as it operates quite effectively with pacemakers.

REAL WORKOUT

We suggest you order a Pulsetach for our 30-day no-obligation trial. When you receive your unit, give it a real workout. Notice how simple it is to operate and how easily you



The Pulsetach will shortly become the number one selling system of its type in the nation.

can read your pulse rate. Use it to stay in your Target Zone and to determine and then improve your Cardiac Recovery Time.

Monitor your Cardiac Recovery Time. Determine your Target Zone and see if you're really exercising in that area. Then use the Pulsetach to watch those important signs slowly improve thanks to the accuracy and information you get from the unit.

By knowing the important factors that help you monitor your health, you'll feel better, exercise more effectively, and many doctors feel you'll live longer.

TWO UNITS AVAILABLE

To order your Pulsetach pulse meter, send your check for **\$119.95** plus \$2.50 postage and handling (Illinois residents add 6% sales tax) to the address below. (Allow 20 days for personal checks to clear.) Credit card buyers may call our toll-free number below.

You can also order the more expensive hospital unit that averages 16 beats and has all the features including the small size of the previous unit. It costs **\$169.95**.

We'll send your Pulsetach pulse meter complete with 90-day limited warranty and instructions which include information on determining your Target Zone, Cardiac Recovery Time and other helpful information.

Then after your test, if you're not fully convinced that the Pulsetach is the best unit of its kind, the most convenient, and the greatest value, return it within 30 days for a prompt and courteous refund including the \$2.50 charge for postage and handling. You can't lose.

Your Pulsetach is totally solid-state so service should never be required, but if it is, the manufacturer has a national service-by-mail facility backing each unit. JS&A is America's largest single source of space-age products—further assurance that your Pulsetach is backed by a substantial company.

We've waited an awful long time to jump into the pulse monitoring field. But what a great entry. Order your Pulsetach at no obligation today.

JS&A PRODUCTS
THAT THINK®

Dept. RA One JS&A Plaza
Northbrook, Ill. 60062 (312) 564-7000
Call TOLL-FREE 800 323-6400
In Illinois Call (312) 564-7000

© JS&A Group, Inc., 1980

A LIFETIME GUARANTEE AND 11 OTHER REASONS TO BUY AN "OPTOELECTRONICS" FREQUENCY COUNTER

- 1. SENSITIVITY:** Superb amplifier circuitry with performance that can't be matched at twice the price. Average sensitivity of better than 15 mV from 10 Hz to 500 MHz on every model and better than 30 mV from 500 MHz to 1.1 GHz on the Series 8010A and 8013.
- 2. RESOLUTION:** 0.1 Hz to 12 MHz, 1 Hz to 50 MHz, 10 Hz over 50 MHz.
- 3. ALL METAL CASES:** Not only are the heavy gauge aluminum cases rugged and attractive, they provide the RF shielding and minimize RFI so necessary in many user environments.
- 4. EXTERNAL CLOCK INPUT/OUTPUT:** Standard on the 8010/8013 series and optional on the 7010 series is a buffered 10 MHz clock time base input/output port on the rear panel. Numerous uses include phase comparison of counter time base with WWVB (U.S. National Bureau of Standards). Standardize calibration of all counters at a facility with a common 10 MHz external clock signal, calibrate scopes and other test equipment with the output from precision time base in counter, etc., etc.
- 5. ACCURACY:** A choice of precision to ultra precision time base oscillators. Our ± 1 PPM TCXO (temperature compensated xtal oscillator) and ± 0.1 PPM TCXO are sealed units tested over 20-40°C. They contain voltage regulation circuitry for immunity to power variations in main instrument power supply, a 10 turn (50 PPM) calibration adjustment for easy, accurate setability and a heavily buffered output prevents circuit loads from affecting oscillator. Available in the 8010 and 8013 series is our new ultra precision micro power proportional oven oscillator. With $\pm .05$ PPM typical stability over 10-45°C, this new time base incorporates all of the advantages of our TCXO's and virtually none of the disadvantages of the traditional ovenized oscillator: Requires less than 4 minutes warm-up time, small physical size and has a peak current drain of less than 100 ma.
- 6. RAPID DISPLAY UPDATE:** Internal housekeeping functions require only .2 seconds between any gate or sample time

period. At a 1 second gate time the counter will display a new count every 1.2 seconds, on a 10 second gate time a new count is displayed every 10.2 seconds. (10.2 seconds is the maximum time required between display updates for any resolution on any model listed).

- 7. PORTABILITY:** All models are delivered with a 115 VAC adapter, a 12 VDC cord with plug and may be equipped with an optional ni-cad rechargeable battery pack installed within its case. The optional Ni-Cad pack may be recharged with 12 VDC or the AC adapter provided.
- 8. COMPACT SIZES:** State-of-the-Art circuitry and external AC adapters allowed design of compact easy to use and transport instruments.
Series 8010/8013: 3" H x 7-1/2" W x 6-1/2" D
Series 7010: 1-3/4" H x 4-1/4" W x 5-1/4" D
- 9. MADE IN U.S.A.:** All models are designed and manufactured at our modern 13,000 square foot facility at Ft. Lauderdale, Florida.
- 10. CERTIFIED CALIBRATION:** All models meet FCC specs for frequency measurement and provided with each model is a certificate of NBS traceable calibration.
- 11. LIFE TIME GUARANTEE:** Using the latest State-of-the-Art LSI circuitry, parts count is kept to a minimum and internal case temperature is only a few degrees above ambient resulting in long component life and reliable operation. (No custom IC's are used.) To demonstrate our confidence in these designs, all parts (excluding batteries) and service labor are 100% guaranteed for life to the original purchaser. (Transportation expense not covered).
- 12. PRICE:** Whether you choose a series 7010 600 MHz counter or a series 8013 1.3 GHz instrument it will compete at twice its price for comparable quality and performance.

MODEL 8010A/8013 1.1 GHz/1.3 GHz

MODEL 7010A 600 MHz



| MODEL | RANGE (From 10 Hz) | 10 MHz TIME BASE | | | AVG. SENSITIVITY | | GATE TIMES | RESOLUTION | | | EXT. CLOCK INPUT/OUTPUT | SENSITIVITY CONTROL | NI-CAD BATTERY PACK |
|----------|-----------------------|------------------|-----------|--------|------------------|--------------------|-------------------------|------------|--------|--------------------|----------------------------|------------------------|------------------------|
| | | STABILITY | AGING | DESIGN | 10 Hz to 500 MHz | 500 MHz to 1.1 GHz | | 12 MHz | 60 MHz | Max. Freq. | | | |
| 7010A | 600 MHz | ± 1 PPM | 1 PPM/YR | TCXO* | 15 mV | N/A | (3) 1, 1, 10 sec | 1 Hz | 1 Hz | 10 Hz (600 MHz) | YES OPTIONAL | NO | YES OPTIONAL |
| 7010 1A | | ± 0.1 PPM | | | | | | | | | | | |
| 8010A | 1.1 GHz | ± 1 PPM | <1 PPM/YR | TCXO* | 15 mV | 30 mV | (4) 01, 1, 1, 10 sec | 1 Hz | 1 Hz | 10 Hz (1.1 GHz) | YES STANDARD | YES | YES OPTIONAL |
| 8010 1A | | ± 0.1 PPM | | | | | | | | | | | |
| 8010 05A | | $\pm .05$ PPM | | | | | | | | | | | |
| 8013.1 | 1.3 GHz | ± 0.1 PPM | 1 PPM/YR | TCXO* | 15 mV | 30 mV | (4) 01, 1, 1, 10 sec | 1 Hz | 1 Hz | 10 Hz (1.3 GHz) | YES STANDARD | YES | YES OPTIONAL |
| 8013 05 | | $\pm .05$ PPM | | | | | | | | | | | |

*TCXO = Temperature Compensated Xtal Oscillator

**OCXO = Proportional Oven Controlled Xtal Oscillator

SERIES 7010A

| | | |
|-------------|--|----------|
| #7010A | 600 MHz Counter - 1 PPM TCXO | \$199.95 |
| #7010 1A | 600 MHz Counter - 0.1 PPM TCXO | \$249.95 |
| OPTIONS: | | |
| #70-H | Handle/Tilt Bail (not shown) | \$2.95 |
| #Ni-Cad-701 | Ni-Cad Battery Pack & Charging Circuitry Installed Inside Unit | \$19.95 |
| #EC-70 | External Clock Input/Output | \$35.00 |
| #CC-70 | Carry Case - Padded Black Vinyl | \$9.95 |

SERIES 8010A/8013

| | | |
|-------------|--|----------|
| #8010A | 1.1 GHz Counter - 1 PPM TCXO | \$399.00 |
| #8010 1A | 1.1 GHz Counter - 0.1 PPM TCXO | \$450.00 |
| #8010 D5A | 1.3 GHz Counter - .05 PPM Oven | \$499.00 |
| #8013.1 | 1.3 GHz Counter - 0.1 PPM TCXO | \$550.00 |
| #8013 05 | 1.3 GHz Counter - .05 PPM Oven | \$599.00 |
| OPTIONS | | |
| #Ni-Cad-801 | Ni-Cad Battery Pack & Charging Circuitry Installed Inside Unit | \$49.95 |
| #CC-80 | Carry Case - Padded Black Vinyl | \$9.95 |

ACCESSORIES

| | | |
|-----------|--|----------|
| #TA-100 | Telescope antenna with right angle BNC | \$9.95 |
| #P-100 | Probe, 50 Ohm, 1X | \$13.95 |
| #P-101 | Probe, Lo-Pass Audio Usage | \$13.95 |
| #P-102 | Probe, Hi-Z General Purpose | \$15.95 |
| #LFM:1110 | Low Frequency Multiplier X 10, X 100, X 1000 For High Resolution of Audio Freq | \$119.95 |



Optoelectronics inc

5821 N.E. 14th Avenue, Fort Lauderdale, Florida 33334

1-800-327-5912

TERMS: Orders to U.S. and Canada, add 5% for shipping, handling and insurance to a maximum of \$10.00. All other orders add 15% C.O.D. collection fee \$2.00. Florida orders add 4% state tax. Personal checks must clear before goods are shipped.

FROM FLORIDA (305) 771-2051/2
CIRCLE 20 ON FREE INFORMATION CARD

| | | |
|--------------|-----------|--|
| BUILD | 43 | ENVIRONMENTAL CONTROL CENTER Technology and Mother Nature work together to reduce home heating and cooling costs. Tom Stults |
| | 63 | HOME INTERCOM SYSTEM Simple and inexpensive way to hear—and be heard—all through the house. David J. Sweeney |
| | 65 | SYNTHESIZED FUNCTION GENERATOR Part 2—Complete construction details. A professional-quality tool for the experimenter or technician. Gary McClellan |

| | | |
|-------------------|-----------|---|
| TECHNOLOGY | 4 | LOOKING AHEAD Tomorrow's news today. David Lachenbruch |
| | 16 | SATELLITE TV NEWS The latest happenings in an exciting new industry. Gary H. Arlen |
| | 55 | VMOS—A GIANT STEP TOWARD THE IDEAL The closest thing yet to the "perfect" transistor. Bill Roehr |
| | 73 | NEW IDEAS A winning circuit application from our readers. |
| | 74 | HOBBY CORNER More about tide clocks, and other items. Earl "Doc" Savage, K4SDS |

| | | |
|--------------|-----------|---|
| VIDEO | 48 | COAX vs. TWIN-LEAD Shielded cable is better than twin-lead... or is it? James E. Kluge |
| | 81 | SERVICE CLINIC Oscilloscopes simplify troubleshooting. Jack Darr |
| | 82 | SERVICE QUESTIONS R-E's Service Editor solves technicians' problems. |

| | | |
|--------------|-----------|---|
| AUDIO | 58 | DESIGNING SMALL SPEAKER SYSTEMS Many factors must be weighed and balanced to obtain optimum performance. Len Feldman |
| | 70 | R.E.A.L. SOUND LAB TESTS AUDIO CONTROL CIO EQUALIZER/ANALYZER Combination graphic equalizer and real-time analyzer rates excellent. |

| | | |
|--------------|-----------|---|
| RADIO | 78 | COMMUNICATIONS CORNER The most comprehensive piece of test equipment we've seen yet. Herb Friedman |
|--------------|-----------|---|

| | | |
|------------------|-----------|--|
| COMPUTERS | 51 | CONNECT A D/A CONVERTER Interfacing microprocessors to the analog world. Joseph J. Carr |
|------------------|-----------|--|

| | | |
|--------------------------|-----------|---|
| EQUIPMENT REPORTS | 26 | Kikusai 5512A Oscilloscope |
| | 32 | Doric 130-A Capacitance Meter |
| | 38 | Mem-Explorer PET Computer Software |
| | 38 | Radio Shack Quick Printer II |

| | | | | |
|--------------------|------------|----------------------------------|-----------|-----------------------|
| DEPARTMENTS | 102 | Advertising Index | 83 | Market Center |
| | 14 | Advertising Sales Offices | 76 | New Products |
| | 77 | Computer Products | 36 | Next Month |
| | 14 | Editorial | 80 | Radio Products |
| | 103 | Free Information Card | 7 | What's News |
| | 22 | Letters | 72 | Correction |

ON THE COVER

Sitting on the desk in front of the window is the thermostat portion of the Environmental Control System. This system connects to your heating, air conditioning and ventilating systems and controls their operation in accordance with inside and outside temperature, and humidity. Energy savings of up to 20% can be realized with this system. Get started building yours today. The construction details starts on page 43.

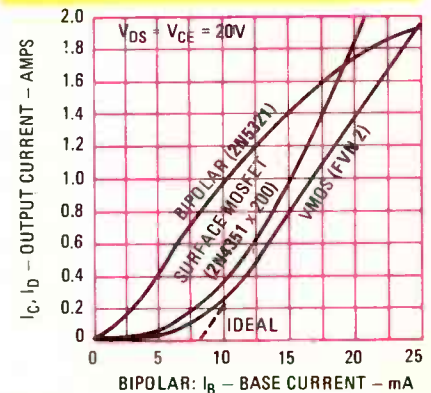

VMOS DEVICES have near ideal characteristics. For the complete story on VMOS, turn to page 55.



COAX VS. TWINLEAD for your TV antenna. Shown above is one of 9 steps in making ideal coaxial connections. For the other 8 steps and the full story, turn to page 48.

Radio-Electronics, (ISSN 0033-7862) Published monthly by Gernsback Publications, Inc., 200 Park Avenue South, New York, NY 10003. Phone: 212-777-6400. Controlled Circulation Postage Paid at Concord, NH. One-year subscription rate: U.S.A. and U.S. possessions, \$13.00. Canada, \$16.00. Other countries, \$18.00. Single copies \$1.25. © 1980 by Gernsback Publications, Inc. All rights reserved. Printed in U.S.A.

Subscription Service: Mail all subscription orders, changes, correspondence and Postmaster Notices of undelivered copies (Form 3579) to Radio-Electronics Subscription Service, Box 2520, Boulder, CO 80322.

A stamped self-addressed envelope must accompany all submitted manuscripts and/or artwork or photographs if their return is desired should they be rejected. We disclaim any responsibility for the loss or damage of manuscripts and/or artwork or photographs while in our possession or otherwise.

As a service to readers, Radio-Electronics publishes available plans or information relating to newsworthy products, techniques and scientific and technological developments. Because of possible variances in the quality and condition of materials and workmanship used by readers, Radio-Electronics disclaims any responsibility for the safe and proper functioning of reader-built projects based upon or from plans or information published in this magazine.

looking ahead

Pioneer's videodisc plans: U.S. Pioneer is now in the process of entering the American videodisc player market with an optical player, designed to play the same DiscoVision discs as the Magnavox unit that is currently being sold in an increasing number of geographic regions. The principal difference between the Magnavox and Pioneer players is that the latter contains a digital keypad which permits the user to call up any one of the 54,000 frames on one side of a two-sided 60-minute disc. The suggested list price of the Magnavox player is \$775, of the Pioneer player \$749, and a full-function wireless remote control for the latter is \$50 extra. Like the Magnavox player, Pioneer's will play one-hour-per-side discs, but without the random-access feature, as well as 30-minute-per-side random-access discs. The first markets for the Pioneer player are Dallas-Fort Worth, Minneapolis-St. Paul, Syracuse NY, and Madison WI, with four additional markets scheduled to be added every 60-90 days. Pioneer's first major dealers are expected to be hi-fi retailers, and the company has formed a new subsidiary, Pioneer Artists, which will release videodiscs featuring stereophonic musical performances.

...and VHD makes 3: The third non-compatible videodisc system—JVC's VHD, or Video High Density, system (see **Radio-Electronics**, June 1980), now is scheduled for marketing in America, as a competitor to the Philips-MCA-Pioneer grooveless optical system and the RCA-Zenith-CBS grooved capacitance (SelectaVision) system. VHD is a grooveless capacitance system, combining some of the features of both of the others, but completely non-compatible with either.

JVC has signed an agreement with Thorn-EMI of U.K. for the latter to manufacture and market VHD. Thorn is a major British TV manufacturer and its subsidiary EMI is a worldwide record company whose American operation is Capitol Records. In addition, both JVC and its parent Matsushita Electric plan to make players for the system. In the United States, Matsushita's subsidiaries Panasonic and Quasar, as well as JVC, are expected to market the system. In addition, JVC is seeking to make licensing arrangements with other uncommitted hardware and software manufacturers. JVC estimates that its system will be on the market around the end of 1981 and that players will cost in the neighborhood of \$500. RCA has already announced that its players and discs will be in national distribution early next year at "under \$500."

Videocassette duplicator: Videocassette programming is currently duplicated in real time, with banks of video recorders taping the output of a master player. Matsushita Electric is now demonstrating a high-speed videocassette duplicator (which it calls VTP (for *Videotape Printer*), designed to turn out a two- or four-hour videocassette program in four minutes. It uses the principle of contact printing and is completely automatic.

The master tape is coated with an iron-cobalt composition with a high coercivity of 2,000 oersteds. It is recorded with a "mirror image" of what is desired on the duplicated tape. For duplication, up to 12 VHS cassettes may be stacked in a loader. The cassette drops onto the

duplicator, the tape is extracted, cut from the leader, wound around a drum in contact with the master tape, where it is subjected to a 900-oersted magnetic field. After the high-speed printing is accomplished, the recorded tape is wound back into the cassette and the leader respliced to it, and it drops into a bin, the next tape from the hopper falling into place for duplication. Some tape duplicators are dubious of the high-speed printer because of cost—the printer itself costs \$60,000, and the companion recorder (required to make the master tape) is \$40,000.

20-hour VCR here: The battle of recording time in home videocassette recorders is probably over—since very few people will need more than 20 hours. Sony has introduced a cassette changer for its current-model Betamax VCR's (it will also fit current Zenith units) which will automatically record, play, or rewind up to four cassettes completely unattended. It can be attached by anyone with a screwdriver—and just to make certain anyone can do it, Sony even includes the screwdriver. Sony recommends the Betastack for use with its SL-5600 programmable VCR, which can be programmed to record over a two-week period. Using 5-hour cassettes, Betastack makes it unnecessary to miss your favorite programs while you're on vacation. At presstime, Betastack was still unpriced, but a previously introduced three-cassette changer for older Sony models is \$125.

Rear TV projectors: Compact, one-piece rear projection systems, with the picture viewed on a translucent screen at the front of the cabinet, is the latest trend in giant-screen TV. It was started by General Electric two years ago, but the newer units are brighter and less directional, using three projection tubes and improved screens. The first three-tube unit to be shown was made by Projection Systems Inc. (PSI) and has a 50-inch screen with a Sylvania remote-controlled VIR chassis. It sells for \$3,100. Panasonic this fall will offer a three-tube rear-screen remote-controlled 45-inch projection set at \$3,299; Quasar is expected to have a similar unit. Late this year or early next, General Electric will offer a three-tube type, and Sylvania will field its own version of the PSI projector.

Multicolored LED: Another development which could lead to flat-screen color TV is highlighted in an announcement from Sanyo that it has developed the first multicolored light-emitting diode, which emits colors from red through green, including in-between hues. (The nearest thing to this available commercially is the bi polar LED, which actually contains two elements—one just for red and one for green. The LED is made to change color when polarity of the applied voltage reverses.) Made from phosphorized gallium, the new LED is claimed to have a life of "several tens of thousands of hours" and is scheduled for mass production this fall. Sanyo's next step is an LED capable of emitting TV's primary colors of red, blue, and green.

DAVID LACHENBRUCH
CONTRIBUTING EDITOR

Facts from Fluke on low-cost DMM's

Three good reasons to buy your handheld DMM from Fluke.

Ask yourself what you're really looking for in a handheld DMM, and then take a good long look at ours.

CHOICES? The Fluke line of handheld DMM's now offers three clear performance choices. There's the 8022A Troubleshooter, a solid value for basic voltage/current/resistance measurements that offers 0.25% basic dc accuracy. The 8020A Analyst is the world's best-selling DMM and first to offer conductance for high-resistance measurements to 10,000 Megohms — now with accuracy improved to 0.1%. And the new 8024A Investigator, a powerful instrument also with 0.1% accuracy that boasts three unique capabilities: *logic level/continuity detection* with an audible "beeper" for

instant continuity testing, and slow-speed logic checking, *peak hold* to lock onto elusive transient signals, and *direct temperature readings* to 1265°C via K-type thermocouples.

CONVENIENCE? Pick one up and you'll know what *true* one-hand operation means — tough, lightweight, palm-size packages designed with in-line push buttons for quick range and function changes.

RELIABILITY? Count on it. A substantial number of components are used exclusively to insure reliability and to guard against overloads.

Calibration is traceable directly to the National Bureau of Standards.

LOW COST? Compare these U.S. prices: \$139 for the 8022A, \$179 for the 8020A and \$219 for the powerful 8024A.

Fluke standards of quality and customer service, of course, are uncompromising — for our line of handheld DMM's and all our products. For more facts call toll free **800-426-0361**; use the coupon below; or contact your Fluke stocking distributor, sales office or representative.



IN THE U.S. AND NON-EUROPEAN COUNTRIES:

John Fluke Mfg. Co., Inc.
P.O. Box 43210 MS #2B
Mountlake Terrace, WA 98043
(206) 774-2481
Telex: 152662

IN EUROPE:

Fluke (Holland) B.V.
P.O. Box 5063,
5004 EB Tilburg,
The Netherlands
(013) 673 973 Tlx: 52237

- Please send all the facts on Fluke low-cost DMM's.
- Please have a salesman call.

Name _____

Title _____ Mail Stop _____

Company _____

Address _____

City _____ State _____ Zip _____

Telephone () _____ Ext. _____

For technical data circle no. 9 RE 7/80

Yamaha's PX-2 linear tracking turntable. A class of one.



Yamaha's new PX-2, the flagship of a remarkable new series of turntables from Yamaha, is destined to become the new standard of the audio industry. It is a masterpiece in the art of music reproduction. Totally in a class by itself.

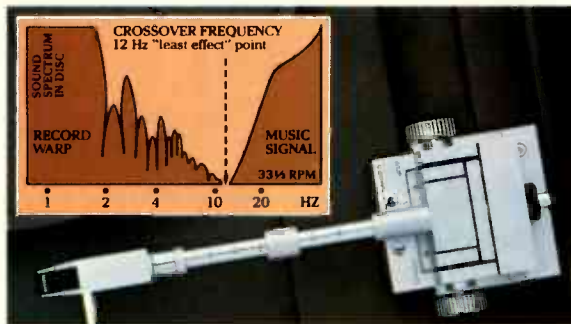

One of the major performance advancements on the PX-2 is Yamaha's unique optimum mass straight tonearm assembly. This design concept is Yamaha's direct challenge to the industry trend of low-mass tonearms. Among the most significant benefits of optimum mass is that it specifically addresses two of the most critical elements of music signal tonal quality—tonearm resonant frequency characteristics and high trackability with a wide range of cartridges. Tonearm mass is such a critical element in sound reproduction (especially in the low and high frequency ranges) that Yamaha has designed this optimum mass tonearm to insure its resonance frequency is at the "least effect" point. (See graph.) As a further benefit, the vast majority of available cartridges can be effectively

matched with the Yamaha tonearm. Even MC types.

But the optimum mass tonearm is only one factor that puts the PX-2 in a class by itself. There's much more. Like an extraordinary 80dB S/N ratio, with incredibly accurate tangential tracking—constantly monitored by an opto-electronic sensor. The PX-2 is also a study in durability with its solid, anti-resonant monolithic diecast aluminum base. And the combined effect of the hefty platter and the heavy-duty DC motor depresses wow and flutter to below 0.01%.

Yet with all this performance, the PX-2 is deceptively easy to operate. All the microprocessor-activated controls are easily accessible—without lifting the dustcover.

The balance of the turntables in our new line (the P-750, P-550, P-450 and P-350) all incorporate this same optimum mass tonearm philosophy. Each will set new standards for performance per dollar invested.

Visit your local Yamaha Audio Specialty Dealer for a personal test of our remarkable PX-2 and the other superb turntables in our new series. You'll hear music that's truly in a class by itself.

For more information write us at Yamaha, Audio Division, P.O. Box 6600, Buena Park, CA 90622.

*Yamaha cartridges shown (MC-1X and MC-7) on both models are optional.



Experiments with Teletext going on in Los Angeles

Public Television station KCET, Channel 28, is making experiments with Teletext, an information system using digital data that is tied in to home-television receivers. It is now being employed in a number of European countries, supplying such data as stock prices, weather, airline schedules, and similar materials.

The digital data signals are transmitted on two lines in the vertical blanking interval and require special decoders attached to a standard TV receiver. The Teletext tests are part of an investigation sponsored by the Electronic Industries Association in the search for a potential standard for U.S. television broadcasting.

KCET is using the techniques of the Antiope Videotext Systems of Paris, France, and Washington, DC. Antiope includes a wide character set that covers the Roman, Cyrillic (Slavic-language), and Arabic alphabets, and is compatible with both one-way (Teletext or Viewdata) and interactive systems.

Thermostat and heat pump bring awards to Honeywell

Honeywell engineering teams won two of seven awards in the 1979 "Seven Wonders of Engineering" competition put on annually by the Minnesota Society of Professional Engineers (MSPE).

The awards were won by the engineering teams who developed the world's first Microelectronic T800 pushbutton-setback thermostat, and an advanced heat-pump logic center for improved control of the increasingly popular heat pumps for home heating and air conditioning.

Other awards in the Minnesota contest were won by: 3M, for an air cycle heat-pump solvent and heat-recovery system, and an E.O. sterilizer; Barr Engineering, for rehabilitation of the Lake Byllesby Dam; Minnesota Power and Light Co., for a fiber optic transmission system and the Minnesota Department of Transportation, for the Blue Earth roadside rest area.

Open reel recording follows steady course

"Open reel is alive and well," says Steve Frederickson of 3M's Magnetic Audio/Video Products division. "Though the open-reel audiophiles represent less than five percent of the recording population, they influence all other tape users significantly," he states. "Audiophiles are the most demanding of all recordists. The fact that they use open reel tapes when the quality of cassette recordings has improved to the point that most ears can't hear a difference is one indicator that the market will continue to find ardent enthusiasts. We have indicated our confidence in this small, but important, market by building a tape that

meets the open-reel recordist's demanding requirements," Frederickson says. "The 'Scotch' Master XS open-reel tape introduced at the Winter Consumer Electronics Show was developed first for the professional market and then adapted for the retail market."

There's no wild boom in install-your-own phones

The market for install-your-own telephones has been disappointing to retailer and manufacturer alike, reports Venture Development Corp., a Massachusetts consulting firm that has made a study of the subject. (See **Radio-Electronics**, Feb. 1980, page 6.)

Some of the disappointment is due to high expectations—some retailers apparently expected an explosive sales growth like that shown by CB and calculators in years past.

But the main reason phone owners are not rushing to buy additional phones, the study says, is that "three out of five people are satisfied with their present phone service and that's why they haven't purchased a telephone." Others are concerned about the phone company's possible reaction, or feel there would be service problems with individually-owned phones.

Probably the greatest drawback is lack of knowledge. Large numbers of people have no idea of what they can or cannot do about installing their own phones. (The problems are not always simple—for example people who have extra extension jacks can buy phones and plug them in without restrictions. But only the phone company can install the jacks.) About one-fifth of all the people interviewed believed that only the phone company has the right to put in extra phones.

Venture Development believes that with increase of knowledge, the market will expand, and that "for the 1980's, the future of retail phones is hardly bleak."

TV, record player imports dropped sharply in 1979

Imports of most consumer electronics products declined in 1979, the Electronic Industries Association reports. Color television dropped hardest, falling to 1,367,600 units, from 2,774,856 imported in 1978, a decline of 50.7%. In the last quarter of 1979, color TV imports were off 62.6% from the same period in 1978. Black-and-white TV imports showed no significant change.

Imports of record players, record changers, and turntables dropped 36.7% from the 1978 figures, and home radios declined 23.6%. Video tape recorder/player imports, on the other hand, increased 23% over 1978, to a total of 629,280 units.

Exports of entertainment band radios, audio and video tape equipment from the United States increased in 1979, but ex-

ports of television receivers, auto radios, and phonographs declined.

CBS will make videodiscs under SelectaVision license

CBS President John D. Backe and RCA Chairman Edgar H. Griffiths have confirmed an agreement under which CBS is licensed to manufacture videodiscs worldwide under the RCA SelectaVision patents. Developmental work on videodiscs is being carried out at the CBS Technology Center at Stamford, CT, CBS's advanced-research center.

The 12-inch discs will furnish the viewer with two hours of program (1 hour per side). The SelectaVision discs will be on the market in the first quarter of 1981, Mr. Griffiths states.

Industry makes plans for the changeover to metric

Plans for converting to the metric system of measurements were analyzed and debated at the 6th Annual Conference of the American National Metric Council (ANMC) in San Francisco May 11-14. The ANMC is a private nonprofit organization supported by more than 1700 companies, organizations, and individuals. It was established in 1973 to serve as a planning forum for voluntary conversion to the metric system.

Dr. Louis F. Polk, chairman of the U.S. Metric Board, described the plans of that agency for the years just ahead. ANMC president Charles Buckingham pointed out that American industry must act now to control the changeover to metric or be faced with increased costs and confusion. "Now, not later, is the time to plan and prepare for metric conversion," he said. "Industry must act to shape events, or it will be shaped by them."

Wisconsin researchers find arteriosclerosis detector

A device developed at the University of Wisconsin may be able to detect arteriosclerosis (vulgarly called hardening of the arteries) in its early stages. Up to the present there has been no way of screening a person for the condition (as there is for high blood pressure, for example) and it can go undetected until such serious complications as stroke, senility, or heart attack result.

The instrument measures arterial compliance—how much the artery expands as blood pulses through it—by changes in a limb's electrical resistance. Hardened arteries are much less compliant than normal ones. Since blood is a good conductor, a large increase in artery diameter at each pulse will create a greater change in the limb's resistance than if the artery cannot change its diameter greatly.

The Wisconsin device—which resembles
continued on page 12

Microcomputers are here! Get in on the ground floor with NRI's new "at home" training in computer technology.

Only NRI Gives You "Hands-on" Experience as You Build Your Own
Designed-for-learning Microcomputer

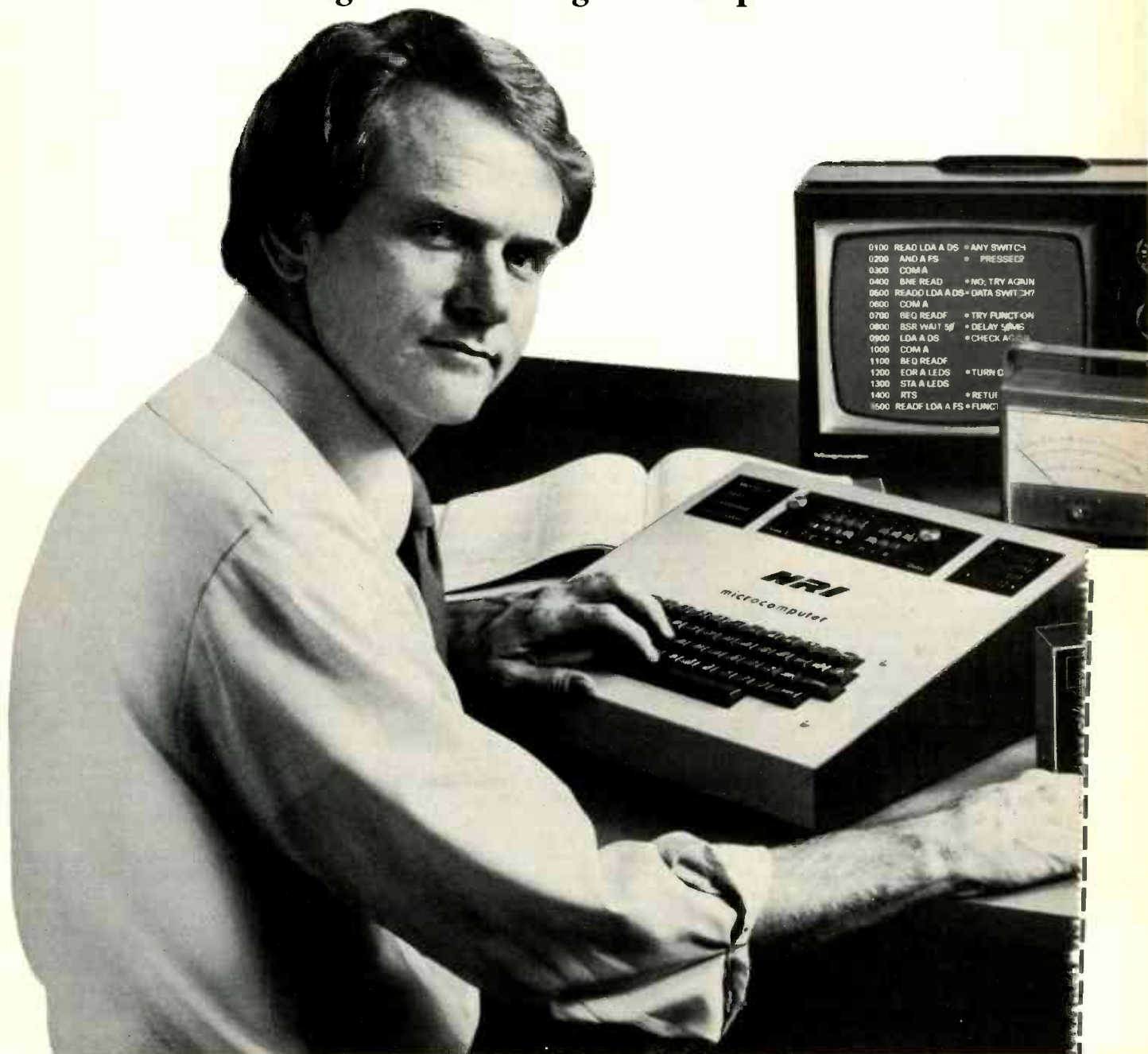

The microprocessor, that amazing little chip which shrinks electronic circuitry to microscopic size, has changed the world of the computer with dramatic speed. Now, big-performance computers are here in compact sizes...priced to make them practical for thousands of medium and small businesses, even homeowners and hobbyists.

Microcomputers are already being put to work on jobs like inventory control, payrolls, cost analysis, billing, and more. In homes, they're able to handle budgets and tax records, control environmental systems, index recipes, even play sophisticated games. And hobbyists across the country are expanding the state of the art while developing their own programs.

**Become a Part of This Incredible World ...
Learn at Home
in Your Spare Time**

NRI can give you the background you need to get into this booming new field. Microcomputers require a new discipline, a broader viewpoint... the ability to think in both hardware and software terms. And NRI's new course in computer technology is geared to bridge the gap.

You get a firm foundation of digital theory while you get practical,



"hands-on" experience working with the NRI Discovery Lab®, assembling test instruments you keep, and even building your own fully functional microcomputer.

Best of all, you do it at your own convenience. You learn at home with clearly written, "bite-size" lessons that carry you through the course in logical progression. There's no need to go to night school or quit your job...you progress at the pace that's most comfortable to you, backed by your personal NRI instructor and individual counseling whenever you want it.

Assemble an Advanced Microcomputer with Exclusive Designed-for-Learning Features

Only NRI trains you with a microcomputer that's specifically designed to teach you important principles as you build it. This state-of-the-art unit performs every function of comparable commercial units, has capabilities well beyond many. But each step of construction provides specific training, reinforces theory to make it come alive. And once you've finished, your microcomputer is ready to go to work for you. Or you can even sell it commercially.

You also assemble professional test instruments for use in your training. You get your own CMOS digital frequency counter and transistorized volt-ohm meter to keep and use in diagnosing problems and servicing computers. Together with up-to-the-minute lessons and NRI's 60-plus years of home study experience, you get the most in training and value.

Other Courses in Today's Electronics

Even the servicing of home entertainment equipment has taken quantum jumps forward. NRI keeps you right up with the latest, with training in stereo, video tape and disc players, and the latest TVs. You even build your own 25" diagonal color TV, the only one complete with built-in digital clock, varactor tuning, and computer control that lets you program an entire evening's entertainment. In our complete communications course, you learn to service two-way radio, microwave transmitters, radar, AM and FM transmitters, CB radio, paging equipment, and more. And you build your own 2-meter transceiver or 40-channel CB while you learn.



**Free 100-Page Catalog
No Salesman Will Call**

Send the postage-paid card today for your personal copy of the NRI electronics course catalog. It shows all the equipment, training kits, and complete lesson plans for these and many other courses. There's no obligation of any kind and no salesman will ever bother you. Find out how you can learn new skills, keep up with technology, advance your future with training for new opportunities. Get in on the ground floor now! If card has been removed, write to:



NRI Schools
McGraw-Hill Continuing
Education Center
3939 Wisconsin Ave.
Washington, D.C. 20016

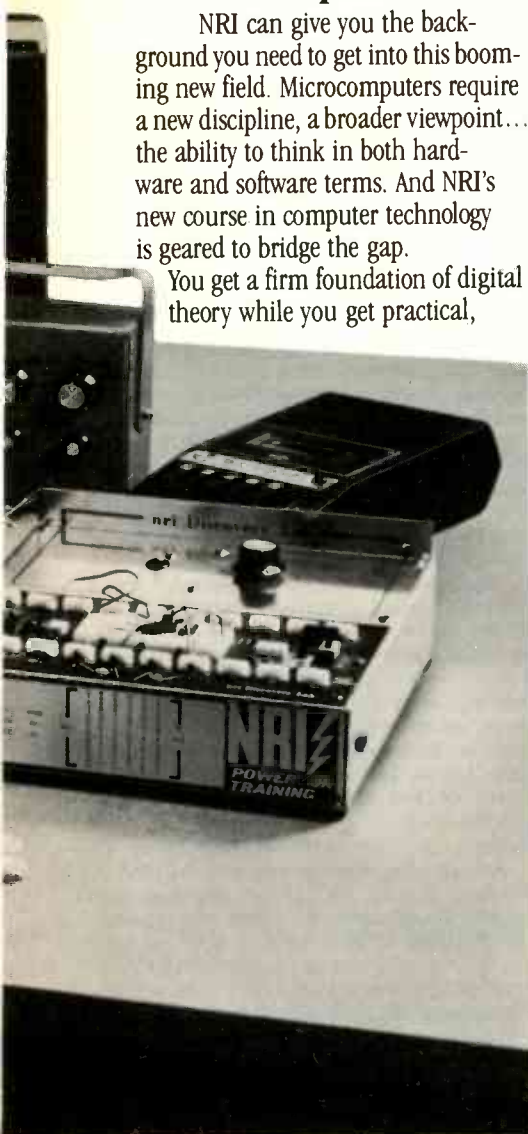

what's news

continued from page 7

a blood-pressure sleeve—is in essence an AC ohmmeter. It sends a small alternating current through the limb, measures the voltage drop from one part of the limb to another, and displays it on a meter, which can be calibrated directly in ohms. A large change in resistance indicates a high value of compliance—a smaller change may indicate a greater or lesser degree of arteriosclerosis.

The instrument—now in an early experimental stage—is undergoing tests. If it proves successful, it may become as standard an item in doctors' offices as devices for measuring blood pressure.

Fivefold growth predicted in telecommunications

By the year 2000, the demand for telecommunications services will have increased five times, according to a study made by the Lewis Research Center of the National Aeronautics and Space Administration (NASA). At that time, one-fourth of all long-distance voice traffic (which will still make up the greater part of the increased services) may be carried by satellites.

The studies show that by the early 1990's long-distance telecommunications will have saturated the nation's existing domestic satellite capacity in the 4-6 and 11-14 GHz bands. To accommodate the rapid growth in demand, higher-capacity satellites operating in the 20-30 GHz band will be required. It is urgent to develop the technology needed to open that band for commercial use in a cost-effective and spectrum-conserving manner. The band has not been used in this country up to the present.

Recording system doubles dynamic range of discs

A new development in recording technology is claimed by dbx, Inc. of Newton, MA. In cutting the master disc for an album (from a digitally-recorded tape) the music signal is compressed linearly in decibels by 50% at all levels ("dbx encoded"). Playback through a "dbx decoder" expands the signal to recreate the dynamic range of the original master tape. Thus the possible dynamic range of such a disc recording is doubled.

The decoder retails for a little over \$100, and dbx-encoded records are already available, under the M&K *RealTime* label.

Biggest CB organization conquers financial crisis

REACT (Radio Emergency Associated Citizens Teams) International Inc. has overcome a serious potential operating deficit and ended the year 1979 with a surplus, the Board of Directors reported after its annual meeting. A combination of substantial cost reductions and emergency-fund contributions from REACT teams and others turned

the situation around from that at August 1 (when it was estimated that the year-end deficit would be \$34,000) and resulted in an operating surplus of about \$17,000.

Simultaneously, REACT International launched its annual membership drive to recruit new teams and new members for 1980. As of January 20, the Board reported, the rate of registration was lagging well behind the previous year. This, the Board believes, was partly due to the drastic decline in the number of new CB licenses and partly to uncertainties about REACT's future—uncertainties created by the financial crisis.

REACT International headquarters will continue operations with minimum staff and services throughout the first half of the year, unless and until team registration and new membership are substantially accelerated. Of the 1,688 teams, with a combined membership of 40,454, less than 50% had re-registered for 1980 by mid-January.

The Board meeting laid plans for the election of field members of the Board of Directors directly by the membership at the Annual Convention, and for a "REACT Forum" to be set up by the Teams via State Councils to develop additional training and operational programs. Those plans will be fully implemented at the 1980 REACT convention July 17-19 in Atlanta, GA.

Home heating system control varies boiler water heat

A new control system for hot water heating systems uses an outdoor sensor to adjust boiler-water temperature in accordance with the outside temperature. Called Master Mind by its manufacturer, Surgeonics, of Mount Kisco, NY, the system is described as a solid-state electronic computer that uses two sensors, one measuring the outside temperature and the other the temperature of the boiler water. The control unit, or "computer," compares these and sets boiler water temperature accordingly.

The advantage, the manufacturer explains, is that by maintaining the water at the lowest desirable temperature the circulating time is increased, with a corresponding increase in system efficiency. The circulating water is held at the precise temperature required to supply only the heat required to satisfy the room thermostat.

Other systems have used outside sensors, which have been valuable, especially where temperatures may drop rapidly in a short time. But in those systems the water temperature still rises to a fixed maximum and the water remains idle in the boiler, with continuous loss of heat, until the room thermostat calls for heat.

The Master Mind approach is claimed fuel savings of up to 15%, and to make the living space more comfortable by supplying a steadier and more even heat.

Nakamachi now making 15/16 IPS cassettes

SBI Publishers in Sound, makers of 15/16 IPS cassette books, has expressed "elation" at the announcement by Nakamachi that it is adopting the extended-time, long-playing cassette speed of 15/16 inches per second, and feels that the 15/16 IPS speed will become "the next industry standard for speech recording."

The lower speed, SBI says, will make it possible to put a book on three cassettes instead of the six needed at the older 1 7/8 IPS speed. Further, there is a great advantage in recording speeches or public meetings, where a stop to change cassettes often loses important sentences.

SBI puts out between two and four of its books or "Sound Editions" per month, and sells a cassette machine with speeds of 15/16, 1 7/8 and a continuously variable speed feature. Sound Editions are sold by mail order, and a free catalog is available by writing to: SBI, Box 48, South Lee, MA 01260.

Orbital test satellite helps nuclear research

Marconi Communications Systems Ltd. hailed the recent inauguration of a satellite link between Switzerland and England enthusiastically as "a new era in telecommunications technology."

An orbital test satellite was launched in May 1978, as part of the European Space Agency program of experiments leading to the launching of a series of communications satellites during the early 1980's. This OTS is being used to link the European Nuclear Research Center in Geneva with the Rutherford Laboratories in England. Other European laboratories will be hooked up at a later date.

High energy nuclear accelerator research ("atom smashing"), Marconi explains, involves vast quantities of highly complex data, and its exchange between laboratories is a real problem. The normal method is to send the tapes by courier. Now, using satellite transmission, the data can be exchanged between cooperating laboratories in less than two hours, and even the possibility of real-time remote participation in experiments exists for the future.

Reception is made simple with the novel Marconi 3-meter data ground terminal. Its equipment occupies the same floor space as an ordinary filing cabinet and can be installed in a corner of the office. With the increasing use of computers in commercial operations, the time cannot be too far off, says Marconi, when commercial users will be offered communication facilities directly through a 3-meter antenna on the roof, and their computers will be linked to one-another through the small and unobtrusive ground terminals.

Now Available For Faster, More Profitable Color TV Servicing!

VOLUME 2 . . . a new addition to the popular **RCA** Technical Reference Library

A handy, binder-encased collection of RCA Workshop Manuals that give you step-by-step procedures for fast troubleshooting of the following RCA color TV chassis and related systems . . .

- ColorTrak CTC 74/81/90
- XL-100 CTC 85/86/87
- XtendedLife CTC 93/99/101
- ColorTrak Direct Address Tuning System
- Frequency Synthesis Tuning Systems . . .

Over 300 pages of time-saving service information . . . equally useful as a circuit-operation/troubleshooting bench reference or for chassis-familiarization training . . . fully illustrated, with simplified schematics, block diagrams, and chassis/circuit board photos that show component and test point locations . . . concise but thorough explanations of how circuits and systems function . . . step-by-step descriptions of troubleshooting procedures that isolate troubles in minimum time . . . common trouble symptoms and their most probable causes



ONLY \$19.95*

With the same easy-reference features you said you wanted, and got, in Volume 1 . . .

- Durable 11"X11½" looseleaf binder
- Three-Way Index
- Index Tabs

VOLUME 1 . . . Available But Supply Limited!

Covers RCA Color TV Chassis CTC 40 through CTC 78 . . . over 400 pages of illustrated step-by-step troubleshooting procedures and service-oriented descriptions of circuit and system operation . . . three-way indexed and tabbed for quick reference . . . encased in a durable 11"X11½" looseleaf binder . . . **Only \$24.95***

LIMITED-TIME BONUS OFFER!
Free RCA ColorTrak Home Service Handbook . . .

Order Volume 1 or 2 or the complete two-volume **RCA Technical Reference Library** and, while the supply lasts, you'll receive at no additional cost the **RCA ColorTrak Home Service Handbook** . . . covers in-home servicing of CTC 74/81 . . . 114 pages of illustrated trouble symptoms and their most probable causes that can be corrected in the customer's home, including related adjustments . . . in a durable 10"X6" looseleaf binder . . . **a \$4.95 value you receive FREE!**



SPECIAL TWO-VOLUME PACKAGE OFFER! SAVE OVER 20% . . . Order both

Volume 1 and 2 of the **RCA Technical Reference Library** now and you'll save over 20% of the combined single-volume prices . . . plus you'll also receive the \$4.95 **RCA ColorTrak Home Service Handbook** at no additional cost . . . **a \$49.85 service-information value for only \$35.50.**

Technical Reference Library Order Form — Please print clearly

MAIL TO: RCA Technical Publications 1-450

600 North Sherman Drive
Indianapolis, IN 46201



***FREE RCA COLORTRAK HOME SERVICE HANDBOOK INCLUDED**

Quantity

_____ Volume 1 @ \$24.95 each*

_____ Volume 2 @ \$19.95 each*

_____ Two-Volume set @ \$35.50*

TOTAL (ENCLOSE CHECK WITH ORDER) \$ _____

NAME _____

STREET ADDRESS _____

CITY _____ STATE _____ ZIP _____

Check here for free RCA Technical Publications Catalog

8007R

AM Stereo

On April 9, the proverbial mountain moved. For it was on that day that the sleepy giant known as the FCC awoke for just an instant and the commissioners decided to approve an AM stereo-broadcast system. Out of five possible systems, it is the Magnavox system that will become part of our everyday lives.

AM stereo did not just happen, or did it? In the 1950's, it was proposed that the FCC issue rules for broadcasting FM stereo, AM stereo, and for broadcasting the audio portion of television in stereo. Only FM stereo was approved and FM-stereo broadcasts began in 1961. At the time, the FCC felt that the AM radio industry was healthy while the FM radio industry was financially hungry. That's what prompted the approval of FM stereo. Also, the FCC felt that there was no real need for broadcasting the audio portion of TV in stereo. (The EIA currently has a committee considering systems for that purpose—but that's because the United States is so far behind in this area. Today, stereo is very much a part of television in Japan.)

Stereophonic broadcasting caused the FM radio industry to grow in leaps and bounds, at the expense of AM radio stations. That's part of what prompted the decision on April 9. The other half was the pressure that was being applied by the manufacturers of automotive sound equipment. They needed something to boost their sales.

Why the Magnavox system? Your guess is as good as mine. From a performance standpoint, there seem to be few differences among the various systems. Actually, the decision of April 9 was merely a directive to the FCC's engineering staff to write a Report and Order selecting the Magnavox system. The Report and Order is to be issued nine weeks following the April 9 directive, and it will try to justify the selection of the Magnavox system. Not that the Magnavox system is bad—it isn't; but the real reason for the selection will remain in the minds of the commissioners. One unsubstantiated rumor floating around Washington has it that the Magnavox system was the only system the commissioners could understand. In the interim, some of the proponents of the other systems are already talking about obtaining an injunction against the FCC decision.

The Report and Order will also outline an orderly implementation of the system. The manufacturers must be allowed enough time to design good receivers. If AM broadcasting starts from Day 1 (just as FM stereo did), then consumers will find themselves deluged with inferior receivers. Manufacturers and distributors will also find themselves buried in a lot of obsolete equipment. (Remember 23-channel CB radios?) The EIA has recommended a delay of nine months before AM stereo broadcasting is permitted to begin. By the time you read this, the Report and Order will have already been issued. In the interim, I can only hope for the best.

There is one final *caveat* in all this. True high-fidelity requires an audio bandwidth of at least 15 kHz. Some AM broadcasters, however, are using only a very small portion of the audio bandwidth that is presently available to them. Adding a second channel will not automatically produce high-fidelity. If more broadcasters don't start transmitting better signals, and the manufacturers don't start producing better receivers, we will have two channels of noise instead of one.

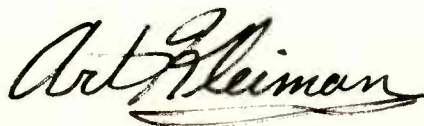

ART KLEIMAN
Managing Editor

Radio-Electronics®

Hugo Gernsback (1884-1967) founder

M. Harvey Gernsback, editor-in-chief

Larry Steckler, CET, publisher

Arthur Kleiman, managing editor

Robert F. Scott, CET, W2PWG,
technical editor

Josef Bernard, K2HUF, associate
technical editor

Jack Darr, CET service editor

Leonard Feldman
contributing high-fidelity editor

Karl Savon, semiconductor editor

Herb Freidman, communications editor

David Lachenbruch, contributing editor

Earl "Doc" Savage, K4SDS, hobby editor

Ruby Yee, production manager

Robert A. W. Lowndes, production
associate

Marie J. Stolfi, production assistant

Gabriele Margules, circulation director

Arline R. Fishman,
advertising coordinator

Cover design by Louis G. Rubsamen

Cover photo by Robert Lewis

Radio Electronics is indexed in *Applied Science & Technology Index* and *Readers Guide to Periodical Literature*.

Gernsback Publications, Inc.
200 Park Ave. S., New York, NY 10003
(212) 777-6400
President: M. Harvey Gernsback
Vice President: Larry Steckler
Secretary/Treasurer: Carol A. Gernsback

ADVERTISING SALES

Larry Steckler
Publisher

EAST

Stanley Levitan
Radio-Electronics
200 Park Ave. South
New York, NY 10003
(212) 777-6400

MIDWEST/Texas/Arkansas/Okla.

Ralph Bergen
The Ralph Bergen Co.
540 Frontage Road—Suite 361-A
Northfield, Illinois 60093
(312) 446-1444

PACIFIC COAST Mountain States

Jay Eisenberg
J.E. Publishers Representative Co.,
8732 Sunset Blvd.,
4th Floor,
Los Angeles, CA 90069
(213) 659-3810
San Francisco, CA 94124
(415) 864-3252

SOUTHEAST

Paul McGinnis
Paul McGinnis Company
(212) 490-1021



COMPUTER BOOKS THAT TALK YOUR LANGUAGE... FROM BEGINNER TO EXPERT.

Howard W. Sams is the source for the best and latest in computer technology. The world's leading authors. Clear, concise, easy-to-understand text. Fully illustrated for better comprehension. Actual programs for today's personal computers. Informative and entertaining. Titles for everyone... from the novice to the hobbyist to the expert.

THE STARTERS

Entry-level books for the beginner can bring the novice up to a high level of knowledge quickly.

- THE HOWARD W. SAMS CRASH COURSE IN MICROCOMPUTERS**
The short-cut to understand microcomputers. Spend a few hours with this self-instructional course and gain a working knowledge of all aspects of microcomputers from fundamentals to operating systems, programming, peripheral equipment and much, much more. 264 pages. No. 21634. By Frenzel. \$17.50.
- MICROCOMPUTERS FOR BUSINESS APPLICATIONS**
A microcomputer expert discusses the benefits of microcomputer systems for small business owners. Explains types of microcomputers available, points out pitfalls to avoid, and defines computer-related terms in easy-to-understand language. 256 pages. By Barden. No. 21583. \$8.95.
- A GUIDEBOOK TO SMALL COMPUTERS**
If you are contemplating buying a small computer system for home or business, this book can save you time and trouble. Covers fundamentals of small computers including hardware and software. Includes information on manufacturers' warranties, service and a handy directory of small computer manufacturers. By Barden. No. 21698. \$5.95.
- GETTING ACQUAINTED WITH MICROCOMPUTERS**
Provides a complete working knowledge of microcomputer organization, operation, and programming. 288 pages. By Frenzel. No. 21486. \$8.95.
- FUNDAMENTALS OF DIGITAL COMPUTERS (2nd ED.)**
Unravels the mysteries of computers and programming. 320 pages. By Spencer. No. 21534. \$9.95.
- INTRODUCTION TO MICROCOMPUTERS FOR THE HAM SHACK**
Gives the radio amateur an opportunity to be in the forefront of utilizing and developing techniques in "computerations." 96 pages. By Helms. No. 21681. \$4.95.
- LEARN ABOUT MICROCOMPUTERS, SAVE 10%... AND GET A FREE GIFT!**
- THE COMPUTER PRIMER LIBRARY**
This 3-volume "starter" library was selected for the novice who wants to learn about microcomputers. Concepts. Programming. Computer graphics. Languages. Games. By Mitchell Waite and Michael Pardee—two of the leading authors in the field of computers.
MICROCOMPUTER PRIMER—368 pages of up-to-date facts on microcomputers and computer concept.
COMPUTER GRAPHICS PRIMER—Over 20 programs for creating your own video graphics (complex drawings, plans, maps, and schematics) on the new 6502-based personal computers.
BASIC PROGRAMMING PRIMER—Provides a working knowledge of BASIC, the most popular computer language today. Explains fundamentals of BASIC, program control, organization, additional functions, variations, and includes a game program.
3-VOLUME LIBRARY PACKAGE ONLY \$30.47—Includes a FREE COPY of YOUR OWN COMPUTER—an introduction to home computers. No. 21706

THE PROGRAMMERS

A computer is only as good as the software. Sams offers several books that explain programming and tell you how to develop, debug and test programs for your equipment.

- PROGRAMMING & INTERFACING THE 6502, WITH EXPERIMENTS**
Dr. De Jong has compiled 14 chapters of information and programs for 6502-based microcomputer systems. Experiments and examples are written so that a KIM, AIM or SYM system may be used to reinforce the material in each chapter. 448 pages. By De Jong. No. 21651. \$11.95.
- HOW TO PROGRAM AND INTERFACE THE 6800**
Discusses the internal structure, instruction set, and programming techniques for the 6800. Experiments demonstrate "real world" applications. By Staugaard. 432 pages. No. 21684. \$13.95.
- DEBUG: AN 8080 INTERPRETIVE DEBUGGER**
Covers program operation and how it's applied to program development and testing. 112 pages. By Titus and Titus. No. 21536. \$4.95.
- 6502 SOFTWARE DESIGN**
Tells how to program for the 6502 assembly language. 288 pages. By Scanlon. No. 21656. \$10.50.
- 8080/8085 SOFTWARE DESIGN—2 VOLUMES**
 VOLUME 1 gives you an introduction to assembly language programming. 336 pages. By Titus, Larsen, Rony, & Titus. No. 21541. \$9.50
 VOLUME 2 is a unique, one-of-a-kind computer science book for the design engineer. Written in Intel machine code. 352 pages. By Titus, Larsen, & Titus. No. 21615. \$9.95.
- TWO-VOLUME SET** No. 21659 ONLY \$17.50
- TEA: AN 8080/8085 CO-RESIDENT EDITOR-ASSEMBLER.**
256 pages. No. 21628. By Titus. \$8.95.

THE COMPUTER TECHNOLOGY LEADERS

Even if you're an avid computer buff, rapidly changing technology makes it difficult to stay current. Sams has a complete line of books and reference publications to help you keep abreast of the current state-of-the-art.

- MICROCOMPUTER-ANALOG CONVERTER SOFTWARE & HARDWARE INTERFACING.**
Concepts and techniques of interfacing digital computers to analog devices. 288 pages. By Titus, Titus, Rony, & Titus. No. 21540. \$9.50.
- TRS-80 INTERFACING.**
192 pages. No. 21633. By Titus. \$8.95.
- INTERFACING & SCIENTIFIC DATA COMMUNICATIONS EXPERIMENTS.**
160 pages. By Rony, Larsen, Titus, & Titus. No. 21546. \$5.95.
- MICROCOMPUTER INTERFACING WITH THE 8255 PPI CHIP.**
224 pages. By Goldsbrough. No. 21614. \$8.95.

- Z-80 MICROPROCESSOR PROGRAMMING & INTERFACING—2 VOLUMES.**
800 pages. By Nichols, Nichols, & Rony. No. 21611. \$21.95.
- INTRODUCTORY EXPERIMENTS IN DIGITAL ELECTRONICS AND 8080A MICROCOMPUTER PROGRAMMING AND INTERFACING—2 VOLUMES.**
912 pages. By Rony, Larsen, & Titus. No. 21552. \$20.95.

A BEST-SELLER... A TREMENDOUS VALUE!

This is the most comprehensive reference available on all phases of computers and their applications. Contains over 22,000 definitions, acronyms, and abbreviations. 14 appendices. Hardbound. 944 pages. By Sippl & Sippl. No. 21632. \$29.95.

- COMPUTER DICTIONARY & HANDBOOK (3RD EDITION)**

THE LOGIC COOKBOOKS

- LANCASTER'S COOKBOOK LIBRARY**
A famous resource for all electronics buffs who want to know what makes TTLs, CMOS, and active filters cook—what they are, how they work and how to use them. By Don Lancaster, one of the most popular authors in the electronics industry.
TTL Cookbook No. 21035 \$ 9.50
CMOS Cookbook No. 21398 \$10.50
Active-Filter Cookbook No. 21168 \$14.95
TOTAL LIST PRICE \$34.95
Less 15% Discount 5.24
YOU PAY ONLY \$29.71
- ORDER SPECIAL LIBRARY PACKAGE NO. 21707 AND SAVE!**

ORDER FORM

HOWARD W. SAMS & CO., INC.
4300 West 62nd Street, P.O. Box 7092
Indianapolis, Indiana 46206
(317) 298-5400

Indicate quantity in boxes above and complete ordering information below.

Sub Total _____

Add local sales tax where applicable _____

GRAND TOTAL _____

- PAYMENT ENCLOSED
- CHECK MONEY ORDER
- MASTER CHARGE BANK AMERICARD/VISA

Exp. Date _____

Account No. _____

Interbank No. (Master Charge only) _____
Minimum Credit card purchase \$10 **AD020**

Name (print) _____

Signature _____

Address _____

City _____ State _____ Zip _____

Prices subject to change without notice. All books available from Sams Distributors, Bookstores, and Computer Stores. Offer good in U.S. only. In Canada, contact Lenbrook Industries Ltd., Scarborough, M1H 1H5, Ontario, Canada.

Howard W. Sams & Co., Inc.

SPACE taking shape

SPACE, the first trade association created to represent the interests of satellite earth-station users, is being organized. The letters stand for the Society for Private And Commercial Earth terminals, and the group's chairman, Eugene Martin, says that the organization will present the interests of individuals and companies when Congress, and other government agencies, begin to consider policies and rules for home TV reception via satellite. Initially SPACE will have four categories of membership: manufacturers, retailers/distributors, earth-station owners, and associates (which Martin describes as "anyone else" including consumers thinking about getting into satellite TV). SPACE got its start during the recent Satellite Private Terminal Seminar in Miami and is expected to hold another meeting during forthcoming symposiums of satellite users. For information about membership fees and other specifics, contact the group's office at 1521 O Street NW, Washington DC 20005; telephone 202-387-1856.

Getting ready for DBS

Enthusiasm about direct-to-home broadcasting satellites continues to grow, and indications now point toward widespread use of the \$300, 3-foot receivers within the decade. Such a system, which could offer 10 or more channels of programming, perhaps on a regionalized basis, would bypass the familiar set-up we have today: broadcast TV or cable TV. Channels would be devoted to movies, sports, teletext, education, and other programming. The envisioned DBS service would probably use the 12/14 GHz range and would be enormously expensive to start up—in the magnitude of half-a-billion to a billion dollars. In addition, there are a huge number of legal and policy hurdles ahead—ranging from questions about how DBS should be regulated to what kind of standards should be created for small-dish receivers.

A series of developments this spring indicate how optimistic people are becoming about DBS. The FCC's Network Inquiry task force published a sizable document outlining the policy issues that will affect DBS. Quick on the heels of that report, the National Academy of Sciences held a one-day symposium in Washington. The conference attracted nearly 500 experts, who discussed a framework for the development of Direct Broadcasting Satellites.

Meanwhile, plans for a DBS system were being drawn up by Comsat, which announced last summer that it wants to launch such an offering by 1983. (The Comsat plans suffered a set-back in April when Sears pulled out of a tentative partnership with Comsat which would have involved sales and installation of the small dishes; Comsat is looking for other partners in the retail/electronics business.)

Most of the experts we talk to doubt whether Comsat's optimistic goal of 1983 is realistic. But they do believe that DBS will come into being by the late 1980's—if some roadblocks can be overcome. First among them is the 1983 Regional Administrative Radio Conference, which will decide Western Hemisphere spectrum allocations for DBS. Then comes the question of how to deal with those three-foot receivers. Several authorities emphasize the need to come up with technical standards that will hold up even as the technology itself moves beyond the current state-of-the-art.

Of course there are drawbacks to a DBS system. As the FCC report noted, and many other experts echoed, DBS is not always the most efficient use of spectrum. The current set-up of fixed satellites which beam signals to earth terminals that then relay

them locally (via standard broadcasting, cable TV and other means) can provide four to ten times more channels. Furthermore, the extraordinary high power needed to beam the DBS signals to those small dishes—even for a regionalized footprint—will pose other RF interference problems. In addition, the existence of DBS creates a thirst to put very special-interest programming aboard (for example, educational shows or public service information) which will only be interesting to narrow audiences. That again is inefficient use of spectrum, critics point out. Similarly, no matter how many channels are available, they would all have to be served by similarly polarized channels from a single satellite or from co-located satellites broadcasting on different frequencies; the only alternatives are for users to buy more than one antenna or for someone to develop a cheap steerable dish.

Most of the experts agree, though, that DBS is an idea whose time will come. The rapid acceptance of today's fixed satellite communications—and the eagerness of hobbyists and professional organizations to have their own earth stations—proves that DBS will catch on, they point out.

Going up to 20/30 GHz

Get ready to add the Ka-band to your satellite vocabulary. A recent NASA study indicates that the growing demand for space communications by the year 2000 will necessitate opening up the Ka-band at 20/30 GHz for commercial services. The additional spectrum space would increase capacity by 50 to 100 times over the range of the widely used C-band (4/6 GHz). The NASA studies found that voice services (such as telephone and private line calling) will be the major factor in the booming use of satellites—but it also suggests that within 20 years at least half of all video communications beamed around the U.S. will travel via satellite. That will include private teleconferencing as well as broadcasting and cable TV programs. NASA's analysis of satellite usage indicates that by the early 1980's, the C-band and the Ku-band (14/12 GHz) will be completely filled. That is why NASA believes we should start looking at the Ka-band.

Newspapers via satellite

TV isn't the only mass medium that has latched onto satellites for speeding its material around the country. Starting in late summer, the *New York Times* will publish a Midwest edition in Chicago each day, with facsimile pages transmitted from the east coast to a printing plant in Chicago via a Westar II transponder. For the Chicago edition, pages will be scanned by a laser in New York and transmitted to an existing plant in New Jersey; there the data will be compressed and beamed to the Chicago downlink, where it will be reconstituted and laser masks etched to make offset printing plates.

Several other newspapers—notably the *Wall Street Journal*—already use such satellite facsimile processes to rush page plates to regional printing plants. *Time* magazine recently started a similar venture to help speed production of its Hong Kong edition each week. And the American Newspaper Publishers Association task force on satellite policy recently came up with a seven-point proposal which would enlarge the use of satellites for delivery of everything from wire service stories to classified ads.

GARY H. ARLEN

Do more than ever before - spend less than you planned



Heath makes the All-In-One Computer more versatile

Many satisfied customers know Heath takes the risk out of buying a balanced computer system. With the Heathkit All-In-One Computer, you get 16K Random Access Memory (expandable to 48K), keyboard, video terminal and floppy disk system - together in one self-contained, compact unit - for up to hundreds of dollars less than comparable systems.

Heath now makes the All-In-One Computer more versatile than ever! The new Heathkit H77 Floppy Disk System gives the All-In-One even more data storage and recall capacity. Combined, the All-In-One and H77 Floppy Disk give you up to 300K

bytes of on-line data storage - enough to hold entire files. You can mount operating system and program disks at the same time, to make computing even faster.

You can run programs written in MICROSOFT™ BASIC™ and Assembly Languages, and all current software written for the popular Heathkit H8 Computer.

Heath User's Group (HUG) will share with you a library of over 500 programs to make your computer serve you in ways you never imagined.

There's no better way to learn about computer systems - and save money - than by building one yourself.

Concise, easy-to-follow Heathkit assembly manuals show you the way, from start to finish. And a nationwide network of service centers protects your computer investment.

Join the Heathkit computer family today - and pocket the savings!

For complete details on Heathkit computer systems, as well as nearly 400 other electronic kits for your home, work or pleasure, send today for your free, value-packed Heathkit catalog. Or pick up your copy at the nearest Heathkit Electronic Center.

CIRCLE 30 ON FREE INFORMATION CARD

Heathkit®

SEND FOR FREE CATALOG | VISIT YOUR HEATHKIT STORE

Write to: HEATH COMPANY,
DEPARTMENT 020-674,
BENTON HARBOR, MI 49022



In the U.S. and Canada, visit your nearby Heathkit Electronic Center where Heathkit products are also displayed, sold and serviced. See the white pages of your phone book. In the U.S., Heathkit Electronic Centers are units of Veritechnology Electronics Corporation.

CP-184

You gotta shop around.

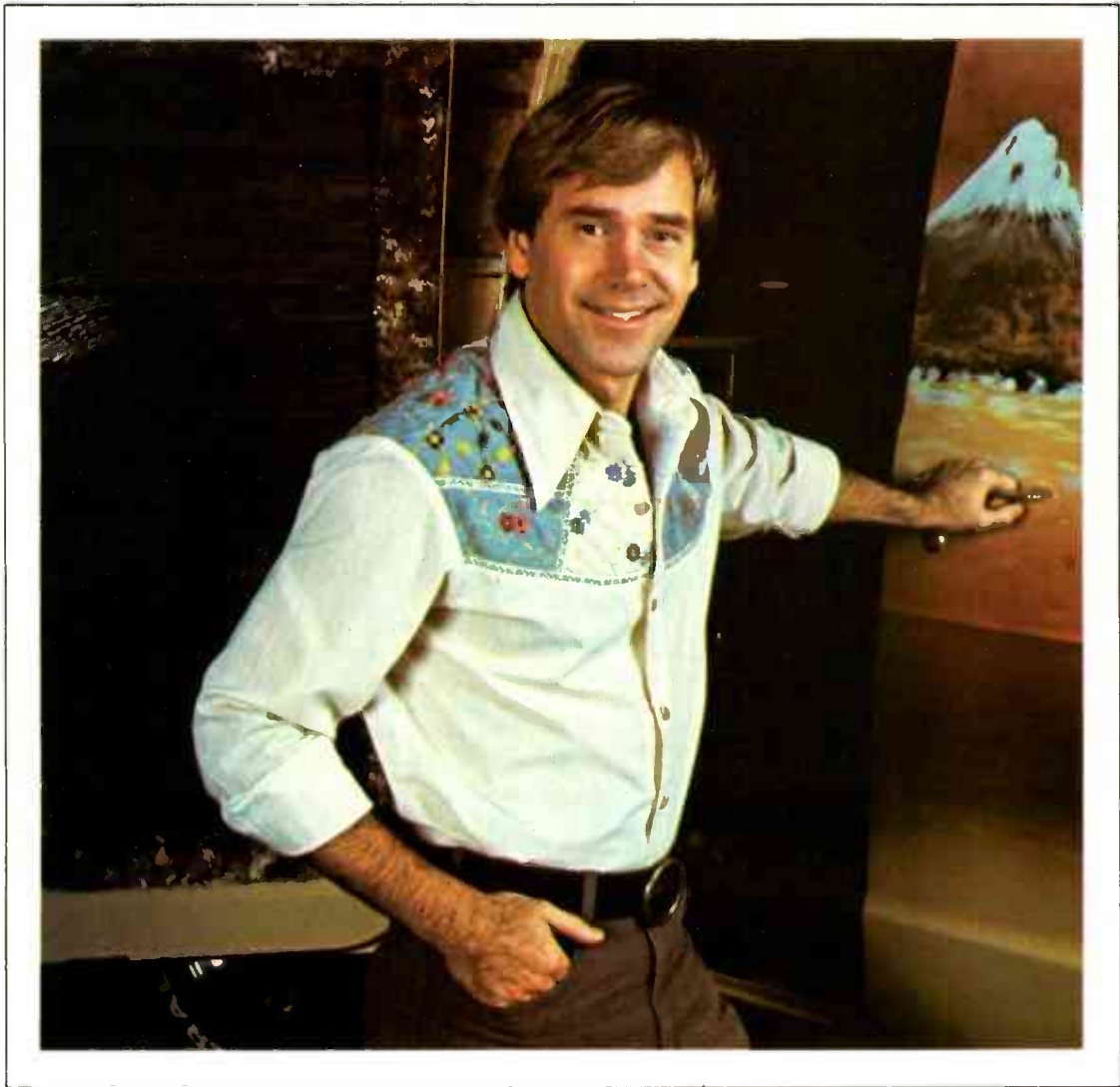

**When you do, you'll probably pick CIE.
You can't afford to settle for
less when it comes to something like
electronics training that could
affect your whole life.**

When you shop around for tires, you look for a bargain. After all, if it's the same brand, better price—why not save money?

Education's different. There's no such thing as "same brand." No two schools are alike. And, once you've made your choice, the training you get stays with you for the rest of your life.

So, shop around for your training. Not for the bargain. For the best. Thorough, professional training to help give you pride and confidence.

* * *

If you talked to some of our graduates, chances are you'd find a lot of them shopped around for their training. They pretty much knew what was available. And they picked CIE as number one.

Why you should shop around yourself.

We hope you'll shop around. Because, frankly, CIE isn't for everyone.

There are other options for the hobbyist. If you're the ambitious type—with serious career goals in electronics—take a close look at what we've planned for you at CIE.

What you should look for first.

Part of what makes electronics so interesting is it's based on scientific discoveries—on ideas! So the first thing to look for is a program that starts with ideas and builds on them!

That's what happens with CIE's Auto-Programmed® Lessons. Each lesson takes one or two principles and helps you master them—before you start using them!

How practical is the training?

This is the next big important question. After all, your career will be built on what you can do—and on how well you do it.

Here are ways some of CIE's troubleshooting programs help you get your "hands-on" training...

With CIE's Personal Training Laboratory...

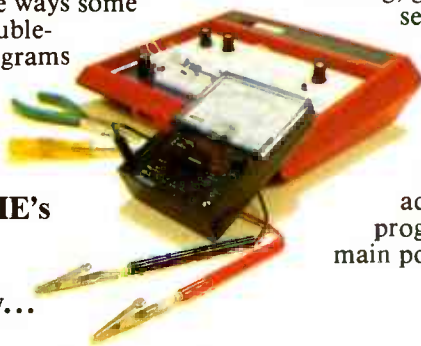

you learn and review the basics—perform dozens of experiments. Plus, you use a 3-in-1 precision Multimeter to learn testing, checking, analyzing!



When you build your own 5 MHz Triggered-Sweep, Solid-State Oscilloscope you take your first real professional step. You use it as a doctor uses an X-ray machine—to "read" waveform patterns... lock them in... study, understand and interpret them!

When you get your Digital Learning Laboratory you'll be into digital theory—essential training today for anyone



who wants to keep pace with the state of the art of electronics in the eighties. With CIE's Digital Lab, you'll be applying in dozens of fascinating ways the theory you've learned. For example, you'll compare analog and digital devices. You'll learn to make binary to decimal conversions and to work with semiconductor devices and circuits. You'll see how digital equipment is vital in today's exciting, growing fields such as security where digital theory provides the brains for space-age alarm and protective devices.

Of course, CIE offers even more advanced training programs, too. But the main point is simply this:

All this training takes effort. But you'll enjoy it. And it's a real plus for a troubleshooting career!

Do you prepare for your FCC License?

Avoid regrets later. Check this out before you enroll in any program.

For some troubleshooting jobs, you must have your FCC License. For others, employers often consider it a mark in your favor. Either way, it's government-certified proof of specific knowledge and skills!

More than half of CIE's courses prepare you for the government-administered FCC License exam. In continuing surveys, nearly 4 out of 5 CIE graduates who take the exam get their Licenses!

Shop around...but send for CIE's free school catalog first!

Mail the card. If it's gone, cut out and mail the coupon. If you prefer to write, mention the name and date of this magazine. We'll send you a copy of CIE's FREE school catalog—plus a complete package of independent home study information! For your convenience, we'll try to have a representative contact you to answer your questions. Mail the card or coupon—or write:

CIE, 1776 East 17th St.,
Cleveland, OH 44114.

CIE Cleveland Institute of Electronics, Inc.

1776 East 17th Street, Cleveland, Ohio 44114
Accredited Member National Home Study Council

YES...I'm shopping around for the right kind of career training in electronics troubleshooting—and CIE sounds well worth looking into. Please send me my FREE CIE school catalog—including details about troubleshooting courses—plus my FREE package of home study information! RE-91

Print Name _____

Address _____ Apt. _____

City _____

State _____ Zip _____

Age _____ Phone _____ (area code)

Check box for G.I. Bill information:
 Veteran Active Duty

Mail today!

The surprising leader.

10 to 30 MHz oscilloscopes with more performance and reliability than you ever thought possible.



LBO-508A/507A,
20 MHz dual or single
trace—\$835 or \$610.

LBO-520,
30 MHz dual trace,
signal delay—\$1100.

LBO-308S, 20 MHz
dual trace, battery/ac
portable—\$950.

LBO-514/513, 10 MHz
dual or single trace,
1 mV—\$645 or \$495.

LBO-515B,
30 MHz dual trace,
delayed sweep—\$1530.

It's easy to see why LEADER oscilloscopes are now specified more than ever. More performance for less cost... with immediate deliveries from over 100 stocking distributors... and the industry's best two-year warranty backed by East and West Coast factory service depots.

For bench or field work, single and dual trace, there are 11 different models to choose from. All offer comprehensive triggering, TTL Z-axis, front-panel trace alignment, and human-engineered control layouts.

Call free (800) 645-5104 for 40-page catalog, evaluation units, and the name of your local distributor.

When Quality Counts

LEADER
Instruments Corporation

380 Oser Avenue, Hauppauge, N.Y. 11787
(516) 231-6900
Offices in Chicago, Los Angeles, Dallas.

CIRCLE 32 ON FREE INFORMATION CARD

TO BE CONTACTED BY LOCAL DISTRIBUTOR

letters

DOPPLER RADAR

In the June 1979 issue of *Radio-Electronics*, John W. Elkin's letter discussed a problem about Doppler radar. Because of the ambiguous results he arrived at, he questioned whether the velocity of light (c) was truly constant. In the October issue, Dr. H. Mark dealt with Elkin's question by explaining Elkin's ambiguous results in terms of the impossibility of simultaneity and the Lorenz-Fitzgerald contraction, as we understand them from relativity theory.

As Elkin's problem involved simultaneous measurements and relative velocity, Dr. Mark's response was understandable. However, I believe that his response ignores Elkin's main error, namely, a misconception of the Doppler effect. I hasten to add that there are probably thousands of ex-physics students who have the same misconception; I did, too, a decade or more ago.

Most of us were introduced to the Doppler effect in an undergraduate physics course, via the old train-whistle problem. To determine what frequency the stationary observer hears, we are told to add the train velocity to the speed of sound, if the train is approaching; or to subtract the velocity from the speed of sound if the train is receding, and plug this value into a formula. Without further explanation from the instructor, or the text, it's only natural to conclude that the Doppler effect is caused by a change in the velocity of the waves, imparted by the velocity of the source.

I only recognized that as a misconception when I used it to understand the red shift, prime evidence for Hubble's expanding universe. With c constant, regardless of the velocity of the light source, or of the observer, it seemed to me that electromagnetic radiation could never display a Doppler shift. But that conclusion was ridiculous, on the face of it; so I sought a better understanding of the Doppler shift.

When I questioned several associates, I found that my misconception was widespread. Finally, a friend called my attention to an explanation of the Doppler effect in *The Encyclopedia of Physics* that deals with the Doppler shift in terms of wavelength, λ , instead of velocity. Considering the familiar equation $f = c/\lambda$ it's apparent that either Δc or λ will cause a Δf .

With f and c constant, as each crest of the wave leaves the source moving at velocity v , the wavelength in the direction of v is $\lambda = (c-v)T = c-v/f$ while in the opposite direction, $\lambda = c+v/f$. In other words, the wavelength toward v shortens and lengthens in the opposite direction. The 1966 edition of the *Encyclopedia* contains a diagram that illustrates the principle very well.

Returning to Elkin and the train whistle, the foregoing indicates that there is no

continued on page 24

CB, AMATEUR or COMMERCIAL COMMUNICATIONS

Hustler has the antenna you're looking for!

Mobile or base station. Whatever your needs, Hustler has the quality for exceptional mechanical and electrical performance. The result of unique engineering expertise and innovation, respected throughout the industry.

For outstanding antenna quality, look to Hustler!

Clearly the choice of those who know quality.

See your dealer or write:

HUSTLER INC.

3275 North B. Ave
Kissimmee, Florida 32741



Satellite TV Reprints

To order your 36-page booklet containing complete reprints of all seven articles in the series on Backyard Satellite TV Receivers by Robert B. Cooper, Jr., complete the coupon below and enclose it with your check or money order for \$6.00.

We will ship your reprint, postpaid in U.S. and Canada, within 6 weeks of receipt of your order. All others add \$3. for postage. New York State residents must add 48¢ sales tax.

Radio-Electronics
Satellite TV Reprints
45 East 17th Street
New York, NY 10003

I want _____ reprints @ \$6.00 each, postpaid.
I have enclosed \$_____. NY State residents must add 48¢ sales tax.

(Name) _____

(Street Address) _____

(City) _____ (State) _____ (Zip) _____

An in-depth look at the only "plug-in" remote control system you'll ever need for your home.

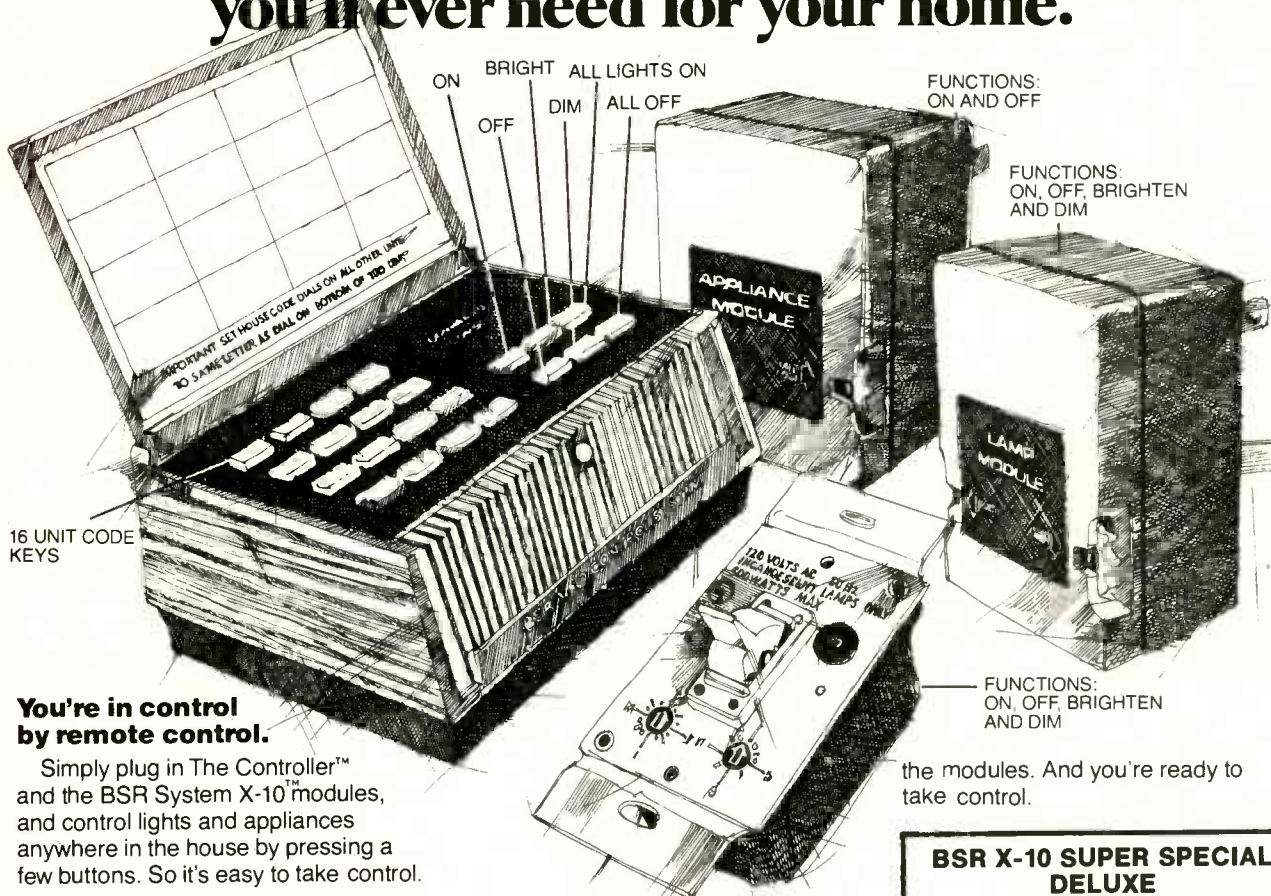

You're in control by remote control.

Simply plug in The Controller™ and the BSR System X-10™ modules, and control lights and appliances anywhere in the house by pressing a few buttons. So it's easy to take control.

There's no end to all of the control you've got.

You can turn on the TV, radio or stereo in the morning to help you wake up without getting up from bed. Or at night, turn on the lights before going downstairs so you don't have to fumble in the dark. Turn off unnecessary lights and help get your electric bill under control. Or, dim the lights and save energy, too.

And when it's time to turn in, just push a button and turn everything off. And sleep soundly. But, if you hear a strange noise in the middle of the night, you can press a button to turn on all the lights and scare the daylighters out of an intruder.

The Controller is designed to control every room in the house.

By pressing the buttons on the Command Console keyboard, command signals are transmitted over

existing household wiring to the module of your choice. The Lamp Module turns on, off or dims any incandescent lamp up to 300 watts. The Appliance Module turns appliances like TVs, window fans or stereos on and off. And the Wall Switch Module is designed to turn on, off or dim any light or lamp up to 500 watts normally operated by a wall switch.

There's even a Cordless Controller that transmits signals to an Ultrasonic Command Console from up to 30 feet away. So there's plenty of control for everyone.

Simplicity is built into the system.



No special wiring is needed. Simply plug The Controller Command Console into any wall outlet in any room of the house.

Then plug your lamps and appliances into the appropriate modules. Plug in

the modules. And you're ready to take control.

BSR X-10 SUPER SPECIAL DELUXE ULTRASONIC CONSOLE

REGULARLY \$49.95
NOW \$29.95

With the purchase of three or more modules

Modules normally \$17.00 ea.

Modules of your choice

3 for \$47.95 6 for \$83.95

Ultrasonic Hand Unit

Normally \$24.95 Now \$18.95

Please add \$3.00 for shipping

TOLL FREE HOT LINE

800-223-0474

THE TIMER™ Automatically Programs Lights, Appliances. Just plug in The Timer and the BSR X-10 modules and you can program up to 8 lights and appliances to go On and Off up to twice a day. UL listed. \$74.95 if purchased separately. If purchased with 3 or more modules \$59.95

NEW



ADVANCE ELECTRONICS

54 West 45 Street, New York, N.Y. 10036 212-687-2224

Available June 30, 1980

LETTERS

continued from page 22

need to assume that the wave velocities (c for electromagnetic waves, or 1100 ft./sec. for sound) changed. Then what are those velocities of $(c \pm v)$ or $(1100 \text{ ft./sec} \pm v)$? Actually, they are mathematical abstractions, or devices, to simplify the calculation of the Doppler shift. In other words, they do not exist physically. A more "honest" (or at least less ambiguous) way of determining the Doppler shift would be to calculate the effect of the source or observer movement (v) upon the wavelength from the formulas given above, and then calculate f from

$$f = \frac{c \text{ or } 1100\text{ft/s.}}{\lambda}$$

I hope that the above will clarify things for Elkin and induce educators to present the Doppler effect in a different manner.

WILLIAM L. CLEMENTS,
Webster, NY

SUPERBOARD CLUB

As an owner of an Ohio Scientific *Superboard*, I, like many thousands of others of my breed, am fed up with the lack of technical information about the system. So I've decided to do something about it and propose to head a Superboard Club.

The object will be to publish a newsletter every two months, containing programs, ideas, technical data, hints, and suggestions submitted by participating members. The club is to be non-profit, and exist as an information center for all who wish to join.

Anyone interested can obtain further information by sending me a self-addressed business envelope and \$1.00.

C. BRIAN SMITH,
Superboard Club,
Box 55, Agincourt, Ontario,
Canada M1S 3B4

ENERGY ALTERNATIVES

The only negative comment I have to make on my first issue of *Radio-Electronics* (December 1979) concerns the letter by Brad Brown. Apparently he has overlooked the obvious solution to the energy crisis. Don't just use tachyons ("supposedly exist in some other dimension") for information-processing and control of magnets. Why not build an interdimensional-reciprocal-frequency-downconverter. That device could bring those tachyons into our dimension (3rd? 4th?) at an increased mass (infinite) and reduced speed (warp factor 2), according to A. Einstein's equation $E = mc^2$.

Those very energetic particles could then be used to power a conventional steam turbine (Big Allis). The only problem would be to locate the microprocessor and EPROM for the turbine controller far enough away from the tachyon-H₂O interface so that the stray U.V. won't erase the EPROM. (Maybe we could synthesize a 5th-dimensional material to absorb that radiation. Come on now—that letter might suffice in a pinch for an April issue, but don't let your letters department become a platform for quacks).

Speculation is fine as long as it is bounded by the confines of good science. Nuclear Physics, Particle Physics, Special Relativity, and Computer Science are all exciting fields and subjects for exciting

Five reasons why

hy-gain[®]

base station
antennas are
WORLD FAMOUS

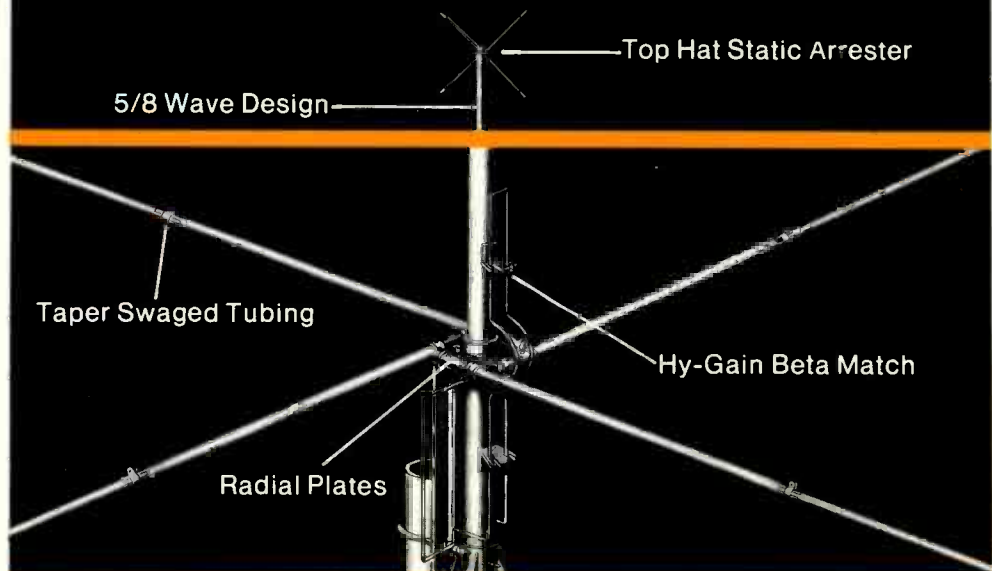

1. Hy-Gain's pioneering innovations in CB base antenna design.

This powerful 5/8 wave base station antenna design was an original Hy-Gain concept. Efficiency is increased substantially over conventional designs. Furthermore, Hy-Gain's CB antennas are subjected to the same demanding requirements established for amateur, military and commercial antennas.

2. The Exclusive Hy-Gain Beta Match.

The Beta Match provides proper matching between feedline and antenna for optimum performance. The Beta Match also puts the antenna at dc ground, thus draining off precipitation static.

3. Taper Swaged Tubing.

Hy-Gain uses taper swaged, heavy-gauge, aircraft quality, seamless aluminum tubing for all radiators and radials. This gives our collinears less wind loading and more stability than with most other designs available.

4. The Top Hat Static Arrester.

Hy-Gain engineering expertise developed what we call the "Top Hat" Static Arrester. This wire configuration atop many of our base station antennas is designed to reduce precipitation static to an absolute minimum, resulting in crystal-clear, two-way communication.

5. Radial Plates.

High wind survival and extra years of high performance are assured because of our rugged construction techniques. A good example of this is the machine-formed radial plates fitted to each Hy-Gain omnidirectional antenna. These precision plates hold the radials firmly in place, thus preventing them from loosening or even falling off.

TELEX[®] hy-gain[®]

TELEX COMMUNICATIONS, INC.

8601 Northeast Highway Six, Lincoln, NE 68505 U.S.A.
Europe: 22, rue de la Légion-d'Honneur, 93200 St. Denis, France.

The world's most popular CB base antenna! Hy-Gain was the first to design a 5/8 wave collinear antenna. It was the ultimate omni when we invented it and it still is. Its impressive 5.3 dB gain in all directions has become the industry standard that other 5/8 wave omnis are measured against.

The Penetrator's signal is compressed at the horizon for extra power and distance because of its extra long 22' 9" (6.9m) radiator length. Its unique top hat discharges static buildup to nearly eliminate noise. This is not just another ground plane antenna; its superb design and heavy-duty construction will handle 1500 watts of power with no problem because there are no power-robbing loading coils to burn out.

Model 500 The Super Penetrator

- 5.3 dB gain
- 1500 watts power handling capability
- Low signal-to-noise ratio
- Compressed signal for extra power

Model 473 CLR II

This is the most copied 5/8 wave colinear antenna on the market. The CLR II achieves a powerful, no-nonsense 4.2 dB gain at the horizon, and a big 500 watts of power handling capability. This is, by far, the best value in Base Station Antennas available today.

Model 410 The Original Long John

This five-element yagi with 24' (7.3m) boom delivers an amazing 12.5 dB forward gain with 31 dB front-to-back ratio. For long distance, high powered action, this one has all other five-element yagis beat. This famous Hy-Gain Long John can handle 2000 watts of power with ease. Top quality materials and exclusive Beta Match feedpoint system with direct dc ground guarantees efficient power transfer and increases your talk power 18.4 times the normal output of your radio.

Model 542 SDB 6

Two 12' (3.7m) beams on a 14' (4.3m) cross boom for 12.7 dB forward gain.

speculation. Only—please let it be done by people who know what they are talking about.

Aside from that, I'm favorably impressed with your magazine.

P.S.: But now suppose you have two mini-black holes rotating at .5 times the speed of light, and you accelerate powdered 8080's just outside their Schwarzschild Radius, and . . .

DANIEL J. HURLEY,
Franksville, WI

ROBOTICS

I would like to compliment Mr. Weinstein on his "android" articles in **Radio-Electronics** (January and February 1980 issues). I have built (according to his definition) one robot and two automatons. I find robotics (or cybernetics, andronics, or whatever you want to call it) a fascinating hobby. After I finish high school, I plan to go to Stanford or MIT to study the subject further, and hope to make a career of it. I have a TRS-80 computer and an IMSAI 8080 microcomputer. I also have a KIM-1 and a homebrew 8085 system for use on my automatons.

I found the articles to be quite interesting, especially since they included a discussion of manipulator arms—something I have not found in any of the robotics books I've seen. That's an important point since, as he said in the first part of the article, a useful robot must be able to manipulate external objects. For manipulator motors, one might contact Warner Electric Brake and Clutch Company, Beloit, WI 53511. They sell electromechanical linear actuators with movement ranges from four to twelve inches and load ratings from 250 to 1000 pounds. They can be ordered for operation from many AC and DC voltages, as well.

I hope that we'll see more such articles in early issues of **Radio-Electronics**.

W. M. RICHMAN II,
North Platte, NE

Mr. Richman's comments are very much appreciated. I'd like to discuss briefly two points he brings up.

First, since one of our stipulations for an android is that it be able to exist and function harmoniously in a human environment, I would suggest a caveat on using the excellent Warner mechanism: While it's able to help the android reach many points in space, it can't easily accomplish a reach-around. For example: Let's say that the peanut-butter jar in your cupboard is behind the syrup bottle. Linear drives would find the latter a blockade in its attempts to reach the former, and we might wind up with a sticky, if not a sweet problem.

*Second, I am now finishing my manuscript for a book-length version of my notes on android design for Hayden Books. It includes a much more detailed discussion of each of the subjects covered in the original **Radio-Electronics** articles, plus mechanical drawings, examples, sources for parts, alternate approaches, and some of the necessary formulae for determining values and dimensions. The compendium will permit a determined reader to derive his own detailed plans with ease. This first of the android (versus robot) books should be available by 1981, if not sooner.*

MARTIN BRADLEY WEINSTEIN

R-E

equipment reports

Kikusui Model 5512A Oscilloscope



CIRCLE 101 ON FREE INFORMATION CARD

TODAY'S ELECTRONIC EQUIPMENT IS CREATING a demand for higher-quality test instruments than those that were once used in the service industry of years gone by. In keeping with that demand, Kikusui International Corp. (17121 South Central Avenue, Unit No. 2M, Carson, CA 90746) has introduced a new line of test equipment. One of them is the model 5512A oscilloscope.

One of the first observations made when the Kikusui 5512A was put into service was the ease of operation and the stability of the adjustments and the waveforms being monitored. The unit is housed in a handsome steel cabinet measuring $9\frac{1}{4} \times 7\frac{1}{4} \times 14\frac{3}{4}$ inches ($242 \times 184 \times 370$ mm) and weighing $17\frac{1}{2}$ pounds (8 kg). There is a handy bail-type stand attached to the bottom side of the cabinet that can be "flipped" to a locking position allowing the scope to be placed on the bench in a tilted position. In addition, for use with the unit in a portable location, there are feet at the rear of the cabinet making it possible to stand the instrument upright. Those feet are designed to do double duty since they are extra long and can be used as a cord storage reel when carrying the 5512A. For carrying there is a strap-type handle attached to the top of the cabinet. The balance is excellent and the grip is quite comfortable.

The 5512A can be used anywhere a DC-15MHz dual-trace scope is needed. According to Kikusui's instruction book, it was designed for production-line use, maintenance, service, research and development use, and there is a place for it in many other applications. It is a natural for the consumer electronic service industry and even includes special markings for the TV vertical and horizontal frequencies on the timebase knob. In addition, it contains a sync separator for use when viewing composite video signals.

The high brightness 5.24-inch (133mm) round CRT produces a bright, sharp waveform even at the fast-sweep speeds. There was a very slight change in brightness round when changing from single to dual-trace modes. Terminals

are provided on the rear of the cabinet to intensity modulate (Z-axis) the CRT. The 5512A can be adjusted by internal taps to accept line voltages that may range from 90 volts to 264 volts. The line frequency is listed as 50/60 Hz and the power consumption is 30 VA.

Published specifications include a sensitivity of 5 mV-per-division from DC to 15 MHz and a maximum sweep speed of 100 nanoseconds-per-division (magnified). The vertical amplifiers actually operate from 5 mV-per-division to 10 V-per-division in a 1, 2, 5 sequence. The accuracy was found to be well within the $\pm 3\%$ of indicated value when in the calibrated position. The risetime is approximately 23.3 ns according to the specifications and the calibrated vertical sensitivity can be fully adjustable if so desired. The shift in the baseline caused by range switching was found to be less than the 0.5 division specified.

A quick check of the Kikusui model 5512A scope reveals a well laid out front panel. Although somewhat different than most scopes on the market today, the layout is extremely easy to use once the positions of the controls are learned. The vertical adjustments are located to the upper right hand side of the panel. The Channel "A" vertical amplifier is at the top and Channel "B" is directly under that, near the horizontal centerline of the panel. Directly beneath these vertical controls can be found the timebase switch.

For ease of operation, all the variable/calibrate controls are colored a bright red. All other variable controls are finished in black. The front panel also includes the mode switches, the AC/DC/GND switches for the vertical inputs, triggering switches and trigger-mode selectors. All of the latter are indicated by a blue color.

To overcome variations in the earth's magnetic field, the 5512A makes use of an easily adjustable trace-rotation control. Selection of the chopped or alternate modes is accomplished by the position of the timebase switch as is the sync separator for TV signals. Position controls to adjust the centering of the traces on the CRT and the switches that select the X-Y mode of operation are also located on the front panel. The CRT itself is masked by a rectangular bezel that includes provisions for attaching a camera for waveform photography. There is an illuminated graticule that is divided into eight vertical segments and ten in the horizontal plane. In use, the timebase and vertical calibrations allow easy computation of voltage, frequency, and other information.

The timebase is completely adjustable to accommodate variations in time from 0.5 second-per-division to 0.5 ns-per-division. The timebase switch positions are arranged in a 1, 2, 5 sequence. Sweep magnification of 5-times is available from a front-panel switch and there is a control that allows the sweep time to be adjustable by 2.5 times.

Although the maximum voltage to be applied to various inputs is different for the

selected ranges, it is no lower than 400 volts (DC plus AC P-P) on the 20 mV range and under. All other ranges list a maximum of 600 volts (DC plus AC P-P). There is a 3 V P-P input for the z-axis required to blank the trace. The maximum allowable voltage at this point should not exceed 50 volts (DC plus AC P-P). The external trigger input should be limited to 100 volts maximum (DC plus AC P-P).

Input to the vertical amplifiers is accomplished through BNC-type connectors on the front panel of the unit. There are two (2) low-capacitance (10:1) probes supplied and they are of the slim variety of present-day test probes. That feature makes them very handy to use on the smaller equipment found today. The probe has a built-in hook for ease of connection to the circuit under test. By making use of BNC connectors, the probes are simple and quick either to remove, install, or change to another type such as a demodulator, etc. The probes are frequency-compensated and such compensation is adjustable.

There is a most complete service manual combined with the operational instructions. You could use this manual as a course of instruction in the uses of dual-trace triggered-sweep scopes. The manual contains a wealth of information arranged in an easy-to-follow sequence. For instance, one complete section deals with the determination of unknown frequencies by using Lissajou patterns. Phase difference, overshoot, and ringing are just a few of the examples given in the manual. As for servicing of the unit itself, there is a surprise awaiting the technician who opens the manual to the schematic diagram. After being accustomed to finding entire schematics of such equipment as scopes reduced down to fit on one single page or less, it is a pleasure to find that the Kikusui model 5512A schematic diagram is reproduced on no less than four double-sized fold-out sheets. No squinting or microscopes are required to see the parts designations. Certainly a fresh outlook.

Another portion of the operation manual is a complete calibration procedure to be used in periodic checking and also when some defect may require recalibration. That is another item often not fully covered in many scope documents. Again, very refreshing.

In summary, using this scope was very enjoyable and it performed as the published claims would lead one to expect. Several hours of bench time during actual troubleshooting were logged using the 5512A. It can be presumed that, within the limitations of the 15MHz response, there is little reason to believe anyone could be unhappy with the scope. Pricewise, the tag is competitive with other 15MHz scopes on the market. It should do an admirable job on the bench of a TV shop since it contains the sync separators for rock-steady waveforms. Other applications should be a snap for the Kikusui 5512A to handle. The Kikusui model 5512A sells for \$795. **R-E**

continued on page 32

DMM + VARI-PITCH + LOGI-TRAK = MX 333

World's fastest troubleshooter

**A DMM SO UNIQUE... SO VERSATILE...
SO SUPERIOR WE WERE TEMPTED TO
CALL IT SOMETHING ELSE**

We believe the MX333, with the VARI-PITCH™ and LOGI-TRAK™ functions, to be the greatest time saving tool in electronics today. It has all the functions, ranges and accuracy you expect from the best along with the two additional features which will save enormous amounts of troubleshooting time. And the MX333's 20Ω range gives you 10 milliohm resolution for those critical low resistance tests. Both MX series DMM's have 0.1% basic accuracy plus a 10A range, plus the intelligent case styling that has the size of a hand held, but the shape of a better idea. With either unit you get more performance per dollar than with competitive models. And the MX333 gives you more, much more, than you ever thought possible! *Effort cutting innovations that will save you hours by the second!*

EXCLUSIVE VARI-PITCH

Not just a beep... not just instant ohms. MX333's VARI-PITCH audible tone changes frequency proportionate to the reading so you can literally troubleshoot by ear! The higher the pitch, the higher the reading. No need to take your eyes off the probe or wait for a reading to settle. VARI-PITCH responds instantly, proportionally and accurately in all voltage, current, resistance and diode test ranges. It even provides analog-like audible response to variations for quick and easy adjustments and nulling.

FAST LOGI-TRAK (5 nsec fast)

Combines the features of a high performance logic probe and voltmeter in one convenient function. Use any standard 10:1 high frequency scope probe to find high and low logic levels and positive or negative pulses as narrow as 5 nsec without taking your eyes off the circuit! The VARI-PITCH output tells it all. And, unlike ordinary logic probes, LOGI-TRAK spots ground shorts, supply shorts, opens, marginal or ambiguous logic states and infrequent pulses instantly! Then, without changing anything but the direction of your glance, it's easy to verify actual voltage on the digital readout!

NEW UNIVERSAL SIZE AND SHAPE

MX333 and MX331 are the first digital multimeters designed from the ground up for LCD technology. The display's 45° angle is easy to read at any viewing point; from directly above to straight on. Powered by a single 9 volt battery, their compact size and unique shape make them ideal for all portable applications.

No matter how you use a multimeter in your hand clipped to your belt or on a shelf, no other DMM is as convenient as the Hickok MX333 or MX331! And, with VARI-PITCH, MX333 is *really out of sight* in performance.

For an exciting demonstration contact your nearby Hickok distributor. For the name of your nearest distributor call, toll free, 800-321-4664.

MX333
\$235.00

MX331
\$179.00



THE HICKOK ELECTRICAL INSTRUMENT CO.
1054 Dupont Avenue • Cleveland, Ohio 44108
(216) 541-8060 • TWX: 81C-421-8286

CIRCLE 29 ON FREE INFORMATION CARD

EQUIPMENT AND TRAINING NO OTHER SCHOOL CAN MATCH.

**NTS HOME TRAINING INVITES YOU TO EXPLORE MICROCOMPUTERS,
DIGITAL SYSTEMS AND MORE, WITH STATE-OF-THE-ART EQUIPMENT
YOU ASSEMBLE AND KEEP.**

Without question, microcomputers are the state of the art in electronics. And NTS is the only home study school that enables you to train for this booming field by working with your own production-model microcomputer.

We'll explain the principles of troubleshooting and testing your microcomputer and, best of all, we'll show you how to program it to do what you want.

You'll use a digital multimeter, a digital logic probe and other sophisticated testing gear to learn how to localize problems and solve them.

Send for the full color catalog in the electronics area of your choice—discover *all* the advantages of home study with NTS!

NTS also offers courses in Auto Mechanics, Air Conditioning and Home Appliances. Check card for more information.

1.



2.

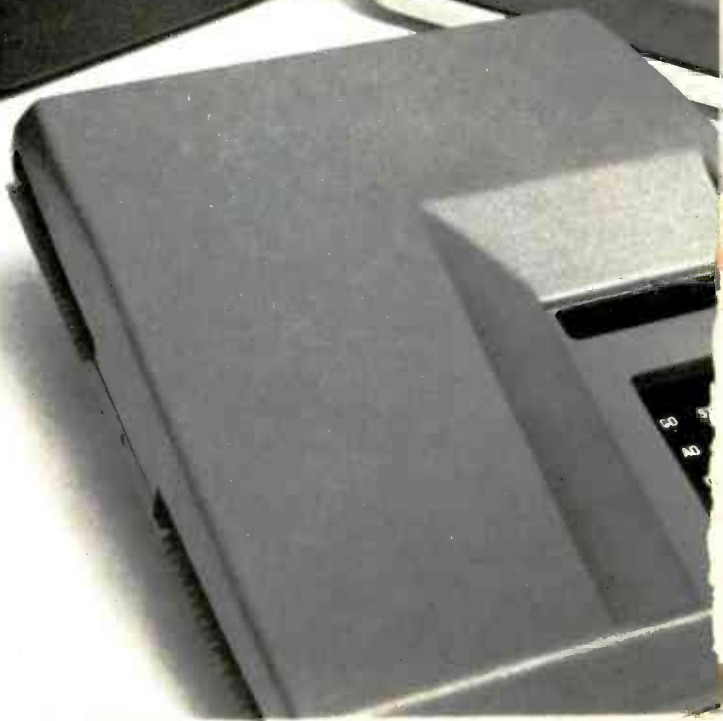

We believe that training on production-model equipment, rather than home-made learning devices, makes home study more exciting and relevant. That's why you'll find such gear in all 14 of NTS's electronics programs.

For instance, to learn Color TV Servicing, you'll build and keep the 25-inch (diagonal) NTS/HEATH digital color TV.

In Audio Electronics, you'll be able to assemble your own NTS/HEATH digital stereo receiver with 70 watts per channel.

But no matter which program you choose, NTS's Project Method of instruction helps you quickly acquire practical know-how.



Simulated TV Reception

3.

1. **The NTS/Rockwell AIM 65 Microcomputer** A single board unit with on-board 20 column alphanumeric printer and 20 character display. A 6502-based unit 4K RAM, expandable.
2. **The NTS/KIM-1 Microcomputer** A single board unit with 6 digit LED display and on-board 24 key hexadecimal calculator-type keyboard. A 6502 based microcomputer with 1K RAM, expandable.
3. **The NTS/HEATH H-89 Microcomputer** features floppy disk storage, "smart" video terminal, two Z80 micro-processors, 16K RAM memory, expandable to 48K.
4. **The NTS/HEATH GR-2001 Digital Color TV (25" diagonal)** features specialized AGC-SYNC muting, filtered color and new solid-state high voltage tripler rectifier.

NATIONAL TECHNICAL SCHOOLS

TECHNICAL-TRADE TRAINING SINCE 1905
Resident and Home-Study Schools
4000 South Figueroa St., Los Angeles, Calif. 90037

**NO OBLIGATION. NO SALESMAN WILL CALL.
APPROVED FOR VETERAN TRAINING.**

NTS Training Programs
in Consumer and
Industrial Electronics



NATIONAL TECHNICAL SCHOOLS

4000 South Figueroa Street,
Los Angeles, California 90037 Dept. 206-070

Please rush FREE color catalog on course checked below

- | | |
|---|--|
| <input type="checkbox"/> MicroComputers/MicroProcessors | <input type="checkbox"/> Audio Electronics |
| <input type="checkbox"/> Communications Electronics | <input type="checkbox"/> Auto Mechanics |
| <input type="checkbox"/> Digital Electronics | <input type="checkbox"/> Air Conditioning |
| <input type="checkbox"/> Color TV Servicing | <input type="checkbox"/> Home Appliances |

Name _____ Age _____

Address _____

Apt. _____ City _____

State _____ Zip _____

- Check if interested in G.I. information.
 Check if interested ONLY in classroom training in Los Angeles.

EQUIPMENT REPORTS

continued from page 26

Doric Model 130-A Capacitance Meter

IT DOESN'T SEEM LONG AGO THAT THE BEST way to measure capacitance was with the time-honored bridge method. L-C bridges were readily available, many as kits, for the lab, test bench, or home experimenter. Those early instruments used headphones or a visual null indicator such as a meter or tuning eye to signal the proper setting of the dial. They were reasonably accurate, but quite cumbersome.

Recently, there has been a revolution in test equipment. Large-scale IC's and digital readouts have contributed to the reduction in size

and improved accuracy. Instruments that formerly required large-volume cabinets have been replaced with pocketable instruments that provide equal or better performance and reliability.

One of the nicest capacitance meters we have yet seen is the *model 130-A C-METER* from Doric. Approximately $6 \times 3 \times 2$ inches, the unit weighs a scant 15 ounces. Four internal AA cells guarantee at least a year of normal laboratory use—and that's enough to test over 20,000 capacitors!

Probably the most obvious feature of the *C-Meter* is its giant $3\frac{1}{2}$ -digit LCD readout with 0.6-inch-high characters. Contrast is excellent, and there is no misinterpretation of a display like that. The instrument is activated by pressing a large pushbutton in the center of the panel.



CIRCLE 102 ON FREE INFORMATION CARD

Also of considerable importance is the meter's autoranging feature. Unlike many competitive units that must be set manually for the correct range, the *model 130A* automatically displays the digital readout on any capacitance within its test range. A matching LED signals the correct multiplier.

Four multiplier ranges are used: mF (millifarads), μ F, nF, and pF. A floating decimal point places itself properly, depending upon the autorange selected. Ten ranges are automatically selected with full-scale readings from 200 pF to 200,000 μ F. Resolution is to 0.1 pF or the lowest range.

The reading for each display goes to a maximum value of 199.9 before switching to the next larger range.

The handsome gray-and-black-toned plastic case is impact resistant. A thumbwheel capacitance offset control is used to zero the meter when test leads are used that introduce stray capacitance. Up to 15 picofarads of compensating capacitance may be introduced, equalizing even the severest test lead loading.

Capacitor leads may be inserted into one of two test jacks. For assembly-line testing of taped rolls of capacitors, an accessory component clip is included that allows rapid checking of the capacitors without removing them. Leadless capacitors, or those with leads too large for insertion into the test terminals provided, are tested by a clip-lead accessory (which is also provided.)

Sampling time is rapid. The first reading appears within half a second for capacitors of less than 200 microfarads; subsequent readings are presented every 600 milliseconds. Gradually, the display rate decreases to once every five seconds with capacitances in the range of 200,000 microfarads.

Accuracy is within 0.1% (± 1 count) up to 200 microfarads, and $\pm 1\%$ on higher ranges.

One of the criticisms often made of LCD instruments is their slow speed and limited ambient temperature applications. But to look at it realistically, we must remember that it is extremely unlikely that a user would be making capacitor measurements in an environment that would exceed the normal limits of the recommended LCD operating range. In the case of the *C-Meter*, that range is 0° to 40° C. (32° to 102° F).

Although the literature which accompanied our sample unit did not refer to it, our *model 130A* was equipped with a power-supply jack on the side of the cabinet. It appeared that an external AC adaptor would disconnect the internal AA-cell supply and permit extended bench use of the instrument.

We decided to explore that unmentioned feature farther. We discovered that when a 6-volt power supply was inserted into the jack the instrument came alive automatically, allowing rapid component testing in an assembly line without the necessity of depressing the test

continued on page 38

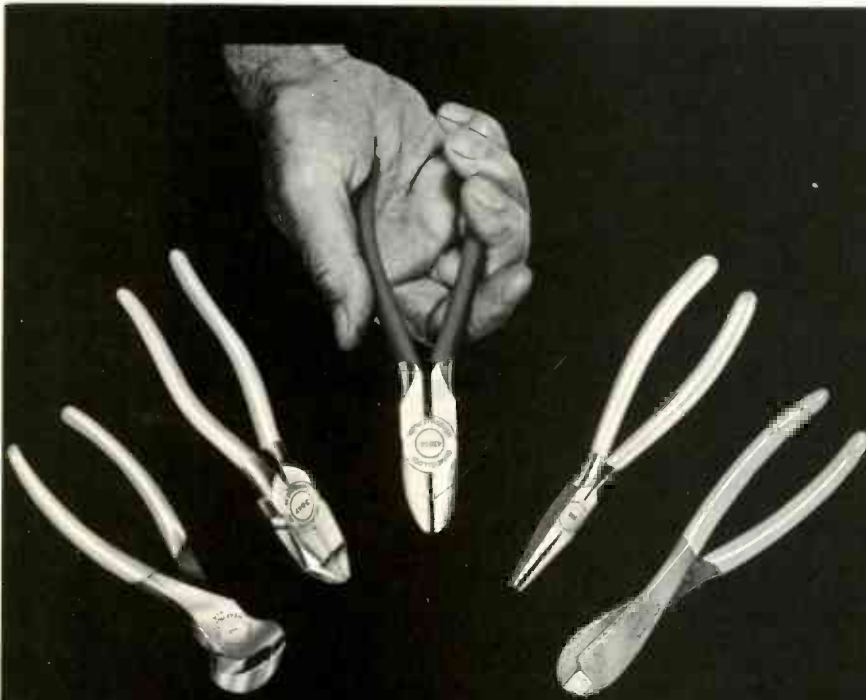

There's Never A Dull Moment With One Of These On The Job

Keen enough to cut a human hair, tough enough to cut piano wire - cleanly, quickly, time after time, year after year. Cutting pliers by CHANNELLOCK. Hand honed, perfectly mated cutters scientifically heat treated to hold their edge. Precision made of highest grade forged steel. Beautiful high polished finish. Blue dipped plastic comfort grips. Quality in every detail (at no premium in price). CHANNELLOCK. Be sure that name is on the pliers you buy.

CHAN NEL LOCK

CHANNELLOCK, INC. • Meadville, Pennsylvania 16335

Meet The Rest Of The Family. Send For Free Catalog.

CIRCLE 6 ON FREE INFORMATION CARD

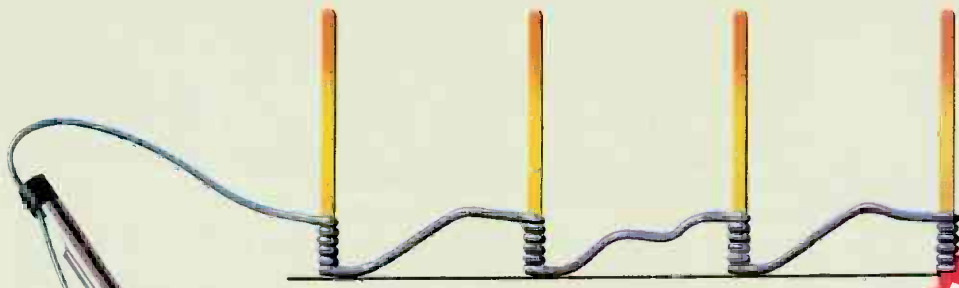

WHY CUT? WHY STRIP? WHY SLIT?
WHY NOT...

NEW

JUST WRAP™

WIRE WRAPPING TOOL

- AWG 30 Wire
- .025" Square Posts
- Daisy Chain or Point To Point
- No Stripping or Slitting Required
- ...JUST WRAP™...
- Built In Cut Off
- Easy Loading of Wire
- Available Wire Colors: Blue, White, Red & Yellow

traditional Wire-Wrapping

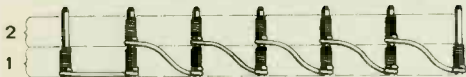

JUST WRAP Wire-Wrapping

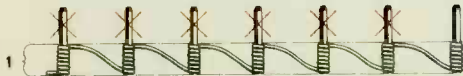

U.S.A., FOREIGN PATENTS PENDING

| JUST WRAP TOOL WITH ONE 50 FT. ROLL OF WIRE | | |
|---|----------|-----------------|
| COLOR | PART NO. | U.S. LIST PRICE |
| BLUE | JW-1-B | \$ 14.95 |
| WHITE | JW-1-W | 14.95 |
| YELLOW | JW-1-Y | 14.95 |
| RED | JW-1-R | 14.95 |
| REPLACEMENT ROLL OF WIRE 50 FT. | | |
| BLUE | R-JW-B | \$ 2.98 |
| WHITE | R-JW-W | 2.98 |
| YELLOW | R-JW-Y | 2.98 |
| RED | R-JW-R | 2.98 |
| JUST WRAP-UNWRAPPING TOOL | | |
| | JW-1 | \$ 3.49 |



OK MACHINE & TOOL CORPORATION 3455 CONNER ST.,
BRONX, N.Y. 10475 (212) 994-6600/TELEX 125091

* MINIMUM BILLING \$ 25.00/ADD SHIPPING CHARGE \$ 2.00/NEW YORK CITY/STATE RESIDENTS ADD APPLICABLE TAX.

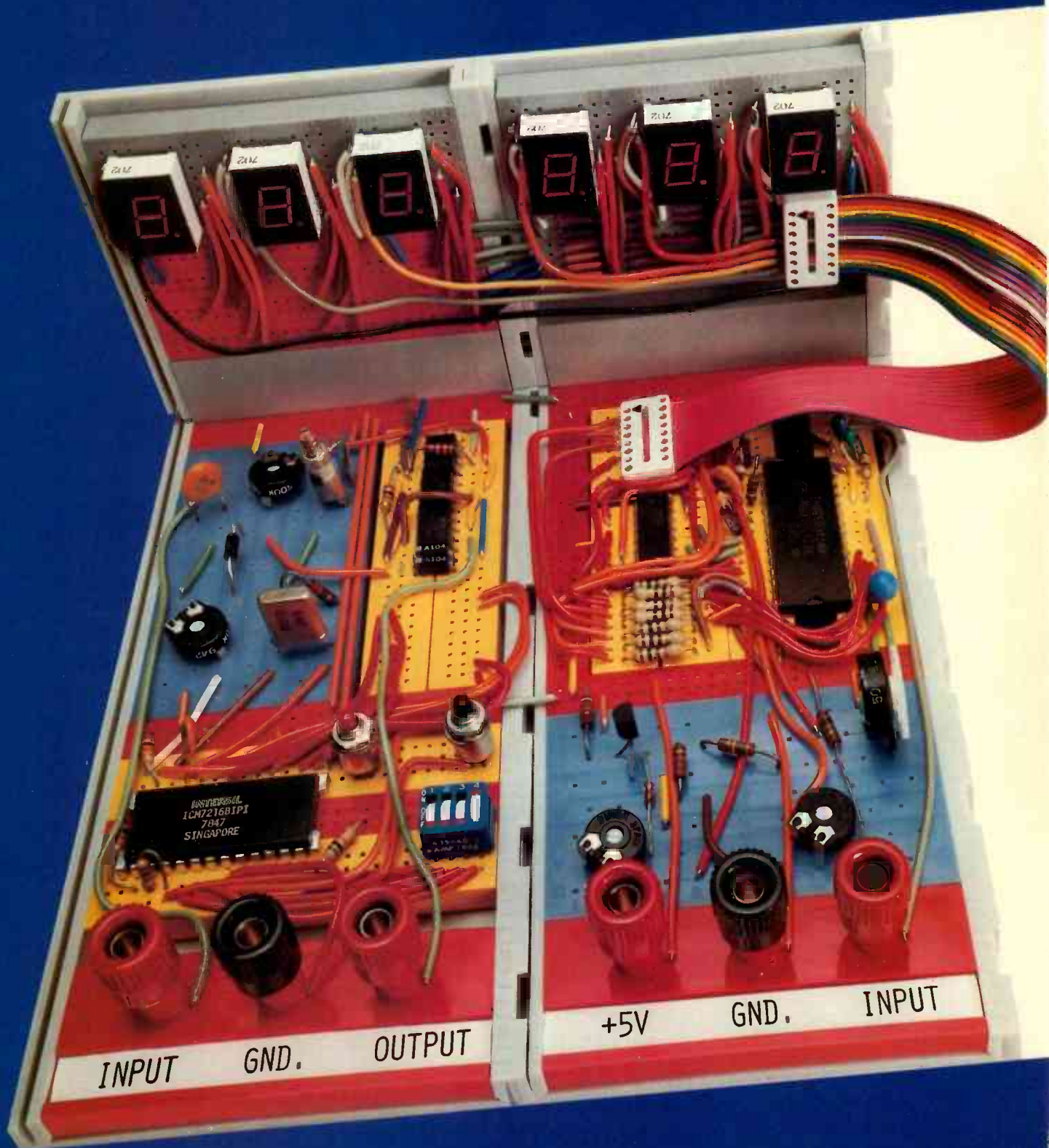

INTRODUCING THE NEW HOBBY-BLOX™ SYSTEM.

HOBBY-BLOX™. The new modular circuit building system designed especially for electronic hobbyists.

Until now, hobbyists had to buy "professional" solderless breadboards for their projects and pay "professional" prices. But now there's Hobby-Blox™, a brand new solderless breadboarding system that's not only economically priced but offers far more advantages to the hobbyist.

At the core of the system are two starter packs, one for discrete component projects, the other for integrated circuit projects. Each comes with a number of Hobby-Blox system modules that fit into a tray and an illustrated project booklet which shows you step-by-step how to build ten projects with the existing modules of each pack. Either starter pack is available for under \$7.00.

You can add modules at any time to build new projects or expand on existing ones. The Hobby-Blox system includes 14 separate module packs that can be purchased individually.

Modules include Tray, Terminal Strip Pack, Distribution Strips, Bus Strip, 3 x 16 Terminal Strip, Discrete Component Strip, L.E.D. Strip, Vertical Tray Pack, Speaker Panel Pack, Control Panel Pack, Blank Panel Pack, Battery Holder Pack, Binding

Post Strip, Tray Extender Clips. Modules are priced from \$1.29 to \$3.59.

All modules are color-keyed and letter-number indexed to make circuit building even easier.

The Hobby-Blox system is compatible with DIPs of all sizes and a wide variety of discrete components. Simply plug in your components and interconnect with hookup wire. No soldering, and all components can be used again and again.

How far can you go with the Hobby-Blox system? Take a look at the example on the page to the left and see for yourself. Then you'll know why we say, "with Hobby-Blox, your only limit is your imagination!"

For a free catalog and the name of your nearest Hobby-Blox dealer call Toll Free (800) 321-9668.

Patents Pending
©A P PRODUCTS INCORPORATED 1980
Prices shown are current suggested U.S. resale.

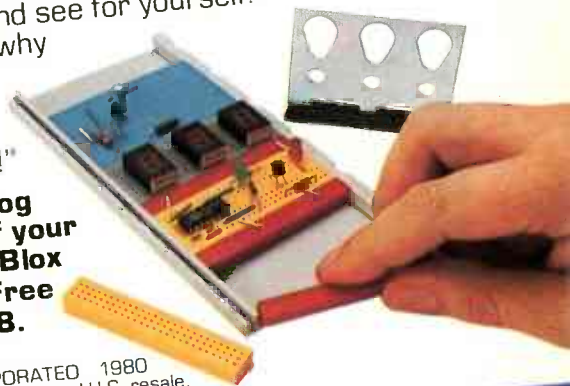

A P PRODUCTS INCORPORATED
1359 West Jackson Street
Painesville, Ohio 44077
(216) 354-2101

In Europe, contact A P PRODUCTS GmbH
Baeumlesweg 21 • D-7031 Weil 1 • W. Germany

CIRCLE 19 ON FREE INFORMATION CARD



BW-2630 Battery Tool



BW-2630 \$19.85*
 BT-30 \$ 3.95*
 BT-2628 \$ 7.95*

BW-2630 BATTERY TOOL

The new BW-2630 is a revolutionary battery powered wire-wrapping tool. The tool operates on 2 standard "C" size NiCad batteries (not included) and accepts either of two specially designed bits. Bit model BT-30 is for wrapping 30 AWG wire onto .025" square pins; BT-2628 wraps 26-28 AWG wire. Both produce the preferred "modified" wrap.

Designed for the serious amateur, BW-2630 even includes both positive indexing and anti-overwrapping mechanisms - features usually found only in industrial tools costing five times as much. Pistol grip design and rugged ABS construction assure performance and durability. In stock at local electronic retailers or directly from

OK Machine & Tool Corporation
 3455 Conner St., Bronx, N.Y. 10475 U.S.A.
 Tel. (212) 994-6600 Telex 125091

Minimum billings \$25.00, add shipping charge \$2.00
 New York State residents add applicable tax

next month

AUGUST 1980

■ Build The Unicorn 1 Robot

Part 1 of an 8 part construction series describing how to build a versatile robot. This robot is fully mobile and can be built for under \$400 complete with manipulator arms. Various levels of control and intelligence are described, including an on-board computer.

■ Six Instruments For Audio Testing

Construction details for 6 easy to build test instruments designed for the audio test bench. Useful for troubleshooting and for checking the performance of your hi-fi system.

■ \$10 Digital Logic Probe

A must for de-bugging and troubleshooting your digital projects. You can build this logic probe for just \$10.

■ Servo-controlled Pick-Up Arm

Unique pick-up arm design on JVC's new turntable let's you electrically adjust the damping characteristics and resonant frequency to match virtually any cartridge. Complete details on how it works and its performance.

■ Raceway Video Game

After promising that this article will appear in this issue, a mess up forced us to postpone it until next month. After you build this video game, you can pretend to be an Indy 500 race driver without ever leaving the comfort of your armchair.

PLUS:

Details On How To Align The Video-IF Section Of Your TV Receiver.

A Close Look At The Transport Mechanism Used in VHS Video Cassette Recorders.

Hobby Corner

Service Clinic

More

BK PRECISION



PHILIPS

TRIPLETT

VIZ formerly **ROU**

LEADER

HICKOK



Hitachi

Simpson

FLUKE



Non-Linear Systems

KEITHLEY

DORIC



DATA PRECISION



**DATA PRECISION
Model 938**

**0.1%, 3 1/2-Digit, LCD DIGITAL
CAPACITANCE
METER**



\$169

- **WIDE RANGING** — from 199.9 pF full scale (0.1 pF resolution) up to 1999 µF full scale, in eight ranges...virtually every capacitance you'll ever need to measure.
- **FAST AND EASY TO USE** — Direct reading, pushbutton ranges. Just plug in and read.
- **EXCEPTIONALLY ACCURATE** — provides ±0.1% basic accuracy.
- **TOUGH AND COMPACT** — Built to take rough usage without loss of calibration accuracy. Fits and goes anywhere; takes very little bench space; always handy for quick capacitance checkout, matching, calibration, and tracking.
- **PORTABLE** — Palm-sized, light-weight, operates up to approximately 200 hours on a single 9V alkaline battery.
- **EASY READING** — big, clear, high-contrast 3 1/2-digit LCD display, a full 0.5" high, readable anywhere.
- **VALUE PACKED** — Outstanding measurement capability and dependability. Outperforms DC time-constant meters, and even bridges costing 2 to 5 times as much.
- **RELIABLE** — warranted for 2 full years.

FLUKE

DIGITAL MULTIMETERS

**Model 8022A:
The Troubleshooter**

\$139

- Six functions
 - dc voltage
 - ac voltage
 - dc current
 - ac current
 - resistance
 - diode test
- 3 1/2-digit resolution
- 0.25% basic dc accuracy
- LCD display
- Overload protection

**Model 8020A:
The Analyst**

\$179

**Model 8024A:
The Investigator**

\$219



NEW

- Seven functions
 - dc voltage
 - ac voltage
 - dc current
 - ac current
 - resistance
 - diode test
 - conductance (1/R)
- 3 1/2-digit resolution
- 0.1% basic dc accuracy
- LCD display
- Overload protection
- **Free case**
- Two year parts and labor warranty

- Nine functions
 - dc voltage
 - ac voltage
 - dc current
 - ac current
 - resistance
 - diode test
 - conductance (1/R)
 - logic level and continuity detect
 - temperature (K-type thermocouple)
- Peak hold on voltage and current functions
- Selectable audible indicator for continuity or level detection
- 3 1/2-digit resolution
- 0.1% basic dc accuracy
- LCD display
- Overload protection

**KEITHLEY MODEL 130
DIGITAL MULTIMETER**



NEW

\$99

| | RANGE | ACCURACY |
|-------------------|-------------------------------|----------|
| DC VOLTAGE | 200mV, 2V, 20V, 200V, 1000V | .5% |
| AC VOLTAGE | 200mV, 2V, 20V, 200V, 750V | 1% |
| DC CURRENT | 2mA, 20mA, 200mA, 2000mA, 10A | 2% |
| AC CURRENT | 2mA, 20mA, 200mA, 2000mA, 10A | 3% |
| RESISTANCE | 200Ω, 2kΩ, 20kΩ, 200kΩ, 20MΩ | .5% |

New Portable Digital Capacitance Meter

BK PRECISION

MODEL 820



Call For Our Price

- Measures capacitance from 0.1 pF to 1 Farad
- Resolves to 0.1 pF
- 10 ranges for accuracy and resolution
- 4 digit easy-to-read LED display
- 0.5% accuracy
- Special lead insertion jacks or banana jacks
- Fuse protected
- Uses either rechargeable or disposable batteries
- Overrange indication



HITACHI

- V-151 15 MHz Single Trace
- V-152 15 MHz Dual Trace
- V-301 30 MHz Single Trace
- V-302 30 MHz Dual Trace
- V-550B 50 MHz Dual Trace, Dual Time Base

Call For
Special Intro
Price Offer



THE TEST EQUIPMENT SPECIALISTS

TOLL FREE HOT LINE

800-223-0474

54 WEST 45th STREET, NEW YORK, N.Y. 10036 212-687-2224

**ADVANCE
ELECTRONICS**



button. We can only assume that this worthwhile feature was forgotten when the promotional literature was prepared, and are glad to be able to provide you with the information.

Battery replacement is quite simple. Four cabinet screws are removed, and the housing slides apart on rigid guides. The cabinet itself is very durable.

Internal circuitry is compact and built around a glass epoxy PC board which is wave soldered. Everything about the *C-Meter* boasts of high quality, and a 6-month warranty backs it up. The model 130-A *C-Meter* sells for \$325 from Doric Scientific, 3883 Ruffin Road, San Diego, CA 92123. R-E

Mem-Explorer Software For the PET Computer

CIRCLE 103 ON FREE INFORMATION CARD
MEM-EXPLORER IS A BASIC COMPUTER PROGRAM that is designed to open a "window" in the Commodore PET's memory. Its primary function is to examine memory contents by decoding the memory words at selected locations as ASCII characters, system commands, or BASIC keywords, constants, or indirect memory address references or links.

After loading and executing the program, a 4-command menu is displayed: ADD FROM TAPE, CREATE TAPE, EXPLORE, STOP.

Typing E selects the EXPLORE mode. That mode requires a user choice between display of lower-case letters or reserved words. PET BA-

SIC stores multi-letter commands and keywords as single byte words. The user choice is necessary to resolve conflicts between identical codes used to represent lower case letters and reserved words.

Next, the program asks for the starting address of the memory area to be examined. Twenty rows of five columns of data then appear on the PET's CRT. The first column displays the memory location, the second column lists the decimal equivalent of the binary contents of each location, and the third column displays the decoded ASCII characters or reserved words. The fourth column shows addresses calculated from each memory word and the following one, that are useful in interpreting BASIC program links and pointers. Column five lists the decimal integer equivalents of the combination of each memory byte and the subsequent one.

After each 20 lines of data is printed, a new memory segment can be examined by entering a new start location, or -1 can be entered to return to the menu.

The additional menu-selected program routines are used to prepare and load previously prepared cassette tapes, so that *Mem-Explorer* can be combined with user programs. Detailed instructions show how to carry out the combination procedure. This special operation is required because *Mem-Explorer* and a second BASIC program cannot be simultaneously saved in PET memory by the conventional load method. Loading a second program normally overwrites the first.

A reprint of an article written by Roy Busdiecker that reveals many of the program's "secrets" is included. Armed with some basic knowledge about the 6502 microprocessor and the supplied reprint, that program should give a good insight into some of the PET's inner mysteries. A few sessions with the program will provide an understanding of the way PET memory is organized, how real numbers, integers, and characters are stored, and how the various pointers keep track of the program and data boundaries.

Mem-Explorer is \$7.95 a copy from Micro Software Systems, P.O. Box 1442, Woodbridge, VA 22193. R-E

Radio Shack Quick Printer II



CIRCLE 104 ON FREE INFORMATION CARD

ANYONE WHO HAS USED A COMPUTER FOR EVEN a short period will appreciate the usefulness of a low-cost printer. It is a handy accessory for program documentation as well as recording printed output from the computer.

Printers come in a variety of sizes, formats, printing mechanism, and prices. At only \$219, the *Quick Printer II* from Radio-Shack (One Tandy Center, Fort Worth, TX 76102) is certainly one of the least expensive.

This printer is a lightweight, measuring a
continued on page 40

The MORE store...

...your
Sprague distributor.

Sprague distributors have *MORE* to offer . . . more component types, more styles, more ratings, more sizes, more quality, more value. With Sprague distributors, you save time by getting *what you want when you want it*, faster and easier.

For the name of your nearest Sprague distributor and a copy of Catalog C-622, write to:

Sprague Products Company
Distributors' Division of the Sprague Electric Co.
81 Marshall Street
North Adams, Mass. 01247.

Where MORE is more than a promise.



a subsidiary of GK Technologies

CIRCLE 4 ON FREE INFORMATION CARD

NOW AVAILABLE!

WATT WIZARD™

POWER FACTOR CONTROLLER CUTS THE COST OF RUNNING ELECTRIC APPLIANCES BY AS MUCH AS 50% -- AND YOU CAN EVEN SEE THE SAVINGS!

For over a year now, in magazines and newspapers the world over, there have been enthusiastic write-ups on a remarkable new device that can cut your electric bill while helping the U.S. save huge quantities of fuel.

"The NASA/Nola power saver," wrote a **Popular Science** senior editor, "was developed by Frank Nola at NASA's George C. Marshall Flight Center as an offshoot of a program to reduce power consumption in spacecraft motors. Nola calls it a PFC — power-factor controller. I prefer to call it a power saver, however, because that's what it does."

NASA TESTED IT

According to Clyde S. Jones of NASA, "The device has been tested at Marshall Center on over 40 types of motors, with power savings ranging up to 60%, depending on the loading. The motors tested were both single-phase and three-phase, ranging from 1/2 H.P. to 5 H.P. Most motors will show up to 40-to-50% savings when running lightly loaded or unloaded, and some will show 5-to-7% savings at rated load."

NASA's Technical Support Package showed the test results and noted that "The Power Factor Controller applies to induction type electric motors — the most commonly used type in all major home appliances and the most commonly used by industry."

HOW IT SAVES POWER

Popular Electronics explained it this way: "AC induction motors characteristically run at a nearly constant speed that's fixed by power-line frequency and independent of load and supply voltage. When heavily loaded, the motor draws line current that is nearly in phase with the applied voltage... Under light load conditions, the motor develops less torque by allowing more lag between the voltage and current. This reduces the power factor while leaving the current essentially the same in magnitude.

"Though the low power factor means that conversion of electricity to mechanical power is small, the large current causes considerable (heat) losses in the supply lines and motor windings. This is what reduces efficiency.

"To minimize this waste, Nola's device monitors the motor's power factor and, when it detects light load conditions, it reduces the supply voltage... The current, now more nearly in phase with the voltage, therefore does as much useful work as before, but it and the voltage are smaller, resulting in a net savings of electric power."

THE SAVINGS CAN ADD UP

Like everything else, the cost of electric power keeps going up. Not only is the basic rate you pay going up, the power companies have now added on a "fuel adjustment" charge to help pay for running their generators. In 1980, 1981 and beyond, you'll pay more and more for the privilege of running your electric appliances.

*National Aeronautics
and Space Administration
Patent No. 4,052,648*



Right now, the typical consumer pays about \$8 per month to operate a 16.5 cu. ft. frost-free freezer... \$10 to run a 17.5 cu. ft. frost-free refrigerator... \$8.25 for an attic fan operating 12 hours a day... and about \$60 for an air conditioner used during summer months. It's not hard to figure out what you're paying per year just to run **one** of these appliances. And in many parts of the country, the cost is even higher.

That's why Nola's power saver can soon pay for itself, then start reducing your electric bills — the amount of savings, of course, depending on which appliance(s) you use it with.

There's just one catch. Until now, the device has not been **available** — except for industrial models priced at \$80 or more.

INTRODUCING THE WATT WIZARD

Cynex, an American manufacturer of electrical and electronic products and a prime contractor for the U.S. Government, has been licensed by NASA to manufacture Frank Nola's power saver. Cynex calls it the Watt Wizard.

"The Watt Wizard," says Ray Beauchea, the firm's Marketing Director, "regulates the voltage fed into an induction motor, reducing or boosting power as required, when loads go up or down. Simply stated, it makes motors run more efficiently, especially when idling. It reduces motor heat, affording longer motor life and reducing the amount of air conditioning required for cooling (rooms) in summer months. It saves electric power, because kilowatt hours are greatly reduced. And it causes the motor to run quieter."

SIMPLE TO USE

Cynex makes several models of the Watt Wizard (all with solid state design), including the 110 VAC plug-in model we're offering. It's for single phase fractional H.P. motors (less than 1 H.P.) which is the type used in most made-for-the-home freezers, refrigerators, window and attic fans, swimming pool pumps, furnace fans, vacuum cleaners, sewing machines, power drills, etc.

Simply plug the Watt Wizard into any electric outlet, then plug the appliance into the Watt Wizard. There's no wiring required. Unlike some competitor's models (if and when available), the appliance does **not** have to be turned on before being plugged into the power saver. You can leave the appliance — whether on or off — plugged into the Watt Wizard all the time. Or you can move the Watt Wizard to various locations, depending on which appliance is being used. (Better yet, order several Watt Wizards.)

OTHER MODELS AVAILABLE

Air conditioners, washers and dryers require wire-in model. If you lack mechanical skill, you probably need an electrician to install it. We also offer it in 220 VAC single or three-phase.

ADVANCE FEATURES

The Watt Wizard also includes two more unique features. It's fused, so if you accidentally overload the device, it won't burn out. Just change the fuse, which is available at any auto supply store.

And the Watt Wizard features an LED readout, so you can actually tell, at any moment, exactly how much power you're saving — 10%, 20%, 30%, 40% or 50%.

There's a "Power On" light, too. And the Watt Wizard comes with the manufacturer's 1-year limited warranty.

LOW COST — AND A TAX CREDIT

We're offering the Watt Wizard for only **\$39.95**, with **immediate delivery**. Want two? Then it's just **\$37.95** each. Or splurge and get three at **\$34.95** each. Wire-in models for heavy duty motors are **\$6** more for each unit. Add just **\$2.50** postage/handling for each order (not each unit).

And next year, when you fill out your tax return, you can deduct a full 15% energy tax credit — for additional savings.

30-DAY MONEY-BACK GUARANTEE

Try the Watt Wizard for up to 30 days. If not completely satisfied, return it (insured) for a full refund.

The sooner you send for the Watt Wizard, the more you can save on your electric bills. To order, send your check or money order to the address below. Or charge it to your Visa, MasterCard, American Express or Carte Blanche credit card. If using your charge card, you can also order via our toll-free phone number:

800-257-7850

(In New Jersey, Call: 800-322-8650)
N.J. residents, add 5% sales tax.

Or mail your order to:

Dept. RE, Lakewood Plaza
Lakewood, N.J. 08701



The Imagination People®

CIRCLE 54 ON FREE INFORMATION CARD

EQUIPMENT REPORTS

continued from page 38

scant 3 1/2 x 7 x 9 inches (approximate). It uses 2 1/4-inch wide aluminum-coated paper. Characters are actually burned onto the paper by an electric spark, reminiscent of the early Western Union drum facsimile machines; but unlike those earlier machines, this one produces no permeating odor or smoke.

In operation, we noticed a moderate degree of electrical interference induced in nearby radio receiving equipment caused by the arcing of the print head on the paper. The characters are easy to read, and the character size may be increased by software instruction.

The *Quick Printer II* format provides 32 or 16 characters-per-line in a 5 x 7 dot matrix. Printing speed is rapid—64 characters per second, 120 lines per minute. Horizontal spacing is selectable—you may have either 18 or 9 characters per inch.

The life expectancy of the print head is adequate to anticipate some 30 million characters. Occasional cleaning of the print head is the only maintenance required; the mechanism itself requires no lubrication.

The character set provided is a modified subset of ASCII, with 96 characters in upper and lower case. Operating noise is quite tolerable. It must be remembered that a printer does not run constantly, so the occasional minor noise of the printer is hardly disruptive; as a matter of fact, it may be reassuring to the operator to hear the busy little machine humming away as it obediently produces its copy!

Loading the paper roll is a snap—easy as loading a printing calculator or adding machine. The roll of paper is long enough for many print operations before it is in need of

replacement. Two rolls of aluminized paper are provided with the *Quick Printer II*; replacement rolls are available from Radio Shack (\$3.95 per 2-roll set). As with adding machines, a serrated cutting edge is used to tear the printed strip from the machine.

Inputs to the printer are switch-selectable. The unit connects directly into the card-edge bus of a TRS-80 level II, or the expansion interface, or serial interface. Another switch may be used to isolate the printer from the line (marked ON-LINE/BUSY/RESET). When switched ON LINE, the printer is ready to receive a print command. The RESET position clears the printer in case of an accidental hang-up in the loop.

The manufacturer recommends that the printer always be turned on *before* the keyboard terminal, and off *after* it. That prevents any accidental erasure of the keyboard program or memory. A bright red LED signals the ON status of the printer.

A flat length of computer-type ribbon cable (supplied) is fitted with card-edge connectors to interconnect the printer and the keyboard terminal or interface. An automatic power-up message will be printed on the paper when the unit is switched on, informing the user that all systems are "go."

The *Quick Printer II* does not print isolated characters, only full line statements. (That's why it's called a line printer rather than a character printer.) For long lines of print, automatic wrap-around assures continuation on the next line; no characters will be lost.

In the double-size mode, large characters will be printed at 16 characters per line. That feature is especially useful for titling purposes and column headings for lists. It is also possible to down-shift to lower-case letters selec-

tively, using keyboard commands.

The *Quick Printer II* can produce all ASCII characters from hex 20 through hex 7F (decimal 32 through 127). That includes upper and lower case alphabet, all numerals, common punctuation marks, mathematical operands, and arrows, as well as a number of special graphics symbols.

The owner's manual supplied with the little printer is certainly adequate. A full schematic diagram is included, along with some basic maintenance suggestions. Operational hints are provided, as well as full instructions for the variety of applications available with the unit.

Naturally, aluminum-coated paper cannot be expected to provide the speed, contrast, or line size of an IBM printer. But then, it doesn't cost several thousand dollars, either! We were completely satisfied with the performance of this little line printer, and feel that it is realistically priced. We think you will agree. **R-E**



"Isn't it more fun waking up by my strobe light than that old alarm clock, Pa?"

BUILD A MASTERPIECE OF SOUND

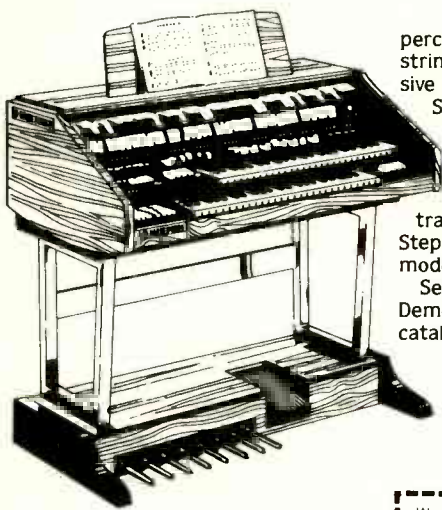

percussion and sustain. Wersi's famous string orchestra and bass guitar. Exclusive Sound Computer for 32-128 "One Stop Sounds" (total organ presets). Transposer. And lots more.

Build your own masterpiece of sound. No technical knowledge required. Just follow the clearly illustrated, easy to understand instructions. Step by step. Choose from at least 10 models. (Also factory assembled.)

Send \$6.00 with coupon for your Wersi Demo-Package (LP with 104-page color catalog).

WERSI

Wersi Electronics, Inc. Wersi Organs & Kits
Dept. 21 Dept. 21
1720 Hempstead Road 14104 E. Firestone Blvd.
Lancaster, PA 17601 Santa Fe Springs, CA 90670

Enclosed is \$6.00 for my Demo-Package (LP with 104-page color catalog.)

Name _____
Address _____
City _____ State _____ Zip _____

Wersi has combined select features of the electronic music field, added its own creations and years of research by top engineers and musicians, to produce an incomparable line of organs.

Space-age technology. True-to-life voicing with full drawbar system. Polyphonic

C.E.T.

FOR TECHNICIANS WHO TAKE PRIDE IN THEIR PROFESSION

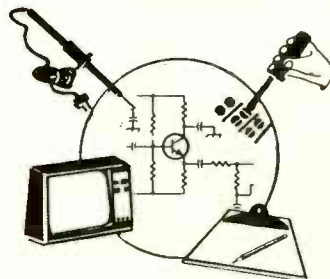

CERTIFIED ELECTRONICS TECHNICIAN
Certification is available in the following areas:
AUDIO MATV
COMMUNICATIONS MEDICAL
INDUSTRIAL RADIO-TV

Write to: THE INTERNATIONAL SOCIETY OF CERTIFIED ELECTRONICS TECHNICIANS
2708 West Berry, Fort Worth, TX 76109

Please send me:

- Free booklet: CAREERS IN THE ELECTRONICS INDUSTRY (a stamped self-addressed envelope is enclosed)
- Information about the CET Test.
- A list of test administrators in my state/country.
- I am already a CET. Send me information about ISCET membership. CET No. _____

NAME _____
ADDRESS _____
CITY _____ STATE _____
ZIP _____ PHONE () _____

Start Computing For Just \$129.95 With An 8085-Based Professional Computer Kit—

Explorer/85

100% compatible with all 8080A and 8085 software & development tools!

No matter what your future computing plans may be, Level "A"—at \$129.95—is your starting point.

Starting at just \$129.95 for a Level "A" operating system, you can now build the exact computer you want. Explorer/85 can be your beginner's system, OEM controller, or IBM-formatted 8" disk small business system... yet you're never forced to spend a penny for a component or feature you don't want and you can expand in small, affordable steps!

Now, for just \$129.95, you can own the first level of a fully expandable computer with professional capabilities—a computer which features the advanced Intel 8085 cpu, thereby giving you immediate access to all software and development tools that exist for both the 8085 and its 8080A predecessor (they are 100% software compatible)—a computer which features onboard S-100 bus expansion—plus instant conversion to mass storage disk memory with either 5-1/4" diskettes or standard IBM-formatted 8" disks.

For just \$129.95 (plus the cost of a power supply, keyboard/terminal and RF modulator, if you don't have them already), Explorer/85 lets you begin computing on a significant level... applying the principles discussed in leading computer magazines... developing "state of the art" computer solutions for both the industrial and leisure environment.

Level "A" Specifications

Explorer/85's Level "A" system features the advanced Intel 8085 cpu, an 8355 ROM with 2k deluxe monitor/operating system, and an 8155 ROM-I/O—all on a single motherboard with room for RAM/ROM/PROM/EPROM and S-100 expansion, plus generous prototyping space.

(Level "A" makes a perfect OEM controller for industrial applications and is available in a special Hex Version which can be programmed using the Netronics Hex Keypad/Display.)

PC Board: glass epoxy, plated through holes with solder mask
• I/O: provisions for 25-pin (DB25) connector for terminal serial I/O, which can also support a paper tape reader... provision for 24-pin DIP socket for hex keypad/display... cassette tape recorder input... cassette tape recorder output... speaker output... LED output indicator on SOD (serial output) line... printer interface (less drivers)... total of four 8-bit plus one 6-bit I/O ports • Crystal Frequency: 6.144 MHz • Control Switches: reset and user (RST 7.5) interrupt... additional provisions for RST 5.5, 6.5 and TRAP interrupts onboard • Counter/Timer: programmable, 14-bit binary • System RAM: 256 bytes located at F800, ideal for smaller systems and for use as an isolated stack area in expanded systems... RAM expandable to 64k via S-100 bus or 4K on motherboard.

System Monitor (Terminal Version): 2k bytes of deluxe system monitor ROM located at F000 leaving 0000 free for user RAM/ROM. Features include tape load with labeling... tape dump with labeling... examine/change contents of memory... insert data... warm start... examine and change all registers... single step with register display at each break point, a debugging/training feature... go to execution address... move blocks of memory from one location to another... fill blocks of memory with a constant... display blocks of memory... automatic baud rate selection... variable display line length control (1-255 characters/line)... channelized I/O monitor routine with 8-bit parallel output for high speed printer... serial console in and console out channel so that monitor can communicate with I/O ports.

System Monitor (Hex Version): Tape load with labeling... tape dump with labeling... examine/change contents of memory... insert data... warm start... examine and change all registers... single step with register display at each break point... go to execution address... move blocks of memory from one location to another... fill blocks of memory with a constant... display blocks of memory... automatic baud rate selection... variable display line length control (1-255 characters/line)... channelized I/O monitor routine with 8-bit parallel output for high speed printer... serial console in and console out channel so that monitor can communicate with I/O ports.

System Monitor (Hex Version): Tape load with labeling... tape dump with labeling... examine/change contents of memory... insert data... warm start... examine and change all registers... single step with register display at each break point... go to execution address... move blocks of memory from one location to another... fill blocks of memory with a constant... display blocks of memory... automatic baud rate selection... variable display line length control (1-255 characters/line)... channelized I/O monitor routine with 8-bit parallel output for high speed printer... serial console in and console out channel so that monitor can communicate with I/O ports.



registers... single step with register display at each break point... go to execution address. Level "A" in the Hex Version makes a perfect controller for industrial applications and can be programmed using the Netronics Hex Keypad/Display.



Hex Keypad/Display.

Level "B" Specifications

Level "B" provides the S-100 signals plus buffers/drivers to support up to six S-100 bus boards and includes: address decoding for onboard 4k RAM expansion select-able in 4k blocks... address decoding for onboard 8k EPROM expansion select-able in 8k blocks... address and data bus drivers for onboard expansion... wait state generator (jumper select-able), to allow the use of slower memories... two separate 5 volt regulators.



Explorer/85 with Level "C" card case.

Level "C" includes a sheet metal superstructure, a 5-card gold plated S-100 extension PC board which plugs into the motherboard. Just add required number of S-100 connectors

Level "D" Specifications

Level "D" provides 4k or RAM, power supply regulation, filtering decoupling components and sockets to expand your Explorer/85 memory to 4k (plus the original 256 bytes located in the 8155A). The static RAM can be located anywhere from 0000 to EFFF in 4k blocks.

Level "E" Specifications

Level "E" adds sockets for 8k of EPROM to use the popular Intel 2716 or the TI 2516. It includes all sockets, power supply regulator, heat sink, filtering and decoupling components. Sockets may also be used for soon to be available RAM IC's (allowing for up to 12k of onboard RAM).

Order A Coordinated Explorer/85 Applications Pak!

Experimenter's Pak (SAVE \$12.50)—Buy Level "A" and Hex Keypad/Display for \$199.90 and get FREE Intel 8085 user's manual plus FREE postage & handling!

Student Pak (SAVE \$24.45)—Buy Level "A", ASCII Keyboard/Computer Terminal, and Power Supply for \$319.85 and get FREE RF Modulator plus FREE Intel 8085 user's manual plus FREE postage & handling!

Engineering Pak (SAVE \$41.00)—Buy Levels "A", "B", "C", "D", and "E" with Power Supply, ASCII Keyboard/Computer Terminal, and six S-100 Bus Connectors for \$514.75 and get 10 FREE computer grade cassette tapes plus FREE 8085 user's manual plus FREE postage & handling!

Business Pak (SAVE \$89.95)—Buy Explorer/85 Levels "A", "B", and "C" (with cabinet), Power Supply, ASCII Keyboard/Computer Terminal (with cabinet), 16k RAM, 12" Video Monitor, North Star 5-1/4" Disk Drive (includes North Star BASIC with power supply and cabinet, all for just \$1599.40 and get 10 FREE 5-1/4" mindiskettes (\$49.95 value) plus FREE 8085 user's manual plus FREE postage & handling!

Continental U.S.A. Credit Card Buyers Outside Connecticut

CALL TOLL FREE 800-243-7428

To Order From Connecticut Or For Technical Assistance, Etc. Call (203) 354-9375

By Netronics

ASCII/BAUDOT, STAND ALONE

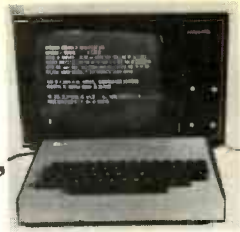

Computer Terminal COMPLETE FOR ONLY \$149.95

The Netronics ASCII/BAUDOT Computer Terminal Kit is a microprocessor-controlled, stand alone keyboard/terminal requiring no computer memory or software. It allows the use of either a 64 or 32 character by 16 line professional display format with selectable baud rate, RS232-C or 20 ma. output, full cursor control and 75 ohm composite video output.

The keyboard follows the standard typewriter configuration and generates the entire 128 character ASCII upper/lower case set with 96 printable characters. Features include onboard regulators, selectable parity, shift lock key, alpha lock jumper, a drive capability of one TTY load, and the ability to mate directly with almost any computer, including the new Explorer/85 and ELF products by Netronics.

The Computer Terminal requires no I/O mapping and includes 1k of memory, character generator, 2 key rollover, processor controlled cursor control, parallel ASCII/BAUDOT to serial conversion and serial to video processing—fully crystal controlled for superb accuracy. PC boards are the highest quality glass epoxy for the ultimate in reliability and long life.

VIDEO DISPLAY SPECIFICATIONS

The heart of the Netronics Computer Terminal is the microprocessor-controlled Netronics Video Display Board (VID) which allows the terminal to utilize either a parallel ASCII or BAUDOT signal source. The VID converts the parallel data to serial data which is then formatted to either RS232-C or 20 ma. current loop output, which can be connected to the serial I/O on your computer or other interface, i.e., Modem.

When connected to a computer, the computer must echo the character received. This data is received by the VID which processes the information, converting to data to video suitable to be displayed on a TV set (using an RF modulator) or on a video monitor. The VID generates the cursor, horizontal and vertical sync pulses and performs the housekeeping relative to which character and where it is to be displayed on the screen.

Video Output: 1.5 P/P into 75 ohm (EIA RS-170) • **Baud Rate:** 110 and 300 ASCII • **Outputs:** RS232-C or 20 ma. current loop • **ASCII Character Set:** 128 printable characters—

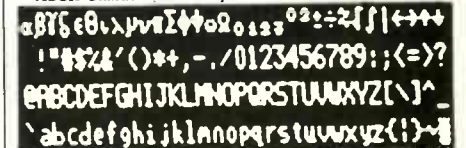

BAUDOT Character Set: ABCDEFGHIJKLMNOPQRSTUVWXYZ - ? * 3 \$ % () . , 9 0 1 4 1 5 7 ; 2 / 6 8 • **Cursor Modes:** Home, Backspace, Horizontal Tab, Line Feed, Vertical Tab, Carriage Return. Two special cursor sequences are provided for absolute and relative X-Y cursor addressing • **Cursor Control:** Erase, End of Line, Erase of Screen, Form Feed, Delete • **Monitor Operation:** 50 or 60Hz (jumper selectable).

Continental U.S.A. Credit Card Buyers Outside Connecticut

CALL TOLL FREE 800-243-7428

To Order From Connecticut Or For Technical Assistance, Etc. Call (203) 354-9375

Netronics R&D Ltd., Dept. RE-7
333 Litchfield Road, New Milford, CT 06776

Please send the items checked below—

- Netronics Stand Alone ASCII Keyboard/Computer Terminal Kit, \$149.95 plus \$3.00 postage & handling.
- Deluxe Steel Cabinet for Netronics Keyboard/Terminal In Blue/Black Finish, \$19.95 plus \$2.50 postage and handling.
- Video Display Board Kit alone (less keyboard), \$89.95 plus \$3 postage & handling.
- 12" Video Monitor (10 MHz bandwidth) fully assembled and tested, \$139.95 plus \$5 postage and handling.
- RF Modulator Kit (to use your TV set for a monitor), \$8.95 postpaid.
- 5 amp Power Supply Kit In Deluxe Steel Cabinet (±8VDC @ 5 amps, plus 6-8 VAC), \$39.95 plus \$2 postage & handling.

Total Enclosed (Conn. res. add sales tax) \$ _____

By _____
 Personal Check Cashiers Check/Money Order
 Visa Master Charge (Bank # _____)

Acct. # _____ Exp. Date _____

Signature _____
Print Name _____

Address _____
City _____

State _____ Zip _____

Send Me More Information

Netronics R&D Ltd., Dept. RE-7

333 Litchfield Road, New Milford, CT 06776

Please send the items checked below—

- Explorer/85 Level "A" Kit (ASCII Version), \$129.95 plus \$3 p&h.
- Explorer/85 Level "A" Kit (Hex Version), \$129.95 plus \$3 p&h.
- 8k Microsoft BASIC on cassette tape, \$64.95 postpaid.
- 8k Microsoft BASIC in ROM Kit (requires Levels "B", "D", and "E"), \$99.95 plus \$2 p&h.
- Level "B" (S-100) Kit, \$49.95 plus \$2 p&h.
- Level "C" (S-100 6-card expander) Kit, \$39.95 plus \$2 p&h.
- Level "D" (4k RAM) Kit, \$69.95 plus \$2 p&h.
- Level "E" (EPROM/ROM) Kit, \$5.95 plus 50¢ p&h.
- Deluxe Steel Cabinet for Explorer/85, \$49.95 plus \$3 p&h.
- ASCII Keyboard/Computer Terminal Kit (features a full 128 character set, upper & lower case, full cursor control, 75 ohm video output convertible to baudot output, selectable baud rate, RS232-C or 20 ma. I/O, 32 or 64 character by 16 line formats, and can be used with either a CRT monitor or a TV set (if you have an RF modulator), \$149.95 plus \$2.50 p&h.
- Hex Keypad/Display Kit, \$69.95 plus \$2 p&h.
- Deluxe Steel Cabinet for ASCII Keyboard/Terminal, \$19.95 plus \$2.50 p&h.
- Power Supply Kit (±8V @ 5 amps) in deluxe steel cabinet, \$39.95 plus \$2 p&h.
- Gold Plated S-100 Bus Connectors, \$4.85 each, postpaid.
- RF Modulator Kit (allows you to use your TV set as a monitor), \$8.95 postpaid.
- 16k RAM Kit (S-100 Board expands to 64k), \$199.95 plus \$2 p&h.
- 32k RAM Kit, \$329.95 plus \$2 p&h.
- 48k RAM Kit, \$459.95 plus \$2 p&h.
- 64k RAM Kit, \$589.95 plus \$2 p&h.
- 16k RAM Expansion Kit (to expand any of the above up to 64k), \$139.95 plus \$2 p&h each.
- Intel 8085 cpu User's Manual, \$7.50 postpaid.
- Special Computer Grade Cassette Tapes, \$1.90 each or 3 for \$5, postpaid.
- 12" Video Monitor (10 MHz bandwidth), \$139.95 plus \$5 p&h.
- North Star Double Floppy Disk Kit (One Drive) for Explorer/85 (includes 3 drive S-100 controller, DOS, and extended BASIC with per-

sonalized disk operating system—just plug it in and you're up and running!), \$699.95 plus \$5 p&h.

Power Supply Kit for North Star Disk Drive, \$39.95 plus \$2 p&h.

Deluxe Case for North Star Disk Drive, \$39.95 plus \$2 p&h.

Experimenter's Pak (see above), \$199.90 postpaid.

Student Pak (see above), \$319.85 postpaid.

Engineering Pak (see above), \$514.75 postpaid.

Business Pak (see above), \$1599.40 postpaid.

Total Enclosed \$ _____ (Conn. res. add sales tax) By—

Personal Check M.O./Cashier's Check Visa Master Charge (Bank # _____)

Acct. # _____ Exp. Date _____

Signature _____
Print Name _____

Address _____
City _____

State _____ Zip _____

Send Me More Information

CIRCLE 52 ON FREE INFORMATION CARD



ELECTRONICS

A DIVISION
OF ALLIANCE
RESEARCH CORPORATION

7241 CANBY AVE. • RESEDA, CALIFORNIA 91335

The Professional's Choice

Test equipment, prime grade original replacements, chemical tape heads . . . and MORE!



We feature only quality test equipment: Leader Instruments, Hitachi, Beckman, Hickok, and others.



Leader LB0515B



Hitachi V-302



Beckman 330



Hickok LX 304

SPECIAL OFFER

A top quality 30 mhz, dual trace, triggered oscilloscope with 1 mV sensitivity and delay line **FOR UNDER \$800.00!** (including 2 probes).

Limited to professional technicians, engineers, and members of the trade. Call in for details and complete specifications.

SHIPPED THE SAME DAY • SHIPPED THE SAME DAY

SENDUST ALLOY HEADS

Metal tape compatible!

Standard configuration stereo:

\$13.50

Longer life.

Best frequency response.



AS-2



AS-3

SENDUST ALLOY AUTO REVERSE HEADS

\$20.00 ea.

TAPE HEADS

PERMALLOY HEADS

Cassette stereo

\$4.50



WY032



WY435



WY488



WY902



WY822RP

PERMALLOY AUTO REVERSE HEADS

\$7.00

E721

HIGH QUALITY TEST CASSETTES



- PTC 1 Level Test (-10 dB)
- PTC 2 S/N Ratio (0 dB)
- PTC 3 Speed Test (3000 Hz)
- PTC 4 Head Alignment
- PTC 5 Frequency Response
- CT 120 Torque Meter

ORIGINAL JAPANESE REPLACEMENT PARTS IN STOCK!

I.C.s — Prime Grade

These prices are for 1-11 qty!
Call for better price quotes.

| | | |
|----------|--------------------|----------------|
| AN 306 | UCR Chroma | 12.00 |
| AN 318 | UCR Servo | 9.00 |
| AN 7130 | Power Amp. | 3.00 |
| AN 7150 | Power Amp. | 3.25 |
| AN 7156N | BTL Amp. | 4.00 |
| BA 1320 | PLL Demod. | 3.50 |
| DA 101 | Delco DM98 | 7.00 |
| HA1366W | Power Amp | 2.80 |
| HA1368 | Power Amp | 2.80 |
| HA1377A | 20 Watts Amp | 4.90 |
| HA1457 | L.M. Preamp | 1.80 |
| LA1368 | Chroma Processor | 3.50 |
| LA1460 | Deflection CKT | 4.50 |
| LA3155 | Equalizer | 1.80 |
| LA3160 | Preamp | 1.60 |
| LA3201 | Mini Preamp | CALL FOR PRICE |
| LA4032P | 3W Amp | 2.25 |
| LA4051P | 2.5W Amp | 2.50 |
| LA4420 | 5.5W Amp | 2.50 |
| LA4430 | 4.5W Amp | 2.85 |
| LA5110 | Regulator | 2.00 |
| LB1331 | VIR Sig. Processor | 6.50 |
| M53273 | VCD for CB | 1.00 |
| MB3705 | 4.5W Amp | 3.00 |
| MB3712 | 5.0W Amp | 3.85 |
| MB3756 | SIL Regulator | 3.50 |
| MB8719 | Programmable PLL | 7.50 |
| S-40W | 40W Amp | 13.90 |
| S-60W | 60W Amp | 17.90 |
| S-100WA | 100W Amp | 27.90 |
| S-200W | 200W Amp | 45.25 |
| SM5104 | PLL Circuit | 9.00 |
| STK0029 | Darlington HYB | 6.00 |
| STK0039 | Darlington HYB | 7.10 |
| STK0050 | Darlington HYB | 8.90 |
| STK011 | Hybrid 6.5W Amp | 4.50 |
| STK013 | Hybrid 15W Amp | 13.50 |

I.C.s — Prime Grade

Continued

| | | |
|----------|------------------|----------------|
| STK040 | Dual 10W Amp | 12.00 |
| STK415 | 2 Ch. Hybrid Amp | 9.00 |
| TA7109AP | Amplifier | 5.00 |
| TA7205AP | BTL Amp | 2.50 |
| TA7217AP | 5.8W 4 ohms amp | 4.25 |
| TA7222P | 5.8 Amp | 3.80 |
| TA7227P | BTL Amp | 7.00 |
| TA7312P | L.A. Preamp | CALL FOR PRICE |
| TC9106P | C.B. PLL | 7.00 |
| UPC671C | Amp | 5.00 |
| UPC1181H | BTL Amp | 3.50 |
| UPD857C | Ham PLL | 7.80 |
| UPD858C | C.B. PLL | 6.50 |
| UPD2815 | Freq. Synth. | 12.50 |
| UPD2816 | Freq. Synth. | 12.50 |

TRANSISTORS — Prime Grade

These prices are for 1-11 qty!

| | |
|----------|-------|
| 2SA509 | .50 |
| 2SA606 | 1.45 |
| 2SA684 | .60 |
| 2SA699A | .80 |
| 2SA912 | .80 |
| 2SA912 | .80 |
| 2SA917 | 1.80 |
| 2SA981 | 8.00 |
| 2SB471 | 2.00 |
| 2SB507 | 1.50 |
| 2SB555 | 4.60 |
| 2SB618 | 3.00 |
| 2SB681 | 5.75 |
| 2SB688 | 3.30 |
| 2SB700 | 4.00 |
| 2SB754 | 3.75 |
| 2SC281 | .60 |
| 2SC937 | 8.50 |
| 2SC1111 | 5.20 |
| 2SC1209 | 1.50 |
| 2SC1964 | 3.00 |
| 2SC1942 | 4.50 |
| 2SC2001 | .50 |
| 2SC2086 | .60 |
| 2SC3101A | 11.95 |
| 2SC2103A | 15.00 |
| 2SC2166 | 2.00 |
| 2SD91 | 1.90 |
| 2SD425 | 3.50 |
| 2SD588 | 3.00 |
| 2SD712 | 1.20 |
| 2SD725 | 6.50 |
| 2SD870 | 7.50 |
| 2SD870 | 7.50 |
| 2SD903 | 6.50 |
| MRF454 | 22.00 |
| MRF455 | 15.95 |
| MRF901 | 3.20 |

PLUS MANY MORE!

Plus more I.C.s at same low price. Ask for our quantity discount!

"Our Service Makes The Difference"

AIR CORE INDUCTOR

(for crossover network)

20 AWG Wire!

| | |
|--------|------|
| 28 mH | 1.60 |
| 5 mH | 1.86 |
| 1.0 mH | 2.75 |
| 1.8 mH | 3.36 |
| 2.5 mH | 4.35 |

CRYSTALS

1-11 **\$3.50 ea.**
12-up **\$3.00 ea.**
20 pF Load Impedance!

| | |
|-------------|-------------|
| 7.0025 MHZ | 11.3258 MHZ |
| 7.7975 MHZ | 11.2850 MHZ |
| 10.240 MHZ | 11.2842 MHZ |
| 10.695 MHZ | 11.240 MHZ |
| 11.125 MHZ | 11.730 MHZ |
| 11.2858 MHZ | 36.570 MHZ |

Build your own speaker system!

CROSS OVER NETWORKS



ONLY \$9.00 ea.

4 ohms or 8 ohms — Made with AIR CORE COILS or FERRITE CORE. Many to choose from. Example: NT406H crossover network: 100 watts input! 3 day, all air core construction for lowest distortion.

NON POLARIZED ELECTROLYTIC CAPACITORS

For crossover use (axial lead)



| uF/V | 1-11 | uF/V | 1-11 |
|---------|------|---------|------|
| 1/100 | .50 | 14/100 | .60 |
| 2.2/100 | .50 | 16/100 | .65 |
| 3.3/100 | .55 | 22/100 | .70 |
| 4.7/100 | .55 | 33/100 | .95 |
| 6.8/100 | .55 | 47/100 | 1.20 |
| 8.0/100 | .60 | 100/100 | 1.65 |
| 10/100 | .60 | 150/100 | 2.55 |
| 12/100 | .60 | 200/100 | 3.00 |

We sell exclusively to professionals and members of the trade. Minimum order **\$25.00.** We pay shipping and insurance on pre-paid orders in the continental U.S.A. C.O.D. orders, VISA/MasterCard welcome!

TO ORDER, CALL TOLL-FREE:
(800) 423-5336 • In Calif. (800) 382-3663
Local (213) 705-0022 • Telex 181011

BUILD THIS

ENERGY SAVING

HOME THERMOSTAT

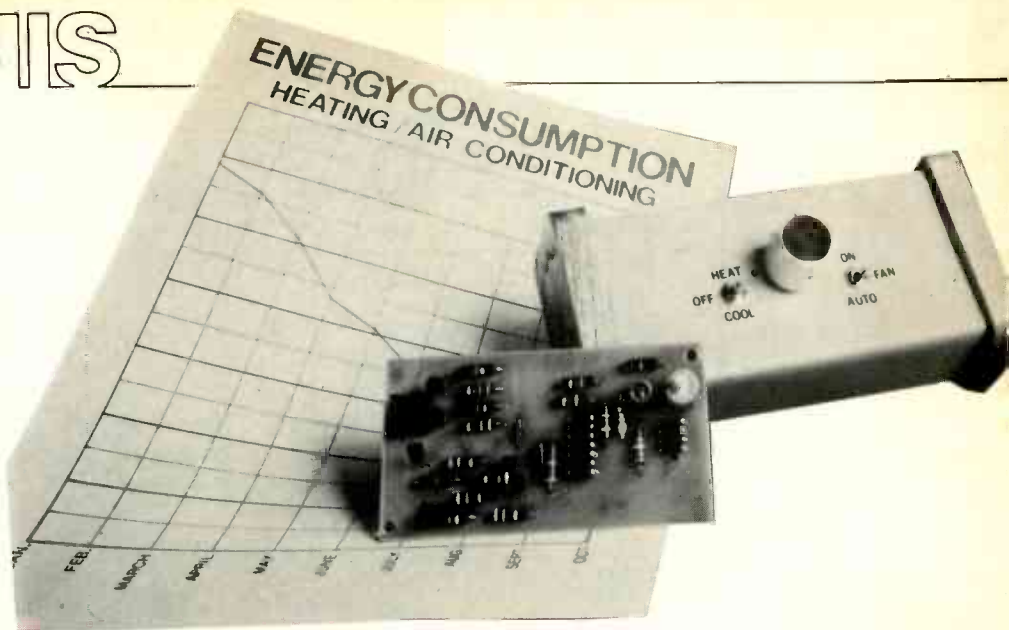

TOM STULTS

THE RISING COST OF ENERGY USED TO SUPPORT home-heating and air-conditioning systems can be offset by using nature's own temperature cycles to supplement costly equipment operation. The house can be maintained at a chosen temperature setting without involving sacrifices in comfort.

The outside temperature rises and falls from daytime to night because of solar heat. As long as the coolest nighttime temperature remains above the "comfort" setting of your thermostat you must, of necessity, supply continuous air conditioning to your house. Generally, that only happens for six to eight weeks in the summer, depending on where you live. On the majority of cooler days, the outside temperature will be lower than the inside "comfort" setting from sometime in the evening to well into the next morning.

But, even though it's getting cooler outside, the inside of the house can still be warming up! That is because the warmth of the sun on an outside wall takes time to soak through the wall to the inside and while insulation can slow down the process, it can never stop it. How many times have you stepped outside on a cool fall evening and heard your air conditioner still running? It's obvious that, at times like this, we are unnecessarily cooling the house artificially (at great cost) when we could easily be using a limitless free source of energy, Mother Nature herself.

The expenses involved in heating and cooling a home have never been higher! This Environmental Control Center could save you up to 20% in energy costs.

In cooler weather, the same principles apply in reverse. In the late fall and early spring the morning temperature will often rise above the thermostat setting and fresh air can be used to warm the house.

That is the function of the Environmental Control Center—to furnish free cooling or heating whenever possible by using outside air.

Like large commercial systems that have been using fresh air to help in heating and cooling for years, the Control Center can save an estimated 20% in

operating costs and energy every year.

Environmental Control Center

The Control Center (Fig. 1) uses readily available IC's to do the switching and decoding needed to make the outside air available when required. Inside and outside temperatures are monitored by a pair of thermistors and a difference amplifier and converted into a digital signal for decoding. The decoded signal controls the operation of the mechanical components of the heating/cooling system.

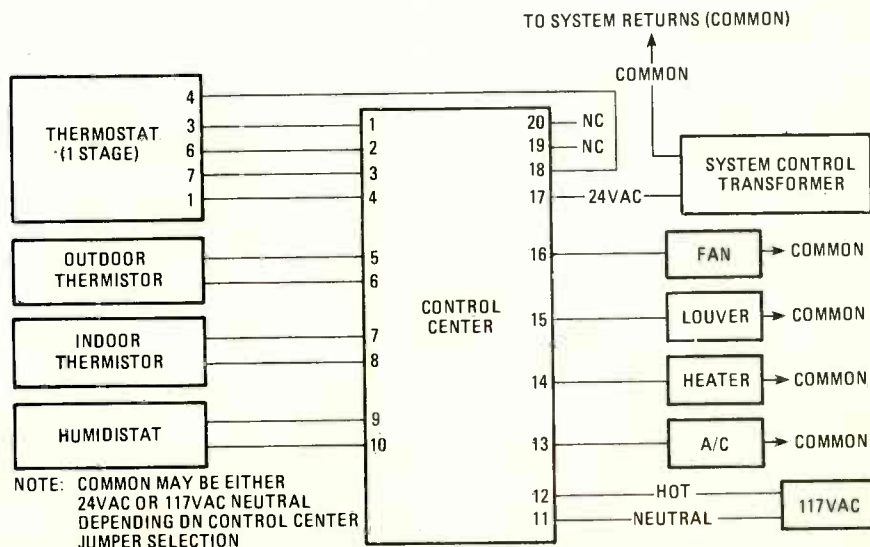

Fig. 1—BLOCK DIAGRAM of the Environmental Control Center showing the input sensors at left and the devices controlled at right. Note that the system may use either 24 or 117 VAC.

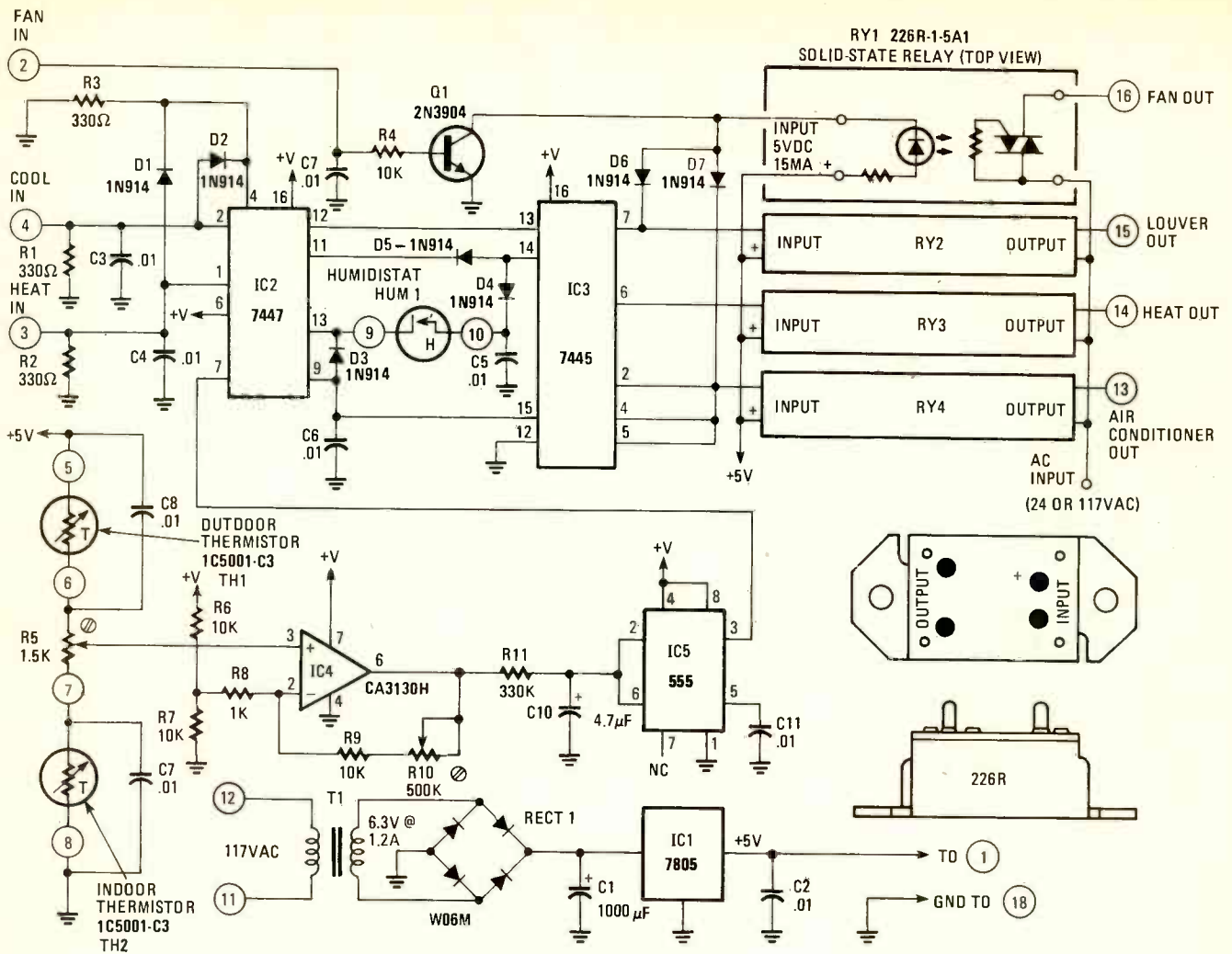
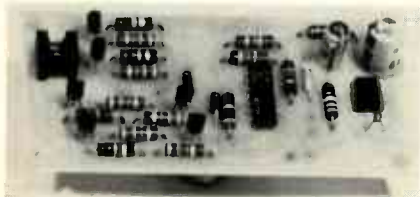

Fig. 2—SCHEMATIC DIAGRAM of Environmental Control Center. Circled numbers refer to Fig. 1. Solid-state relay is shown at lower right. Humidistat, HUM1, is located off PC board.



COMPLETED THERMOSTAT PC board. Socket at upper left is for plug to controller.

The schematic diagram of the control center is shown in Fig. 2. Thermistors TH1, TH2 and potentiometer R5 form a voltage divider that supplies a differential signal to the non-inverting input of the high-impedance amplifier, IC4. To calibrate the input, place voltmeter probes on pins 2 and 6 of IC4 and, with the voltmeter on its most sensitive scale, adjust resistor R5 until the voltmeter reads as near to zero volts as possible. In order to make that adjustment, submerge both sensors in a glass of water and wait until the reading on the voltmeter is stable. This will indicate that both sensors are at the same temperature and that R5 can be set accurately.

In practice, the resistance of the thermistor sensors will not change equally, producing a difference signal at the input

of IC4. That signal will be amplified and applied to the input of IC5, a timer connected as a Schmitt trigger with hysteresis. Applied to pin 6 of IC5, $2/3 V_{cc}$ or more will cause pin 3, the output of the timer, to go low. A potential of $1/3 V_{cc}$ or less at pin 2 will cause the output to go high. With the two inputs tied together, the timer has a dead band between $1/3$ and $2/3 V_{cc}$ where the timer will not switch. By adjusting the gain of the difference amplifier IC4, the temperature difference required to switch the output of the sensor circuit can be changed. To make that adjustment, set R10 to center-travel and momentarily short sensor TH1 at Control Center terminals 5 and 6, forcing IC5 to go low. Using an accurate thermometer, set up two glasses of water and cool one of them by 2°F with ice cubes. Remove the cubes when this difference has been reached. Submerge TH1 in the cooler glass and TH2 in the warmer. Allow time for the temperature to stabilize. Adjust IC4 output (pin 6 to ground) to $1/3 V_{cc}$, the switching point of IC5. (It is not practical to measure that signal at the input of IC5 because of the time delay generated in R11 and C10.) This adjustment will set the temperature

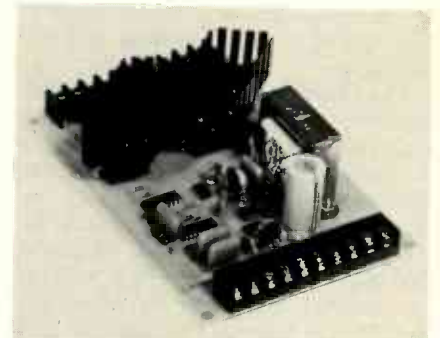

CONTROL CENTER board. The solid-state relays must be adequately heat-sinked!

switching difference at two degrees and, in addition, the dead band will prevent fast cycling when the temperature outside hovers around the switching point and a vagrant breeze or gust might cause the Control Center to switch back and forth unnecessarily.

Input decoding is accomplished by IC2 and IC3. With no input from the thermostat, pin 4 of IC2 will be low and will shut the system down. Either input (pin 1 or pin 2) will cause pin 4 to go high and turn on the system. Given 5 volts on pin 1, a heating command, the output will be low at pin 11. However, if TH1 is warmer, pin 7 will be driven low by the temper-

PARTS LIST Control Center

All resistors 1/2 watt, 10% unless otherwise noted

- R1-R3—330 ohms
 R4, R6, R7, R9—10,000 ohms
 R5—1500 ohms, trimmer resistor, vertical PC mount (Mallory MTC152L1 or equal)
 R8—1000 ohms
 R10—500,000 ohms, trimmer resistor, vertical PC mount (Mallory MTC55L1 or equal)
 R11—330,000 ohms
 C1—1000 μ F, 25 volts, electrolytic
 C2-C9, C11—.01 μ F ceramic
 C10—4.7 μ F, 16 volts, electrolytic
 D1-D7—1N914
 Q1—2N3904
 RECT1—full-wave bridge rectifier, 600 PIV, 1.5 A, (General Instrument WO6M or equal)
 IC1—7805
 IC2—7447
 IC3—7445
 IC4—CA3130
 IC5—555
 TH1, TH2—thermistor, 5000 ohms @ 25°C, -4.4%, \pm 0.2°C, 0-70°C (Western IC5001-C3, Fenwal UUA35J1, Yellow Springs Instruments 44007 or equal)
 RY1-RY4—solid-state relay, (Sigma 226R-1-5A1)
 HUM1—humidistat, makes on increase in humidity (Honeywell H46E1013 or equal)
 T1—power transformer, secondary 6.3 volts @ 1.2 amps (Radio Shack 273-050)
 Heat sinks for RY1-RY4—Wakefield 291-80ABC2 or similar for TO-3 devices.
 Barrier strips—10 terminals on .375-inch centers for PC mount.

The following parts are available from LSE, Box 392, Yukon, OK 73099: PC board \$11.95, Sigma 226R-1-5A1 solid-state relay \$12.89 each, thermistors \$5.06 each, humidistat \$41.16 each. Oklahoma residents please include local sales taxes.

PARTS LIST Two-Stage Thermostat

All resistors 1/2 watt, 10% unless otherwise noted

- R1, R3—470 ohms
 R2—330K ohms
 R4, R5, R6—270 ohms
 R7—5000 ohm pot, linear taper
 R9, R11, R13, R15, R16, R18—470 ohms
 R10, R12, R14, R17—12,000 ohms
 C1—68 μ F, electrolytic
 C2—4.7 μ F, electrolytic
 Q1, Q2, Q4, Q6—2N3905
 Q3, Q5—2N3904
 IC1—SN741N
 IC2—LM339N
 TH1—thermistor, 5000 ohms @ 25°C, -4.4%, \pm 0.2°C, 0-70°C (Western IC5001-C3, Fenwal UUA35J1, Yellow Springs Instruments 44007 or equal)
 S1—switch DPDT
 S2—switch SPST
 output connection—1/2 16 pin DIP socket
 D1, D2—1N4001

The following parts are available from LSE, Box 392, Yukon, OK 73099: PC board \$7.25, Sensor \$5.06. Oklahoma residents please include local sales tax.

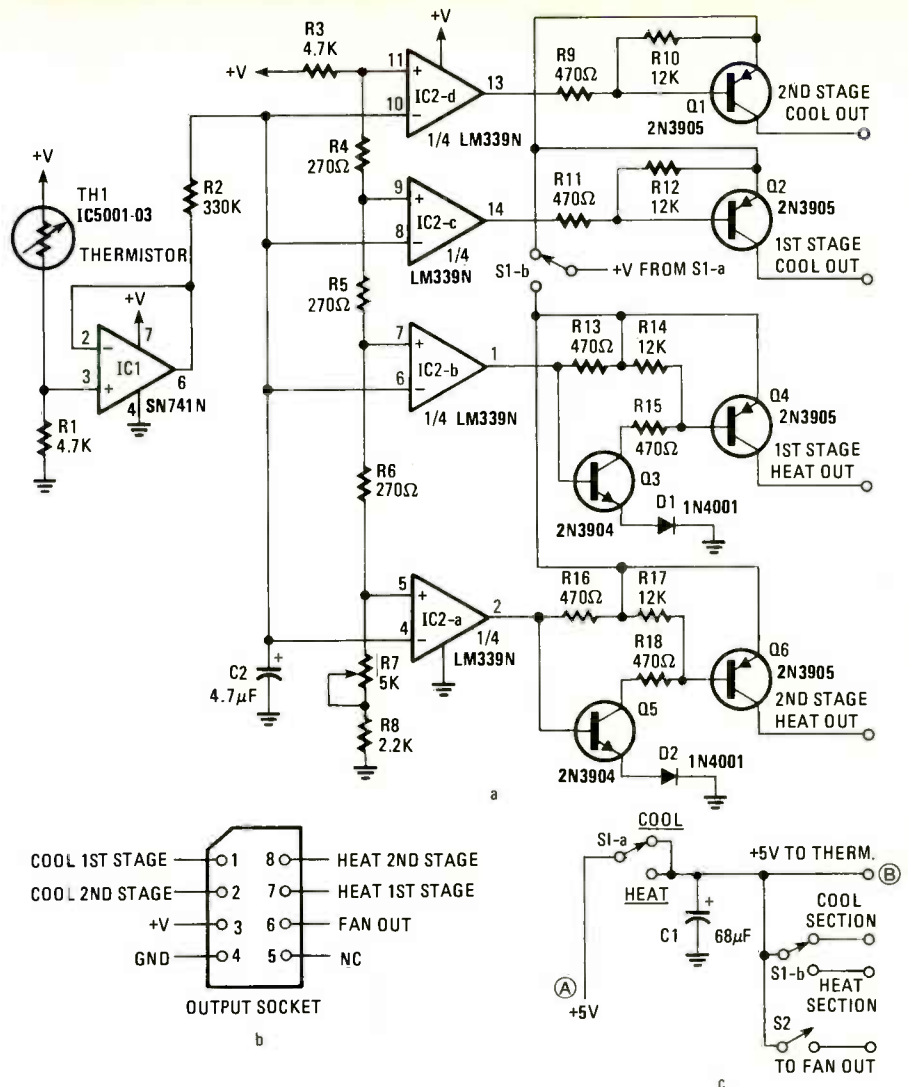

Fig. 3—TWO-STAGE thermostat. See text and Figs. 1 & 4 for description and hookup information. Output socket and switches are shown in b and c. Switch S1-b is shown twice.

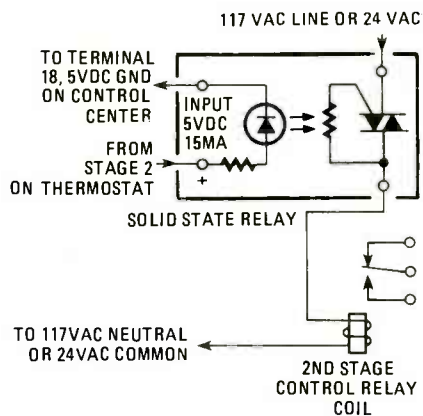

Fig. 4—ADDITIONAL RELAY hookup for 2-stage system. Refer to text for details.

ature comparison circuit and the output will be routed to pin 9 instead, calling for fresh air. With 5 volts on pin 2, an air-conditioning command, pin 12 will go low unless TH2 is warmer, in which case the output will be low at pin 13, calling for fresh air.

The outputs of IC2 drive IC3, which can generate a high humidity over-ride in the fresh-air cooling cycle. The humidistat contacts close when the humidity rises above a certain level and should be

placed in the central system ductwork to monitor the humidity of the conditioned area. On a humid or rainy day, large amounts of moisture can be drawn into the house making it necessary for the next air-conditioning cycle to remove it and impairing efficiency. IC3 and the diodes D3, D4 and D5 make up a circuit that will cause the Control Center to switch from fresh-air cooling back to air conditioning when the humidity reaches a predetermined level. A relative humidity of 50% is comfortable. The humidistat has no effect in the heating cycle.

IC3 drives solid-state relays which turn on the central-system equipment. Diodes D6 and D7 turn on the fan used with the fresh air system or the air conditioner, a function that would be handled by the thermostat in a conventional system. The output relays, when properly heat sinked, will handle up to 7.5 amps, sufficient to handle a fan motor or a louver actuator. The output voltage of the relays can be either line voltage (117 VAC) or a control voltage (24 VAC) depending on the position of jumpers provided for on the Control Center PCB. Before soldering in those jumpers be sure to check the operating voltage of your equipment.

SOLID-STATE RELAYS

THE SIGMA 226R-1-5A1 SOLID-STATE relay specified is designed to use 5 volts DC to control a load with a nominal level of 120 volts RMS and a minimum of 80 volts RMS. For this reason, it would seem that this relay is not suitable for handling 24-volt AC control relays in heating or cooling systems. However, we have tested several of these relays and have found this type entirely satisfactory. With a 24-volt AC control relay as a load, we found that the *DC input turn-on voltage* is the critical factor.

With 5 volts DC control the control pins, the solid-state relay dropped 1.1 volts in the load circuit—insignificant as far as a 24-volt AC control relay is concerned. With 4 volts DC control, the load voltage dropped 1.2 volts. When the control voltage was reduced to 2 volts DC, the relay dropped 5.7 volts in the load circuit and the load relay chattered. These readings were averaged from measurements made on several relays with digital VOM.

Two-stage controls are used in most commercial heating and cooling systems and can also be found in some residential installations. In some homes you may find single-stage cooling and two-stage heating, or vice versa. You can tell a lot about the operation of your heating and cooling system by examining the thermostat. The operation and connections to the original-equipment thermostat can be identified as follows:

| Terminal | Function |
|----------|--------------------------------|
| R | 24VAC from control transformer |
| Y | output to cooling equipment |
| W | output to heater or furnace |
| G | output to fan relay |
| Y2 | 2nd stage cooling output |
| W2 | 2nd stage heat output |

The universally followed wiring color code for a single-stage heating-cooling system is R—red, Y—yellow, W—white and G—green. There is no universal color code applied to either 2nd-stage heat or 2nd-stage cool. Examine the terminals on the original-equipment thermostat to see whether or not you require two stages when setting up the Control Center.

The thermostat

A two-stage thermostat (see discussion and explanatory information elsewhere in

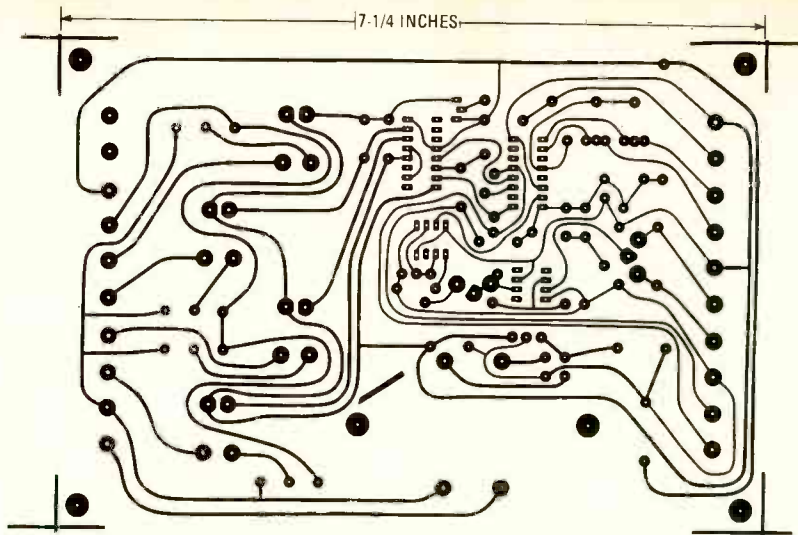

Fig. 5—FOIL PATTERN for the Control Center. Drill corner pads for mounting holes.

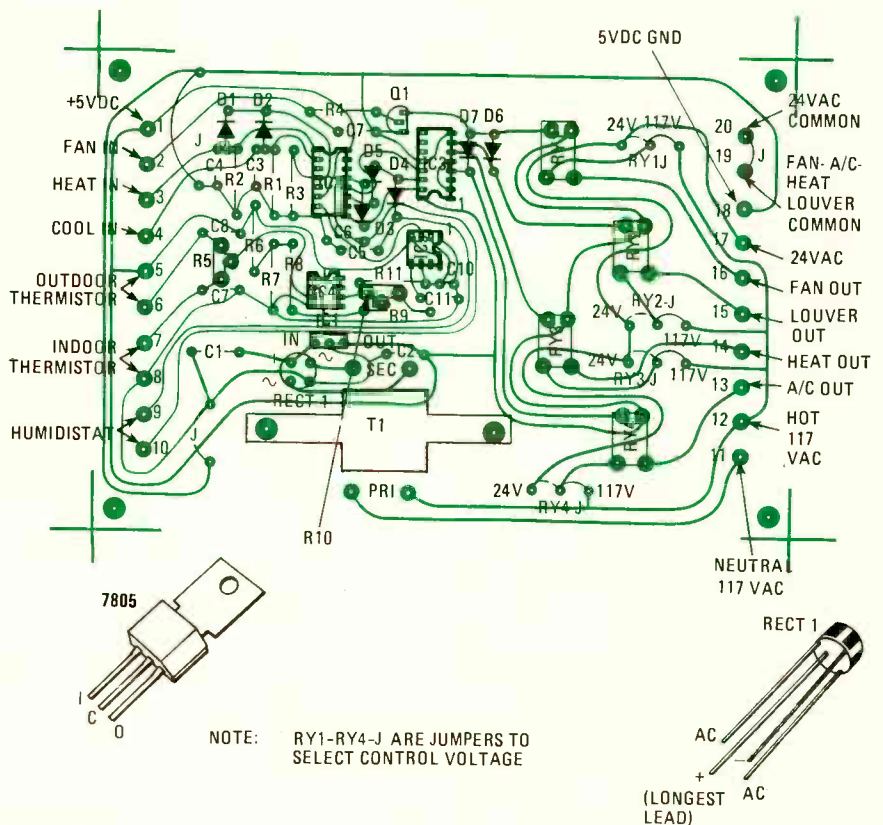

Fig. 6—PARTS LAYOUT for the Control Center. Outboard humidistat is connected to pads 9 and 10.

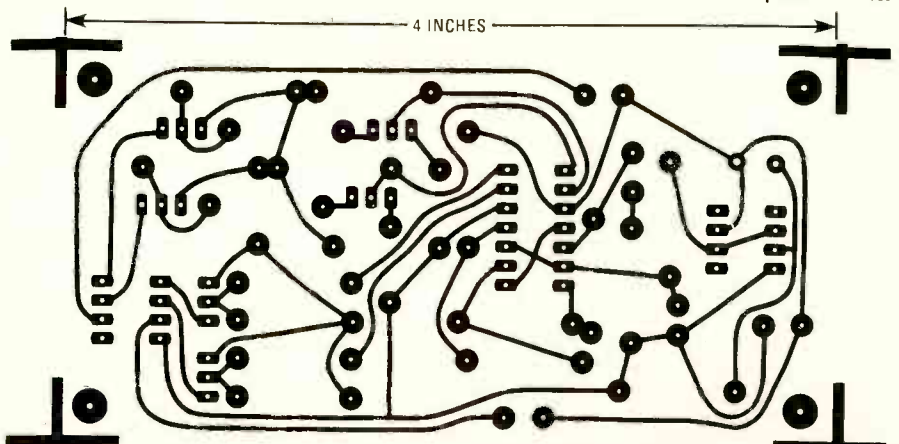

Fig. 7—TWO-STAGE thermostat board foil pattern. Actual board is four inches wide.

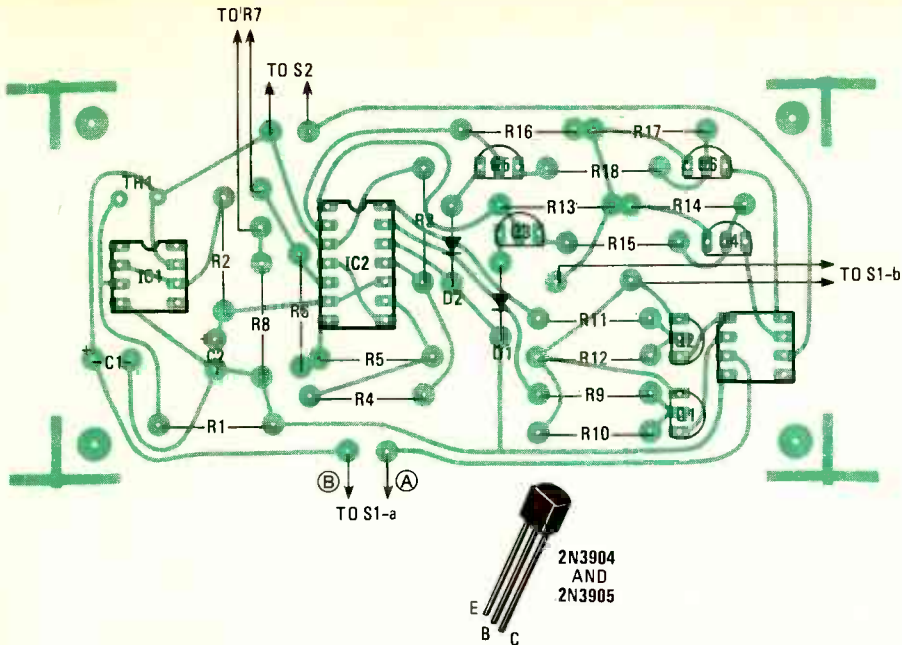

Fig. 8—PARTS PLACEMENT DIAGRAM for the thermostat. Unmarked 8-pin (or 1/2 16-pin) socket at lower right is for DIP plug connecting thermostat with the Control Center.

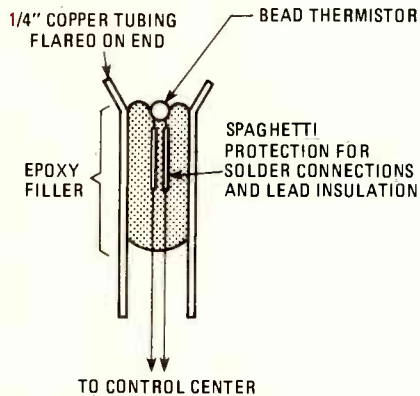

Fig. 9—CUTAWAY DRAWING of thermistor probe. See text for construction details.

this story) is shown in Fig. 3. In it, another 5K thermistor, isolated from the switching circuits by follower amplifier IC1, is the temperature-sensing element.

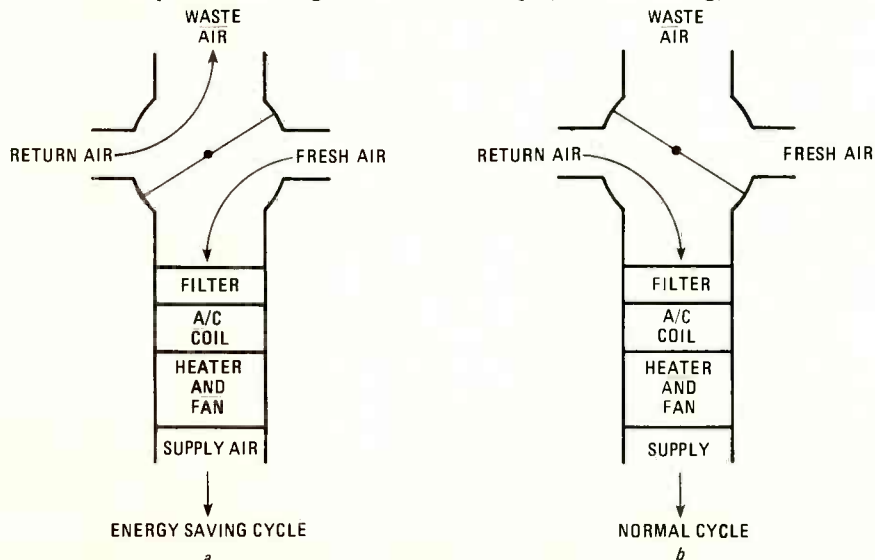

Fig. 10—AIR FLOW through ventilation system during a) energy-saving cycle and b) during normal cycle. Rotatable damper determines whether air is recirculated or not.

Resistor R2 and capacitor C2 generate a time delay to prevent short-cycling due to transient drafts at the thermostat.

IC2 is a four-level detector referenced by the voltage-divider string, R3 through R8. Resistors R4, R5, and R6 set the switching levels 2° apart. Assume that the system has been set in the heating mode by S1. At 4° below the level set by temperature-adjust pot, R7, no comparators will be tripped, and their collector outputs will be open. Transistors Q3 and Q5 will be biased on, turning on Q4 and Q6 to turn on the heat. The collector current of Q4 controls the first stage of the heating system through terminal 3 of the Control Center (Fig. 2) while Q6 is connected to the second stage of the heating system through a solid-state relay connected as in Fig. 4. The open-collector output of IC2-c and IC2-d as well as the open contact of S1-b will insure that Q1 and Q2 (air conditioning) are off. As the

house temperature rises to less than 4°, but more than 2°, below the set-point, IC2-a will switch low turning off Q5 and Q6. Stage-1 heat, will be turned on. A further increase in temperature will switch IC2-b low, turning Q3 and Q4 off—leaving all outputs off and the Control Center in standby.

In the air-conditioning mode, an inside temperature 4° higher than the set-point will satisfy the inputs to IC2-c and IC2-d, turning on Q1 and Q2. Stage-1 and stage-2 cooling will be turned on. As the temperature decreases, IC2-d will turn off leaving only stage-1 active, and with a further decrease, IC2-c will turn off leaving the Control Center in standby.

Construction

The environmental control system is constructed on two circuit boards. Figs. 5 and 6 show the foil pattern and parts placement for the control center, respectively. The electronic thermostat is on the smaller PC board. The foil pattern is in Fig. 7 and the parts placement guide in Fig. 8. The humidistat should be mounted in the system to monitor the humidity of the air supplied to the living area.

The two temperature sensors are easily assembled by flaring one end of a 4-inch length of 1/4-inch copper tubing and embedding a 5K thermistor in epoxy compound as shown in Fig. 9. Use spaghetti (thin plastic tubing) to insulate the thermistor leads. Be sure to use enough epoxy compound to make the assembly completely watertight and weatherproof.

Installation and operation

Completely automatic operation of the heating and cooling outputs may be selected by jumpers on the board which will bypass switch S1-b and route power-supply voltage to both the heating and cooling outputs simultaneously. If that is done, S1-a should be retained as a SPST switch to provide an off function.

Not all central air-conditioning units have two stages, and if yours doesn't, then eliminate Q1, Q5 and Q6 from the PC board, along with their supporting resistors. If your unit *does* have two stages, connect the output of the thermostat in the second stage to the control voltages of the central unit with an additional relay of the type used in the Control Center. (see Fig. 4)

The Control Center is easily compatible with the Educated Thermostat featured in the July '79 issue of **Radio-Electronics** and the combination would result in an integrated system offering the highest possible efficiency and energy savings. Supply one side of the cold contacts in the Educated Thermostat with 5 volts from the Control Center and connect the other side of the contacts to the FAN, HEAT, and COOL inputs of the Control Center. No ground from the Control Center

continued on page 82



COAX vs.

Coaxial cable costs more than ordinary 300-ohm twin-lead. Its advantages, though, can actually make it cheaper in the long run. This article explains why.

JAMES E. KLUGE*

WHENEVER YOU SEE A TECHNICIAN INSTALLING A MASTER antenna system, it seems he's always using coaxial cable. So—what's so great about coax? Before you try installing your own MATV (Master Antenna Tele Vision) system, learn a few basic facts about this increasingly popular means of running all types of signal around a house or a building.

Why use coaxial cable?

The concept of coaxial cable is pretty simple. Coaxial cable is merely two conductors, one inside the other. The outside conductor is cylindrical or tubular; the inside is conventional copper wire centered inside the tubular conductor by means of solid or foam-type plastic insulation. The entire assembly is then jacketed with a polyvinyl chloride (PVC) or polyethylene cover.

If you chopped off a short piece of common RG-59/U-type MATV cable, for instance, you would see a cylinder of PVC jacket material surrounding another cylinder of aluminum braid over another cylinder of aluminum foil bonded to a relatively thick cylinder of solid polyethylene or foam. Centered coaxially inside this cylinder of polyethylene would be a copper-clad, steel wire—known as the center conductor. Those coaxial cylindrical sections then extend for approximately 1000-ft. lengths as they are produced in factory runs.

In comparison, if you look at the familiar 300-ohm twin-lead transmission line, you will observe two stranded-copper wires enclosed in solid polyethylene plastic insulation, separated by about a ¼-inch-wide web of the same plastic. Except for characteristic impedance and its fabrication, one is just a different configuration from the other, i.e. they perform exactly the same function. However, coaxial cable has several significant advantages over twin-lead that makes it especially useful for wiring MATV systems.

Probably, the biggest advantage that coax has over other transmission lines is its ability to exclude extraneous interfering signals (whose fields fill the air) from interfering with the signals carried by the cable. For example, if you've ever tried to watch a critical play during a football game on TV, as your wife starts up her sewing machine, vacuum cleaner, or

electric mixer, you know how annoying electrical interference can be. Most brush-type electric motors generate electrical interference, as do poorly maintained automobile ignition systems, advertising signs, and some electrical equipment used in hospitals and doctors' offices.

The ability of coaxial cable to exclude such interference is inherent in its design. The outer metallic sheath or braid is at ground potential and simply shields the center conductor, which is carrying the TV signal, from those extraneous signals and noise.

Differences in coax

There are three common types of coaxial cable that you're likely to encounter. All three have a tough, outer protective jacket of plastic, usually polyvinyl chloride (PVC). The principal differences among the three are in the sheath or outer conductor that lies just under the PVC jacket. Outer conductors are made of:

1. Aluminum foil plus either a braid or drain wires—those are probably the most common; used in MATV applications where movement and flexing is minimal.
2. Solid aluminum sheath; found on larger cables; generally used for CATV trunk lines. Installed on poles or buried.
3. Copper braid; found on some MATV/CATV cables and commonly found on 50-ohm communication cable; used in applications where flexing is frequent.

Inner conductors are generally copper, either solid or stranded. Some small drop cables (RG-59/U type) may use copper-coated solid steel conductors for reasons of strength and economy.

The insulating dielectric material separating the inner and outer conductor will be either solid polyethylene or, in low-loss cables, foam polyethylene. In larger, solid-sheath-type cables, the dielectric may be dry air or gas in which case the center conductor is supported by discs spaced periodically or by using a helical insulator inside the sheath.

In addition to excluding extraneous interfering signals, the advantages of coax cable are its ease of installation, long life, and consistent performance. Because the outside conductor is always at ground potential and shields the inner conductor,

* Technical Editor, Winegard Company

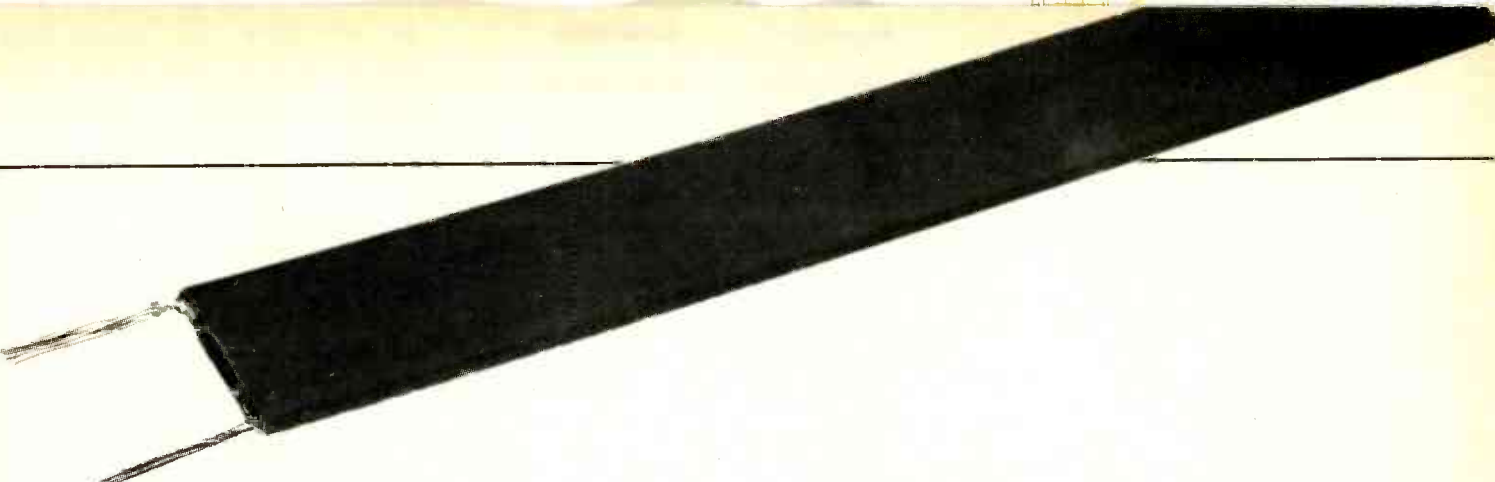

TWIN-LEAD

the cable can be routed through metal ducting, conduit, or steel-and-aluminum window sash. In fact, the proximity of tools, machinery, or metal of any kind has little or no effect on the signal voltage being carried on the inside conductor. Excess cable lengths can also be conveniently coiled for storage without affecting the picture quality. Don't try any of the above with twin-lead!

Why coax is unaffected

You see, the electric field that exists between the two conductors when a signal voltage is present on the coax line is wholly contained within the grounded shield (outer conductor) while in twin-lead, the electric field not only surrounds both conductors but arches between them. Thus, any metal brought near the conductors or between them severely distorts the field and affects the waveform of the voltage on the line. It's no wonder when using twin-lead that coiling and/or close proximity to metal affects the picture. Likewise, short horizontal runs of twin-lead act as antennas; TV signals are induced in them and produce leading ghosts.

It's an easily overlooked fact that TV signals are horizontally polarized and that any horizontally oriented piece of wire having a length anywhere near a multiple of a quarter-wavelength at the signal frequency will have the signal voltage impressed on it. If that unshielded wire, twin-lead or otherwise, is connected to the antenna terminals of the TV set, it will produce a second image on the picture tube slightly ahead of the main image; i.e. a leading ghost. On coax, those stray fields can't do any harm.

Limitations of twin-lead

Now, I don't mean to imply that there's anything wrong with twin-lead. It is perfectly good transmission line, has been used successfully for decades, and companies are still manufacturing and selling thousands of feet of it. The thing you must remember about twin-lead transmission line is that, like anything else, it has limitations. Properly installed out of the weather, in an area relatively free of electrical noise and strong signals, it does an excellent job. Those qualifications restrict it to rural areas and experienced installers. However, the bulk of the installations are in or near metropolitan areas where the problems occur.

It's true that twin-lead has lower loss than, coax but not that much where you're dealing with less than 100 feet—adequate for most residential installations.

It's also true that foot-for-foot, it costs less but again, if you're paying someone to install it properly, there's an excellent chance that the additional cost of using coax will be

more than offset by fewer hours required to install it. Labor costs these days significantly affect the bottom-line figure on labor and materials contracts.

Tips on coax

When running coax either from an antenna to the TV set or interconnecting an MATV distribution system throughout a building, it's pretty hard to do anything wrong except through ignorance. So here are a few tips on how to avoid the common pitfalls of installing coax.

First, you can run it just about anywhere you please, indoors or out, without fear of weather or deterioration. It holds up over a considerable number of years provided you follow some simple rules. Don't pinch or squeeze the coax. Any pressure exerted against it will cause the plastic to "flow" resulting in a deformity. Such deformities cause an abrupt change in the cable's characteristic impedance that will result in a portion of the signal voltage being reflected back toward the source. Strong reflections of that kind cause ghosts and smear.

Coax can be deformed by bending it too sharply, pinching it between wallboard and studs, closing a window or door against it, or stapling it too tight. Tight staples uniformly spaced at multiples of a wavelength (accumulative effect) may completely wipe out the picture.

Coax should not be bent sharply—a bend radius of ten times the cable diameter should be considered maximum. Staples should never penetrate the cable and should be loose enough to support the cable and hold it securely in place, but not compress it. You may tape it, tie it or wire it to vertical and horizontal supports; it may be run through pipe, air duct, conduit, or raceways. Excessive heat and/or water (or chemicals) may harm the cable if they deform or penetrate the dielectric material inside the shield. The possibility of corrosion should always be avoided.

When cable is buried underground, moisture and corrosion are potential problems. A moisture-impervious jacket may be required. Above all, never allow a cut or break in the jacket to be below ground. Always make connections above ground, preferably in a weathertight enclosure inside a pedestal.

Connecting to coax

When it comes time to make connections with coaxial cable, put your soldering iron away. Heat will only damage or soften the plastic insulation. There is an accepted and fast technique for putting connectors on coaxial cable. It is simple, reliable, and cost-effective. Connectors are usually included with equipment requiring them. It is just a matter of

installing them on the connecting cable.

Putting a connector on coaxial cable can be fast and easy if you learn the basic technique properly. Whether you use a knife, a stripping tool, or diagonal cutter, you can make good connections every time if you exercise care and knowhow. Choose your own tools but do a precise job. Failure to do so will cost you time and money. Trying to locate an intermittent or buried fault can be extremely time-consuming. Install the connectors properly and I doubt if you'll ever use 300-ohm twin-lead again.

However, if I'm wrong and you're bent on using twin-lead, then use *good* twin-lead and be sure its carefully installed. You should consider several important variables to insure a proper and secure installation.

What is good twin-lead?

First, good twin-lead should have at least No. 20 AWG conductors. Twin-lead conductors usually consist of not one, but several smaller strands of wire twisted to make the equivalent wire size desired. Stranded conductors provide additional strength and flexibility to avoid breakage when the line is sharply bent or is whipped by strong winds.

Second, to provide a close 300-ohm impedance match the conductors must be correctly spaced with high-quality dielec-

tric material. Spacing for No. 18 AWG conductors is approximately 1/4-inch in air. Flat twin-lead conductors are separated by a dielectric which is partly air and partly polyethylene. The polyethylene web increases the capacitance between conductors. This upsets the characteristic impedance so the conductor spacing is increased to return the capacitance value to what it would be if only air were present.

Spacing for two No. 20 AWG conductors in air would be 0.2 inch. When a polyethylene web is introduced the spacing increases to nearly 1/4 inch.

A third important feature of twin-lead is web-insulation thickness. Minimum insulation thickness should be 0.080 inch to provide the necessary insulation between conductors.

The web should also be made from 100-percent polyethylene for lowest RF loss and to provide resistance to oxidation and weathering. Several manufacturers sell twin-lead designed specifically for outdoor use.

Where the line must carry UHF signals, we advise polyethylene-foam insulation to prevent high loss in damp or wet weather.

What about loss?

There is no question that twin-lead has lower loss than
continued on page 72

9 STEPS TO MAKING IDEAL COAXIAL CONNECTIONS

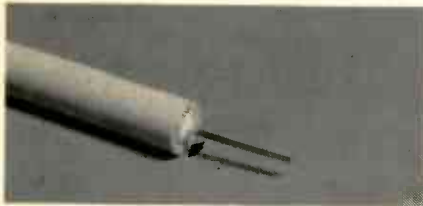

STEP 1—CUT THE CABLE FLUSH. Strip the outer jacket off, then trim the dielectric by cutting partially through. Twist and pull off leaving a 1/2" minimum of exposed center conductor. Do not nick the center conductor! It helps to use the UT-5900 cable-stripping tool which does all those operations in one motion.



STEP 2—REMOVE ADDITIONAL 3/16-inch of the outer jacket. Pull the braid away from the dielectric and fold back over the jacket. If there's any residue on the center conductor scrape off with non-metallic object, e.g. fingernail. Be careful not to damage the thin copper plating.



STEP 3—SLIDE THE FERRULE over the jacket. Slide the connector body between the braid and the dielectric. Trim off excess braid, or if desired, fold back over jacket so to be crimped between jacket and ferrule. That will help eliminate possibility of braid or shield creeping back inside the jacket due to strain or temperature.



STEP 4—LOOK INTO END OF CONNECTOR to make sure that braid or aluminum foil does not touch (or has the possibility of touching) the center conductor. Shorting can result if either comes in contact with center conductor.



STEP 5—SLIDE FERRULE just ahead of bulge in jacket caused by end of connector body. Close crimping tool around ferrule so as to crimp jacket and braid against connector body making correct crimp (see steps 8 and 9).



STEP 6—IN HOT WEATHER: Trim off center conductor leaving 3/16-inch beyond the connector. The center conductor expands at higher temperatures. If a little extra is not provided, it may contract enough in the winter to create an open connection and result in loss of picture.



STEP 7—IN COLD WEATHER OR INDOORS: Trim off center conductor leaving it extended 1/16-inch beyond the connector. (Use diagonal pliers for cutting center conductor.)



STEP 8—THE FERRULE PROPERLY CRIMPED using a crimping tool—do not use a pliers (cable not shown for clarity).



STEP 9—CHECK FERRULE for proper crimping. The ferrule on the right has been crimped correctly. The ferrule on the left has been crimped incorrectly. (Cable not shown for clarity.)

Connect A D/A Converter

Microprocessor-based projects must communicate with the outside world in analog terms. There are two ways to interface digital-to-analog converters.

JOSEPH J. CARR

THE MICROPROCESSOR ALLOWS THE CONSTRUCTION OF SOME very low-cost computer systems, intelligent devices, and projects. By itself, a typical microprocessor IC will not do very much. Almost all of those currently on the market require some other IC's before they will "do their thing." Add a little bit of memory, and some input/output (I/O) capability, however, and the microprocessor becomes an intelligent controller.

The circuit designer has found and will continue to find many uses for the microprocessor. Whether it is in a computer programmed in BASIC or just as an IC in a larger non-computer product, the microprocessor will revolutionize the world around us.

The trouble is the microprocessor is a digital device while the world surrounding it is an analog one. Whether the microprocessor is part of a computer system or part of an intelligent product, many applications require interfacing it to analog signals. The hobbyist who wants to design and build a microprocessor-based project, will quickly discover that problem.

Interfacing a microprocessor to analog signals is a two-way affair—analog signals must be input to the microprocessor and the microprocessor must be capable of controlling analog signals. To input an analog signal, an analog-to-digital (A/D) converter is used. Interfacing an A/D converter to a microprocessor was covered in the June 1980 issue of *Radio-Electronics*.

For a microprocessor to control analog functions, a digital-to-analog (D/A) converter is needed. A D/A converter will produce an analog current, or voltage, output that is proportional to the product of a reference current, or voltage, and a digital word. The digital word is applied by the microprocessor IC or microcomputer.

But how does one go about interfacing a D/A converter to the microprocessor? It is all very well and good to talk about controlling an analog current or voltage with the computer, but what connections must be made? Also, what additional IC's or other hardware are needed? There are actually several different methods, but all of them are variations of only two basic schemes: *I/O-based* and *memory mapped* interfacing.

Direct I/O interface

Perhaps the easiest interfacing task is one when we have a microcomputer that provides I/O ports for our use. Many of the hobby and professional microcomputers provide unused I/O ports for the user to allocate as desired. In some com-

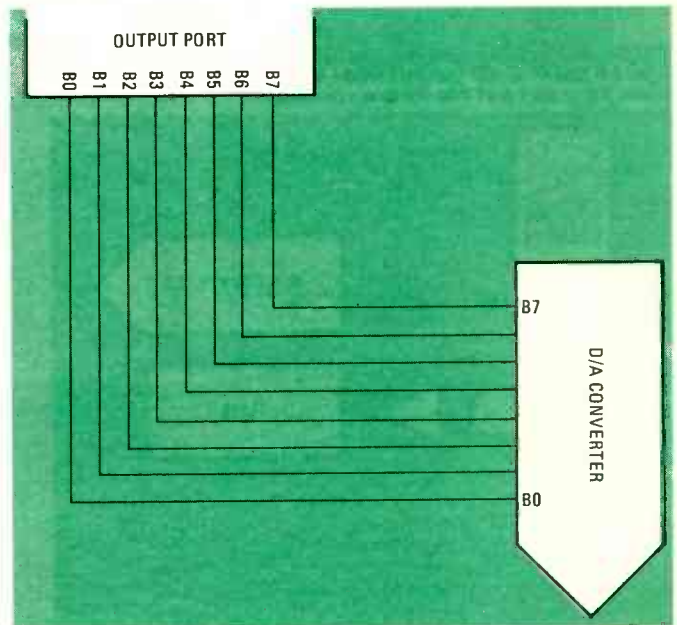

FIG. 1—A D/A CONVERTER can be connected directly to the latched output port of a microcomputer.

puters, such as those based on the S-100 bus, additional I/O ports can be accommodated merely by purchasing or building an additional I/O card. In those machines, it is easy to add on up to 256 additional ports, of which most people will only need a handful.

Figure 1 shows the inputs of a D/A converter directly to the output port of the microcomputer. This simple connection would be used by those people who have an assembled machine, instead of a microprocessor. In that case, the I/O circuitry is already provided. It also assumes that the I/O ports are *latched*. That means that the output port will retain the last valid data fed to it by the microprocessor IC, and will hold it until updated data is provided. This is the scheme used by almost all hobbyist and professional microprocessor-based computers.

When using a scheme such as the one shown in Fig. 1, it is necessary that any programs used to output data to the D/A converter initialize the output port first. It is usually required that the output port serving the D/A converter see all zeroes (00000000) or all ones (11111111) before it is used, and after it is finished being used. Otherwise, the last value applied to the

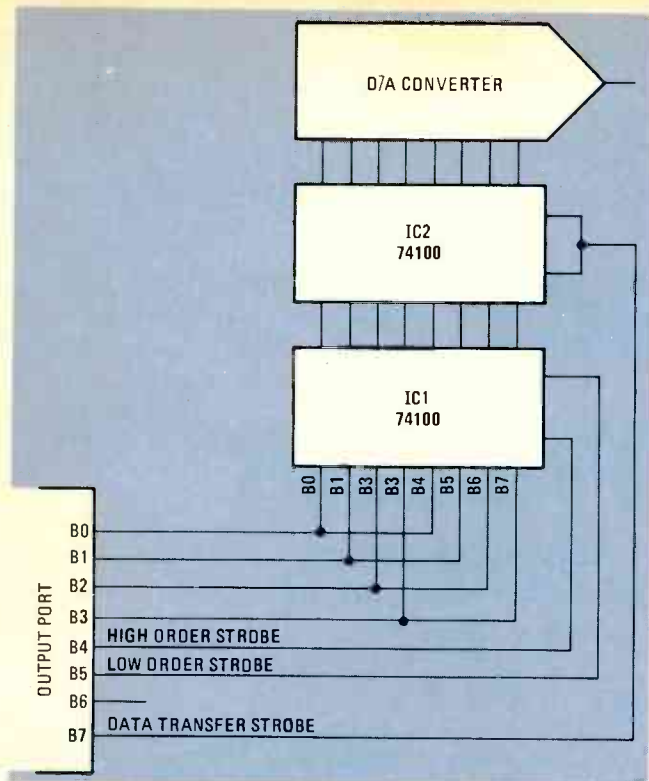

FIG. 2—AN UNLATCHED OUTPUT PORT can be used by placing a latch between the output port and the D/A converter.

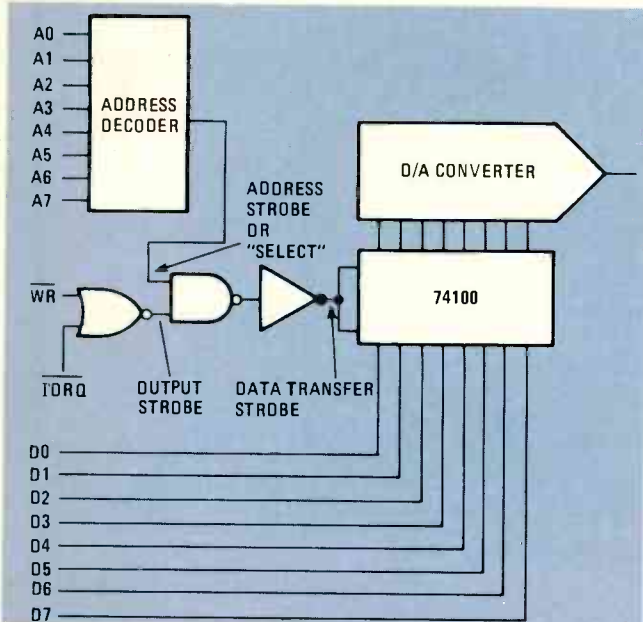

FIG. 3—INTERFACING TO A MICROPROCESSOR is accomplished by creating an output port.

port will be retained by the D/A converter. Whether ones or zeroes are used depends largely on the type of D/A converter and whether it wants to see zero or full scale values when not in use.

But what about the person who is using a microprocessor in a non-computer project, or a small-scale homebrew computer? Or the person who buys one of those "single-board computer" kits that have only a single I/O port that is being used for other purposes? Those people will have to create a latched output port by connecting the circuit shown in either Fig. 2 or Fig. 3.

The circuit of Fig. 2 is used when the output port exists, but is *not* latched. In this circuit, a quad latch (74100 IC) is used as an 8-bit register. Note that several microprocessor manufacturers also offer I/O IC's, but for this application, the ordinary TTL 74100 device does just as well at a fraction of the cost.

The data at the outputs of the 74100 IC remains stable whenever the strobe lines are low. Recall that any latch circuit is actually a special case of the type-D flip-flop (the clock lines of the type-D flip-flops are tied together to form a strobe line). When the strobe line is low, then the outputs retain the last valid data that existed when the strobe line was high. But when the strobe line is high, then the output lines will follow the input data.

The circuit of Fig. 2 is known as a *double-buffered latch*, and it is used when we are trying to interface with an existing microcomputer that has but one port available.

Bits B0—B3 are the data lines from the output port of the microcomputer. Bits B4 and B5 of the output port are used to strobe the two halves of IC1, while B7 is used to strobe IC2.

In this circuit, we are multiplexing the data. We load the high-order four bits by outputting them on B0—B3 and making B4 high. That will latch the high, order four bits into one half of IC1. Next, we must output the low-order four bits on B0—B3, but in this case we make B5 high so that the data appearing on the four lines are latched into the other half of IC1.

When both halves of the 2 x 4 bit 74100 device have been loaded, and latched, then we must apply a data transfer strobe (i.e. make B7 high), so that the entire contents of IC1 are transferred to IC2 at one time. When that is finished, the digital inputs to the D/A converter will see the entire word B0—B7.

After the data has been transferred to IC2, we are free to begin loading another word into IC1, if that is needed.

Note that this method is cumbersome and time-consuming. We are required to make three separate operations to affect the output of the D/A converter: load IC1-a, load IC1-b, and load IC2. That circuit would only be used with an unlatched output port.

If you are building from scratch, using a microprocessor, or if you are brave enough to pry into the innards of your microcomputer to get to the control signals from the microprocessor, then you might want to make use of the more efficient scheme shown in Fig. 3. We are still using I/O-based interface techniques, but are interfacing directly to the microprocessor instead of an I/O port.

Before you can interface directly with a microprocessor, however, you must be familiar with the control signals generated by the IC to control and direct I/O operations. Although the details vary from one device to another, there is a similarity between IC's. In this case, we are going to consider the Z-80 device.

In the Z-80 microprocessor, there is an \overline{IORQ} (I/O ReQuest) terminal that will be forced low when an I/O operation is to take place, as commanded by the program instructions.

There are also separate *read* (\overline{RD}) and *write* (\overline{WR}) lines. If the instruction given to the microprocessor is for an input operation, then the \overline{RD} line will go low along with the \overline{IORQ} line. But if the instruction calls for an output, then the \overline{WR} lines goes low simultaneously with the \overline{IORQ} . One *reads* from an input, and *writes* to an output.

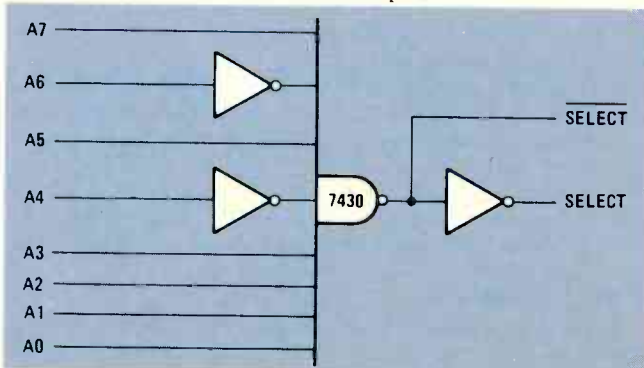

FIG. 4—AN ADDRESS DECODER is used to control the output port shown in Fig. 3.

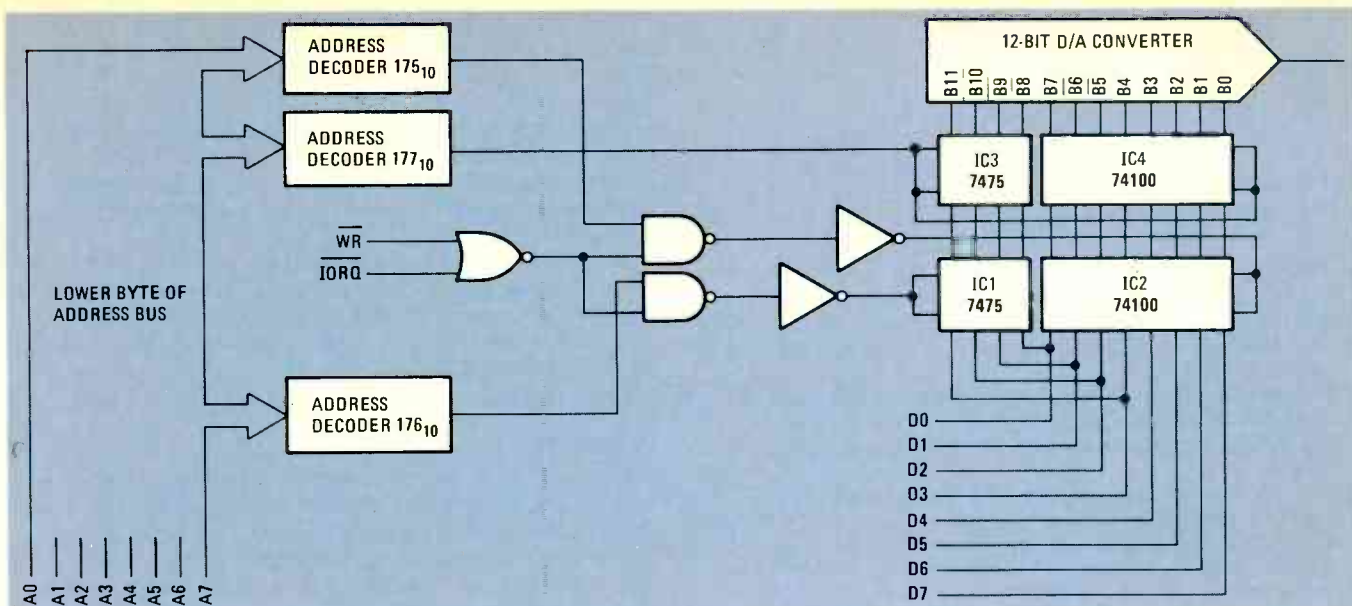

FIG. 5—INTERFACING 10- AND 12-BIT D/A converters directly to a microprocessor.

The instruction that we are interested in using is an immediate output instruction. In the Z-80 instruction set there is an instruction of the form `OUT n, A`. That means that the contents of the accumulator are output to a device whose address code appears in the next byte. The code for that instruction is `D3` in hexadecimal, followed by the number of the device. The program code would look like this:

| Location | Byte |
|----------|------|
| 1 | D3 |
| 2 | (n) |

During the execution of that instruction, the number of the output device being addressed (n) will appear on the lower eight bits of the sixteen-bit address bus.

There are two ways to use that instruction. One, of course, is to use one of the peripheral interface IC's made by various manufacturers. But that is costly. At the time of this writing, I priced one for the Z-80 at \$15. The other is to use our old, and inexpensive, friend, the 74100, which is shown in Fig. 3.

Since the address is in an eight-bit form, we can select any of 256 different numbers (000 - 255) for an output device. For example, let us say that we want to use `17510` (`AF16` in hexadecimal) as the number of the output port assigned to the D/A converter. That means we will want that port active when the lower eight bits of the Z-80 address bus contains `1010111` (binary for `AF16`).

An address decoder (see Fig. 4) must be used so that the D/A converter will recognize *only* its own number (`AF16`). The 7430 used as the decoder is a NAND gate, so its output will remain high as long as any one of the eight input lines is low. A combination of inverters and straight wiring must be used that will make all inputs of the 7430 high when the binary word appearing on the address bus is `1010111` (`AF16`). For that address, only lines `A4` and `A6` must be inverted before being applied to the 7430 inputs. When the selected address appears on the address bus, the output of the 7430 will go low, so the output of the inverter following the 7430 will go high.

But we must also pay attention to the control signals: `IORQ`, `WR`, and `RD`. Those will tell us whether the operation is an input, output, or a non-I/O (in which case no action is to be taken, regardless of the number appearing on the address bus.) Since we are dealing with an output operation to a D/A converter, we will want to monitor the `IORQ` and `WR` lines. Those lines are from the microprocessor and are connected to the inputs of a two-input NOR gate. The output of the NOR gate will go high, forming an *output strobe* signal only when both the `IORQ` and `WR` signals are low.

The circuit of Fig. 4 is the address-decoder portion shown

in block diagram form in Fig. 3. The *output strobe* and the *select* signals are combined at the inputs of a NAND gate. When both of these signals are high, the output of the NAND gate drops low, forcing the output of the inverter stage high. That action will cause the 74100 data latch to transfer the eight bits appearing on the Z-80 data bus to the D/A converter inputs.

Note that we can simplify this circuit even more if the assigned port number `17510` (`AF16`) is used exclusively for *output* operations; e.g. there is no input port assigned to the number 175. We may then eliminate the `WR` signal. We would then NOR together the *select* signal from the address decoder (Fig. 4) and the `IORQ` signal from the Z-80. Those signals would then strobe the 74100.

10-bit and 12-bit D/A's

The cost of D/A converters, in general, has come down a great deal in only the past several years. Because of advances in IC technology, we can now buy an 8-bit D/A converter of good quality for less than \$10. 10-bit and 12-bit D/A converters can be purchased for less than \$20, and even the best quality costs less than \$100. The extra resolution afforded by the 10- and 12-bit models makes them very attractive in many applications where the 8-bit models are inadequate.

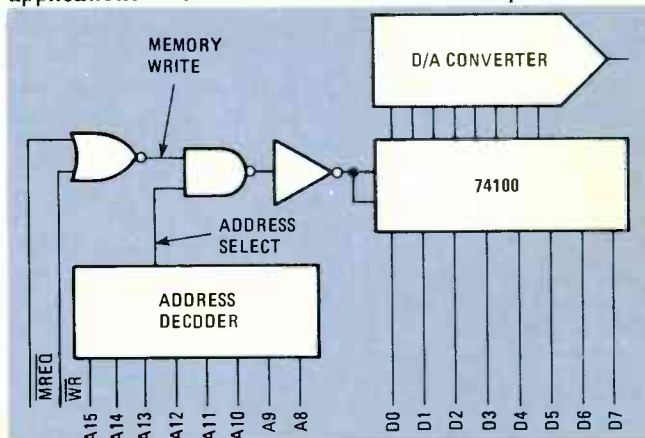

FIG. 6—MEMORY-MAPPED INTERFACING makes the D/A converter appear as a memory location to the microprocessor.

Fig. 5 shows one method for interfacing 10- and 12-bit D/A converters to a microprocessor IC. Again, we are using the Z-80 as the example. The 8-bit microprocessor can output only 8 bits at a time, because (of course) there are only 8 bits on the data bus. Once again, we must multiplex the data on

the data bus.

To illustrate: Let's assign three output-port numbers, as follows:

- 175₁₀ (AF₁₆): lower eight bits of data to D/A
- 176₁₀ (B0₁₆): higher 2 bits, or 4 bits (depending on whether a 10- or 12-bit D/A is used) of data to D/A.
- 177₁₀ (B1₁₆): control of output latch

This circuit will first load the data into IC2, then load the remaining part of the data into IC1, and then simultaneously transfer the data in IC1 and IC2 into IC3 and IC4, respectively. To do that job we need a program that does the following:

1. Loads the CPU accumulator with the lower eight bits of the 10- or 12-bit word.
2. Outputs the lower eight bits to port 175₁₀ (e.g. loads IC2).
3. Loads the CPU accumulator with the high order 2- or 4-bits of the D/A word.
4. Outputs the contents of the accumulator on port 176₁₀ (e.g. loads IC1).
5. Generates an output instruction to port 177₁₀ to strobe the data in IC1/IC2 into IC3/IC4.

Memory mapping

The use of input and output instructions is not always very efficient. We can use memory-mapping techniques, however, to make better use of the CPU time. By considering the D/A converter as merely another slice of memory, we can use the data-movement instructions without first using an input/output instruction.

Most hobby and professional microcomputers do not use more than 32K of memory. It is, then, common practice to assign locations in the upper (unused) 32K of the possible 64K to memory-mapped devices such as a D/A converter.

The idea in memory-mapped output is to assign a memory location to the D/A converter, and then use instructions that produce a memory-write operation to that location whenever we want to output a new value.

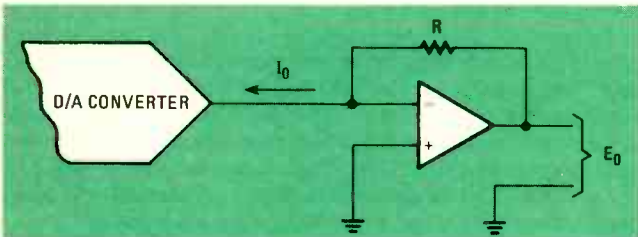

FIG. 7—CURRENT-TO-VOLTAGE converter is used with current-output D/A converters.

In the case of memory-mapping, we will use the \overline{WR} and \overline{MREQ} lines. The \overline{WR} has already been described as going low when the CPU is writing data to someplace. The \overline{MREQ} line is a memory-request control signal generated by the Z-80. When the instruction being executed calls for a read or a write memory operation, the \overline{MREQ} lines goes low.

The circuit used (Fig. 6) is similar to that used in the I/O scheme discussed earlier. An address decoder (similar to Fig. 4), set for a location in the upper 32K of memory (i.e. using address lines A8 - A15), generates a positive-going pulse whenever the correct address appears on the address bus.

Similarly, a NOR gate connected to monitor the \overline{WR} and \overline{MREQ} lines will generate a positive-going pulse whenever the instruction being executed by the microprocessor is a memory-write operation.

The coincidence of the memory-write and address-select pulses forces the output of the NAND gate low, and the inverter output HIGH. That condition will strobe the data appearing on the data bus (D0 - D7) into the 74100 and, therefore, to the input of the D/A converter. This data is held on the outputs of the 74100 until another command is received.

If 10- or 12-bit D/A converters are used instead, we would simply adapt a scheme similar to Fig. 5, only using the memory-control signal instead of the I/O control. Again, the data would be loaded into the latches serving the D/A converter in three cycles: the first 8-bits, then the remaining 2- or 4 bits, and finally, the whole 10- or 12-bits would be strobed into the output latch simultaneously. We would probably see fit to assign the two halves of the D/A converter to sequential memory locations.

Burr-Brown produces a product line called the MP-10 and MP-11 analog output modules. Those devices are memory-mapped D/A converters that are designed specifically for use with microprocessor IC's. The MP-10 works with the 8008, 8080, and Z-80 IC's, while the MP-11 works well with the 6502 and 6800 devices.

Output circuits

Many of the lower cost, and most popular, IC D/A converters on the market are current-output devices. This means that the analog output of the device is an electrical current. Unfortunately, most of the amplifiers, oscilloscopes, strip-chart recorders, and circuits that we would want to interface with the output of a D/A converter want to see a voltage, not a current!

The solution to that problem is to provide a current-to-voltage converter stage, such as the one shown in Fig. 7. Here, we use an operational amplifier to convert the output current (I_o) to a voltage level. No input resistor to the op-amp is needed because the D/A converter is a high-impedance output device. The output voltage E_o is given by:

$$E_o = I_o \times R$$

Select a value for resistor R that will produce the desired full-scale output voltage when the output current is full-scale. If that procedure produces an inverted output voltage, i.e. the wrong polarity, then follow that circuit with a unity-gain op-amp inverter circuit.

Another problem that might affect the output display is the step-function nature of the D/A converter output. The output levels can vary only by the amount produced by a change in the least significant bit applied to the digital inputs. If you program the D/A converter to produce a ramp output, i.e. a linearly rising voltage, and then examine the output voltage on an oscilloscope, you would find that it resembles not a ramp, but a staircase. If that is objectionable in any given application (it can be!), then it may be necessary to filter the output from the amplifier. One approach, of course, is simply to connect a capacitor across resistor R in Fig. 7. If the value of the capacitor is selected with care, then the desired filtering will be obtained. A somewhat more elegant approach, however, is to use an op-amp active filter. That will produce much better filtering action.

R-E



"Tell me, dear, did you get the bonus you were promised?"

VMOS

A Giant Step Toward the Ideal

BILL ROEHR

VMOS (VERTICAL MOS) TECHNOLOGY offers the circuit designer an active device with a combination of characteristics closer to the ideal than is found in any other device available. Since the development of planar technology in the early 1960's, the MOS type of field-effect transistor has revolutionized the integrated-circuit field, but discrete MOSFET devices have found wide use mainly as RF amplifiers and mixers. Conventional MOSFET's have a very high saturation resistance that makes them unsuitable for switching large amounts of current, and a square-law transfer characteristic that rules them out for linear audio or video applications. The VMOS* field-effect transistor overcomes those serious FET limitations and presents a challenge to the bipolar transistor with the following array of impressive characteristics:

1. High input impedance—direct interface to CMOS and TTL.
2. Nanosecond switching time—no inherent time delay.
3. Low feedback capacitance.
4. No thermal runaway or second breakdown.
5. High transconductance.
6. Linear transfer characteristics.
7. Low on-state voltage—no off-set voltage.

One way to gain insight into the inherent advantages of one type of active element over another in particular appli-

*The term VMOS is sometimes used to describe a V-grooved device used in integrated-circuit memories in which both source and drain contacts are on the top surface. As used here, VMOS refers to the device's construction that causes current flow to be vertical, rather than horizontal as in standard FET's.

Ideal transistor characteristics are easily demonstrated—on paper. VMOS technology puts them on silicon.

cations is to compare the actual device to a theoretical ideal. In the following paragraphs, characteristics of the three kinds of transistors—bipolar, conventional MOSFET and VMOS—are compared to the ideal. Wherever practical, data on devices of comparable chip size are used. Two modes of transistor operation must be considered—linear amplification and switching. First, we'll discuss linear applications.

The ideal linear device

An ideal linear element can be defined as one with constant gain—i.e., the relationship between a change of input signal and a change of output signal is constant, regardless of the magnitude or frequency of the input signal or environmental changes such as temperature. To minimize the number of elements required for a given amplification, the gain should be high, but not so high that noise or spurious signals are troublesome.

Figure 1 shows transfer curves—the relationship between input and output—

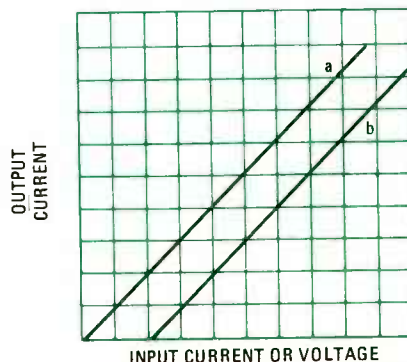

FIG. 1—TRANSFER CURVES for two types of ideal linear active devices.

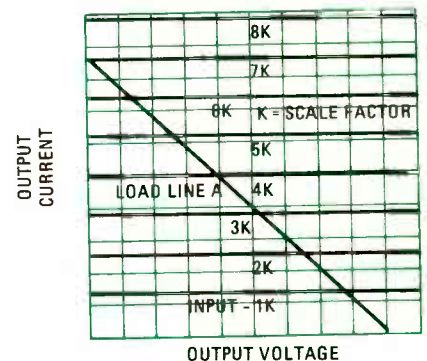

FIG. 2—OUTPUT CHARACTERISTIC of an ideal active linear device.

for the two types of ideal active devices. To minimize input-power requirements, the device should have a low-input impedance if input current is the variable, or a high-input impedance if input voltage is varied. Assuming the transfer curve is independent of output voltage, devices having the characteristics of either curve *a* or curve *b* are capable of linear amplification if the zero signal (quiescent) operating point is placed midway in the curve (Class A operation). For Class B operation, devices having the characteristics of curve *a* simplify biasing requirements.

The output-characteristic curve showing the relationship between output current and voltage for one type of ideal device is found in Fig. 2. Output voltage does not affect output current, except at 0 volts. For high power efficiency, a load line such as that shown in Fig. 2 can be used to achieve voltage-

Reprinted from "Fairchild Journal of Semiconductor Progress," Vol. 7 No. 1 ©Copyright 1979, Fairchild Camera & Instrument Corp.

output swings that are equal to the power-supply voltage.

To keep circuit behavior independent of frequency, the active device should be free of reactive effects or other sources of time or phase delay.

Actual linear devices

Figure 3 shows typical static transfer curves for a bipolar transistor, a standard MOSFET and a VMOS FET, compared to the ideal linear device. The bipolar curve is the most non-linear. The current gain of a bipolar transistor can never be constant over its operating current and temperature range. It is ad-

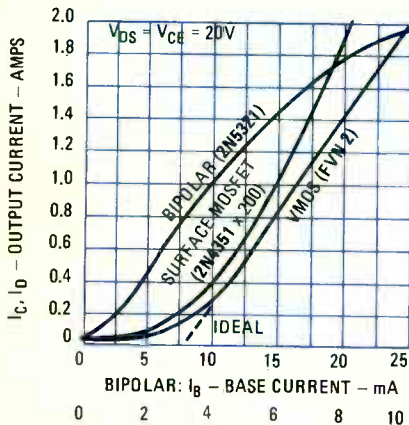

FETS: V_{GS} - GATE TO SOURCE VOLTAGE - VOLTS
FIG. 3—STATIC TRANSFER CURVES shows comparison between available active semiconductor devices.

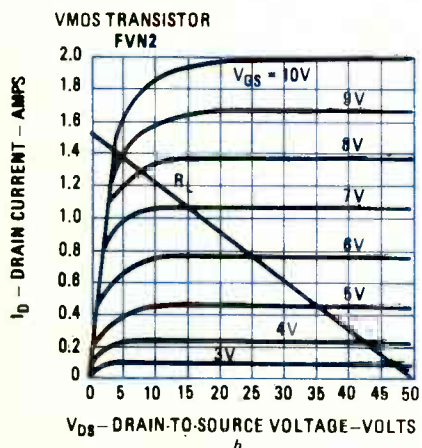
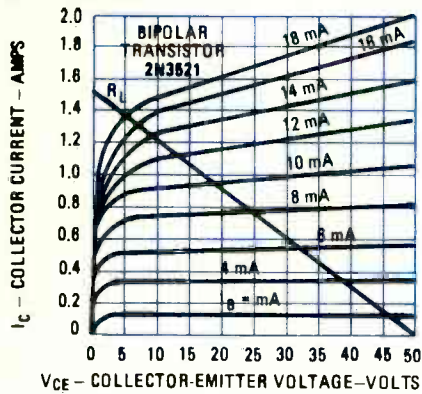

FIG. 4—OUTPUT CHARACTERISTICS of a bipolar transistor is shown in a, while a VMOS transistor is shown in b.

versely affected at low signal levels by surface and volume recombination, and at high current by loss of emitter efficiency, base-region current crowding and base-region conductivity modulation. Using bipolar transistors in high-fidelity amplifiers requires enormous amounts of local and overall negative feedback.

The MOSFET transfer curve in Fig. 3, obtained by scaling up the 2N4351 drain current by a factor of 200, is also non-linear. A characteristic of long-channel FET's is that the square root of output current is proportional to the gate voltage, which generates second-harmonic and intermodulation distortion. That problem, along with low gain, explains why FET's are rarely found in audio equipment. They are acceptable in push-pull applications, but push-pull is usually used only in power-output stages, above the current levels of conventional FET's.

The third transfer curve in Fig. 3 is for a Fairchild FVN2 VMOS transistor. Except for square-law curvature in the low-current region, it closely approximates the ideal transfer curve *b* in Fig. 1. An inherent property of short-channel FET's (VMOS) is constant gain over most of the operating range; low distortion is an obvious benefit.

Static transfer curves are measured at a fixed output voltage. Figure 4 includes the effect of output impedance by showing the output characteristics for a bipolar (Fig. 4-a) and a VMOS transistor (Fig. 4-b) of equal silicon area. The non-linearities previously mentioned are evident from the non-uniform spacing of the curves. In addition, a region of gross non-linearity exists in the low-voltage areas (referred to as the saturation region in bipolar transistors and the ohmic region in FET's) where severe distortion results.

It is not apparent from Fig. 4 which device produces maximum output-voltage swing without distortion. The VMOS device has a higher saturation region resistance, but the bipolar device

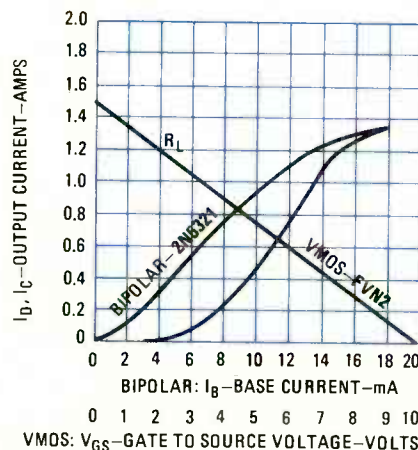

FIG. 5—DYNAMIC TRANSFER CURVES of a VMOS and a bipolar transistor.

is plagued with a quasi-saturation region at higher current levels. Figure 5 shows the dynamic transfer curves obtained from Figs. 4-a and 4-b. Note that the maximum current available for either device is about 1.3 amps; however, the VMOS curve shows a region of very good linearity, while the bipolar is not linear at all.

No active device can fully meet the ideal requirement of a gain unaffected by frequency. In bipolar devices, frequency response is affected by a number of factors—base transit time, collector depletion-layer transit time, and R-C time constants associated with emitter-base and collector-base capacitances. FET capacitances can be made much smaller than those of equivalent bipolar transistors, and all FET's are essentially free of other time delays.

Now let's discuss the various switching applications.

The ideal switch

The ideal switch has no power loss when used to interrupt current through a load and no limitation upon repetition rate. That definition imposes three severe requirements:

1. When the device is fully saturated, no voltage exists across the device's terminals.
2. When cut-off no current flows through the load.
3. The transition between states must be performed without time delays.

An ideal device having the output characteristics shown in Fig. 2 meets the first two requirements. To fulfill the third requirement, the device must have no reactive effects or other sources of time delays. Also, as a general rule, the smaller the energy requirement to actuate the switch, the better—up to the point where system noise or spurious signals can cause erroneous actuation. Devices with the transfer curves shown in Fig. 1 can have a zero actuation energy, even though a finite control signal is required. The input impedance must be zero for a current-controlled device or infinite for a voltage-controlled device. A device having the characteristics of curve *b* (Fig. 1) would be preferable as a switch since it is cut off even when a residual signal from a preceding stage is present.

Actual switching devices

The output characteristic curves of Fig. 4 indicate how well solid-state devices approximate the ideal switch. At higher currents, the on-state voltage is higher for the VMOS transistor than for the bipolar. Although it is not evident from the figure, VMOS curves intersect the origin and do not exhibit the offset voltage characteristics of bipolar devices, making VMOS preferable at lower currents.

All types of silicon solid-state devices have satisfactorily low leakage currents compared to the load currents. However, the leakage current in a bipolar flows out the base, thus requiring a low-impedance source or some means to reverse bias the base to maintain the cut-off condition.

The VMOS transistor, an enhancement-mode device, remains cut-off even with a slight forward voltage present on the gate (see Fig. 3) and has exceptionally low gate-leakage current, practical for direct coupling to logic outputs and for use in high-impedance circuits.

Switching speed is directly related to the time delays and capacitances of the active element. A bipolar device not only has a frequency response limitation, but also a storage time that is often a microsecond or more in power transistors. Storage time limits switching speed and makes it necessary to design a "dead time" into the drive circuits of power converters to avoid the excessive dissipation that occurs when a pair of devices in a push-pull circuit are on at the same time. All FET's are completely free of storage time and can switch an ampere in less than 10 nanoseconds when driven from low-impedance sources. Switching time in FET's is primarily determined by the rate at which the device capacitances can be charged. Turn-on time is only about 1 ns, the transit time of the carriers in the channel.

VMOS technology

To understand the fundamental characteristics of VMOS transistors, it is necessary to examine VMOS construction. Figure 6 shows cross sections of two types of VMOS FET's, a V-groove and a horizontal-channel. As in all MOSFET's, the FET is built in parallel with a bipolar transistor. In Fig. 6-a, the V-groove cut into the structure forms the MOSFET gate. In Fig. 6-b, the MOSFET gate is in a horizontal plane. The base of the bipolar is shorted to the emitter, keeping the bipolar inactive and stabilizing the threshold voltage of the FET since the body region is not electrically floating.

For current flow in an N-channel device (the V-groove VMOS shown in Fig. 6-a), the gate is made positive with respect to the source and body, causing electrons to be attracted into the P-region surface under the gate. Above a certain voltage the P-type silicon surface inverts, forming an N-type channel and creating a low-resistance path from source to drain. Since the P-type body is made short to provide high gain, it cannot support significant voltage at the drain without punch-through occurring. The N-type epitaxial layer provides a sufficient depletion region for the drain-source voltage.

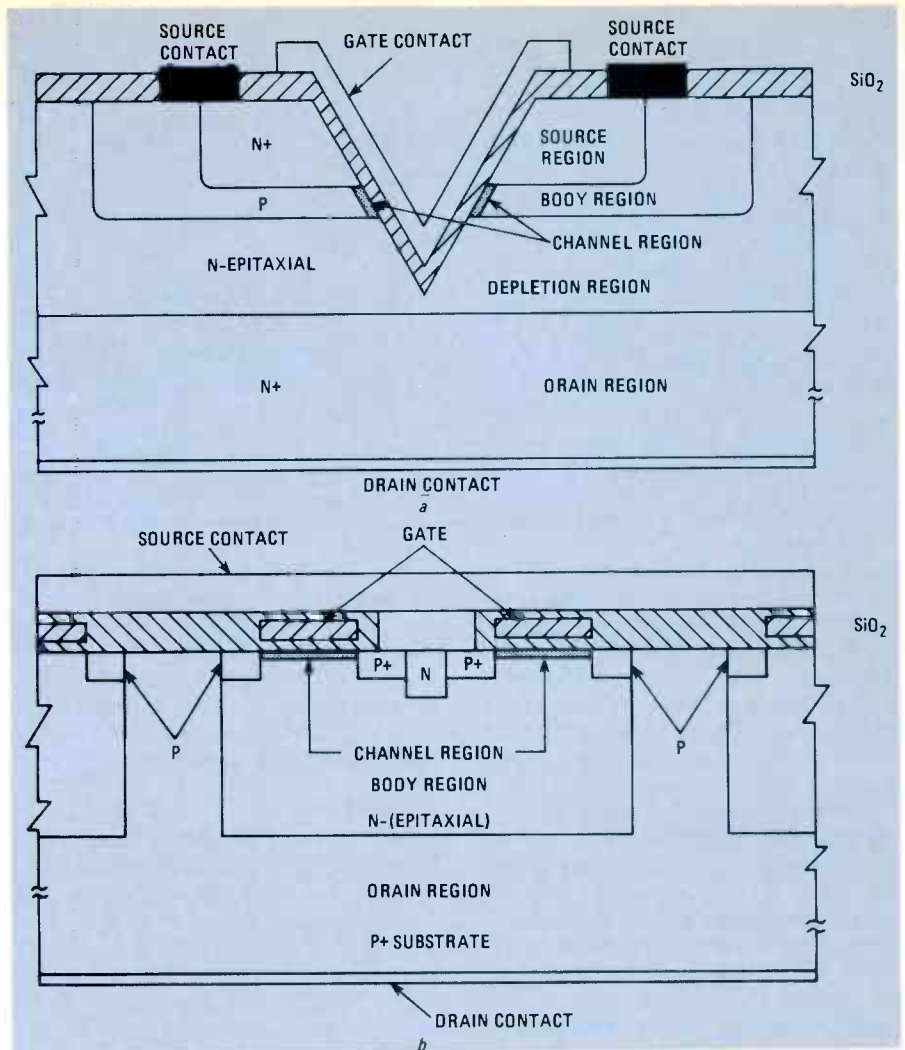

FIG. 6—CROSS-SECTIONAL VIEW of a V-groove VMOS transistor is shown in a, while a horizontal-channel VMOS transistor is shown in b.

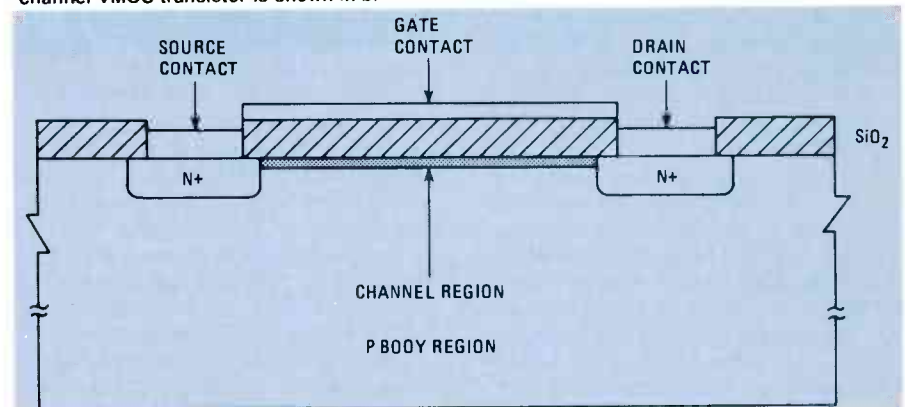

FIG. 7—N-CHANNEL MOSFET has channel region located directly under the top surface.

The P-channel horizontal channel VMOS shown in Fig. 6-b operates in a similar manner. In that structure, the channel is long enough to support the breakdown voltage without punch-through occurring, and the additional layer to accommodate the depletion region is not needed. However, because of the longer channel, the device exhibits more of a square-law transfer curve than the V-groove VMOS FET. Since the drain occupies some area at the top surface, the design results in less current-handling per unit area than the V-groove design.

Figure 7 shows the horizontal construction of the conventional MOSFET. The N+ source and drain regions are simultaneously diffused into the P-type substrate and the channel region is on the top surface of the substrate. Although the structure is admirably suited for complex digital integrated-circuit applications, some undesirable characteristics make it less suited for linear and not at all suited for power applications. The length of the channel in a conventional MOSFET is determined by the tolerances of the masks used to define the source and drain patterns. Since

DESIGN SMALL

LEONARD FELDMAN
CONTRIBUTING HI-FI EDITOR

FASHIONS IN LOUDSPEAKERS. AS IN clothing, come and go. The age of the large floor-standing speaker enclosure was supplanted by the bookshelf speaker in the 1960's and early 1970's, only to appear again, in modified form, in more recent years. And all the while amplifier power requirements and trends vary to keep pace with the so-called efficiencies of each era's favorite crop of loudspeakers.

For any speaker system in which the diaphragm of the low-frequency driver acts directly upon the air without the aid of a horn, three basic quantities—enclosure volume, efficiency, and bass response—are interrelated in such a way that each can be traded off against the others. A requirement such as high efficiency, previously deemed important because of the use of low-powered vacuum-tube amplifiers, is no longer as important now that solid-state high-powered amplifiers at relatively low cost are available. The optimum design of a loudspeaker depends not only upon the total cost allowed for the amplifier/speaker combination and the space available for the equipment, but also on the type of music to be reproduced, the maximum sound level required, the acoustics of the listening room, and the listening distance to the speaker.

During a recent visit to Great Britain, in connection with the Audio Engineering Society Convention held there, several other audio journalists and I had the rare opportunity of visiting the speaker manufacturing and design facilities of KEF Electronics Limited.

It was during that visit that I was supplied with much of the information concerning speaker efficiency and enclosure design that forms the basis of this article, and I am grateful to the people at KEF for their assurance in reducing what is a very complex subject to a form that is more readily understood.

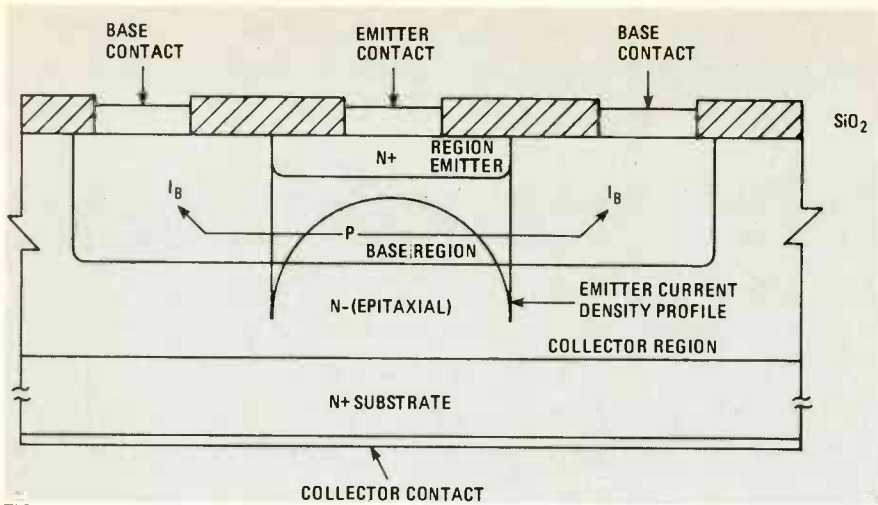

FIG. 8—BIPOLAR POWER TRANSISTOR has non-uniform current distribution resulting from base current flow.

those cannot be finely controlled, the channel must be relatively long. That results in a fairly low gain-per-unit-area, a high on-state resistance $R_{DS(ON)}$, and a square-law transfer curve. In contrast, the channel in a VMOS is determined by diffusion, so that a short channel can be achieved (about $\frac{1}{3}$ shorter), which increases gain, reduces $R_{DS(ON)}$, and provides a linear transfer curve.

The double-diffused (DMOS) transistor process also produces a short-channel FET by sequentially diffusing through the same opening in the oxide. Although that process produces an exceptionally good small-signal device, the DMOS FET is still of horizontal construction. A serious limitation of any horizontal FET is that, since both source and drain are on the top surface, separated by the channel, the current-handling capability per unit of silicon area is low compared to that of a bipolar device. As a result, the horizontal FET structure is only practical in low-power applications.

VMOS construction also has a positive effect on semiconductor longevity. If any part of the chip temperature exceeds the critical intrinsic temperature, second-breakdown may occur, making the device incapable of supporting voltage and usually resulting in destruction of the transistor. Although second-breakdown has been observed in MOS devices, the power levels required are extremely high compared to the power rating of the transistor. In contrast, second-breakdown is a basic limitation of bipolar transistors and is the primary factor in determining transistor power rating, especially at voltages close to the rated $V_{CEO(SUS)}$. As seen in Fig. 8, the base current flow in a bipolar is transverse to the main current flow in the base region, forward-biasing the edge of the emitter more than the center and resulting in the indicated current distribution. When a reverse-bias current is used to cause rapid turn-off, the bias causes current crowding in the center. Either situation results in local-

ized hot spots that can produce second-breakdown if a critical temperature is exceeded.

In a VMOS device, there is no mechanism to cause current density non-uniformities. Tests indicate that VMOS power capability is determined essentially by thermal resistance.

Conclusion

The ideal amplifier and the ideal switch have many of the same characteristics—zero on-state voltage, high gain, and freedom from reactive effects. The device represented by curve *b* in Fig. 1 is preferable for a switch. In actual devices, VMOS power transistors are the closest electronic device to the ideal amplifier or the ideal switching device. They overcome the severe non-linearities and frequency and switching-speed limitations of the bipolar device, as well as the poor linearity and high on-state voltage of conventional MOS-FET's. The only advantage of bipolar transistors is superiority in on-state voltage when used as a switch. In linear applications, however, the quasi-saturation region of bipolars limits load-line swings to about the same as VMOS. The VMOS construction results in higher gain than conventional MOS-FET's with less of a square-law characteristic problem, while eliminating the second-breakdown danger present with bipolar transistors.

Vertical MOS transistors can be produced with two different construction techniques; one uses a V-groove, while the other is a variation of the DMOS process. The resulting transistors are quite similar; however, the V-groove technique allows better use of silicon area.

VMOS transistors, therefore, are very useful in power applications as switches and amplifiers. With designer consideration of VMOS high frequency characteristics and a few circuit restrictions due to structure, VMOS transistors prove to be rugged devices, requiring simple circuitry. R-E

NING

SPEAKER SYSTEMS

The smaller a speaker system, the more critical the factors involved in its design become. Some of the relationships which must be considered are described here.

Efficiency and sensitivity

Because the human ear is a pressure-sensitive device, the output of a loudspeaker is generally specified as a sound-pressure level (SPL) in decibels, measured at a given distance from the speaker, rather than as an acoustic power output in watts. The concept of efficiency is therefore often expressed by a sensitivity figure, usually quoted as the dB SPL produced at a distance of 1 meter on-axis, for an input power of 1 watt.

Usually, the sensitivity is averaged over the mid-frequency range. The efficiency curve (curve *a*) of Fig. 1 shows the relationship between mid-band efficiency and sensitivity for a typical high-quality, high-fidelity loudspeaker system. Even though a speaker may have a relatively "flat" frequency response over its entire range in terms of sound pressure, its efficiency will not be uniform throughout its working range. Normally, if a flat pressure response over the whole frequency range of the speaker is the design goal, then the efficiency of the system at low frequencies may have to be twice as great or more than the efficiency at mid-frequencies.

While the sensitivity of a loudspeaker is usually measured in free air or anechoic conditions (no echoes), for practical purposes it is necessary to relate that figure to results obtained in a listening room. In an actual room, the reverberant sound has a predominant influence on the pressure level at the listening location. To determine properly the amount of amplifier power required, not only the distance from the speaker and maximum sound level, but also the cubic volume and sound absorption of the room have to be considered. Curve *b* of Fig. 1 shows the approximate amplifier rating required for a maximum SPL of 96 dB at a distance of 2 meters

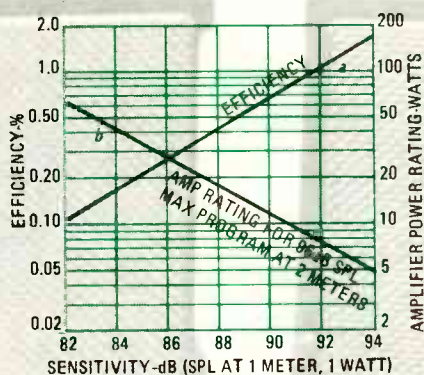

FIG. 1—EFFICIENCY VS. SENSITIVITY in the midrange frequencies for a typical hi-fi loudspeaker system is shown by curve *a*. Sensitivity vs. required amplifier power for a maximum SPL of 96 dB at 2 meters.

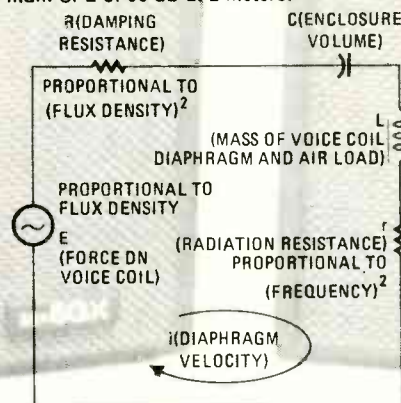

FIG. 2—EQUIVALENT CIRCUIT of a speaker system. Each electrical component represents a mechanical property.

in a typical listening room. For rooms having a high degree of sound absorption, more power would be required and vice versa. An increase of only 3 dB SPL would, of course, require a doubling of amplifier power. With some small loudspeakers, the power indicated by using Fig. 1 may well be more than the speaker can safely handle. In such cases, the user must be content with either lower volume levels or a reduce listening distance.

Equivalent circuit analysis

Midband sensitivity of a loudspeaker system is linked indirectly to efficiency in the bass region. Efficiency in the bass region, in turn, is related to enclosure volume and a lower cutoff frequency. That three-way relationship, which is similar for all types of loudspeakers in common use, can be illustrated by analyzing the behavior of a sealed enclosure—the so-called "infinite baffle" system. The efficiency and pressure response of a loudspeaker at the low end of the frequency range, where all the dimensions are small compared with the wavelength of the sound, are not too difficult to calculate. The acoustic impedance of the enclosure can be represented by a single constant while the diaphragm, moving as a whole, can be treated as a combination of mass and compliance having the radiation characteristics of a rigid piston mounted at the end of a long tube.

It is usual to represent the loudspeaker system at low frequencies by an equivalent electrical circuit. For that analysis, the most convenient form of the circuit is an electrical analog of the mechanical system, in which force is represented by voltage, velocity by current, mass by inductance, compliance by capacitance and damping by resistance. The circuit shown in Fig. 2 represents an "infinite baffle" system treated in that way. Signal voltage *E* is the driving force produced by current flowing through the voice coil, and is therefore proportional to the flux density of the magnetic field in which the coil moves. Resistor *R* represents the damping effect of the circuit formed by the voice coil and the amplifier output. If, for simplicity, we assume that the stiffness of the suspension is small enough to be neglected, that leaves only the stiffness due to the air trapped in the enclosure,

which is inversely proportional to the enclosure volume. The corresponding compliance, shown in the circuit as capacitor C, is therefore proportional to the enclosure volume.

Inductor L represents the mass of the voice coil and diaphragm, plus a small added mass that is part of the load imposed by the outside air. That air load also includes a small resistive component—the radiation resistance, represented by r. The power dissipated in that resistor is equal to the acoustic power output of the speaker. The value of r in that case is not constant but is proportional to the square of the frequency—a fact that has to be allowed for in calculating the response of the system—but it is too small to affect currents and voltages in the rest of the circuit. Finally, the velocity with which the diaphragm moves is represented by current I flowing through R, C, L, and r.

Given the values of E, R, C, L, and r, the low-frequency characteristics of the entire system can be calculated. It is also convenient to measure the response of an electrical simulation of the equivalent circuit to study the effect of varying different circuit constants. Curve a in Fig. 3 was obtained in that way and shows the response of a closed-box loudspeaker with an internal volume of 30 liters, which was designed to give a filter characteristic having a nominal cut-off frequency, f_3 (the frequency at which response is down 3 dB) of 50 Hz. The characteristic is of the form de-

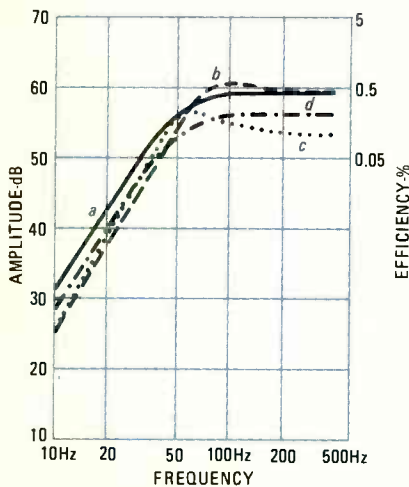

RESPONSE OF INFINITE Baffle SPEAKER DESIGNED AS MAXIMALLY FLAT 2ND-ORDER HIGH-PASS FILTER. ENCLOSURE VOLUME = 30 LITERS, CUT-OFF FREQUENCY, $f_3 = 50$ Hz

- ENCLOSURE VOLUME HALVED, ALL OTHER PARAMETERS THE SAME
- ENCLOSURE VOLUME HALVED, MOVING MASS DOUBLED
- - - ENCLOSURE VOLUME HALVED, MOVING MASS DOUBLED, FLUX DENSITY INCREASED $\sqrt{2}$ TIMES

FIG. 3—BASS RESPONSE of infinite-baffle speaker system. Curves show various effects of halving enclosure volume and altering various other parameters in order to maintain original response.

scribed in filter theory as maximally flat; a smooth curve without peaks or ripples, in which attenuation within the passband is kept as small as possible down to f_3 .

By changing component values in the electrical analog a number of alternative possibilities can be investigated. Would it be possible, for example, using the same diameter driver to achieve the same frequency response with only half the enclosure volume? Since L and C resonate at a frequency that is proportional to $1/\sqrt{LC}$, simply halving C (enclosure volume equivalent) will increase the frequency by $\sqrt{2}$ times. Curve b in Fig. 3 shows the resulting response. Frequency f_3 is now 55 Hz and the response is underdamped, resulting in a broad peak in the response at around 100 Hz. One approach to restoring the original frequency response

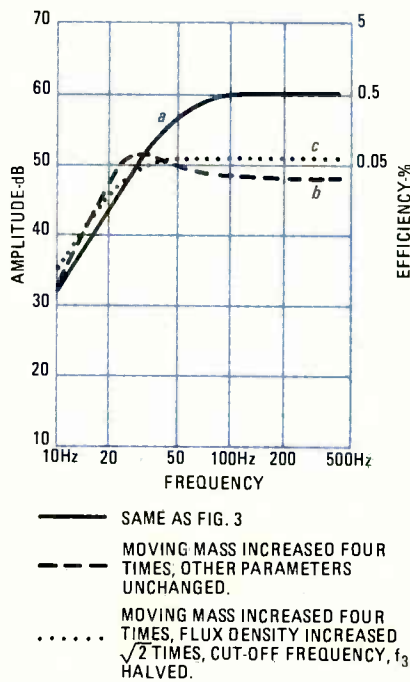

FIG. 4—DOUBLING VOICE-COIL mass extends bass response of infinite-baffle speaker system but at the cost of sensitivity.

would be to restore the original resonance frequency by increasing the mass of the diaphragm and/or the voice coil so that L is doubled. But that change in itself will not be enough. The resulting characteristic shown in curve c of Fig. 3 has an even higher peak than before and, worse still, on the flat part of the curve (at frequencies at which C has no effect) doubling the value of L has halved the current I, so that the level in the passband of the filter has been reduced by 6 dB.

Since the reactive impedances of L and C have been doubled, the only way to approach the original response curve (curve a) is to double the resistance R so as to preserve the proper reactance/resistance relationship. That can be done by increasing the flux density of

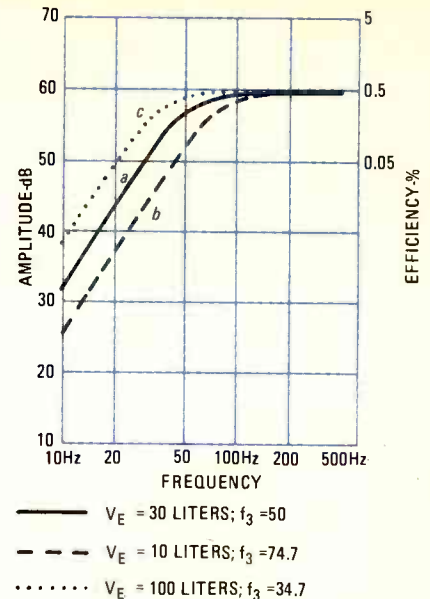

FIG. 5—CHANGING ENCLOSURE VOLUME while altering other parameters to maintain a constant efficiency results in a shift of the cut-off frequency.

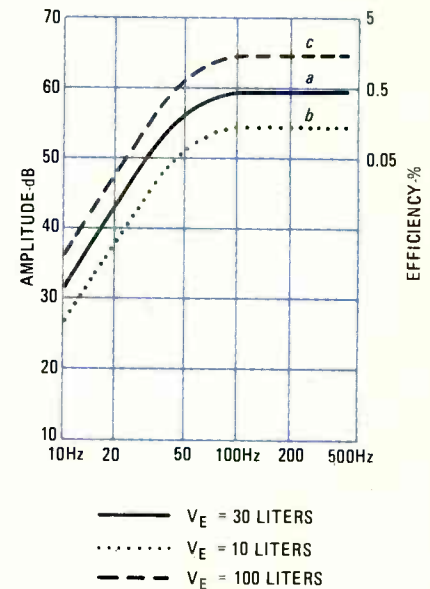

FIG. 6—MAINTAINING THE CUT-OFF FREQUENCY constant while changing the enclosure volume results in different efficiencies.

the magnet by a factor of $\sqrt{2}$. Signal voltage E will then be increased in the same proportion, recovering 3 dB of the 6 dB loss in level. Curve d of Fig. 3 shows the net result. The original frequency response has been achieved with an enclosure of half the previous volume, but at the cost of a more expensive magnet (for increased flux density) and a loss of efficiency of 50% which would now require an amplifier having twice the power rating than before.

Now suppose we wanted to keep the original enclosure volume and the original driver diameter but wanted to shift the whole frequency response curve down by one full octave, so that f_3 is half its previous value. For convenience, curve a of Fig. 3 has been

redrawn in Fig. 4. To extend response by an octave, the frequency of resonance between L and C must be halved, but since enclosure volume V_E is unchanged, the value of L will have to be multiplied by four, thereby reducing the level for the flat part of the response characteristic (curve *b* of Fig. 4) by 12 dB. Once again, this change in itself is not enough because at the new resonance frequency the reactances in the circuit are now twice what they were before, while the resistance is still the same, so that the system is now underdamped and the response curve is peaked. To restore the original curve shape, the damping resistance R is doubled, as in the previous example, by increasing the flux density $\sqrt{2}$ times, recovering 3 dB of the 12 dB

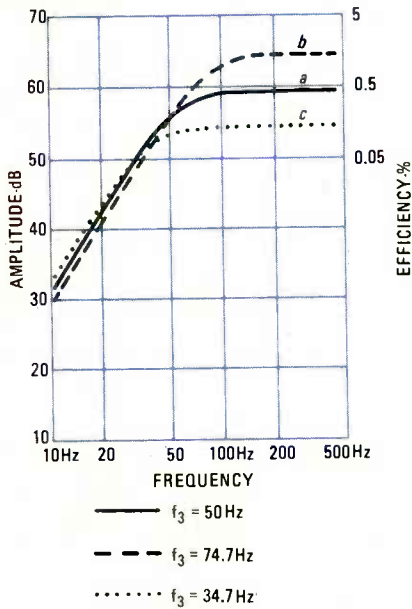

FIG. 7—MAINTAINING ENCLOSURE VOLUME constant while altering the cut-off frequency and designing for a maximally flat response.

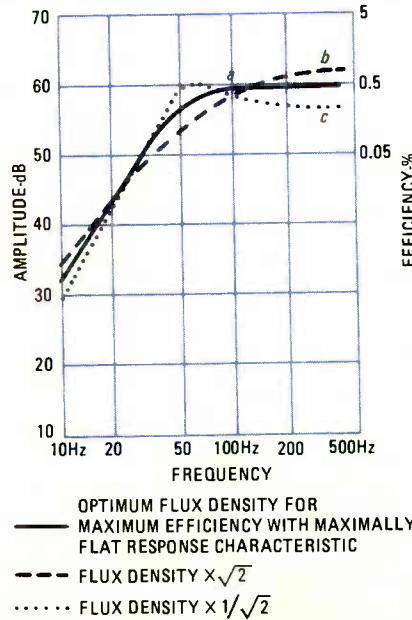

FIG. 8—ALTERING FLUX DENSITY while maintaining other parameters constant.

loss in the process. In curve *c* of Fig. 4 we see the net result and conclude that the price we had to pay for reducing the cut-off frequency of the system is a net reduction of level of 9 dB, despite the use of a more expensive magnet for the driver. A 9 dB loss in level represents an eight-fold loss in efficiency so that an amplifier having eight times the original power would be required for the same volume level.

A formula for efficiency

The efficiency (n) of a speaker that acts as a high-pass filter at low frequencies, is proportional to the internal volume V_E of the enclosure and to the cube of the cut-off frequency f_3 .

$$n = f_3^3 \times V_E k$$

The factor k depends upon the type

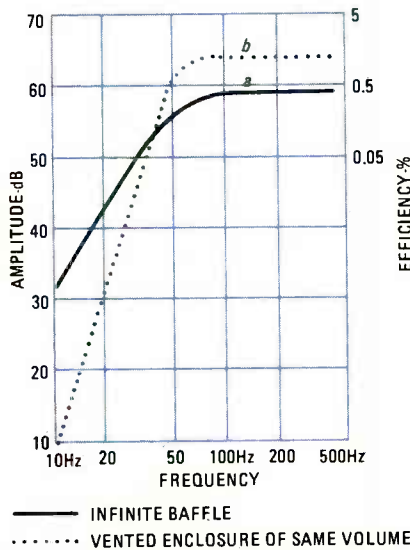

FIG. 9—INFINITE-BAFFLE enclosure vs. a vented enclosure of the same volume.

of filter network and upon whether the response takes the form of a gradual roll-off towards the bass, a maximally flat characteristic as shown in curve *a* of Fig. 3 or a peaked characteristic as shown in curve *b* of Fig. 3. In general high values of k (and hence high values of efficiency) are achieved at the cost of reduced bass, all other things being equal.

The relationships shown by the formula above are illustrated in systematic form in Figs. 5, 6, 7, and 8. In each of those figures, the reference curve is the same as that first shown in Fig. 3 (curve *a*) and represents the maximally flat response of an infinite baffle system with V_E equal to 30 liters and f_3 equal to 50 Hz. Curve *b* of Fig. 5, for example, shows the effect of reducing the enclosure volume to 10 liters while altering the diaphragm/voice coil mass and the magnet flux density by the amounts necessary to maintain the same efficiency and a flat frequency characteristic as before. Frequency f_3 has gone up to 74.7 Hz. Curve *b* of Fig. 5, on the other hand,

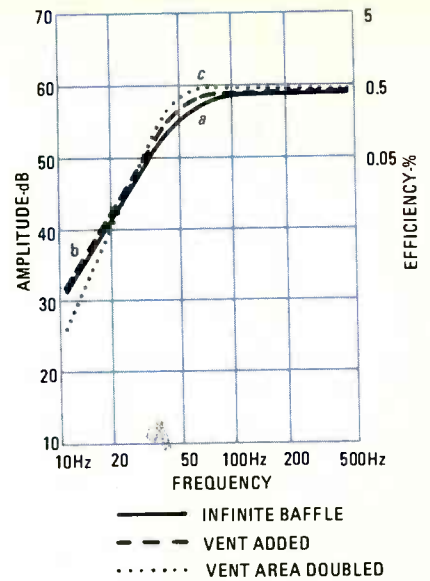

FIG. 10—ADDING A VENT to an infinite-baffle enclosure does not result in greater efficiency.

shows the response when the enclosure volume is increased to 100 liters with the driver parameters again having been adjusted to provide the same efficiency and curve shape. Frequency f_3 has now moved down to 34.7 Hz. A comparison of curves *b* and *c* of Fig. 5 reveals, as expected from the formula, that the change in enclosure volume in a ratio of 1:10 corresponds to a change in f_3^3 in the ratio of $74.7^3:34.7^3$, or 10:1.

In Fig. 6, curves *b* and *c* show the effect of reducing the enclosure to 10 liters and increasing it to 100 liters while at the same time altering the driver parameters to give the same value of cut-off frequency f_3 and the same general curve shape. The two extreme characteristics are separated in level by 10 dB (an efficiency difference of 10 to 1) as expected for a 10-to-1 increase or decrease in enclosure cubic volume, based on the formula shown earlier.

In Fig. 7, the enclosure volume is kept constant at 30 liters, but the parameters of the main driver are adjusted to give different values of f_3 while retaining the maximally flat overall response characteristic curves. Curves *b* and *c* are for cut-off frequencies of 74.7 and 34.7 Hz respectively. The 10 dB difference in level over the flat portions of the curves in each case represents a ten-to-one difference in sensitivity or efficiency.

Finally, Fig. 8 illustrates the importance of magnetic flux density, both in relation to efficiency and to frequency response of the system. Curve *a* represents a condition in which the flux density is exactly sufficient to give a maximally flat characteristic. Curve *b* shows the effect of increasing this value by $\sqrt{2}$ times; the response flattens out at a 3 dB higher level, which corresponds to a doubling of effi-

ciency, but it also droops badly at the bass end. Curve *c* shows the opposite effect of reducing flux density to $1/\sqrt{2}$ of its original value; the efficiency is now reduced by half, the system is underdamped and the response has a peak at 58 Hz.

Vented enclosures

The basic efficiency formula shown earlier applies to the vented type of speaker enclosure, which can be shown to act as a fourth-order high-pass filter. In the case of vented enclosures however, the value of *k* is higher, because the loss incurred through impedance mismatch at the bass extremes can be made less than it is with sealed-box systems. As a result, all other things being equal, the efficiency of a vented enclosure is generally higher.

A comparison between the infinite baffle and vented loudspeaker of equal enclosure volume, each designed for maximum efficiency with maximally flat characteristics is shown in Fig. 9. Though the response outside the passband falls off more rapidly with the fourth-order filter design (curve *b*), that system has 5 dB greater output level within the passband or about three times the efficiency of the corresponding "infinite baffle" design.

As KEF Electronics Limited point out in their study of efficiency and enclosure design, the high efficiency of a vented enclosure cannot be obtained simply by adding a vent to a system which has been optimized as an infinite baffle design. That is clearly demonstrated in Fig. 10, where the response of the infinite baffle design used in previous examples is shown in curve *a*, while curves *b* and *c* show some of the results obtained by introducing vents of different areas. Curve *b* is for a system in which the resonant frequency of the vent and enclosure together was made equal to the resonant frequency of the driver in free air and approximates a maximally flat characteristic with f_3 about 10% lower than in the comparable infinite baffle design. Note, however, that there is no increase in efficiency within the passband. In curve *c*, the vent area has been doubled and we begin to see the beginnings of a peak in the response but no improvement in efficiency. Clearly, to get any more out of this system a radical redesign would be necessary.

What has been said about vented enclosures applies in practice to so-called passive radiator designs in which a drone-cone or diaphragm takes the place of an actual open port or vent. Based upon what we have seen so far, one might expect the vented enclosure (or its passive radiator equivalent) to dominate the speaker marketplace. For small enclosures, however, the

effectiveness of a vented design is offset by frictional losses, and there are practical dimensional obstacles to the use of passive radiator designs, so that most "bookshelf" type loudspeakers remain sealed enclosure designs.

With large floor-standing models, too, a sealed box design is sometimes preferred, because at subsonic frequencies, the constraint imposed upon the driver diaphragm by the enclosed air reduces the degree of cone displacement that might be caused by record warp or amplifier DC offset (especially if some of the newer DC-coupled amplifiers are used). Such subsonic excursions, if excessive, produce audible levels of intermodulation distortion and might even damage the driver. Furthermore, it is often possible to raise the efficiency of an infinite baffle system so that it is equal, or nearly equal, to that of a corresponding vented enclosure by introducing additional electrical components at the input to the loudspeaker. Because of the close electromagnetic coupling in the driver, those components become, in effect, an integral part of the mechanical system, converting the simple second-order filter circuit (infinite baffle) to a more complex filter form that can be designed to give a better match at the extreme bass end.

Summary

To meet the demand for a response characteristic that remains substantially flat down to the nominal bass cut-off frequency, the enclosure volume for a given midband speaker efficiency has to be greater—or the efficiency for a given sized enclosure has to be less—than with a system in which the response is allowed to droop at the bass end. Enclosure volume and efficiency are critically dependent upon the cut-off frequency. An extension of the useful working range of a speaker by as little as one third of an octave (e.g. from 55 Hz to 43.6 Hz) would require either a doubling of enclosure volume or a reduction of efficiency by one half, or some combination of both conditions.

While relative efficiencies and speaker sensitivities can be reliably predicted using the analog circuitry described earlier, the subjective impression of loudness produced by any loudspeaker depends upon the acoustics of the listening room and cannot be judged from considerations of efficiency alone. In selecting a speaker system, therefore, whenever possible, subjective judgments should be made with the loudspeaker set up in the location where it is to be used and using program material of the type that will normally be played through it at maximum desired loudness levels. R-E

BUILD THIS

HOME INTERCOM

DAVID J. SWEENEY

DOES YOUR FAMILY USE YOUR HOME intercom system? Or did interest in the little boxes disappear once the novelty had worn off? For the ordinary communications that are usually shouted around the home, the wired "all-call" system described here can actually be used with very little effort.

Although the system operates as an "all-call," the need for only a single two-conductor bus wire keeps the installation simple and inexpensive. And the system is simple to operate: When Mom wants Junior, whether she's in the kitchen, basement, or wherever else there's an intercom unit installed, she presses the switch and speaks. Then Junior (wherever he is) hears the call, and presses the switch on a convenient unit to answer.

When someone presses a TALK switch the speaker's voice is transmitted to all other units. There's no need to find a correct channel or even to think about the system's operation. With no volume to set, no squelch to adjust, and no beeper to answer, the design offers no resistance to conversations, but instead offers convenience. The results are reduced walking and less shouting.

Another benefit of the construction technique is that each wall unit contains identical circuitry and can be connected at any point along the two-conductor wire. Additional units are easily added; maintenance is simple. If one unit fails the rest of the system continues to operate.

System description

Integrated-circuit technology has made amplifier gain and amplifier power inexpensive. The cost for a basic IC amplifier compares favorably with the cost of nuts and bolts! In the intercom system described here, a number of IC's form a system of distributed amplifiers, each with a speaker and a push-to-talk switch (there is no central amplifier). The power and signal input to all amplifiers is from a low-impedance two-conductor speaker wire (see Fig. 1) that runs through the house.

When any unit is switched to the TALK position by pressing the DPDT switch, the amplifier is turned around.

INTERCOM SYSTEM



An intercom in the home saves wasted steps and needless shouting. This all-master intercom system has a simple amplifier in each station and uses 2-conductor cable throughout.

The speaker becomes a microphone and the amplifier output drives the signal-side of the two-conductor wire. The amplifier provides a low-impedance output with enough signal voltage to drive the inputs to the remaining ampli-

fiers. The output voltage is dissipated by an attenuator at the input of each amplifier. In parallel, the attenuators keep the signal wire at a low impedance to ground. Each attenuator includes a variable resistance. That screwdriver

adjustment sets the input to a comfortable level for the IC.

Normal operation requires the user to press the switch and speak. There is no need to move close to the speaker or to shout: the speaker/microphone sensitivity is more than adequate. If the caller decides to shout, the dynamic range of the complete loop from microphone to the outputs of the other units provides a very loud output with perhaps a slight loss of intelligibility.

The wall unit

For such applications, special-purpose speakers are available that can be used as a microphone. Those speakers are designed to generate high voltages to drive a long line, and are usually built with a 45-ohm impedance. With this distributed amplifier design, however, the output is driven by an active circuit, and special speakers are *not* required. All components used in the wall unit are common, inexpensive, and readily available from supply houses.

The heart of the unit is the TAA621 linear integrated circuit (see Fig. 2). That monolithic audio amplifier operates well on any supply voltage from 6 to 24. For this application a 9-volt supply works well and no heat sink is required. (The power-amplifier IC is supplied with a heat sink and spacer bar as part of the mounting assembly. We recommend that you use those accessories and follow the mounting details shown in Fig. 3.—*Editor*)

Although the unit is basically an operational amplifier, bias centering is handled internally. The open-loop voltage gain is on the order of 70 dB, which means that no preamplifier is needed. With a direct-coupled, high-input impedance, the overall frequency response compares favorably with that found in TV receivers or table radios. Each unit draws about 20 mA. Batteries could be used to power the system if desired.

When someone speaks, transformer T1 (Fig. 2) steps up the voltage from the speaker (which is now a microphone) to a usable level. The transformer is used

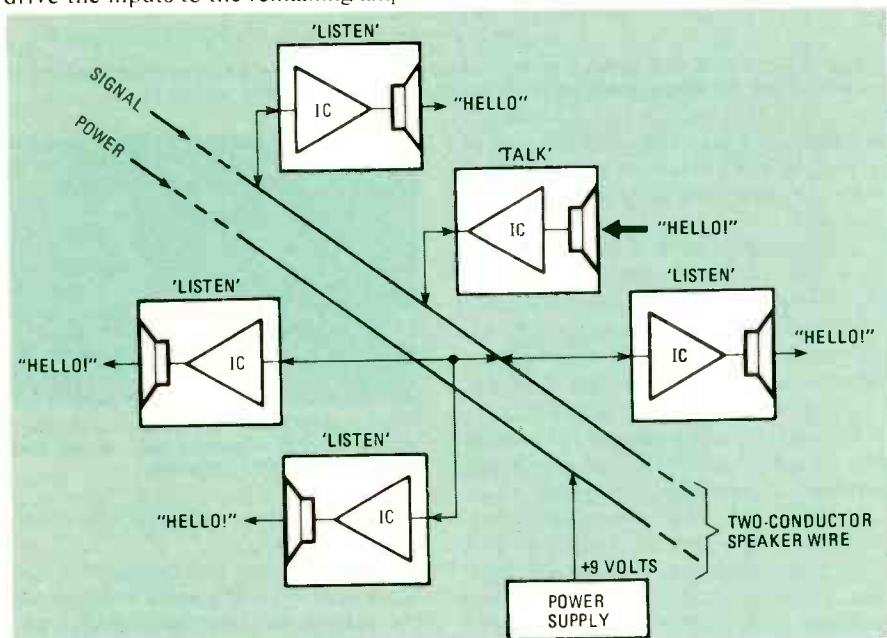

FIG. 1—ALL DISTRIBUTED INTERCOM wall units are normally in the LISTEN mode. Unit changes to TALK mode when switch is depressed.

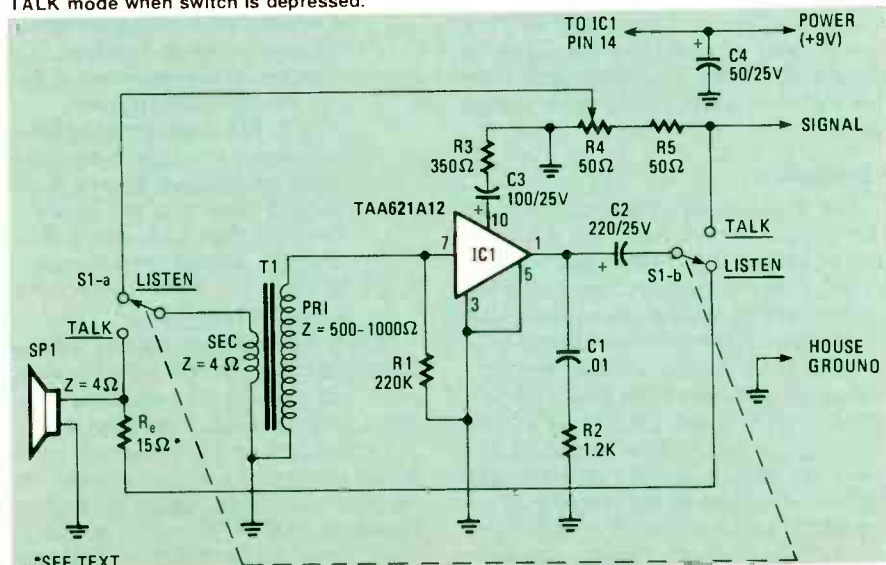

FIG. 2—HEART OF INTERCOM unit is linear-IC monolithic amplifier; works on 6-24 volt power supply.

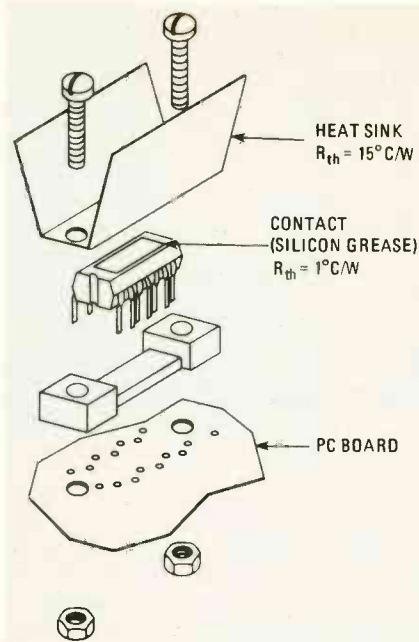

FIG. 3—MOUNT the TAA621A12 with spacer and heat sink for good mechanical stability and heat dissipation.



FIG. 4—CIRCUIT BOARD, speaker, and switch are set into wall on a piece of paneling, near a wall switch to connect to house ground.

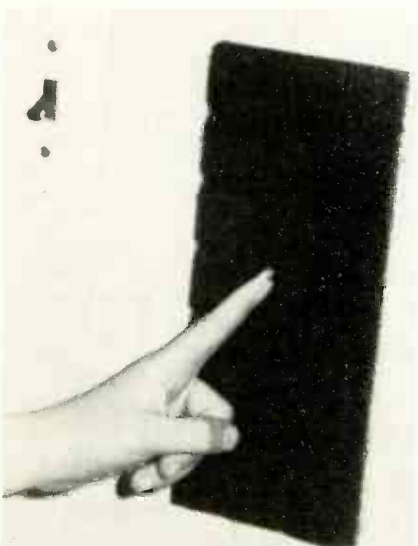

FIG. 5—FOAM GRILLE CLOTH covers wall unit face, with the toggle switch available through a small hole.

PARTS LIST (for each station)

All resistors are ¼ watt, unless otherwise noted

R1—220,000 ohms
 R2—1.2 ohms
 R3—350 ohms
 R4—Potentiometer, 50 ohms, ½ watt
 R5—50 ohms
 Re—15 ohms
 C1—0.01 μ F, 25 volts
 C2—220 μ F, 25 volts
 C3—100 μ F, 25 volts
 C4—50 μ F, 25 volts
 IC1—TAA621A12 integrated audio amplifier (SGS-ATES)

F1—¼ amp fuse
 S1—DPDT spring-return rotary or lever switch
 SP1—loudspeaker, 1 watt, 3.2 ohms, 3-inch diameter
 T1—miniature audio output transformer; 500–1000 ohms primary, 4 ohms secondary

Note: The TAA621A12 audio-amplifier IC can be ordered from Lorcor, 4 Lakeside Park, Wakefield Park, Wakefield, MA 01880 for \$3.90 each including postage and handling.

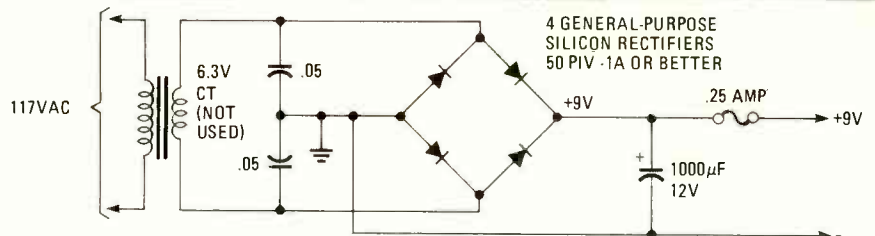

SUGGESTED AC POWER SUPPLY for the intercom system. Note that the transformer need not be center tapped. Rectifier diodes can be 1N4001 or higher value (1N4002/3/4, etc.)

in either the TALK mode or in the LISTEN mode. In the LISTEN mode, the input from the signal line is attenuated by R4 and R5.

The output (pin #1) is applied through R_e to the speaker. Resistor R_e provides the 16-ohm output impedance for the IC. The impedance of the speaker is only 3.2 ohms, which is too low for the amplifier. Resistor R_e also protects the IC in the event of shorted speaker leads.

Resistor R3 and capacitor C3 control the amplifier gain. The values shown provide a good frequency-gain characteristic. All other components are used to satisfy the IC operation. Pay close attention to C4. The power-supply line picks up noise because the impedance to ground is not low, and the noise must be bypassed by C4. The capacitor value of 50 μ F is a minimum value; any smaller value could result in some static or hum when the unit is in the LISTEN mode. However, with a 50- μ F capacitor, there should be no audible noise.

Installation

The wall unit can either be mounted directly in the wall (see Figs. 4 & 5) or in a box that hangs on the wall. In either case a two-conductor connector is recommended for the power and signal lines. The unit should be mounted near a light switch or receptacle for convenient connection to the house ground. At the power supply, the house ground should be connected to the chassis and used as the negative power-supply return. The power supply should be fused at ¼ amp or less. The schematic for a suitable power supply is shown in Fig. 6. The transformer should be any

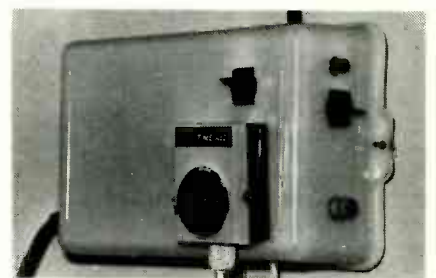

FIG. 7—LAMP TIMER connected to 9-volt power supply through a special timer socket turns system on and off as desired.

standard filament type that can supply 300 mA or more.

For pushbutton-free operation, a lamp timer (see Fig. 7) can be used to turn the system on in the morning and off in the evening. Here are some other useful options:

- Individual power switches for bedrooms, since someone who is napping may not want to hear the all-call conversations.
- A LED (Light-Emitting Diode) pilot light. If a lamp timer is not used, an indicator may be necessary to show that the system is on or off. The LED with a series resistor should be connected across the input power after wall unit fuse F1.

When you decide on the unit location, keep in mind the possibility of feedback from one unit that is very close to another unit. If such a problem occurs, the attenuator in each unit can be adjusted to prevent one unit's sound from feeding the mike input of another. However, unless the units are in the same room, that problem will probably not occur.

R-E

Synthesized

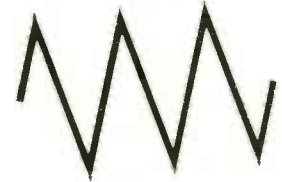
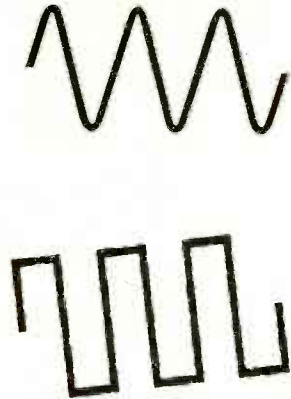

Function Generator

GARY McCLELLAN

Part 2—Here are complete instructions for building and using the Synthesized Function Generator.

LAST MONTH YOU STARTED OBTAINING the parts and PC boards for the SFG. We hope that you were successful and are now ready to start building. The first thing to do is to "stuff" the two PC boards; then you wire the case. Take your

time and this should be an easy project. Before starting with the construction, first take a look at Figs. 5 and 6 which are the parts-placement diagram and photo of the analog board. Study the parts locations carefully, then start construction of

the analog board. Install an 8-pin socket at the IC1, IC6 locations, a 14-pin socket at IC2, and a 16-pin socket at IC3. Do not install the IC's themselves until after all assembly has been completed.

Next, install the voltage-regulator

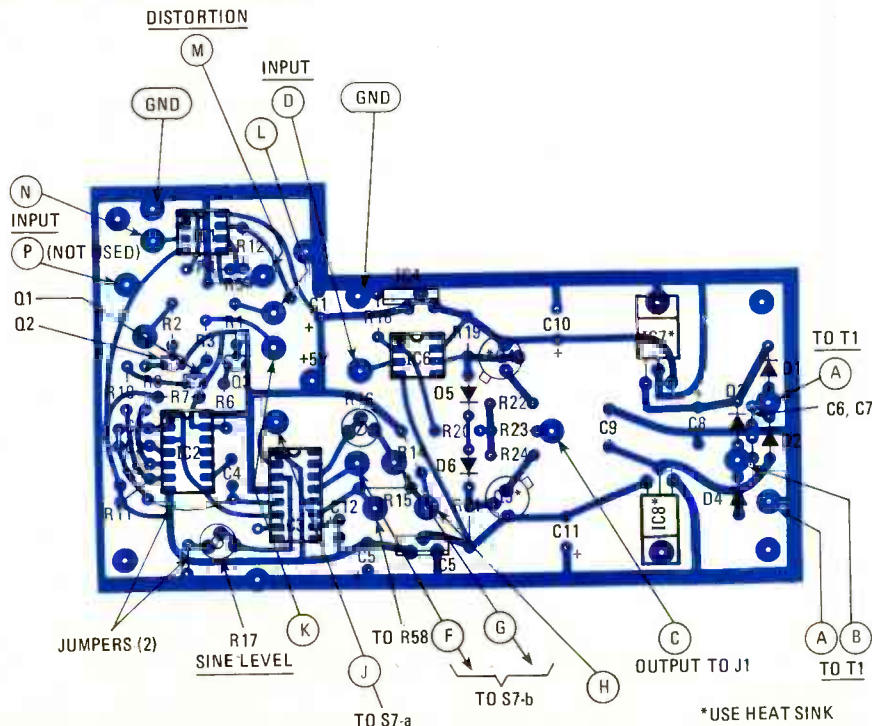

FIG. 5—PARTS PLACEMENT on the analog board. Don't overlook the jumpers, watch the polarity of the electrolytic capacitors, and be sure that the semiconductors are properly oriented.

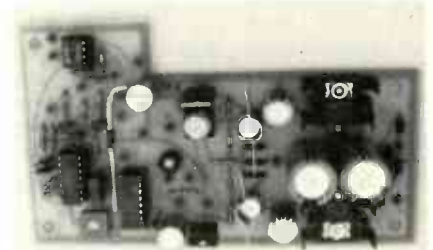

FIG. 6—TOP VIEW of the analog board. Study this carefully before you begin "stuffing" the board. Note the heatsinks on IC7, IC8, Q4 and Q5.

IC's—IC4, IC5, IC7 and IC8. Note that heatsinks are required for IC7 and 8 only; they are small ones and mount directly on the board with the IC's. Now install the two jumpers in the lower left corner of the board. Those are the only jumpers to be installed. Continue by installing the electrolytic capacitors. Start with C8 and C9 (1000 μ F), then move left and install C10 and C11 (100 μ F). Be sure to watch the polarity of those capacitors; for your convenience it is printed on the foil side of the PC board. Continue by installing C1 and C5 (47 μ F); and, finally, install C12 (1 μ F tantalum) next to C5.

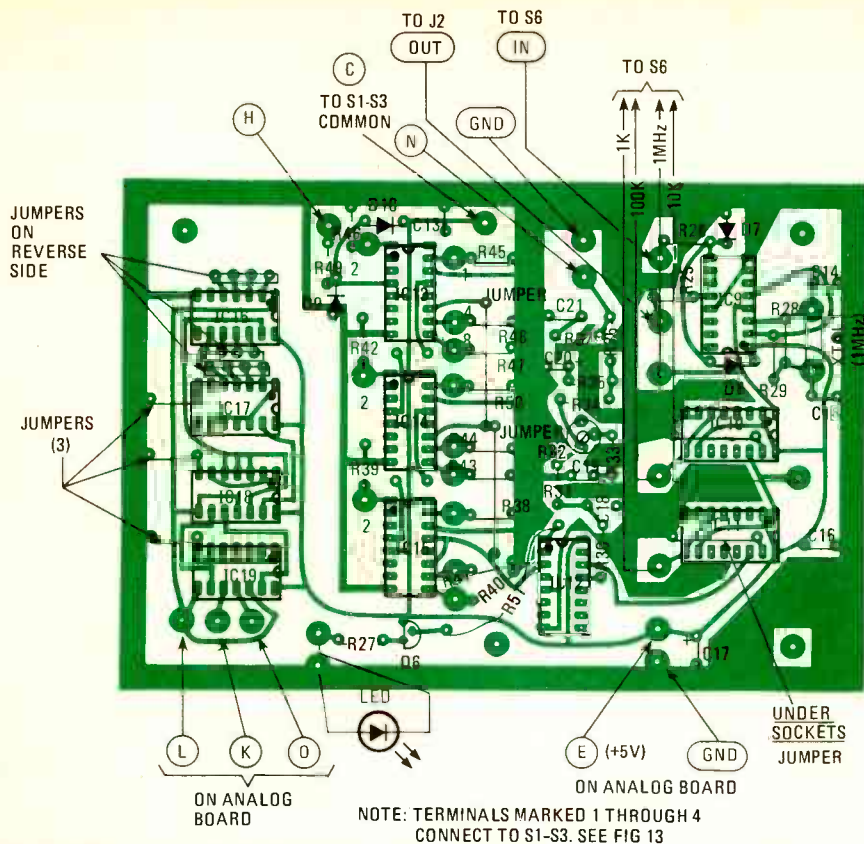

FIG. 7—HOW PARTS ARE POSITIONED ON the digital board. Follow text for wiring sequence for easier assembly. Don't forget the jumpers that are on the foil side of the board.

At this point you have the major components installed and should be able to see that the board has taken shape and looks like Fig. 6. Continue by installing diodes D1–D4 (1N4004's) near the edge of the board, then install D5–D6 (1N4148's) in the spaces near the center. After you finish, recheck the diodes for proper installation. Now the resistors can be installed. Start with R22, R23, R24 (10 ohms, 1/2 watt), which mount in the center of the board; then jump left and install R19 and R21 (4.7K). Next, add R20 (2.2K) in the middle of the board. Go left still farther and install two 2.2K resistors at R14 and R15; then install pot R16 (500 ohm) and R18.

Stop for a moment and check carefully to be sure that the resistors are in the proper places and all connections are soldered properly. Now move left across the board still farther and install R12, R4, and R5 (100K). Next, go down and install R1, R2, and R3 (10K). Continue with R6 (1K) and R7 (15K). Move left slightly and install R8 and R10 (1K). Move down and install R9 and R11 (15K). Then jump right and install pot R17 (50K). Finish up by installing R13 (2.7K), noting that it stretches between two widely separated points on the board. Use spaghetti tubing on the exposed leads to insure that there are no shorts with adjacent components.

Take a short breather and continue with the transistors. Install Q4 (2N2219) first, then slip a heatsink over the case. Now install Q5 (2N2905) and slip another

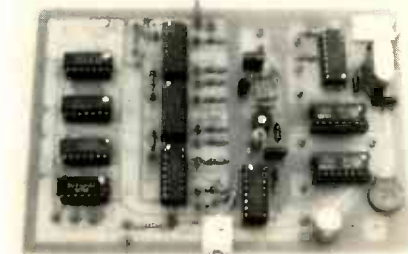

FIG. 8—TOP VIEW OF the digital board. The white pieces at bottom center and top right corner are metal mounting brackets.

er heatsink over the case. **Be sure that the two sinks don't touch after they are installed.** Then move to the left of the board and install Q1, Q2, and Q3. Note that the flat spot on each case faces to the top of the board. Complete construction by installing the remaining capacitors. Start at the right of the board with C6 and C7 (0.01 μ F) which go between the diodes. Then go left and install C4 (0.1 μ F Mylar) next to the 14-pin IC socket. Move to the other side of the socket and install C2 (0.001 μ F Mylar) and C3 (0.01 μ F Mylar). Finish up the board by installing the IC's.

That completes the construction of the analog board. Be sure to check for proper parts placement and to be certain that all solder connections are good before going any farther. Make any corrections necessary, then set the board aside until later.

Wiring the digital board

Now you can stuff the digital board.

First, refer to Fig. 7 for parts placement; start construction when you are reasonably familiar with that drawing. Position the board as shown with the large foil block in the top left-hand corner. Now you are all set to begin construction. Start with the wire jumpers on the component side. Note that there are a total of seven. Begin by installing the two in the IC10 and IC11 spots, noting that they run between the IC's and ground. It is important to install them now, as IC sockets will be installed over them shortly. Then move to the center of the board and install the two long jumpers as shown. They link the pin-11 terminals on IC13, IC14 and IC15, and are important. Next, go over to the left edge of the board and install the three jumpers next to IC's 17, 18 and 19. That takes care of the component side jumpers.

Now install the sockets. If desired, start by installing a 16-pin unit at IC9, IC10, and IC11. Then move to the bottom center of the board and install the socket for IC12. Now install the remaining 16-pin sockets at IC13, IC14, and IC15. Stop for a moment to recheck all solder connections (it's easy to miss one!), then continue with the 14-pin sockets. Install one at IC16, IC17, IC18 and IC19. Recheck your solder connections and take a short breather.

The next step is to continue with the resistors. Note that most of them are of 100K value on this board. We'll get to them shortly, but first let's install R28 (22 megs) next to IC9. Then install R29 (1K) adjacent to it. Move up to the top of the board and install R26 (15K) on the other side of IC9, then go below it and install R25 (100 ohms). Install R36 (100K), then R37 (10K) next. Move down a little more and install R35 (47K) and R34 (100K), which are next to each other. Continue with R33 (100 ohms) and R31 (10K) which are at right angles to each other. Then install R30 (47 ohms) and R51 (15K) on either side of IC12. Use spaghetti tubing on R51's leads to avoid shorts.

Stop for a moment and recheck all resistors for proper placement. Then continue by starting at the top center of the board. Install 100K resistors in the following places: R45, R48, R47, R50, R44, R43, R38, R41 and R40. Be sure not to miss soldering any of the leads. Then jump over IC15 and install the remaining 100K resistors at R39, R42, and R46. Finish up by installing a 15K resistor at R49 and trimpot R32. **Be sure not to get the R46 and R49 positions mixed up!** Take a breather and recheck your work, making any corrections necessary.

Resume construction by installing crystal XTAL1, next to IC9. Use the soldering iron sparingly to avoid overheating and damaging the crystal. Then install the diodes. Note the position of the banded ends as you install them. First, install D7 and D8 (1N4148) at the ends

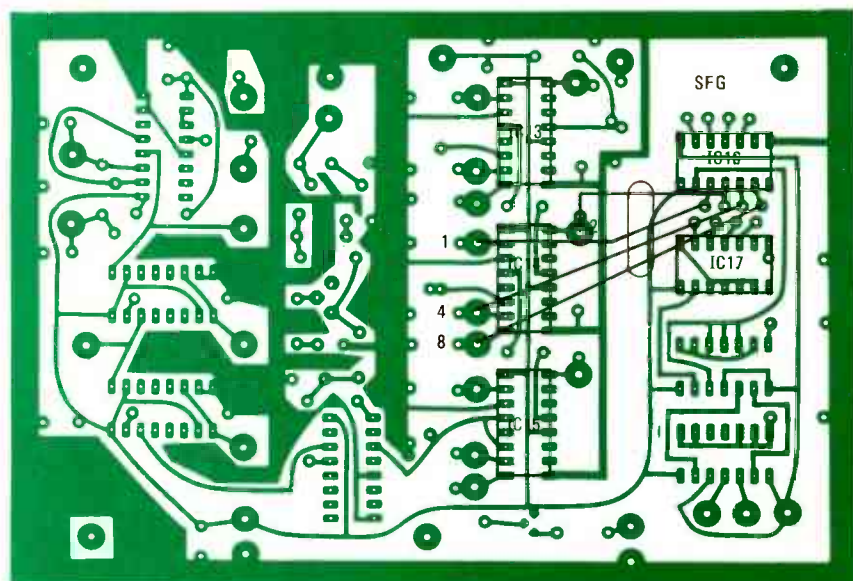
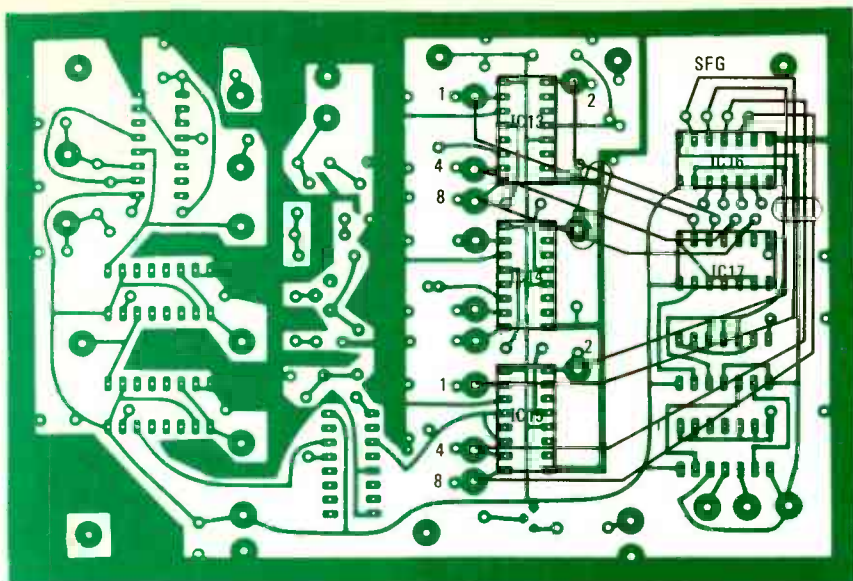

FIG. 9—TWO DIAGRAMS showing placement of the jumpers on the foil side of the digital board. Flat, color-coded cable can be used for the jumpers.

of IC9, and move over to IC13. Then add D9 and D10 (1N4148) as shown. Move down to the bottom of the board and install Q6 (2N3906) with the flat spot in the case pointing to the left. At the same time, install R27 (270 ohms) next to Q6 if you haven't done so yet.

The last components to be installed are the capacitors, so start with C14 (10 pF) and C15 (39 pF) first. Then add C16 (0.1 μ F) below them. Move to the bottom of the board and install C17 (47 μ F), being sure to observe polarity. Now go to the top center of the board and install C13 (0.1 μ F) next to IC13. Then move to the right and install C21 (0.068 μ F Mylar). Next, install C20 (4.7 μ F tantalum), being sure to watch the polarity. Move down farther and install C19 (47 μ F tantalum), watching the polarity. And finally, install C18 (0.047 μ F Mylar) as shown. That finishes the component installation on the digital board. Stop and check your wiring carefully for bad solder joints, then correct any you find. Your

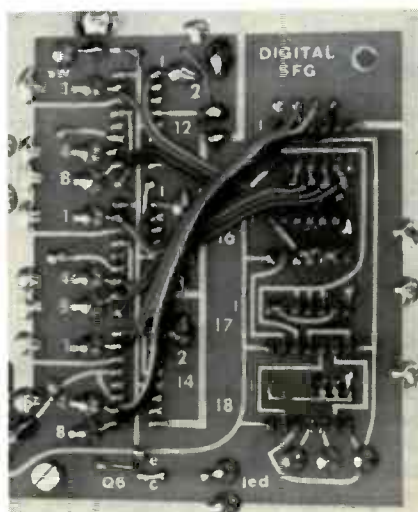

FIG. 10—FOIL SIDE of the digital board shows wire jumpers as they appear when formed from flat cable. digital board should now look like that in Fig. 8.

The remaining wiring on the digital

board consists of connecting some jumpers on the foil side. Fig. 9 shows the details, so look it over first before starting the wiring. As you can see, the jumpers connect the "1", "2", "4", "8" inputs on IC13-IC15 to the inputs of gates IC16 and IC17. Use short pieces of ribbon cable for the connections. Start with the inputs off IC16, pins 2-5. Cut a short length of 4-conductor cable and connect the ends as shown to IC15 first, then IC16. Cut another piece of cable and connect it as shown between pins 2-5 of IC17 and the inputs of IC13. Finally, repeat the process with a short piece of cable between pins 9-12 of IC16. Finish up by checking for shorts, inserting the ICs. Compare your board with Fig. 10 then set the board aside temporarily.

Final assembly

The last thing to do with the SFG is to prepare the case and install the PC boards in it. The photos of the project readily show how this can be done. Start by preparing the cabinet (drilling the holes, painting, and labelling it) to suit your requirements or else to match the prototype. Next, mount the front-panel devices like the switches, pots, and connector; then mount transformer T1, the fuseholder, jack J2 and the switch on the back of the cabinet. Now you are all set to mount the analog and digital boards. Use 4-40 threaded 1/4-inch spacers to mount the analog board temporarily on the bottom of the cabinet; then mount the digital board "standing up" as shown in Fig. 12 using two aluminum "L" brackets and 4-40 hardware to hold it in place. That should take care of the mechanical construction of the project.

The next thing to do is wire the boards together and to the components in the box. The drawing in Fig. 11 and photo in Fig. 12 show how. To make working with the boards easier, push-on connectors were obtained from AMP Electric. However, since those connectors aren't readily available, low-cost Molex connectors may be used instead. Start by wiring the power connections first to T1, then continue by connecting the secondary leads to the analog board. Next, start wiring the front panel pots, connector, and switch to the board. Be sure to use shielded cable for the LEVEL pot to minimize noise pickup. Use subminiature coaxial cable such as RG-174 for the connections. Finally, connect the ground pad on the circuitboard to the case ground.

It is rather important to note that there is only one ground point in this project. Having several grounds might introduce noise in the output signal, so you don't have to make any more ground connections other than this one. Next, the digital board is wired. A good place to start is by making the connections between it and the analog board—and that includes the lone ground connection as shown in Fig. 11. As you did for the LEVEL control, be

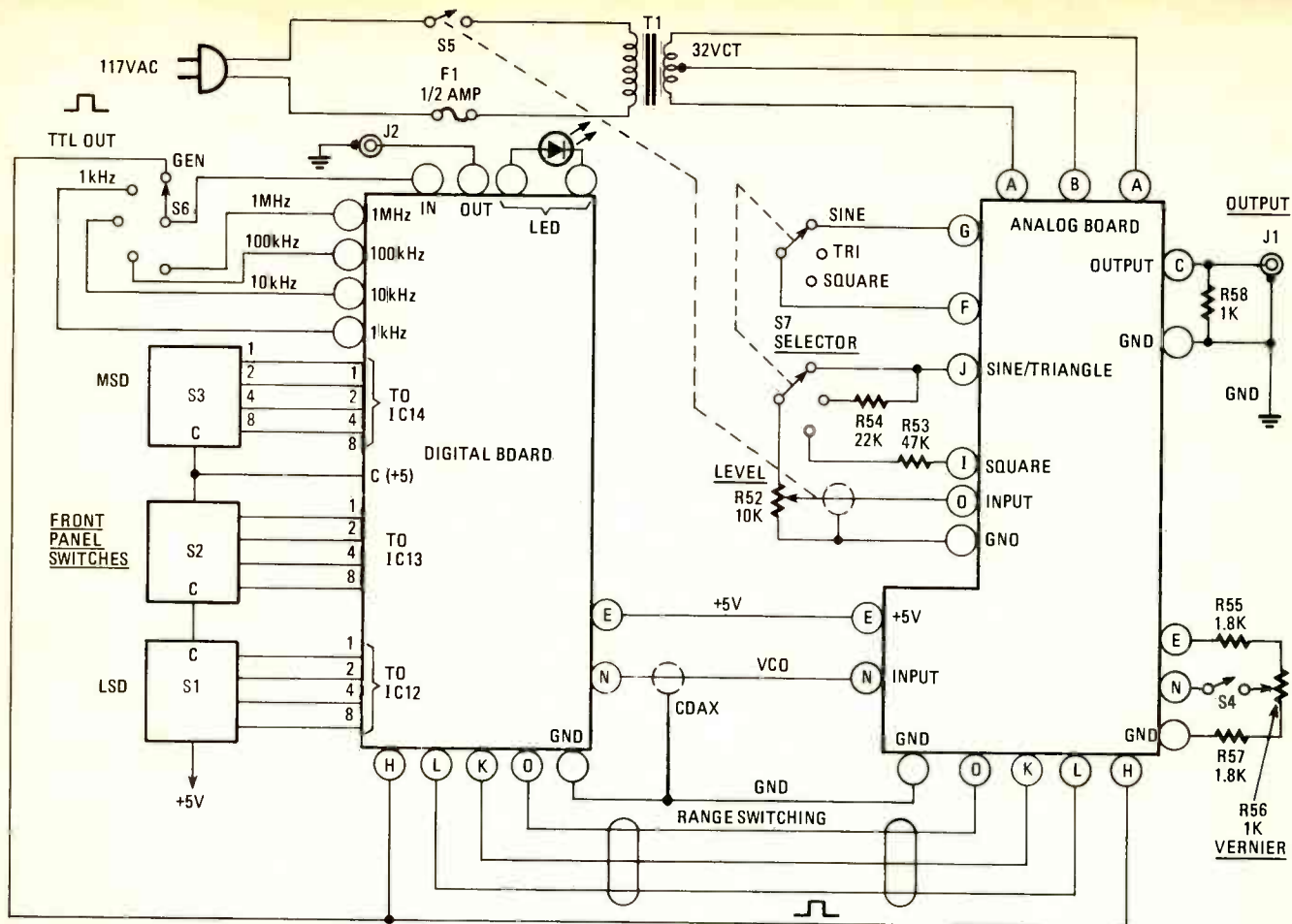

FIG. 11—FUNCTIONAL DIAGRAM shows how the boards connect together and to off-board components.

sure to use coax cable for the VCO line (pin "N"); that will reduce noise on the output signal. Note that the cable is grounded *only* at the digital board end; that minimizes noisy groundloops. The next step is to connect up the frequency switches. Tie all the "C" terminals together with a piece of bus wire, and bring out a short piece of wire for connection to the +5-volt supply. Then get some 4-conductor ribbon cable and cut it into three pieces of about 6 inches each. Solder the wires of each cable to the "1" "2" "4" "8" terminals on each switch deck. After that, connect each wire to the corresponding pad near IC13-IC15 (74C192) on the digital board. Finally, finish up the wiring by hooking up switch S7 and jack J2 on the rear panel. For a neater appearance you can use a short length of six-conductor ribbon cable for those connections. That takes care of the cabinet wiring. Be sure to give it a quick once-over to check for errors, and correct any you find.

At this point you are all set to try the project out, calibrate it, and then put it to good use.

Calibration

To calibrate this project effectively, and get maximum performance out of it, you'll need a few pieces of test equipment. At the least, obtain an oscilloscope with triggered sweep. A distortion ana-

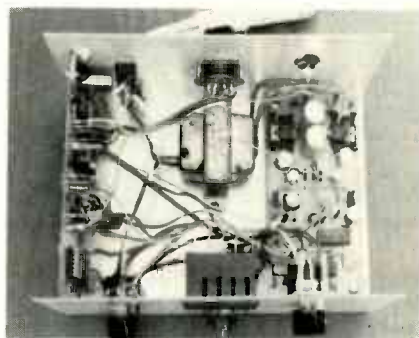

FIG. 12—INTERIOR VIEW of the instrument shows how the boards and off-board parts are positioned.

lyzer (THD type) would be desirable for adjusting the sine distortion. However, you can do a good job with just the oscilloscope.

Start calibration by setting the frequency switches for 010 (1 kHz), VERNIER OFF, and the selector for a sinewave. Connect the scope across the output jack and apply power to both the project and the scope. Moving inside the cabinet, carefully set all three pots to the center of their ranges.

Note that the ERROR light is out or possibly blinking very slowly. If it is blinking, adjust DAMPING pot R32 carefully until it stops. When that light is out, the project is both working properly and in frequency calibration. If it won't go out, there's a problem and you should see

the Troubleshooting section. Once that is taken care of, advance the LEVEL control and look at the sinewave on the scope. Next, adjust R16, DISTORTION, on the analog board until you get a smooth-looking sinewave. Expand the scope sweep to be sure that the top and bottom of the sinewave are nicely rounded. Then adjust the SINE LEVEL pot, R17, for maximum output without clipping (flattening). Back it off slightly to be safe. Now switch to the TRIANGLE position and note the peak-to-peak value of the waveform. Switch back to the SINE position and adjust R17 so that the peak values are approximately equal. That takes care of the sinewave calibration. If desired, switch to 99.9 kHz and then 100 Hz to check the quality of the waveform. A slight adjustment may be necessary to give good performance over the frequency range. Or, better yet, connect a THD distortion analyzer and adjust for the lowest distortion.

The last adjustment is the DAMPING adjustment. You may already have performed that adjustment to extinguish the ERROR indicator, but let's do it right. Switch to 100 Hz and view the square-wave output. There may be a little side-to-side jitter on your triggered sweep oscilloscope. If so, slowly adjust R32 (DAMPING) until it stops or is at a minimum. Be sure not to go too far or the waveform will sweep violently back and

PARTS LIST

Resistors 1/4 watt, 5% unless otherwise noted

R1-R3—10,000 ohms
 R4, R5, R12, R34, R36, R38-R48, R50—100,000 ohms
 R6, R8, R10, R29, R58—1000 ohms
 R7, R9, R11—15,000 ohms
 R13—2700 ohms
 R14, R15, R20—2200 ohms
 R16—500 ohm, trimmer pot
 R17—50,000 ohms, trimmer (Jim-pak 840-50K or equal)
 R18—180 ohms
 R19, R21—4700 ohms
 R22-R24—10 ohms, 1/2 watt
 R25, R33—100 ohms
 R26, R49, R51—15,000 ohms
 R27—270 ohms
 R28—22 megohms
 R30—47 ohms
 R31, R37—10,000 ohms
 R32—500 ohm, trimmer pot
 R35, R53—47,000 ohms
 R52—10,000 ohms, linear-taper pot with SPST switch
 R54—22,000 ohms
 R55, R57—1800 ohms
 R56—1000 ohms, linear-taper pot with SPST switch

Capacitors

C1, C5, C17—47 μ F, 6 volts, electrolytic, PC mount
 C2—0.001 μ F, 100 volts, Mylar
 C3, C6, C7—0.01 μ F, 100 volts, Mylar
 C4—0.1 μ F, 50 volts, Mylar
 C8, C9—1000 μ F, 25 volts, electrolytic, PC mount

C10, C11—100 μ F, 16 volts, electrolytic, PC mount
 C12—1 μ F, 16 volts, tantalum
 C13, C16—0.1 μ F, 25 volts, ceramic disc
 C14—10 pF mica
 C15—39 pF mica
 C18—0.047 μ F, 100 volts, Mylar*
 C19—47 μ F, 6 volts, tantalum*
 C20—4.7 μ F, 6 volts, tantalum*
 C21—0.068 μ F, 100 volts, Mylar*
 C22—47 pF ceramic disc
***Do not substitute.**

Semiconductors

D1-D4—1N4004
 D5-D10—1N4148
 IC1—CA3240AE dual BiMOS op-amp
 IC2—CD4066 quad analog switch
 IC3—XR 2206 function generator (EXAR)
 IC4—7805 or LM340T-5 +5-volt regulator
 IC5—7905 or LM320T-5 -5-volt regulator
 IC6—CA3100EM wideband op-amp
 IC7—7812 or LM340T-12 +12-volt regulator
 IC8—7912 or LM320-12 -12-volt regulator
 IC9—CD4049 CMOS hex inverter
 IC10, IC11—CD4518 CMOS dual BCD up-counter
 IC12—CD4046 CMOS Micropower phase-locked loop
 IC13-IC15—MM74C192 CMOS BCD up/down counter
 IC16, IC17—CD4002 dual 4-input NOR gates
 IC18—CD4023 CMOS triple 3-input NAND gates

IC19—CD4011 CMOS quad 2-input NAND gates
 Q1-Q3, Q6—2N3906
 Q4—2N2219
 Q5—2N2905
 LED1—NSL5054 LED and holder

Miscellaneous

XTAL1—crystal, 1 MHz, 32 pF parallel mode, HC-6/U case
 S1-S3—BCD thumbwheel switch (C&K Type 332110000, Cherry Switch Type T35-02A3 (Herbach & Rademan) or Unimax Type SF-21X3 or equal approximately \$10.00 completely assembled.
 S4, S5—SPST, on R52 and R56
 S6—rotary switch, 1 pole, 5 positions
 S7—rotary switch, 2 poles, 3 positions
 T1—power transformer, 32 volts, CT, 1 amp
 J1, J2—BNC connectors
 F1—fuse, 0.5A with holder
 IC sockets: two 8-pin, eight 16-pin, five 14-pin
 Heatsinks: two TO-220, two TO-5
PC boards and plans are available. If desired, the plans can be ordered separately or combined with a set of boards. Here's how to order: SFG-1 complete set, \$12.00 postpaid in U.S.A. SFG-2 plans only, \$5.00 postpaid in U.S.A.
California residents add sales tax. Foreign residents add \$3.00 for shipping and handling. No COD's or foreign currency, please. Order from Technico Services, PO Box 20HC, Orangehurst, Fullerton, CA 92633

forth. Back off on the pot and try again. After that adjustment is made at 100 Hz, switch to 99.9 kHz and repeat the process. A slight compromise may be necessary in order to get best results over the frequency range.

That completes calibration of the SFG, and it is now ready to use. If you have any problems with calibration, read over the next section on troubleshooting before going any farther.

Troubleshooting

Servicing the SFG has been made easier by several built-in features. For one thing, the board connections have been designed so that a wrong wiring connection is less likely to damage parts. And, as a bonus, this project has built-in diagnostics! Since the diagnostics is the most important feature, let's discuss it. The front panel ERROR indicator will tell you if there are any problems. If it lights, the synthesizer loop is out of lock; and most likely the problem is on the digital board. So if you have problems and the indicator stays lit, check the digital board. On the other hand, if it goes out after a frequency is selected, check the analog board. Now you know where to look for the trouble in a general way.

Finding the exact cause of the problem can be confusing if you have never worked with a synthesizer before. That is

because any defect in the loop circuitry will cause it to stop working. Here's an effective procedure to isolate the problem quickly. Only an oscilloscope and voltmeter are required for troubleshooting, although a frequency counter would be helpful to check the accuracy of the 1-MHz reference. Start troubleshooting by checking the power-supply voltages. Check the 12- and 5-volt supplies on the analog board first, then check for +5 volts on the digital board. If those are OK, check to see that the digital board is grounded, and that the analog board is grounded to the case.

In all likelihood, correcting any power-supply defects will cause the project to begin normal operation. If not, connect the scope to the high end of the LEVEL control and look at the output. You should be able to select sine, triangle and square waveforms. If the same signal isn't present on the output jack, troubleshoot everything after the LEVEL control. If there is no signal present, the ERROR indicator won't be lit. Turn to the digital board and use the scope to see if there is a 100-Hz signal at pin 14 of IC11 (CD4518) and going to pin 14 of IC12 (CD4046). If not, check the IC9-12 circuitry. Use a counter, if available, to verify that the output of IC9 is 1 MHz.

Those checks will probably solve most of the tougher problems, if experience is

any indication. In the event you are still not getting results, check the performance of the function generator IC circuitry on the analog board. That is easy to do, but requires an adjustable 1.5- to 4-volt DC power source and a few clip leads. Disconnect the VCO cable from point "N" on the digital board, and disconnect the leads from "O", "K", and "L" as well. Ground point "L" with a cliplead, and ground the minus terminal of the power supply as well. Then set the supply voltage to zero, and connect the output terminal to point "N". If everything's working on the analog board, you should get an output as you adjust the power supply from about 1.5 volts to 4.0 volts. This indicates that there is a problem on the digital board with IC13-19, so check. On the other hand, if you can't get a signal out, check IC1-3. That takes care of troubleshooting.

Using the SFG

Putting the SFG to work on your test-bench is a snap. Just select the type of waveform to suit your job, and set the desired frequency on the switches. The ERROR indicator will blink a few times, and go out. Whenever that indicator is out, you are locked on frequency, and are all set to do your job. Simply adjust the output level to suit your application. That's all there's to it!

R-E

R.E.A.L. SOUND



CIRCLE 106 ON FREE INFORMATION CARD

Audio Control Model C-101 Equalizer/Analyzer

LEN FELDMAN
CONTRIBUTING HI-FI EDITOR

GRAPHIC EQUALIZERS HAVE BECOME A VERY popular add-on component for stereo systems whose owners want to be able to compensate for minor frequency-response variations caused by other components in the system and for deviations from flat response (often extreme) caused by the acoustics of the listening room. Clearly, the greater the number of individual bands over which the user has control, the more accurately can he or she tailor the system response so that it is as close to "flat" at the listening chair as possible. Most popular graphic equalizers have settled for ten separate control bands, which come to one-per-octave of the audio range.

But what is the user to do once he or she gets the equalizer hooked into the rest of the stereo system (usually via the handy tape-monitor circuitry, or between preamp output and amp input, in the case of system comprised of separates?) Where do you set all those levers? Many users of equalizers, for want of an easy method of calibration, end up with sound that is more unbalanced and farther from being truly "flat" than when they started. Wouldn't it be nice if someone came up with a graphic equalizer that, in addition to permitting octave-by-octave tonal adjustment, allowed you to see exactly what overall response you are obtaining as you vary the controls?

Well, a company called Audio Control, located in Lynnwood, Washington, has done just that—and at a price that seems unbelievable. Their *model C-101*, shown in Fig. 1, is a full ten-band equalizer, with separate controls for left and right stereo channel ganged close

to each other. So far, that's nothing special. But, over at the right of the panel is a display panel consisting of 90 red LED's and 11 green LED's plus an assortment of pushbutton switches that comprise a real-time audio analyzer. Each vertical row of nine red LED's corresponds to one of the octaves controlled by the equalizer. Also built into the *model C-101* and accessible from the rear panel (see Fig. 2) is a pink-noise generator. Pink noise, for those who don't know, is random noise containing all frequencies of the audio spectrum, with equal noise-energy in each octave. Because of the

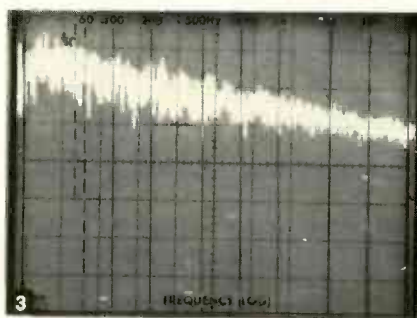

logarithmic nature of the audio spectrum, plotting the *amplitude* of a pink noise generator against a log-frequency scale should produce a random noise output that decreases in amplitude by 3 dB-per-octave. As you can see from Fig. 3, that's exactly what the pink-noise out-

RADIO-ELECTRONICS AUDIO LAB

R.E.A.L. SOUND

RATES

MODEL C-101
EQUALIZER/ANALYZER

EXCELLENT

Copyright © Gernsback Publications Inc., 1979

put from the jack on the rear panel of the *C-101* does.

Now, if this pink-noise source is connected to a high-level input in your hi-fi system, with the *C-101* connected, the LED display will show the overall response, octave by octave, of the entire system. That's fine for making sure that the electronics of your stereo system are adjusted for flat response, but, as everyone knows, when the speakers reproduce those sounds and the room begins to play tricks with them, the response reaching your ears is seldom flat. Well, the usefulness of the *C-101* is only beginning. With it, comes a calibrated electret microphone. When that mike is plugged into the back of the analyzer, it automatically switches over the LED display so that it now reads whatever the microphone hears. You simply set the mike up at your favorite listening spot, turn up the pink noise until the sounds from your speakers overcome the ambient noise in the room, and start adjusting the octave controls on the graphic equalizer section. The entire operation can be completed in a matter of minutes!

To make the job easy, the display section has several switches. There's a sensitivity switch that selects either 2 dB or 4 dB per LED. (It's wise to start equalizing with that switch set to 4 dB. Then, as you come close to flat response, you switch over to 2 dB per LED for final, fine adjusting.) Because pink noise is random in nature, and tends to fluctuate somewhat in amplitude of individual frequencies, there is a "slow" setting for the display, so that you can visually average out those rapid fluctuations.

Finally, when you've got the entire system properly equalized, you can press a button that converts the display to a sound-level meter than reads *overall* sound level over a range

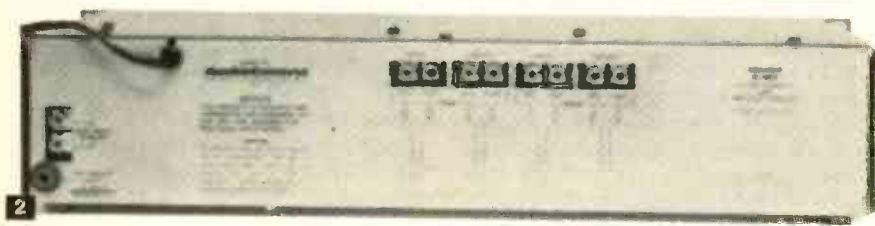

MANUFACTURER'S PUBLISHED SPECIFICATIONS:

Distortion at 1V Output, 20 Hz to 20 kHz: 0.025%. **Frequency Response:** 3 Hz to 100 kHz, ± 0.75 dB. **Hum and Noise (ref: 1.0 volt):** 96 dB (A-weighted). **Maximum Input and Output:** 7.0 Volts. **Input Impedance:** 100K ohms. **Output Impedance:** 680 ohms. **Center Frequencies:** 32 Hz, 60 Hz, 120 Hz, 240 Hz, 480 Hz, 960 Hz, 1.9 kHz, 3.8 kHz, 7.7 kHz, 15.5 kHz. **Control Range per Band:** ± 15 dB. **Control Bandwidth (Q):** 2.5. **Subsonic Filter Slope:** 18 dB-per-octave. **Subsonic Filter Cutoff:** -3 dB at 20 Hz. **Pink Noise Output Level:** 100 mV (nominal). **Pink Noise Output Impedance:** 680 ohms. **Dimensions:** 19 \times 3 1/4 \times 8 1/2 inches deep. **Net Weight:** 7 1/4 lbs. **Suggested Retail Price:** \$549.00

from 64 dB SPL to 92 dB SPL—the typical loudness-range that most of us use when listening to our hi-fi systems. Additional switches on the front panel permit you to equalize either the program to which you are listening or the signal feeding your connected tape deck, since the back of the unit includes tape-out and tape-play jacks which may have been used up on your receiver or amplifier in connecting the C-101 to your system. As an added bonus, the designers of the C-101 have also included a subsonic filter, just in case your own amplifier or receiver is not equipped with that feature, and what they call a rumble-reducing circuit that sums the low frequencies from both stereo channels, cancelling some of the out-of-phase rumble components generated by your turntable system.

Lab measurements

Table I summarizes the measurements made in the R.E.A.L. sound lab for both the ten-octave equalizer section and the pink noise/analyzer section of the C-101. It is clear from those measurements that the insertion of the equalizer into the signal path of your hi-fi system is not about to introduce any audible distortion or response aberrations other than those which you yourself dictate by means of the octave band controls. Figure 4 shows the range of control of each of the ten hand controls of the equalizer and, as you can see, center frequencies are very precisely positioned exactly an octave apart. (The glitches in the display at the low-frequency end of Fig. 4 are caused by the test set-up that contains a bit of a hum-loop at those low levels, and not by the product being tested.)

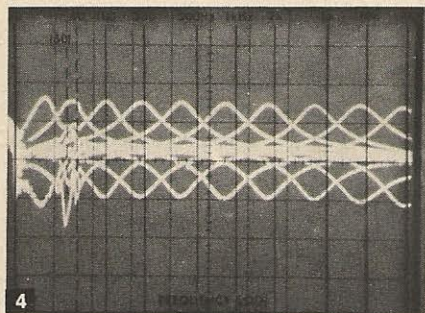

Summary and use tests

That the equalizer section worked perfectly came as no surprise, but the real excitement of this product comes when you begin using its real-time analyzer. The convenience of *knowing* just where you are when adjusting an equalizer, or tone controls, or any frequency-modifying elements in a hi-fi system has to be experienced to be fully appreciated.

Table II presents our overall product analysis as well as our summary comments regarding its use and its effectiveness. Admittedly, the analyzer section is limited in its dynamic range, compared with more expensive professional real-time analyzers, but as Audio Control states clearly on the rear panel of the instrument, "This product is designed and warranted for consumer hi-fi use only. Not intended for pro-audio applications." Probably true enough, but our guess is that semi-pro and professional audio people who can't afford the multi-kilobuck analyzers for their work will beat a path to Audio Control's door as soon as they discover how amazingly much this low-cost product can do.

R-E

TABLE I

RADIO-ELECTRONICS PRODUCT TEST REPORT

Manufacturer: Audio Control

Model: C-101

GRAPHIC EQUALIZER MEASUREMENTS

| | R-E Measurement | R-E Evaluation |
|--|--|----------------|
| Harmonic distortion, at rated output (%) | | |
| 1 kHz | 0.006 | Superb |
| 20 Hz | 0.008 | Superb |
| 20 kHz | 0.008 | Superb |
| Frequency response, (Hz-kHz) \pm 1.0 dB | 3-39 | Excellent |
| Hum and noise, ref: rated output (dB) | 90 | Excellent |
| Maximum input (volts) | 7.0 | Very good |
| Maximum output (volts) | 7.0 | Very good |
| Control range per band (dB) | \pm 12 | Good |
| Control bandwidth (Q) | 2.5 | Very good |
| Subsonic filter cutoff and slope (Hz, dB/octave) | 22, 18 | Excellent |
| Center frequencies (Hz) | 32, 60, 120, 240, 480, 960, 1.92K, 3.84K, 7.68K, 15.5K | Very good |
| Maximum pink noise output level (mV) | 200 | Excellent |

SUBJECTIVE EVALUATIONS

| | |
|-------------------------------|-----------|
| Ease of use | Very good |
| Effectiveness of controls | Very good |
| Control action | Very good |
| Accuracy of control settings | Excellent |
| Accuracy of real time display | Good |
| Accuracy of pink noise source | Excellent |
| Overall analyzer performance | Very good |
| Overall equalizer performance | Excellent |

TABLE II

OVERALL PRODUCT ANALYSIS

| | |
|-------------------------|-----------|
| Retail price | \$549.00 |
| Price category | Medium |
| Price/performance ratio | Excellent |
| Styling and appearance | Good |
| Sound quality | Excellent |
| Mechanical performance | Excellent |

Comments: Not very long ago, a real-time analyzer with the capabilities of the analyzer section of the Audio Control C-101 would have cost several times as much as this compact unit, which not only serves as a real-time audio analyzer but can be operated as a sound-level meter (over a limited range, to be sure) and also provides a well designed ten-octave graphic equalizer. Of course, it makes complete sense to combine the functions of an audio analyzer and a graphic equalizer in one component. The serious user of an equalizer, at some time or other, will have to be able to measure overall system response in the acoustic environment of the listening room if the equalizer is intended for anything more than a fancy sound-effects toy. Admittedly, there are other indirect ways of setting up a graphic equalizer, such as the use of supplied test records and inexpensive sound-level meters, but the procedure of using those accessories is laborious and seldom as accurate as one would like.

The amazing thing to us is the fact that some enterprising young engineers from a relatively small company in the state of Washington were able to come up with such an inexpensive package that does so much. The unit meets all of its specifications, is a pleasure to use, and leaves the user with the feeling that this product is an absolute must with any high-quality high-fidelity component system.

When we first saw a prototype of this unit nearly a year ago, its designers had intended *not* to supply a calibrated microphone, on the assumption that "most serious audiophiles own one anyway." We assured them that this was not the case, and that if they really wanted to offer an equalizer/analyzer system that was complete in every way, they should try to include a microphone. Sure enough, by the time the product reached production, a good-quality electret microphone was included in the package. We hope we haven't upset Audio Control's profits, since the addition of the microphone did *not* result in any price increase over their original price projections. Aside from the difficult-to-read front panel graphics, this little add-on device comes closer to being the "perfect" new product than anything else that we have analyzed in our lab in some time.

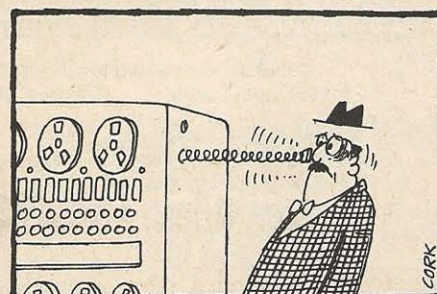
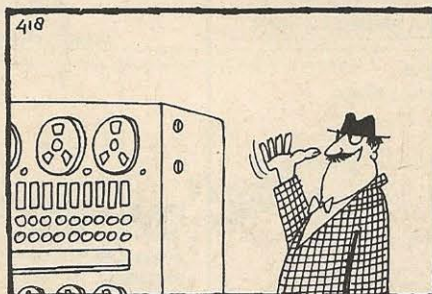

CORK

COAX vs TWIN-LEAD

continued from page 50

coaxial cable as compared on the manufacturer's spec sheet. However, most installations are made when weather conditions are good (e.g., who wants to be on a roof during an electrical storm, rainy or sleeting conditions).

When the twin-lead becomes wet or covered with ice, the loss increases substantially, exceeding that of even poor-quality coaxial cable. Have you ever returned to check reception on a twin-lead system during inclement weather?

Coaxial-cable losses are not affected by water, ice or snow, or even being buried in the ground. A high-quality, low-loss coaxial cable has closed-cell construction that prevents the cable from drawing moisture.

The difference in loss between 50 feet of twin-lead and RG-59/U foam-type cable is only about 1.2 dB—about 15 percent more.

If you should find that switching over from twin-lead to coax produces perceptible snow in the picture at the higher channels don't blame the coax for a bad picture. What it is telling you is that the signal voltage at the antenna is too weak and is marginal. What you need is an antenna preamp or a larger antenna. With such a marginal signal, even the twin-lead will produce snow if the weather becomes inclement.

Is twin-lead cheaper?

If you think coax is too costly, don't forget to include, with the twin-lead, the cost of standoffs, the time and expense of mounting them, twisting the twin-lead and routing it away from metal and conducting surfaces. The latter includes shake shingles, siding, and anything that will hold or absorb water. That is especially critical in high-humidity areas of the country.

There are dealers who offer only one installation price whether it's twin-lead or coax; That is an inducement to sell the customer on coax. As you might expect, the coax cable is slightly more costly, but the dealer knows that the installation will cost less and therefore will be more profitable. How? Because, he is doing both the customer and himself a service by offering a longer-lasting, more professional installation; and, he's sure that, if he's done everything right, there will be no costly callbacks—just referrals! **R-E**

OOOOOOPS!

The diagram shown below is the corrected version of Fig. 5 that appeared on page 49 of the June 1980 issue of *Radio-Electronics*.

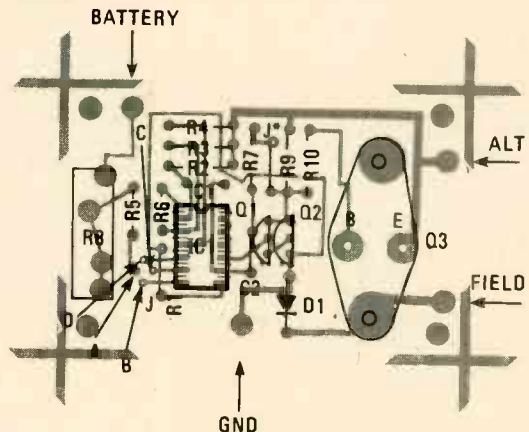

***THIS JUMPER ONLY IN THE GROUNDED-FIELD**

FIG. 5—PARTS PLACEMENT GUIDE for the voltage regulator. Note that the jumper between R7 and R9 is used only when the circuit is used with a grounded-field alternator. A jumper must be installed between point "A" and point "B", "C", or "D", depending on the desired temperature coefficient.



Clever Kleps

Test probes designed by your needs — Push to seize, push to release (all Kleps spring loaded).

Kleps 10. Boathook clamp grips wires, lugs, terminals. Accepts banana plug or bare wire lead. 4¾" long.

Kleps 20. Same, but 7" long.

Kleps 30. Completely flexible. Forked-tongue gripper. Accepts banana plug or bare lead. 6" long.

Kleps 40. Completely flexible. 3-segment automatic collet firmly grips wire ends, PC-board terminals, connector pins. Accepts banana plug or plain wire. 6¼" long.

Kleps 1. Economy Kleps for light line work (not lab quality). Meshing claws. 4½" long.

Prof 10. Versatile test prod. Solder connection. Molded phenolic. Doubles as scribing tool. "Bunch" pin fits banana jack. Phone tip. 5½" long.

Write for complete catalog of - test probes, plugs, sockets, connectors, earphones, headsets, miniature components.



Available through your local distributor, or write to:
RYE INDUSTRIES INC.

131 Spencer Place, Mamaroneck, N.Y. 10543
In Canada: Rye Industries (Canada) Ltd.

CIRCLE 26 ON FREE INFORMATION CARD

THE BIG PLUS + Graphic Equalizer

ASSEMBLED
\$200⁰⁰

KIT
\$120⁰⁰



LOADED with Quality Features!

- Stereo . . . Eleven Bands Per Channel • Extremely Low Noise & Distortion • LED Peak Indicators • Center Detent ("flat") sliders • Built-in "record" Switching • Line and Microphone Level Inputs/Outputs • Regulated Power Supply • Fully Guaranteed • Horizontal or Vertical Cabinets • Kit or Fully Assembled • Plus Much, Much More!

Absolutely equals or exceeds overall performance and features of any graphic equalizer made today!

AARON-GAVIN INSTRUMENTS, INC.
17231 Corla Avenue Tustin, California 92680

Yes! I've enclosed \$ _____; RUSH me: assembled equalizers at \$200.00, p.p.d. cabinet send brochure un-assembled equalizer kits at \$120.00, p.p.d. Horizontal (flat) Vertical (up right)

California residents include 6% sales tax. Visa & Master Charge orders accepted

Name _____ Card No. _____
Address _____ Exp. Date _____ Bank No. _____
City _____ State _____ Zip _____

Dealer inquiries invited

CIRCLE 3 ON FREE INFORMATION CARD

new ideas

MUSIC MAKER

MY NEW IDEA IS A TONE SEQUENCER WITH a variable tempo. A 555 timer operated in an astable mode produces the tempo. The 555's output clocks a 7490 counter which then drives a 7442. The 7490 counts from 0 to 9 in binary and sequences the 7442 from 0 to 9. The 1 output of the 7442 goes low when its binary equivalent appears at the 7442's input. The 7442's output goes through some tone resistors to another 555 which is the tone generator. Its output goes to an LM380 amplifier IC and to the speaker.

Here is a way you can choose a set of fixed tone resistors for the circuit. Connect one outer terminal of a 1000-ohm potentiometer to ground. The center ter-

minial of the pot is connected to pin 1 of the 7442. Turn the circuit on and as soon as a tone appears, deactivate the 555 clock by disconnecting pin 14 of the 7490. If you deactivate the clock circuit as soon as the tone burst is heard you can then start the programming procedure. When a fixed tone is heard from the speaker, rotate the pot's shaft until the desired tone is heard. Then disconnect the pot from the circuit and measure the resistance with an ohmmeter. You can then replace the pot with a fixed resistor. You then repeat the procedure for the rest of the outputs of the 7442.

The original circuit (see Fig. 1) was breadboarded but any method of construction may be used to build a working device.—Mark Dittmar

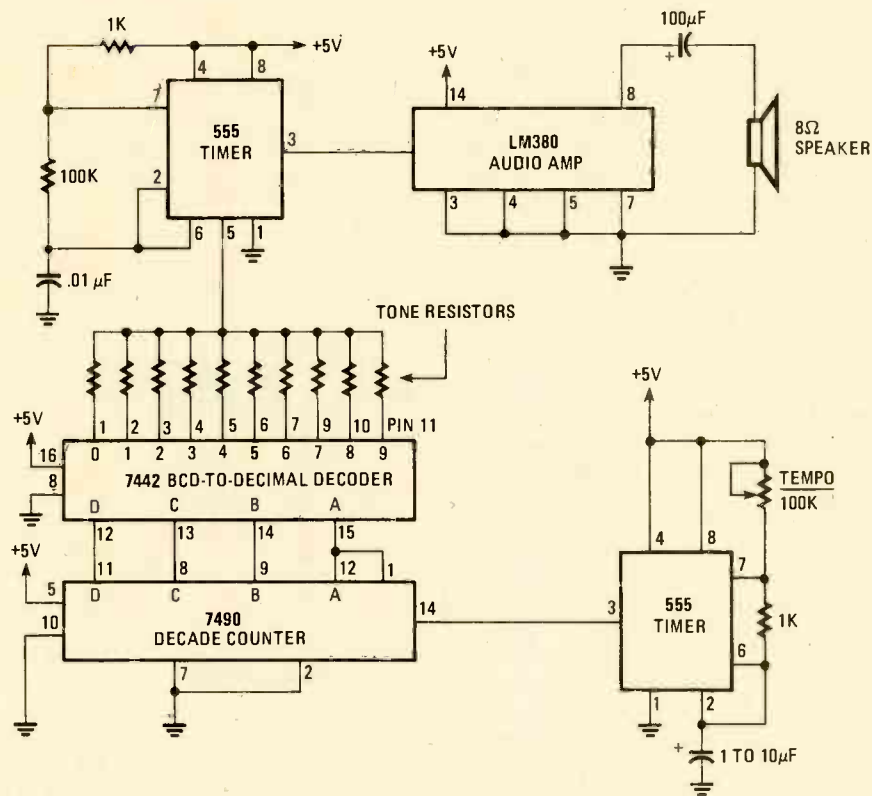
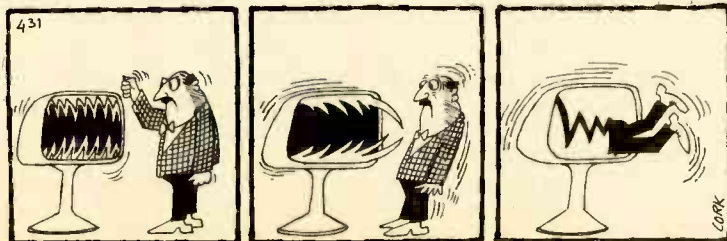

Fig. 1



NEW IDEAS

This column is devoted to new ideas, circuits, device applications, construction techniques, helpful hints, etc.

All published entries, upon publication, will earn \$25 plus a Circuit Board Holder, Standard Base and Tray Base Mount from Panavise Products, Inc. (See photo below.) Selections will be made at the sole discretion of the editorial staff of **Radio-Electronics**.



I agree to the above terms and grant **Radio-Electronics Magazine** the right to publish my idea. I declare that the attached idea is my own original material and that its publication does not violate any other copyright. I also declare that this material had not been previously published.

Title of Idea

Signature

Print Name

Date

Street

City

State

ZIP

Mail your idea along with this coupon to:

**New Ideas
Radio-Electronics
200 Park Ave. South
New York, NY 10003**

hobby corner

Tide clocks are more complex than anticipated, plus a look at new enclosures, a logic probe, and other tidbits.

EARL "DOC" SAVAGE, K4SDS, HOBBY EDITOR

YOU WILL RECALL THE SUGGESTIONS from Art Williams of North Carolina in this column that appeared in the March 1980 issue about the construction of a tide clock. Well, that one caused some interest, primarily because it can be built for much less than the cost of a commercial tide clock. However, there is a catch.

I must confess to being a landlubber but several of you opened my eyes to the very real complexities of tides. The value of a tide clock that runs at a constant rate depends upon where you live! In some places the tides are fairly regular—varying only a few minutes over a month's span. In others, the variation is quite great—hours. If you didn't know that, welcome to the club—now we both know better.

Jim Wamsley of New York sent along copies of the tide charts for three different locations covering several months. Now those pages of figures really were more than I could comprehend, so I wrote a simple program for my TRS-80 micro-computer to analyze and chart them. Voila!—there it was in a form that could be understood.

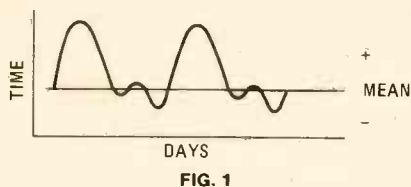

FIG. 1

Some of the variations were enormous. Fig. 1 is a fair approximation of one of the charts. The time differences varied around the mean in cycles. Furthermore, I found that though the curves were repetitive in each of the three coastal cities, there were great differences from one location to another. In one, the magnitude of the changes was much greater; in another, the curves were backwards!

In any case, predicting tides is not as cut-and-dried as I had thought. If you live in a place where the tides are pretty regular, then our clock and the \$75 commercial ones will do quite well. Others will need a rather complex circuit to stay within even 15 or 20 minutes of the actual tides.

Now there's a puzzle for you—a tide clock in which the rate variations are programmable. Unfortunately, neither the shape nor the amplitude of the curves is constant. A variable clock without the programming feature might be just right for one coastal area and less than worthless in another.

Of course, you can do the job with a computer but how about with a handful of IC's? What kind of a circuit have you developed or can you suggest?

Tool source

Do you ever goof up a project (electronic or other) because you don't have the right tool for a certain task? I used to "make do" with the closest thing I could find—sometimes it worked and sometimes it didn't. The basic problem was that I could easily find conventional tools in conventional sizes but special sizes or special tools were hard to locate. Then, I discovered Jensen.

Jensen Tools and Alloys (1230 South Priest Drive, Tempe, AZ 85281) has just about anything you can dream up and many tools you have never imagined. Just reading their catalog is an education in itself. Jensen seems to have an extremely wide selection of name-brand tools, unusual tools for special applications, and imported tools.

Though specializing in tools and accessories for electronics, they offer others for a variety of types of work. If you need something special, the chances are that Jensen has it.

Neat cabinets

PAC-TEC has come up with a great line of molded plastic enclosures for electronic applications. If you need a cabinet for your latest project, they have a wide variety of styles, types and sizes. A sampling is shown in Fig. 2.

The PAC-TEC cabinets have many interesting and useful features. For example, many models have boss patterns for mounting components and/or mounting rails and guides for PC boards.

I am sure that you, too, have suffered through the problem of finding an enclosure of just the right size for something you have built. If one of PAC-TEC's regular sizes isn't right, there are models



FIG. 2

which are of *adjustable* size. That's right—adjustable! But make no mistake: Those aren't flimsy cabinets. Even the adjustable ones are firm and sturdy.

For information and the name of your nearest distributor, contact PAC-TEC, Enterprise and Executive Avenues, Philadelphia, PA 19153.

Logic probe kit

Recently I assembled and tested the new logic-probe kit by Global Specialties Corp. (formerly Continental Specialties), 70 Fulton Terrace, New Haven, CT 06509. The *LPK-1* is an inexpensive (about \$20) test instrument for use with digital circuits. The *LPK-1* is shown in Fig. 3.



FIG. 3

The probe has a number of valuable features: high input impedance; a *stretch* circuit to show very fast pulses, and a wide voltage range to accommodate most IC families. Such a probe is all but indispensable for building or trouble-shooting digital circuits. Three LED's (HI, LO and PULSE) show the logic state of the point being monitored.

The kit, itself, is well designed and includes an unusually good assembly/instruction manual. With care, even the outright beginner should have no trouble building the *LPK-1* logic probe kit.

Breadboard accessories

I am sure that you are familiar with Global Specialties' solderless breadboards. How about the new accessories to use with them?

The first is a pad of worksheets printed with the breadboard pattern. These can be used to *plan* how you will put a circuit on the breadboard and to *record* the cir-

cuit before you disassemble it.

The second accessory is a pre-etched and pre-drilled printed circuit board with a pattern matching the boards and worksheets. Circuits can be transferred from the breadboard directly to a PC board for a finished product at a considerable saving in time and trouble.

Ah! What will they think of next to make our "work" easier!!

Unusual parts

The ETCO people have come out with their largest catalog yet—issue "H."

The especially interesting thing about this company is the nature of their stock. Of course, they have a wide variety of the usual types of items. In addition, however, ETCO specializes in manufacturers' surplus—finished items, sub-assemblies, and parts.

You can get the new catalog on request from ETCO Electronics, Dept. 113, Box 796, Plattsburgh, NY 12901. You never know what you may find on the next page.

Educational booklet

A new edition of Radio Shack's "The Science Fair Story of Electronics . . . The Discovery That Changed the World!" is being distributed. Previous issues of this very popular educational comic book were used widely in schools

and other groups. The current issue is quite well done and should prove even more useful.

Copies of this free booklet can be had from the nearest Radio Shack store. For an added bonus, there are some valuable coupons inside.

Letters

I just finished answering a "pot" full of your letters. They prove to me that you are designing and building and trouble-shooting.

Now, I don't mind hearing about your problems and on occasion, I may be able to help a little. I would like to hear about your successes, too. I'll be glad to pass along (and your fellow readers will be glad to see) your new circuits, unusual applications, construction and repair tricks, and so on.

By the way, Tom Faron told me that when his mystery-lights puzzle first appeared, he got a telephone call from an office full of engineers halfway across the country. Those guys wanted to tell him that there was no solution! I'll bet they learned something the following month—such is life!

R-E

Help light the candle of understanding. Contact your local chapter of the Epilepsy Foundation of America. Or write Epilepsy, Washington, D.C. 20036. (Incorporating the former National Epilepsy League.)

FREE

The newest in home computers, fine stereo components, color TV, HAM radio, precision test equipment, innovative electronics for the home—all in easy-to-build, money-saving kits.

Send today for your **FREE Heathkit® Catalog**

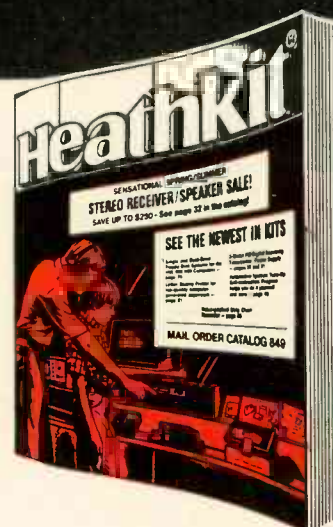

If coupon is missing, write Heath Co., Dept. 020-672 Benton Harbor, MI 49022

Send to: Heath Co., Dept. 020-672 Benton Harbor, MI 49022

Send my free Heathkit Catalog now. I am not currently receiving your catalog.

Name _____

Address _____

City _____ State _____

CL-724A Zip _____

This is easy- anyone can solder- WITH KESTER SOLDER

KESTER SOLDER



Handymen! Hobbyists! DO-IT-YOURSELFERS!

Let Kester Solder aid you in your home repairs or hobbies. For that household item that needs repairing — a radio, TV, model train, jewelry, appliances, minor electrical repairs, plumbing, etc. — Save money — repair it yourself. Soldering with Kester is a simple, inexpensive way to permanently join two metals.

When you Solder go "First Class" — use Kester Solder.

For valuable soldering information send self-addressed stamped envelope to Kester for a FREE Copy of "Soldering Simplified".



KESTER SOLDER

Litton 4201 WRIGHTWOOD AVENUE/CHICAGO, ILLINOIS 60639

CIRCLE 24 ON FREE INFORMATION CARD

CIRCLE 53 ON FREE INFORMATION CARD

Catch the fastest C-meter under \$200 the autoranging B&K-PRECISION 830



Model 830 \$199
Model 820 \$140 (not shown)

B&K-PRECISION was the first company to offer a lab-quality capacitance meter for under \$150, now we're first with autoranging for under \$200. The new 830 is fast, accurate and built with famous B&K-PRECISION dependability.

The 830 offers features that are tough to match at any price, such as 0.1 pF resolution, large 3½-digit LCD display and fuse protection against charged capacitors. Basic accuracy is 0.2%, much greater than the tolerance of most capacitors. Measurement range extends to 199.9 mF.

Simplicity of operation is another strong suit for the 830. For checks limited to a narrow value range, the "range hold" capability can lock the 830 onto one range—an added time saver. This feature, along with its fast reading time, makes the 830 especially valuable for incoming inspection applications.

For applications suited to manual ranging, B&K-PRECISION offers the LED readout 820 at an even lower cost.

With either B&K-PRECISION C-meter you can, measure unmarked capacitors... verify capacitor tolerance... measure cable or switch capacitance... match capacitors for critical applications... measure complex capacitor networks... set trimmer capacitors.

For more information, contact your local distributor and see why B&K-PRECISION is now the leading supplier of digital capacitance meters.

BK PRECISION
DYNASCAN
CORPORATION

6460 West Cortland Street
Chicago, Illinois 60635 • 312/889-9087

Int'l. Sls., 6460 W. Cortland St., Chicago, IL 60635
Canadian Sales: Atlas Electronics, Ontario

CIRCLE 37 ON FREE INFORMATION CARD

new products

More information on new products is available. Use the Free Information Card inside the back cover.

DIGITAL MULTIMETERS, model WD-759 and model WD-758, are 3½-digit instruments with a choice of LCD or LED displays. The LCD model WD-759 indicates function as well as value on its display. Measurement ranges for both models are from 100 mV to 1000 VDC and up to 600 VAC.

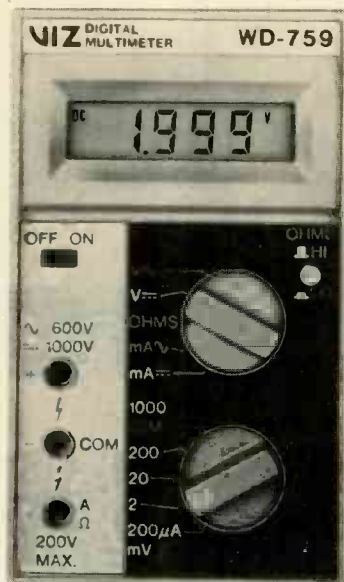

CIRCLE 151 ON FREE INFORMATION CARD

The DMM's have an accuracy of 0.1%, input impedance of 10 ohms, and can measure high or low power ohms on all resistance ranges. A 1 amp fuse, high-voltage probe, AC adaptor, and carrying case are supplied. Model WD-759 is \$159 and Model WD-758 is \$149.—VIZ Mfg. Co., 335 E. Price St., Philadelphia PA 19144.

PROTOTYPE BOARD, model CM-600, is designed for solderless construction of prototype circuits. The neoprene board measures 4½ X 6 inches and has 2280 holes on .100-inch centers. Components are easily mounted by inserting leads into holes, and interconnections can be made using No. 20 or No. 22 AWG wire jumpers. Components or leads are simply pulled out, making easy circuit changes possible. Accessory kit RW-50 contains 50 pieces of No. 20 AWG jumper

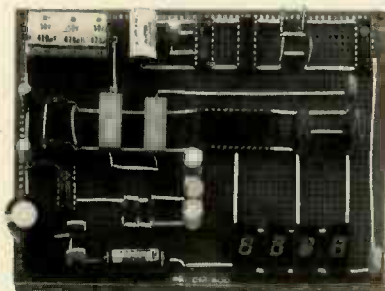

CIRCLE 152 ON FREE INFORMATION CARD

wires from ½ inch to 4 inches long. RW-50 is \$2.95; CM-600 is \$6.95.—O.K. Machine & Tool Corp., 3455 Conner St., Bronx, NY 10475.

BENCH-TOP VARIABLE TRANSFORMERS, models 3PN1510V and 3PN1520V, come equipped with integral voltmeter. Model 3PN1510V is rated at 15 amps, 0-140 volts AC output from 120 volts AC in. Model 3PN1520V can supply 9.5 amps, 0-280 volts AC from 240



CIRCLE 153 ON FREE INFORMATION CARD

volts AC line input. Each variable transformer features a built-in expanded-scale voltmeter; ventilated steel enclosure; three-conductor grounded plug; on-off switch; pilot lamp, and fused output circuit. Price for the 3PN1510V is \$158 and for the 3PN1520V, \$162.—Staco Energy Products Co., 301 Gaddis Blvd., Dayton, OH 45403.

MODULAR TELEPHONE ACCESSORIES and free-standing rack display are intended for retailers of home-improvement products. Designed exclusively for the do-it-yourself market, the line features 10 items—from 25-foot replacement cords with modular plugs to modular phone jacks and free-end phone hook-up wire in 50-foot coils. Each accessory is available individually, or retailers can order an assortment with a free-standing display rack and sign. A free consumer booklet



CIRCLE 154 ON FREE INFORMATION CARD

with helpful information on planning and installing modular phone accessories is offered for display with the line.—GE Wiring Device Business Department, 95 Hathaway St., Providence, RI 02940.

R-E

computer products

More information on computer products is available.
Use the Free Information Card inside the back cover.

AUDIO-SPECTRUM ANALYZERS for the TRS-80 and Apple computers, the VTU02 and AIB232 provide real-time video display of audio spectrum from 20 Hz to 20 kHz. The spectrum is divided into 31 third-octave bands making the device useful for both serious audiophile and professional use. The analyzers can be used for measuring sound and noise levels, for optimizing the equalization of audio systems and for speech and sound pattern recognition.

Each analyzer is designed to interface with its host computer with a minimum of fuss. The model VTU02 plugs directly into the TRS-80 expansion port (and provides an equivalent port for further expansion), and the model AIB232 goes into one of the Apple's card slots.

The AIB232 can make dynamic use of the color capabilities of the Apple since the color of each bar of the display is under software control. One or several of the bars can change color in real time.



CIRCLE 121 ON FREE INFORMATION CARD

Because of the capabilities of the computers, great flexibility in the manipulation of the analyzed data is permitted. Data can be stored and compared with past, future or other channel information. The software to run the analyzer is supplied in machine language but is accessed from BASIC. Three BASIC programs are provided with each unit: Interactive Operation, Minimal Operation and Self-Test. Because the machine-language program is callable from BASIC, the user can easily write his own programs tailored to his particular needs.

The VTU02 for the TRS-80 lists for \$595 and the AIB232 for the Apple is \$545. A similar unit for the PET, the THS224, is available for \$595.—Eventide Clockworks, Inc., 265 W. 54th St., New York, NY 10019.

VOICE-RECOGNITION DEVICE, the TRS-80 VOXBOX, permits owners of TRS-80 computers to experiment with "voice recognition." The unit makes it possible to program the computer to respond to spoken words. Single words or phrases may be used to enter data, to control and instruct the TRS-80 without having to type on the keyboard.

The VOXBOX can be programmed to recognize up to 32 words or phrases. The user decides what words are to be used and programs the computer to respond to them appropriately.

The VOXBOX is said to recognize correctly 85-95% of the words used, provided that the user takes reasonable care in speaking clearly and distinctly. However, it is recommended that the unit be used primarily for entertainment and experimentation.

A Level II TRS-80 system with at least 16K of



CIRCLE 122 ON FREE INFORMATION CARD

RAM and cassette recorder are required to use the device. A machine language "driver" program and three demonstration programs, comprehensive owner's manual and push-to-talk dynamic microphone are supplied with the unit.

The TRS-80 VOXBOX is available for \$169.95 from Radio Shack Computer Centers and participating Radio Shack stores and dealers nationwide.—Radio Shack, One Tandy Center, Fort Worth, TX 76102.

Z-80 BOARD for the Apple II, the Z-80 SoftCard, allows Apple users to run software written for Z-80-based computers. In addition to the plug-in card, the SoftCard package includes CP/M and Microsoft Disk BASIC.

The package will run on any Apple, from the Apple II to the Apple II Plus with Language Card. No hardware or software modifications are needed to use the SoftCard and the user has the option of using either it or the Apple's own 6502 microprocessor.

The package requires an Apple II with at least 48K of RAM and a single-disc drive. Suggested retail price is \$349.—Microsoft Consumer Products, 10800 Northeast Eighth, Suite 507, Bellevue, WA 98004.

CIRCLE 123 ON FREE INFORMATION CARD

ARITHMETIC PROCESSOR UNIT, model 7811B, enhances the mathematical capabilities of the Apple II. The board, which plugs into one of the Apple II's expansion slots, executes all Applesoft mathematic functions, plus additional trig func-

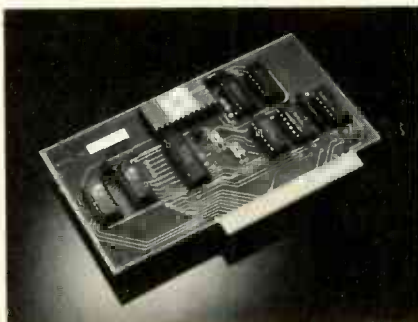

CIRCLE 124 ON FREE INFORMATION CARD

tions not available in that language. The 7811B has a precision of 6.5-plus significant digits and offers a range of approximately $10^{\pm 20}$. It is available fully assembled and tested, with complete documentation. Price is \$399.95.—California Computer Systems, 250 Caribbean Drive, Sunnysvale, CA 94086.

TUNE IN!

Build the World Famous CHROMA-CHIME KIT

Give your friends a warm welcome. Yes, think how delighted and amazed they will be to hear the musical Chroma-Chime play when they press the front door bell!

The Chroma-Chime uses a microcomputer to play 24 well-known tunes. Instead of the regular ding-dong bell or buzzer. This British designed unit uses a Texas Instruments TMS 1000 specially programmed with a complete repertoire of tunes built in. The kit is simply itself for ease of construction. Absolutely everything needed is supplied, including:



- * Resistors, Capacitors, Diodes, Transistors, I.C. Socket and all hardware
- * Texas Instruments TMS 1000 microcomputer
- * Comprehensive kit manual with full circuit details
- * Ready drilled and legended PCB Included

only \$39.95 incl. p & p

When built, simply substitute for your old door chime or bell, no additional wiring needed, can be operated either from a 16 volt AC transformer or from two regular 9 volt batteries.

Plays 24 well-known tunes including:
Star Spangled Banner
William Tell Overture
Greensleeves
Mozart Sonata
Oh come all ye faithful
plus many other popular favourites.

- * No previous microcomputer experience necessary
- * All programming retained is on chip ROM
- * Fully guaranteed.

TMS 1000 N-MP0027A Microcomputer chip available separately if required. Full 24 tune device supplied with data sheet and fully guaranteed only \$12.50 incl. p & p.



To order, send either a personal check or money order, alternatively we can deduct from your Visa or Master Charge account.

Absolutely no risk, money back if not delighted. \$39.95 inclusive of air mail, direct to the USA. Delivery may take 14 to 28 days.

Ordering from the UK is just like any other place in the USA. 10,000's already sold!

To: CHROMATRONICS, RIVER WAY,
HARLOW, ESSEX, ENGLAND.
Our phone (01144) 279 418611

Please send me..... kits

NAME

ADDRESS

I enclose checks value \$ R.E. 7. 80
or debit my Visa/Master Charge account no:

Signature

Dealers note: Available in kit or ready built from: Timely Products Sales Inc. Chicago. Tel: (312) 263 6231



communications corner

A new all-in-one communications analyzer that does just about everything except replace defective components.

HERB FRIEDMAN, COMMUNICATIONS EDITOR

THE DIFFICULTY WITH CONSUMER EQUIPMENT designed "to the leading edge of the state of the art" (a phrase that rolls off the tongue with grace and style) is that it is often ahead of the test equipment needed for service, and for certification that it works within specifications. I well remember the seemingly unending quantity of BC-221 frequency meters, sold as WWII surplus, that ended up in both amateur shacks and professional service shops. Almost as endless were the technical articles on how to upgrade the BC-221's accuracy from 0.05% to 0.01%. Suddenly, along came CB with its 0.005% frequency tolerance and the king was dead, for the technology that went into the least expensive CB transceiver was years ahead of the average test equipment—in particular, "surplus" frequency meters.

Fortunately, solid-state service equipment was able to meet the new, tighter tolerances at modest cost, and for almost a decade we have been able to accommodate the new radio devices by simply adding another instrument or two to the workbench.

But with the expansion of the radio services to 220 MHz, then 450 MHz, and now the 900 MHz (for telephone "cells"), greater use of FM and SSB,

and assorted FM bandwidths, the user-equipment has once again moved beyond the limits of much test equipment, and the test bench is starting to fill up again with bits and pieces of test equipment.

The truth of the matter is that much of our test gear is obsolete for communications use, particularly so if we consider the computerized communication equipment standing on the sidelines, waiting to enter the marketplace.

One way to clean off the test bench, accommodate the servicing and testing of most modern communications gear, and be prepared for the computerized equipment of tomorrow is with the new Motorola R-2001A Series Communications System Analyzer.

You name it, and the R-2001A does it. For example, the operating modes are: AM/FM/CW/SSB Monitor, AM/FM/CW/DSBSC generator from 10 kHz to 999.9999 MHz, code synthesizer, spectrum analyzer, duplex generator, frequency counter, digital voltmeter, wattmeter, IF display, and oscilloscope.

The scope alone is "something else" in test gear. In addition to functioning as an ordinary scope, it provides both graphic and alphanumeric display of the test results, as well as alphanumeric in-

formation on the test signals.

A front-panel view of the R-2001A along with one of the many scope displays is shown in Fig. 1. Starting at the upper left of the scope display and going across we see that the Motorola test set is functioning as an FM signal generator with a 451.9550-MHz output frequency accompanied by a 127.4-Hz PL (Private Line) tone; the RF output level has been set for 0.40 μ V (-114.9 dBm), the SINAD (receiver sensitivity) is 12.8 dB and is also represented by an analog line segment, and the transmitter's deviation is ± 4.15 kHz, also represented by a line segment.

To accumulate the individual test equipment necessary to duplicate the R-2001A's functions would be prohibitively expensive; the RF spectrum-analyzer mode alone represents about \$5000 worth of hardware. It would also require a small room or a large closet to house the individual pieces. Yet, thanks to computerization (a 6800-series microprocessor and digitizing), all functions are accommodated in a cabinet measuring about 16" wide \times 8" high \times 21" deep. It weighs 45 lbs when AC-powered, but is a little heavier when equipped with batteries for portable operation.

As for complexity: Again, the computer comes to the rescue. If we exclude the scope's normal operating controls, such as trace position and horizontal timebase, the grand total is 23 controls and switches plus a keypad, with most of the control being accomplished through the keypad. LED indicators clearly show what functions are in use and what's being displayed on the scope.

For example, assume that you want the generator set to the FM mode. Under the row of LED's indicating the signal-generator mode are small push-buttons with up and down arrows. Simply press the appropriate button until the LED that indicates FM is lit. Do you need a continuous private-line tone? Look at the row of LED's indicating modulation and depress the up or down button until the PL LED lights. Do you want the display to indicate the percent modulation? Simply press the appropriate button until the LED opposite the MODULATION legend lights.

Virtually all functions and frequencies are at the touch of a button, making one of the most modern, complex test sets no more difficult to operate than many

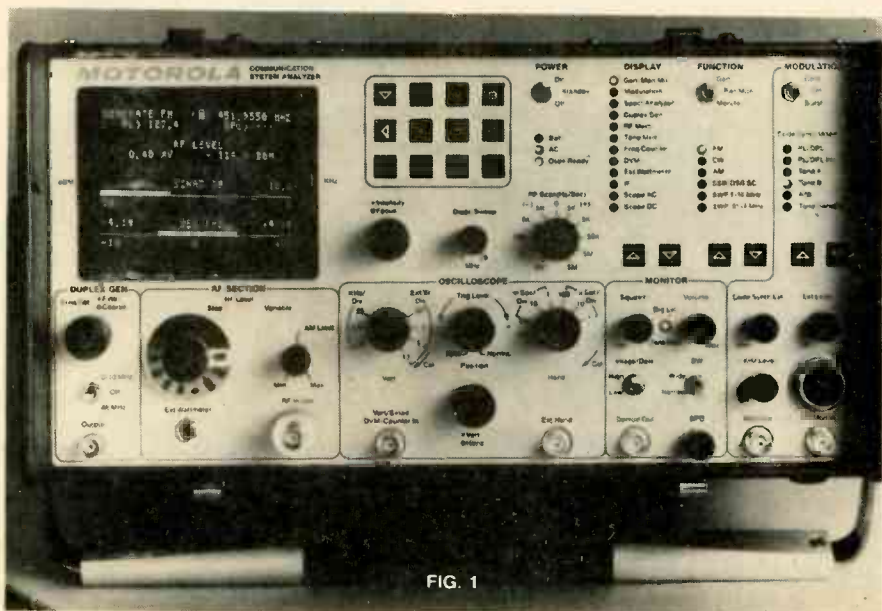

FIG. 1

toys. (In fact, I know of some toys that are more difficult to get working.)

Now that we've touched on some of the most popular functions of the R-2001A it's time to go a little deeper into the nitty-gritty.

The oscillator can be set to within 100-Hz resolution with an accuracy of $\pm 1 \times 10^{-6}$ from 0°C to 55°C. If you need even greater accuracy, select a timebase housed in an oven. This type is available with an accuracy of $\pm 5 \times 10^{-8}$ over the same temperature range. (Warmup to $\pm 5 \times 10^{-7}$ of final frequency in 20 minutes.)

The oscillator's spurious output is better than 40 dB down, while harmonic attenuation is greater than 15 dB.

FM frequency deviation is 0 to 50 kHz peak, from 5 to 10 kHz, ± 1 dB, using internal, external, or microphone modulation or all simultaneously.

Amplitude modulation is 0 to 80% with $\pm 10\%$ full scale readout accuracy, from 5 to 10 kHz, ± 1 dB, again with internal, external or microphone modes.

The carrier suppression of the DSBSC carrier output (1-500 MHz) is better than 25 dB.

The frequency range of the monitor mode is 1 to 999.9999 MHz, with 100-Hz resolution. Accuracy is equal to that of the master oscillator timebase. Input sensitivity is 1.5 μ V for 10 dB SINAD (± 6 kHz modulation acceptance) and 7 μ V for 10 dB SINAD (± 100 kHz modulation acceptance).

A built in RF-wattmeter covers 0.2 to 125 watts from 1 to 1000 MHz.

The code synthesizer generates frequencies from 50 Hz to 9.9999 kHz with a 0.1-Hz resolution and an overall frequency accuracy and stability of 0.01%.

The spectrum analyzer's frequency range is 2 to 1000 MHz, with full-scale frequency dispersion adjustable between 1 and 10 MHz.

There are other goodies, too numerous to mention, including an adjustable frequency-offset duplex generator. Your best bet for additional information and in-depth coverage of the Communications System Analyzer, giving many ideas on using the device for all communications equipment—CB, amateur, VHF/UHF—is Motorola's descriptive brochure, available from Motorola's Test Equipment Products Dept., 1313 E. Algonquin Rd., Schaumburg, IL 60196. **R-E**

Epilepsy

It's not what you think.

Help light the candle of understanding. Contact your local chapter of the Epilepsy Foundation of America. Or write Epilepsy, Washington, D.C. 20036. (Incorporating the former National Epilepsy League.)

Get A GNOME

the original micro-synthesizer

Every day more people discover that PAIA's GNOME is the most versatile, cost effective special effects device on the market today.

John Simonton's time-proven design provides two envelope generators, VCA, VCO and VCF in a low cost, easy to use package. Use alone with it's built in ribbon controller or modify to use with guitar, electronic piano, polytonic keyboards, etc.

The perfect introduction to electronic music and best of all, the Gnome is only \$59.95 in easy to assemble kit form. Is it any wonder why we've sold thousands?



1020 W. Wilshire Blvd. Oklahoma City, OK 73116

- Send GNOME MICRO-SYNTHESIZER Kit (\$59.95 plus \$2.00 postage)
 GNOME MICRO-SYNTHESIZER (Fully Assembled) \$100.00 plus \$2 postage
 Send FREE CATALOG

name _____
 address _____
 city _____ state _____ zip _____
 visa _____ card no. _____
 phone _____

PAIA 1020 W. Wilshire Blvd. Oklahoma City, OK 73116 (405) 843-9626

CIRCLE 8 ON FREE INFORMATION CARD

Put Professional Knowledge and a COLLEGE DEGREE

in your Electronics Career through

HOME STUDY

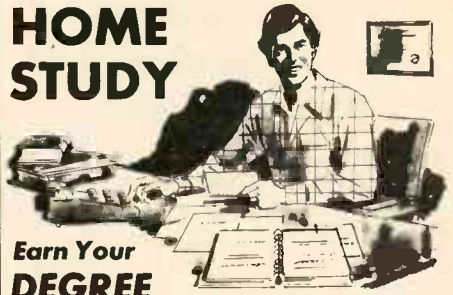

Earn Your DEGREE

by correspondence, while continuing your present job. No commuting to class. Study at your own pace. Learn from complete and explicit lesson materials, with additional assistance from our home-study instructors. Advance as fast as you wish, but take all the time you need to master each topic.

The Grantham electronics degree program begins with basics, leads first to the A.S.E.T. degree, and then to the B.S.E.T. degree. Our free bulletin gives complete details of the program itself, the degrees awarded, the requirements for each degree, and how to enroll. (We are located at 2500 S. LaCienega Bl., Los Angeles, Calif.) Write to our mailing address shown below for Bulletin R-80

Grantham College of Engineering
 P. O. Box 35499
 Los Angeles, California 90035

Worldwide Career Training thru Home Study

Hold everything!

Get a #324 PanaVise Work Center.

Here's everything you need to hold everything you work with...in one money-saving package! Write for FREE catalog today.

PANA VISE®

2850 E. 29th St.,
 Long Beach, CA 90806

Famous PanaVise standard base tilts, turns, rotates to exact work position.

6-compartment Tray Base Mount with 6 anti-slip feet.

Self-centering wire and Solder Holder* attaches to unit.

Adjustable Circuit Board Holder holds up to 10" board.

FREE 2 Nib Sponges with self-purging slits for easy cleaning.

Solder Iron Holder* with perfect angle for holding constant heat. Attaches to unit.

*Solder wire and solder iron not included.

CIRCLE 47 ON FREE INFORMATION CARD

Want to cut out a career as a two-way radio technician?

MTI offers the only training for professional FM two-way radio available. Qualified technicians are employed in government, industry, and public service. But training is your key.

You could cut out a career as a two-way radio technician by cutting out this coupon. We'll send you information on how you can learn more about this specialized field, at home.

Name _____

Address _____

City _____

State/Zip _____

B3G

MTI

Mobile Training Institute

Box 735, Camp Hill, PA 17011-U.S.A.

CIRCLE 41 ON FREE INFORMATION CARD

BIG 2 1/2" DISPLAY



SOLID STATE CLOCK/CALENDAR KIT

0101 Displays time of day, date or alternates between both automatically. May be connected to 8 ohm speaker for alarm clock. Operates from 120 VAC 60 Hz.

\$49.95 Oak case extra, \$29.95

UNIVERSAL DESIGNER KIT 6100

Indispensable aid to digital IC design. 2 pushbuttons, 2 readouts, 4 switch outputs, 8 LEDs, 2 generators, 2 counters, 5V supply pins.

Breadboard extra. \$59.95 assembled

6101 Digital Logic Course \$29.95

ASK FOR OUR FREE 8-PAGE CATALOG

PACCOM

VISA

Master Charge

14905 N.E. 40th, Redmond, WA 98052 (206) 883-9200

- 0101 SOLID STATE CLOCK CALENDAR KIT \$ 49.95
 - 0101 OAK CASE FOR ABOVE 29.95
 - 6100 UNIVERSAL DESIGNER KIT 49.95
 - 6100 ASSEMBLED DESIGNER KIT 59.95
 - QT 59S BREADBOARD 11.00
 - QT 59B BREADBOARD 2.50
 - 6101 DIGITAL LOGIC COURSE 29.95
- ADD \$2.50 PER ORDER POSTAGE AND HANDLING.

NAME _____ R-7

ADDRESS _____

CITY, ST, ZIP _____

CARD NO. VISA MSTR CHG

SIGNATURE _____

CIRCLE 46 ON FREE INFORMATION CARD

radio products

More information on radio products is available. Use the Free Information Card inside the back cover.

SCANNER, The *Bearcat 300 Service Search*, is a radio with over 2000 pre-programmed frequencies and offers 11 services, including police, fire, marine, ham, government, and business. By pushing a button, the radio will automatically search the actively assigned frequencies for the service selected. The scanner also has 50 user-

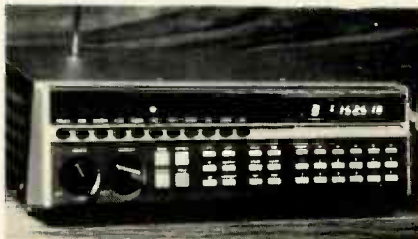

CIRCLE 111 ON FREE INFORMATION CARD

programmable channels. Frequencies are changed and stored by keyboard entry and can be in any combination from the seven VHF and UHF bands. Other features include HOLD, RESUME, and SPEED controls, search between frequencies, and a digital display that also shows time. Measures 12 1/4" X 3 3/8" X 7". Price is \$499.95. —**Electra Co.**, P.O. Box 29243, Cumberland, IN 46229.

ANTENNA SIGNAL BOOSTER, the *Indy Long Ranger*, is a solid-state system designed for CB radios. It operates by a preamp that boosts the receiving signal up to three times, giving an additional three S units or more for AM or SSB. Tuned

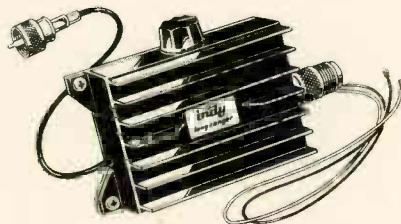

CIRCLE 112 ON FREE INFORMATION CARD

to 27 MHz, it runs on positive or negative ground, and features an adjustable gain control. Comes complete with instructions and adhesive pad for installation. Suggested retail price is \$19.95. —**ESP Systems Development, Inc.**, 28189 Kehrig Dr., Mt. Clemens, MI 48085.

AMATEUR RADIO SPEECH CLIPPER, model *HDP-1220 BW*, is designed for use with the Heath Company's *SB-100/101/102* and *HW-100/101*



CIRCLE 50 ON FREE INFORMATION CARD

transceivers, and with the *SB-400/401* transmitters. Average SSB output is increased by 66%—a little below full key-down CW output. Unlike some other speech clippers on the market, the *HDP-1220* installs in the IF strip of the rig to produce true RF processing. A specially-designed IC gives hard, symmetrical clipping, and a built-in SSB filter keeps both audio and signal narrow and clean. The unit comes fully-assembled and can be installed in just 15 to 30 minutes using only three cables (supplied). No irreversible modifications need be made to the rig. Price of the *HDP-1220* speech clipper is \$149.95 fully assembled. **Heath Company**, Benton Harbor, MI 49022.

AM/FM/CB ANTENNA, model *TL-15*, is a manually-operated triway antenna designed to fit General Motors and narrow-fender cars. The custom top-mount antenna has a 72-inch cable and a single 42-inch mast. Its top-loaded whip is easily removable for protection against theft. Suggested retail price for the *TL-15* is \$39.30. **Harada**

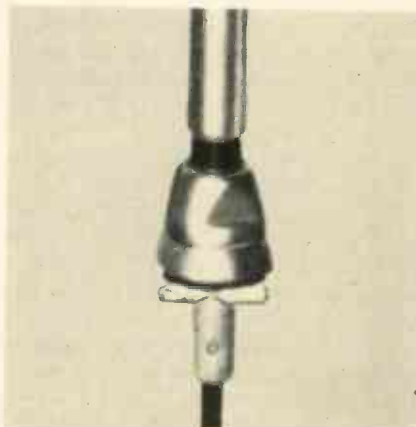

CIRCLE 113 ON FREE INFORMATION CARD

Industry of America, Inc., Dept. P, 1900 W. Artesia Blvd., Compton, CA 90220.

SATELLITE TV RECEIVER, model *4200*, is a low-cost fully tunable receiver covering all channels from 3.7 to 4 GHz. It provides dual-audio outputs of 6.2 to 6.8 MHz, with other outputs available. The unit features a built-in LNA power supply and is compatible with video monitor and VTR input.



CIRCLE 114 ON FREE INFORMATION CARD

Available in 1-9 quantities for \$1,995; other quantities prices on request. —**International Crystal Mfg. Co., Inc.** 10 No. Lee, Oklahoma City, OK 73102. **R-E**

Use your oscilloscope for easier and faster troubleshooting

JACK DARR, SERVICE EDITOR

THIS DEPARTMENT GETS A LOT OF MAIL asking for help in locating faults in anything electronic. In our "armory" we have one instrument that can make finding those answers a lot easier: that is the oscilloscope. (Up to just a few years ago, it was the most bought and *least used* instrument in a shop. From a random survey, I doubt if as much as 10% of the service technicians used the scopes they had!) Yet, it's the most versatile test instrument in the shop. Properly used, it can do almost anything. Many of us think it's hard to use; it is not. Let's have a look at a few typical jobs it does so well, and how easy they are to do.

What's the first question we ask ourselves when we begin a diagnosis? It should be "What is this not doing that it ought to be doing?" In all cases, that means that something in there is *stopping* a signal—keeping it from going through the circuitry and getting to the places it ought to be. It can be anything from a sweep signal, to audio, IF, color—anything. What we must have is an instrument that will *show* us the signal and find out just how far it goes.

That instrument is the scope; it's the only tool that can do it. You can look at it and get an unmistakable answer. Other instruments may be reading hum, interference, oscillation, etc., and make you think it is a signal. Not the scope; it shows you the signal, or—just as important—shows you where it isn't. Find out where the signal stops and you have the one clue that will help you solve the problem.

In many cases, you *must* use the scope—in sync problems, for instance. Letters ask me "How can I solve this sync problem? I don't have a scope—just a multimeter." The answer is "Only with great difficulty!" Meters are important: After you find the point of failure you use them to get more clues as to the exact nature of the fault. DC voltage, resistance readings, continuity, etc., are necessary, but you do not want to waste time making them at random. That isn't testing; that's just "poking at it!"

The scope is the major instrument for my favorite test-method. First, identify the faulty stage. Start at one end of it and go through it from input to output until you find where the signal stops. Just hit each test point with the scope probe and

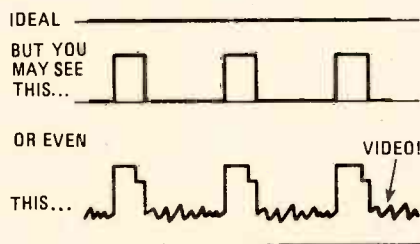

FIG. 1

see what's there. It takes longer to identify the test points than it does to make the tests.

Let's look at some actual cases where a scope provided the key to the problem. One very old symptom is "no video, but a good raster." The signal is being stopped dead somewhere in the signal-path. The best test for that is to check for the video signal at the video-detector output. If it's there, you have cleared all of the RF/IF stages and the AGC, in one jab! The problem is then in the video stages.

Another, and really annoying fault is feedback. The stock symptom of that is a whole lot of problems all at once—weak video, distortion, poor sync, lines and wiggles in the picture, and others. When you see something like that, start looking for something that is *common* to all of the

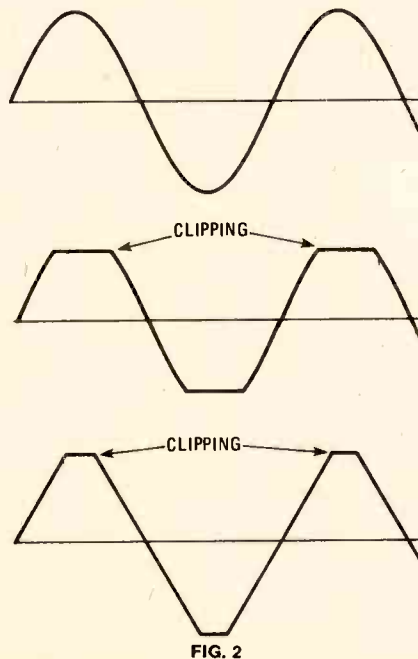

FIG. 2

affected stages. That is the DC power supply. Poor filtering can allow feedback between stages and cause all kinds of weird things. Here again, a "one-jab" test with the scope tells you. Just touch any of the B+ lines and look for any sign of a signal. You should see nothing but a nice straight line; if you see any signal at all—pulses, hash, or anything else—the filter circuits aren't doing the job. (See Fig. 1). Check the filter capacitors.

Speaking of testing filter and bypass capacitors, the scope makes a great in-circuit tester. Touch the scope probe to the terminals of a capacitor in the set while the set is in actual operation. That will catch bypass capacitors that aren't doing the job. Just check on the hot terminal; you should see no signals at all. Check every bypassed point; emitters, bottom ends of coupling transformer primaries, etc. That is very useful in color circuits!

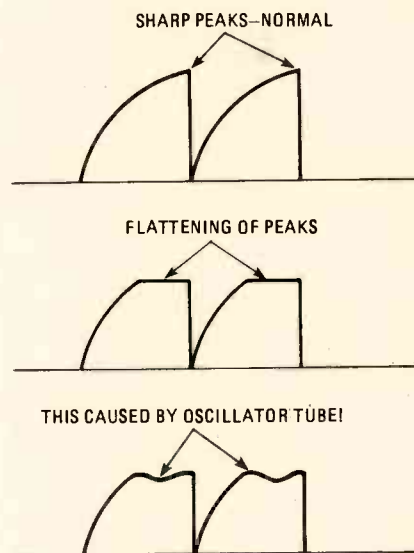

FIG. 3

Audio distortion can be tough, but a scope makes it easy. Feed in a known signal, then just follow it through until you find the point where the distortion shows up. Distortion is a common problem in common-emitter amplifiers with a bypassed emitter resistor. Scope the emitter of the output transistor; there should be no signal here. If there is, the bypass capacitor is open and the resulting degeneration upsets the stage. Clipping is another common problem. Follow the same test method. Feed in a signal at the proper level and trace until you find the stage

that is clipping. If you have a function-generator with a triangle-wave output, try using it as the signal source. The sharp peaks will instantly show up any sign of clipping. (Fig. 2.)

Checking the output power of power amplifiers is easy. Feed in a signal and scope the output. Now, raise the volume until you see it start to clip. Back off until the clipping has disappeared, then read the P-P voltage. That can be converted to power using the formula: $P = E \times I$. (Don't forget to convert P-P to RMS!)

Some really obscure problems are a cinch to isolate with a scope. One is creeping current in horizontal output stages (tube sets). Scope the grid drive and watch the waveform (See Fig. 3). The normal waveform has a sharp peak. You may see that peak start to flatten out as the tube warms up. The current rises in step with the flattening. The flat peak keeps the tube *turned on* for much too long, and raises the average current. That is caused by grid-emission in the tube.

The scope can be the most useful instrument on the bench. Get one—and use it. It's not at all hard; all you do is touch the probe to the point you want to check, and adjust the controls for a stable waveform. Some of the new DC-coupled scopes can be used as DC voltmeters although I'm not really too impressed with that application. I prefer to use a DC voltmeter.

I've always been an ardent advocate of using a scope. Try using yours for a while and I'm sure that you will become as strong an advocate as I am.

Correction

In the April issue, I said that I couldn't find an address for an old and reputable company, Dynaco. That much was true—I couldn't. However, I have had quite a few letters already from (rightfully) indignant readers, saying "Dynaco is not dead; they're alive and well, and living in Canton, MA 02021!" My apologies to all, and especially to the company who have been making very good hi-fi equipment for a long while. The correct address is "Dynaco, Inc., 110 Shawmut Road, Canton, MA 02021". This information is now in my files!

R-E

service questions

TOUCH-PLATE SWITCH

Someone has "worked" on this Panasonic set before. Most of the damage is now cleared up, but that feather-touch switch puzzles me. It's been taken apart and I can't tell what's missing. I'm a little lost.—K.M., Pittsburgh, PA.

This is a "touch-plate" switch circuit. Just touch the switch and it turns on or off. So, all the switch has in it is a small metal blob or contact. This goes to an oscillator circuit, then to a waveshaper squaring amp, then to a trigger that turns on the switch transistor. This last stage is apparently a flip-flop. The first touch turns it on; the next touch turns it off.

Trace the circuit through from the oscillator, checking the pulses, DC voltages, etc. This is a rather unusual circuit, and I don't understand all of it. However, it should be fairly easy to check out. Look for open diodes, transistors, etc., plus bad solder joints!

VERTICAL OUT

The vertical sweep went out on this Zenith 19FC45. Found that the picture tube was also out, too! Replaced all parts but I'm afraid to turn it on. Any advice?—G.A., Richmond Hill, NY.

One very good piece of advice! Find the 4-legged capacitor on the collector of the horizontal output transistor, C229-a and C229-b, and change it! If this breaks down it can cause damage to the picture tube. Zenith distributors have an improved version of this capacitor and I would definitely recommend putting this in before you light the fire.

RED HOT DAMPER

I'm up a tree! The damper tube in this CTC-31 gets red hot. New damper tube, flyback, yoke, etc., didn't help. I've checked everything I can think of and no results, I even unhooked L29 from the cathode of the damper, and it still gets hot! Can you tell me what's going on here?—J.R., Detroit, MI.

Red-hot with the cathode of the damper floating? Current has no place to go, or shouldn't have. Logical analysis says that the cathode of this tube is grounded somehow. If an ohmmeter shows no ground here, replace the damper socket. I suspect a carbon path or breakdown of the insulation between this socket pin and ground. *Something* is taking a lot of current here, and this is about the only thing you haven't tried. (Good luck!)

TAPE-PLAYER MOTOR HINT

Ken Boren (who forgot to include his address!) sends this one along, and it sounds good. He says that he was replacing motors in 8-track tape units, because of excess slippage. Cleaned motors, put back together, and they did much better. Finally got a callback on one that had just been replaced.

Noticed that when the flywheel was taken off, the motor shaft looked very shiny and smooth; new motor's shaft was dull and rough looking. Got idea; sanded the old shaft till dull, put flywheel back, and it runs like a charm. Been working for a month or more!! So, look for polished shafts and roughen them up and these things can be fixed a lot easier. R-E

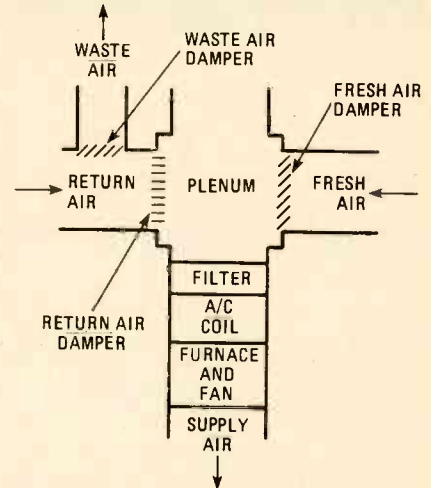

Fig. 11—ALTERNATE MEANS of air flow control. It is important that dampers close tightly.

Center power supply will be needed.

A special inlet must be added to your heating/air-conditioning system to supply the fresh air. That inlet should be placed under the eaves of the house so it will be shaded and not subject to the direct rays of the sun. The outside sensor should be installed near it. A filter grill, or at the minimum, a 1/4-inch screen grid cover, is advisable at the opening. Attic air should not be used because of the extreme temperatures encountered in the summer.

The fresh air should be ducted into the return air plenum to enable the central-system fan to distribute the air equally throughout the conditioned area. An outlet for the waste air should be provided for use in the fresh-air mode and the air should be exhausted into the attic to keep the attic temperature closer to inside temperature, thus reducing the heating and cooling load. Diagrams showing the two methods of feeding fresh air into the home's climate-controlled environment are in Figs. 10 and 11. The integrity of the fresh air duct and louvers is important in that, if air leakage occurs, the efficiency of the heating or cooling units will be impaired. Finally, remember that this system is not proportional and that a simple open-close actuator will suffice. R-E

Put your money where your Heart is.



market center

FREE KIT Catalog

AUTORANGE DIGITAL CAP-METER contains TEST & EXPERIMENTER'S EQUIP. KIT. Still the best for only \$74.95
Phone 415-447-3433
 Write or Phone for FREE CATALOG. Average 1 minute Saturday call is 21¢.

DAGE SCIENTIFIC INSTRUMENTS
 BOX 1054R LIVERMORE CA 94550

PLANS & KITS

ELECTRONIC organ kits. The ultimate design. Sounds like a pipe organ. Build it to sell or build it to keep. Models for churches, homes, clubs, pizza parlors. Send \$2.00 for demo record and catalog. **DEVTRONIX**, Dept. 70, 6101 Warehouse Way, Sacramento, CA 95826

PRINTED circuit boards from sketch or artwork. Kit projects. Free details. **DANOCINTHS INC.**, Box 261, Westland, MI 48185

SPEAKERS. Save 50%. Build your own speaker system. "Free catalog" write: **MC GEE RADIO**, RE 1901, McGee Street, Kansas City, MO 64108

SATELLITE TV antenna build for \$300. Detailed plans \$30. **NUMAN ENTERPRISES**, Rt. 1, Box 357, Jonesboro, TE 37659

PROJECTION TV. . . Convert your TV to project 7 foot picture. Results equal to \$2,500 projector. Total cost less than \$20.00. Plans & lens \$16.00. Illustrated information free. **MACROCOMGJ**, Washington Crossing, PA 18977

"PCB as low as 15¢ sq-in, free drilling, also PTH. **INTERNATIONAL ENTERPRISE**, 12507 Brent, Cerritos, CA 90701

ATV Research ...specialists in CCTV and computer monitors!

Video monitors - color & B/W * TV Cameras, kits, parts & plans * Video-to-RF modulators * Free catalog, Phone or write. (402) 987-3771

13-RE Broadway Dakota City, NE. 68731

LED projects, bargraphs, VU, oscilloscopes, controllers, clocks, \$3.50. **EMERY ELECTRONIC ENTERPRISES**, 731 N. Olive, Anaheim, CA 92805

CB/HAM Circularly polarized beam antenna. Plans \$4.00. Free catalog-plans/kits. **PANAXIS**, Box 130-F7, Paradise, CA 95969

AMATEUR radio books. Free catalog. **SCELBI PUBLICATIONS**, 20-R Hurlbut Street, Elmwood, CT 06110

EINSTEIN superCeded! Free! 408 Vermont, Daytona, FL 32018

NEGATIVE ion generator: build with easy-to-get parts for less than kit prices! Complete plans \$5.00. **LUNATRIX**, Box 891-RE, Yucaipa, CA 92399

SATELLITE Television. Build your own satellite receiving station. Quick and easy to construct. For more information write: **Robert Coleman**, Rt. 3, Box 58-A, Travelers Rest, SC 29690

SECRET guide to computers. Free catalog. **SCELBI PUBLICATIONS**, 20-R Hurlbut Street, Elmwood, CT 06110

WHOLESALE TO DEALERS

DEALERS: send letterhead for free wholesale pricelist of CB radio and scanner equipment. **FOUR WHEELER COMMUNICATIONS**, 10-R New Scotland Ave., Albany, N.Y. 12208 (518) 465-4711

CLASSIFIED COMMERCIAL RATE (for firms or individuals offering commercial products or services) **\$1.50 per word prepaid (no charge for zip code)** . . . **MINIMUM 15 WORDS**. 5% discount for 6 issues, 10% for 12 issues within one year, if prepaid.

NON-COMMERCIAL RATE (for individuals who want to buy or sell a personal item) **85¢ per word prepaid** . . . no minimum.

ONLY FIRST WORD AND NAME set in bold caps. Additional bold face (not available as all caps) at 10¢ per word. All copy subject to publisher's approval. **ADVERTISEMENTS USING P.O. BOX ADDRESS WILL NOT BE ACCEPTED UNTIL ADVERTISER SUPPLIES PUBLISHER WITH PERMANENT ADDRESS AND PHONE NUMBER**. Copy to be in our hands on the 26th of the third month preceding the date of the issue (i.e., August issue closes May 26). When normal closing date falls on Saturday, Sunday, or a holiday, issue closes on preceding working day.

HIGHLY PROFITABLE

ONE-MAN ELECTRONIC FACTORY

Investment unnecessary, knowledge not required, sales handled by professionals. Ideal home business. Write today for facts! **Postcard will do. Barta-RE-E, Box 248, Walnut Creek, CA 94597.**

BUSINESS OPPORTUNITIES

MECHANICALLY inclined individuals desiring ownership of Small Electronics Manufacturing Business—without investment. Write: **BUSINESS-ES**, 92-R, Brighton 11th, Brooklyn, NY 11235

BOOKS

"**CRIME** By Computer" \$6.95. Postpaid—300 pages. **COMP-U-TRONIX**, Box 3401, Kent, WA 98031

WANTED

ELECTRONIC products assembled. Company seeks contracts from manufacturers large and small. U.S. labor and knowhow isn't priced out of reach. Details write: **PRODUCTION DEVELOPMENT INC.**, 1320 Water St., Brownsville, PA 15417

EIMAC/Varian tubes 304TL, 4CX1000, etc. Also need 53, 6L6 metal, 7F7, 7C5. **Ted Dames**, W2KUW, 10 Schuyler Avenue, North Arlington, NJ 07032. (201) 998-4246, (800) 526-1270

PICTURE TUBE MACHINE
 We buy and sell NEW and USED CRT rebuilding machinery. **COMPLETE TRAINING**. Buy with **CONFIDENCE** from the ORIGINAL MFR.
 For complete details send name, address, ZIP to:
LAKESIDE INDUSTRIES
 4071 N. Elston Avenue
 Chicago, Ill. 60618
 Phone: 312-583-6565



To run your own classified ad, put one word on each of the lines below and send this form along with your check for \$1.50 per word (minimum 15 words) to:

Radio-Electronics, 200 Park Avenue South, N.Y., N.Y. 10003

ORDER FORM

PLEASE INDICATE in which category of classified advertising you wish your ad to appear. For special headings, there is a surcharge of \$10.

() Plans/Kits () Business Opportunities () For Sale
 () Education/Instruction () Wanted ()

Special Category: \$10

(PLEASE PRINT EACH WORD SEPARATELY, IN BLOCK LETTERS.)

| | | | | |
|----|----|----|----|----|
| 1 | 2 | 3 | 4 | 5 |
| 6 | 7 | 8 | 9 | 10 |
| 11 | 12 | 13 | 14 | 15 |
| 16 | 17 | 18 | 19 | 20 |
| 21 | 22 | 23 | 24 | 25 |
| 26 | 27 | 28 | 29 | 30 |
| 31 | 32 | 33 | 34 | 35 |

PLEASE INCLUDE FOR OUR FILES YOUR PERMANENT ADDRESS AND PHONE NUMBER.

SATELLITE TV FOR THE HOME

Our receiver lets you get over 75 channels of television directly from earth-orbiting cable TV satellites! HBO, Showtime, super stations, sports and movies from around the world.



Sick of Network TV? Buy Complete or Build our kit and save!

Our 24-channel receiver provides "studio quality" TV reception. Easy to install! Ultra low power consumption! Brilliant color! Works anywhere! FCC licensing no longer required. Order today!

Complete details covered in our Home Earth Station manual. Send \$7.95 today (refundable against any purchase), or call:
24-hour C.O.D. Hotline (305) 869-4283
SPACECOAST RESEARCH
Dept. T, P.O. Box 442, Altamonte Springs, FL 32701

SATELLITE TELEVISION

SATELLITE TV buyers guide. Exclusive comparisons plus how to install your own saving big \$. Worldwide movies, news, sports, religion, entertainment on your set. Well over 35 channels. Book guaranteed. US funds please. \$12.95 post-paid or \$14.95 First class (Airmail). **REED PUBLICATIONS**, Box 219-E, Maitland, FL 32751

SATELLITE television—satellite weatherfax. Will your receiving antenna clear local obstructions? Get antenna aiming data for geostationary satellites, custom computed for your latitude and longitude. Included is chart of U.S. and International satellites around the globe and instructions on how to find them in the sky. Send \$5.00 to **COMPUSAT**, 643 South Route 83, Elmhurst, Illinois 60126.

ANTENNA azimuth and elevation for all Western Hemisphere geostationary satellites. \$3.00 and your latitude and longitude. Free sample SASE. **DAVID FREY**, Box 2591, Satellite Beach, FL 32937

LNA GaAs FET's 45.00, duroid boards \$10.00, parabolic dishes, bandpass filters, IF amps, demodulators, IC's for Radio-Electronics satellite receiver. Connectors. We have parts and modules or entire terminals. Send \$4.00 (refundable) for information. **EWG**, 38005 Pueblo Rd, Hinkley, CA 92347

SATELLITE downconverter 3.7—4.2 GHz in, 70 MHz out. Commercial quality performance, provision for onboard local osc. \$75.00 includes PCB w/parts \$1.00 brings manual, birkill LNA PCB chip caps sase **NORMAN GILLASPIE**, 2225 Sharon Rd, #224, Menlo Park, CA 94025

KEEP YOUR CARRIERS CRYSTAL CLEAR



The C-1000 gives you greater accuracy and wider frequency range than many frequency counters that cost much more. Accuracy to 1 PPM (0.0001%) from 0° to 40°C. Full frequency range from 10Hz to 1GHz. Rugged metal case. 8 1/2 digit resolution. Selectable 1, 1 and 10 second gate times. Standby feature allows oven to remain ready

\$499.95

BRIGHT ELECTRONICS

P.O. Box 76972 • Atlanta, Georgia 30328
Order toll free 800-241-3939
In Georgia call 404-257-1494

AUTHORIZED **TRS-80®** DEALER A301

COMPUTER SPECIALISTS



Up to **15% Discount** on TRS-80's

26-1051 4K LEVEL I \$424.00
26-1056 16K LEVEL II \$715.00

1-800-841-0860 TOLL FREE

MICRO MANAGEMENT SYSTEMS, INC.
Downtown Plaza Shopping Center
115 C. Second Ave., S.W.
Cairo, Georgia 31728
(912) 377-7120 Go. Phone No.

FOR SALE

RADIO & TV tubes 49¢ each. One year guaranteed. Plus many unusual electronic bargains. Free catalog. **CORNELL**, 4217-E University, San Diego, Calif. 92105

SCANNER/monitor accessories—kits and factory assembled. Free catalog. **CAPRI ELECTRONICS**, Route 1R, Canon, GA 30520

FREE catalog, IC's, LED's, semi's, parts. **CORONET ELECTRONICS**, 649A Notre Dame W., Montreal, Que., Canada H3C 1H8. U.S. inquiries.

RECONDITIONED test equipment. \$1.00 for catalog. **JAMES WALTER TEST EQUIPMENT**, 2697 Nickel, San Pablo, CA 94806

SAVE up to 50% on name brand test equipment. Free catalog and price list. **SALEN ELECTRONICS**, Box 82-M, Skokie, IL 60077

VARACTOR television tuners. These are small high performance units with separate VHF and UHF tuners. With data, new \$19.75 ppd. USA. **L.R. DESIGN**, Box 41, McMinnville, OR 97128

STEREO RADIO



5804 **MADE BY THE AUTO RADIO SPECIALISTS!!**
AUTOMATIC RADIO
Models May Vary
PUSH BUTTONS



UNBELIEVABLE

44⁵⁰ \$170 STEREO 8-TRAK TAPE

\$3.00 FOR SHPG. AM-FM-MUX

BY POPULAR DEMAND! Delta is the first in the world to offer these new, first-grade stereo radios at surplus!!! They are 100% solid state AM-FM-MPX stereo radios & stereo 8-track player. With knobs and 5 push buttons!

AM-FM **Convert Your Car Into A Concert Hall!**



19⁹⁵ \$100 AM-FM AUTO RADIO

FACTORY CLOSEOUT! One of America's largest manufacturers of auto radios has given up. We've been fortunate in acquiring the last auto radios in production. These are AM-FM sets... designed for new cars. All are tested 100% operational and come with knobs and push buttons. Ideal for installing in your auto, van, camper, boat, truck.

NEWS ITEM! Auto hi-fi has become as sophisticated as home hi-fi—and nearly as expensive. You can spend \$200 for simple components—which means hi-fi can be out of reach for many folks and 2nd cars. If you want hi-fi FM, you can start with the purchase of a \$100 radio for a mere \$19.95... This price will not last long—order today while our limited supply lasts!

TOO GOOD TO BE TRUE! This sale is not available to the general public as they would sell out instantly. However, our loyal customers have the opportunity to scoop up these new SURPLUS GEMS and save big dollars.

| Delta No. | Size | Compare | SALE |
|-----------|------------------------|----------|----------|
| 5801R | 7/4 x 2 1/2 x 7 1/4" | \$160.00 | \$39.95* |
| 5802R | 7/4 x 2-5/16 x 7 | \$160.00 | \$39.95* |
| 5803R | 7-3/8 x 3 1/4 x 6 1/4" | \$170.00 | \$44.50† |
| 5804R | 7 1/2 x 3-3/8 x 7 1/4" | \$170.00 | \$44.50† |

* Manual tuning. † Push buttons!
Negative ground. 5 3/4" knob spacing.

MAIL-ORDER ADDRESS:

FREE 120-PG. 'SURPLUS' CATALOG

DELTA ELECTRONICS

176 SECOND AVE. WALTHAM, MASS. 02154
Minimum Order \$8.00
TEL. (617) 388-4705

MINIATURE ADJUSTABLE CAPACITOR

3.5-13 pf or 7-35 pf 1/4" dia. 1/4" high
50¢ each specify value

SPRAGUE 100Vdc \$1.00 each
600 mfd. 2-11/16" long 1" dia.

DUAL 50K SLIDE POT linear taper \$1.50 each
3 inch long 2 1/4 inch slide knobs for slide pots 20¢ each

10 MEG POTS Standard 1/2 Watt Size
1/4" Long Shaft 1/4" Dia
25 For \$5.00 4 For \$1.00

50K SLIDE POT 75¢ Each
Knobs for Slide Pots 20¢ each
audio taper
3-1/2 inch long 2-3/4 inch slide

REED RELAYS

9-15 VOLT D.C. NORMALLY OPENED
CONTACTS: 1 amp max. switch—2 amp max. carry
BODY SIZE: approx. 1 inch long 1/4 inch high
S.P.S.T. 1500 ohm coil \$1.15 each
D.P.S.T. 1200 ohm coil \$1.30 each
3.P.S.T. 750 ohm coil \$1.50 each

ALCO HEAVY DUTY MINIATURE SIZE TOGGLE

Rated: 10 amps @ 120 vac
Contacts: solid silver S.P.D.T.
Body Size: 9/16" dia. cylindrical body 1/4" high
\$1.50 each specify handle style
Flat Lever Standard 1/4" miniature
Bat 1522 Bat 1522 Bat 1522
Bushing 1/4" dia. Bushing 1/4" dia. Bushing 1/4" dia.

HOUSE MARKED DARLINGTON TRANSISTOR
SPECIFY 5 AMPS 65 WATTS
NPN 80 VOLTS
PNP SIMILAR TO TIP 124NPN 10220
75¢ each TIP 125 PNP CASE

1 OHM 175 WATT WIREWOUND RESISTOR \$1.75 each
8 1/4" long, 1-1/8" dia.

2244 EDGEBOARD CONNECTOR TIN SOLDER TAIL .156" x 2.00"

LARGE QUANTITIES AVAILABLE \$1.35 each 10 for \$12.50

PHOTO—FLASH CAPACITOR

1100 MFD 330 VOLTS
3/4" x 1 1/4" \$1.50 Each

3x5" OAKTRON SPEAKER \$2.50 each
3oz. Magnet
8 OHM Impedance

ALL ELECTRONICS CORP.

905 S. Vermont Ave. SEND FOR OUR FREE CATALOG
Los Angeles, CA 90006
(213) 380-8000

Store & Warehouse Hours
9 AM - 5 PM
Monday thru Friday
Saturday
10 AM - 3 PM

TERMS
• Quantities Limited
• Min. Order \$10.00
• Add \$2.00 Shipping USA
• Calif. Res. Add 6%
• Prompt Shipping

ECG, RCA AND GE SEMICONDUCTORS SOLVE SERVICE PROBLEMS.

**MCM SEMICONDUCTORS
SOLVE THOSE SAME PROBLEMS AND COST LESS.
MUCH LESS.**

Here's Proof! SAVE UP TO 40% ON 10 OR MORE OF THE SAME ITEM!

ECG is a registered trademark of GTE Sylvania.

| EQUIV. | EQIV. | EQUIV. | EQIV. | EQUIV. | EQUIV. | EQUIV. | EQUIV. | EQUIV. | EQUIV. | EQUIV. | EQUIV. | EQUIV. |
|----------|-----------|-----------|----------|-----------|------------|-----------|-----------|------------|--|--------|--------|--------|
| 102A .40 | 135A .40 | 171 2.25 | 231 4.90 | 298 1.10 | 381 3.10 | 720 1.50 | 791 2.80 | 975 1.60 | 1036 3.20 | | | |
| 103A .80 | 136A .40 | 176 1.30 | 233 .80 | 299 .75 | 382 1.00 | 721 3.80 | 793 3.20 | 978 1.60 | 1037 3.00 | | | |
| 104 2.00 | 137A .40 | 176 1.10 | 234 .40 | 300 .70 | 383 1.10 | 722 1.50 | 801 2.00 | 987 1.40 | 1040 1.40 | | | |
| 105 3.90 | 138A .40 | 177 .25 | 235 1.60 | 302 1.30 | 390 1.10 | 723 1.50 | 802 8.80 | 990 4.80 | 1041 1.20 | | | |
| 106 .40 | 139A .40 | 180 4.60 | 236 1.80 | 306 1.30 | 391 1.10 | 724 2.80 | 803 8.80 | 992 1.80 | 1042 2.40 | | | |
| 107 .80 | 140A .40 | 181 3.40 | 237 2.40 | 307 .50 | 500A 12.40 | 725 1.50 | 804 2.90 | 1002 1.20 | 1043 3.90 | | | |
| 108 1.20 | 142A .40 | 182 3.20 | 238 3.35 | 308 7.40 | 506 1.50 | 726 3.50 | 805 3.20 | 1003 1.20 | 1045 2.60 | | | |
| 109 .20 | 143A .40 | 183 3.75 | 236 7.90 | 310 7.40 | 523 18.80 | 728 3.80 | 806 3.80 | 1004 2.40 | 1046 3.20 | | | |
| 110 .40 | 144A .40 | 184 1.30 | 237 7.80 | 312 .60 | 525 1.35 | 729 4.20 | 807 3.20 | 1006 2.20 | 1049 3.90 | | | |
| 113 .55 | 145A .40 | 185 .90 | 239 7.40 | 313 .80 | 526A 18.80 | 731 1.50 | 814 4.00 | 1009 2.20 | 1050 2.00 | | | |
| 116 .20 | 152 1.30 | 186A .60 | 280 3.40 | 315 1.00 | 551 2.00 | 737 3.80 | 815 3.80 | 1010 2.20 | 1051 5.90 | | | |
| 117 .20 | 153 .90 | 187A .80 | 281 4.60 | 320 10.60 | 601 .30 | 738 4.80 | 818 3.80 | 1011 2.25 | 1052 1.00 | | | |
| 118 .90 | 155 2.90 | 190 1.80 | 282 2.00 | 321 3.60 | 605 1.65 | 739 3.20 | 823 1.20 | 1014 1.90 | 1053 2.70 | | | |
| 121 2.75 | 156 .60 | 192 .45 | 283 4.60 | 323 2.20 | 612 .35 | 740A 2.60 | 824 2.50 | 1016 2.20 | 1054 1.70 | | | |
| 123A .35 | 157 1.50 | 193 .55 | 284 4.30 | 324 2.50 | 613 .40 | 742 4.20 | 904 6.90 | 1019 1.20 | 1055 2.70 | | | |
| 124 2.00 | 158 .40 | 195A 2.00 | 285 6.20 | 325 29.20 | 703A 1.50 | 743 3.80 | 905 4.50 | 1020 2.20 | 1056 2.80 | | | |
| 125 .20 | 159 1.10 | 196 1.30 | 287 .70 | 333 19.00 | 708 1.50 | 744 5.20 | 912 2.40 | 1021 2.20 | 1057 3.10 | | | |
| 126 .80 | 160 1.80 | 197 1.50 | 289 .60 | 334 19.00 | 709 1.50 | 746 3.80 | 917 3.20 | 1024 4.20 | 1058 1.95 | | | |
| 127 2.95 | 161 1.20 | 198 1.50 | 290 .60 | 335 26.00 | 710 3.00 | 748 2.80 | 923 1.30 | 1025 5.90 | | | | |
| 128 1.40 | 162 4.60 | 199 .60 | 291 1.30 | 336 26.00 | 712 2.25 | 749 2.90 | 925 7.80 | 1027 4.90 | | | | |
| 129 1.20 | 163A 4.60 | 220 1.60 | 292 1.50 | 373 2.50 | 713 1.50 | 778A 1.80 | 941M .90 | 1028 10.40 | Many more items to choose from but space does not permit listing them all. | | | |
| 130 1.30 | 165 3.35 | 221 1.40 | 293 1.00 | 374 2.60 | 714 2.80 | 780 3.20 | 955M 1.40 | 1029 2.60 | | | | |
| 131 1.00 | 166 1.45 | 222 1.60 | 294 1.10 | 375 1.50 | 715 3.20 | 783 2.60 | 966 1.30 | 1030 3.60 | | | | |
| 132 .60 | 167 1.45 | 229 .80 | 295 .60 | 376 2.25 | 718 1.50 | 788 1.50 | 973 1.80 | 1032 2.90 | | | | |
| 133 .60 | 168 1.45 | 230 4.60 | 297 1.00 | 380 3.00 | 719 1.50 | 790 2.80 | 9730 2.00 | 1035 4.60 | | | | |

Special

Equivalent to ECG 163A



\$3.90
Horizontal Deflection TO-3 CASE

Equivalent to ECG 165



\$2.40
Horizontal Deflection TO-3 CASE

Equivalent to ECG 238



\$2.45
Horizontal Output TO-3 CASE

mcm audio, inc.
Parts for the TV, Stereo & Communications World
639 Watervliet Avenue, Dayton, Ohio 45420

Call This Toll-Free 24 Hour Hot Line

1-800-543-3528

Ohio Watts 1-800-762-3418

**ALL ORDERS
SENT U.P.S.
WITHIN
24 HOURS.**

CIRCLE 10 ON FREE INFORMATION CARD

www.americanradiohistory.com

FOR SALE

RAW speakers and finished systems for Hi-Fi and Sound Reinforcement. Also cabinet plans, hardware, grille cloth, crossovers, microphones, accessories, much more. Information-packed catalog, \$1.00. **UNIVERSAL DISCOUNT SOUND**, Dept. RE, 2243 Ringling Blvd, Sarasota, FL 33577

TOP quality components, bottom line prices. Enclosures, carbide drill bits, and much more. Stamp brings catalogue. **MIDNIGHT ENGINEERING GROUP**, P.O. Box 349, Galesburg, IL 61401

BOOKS learn electronics, lasers, robotics, computers, TV, solar, etc. Catalog 30¢. **DOT**, 9719R Southwest Highway, Oaklawn, IL 60453

NICKEL cadmium cells, wet type, used, tested. 34AH \$6.00ea. 22AH \$5.00ea. **JOE CONNER**, 8346 Bagley, Ashley, MI 48806

CRYSTALS, monitor. Free frequency look up with order. Only \$4.95 each plus .50¢ shipping/order. Buy four get fifth free. List radio brand. **ARNIE ELECTRONICS**, 69 E. Northfield Rd., Livingston, NJ 07039

TELEVISION downconverters 1.6-2.7 GHz \$99.95 assembled. Details for stamp. **GW ELECTRONICS**, POB 688, Greenwood, IN 46142

"**THE Intelligence Library**" technical secrets. Books on **Electronic Surveillance, Lock-Picking, Demolitions, Covert Sciences**, etc. One dollar. (refundable): **MENTOR PUBLICATIONS**, Dept. Z, 135-53 Northern Boulevard, Flushing, NY 11354

CABLE TV converters \$39.95. Incredible 96-page catalog free. **ETCO**, Box 762, Plattsburgh, NY 12901

TEST equipment, new and used. Catalog \$1.00. **PTI**, Box 8756, White Bear Lake, MN 55110

LASER handbook with burning, cutting, Ruby Reds, Co's, complete plans, books, and parts. Send \$4.00 to **FAMCO**, dept re, box 1902, Rochester, NH 03867

GOVERNMENT surplus receivers, transmitters, sniperscopes, parts, fantastic 72 page catalog 25¢. **MESHNA**, Nahant, Mass. 01908

PASS FCC EXAMS

The Original FCC Tests Answers exam manual that prepares you at home for FCC First and Second class Radiotelephone licenses. Newly revised multiple-choice exams cover all areas tested on the actual FCC exam. Plus "Self-Study" Ability Test. Proven! \$9.95 postpaid. Moneyback Guarantee.

COMMAND PRODUCTIONS P.O. Box 26348 E
Radio Engineering Division San Francisco, CA 94126

EDUCATION & INSTRUCTION

UNIVERSITY degrees by mail! Bachelors, Masters, Ph.D's . . . Free revealing details. **COUNSELLING**, Box 317-RE7, Tustin, CA 92680

BROADCASTING! Start your own radio station at home, school, church! Become a DJ! Free information. "**BROADCASTING**", Box 130-F7, Paradise, CA 95969

HOME study degree program in electronics engineering. 75 specialized courses also available. For information write: **CIEE**, P.O. Box 9196, Pittsburgh, PA 15224

SAMS books—How to Buy and Use Minicomputers and Microcomputers \$9.95, The Incredible Secret Money Machine \$5.95, **RVI**, Box 1116, Waldorf, MD 20601

FREE microcomputer book catalog. **SCELBI PUBLICATIONS**, 20-R Hurlbut Street, Elmwood, CT 06110

HOW to do important mathematics with your scientific calculator? Differentiating . . . Integrating . . . Solving differential equations—Algorithms . . . Limits . . . Trigonometry . . . ?? "I'll show you how in just 10 days or money back!!! Order my giant new guidebook today—271 pages . . . quick . . . easy guaranteed . . . fun." Send \$14.95 to **PROFESSOR McCARTY**, Box 974-M, Laguna Beach, California 92652

8 Instruments in 1

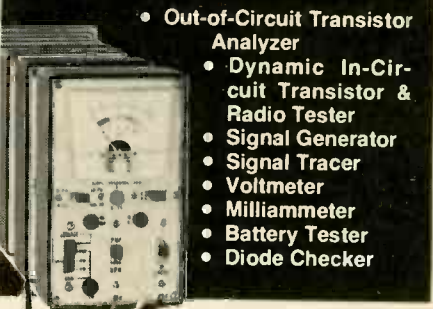

Model
Transistor Analyzer 212
Factory Wired & Tested — \$35.98
Easy-to-Assemble Kit — \$23.97

- Out-of-Circuit Transistor Analyzer
- Dynamic In-Circuit Transistor & Radio Tester
- Signal Generator
- Signal Tracer
- Voltmeter
- Milliammeter
- Battery Tester
- Diode Checker

Now you can pinpoint defective transistors and their circuit troubles speedily with a single, feature-packed instrument instead of a costly elaborate set-up. Performance-proven by thousands! Checks all transistor types, hi or low power, for DC current gain (beta) to 200 in 3 ranges, and leakage.

Universal test socket accepts all base configurations. Identifies NPN or PNP transistors. Dynamically tests all transistors (oscillator check) and AF, IF, RF circuits.

No external power needed. Measures DC currents to 80 ma. Complete with test leads, instruction manual and transistor listing.

Write for FREE catalog of the world-famous EMC line of test instruments.

EMC ELECTRONIC MEASUREMENTS CORP.
625 Broadway, New York, NY 10012

APPLE EXPANSION KIT

16K
Memory add-on with instructions
\$4750

LOGIC PROBE KIT



\$1795

SOROC TECHNOLOGY, INC.



IQ120 \$699.00

DUST COVERS

- Apple Disk 3.75
- Apple Keyboard 8.75
- TRS-80 Keyboard 7.75
- TRS-80 Recorder 3.75
- TRS-80 Single Disk 3.75
- TRS-80 Double Disk 6.75
- TRS-80 Model Keyboard 7.75
- Pet Disk 7.75
- Pet Terminal/Comp 15.75
- Northstar Computer 11.75
- Soroc Terminal 10.75

2716 16K EPROM
\$24.95
450ns single+5V

I.C. MASTER
NEW
"1980" \$54.95

CIRCUIT SPECIALS

- 74LS240 2.25
- 74LS241 2.25
- 74LS243 2.25
- 74LS244 2.25
- 74LS373 2.55
- 74LS374 2.55
- 74S138 3.95

8212 I/O PORT
\$2.95

8216 BUS DRIVER
\$2.95

2708 1024x8 EPROM
\$7.95

8038C VCO Waveform Gen. w/sine
\$265

video 100



\$12900

Leedex Corp.

12" BLACK & WHITE
LOW COST VIDEO
MONITOR

TRS 80 16K Memory Add-On
\$49.95 KIT
With jumpers and instructions

8086 CPU
16BIT Microprocessor
\$6495

16K STATIC RAM
S-100 MEMORY ADD-ON

- ** FULLY STATIC OPERATION
- ** USES 2114 TYPE STATIC RAMS
- ** +8 VDC INPUT AT LESS THAN 2 AMPS
- ** BANK SELECT AVAILABLE BY BANK PORT AND BANK BYTE
- ** PHANTOM LINE CAPABILITY
- ** ADDRESSABLE IN 4K BLOCKS IN 4K INCREMENTS
- ** LED INDICATORS FOR BOARD/BANK
- ** SOLDER MASK ON BOTH SIDES OF BOARD

ASSEMBLED & TESTED \$249.00

California Computer Systems

CONCORD COMPUTER COMPONENTS

1971 SOUTH STATE COLLEGE ANAHEIM, CA. 92806

VISA-MASTERCARD (714) 937-0637 MINIMUM ORDER \$10.00
CHECK OR M.O. ADD \$1.50 FOR FRT
NO COD. We stock and sell over 12,000 types of semi-conductors CAL RES ADD 6%

Active Electronic Sales Corp.

Zilog

Z8001 \$195.00 16 Bit CPU with segmented address space to 8 Megabytes.

Z8002 \$150.00 16 Bit CPU with non segmented address space to 64K bytes.

All Products Stocked in Depth Largest Zilog Inventory

| | | | | | |
|----------|---------|---------|------------|---------|-------|
| Z80-CPU | 2.5 MHz | \$10.40 | Z80-SIO/0 | 2.5 MHz | 30.50 |
| Z80A-CPU | 4.0 MHz | 12.05 | Z80A-SIO/0 | 4.0 MHz | 36.70 |
| Z80-PIO | 2.5 MHz | 6.65 | Z80-SIO/1 | 2.5 MHz | 36.00 |
| Z80A-PIO | 4.0 MHz | 8.00 | Z80A-SIO/1 | 4.0 MHz | 44.10 |
| Z80-CTC | 2.5 MHz | 6.65 | Z80-SIO/2 | 2.5 MHz | 36.00 |
| Z80A-CTC | 4.0 MHz | 8.00 | Z80A-SIO/2 | 4.0 MHz | 44.10 |
| Z80-DMA | 2.5 MHz | \$22.95 | | | |
| Z80A-DMA | 4.0 MHz | 28.00 | | | |

MICROPROCESSOR CHIP SETS

| Part No. | Price | Part No. | Price | Part No. | Price |
|----------|--------|----------|--------|----------|--------|
| 8080A | \$5.95 | 6800 | \$6.50 | 6502 | \$9.95 |
| 8085 | 11.95 | 6802 | 11.95 | 6504 | 9.95 |
| | | | | 6505 | 9.95 |
| 8212 | 2.75 | 6810 | 3.75 | | |
| 8214 | 3.95 | 6820 | 4.95 | 6520 | 6.95 |
| 8216 | 2.95 | 6821 | 3.75 | 6522 | 9.95 |
| 8224 | 3.45 | 6850 | 3.95 | 6532 | 13.95 |
| 8226 | 2.95 | 6852 | 3.75 | 6551 | 13.95 |
| 8228 | 4.96 | | | | |
| 8238 | 4.96 | | | | |
| 8251 | 6.95 | | | | |
| 8253 | 10.95 | | | | |
| 8255 | 6.95 | | | | |
| 8257 | 10.95 | | | | |
| 8259 | 12.95 | | | | |

SCR's and TRIAC's

| | | |
|---------|------|--------------------------|
| C106D | .34 | SCR 5 amp 400V TO-220 |
| TIC116B | .97 | SCR 8 amp 200V TO-220 |
| TIC126B | 1.09 | SCR 12 amp 200V TO-220 |
| TIC216B | .99 | Triac 6 amp 200V TO-220 |
| TIC226D | .95 | Triac 8 amp 400V TO-220 |
| TIC236D | 1.45 | Triac 12 amp 400V TO-220 |
| TIC246D | 1.45 | Triac 16 amp 400V TO-220 |

Bi-Fet OP AMPS

| | | | | | |
|---------|------|----------------|---------|------|------------------|
| TL06-CN | 2.75 | Quad low power | TL081CP | .49 | J-FET input |
| TL07-CP | .59 | Low noise | TL082CP | .99 | Dual J-FET input |
| TL072CP | 1.19 | Dual low noise | TL084CN | 1.95 | Quad J-FET input |
| TL07-CN | 2.35 | Quad low noise | | | |

MOS MEMORIES

MOS Static RAM's

| Part No. | Price |
|-------------------------------|-------|
| 2102-35 | 1.49 |
| 1K (1K x 1) 350NS 16 PIN | |
| P2111-45 | 3.50 |
| 1K (256 x 4) 450NS 18 PIN | |
| P2112-35 | 3.25 |
| 1K (256 x 4) 350NS 18 PIN | |
| 2114L | 7.95 |
| Low Power 4K (1024 x 4) 300NS | |

MOS Dynamic RAM's

| | |
|--------------------------|------|
| TMS4060-30 | 3.25 |
| 4K (4K x 1) 300NS 22 PIN | |
| TMS4060-20 | 3.95 |
| 4K (4K x 1) 200NS 22 PIN | |

UART's

| | |
|---------------------------------------|------|
| AYS-1013A | 3.95 |
| 0 to 40K BAUD 40 PIN | |
| AY3-1015 | 4.95 |
| 0 to 30K BAUD 40 PIN Single 5V supply | |

1K CMOS RAM

| | |
|-------------------------------------|------|
| 5101 | 6.95 |
| 1K (256 x 4) 450NS 22 PIN Low Power | |

4K CMOS RAM

| | |
|------------------------------------|-------|
| P4315-45L 4K (4K x 1) 450NS 18 PIN | 14.95 |
| P6504 | 13.95 |
| 4K (4K x 1) 550NS 18 PIN 110MW | |
| P6514 | 16.95 |
| 4K (1K x 4) 450NS 18 PIN 110MW | |

SHIFT REGISTERS

| | |
|------------------------------|------|
| 3341APC FIFO 1 MHz | 5.50 |
| 3342PC 64 Bit Shift Register | 4.45 |
| 3347PC 80 Bit Shift Register | 3.95 |

ECL RAM

| | |
|---------------------------------------|--------------|
| 10410ADC/HM2106 | Special 1.95 |
| 256 x 1 Bit Fully Decoded 15ns 16 PIN | |

1980 IC MASTER

over 2700 PAGES

Complete integrated circuit data selector. Master guide to the latest I.C.'s including microprocessors and consumer circuits. 45,000 device types listed. 5,000 new device types added. Complete new section on MPU boards & Systems.

Free Quarterly Updates ~~\$75.00~~ **Special \$49.95**



Memory special of the month EPROM'S

16K MOS DYNAMIC RAM's (16 PIN)

| | |
|-----------------------|--------|
| 416-3 (200ns) CERAMIC | \$6.95 |
|-----------------------|--------|

1K BiPolar RAM (25ns)

| | |
|-----------------|--------|
| 93425APC/2511-1 | \$8.95 |
|-----------------|--------|

LINEAR I.C.'s

| | | | |
|-----------------|------|------------|------|
| LM301AN-8 | .34 | LM723CH | .69 |
| LM304CH | .89 | LM723CN-14 | .49 |
| LM307N-8 | .29 | LM725CN-8 | 1.25 |
| LM308N-8 | .89 | LM733CN-14 | 1.59 |
| LM308CH | .95 | LM739CN-14 | 1.29 |
| LM309K | 1.29 | LM741CH | .65 |
| LM310HC | 1.49 | LM741CN-8 | .44 |
| LM311N-8 | .59 | LM747CN-14 | .59 |
| LM317T (TO-220) | 1.49 | LM748CN-8 | .39 |
| | | TB810DAS | 1.29 |
| LM318N-8 | 1.45 | LM1458N-8 | .49 |
| LM318CH | 1.75 | LM1488N-14 | .69 |
| LM324N | .59 | LM1489N-14 | .69 |
| LM339N | .59 | LM3046N-14 | .99 |
| LM348N-14 | .99 | LM302N-14 | .55 |
| LM358N-8 | .79 | LM3403N-14 | .89 |
| LM380N-14 | 1.19 | LM3900N | .49 |
| LM555N-8 | .49 | LM4136N-14 | .99 |
| LM556N-14 | .49 | ULN2003AN | .99 |

SUMMER SPECIAL

10% qty discount on 100 pieces per device type (offer valid until August 31, 1980)

"ACTIVE IS AGGRESSIVE"

DUAL-IN-LINE — LOW PROFILE — I.C. SOCKETS

| CONTACTS | PRICE | CONTACTS | PRICE |
|----------|-------|----------|-------|
| 8 PIN | .07 | 22 PIN | .21 |
| 14 PIN | .11 | 24 PIN | .23 |
| 16 PIN | .13 | 28 PIN | .27 |
| 18 PIN | .17 | 40 PIN | .39 |
| 20 PIN | .19 | | |

• LOWEST PRICES ANYWHERE FOR THE HIGHEST QUALITY. AN UNBEATABLE COMBINATION.

SOCKET SALE

OPTO SALE

L.E.D. LAMPS

| | | |
|--------|---------------------|-----|
| LED209 | T-1 3 mm Red | .09 |
| LED211 | T-1 3 mm Green | .19 |
| LED212 | T-1 3 mm Yellow | .14 |
| LED220 | T-1 1/2 5 mm Red | .11 |
| LED222 | T-1 1/2 5 mm Green | .24 |
| LED224 | T-1 1/2 5 mm Yellow | .16 |

DISPLAYS

| | | |
|--------|--|------|
| FND357 | .375" Common Cathode | .99 |
| FND367 | .360" Common Cathode (high brightness) | 1.24 |
| FND500 | .500" Common Cathode | .99 |
| FND507 | .500" Common Anode | .99 |
| FND560 | .500" Common Cathode (high brightness) | 1.24 |
| FND567 | .500" Common Anode (high brightness) | 1.24 |
| DL704 | .300" Common Cathode | 1.29 |
| DL707 | .300" Common Anode | 1.29 |
| DL747 | .630" Common Anode | 2.29 |

ISOLATORS

| | | | |
|--------|--------------------|-------|------|
| ILD74 | Dual Opto Isolator | 1500V | 1.29 |
| ILQ74 | Quad Opto Isolator | 1500V | 3.95 |
| MCT6 | Dual Opto Isolator | 1500V | 1.29 |
| TIL111 | Opto Coupler | 1500V | .54 |
| 4N26 | Opto Isolator | 2500V | .54 |
| 4N32 | Opto Isolator | 2500V | .69 |
| 4N33 | Opto Isolator | 1500V | .65 |
| 4N36 | Opto Isolator | 2500V | .79 |
| 4N37 | Opto Isolator | 1500V | .85 |

CMOS

| | | | | | | | | | |
|----------|------|----------|------|----------|------|----------|------|----------|------|
| CD4000BE | .19 | CD4021BE | .99 | CD4046BE | 1.25 | CD4081BE | .29 | CD4522BE | 1.75 |
| CD4001BE | .39 | CD4022BE | 1.29 | CD4047BE | 1.25 | CD4082BE | .29 | CD4526BE | .99 |
| CD4002BE | .34 | CD4023BE | .39 | CD4049BE | .69 | CD4085BE | .79 | CD4527BE | 1.45 |
| CD4006BE | 1.29 | CD4024BE | .79 | CD4050BE | .69 | CD4086BE | .95 | CD4528BE | .99 |
| CD4007BE | .29 | CD4025BE | .39 | CD4051BE | .99 | CD4093BE | .79 | CD4531BE | .99 |
| CD4008BE | .84 | CD4026BE | 1.79 | CD4052BE | 1.25 | CD4099BE | 1.75 | CD4532BE | 1.50 |
| CD4009BE | .39 | CD4027BE | .49 | CD4053BE | 1.25 | CD4104BE | 2.95 | CD4539BE | 1.15 |
| CD4010BE | .39 | CD4028BE | .89 | CD4060BE | 1.99 | CD4502BE | 1.45 | CD4543BE | 1.65 |
| CD4011BE | .49 | CD4029BE | 1.29 | CD4066BE | .89 | CD4508BE | 1.99 | CD4553BE | 3.95 |
| CD4012BE | .39 | CD4030BE | .79 | CD4068BE | .34 | CD4510BE | 1.25 | CD4555BE | .89 |
| CD4013BE | .59 | CD4033BE | 1.79 | CD4069BE | .34 | CD4511BE | .99 | CD4556BE | .89 |
| CD4014BE | .39 | CD4034BE | 2.99 | CD4070BE | .49 | CD4512BE | .99 | CD4581BE | 2.25 |
| CD4015BE | .39 | CD4035BE | 1.39 | CD4071BE | .39 | CD4514BE | 2.45 | CD4582BE | .99 |
| CD4016BE | .59 | CD4040BE | 1.89 | CD4072BE | .29 | CD4515BE | 2.45 | CD4584BE | .89 |
| CD4017BE | .39 | CD4041BE | 1.75 | CD4073BE | .54 | CD4516BE | 1.75 | CD4585BE | 1.50 |
| CD4018BE | .39 | CD4042BE | .89 | CD4075BE | .59 | CD4518BE | 1.25 | CD4702BE | 9.95 |
| CD4019BE | .89 | CD4043BE | .99 | CD4076BE | 1.29 | CD4519BE | .89 | CD4724BE | 1.95 |
| CD4020BE | 1.39 | CD4044BE | .99 | CD4078BE | .45 | CD4520BE | 1.25 | | |

PLASTIC POWER TRANSISTORS

| | | |
|---------|-----|----------------|
| TIP29 | .39 | NPN 1 AMP 100V |
| TIP30 | .39 | PNP 1 AMP 100V |
| TIP31 | .42 | NPN 3 AMP 100V |
| TIP32 | .43 | PNP 3 AMP 100V |
| TIP41 | .59 | NPN 6 AMP 100V |
| TIP42 | .64 | PNP 6 AMP 100V |
| TIP115 | .59 | PNP 2 AMP 60V |
| TIP120 | .64 | NPN 5 AMP 60V |
| TIP122 | .74 | PNP 5 AMP 100V |
| TIP125 | .74 | PNP 5 AMP 60V |
| TIP127 | .85 | PNP 5 AMP 100V |
| TIP2955 | .83 | PNP 15 AMP 60V |
| TIP3055 | .70 | NPN 15 AMP 60V |
| FT3055 | .59 | NPN 10 AMP 60V |

74LS447N .59

BCD to 7 segment decoder/driver o/c

Active Electronic Sales Corp.

P.O. BOX 1035 FRAMINGHAM, MASSACHUSETTS 01701

Over-the-counter sales, 12 Mercer Rd., Natick, Mass 01760
Behlind Zayres on Rte. 9
Telephone Orders & Enquiries (617) 879-0077
Massachusetts customers add 5% sales tax

MINIMUM ORDER \$10.00 + ADD \$2.00 TO COVER POSTAGE & HANDLING

Foreign customers please remit payment on an international bank draft or international postal money order in American dollars.

IN CANADA
5651 FERRIER ST. MONTREAL, QUEBEC H4P 2K5
Tel. (514) 731-7441

4800 DUFFERIN ST. DOWNSVIEW, ONTARIO M3H 5S9
Tel. (416) 661-1115

BAXTER CENTRE 1050 BAXTER ROAD OTTAWA ONTARIO K2C 3P2
Tel. (613) 820-9471

3070 KINGSWAY VANCOUVER, B.C. V5R 5J7
Tel. (604) 438-3321

CHARGE VISA
master charge

CIRCLE 22 ON FREE INFORMATION CARD

Make The Shack[®] Your Parts Place!

Low Prices and New Items Every Day



Speed Up Your Wiring with This No-Strip Wrapping Tool!

12⁹⁵

Pro-Quality Wiring

Quick-Wrap Tool[®] is ideal for daisy chain or point-to-point wiring between std. 0.025" square wrapping posts. Cuts, strips, easy to load!
 276-1572 12.95
 30-Gauge Kynar Wire. For above. 50 ft. spool.
 Red. 278-501 1.99
 White. 278-502 1.99
 Blue. 278-503 1.99

Project Case With Panel

Flip-Open Cover

Only **2⁹⁹**



Easy-to-work reversible inner panel accepts a meter, switches or readouts.
 5 1/2 x 3 3/8 x 2"
 270-290 2.99

Accurate Sensitive VOM



29⁹⁵

• 27 Ranges
 • 30K Ohms/Volt

Ideal for testing solid-state circuits! 4"-wide color-coded, mirrored scale. Reads DC Volts: 0 to 0.3-1-3-10-30-100-300-1000. AC Volts: 0 to 10-30-100-300-1000. DC Current: 0 to 100µA-3mA-30mA-300mA-10A. Resistance: 0 to 1K-10K-1 Meg-10 MegΩ. Decibels: -10 to +62 in 5 ranges. Accuracy: ±3% DC, ±4% AC. 6 1/2 x 4 1/2 x 1 3/4". With 47" leads. Requires one 9V, one "AA" batteries. 22-203 29.95

8-Position DIP Switch

1⁹⁹



8 SPST sections. Fits standard 16-pin DIP socket. Ideal for digital and low current circuits.
 275-1301 1.99

Tricolor and Pulsing LEDs

Low As **1²⁹**



[A] Red on DC, green on reverse DC, yellow on AC! 25 mA max. at 2.2VDC. T-1 3/4 case. 276-035 1.39
 [B] Red. Built-in 3 Hz flasher! 20 mA max. at 5VDC. 276-034 1.29

Alarm Clock/Thermometer Module



User Programmable 12 or 24-Hour Format!

24⁹⁵

Bright 0.7"-tall LED readout displays 12/24-hour time plus temperature in degrees C or F! 24-hour alarm and snooze features. With complete data. 277-1006 24.95
 Temp. Sensor IC. LM-334. 276-1734 1.99
 Power Transformer. For above. 273-1530 4.99

High Performance Op Amps



Low As **1⁸⁹**

BIFET Design

[A] LF353N. Dual. Low noise JFET inputs, wide bandwidth. Fast 13V/µS slew rate. ±18V supply. 8-pin DIP. 276-1715 1.89
 [B] TL084C. Quad. 13V/µS slew rate. ±18V supply. 14-pin DIP. 276-1714 2.99

Engineer's Notebook of IC Circuits

1⁹⁹

Sold Only At Radio Shack

This "must-have" sourcebook gives applications and circuit examples for most popular linear and digital ICs. 128 pages. 276-5001 1.99

12-Hour Auto Clock Module

Reg. 21.95
Save 21% 16⁹⁵

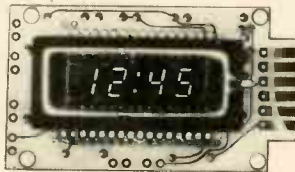

For all 12V neg. ground vehicles. Mounts in dash or with case (below). Bright green display has automatic dimmer, leading zero blanking. With data. 277-1003 Sale 16.95
 Pushbutton Switches. For above. 275-1547 Pkg. 5/2.49
 Custom Case. 270-303 (Reg. 5.95) Sale 3.95

Sound Generator IC



2⁹⁹

SN76477. Creates music and sound effects from phaser guns to steam whistles! Line level audio output. Microprocessor compatible. 28-pin DIP. With data. 276-1765 2.99

Semiconductor Reference Handbook

Only **1⁹⁹**

Cross reference/substitution listings for over 100,000 devices! Pin outs and data for transistors, ICs, diodes, SCRs, LEDs and more. 224 pages. 276-4003 1.99

NEW

Mini DPDT Switches

Low As **1⁹⁹** Contacts Rated 6 Amps @ 125VAC

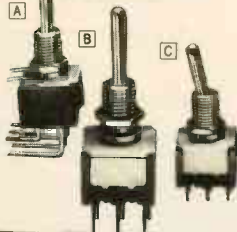

[A] DPDT Right Angle. Ideal for PC board mounting. On-Center Off-On contacts. 275-665 1.99
 [B] DPDT. PC mtg. On-Center Off-On contacts. 275-668 2.19
 [C] DPDT. Solder lugs for panel mounting. On-None-On contacts. 275-669 2.29

4" 120VAC Cooling Fan

12⁹⁵

Very Quiet Operation

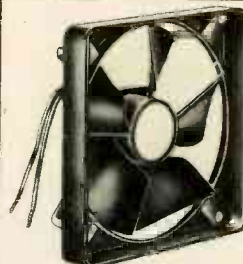

Ideal for cooling power supplies, Ham and hi-fi gear, computers and more! Delivers 70 CFM. Sealed bearings. Diecast venturi. U.L. recognized motor. Corrosion-resistant metal parts. Low power consumption — only 11 watts! 273-241 12.95

WHY WAIT FOR MAIL ORDER DELIVERY? IN STOCK NOW AT OUR STORE NEAR YOU!

Radio Shack[®]

A DIVISION OF TANDY CORPORATION • FORT WORTH, TEXAS 76102
 OVER 7000 LOCATIONS IN 40 COUNTRIES

Prices may vary at individual stores and dealers

CIRCLE 55 ON FREE INFORMATION CARD

20% DISCOUNT

Take 20% Off
The Total Price Of Any Items Shown Below*

- 200 PC-SEMICON SPECIAL, assorted semis of all types. Untested material, (#3300) \$2.99
- 200-MOTORS MOTORS, assid. sizes speeds & types, 1.5-12 volts, (#2551A) 2.99
- 200-LONG LEAD DISCS, prime, marked caps, assorted material, (#2598) 2.99
- 100-PLASTIC TRANSISTORS, untested, TO-92, assid. types (#2604) 2.99
- 50-SLIDE SWITCHES, various shapes, sizes, and types, (#2726) 2.99
- 75-TRANSISTOR ELECTROLYTICS, epoxy encapsulated, assid. values, (#2747) 2.99
- 250-HALF WATERS, 100%, color-coded resistors, assid. values, (#3046) 2.99
- 25-SLIDE VOLUME CONTROLS, various values & types, for HI-FI, etc. (#3057) 2.99
- 50-UPRIGHT ELECTROS, 100%, assorted values & voltages, marked, (#3226) 2.99
- 20-ROCKER SWITCHES, white, rockers, DPDT, solder lugs, 125V 4A, (#3302A) 2.99
- 50-MINI POTS, pc style, single turn, assorted values, (#3345) 2.99
- 20-JUMBO RED LEDS, 3V 10mA, 100% good material, red dome lense, (#3369) 2.99
- 3-SOUND TRIGGERS, sound activated amp, SCR triggered, on 3" board, (#3625) 2.99
- 50-TRANSISTOR SOCKETS, assortment may include: TO-19, 5, 6, 3, etc. (#3845) 2.99
- 100-CABLE TIES, 4" non-slip white plastic, like Ty-wrap, (#5218) 2.99
- 100-FEEDTHRU CAPS, assorted types & sizes, for RF, UHF, etc. (#5668A) 2.99
- 250-1/2 WATT RESISTORS, assid. carbons, carbon films, some 5%, (#5797A) 2.99
- 100-PLESSY CAPS, ceramic blocks in assorted sizes & values, (#6221) 2.99
- 30-HOBBY LEDS, assorted types & colors, mostly dims, some good, (#6225) 2.99
- 100-TTLs, 7400 series, incl. gates, flip-flops, etc. untested, (#6226) 2.99
- 30-NE-2 BULBS, neon, for 110 VAC, requires resistor, (not incl.) (#2613) 2.99
- 3-BRASS LOCKS, with key, 1 1/2" long, for doors, windows, etc. (#6253) 2.99
- 250-MOLEX SOCKETS, "on-a-strip", make your own pc sockets, (#6255) 2.99
- 150-TERMINAL STRIPS, assid. screw and solder lug types, (#6251) 2.99
- 50-RCA PHONO PLUGS, popular audio/speaker plugs, 100% material, (#3293) 2.99
- 25-CRYSTALS, assorted types, some 116/1, some frequency marked, (#6256) 2.99
- 150-SUBMINI IF TRANSFORMERS, assid. may include; osc. antenna, etc. (#6259) 2.99
- 60-SQUARE OHM RESISTORS, prime resistors, assid. values, grab 'em! (#6261) 2.99
- 30-MICRO MINI REED SWITCHES, 1" long, for alarms, relay systems, etc. (#6263) 2.99
- 200-PC-CAPACITOR SPECIAL, assid. mylars, polys, mica, etc. 100% good, (#6264) 2.99
- 40-STEREO INDIA ALARMS SWITCH, 1/2", 1 lb. assid. screws, washers, etc. (#6271) 2.99
- 500-PC-HARDWARE SURPRISE, 1000 items, momentary, NC, w/hardware, (#6267) 2.99
- 30-9V BATTERY CLIPS, snap connectors, coded, insulated leads, (#6281) 2.99
- 6-WATCH CUTS, 5-function, LED style, assorted sizes, untested, (#6282) 2.99
- 10-HEAVY DUTY LINE CORDS, white, 2 cond. 6 ft. 16 gauge, (#6292) 2.99
- 20-SINGLE PIN LEDS, green, micro style, 3V 10mA, 100%, (#6293) 2.99
- 40-LED/TRANSISTOR SOCKETS, "snap-in", 3 pc leads, for TO-5, 18, 46, etc. (#6297) 2.99
- 200-PRE-FORMED 1/2 WATERS, popular values, some 5 & 10 %ers, (#6246) 2.99
- 40-SCRs & TRIACS, 50-600 priv., 3 lead TO-5 cans, 60%+ yield, (#6321) 2.99
- 30-PLASTIC POWERS, 24-28 watt, npr & npp, 50-200 wbebo, TO-220, (#6337) 2.99
- 100-2 WATT RESISTORS, assorted carbons, films, etc. some 5%, (#6238) 2.99
- 10-HOBBY VOLTAGE REGULATORS, TO-3, assorted voltages, untested, (#3330) 2.99
- 25-MAGNETIC DISCS, Plastallo 13/16 dia. x 1/8" discs, (#6294) 2.99
- 150-PLUGS & SOCKETS, assorted types & styles, wide variety, (#3527) 2.99
- 15-PA-263 PC BOARDS, for GE PA-263 stereo amps, pre-etched, (#2013) 2.99
- 40-STEREO INDIA ALARMS SWITCH, tiny red 1.5V bulbs, for HI-FI replacement, (#6244) 2.99
- 40-800V 1A RECTIFIERS, type IN4000 series, axial leads, (#6245) 2.99
- 4-2A 500V BRIDGES, silicon, full wave rectifier, TO-3, (#6246) 2.99
- 10-QUAD PHONO JACKS, 4 RCA jacks on 2 x 1 1/2" Bakelite strip, (#6249) 2.99
- 50-MODULAR SWITCHES, by Centralab, "push-on" DPDT, 6PDT, etc. (#3150A) 2.99
- 150-"4000" RECTIFIERS, IN4000 series, may include; 50 to 1000V, (#6299) 2.99
- 15-THUMB-WHEEL TRIM POTS, snap-in type, assorted values, (#6299) 2.99
- 150-MICA CAPS, popular values by assorted manufacturers, (#6265) 2.99
- 1-1-R. DIODES, various types, hetero-junction coas, for Pulse mode, (#6445) 2.99
- 200-BULLETS, assid. resistor-capacitor networks, various values, (#6282) 2.99
- 150-METAL CAN TRANSISTORS, assid. 2N #'s in TO-5, 18, some unmarked, (#2603) 2.99
- 24-LM-340T VOLTAGE REGULATORS, untested TO-220, may incl. 5-24V, (#2635) 2.99
- 150-POLYSTYRENE CAPS, assorted types, styles, & sizes, all good, (#2729) 2.99
- 100-PLASTIC LENSES, assorted styles & colors, (#6266) 2.99
- 250-CERAMIC CAPS, assid. tubulars, NPO's, temp. coefficient, etc. (#5839) 2.99
- 20-THERMISTORS, various types & styles, neg. coefficient, 100%, (#4089) 2.99
- 25-IC SOCKET, 40 pin, high digits, com. cathode, 2V, 25 mA (#6009) 2.99
- 25-MINI PLUG & CABLE SETS, 3.5mm plug, 6" insulated 2 cond. leads, (#6269) 2.99
- 20-RCA PHONO JACKS, popular HiFi jacks on a Bakelite strip, (#6230) 2.99
- 250-PRE-FORMED DISCS, caps w/leads for PC use, mixed values, (#2605) 2.99
- 50-AXIAL ELECTROS, assid. values, volts, sizes, What a buy! (#3227) 2.99
- 100-METALIC RESISTORS, mostly 1/2 watters, assid. val. 1-5% tol. (#6280) 2.99
- 100-POWERS RESISTORS, 3 to 7 watt power resistors, (#6281) 2.99
- 15-IGNITION SUPPRESSION CAPS, for auto rockers, decks, etc. 0.3 mF (#6224) 2.99
- 200-COILS & CHOKES, assid. RF, Osc. IF, and peaking types, (#6283) 2.99
- 50-POWER TRAP TRANSISTORS, plastic NPN, TO-220, assid. types, untested, (#2425) 2.99
- 24-SKINNY TRIM POTS, multi & single turn, assid. values & types, (#6285) 2.99
- 30-HOBBY OPTO COUPLERS, untested, mini DIP, 1500V isolation, (#6299) 2.99
- 120-2N355 HOBBY TRANSISTORS, manual. fallout, TO-3, U-test, (#6624) 2.99
- 100-DTL IC's, mostly dual JK flip flops, marked, 100% prime, (#6444) 2.99
- 200-ONE WATT CAPS, assid. values, 1/2 watt, 5% tolerance, (#6498) 2.99
- 40-INSTRUMENT KNOBS, for radio, plugs to 1 motorola jack, (#5974) 2.99
- 15-LINE CORDS, heavy-duty, 18 gauge, 6", molded plugs, 2-cond. (#6499) 2.99
- 10-MICRO LED DISPLAYS, 4 tiny 0.1" digits, 12 pin, mlpl's, (#5064) 2.99
- 15-DIGIT READOUTS, flat pak w/bubble mag. .120" high, 14 pin, (#5558) 2.99
- 10-ASST. READOUTS, various types, colors, and styles, (#5862) 2.99
- 15-5 JUMBO LEDS, assorted styles and colors, all new 100%, (#2079) 2.99
- 4-0.3" DIGITS 8-DIGIT, 18" high digits, com. cathode, (#6187) 2.99
- 6-8-1/2 DIGIT LED DISPLAY, 40 pin, high digits, com. cathode, 2V, 25 mA (#6009) 2.99
- 8-INCADESCENT READOUTS, assid. 3 & 6 volt, 5/16" high, com. anode, (#6645) 2.99
- 4-0.5" READOUTS, red FND 507, common anode, PC leads, 7-seg. LED, (#2950) 2.99
- 2-RUBBER DUCKIE, scanner antenna, VHF-HI, 7/8" threaded stud, (#6137) 2.99
- 40-IN4148 SWITCHING DIODES, 4 nsec. 100V, 10 mA, axial, 100%, (#6623) 2.99
- 3-SETS-COMPUTER TAPE HEADS, play/recorder & erase sets, digital appl. (#6646) 2.99
- 6-SHIELDED AUDIO CABLES, 2 cond., with RCA plugs at each end, (#6412) 2.99
- 3-1/2 V ADAPTER, shielded 2 motorola plugs to 1 motorola jack, (#5974) 2.99
- 200-HI-QUALITY RESISTORS, assid. carbons, some metallic, some 5%, (#6627) 2.99
- 40-RADIO-TV KNOBS, various styles, shapes, & colors, w/ w/o shafts, (#6628) 2.99
- 20-PANEL SWITCHES, assorted rotary, micro, slide, etc. (#6629) 2.99
- 30-PAIRS-RCA PLUGS & JACKS, popular for HI FI speakers, etc. (#6630) 2.99
- 100-IN914 SWITCHING DIODES, 4 nsec. axial, glass, untested, (#6632) 2.99
- 4-2N3055 NPN TRANSISTORS, 113 watts, 15 amps, TO-3, 100% material, (#6633) 2.99
- 80-UPRIGHT MYLAR CAPS, 1/2", assid. epoxy, plastic, polystyrene, etc. (#6634) 2.99
- 20-NE-2 BULBS W/RESISTOR, neon, assid. resistors, color-coded, axial leads, (#6621) 2.99
- 100-1/2 WATT METAL FILM, assid. resistors, color-coded, axial leads, (#6621) 2.99
- 100-PREFORMED 1/4 WATERS, assorted values, precul for PC appl. (#6622) 2.99

ORDERING DEADLINE: September 1, 1980
Discount To Be Taken BEFORE Postage Is Added.



SEND FOR FREE CATALOG
POLYPAKS
P.O. BOX 942, R7
SOUTH LYNNFIELD,
MASS. 01940

HOW TO ORDER
We honor MASTERCARD, VISA, check, and C.O.D. Order by phone or mail. Minimum order \$10.
Please state Cat. No. & description, name & month of magazine. POSTAGE: USA; add \$3. CANADIAN; add \$5. FOREIGN; add \$10. US funds. Checks will be returned. DP's and ACQUITS must be listed & dated. D & B Net 30, \$25 Minimum. PHONE: (617) 245-3828.
C.O.D. ORDERS: Payment must be made in Cash. Postal Money Order, or Certified Check. C.O.D. charges will be added to the order.

CIRCLE 38 ON FREE INFORMATION CARD

INTERNATIONAL ELECTRONICS UNLIMITED

| | | | |
|---|--|------------------------------------|------------------------|
| .4" ORANGE LED DISPLAY 7-segment RHD MAN4610 - common anode MAN4630 - common cathode | \$1.19ea 10/\$7.95 25/\$17.50 100/\$65.00 | JUMBO RED LED .20" diffused | 10/\$1.00 25/\$2.00 |
| .4" ORANGE overflow 21 MAN4630 - common anode | \$.89ea 10/\$8.95 | SUBMIN RED LED .125" diffused | 100/\$7.50 |
| .3" RED LED DISPLAY 7 segment RHD XAN27(MAN72 equiv) common anode | \$.99ea 10/\$7.95 25/\$17.50 100/\$65.00 | JUMBO GREEN LED .20" diffused | 7/\$1.00 25/\$2.85 |
| | | SUBMIN GREEN LED .125" diffused | 100/\$9.75 |

| METAL FILM RESISTORS | | | | .5" RED LED DISPLAY 7 segment RHD FHD500 Common Cathode | |
|----------------------------------|--------|-------|-------|---|----------|
| R-OHM R860FY (RN60) ±1% 50ppm/°C | ea | pk-10 | pk-25 | pk-100 | \$.89ea |
| 174w MIL-R-10509 250V/70°C | 1-999 | .25 | 1.50 | 2.25 | 5.50 |
| 138" dia X .355" long (body) | 1000- | .25 | 1.25 | 2.10 | 7.25 |
| ALL STANDARD DECADE VALUES | 5000- | .25 | 1.00 | 1.90 | 6.75 |
| FROM 10ohm to 475K | 10000- | .25 | .95 | 1.75 | 6.00 |

| LINEAR CIRCUITS | | 1/2 PRICE SALE | | | |
|-----------------|-------------|-----------------|---------|-------------|-----------------|
| LM300R | R.G. \$.99 | S.A.L.E. \$.30 | LM376CN | R.G. \$.50 | S.A.L.E. \$.25 |
| LM301CN | .32 | .16 | LM380-8 | .80 | .45 |
| LM302R | .59 | .30 | LM365A | 1.15 | .68 |
| LM307CN | .32 | .16 | LM709H | 1.45 | .80 |
| LM308H | .77 | .40 | LM733H | .89 | .45 |
| LM308CN | .79 | .40 | LM739N | .89 | .45 |
| LM309H | 1.05 | .53 | LM748CN | .35 | .18 |
| LM310CN | 1.07 | .54 | LM1414N | 1.25 | .63 |
| LM311H | .89 | .45 | LM1800N | 2.40 | 1.20 |
| LM311CN | .89 | .45 | 75453CN | | |
| LM311N | .89 | .45 | | .35 | .18 |
| LM322N | .89 | .45 | 75491N | .75 | .38 |
| LM340T-6V | | | 75492N | .89 | .45 |
| (7806) | 1.19 | .60 | | | |

| I.C. SPECIALS | |
|----------------------|--------------|
| 8038B | 2.75 ea. |
| LM556N | .75 ea. |
| LM158CN | .95 ea. |
| LM158CN | .45 ea. |
| LM555CN | .45 ea. |
| XR320N | .85 ea. |
| TRANSISTORS | |
| 2N3904 NPN TO-92 | 10/\$1.50 |
| 2N3906 PNP TO-92 | 25/\$3.00 |
| | 100/\$11.00 |
| IC BREADBOARD | |
| 2 5/16" X 6 9/16" | \$1.50ea. |
| UNIVERSAL BREADBOARD | 10/\$10.00 |
| 3 3/16" X 5 1/16" | 100/\$75.00 |
| CLOCK CHIP #M5355A | |
| 4-6 digit 60hz 12hr | \$1.95 |
| alarm 24 pin | 100/\$17.50 |
| | 100/\$150.00 |

REGULATED POWER SUPPLY

provides simultaneous outputs of plus & minus 5V, 12V, & 15V. uses 115/230VCT transformer - 1amp total output. Kit includes PC board (2 1/8" X 3 15/16"), all parts incl transformer, schematic & layout dwg.

| | |
|-------|-----------|
| 10-24 | \$14.95ea |
| 10-24 | \$13.50ea |
| 25- | \$12.50ea |

CRYSTAL CONTROLLED TIME BASE KIT
provides accurate 1 Hz, 10 Hz & 60 Hz double buffered outputs from 9VDC input. CMOS compatible. Kit includes PC board, (1 5/8" X 3"), all parts (except battery), schematic, layout dwg, & instructions.

| | |
|-------|-----------|
| 10-24 | \$15.50ea |
| 10-24 | \$13.75ea |
| 25- | \$12.50ea |

DIP SWITCH - 4 sw
8 pin DIP SPST

| | |
|-------|----------|
| 1-9 | \$1.65ea |
| 10-24 | 1.55ea |
| 25- | 1.49ea |

DIP SWITCH - 8 sw
16 pin DIP SPST

| | |
|-------|----------|
| 1-9 | \$2.10ea |
| 10-24 | \$1.95ea |
| 25- | 1.85ea |

UART 1602B \$3.95ea 10/\$35.00 100/\$275.00

Payment by check, M.O., UPS-COD, M/C or VISA. Add \$1.00 shipping/handling in US, Canada & Mexico. Other countries \$1.00 + 5% of order. California residents add sales tax. Minimum order \$10.00.

INTERNATIONAL ELECTRONICS UNLIMITED
225 Broadway Jackson Ca 95642
phone 209 223 3870

CIRCLE 45 ON FREE INFORMATION CARD

MICRO MART

552 Summit Ave.
Westfield, N.J. 07090
(201) 654-6008

MOTION DETECTOR: Features include transparent, optical IC completely assembled on circuit board with necessary capacitors. Extensive specs and application notes included. /\$5.00

CRYSTALS - 3.579545 Mhz 9pc
6.0 Mhz 2.95

JUMBO LED'S
Green, 7/1.00-Yellow, 7/1.00-Red, 10/1.00
100/13.00 100/13.00 100/9.00

MOUNTING CLIPS - 12/1.00

7 SEG Displays (comp. grade)
3"/95¢-6"/1.45 (specify ann. or cath.)

AM/FM RADIO CHIP - (#4408) 2.00 or 3/5.00
Complete AM/FM IC-external IF required

DIPPED TANTALUMS
47 µf 35V (1" leads) 10/1.00

SUPER SUB MINI LYTICS
(1" rad. leads, by Nichicon)
1000µf 50V (1 1/4" L X 1/4" W), 75¢ or 10/6.00
47 µf 25V (1 1/4" L X 3/4" W), 10/1.00
400µf 330V (photo flash or laser circuits)-2/1.00

COMPUTER GRADE TWIST LOCKS
3200µf 50V (ideal for power supplies) 2.00
1000µf 50V-1.00 1000µf 185V-2.00

DISCS - 001 1KV 25/1.00, 1.50 15V 1/1.00

HEAT SENSITIVE SWITCH - 4/1.00
self contained unit opens at 150°C

9 DIGIT FLOURESCENT DISPLAY by NEC
complete with driving circuitry-2.50

EXTRA LOUD 9V BUZZER - 3/2.00

WALL PLUG ADAPTER - 5VDC @ 160ma-1.50
6.3V 1.2 Amp Transformer - 1.75

MINI AUDIO TRANSFORMERS - 3/1.00

DIGITAL MOTION/UNIT COUNTER MODULE
(Fairchild) with large 4 digit display & specs-7.00

8035 Microprocessor, 17.00

INTERFACE CHIP-D8243
16 line I/O extender for all single chip µ Ps 5.75

BRAND NEW ITEM
FREQUENCY COUNTER CHIP
ICM 7225 IPL
(40 pin), with on board dividers, decoders/drivers. 18.95-specs included

SUBSCRIPTION TV EDUCATIONAL KIT
If there's a TV channel in your area which you can't tune to and get a proper picture or sound, chances are you're seeing a subscription TV signal. Now you can find the signal. Our 24-page illustrated manual contains a description of how such a system works and includes construction details for building a circuit to restore the audio and video signals to their original state. A great opportunity to learn more about TV broadcasting techniques.
Manual only \$12.00
Drilled and etched PC project board 20.00
Board and manual 27.00
Complete kit 65.00

ZENER DIODES - 20V 1 amp 10/1.00

TV SATELLITE TRANSISTOR
MRF 901 (prime) \$4.50

| LINEAR | | | |
|------------|------|----------|------|
| LM 323K | 5.00 | LM 1303 | 1.50 |
| LM 300H | .75 | LM 1304 | .95 |
| LM 301AN | .33 | LM 1305 | 1.15 |
| LM 307H | .50 | LM 1307 | .90 |
| LM 307S | .35 | LM 1307E | .90 |
| LM 310H | .95 | LM 1310 | 1.75 |
| LM 310B | .95 | LM 1311 | 1.50 |
| LM 311H | .85 | LM 1800 | .90 |
| LM 317K | 5.00 | LM 1808 | 2.75 |
| LM 318H | 1.25 | LM 1820 | 1.75 |
| LM 320K-15 | 1.15 | LM 1828 | 1.75 |
| LM 320K-12 | 1.15 | LM 1830 | 1.50 |
| LM 324 | .25 | LM 1841 | 1.75 |
| LM 325 | 1.85 | LM 1848 | 1.75 |
| LM 339J | 1.00 | LM 1889 | 2.50 |
| LM 340K-12 | 1.25 | LM 2111 | 1.50 |
| LM 341P-12 | 1.25 | LM 2113 | 1.75 |
| LM 343H | 3.50 | LM 2907 | 2.40 |
| LM 372 | 2.95 | LM 2917 | 1.95 |
| LM 377 | 2.00 | LM 3046 | 1.10 |
| LM 380 | 1.15 | LM 3054 | 1.50 |
| LM 381 | 1.60 | LM 3064 | 2.00 |
| LM 384 | 1.85 | LM 3065 | 1.50 |
| LM 386 | 1.50 | LM 3067 | 2.50 |
| LM 389 | 1.50 | LM 3070 | 2.50 |
| LM 390 | 1.95 | LM 3071 | 2.00 |
| LM 746 | 2.50 | LM 3075 | 2.75 |
| LM 748CN | .39 | LM 3089 | 1.75 |
| | | LM 3900 | .75 |

Terms MICRO-MART accepts VISA, MC, and telephone COD'S. Foreign orders \$50.00 minimum plus shipping-US funds only. Orders under \$10.00 include \$2.00 for shipping/handling. All components guaranteed or money refunded. Immediate shipping. N.J. residents add 5% sales tax.
MICRO-MART • 552 SUMMIT AVE., WESTFIELD, N.J. 07090 • (201) 654-6008

CIRCLE 49 ON FREE INFORMATION CARD

We now have available a bunch of goodies too good to bypass. Items are limited so order today.

Call Your Phone Order in Today

**MINI KITS - YOU HAVE SEEN THESE BEFORE NOW
HERE ARE OLD FAVORITE AND NEW ONES TOO.
GREAT FOR THAT AFTERNOON HOBBY.**

**FM
MINI
MIKE**



A super high performance FM wireless mike kit! Transmits a stable signal up to 300 yards with exceptional audio quality by means of its built in electret mike. Kit includes case, mike, on-off switch, antenna, battery and super instructions. This is the finest unit available.

FM-3 Kit **\$14.95**
FM-3 Wired and Tested **19.95**

Color Organ

See music come alive! 3 different lights flicker with music. One light each for, high, mid-range and lows. Each individually adjustable and drives up to 300 W. runs on 110 VAC.

Complete kit, ML-1 **\$8.95**

Video Modulator Kit
Converts any TV to video monitor. Super stable, tunable over ch. 4-6. Runs on 5-15V, accepts st. video signal. Best unit on the market! Complete kit, VD-1 **\$7.95**



Led Blinky Kit
A great attention getter which alternately flashes 2 jumbo LEDs. Use for name badges, buttons, warning panel lights, anything! Runs on 3 to 15 volts. Complete kit, BL-1 **\$2.95**

Super Sleuth
A super sensitive amplifier which will pick up a pin drop at 15 feet! Great for monitoring baby's room or as general purpose amplifier. Full 2 W rms output, runs on 6 to 15 volts, uses 8-45 ohm speaker. Complete kit, BN-9 **\$5.95**

CPO-1
Runs on 3-12 Vdc. Full wall out, 1 KHZ good for CPO. Alarm, Audio Oscillator. Complete kit **\$2.95**

CLOCK KITS

Your old favorites are here again. Over 7,000 Sold to Date. Be one of the gang and order yours today!

Try your hand at building the finest looking clock on the market. Its satin finish anodized aluminum case looks great anywhere, while six .4" LED digits provide a highly readable display. This is a complete kit, no extras needed, and it only takes 1-2 hours to assemble. Your choice of case colors: silver, gold, black (specify).
Clock kit, 12/24 hour, DC-5 **\$24.95**
Clock with 10 min. ID timer, 12/24 hour, DC-10 **\$29.95**
Alarm clock, 12 hour only, DC-8 **\$29.95**
12V DC car clock, DC-7 **\$29.95**

For wired and tested clocks add \$10.00 to kit price. Specify 12 or 24 hr. format

FM Wireless Mike Kit



Transmits up to 300' to any FM broadcast radio, uses any type of mike. Runs on 3 to 9V. Type FM-2 has added sensitive mike preamp stage.

FM-1 kit **\$3.95** FM-2 kit **\$4.95**

Whisper Light Kit

An interesting kit, small mike picks up sounds and converts them to light. The louder the sound, the brighter the light. Includes mike, controls up to 300 W, runs on 110 VAC. Complete kit, WL-1 **\$6.95**

Tone Decoder
A complete tone decoder on a single PC board. Features: 400-5000 Hz adjustable range via 20 turn pot, voltage regulation, 567 IC. Useful for touch-tone burst detection, FSK, etc. Can also be used as a stable tone encoder. Runs on 5 to 12 volts. Complete kit, TD-1 **\$5.95**



Siren Kit
Produces upward and downward wail characteristic of a police siren. 5 W peak audio output, runs on 3-15 volts, uses 3-45 ohm speaker. Complete kit, SM-3 **\$2.95**

Universal Timer Kit

Provides the basic parts and PC board required to provide a source of precision timing and pulse generation. Uses 555 timer IC and includes a range of parts for most timing needs.

UT-5 Kit **\$5.95**

Mad Blaster Kit

Produces LOUD ear shattering and attention getting siren like sound. Can supply up to 15 watts of obnoxious audio. Runs on 6-15 VDC

MB-1 Kit **\$4.95**

Car Clock

The UN-KIT, only 5 solder connections

Here's a super looking, rugged and accurate auto clock, which is a snap to build and install. Clock movement is completely assembled — you only solder 3 wires and 2 switches, takes about 15 minutes! Display is bright green with automatic brightness control photocell — assures you of a highly readable display, day or night. Comes in a satin finish anodized aluminum case which can be attached 5 different ways using 2 sided tape. Choice of silver, black or gold case (specify).

DC-3 kit, 12 hour format **\$22.95**
DC-3 wired and tested **\$29.95**

Calendar Alarm Clock

The clock that's got it all: 6-.5" LEDs, 12/24 hour, snooze, 24 hour alarm, 4 year calendar, battery backup, and lots more. The super 7001 chip is used. Size: 5x4x2 inches. Complete kit, less case (not available) **\$34.95**

Under Dash Car Clock

12/24 hour clock in a beautiful plastic case features 6 jumbo RED LEDs, high accuracy (0.01%), easy 3 wire hookup, display blanks with ignition, and super instructions. Optional dimmer automatically adjusts display to ambient light level. DC-11 clock with mtg bracket **\$27.95** kit
DM-1 dimmer adapter **\$2.50**
Add \$10.00 Assy. and Test

Video Terminal

A completely self-contained, stand alone video terminal card. Requires only an ASCII keyboard and TV set to become a complete terminal unit. Features are: single 5V supply, XTAL controlled sync and baud rates (to 9600), complete computer and keyboard control of cursor. Parity error control and display. Accepts and generates serial ASCII plus parallel keyboard input. The 6416 is 64 char by 16 lines, with scrolling, upper and lower case (optional) and has RS-232 and 20ma loop interfaces on board. Kits include sockets and complete documentation. RE 6416, terminal card kit (add \$60.00 for wired unit) **\$189.95**
Lower Case option **\$13.95**
Power Supply **\$14.95**
RF Modulator kit **\$7.95**

PARTS PARADE

IC SPECIALS

| | | | |
|---|--|--|--|
| LINEAR | TTL | Resistor Ass't Assortment of Popular values - 1/4 watt. Cut lead for PC mounting, 1/8" center, 1/2" leads, bag of 300 or more. \$1.50 | Crystals 3.579545 MHZ \$1.50 10.000000 MHZ \$5.00 5.248800 MHZ \$5.00 |
| 301 \$.35 324 \$1.50 380 \$1.50 555 \$.45 556 \$1.00 555 \$1.00 556 \$1.00 567 \$1.25 741 \$2.00 1458 \$.50 3900 \$.50 3914 \$2.95 8038 \$2.95 | 74S00 \$.40 7447 \$.65 7475 \$.50 7490 \$.50 74196 \$1.35 | Switches Mini toggle SPDT \$1.00 Red Pushbuttons N.O. 3/\$1.00 | AC Adapters Good for clocks, nicad chargers, all 110 VAC plug one end 8.5 vdc @ 20 mA \$1.00 16 vdc @ 160mA \$2.50 12 vdc @ 250mA \$3.00 |
| CMOS | SPECIAL | Earphones 3" leads, 8 ohm, good for small tone speakers, alarm clocks, etc. 5 for \$1.00 | AC Outlet Panel Mount with Leads 4/\$1.00 |
| 4011 .50 4013 .50 4048 \$1.85 4049 .50 4059 \$8.00 4511 \$2.00 4518 \$1.35 4519 \$1.75 | 11C90 \$15.00 10116 \$ 1.25 7208 \$17.50 7207A \$ 5.50 7216D \$21.00 7107C \$12.50 5314 \$ 2.95 5375AB/G \$ 2.95 7001 \$ 6.50 | Mini Speaker Approx. 2 1/2" diam. Round type for radios, mike etc. 3 for \$2.00. | Solid State Buzzers small buzzer 450 Hz, 86 dB, sound output on 5-12 vdc at 10-30 mA, TTL compatible. \$1.50 |
| | FERRITE BEADS | Slug Tuned Coils Small 3/16" Hex Slugs turned coil. 3 turns. 10/\$1.00 | AC Outlet Panel Mount with Leads 4/\$1.00 |
| | With info and specs 15/\$1.00 8 Hole Balun Beads 8/\$1.00 | CAPACITORS | |
| | | TANTALUM Dipped Epoxy 1.5 uF 25V 3/\$1.00 1.8 uF 25V 3/\$1.00 .22 uF 25V 3/\$1.00 | DISK CERAMIC 01 16V disk 20/\$1.00 1 16V 15/\$1.00 001 16V 20/\$1.00 100 pf 20/\$1.00 047 16V 20/\$1.00 |

Audio Prescaler

Make high resolution audio measurements, great for musical instrument tuning, PL tones, etc. Multiplies audio UP in frequency, selectable x10 or x100, gives .01 HZ resolution with 1 sec. gate time! High sensitivity of 25 mv, 1 meg input z and built-in filtering gives great performance. Runs on 9V battery, all CMOS. PS-2 kit **\$29.95**
PS-2 wired **\$39.95**

600 MHz PRESCALER

Extend the range of your counter to 600 MHz. Works with all counters. Less than 150 mv sensitivity. specify -10 or -100
Wired, tested, PS-1B **\$59.95**
Kit, PS-1B **\$44.95**



READOUTS

FND 359 4" C.C. **\$1.00**
FND 507/510 5" C.A. **1.00**
MAN 72/HP7730 33" C.A. **1.00**
HP 7651 43" C.A. **2.00**

Sockets

8 Pin **10/\$2.00**
14 Pin **10/\$2.00**
16 Pin **10/\$2.00**
24 Pin **4/\$2.00**
28 Pin **4/\$2.00**
40 Pin **3/\$2.00**

DC-DC Converter

+5 vdc input prod. -9 vdc @ 30ma
+9 vdc produces -15 vdc @ 35ma **\$1.25**

Ceramic IF Filters

Mini ceramic filters 7 KHz B. W. 455KHz **\$1.50 ea.**

RF actuated relay senses RF (1W) and closes DPDT relay.

For RF sensed T-R relay. TR-1 Kit **\$6.95**

Power Supply Kit

Complete triple regulated power supply provides variable 6 to 18 volts at 200 ma and +5 at 1 Amp. Excellent load regulation, good filtering and small size. Less transformers, requires 6.3 V (a 1 A and 24 VCT. Complete kit, PS-3LT **\$6.95**

TRANSISTORS

2N3904 NPN **15/\$1.00**
2N3906 PNP **15/\$1.00**
2N4403 PNP **15/\$1.00**
2N4410 PNP **15/\$1.00**
2N4918 FET **4/\$1.00**
2N5401 PNP **5/\$1.00**
2N6028 **4/\$1.00**
2N3771 NPN Silicon **11.50**
2N5179 UHF NPN **3/\$2.00**
Power Tab NPN 40W **3/\$1.00**
Power Tab PNP 40W **3/\$1.00**
MPF 102/25484 **5.50**
NPN 3904 Type **50/\$2.50**
PNP 3906 Type **50/\$2.50**
2N3055 **.80**
2N2646 UJT **3/\$2.00**

Diodes

5.1 V Zener **20/\$1.00**
1N914 Type **50/\$1.00**
1KV 2Amp **8/\$1.00**
100V 1Amp **15/\$1.00**

Crystal Microphone

Small 1" diameter 1/2" thick crystal mike carrier **\$.75**

Mini RG-174 Coax

10 ft. for **\$1.00**

Coax Connector

Chassis mount **\$1.00**
BNC type **\$1.00**

9 Volt Battery Clips

Nice quality clips **5 for \$1.00**
3/4" Rubber Grommets **10 for \$1.00**

OP-AMP Special

BI-FET LF 13741 - Direct pin for pin 741 compatible, but 500,000 MEG input z, super low 50 pa input current, low power drain.
50 for only **\$9.00** 10 for **\$2.00**

Regulators

78Mg **\$1.25**
79Mg **\$1.25**
723 **\$.50**
309K **\$1.15**
7805 **\$1.00**
7812 **\$1.00**
7815 **\$1.00**
7905 **\$1.25**
7912 **\$1.25**
7915 **\$1.25**

Parts Bag

Ass't of chokes, disc caps, tant., resistors, transistors, diodes, MICA caps etc. sm. bag (100 pc) **\$1.00** lg. bag (300 pc) **\$2.50**

Connectors

6 pin type gold contacts for mA-1003 car clock module price **.75 ea.**

Shrink Tubing Nubs

Nice precut pcs of shrink size: 1" x 1/4" shrink to 1/4". Great for splices. **50/\$1.00**

Mini TO-92 Heat Sinks

Thermally Bond **5 for \$1.00**
To-220 Heat Sinks **3 for \$1.00**

Opto Isolators - 4N28 type

Opto Reflectors - Photo diode + LED **\$1.00 ea.**

CDS Photocells

Resistance varies with light, 250 ohms to over 3 meg **3 for \$1.00**

7400

| | | | |
|----------|------|----------|------|
| SN7400N | .19 | SN74123N | .59 |
| SN7401N | .22 | SN74125N | .69 |
| SN7402N | .22 | SN74126N | .44 |
| SN7403N | .22 | SN74128N | .59 |
| SN7404N | .22 | SN74132N | .69 |
| SN7405N | .23 | SN74136N | .95 |
| SN7406N | .23 | SN74139N | .95 |
| SN7407N | .23 | SN74141N | .69 |
| SN7408N | .26 | SN74142N | 2.95 |
| SN7409N | .23 | SN74143N | 2.95 |
| SN7410N | .22 | SN74144N | 2.95 |
| SN7411N | .29 | SN74145N | .82 |
| SN7412N | .29 | SN74147N | 1.95 |
| SN7413N | .39 | SN74148N | 1.20 |
| SN7414N | .59 | SN74150N | .99 |
| SN7416N | .28 | SN74151N | .67 |
| SN7417N | .29 | SN74152N | .67 |
| SN7420N | .22 | SN74153N | .67 |
| SN7421N | .35 | SN74154N | 1.15 |
| SN7422N | .29 | SN74155N | .82 |
| SN7423N | .29 | SN74156N | .89 |
| SN7425N | .29 | SN74157N | .69 |
| SN7426N | .29 | SN74158N | 1.65 |
| SN7427N | .29 | SN74160N | .95 |
| SN7429N | .45 | SN74161N | .95 |
| SN7430N | .23 | SN74162N | .89 |
| SN7432N | .29 | SN74163N | .87 |
| SN7437N | .29 | SN74164N | .97 |
| SN7438N | .29 | SN74165N | .97 |
| SN7439N | .29 | SN74166N | 1.20 |
| SN7440N | .24 | SN74167N | 1.95 |
| SN7441N | .79 | SN74170N | 1.69 |
| SN7442N | .57 | SN74172N | .95 |
| SN7443N | .79 | SN74173N | .79 |
| SN7444N | .79 | SN74174N | .89 |
| SN7445N | .79 | SN74175N | .89 |
| SN7446N | .79 | SN74176N | .85 |
| SN7447N | .59 | SN74177N | .85 |
| SN7448N | .79 | SN74178N | 1.00 |
| SN7450N | .23 | SN74180N | .75 |
| SN7451N | .23 | SN74181N | 1.75 |
| SN7453N | .23 | SN74182N | .75 |
| SN7454N | .23 | SN74184N | 1.95 |
| SN7459N | .23 | SN74185N | 1.95 |
| SN7460N | .23 | SN74186N | .95 |
| SN7470N | .39 | SN74188N | 3.90 |
| SN7472N | .34 | SN74190N | 1.15 |
| SN7473N | .38 | SN74191N | 1.15 |
| SN7474N | .38 | SN74192N | 1.15 |
| SN7475N | .38 | SN74193N | .85 |
| SN7476N | .36 | SN74194N | .85 |
| SN7479N | 4.60 | SN74195N | .25 |
| SN7480N | .59 | SN74196N | .85 |
| SN7481N | 1.10 | SN74197N | 1.10 |
| SN7482N | 1.10 | SN74198N | 1.39 |
| SN7483N | .55 | SN74199N | 1.39 |
| SN7485N | .65 | SN74221N | 1.39 |
| SN7486N | .39 | SN74225N | .95 |
| SN7489N | 1.75 | SN74273N | 1.05 |
| SN7490N | .39 | SN74279N | .89 |
| SN7491N | .65 | SN74283N | 2.15 |
| SN7492N | .52 | SN74284N | 3.90 |
| SN7493N | .49 | SN74285N | 3.90 |
| SN7494N | .72 | SN74289N | 1.25 |
| SN7495N | .65 | SN74298N | .95 |
| SN7496N | .72 | SN74365N | .68 |
| SN7497N | 3.10 | SN74366N | .68 |
| SN74100N | .99 | SN74367N | .79 |
| SN74107N | .32 | SN74368N | .79 |
| SN74109N | .55 | SN74369N | 1.90 |
| SN74116N | 1.95 | SN74393N | 1.90 |
| SN74121N | .29 | SN74490N | 1.90 |
| SN74122N | .39 | | |

74LS00

| | | | |
|----------|------|-----------|------|
| 74LS00N | .35 | 74LS164N | 1.19 |
| 74LS01N | .28 | 74LS165N | .89 |
| 74LS02N | .28 | 74LS166N | 2.48 |
| 74LS03N | .28 | 74LS168N | 1.89 |
| 74LS04N | .39 | 74LS169N | .89 |
| 74LS05N | .28 | 74LS170N | .89 |
| 74LS06N | .39 | 74LS173N | .89 |
| 74LS09N | .39 | 74LS174N | .99 |
| 74LS10N | .28 | 74LS175N | .99 |
| 74LS11N | .39 | 74LS181N | 2.20 |
| 74LS12N | .39 | 74LS190N | 1.15 |
| 74LS13N | .47 | 74LS191N | 1.15 |
| 74LS14N | 1.25 | 74LS192N | .98 |
| 74LS15N | .39 | 74LS193N | .98 |
| 74LS20N | .26 | 74LS194N | 1.15 |
| 74LS21N | .38 | 74LS195N | .95 |
| 74LS22N | .38 | 74LS196N | .89 |
| 74LS26N | .39 | 74LS197N | .89 |
| 74LS27N | .39 | 74LS221N | 1.49 |
| 74LS28N | .39 | 74LS240N | 2.99 |
| 74LS30N | .26 | 74LS241N | 2.49 |
| 74LS32N | .39 | 74LS242N | 2.29 |
| 74LS37N | .79 | 74LS243N | 2.29 |
| 74LS38N | .79 | 74LS244N | 2.29 |
| 74LS40N | .26 | 74LS245N | 8.96 |
| 74LS42N | .79 | 74LS247N | 1.10 |
| 74LS47N | .79 | 74LS248N | 1.10 |
| 74LS48N | .79 | 74LS249N | 1.69 |
| 74LS51N | .28 | 74LS251N | 1.79 |
| 74LS54N | .20 | 74LS252N | .98 |
| 74LS55N | .35 | 74LS257N | .98 |
| 74LS73N | .45 | 74LS258N | .98 |
| 74LS74N | .59 | 74LS259N | 2.95 |
| 74LS75N | .68 | 74LS261N | 2.95 |
| 74LS76N | .45 | 74LS265N | 1.10 |
| 74LS78N | .65 | 74LS266N | 1.75 |
| 74LS83AN | .99 | 74LS273N | 1.75 |
| 74LS85N | 1.19 | 74LS275N | 4.40 |
| 74LS86N | .45 | 74LS279N | .95 |
| 74LS90N | .75 | 74LS280N | 1.10 |
| 74LS92N | .75 | 74LS290N | 1.29 |
| 74LS93N | .75 | 74LS293N | 1.95 |
| 74LS95N | .88 | 74LS295N | 1.10 |
| 74LS96N | .98 | 74LS298N | 1.29 |
| 74LS107N | .45 | 74LS322AN | 1.75 |
| 74LS109N | .45 | 74LS347N | 1.95 |
| 74LS112N | .49 | 74LS348N | 1.95 |
| 74LS113N | .49 | 74LS352N | 1.65 |
| 74LS114N | .55 | 74LS353N | 1.65 |
| 74LS122N | .65 | 74LS356N | 1.49 |
| 74LS123N | 1.19 | 74LS365N | .99 |
| 74LS124N | 1.35 | 74LS366N | .99 |
| 74LS125N | .89 | 74LS367N | .99 |
| 74LS126N | .89 | 74LS368N | 2.75 |
| 74LS133N | 1.90 | 74LS373N | 2.75 |
| 74LS136N | .99 | 74LS374N | 2.75 |
| 74LS138N | .89 | 74LS375N | .69 |
| 74LS139N | .89 | 74LS377N | 1.95 |
| 74LS145N | 1.25 | 74LS385N | 1.95 |
| 74LS148N | 1.49 | 74LS386N | 6.65 |
| 74LS151N | .79 | 74LS390N | 1.95 |
| 74LS153N | .79 | 74LS393N | 1.95 |
| 74LS154N | 2.49 | 74LS395N | 1.70 |
| 74LS155N | 1.19 | 74LS398N | 2.95 |
| 74LS156N | .95 | 74LS424AN | 2.95 |
| 74LS157N | .99 | 74LS566N | 1.75 |
| 74LS158N | .75 | 74LS567N | 2.29 |
| 74LS160N | .95 | 81LS95N | 1.99 |
| 74LS181N | 1.15 | 81LS96N | 1.99 |
| 74LS182N | 1.95 | 81LS97N | 1.99 |
| 74LS183N | .98 | 81LS98N | 1.99 |

CMOS

| | | | |
|--------|------|---------|-------|
| CD4000 | .29 | CD4093 | .99 |
| CD4001 | .29 | CD4094 | 2.95 |
| CD4002 | .29 | CD4096 | 2.49 |
| CD4006 | 1.39 | CD4099 | 2.25 |
| CD4007 | .29 | MC14408 | 12.95 |
| CD4008 | 1.39 | MC14409 | 12.95 |
| CD4009 | .59 | MC14410 | 12.95 |
| CD4010 | .59 | MC14412 | 12.95 |
| CD4011 | .29 | MC14415 | 8.95 |
| CD4012 | .29 | MC14419 | 4.95 |
| CD4013 | .48 | CD4501 | .95 |
| CD4014 | 1.39 | CD4502 | 1.85 |
| CD4015 | 1.39 | CD4503 | .69 |
| CD4016 | .59 | CD4505 | 8.95 |
| CD4017 | 1.19 | CD4506 | .75 |
| CD4018 | 1.19 | CD4507 | .85 |
| CD4019 | .49 | CD4508 | 3.95 |
| CD4020 | 1.19 | CD4510 | 1.39 |
| CD4021 | 1.49 | CD4511 | 1.39 |
| CD4022 | 1.29 | CD4512 | 1.39 |
| CD4023 | .38 | CD4515 | 1.89 |
| CD4024 | .79 | CD4516 | 1.89 |
| CD4025 | .38 | CD4518 | 1.39 |
| CD4027 | .79 | CD4520 | 1.39 |
| CD4028 | .99 | CD4555 | 4.95 |
| CD4029 | 1.29 | CD4556 | 2.95 |
| CD4030 | .69 | CD4566 | 2.25 |
| CD4031 | 3.25 | 74C00 | .39 |
| CD4032 | 2.15 | 74C02 | .39 |
| CD4034 | 3.15 | 74C03 | .39 |
| CD4035 | 1.19 | 74C06 | .49 |
| CD4037 | 1.95 | 74C10 | .49 |
| CD4040 | 1.29 | 74C14 | 1.65 |
| CD4041 | 1.25 | 74C20 | .39 |
| CD4042 | .99 | 74C30 | .39 |
| CD4043 | .99 | 74C18 | .99 |
| CD4044 | .99 | 74C42 | 1.85 |
| CD4046 | 2.25 | 74C48 | 2.39 |
| CD4047 | 1.25 | 74C73 | .99 |
| CD4048 | .69 | 74C74 | .99 |
| CD4050 | 1.49 | 74C85 | 2.75 |
| CD4055 | .69 | 74C89 | 4.95 |
| CD4051 | 1.10 | 74C90 | 1.85 |
| CD4052 | 1.10 | 74C93 | 1.85 |
| CD4053 | 1.10 | 74C95 | 1.85 |
| CD4054 | 1.10 | 74C97 | 1.85 |
| CD4056 | 2.95 | 74C151 | 2.49 |
| CD4059 | 9.95 | 74C154 | 3.50 |
| CD4060 | 1.39 | 74C157 | 2.10 |
| CD4065 | .69 | 74C160 | 2.39 |
| CD4069 | .69 | 74C181 | 2.30 |
| CD4070 | .69 | 74C183 | 2.39 |
| CD4071 | .69 | 74C184 | 2.39 |
| CD4072 | .35 | 74C173 | 2.69 |
| CD4073 | .35 | 74C174 | 2.75 |
| CD4075 | .35 | 74C175 | 2.75 |
| CD4076 | 1.29 | 74C192 | .39 |
| CD4077 | .35 | 74C193 | 2.39 |
| CD4078 | .35 | 74C195 | 2.39 |
| CD4081 | .35 | 74C922 | 7.98 |
| CD4082 | .35 | 74C923 | 6.95 |
| CD4085 | 1.95 | MM90C97 | 1.50 |
| CD4089 | 2.95 | MM90C97 | 1.25 |

LINEAR

| | | | |
|-------------|-------|-----------|------|
| 78-05 | 5.95 | LM144AN | 1.90 |
| 78-06 | 1.45 | LM145CN/N | .49 |
| 78M.G | 1.49 | MC1488N | 1.49 |
| LM105H | .99 | MC1489N | 1.49 |
| LM106AH | .79 | LM1496N | .89 |
| LM300H | 2.95 | LM1555N | 1.50 |
| LM3301CN/N | 1.25 | LM1800N | .95 |
| LM303AH | .88 | LM1820N | .95 |
| LM3035H | .99 | LM1850N | .95 |
| LM306E | 3.25 | LM1889N | 3.95 |
| LM307CN/N | .39 | LM2111N | 1.75 |
| LM309CN/N | .99 | LM2300N | .99 |
| LM309K | 1.49 | LM2901N | 2.50 |
| LM310CN | 1.25 | LM2917N | 2.95 |
| LM311D/CN/N | .88 | CA3013T | 2.29 |
| LM312H | 1.75 | CA3018T | 1.99 |
| LM313H | 2.81 | CA3021T | .79 |
| LM316CN/N | 1.49 | CA3023T | 2.99 |
| LM319NH | 1.25 | CA3035T | 2.75 |
| LM320K-XX | 1.49 | CA3038T | 1.49 |
| LM320T-XX | 1.25 | CA3048T | 1.29 |
| LM3305H | 2.49 | LM3305N | 2.49 |
| LM323K | 4.95 | CA3059N | 3.25 |
| LM324N | 1.25 | CA3060N | 3.25 |
| LM339N | .95 | CA3062N | 4.95 |
| LM340K-XX | 1.49 | LM3065N | 1.49 |
| LM340N | 1.25 | CA3080N | 2.29 |
| LM340D-XX | 1.25 | CA3081N | 1.69 |
| LM344H | 1.95 | CA3082N | 1.69 |
| LM348N | 1.85 | CA3083N | 1.99 |
| LM358CN | .98 | CA3086N | 1.29 |
| LM360N | 1.49 | CA3089N | 2.75 |
| LM372N | 1.95 | CA3096N | 2.49 |
| LM376E | 3.75 | CA3097N | 1.99 |
| LM377N | 3.75 | CA3130T | 2.49 |
| LM380CN/N | 1.25 | CA3140T | 2.49 |
| LM381N | 1.79 | CA3148N | 2.49 |
| LM383T | 1.95 | CA3180T | 1.49 |
| LM386E | 1.49 | CA3190N | 1.95 |
| LM387N | 1.49 | CA3401N | .69 |
| LM390N | 1.95 | MC3423N | 1.49 |
| NE5131Y | 3.75 | MC3450N | 3.95 |
| NE555V | .98 | SG3524H | 8.95 |
| NE556E | .98 | CA3800N | 3.50 |
| NE561T | 19.95 | LM3900N | .59 |
| NE562B | 7.95 | LM3905N | 1.49 |
| NE565H | 1.19 | LM3909N | .98 |
| NE566H/V | 1.50 | RC4131N | 2.95 |
| NE567V/H | 1.75 | RC4136N | 1.10 |
| NE592N | 2.75 | RC4151N | 4.50 |
| LM702H | 2.99 | RC4194 | 4.95 |
| LM709H | .29 | RC4195 | 4.40 |
| LM710N/H | .98 | LM7000N | 1.25 |
| LM711N/H | .39 | ULN2003 | 1.50 |
| LM715N | 1.95 | SN75450N | .59 |
| LM723NH | .75 | SN75451N | .49 |
| LM733H | .98 | SN75452N | .49 |
| LM739N | 1.15 | SN75453N | .49 |
| LM741CN/H | .33 | SN75454N | .49 |
| LM741DN-14 | .19 | SN75491N | .89 |
| LM747NH | .79 | SN75492N | .89 |
| LM748NH | .39 | SN75493N | .89 |
| LM780CN | 2.95 | SN75494N | .89 |
| LM1310N | 1.90 | | |

RETAIL STORES OPEN MON-SAT

STORE #1 1310 "B" E. Edinger Santa Ana, CA 92705
 STORE #2 674 El Camino Real Tustin, CA 92680
 Showrooms, Retail, Warehouse Specializing in Systems

BECKMAN Digital Multimeters

MODELS TECH 300 AND TECH 310

AS LOW AS \$100.00

Choice of Model - The TECH 310 has all above features, 7 functions, 2 1/2 ranges plus 0.5% Vdc accuracy. The TECH 300 has 4.5% Vdc accuracy and all the above features but without Insta-Ohm™ continuity function on the 10 amp current range.

| | |
|-------------------------------|----------|
| TECH 300 Digital Multimeter | \$100.00 |
| TECH 310 Digital Multimeter</ | |

ADVANCED COMPUTER PRODUCTS

GET YOUR 1980 CATALOG

FIRST TO OFFER PRIME PRODUCTS TO THE HOBBYIST AT FAIR PRICES!

1. Proven Quality Factory tested products only.
 2. Guaranteed Satisfaction
 3. Over \$1,000,000.00 Inventory
- ## 1980 CATALOG NOW AVAILABLE.
- Send \$2.00 for your copy of the most complete catalog of computer products. A must for the serious computer user.

STATIC RAM BOARDS

S-100 32K (uses 2114)
 ASSEMBLED Kit
 450ns. 499.00 250ns. 469.00
 250ns. 539.00 250ns. 499.00
 Bare Board 49.95
 Bare Board w/all parts less mem. 99.95

S-100 16K (S-100 Compatible)
 • Low Power
 • 2 MHz or 4 MHz
 • Assembled & Tested

2 MHz ... \$250.00
 4 MHz ... \$265.00

WOW!

LOGOS 16K
 ASSEMBLED
 450 ns. 149.95 KIT 450ns. 125.95
 250ns. 169.95 250ns. 149.95

Bare PC Board w/Data \$21.95
 *Special Offer! Buy (4) 8K 450ns. Kits \$117.00

The VISTA V-80 Disk Drive System
 • 23% more storage capacity than TRS-80
 • 120 day warranty
 • 40 track patch at NO CHARGE

Single drive system ... \$ 395.00
 Two drive system ... \$ 770.00
 Four drive system ... \$1450.00
 Two drive cable ... \$ 29.95
 Four drive cable ... \$ 39.95

The VISTA V-200 FOR EXIDY
 Price Starting as low as \$1199.00

| Year | Capacity | Drive | Weight | Price |
|-----------|----------|---------|---------|---------|
| V200 E-20 | 400 | 2 Drive | 25 lbs. | 1199.00 |
| V200 E-20 | 600 | 2 Drive | 25 lbs. | 1549.00 |
| V200 E-30 | 600 | 3 Drive | 32 lbs. | 1524.00 |
| V200 E-32 | 12 MB | 3 Drive | 32 lbs. | 1999.00 |

DC-500 HARD DISK INTERFACE
 • Apple II • Cromemco • TRS-80
 DATA SYSTEMS INC. * TRS 80 * Others soon

DC-500 Controller - TRS 80 Model I 500.00
 Includes CMC Hawk 10 MB Drive 1500.00
 Interface of Your Choice DC-500 Controller - Apple II 1500.00
 DC-500 Controller - Cromemco 450.00

LOW COST FLOPPY DISK SUBSYSTEM

Shugart 801R Drives (2)
 VISTA Floppy Controller (S-100)
 Case, Power Supply & Cable
 CP/M Disk Operating System
 Assembled & Tested ... \$1499.00
 New only ... \$875.00
 SAVE \$300.00 (S-1799.00 Value)

WATANABE MIPOLOT
 Max print speed 50 mm/sec.
 resolution 10 mm typ. x 10 mm
 05 mm built-in character
 generator with 8 alpha
 character sizes & 4 degrees
 of rotation, absolute cursor,
 relative draw, alpha
 printing done with simple
 commands

\$1195.00

IMS STATIC RAM BOARDS

| | 250 ns. | 450 ns. |
|------------|----------|----------|
| 8K Static | \$209.00 | \$189.00 |
| 16K Static | \$449.00 | \$399.00 |
| 32K Static | \$729.00 | \$629.00 |

ANADEX PRINTER NEW APPLE VERSION
 Model DP-8000 compact, parallel or serial, sprocket feed, 80 cps, 84 lines/min., bi-directional.
 New only ... \$875.00
 DP-8000AP (for Apple) \$875.00

SALE! SD SYSTEMS BOARDS TAKE 10% OFF!

| Kit | ASSEM |
|--------------------------------------|--------------------|
| SBC 100 Single Board Computer (2MHz) | \$285.00 \$ 248.00 |
| SBC 200 Single Board Computer (4MHz) | 399.00 359.00 |
| Z80 Starter System | 319.00 289.00 |
| VDB 8024 Video Display Board | 735.00 665.00 |
| Versa-Floppy II | 325.00 295.00 |
| Expando PROM | 115.00 105.00 |
| SD100 Computer System w/64K | 699.00 635.00 |
| SD200 Computer System w/64K | 799.00 725.00 |

68000 MICROMODULE™ PRICE LIST

| MODEL NO. | DESCRIPTION | PRICE |
|-----------|----------------------------------|----------|
| 9600A | Single Board Microcomputer | \$495.00 |
| 9600B | Advanced Upgrade Bd. Comp (8609) | \$95.00 |
| 9601 | 16 Slot Mother Board | 175.00 |
| 9602 | Card Cage | 75.00 |
| 9603 | 100 Pin Mother Board | 100.00 |
| 9604 | Power Supply | 275.00 |
| 9605 | DC Input Power Supply | 325.00 |
| 9610 | Utility Proto Board | 39.00 |
| 9611 | Anti. Prog/Memory Module | 495.00 |
| 9612 | Buffed Utility Proto Board | 439.00 |
| 9613 | 32K EPROM RAM Module | 250.00 |
| 9617 | EPROM Programming Head | 250.00 |
| 9620 | 16 Channel Parallel I/O Module | 295.00 |
| 9622 | Serial-Parallel I/O Module | 325.00 |
| 9627 | 16K Static RAM Module 470ns | 35.00 |
| 9629 | 32K Static RAM 450ns | 69.00 |
| 9629A | 32K Static RAM 200ns | 89.00 |
| 9630 | Card Extender | 39.00 |
| 9640 | Multiple Programmable Timer | 395.00 |
| 9650 | 8 Channel Dual Serial I/O Mod | 550.00 |
| 9655 | Intelligent Tape Controller | 275.00 |
| 96103 | 32/32 I/O Module | 275.00 |
| 96702 | Contact Closure Module | 55.00 |

APPLE/EXIDY/EXPANDO TRS 80 16K-UPGRADE KIT

\$54.95 TRS-80/APPLE \$54.95

MEMORY EXPANSION KITS,
 4116's, 16K (200/250 ns.)
 8 pcs for \$54.95
 w/instructions & jumpers
 Call For Volume Pricing

* Special: TRS80 Schematic ... \$ 4.95
 * Expansion Interface Schematic ... \$ 4.95
 * Expansion Interface Connector ... 7.95

EXPANDORAM II MEMORY KITS
 • Bank Selectable • Uses 4116 200 ns.
 • Write Protect • Power 8VDC, ±16VDC
 • Phantom Prices • Up to 4 MHz

Expando 64 Kit (4116) Assem. & Tested Add \$50.
 16K \$269.00 48K \$435.00
 32K \$349.00 64K \$505.00

HAZELTINE TERMINALS SALE \$749.00

| Model | 1400 | \$749.00 | Model 1500 | \$1085.00 |
|------------|----------|------------|------------|-----------|
| Model 1410 | \$825.00 | Model 1510 | \$1245.00 | |
| Model 1420 | \$945.00 | Model 1520 | \$1495.00 | |

UV "Eprom" Eraser
 Merges UVs-11E \$69.95
 Holds 4 Eprom's at a time
 Backed by 45 years
 experience.

Model S-52T ... \$265.00

EMAKO-20... Reg. \$777.00 **\$599.00**

UNBELIEVABLE!
 128 Cases 80 Lines Vertical
 Formal Unit - 96 Characters
 Upper/Lower Case -
 4.5" to 9.5" Adjustable
 80/240 cpl double
 width - Full 96 char. ASCII

EMAKO-22.....\$799.00

Prints a 132 col/line. Available with parallel or serial output at same price.

MIKA 20.....\$1280.00
 9x7, 125 cps 136 characters/line
 Full 15" width. Super for business applications
 requiring large IBM format paper.

BASE II PRINTER
 90 Column Impact Printer
 • 60 Lines Per Minute
 • 115/230 VAC, 50 or 60 Hz
 • 7.2, 8.0, 9.6, 120 or 137 Char./Line
 • Self-Tape Switch

ACP PRICE **\$575.00** REG \$649.00

Option "M" Terminal Screen Buffer (1920 Char.) \$50.00
 Option "S" High Speed Paper Advance & Graphics \$50.00
 Option "T" Tractor Feed \$50.00

Z-80/Z-80A/8080 CPU BOARD
 • On board 2708 • 2708 included (450ns.)
 • Power on jump • completely socketed
 • Z-80 Assembled and Tested ... \$185.00
 • Z-80 Kit ... \$129.95
 • Z-80 Bare PC Board ... \$ 34.95
 • For 4MHz Speed Add \$15.00

8080A Kit ... \$ 99.95
 8080A Assembled ... \$149.95

S-100 MOTHERBOARD SPECIAL
 8 slot expandable w/9 conn.
 reg \$69.95 ... NOW \$52.95

SIEMEN'S FLOPPY SALE **SIEMENS \$429.00**
 • Special buy while supply lasts.
 • 8" Drive with Double-Density
 • 90 Day Warranty

ACOUSTIC MODEM NOVATION CAT™
 O-300 Baud
 Bell 103
 Answer/Originate **\$169.00**

DATA BOOKS • COMPUTER BOOKS

1980 IC Master ... \$9.95
 NSC TTL Data ... \$9.95
 NSC Linear App Notes II ... \$9.95
 NSC CMOS ... \$9.95
 NSC Memory ... \$9.95
 Intel MCS 85 Manual ... \$9.95

SALE • OSBORNE BOOKS • SALE

Intro to Micros Vol. 0 ... \$6.75
 Intro to Micros Vol. I ... \$7.75
 8080A Programming ... \$7.75
 6800 Programming ... \$7.75
 Z80 Programming ... \$7.75
 Vol. II Some Real Microprocessors w/Board ... \$7.75
 Vol. III Some Real Support Devices w/Board ... \$7.75
 Intro to Micros Vol. III ... \$7.75

MICROPROCESSORS

| | |
|------------------------|----------|
| Z8001 18 bit to 84K | \$189.00 |
| Z8002 18 bit to 84K | 149.00 |
| Z8003 18 bit to 84K | 107.75 |
| Z8004 18 bit to 84K | 14.50 |
| Z8005 18 bit to 84K | 18.95 |
| Z8006 18 bit to 84K | 18.95 |
| CD1802 | 13.95 |
| 8080A | 2.99 |
| 8080A 4.0 MHz | 19.95 |
| SALE 8085 | 14.95 |
| 8081 | 9.90 |
| 2801A | 16.95 |
| 28013 4-bit Supertimer | 29.95 |
| TMS 9900/1 | 49.95 |
| CP-1800 | 14.95 |
| 8502 | 11.50 |
| 6502A | 18.95 |
| IMC100 | 29.95 |
| 6800 | 11.75 |
| 6800B 20 MHz | 19.95 |
| 6801 | 7.95 |
| 8035 | 18.95 |
| 8755 | 49.95 |
| 8748 | 69.95 |
| 6809 | 69.95 |
| 8086 | 69.95 |

ADVANCED SUPPORT

AM9511 Auth. Processor ... 175.00
 9512 Auth. Processor ... 175.00
 9513 Unit, Timing ... 79.95
 AM9517 DMA Controller ... 18.95
 AM9518 Universal Interrupt ... 18.95

Z-80 SUPPORT CHIPS

| | |
|-------------------|-------|
| Z80-P10 2.5 MHz | 8.75 |
| Z80A-P10 4.0 MHz | 12.50 |
| Z80-CTC 2.5 MHz | 8.75 |
| Z80A-CTC 4.0 MHz | 12.50 |
| Z80-DMA 4.0 MHz | 36.95 |
| Z80-SIO 2.5 MHz | 35.95 |
| Z80-SIO/2 4.0 MHz | 39.40 |
| Z80-SIO/2 2.5 MHz | 35.95 |
| Z80-SIO/2 4.0 MHz | 39.40 |

8080/8085 SUPPORT

| | |
|-----------------------|-------|
| 8155/8156 I/O | 24.95 |
| 8157 I/O with Eeprom | 64.95 |
| 8202 Dyn. Ram Cont. | 34.95 |
| 8205/745 13K Decoder | 27.75 |
| 8212 8 Bit Clock Gen. | 2.25 |
| 8214 Priority Int. | 5.25 |
| 8218 Bus Driver | 2.75 |
| 8224 Clock Gen. | 9.75 |
| 8226 Bus Driver | 2.85 |
| 8228 Bus Driver | 2.85 |
| 8228 Sys. Control | 5.50 |
| 8238 Sys. Control | 5.50 |
| 8251 Prog. I/O | 39.95 |
| 8253 Int. Timer | 18.95 |
| 8255 I/O | 8.50 |
| 8257 Prog. DMA | 18.95 |
| 8259 Prog. DMA | 17.95 |
| 8267 Prog. DMA | 18.95 |
| 8279 Prog. Keyboards | 18.95 |

8080 SUPPORT CHIPS

| | |
|------------------|------|
| 6810 128 x 8 Ram | 4.75 |
| 6820 PIA | 5.95 |
| 6821 8 Bit I/O | 5.95 |
| 6827 8 Bit I/O | 4.95 |
| 6828 8 Bit I/O | 4.95 |
| 6829 8 Bit I/O | 4.95 |
| 682A 8 Bit I/O | 4.95 |
| 682B 8 Bit I/O | 4.95 |
| 682C 8 Bit I/O | 4.95 |
| 682D 8 Bit I/O | 4.95 |
| 682E 8 Bit I/O | 4.95 |
| 682F 8 Bit I/O | 4.95 |
| 682G 8 Bit I/O | 4.95 |
| 682H 8 Bit I/O | 4.95 |
| 682I 8 Bit I/O | 4.95 |
| 682J 8 Bit I/O | 4.95 |
| 682K 8 Bit I/O | 4.95 |
| 682L 8 Bit I/O | 4.95 |
| 682M 8 Bit I/O | 4.95 |
| 682N 8 Bit I/O | 4.95 |
| 682O 8 Bit I/O | 4.95 |
| 682P 8 Bit I/O | 4.95 |
| 682Q 8 Bit I/O | 4.95 |
| 682R 8 Bit I/O | 4.95 |
| 682S 8 Bit I/O | 4.95 |
| 682T 8 Bit I/O | 4.95 |
| 682U 8 Bit I/O | 4.95 |
| 682V 8 Bit I/O | 4.95 |
| 682W 8 Bit I/O | 4.95 |
| 682X 8 Bit I/O | 4.95 |
| 682Y 8 Bit I/O | 4.95 |
| 682Z 8 Bit I/O | 4.95 |

1802 SUPPORT CHIPS

| | |
|---------------------------------|-------|
| 1821 SDC 2K Ram | 25.00 |
| 1822 SDC 256 x 4 Ram | 16.95 |
| 1823 2K x 32 x 4 RAM | 8.95 |
| 1824 2K x 16 x 4 RAM | 10.95 |
| 1825 4K x 16 x 4 RAM | 8.95 |
| 1826 8K x 16 x 4 RAM | 8.95 |
| 1827 16K x 16 x 4 RAM | 8.95 |
| 1828 32K x 16 x 4 RAM | 8.95 |
| 1829 64K x 16 x 4 RAM | 8.95 |
| 1830 128K x 16 x 4 RAM | 8.95 |
| 1831 256K x 16 x 4 RAM | 8.95 |
| 1832 512K x 16 x 4 RAM | 8.95 |
| 1833 1024K x 16 x 4 RAM | 8.95 |
| 1834 2048K x 16 x 4 RAM | 8.95 |
| 1835 4096K x 16 x 4 RAM | 8.95 |
| 1836 8192K x 16 x 4 RAM | 8.95 |
| 1837 16384K x 16 x 4 RAM | 8.95 |
| 1838 32768K x 16 x 4 RAM | 8.95 |
| 1839 65536K x 16 x 4 RAM | 8.95 |
| 1840 131072K x 16 x 4 RAM | 8.95 |
| 1841 262144K x 16 x 4 RAM | 8.95 |
| 1842 524288K x 16 x 4 RAM | 8.95 |
| 1843 1048576K x 16 x 4 RAM | 8.95 |
| 1844 2097152K x 16 x 4 RAM | 8.95 |
| 1845 4194304K x 16 x 4 RAM | 8.95 |
| 1846 8388608K x 16 x 4 RAM | 8.95 |
| 1847 16777216K x 16 x 4 RAM | 8.95 |
| 1848 33554432K x 16 x 4 RAM | 8.95 |
| 1849 67108864K x 16 x 4 RAM | 8.95 |
| 1850 134217728K x 16 x 4 RAM | 8.95 |
| 1851 268435456K x 16 x 4 RAM | 8.95 |
| 1852 536870912K x 16 x 4 RAM | 8.95 |
| 1853 1073741824K x 16 x 4 RAM | 8.95 |
| 1854 2147483648K x 16 x 4 RAM | 8.95 |
| 1855 4294967296K x 16 x 4 RAM | 8.95 |
| 1856 8589934592K x 16 x 4 RAM | 8.95 |
| 1857 17179869184K x 16 x 4 RAM | 8.95 |
| 1858 34359738368K x 16 x 4 RAM | 8.95 |
| 1859 68719476736K x 16 x 4 RAM | 8.95 |
| 1860 137438953472K x 16 x 4 RAM | 8.95 |
| 1861 274877906944K x 16 x 4 RAM | 8.95 |

6502 SUPPORT CHIPS

| | |
|----------------------|-------|
| 6520 PIA | 7.95 |
| 6522 2K x 8 RAM | 11.95 |
| 6500-002,003,004,005 | 21.95 |
| 6522 | 11.95 |
| 6523 | 11.95 |
| 6524 | 11.95 |
| 6525 | 11.95 |
| 6526 | 11.95 |
| 6527 | 11.95 |
| 6528 | 11.95 |
| 6529 | 11.95 |
| 6530 | 11.95 |
| 6531 | 11.95 |
| 6532 | 11.95 |
| 6533 | 11.95 |
| 6534 | 11.95 |
| 6535 | 11.95 |
| 6536 | 11.95 |
| 6537 | 11.95 |
| 6538 | 11.95 |
| 6539 | 11.95 |
| 6540 | 11.95 |
| 6541 | 11.95 |
| 6542 | 11.95 |
| 6543 | 11.95 |
| 6544 | 11.95 |
| 6545 | 11.95 |
| 6546 | 11.95 |
| 6547 | 11.95 |
| 6548 | 11.95 |
| 6549 | 11.95 |
| 6550 | 11.95 |
| 6551 | 11.95 |
| 6552 | 11.95 |
| 6553 | 11.95 |
| 6554 | 11.95 |
| 6555 | 11.95 |
| 6556 | 11.95 |
| 6557 | 11.95 |
| 6558 | 11.95 |
| 6559 | 11.95 |
| 6560 | 11.95 |
| 6561 | 11.95 |
| 6562 | 11.95 |
| 6563 | 11.95 |
| 6564 | 11.95 |
| 6565 | 11.95 |
| 6566 | 11.95 |
| 6567 | 11.95 |
| 6568 | 11.95 |
| 6569 | 11.95 |
| 6570 | 11.95 |
| 6571 | 11.95 |
| 6572 | 11.95 |
| 6573 | |

AVAILABLE NOW!

ONLY \$3.95
Add \$1.00 for shipping

JAPANESE TRANSISTOR SUBSTITUTION MANUAL



An invaluable Japanese to Japanese substitution guide for approximately 3000 transistors

- * Covers the 2SA, 2SD, 2SC and 2SD series
- * Introduction includes a guide to understanding Japanese transistors
- * A 90 page 8 1/2 by 11" soft cover book

PARTS PROCUREMENT PROBLEMS

FUJI-SVEA Has the Largest Inventory of Original Japanese Parts Anywhere

Seeking Original Japanese Replacement Parts for CB, TV and Stereo Repair Use?

| TYPE | 25-UP | 10-24 | 1-9 | TYPE | 25-UP | 10-24 | 1-9 | TYPE | 25-UP | 10-24 | 1-9 | TYPE | 25-UP | 10-24 | 1-9 |
|----------|-------|-------|------|----------|-------|-------|------|-----------|-------|-------|-------|-----------|-------|-------|------|
| 2SA 473 | .45 | .55 | .60 | 2SB 346 | .30 | .35 | .40 | 2SC 693F | .20 | .27 | .30 | 2SD 234 | .60 | .70 | .80 |
| 2SA 483 | 2.00 | 2.25 | 2.50 | 2SB 367 | 1.10 | 1.25 | 1.40 | 2SC 696 | 1.00 | 1.20 | 1.30 | 2SD 235 | .60 | .70 | .80 |
| 2SA 484 | 1.50 | 1.75 | 1.95 | 2SB 368B | 1.80 | 2.00 | 2.25 | 2SC 708 | 1.30 | 1.45 | 1.60 | 2SD 236 | .35 | .40 | .45 |
| 2SA 485 | 1.40 | 1.60 | 1.80 | 2SB 379 | .70 | .80 | .90 | 2SC 710 | .20 | .27 | .30 | 2SD 287 | 2.50 | 2.70 | 2.90 |
| 2SA 489 | 1.10 | 1.25 | 1.40 | 2SB 381 | .30 | .35 | .40 | 2SC 711 | .20 | .27 | .30 | 2SD 300 | 4.50 | 5.00 | 5.60 |
| 2SA 490 | .70 | .80 | .90 | 2SB 400 | .30 | .35 | .40 | 2SC 712 | .20 | .27 | .30 | 2SD 313 | .60 | .70 | .80 |
| 2SA 493 | .45 | .53 | .59 | 2SB 405 | .30 | .35 | .40 | 2SC 715 | .30 | .35 | .40 | 2SD 325 | .60 | .70 | .80 |
| 2SA 495 | .30 | .35 | .40 | 2SC 407 | .80 | .90 | 1.00 | 2SC 717 | .35 | .40 | .45 | 2SD 330 | .60 | .70 | .80 |
| 2SA 498 | .50 | .64 | .70 | 2SB 415 | .30 | .35 | .40 | 2SC 727 | 1.00 | 1.20 | 1.30 | 2SD 350 | 3.80 | 4.00 | 4.40 |
| 2SA 497 | 1.00 | 1.20 | 1.30 | 2SB 434 | .80 | .90 | 1.00 | 2SC 730 | 3.00 | 3.20 | 3.40 | 2SD 380 | 5.20 | 5.40 | 5.95 |
| 2SA 505 | .50 | .64 | .70 | 2SB 435 | .90 | 1.10 | 1.20 | 2SC 731 | 2.50 | 2.70 | 2.90 | 2SD 381 | .85 | 1.00 | 1.10 |
| 2SA 509 | .30 | .35 | .40 | 2SB 440 | .40 | .53 | .59 | 2SC 732 | .20 | .27 | .30 | 2SD 424 | 3.80 | 4.00 | 4.40 |
| 2SA 520 | .50 | .64 | .70 | 2SB 449 | 1.30 | 1.45 | 1.60 | 2SC 733 | .20 | .27 | .30 | 2SD 425 | 2.90 | 3.20 | 3.40 |
| 2SA 530 | 1.50 | 1.70 | 1.90 | 2SB 461 | .90 | 1.00 | 1.20 | 2SC 734 | .20 | .27 | .30 | 2SD 426 | 3.10 | 3.30 | 3.60 |
| 2SA 537A | 1.50 | 1.70 | 1.90 | 2SB 492 | .60 | .70 | .80 | 2SC 735 | .20 | .27 | .30 | 2SD 427 | 1.80 | 2.00 | 2.25 |
| 2SA 539 | .40 | .45 | .50 | 2SB 471 | 1.10 | 1.25 | 1.40 | 2SC 738 | .20 | .27 | .30 | 2SD 525 | .90 | 1.10 | 1.20 |
| 2SA 545 | .45 | .53 | .59 | 2SB 472 | 2.10 | 2.50 | 2.80 | 2SC 756 | 1.50 | 1.80 | 2.00 | 2SD 526 | .60 | .70 | .80 |
| 2SA 561 | .30 | .35 | .40 | 2SB 473 | .80 | .90 | 1.00 | 2SC 756A | 1.50 | 1.80 | 2.00 | 2SK 195L | 1.40 | 1.60 | 1.80 |
| 2SA 562 | .30 | .35 | .40 | 2SB 474 | .70 | .80 | .90 | 2SC 763 | .35 | .40 | .45 | 3SK 39 | .90 | 1.10 | 1.20 |
| 2SA 564 | .20 | .27 | .30 | 2SB 481 | .90 | 1.10 | 1.20 | 2SC 772 | .30 | .35 | .40 | 3SK 40 | .90 | 1.10 | 1.20 |
| 2SA 564A | .20 | .27 | .30 | 2SB 481 | .90 | 1.10 | 1.20 | 2SC 773 | .35 | .40 | .45 | 3SK 41 | 1.30 | 1.45 | 1.60 |
| 2SA 566 | 2.50 | 2.70 | 3.00 | 2SB 507 | .80 | .90 | 1.00 | 2SC 774 | 1.00 | 1.20 | 1.30 | AN 203 | 1.40 | 1.60 | 1.80 |
| 2SA 606 | 1.00 | 1.20 | 1.30 | 2SB 509 | 1.10 | 1.20 | 1.30 | 2SC 775 | 1.40 | 1.60 | 1.80 | AN 210 | 1.50 | 1.70 | 1.90 |
| 2SA 607 | 1.10 | 1.25 | 1.40 | 2SB 511 | .70 | .80 | .90 | 2SC 776 | 2.00 | 2.20 | 2.50 | AN 239 | 4.20 | 4.40 | 4.90 |
| 2SA 624 | .70 | .80 | .90 | 2SB 514 | .70 | .80 | .90 | 2SC 777 | 3.00 | 3.25 | 3.50 | AN 247 | 2.50 | 2.70 | 3.00 |
| 2SA 627 | 3.10 | 3.30 | 3.60 | 2SB 523 | .70 | .80 | .90 | 2SC 777 | 3.20 | 3.40 | 3.60 | AN 274 | 1.50 | 1.75 | 1.95 |
| 2SA 628 | .30 | .35 | .40 | 2SB 523C | .70 | .80 | .90 | 2SC 777 | 3.20 | 3.40 | 3.60 | AN 313 | 3.00 | 3.20 | 3.40 |
| 2SA 630 | .40 | .45 | .50 | 2SB 527 | .80 | 1.10 | 1.20 | 2SC 783 | 2.10 | 2.50 | 2.80 | AN 315 | 1.80 | 2.00 | 2.25 |
| 2SA 640 | .30 | .35 | .40 | 2SB 528D | .70 | .80 | .90 | 2SC 784 | .30 | .35 | .40 | BA 511A | 1.80 | 2.00 | 2.25 |
| 2SA 642 | .30 | .35 | .40 | 2SB 529 | .70 | .80 | .90 | 2SC 786 | .35 | .40 | .45 | BA 521 | 1.90 | 2.10 | 2.40 |
| 2SA 643 | .30 | .40 | .45 | 2SB 530 | 3.20 | 3.40 | 3.70 | 2SC 788 | .80 | .90 | 1.00 | HA 1151 | 1.50 | 1.75 | 1.95 |
| 2SA 653 | 1.90 | 2.10 | 2.40 | 2SB 531 | 1.80 | 2.00 | 2.25 | 2SC 791 | .80 | .90 | 1.00 | HA 1156W | 1.60 | 1.80 | 2.00 |
| 2SA 659 | .35 | .40 | .45 | 2SB 536 | 1.00 | 1.20 | 1.30 | 2SC 795 | 2.00 | 2.20 | 2.50 | HA 1306W | 2.00 | 2.20 | 2.50 |
| 2SA 661 | .50 | .64 | .70 | 2SB 537 | 1.00 | 1.20 | 1.30 | 2SC 799 | 2.00 | 2.20 | 2.50 | HA 1335A | 2.50 | 2.70 | 3.00 |
| 2SA 663 | 3.65 | 3.80 | 4.20 | 2SB 539 | 3.20 | 3.40 | 3.70 | 2SC 828 | .20 | .27 | .30 | HA 1342A | 2.50 | 2.70 | 3.00 |
| 2SA 666 | .35 | .40 | .45 | 2SB 541 | 3.20 | 3.40 | 3.70 | 2SC 829 | .20 | .27 | .30 | HA 1366W | 2.50 | 2.70 | 3.00 |
| 2SA 671 | .80 | .90 | 1.00 | 2SB 554 | 5.00 | 6.00 | 6.60 | 2SC 830H | 2.50 | 2.70 | 3.00 | HA 1366WR | 2.50 | 2.70 | 3.00 |
| 2SA 672 | .30 | .35 | .40 | 2SB 556 | 3.20 | 3.40 | 3.70 | 2SC 836 | .35 | .40 | .45 | LA 4031P | 1.80 | 2.00 | 2.25 |
| 2SA 673 | .35 | .40 | .45 | 2SB 557 | 3.20 | 3.40 | 3.70 | 2SC 839 | .30 | .35 | .40 | LA 4032P | 1.80 | 2.00 | 2.25 |
| 2SA 678 | .35 | .40 | .45 | 2SB 558 | 3.20 | 3.40 | 3.70 | 2SC 841 | .20 | .27 | .30 | LA 4051P | 3.80 | 4.00 | 4.40 |
| 2SA 679 | 4.20 | 4.40 | 4.90 | 2SB 558B | 3.20 | 3.40 | 3.70 | 2SC 843 | .70 | .80 | .90 | LA 4400 | 1.90 | 2.10 | 2.40 |
| 2SA 680 | 4.20 | 4.40 | 4.90 | 2SB 559 | 1.10 | 1.40 | 1.50 | 2SC 847 | 4.20 | 4.40 | 4.90 | LA 4400Y | 2.00 | 2.20 | 2.50 |
| 2SA 682 | .80 | .90 | 1.00 | 2SB 596 | 1.10 | 1.40 | 1.50 | 2SC 867 | 4.20 | 4.40 | 4.90 | LA 4420 | 2.00 | 2.20 | 2.50 |
| 2SA 683 | .30 | .35 | .40 | 2SB 600 | 5.00 | 6.00 | 6.60 | 2SC 870 | 4.20 | 4.40 | 4.90 | LD 3001 | 2.00 | 2.20 | 2.50 |
| 2SA 684 | .35 | .40 | .45 | 2SC 183 | .40 | .53 | .59 | 2SC 871 | .35 | .40 | .45 | SK 5151J | 2.00 | 2.20 | 2.50 |
| 2SA 695 | .40 | .53 | .59 | 2SC 184 | .45 | .53 | .59 | 2SC 895 | 4.20 | 4.40 | 4.90 | STK 013 | 7.60 | 8.00 | 8.80 |
| 2SA 697 | .40 | .53 | .59 | 2SC 185 | .45 | .53 | .59 | 2SC 897 | 2.00 | 2.20 | 2.50 | STK 015 | 4.20 | 4.40 | 4.90 |
| 2SA 699A | 50 | 64 | 70 | 2SC 281 | .30 | .35 | .40 | 2SC 898 | 2.60 | 2.70 | 3.00 | STK 435 | 4.50 | 5.00 | 5.60 |
| 2SA 705 | .40 | .53 | .59 | 2SC 282 | .40 | .53 | .59 | 2SC 900 | .20 | .27 | .30 | STK 439 | 7.90 | 8.00 | 8.80 |
| 2SA 706 | .85 | 1.00 | 1.10 | 2SC 284 | .80 | .90 | 1.00 | 2SC 923 | .20 | .27 | .30 | TA 7045M | 2.00 | 2.20 | 2.50 |
| 2SA 715 | .60 | .70 | .80 | 2SC 317 | .40 | .53 | .59 | 2SC 929 | .20 | .27 | .30 | TA 7055P | 2.00 | 2.20 | 2.50 |
| 2SA 719 | .30 | .35 | .40 | 2SC 352A | 2.00 | 2.20 | 2.50 | 2SC 930 | .20 | .27 | .30 | TA 7057P | 1.10 | 1.25 | 1.40 |
| 2SA 720 | .30 | .35 | .40 | 2SC 353A | 1.40 | 1.60 | 1.80 | 2SC 931 | .20 | .27 | .30 | TA 7203P | 2.50 | 2.70 | 2.90 |
| 2SA 721 | .30 | .35 | .40 | 2SC 354 | 1.40 | 1.60 | 1.80 | 2SC 943 | .35 | .40 | .45 | TA 7204P | 2.00 | 2.20 | 2.50 |
| 2SA 725 | .30 | .35 | .40 | 2SC 369 | .30 | .35 | .40 | 2SC 945 | .20 | .27 | .30 | TA 7205P | 1.60 | 1.80 | 2.00 |
| 2SA 726 | .30 | .35 | .40 | 2SC 370 | .20 | .27 | .30 | 2SC 959 | 1.00 | 1.20 | 1.30 | TA 7222P | 3.40 | 3.55 | 3.90 |
| 2SA 733 | .20 | .27 | .30 | 2SC 371 | .30 | .35 | .40 | 2SC 971 | .70 | .80 | .90 | TA 7310P | 1.30 | 1.45 | 1.60 |
| 2SA 738 | .40 | .53 | .59 | 2SC 372 | .20 | .27 | .30 | 2SC 982 | .70 | .80 | .90 | TBA 8105H | 1.90 | 2.10 | 2.40 |
| 2SA 740 | 1.50 | 1.70 | 1.90 | 2SC 373 | .20 | .27 | .30 | 2SC 983 | .50 | .64 | .70 | TC 5080P | 5.00 | 5.20 | 5.80 |
| 2SA 743A | .85 | 1.00 | 1.10 | 2SC 374 | .30 | .35 | .40 | 2SC 1000 | .30 | .35 | .40 | TC 5081P | 3.00 | 3.20 | 3.40 |
| 2SA 744 | 4.20 | 4.40 | 4.90 | 2SC 375 | .30 | .35 | .40 | 2SC 1012 | 1.20 | 1.40 | 1.50 | TC 5082P | 3.40 | 3.55 | 3.90 |
| 2SA 745R | 3.80 | 4.00 | 4.40 | 2SC 377 | .20 | .27 | .30 | 2SC 1013 | .50 | .64 | .70 | UHC 001 | 4.20 | 4.40 | 4.90 |
| 2SA 747 | 4.20 | 4.40 | 4.90 | 2SC 380 | .20 | .27 | .30 | 2SC 1014 | .50 | .64 | .70 | UHC 002 | 4.20 | 4.40 | 4.90 |
| 2SA 748 | .70 | .80 | .90 | 2SC 381 | .35 | .40 | .45 | 2SC 1017 | .80 | .90 | 1.00 | UHC 003 | 4.20 | 4.40 | 4.90 |
| 2SA 750 | .35 | .40 | .45 | 2SC 382 | .35 | .40 | .45 | 2SC 1018 | .60 | .70 | .80 | UHC 004 | 4.20 | 4.40 | 4.90 |
| 2SA 755 | .80 | .90 | 1.00 | 2SC 383 | .35 | .40 | .45 | 2SC 1030 | 1.80 | 2.10 | 2.40 | UHC 005 | 4.20 | 4.40 | 4.90 |
| 2SA 756 | 2.30 | 2.40 | 2.65 | 2SC 387A | .35 | .40 | .45 | 2SC 1047 | .35 | .40 | .45 | UPC 20C | 2.10 | 2.50 | 2.80 |
| 2SA 758 | 3.40 | 3.55 | 3.90 | 2SC 388A | .40 | .53 | .59 | 2SC 1051 | 3.40 | 3.55 | 3.90 | UPC 253 | 1.90 | 2.10 | 2.40 |
| 2SA 764 | 3.80 | 4.00 | 4.40 | 2SC 394 | .30 | .35 | .40 | 2SC 1060 | .70 | .80 | .90 | UPC 35C2 | 1.30 | 1.45 | 1.60 |
| 2SA 765 | 3.10 | 3.30 | 3.60 | 2SC 403 | .30 | .35 | .40 | 2SC 1061 | .70 | .80 | .90 | UPC 576 | 1.90 | 2.10 | 2.40 |
| 2SA 774 | .40 | .45 | .50 | 2SC 430 | .50 | .64 | .70 | 2SC 1076 | 30.00 | 35.00 | 39.00 | UPC 592H | .70 | .80 | .90 |
| 2SA 777 | .50 | .64 | .70 | 2SC 434 | .20 | .27 | .30 | 2SC 1079 | 3.40 | 3.55 | 3.90 | UPC 1001H | 1.90 | 2.10 | 2.40 |
| 2SA 794A | .60 | .70 | .80 | 2SC 458 | .20 | .27 | .30 | 2SC 1080 | 3.40 | 3.55 | 3.90 | UPC 1008C | 4.20 | 4.40 | 4.90 |
| 2SA 798 | .50 | .55 | .60 | 2SC 460 | .35 | .40 | .45 | 2SC 1096 | .45 | .55 | .60 | UPC 1025 | 1.90 | 2.10 | 2.40 |
| 2SA 814 | .70 | .80 | .90 | 2SC 461 | .35 | .40 | .45 | 2SC 1098 | .50 | .64 | .70 | UPC 1154 | 2.00 | 2.20 | 2.50 |
| 2SA 815 | .60 | .70 | .80 | 2SC 478 | .60 | .70 | .80 | 2SC 1111 | 2.10 | 2.50 | 2.80 | UPC 1155 | 2.00 | 2.20 | 2.50 |
| 2SA 816 | .50 | .64 | .70 | 2SC 481 | 3.80 | 4.00 | 4.40 | 2SC 1114 | 4.20 | 4.40 | 4.90 | UPC 1156 | 1.90 | 2.10 | 2.40 |
| 2SA 818 | .70 | .80 | .90 | 2SC 482 | 1.10 | 1.25 | 1.40 | 2SC 1115 | 2.50 | 2.70 | 3.00 | UPD 861 | 8.00 | 8.40 | 9.50 |
| 2SA 837R | 2.50 | 2.70 | 2.90 | 2SC 484 | 1.30 | 1.40 | 1.50 | 2SC 1116 | 3.20 | 3.40 | 3.70 | UPD 857 | 8.00 | 8.40 | 9.50 |
| 2SA 839T | 1.30 | 1.45 | 1.60 | 2SC 485 | 1.30 | 1.40 | 1.50 | 2SC 1116A | 3.40 | 3.55 | 3.90 | UPD 858 | | | |

100W CLASS A POWER AMP KIT

Dynamic Bias Class "A" circuit design makes this unit unique in its class. Crystal clear, 100 watts power output will satisfy the most picky fans. A perfect combination with the TA-1020 low T.I.M. stereo pre-amp.

Specifications:

- Output power: 100W RMS into 8-ohm 125W RMS into 4-ohm
- Frequency response: 10Hz - 100 KHz
- T.H.D.: less than 0.008%
- S/N ratio: better than 80dB
- Input sensitivity: 1V max.
- Power supply: $\pm 40V @ 5 amp$



TA-1000 KIT \$51.95
Power transformer \$15.00 each

PROFESSIONAL 10 OCTAVE STEREO GRAPHIC EQUALIZER!!



Graphic equalizer have been used for years in sound studios and concert arenas but were too expensive to be considered for home use. Now we offer you the facility at an affordable price. This unit can extend your control of your Hi-Fi system by minimizing the non-linearities of the combined speaker/room system. Fantastic features as follows:

- 10 double slide controls for two channels
- Cut out rumble, surface noise and hiss
- Minimizes speaker/room non-linearities
- Frequency response from 30Hz to 16KHz
- 10 tone controls plus defeat, monitor and tape selector.
- Control range $\pm 12dB$ in 10 octaves (30Hz, 60Hz, 120Hz, 240Hz, 500Hz, 1KHz, 2KHz, 4KHz, 8KHz, 16KHz.)
- Operating voltage 117V 50/60Hz.

FACTORY ASSEMBLED UNIT, NOT A KIT
SPECIAL PRICE \$117.00 ea

SUB MINI SIZE FET CONDENSER MICROPHONE



Specification:

Sensitivity: $-65dB \pm 3db$
FEQ. Response: 50 Hz 8 KHz
Output Impedance: 1K ohm max.
Polar Pattern: Omni-directional
Power Supply: 1.5V 10V D.C.
Sound Pressure Level: Max. 120dB
EMARP \$2.50 ea. or 2 for \$4.50

NEW MARK III 9 Steps 4 Colors LED VU

Stereo level indicator kit with arc-shape display panel!!! This Mark III LED level indicator is a new design PC board with an arc-shape 4 colors LED display (change color from red, yellow, green and the peak output indicated by rose). The power range is very large, from $-30dB$ to $+5dB$. The Mark III indicator is applicable to 1 watt - 200 watts amplifier operating voltage is 3V - 9V DC at max 400 MA. The circuit uses 10 LEDs per channel. It is very easy to connect to the amplifier. Just hook up with the speaker output!

IN KIT FORM \$18.50

SOUND ACTIVATED DISCO LIGHT KIT

Latest design electronic color light organ, with both sound and line input, the three color lights (not included) will change colors with the rhythm of the music; controlled by 3 ranges, low, middle and high. Ideal for party, bar, or home entertainment. Max. controlled output 1000 watts per color (3 colors). Kit includes aluminum cabinet, all electronic parts, P.C. board and transformer.

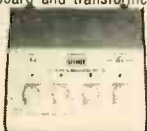

(Color Organ)
\$45.50 per kit

TY-23

MARK IV 15 STEPS LED POWER LEVEL INDICATOR KIT

This new stereo level indicator kit consists of 36 4-color LED (15 per channel) to indicate the sound level output of your amplifier from $-36dB$ to $+3dB$. Comes with a well-designed silk screen printed plastic panel and has a selector switch to allow floating or gradual output indicating. Power supply is 6V ~ 12V D.C. with THG on board input sensitivity controls. This unit can work with any amplifier from 1W to 200W!

Kit includes 70 pcs. driver transistors, 38 pcs. matched 4-color LED, all other electronic components, PC board and front panel.



MARK IV KIT \$31.50

30W + 30W STEREO HYBRID AMPLIFIER KIT

It works in 12V DC as well! Kit includes 1 PC SANYO STK-043 stereo power amp. IC LM 1458 as pre amp, all other electronic parts, PC Board, all control pots and special heat sink for hybrid. Power transformer not included. It produces ultra hi-fi output up to 60 watts (30 watts per channel) yet gives out less than 0.1% total harmonic distortion between 100mz and 10KHz.



\$32.50 PER KIT

BATTERY POWERED FLOURESCENT LANTERN

MODEL 888 R

FEATURES

- Circuitry: designed for operation by high efficient, high power silicon transistor which enable illumination maintain in a standard level even the battery supply drops to a certain low voltage.
- 9" 6W cool/daylight miniature fluorescent tube.
- 8 x 1.5V UM-1 (size D) dry cell battery.
- Easy sliding door for changing batteries.
- Stainless reflector with wide angle increasing lumination of the lantern.

\$10.50 EA

STEREO AMPLIFIER



60 W
+
60 W

COMPLETED UNIT - NOT A KIT!

OCL pre amp. & power stereo amp. with bass, middle, treble 3-way tone control. Fully assembled and tested, ready to work. Total harmonic distortion less than 0.5% at full power. Output maximum is 60 watts per channel at 8 Ω . Power supply is 24 - 36V AC or DC. Complete unit. Assembled \$49.50 ea. Power transformer \$ 8.50 ea.

5W AUDIO AMP KIT

2 LM 380 with Volume Control

Power Suply 6 18V DC

ONLY \$6.00 EACH

PROFESSIONAL PANEL METERS



Type MU-52E

- | | |
|-------------|----------|
| A. 0-50UA | 8.50 ea. |
| B. 0-30VDC | 8.50 ea. |
| C. 0-50VDC | 8.50 ea. |
| D. 0-3ADC | 9.00 ea. |
| E. 0-100VDC | 9.00 ea. |

All meters white face with black scales. Plastic cover.

SPECIAL 0.5" LED ALARM CLOCK MODULE SALE

ASSEMBLED! NOT A KIT!

Features: • 4 digits 0.5" LED Displays • 12 hours real time format • 24 hours alarm audio output • 59 min. countdown timer • 10 min. snooze control.

ONLY \$7.00 EACH

SPECIAL TRANSFORMER FOR CLOCK (FREE)



DIGITAL AUTO SECURITY SYSTEM

4 DIGITS PERSONAL CODE!!

SPECIAL \$19.95



- proximity triggered
- voltage triggered
- mechanically triggered

This alarm protects you and itself! Entering protected area will set it off, sounding your car horn or siren you add. Any change in voltage will also trigger the alarm into action. If cables within passenger compartment are cut, the unit protects itself by sounding the alarm.

3-WAY PROTECTION!

All units factory assembled and tested - Not a kit!

A NEW LED ARRAY AND DRIVER FOR LEVEL METERS

This series covers a wide range of level indication uses, output and input voltage, time related change, temperature, light measurement and sound level. The problem of uneven brilliance often encountered with LED arrangements as well as design problems caused by using several units of varying size are substantially reduced. 12 LEDs in one bar:

LED ARRAY

| | |
|------------------------------|--------|
| GL-112R3 Red, Red, Red | \$5.50 |
| GL-112N3 Green, Yellow, Red | \$6.50 |
| GL-112M2 Green, Green, Red | \$6.50 |
| GL-112G3 Green, Green, Green | \$6.50 |



2.28"

LED DRIVERS

1R 2406G is an I.C. specially designed to drive 12 LED. The number of LED is lineally illuminated according to the control voltage input terminal 21. Operating voltage is 9 12V D.C. \$5.35 EACH

DUOEL CHANNEL VU METER

P.C. BOARD AVAILABLE AT \$4.50 EA.

PROFESSIONAL FM WIRELESS MICROPHONE

TECT model WEM-16 is a factory assembled FM wireless microphone powered by an AA size battery. Transmits in the range of 88-108MHz with 3 transistor circuits and an omni-directional electric condenser. Element built-in plastic tube type case; mike is 6 1/4" long. With a standard FM radio, can be heard anywhere on a one-acre lot; sound quality was judged very good.

\$16.50

FLASHER LED

Unique design combines a jumbo red LED with an IC flasher chip in one package. Operates directly from 5V-7V DC. No dropping resistor needed. Pulse rate 3Hz @ 5V 20mA.

2 for \$2.20

BIPOLAR LED RED/GREEN

2 colors in one LED, green and red, changes color when reverse voltage supply. Amazing!

2 FOR \$1.60

LCD CLOCK MODULE!

• 0.5" LCD 4 digits display • X'tal controlled circuits • D.C. powered (1.5V battery) • 12 hr. or 24 hr. display • 24 hr. alarm set • 60 min. countdown timer • On board dual back-up lights • Dual time zone display • Stop watch function.

NIC1200 (12 hr) \$24.50 EA.
NIC2400 (24 hr) \$26.50 EA.



WANT TO BUILD YOUR OWN BLACK MAGIC BOX ON TOP OF THE TV FOR FIRST RUN MOVIES?

We have all the parts including hard to find UHF variator tuners and P.C. board. Call us for more information.

FLUORESCENT LIGHT DRIVER KIT



With Case Only
\$6.50 Per Kit

12V DC POWERED
Lights up 8 ~ 15 Watt Fluorescent Light Tubes. Ideal for camper, outdoor, auto or boat. Kit includes high voltage coil, power transistor, heat sink, all other electronic parts and PC Board, light tube not included!

SUPER FM WIRELESS MIC KIT — MARK III



FMC-105
\$11.50 PER KIT

This new designed circuit uses high FEQ. FET transistors with 2 stages pre amp. Transmits FM Range (88-120 MHz) up to 2 blocks away and with the ultra sensitive condenser microphone that comes with the kit, allows you to pick up any sound within 15 ft. away! Kit includes all electronic parts, OSC coils, and P.C. Board. Power supply 9V D.C.

PRESS-A-LIGHT SELF GENERATED FLASHLIGHT

EXCLUSIVE!! \$3.95 ea
Model F-179



Never worry about battery, because it has none! Easy to carry in pocket and handy to use. Ideal for emergency light. It generates its own electricity by squeezing grip lever. Put one in your car, boat, camper or home. You may need it some time!

ELECTRONIC DUAL SPEAKER PROTECTOR



Cut off when circuit is shorted or over load to protect your amplifier as well as your speakers. A must for OCL circuits.

KIT FORM
\$8.75 EA.

"FISHER" 30 WATT STEREO AMP



Super Buy
Only \$18.50

MAIN AMP (15W x 2)
Kit includes 2 pcs. Fisher PA 301 Hybrid IC all electronic parts with PC Board. Power supply ± 16V DC (not included). Power band with (KF 1% ± 3dB). Voltage gain 33dB. 20Hz - 20KHz.

UNIVERSAL PROJECT BOARD

All P.C. boards are made from high quality phenolic, predrilled in different patterns for different purpose. All boards 1/16" single sided copper. Hole spacing is standard 0.1". Fits all kinds of I.C. transistors, capacitors and resistors. Ideal for school projects, engineering designs and prototyping.



SB072



BEL-008



M-34



BEL101

BEL202

| | | |
|-------------|-----------------|------------|
| BEL101 | 3 1/2" x 6" | \$1.75 EA. |
| SB072 | 3 1/2" x 6" | \$1.75 EA. |
| M-34 | 3" x 5" | \$1.75 EA. |
| CIRCUIT FIT | 3" x 3 1/2" | \$1.25 EA. |
| BEL202 | 3" x 4" | \$1.25 EA. |
| BEL-008 | 2 1/4" x 5 1/2" | \$1.25 EA. |

PUSH-BUTTON SWITCH



N/Open Contact
Color: Red, White, Blue, Green, Black
3/\$1.00

N/Close also Available
50¢ each
LARGE QTY. AVAILABLE



HEAVY DUTY CLIP LEADS

10 pairs — 5 colors Alligator clips on a 22" long lead. Ideal for any testing.

\$2.20/pack

BATTERIES

PK/\$10.00
2 PK/\$19.00
ILLUSTRATED
LESS COVER



NICKEL CADMIUM
BATTERY
PACK
'D' SIZE

Output: 3.6 Volts @ 3.0 Amp/Hour. Consists of three each 1.2 Volt "D" size Nickel Cadmium Cells stacked and plastic film encapsulated. Tabs are provided at each end for electrical connections. The individual cells can be cut apart if desired. Rated recharge rate is 30 mA, 14-18 hours. Size: 1 1/4" dia. x 7" long. New. Shpg. Wt. each pack, 1 lb.

"C" SIZE BATTERY PACK



10 C size ni-cd battery in dng pack, gives out 12.5V D.C. 1.8 amp per hour. All fresh code, pull-out from movie cameras. Can be disconnected to use as single c cells. Hard to find \$15.00 per pack of 10 batteries

ELECTRONIC ALARM SIREN



AU-999 \$7.50

COMPLETE UNIT
Ideal for use as an Alarm Unit or hookup to your car back-up to make a reverse indicator. Light Output up to 130dB. Voltage supply 6 12V

SUB MINIATURE TOGGLE SWITCH

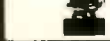

SPST 2 FOR 2.80 SPDT 2 FOR 3.20
6 AMP 125V AC CONTACT



TRANSFORMERS

ALL 117 VOLT INPUT

| | | |
|--------|---------|-------------|
| 30V | 4 AMP | \$8.50 EA. |
| 36V CT | 3 AMP | \$10.50 EA. |
| 48V CT | 3 AMP | \$10.50 EA. |
| 24V CT | 0.5 AMP | \$3.00 EA. |
| 18V CT | 0.5 AMP | \$3.00 EA. |
| 12V CT | 0.5 AMP | \$2.50 EA. |
| 6.3V | 0.5 AMP | \$2.00 EA. |



AC POWER SUPPLY

Wall Type Transformer

| | | |
|-----------|---------------|------------|
| 12V AC | Output 200 MA | \$2.75 EA. |
| 16V CT AC | Output 100 MA | \$2.10 EA. |
| 6V DC | Output 120 MA | \$1.90 EA. |
| 12V DC | Output 100 MA | \$1.90 EA. |



ULTRASONIC SWITCH KIT

Kit includes the Ultra Sonic Transducers, 2 PC Boards for transmitter and receiver. All electronic parts and instructions. Easy to build and a lot of uses such as remote control for TV, garage door, alarm system or counter. Unit operates by 9-12 DC. \$15.50

COMPLETE TIME MODULE



0.3" digits LCD Clock Module with month and date, hour, minute and seconds. As well as stop watch function!! Battery and back up light is with the module. Size of the module is 1" dia. Ideal for use in auto panel, computer, instrument and many others! \$8.95 EACH

SOUND ACTIVATED SWITCH



\$1.75 ea.

All parts completed on a PC Board SCR will turn on relay, buzzer or trigger other circuit for 2 - 10 sec. (adjustable). Ideal for use as door alarm, sound controlled toys and many other projects. Supply voltage 4.5V 9V D.C. 2 for \$3.00

FM WIRELESS MIC KIT



It is not a pack of cigarettes. It is a new FM wireless mic kit! New design PC board fits into a plastic cigarette box (case included). Uses a condenser microphone to allow you to have a better response in sound pick-up. Transmits up to 350 ft.! With an LED indicator to signal the unit is on #FMM2 KIT FORM \$7.95

REGULATED DUAL VOLTAGE SUPPLY KIT

±4 30V DC 800 MA adjustable, fully regulated by Fairchild 78MG and 79MG voltage regulator I.C. Kit includes all electronic parts, filter capacitors, I.C., heat sinks and P.C. board.

\$12.50 PER KIT

AA SIZE NI-CD SPECIAL SALE

RECHARGEABLE BATTERIES
LIMITED QUANTITY AVAILABLE

POCKET SIZE AM-FM RADIO TR-945 with LED TUNING EYE

New design body with see thru speaker grill.
SPECIAL PRICE \$16.50 EACH



TR-945

POWER SUPPLY KIT

0-30V D.C. REGULATED
Uses UA723 and ZN3055 Power TR output can be adjusted from 0-30V, 2 AMP. Complete with PC board and all electronic parts. Transformer for Power Supply. 2 AMP 24V x 2 \$8.50

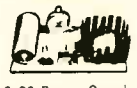

0-30 Power Supply
\$10.50 each

I.C. TEST CLIPS

Same as the E-Z clips \$2.75
With 20" Long Leads \$2.50 EA.
In Black and Red Colors per pair



SOUND GENERATOR I.C.

Creates almost any type of sound — gun shot, explosion, train, car crash, star war, birds, organ ext. A built-in audio amplifier provides high level output. Operates from one 9V battery, 28 pin dip; we supply the datas. \$2.90 EACH



ELECTRONIC SWITCH KIT

CONDENSER TYPE
Touch On Touch Off
uses 7473 I.C. and 12V relay
\$5.50 each



1 WATT AUDIO AMP

All parts are pre-assembled on a mini PC Board. Supply Voltage 6 9V D.C. SPECIAL PRICE \$1.95 ea.



LOW TIM DC STEREO PRE-AMP KIT TA-10 20

Incorporates brand-new D.C. design that gives a frequency response from 0Hz — 100KHz ± 0.5dB! Added features like tone defeat and loudness control let you tailor your own frequency supplies to eliminate power fluctuation!
Specifications: • T.H.D. less than .005% • T.I.M. less than .005% • Frequency response: DC to 100KHz ± 0.5dB • RIAA deviation: ± 0.2dB • S/N ratio: better than 70dB • Sensitivity: Phono 2MV 47K/Aux. 100MV 100K • Output level: 1.3V • Max. output: 15V • Tone control: bass ± 10dB @ 50Hz/treble ± 10dB @ 15Hz • Power supply: ± 24 D.C. @ 0.5A
Kit comes with regulated power supply, all you need is a 48V C.T. transformer @ 0.5A.

ONLY \$44.50
X'former \$4.50 ea.



SOLID STATE ELECTRONIC BUZZER

Mini size 1" x 3/4" x 3/4"
Supply voltage 1.5V - 12V
Ideal for Alarm or Tone Indicator



\$1.50 each



FORMULA INTERNATIONAL INC.

SHIPPING AND HANDLING CHARGES
Under \$50.00 purchase 1.00
Over \$50.00 purchase 1.50
Outside Calif. (includes Mexico & Canada) 1.75
Outside Calif. (includes Mexico & Canada) 2.00
Minimum Order \$18.00/Calif. Residents Add 6% Sales Tax
Phone Orders Accepted on Visa or MC ONLY. NO C.O.D. Store Hours 10-7 Mon. thru Sat.
12603 CRENSHAW BLVD., HAWTHORNE, CA 90250
PHONE: (213) 973-1921 • (213) 678-5182

7/80
Send \$1.00
For Detailed
Catalogue

SOUND EFFECTS GENERATOR BASIC KIT

Now Chaney Electronics makes it possible to build your own sound effects generator without spending a fortune. We supply you with the 1176477 sound chip plus an etched and drilled glass epoxy PC board with schematic and layout instructions. This board makes it simple to build a generator capable of whizzer sounds, locomotive, sirens, airplanes, clocks, etc. Does not require DIP switches or other expensive/unusual components. You supply only a few standard resistors, capacitors, switches, pots, speaker, 2N2222 transistor and 9V battery.

BASIC KIT CONTAINING:
1176477, PC BOARD AND INSTRUCTIONS ONLY \$5.95

2N2222 TRANSISTOR FOR ABOVE \$2.95 EA.
IF YOU HAVE ALREADY PURCHASED THE 1176477 CHIP YOU MAY BUY THE PC BOARD AND INSTRUCTIONS ONLY. C23685 \$4.00

Strobe Tube & Trigger C23681 \$1.75

6VDC Xenon Flasher Kit C23682 \$8.00

120 VAC Xenon Strobe Kit C23683 \$7.50

HIGH OUTPUT SILICON SOLAR CELLS

WE NOW STOCK A FULL LINE OF THESE HARD TO FIND CELLS WHICH CONVERT LIGHT DIRECTLY INTO ELECTRICITY. EACH CELL GENERATES APPROXIMATELY .45 VOLT AND GENERATES CURRENT AS SHOWN BELOW. CONNECT CELLS IN SERIES FOR MORE VOLTAGE AND CONNECT CELLS IN PARALLEL FOR MORE CURRENT. MANY OTHER TYPES ARE LISTED IN OUR CATALOG!

| SIZE | CURRENT | STOCK # | PRICE |
|---------------|---------|---------|---------|
| 2" 1/4 CELL | 100mA | C24154 | \$1.75 |
| 2" 1/2 CELL | 250mA | C24155 | \$2.00 |
| 2" WHOLE CELL | 500mA | C24156 | \$5.50 |
| 3" 1/3 CELL | 300mA | C24157 | \$3.25 |
| 3" 1/2 CELL | 500mA | C24158 | \$5.50 |
| 3" WHOLE CELL | 750mA | C24159 | \$8.50 |
| 4" WHOLE CELL | 1.3 AMP | C24160 | \$10.00 |

RECHARGEABLE AA NIKADS
USED-EXCELLENT CONDITION C24161 79¢

CHANEY electronics inc.

* Minimum order \$5.00
* Please include \$1.00 for postage
* Visa, MC and COD accepted
* Phone orders are welcome

P.O. BOX 27038, DENVER, CO. 80227 (303) 781-5750

Send for our free giant catalog of unique items!!!

CIRCLE 25 ON FREE INFORMATION CARD

LONG PLAY 10 HOUR TAPE RECORDER

Top quality AC-DC cassette recorder, modified to provide 5 continuous hours of recording and playback of true fidelity, distortion-free sound on each side of cassette for a total of 10 hours. Unit has many special built-in features. TDK D-C180 cassette supplied.

ONLY \$125.00*

PHONE RECORDING ADAPTER

Record incoming and outgoing calls automatically with this all solid state unit connected to your telephone jack and tape recorder. Starts recording when phone is lifted. Stops when you hang up, making a permanent record. Easily installed. No monthly charges.

FCC APPROVED \$24.50*

VOX VOICE ACTIVATED CONTROL SWITCH

Solid state. Self contained. Excellent adjustable sensitivity. Voices or other sounds activate and control recorder. Uses recorder mike or remote mike.

2 1/4 x 1 3/4 x 3/4" \$24.95*

Phone call Adapter \$24.50*, VOX \$24.95* (* plus \$1.00 ea. shipping & handling), 10 hr. Recorder \$125.00* (* plus \$4.00 shipping & handling). California residents add tax. Mail Order, VISA, M/C, cod's okay, quantity discounts available. Money back guar. Free data.

AMC SALES, Dept. 19 9335 Lubec St., Box 928
Downey, CA 90241, Phone (213) 869-8519

CIRCLE 27 ON FREE INFORMATION CARD

...ON H8 MEMORY

Limited quantity: 32K static RAM, kit form
With all parts, documentation, mounting bracket, etc. Includes solder masked, fully legended board for easy soldering. 32K kit: \$549

THE ENHANCED/ADVANCED Z-80A S-100 CPU BOARD

Superior design in an IEEE-compatible board gives the power for future expansion as well as system flexibility. Includes all standard Z-80A features along with power on jump/clear, on-board fully maskable interrupts for Interrupt-driven systems, selectable automatic wait state insertion, provision for adding up to 8K of on-board EROM, 4 MHz operation, IEEE compatible 16/24 bit extended addressing. \$225 unkit*, \$295 assm, \$395 CSC**.

NEW! S-100 DUAL PROCESSOR CPU BOARD

The Dual Processor Board is here... and CPU boards will never be the same again. 8088 CPU gives true 16 bit power with a standard 8 bit S-100 bus; an 8085 gives compatibility with CPM and 8080 software. Accesses up to 16 megabytes of memory, meets IEEE S-100 bus specs, runs 8085 and 8086 code in your existing mainframe as well as Microsoft 8086 BASIC and Sorcim PASCAL/M™, and runs at 5 MHz for speed as well as power. Introductory prices: \$385 unkit*, \$495 assm, \$595 CSC**.

*sockets, bypass caps pre-soldered in place for easy assembly
**qualified under our high-reliability Certified System Component program.

TERMS: Cal res add tax. Allow 5% for shipping, excess refunded. VISA*/Mastercard* orders (\$25 min) call (415) 562-0636, 24 hrs. COD OK with street address for UPS. Prices good through cover month of magazine.

GODBOUT

GODBOUT ELECTRONICS
Bldg. 725, Oakland Airport, CA 94614

CIRCLE 33 ON FREE INFORMATION CARD

BULLET ELECTRONICS

P.O. Box 401244R
Garland TX 75040

NPN HIGH VOLTAGE 1.59

VCEO = 450 VDC IC = 3A (5A Peak)
FOR TV HORIZONTAL SECTIONS: HIGH VOLTAGE REGULATORS
REPLACES: 2N5076, 2N5077, 2N5838, 2N5665, BDY94, BU126, 2SC2121, 2N5840, 2SC1046, 2N5466, TIP556 AND MANY OTHERS.

| | | |
|-----------|---------------------------|--------|
| LM3046 | (CA3046) Transistor Array | .75 |
| RCA 40430 | 400V 6A TRIAC TO-66 | .75 |
| CA3086 | RCA Transistor Array | .80 |
| LM567 | Tone Decoder | .99 |
| CD4046 | PLL CMOS | .99 |
| LM3302 | Quad Comparator | .89 |
| 2SC1849 | High Freq NPN TO-92 | 6/1.00 |
| MPS A20 | NPN GEN PUR | 8/1.00 |

Sound Effects Kit 17.50

The SE-01 is a complete kit that contains all the parts to build a programmable sound effects generator. Designed around the new Texas Instruments SN76477 Sound Chip, the board provides banks of MINI DIP switches and pots to program the various combinations of the SLF Oscillator, VCO, Noise, One Shot, and Envelope Controls. A Quad Op Amp IC is used to implement an Adjustable Pulse Generator, Level Comparator and Multiplex Oscillator for even more versatility. The SE-01 PC Board features a prototype area to allow for user added circuitry. Easily programmed to duplicate Explosions, Phaser Guns, Steam Trains, or almost an infinite number of other sounds. The unit has a multiple of applications. The low price includes all parts, assembly manual, programming charts, and detailed 76477 chip specifications. It runs on a 9V battery (not included). On board 1000mA amp will drive a small speaker directly, or the unit can be connected to your stereo with incredible results! (Speaker not included).

* 76477 CHIP IS INCLUDED. EXTRA CHIPS 3.10 EACH
* \$17.50 LESS SPEAKER & BATTERY

AY3-8910 PROGRAMMABLE SOUND GENERATOR

The AY3-8910 is a 40 pin LSI chip with three oscillators, three amplitude controls, programmable noise generator, three mixers, an envelope generator, and three D/A converters that are controlled by 8 BIT WORDS. No external pots or caps required. This chip hooked to an 8 bit microprocessor chip or Buss (8080, Z80, 6800 etc.) can be software controlled to produce almost any sound. It will play three note chords, make bangs, whistles, sirens, gunshots, explosions, bleets, whines, or grunts. In addition, it has provisions to control its own memory chips with two IO ports. The chip requires +5V @ 75ma and a standard TTL clock oscillator. A truly incredible circuit.

\$14.95 W/Basic Spec Sheet (4 pages)
60 page manual with S-100 interface instructions and several programming examples, \$3.00 extra.

1/2W RESISTOR ASSORTMENT

A good mix of 5% and 10% values in both full lead and PC lead devices. All new, first quality.

(Ass't) 200 pieces/2.00

7 WATT AUDIO AMP KIT

SMALL SINGLE HYBRID IC AND COMPONENTS FIT ON A 2" x 3" PC BOARD (INCLUDED) RUNS ON 12VDC GREAT FOR ANY PROJECT THAT NEEDS AN INEXPENSIVE AMP. LESS THAN 3% THD @ 5 WATTS. COMPATIBLE WITH SE-01 SOUND KIT. \$5.95

ULTRASONIC RELAY KIT

INVISIBLE BEAM WORKS LIKE A PHOTO ELECTRIC EYE. USE UP TO 25 FT. APART. COMPLETE KIT. ALL PARTS & PC BOARDS. \$21.50

THE PERFECT TRANSFORMER

117VAC primary. 12VAC secondary @ 200ma
Great for all you CMOS, or low power TTL projects. PC board mount. 99¢ ea. 3/\$2.50
Size: 1.5" W x 1.25" D x 1.25" H

XAN SUPER DIGITS

.6" JUMBO LED RED .99 7 SEGMENT

6920 COMMON CATHODE
6640 COMMON ANODE

NO A SUPER READOUT AT A SUPER BUY! These are factory fresh prime LED readouts, not seconds or rejects as sold by others. Compare our price and send for yours today, but hurry, the supply is limited!
SPECIFY: COMMON ANODE OR COMMON CATHODE

TUNES SYNTHESIZER

The AY3-1350 is a MOS microcomputer synthesizer of pre-programmed tunes for applications in toys, music boxes, and door chimes. The standard device has a set of 25 different popular and classical tunes. In addition there are 3 chimes making a total of 25 tunes.

FEATURES

- Minimal external components
- Automatic switch-off signal at end of tune for power saving
- Envelope control to give organ or piano quality
- Sequential tune mode
- 4 door capability when used as door chime
- Operation with tunes in external PROM if required (2708)
- Single supply (+5V) Operation
- Tunes include: STAR WARS, BEETHOVEN'S 9th & 5th, JINGLE BELLS, YANKEE DOODLE, STAR SPANGLED BANNER, CLEMENTINE, GOD SAVE THE QUEEN, O SOLE MIO, WEST MINISTER AND DESCENDING OCTAVE CHIME PLUS MANY MORE!

WITH DETAILED SPECS AND INSTRUCTIONS \$14.50

PARTS

| | | |
|---------|-----------------------------|--------|
| TL490 | Bar/Graph Driver | 2.50 |
| 7805 | 5V 1A Regulator | .99 |
| 78M05 | 1/2 A TO-5 Reg. 5V (Hse. #) | .60 |
| LM3911 | Temp. Transducer | 1.10 |
| 555 | Timer IC | .49 |
| 723 | Voltage Reg. 14 Pin Dip | .50 |
| 7812 | 1A 12V Reg. | .99 |
| 2N6028 | P.U.T. W/Specs | .50 |
| IL-1 | Opto Isolator W/Specs | .60 |
| LM380 | 2W Audio IC W/Specs | .50 |
| LM377 | Dual LM380 W/Specs | 1.09 |
| TIP-30 | PNP Power TO-220 | 3/1.00 |
| TIP-31B | NPN Comp. to TIP-30 (Hse #) | 3/1.00 |

* NO C.O.D.'s
* SEND CHECK M.O. OR CHARGE CARD NO
* PHONE ORDERS ACCEPTED ON VISA AND MASTERCARD ONLY. (214) 278-3553
* ADD 5% FOR SHIPPING
* TX. RES. ADD 5% STATE SALES TAX
* FOREIGN ORDERS ADD 10% (EXCEPT CANADA) (20% AIRMAIL) U.S. FUNDS ONLY.
catalog free on request

TEST EQUIPMENT, TOOLS, TELEPHONE DEVICES, AUTO STEREO PRODUCTS

FREE 8 pc. Tool Set (value \$14.95) with \$200.00 purchase of merchandise from this ad

Logic Probe

- Compact circuit powered
- Detects pulses as short as 50 μ sec
- DTL TTL HTL CMOS compatibility

\$44.95



Model LP-1

100 MHz 8-Digit Counter

- 20 Hz to 100 MHz range
- LED display
- Fully automatic

Model MAX100

\$127.50

Preassembled Proto Boards

- Fully assembled breadboard contains four QT-59S sockets, seven QT-59B bus strips and four 5-way binding posts

Model PB-104

\$49.95

Function Generator

- Model 2001
- Reg. \$185.95
- 5 sine, square, triangle, and separate TTL square wave output



\$157.95

Proto Board with Built-in Power Supplies

- Regulated
- Short-proof

Reg. \$154.95

\$129.95



Model PB-203A

3 1/2-Digit 0.1% Digital Capacitance Meter

- 9 ranges from 1999 pF to 199.9 μ F
- 0.1% of reading accuracy
- Auto over and under range indication



Model 3001

Reg. \$190.00

\$170

Portable Digital Capacitance Meter

- Measures capacitance from 0.1 pF to 1 Farad
- Resolves to 0.1 pF
- 10 ranges for accuracy and resolution
- 4 digit easy-to-read LED display
- 0.5% accuracy



Model 820

3 1/2-Digit DMM with LCD Readout

- 0.1% DC accuracy
- 0.5" LCD display for high readability
- 100 μ A current range
- 100 μ V, 100 nA, 0.01 Ω resolution
- Battery life of over 100 hours
- Shielded to stay accurate in RF fields
- Low battery warning

Model 2815



Model 820

Dual Trace 5" 30 MHz Triggered Scope

- Rise time 11.7 nS or less
- Built-in signal delay line
- Flat response with smooth rolloff past 30 MHz
- 5mV/cm vertical sensitivity
- Probes included

Call for Discount Prices

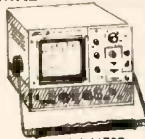

Model 1479P

DIGITAL MULTIMETERS



Sinclair PDM 35
Reg. \$69.95
\$49.95

Hickok LX 303
\$69.50



Beckman TECH 310
22 M Ω input resistance
10 Amp AC DC
1500V Overload
6KV Transient Protection
2 year battery life
\$140.



Simpson 461
Complete with nickel-cadmium batteries, AC charger adapter, test leads
\$149.95

LEADER



RF Wide Band Signal Generator Model LSG-16
Solid state FET oscillator circuitry
100 kHz to 100 MHz freq. range
300 MHz on harmonics

Transistorized LCR Bridge

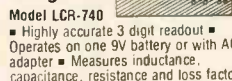

Model LCR-740

Highly accurate 3 digit readout
Operates on one 9V battery or with AC adapter
Measures inductance, capacitance, resistance and loss factor.

25 MHz Dual Trace Time Base



with Calibrated Variable Delay

Model LBD-515A with probes
1 μ sec to 5 sec built-in delay

20 MHz Dual Trace Oscilloscope

Model LBD-508A with probes
Call for Discount Prices

TECHNICIAN AIDS

Weller Xcelite

Attache Style

Model TC100 ST
Reg. \$471
\$299.95

Service Master

Model 99-SM
Reg. \$69.95
\$49.95

EDSYN SOLDAPULL[®] Desoldering Tool

Model DS017
\$16.95



Model 7800

Model 5800

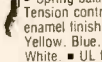
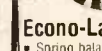

CORDLESS SOLDERING IRON

Model 60
\$29.95

Thermal-Spot Circuit Tester

Finds faulty components quickly and easily
Model WTCPPN
Reg. \$77.50
\$54.95

Weller Controlled Output Soldering Station

Model MG10A
\$49.50

Magnifier Lamp

Precision ground and polished magnification lens
Model MG10A
\$49.50

Econo-Lamp

Spring balanced arms
Tension control knobs
Baked enamel finish
Colors: Red, Yellow, Blue, Black, Oyster White
UL for 60W
Model XL-334A
\$16.95

CAR STEREO PRODUCTS

In-Dash Car Stereos



8-Track Tape Player with AM/FM/MPX Radio
Model C-777
\$52.50



Auto Reverse Cassette Tape Player with AM/FM/MPX Radio
Model CAS-999
\$79.95



Cassette Tape Player with AM/FM/MPX Radio
Model CAS-888
\$57.50

Stereo Power Booster

Model POW-40
40W stereo
20W per channel
Bass boost
\$24.95



6" x 9" 3-Way Speaker

Model BP200-69TR
20 oz. ceramic magnet
\$149.95 ea.

Miniature High Fidelity 3-Way Stereo Speakers

MINI speakers
MAXI sound
Model HF-9
\$69.50 pr
Reg. \$149.95

- Die Cast Aluminum
- Long Throw Woofer
- Soft Dome Tweeter
- Extended Midrange Speaker
- 80-20,000 Hz
- 50W, 8 ohms

30 MHz Portable Frequency Counter

Model 1827
Reg. \$130.00
\$65



HICKOK Digital CB In-Line Tester

Measures all 4 transmitter output characteristics
Frequency Power
SWR Modulation %
Model 388
\$169.95



Portable VOM Multitester

20 K Ω VDC
10 K Ω VAC
Model VM520
\$19.95



SPECIALS

RCA-VIZ Super Chro-Bar

Model WR-538A
Reg. \$129.95
\$89.95

RC Circuit Box

36 resistors (15 Ω to 10 M Ω)
18 capacitors (100 pF to 0.22 μ F)
Reg. \$49.95
\$42.
includes test leads
Model WC 412A



Chess Challenger 7

7 levels of play
Model BBC
Reg. \$110.00
\$79.95



CANON Calculator Printer with Adding Machine Tape

Model P10-0
\$69.98

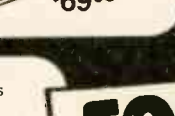

Portable Oscilloscopes

15 MHz Dual Trace Triggered Miniscope

Model MS-215
Reg. \$435.00
\$389.95

15 MHz Triggered Miniscope

Model MS-15
Reg. \$319.00
\$289.95

30 MHz Dual Trace Triggered Miniscope

Model MS-230
Reg. \$559.00
\$499.95

TELEPHONE DEVICES

MURAPHONE Cordless Telephone System

Reg. \$89.95
\$74.95



CODE-A-PHONE Telephone Answering

Model 1550 Automatic Dialing
Reg. \$399.95
\$279.95

Model 1400 Call Control
Reg. \$349.95
\$199.95

Model 1500 Call Control
Reg. \$349.95
\$249.95



GTE Flip-Phone

\$37.95

BSR X-10 Remote Control for Lights & Appliances

4 Pc Standard Starter Kit
One (1) Standard Command Console
Two (2) Lamp Modules
One (1) Appliance Module
Reg. \$87.95
\$79.50

5 Pc Ultrasonic Starter Kit
One (1) Deluxe Ultrasonic Command Console
One (1) Hand Held Remote Unit
Two (2) Lamp Modules
One (1) Appliance Unit
Reg. \$112.95
\$99.95

Lamp Modules \$14.50
Standard Command Console \$36.00
Appliance Modules \$14.50
Ultrasonic Command Console \$59.95
Hand Held Remote \$14.50



FORDHAM

855 Conkin St. Farmingdale, N.Y. 11735

- Master Charge
- BankAmericard
- VISA
- COD
- Money Order
- Check

N.Y. State residents add appropriate sales tax
TOLL FREE (800) 645-9518
FREE in N.Y. State call (516) 752-0050

Package Offer

ELECTRONIC TECHNICAL DATA

- Data Books
- Applications
- Price Lists
- Cross References

only
\$9.90
complete package

LOOK AT WHAT YOU'LL GET!

| Title | Total Pages |
|--|-------------|
| 1. Motorola Master Catalog | 338 |
| 2. Motorola 1980 Price List | 48 |
| 3. Motorola Voltage Regulator Handbook | 202 |
| 4. Motorola MDS Cross-Reference Guide | 4 |
| 5. NPC-Transistor Handbook | 163 |
| 6. Signetics LS Guide | 176 |
| 7. Ferranti Timer Application | 16 |
| 8. Fujitsu-2716 Data Sheet | 8 |
| 9. Silicon General-LM317 Data Sheet | 4 |
| 10. Silicon General-LM323 Data Sheet | 2 |
| 11. Silicon General-1980 Price List | 12 |
| 12. Silicon General-Product Catalog | 218 |

Take Advantage
of This Offer

ANCRONA
Today!!!

Send Check or Money Order to: P.O. Box 2208R,
Culver City, CA 90230. Calif. residents add
6% sales tax. Add \$1.00 to cover postage and handling.
Master Charge and VISA welcomed. Please include your
Interbank number and expiration date with order.
PHONE ORDERS: (213) 641-4064

ATLANTA
3330 Piedmont Rd., N.E.
Atlanta, GA 30305
(404) 761-7100

CULVER CITY
11080 Jefferson Blvd.
Culver City, CA 90230
(213) 390-3555

SANTA ANA
1300 E. Edinger Ave.
Santa Ana, CA 92705
(714) 847-8424

SUNNYVALE
1054 E. El Camino Real
Sunnyvale, CA 94087
(408) 243-4121

PORTLAND
1125 N.E. 82nd Ave.
Portland, OR 97220
(503) 254-5541

TUCSON
4518 E. Broadway
Tucson, AZ 85711
(602) 881-2348

HOUSTON
2649 Richmond
Houston, TX 77098
(713) 629-3489

CIRCLE 51 ON FREE INFORMATION CARD

HIGH STABILITY CRYSTALS FOR FREQUENCY OR TIME USE THE BEST BUY JAN CRYSTALS

- CB
- CB standard
- 2 meter
- Scanners
- Amateur Bands
- General Communication
- Industry
- Marine VHF
- Micro processor crystals



easy
to
charge

Send 10¢ for our latest catalog.
Write or phone for more details.

Jan Crystals



2400 Crystal Drive
Ft. Myers, Florida 33907
all phones (813) 936-2397

CIRCLE 17 ON FREE INFORMATION CARD

ADVERTISING INDEX

RADIO-ELECTRONICS does not assume any responsibility for errors that may appear in the index below.

Free Information Number Page

| | | |
|-------|--|---------|
| 27 | AMC Sales | 100 |
| — | ATV Research | 83 |
| 19 | AP Products, Inc. | 34-35 |
| 3 | Aaron-Gavin Instruments | 72 |
| 22 | Active Electronics | 87 |
| 7,43 | Advanced Computer Products | 94-95 |
| — | Advance Electronics | 23,37 |
| 42 | All Electronics | 84 |
| 39 | American Antenna | Cover 4 |
| 51 | Ancrona | 102 |
| 37 | B & K Precision Dynascan Corp. | 76 |
| — | Karel Barta | 83 |
| — | Bright Electronics | 84 |
| — | Bullet Electronics | 100 |
| 48 | CFR Associates | 96 |
| 25 | Chaney Electronics | 100 |
| 6 | Channellok | 32 |
| — | Chromatronics | 77 |
| — | CIE—Cleveland Institute of Electronics | 18-21 |
| — | Command Productions | 86 |
| 44 | Concord-Computer Components | 86 |
| — | Dage Scientific | 83 |
| 28 | Delta Electronics | 84 |
| — | Deltronics | 102 |
| 35 | Digi-Key | 89 |
| — | EMC—Electronic Measurements | 86 |
| 9 | Fluke | 5 |
| — | Fordham Radio Supply | 101 |
| 11-12 | Formula International | 98-99 |
| 21 | Fuji-Svea | 97 |
| 5 | Global Specialties | Cover 2 |
| 33 | Godbout Electronics | 100 |
| — | Grantham College of Engineering | 79 |
| 30,53 | Heath | 17,75 |
| 29 | Hickok Electrical Instruments | 27 |
| 2 | Hustler, Inc. | 22 |
| — | ISCET | 40 |
| — | Information Unlimited | 102 |
| 45 | International Electronics Unltd. | 92 |
| — | JS & A | 1 |
| 15-16 | Jameco Electronics | 90-91 |
| 17 | Jan Crystal | 102 |
| 24 | Kester Solder | 75 |
| — | Lakeside Industries | 83 |

| | | |
|-------|--|---------|
| 32 | Leader | 22 |
| 10 | MCM Audio | 85 |
| 41 | MTI—Mobile Training Institute | 80 |
| 54 | Mercury International | 39 |
| 23 | Meshna | 96 |
| — | Micro Management Systems | 84 |
| 49 | Micro Mart | 92 |
| — | National Radio Institute (NRI)—Div. of McGraw Hill | 8-11 |
| — | National Technical Schools | 28-31 |
| 52 | Netronics | 41 |
| 34,36 | O.K. Machine & Tool | 33,36 |
| 20 | Optoelectronics | 2 |
| 40 | Ora Electronics | 42 |
| 8 | PAIA | 79 |
| 46 | PacCom | 80 |
| 47 | Panavise | 79 |
| 38 | Poly Paks | 92 |
| — | RCA | 13 |
| 55 | Radio Shack | 88 |
| 13 | Ramsey Electronics | 93 |
| 26 | Rye Industries | 72 |
| — | Sabtronic | Cover 3 |
| — | Howard W. Sams | 15 |
| 14 | Solid State Sales | 96 |
| — | Spacecoast Research | 84 |
| 4 | Sprague Products | 38 |
| — | Telex Communications (Hy Gain) | 24-25 |
| 18 | Wersi Electronics | 40 |
| 56 | Yamaha | 6 |

AMAZING ELECTRONIC PROJECTS and PRODUCTS:
Lasers Super Powered, Burning Cutting, Rifle, Pistol, Pocket. See in Dark—Shotgun Directional Mike—Unscramblers—Giant Tesla—Stunwand—TV Disrupter—Energy Producing, Surveillance, Detection, Electrifying, Ultrasonic, CB, Auto and Mech. Devices, Hundreds More—All New Plus INFO UNLTD PARTS SERVICE. Catalog \$1. Information Unlimited, Dept. R8 Box 716 Amherst, N.H. 03031.

1. 5 Volt, 3 amp, Regulated Power Supply. Great for TTL Projects..... \$19.50
2. EMM 4200A, 4K Static RAMs, Ceramic A local memory boards manufacturer closed. We bought the new memory boards and took these 4200A static RAMs out. They are tested and 90-day guaranteed 100% good. Prime tested 4200A 4K RAMs \$5.50 ea.
3. Super Saver. Micro PD411, Ceramic 4K x 1 dynamic RAMs..... 8 for \$10.00.

DELTRONICS
5151 BUFORD HIGHWAY
ATLANTA, GA 30340
404-458-4690

Sabtronics gives you DMM and Frequency Counter kits with more features, better performance and incredibly lower prices

Model 2010A Bench/Portable DMM: \$79.95 kit

Features: 3½ digit LED display • 31 measurement ranges 6-Functions • 0.1% Basic DCV accuracy • Touch-and-hold capability • Hi-Lo Ohms • 40 Hz to 40 kHz frequency response • Auto Zero, Auto Polarity • Overload protected • Overrange indication • Single chip LSI logic • Laser-trimmer resistor network and ultra-stable band-gap reference for better long term accuracy • Built-in NiCd battery charging circuit.

Brief Specifications: DC Volts 100µV to 1000V in 5 ranges; AC Volts 100µV to 1000V in 5 ranges; DC Current 0.1µA to 10A in 6 ranges; AC Current 0.1µA to 10A in 6 ranges; Resistance 0.1Ω to 20MΩ in 6 ranges; Diode Test Current 0.1µA to 1mA in 3 ranges; Input impedance, 10MΩ on AC and DC volts; Power requirement, 4.5 to 6.5 VDC (4 "C" cells) or optional AC adapter/charger.



\$79.95



\$89.95

Model 2015A Bench/Portable DMM: \$89.95 kit

Same features and specifications as Model 2010A except with large, 0.5" LCD 3½ digit display.

Optional Accessories:

- #AC-115, AC adapter/charger \$7.95
- #THP-20, Touch and Hold Probe \$19.95
- #NB-120 NiCd Battery Set \$18.75

Model 8610A Frequency Counter: \$99.95 kit

Features: 8-digit LED display • 10 Hz to 600 MHz guaranteed frequency range (5 Hz to 750 MHz typical) • 3 Gate times • 10 MHz TCXO Time base • Auto decimal point • Overflow indicator • Leading zero blanking • Resolution to 0.1 Hz • Built-in charging circuit for NiCd batteries.

Brief Specifications: Frequency Range, switch selectable, 10 MHz, 100MHz, 600 MHz • Sensitivity, ± 10mV RMS to 100 MHz, ± 50mV RMS, 100 MHz to 450 MHz; 90mV RMS 450 MHz to 600 MHz • Impedance, 1 MΩ, 10 MHz and 100 MHz ranges; 50Ω, 600 MHz range • Gate time (switch selectable) 0.1 sec, 1 sec, 10 sec • Temperature stability, 0.1 ppm/°C • Ageing rate < ± 5 ppm/yr • Accuracy, 1 ppm or 0.0001% • Input protection, 150V RMS to 10 kHz (declining with frequency) • Power Requirement, 4.5 to 6.5V DC @ 300mA (4 "C" cells) or optional AC adapter/charger (7.5 to 9V DC @ 300mA).

Also available Model 8110A, same as 8610A except maximum frequency is 100MHz and without battery charging circuit: \$69.95 kit

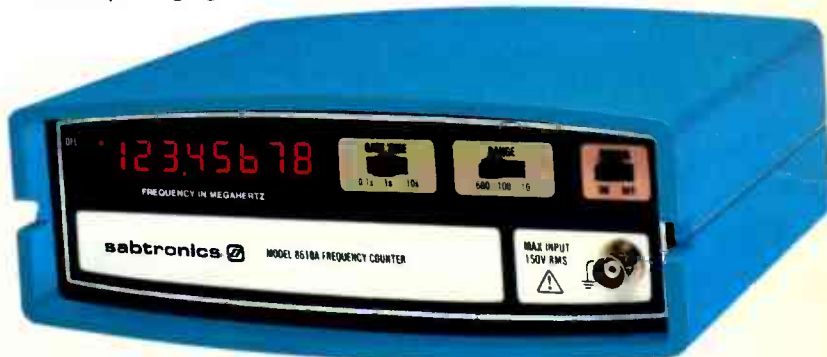

\$99.95

(813) 623-2631

sabtronics INTERNATIONAL INC.

5309 N. 50th Street, M/S 35, Tampa, FL 33610

In Canada contact: Kumar & Co.
Mississauga, Ont. Canada L5L 1H2

Ordering information

USA—Add \$6.00 per kit for shipping & handling. Personal checks have to clear before goods are shipped (allow 2-3 weeks). For faster delivery send cashiers check or money order. 10% deposit for C.O.D. orders. Florida residents add sales tax. OVERSEAS—Add \$25.00 per kit for airmail delivery. Payment by bank draft in U.S. funds.

IF YOU OWN A RADIO, THIS MICROPHONE WILL LET YOU TRANSMIT FURTHER AND CLEARER OR WE'LL GIVE YOU YOUR MONEY BACK!

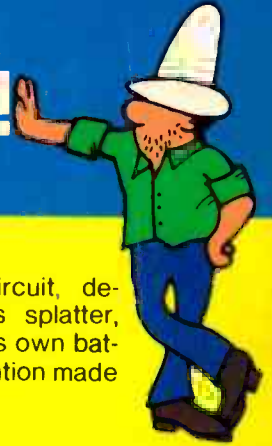

Guaranteed to out perform any mic on any radio!

A speech processor microcircuit, designed by us, that eliminates splatter, boosts power and recharges its own battery. A patented American invention made in an American town.



CHECK OUT THE EXCLUSIVE FEATURES!



- CLIPS ANYWHERE
- PROCESSES SPEECH WITH COMPUTER CIRCUIT
- SOUND SENSITIVE 2 INCHES OR 2 FEET
- NOISE CANCELLING
- TWO MICS WITH ONE SWITCH
- FRESH CHARGE WITH NO BATTERIES

YOUR DOUBLE GUARANTEE

GUARANTEE I:

The K40 Speech Processor is guaranteed to outperform any microphone it replaces or return it for a complete and full refund within 7 days from the K40 Dealer that installed and tuned it.

GUARANTEE II:

Unconditionally guaranteed for 12 months. Guaranteed against cracking, chipping, or rusting. Guaranteed against mechanical failure. Guaranteed against electrical failure. No exclusions. No gimmicks. For a full 12 months.

\$44.50 Suggested Retail

AMERICAN ANTENNA
ELGIN, ILLINOIS 60120
© COPYRIGHT AMERICAN ANTENNA

... Sold exclusively by  American K40 Dealers throughout the U.S. & Canada.

CIRCLE 39 ON FREE INFORMATION CARD