

SPECIAL 32-PAGE FEATURE—PERSONAL COMPUTING

\$1.00 ■ JUNE 1978

# Radio-Electronics

THE MAGAZINE FOR NEW IDEAS IN ELECTRONICS

easy to build  
**BAR-GRAPH DISPLAY**  
uses discrete LED's

roundup for hobbyists  
**CASES AND CABINETS**  
for your projects

telephone accessory  
**BUILD DIGI-TOLL**  
computes cost of calls

special feature  
**PERSONAL COMPUTERS**

- 1 what they can do and how to select your own
- 2 peripheral devices and accessories
- 3 programming languages and how to use them
- 4 roundup of who makes what



## PLUS:

- ★ Build A HI-FI Graphic Equalizer
- ★ MATV Switching System
- ★ All About Audio Oscillators
- ★ Hobby Corner
- ★ State-Of-Solid-State Service Clinic
- ★ 80 Computer Corner



GERNSBACK

562024 DLS 80005496  
 H H DELSCHLAGER  
 BX 5 XG  
 NEW SCRIPT  
 NJ 0553

# NOW YOU CAN AFFORD THE WORLD FAMOUS Diablo Printer Terminal



IPSI PROUDLY ANNOUNCES A PRICE  
BREAKTHROUGH ON DAISY WHEEL  
PRINTER TERMINALS  
The IPSI Model 1622

**Featuring:** RS 232 compatibility at 110, 150, 300, and 1200 baud: **Print speed** of 45 char/sec: **Graphics** capability: Over 30 **print wheels** from 10 to 15 char/inch: 5 ribbons in color, cloth, film or two color: **Form length** adjustable: **Spacing** adjustable from 120 pitch to .1 pitch: Line spacing adjustable from 48 lines/in. to .4 line/in.: Identical in every respect to it's high priced sister the **Diablo HyTerm II\*** model 1620.

**Price:** \$2,595.00 each in single units, quantity discounts available.

**Service:** Major cities in the U.S. and Canada.

You have probably waited a long time to purchase your computer printer at a reasonable price. Wait no longer! The Diablo 1620 lists for \$3,240.00 we sell it for \$2,595.00; save well over \$600.00. For immediate action phone in your order collect and we will ship your terminal the same day.

We also stock Diablo 1345A (Hytype II\*) mechanisms for immediate shipment at the low price of \$1,150.00. Order one now and build your own terminal using your own CPU, or do-it-yourself by buying our 1622 kit and assemble your own terminal within 10 hours for \$2,295.00

If you've always wanted to turn your computer onto word processing, this is the only way to go. Ask for our free word processing software.

**IPSI**  
INTERNATIONAL PERIPHERAL SYSTEMS, INC.  
4982 E. UNIVERSITY AVE.  
FRESNO, CALIFORNIA 93727  
CALL (209) 252-3635

\*Hyterm and HyType are registered trademarks of Xerox Corp.

CIRCLE 94 ON FREE INFORMATION CARD



# Introductory offer to new members of the ELECTRONICS AND CONTROL ENGINEERS' BOOK CLUB

any one  
of these great  
professional books  
for **\$1.89**  
only  
values up  
to \$60.00

Special \$1.89 bonus book comes to you  
with your first club selection

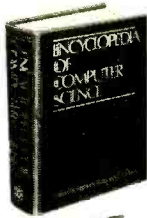

769/01X  
**ENCYCLOPEDIA  
OF COMPUTER  
SCIENCE**  
by A. Ralston  
and C. L. Meek  
Pub. price, \$60.00  
Club price, \$39.95



286/051  
**OPTOELEC-  
TRONIC APPLI-  
CATIONS  
MANUAL**  
by Hewlett-  
Packard  
Pub. price, \$19.25  
Club price, \$14.50



404/453  
**GUIDEBOOK OF  
ELECTRONIC  
CIRCUITS**  
by J. Markus  
Pub. price, \$29.50  
Club price, \$21.50



772/622  
**SEMI-  
CONDUCTOR  
ELECTRONICS  
DESIGN**  
by F. K.  
Manasse  
Pub. price, \$21.95  
Club price, \$18.25



617/97X  
**HANDBOOK OF  
OPERATIONAL  
AMPLIFIER CIR-  
CUIT DESIGN**  
by D. E. Stout  
& M. Kaufman  
Pub. price, \$29.65  
Club price, \$17.50



491/380  
**MICROCOM-  
PUTER-BASED  
DESIGN**  
by J. Peatman  
Pub. price, \$23.00  
Club price, \$17.50



162/468  
**INTEGRATED  
CIRCUITS AND  
SEMICONDUCTOR  
DEVICES:**  
Theory and  
Application, 2/e  
by G. J. Deboo  
& C. N. Burrous  
Pub. price, \$17.95  
Club price, \$13.95



353/670  
**MICROPROCES-  
SORS AND SMALL  
DIGITAL COM-  
PUTER SYSTEMS  
FOR ENGINEERS  
AND SCIENTISTS**  
by G. A. Korn  
Pub. price, \$24.50  
Club price, \$18.95



629/218  
**DIGITAL  
INTEGRATED  
ELECTRONICS**  
by H. Taub and  
D. Schilling  
Pub. price, \$23.50  
Club price, \$16.95



231/494  
**ELECTRONICS  
DESIGNERS'  
HANDBOOK, 2/e**  
by L. J.  
Giacoletto  
Pub. price, \$47.50  
Club price, \$37.50



255/342  
**MANAGEMENT OF  
ENGINEERING  
PROJECTS, 2/e**  
by V. G. Hajek  
Pub. price, \$15.95  
Club price, \$12.50



209/804  
**ELECTRONICS  
ENGINEERS'  
HANDBOOK**  
by D. G. Fink  
Pub. price, \$45.50  
Club price, \$33.50



571/384  
**ELECTRONIC  
COMMUNICA-  
TION, 3/e**  
by R. L. Shrader  
Pub. price, \$16.95  
Club price, \$12.50



637/539  
**DIGITAL INTE-  
GRATED CIR-  
CUITS AND  
OPERATIONAL-  
AMPLIFIER, AND  
OPTOELEC-  
TRONIC CIR-  
CUIT DESIGN**  
by Texas  
Instruments  
Pub. price, \$16.50  
Club price, \$12.50

## save time and money by joining the ELECTRONICS AND CONTROL ENGINEERS' BOOK CLUB



Here is a professional book club designed to meet your on-the-job engineering needs by providing practical books in your field on a regular basis at below publisher prices. If you're missing out on important technical literature—if today's high cost of reading curbs the growth of your library—here's the solution to your problem.

The *Electronics and Control Engineers' Book Club* was organized for you, to provide an economical reading program that cannot fail to be of value. Administered by the McGraw-Hill Book Company, all books are chosen by qualified editors and consultants. Their understanding of the standards and values of the literature in your field guarantees the appropriateness of the selections.

How the club operates: Every month you receive free of charge *The Electronics and Control Engineers' Book Club Bulletin*. This announces and describes the Club's featured book of the month as well as alternate selections available at special members' prices. If you want to examine the Club's feature of the month, you do nothing. If you prefer one of the alternate selections—or if you want no book at all—you notify the Club by returning the card enclosed with each Bulletin.

As a Club member, you agree only to the purchase of four books (including your first selection) over a two-year period. Considering the many books published annually, there will surely be at least four you would want to own anyway. By joining the Club, you save both money and the trouble of searching for the best books.

### MAIL THIS COUPON TODAY

**ELECTRONICS AND CONTROL ENGINEERS' BOOK CLUB**  
P.O. Box 582, Princeton Road, Hightstown, New Jersey 08520

Please enroll me as a member and send me the two books indicated. I am to receive the bonus book at the introductory price of \$1.89 plus my first selection, plus tax, postage and handling. If not completely satisfied, I may return the books within 10 days and request that my membership be cancelled. If I keep the books, I agree to take a minimum of three additional books during the next two years at special Club prices (guaranteed 15% discount, often more). I will receive the Club Bulletin 13 times a year. If I want to examine the featured selection, I need take no action. It will be shipped automatically. If, however, I want an alternate selection—or no book at all—I simply notify the Club by returning the convenient card always enclosed. I will always have a minimum of ten days in which to return the card and you will credit my account fully, including postage, if this is not the case. Membership in the Club is continuous but cancellable by me at any time after the four-book purchase requirement has been filled. This order subject to acceptance by McGraw-Hill. Orders from outside the continental U.S. must be prepaid. All prices subject to change without notice. Offer good for new members only.

Write Code # of \$1.89 bonus  
book selection here

Write Code # of  
first selection here



NAME \_\_\_\_\_

ADDRESS \_\_\_\_\_

CITY \_\_\_\_\_

STATE \_\_\_\_\_ ZIP \_\_\_\_\_

EXTRA SAVINGS: Remit in full with your order, plus any local and state tax, and McGraw-Hill will pay all postage and handling charges. **E33350**

CIRCLE 38 ON FREE INFORMATION CARD



# Get your fastening act together with Mallory-Richco.

Clamps, clips, wire saddles, spacers, cable hangers, circuit board supports, guides and dozens of other accessories. Your Mallory distributor has them. Packaged the way you want them. See him soon. Or contact Mallory Distributor Products Company, a division of P. R. Mallory & Co. Inc., Box 1284, Indianapolis, Indiana 46206 (317) 856-3731.



(Parts shown actual size.)

# MALLORY

Capacitors • Controls • Fastening Devices • Resistors • Security Products • Semiconductors • Solderless Terminals • Sonalart® Signals • Switches

CIRCLE 24 ON FREE INFORMATION CARD

[www.americanradiohistory.com](http://www.americanradiohistory.com)



# Radio-Electronics®

THE MAGAZINE FOR NEW IDEAS IN ELECTRONICS

Electronics publishers since 1908

JUNE 1978 Vol. 49 No. 6

## PERSONAL COMPUTERS SPECIAL SECTION

- 37 Your Own Computer
- 38 Personal Computers—are they right for you?
- 43 Peripherals—arms and legs
- 47 Programing isn't simple
- 56 Computer Corner
- 59 Equipment Directory

## BUILD ONE OF THESE

- 69 **Digi-Toll Times Your Calls**  
Know how much your long-distance calls cost. Nifty toll-timer helps you keep track.
- 78 **LED Bar Graph**  
LEDs all in a row serve as an analog meter in many applications.
- 82 **Graphic Equalizer For Stereo Systems**  
*Part II:* Final construction details and some additional interior photographs.

## GENERAL ELECTRONICS

- 4 **Looking Ahead**  
Tomorrow's news today.
- 73 **Cabinets For Projects**  
Directory of cabinets you can use to house your projects.
- 80 **Audio Oscillators**  
*Part II:* More information on this old standby test instrument.
- 90 **Hobby Corner**  
Keeping records, tool holders, grinding PC boards and reader suggestions.
- 92 **State of Solid State**  
A single IC adds true RMS voltage measurements to a multimeter.
- 94 **Solar Controller**  
Microprocessor runs solar heating system.
- 124 **What is An LCD?**  
Inside the Liquid-Crystal Display.

## TELEVISION

- 88 **New MATV System**  
It's easier to install and costs less to run. The circuitry is what makes it run.
- 96 **Service Clinic**  
Write it down—it's a dollar saver.
- 98 **Service Questions**  
R-E's Service Editor solves reader problems.

## EQUIPMENT REPORTS

- 24 **B & K 1820 Frequency Counter**
- 26 **Hickok 517 Dual Trace Scope**
- 28 **Heath 5280 Test Instruments**
- 35 **Spyderco Portable Hand**

## DEPARTMENTS

- |                              |                           |
|------------------------------|---------------------------|
| 156 Advertising Index        | 125 Market Center         |
| 14 Advertising Sales Offices | 6 New & Timely            |
| 117 Books                    | 110 New Products          |
| 114 Editorial                | 116 Next Month            |
| 16 Letters                   | 157 Reader's Service Card |

## ON THE COVER

When you want to keep track of long-distance phone charges, the first thing you need is a record of how long you've been talking. Digi-Toll does just that. It also reminds you, with a bright red digital readout right at your phone, of how long you've been talking. See construction details starting on page 69.

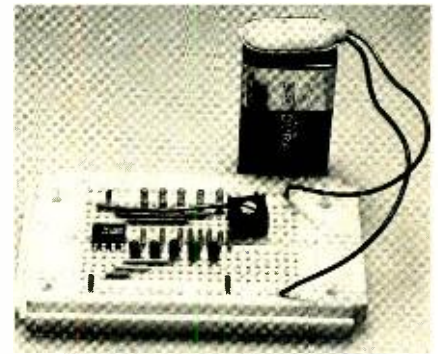

**LED BAR GRAPH** is a nifty substitute for an analog meter . . . and it's easy to read. Turn to page 78



**CABINETS FOR PROJECTS** helps answer that problem question of "What cabinet should I use?". Five pages of listing start on page 73.

Radio-Electronics, Published monthly by Gernsback Publications, Inc., 200 Park Avenue South, New York, NY 10003. Phone: 212-777-6400. Second-class postage paid at New York, NY and additional mailing offices. One-year subscription rate: U.S.A. and U.S. possessions, \$9.98, Canada, \$12.98. Other countries, \$14.98. Single copies \$1.00. © 1978 by Gernsback Publications, Inc. All rights reserved. Printed in U.S.A.

**Subscription Service:** Mail all subscription orders, changes, correspondence and Postmaster Notices of undelivered copies (Form 3579) to Radio-Electronics Subscription Service, Box 2520, Boulder, CO 80322.

A stamped self-addressed envelope must accompany all submitted manuscripts and/or artwork or photographs if their return is desired should they be rejected. We disclaim any responsibility for the loss or damage of manuscripts and/or artwork or photographs while in our possession or otherwise.

As a service to readers, Radio-Electronics publishes available plans or information relating to newsworthy products, techniques and scientific and technological developments. Because of possible variances in the quality and condition of materials and workmanship used by readers, Radio-Electronics disclaims any responsibility for the safe and proper functioning of reader-built projects based upon or from plans or information published in this magazine.

# looking ahead

**Computers go retail:** First mass-market push for the computer as a consumer product is under way, and as of early spring there was heavy activity on several fronts. In some cases, big retailers were testing the waters to see if the buyers and the product were ready for one another. In other cases, the results were already in and dealers were highly pleased with early sales.

Macy's chose the San Francisco area for a market test in 13 of its stores, with a promotion campaign for the \$500 VideoBrain home computer. A store spokesman said some two dozen computers were sold during the first day of the promotion, about one-third going to consumers who weren't technically oriented and "didn't even know what a home computer was" before Macy's broke its ad campaign. Other department stores understood to be handling VideoBrain include Macy's and Bloomingdale's in New York, Maas Brothers in Florida, Dayton's in Minnesota and May Co., Broadway Stores, Bullock's and Robinson's in Los Angeles.

Radio Shack held a special heavily advertised computer promotion in its Phoenix stores, offering the TRS-80 for same-day delivery. Its other stores had been taking orders, promising six-to-eight-week delivery. Radio Shack has also established a new retail division called Tandy Computers, which has issued its first mail-order catalog, and opened its first store in Fort Worth. Apple Computers has been successfully marketing at retail through about 50 Team Electronics stores and is adding other outlets, including traditional hi-fi and camera retailers.

Meanwhile, Magnavox is introducing a new product called "Odyssey Mark II Computer Video Game System." It's actually more a game than a computer and will sell for less than \$200—but it will have both joy-stick controllers and a full alphanumeric keyboard. It uses an Intel microprocessor, and will be programmed by ROM cartridges at about \$20 each. Retail sales will begin in the fall.

**New from Sony:** Sony has been making plenty of news with new and revamped products, some for delivery soon, others later. The company demonstrated in Japan a CCD color camera using three MOS chips measuring  $9.1 \times 10.3$  mm, each with 226 horizontal and 492 vertical elements for a total of 111,192 picture elements. Sony said the camera uses a proprietary "special offsetting technique" which effectively doubles horizontal resolution, claiming that more than 280 lines of horizontal resolution can be attained. The camera's size and weight are claimed to be about the same as a super-8 home movie camera. Sony officials said the color camera will sell for \$835 to \$1,250 when it's marketed in Japan in fall 1979, but that they ultimately hoped to be able to sell a CCD color home video camera for less than \$500. RCA recently demonstrated its own CCD color camera and said it would take commercial orders in 1979 (see **Radio-Electronics**, April, 1978).

Sony also is introducing in the United States for the first time its three-tube projection television system. It uses special 9-inch monochrome tubes as the picture source, with two lenses and a mirror system to throw a bright picture on a screen mounted atop the one-piece fold-up cabinet. The projector will be available this fall in 50- and 72-inch diagonal screen sizes in the \$3,000 range. Bright-

ness is claimed to be 60 footlamberts with the smaller screen and 30 with the 72-inch screen.

At the same time, Sony is updating both its Betamax home videocassette recorder and its color TV line. A new-model Betamax will have built-in LED electronic clock-timer and remote pause control. Unlike the former model, which could record and play in both fast and slow speeds, it will be a single-speed unit, designed for the L-500 tapes, which have a two-hour recording time, or the new L-750, which step this up to three through the use of thinner tape.

Sony's TV line will feature new, brighter Trinitron tubes and a new chassis designated "I2" and said to be designed for "ease of accessibility and service." When two screws are removed, the chassis slides out of the set into an accessible service position with the circuits still connected and operable. The chassis may be turned on its side without tilting the set.

**Service complaints down:** TV servicing complaints received by the National Better Business Bureau declined in 1977 from 1976. Television service companies in 1977 ranked ninth in number of complaints received by local Better Business Bureaus, down from eighth in 1976, complaints dropping from 9,394 to 9,113. In 1977, some 74.8% of complaints were settled as opposed to 72.4% in 1976. Analyzing 1977 television servicing complaints, the National Better Business Bureau said 61.9% of the complaints involved unsatisfactory repair, 16.9% unsatisfactory service, 5.9% guarantee or warranty, 5.6% credit or billing, 2.8% delayed delivery, 2.7% product quality or performance, 1.3% selling practices, 1.2% advertising practices, 0.9% failure to provide refunds and 0.7% discontinued business.

**Varactors & remotes:** Electronic tuning is gradually taking over American television. According to EIA figures, 31.1% of all color sets produced or imported last year contained varactor tuners—including 57.5% of consoles and 20.9% of portables and table models. At the same time, remote control finally became an important TV feature, included in 12.7% of new sets last year, as compared with 10% in 1976.

In black-and-white, the growth trend continued to be toward AC-DC portables, but their share of the market increased only slightly from 1976—to 16.5% of all monochrome sets, up from 15.6%. Incidentally, 11- and 12-inch sets accounted for 57.4% of black-and-white production last year. In color, 19-inch was by far the most popular size, representing 44.2% of production.

Want to know what color sets sell for at the factory? The International Trade Commission makes quarterly studies in connection with the color quota on imports from Japan. Its latest tally represents average factory prices of color sets made in the United States by screen size during the fourth quarter of 1977: A 13-inch averages \$225.56, the 16- and 17-inch bracket \$299.10, 19-inch sets \$297.35, and larger screen (20 inches and up) average \$456.67. All sizes together average out to \$349.23.

**DAVE LACHENBRUCH**  
CONTRIBUTING EDITOR



# FREE

The world's largest catalog  
of easy-to-build, money-saving  
electronic kits



- Personal Computer Systems now including Floppy Disk Storage
- Power Supplies ● Oscilloscopes ● Frequency Counters ● VTVM's and VOM's
- Ham Radio Gear ● Digital Programmable Color TV ● Hi-Fi Components
- Electronic Clocks and Weather Instruments ● Learn-at-home Electronics Courses
- Auto, Fishing, Marine and Aircraft Accessories – nearly 400 kits in all!

Every Heathkit product comes with a fully-illustrated, step-by-step assembly manual that tells you everything you need to know to make kitbuilding fun and easy. Thousands of people have discovered the satisfaction – and savings – of handcrafting a fine piece of electronic equipment. You can build it better... let us show you how.

Send for your **FREE** Catalog today! ►

Heath Company, Dept. 020-420, Benton Harbor, Michigan 49022

HEATH Schlumberger	Heath Company, Dept. 020-420 Benton Harbor, Michigan 49022	<b>FREE</b>
Please rush me my <b>FREE</b> Heathkit Catalog. I am not on your mailing list.		
NAME _____		
ADDRESS _____		
CITY _____		STATE _____
CL-657		ZIP _____

CIRCLE 100 ON FREE INFORMATION CARD

## District of Columbia communications system links city ambulances with hospitals

A major communications network between the District of Columbia ambulances and 15 participating hospitals in the area will soon be complete, according to Albert P. Russo, director of the Department of Human Resources.

This network is a vital element in the D.C. Emergency Medical Services System, which will not only provide city ambulances with a direct communication line to the hospitals, but, Mr. Russo adds, also allow for interhospital communication, thus paving the way for future linkage with emergency medical communications systems in other surrounding areas.

The system consists of a transmission console at the District Fire Department Communications Center, in addition to receiving consoles at the hospitals. The signals are transmitted via a 180-foot tower at the center, which handles all voice and telemetry communications between ambulances and hospitals. When the system is complete, all 15 participating hospitals will be able to avail themselves of voice communications, while seven hospitals will be equipped to receive medical data telemetry (i.e., electrocardiogram data).

Fire Department ambulances are equipped with 10-channel two-way radios, plus patient-side portable radios, so that physicians can relay vital information on patient treatment.

## General Motors trip computer system is option in '78 models

General Motors has developed a trip-computer system called the *TripMaster* that can be had as an option in their 1978 Cadillac Seville models for \$875.



**GENERAL MOTORS TRIP COMPUTER** is available in 1978 models. Pushbutton-controlled, dash-mounted system provides 11 pieces of information, from estimated and actual fuel consumption to estimated time of arrival based on remaining fuel and driving range in miles.

The *TripMaster* (with which the car owner also receives a digital speedometer and digital fuel readout gauge) is pushbutton-controlled, providing such information as amount of fuel remaining; average speed; average and actual miles-per-gallon; total

elapsed trip time; miles car can be driven on remaining fuel; miles to destination; estimated arrival time; time of day; the engine RPM; temperature; and system voltage. The heart of the system is a M6800 microcomputer. The digital display is a gas-discharge readout for maximum daytime visibility.

The *TripMaster* is envisioned as only the first step in what will eventually be a completely computerized automobile. Computers will soon control such operations as the carburetor system, fuel injection, exhaust gas recirculation, air conditioning, cruise control and theft-alarm systems.

## 24-hour electronic "beeper" protects the elderly or ailing

Heart patients, disabled or elderly persons living in isolated conditions can now avail themselves of a 24-hour electronic "beeper" device that can be worn around the neck or carried in a pocket for help in emergencies. It has an effective range of only 300 feet, because Federal regulations prohibit greater distances.

The device is a battery-powered transmitter and weighs about an ounce. Pressing a button or squeezing the device activates a transistorized unit hooked up to a telephone in the home. This unit then dials a pre-recorded message (giving name, address and type of emergency). This message is sent either to a centralized computer, which translates the coded beep for a private operator who contacts the necessary party, or dials the call directly to a preselected list of numbers—police, fire department, physicians, hospitals, friends and neighbors.

There are several systems on the market, among them the *Lifeguard* (Life-Guard Systems, Inc. Kenilworth, OH), *Safeguard* (ADT Security Systems, Inc., of Ohio) and *Microalert* (Microalert Systems, Toms River, NJ). Their cost is high: The *Microalert* pocket transmitter costs \$695, and the pendant transmitter, \$995; rental costs run from \$30 to \$50 a month. (A Life-Guard Systems spokesman says the *Lifeguard* can be rented for \$20 a month, less installation costs and telephone line rental.) At present, no Medicaid or Medicare funds are available to help defray these costs, although some people have been able to list the devices as a tax deduction if they are doctor-recommended. Presently, more than 1000 people are using such systems in the United States.

## New York organization for the blind tapes best sellers

In New York City, the Jewish Guild for the Blind has gone into the "best seller" business. They have developed a cassette library of current fiction and nonfiction that

is recorded almost as soon as the books themselves hit the market. Bruce Massis, Guild librarian, cites the fact that the classics are already available on records, and adds that the Guild is the only organization that does the best sellers "hot off the press." And about a year and a half ago, different sound effects were added to the recordings, greatly adding to their popularity.

It takes both sides of about 10 cassettes to record a complete book. The cassettes are marked in Braille so that the blind person is able to play them in sequence. The average recording time for a book is approximately a month, depending on how much time the volunteer reader can devote to it. Copies of a given book can be made by machine, producing nine cassettes on both sides in about nine minutes.

The cassettes are mailed free anywhere in the U.S., the cost of mailing being underwritten by the U.S. Library of Congress. To date, the Guild claims 950 steady customers; however, many more are able to hear the recordings via special network programs for the blind. Printed catalogs are available that are updated four times a year with supplementary listings sent out to regular readers. Special Braille catalogs are also available for those who prefer them. For information, contact the Jewish Guild for the Blind, 15 West 65th Street, New York, NY 10023.

## Top 1977 vocational students compete in '78 vocational Olympics

In February, 1978, a week-long competition was held in Dayton among last year's top vocational students. The young contestants were vying for selection to the 1978 U.S. International Skill Olympics, to be held in Pusan, Korea, in September.

The 28 contestants were all high scorers in the 1977 U.S. Skill Olympics, sponsored by the Vocational Industrial Clubs of America (VICA), the national organization for students enrolled in trade, industrial, technical and health education studies.

The individual selected to represent the *electrical trades* in the International Olympics is Mark Agee, Spokane, WA. The field of *industrial electronics* will be represented by Neal Sedell, Vancouver, WA, and Erik W. Wolfner, Miramar, FL (alternate). For *radio and TV repair*, the participants will be Richard A. Lomax, Camden, DE, and Terry M. Williams, Wheelersburg, KY (alternate).

## Hams invited to participate in Enterprise space launch

The Kennedy Space Center Amateur Radio Society (SCARS) once again will invite amateur radio stations around the world to call the SCARS station to participate in the

*continued on page 12*



# Uncompromising performance. Incredible price. A professional 3½ digit DMM Kit for less than \$70.



**Incredible? True!** Professionals and hobbyists alike are believers in this Sabtronics 2000, the only portable/bench DMM which offers such uncompromising performance at the astonishingly low price of \$69.95.

**Uncompromising performance** you'd expect only from a specialist in digital technology such as Sabtronics: Basic DCV accuracy of 0.1% ± 1 digit; 5 functions giving 28 ranges; readings to ±1999 with 100% overrange; overrange indication; input overload protection; automatic polarity; and automatic zeroing.

**The low price of \$69.95?** Simple: The Model 2000 is all solid-state, incorporating a single LSI circuit and high-quality components. You assemble it yourself, using our clear, easy-to-follow, step-by-step assembly manual. Kit is complete, including a high-impact case.

Now you too can have it! A professional-quality, 3½ digit Sabtronics Model 2000 DMM kit for only \$69.95. If you don't have one in your lab, use the coupon below to order NOW.

#### BRIEF SPECIFICATIONS:

DC volts in 5 ranges: 100 µV to 1 kV • AC volts in 5 ranges: 100 µV to 1 kV • DC current in 6 ranges: 100 nA to 2 A • AC current in 6 ranges: 100 nA to 2 A • Resistance: 0.1 Ω to 20 MΩ in 6 ranges • AC frequency response: 40 Hz to 50 kHz • Display: 0.36" (9.1 mm) 7-segment LED • Input impedance: 10 MΩ • Size: 8" W x 6.5" D x 3" H (203 x 165 x 76 mm) • Power requirement: 4 "C" cells (not included).

#### GUARANTEE:

Examine the 2000 DMM kit for 10 days. If not completely satisfied, return unassembled for full refund of purchase price. (Less shipping and handling)

Use your Master Charge or Visa.  
To order by phone call: (214) 783-0994



Made in U.S.A.

**sabtronics**   
INTERNATIONAL INC.

13426 Floyd Circle • Dallas, Texas 75243

To: Sabtronics International, Inc.  
13426 Floyd Circle, Dallas, TX 75243

RE-6

Please send me \_\_\_\_\_ Sabtronics Model 2000 DMM kit(s)  
at \$69.95 each..... \$ \_\_\_\_\_  
Shipping and handling, \$5.00 per unit\* \$ \_\_\_\_\_  
Texas Residents Add Sales Tax \$ \_\_\_\_\_  
TOTAL enclosed \$ \_\_\_\_\_

Name \_\_\_\_\_

Street \_\_\_\_\_

City \_\_\_\_\_

State \_\_\_\_\_ Zip \_\_\_\_\_

\*USA only. Canada \$6.50. All other countries, \$10.00 (surface mail)

NRI BRINGS "POWER-ON"  
 TRAINING TO YOUR HOME...  
 FOR QUICKER, EASIER  
 LEARNING AND  
 FASTER EARNING

# NRI FIRSTS

**First** and only school with designed-for-learning Quadraphonic Audio Center with four SP14 speaker systems. This solid state SQ™ system is designed so that you perform meaningful experiments at every stage of assembly . . . for thorough training in audio technology.



™Trademark of CBS, Inc.

**You get trouble-shooting experience from the chassis up . . . with NRI's unique training equipment.**

The "firsts" described here are typical of NRI's over 63 years of leadership in electronics home training. When you enroll as an NRI student, you get the technical knowledge and the priceless confidence of "hands-on" experience sought by employers in communications, TV-audio servicing, computers, and industrial and military electronics. NRI training is designed for your education . . . from the educator-acclaimed Achievement Kit sent the day you enroll, to bite-size, well illustrated, easy-to-read lessons programmed with designed-for-learning training equipment.

**NRI Firsts** make learning at home fast and fascinating. More than a million have come to NRI for home training. Professional TV/Audio technicians who learned their profession through home training rate NRI as first choice by far, over any other school.

SEND FOR THE FREE FULL-COLOR CATALOG . . . for full details on NRI home training. There is no obligation . . . *no salesman will call.*

**First** with an electronics Discovery Lab™. This self-contained advanced solid-state lab gives you fast, hands-on access to fully-powered semiconductor circuitry. NRI is the only school with all these modern solid state component experiments in: bipolar and field effect transistors, Zener diodes, light-emitting diodes, SCR's and phototransistors.

™McGraw Hill CEC.



**First** and only school with new Optical Transmission System engineered to allow you to analyze digital and analog signal transmission via light beam. Systems you build use LED and phototransistor technology, simulating basic principles of laser communications as used in video disc home entertainment systems.



**First** and only school with designed-for-learning 25" diagonal solid state Color TV complete with cabinet. This solid state set was designed by NRI's own engineers from the chassis up so that students can perform over 25 in-set experiments during construction, including valuable "Power-On" trouble-shooting



**First** and only training with an actual programmable digital computer to give you the only home training in machine-language programming . . . essential to trouble shooting digital computers. Extra Memory Expansion Kit doubles memory size for practice in advanced programming techniques.

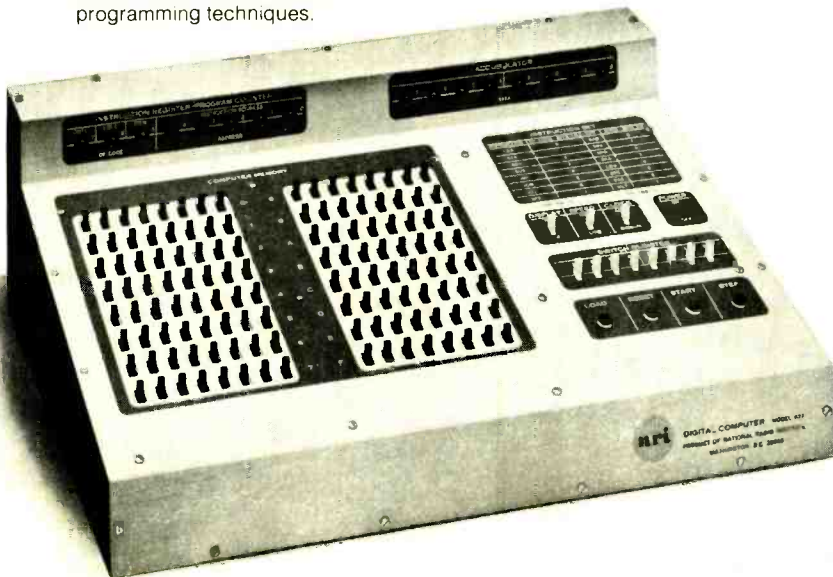

**First** and only school with a portable CMOS digital frequency counter engineered by NRI to give you experience in the newest types of digital systems coming into expanded use in consumer electronics.

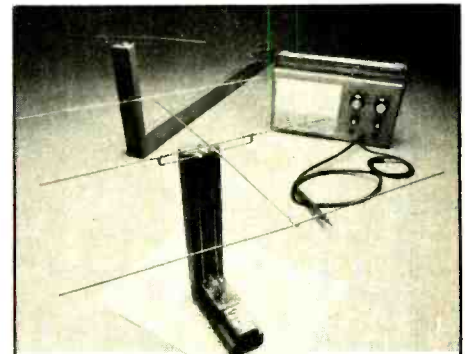

**First** and only school with an Antenna Applications Lab engineered to give you a thorough understanding of practical communications antenna requirements. You assemble and test several different types of antennas and matching sections, measuring gain and radiation patterns.



**First** and only school with a solid state regulated power supply engineered by NRI to give you experience with modern power supply designs; to give you a premium power supply for your NRI Transceiver, or to use in trouble-shooting mobile equipment.



**First** and only school with designed-for-learning, 400-channel, digitally-synthesized VHF Transceiver to give you the only fully-up-to-date 2-meter equipment for complete training in commercial, amateur, and CB communications. The design incorporates circuitry and components representative of the latest state of the art. Circuitry is on five plug-in circuit cards to take full advantage of NRI "Power-On" training.

If card is missing, write to:



NRI Schools  
McGraw Hill Continuing  
Education Center  
3939 Wisconsin Ave.  
Washington, D.C. 20016

first launch of U.S. space shuttle *Enterprise*. Those hams that successfully contact the station will receive a Special Event Commemorative Certificate showing the space shuttle.

For this special event, the station plans to operate on three separate modes: single sideband, radio telegraphic and novice code, all timed to coincide with lift-off operations. Those amateur operators who wish to participate in this event should contact the Space Center Amateur Radio Society, Box 21073, Kennedy Space Center, FL 32815, or call Carl Zelich (305) 867-2194 or (305) 452-6410.

### Vanadium disulfide—adds new life to lithium battery

Bell Laboratories have developed an experimental rechargeable high-energy lithium battery cell that can operate at room temperature without any noticeable physical change or deterioration. What has added new life to the lithium battery is previously undiscovered material, *vanadium disulfide*, that provides the stability lacking in other battery materials, such as nickel cadmium.

The Bell studies of "layered compounds"—materials resembling mica and graphite—led to the discovery of vanadium disulfide's special properties. In the Bell battery, vanadium disulfide makes up the basic positive electrode terminal, while lithium forms the negative electrode. During battery operation, electrons leave the lithium electrode and pass through the layers of vanadium disulfide; simultaneously, lithium ions in the electrolyte flow into the spaces between the layers of vanadium. This results in minimal physical changes; thus, when the battery is recharged the electrons and lithium ions are expelled and the structure returns to its original condition.

The new lithium battery is lightweight and provides 2.5 volts, or almost twice the voltage of NiCad cells, used in most modern electronic devices.

### Radio Shack microcomputer system rated leading contender in field

Speaking before a meeting of the Morgan Stanley first annual Personal Computer Conference, Radio Shack president Lewis Kornfeld expressed his confidence that Radio Shack's TRS-80 Microcomputer System will be one of the leading systems in the field. He underscored this by asserting that it was Radio Shack's intention to "explore and enter the market for computers in order to serve small business . . . professionals, students and hobbyists."

The TRS-80 system was introduced in 1977. It is completely prewired and tested and consists of a 53-key professional keyboard and microcomputer, power supply,

data-cassette recorder, video display monitor, plus a comprehensive owner's manual—the whole system selling for \$599. Pre-recorded cassette programs are available for small business payroll and personal finance management and educational courses such as math, algebra and a programming course.

Mr. Kornfeld also announced a new expansion interface and ROM converter, a mini-floppy disc drive, a line printer, new software, as well as complete TRS-80 expanded systems.

### Domestic satellites to provide large-scale telecommunications services

Satellite Business Systems (comprising Aetna Life & Casualty, Comsat General and IBM) and Hughes Aircraft have joined forces to build three domestic satellites, the first designed to provide large-scale telecommunications services to both commercial and government users in the U.S.

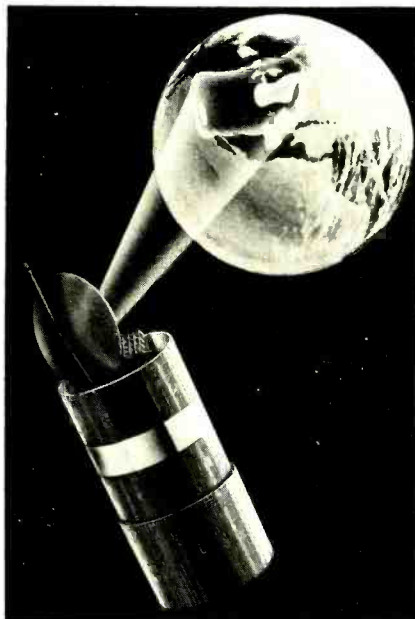

**SATELLITE BUSINESS SYSTEMS** spacecraft will transmit high-frequency signals to be received by roof-mounted earth antennas. The solid white beam represents area of U.S. covered by spacecraft's strongest signals.

The SBS satellite system will permit installing unmanned, automatic earth antennas in urban areas without interfering with other terrestrial signal systems or spacecraft. The 12-gHz signal output will be 20 watts, rather than the normal 5 or 6 watts, and the stronger signals will enable roof-mounting the antennas, or installing them in office parking lots. All 48 states will be served by the system, with the strongest signals beamed to 5-meter dish antennas in densely populated east-central and west

coast areas; the rest of the country will be served by 7-meter parabolic earth antennas.

It is expected that the satellites will be launched via space shuttle to an eventual orbit at an estimated altitude of 36,000 kilometers (22,300 miles). The projected date of launch is 1981.

### New executive director for IESA

As of February 1, 1978, Leon F. Howland, CET, will be the new executive director of the Indiana Electronic Service Association (IESA). Mr. Howland will take the place of retiring Tom Bertrand.

Mr. Howland has served as IESA director, as well as a legislative lobbyist whenever the state of Indiana enacts legislation concerning the electronic service business and technicians. He has also served as chairman of the TV-Radio licensing board; as a past president of IESA (twice); and as an officer in NEA. He is presently also director of ITTA, an Indianapolis association of more than 100 trade firms.

### Cable TV subscribers to get computer-controlled alarm systems

A new computer-controlled alarm system in Dayton, OH, connects the area's cable TV subscribers with a central computer-controlled alarm panel that is monitored for 24 hours.

In this system, the fire, smoke or burglar alarm detectors are installed at the subscribers' home entrances, and are connected both to the central alarm panel and to the TV cable. Triggering the detector flashes a set of programmed instructions to the central video screen at the monitoring station. At his end, the subscriber, if he is home, can press a pushbutton to show what specific emergency aid he needs—medical help, an emergency squad, or the assistance of a nearby relative.

Although no rates or installation charges have yet been determined, it is estimated that a complete cable TV alarm system could cost several hundred dollars.

### SCTE elects 1978 slate of officers

The Society of Cable Television Engineers (SCTE) recently announced its new officers and board for the 1978-1979 term:

Robert Bilodeau, president for the second term; Harold Hull of Sarasota, FL, Eastern vice president; Gayheart C. Kleycamp, San Angelo, TX, Western vice president; Judith Scharf, Denver, CO, secretary; and Edward Horowitz, NY, treasurer.

The following regional directors were also elected: Frank J. Bias (Region 1); Glenn Chambers (Region 2); Bruce Uerling (Region 3); William Ellis (Region 4); John Weeks (Region 5); James Grabenstein (Region 6); and John Morovich (Region 7).



# READY for BUSINESS

We've got it all together—the cost effectiveness and reliability of our 6800 computer system with a high capacity 1.2 megabyte floppy disk system. . . PLUS—an outstanding new DOS and file management system.



## 1 MEGABYTE DISK SYSTEM

DMAF1 introduces a new level of capability to small computer systems. This disk system features two standard size floppy disk drives using the new double sided disk and two heads per drive. Usable storage space of over 600 kilobytes per drive, giving a total of over 1.0 megabyte of storage on line at all times. Ideal for small business applications, or for personal "super" systems.

## DMA CONTROLLER

The controller occupies one main memory slot in an SS-50 bus and uses the Motorola MC-6844 DMA controller. The combination of a DMA

type controller and double sided disks give the system speed of data transfer unobtainable with smaller drives.

## OPERATING SYSTEM

To compliment this outstanding hardware we are supplying equally superior software. The disk operating system and file management system is called FLEX. It is one of the most flexible and complete DOS's available for small systems, but just as important; it is easy to use. No one can match the variety of compatible peripherals offered by Southwest Technical Products for the SS-50 bus and the 6800 computer system. Now more than ever there is no reason to settle for less.

DMAF1 Disk System (assembled) . . . . .	\$2,095.00
DMAF1 Disk System (kit) . . . . .	\$2,000.00
68/2 Computer with 40K of memory (assembled) . . . . .	\$1,195.00

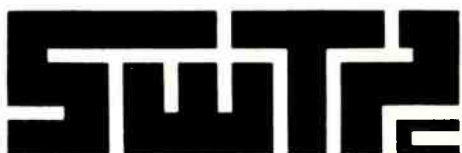

SOUTHWEST TECHNICAL PRODUCTS CORPORATION  
219 W. RHAPSODY  
SAN ANTONIO, TEXAS 78216

CIRCLE 27 ON FREE INFORMATION CARD

## Where have all the designers gone?

The integrated circuit has done a lot of good things. Actually, it has *caused* a lot of good things. Complex electronic devices grow smaller. Prices of electronics devices seem to manage to hold their own in the face of inflation. And electronic equipment steadily grows more reliable.

But what seems to be missing is the designer. Oh sure, there's still an engineer around who takes a bunch of IC's (black boxes) and wires them up to form a "new device". The only trouble with this is that this is not really designing . . . or is it?

We have our ideas on this subject, and would like to compare them with yours. We want to know what you think about the state of electronic design today. What exactly is electronic design? What does an electronic designer do? Is he designing when he takes IC's and connects them together to make a circuit? Is the only designer left, the man who devises those IC's we all use?

Most important of all, do you think that the integrated circuit has slowed down the development of new electronic devices or has the integrated circuit shortened development time? Remember! Making a device smaller or less expensive is not the same as coming up with an entirely new device.

The subject is interesting and important. Let's have your comments.

  
**LARRY STECKLER**  
Editor

## Radio-Electronics®

**Hugo Gernsback** (1884-1967) founder

**M. Harvey Gernsback**, editor-in-chief and publisher

**Larry Steckler**, KTX-3644, CET, editor

**Arthur Kleiman**, KTZ-3288, managing editor

**Robert F. Scott**, CET, W2PWG, KXX-8533, technical editor

**Sonia Greenbaum**, copy editor

**Jack Darr**, CET service editor

**Leonard Feldman**, contributing high-fidelity editor

**Karl Savon**, semiconductor editor

**David Lachenbruch**, contributing editor

**Earl "Doc" Savage**, K4SDS, hobby editor

**Vincent P. Cicenia**, production manager

**Harriet I. Matysko**, circulation director

**Sheila Wertling**, circulation assistant

**Arline R. Bailey**, advertising coordinator

Cover design by Louis G. Rubsamen

Cover photo by Mel Small

**Radio Electronics** is a member of the *Institute of High Fidelity* and is indexed in *Applied Science & Technology Index* and *Readers Guide to Periodical Literature*.

Gernsback Publications, Inc.  
200 Park Ave. S., New York, NY 10003  
(212) 777-6400  
President: M. Harvey Gernsback  
Vice President: Larry Steckler  
Treasurer: Carol A. Gernsback  
Secretary: Bertina Baer

### ADVERTISING SALES

Paul McGinnis  
Director of Marketing

### EAST

Stanley Levitan  
Radio-Electronics  
200 Park Ave. South  
New York, NY 10003  
(212) 777-6400

### MIDWEST/Texas/Arkansas/Okla.

Ralph Bergen  
The Ralph Bergen Co.  
540 Frontage Road—Suite 361-A  
Northfield, Illinois 60093  
(312) 446-1444

### PACIFIC COAST

#### Mountain States

Jay Eisenberg  
J.E. Publishers Representative Co.,  
8732 Sunset Blvd.,  
4th Floor,  
Los Angeles, CA 90069  
(213) 659-3810  
Sales Mart Building  
1485 Bayshore Blvd., Box 140  
San Francisco, CA 94124  
(415) 467-0125

### SOUTHEAST

J.E. Publishers Representative Co.,  
214-387-2424





# NTS trains you on tomorrow's equipment. Today.

Microcomputers, digital systems and more...  
from the first name in home study.



Now NTS training programs include an even wider choice of solid-state digital equipment than ever before offered in any electronic home study course. Advanced NTS/Heath digital color TV (25" diagonal with optional programming capability), NTS/Heath digital computer, digital test equipment, digital stereo receiver (70 watts per channel) plus much more state-of-the-art equipment to make your training exciting and relevant. Learn servicing and maintenance easily with step-by-step Project Method lessons and kits.

An all-new full color catalog shows you exactly what each of the fourteen courses cover, and every piece of equipment you receive.

Send for it today and see for yourself what's really happening in electronics training technology at NTS. It's free. Just send the coupon.

**NO OBLIGATION. NO SALESMAN WILL CALL.  
APPROVED FOR VETERAN TRAINING.**

## NATIONAL TECHNICAL SCHOOLS

TECHNICAL-TRADE TRAINING SINCE 1905  
Resident and Home-Study Schools  
4000 South Figueroa St., Los Angeles, Calif. 90037

**NATIONAL TECHNICAL SCHOOLS** Dept. 206-068  
4000 South Figueroa Street, Los Angeles, California 90037

Please send FREE Color Catalog and Sample Lesson.

- |   |   |
|---|---|
| <input type="checkbox"/> Color TV Servicing           | <input type="checkbox"/> Electronics Technology         |
| <input type="checkbox"/> B & W TV and Radio Servicing | <input type="checkbox"/> Audio Electronics Servicing    |
| <input type="checkbox"/> FCC License Course           | <input type="checkbox"/> Digital Electronics            |
| <input type="checkbox"/> Electronic Communications    | <input type="checkbox"/> MicroComputers/MicroProcessors |

Name \_\_\_\_\_

Address \_\_\_\_\_

Apartment Number \_\_\_\_\_ Age \_\_\_\_\_

City \_\_\_\_\_

State \_\_\_\_\_ Zip \_\_\_\_\_

- Check If Interested In G.I. Bill information.  
 Check if Interested ONLY in classroom training in Los Angeles.

# letters

## IN DEFENSE OF AMERICAN TV'S

I would like to answer some points raised by Mr. Kubilus in the Letters column of the January 1978 issue.

I have been associated with the TV industry for 11 years as an electronics engineer, and for two of those years operated a TV service business. I am also English, and during visits across the Atlantic have taken a natural curiosity in TV sets over there.

Mr. Kubilus questions the large number of screws used to secure the backs of U.S.-made TV sets. In this country, manufacturers voluntarily subscribe to Underwriters Laboratories, and meet or exceed all the safety specifications laid down by that independent organization. These specifications apply to the back of the set as well as to the rest of it. For example, the maximum slot size, distance of back material from chassis parts and back security are all specified. After all, removal should not be so simple a child could do it!

U.L. has also determined the type of wall plug to be used: polarized for a "hot" chassis and, if desired, nonpolarized for

sets with an isolation power transformer. I am sure no one would disagree with this elementary safety precaution.

Mr. Kubilus may be a competent "do-it-yourself" expert, but many are not. Experience in the TV repair business has amply demonstrated to me that "a little knowledge can be a dangerous thing." A schematic diagram invites the attention of such people into an area that is potentially very dangerous. Special techniques must often be used, particularly with today's solid-state technology.

In many states, the law requires an itemized receipt for repair work be given the customer together with the return of old parts. In Utah, for example, the state requires samples of shop tags, etc., and checks they meet quite extensive legal requirements. So, if a previously repaired set does not have the repair information attached, the customer should have his copy. However, I doubt if such information is of much use to service technicians.

It is my opinion that TV sets produced in the U.S. within the last five years are very serviceable indeed. Plugs and sockets are

widely used, and, in many cases, only two screws have to be removed to take off or slide back the chassis. Plug-in modules have been used extensively by some manufacturers and are easily replaced. Tuners can usually be removed by loosening either two or four screws.

I do not share Mr. Kubilus' concern for parts standardization. Several parts suppliers in this country make it their business to analyze TV sets as they come on the market. They produce extensive cross-reference manuals and cover everything from transformers to IC's. Besides, an experienced technician will know what available part he can use with safety when faced with a faulty original.

U.S. consumers are very fortunate. They have a considerable selection of good-quality TV sets available at very reasonable cost. To purchase a medium-priced 25-inch color console model represents an investment of about 4½% of the average wage-earner's yearly salary. In Europe the investment is closer to 12%.

DAVID J. H. APPLEBY  
El Paso, TX

*continued on page 22*

## Another reason to join RCA's QT Parts Program! You get four free information packages every year.



### RCA's QT-150 Parts Program is better than ever!

Registered dealers receive four free information mailings per year through RCA's Direct Information Service program.

Quarterly mailings include:

- Complete Dealer Price Book — RCA Consumer Parts • Latest Price Supplement • RCA Drawing Number to Stock Number Cross Reference • Color TV Module Cross Reference • B&W TV Module Cross Reference • Dealer QT Inventory Control Form; and many other useful publications.

**To join, contact your RCA Distributor** and register as a QT Dealer. You will receive your package of 150 of the most-needed, fastest-moving parts to repair older TV sets.

You will also receive your first quarterly information package. Every information mailing will include the latest price publication, plus additional information about RCA Parts required in your servicing business.

**Don't forget, your QT Parts inventory program has automated annual drop-ship updating for your convenience.** A special QT Parts Rack is also available to save time and space.

Call your RCA Distributor or write to RCA Distributor and Special Products Division, Deptford, N.J. 08096.

# RCA QT Parts



# TRI-COLOR

## WIRE CUTTING AND STRIPPING DISPENSER



Model No. **WD-30-TRI**  
Patent Pending

- 3 Rolls of wire in one convenient dispenser
- 3 Colors, Blue/White/Red, 50 ft. (15m) of each color
- AWG 30 (0,25mm) KYNAR® insulated wire
- Built-in cutting plunger cuts wire to desired length
- Built-in stripper strips 1" of insulation
- Easily refillable
- For wire-wrapping and other applications.

WD-30-TRI	DISPENSER WITH WIRE	\$5.95
R-30-TRI	TRI-COLOR REPLACEMENT SPOOLS	\$3.95

Kynar® Pennwalt

MINIMUM BILLING \$25.00/ ADD SHIPPING CHARGE \$1.00/ NEW YORK STATE RESIDENT ADD APPLICABLE TAX



MACHINE & TOOL CORPORATION 3455 CONNER ST. BRONX, N.Y. 10475 (212) 954-6600/Telex 125091

CIRCLE 42 ON FREE INFORMATION CARD

[www.americanradiohistory.com](http://www.americanradiohistory.com)

---

# At CIE, you get electronics career training from specialists.

**If you're interested in learning how to fix air conditioners, service cars or install heating systems – talk to some other school. But if you're serious about electronics, come to CIE – The Electronics Specialists.**

---

*John E. Cunningham*

**Special Projects Director  
Cleveland Institute of Electronics**





**M**y father always told me that there were certain advantages to putting all your eggs in one basket. "John," he said, "learn to do one important thing better than anyone else, and you'll always be in demand."

I believe he was right. Today is the age of specialization. And I think that's a very good thing.

Consider doctors. You wouldn't expect your family doctor to perform open heart surgery or your dentist to set a broken bone, either. Would you?

For these things, you'd want a specialist. And you'd trust him. Because you'd know if he weren't any good, he'd be out of business.

### **Why trust your education and career future to anything less than a specialist?**

You shouldn't. And you certainly don't have to.

**FACT:** CIE is the largest independent home study school in the world that specializes exclusively in electronics.

We have to be good at it because we put all our eggs in one basket: electronics. If we hadn't done a good job, we'd have closed our doors long ago.

### **Specialists aren't for everyone.**

I'll tell it to you straight. If you think electronics would make a nice hobby, check with other schools.

But if you think you have the cool — and want the training it takes — to make sure that a sound blackout during a prime time TV show will be corrected in seconds — then answer this ad. You'll probably find CIE has a course that's just right for you!

### **At CIE, we combine theory and practice. You learn the best of both.**

Learning electronics is a lot more than memorizing a laundry list of facts about circuits and transistors. Electronics is interesting because it's based on some fairly recent scientific discoveries. It's built on ideas. So, look for a program that starts with ideas — and builds on them.

That's what happens with CIE's Auto-Programmed® Lessons. Each lesson uses world-famous "programmed learning" methods to teach you important principles. You explore them, master them completely... before you start to apply them!

But beyond theory, some of our courses come fully equipped with the electronics gear to actually let you perform hundreds of checking, testing and analyzing projects.

In fact, depending on the course you take, you'll do most of the basic things professionals do every day — things like servicing a beauty of a Zenith color TV set... or studying a variety of screen display patterns with the help of a color bar generator.

Plus there's a professional quality oscilloscope you build and use to "see" and "read" the characteristic waveform patterns of electronic equipment.

### **You work with experienced specialists.**

When you send us a completed lesson, you can be sure it will be reviewed and graded by a trained electronics instructor, backed by a team of technical specialists. If you need specialized help, you get it fast... in writing from the faculty specialists best qualified to handle your question.

### **People who have known us a long time, think of us as the "FCC License School."**

We don't mind. We have a fine record of preparing people to take... and pass... the government-administered FCC License exams. In fact, in continuing surveys nearly 4 out of 5 of our graduates who take

the exams get their Licenses. You may already know that an FCC License is needed for some careers in electronics — and it can be a valuable credential anytime.

### **Find out more! Mail this card for your FREE CATALOG today!**

If the card is gone, cut out and mail the coupon.

I'll send you a copy of CIE's FREE school catalog, along with a complete package of independent home study information.

For your convenience, I'll try to arrange for a CIE representative to contact you to answer any questions you may have.

Remember, if you are serious about learning electronics... or building upon your present skills, your best bet is to go with the electronics specialists — CIE. Mail the card or coupon today or write CIE (and mention the name and date of this magazine), 1776 East 17th Street, Cleveland, Ohio 44114.



Patterns shown on TV and oscilloscope screens are simulated.

## **CIE** Cleveland Institute of Electronics, Inc.

1776 East 17th Street, Cleveland, Ohio 44114  
Accredited Member National Home Study Council

**YES...** John, I want to learn from the specialists in electronics — CIE. Send me my FREE CIE school catalog — including details about troubleshooting courses — plus my FREE package of home study information. **RE-36**

Print Name \_\_\_\_\_

Address \_\_\_\_\_ Apt. \_\_\_\_\_

City \_\_\_\_\_

State \_\_\_\_\_ Zip \_\_\_\_\_

Age \_\_\_\_\_ Phone (area code) \_\_\_\_\_

Check box for G. I. Bill information:  Veteran  Active Duty

**Mail today!**

**LETTERS**

*continued from page 16*

**TEXAS COMPUTER GROUP**

Your readers in the Permian Basin area of Texas might be interested to know about the Permian Basin Computer Group.

Our group has monthly meetings in the cities of Midland and Odessa. (In Midland, the meetings are held on the second Monday of the month, and in Odessa, on the second Saturday of the month.) Everyone is invited to attend the meetings, regardless of educational background, and no dues are collected.

For further information, write Permian Basin Computer Group, John Rabenaldt, Ector County School District, Box 3912,

Odessa, TX 79760, or phone (915) 332-9151, Ext. 43.

JOHN RABENALDT  
Odessa, TX

**CAPACITORS & BATTERIES**

Hurray! I was sure glad to read your February 1978 Service Clinic on the solid-state horizontal-output stage that uses those four-legged capacitors. I have replaced several of these and didn't really know why they opened up. However, you should have told your readers never to bypass the open link between capacitors. It doesn't work! It can blow those output transistors faster than you can think!

Your Hobby Corner advice, also in the February 1978 issue, on avoiding battery troubles was right in line with my thinking. If

one has several pieces of battery-operated equipment, one low-cost AC or DC adapter can be used. I prefer using the 12-volt AC adapter, and in each piece of equipment install a bridge rectifier and suitable resistor to limit the battery-charging current to the recommended level. All equipment has the same input jack. Now you can use the inexpensive adapter for all your equipment and never worry about polarity. Even if someone plugs a DC adapter in, no harm will be done.

STUART SJALUND  
Ontario, Canada

**WIRE AND CABLE**

Your article on "Coping with Wire and Cable" in the January 1978 issue was disappointing to me. I'm sure the article will be of some information and benefit to those who are uninformed. However, when an article excludes the most prominent people in the wire-stripping industry, as well as their tools, it seems that even the people who are supposed to be informed, are not.

I would like to bring the following to your attention:

1. Ideal Industries manufactures more different types of wire strippers for more different applications than anyone else.

2. On page 36 in Table I, Wire Stripping Tools & Crimpers, you list the name "Ideal" along with the part numbers, but you show the address as Great Bend, PA. Ideal Industries is located in Sycamore, IL.

3. Under the cut on page 36, the caption indicates: "Wire splices can be made with wire-nuts." I'm sure Ideal Industries appreciates your using its registered trademark of *Wire-Nut*; however, this should only be used with proper trademark recognition of Ideal Industries.

I'm very happy to see that you are making an effort to be of service to the market and the industry by showing the various tools, what they should be used for and the benefits of using them. I'm sure Ideal Industries would appreciate the opportunity to help you enlighten the professional and the hobbyist.

P.V. MALL  
I D I Electric (Canada) Ltd.  
Ajax, Ont.

**FREE ENERGY**

Apparently Mr. Ecklin (Letters, February 1978 issue) believes that the laws of physics were made up by humans and, like speed limits, can be ignored. These laws have always been with us, and we are just beginning to understand them. We can't break the laws, or even bend them by intent or inadvertance.

I want to know where Mr. Ecklin is going to find the lossless spring that generates no heat as it is flexed.

Something he might try that will bring the point home would be to ride a really well-balanced 10-speed bike around for a while and then fit it with one of those little generators that light the lights for "free." I think he may go back to buying batteries when he finds out how much work is required to move those coils of wire past a magnet to generate 6 volts at a few hundred milliamps.

W. COCHRAN  
Chalfont, PA

R-E

**NEW FROM LEADER**  
**One-Button Range**  
**Digital Multimeter.**

3 1/2 Digit LED Readout,  
0.5% Accuracy.

1mV to 1000V,  
16 Ranges. Coverage.

Semi-Automatic Ranging  
One Pushbutton.

Fully Automatic  
(200MegΩ) Range.

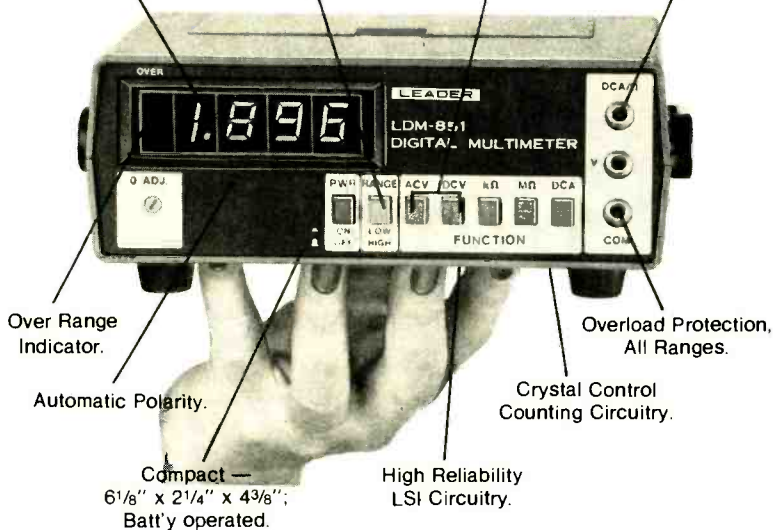

Over Range  
Indicator.

Overload Protection,  
All Ranges.

Automatic Polarity.

Crystal Control  
Counting Circuitry.

Compact —  
6 1/8" x 2 1/4" x 4 3/8";  
Batt'y operated.

High Reliability  
LSI Circuitry.

**Now, Easy Pushbutton**  
**Operation Is Yours...**  
**New Reduced Price.**

Model LDM-851 ... ~~\$199.95~~ \$169.95 AC Adapter Included

See your distributor or write direct for details.

151 Dupont Street, Plainview, N.Y. 11803  
(516) 822-9300  
In Canada: Omnitronix Ltd., Quebec

When Quality Counts...

**LEADER**  
Instruments Corp.

CIRCLE 74 ON FREE INFORMATION CARD



# DUAL TRACE 15 MEGAHERTZ

# \$39500

## PORTABLE MINISCOPE



**MADE  
IN THE  
U.S.A.!**

**BATTERY  
OPERATED!**

### FEATURES

- Dual Trace - 2 channel: separate, chopped or alternate modes.
- 15 megahertz bandwidth.
- External and internal trigger.
- Time Base - 0.1 microseconds to 0.5 Sec/div - 21 settings.
- Battery or line operation.
- Automatic and line sync modes.
- Power consumption less than 15W.
- Vertical Gain - 0.01 to 50 volts/div - 12 settings.
- Weight is only 3 pounds.

From the originator of the Digital Voltmeter, Non-Linear Systems comes the MS-215 Miniscope. It is a fine electronic instrument with a great deal of measuring capability and excellent accuracy. Its design is modern, utilizing the latest in low-powered integrated circuits, and it is packaged into the smallest practical size. The instrument fits into many briefcases and tool boxes with room to spare.

Operating characteristics have been chosen so that the MS-215 will make all of the measurements needed in servicing most electronic equipment. It is field-portable so its use is not restricted to the bench.

### SPECIFICATIONS:

**Vertical Mode:** CH1, CH2, CH1 & CH2 (Chopped) & CH1 & CH2 (Alt.)  
The Following Specifications apply to each channel

**Y Axis Vertical Input:** 10mV/div to 50V in 12 Calibrated ranges, as follows:  
x1 -10mV/div to 10V/div in four ranges, each continuously variable.  
x2 -20mV/div to 20mV/div in four ranges, each continuously variable.  
x5 -50mV/div to 50mV/div in four ranges, each continuously variable.  
Accuracy is 3%

**Input Impedance:** 1M ohm shunted by 50 pF

**Bandwidth:** DC/DC to 15 Mhz 18 db (DC to 8 Mhz 13 db). AC, same as DC down to 3Hz

**Rise Time:** Approximately 23 nS @ 1 division deflection.

**Input Voltage:** 250 maximum (DC and Peak AC)

**Horizontal Mode:** Internal Time Base or External Horizontal, switch selectable. In the XY mode, vertical input is through CH1 and horizontal input is through CH2

**Bandwidth:** DC to 200 KHz (13 db)

**Coupling:** AC, DC or ground, switch selectable. Low frequency point on AC is 3 Hz

**Input Impedance:** 1Meg ohm shunted by 50 pF

**Deflection Factor:** 10mV/div to 50V/div in 12 calibrated ranges. The ranges can be calibrated with the CH2 gain control

**Input Voltage:** 250V maximum (DC and Peak AC)

**Time Base:** 0.1uS/div to 0.5 Sec/div in 21 calibrated ranges, as follows:  
x1, uS-0.1uS/div to 100 uS/div. x2, uS-0.2uS/div to 200 uS/div.  
x5, uS-0.5uS/div to 500 uS/div. x1, mS-0.1mS/div to 100 mS/div  
x2, mS-0.2mS/div to 200 mS/div. x5, mS-0.5mS/div to 500 mS/div.  
all in four ranges, each continuously variable. (Range increments are 1, 1, 10, 100.) With vernier in full clockwise position, calibrated time measurements are possible. Accuracy is 3%.

**Triggering**  
**Internal:** Sweep triggered from internal trigger source (In the dual trace modes, the internal trigger source is CH1).  
**Automatic:** Trigger source is internal calibrator frequency. To be used if there is no other trigger source available to synchronize the sweep.  
**Line:** Trigger is derived from line frequency when using the battery charger.  
**External:** Controls function as for internal triggering (1 Megohm input impedance).  
**Slope:** Selects sync to positive- or negative- going waveform.  
**Coupling:** AC  
**Sensitivity:** Less than 1 div for internal trigger and less than 1 volt for external trigger.  
**Level:** Trigger level control permits continuous adjustment of trigger point in all modes except Auto.  
**Internal Calibrator:** A square-wave signal of 1 volt p-p 15% is provided. Frequency is approximately 1KHz.

**Display**  
**Graticule:** 4x5 div, each division is 0.25 inch. Viewing area 1.1"x1.35" w  
Bluish-white phosphor, medium persistence. CRT uses low power filament for low battery drain. Instant on!

**Power**  
**On-Board Batteries:** Three sealed, rechargeable lead acid "D" Cells  
**Operating Time:** Typically 4 hours  
**Charging Time Scope Operating:** Will run indefinitely but not reach full charge  
**Non-operating:** Sixteen hours.  
**External Power:** Battery charger 115 vac (220 vac on request). 50-400Hz, less than 15 watts.  
**Dimensions:** 3.1" Hx6.4" Wx8.0" D.  
**Weight:** Three pounds.

**Environment**  
**Operating Temperature:** 0° to 40°C  
**Shock and Vibration:** Designed to withstand normal shock and vibration encountered in commercial shipping and handling.

**Accessories Furnished:** Tilt stand, battery charger, 2 input cables, and 3 miniature banana plugs.  
**Optional:** Leather carrying case and probes  
**Warranty:** One year parts and labor. Made in the U.S.A.

**MS-215 with Rechargeable Batteries and Charger \$395.00**

### Leather Carrying Case

The leather case has 2 separate compartments. One to hold the scope, the other to hold the charger, probe, shoulder strap, etc. The case can be worn on the belt, or over the neck.  
The snaps used on the case are "one way", thus accidental striking of the case against an object will not undo the snaps or let it be pulled off your belt.

**41-140 \$30.00**

### Probes

10 to 1 probe with 10 megohm input. Probe uses spring hook tip for sure connection. Compensation network is located at the connector rather than at the probe, so as to keep size and weight to a minimum.

**41-141 \$24.50**

### Deluxe Combination Probe

Switchable 10to1/1to1 probe with an assortment of probe tips to suit any situation.

**41-3495 \$34.95**

## \$40.00 OFF

On Any Accescries Purchased with MS-215 MINISCOPE, Just Send or Mention the COUPON and Radio-Electronics Magazine

MS-15 Single Trace version of MS-215

# \$28900

**PRIORITY ONE ELECTRONICS®**

10031 S Woodley Ave. Sepulveda CA. 91343

Terms: VISA MC BAC check Money Order C.O.D. U.S. Funds Only. LA residents add 6% sales tax. Minimum order \$10.00. Orders less than \$75.00 include 10% shipping and handling. excess refunded. Just in case please include your phone no. "Sorry, no over the counter sales" Good thru July 15, 1978

Send for our latest brochure

phone orders welcome (213) 893-8202

OEM and institutional inquiries invited

# equipment report

## B&K-Precision Model 1820 Universal Frequency Counter

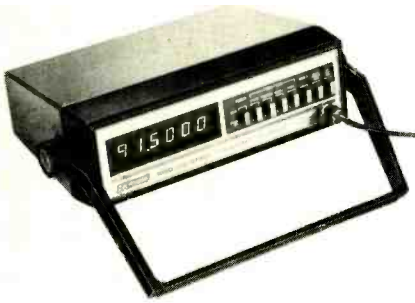

CIRCLE 102 ON FREE INFORMATION CARD

B&K-PRECISION (6460 W. CORTLAND STREET, Chicago IL 60635) have brought out a new frequency counter, the *model 1820 Universal*, which sells for \$260. It counts frequencies from 5 Hz up to 80 MHz. Besides this, it will perform tricks that I'd never thought of, and there are full instructions for doing all of

them.

The 6-digit *model 1820* has eight pushbutton controls. It's housed in a plastic cabinet with an adjustable bail that serves as a benchrest (you can set it at any angle needed) or a handle. It's AC-powered, and the total drain of only 15 watts makes it easy to use in the field, with a DC/AC converter.

The gate time is pushbutton-controlled. Set in the AUTO position, the pushbutton automatically selects the correct range and place the decimal point to display the maximum number of digits without overranging. Indicator LED's tell you the display is reading in kHz or MHz. Set to the 1-SEC position, the counter reads out the frequency to the nearest Hz. For example, on a CB transmitter, this will push the "27" off to the left, and the frequency is read to 6 digits to the right of the decimal point.

An internal 10-MHz clock oscillator is crystal-controlled, with a  $\pm 0.1$ -PPM stability. By replacing this oscillator with a TCXO (temperature-controlled crystal oscillator) the stability can be raised by a factor of 10! The substitution is very simple. Just unsolder the original oscillator and drop the TCXO into the

holes.

Now, for the instrument's handy tricks: pressing the PERIOD pushbutton displays the period (the elapsed time for one complete cycle) of the input signal. This is very useful on low frequencies, since it provides much better resolution. To convert the reading to frequency, just take the reciprocal number, using the period vs. frequency tables so thoughtfully included in the Appendix to the instruction manual.

This procedure can be used for telephone touch-tone frequency pairs; modem frequencies; both U.S. and CCITT frequency standards; CTCSS (Continuous Tone-Controlled Squelch System) frequencies used in two-way radio; all the TV sweep frequencies; the multiplex pilot carrier, power-line frequencies; amateur radio RTTY; and slow-scan TV frequencies. There is even a full-page frequency vs. period table for a complete "equally tempered scale" for pianos and organ tuning! For example, the key of low C has a 16.351-Hz frequency, but you can read the period and get one more digit of accuracy—it's 61.1583 ms.

*continued on page 26*

# Vector

## PLUGBORDS OFFER MORE...

- Unique time saving bus patterns
- Press-fit wrap-posts & solder terminals
- Many board and contact sizes



- Easy to wire hole and pad patterns
- .042" diameter holes on .1" grid
- P.C. plug or flexcable connections

**4493-1 ANY DIP, \$14.95.** Accepts all DIPs. Offset power and ground planes. 36/72 contacts. 4.5" x 9.6" (6.5" also available). 22/44 contacts also offered in both sizes.

**8804 ANY DIP, \$19.95.** Accepts all DIPs. Offset power and ground planes. 50/100 contacts spaced .125". S-100 size.\*

**4112-5 PAD BOARD, \$12.23.** Pad per 3 holes. Ground plane on back-side. 4.5" x 4.5" or 4.5" x 6.5" or 4.5" x 9.6". 22/44 contacts spaced 0.156".

**8802-1 PAD BOARD, \$19.95.** Pad per 2 holes, each side, peripheral buses. 50/100 contacts spaced at .125". S-100 size.\*

**8801 PAD BOARD, \$19.95.** Pad per each hole, each side, peripheral buses. 50/100 contacts at .125". S-100 size.\*

**8801-1, \$14.95.** No pads — just holes. 50/100 contacts at .125". S-100 size.

\*S-100 size is 5.3" high by 10" wide.

**VECTOR ELECTRONIC COMPANY**  
12460 Gladstone Avenue  
Sylmar, California 91342

Phone (213) 365-9661  
TWX (910) 496-1539  
Send for new data.

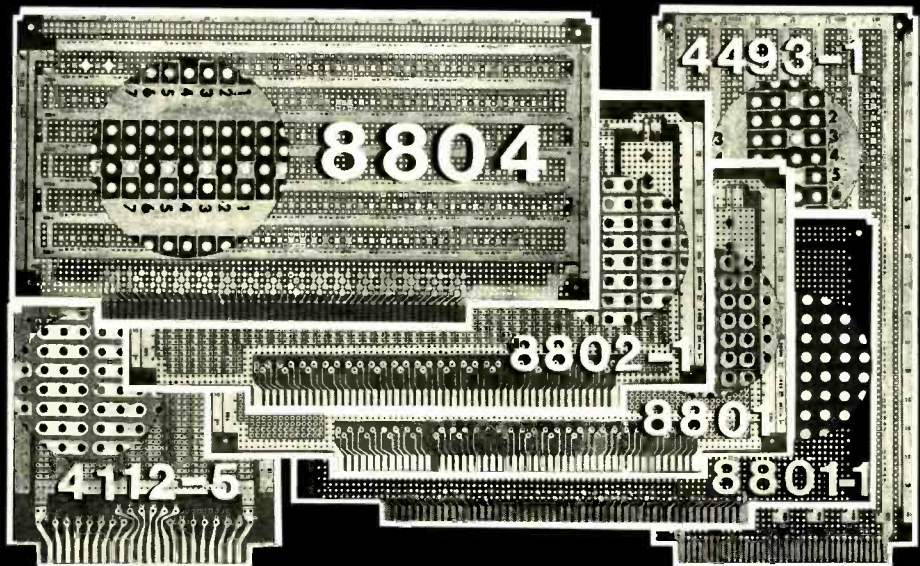

**FULL LINE OF SUPPORTING PRODUCTS:** Card cages and enclosures for all Plugboards, mating receptacles, interconnect products.

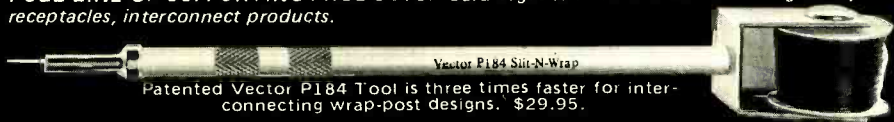

Patented Vector P184 Tool is three times faster for inter-connecting wrap-post designs. \$29.95.



**“The Sansui AU-717 is a superb amplifier. We like it with no ifs, ands, or buts.”** (Julian Hirsch)  
**It offers “as much circuitry sophistication and control flexibility as any two-piece amplifying system.”**

(Len Feldman)



**Everyone says great things about the new Sansui AU-717, but the experts say it best.**

The Sansui AU-717 DC integrated amplifier is “Sansui’s finest .... It incorporates a fully direct-coupled power amplifier section whose frequency response varies less than +0, -3dB from 0Hz (D.C.) to 200 kHz. The amplifier’s power rating is 85 watts per channel (min, RMS) from 20 to 20,000Hz into 8-ohm loads, with less than 0.025 per cent total harmonic distortion ..... If any amplifier is free of Transient Intermodulation Distortion (TIM) or any other slew-rate induced distortion, it is this one .... The slew rate ... was the fastest we have measured on any amplifier, an impressive 60 V/usec.

“The preamplifier section of the AU-717 .... has very impressive specifications for frequency response, equalization accuracy, and noise levels ... The AU-717 has dual power supplies, including separate power transformers, for its two channels ... [and] exceptionally comprehensive tape-recording and monitoring facilities .... Good human engineering .... separates this unit from some otherwise fine products ....

“The Sansui AU-717 is a superb amplifier. We like it with



Julian D. Hirsch, Contributing Editor, Stereo Review

no ifs, ands, or buts.” [Reprinted in part from Julian Hirsch’s test report in **Stereo Review**, February, 1978.]

“One clear advantage of DC design is apparent. Even at the low 20Hz extreme, the amplifier delivers a full 92 watts – the same value obtained for midfrequency



Leonard Feldman, Contributing Editor Radio-Electronics

power – compared with its 85 watt rating into 8 ohms....

“The equalization characteristic of the preamplifier was one of the most precise we have ever measured, with the deviation from

the standard RIAA playback curve never exceeding more than 0.1dB.....

“Sansui claims that this unit has reduced transient intermodulation distortion – a direct result of the DC design, and, indeed, the model AU-717 delivered sound as transparent and clean as any we have heard from an integrated amplifier....

“... worth serious consideration – even by those who prefer separate amplifiers and preamplifiers.” [Reprinted in part from Len Feldman’s test report in **Radio-Electronics**, January, 1978.]

Listen to the superb sound of the Sansui AU-717 at your Sansui dealer today. And be sure to ask him for a demonstration of the matching TU-717 super-tuner.

**SANSUI ELECTRONICS CORP.**

Woodside, New York 11377 • Gardena, California 90247 • SANSUI ELECTRIC CO., LTD., Tokyo, Japan  
 SANSUI AUDIO EUROPE S.A., Antwerp, Belgium • In Canada: Electronic Distributors



CIRCLE 73 ON FREE INFORMATION CARD

www.americanradiohistory.com

# AVANTI® HIGH PERFORMANCE C.B. ANTENNAS

40 CHANNEL ENGINEERED

## ASTRO PLANE™ CB Base Antenna Co-inductive

The omni-directional CB antenna that radiates from the top — for greater range and performance. 4.46 db gain over isotropic — stronger signal, clearer reception. No coils to burn or short. Vertical polarity. Patent #3587109  
**Model AV-101...price \$39.95**  
2.8x more power  
E.R.P.

Avanti CB base antennas  
from \$20.50 to \$404.00



## RACER 27™ CB Mobile Antenna Magnetic mount

Easy to mount on roof or trunk for car, van or truck — no holes to drill — fast removal for hide away or car washing. Strong magnet assures position. Mylar pad guards vehicle finish.

Hermi-coil (Hermetically sealed coil) — A special molding process provides a weather-proof coil environment. Helps maintain the characteristic antenna impedance, even in damp or salt water atmosphere. Hermi-coil also helps eliminate internal surface leakage.

Ribbed base — Provides a long leakage path used in high voltage insulators, spark plugs, etc.

Specifications: Electrical ¼ wave length  
• Unity gain • 27 MHz  
• V.S.W.R. — 1.3:1 or better  
• Coil — shunt fed hermicoid

**MODEL AV-727 Mobile Antenna System**  
with 48" whip, 17' coaxial cable with magnetic mount. 40 channel \$32.95

Avanti makes a complete line of high performance mobile CB antenna systems from \$11.95 to \$72.50



FREE 24 PAGE CATALOG

# avanti

Avanti Research & Development, Inc.

Established 1964

340 Stewart Ave., Addison, IL 60101 USA

creators of the  
famous

MOONRAKER®

© Copyright 1977.  
All rights reserved

CIRCLE 79 ON FREE INFORMATION CARD

## EQUIPMENT REPORT

continued from page 24

Finally, the table contains a listing for the Kansas City Standard Cassette Interface used by computer hobbyists. The frequency counter can also be used to test TV ultrasonic remote control systems. The transmitters can be set right on the button for each function, and the receivers checked with equal ease.

The ACCU pushbutton stands for accumulate and reads the total number of cycles or events (switch opening or closing, etc.) occurring at a given time. This reading is set to zero by pushing the RESET button, and stopped by opening the input circuit at the end of the desired time.

When you press the pushbutton marked TIME, the display starts counting instantly in hundredths of a second. The reading can be returned to zero by pressing the RESET pushbutton. This function can also be used as a electronic stopwatch. A control cable with a pushbutton switch or electronic actuator on it is plugged into the rear-panel jack. Press the TIME button and then the RESET button. To start the count, the control switch is opened (or the electronic actuator is driven to a logic-high level, not more than 5 volts). When the switch is closed, the count stops (to a logic-low level), and is retained on the display until the RESET button is pressed.

Next to the RESET button is the gate TIME pushbutton mentioned before, for higher resolution. Finally, the last pushbutton on the far right is a  $\times 1$ – $\times 10$  attenuator selector for reading signals at a higher level than the input limit: up to 200 volts (DC + AC peak) to 500 Hz, and 100 volts on higher frequencies. The input is a standard BNC jack and has a 1.0-megohm input impedance. Therefore, standard 10:1 oscilloscope probes can be used where circuit loads must be kept low.

The instruction manual gives complete details of all the tests that can be made by the model 1820. It even includes schematic diagrams of the electronics needed to make this kind of control possible, mostly debouncing circuitry for greater accuracy. Practically any kind of electrical transducer can be used with it to make many measurements. **R-E**

## Hickok Model 517 Dual-Trace Oscilloscope

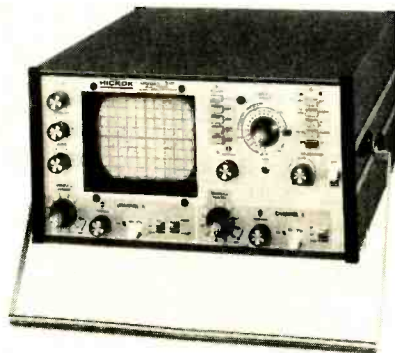

CIRCLE 103 ON FREE INFORMATION CARD

THE HICKOK ELECTRICAL INSTRUMENT COMPANY, 19514 Dupont Avenue, Cleveland, OH 44108 has just released two triggered-sweep oscilloscopes; the model 515 (a single-trace scope) and the model 517 (a dual-trace version, shown here). The specifications are identical, except for an added channel on the model 517, which was the one tested.

This scope is an impressive instrument. The cabinet is a "laydown" style with the cathode-ray tube (CRT) at the top on the left-hand side, and controls placed below and to the right. The controls for the two input channels are side by side at the bottom, making them easy to get at. All panel controls are grouped into two color-coded areas: Blue for the vertical inputs, for the level control and for all switches used with these. All the triggering controls, the level set, etc., are contained in the green area at the top of the panel on the right. The case has a locking bail-handle that can be used to set it at any desired viewing angle.

Each channel has a calibrated step attenuator with a 12-step range from 10 mV-per-centimeter to 50 volts-per-centimeter. This control serves a dual function. The center knob is a variable attenuator; turning it fully clockwise and clicked puts it in the CALIBRATE position. A full turn counterclockwise extends the vertical range down to 5 mV-per-centimeter. Channel amplifiers A and B are identical, and can be AC- or DC-coupled; the center position grounds the input for positioning of the trace. The bandwidth is given as up to 15 MHz in either channel. Our tests proved this rating is quite conservative, since we observed signals up to 27 MHz with readable deflection.

The TIME/CM (horizontal sweep speed) switch can be varied from 0.5  $\mu$ s-per-division down to 0.2 seconds-per-centimeter, in 18 calibrated steps. A  $\times 5$  sweep-multiplier extends the upper limit to read only 100 ns-per-centimeter. The model 517 can be triggered by internal sync, or by an external trigger pulse. An AUTO-NORMAL switch triggers the sweep so that you can see the baseline for setup and adjustments. A selector switch marked "+/-" lets you select either positive or negative polarity for triggering. All these controls are widely spaced pushbuttons. A continuously variable trigger level gives positive trigger control. Other pushbuttons display only the Channel A, Channel B or DUAL (both channels at once) modes; the ADD mode displays the Channel A signal added to Channel B, with the resultant waveforms.

Both model 515 and model 517 are meant to be general-purpose scopes for any industrial/lab/radio/TV application. For TV work, a special TV-V/H switch selects a sync-separator circuit so that the pattern locks on either horizontal or vertical signals. Whether horizontal or vertical sync is used depends on the position of the TIME/CM switch, which automatically selects the correct sync, depending on the sweep speed. We gave the model 517 our pet "acid test": display a color-bar signal from a generator at horizontal rate. This is a beast to lock onto, since it consists of a whole row of sharp pulses of the same amplitude. The model 517 grabbed it and held it firmly.

The resolution is very good. In this same test (using the sweep expander) we were able to count the number of cycles (10 in all) in one bar of the color-bar pattern! Actually, the expanded sweep wasn't needed; we just used it to verify our count in normal operation. The risetime is very good. We fed it patterns from a digital color-bar generator having an excellent squarewave output, and the risetime was almost unmeasurable. A good squarewave probe-calibration signal (7.5 volts P-P) is provided via a jack on the panel. This is used for setting frequency-compensating trimmer in the  $\times 10$  probes.

The model SP-17 Probe Kit contains two special probes. One probe is the model SP-7, a

continued on page 28



# Vaco.



## Super Case

Vaco means value and variety.

Like our Super Case. A great value with great variety. 48 professional problem-solving tools from screwdrivers and nutdrivers to pliers, wrenches, crimping tools, and more! All right at hand. And all unconditionally warranted.

You'll find the Super Case and all the other fine Vaco tools in our exciting new 72-page 1978 catalog. FREE for the asking! Just write:

Vaco Products Company, 1510 Skokie Boulevard, Northbrook, Illinois 60062

Send for your **FREE**

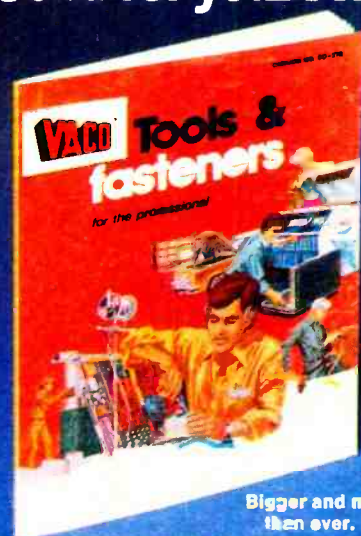

Bigger and more colorful than ever. It's Super!

**1978 VACO catalog!**

CIRCLE 72 ON FREE INFORMATION CARD

**FC45 Only \$448**

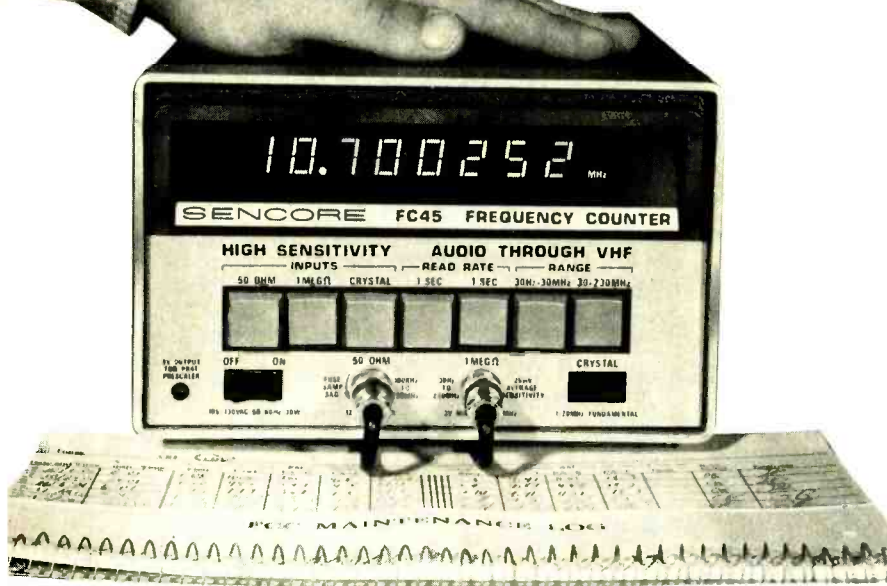

**the interference free frequency counter**  
**all the way through 30 MHz & 600 MHz with Prescaler**  
**A Frequency Counter that you can really count on...**

**Right at the radio or TV transmitter site**, next to a high power transceiver and even on top of a color TV high voltage cage. Engineers and technicians are amazed as they pick up the only double-shielded frequency counter and use it where their high-priced counter won't stand still. Only the FC45 has a vinyl-clad, steel-covered case, to do that extra shielding, and matched and shielded input leads. Others don't even provide the test leads, let alone match them to your instrument.

**When needing super accurate frequency measurements** to five times better than FCC specs all the way through 600 MHz UHF. The easy to use, direct-reading, 8-digit pushbutton FC45 has an accuracy of 1 part per million (.0001 percent). Time base crystal is hand selected, baked in an oven for 30 days, installed into your FC45 and run for 30 days again before redocumenting and shipping. That's how far Sencore goes to protect your FCC license.

**When checking in low level circuits** all the way down to 25 millivolts and all the way up through 230 megahertz. Other counters fall off at about 80 MHz on their once Megohm input. Exclusive "Snoop Loop", with this outstanding sensitivity, enables you to "pick up" all the way back to the oscillator without loading the circuit; avoids direct connection to transmitter output, too. Plus exclusive crystal check for checking crystals out-of-circuit.

**And you can extend these FC45 reliable uses even further with...**



**PR47 600 MHz Prescaler:** Extends FC45 from 230 MHz to 600 MHz by plugging into special FC45 power jack and inserting into input lead .....\$125

**PR50 Audio Prescaler:** Extends use of FC45, or any other frequency counter, to .1 Hz and .01 Hz for audio and subaudible measurements. Same size and use as PR47 .....\$125

**PL207 "Snoop Loop":** RF pick-up loop with cable to avoid direct circuit connection .....\$9.95

Write for 24-page FC45 Frequency Counter Sencore News or order instrument from: **Sencore, Inc., 3200 Sencore Drive, Sioux Falls, South Dakota 57107**

**SENCORE** In Canada Superior Electronics Form 1753  
CIRCLE 28 ON FREE INFORMATION CARD

×10 low-capacitance probe, and the other is the *model SP-6*, a combination ×1/×10 probe. A slide switch on the probe handle selects either mode; the center switch position grounds the input for setup. The basic probe has a very sharp tip. There are four slip-on adapters: a spring-loaded hook; an insulator cap that covers everything but the sharp probe tip; a special adapter with two small guard insulators that have a sharp tip between them, for checking one pin of an IC without shorting; and a BNC adapter. A tiny insulated screwdriver adjusts the trimmer in the probe. The *model SP-17 Probe Kit* comes in a sturdy plastic pouch with a zipper, so you can't lose those little adapters in your kit. The cables are 1.5 meters long or about 5.5 feet.

Unlike some early triggered-sweep scopes, the *model 517* can perform sweep alignment. The last TIME/CM switch position is labeled EXT HORIZ. The horizontal sweep signal is fed into the external trigger jack; the variable control on the TIME/CM switch then acts as a horizontal-gain control. A vertical input signal is fed into the Channel A input. The *model 517* has one feature I used to like on my old scopes, but haven't seen lately: a trace-invert switch. This switch can "make the curve go the right way," if you're like me, and want the curve to go up. The switch has other uses: In normal operation, in the ADD mode (Channel A + Channel B), flipping the switch to the INVERT position displays the difference signal, or Channel A - Channel B. For best triggering on video signals, this switch should be set so that the sync-tips point down.

The CRT is a rectangular SDEP31 with a built-in graticule. For vectorscope analysis, you can slip in a vector graticule over this graticule; this, too, comes with the instrument. The INTENSITY, FOCUS and ASTIGMATISM controls are grouped out of the way at the top left-hand corner of the panel.

This is a good, versatile instrument, and it should prove of great value to anyone who needs a reliable and accurate oscilloscope. Its price tag is \$695. **R-E**

**Heathkit Series 5280 Test Instruments**

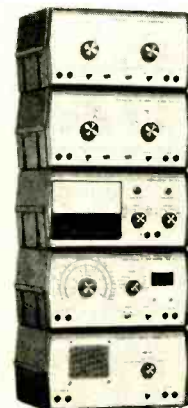

**CIRCLE 50 ON FREE INFORMATION CARD**

THE HEATH COMPANY HAS JUST RELEASED its Series 5280 test instruments. There are five instruments, all in identical plastic cases that can be stacked for a neat test-center layout. The cases are 11 inches wide, 5 1/4 inches high  
continued on page 30



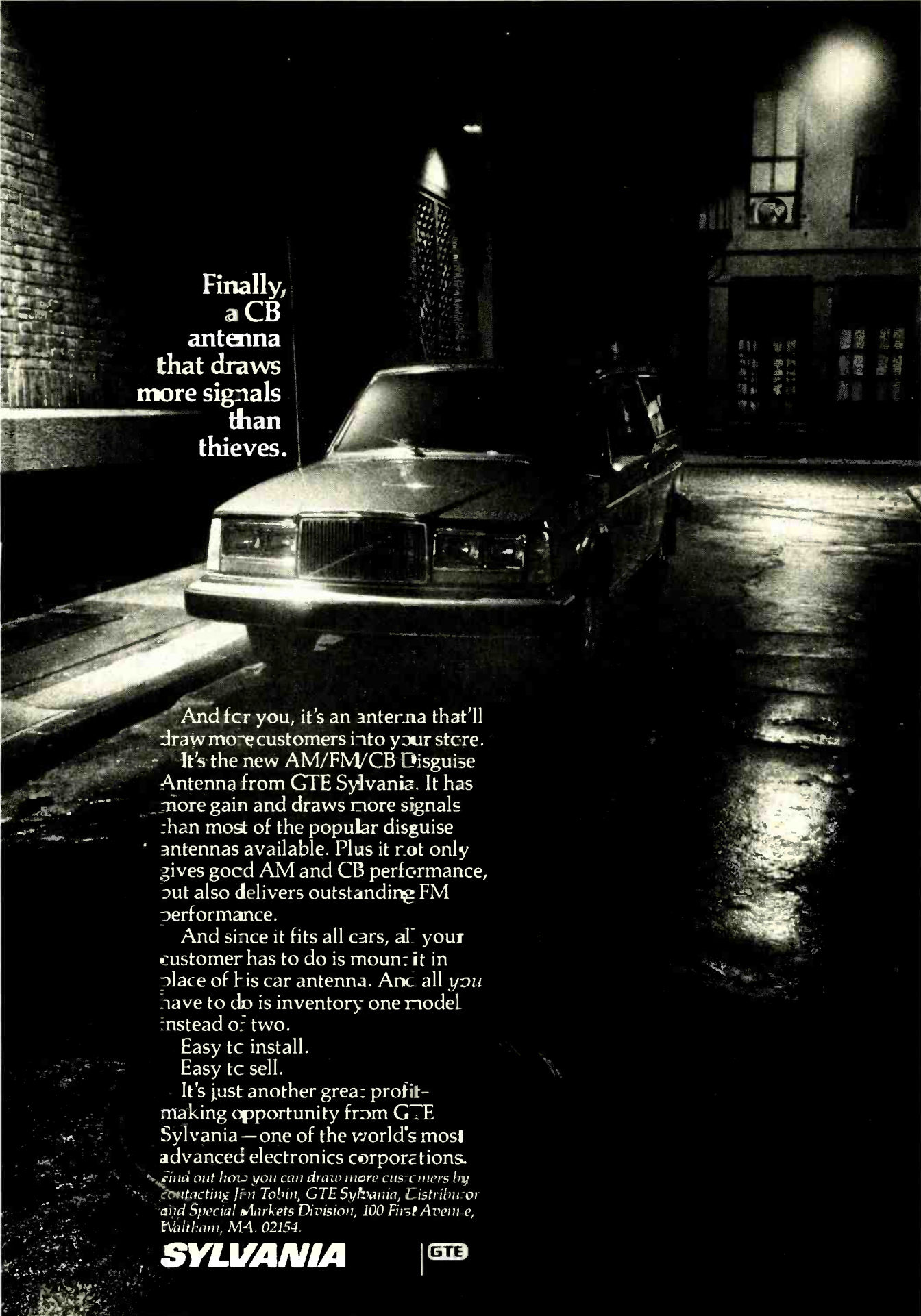

Finally,  
a CB  
antenna  
that draws  
more signals  
than  
thieves.

And for you, it's an antenna that'll draw more customers into your store.

It's the new AM/FM/CB Disguise Antenna from GTE Sylvania. It has more gain and draws more signals than most of the popular disguise antennas available. Plus it not only gives good AM and CB performance, but also delivers outstanding FM performance.

And since it fits all cars, all your customer has to do is mount it in place of his car antenna. And all you have to do is inventory one model instead of two.

Easy to install.

Easy to sell.

It's just another great profit-making opportunity from GTE Sylvania — one of the world's most advanced electronics corporations.

Find out how you can draw more customers by contacting Jim Tobin, GTE Sylvania, Distributor and Special Markets Division, 100 First Avenue, Waltham, MA, 02154.

**SYLVANIA**

**GTE**

CIRCLE 5 ON FREE INFORMATION CARD

## EQUIPMENT REPORT

continued from page 28

and 7/8 inches deep. Typical weight is 3 1/4 pounds. All solid-state, the instruments can be powered either by two 9-volt batteries or by an AC power supply having five plugs that fit sockets on the back of each unit.

First, in numerical order, is the *model IG-5280* RF Oscillator. It has an RF output from 310 kHz to 110 MHz on fundamental frequencies, in five overlapping bands. An extra band is calibrated on the scale, 110 to 220 MHz on harmonics. The AF modulation is 1 kHz, and can be used as an audio test signal. Both RF and AF outputs have variable controls; the AF control serves as a modulation-percentage control for RF. Our test sample showed excellent accuracy.

Next, the *model IB-5281* Inductance-Resistance-Capacitance Bridge. It uses a Wheatstone circuit that is AC-driven so that capacitors and inductors can be checked. The instrument's resistance is from 10 ohms to 10 megohms; inductance is from 10  $\mu$ H to 10 H; and a capacitance from 10 pF to 10  $\mu$ F, all on three ranges. The panel meter shows the null, and parts can be checked against an external standard for matching. A special scale shows matching and the percentage of error. We checked several known components with good results.

The *model IG-5282* Audio Oscillator has a range from 10 Hz to 100 kHz, and has separate sinewave and squarewave outputs. For sinewave operation, only the sinewave section need be switched on; for a squarewave, both sections must be on. This confused me at first, but after taking my usual drastic step (reading the manual!) the problem cleared up. Sinewaves

are clean and the squarewave has excellent risetime. Sample waveforms for checking and identifying both sinewave and squarewave distortion are shown in the manual.

The *model IT-5283* is an RF/AF Signal Tracer. This instrument follows RF-IF signals through any radio, as well as AF signals from the detector on. Switching is performed in the test-probe tip; a diode symbol shows you the RF reading. A novel feature is used in the third switch position: it becomes an audible voltohmmeter! The input goes to a relaxation oscillator using a unijunction transistor. You can read resistance from 0 up to 5 megohms. You hear an audible tone, and as resistance goes higher, the frequency goes down. The *model IT-5283* can also be used as a DC voltmeter, from -3 volts to +20 volts; as the voltage goes down, the frequency goes down. This instrument can also be used for checking logic states. You soon learn to identify the tone produced by a logic high (1) and a logic low (0).

Last, but not least, the test instrument you should build first (if you plan to obtain them in kit form) is the *model IM-5284* Multimeter. The AC or DC voltage ranges are from 1.0 volt up to 1000 volts. On the DC range, the input impedance is 10.0 megohms; on the AC range, the impedance is 1.0 megohm. The ohmmeter reads from  $R \times 1$  to  $R \times 1.0$  megohm. The analog panel meter is a 4.5-inch rectangular unit. There are four separate scales and four ranges, 0-1, 0-10, 0-100 and 0-1000, are used. Also provided are an ohms scale and a special scale for the 0-1.2-volt AC range. The ZERO ADJUST and OHMS ADJUST controls are located on the front panel along with the RANGE and FUNCTION switches and the input jacks.

This instrument was checked on all ranges against a high-accuracy digital meter. All the AC and DC voltage ranges read right on the nose. The AC voltage ranges have a good frequency response, accurate up to 100 kHz. The resistance ranges, which were checked against our lab standards, were also accurate. The drift was almost undetectable over a fairly long test.

The operating power supply for all five Series 5280 instruments can be provided by the *model IP-5280-1* AC Power Supply. This has a +9- and -9-volt output, each regulated by its own IC regulator; currents up to 100 mA can be drawn. There are five cables, each with plugs, that are long enough to reach all the instruments even if they are stacked one on top of the other. This compact power supply can be tucked away anywhere. It has an isolating fuse-protected power transformer. No special switch is needed; you just use the on-off switches of the individual instrument.

The Series 5280 can provide the beginner or advanced experimenter with low-cost, accurate and versatile test instruments that are available in kit form or fully built and tested. They should be ideal for use in electronics and electrical schools, or for servicing any kind of equipment. And the stacking feature makes it possible to create some neat and useful layouts for any kind of work. **R-E**

### Spyderco Company Portable Hand

LET'S SUPPOSE YOU WANT TO SOLDER TWO resistors together for a test. You hold one resistor in one hand, and the soldering iron in *continued on page 35*

# Use this versatile frequency counter when accuracy counts.



WD-752A  
\$200.00

See it at your  
VIZ distributor

Exceptional accuracy and sensible features make our new wide-range frequency counter the ideal choice for checking out audio, video, CB, ham radio and other communications equipment.

- Wide range—10Hz to 60MHz
- Precise 10.000MHz crystal-controlled time base for  $\pm 0.1$ ppm stability
- 1KHz audible tone for SSB carrier frequency measurement
- Selectable input sensitivity (for noise rejection)—10 or 100mV
- 6-digit bright LED readout
- Indicators for signal, overflow, and range
- Small and compact; ac operated

**VIZ Test  
Instruments Group  
of VIZ Mfg. Co.**

335 E. Price St., Philadelphia, Pa. 19144

Formerly  
Instruments







# Foggy about computers?

## Sams new library of computer books provides your clear course

You've counted on Sams for years to bring you clear, concise information about many subjects. Now obtain explanations and data you need to work with and enjoy the fascinating computer world — written by experts.

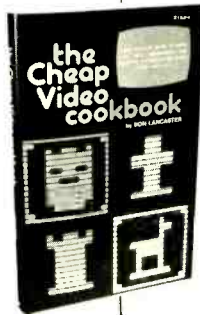

### The Cheap Video Cookbook

By Don Lancaster

A complete guide to super low cost alphanumeric and graphic microprocessor-based video displays. Contains complete construction details on a seven IC circuit that dramatically slashes the cost of getting words, op-code, and graphics out of a microcomputer and into a television set. Includes thoroughly documented and debugged software. Enables you to produce virtually any alphanumeric format, including scrolling 24 lines by 80 characters, and virtually any graphics format, including high resolution 256 X 256 mode and four-color graphics. Also contains complete details on transparency techniques that let you compute and display at the same time with high throughput. 288 pages; 5½ X 8½; softbound. No. 21524 \$8.95

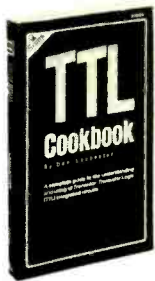

### TTL Cookbook

By Don Lancaster

You'll discover what Transistor-Transistor Logic is, how it works and how to use it. Discusses practical digital applications. You'll learn to build TTL systems that entertain, test and train. 336 pages; 5½" X 8½" softbound. No. 21035 \$9.50



### TV Typewriter Cookbook

By Don Lancaster

Your comprehensive guide to low cost television display of alpha-numeric and graphics data for microprocessor systems, word processing, TV titling and video games. Covers configurations, memories, keyboards, techniques and much more. 256 pages; 5½" X 8½" softbound. No. 21313 \$9.95

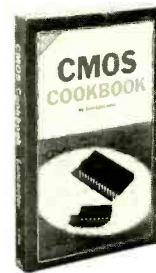

### CMOS Cookbook

By Don Lancaster

Your complete guide to the understanding and use of Complementary Metal-Oxide-Silicon integrated circuits. Gives usage rules; power supply design examples; applications; information on breadboards, testing, tools, and interface. Detailed coverage of logic and more.

416 pages; 5½" X 8½" softbound.  
No. 21398 \$10.50



### How to Buy & Use Minicomputers & Microcomputers

By William Barden, Jr.

This manual gives you the basics of minicomputers and microcomputers. Explains their hardware and software, the peripheral devices available and various programming languages and techniques. Allows you to decide which system is best for your needs. 240 pages; 8½" X 11" softbound. No. 21351 \$9.95



### Microcomputer Primer

By Mitchell Waite and Michael Pardee

Written for the beginner in the computer field. All the basic concepts and characteristics of microcomputers are explored. The easy to understand language prepares you for further study. 224 pages; 5½" X 8½" softbound. No. 21404 \$7.95

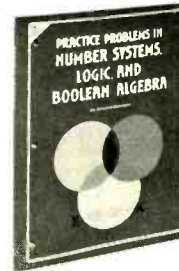

### Practice Problems in Number Systems, Logic, and Boolean Algebra (2nd Edition)

By Edward Bukstein.

This workbook is a 64-lesson introduction to digital computer mathematics. Problems designed for classroom or individual use. Pages are removable. Includes answers for all exercises. 144 pp. 8½ X 11; softbound. No. 21451. \$6.50



### Z-80 Microcomputer Handbook

By William Barden, Jr.

The Zilog Model Z-80 represents a microprocessor that is extremely sophisticated and attractive to many computer users. Provides essential information on Z-80 technology. Organized into three sections: hardware; software; microcomputers; built around the Z-80. 304 pages; 5½ X 8½; softbound. No. 21500 \$8.95



### Your Own Computer

By Mitchell Waite, and Michael Pardee

An introduction for the novice to the fascinating world of home computers. Reveals the potential of these technical marvels. Tells how personal computers will soon be used to regulate energy in the home, regulate spending habits and even to provide entertainment for the family. 80 pages; 5½ X 8½; softbound. No. 21483 \$1.95

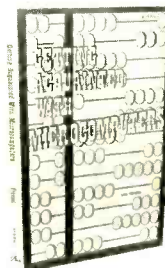

### Getting Acquainted With Microcomputers

By Louis E. Frenzel

Learn about microcomputers in an effective, lowcost manner. The essential information contained in this book has been compiled especially for engineers, technicians, scientists, but it will also prove invaluable to those who want to learn more about hobby and personal computing. 288 pages; 5½ X 8½; softbound. No. 21486 \$8.95





### How To Program Microcomputers

By William Barden, Jr.

Explains assembly-language programming of microcomputers based on the Intel 8080, Motorola MC6800, and MOS Technology MCS6502 microprocessors. Basic concepts, number systems and operations, computer operation and computer codes are examined. Microcomputer architecture and operation are discussed. The author concludes with a number of useful precanned operations. 256 pages; 5 1/2 X 8 1/2; softbound. No. 21459 \$8.95



### Using The 6800 Microprocessor

By Elmer Poe

Acquaints the reader with the hardware and the software of the 6800 "fun" machine. No special background in digital electronics is necessary. Guides the reader through all phases of programs that demonstrate the practical use of a 6800 system. Fifteen information packed chapters. Appendix includes a programmer's card. 176 pages; 5 1/2 X 8 1/2; softbound. No. 21512 \$6.95

## The Blacksburg Continuing Education Series™

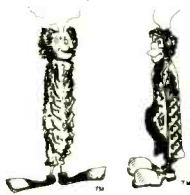

It has long been the objective of the "Blacksburg Group" to develop timely and effective educational materials and aids that will permit students, engineers, scientists and others to quickly learn how to apply new technologies to their particular needs. The members of this group have long been involved in digital electronics, minicomputers and microcomputers. Since 1974 they have collaborated as a group in the development of textbooks, short courses, magazine columns and hardware. *The Blacksburg Continuing Education Series* is an easy to read format consisting of 15 titles. Subjects range from basic electronics through microcomputers, operational amplifiers and active filters. Each title in the series includes detailed experiments, "hands-on" learning experiences, and examples to reinforce basic concepts. Book Size 5 1/2" X 8 1/2", softbound.



### 8080 A Bugbook: Microcomputer Interfacing And Programming

By Peter H. Rony, David G. Larsen, and Jonathan A. Titus

Teaches the skills needed to use an 8080-based breadboard microcomputer system. Covers the principles, concepts and applications of an 8-bit microcomputer based on the 8080 microprocessor IC chip. Presents the four fundamental tasks of computer interfacing: (1) generation of device select pulses; (2) latching of output data; (3) acquisition of input data; (4) servicing of interrupt signals. 416 pages No. 21447 \$10.50

### DEBUG: An 8080 Interpretive Debugger

By Jonathan A. Titus and Christopher A. Titus

Describes DEBUG, a software debugging package for 8080-based microcomputers, and how it can be applied to program development and testing. Complete with hexadecimal and octal listings. 112 pages. No.21536 \$4.95

### NCR Data Processing Concepts Course

By NCR Corporation

Here is a general introduction to data processing, computers, and logic for those interested in how a computer works. Includes sections on digital logic and mathematical operations. Also covers Input/Output devices, memories, and computer control. 320 pages. No. 21547 \$9.50

### Microcomputer Software

By David G. Larsen, Peter R. Rony, Jonathan A. Titus, and Christopher A. Titus

A detailed approach to assembly language programming for 8080 or 8085-based computers. Covers basic and advanced instructions, mathematical manipulations, number-base conversions, command decoders, arrays and tables, interrupt programming, and more. With complete, tested programs in standard mnemonics. 304 pages No. 21541 \$9.50

### Logic and Memory Experiments Using TTL Integrated Circuits

By David G. Larsen and Peter R. Rony

A "hands on" introduction to the use of 7400-series devices, memories, display and arithmetic elements. The emphasis is on experiments that are used by the reader to explore and use digital circuits. Two books.

Book 1; 384 pages No. 21542 \$10.50

Book 2; 352 pages No. 21543 \$9.95

Two Volumes No. 21544 \$18.95

### Interfacing and Scientific Data Communications Experiments

By David G. Larsen and Peter R. Rony

Describes the use of UART and USART "chips" for serial data communications between instruments and computers. The operation of teletypewriter interfaces and serial transmission circuits are explored. With experiments and circuit details. 160 pages; No. 21546 \$5.95

### NCR Data Communications Concepts

By NCR Corporation

Explores the various concepts, techniques, and limitations of data communications. Written mainly for telephone-based communications, but just as applicable to other forms of data communication. Basic carrier systems, transmission lines, modems, and more. 192 pages No. 21548 \$6.95

### Introductory Experiments in Digital Electronics and 8080A Microcomputer Programming and Interfacing

By Peter R. Rony, David G. Larsen, and Jonathan A. Titus

A combined approach to digital electronics and 8080-based microcomputers covering basic gates through microcomputer interrupts, with hardware and software examples. Experiments teach digital logic breadboarding, circuit design and microcomputer interfacing. Two books: 512 pages each;

Book 1 No. 21550 \$12.95

Book 2 No. 21551 \$12.95

Two Volumes No. 21552 \$23.95

### Microcomputer-Analog Converter Software and Hardware Interfacing

By Jonathan A. Titus, Christopher A. Titus, Peter R. Rony, and David G. Larsen

Covers the microcomputer hardware and software necessary to interface A/D and D/A converters to 8080-based microcomputer systems. Also discusses sample-and-hold and multiplexer circuits. With experiments and completely documented computer programs. 320 pages;

No. 21540 \$9.50

## Send Your Order TODAY!

Send books checked below, \$\_\_\_\_\_ enclosed (please enclose check of money order). \* I understand that, if not completely satisfied, I may return my order within 10 days for a full refund.

\*Include sales tax where applicable. Canadian prices slightly higher.

- |  |  |  |
|--|--|--|
| <input type="checkbox"/> 21035 \$ 9.50 | <input type="checkbox"/> 21404 \$ 7.95 | <input type="checkbox"/> 21486 \$ 8.95 |
| <input type="checkbox"/> 21313 \$ 9.95 | <input type="checkbox"/> 21451 \$ 6.50 | <input type="checkbox"/> 21500 \$ 8.95 |
| <input type="checkbox"/> 21351 \$ 9.95 | <input type="checkbox"/> 21459 \$ 8.95 | <input type="checkbox"/> 21512 \$ 6.95 |
| <input type="checkbox"/> 21398 \$10.50 | <input type="checkbox"/> 21483 \$ 1.95 | <input type="checkbox"/> 21524 \$ 8.95 |

NAME \_\_\_\_\_ (Please print)

ADDRESS \_\_\_\_\_

CITY \_\_\_\_\_ STATE \_\_\_\_\_ ZIP \_\_\_\_\_

### THE BLACKSBURG CONTINUING EDUCATION SERIES™

- |  |                                       |                                       |
|--|---------------------------------------|---------------------------------------|
| <input type="checkbox"/> 21447 \$10.50 | <input type="checkbox"/> 21536 \$4.95 | <input type="checkbox"/> 21547 \$9.50 |
|--|---------------------------------------|---------------------------------------|

The following books will be available during the month specified.

- |  |   |
|--|---|
| <input type="checkbox"/> 21548 June 1978 \$ 6.95   | <input type="checkbox"/> 21541 Sept. 1978 \$ 9.50 |
| <input type="checkbox"/> 21550 July 1978 \$12.95   | <input type="checkbox"/> 21542 Oct. 1978 \$10.50  |
| <input type="checkbox"/> 21551 July 1978 \$12.95   | <input type="checkbox"/> 21543 Oct. 1978 \$ 9.95  |
| <input type="checkbox"/> 21552 July 1978 \$23.95   | <input type="checkbox"/> 21544 Oct. 1978 \$18.95  |
| <input type="checkbox"/> 21540 August 1978 \$ 9.50 | <input type="checkbox"/> 21546 Oct. 1978 \$ 5.95  |

# Howard W. Sams & Co., Inc.

4300 West 62nd Street/Indianapolis, Indiana 46206

Available in Canada: Lenbrook Industries Ltd., Scarborough Ontario M1H 1H5.

TKG42

# Performance and Price... there's no tradeoff in B&K-PRECISION scopes.

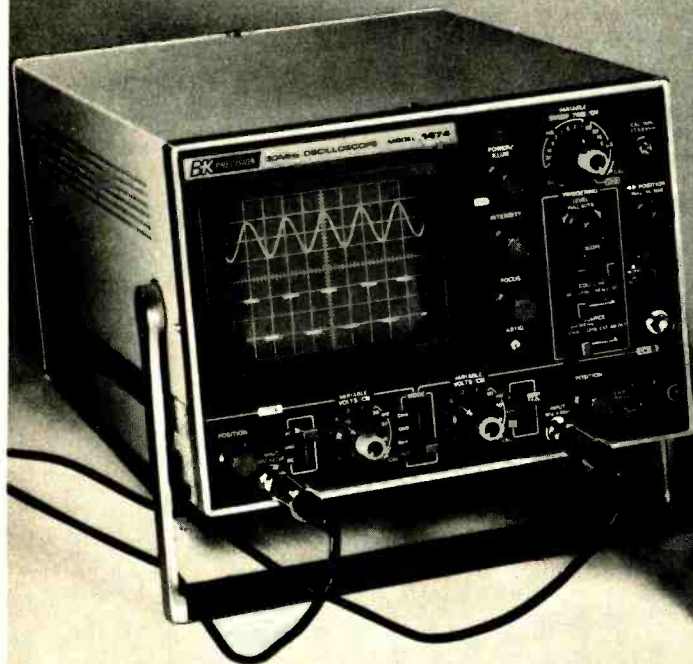

Model 1474 \$999 including probes



Model 1432 \$750 including probes

**F**or field or lab work, Dynascan has a quality scope to fit your needs. B&K-PRECISION has taken a no-nonsense, cost-effective approach to oscilloscope design. Our scopes are rugged dependable instruments, designed to match the features and performance of far more expensive scopes, without matching their high prices. Typical of this approach is our Model 1474 30MHz dual-trace lab scope and our new Model 1432 15MHz portable dual-trace scope.



The B&K-PRECISION Model 1474 is the most cost-effective dual-trace scope available. No compromise features include a built-in signal-delay line, 5mV/cm sensitivity, switchable high- and low-pass triggering filters and a TTL compatible Z-axis input. Vertical response is typically down only -6dB at 49MHz. The 1474 is excellent for microprocessor work, as signal delay and the 30MHz minimum bandwidth allow you to examine short pulse waveforms.



The new Model 1432 portable dual-trace scope is one of our best values. This compact portable offers optional rechargeable battery pack and full lab-scope features. An automatic battery charger is built-in as a standard feature. Sensitivity is 2mV/division over a DC to 15MHz range. Bandwidth response is typically down only -6dB at 25MHz. Special features include algebraic addition and subtraction of two input signals, 19 calibrated sweep ranges and front-panel X-Y operation.

Off-the-shelf delivery is another of our features, and it's the one you can take advantage of first. We're so sure that B&K-PRECISION scopes will fill your needs, that we can offer a no-obligation, ten-day free trial. Contact your local B&K-PRECISION distributor for immediate delivery or a demonstration.

**BK PRECISION** **DYNASCAN CORPORATION**

6460 West Cortland Street, Chicago, Illinois 60635 • 312 / 889-9087

In Canada: Atlas Electronics, Ontario • Intl. Sls: Empire Exporters, Inc., 270 Newtown Road, Plainview, L.I., NY 11803

CIRCLE 80 ON FREE INFORMATION CARD

[www.americanradiohistory.com](http://www.americanradiohistory.com)



## EQUIPMENT REPORTS

continued from page 30

the other. Then, you chase the loose resistor all over the bench, solder it, and then you move just as the solder sets! What you need at times like this is another hand.

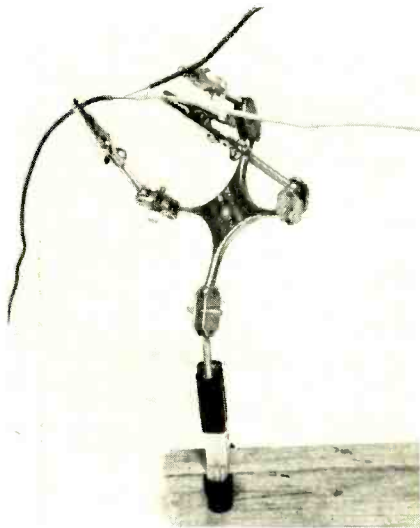

CIRCLE 105 ON FREE INFORMATION CARD

The Spyderco Company, Box 3517, Redding, CA 96001 has one for you called *The Portable Hand*. It has four arms, each with an adjustable ball-socket joint with a thumb-screw. The arms can be set to any position or angle you wish, and are mounted on a stamped

metal star that can be placed on the bench as a base, or fastened with a screw through the center. Three of the arms end in standard Mueller Series 60 alligator clips. These clips are secured by a brass collar with a set-screw, which makes them easy to replace if damaged. The clips will hold the leads of any small components. If necessary, they can be padded by slipping a piece of spaghetti wire over the jaws.

The fourth arm has a larger Mueller *Hippo-Clip* with rubber-padded jaws and grips. You can use this clip to fasten *The Portable Hand* to the bench edge, a shelf, or the top of a TV cabinet, and then just use the other three arms.

This is the kind of handy timesaving device that I love! An illustrated folder comes with it that shows 18 possible things you can do with it. It is definitely not a toy or a cheaply made gadget to play with. It's very well-built, strong and should withstand long and hard use on the bench. *The Portable Hand* sells for \$9.95, and it should pay for itself soon. **R-E**



*"Of course you're welcome to get a second opinion, doctor! But this first one is still going to cost you \$47.00!"*

**Need help? Call us. Want to help?  
Call us.**  
**Red Cross. The Good Neighbor.**

A Public Service of This Magazine  
& The Advertising Council **Ad Council**

# As Featured in R-E

You probably first found out about the Central Data 2650 computer board when it was featured in the April-June, 1977 issues of Radio-Electronics. Since then we've designed a 16K and 24K RAM board for greater memory capability, an S-100 compatible extender board for easy expansion and two new software packages for program sophistication. We also offer all of the peripherals for a complete computer system. Of course, our board still has all of the same high quality standard features it has always had.

- a 2650 microprocessor
- an 80 character by 16 line display
- a powerful Supervisor Program
- a 300 Baud Cassette Interface
- one parallel input port and one bit settable output port
- 2048 bytes of read-write memory for the video display and your programs

Whether you're an experienced computer user or just a beginner, we can help you build a system suited to your needs. Let us know what you need today.

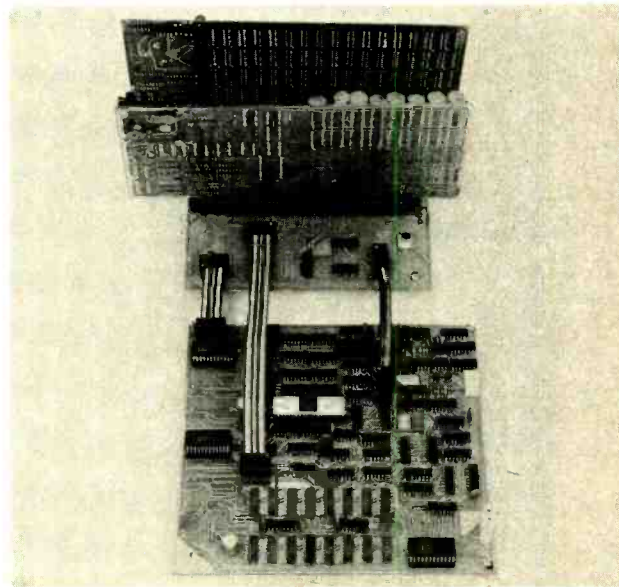

Central Data Corp.

PO Box 2484, Station A  
Champaign, IL 61820  
217-359-8010

CIRCLE 67 ON FREE INFORMATION CARD



# This 8-bit machine, by itself, is as versatile as a lot of systems that include peripherals



Skeptical? For starters, because of its unique design the H8 is the only machine in its price class that offers full system integration yet, with just 4K of optional memory and using only its "intelligent"



Memory Display



Register Display



I/O Port Display

front panel for I/O, may be operated completely without peripherals! In addition, by using the features of its built-in PAM-8 RCM panel control program, the H8 actually allows you to dig in and examine machine level circuitry. Responding to simple instructions, the "intelligent" panel displays memory and

register contents and lets you inspect and alter them even during operation. And for greater understanding, the front panel permits you to execute programs a single instruction at a time. The H8's memory is fully expandable, its 8080A CPU extremely versatile, and with the addition of high speed serial and parallel interfacing you gain the added flexibility of I/O operation with tape, CRT consoles, paper tape reader/punches, and soon floppy disk systems! The H8 offers superior documentation including complete step-by-step assembly and operation manuals, and comes complete with BASIC assembler, editor, and debug software that others charge over \$50 for. H8, simplicity for the beginner, sophistication for the expert and at \$375\* just right for you.



\*Prices are mail order no. FOB, Beaton Harbor, Michigan. Prices and specifications subject to change without notice.

## HEATHKIT COMPUTERS

System Engineered  
for Personal Computing

# H8

Computers, peripherals and nearly 400 exciting, easy to build electronic kits all in your

### FREE Heathkit Catalog



HEATH Schlumberger	Heath Company, Dept. 020-20 Beaton Harbor, MI 48022
Please send me my FREE Heathkit catalog. I am not on your mailing list.	
Name _____	
Address _____	
City _____	State _____
CP-50 _____	Zip _____

CIRCLE 100 ON FREE INFORMATION CARD





# YOUR OWN **Computer**

JUNE 1978

## RADIO-ELECTRONICS SPECIAL FEATURE

- 1 INTRODUCTION TO PERSONAL COMPUTERS—WHAT THEY CAN DO AND HOW TO SELECT YOUR OWN
- 2 WHAT MAKES A COMPUTER A SYSTEM—PERIPHERAL DEVICES AND ACCESSORIES
- 3 THE DIFFERENT WAYS YOU CAN TALK TO YOUR COMPUTER—PROGRAMMING LANGUAGES AND HOW TO USE THEM
- 4 COMPUTER CORNER
- 5 A ROUNDUP OF THE EQUIPMENT AND WHO MAKES IT



# Personal Computers

*Ever wonder what you would do with a possibilities are limited only by your imagination. plus a look at what a computer system consists of and*

**WILLIAM BARDEN**

Buying a personal computer system today is somewhat similar to choosing a wife. Rather than evaluating the field qualitatively and making the choice based on logic, a lot of emotion is involved. This article describes currently available microcomputers and attempts to give the reader some selection guidelines.

### Why buy a microcomputer?

Personal computers are essentially composed of logic circuitry. Unlike complicated special-purpose circuitry



**BYT-8 microcomputer from Byte Incorporated has toggle switches and LED indicators on the front panel.**

that performs only one dedicated function, however, the microcomputer can be rapidly and easily changed to perform a variety of functions by reprogramming. The circuitry is "told" how to perform each specific job demanded of it by its owner. Using any of the many microcomputers available today it is possible (at reasonable cost) to:

- Play a variety of games from Star Trek to involved combat games.

- Create and play synthesized musical selections
- Understand human voice commands.
- Speak with a Scots brogue.
- Set up an energy conservation system for your home with the computer controlling the heating and cooling, and possibly even opening and closing windows automatically.
- Prepare your income tax.
- Set up a weight-loss program that is specifically tailored to the amount of weight you want to lose, how fast you want to lose it and how much work you want to put into it.
- Compute your payroll; figuring tax deductions, health insurance, social security, etc.
- Act as a bill collector; automatically preparing collection letters that are individualized for each customer and reporting back to you on the status of each customer and the total of your unpaid accounts.
- Balance your checkbook and estimate your net worth.
- Inventory parts for your small business.
- Decipher and generate Morse code for an amateur radio transceiver.
- Provide a burglar and fire alarm for home or business.
- Provide automatic telephone dialing and decode remote telephone commands.
- Control lights, sprinklers and heating.
- Tutor yourself, spouse and children.
- As more software is developed (more instructions), your computer system can grow to accomplish additional tasks. It is never limited to a specific set of tasks. Whenever you come up with a new job for your machine, a little programming will make it possible for the computer to add still another job.

Now it is possible to design individual, special-purpose circuits so that they can provide most of these functions, but what other design can perform *every* one of these functions and at such a low cost?



**pdp 11/03 MINICOMPUTER from digital shows how information is displayed on a CRT.**

Several years ago, a properly equipped minicomputer would have cost about \$40,000. Now, all the functions described above can easily be implemented on a \$2000 microcomputer system, and many can be performed on a \$600 system. If you're ready to spend what you'd pay for a new TV set or stereo system, just take a look at what your money will buy.

### Microcomputer components

Figure 1 shows typical microcomputer components. The logic components are grouped into *hardware*, *software* and *firmware*.

Hardware consists of the cabinetry that contains the circuitry, necessary power supplies, a real or imaginary bus representing system logic signals, memory, a central processing unit (CPU) and firmware. The bus is the master wiring system of the computer. It can most conveniently be



# Are They Right For You?

computer if you had one in your home? The Here's a look at a few of the many possibilities, what you should look for when selecting your own.

thought of as a wide ribbon cable consisting of as many as 100 separate wires.

In the S-100 bus, for example, there are 100 wires. Each one carries a specific signal. Each circuit board in the computer is set up with a connector that matches the bus. Lead number 1 is always the same in that system, as is lead number 2, and 3 and so on. All bus systems are not compatible. Each one has its own set of connections. This can be both an advantage and a disadvantage.

The good side is that several companies can make products that fit a particular bus. As the computer owner you can then buy plug-ins from a variety of suppliers. However, in practice, there are multiple suppliers for only a small number of the available bus systems. For the others, the only source of add-ons is the original system manufacturer. Don't forget this point. It could cost you dollars when you want to expand your system.

Software is the instructions that

enable the computer to follow your directions and accomplish its task. Again, there are options, mostly in terms of the "language" you use. (For more information on language and programming, see the following article in this special section.) There is also available for almost all personal computers, prepared software on magnetic tape or paper tape that can be used to tell the computer how to do a specific job. Firmware is hard-wired software and cannot be easily changed.

The cabinet in many cases is quite unimpressive. The Apple II and Radio Shack TRS-80 systems are of this type; they contain a minimum of controls and switches. Other microcomputers have a cabinet with a control panel, as is the case with the MITS 8800b and IMSAI 8080 microcomputers; however, a control panel's usefulness is debatable.

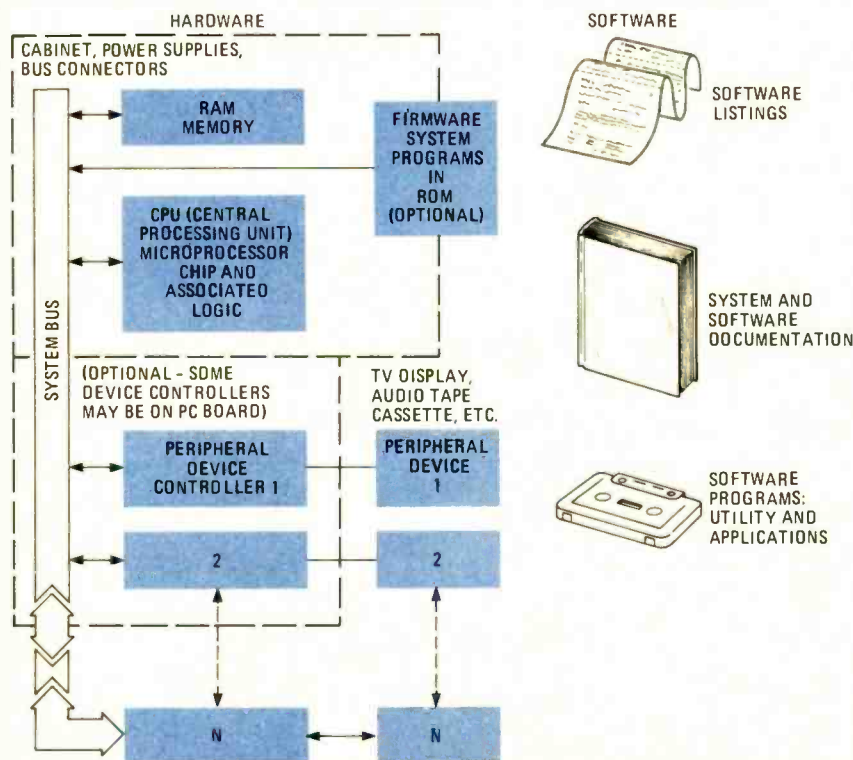
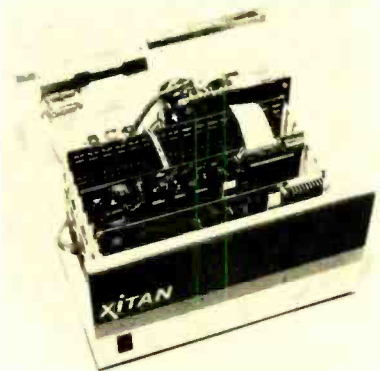

FIG. 1—A MICROCOMPUTER SYSTEM consists of RAM memory, a central processing unit plus system programs stored in ROM memory. Peripheral devices, such as a CRT terminal, printer, or additional external memory are connected to the system via peripheral device controllers. Signals to the various parts of the system are carried along the system bus.



XITAN MAINFRAME from Technical Design Labs has an S100 bus structure.

Within the cabinet are the power supplies and system bus. If the microcomputer is similar to the Byte Incorporated BYT-8, it contains a

crocomputer is an integrated single-board type (PET), the CPU forms part of the logic IC's on the board itself.



**STATIC RAM MEMORY** from Vector Graphic is designed for the S100 bus structure.

The CPU consists of the *microprocessor* IC and any TTL or MOS IC's required to interface the microprocessor to the rest of the system. Almost all personal computers use either the 8080, 6800, 6502, or Z-80 microprocessors as a base around which the microcomputer is built. A comparison of the four types is beyond the scope of this article, but, in general, the current versions of these microprocessors are approximately equal in speed, instruction set and efficiency—much more so than, for instance, the differences between an 8080 microprocessor and its predecessor, the 8008.

(Time out for some definitions. The instruction set is the set of built-in instructions that the microprocessor can inherently perform. Every microprocessor type has its own specific instruction set. Speed relates to how quickly the microprocessor can complete a step in its operation. This time is usually measured in microseconds.)

In many applications, the actual microprocessor IC used will be *transparent* (transparent means that the user will not be aware of the microprocessor and will not know what type is in the machine unless he checks the manual to find out) to the



**H9 CRT TERMINAL** from Heathkit has CRT display plus alphanumeric keyboard.

system user. The differences in speeds and efficiency between the

discrete physical bus. You can look into the cabinet and observe a series of 100-pin connectors mounted on a PC board with 100 etched lines representing the bus. If the microcomputer is a Commodore PET, the bus may be represented only by external connectors and various etched lines on a single large PC board. The bus of a microcomputer is usually similar to the pinout (the diagram that shows where the individual pins on the microprocessor connect and shows their functions) of the microprocessor itself. A microcomputer built around the 8080A microprocessor

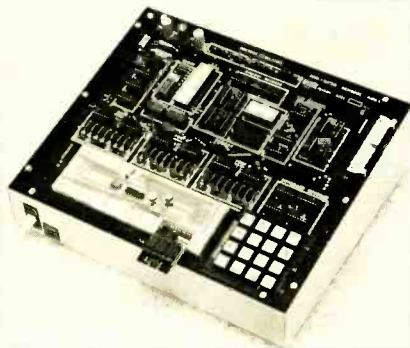

**MINI-MICRO DESIGNER** from E & L Instruments is a breadboarding system for prototyping computer circuits.

has 8080-type signals, one constructed around the 6800 microprocessor has 6800-type signals, etc.

If the microcomputer has a bus with plug-in connectors (as in the MITS 8800b), the microprocessor and associated circuitry will be on a plug-in board called the CPU board. (The CPU is the central processor unit. It is the brain, the control center, of the computer.) If the mi-

**TABLE I—Peripheral Devices For Current Microcomputers**

Device	Explanation	Availability On System Type			
		I	II	III	IV
Keyboard	Similar to typewriter keyboard	BC	A	AB	A
Video display	Alphanumeric and/or graphic	BD	A	AB	A
Teletype	ASR-33 series	BD	A	AB	CD
Audio cassette tape	Secondary storage	BD	A	AB	A
Floppy disc	Secondary fast storage	DE	A	AC	AB
Printer	High-speed hard copy	CE	A	AC	BD
Paper tape equipment	Auxiliary storage	CE	A	BC	CE
A/D, D/A	Analog-to-digital input, D/A output	CE	A	AC	CE
Music synthesizer	Better than a MOOG	CE	A	AC	CE
Speech input/output	Actually sound input/output	CE	A	BC	CE
Relay drivers	For control applications	CE	A	AC	CE

**Notes:**

- I. Microcomputer on a board; II, S-100; III, non-S-100; IV, turnkey system.
- A. Readily available.
- B. Sometimes available.
- C. May be connected with some difficulty or design work.
- D. May be connected with more difficulty or design work.
- E. A major effort.



microprocessors themselves will be secondary to other system attributes such as the efficiency of the software, the design and the bus structure.

Memory will also be contained on separate plug-in modules in a bus-oriented microcomputer (8800b), or on a portion of the motherboard (PET). All current microcomputers can address up to 65,536 bytes of



**RADIO-SHACK'S TRS-80 microcomputer system has memory and keyboard.**

memory directly (sixty-four 1024-byte segments, or 64K). In practice, this memory range is divided between user-accessible memory and

firmware memory. If 10K bytes are used for firmware, for example, only 54K bytes are available to the system user.



**COMPUCOLOR offers microcomputer and full-color graphics terminal in single enclosure.**

The firmware portion of memory consists of read-only memory, physically represented by ROM, PROM, or EPROM (Read-Only Memory, Programmable Read-Only Memory, or Erasable PROM). Generally, the firmware includes the manufacturer's systems software programs to provide

file manage, an operating system and a BASIC interpreter. Firmware is included with such microcomputers as Radio Shack's TRS-80 and Commodore's PET, and can be added to virtually any other microcomputer. Firmware programs are nonvolatile, that is, turning off the computer will not destroy the program burned into the PROM.

Firmware is an easy way to add specific functions to a computer. Unlike entering a program into memory, firmware does not consume any memory space and it cannot be erased (with the exception of EPROM's which can be erased and reprogrammed after being removed from the computer). One way to think of firmware is as a plug-in program—the program is in the form of an integrated circuit.

The remaining portion of memory is RAM (Random Access Memory or Read-Write Memory) and is user-accessible for program storage. Naturally, the more memory, the more flexible and powerful the system. A small system can have 4K of RAM, while a larger configuration might have 32K or more.

**TABLE II—Current Microcomputer Types**

Company	Computer	Type	Microprocessor
Apple Computer	Apple II	I	6502
Central Data	2650 Computer	I	2650 (Signetics)
E&L Instruments	MMD-1	I	8080A
iasis	ia7301	I	8080A
IMSAI	IMSAI 8048	I	8048 (Intel)
MOS Technology	KIM-1	I	6502
Alpha Digital Systems	Alpha Z-80	II	Z-80
Byte Inc.	BYT-8	II	8080A
Cromemco	Various	II	Z-80
Equinox	Equinox System	II	8080A
IMSAI	8080	II	8080A
IMSAI	80/30	II	8080A
MITS	Altair 8800b	II	8080A
North Star	Horizon	II	Z-80A
PolyMorphic Systems	POLY 88	II	8080A
Processor Technology	Various	II/IV	8080A
Vector Graphic	Vector 1	II	8080A
Vector Graphic	Vector 1+	II	8080A
Digital Group	Various	III	Z-80, 8080, 6800, 6502
Heathkit	H8	III	8080A
Heathkit	H11	III	LSI-11 (DEC PDP-11)
Intelligent Systems	Intecolor 8001	III	8080A
Midwest Sci. Instr.	MSI-6800	III	6800
MITS	Altair 680B	III	6800
Ohio Scientific	Challenger II	III	6502A
Southwest Technical	SWTP 6800	III	6800
Apple Computer	Apple II	IV	6502
Commodore	PET 2001	IV	6502
Ohio Scientific	Challenger IIP	IV	6502A
Radio Shack	TRS-80	IV	Z-80

- I—Microcomputer on a board.
- II—S-100 type.
- III—Non-S-100 type.
- IV—Turnkey system.

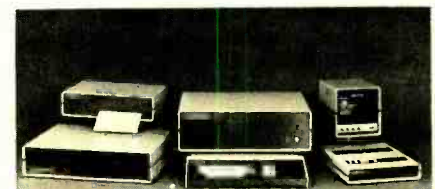

**COMPUTER SYSTEM from The Digital Group shows the various peripheral devices.**

Peripheral devices and controllers for the devices are connected to the microcomputer either directly through the bus or through input/output (I/O) ports and connectors.

The peripheral devices shown in Table I are available for use with current microcomputers. Not every device, however, is available for every microcomputer. Many devices can be connected to virtually any bus by simple interfacing-design work.

A minimum workable system consists of a keyboard (to enter alphanumeric characters), a video display (to display characters or graphic lines), a CPU and memory. Each peripheral device needs a controller, essentially an interface between the bus and device. Since the peripheral devices operate much more slowly than the CPU's hundreds of thousands of instructions per second, the controller buffers the data to match the CPU and device speeds and per-

forms handshaking (a constant back-and-forth verification of the transmission of data) between the CPU and the device. The controller logic again may be contained on a portion of the single-board microcomputer (represented as dashed lines in Fig. 1), or it may be a separate module. Generally, for each new peripheral device that is added to the system, a new controller board must be attached to the bus or to an I/O port.



**ACT-IV CRT TERMINAL** from Micro-Term has alphanumeric keyboard.

Two general types of software are available: *system* (or *utility*) *software* and *applications software*. System software includes programs to help develop other programs, debug or troubleshoot other programs, or manage data in memory or in secondary memory storage, such as a floppy disc or audio cassette tape. System software can be supplied in firmware or on an easily *loadable* program medium, such as audio cassette tape or paper tape. Applications programs range from game packages to accounts-receivable programs, in fact, any program for which the microcomputer system will be used.

Although system software may be supplied in firmware as part of the system, application programs generally come separately in the form of audio cassette tapes, listings and documentation. Not all microcomputer manufacturers supply huge quantities of applications programs. For this reason and for the fun involved, you can write your own applications (or systems!) programs. There are three types of programming available to the user—*machine language*, *assembly language* and *higher-level languages*.



**ALTAIR 680 FROM MITS** has toggle switches and discrete LED indicators on front panel.

*Machine language* is the most basic, tedious and (although some will disagree) least enjoyable of the three methods of programming. Rarely necessary on today's systems, it requires you to enter strings of binary data to program the computer. *Assembly language* allows you to automatically assemble the instructions for the microprocessor being used in the microcomputer, thus eliminating the manual machine language meth-

od. Although machine language and assembly language programs can be executed much faster than other higher-level languages, they are more time-consuming to write. *Higher-level languages* such as BASIC let you program statements that resemble the English language. BASIC is by far the easiest language to learn and the most readily available for microcomputers. Other languages that are offered are FORTRAN, COBOL or APL. Figure 2 compares the three programming types used for a simple program. For more details on the three major programming methods, see "How To Program A Computer" elsewhere in this special section.

### Available microcomputers

Currently, four basic personal microcomputer types are available: the *microcomputer on a board*, the *non-S-100 modular microcomputer*, and the *turnkey system*. Table II lists the lower-cost systems of the four microcomputer types.

The *microcomputer on a board* format is exemplified by such systems as MOS Technology's KIM-1. Other microcomputers of this type



**SYSTEM 8813** from Polymorphic has three floppy disk drives.

are offered by microprocessor manufacturers as single-board evaluation modules. These are designed primarily for the engineer who will either evaluate the microprocessor or integrate the module in a production system.

This type of module (available either as a kit or fully assembled) may include an LED display, a small numeric keyboard, a small systems software program in the firmware and a small user-accessible RAM memory. In some cases, additional memory or I/O devices are added to the basic system. Programming is generally possible only by using machine language.

The advantages of this system are its low cost, hardware simplicity, small size and low power drain. Its disadvantages are its lack of expandability (there are few add-ons avail-

#### MACHINE LANGUAGE

As input on hexadecimal key pad:

- A8
- 0E
- 0A
- 81
- 0D
- C2
- 00
- 01

#### ASSEMBLY LANGUAGE

As input on keyboard:

- XRA A
- MVI B, 10
- LOOP ADD B
- DCR B
- JNZ LOOP

#### HIGHER-LEVEL (BASIC) LANGUAGE

As input on keyboard:

- 350 LET S=0
- 360 FOR I=1 TO 10
- 370 LET S=S+I
- 380 NEXT I

**FIG. 2. ADDING 1+2+3 . . . +10 in three languages**



able) and its less-sophisticated software. This type of microcomputer is probably ideal for an experimenter who wants to obtain the most basic hardware and software in order to learn and understand how both aspects of a personal computer function.

The S-100 modular microcomputers started with the MITS 8800.

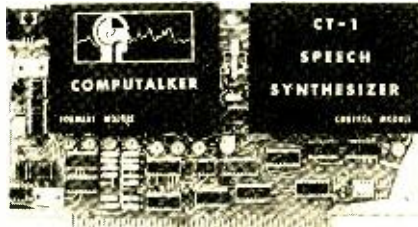

MODEL CT-1 from Computalker Consultants is a speech synthesizer board.

MITS defined the MITS (or S-100) bus, and many other manufacturers copied it in their microcomputer designs. There are literally dozens of memory boards, I/O devices and special-purpose interfaces that plug directly into the S-100 bus. Most are compatible with each other, even if they are produced by different manufacturers. A control panel may or may not be offered. Firmware is not stressed but may be provided. In general, the S-100 microcomputers

cannot simply be plugged in and operated. Kits or fully assembled systems are available.



VECTOR 1 MICROCOMPUTER from Vector Graphic.

This system's advantages are its low cost, a wide range of add-on peripherals and sophisticated hardware and software. The chief disadvantage is the lack of good general-purpose firmware (preprogrammed plug-in PROM's to take care of things like programming language).

The third group of microcomputers do not use the S-100 bus and provide a modular, rather than a turnkey, system. Since the S-100 bus is not used, additional modules or peripheral devices that are compatible with the system are probably provided only by the manufacturer of the system—for example, the Southwest Technical Products SWTP-6800. As with S-100-type microcom-

puters, systems in the non-S-100 group are available as kits or fully assembled. The primary advantage of this group is their somewhat lower cost. The greatest disadvantage is their reliance upon the manufacturers' own add-on devices.

The last group of microcomputers are the *turnkey* (plug it in and turn it on) systems, as for example, the Radio Shack TRS-80. These systems are fully assembled, warrantied and ready to operate. Firmware includes an operating system and a BASIC interpreter; a keyboard, video display and audio cassette interface are usually provided.

The advantages of this group are the low cost, the "plug it in and turn it on" configuration, the integrated systems software, and a wide range of user-developed application programs. The disadvantages are the possible limited expandability and the reliance upon manufacturers' own add-on modules and peripheral devices.

This represents a rather brief summary of the current personal computer marketplace. Although there are many factors involved in selecting a microcomputer, unlike choosing a wife, the purchaser won't be rejected if he has the cash!

R-E

# Peripherals—arms and legs

*To perform useful functions, a computer needs peripheral devices. These devices interface between man and machine and greatly expand a computer's capability.*

**KARL SAVON**  
SEMICONDUCTOR EDITOR

PERIPHERALS ARE THE ARMS, LEGS, mouth and ears of the microcomputer. Without them, the computer is no more than a theoretical curiosity. Peripherals perform two basic functions: First, they interface between man and machine. They appear in the form of terminals, graphic displays and printers. Second, they expand the computer's capability from theoretical to highly practical applications through the use of such devices as cassette recorders, floppy-disk drives and analog interfaces.

## Terminals

The most basic peripheral needed for a microcomputer is a terminal that lets you talk to the machine, program it, enter data into it and receive answers from it. Toggle switches and LED displays are adequate for a learning system, but once past basics it is vital to be able to move information in and out at conversational and at higher rates. Program-development cycles require an efficient link between you and the assemblers, compilers, interpreters and file management software. Even though there are diverse forms of

data terminals, the most generally used is a keyboard-display combination.

A terminal, unlike a typewriter, consists of two electrically separate parts that are actually *physically* separated in some systems. The keyboard-driven transmitter usually has a standard typewriter key arrangement, plus several control keys. Often, only upper case letters are implemented and separate numeric keyboards are built-in for convenience. On the receive end of the terminal, the most common devices are impact ribbon printers and video display.

For the computer and terminal to understand each other, they must speak the same language. Several standard formats have been composed so that system components from different manufacturers can work together:

- The predominant format in use is the **American Standard Code for Information Interchange (ASCII)**. It is a 7-bit code plus a parity bit with a particular combination of bits corresponding to each character in its vocabulary.
- Some older equipment use a five-level **Baudot code** that was developed for telegraphic purposes. Its basic set of  $2^5$  or 32 codes is nearly doubled in keyboard characters, using letter and number keys that precede characters in one of two sets. Although similar in function to a typewriter shift key, these keys are not depressed simultaneously with other keys.
- The **EBCDIC code** is an eight-level language used by IBM and others that has twice the characters of ASCII ( $2^8 = 256$  vs.  $2^7 = 128$ ), and is suited for more complex control and graphic applications.

Diode or IC encoders convert key closures into ASCII or other codes.

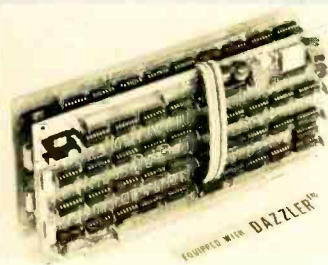

**DAZZLER** from Cromemco interfaces between S100 bus and TV set to add graphics.

These relatively slow, operator-limited terminals use serial data flow over one or two wires (plus ground). Parallel-to-serial conversion in the transmitter converts the parallel output of the keyboard-encoder into the serial bit stream, and corresponding serial-to-parallel conversion and decoding are performed in the receiver. UART integrated circuits have been designed that perform the conversion and the related tasks of parity-checking and start-and-stop bit generation.

When the ASCII code is combined with start-and-stop bits, sequences of 10 or 11 bits represent each transmitted or received character. Transmission is asynchronous, which means it does not require a transmitted clock signal.

The ones and zeroes of the data stream on the wires that connect the terminal and computer are distinguished by two DC levels. Several

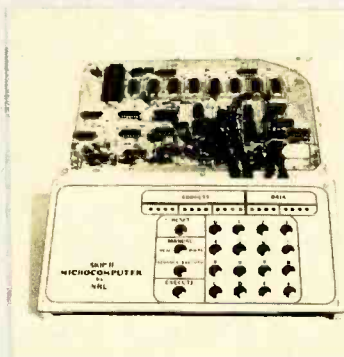

**SKIP II MICROCOMPUTER** by NBL has hexadecimal keyboard and LED indicators.

different voltage or current levels are used for compatibility with TTL, RS232C (bipolar) or 20- or 60-mA current-loop equipment.

The terminal receive-and-transmit sections are independent of each other. It is only by electrical interfaces in the terminal or through the computer that the printer mechanism or CRT screen displays the keyboard data entries. In a full-duplex system, the computer and terminal communicate in both directions simultaneously. The computer is programmed to echo back what is transmitted to it. Control characters would normally produce nonprinting codes, but the computer can return intelligent responses; for example, "control C" or "1C" when the control-C combination is typed on the keyboard. In half-duplex systems, communication takes place in one direction at a time. In most cases the terminal is wired so that the printer or display responds directly to the keyboard because the

computer does not have time to echo the response. Otherwise, after you typed a letter you would then have to wait for the computer to return the character before you could type a second letter. Inadvertently hooking a half-duplex terminal to a full-duplex system produces strange results—typically, the double-printing of pressed keys. Many terminals can be switched between half-duplex and full-duplex modes.



**IBK-1 MICROCOMPUTER** from IMSAI has built-in card cage, CRT terminal and power supply

Terminal data rates are from 10 to 30 characters-per-second for strictly manual keyboard devices. Those keyboards having built-in paper tape or magnetic tape storage have data rates of 30 to 480 characters-per-second and even higher.

Keyboards may have 64 or 128 ASCII characters, and may have such features as numeric pads, tactile feedback and rollover. During an entry sequence, a fast typist, or a slower one with an uneven technique, may depress more than one key at any given instant. N-key rollover (NKRO) recognizes the key closures in the time order in which they are entered, and does not become confused when more than one key remains depressed. Two-key rollover (2KRO) is a less-sophisticated method that only recognizes two key closures simultaneously. The third and subsequent closures are ignored.

Keyboards are classified as *contacting* and *noncontacting*, depending on how the electrical current path is interrupted. Key pressure sensing may be performed mechanically, capacitively, photoelectrically, or by using reed switches, saturating cores, Hall-effect devices or elastomers.

Hard-copy printers are classified as *impact* and *nonimpact*, each with its own particular advantages and drawbacks. Impact printers use mechanical hammers, wheels or dot-matrix pins that strike the paper through an inked ribbon, and one



column or one line is printed at a time. Impact printers are low-cost and can make copies, but they are generally noisy, may have poor print quality and are not as reliable as well-designed nonimpact printers.

Nonimpact printers are fast and quiet. One type uses ink jets that are sprayed onto the paper and controlled electrostatically. *Electrolytic printers* pass an electric current through chemically treated paper with wires or pins. *Electrostatic printers* use precharged dielectric-coated paper that is passed through a toner. The toner has ink particles that are oppositely charged to the printed charges on the paper. *Thermal printers* use transistor dot-matrix printheads that move across temperature-sensitive paper. Character fonts are electrically stored in read-only-memories (ROM's).

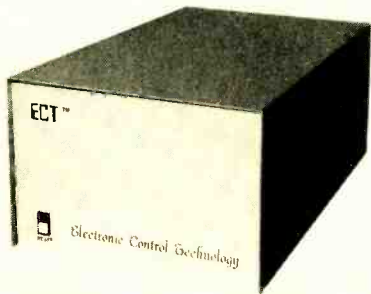

**ECT MICROCOMPUTER FROM Electric Control Technology has S100 bus structure.**

Some stand-alone computer systems have a keyboard and video display or printer built right into the main housing. Sometimes a video or RF output is provided so a video monitor or TV receiver can be used as an economical display.

The video terminal is expected to become the main home-computer peripheral because of its low cost and graphic capability. Video terminals have editing options that allow corrections before the characters are fed to the computer. Other options include page and scrolling formats, character accents, selectable baud rates and cursor controls. Video terminals do not make hard copies. A preferred arrangement is a video terminal backed up by a printer that can generate a permanent record of the data that must be saved.

There is an intermediate class of terminals that use a TV display and a low-cost hex keypad. Primarily used in learning systems, they are adequate and even preferred for special applications where the input is mainly numeric.

The final choice of terminal must be made on the basis of cost, multiple-copy capability, speed, interface requirements, printing-vs.-plotting characteristics, font, print quality and color, noise, ease of operation, serviceability, type of paper, and reliability.

#### **Tape cassettes and cartridges**

As system and user programs grow in length and number, you must find a sensible way to store them. Virtually all microcomputer manufacturers have recognized the advantages of using standard audio cassette recorders for program storage. In-

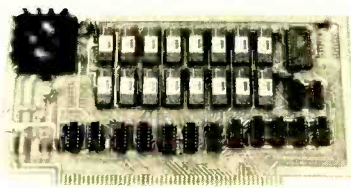

**RAM MEMORY BOARD from Electronic Control Technology mates with the S100 bus.**

terfacing hardware and software are important resident or optional parts of their systems. Frequency shift keying (FSK), pulse-width modulation (PWM), phase encoding (PE), nonreturn-to-zero (NRZ), biphasic encoding, group-coded recording (GCR), Manchester coding and the Kansas City Standard (KCS) are some methods used to both store data on audio tape and retrieve it. Phase encoding is popular because it is self-clocking, making it tolerant of speed variations and has good noise performance. Manchester coding is a type of phase-transitional encoding in which positive signal transitions represent ones and negative transitions represent zeroes. The KCS method is a variation of Manchester code that represents zeroes as 1200-Hz tone bursts and ones as 2400-Hz bursts.

Although at one time paper tape was very popular, it is being gradually displaced by digital magnetic-tape cartridges and cassettes that offer much greater reliability than either paper tape or audio cassettes. Lower-performance machines use drives that have evolved from audio recorders. In these systems the tape is caught and held between a capstan drive shaft and a free-wheeling pinch roller. At higher tape speeds and data densities, direct servomotor drives are used. Two motors drive the cassette hubs in a very clean mechanical arrangement.

Digital recorders use phase encoding with typical tape densities of 800 bits-per-inch. They have versatile control functions including write, stop, reverse one block or line, read one block or line, read continuously, erase, rewind for cassette removal and wind past tape leader. Extensive error checking is performed for dropouts, bit timing and character parity. The unformatted capacity of a cassette is about 720 kilobits and data transfer rates are 24 kilobits-per-second.

Cartridge drives provide improved performance and are used wherever higher operating speeds (48 kilobit-per-second transfer rate) and greater storage capacity (2.9 kilobits) are needed. Quarter-inch tape is recorded with densities of 1600 bits-per-inch on up to four tracks. Cartridge-drive manufacturers plan to compete with floppy disks by reducing access times. But for the present the tape heads and system mechanics limit search speeds to about 30 inches-per-second.

#### **Floppy disks**

Given enough financial resources, there are very few computer enthusiasts who would not invest in a large-capacity, floating-head, magnetic disk system. Random-access addressing of large amounts of stored data makes such a system look almost like a huge chunk of RAM. Some ad-



**RADIO SHACK TRS-80 microcomputer shown with video monitor.**

vanced computer systems exchange segments of disk memory with main computer memory to give the computer the *virtual* appearance of a machine with a very large main memory. Real-life budgets have forced computer manufacturers alike to find an economical compromise. The floppy disk does not have the data capacity of cassettes and cartridges, but is a random-access device with almost 500 times faster access. The *Mylar* disk is 9 inches in diameter and 0.003-inch thick, coated with a mag-

netic oxide and protected in an 8-inch-square jacket. The jacket has holes through which the spindle rotates the disk at 360 RPM, the head contacts the disk, and (on hard-sectored disks) the index holes are exposed. Hard-sectored disks use photoelectrically sensed index holes to locate data; soft-sectored disks rely on reading the block headings recorded on the disk.



**FLOPPY DISC DRIVE from Mits adds additional memory to microcomputer system.**

On IBM-compatible disks, data is recorded on 77 concentric tracks that are numbered 00 to 76 from the outside of the disk in. Track 00 holds labels and system and disk information, two tracks are reserved as alternates, leaving 73 tracks for data. Each track has 26 sectors, and each record or sector stores 128 bytes. This calculates to a total of  $73 \times 26 \times 128 = 242,944$  bytes. There are double-sided, higher-density floppy disks and other non-IBM-compatible disks with greater capacity.

In a step to reduce costs even further, the *minifloppy* disk was created, packaged in a 5¼-inch-square jacket. Hard-sectored *minifloppy* disks have 16 records-per-

track and soft-sectored 18 records-per-track. The record length remains 128 bytes, with either 35 or 40 tracks. Maximum storage capacity is then  $18 \times 40 \times 128 = 92,160$  bytes (one byte = 8 bits). Data transfer rates are about 125 kilobits-per-second. It is rumored that a \$100 *minifloppy* drive will soon appear on the market.

Floppy disks also have their difficulties, the main problem being much higher wear than their floating-head big brothers. Disk life is typically specified in the millions of passes-per-track.

### Other equipment

Having deliberately skipped over terminals different than the keyboard-printer, it is time to backtrack a little. A terminal is any device that reads in and writes out information; it can be equipment that handles punched paper tape or cards, magnetic cards and tape, bar codes, and so forth.

Paper tape is useful if you own an ASR *Teletype* machine with its built-in paper-tape reader and punch. With no additional expense except for the paper tape, you have a readily available storage medium. Unfortunately, this system is also slow and noisy. More sophisticated photoelectric readers and high-speed punches are available but they are fairly expensive. Low-cost optical readers eliminate some of the complexity and expense: The tape is pulled manually through the reader. This type of equipment is attractive if you have quite a lot of paper-tape software available.

Card readers and punches are not very popular. They are most familiar in the 80-column by 12-row format. One of their peculiar advantages is the ease with which a single program statement or data line can be modified without upsetting the rest of the program.

The line printer is an extension of the terminal printer or display, except it tends to be a high-speed device (for example, 125 lines-per-minute with each line having 132 characters) used when there are many pages of data to be printed.

Plotters use servocontrolled coordinate positioning arms to produce permanent graphic records. They differ from chart recorders in that the stylus can draw complex patterns back and forth over the stationary paper.

If a terminal is situated far away and telephone lines or radio waves are used as the connecting medium, some type of communications interface or modem (modulator-demodulator) is needed. Tone and phase-modulation schemes are used, and error-correcting codes are added to enhance reliability. Acoustic couplers and modems are either built into terminals or are separate entities. The coupler connects to a telephone handset and converts the received telephone tones into an electrical output signal. It also converts an electrical input signal from the modem into sound that drives the phone's transmitter element. A portable terminal can be taken anywhere and the computer called up for field access. The modem performs the phase or frequency encoding to condition the digital bit stream for the communications channel.

Charged-coupled mass memories may become competitive with cassettes, cartridges and disks in the near future. Access is completely electronic and about 50 times faster than a high-speed disk. There are some devices already on the market with capacities of 1 million bytes.

If your application is highly scientific or mathematic and you perform such operations as evaluating matrices, you may find that your BASIC interpreter or other software is much too slow. Peripheral floating-point hardware solves such problems with their high-speed parallel computation methods.

### Interfaces

Interfacing between the computer and the peripheral device is an essential consideration. The interface can be as expensive as the peripheral itself. Unless the peripheral is directly compatible with the computer's voltage levels and timing, a controller will be necessary to match up the two. A widely adopted technique minimizes hardware modification by using software drivers stored in ROM or RAM to produce the signals needed by the peripheral. Software or firmware (ROM) approaches may adversely affect the performance of the peripheral or the entire system. Before rushing out to purchase any peripheral device, it is best to know exactly what other hardware and software components are needed to make it work (and at what performance level) with a particular computer system.

R-E



# how to Program A Computer

*To get a computer to do what you want it to, you must communicate with it. Here's a look at three different levels of programming and how to use each one.*

**ART KLEIMAN**  
MANAGING EDITOR

THERE'S NOTHING DUMBER ON THE face of this earth than a computer. Oh boy, are they ever stupid! Go ahead, make one perfectly human mistake when writing or entering a program, hit "go" and . . . . . nothing! A pathetic 20th-century staring match between man and machine. So, instead of finding out the winner of that match, let's grab the latest computer catalog.

What are we looking for in the catalog? Don't be silly, we're looking for help. Help comes in the form of a higher-level language. So, we scan past the paragraphs describing the CPU boards, memory, I/O peripherals, etc., and go right to the software section. Here, we're bombarded with terms like machine code, assembly language, interpreter, compiler, BASIC, FORTRAN, APL, EMPL. . . . . whew! Before you blow a human fuse, let's take a look at what these terms mean, and what they mean to the computer. To get a better understanding, however, let's first get back to basics.

## How a computer is programmed

Digital computers are digital because they're built using digital logic IC's. And digital logic IC's eat, chomp and spit out binary numbers (zeroes and ones). That's it! It doesn't matter whether we're discussing the data base at the Pentagon or the most simplistic single-board microcomputer trainer. The only things flowing through those circuits are zeroes and ones.

The heart of the computer is the CPU, or microprocessor. This nifty device performs many functions, such as adding, subtracting, comparing, etc., in response to instructions. In other words, it can do many things, but it must be told what to do by giving it an instruction. Remember, this is a digital device, so when it adds or subtracts, it adds and subtracts binary numbers (zeroes and ones) and the instruction given to it must be in the form of a binary number.

If the microprocessor has one thing going for it, it's speed. It can perform many operations in a very short time. If we wanted to perform just one operation, we wouldn't need a computer. So, to perform many operations (hundreds, thousands, or even hundreds of thousands) very fast, we must feed the instructions to the microprocessor just as fast. To do this, we connect the microprocessor



**EQUINOX 100 computer from Parasitic Engineering has an octal keyboard.**

to a memory. The instructions and the necessary data are stored in the memory and called a program.

Inside the microprocessor is a register (a device for the temporary storage of a binary number) called a program counter. After storing the program in the memory, the program counter is set to the beginning ad-

dress (location) of the program. Then, you hit GO (instruct the microprocessor to begin execution). The program counter addresses the first memory location and the memory responds by feeding the first instruction to the microprocessor. After the microprocessor does its thing by executing the instruction, the program counter is incremented (advances) by one and addresses the next memory location. Again, the memory responds by feeding the next instruction to the microprocessor. The microprocessor executes this instruction and again increments the program counter by one. This process continues until the entire program is executed.

So, programming a computer means that you have to store the program in the memory. This is done by writing and then entering the program in the computer's memory. This can be done at three different levels—machine language, assembly language and higher-level language.

## Machine-language programming

You could write the program in digital form and then enter the program into the memory one digit at a time. This is machine-language programming. Figure 1 shows a simple program for adding two numbers together. The program is written for the 8080 microprocessor, one of the more popular 8-bit microprocessors. (A bit is a binary digit and a byte is 8 bits.) The 8080 is an 8-bit microprocessor because it physically has eight data lines. These data lines are used to input instructions and data and also to output the results. The 8080 also has address lines for addressing memory. However, eight address

lines aren't enough. Eight bits would enable the 8080 to address only 256 memory locations, hardly enough program space to do anything except add two numbers together. So, internally, the 8080 gangs two bytes together and feeds them out on 16 address lines. Sixteen address lines enable the 8080 to address 65,536 memory locations—quite a lot! To feed a memory location to the microprocessor on the eight data lines, however, requires two operations. First, the low-order address byte (the eight least significant bits of the memory address) is input and then the high-order address byte (eight most significant bits of the memory address) are input. This idea is implemented in the simple addition program shown in Fig. 1. Let's take a look at it and see what happens at each step of execution.

The addition program occupies 15 memory locations starting at location 0 (represented by the 16-bit binary number 0000000000000000). Basically, the program takes the binary number stored in a specific memory location, adds it to the binary number stored in another memory location and stores the result in a third memory location. For discussion purposes, the left-hand column in Fig. 1 numbers each program step the way you're used to seeing numbers—in decimal form. This will make it easier for us to refer to each program step.

The very first memory location (program step 1) contains an instruction that tells the microprocessor to load the HL register pair with the immediately following two data

bytes. Both the H and the L registers are 8-bit registers located inside the microprocessor IC. When told to do so by the instruction, the microprocessor gangs these two registers together to form a single 16-bit register, called the HL register pair. The 16-bit HL register pair is used to specify a 16-bit memory location. The microprocessor instruction is also called the *op-code*.

Now, back to the program. The next memory location (program step 2) contains the low-order 8-bits of the memory address, which is to be loaded into Register L of the HL



**SOL TERMINAL COMPUTER** has computer and alphanumeric keyboard in a single enclosure.

register pair (by program step 1). Program step 3 contains the high-order 8-bits of the memory address, which is to be loaded into Register H of the HL register pair. After the microprocessor completes program step 3, the HL register pair con-

tains the memory address 0000000000001100. This memory location, coincidentally, contains the first number of our addition problem. Program steps 4, 5 and 6 do the same things that program steps 1, 2 and 3 do but with the DE register pair. Here, the DE register pair is loaded with memory address 0000000000001101. This memory location contains the second number of our addition problem. So far, we've got the HL and DE register pairs loaded with two memory addresses, each one of the memory locations containing one number of our addition problem.

Program step 7 contains an instruction that tells the microprocessor to load the accumulator with the contents of the memory location specified by the DE register pair. The accumulator is another internal register within the microprocessor. This register is the working register. It is used to manipulate data, perform math and logic operations, store results, etc. The accumulator is involved with just about every operation the microprocessor performs. So far, we have the accumulator loaded with the first number of our addition problem.

Program step 8 is where the two numbers are actually added. This instruction tells the microprocessor to add the contents of the accumu-

Program Step	Memory Location		Instruction Data	Comment (Meaning of Instruction)
	High-Order	Low-Order		
1	00000000	00000000	00100001	Load the HL register pair with the two immediately following data bytes
2	00000000	00000001	00001100	Memory address, low-order byte
3	00000000	00000010	00000000	Memory address, high-order byte
4	00000000	00000011	00010001	Load DE register pair with the two immediately following data bytes
5	00000000	00000100	00001101	Memory address, low-order byte
6	00000000	00000101	00000000	Memory address, high-order byte
7	00000000	00000110	00011010	Load accumulator with contents of memory location specified by DE
8	00000000	00000111	10000110	Add accumulator contents of memory location specified by DE. Store results in accumulator.
9	00000000	00001000	00110010	Store accumulator in memory location specified by two following data bytes
10	00000000	00001001	00001110	Memory address, low-order byte
11	00000000	00001010	00000000	Memory address, high-order byte
12	00000000	00001011	01110110	Halt
13	00000000	00001100	XXXXXXXX	First number of addition problem
14	00000000	00001101	XXXXXXXX	Second number of addition problem
15	00000000	00001110	XXXXXXXX	Result of addition

**FIG. 1—MACHINE-LANGUAGE PROGRAM** for adding two numbers together. The actual program consists of the instruction/data that is stored in the corresponding memory locations.



lator with the contents of the memory location specified by the HL register pair. The result of the addition operation is stored in the accumulator. We could leave the result of the addition in the accumulator if we wanted to, but in actual practice this is hardly ever done. The result is either fed to an output port that is connected to a CRT terminal, a printer or something similar, or it can be stored in another memory location. Since we don't have any peripheral equipment connected to our computer, we'd simply store the result in another memory location. Program step 9 does just this.

Program step 9 contains an instruction that tells the microprocessor to store the contents of the accumulator in the memory location specified by the immediately following two data bytes. Program step 10 contains the low-order byte of the memory address, and program step 11 contains the high-order data byte of the memory location. Now, we have the result of the addition operation stored in memory location 0000000000001110.

Program step 12 is a HALT instruction. This tells the microprocessor that the program is finished and to stop execution. Program step 13 is

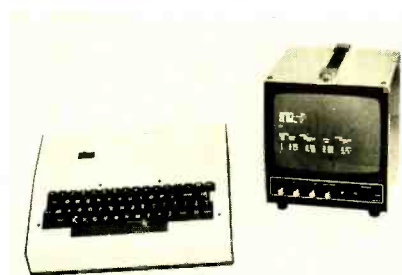

**ACT-1 TERMINAL** has alphanumeric keyboard. Monitor shows how information is displayed.

the memory location containing the first number of the addition problem, program step 14 is the second number in the addition problem and program step 15 is the result of the addition operation.

To run the program, we would simply load program steps 13 and 14 with the two numbers and set the program counter to 0000000000000000. Then hit GO. You could examine the contents of memory location 0000000000001110 to obtain the result.

### Entering a machine-language program

Now that you know what a machine-language program is and what

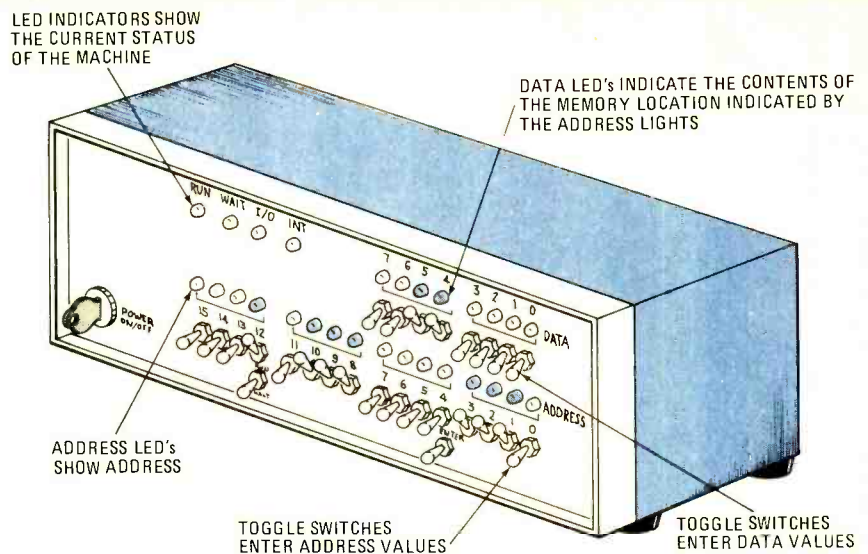

**FIG. 2—TYPICAL FRONT PANEL** of computer showing toggle switches and LED indicators.

it looks like, let's take a look at how we load it into the machine. The program isn't fed to the microprocessor; it's stored in the memory. This means that we would have to address the right memory location and store the data/instruction at that location. We could do this by using toggle switches on the front panel of the computer—16 toggle switches connected to the address lines and eight toggle switches connected to the data lines (see Fig. 2). We would also need another toggle switch to instruct the memory IC's to store the data on the data lines. This switch could be labeled STORE, WRITE, ENTER, or anything appropriate. An example of how one such toggle switch is connected is shown in Fig. 3. One position of the toggle switch would be labeled 0 and would ground the line, the other position would be labeled 1 and connect the line to +5 volts.

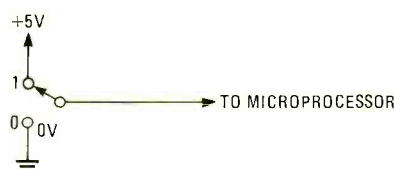

**FIG. 3—FRONT PANEL TOGGLE SWITCHES** apply +5 volts to microprocessor in one position, and ground in the other position.

Now, we're set. Well, almost. The toggle switches permit us to enter the program, but there is no way we can check the data stored in the memory to see if we entered it correctly. So, we connect eight LED's to the data lines and install them on the front panel along with the toggle switches; a lit LED signifies 1. Now we are set.

To load the program into memory, set the address switches to the first memory location, set the data switches to the first instruction and then hit ENTER. Then, set the 16 address switches to the next memory location, set the eight data switches and again hit ENTER. Continue this procedure until the entire program is loaded. Be careful, though, don't make any errors. If you do, the program won't run. Make a mistake entering just one bit, just one, and the program won't run.

As you see, entering a program this way can be quite tedious. Of course, with short programs such as the one shown in Fig. 1, the procedure isn't too bad. But with longer programs that really do something, the situation becomes more complicated. Some programs can run 2000, 5000, 10,000 program steps or longer, and the situation gets a lot worse. With patience and diligence, however, you can become quite good at entering programs this way. With a lot of practice, you can whiz your fingers across those toggle switches so fast that you will dazzle your family and friends. However, those toggle switches may grow limp with fatigue, not to mention your fingers.

This type of front panel was common in the early microcomputers. One of the very first hobbyist computers was the Mark 8 and it had a similar front panel. It was a construction project published in the July 1974 issue of **Radio-Electronics**. The first commercially available microcomputer was the Altair, which also had a similar front panel. Another early microcomputer was the Im-

sai, again with the same type of front panel. Both the Altair and the Imsai are popular microcomputers, still going strong in the marketplace. That's because they can be programmed using higher-level languages. You'll discover what these languages are later on in this article, but now let's get back to the front panel.

It's obvious that using toggle switches is no way to enter a machine-language program. There must be a better way, and there is. Let's sit back for a moment and take a look at that 8-bit data word we are entering. Is there another, shorter way to represent those same 8 bits? If we split these 8 bits up into two groups of 4 bits, we could represent each 4-bit group by a *hexadecimal* digit. A group of 4 bits provides 16 possible combinations of zeroes and ones. If

Binary	Hexadecimal
0000	0
0001	1
0010	2
0011	3
0100	4
0101	5
0110	6
0111	7
1000	8
1001	9
1010	A
1011	B
1100	C
1101	D
1110	E
1111	F

FIG. 4—FOUR-BIT BINARY WORD and corresponding hexadecimal value.

Program Step	Memory Location		Instruction Data
	High Order	Low Order	
1	00	00	21
2	00	01	0C
3	00	02	00
4	00	03	11
5	00	04	0D
6	00	05	00
7	00	06	1A
8	00	07	86
9	00	08	32
10	00	09	0E
11	00	0A	00
12	00	0B	76
13	00	0C	XX
14	00	0D	XX
15	00	0E	XX

FIG. 5—HEXADECIMAL MACHINE-LANGUAGE program is identical to the program shown in Fig. 1, except the binary numbers are represented by their hexadecimal equivalents.

we want to represent each of those 16 combinations with a single digit number, we need a numbering system to the base 16. Figure 4 shows the 4-bit group and the corresponding hexadecimal digit. Don't be confused—here A, B, C, D, E and F represent numbers, not letters. Now, if we recombine those two 4-bit groups back into a single 8-bit group, we can represent those 8 bits with 2 hexadecimal digits. For example, 00000000 would be represented as 00, and 11111111 would be represented as FF.



CONNECT A TV SET to the Apple II computer and you have a computer and CRT terminal.

Now we can construct a front panel using a hexadecimal keypad rather than toggle switches. Instead of the discrete LED's, we can use a 2-digit LED alphanumeric display for the data. (Remember in hexadecimal we count 0, 1, 2, 3, 4, 5, 6, 7, 8, 9, A, B, C, D, E, F, and so on. So we need 2

digits of readout, each one capable of counting from 0 through F.) We'll also have to include some circuitry to decode the hexadecimal digits into the corresponding 8-bit word. Since the memory address requires 16 bits (2 bytes), we can represent it by using 4 hexadecimal digits.

To use this type of front panel, first switch to the MEMORY mode and enter the starting memory address. Figure 5 shows the simple addition program shown in Fig. 1 but in hexadecimal format. If you wanted to enter the program shown in Fig. 5, you would select the MEMORY mode and enter 0000. You would then select the ALTER mode and enter the first instruction, which is 21. Memory location 0000 would automatically be loaded with 21, and the memory address would be advanced by 1. The next data byte would then be entered by simply hitting 0 followed by a C. This process is continued until the entire program is entered. If while you were entering the program, you came across a memory location that you did not want to alter, you would simply hit the MEMORY INCREMENT switch and the contents at the memory location would remain intact. Or you could re-enter the contents at that memory location. In any event, entering machine-language programs in hexadecimal form is easier, both on the eyes and on the fingers, and there is much less of a chance of making a mistake.

Are binary and hexadecimal the only two ways to enter a machine-language program? No. There is a third way being used by a few manufacturers. The 8-bit data word is



again split up but this time into three groups instead of two. The first group contains 2 bits and the last two groups contain 3 bits each. Since the maximum number of bits in any group is 3, we could use the octal number system to represent the binary number contained in each group. Figure 6 shows the 3-bit groups and the corresponding octal number. Since the first group contains only 2 bits instead of 3 bits, this group will have a maximum octal number of 3. Since the other groups contain 3 bits, they will have a maximum possible octal number of 7. We then recombine the groups to form a single 8-bit data word, just like we did with the hexadecimal system. The octal numbers will range from 000, corresponding to the data byte (a binary number) 00000000, to 377 (equivalent to decimal 255), corresponding to binary 11111111.

Binary	Octal
000	0
001	1
010	2
011	3
100	4
101	5
110	6
111	7

FIG. 6—THREE-BIT BINARY WORD and corresponding octal value.

We can now build a front panel just like we did for the hexadecimal system. But this time instead of using a hexadecimal keypad, we would use an octal keypad. Instead of using a 2-digit LED display for the data, we would use a 3-digit LED display. The memory address requires a 6-digit LED display instead of a 4-digit LED display. Otherwise, the front panel remains basically the same. Even the way we enter the programs remains basically the same. To see what an octal-based machine-language program looks like, the simple addition program already discussed is shown in Fig. 7 in octal format.

One final note on front panels: Front panels from different manufacturers differ in their features and therefore in the way programs are entered. Some front panels have automatic incrementing features while others may not. Some front panels are octal while others are hexadecimal. The Heath H8 and the Equinox from Parasitic Engineering are examples of full-featured octal front panels

Program Step	Memory Location		Instruction/Data
	Low Order	High Order	
1	000	000	041
2	000	001	014
3	000	002	000
4	000	003	021
5	000	004	015
6	000	005	000
7	000	006	032
8	000	007	206
9	000	010	062
10	000	011	016
11	000	012	000
12	000	013	166
13	000	014	XXX
14	000	015	XXX
15	000	016	XXX

FIG. 7—OCTAL MACHINE-LANGUAGE PROGRAM is identical to the program shown in Fig. 1, except the binary numbers are represented by their octal equivalents.

(with display and keyboard). In any event, since the exact sequence of pushing buttons to enter a machine-language program does vary from computer to computer, do take a close look at the front panel before you buy your computer. Some computers are completely devoid of front-panel controls. This means that they have no switches or displays on the front panel other than a reset and/or a power ON-OFF switch.

The Alpha computer from TDL and the 6800 from Southwest Technical Products are examples of this type. To program this type of computer in machine language or any other language requires a keyboard connected to the computer's input port. Even though the nitty-gritty may be different, entering a machine-language program is basically (and I mean basically) the same no matter which computer you use.

Now you know what a machine-language program is and what it looks like. As you probably already guessed, it's no fun programming in machine language. The 8080 microprocessor has no less than 78 instructions, while the Z-80 microprocessor has 158. This means that if you were to program in machine language, you would need a list of the instructions and the corresponding op-code (the binary form of the instruction). Then, depending on the computer, you might have to convert the op-code into octal or hexadecimal. If you were lucky, you might even find an instruction list with the op-code already in hexadecimal or octal. In any case, having to look up the op-code

for each instruction is slow and tedious. If you were ambitious, you could get around this by memorizing the entire instruction list and corresponding op-code for each instruction. But I, for one, do not relish the prospect of having to commit such a list to memory. There must be a better way, and there is.

### Assembly language

Let's suppose that we were able to program the computer using alphanumerics instead of just plain numbers. We could code the instructions



VECTORS VP2 enclosure permits you to design your own microcomputer.

into a 3- or 4-letter group very similar to the original instruction, and the computer would translate this code group into the machine-language instruction. We could use a hexadecimal keyboard to speed the process. Certainly, a group of meaningful characters are much easier to commit to memory than a group of 8 zeroes and ones. Also, if we wrote this "translator" program so that it takes care of all the memory addresses, programming would be much easier.

The translator program is called an assembler program and the 3- or 4-letter groups that stand for the instruction are called a mnemonic (*nee-monik*—an easy-to-remember code word). A mnemonic is an abbreviated word that is intended to remind us of the original word. Let's take a closer look at mnemonics.

Program step 7 in Fig. 1 is an instruction that loads the accumulator with the contents of the memory location specified by the DE register pair. The corresponding mnemonic for this instruction is LDA (*LoaD Accumulator*). Program step 9 contains a store accumulator instruction. The mnemonic for this is STA (*STore Accumulator*). Another instruction is the halt instruction, and the corresponding mnemonic is HLT (*HaLT*). As you can see, mnemonics are definitely easier to remember than the binary op-code. In fact, we really don't even have to memorize the mnemonics. It's enough just to become familiar with them.

Let's take a look at what an assembly-language program is. Programming in assembly language is a little more difficult to grasp at first than machine language, but stick with it. We'll try to walk it through one step at a time. For discussion purposes, let's suppose you were writing the program down on a piece of paper. The assembly-language program is divided into four vertical columns. Each column is referred to as a field. The four fields are, from left to right, the LABEL, OPCODE, OPERAND and COMMENT fields.

So far you have a piece of paper

divided into four columns. The LABEL field is always the first column. A label is a letter, or a group of letters, that reference a memory location. For example, suppose you assigned the first line of your assembly program with the label START. Then, if at any place in the program you had to refer to the starting address of the program, you could simply use the word START. The assembly program would automatically translate the word START into the starting address of the program. Or, suppose you wanted to store the result of a calculation in a memory location. You could assign a label to that memory location. Then, if you wanted to fetch the result from memory, you could simply use that label. You don't have to label every memory location when you write the assembly program if you don't want to. In fact, you don't have to use any labels at all. To avoid labeling, simply leave the first column (label field) blank.

The second column (the OPCODE field) contains the mnemonic abbreviation of the instruction. Some instructions, however, require more information than just the mnemonic. For example, suppose you wanted to store the contents of the accumulator in a memory location. You would use the STA mnemonic in the opcode field, but you would also have to specify the memory location where you want the accumulator stored. This information would go in the OPERAND field. Depending on the particular assembler you were using, you could specify the memory location as a 16-bit binary number, or an octal number, or hexadecimal, or even good old decimal. If you don't want to, you don't even have to worry about keeping track of memory locations. Remember the label field? If you assigned a label to the memory location, you could specify that memory location by using the label in the

operand field. The operand field contains necessary information other than just memory locations. For example, suppose you used a mnemonic (instruction) that involved a register pair. The operand field would specify which register pair the instruction would operate on. In other words, the operand field contains any additional information that the particular instruction requires.

The last column, the COMMENT field, is not used by the computer at all. It contains documentary information that you, as a programmer, can add to help you understand the program. You can add whatever alphanumeric information you desire in this column.

Now that you have at least a basic understanding at what an assembly language is, let's look at an actual program written in assembly language. The simple addition program that was discussed throughout this article appears in Fig. 8 in assembly language.

The first line of the assembly-language program contains the label START. The first line also contains the first instruction of the program in the form of the mnemonic LXI. This LXI mnemonic instructs the microprocessor to load the register pair with the immediately following data bytes (X's in the mnemonic stand for register pairs.) The operand column leads off with an H. This defines the register pair as the HL register pair. Next comes the hexadecimal data that is to be loaded in the HL register pair. A comma separates the two pieces of information in the operand field. The second line of the program contains another LXI instruction, but this time, as you can see from the operand field, it operates on the DE register. The comma again separates the hexadecimal data that is to be stored in the DE register pair.

The third line of the program con-

Label	Opcode	Operand	Comment
START	LXI	H, 000C	Load HL register pair with 000C
	LXI	D, 000D	Load DE register pair with 000D
	LDAX	D	Load accumulator with memory specified by DE
	ADD	M	Add accumulator and contents of memory specified by HL
	STA	000E	Store accumulator in 000E
	HLT		Halt
	END	START	Assembler directive, load program counter with starting address

FIG. 8—ASSEMBLY-LANGUAGE PROGRAMMING involves using mnemonics to represent machine-language instructions.



tains the mnemonic LDAX, which instructs the microprocessor to load the accumulator with the contents of the memory location specified by a register pair. The operand field specifies the DE register pair. In the next line of the program, the combination of the mnemonic and operand instructs the microprocessor to add the contents of the accumulator and the contents of the memory location specified by the HL register pair. The next line stores the contents of the accumulator in the memory location specified in the operand field. The next-to-last instruction is the HLT mnemonic, which instructs the



**SOUTHWEST TECHNICAL'S 6800 system has optional floppy disc, printer and CRT terminal.**

microprocessor to stop execution.

So far, as you can see, the assembly-language program is exactly the same as the machine-language program, but written differently in a much easier format to look at and understand than just binary numbers. The last line in Fig. 8 contains a mnemonic that is not a microprocessor instruction. The assembler program, in addition to understanding a mnemonic for each microprocessor instruction, understands several additional mnemonics called *assembler directives*. These are used to direct the assembler itself to do something. The mnemonic END tells the assembler that the program is complete and to stop assembling the program. The operand field contains the label START that loads the program counter with the starting address of the program. This means that after the program is assembled and loaded into the computer in that machine language, the program counter is set to the memory address that contains the first LXI instruction.

That is basically what assembly language looks like. Incidentally, the program shown in Fig. 8 is called a *source program*. It is in its raw form, it hasn't been translated into machine language. The assembler will translate into machine language, and Fig. 8 is the source for the assembler.

However, thus far you only have the source program written down on a piece of paper. Now, you'll have to put it into a form that the assembler can use. This requires some additional equipment for your computer.

Since assembly language is written in alphanumeric, you'll need an alphanumeric keyboard and an alphanumeric display; both of these are contained in a CRT terminal. To connect the terminal to your computer, you'll need a parallel interface board if your computer doesn't already have one. You'll also need an external device to store your source and assembler programs, and then load them back into the computer when needed at a later time. The most common storage device used in personal computing is the audiocassette tape recorder. This device is inexpensive and surprisingly reliable. To interface the cassette recorder to your computer, you need a cassette interface.

You also need a program to drive the cassette interface. This software is a program that directs the microprocessor to transfer the contents of memory, one location at a time, to the cassette interface when you want to store a program on a cassette tape. It also contains a routine that takes the digital data stored on the cassette tape and transfers it to sequential memory locations. This software is called a *bootstrap program*. You'll

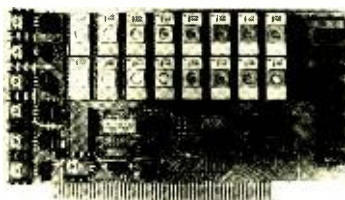

**COMBINATION RAM AND ROM memory board mates directly with the S100 bus.**

also need software to drive the CRT terminal. If you're lucky, your computer contains both these programs, as well as several additional systems programs, stored in a permanent memory called a ROM. The system software is called a monitor program. If your computer doesn't contain a monitor ROM, then you'll first have to load the bootstrap program into the computer through the front-panel switches. Once the bootstrap program is loaded, you can then load the rest of the programs using the cassette tape recorder.

Now that you have the necessary equipment, you can write your source program in assembly language.

### **Assembly-language programming**

To write your source program on the CRT terminal requires an additional program called a *text editor*. The text editor makes it much easier to write text on the terminal. It provides you with various edit functions in case you make a mistake, it has a tab function for setting up columns on the terminal, and it even has a cassette file routine that enables you to transfer several source programs to the same cassette tape.



**X-Y PLOTTER connected to computer permits hard copy drawings.**

The text editor is loaded into the computer via the cassette tape recorder. Once this is loaded, you can write your source program on the terminal. The keyboard on the terminal is very similar to a typewriter keyboard. It has all the letters and numbers, and it even has a shift key, space bar and carriage return. So to enter the source program, you merely type it out as if you were entering it on a typewriter.

The source program is entered by typing it one line at a time. The four fields are separated by spaces. For example, to designate the end of the opcode field and the beginning of the operand field, you enter a space by hitting the space bar on the keyboard. There will be times when you run across a column with nothing in it. To get around this, you again hit the space bar. For example, if the first column, the label field, is to be left blank, simply hit the space bar and you'll automatically start the next field, which is the opcode field.

The technique of using just a single space to separate the various fields results in a CRT display with the four fields appearing slightly shifted on each line. This may be confusing when you want to analyze the source program on the CRT display. I get around this by using the tab function associated with the text editor to automatically insert the correct num-

ber of spaces so that the four fields appear in four vertically aligned columns. Figure 9 shows what the source program in Fig. 8 would look like on the CRT display after you enter it. You'll notice that Fig. 9 looks exactly like Fig. 8 but without the names of the four fields. I also left out the comment field in Fig. 9.

START	LXI	H, 000C
	LXI	D, 000D
	LDAX	D
	ADD	M
	STA	000E
	HLT	
END	START	

FIG. 9—ASSEMBLY-LANGUAGE source program as it would appear on a CRT terminal.

Once the source program is entered on the terminal, you then transfer the source program to a cassette tape. This is done by using the various commands provided us by the text editor.

You're now ready to use the assembly-language program to translate the source program into machine language. For the sake of discussion, let's assume that you're using a two-pass assembler. It gets its name because the source program is loaded into the computer twice. The first thing you do is load the assembler program into the computer using the cassette tape recorder. Then, the source program is loaded into the computer, again using the cassette recorder. Next, rewind the cassette tape containing the source program and load it into the computer a *second* time. The CRT display will then tell you if there are any mistakes

in the source program as the computer compares the two programs. If there are no mistakes, you can then store the machine-language program on another cassette tape.

If there was a mistake, the source program will have to be corrected. To make a correction, first load the text editor back into the computer. Then load the source program. The corrections are easily made using the various edit commands available with the text editor. The corrected source program is then stored on the cassette tape and the whole assembly procedure is repeated.

### Assembler programs are different

Not all assembler programs are the same. Before you buy an assembler program, make sure that it is intended to be used with the micro-



UC-2000 from Infinite Systems contains computer, CRT terminal, and floppy disc drives.

processor you have in your computer. Since assembler programs generate machine language, the machine language must be compatible with the particular microprocessor in your computer. For example, if you have an 8080 microprocessor in your computer, you must use an 8080 assembler program.

There are two types of assembler programs available; the most common type used in personal computers is the *two-pass assembler*. The other type of assembler program is called a *one-pass assembler*. Without going into the details of how an assembler program works, let's take a look at what the differences between these two types mean to you as a programmer. First, the two-pass assembler requires less memory to assemble the exact same source program than a one-pass assembler requires. So, with the same amount of memory in your computer, you could assemble larger programs using a two-pass assembler than with a one-pass assembler. However, using a two-pass assembler

requires more time since the source program must be loaded into the computer twice. As fast as cassette tape recorders seem for loading programs, they're still relatively slow. So, the trade-offs for the two types of assemblers are speed and memory requirements. Since memory is still quite expensive, the two-pass assembler is most commonly used in personal computers. The total memory requirements for using either type of assembler depends on the length of your source programs.

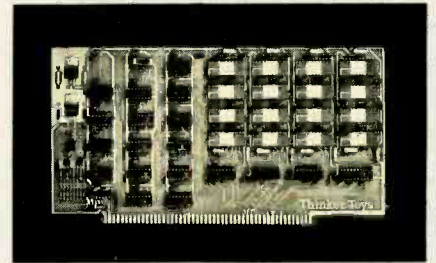

8K RAM memory board from Thinker Toys mates directly with the S100 bus.

### Higher-level languages

So far, this article has been discussing machine language and assembly language. When you program in machine language, you communicate with the computer on the same level as the microprocessor. When you program in assembly language, you communicate with the computer by using mnemonics, and the assembler program translates the mnemonics into machine language. Is assembly language considered a higher-level language? The answer is no. The mnemonics are just another form of microprocessor instructions. One mnemonic is translated into one microprocessor instruction by the assembler program. A higher-level language translates one instruction into many microprocessor instructions.

The most common higher-level language for personal computers is BASIC. This language uses English-like statements and commands. For example, let's look at your addition program again, but this time written in BASIC. The program is written so it will add the numbers 2 and 3 together:

```
10 A = 2 + 3
20 PRINT A
30 END
```

The numbers preceding the statements are called *line numbers*. These tell the computer which statements to execute first. The computer merely executes the statements in numerically ascending order. The line num-



bers are also used for reference by a few other commands in the BASIC repertoire. The first statement sets the value of the variable A equal to the sum of 2 and 3. The PRINT A statement outputs the result to either the CRT display or a hard-copy printer if you have one. The last statement tells the computer that the program is finished and to stop execution. As you can see, writing programs on this level frees you from worrying about such things as memory locations, microprocessor registers, etc. You simply tell the computer what to do and the BASIC takes care of the rest.

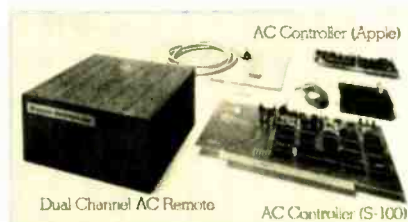

**MICROCOMPUTER CONTROL of AC appliances is possible with AC controller boards.**

To program in BASIC, you again need a CRT terminal and a cassette tape recorder. First, you load the BASIC software into the computer using the cassette tape recorder. Then, you write the BASIC program on the alphanumeric keyboard. The program is written one line at a time. When you're finished, the CRT display will look exactly like the simple addition example. To execute the program, simply type RUN and hit the return key on the keyboard.

There are many, many variations of BASIC available. First, there's BASIC, and then there's EXTENDED BASIC. EXTENDED BASIC adds more features and commands to the BASIC repertoire. Also, there are variations between

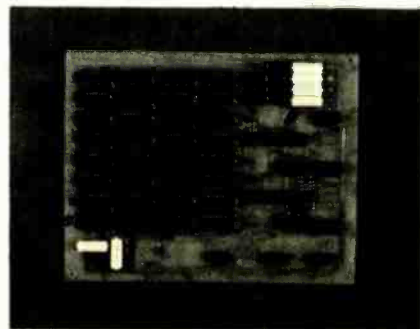

**WWW ENTERPRISES memory board uses Texas Instruments TMS-4060 memory IC's.**

BASIC's written by different software suppliers. A program written using one kind of BASIC may not

run under another BASIC without some minor modifications. The use of semicolons, colons, commas, quotation marks, etc., in the program is called *syntax*. Some BASIC's are very flexible in the use of syntax while others are quite rigid . . . a point you should investigate before purchasing a BASIC.

Other higher-level languages are also available, including APL, EMPL, FORTRAN and others. However, these languages are not in common use in personal computers for various reasons. For example, APL requires the use of additional symbols not found on a standard alphanumeric keyboard. So, to use APL requires a special APL keyboard.

Higher-level languages are also classified as either *compilers* or *interpreters*. A compiler is very similar to an assembler program. That is, a compiler translates a source program into machine language, except that the source program is written using the statements associated with the higher-level language instead of mnemonics. The higher-level compiler resides in a high-speed external memory, such as a floppy disc. The source program is written and the compiler



**HEATH H8 computer has an octal display and keyboard on the front panel.**

translates it into machine language. Then the machine-language program is loaded into the computer and executed.

An interpreter, on the other hand, resides within the computer's internal memory. The source program is written using the higher-level statements, just as you did with the simple addition program. The interpreter translates the source program *one statement at a time* into machine language, the computer executes the machine-language statements and then the interpreter translates the next statement in the source program. This process continues until the entire source program is translated *and* executed.

The disadvantage of using any higher-level language is the additional memory requirements. For example, even a BASIC interpreter is also classified by the additional internal memory it occupies. There are 4K, 8K and 12K BASIC's available. The



**DIABLO PRINTER is offered by International Peripheral Systems for personal computer systems.**

4K and 8K usually signify a standard BASIC, while 12K usually signifies an extended BASIC. If you have a computer with 16K of internal memory and you use a 12K BASIC, you only have 4K of memory left to write your programs in.

The disadvantage of using an interpreter is lack of speed, since each



**COMPUTER BOARDS from Processor Technology mates with the S100 bus.**

time a source program is executed, it must be translated. A compiler, on the other hand, translates the source program only once. Each time the program is executed, it is the machine-language program that is executed. A compiler, therefore, is much faster than an interpreter.

The disadvantage of using a compiler is the high-speed external memory requirements. This high-speed external memory is expensive. It is for this reason that interpreters are in far more common use than compilers.

R-E

# computer corner

## How to prepare programs for microcomputers.

PETER RONY, CHRIS TITUS, DAVID LARSEN AND JONATHAN TITUS\*

### DEFINITIONS

**Editor**—Allows edit functions such as addition of a line or character to a program, insertion, deletion, etc. It permits you to alter your program. The input could be anything from programs or reports to raw instrument data.

**Assembler**—Converts the assembly language code into machine code, accepting mnemonics and symbolic addresses instead of actual binary values for addresses, instructions and data.

**Monitor**—Controls the operation of the various programs available. The monitor can access the editor, assembler or other programs.

**Debugger**—Allows a step-by-step observation of the program flow and the results of the program's operation. A debugger can be used to change data or instructions, alter registers, etc.

**Breakpoint**—A special instruction that can be inserted in a program to break off the normal program control and return control to a debug-type program. When a breakpoint is executed, the debug program indicates what the computer was doing at that point.

**Cross Assembler**—An assembler program that generates the program binary code for a computer other than the type it is being used with. For example, an 8080 cross-assembler could operate on a PDP-8 minicomputer.

ONE OF THE PROBLEMS MANY MICROCOMPUTER users face is preparing software for their particular applications. The software examples that we have provided in past columns are short enough to be put together or *assembled* by hand; that is, we translated each mnemonic into its octal, hexadecimal or binary equivalent. Addresses for jumps, calls and input/output devices are easily added or changed since the computer programs are short and the addresses are probably listed in sequential order on the rough draft. Unfortunately, not all software preparation is this easy. Many application programs can be many thousands of steps long. This column will discuss the aids that are available for microcomputer program development.

One difficulty in software development is a clear, concise statement of the problem and how it is to be solved. All the desired results, inputs, outputs and the complete program flow, including all decision-making, must be considered before starting to program. An outline or block diagram can be used, but a flow chart is much easier to follow. Figure 1 shows a typical flow chart.

After the problem has been well thought out and a solution put in flow-chart form, a decision must be made. Is the program short enough to be easily translated by hand? In many cases, particularly with simple programs, hand assembly makes sense. In other cases, software development aids called *editors* and *assemblers* are faster and more efficient. To understand how editors and assemblers work,

consider the process we used to put together this column.

We first outline the subject so that it can be covered well in short-column format. A handwritten copy is then typed, corrected, retyped and perhaps corrected and typed a final time. The illustrations and examples are formulated and drawn separately. This is the *editing* process. When writing a column, avoid references such as, "... the example below" or "the table on the following page." When the column is composed or *assembled*, references to tables, figures, etc., are much easier to follow.

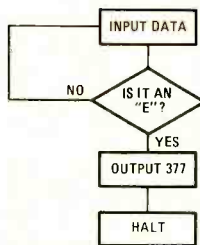

FIG. 1

Computer software is similarly developed. An editor program is used, either on a microcomputer or a timesharing system, to edit the individual program steps. The editor can correct, change, insert and delete steps in the program, just as with a manuscript. The editor program is generally unaware that you are writing a computer program, since you can use most editors to write a letter, prepare mailing lists, etc. When an editor is used to prepare a mnemonic program, *symbolic addresses* are often assigned to software tasks within the program. In this way, the actual value of the addresses for subprograms or subroutines is not needed. Just as in a column we refer to Fig.

4, the program refers to the letters, LOOP, as the starting address of a time-delay loop. Allowing the use of symbolic addresses for program steps means that the program can be changed without regard to the actual numeric values of addresses.

The assembler program must accept information from the editor and generate an output in a form that is compatible with your computer. Just as you assemble short programs one step at a time, so does the assembler. The assembler contains a table of mnemonics and their equivalent values. For example, an 8080 assembler would translate an MVIA instruction into 076 octal. The assembler also assigns real, 16-bit addresses to your symbolic addresses, such as LOOP. When using symbolic addresses, be sure to have a program step for each symbolic address and assign an address if you use a symbol. You cannot assign the same "name" to more than one address. Most assemblers will recognize a *redefined symbol* or an *undefined symbol*, and will produce an error message to let you know what needs to be corrected.

The final assembler output will be in punched paper tape, cassette or disc form ready to run on your system. Most assemblers will also produce a program listing showing the address of each step, the date in each successive location, a symbolic address name and the mnemonic plus any comments.

After a program has been assembled it will probably have to be debugged. The program checkout and debugging can be difficult without additional software "tools." Computer control panels are useful, but reading binary codes can become tedious, and there are many computers without external controls and readouts. There are *debugging programs* for most microcomputers that allow you to change instructions, list blocks of data or instructions and single-step through a program.

Many debug programs can establish a *breakpoint* in the software being tested. When the computer reaches a breakpoint, the instruction at that address is executed and an output device, such as a teletypewriter, lists the contents of important internal CPU registers. Breakpoints indicate not only that the computer reached a certain point in the software, but also what the computer did when it got there. If a breakpoint is set in the normal program flow and it is not reached, there is something wrong with the program. In this case, the breakpoint is moved closer and closer to the start of the program until the error is found. When the error is found, it can be corrected by using the debug program to change an instruction, data, etc.

Once the program operates correctly, the debug program should be able to save it on paper tape, a cassette, or some other medium. It should also be able to read such programs back into memory. In any case, when errors are found you should re-edit and reassemble the software to produce a complete, error-free documented listing. **R-E**

\* This article is reprinted courtesy of American Laboratories. Dr. Rony, Department of Chemical Engineering, and Mr. Larsen, Department of Chemistry, are with the Virginia Polytechnic Institute & State University. Mr. Jon Titus is president of Tychon, Inc., a microcomputer consulting firm in Blacksburg, VA.



## Integer multiplication and division routines for the 8080 microprocessor.

SINCE MICROPROCESSORS LIKE THE 8080 and 6800 do not have multiplication and division instructions, subroutines (containing addition and subtraction instructions) must be written to perform these operations. A typical paper-and-pencil decimal and binary multiplication for two different number sets is shown in Fig. 1.

### Multiplication

Figure 1 shows that the mechanics of multiplication in the two number sets are

1024	00100110
× 596	× 00011011
6144	00100110
92160	001001100
+ 512000	000000000
610304	00100110000
	001001100000
	0000000000000
	00000000000000
	+ 000000000000000
	000010000000010

FIG. 1—MULTIPLICATION EXAMPLES shown in decimal and binary.

very similar. As the multiplicand is multiplied by larger and larger powers of 10 or powers of 2, the result of the multiplication must be shifted to the left by one, to increase the significance of the result. For instance, when 1024 is multiplied by the 9 in 596, the result (9216) is shifted to the left by one place, because the multiplication is really  $90 \times 1024$  and the result is really 92,160.

To multiply two binary numbers, the 8080 must examine the multiplier one bit at a time. If the bit is a logic 1, the multiplicand is added to the *partial sum* (initially 0). If the bit examined is a logic 0, then the multiplicand is not added to the partial sum. Regardless of whether or not that addition takes place, the partial sum *must* be shifted one bit position, after each bit in the multiplier is examined.

To keep the 8080 multiplication software example (see Table 1) as simple as possible, we write a subroutine that multiplies two 8-bit numbers. These two numbers must be stored in registers D and E of the 8080, and the 16-bit result is stored in registers B and C (register pair B). When the subroutine is called, register pair B is cleared because it will be

used to store the *partial sum* and finally the 16-bit result of the multiplication. Register L is loaded with the number of bits in the multiplier, octal 010, hexadecimal 08 or decimal 8. At NXTBIT, the multiplier that is contained in register D is moved to register A, shifted once to the right and saved back in register D. These instructions shift a single bit of the multiplier into the carry so that the state of the bit (logic 1 or logic 0) can be tested with software instructions.

If the state of the carry after the shift is a logic 0, this means that the multiplicand is not added to the partial sum, so the JMP to NOADD (NO ADDITION) is executed. If the carry is a logic 1, the JMP to NOADD is not executed. Instead, the multiplicand, contained in register E, is added to the partial sum, which is contained in register pair B.

At NOADD, the 16-bit number contained in register pair B is shifted to the right by one bit position. The multiplier's bit count, which is contained in register L, is then decremented by one. When this bit count is decremented to 0, the 8080 will return from the subroutine, with the 16-bit result of the multiplication in register pair B. If the bit count is nonzero,

the JMP to NXTBIT is executed, so that another bit in the multiplier can be tested and any additions performed.

### Subtraction

The multiplication of the two 8-bit binary numbers was performed by an *add and shift algorithm*. Binary division can be performed by a *subtract and shift algorithm*. An example of binary division is shown in Fig. 2. Binary division is more

	00001110
1011	10011011
	- 1011
	10000
	- 1011
	1011
	- 1011
	00001

FIG. 2—BINARY DIVISION example.

complex than binary multiplication. To divide two binary numbers, the divisor is subtracted from a larger and larger portion of the dividend that has less and less significance. If the divisor is larger than the part of the dividend from which it is being subtracted, a borrow occurs. In this case, the divisor is added to the *result of*

TABLE 1—EIGHT-BIT MULTIPLICATION SUBROUTINE

MP88,	LXIB 000 000 MVL 010	/SET THE REGISTER PAIR THAT WILL HOLD THE /RESULT OF THE MULTIPLICATION, TO /000 000 (HEXADECIMAL 0000) /LOAD L WITH 8 (DECIMAL), THE BIT COUNT /OR THE NUMBER OF SHIFTS TO TAKE PLACE
NXTBIT,	MOVAD RAR MOVDA	/MOVE THE MULTIPLIER INTO A /SHIFT IT ONE BIT TO THE RIGHT /THE CARRY IS EITHER 1 OR 0, SAVE THE MULTIPLIER
NOADD,	JNC NOADD 0 MOVAB ADDE MOVBA MOVAB RAR MOVBA MOVAC RAR MOVCA DCRL JNZ NXTBIT 0 RET	/IF THE CARRY IS 0, JUST SHIFT THE /RESULT. IF THE CARRY IS A 1, ADD THE /MULTIPICAND TO THE RESULT, THEN SHIFT IT /GET THE MSBY OF THE RESULT /ADD THE MULTIPLICAND /AND SAVE THE MSBY OF THE RESULT /NOW SHIFT THE 16—BIT RESULT ONE /PLACE TO THE RIGHT. /SAVE THE NEW MSBY /NOW SHIFT THE LSBY TO THE RIGHT.  /HAVE ALL 8 BITS OF THE MULTIPLIER /BEEN TESTED YET? NO, TEST ANOTHER BIT  /YES, THE ANSWER IS IN REGISTER PAIR B

TABLE 2—EIGHT-BIT DIVISION SUBROUTINE

DIV88,	LXIH	/LOAD THE L REGISTER WITH 010 (DECIMAL 8)
	010	/OR HEXADECIMAL 08 AND LOAD THE H
	000	/REGISTER WITH 000 (THE RESULT WILL BE IN H)
	MVIC	/LOAD THE C REGISTER WITH 000
	000	/THIS REGISTER WILL BE USED FOR STORAGE
NXTBIT,	MOVAE	/MOVE THE DIVIDEND TO A
	RAL	/SHIFT THE MSB OF A INTO THE CARRY
	MOVEA	/SAVE THE SHIFTED DIVIDEND BACK IN E
	MOVAC	/GET THE PARTIAL DIVIDEND STORED IN C
	RAL	/SHIFT THE CARRY INTO THE LSB OF A.
	SUBD	/SUBTRACT THE DIVISOR FROM THIS NUMBER
	JNC	/IF THE CARRY=0, THE SUBTRACTION DID NOT
	NOADD	/PRODUCE A BORROW. THEREFORE, SHIFT THE
	0	/QUOTIENT. OTHERWISE ADD THE DIVISOR BACK TO
		A
	ADD	/ADD THE DIVISOR BACK TO THE CONTENT OF A.
NOADD,	MOVCA	/SAVE THE PARTIAL DIVIDEND BACK IN C.
	CMC	/COMPLEMENT THE CARRY.
	MOVAH	/AND SHIFT THE CARRY INTO THE LSB
	RAL	/OF THE H REGISTER. IF A BORROW, C=0
	MOVHA	/IF NOT, C=1
	DCRL	/HAVE ALL EIGHT BITS BEEN SHIFTED YET?
	JNZ	/NO, SHIFT ANOTHER BIT OF THE
	NXTBIT	/DIVIDEND AND TRY ANOTHER SUBTRACTION
	0	
	RET	/THE ANSWER IS IN H WHEN THE 8080 RETURNS

register C is then moved to register A, and the bit from the dividend is shifted from the carry into the least-significant-bit (LSB) of register A. The SUBD instruction subtracts the divisor from the partial dividend, which was in register A. If the divisor is subtracted from a larger or equal number, the JMP to NOADD is executed. If the divisor is greater than the partial dividend, a borrow occurs, therefore the divisor is added to the result of the subtraction by the ADDB instruction. Register A now contains the original partial dividend.

When the 8080 executes the instructions at NOADD, it must enter a logic 0 or logic 1 into the quotient. Therefore, the state of the carry is complemented by the CMC instruction and then saved in register H. If the subtraction did not generate a borrow, then the carry is a logic 0, but a logic 1 must be entered in the quotient. If a borrow was generated, the carry is a logic 1. This means that a logic 0 must be entered into the quotient. The CMC instruction simply complements the state of the carry to the state needed in the program. Finally, the content of register L is decremented by the DCRL instruction. If more bits within the dividend must be tested, the 8080 jumps back to NXTBIT, otherwise it returns from the subroutine with the quotient in register H and the remainder in register C.

There are a number of *software tricks* that can be used to simplify these two mathematical subroutines. However, unless your microcomputer can execute multiply-and-divide instructions or has special *multiply/divide hardware*, these operations will have to be performed using these or similar algorithms. R-E

the subtraction to re-generate the original part of the dividend being tested. A 0 is then entered in the quotient for the bit position being tested. If no borrow occurs when the subtraction is performed, the result of the subtraction is used as the new partial dividend, and a 1 is entered into the quotient since the divisor was successfully subtracted from the dividend. The subroutine listed in Table 2 divides the content of register E (the dividend) by the 8-bit content of the register D (the divisor) and the 8-bit result (the quotient) is saved in register H

and the remainder is saved in register C. The LXIH instruction in the subroutine (Table 2) loads the number of bits in the divisor (octal 010, decimal 8) into register L and register H is loaded with 0. This is done because register H will be used to store the quotient. The MVIC instruction loads register C with 0. Register C will be used to store the *partial dividend*. At NXTBIT, the dividend is shifted one bit to the right. The most-significant-bit (MSB) is shifted into the carry, and the remaining bits of the dividend are saved back in register E. The partial dividend in

## NOT IN THE CHARTS

The following companies provide products of interest to the computer hobbyist, but are not listed in the charts on the following pages.

NAME OF COMPANY	PRODUCT	ADDRESS
COMPUTER FAIRE	Proceedings & Silicon Gulch Gazette—	Box 1579, Palo Alto, CA 94302
COMPUTER PROFESSIONALS	Book Club	P.O.B. 582, Princeton Rd., Hightstown, NJ
CREATIVE COMPUTING	Books	P.O. Box 789-M, Morristown, NJ 07960
HAYDEN PUBLISHING	Books	50 Essex St., Rochelle Park, NJ 07662
HOWARD H. SAMS & CO., INC.	Books	4300 W. 62nd St., Indianapolis, IN 46206
LEXINGTON BOOKS	Books	125 Spring St., Lexington, MA 02173
LOGICAL SERVICES INC.	Microcomputer Programming Course	1080-H E. Duane Ave., Sunnyvale, CA
MCGRAW-HILL PUBLISHING	Books	1221 Ave. of the Americas, New York, NY
O A E	PROM Programmer	676 W. Wilson Ave., Glendale, CA 91203
OSBORNE & ASSOC.	Books	P.O. Box 2036, Berkeley, CA 94702
PRENTICE-HALL, INC.	Books	Route 9W, Englewood Cliffs, NJ 07662
POWER-ONE, INC.	Open frame DC power supplies single dual & triple output models	Power-One Drive, Amarillo, CA 93010
RONDURE COMPANY	IBM Selectric Terminals	2522 Butler St., Dallas, TX 75135
SHUGART ASSOC.	Floppy & Minifloppy™ Disc Drives	435 Oakmead Pkwy., Sunnyvale, CA 94086
SYLVANHILLS LAB INC.	X-Y Plotter	P.O. Box, Pittsburg, KS 66762
SYSTEX ENTERPRISES INC.	Computer Portrait System	P.O. Box 402, King of Prussia, PA 19406
TAB BOOKS	Books	Monterey & Pinola Aves., Blue Ridge Summit, PA 17214



# Personal Computers DIRECTORY

*The following pages contain detailed information on the personal computer products made by a large number of manufacturers. We think you'll find it informative*

- 60 About The Charts
- 61 Mainframes
- 62 CPU And Memory Boards
- 63 Parallel And Serial I/O Boards
- 64 Cassette And Disc I/O Boards
- 65 Video Modules
- 66 Video Terminals
- 67 Other Boards
- 68 List of Manufacturers

## EDITORIAL CALL

(Response required by March 6, 1978)

The June issue of RADIO-ELECTRONICS will contain a special 32-page section on hobby computers. An important part of the special section will be a complete, detailed product directory. The following pages in this booklet request the specific information we require about your products to complete your listing in our directory. Please complete these forms. Add any additional notes and comments in the spaces provided, or as additional sheets.

Also include photographs, product literature and any other data you feel will help us inform our readers about your products. Keep in mind that this story will reach our subscribers in early May, and will appear on the newsstands about the 18th of May. If you have products scheduled to appear about that time, feel free to send us data on them now.

Your reply must be in our offices no later than March 6, 1978. Any material received after that date may not be included. Many thanks for your assistance in making this directory as complete as possible.

Sincerely,

*Larry Steckler*

Larry Steckler  
Editor

Enclosures

The letter reproduced at the top of this page was sent as a part of an 8-page questionnaire to all of the personal computer product manufacturers we could locate. We followed up by handing out additional forms at personal computer shows. The resulting tables, on the pages that follow, were compiled from the data we received. For further information on any of the items described, please contact the individual

manufacturer. You'll find the name, address and phone number of everyone who participated, on the last page of this special section. When you write or phone for more information please inform the company that you read about their products in this special section. By doing so, you'll help us guarantee a more complete response from all personal computer manufacturers the next time we do this kind of report.



MAIN FRAMES

MANUFACTURER	MODEL	BUS SYSTEM	FRONT PANEL			SLOTS FOR PLUGS	COMMENTS
			SWITCHES	KEYBOARD	DISPLAY		
APPLE	A250016X	APPLE 50		TYPEWRITER		8	FAN
COMPAL	80	S-100		ARS-33.37		5	
COMPCOLOR	II	40-PIN		ASC11	CRT	0	CONVECTION COOLED FAN BATTERY BACK UP
COMPUTER SHOP	CS-100	S-100		ASC11 HEX	HEX		EXPANSION THROUGH SELF-POWERED ADD ONS
E & L	MMD-1	E & L		OCTAL HEX	LED		
ELECTRONIC CONTROL TECHNOLOGY	TT-10	S-100	YES			10	WHISPER FAN
HEATH COMPANY	H-8 H-11	BH-50 38-PIN	YES YES	OCTAL		10 6	CONDUCTION COOLED FAN
INFINITE INC.	UC2000	S-100		ASC11	CRT	8	AXIAL FAN
ITHICA AUDIO		S-100	YES	BINARY			SMART FRONT-PANEL BOARD
JADE COMPUTER PRODUCTS	S-100, SS-50 KIM-1	S-100	YES	YES	CRT	16	FAN
MIDWEST SCIENTIFIC INSTRUMENTS	MSI-6800	SS-50	YES	HEX	BINARY		
NBL		SPECIAL					
NETRONICS R & O	ELF II	EEF II	YES	HEX	7-SEG HEX	5	ON BOARD FILTER & REGULATOR
NORTH STAR	HORIZON	S-100	YES			12	FAN
NOVAL INC.	760	44-PIN	YES	ASC11	VIDEO	7	
OHIO SCIENTIFIC	C2-4P C2-S1S C3-S1	48-PIN 48-PIN 48-PIN	YES YES YES	ASC11	VIDEO	4 8 8	INCLUDES AUDIO CASSETTE INTERFACE, 4K RAM, 8K BASIC IN ROM, FAN
PARASITIC ENGINEERING	EQUINOX-100	S-100	YES	12-KEY OCTAL	OCTAL LED	20	CONSTANT VOLTAGE FERRO-RESONANT TRANSFORMER INTELLIGENT FRONT PANEL BOX FAN
QUAY	8000	S-100	YES			12	MUFFIN FAN
REALISTIC CONTROLS	Z1110	S-100		FULL A/N		6	FAN
SEALS ELECTRONICS	PUP-1	S-100	YES		INDICATORS	11	FAN
SOUTHWEST TECHNICAL PRODUCTS	68/2	SS-50	YES			15	7 MAIN PLUG-IN SLOTS 8 I/O PLUG-IN SLOTS
TEI INC.	MCS-112, 122, RM12, RM22	S-100	YES			12 OR 22	FAN
VECTOR GRAPHIC	VECTOR 1, 1+, 1++	S-100	YES			18	FULLY SHIELDED AND TERMINATED MOTHERBOARD WHISTLER FAN
WAVE MATE	JUPITER II, III	72-PIN	YES		4 DIGIT HEX	11	CONVECTION COOLED

CPU			MEMORY													
MANUFACTURER	BUS SYSTEM	MICRO-PROCESSOR	FEATURES			RAM (K)	ROM (K)	BUS SYSTEM	RAM (K)	ROM (K)	EPROM (K)	SPEED $\mu$ s	DIRECT MEMORY ACCESS	ON BOARD REGULATORS	ADDRESS SELECTION	COMMENTS
			MON. PROM	PARALLEL I/O	SERIAL I/O											
APPLE	APPLE 50	6502	•	•	•	48	12	APPLE 50	48	12	12	500	YES	NO	PLUG IN JUMPERS	
CENTRAL DATA									16 OR 32	12		450	NO	YES	16K BLOCKS WITH 2K OG SELECT	
COMPAL	S-100	8080	•	•	•	512 BYTES		S-100	UP TO 64	UP TO 3	250	YES	YES			
COMPUCOLOR	40-PIN	8080	•	•	•	4, 32	16, 24	40-PIN	16	16	400	NO	YES	NO		MEMORY IS ON CPU CARD
COMPUTER SHOP	S-100	Z80	•	•	•			S-100	16 TO 64		200	YES	YES	4K		
THE COMPUTERIST																
E & L INSTRUMENTS	E & L	8080	•	•	•	512 BYTES	512 BYTES	KIM-1	8	8	450	YES	YES			INDEPENDENTLY JUMPERABLE AT ANY 2K BOUNDARY
ELECTRONIC CONTROL TECHNOLOGY	S-100	8080, Z-80	•	•	•			E & L	2, 16	2	450	YES	YES	4K BLOCKS		MOUNTS ON CPU POWERED FROM CPU
ELECTRONIC SYSTEMS									8		450	YES	YES			
FRANKLIN ELECTRIC									8		450, 250	YES	YES			
GOUBOUT									8-16, 12							4K BLOCKS
HEATH COMPANY	BH-50 LSI-11	8080 LSI-11	•	•	•	4	1 X 8	BH-50	8 X 8		450	YES	YES			
IMSAI MFG.	S-100	8080, 8085	•	•	•	1 TO 4	2	S-100	4, 16, 32, 64	4, 16	475	YES	YES			
INFINITE INCORP.	S-100, CS-100 INFINITE 72, Z-80, 1802 COSMAC	8080, 8085, Z-80, 1802	•	•	•	.5	3									
ITHICA AUDIO																
JADE COMPUTER PRODUCTS	S-100 KIM-1	Z-80 8080, 6502, Z-80	•	•	•			S-100	8 STATIC 16, 32, 64 DYNAMIC	16/32	250 OR 450	YES	YES			DIP SWITCH EPROM 1K INCREMENTS
MARINCHIP SYSTEMS	S-100	9900	•	•	•											
MIDWEST SCIENTIFIC INSTRUMENTS	SS-50	6800	•	•	•	128	4	SS-50	56	56	250	YES	YES	SWITCH		
MOUNTAIN HARDWARE																
NBL																
NETRONICS	ELF-II	1802	•	•	•	2.56		ELF-II	4		100	YES	YES			FULLY BUFFERED & TRISTATE
NORTH STAR	S-100	8080, Z-80	•	•	•			S-100	16		200	YES	YES			
NOVAL INC.	44-PIN	Z-80	•	•	•				32			NO	YES			EACH 8K OF MEMORY CAN BE JUMPERED ON 8K BOUNDARIES
OHIO SCIENTIFIC	48-PIN	8080, 6502 Z-80	•	•	•	4 16	8	S-100	4 16	8 ON CPU	350 250	NO	NO			PIA BASED PARALLEL I/O OPTIONAL
PARASITIC ENGINEERING	S-100	8080A	•	•	•	512 BYTES	512 BYTES	S-100	4 STATIC	4	450	YES	YES			DIP SELECTABLE TO ANY 4K BLOCK



MEMORY

CPU

MANUFACTURER	BUS SYSTEM	MICRO-PROCESSOR	FEATURES			RAM (K)	ROM (K)	BUS SYSTEM	RAM (K)	ROM (K)	EPROM (K)	SPEED $\mu$ S	DIRECT MEMORY ACCESS	ON BOARD REGULATOR	ADDRESS SELECTION	COMMENTS
			SERIAL I/O	OTHER												
QUAY	S-100	Z-80	●	●	1		S-100	8 STAT IC	ON CPU		450	YES	YES	4K BLOCKS		
REALISTIC CONTROLS	S-100	Z-80	●	●	64	2	S-100	64			250	YES	YES	0000 <sub>H</sub> -FFFF <sub>H</sub>		
SD COMPUTER PROD	S-100	Z-80	●	●	1	4	S-100	4, 8 STATIC 8 TO 64	16 & 32	250/500 STATIC RAM 375 EXPANDRAM 450 EPROM		YES	YES	AT ANY LOCATION		
SEALS						8	S-100 SS-50	8, 16 32, 8	4	250 & 500						
SMOKE SIGNAL BROADCASTING							SS-50	16	8	250 & 400		YES	YES	SWITCH SELECT		
SOLID STATE SALES							F8, KIM, 6800	4		450		YES	NO			
SOUTHWEST TECHNICAL PRODUCTS	SS-50	6800	●			8 BYTES	SS-50	4, 8 16, 32	UP TO 8 BYTES		450	YES	YES	ANY 8K BLOCK		
SZERLIP ENTERPRISES							S-100	1		UP TO 32		YES	YES			
TEI INC	S-100	8080, Z-80					S-100	16			250		YES			
THINKER TOYS	S-100	8080		●		1 BYTES	S-100	8 65			250 250	NO		4K BLOCKS 8K WINDOWS SWITCH 8K BLOCKS		
VECTOR GRAPHICS	S-100	8080, Z-80					S-100	8, 16	2, 12		270 DYNAMIC 250 STATIC	YES	YES			
WWW ENTERPRISES							NONE	16				YES	NO			
WAVE MATE	72-PIN	Z-80, 6800					72-PIN	UP TO 32	350		350	YES	YES			

I/O BOARDS

MANUFACTURER	BUS SYSTEM	NO PORTS	HANDSHAKING	I/O PARALLEL			I/O SERIAL			BUS SYSTEM	COMMENTS	START/STOP CONTROL	RECORDING FORMAT	BAUD RATE	COMMENTS	
				SOFTWARE SELECT	JUMPER SELECT	COMMENTS	SOFTWARE SELECT	JUMPER SELECT	COMMENTS							
APPLE	APPLE 90	1	●				9600 110	1	APPLE 90				APPLE ENCODED PHASE ENCODED	1500		
COMPAL		1					5600 50	2					2400 300			
COMPUCOLOR																ON CPU CARD
COMPUTER SHOP	S-100		●				9600 55	2	S-100							
E & L INSTRUMENTS	E & L	3					110 110	1	E & L					300 300		PART OF CPU CARD





MANUFACTURER	FLOPPY INTERFACE							OTHER BOARDS				
	BUS SYSTEM	MINI 5"	FLOPPY 8"	NO. DRIVES	HARD SECTORED	OPERATING SYSTEM	COMMENTS	BUS SYSTEM	SPEECH	MUSIC	CONTROLLERS	OTHERS
APPLE		•		2	•	YES			•	•	•	MOTHER BOARD REAL TIME CLOCK AC POWER SWITCH 4-SLOT EXPANDER AUDIO AMPLIFIER AND SPEAKER REQUIRED
CALIFORNIA INDUSTRIAL												
CANDA SYSTEMS						YES		S-100	•	•	•	
COMPAL	S-100	•		4	•	MICROPOLIS						
COMPUTALKER												
COMPUCOLOR		•			•	IN ROM						
COMPUTER SHOP	S-100	•		1 TO 3	•	NORTH STAR						
E & L								E & L				EPROM & 8K RAM CARD CAGE, MOTHER BOARD, EXTENDER VART & BAUD-RATE GENERATOR TV TYPERWRITER MODEM
ELECTRONIC CONTROL TECHNOLOGY												
ELECTRONIC SYSTEMS												
HEATH COMPANY	BH-50	•		2	•							
IMSAI	S-100	•		7	•	ENHANCED CP/M						
INFINITE	S-100	•		3		NORTH STAR						
ITHICA AUDIO	S-100	•		8	•				•	•	•	A/D-D/A-8 BIT A/D-D/A-12 BIT
JADE COMPUTER PRODUCTS												
MICRONICS												
MIDWEST SCIENTIFIC INSTRUMENTS	S-100 SS-50	•		4	•	YES						BUG TRAP CALENDAR CLOCK OPTO ISOLATOR REMOTE CONTROL CLOCK CALENDAR PROTOTYPE HARDWARE, FLOATING POINT PROM BURNER 2ND DISPLAY DRIVE COLOR SELECTOR PROGRAMMABLE CHARACTER GEN 512 X 256 GRAPHICS 128 X 128 4 COLOR ALPHABETICS
MOUNTAIN HARDWARE												
NETRONICS												
NORTH STAR	S-100	•		3		2.5K DOS						
NOVAL	44-PIN	•		2	•	YES						
OBJECTIVE DESIGN												
OHIO SCIENTIFIC	48-PIN	•		1 2	•	YES						
PAIA												
PARASITIC ENGINEERING	S-100	•		4	•	CP/M						

FLOPPY INTERFACE										OTHER BOARDS			
MANUFACTURER	BUS SYSTEM	MINI 5"	FLOPPY 8"	NO. DRIVES	HARD SECTORED	SOFT SECTORED	OPERATING SYSTEM	COMMENTS	BUS SYSTEM	SPEECH	MUSIC	CONTROLLERS	OTHERS
PERCOM	SS-50	●					IN IK ROM						
PERSONAL COMPUTING	SS-50	●	●	4	●	●	YES		SS-50				PROTOTYPE
PROCESSOR CONTROL SYSTEM							QUAY						PROGRAM ORGAN
QUAY	S-100	●	4	4			CP/M		S-100	●	●	●	
REALISTIC CONTROLS	S-100	●	●	8	●		YES						
SMOKE SIGNAL BROADCASTING	SS-50	●			●		YES						
SOUTHWEST TECHNICAL	SS-50	●	●	4	●	●	YES		SS-50			●	INTERRUPT TIMER CALCULATOR INTERFACE
TEI	S-100	●	●	3 TO 8	●	●	CP/M						
THINKER TOYS	SS-50	●	●	3 TO 8			CP/M						WUNDERBUS MOTHER BOARD CARD CAGE S-100 HARDWARE PROTOTYPE
VECTOR													
VECTOR GRAPHICS	S-100	●	●	2	●	●	CP/M	DUAL STORE					
WAVE MATE	72-PIN	●	●	2 OR 4	●	●	YES						

### VIDEO DISPLAY MODULES

MANUFACTURER	BUS SYSTEM	RF OUTPUT	VIDEO OUTPUT	GRAPHICS	GRAPHICS RESOLUTION		DOT MATRIX	CHARACT. PER LINE	NO. LINES	PROGRAMMABLE CURSOR CONTROL	BLACK ONLY	WHITE ON BL	SCROLLING	HIGHLIGHT	UPPER CASE	LOWER CASE	COLOR	ON BOARD MEMORY (K)	SYSTEM MEMORY REQUIRED	SERIAL I/O	KEYBOARD INPUT	PARALL I/O	COMMENTS
					VERT ELEM	HORIZ ENTS																	
APPLE	APPLE	●	●	●	280	192	5 X 7	40	24	●	●	●	●	●	●	●		UP TO 46 RAMIZROM	8K	●	●	●	15 COLORS STANDARD 4-COLOR HI RESOLUTION INCLUDES 2650, CASSETTE INTERFACE
CENTRAL DATA	S-100	●	●	●	640	192	6 X 8	80	16	●	●	●	●	●	●	●		2	0				
COMPAL	S-100	●	●	●	128	48	7 X 9	64	16	●	●	●	●	●	●	●		1	0				
COMPUCOLOR				●	384	256	5 X 7	64	32	●	●	●	●	●	●	●		4	0				
COMPUTER SHOP	S-100	●	●	●	64	16	YES											16 TO 64	16				
ELECTRONIC SYSTEMS	STAND ALONE	●	●	●			5 X 7	32	16	●	●	●	●	●	●	●		1	0				
IMSAI MANUFACT.	S-100	●	●	●			5 X 7	80	24	●	●	●	●	●	●	●		2 RAM 1 PROM					
INFINITE INC.	S-100	●	●	●	128	48	7 X 9	64	16	●	●	●	●	●	●	●		1	2				





# LIST OF PERSONAL COMPUTER MANUFACTURERS

Here's a list of names addresses and phone numbers for every company that filled out one of our questionnaires. If a name you are looking for is missing, they did not respond to our request for information.

**APPLE COMPUTER INC.**  
10260 Bandley Drive  
Cupertino, CA 95014  
(408) 996-1010

**CALIFORNIA INDUSTRIAL**  
15214 Grevill Ave.  
Lawndale, CA 90260  
(213) 772-0800  
**T. RYDER**

**CANADA SYSTEMS, INC.**  
1353 Foothill Blvd.  
La Cañada, CA 91011  
(213) 790-7957  
**KEN FINSTER**

**CENTRAL DATA CO.**  
P.O. Box 2484, Station A  
Champaign, IL 61820  
(217) 359-8010  
**JEFF ROLOFF**

**COMPAL**  
(Computer Power & Light)  
12321 Ventura Blvd.  
Studio City, CA 91604  
(213) 760-3345  
**IVA KALB**

**COMPUCOLOR CORP.**  
5965 Peachtree Corners East  
Norcross, GA 30071  
(404) 449-5961  
**RODNEY HUNT**

**COMPUTALKER CONSULTANTS**  
P.O. Box 1951  
Santa Monica, CA 90406  
(213) 392-5230

**THE COMPUTER FAIRE**  
Box 1579  
Palo Alto, CA 94302  
(415) 851-7075  
**JIM WARREN**

**COMPUTER SHOP**  
288 Norfolk St.  
Cambridge, MA  
(617) 473-2323  
**R. RIVERA**

**THE COMPUTERIST**  
P.O. Box 3  
S. Chelmsford, MA 01824  
(617) 256-3649  
**ROBERT M. TRIPP**

**E & L INSTRUMENTS**  
61 First Street  
Derby, CT 06418  
(203) 735-8774  
**RICHARD J. VUILLEQUEZ**

**ELECTRONIC CONTROL TECHNOLOGY**  
763 Ramsey Avenue  
Hillsdale, NJ 07205  
(P.O.B. 6, Union, NJ 07083)  
(201) 686-8080  
**DENNIS P. DUPRE**

**ELECTRONIC SYSTEMS**  
P.O. Box 212  
Burlingame, CA 94010  
(408) 374-5984

**FRANKLIN ELECTRIC**  
733 Lakefield Rd.  
Westlake Village, CA 91361  
(805) 497-7755  
**FRANK PETERS**

**GENERAL MICRO-SYSTEMS**  
12369 W. Alabama Place  
Lakewood, CO 80228  
(303) 985-3423  
**BOB SMITH**

**BILL GODBOUT ELECTRONICS**  
Box 2355  
Oakland Airport, CA 94614

**THE HEATH COMPANY**  
Benton Harbor, MI 49022  
(616) 982-3417  
**V. VIRGIL BENNETT**

**IMSAI MFG. CORP.**  
14860 Wicks Blvd.  
San Leandro, CA  
(415) 483-2093

**INFINITE INC.**  
1924 Waverly Place  
Melbourne, FL 32901  
(305) 724-1588  
**BILL HABERHERN**

**I O R**  
P.O. Box 28823  
Dallas, TX 75228  
(214) 358-2671

**ITHACA AUDIO**  
P.O. Box 91  
Ithaca, NY 14850  
(607) 273-3271

**JADE COMPUTER PRODUCTS**  
5351 West 144th  
Lawndale, CA 90260  
(213) 679-3313

**LEXINGTON BOOKS**  
D.C. Heath & Co.  
125 Spring Street  
Lexington, MA 02173  
(617) 862-6650

**LOGICAL SERVICES INC.**  
1080-H East Duane Ave.  
Sunnyvale, CA 94086  
(408) 245-8855

**MARINCHIP SYSTEMS**  
16 St. Jude Road  
Mill Valley, CA 94941  
(415) 383-1545  
**JOHN WALKER**

**MICRONICS, INC.**  
P.O. Box 12545  
Raleigh, NC 27605  
**LENNY HEATH**

**MIDWEST SCIENTIFIC INSTRUMENTS, INC.**  
220 W. Cedar St., Olathe, KS 66061  
(913) 764-3273  
**DR. CHILDRESS**

**MOUNTAIN HARDWARE, INC.**  
P.O. Box 1133  
Ben Lomond, CA 95005  
(408) 336-2495  
**D. PACE**

**NBL**  
Box 1564  
Richardson, TX 75080  
(214) 231-2703  
**W.A. KLUCK**

**NETRONICS-R&D LTD.**  
333 Litchfield Road  
New Milford, CT 06776  
(203) 354-9375

**NORTH STAR COMPUTERS, INC.**  
2547 Ninth Street  
Berkeley, CA 94710  
(415) 549-0858  
**CA GRANT**

**NOVAL, INC.**  
8401 Aero Drive  
San Diego, CA 92123  
(714) 277-8700  
**AGO KISS**

**OAE (Oliver Advanced Engineering)**  
676 West Wilson Avenue  
Glendale, CA 91203  
(213) 240-0080  
**DOUGLAS E. OLIVER**

**OHIO SCIENTIFIC**  
Box 36  
Hiram, OH 44234  
(216) 562-3101  
**DON MUCHOW**

**OSBORNE & ASSOC.**  
P.O. Box 2036  
Berkeley, CA 94702  
(415) 548-2805

**PARASITIC ENGINEERING**  
P.O. Box 6314  
Albany, CA 94706  
(415) 547-6612

**PCS (Processor Control Systems)**  
Box 544  
Celoron, NY 14720  
(716) 664-2871  
**WALTER E. PELTON, Gen'l Mgr.**

**PERCOM DATA CO., INC.**  
318 Barnes  
Garland, TX 75042  
(214) 276-1968  
**LUCY MAUCH**

**PERSONAL COMPUTING CO.**  
3321 Towerwood Drive  
Dallas, TX 75234  
(214) 620-2776  
**STEVIE GENTRY**

**POWER-ONE, INC.**  
Power-One Drive  
Amarillo, CA 93010  
(805) 484-2806  
**STEVE COLE**

**QUAY CORP.**  
P.O. Box 386  
Freehold, NJ 07728  
(201) 681-8700  
**Mr. ROESSLER**

**REALISTIC CONTROLS CORP.**  
404 West 35th Street  
Davenport, IA 52806  
(319) 386-4400

**RONDURE COMPANY**  
2522 Butler Street  
Dallas, TX 75235  
(214) 630-4621

**SD COMPUTER PRODUCTS**  
Div. SD Sales  
P.O. Box 28810  
Dallas, TX 75228  
(214) 271-4667  
800 527-3460

**SEALS ELECTRONICS, INC.**  
10728 Dutchtown Rd.  
Concord, TN 37922  
(615) 966-8771  
**ROBIN CONTENT, Mktg. Dir**

**SHUGART ASSOC.**  
435 Oakmead Pkwy.  
Sunnyvale, CA 94086  
(408) 733-0100  
**GARY YOST**

**SMOKE SIGNAL BROADCASTING**  
6304 Yucca  
Hollywood, CA 90028  
(213) 462-5652  
**RIC HAMMOND**

**SOLID STATE SALES**  
P.O. Box 74  
Somerville, MA 02143  
(617) 547-4005  
**J. HEFFRON**

**SOUTHWEST TECHNICAL PRODUCTS CORP.**  
219 W. Rhapsody  
San Antonio, TX 78216  
(512) 344-9778  
**DAN MEYER**

**SYLVANHILLS LAB INC.**  
P.O. Box 646  
Pittsburg, KS 66762  
(316) 231-4440  
**SHARON BELL**

**SYSTEX ENTERPRISES INC.**  
P.O. Box 402  
King of Prussia, PA 19406  
(215) 482-9481  
(215) 631-1318

**SZERLIP ENTERPRISES**  
1414 W. 259th Street  
Harbor City, CA 90710

**TEI Inc.**  
c/o CMC MARKETING CORP.  
5601 Bintliff #515  
Houston, TX 77036  
(713) 783-8880

**THINKER TOYS**  
1201 10th Street  
Berkeley, CA 94710  
(415) 527-7548  
**JEAN MORROW**

**VECTOR ELECTRONICS CO., INC.**  
12460 Gladstone Avenue  
Sylmar, CA 91342  
(213) 365-9661  
**FLOYD HILL**

**VECTOR GRAPHIC INC.**  
790 Hampshire Road A&B  
Westlake Village, CA 91361  
(805) 497-6853

**WWW ENTERPRISES**  
P.O. Box 548  
Harbor City, CA 90710  
(213) 835-9417  
**WARREN WEIMER**

**WAVE MATE**  
1015 W. 190th Street  
Gardena, CA 90248  
(213) 329-8941  
**DENNIS BROWN**



# BUILD DIGI-TOLL

## Save On Long Distance Phone Calls



*A digital timekeeping accessory that displays the time of day and elapsed-time data in step with the Telco billing timer. Use it wisely and reduce toll charges 15%.*

FRED BLECHMAN, K6UGT

UNTIL RECENTLY, ONLY THE LARGEST corporations could afford the expensive computerized systems required to effectively manage long-distance telephone call expenses. Now, for less than \$50, the *Digi:Toll* (Cervco, Inc., 211 Mill Creek Drive, Youngstown, OH 44512) solid-state digital clock/elapsed timer makes it possible to control the cost of long-distance and other toll calls *as they are being made*.

The *Digi:Toll* is a digital timekeeping instrument designed specifically for toll-call management applications. Although it is *not* connected to the telephone line, its special circuits continuously display the same time-of-day and elapsed-time data used by the telephone company to calculate toll charges. With this data and an understanding of phone company timing and discount procedures (covered later on in this article) you can reduce the monthly cost of long-distance and timed local calls by 10% to 20% on each phone equipped with a *Digi:Toll*. Table I shows the projected savings possible if the *Digi:Toll* only reduces your toll charges by 15%.

The standard *Digi:Toll* can be operated from a 117-VAC 60-Hz source and functions as a 12-hour time-of-day clock and a 24-minute call timer. Four versions can be built by cutting foil traces and using wire jumpers. The 24-hour-display "T" version is useful for ham operation or for international calls. The "L" (Legal) version can be used by attorneys, accountants, advertising agencies and oth-

ers who need a long-duration (24-hour) timer for billing, timing conferences, etc., as well as a 24-minute call timer. The "W" (WATS) version *Digi:Toll* is a *totalizing* timer for WATS-line users. This version *totals* (up to 24 hours) each individual call measured on the 24-minute timer. Also, for use in foreign countries at 50 Hz, modification "P," usable with all other versions, can be constructed with only one foil break and one jumper wire.

All *Digi:Toll* versions are also useful for special applications such as in photo and test labs, where they can even be built into other equipment.

### Features of the unit

The use of digital display is a significant improvement over past telephoning devices, such as stopwatches and

hourglasses, since it combines continuous data presentation with ease of interpretation. The *Digi:Toll's* unique physical design (Patent No. 242,847) contributes to its overall effectiveness. The anodized aluminum enclosure fits conveniently in front of all commonly used desk phones and is held firmly in place, ready for instant use, by the weight of the telephone itself, as shown in Fig. 1. This arrangement encourages continued use of the *Digi:Toll* for cost-reduction purposes. Since no connection to the phone lines is required, no phone company approval or monthly charges are involved.

The extra-bright 1/2-inch-high LED display and special glare-reducing filter make for easy readability under a wide range of viewing angles and ambient light conditions. Important timing and discount-data tables are prominently located

TABLE I—TYPICAL SAVINGS USING A DIGI: TOLL

Average Long Distance Cost/Month/Phone (\$)	Savings/Month at 15% (\$)	1st Year Savings (\$)	5-Year Savings (\$)
25	3.75	45	225
50	7.50	90	450
75	11.25	135	675
100	15.00	180	900
125	18.75	225	1125
150	22.50	270	1350
175	26.25	315	1575
200	30.00	360	1800

above the LED display for easy reference. The proper use of these tables (described later) is a key to the effective use of the *Digi:Toll*.

Operating power is furnished through a Class II, wall-plug enclosed transformer that eliminates batteries. The line cord is thin and unobtrusive. If a power failure or brownout occurs, a flashing display warns

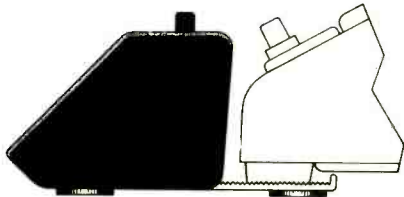

FIG. 1—THE DIGI-TOLL mounts in front of desk telephone and is held in position by its weight.

of possible incorrect time information. Construction is simple and uncrowded, and complete parts kits, with step-by-step instructions, are available, as are pre-assembled units. See parts list for the various options.

### Circuit description

The *Digi:Toll* circuit, shown in Fig. 2, uses only one clock IC to count and display *all* the time-of-day and elapsed-time functions for *all* versions. The IC, a Fairchild 3817 (interchangeable A or D type) is the only IC available that can provide all display-sharing functions without having to provide additional external counter or divider circuits. (Although the 3817 appears identical to the National MM5316 pin-for-pin, some internal functions are not the same.) In addition, several special circuits have been incorporated in the clock/timer's overall design to optimize performance.

The AC input from wall-plug transformer T1 is converted to DC voltage by bridge rectifier RECT1 and filtered by

**All resistors are 1/4-watt, 5%, unless noted.**

- R1-R3—100,000 ohms
- R4—22 ohms
- R5—47 ohms
- R6—33 ohms, 2 watts, wire-wound
- C1—1000  $\mu$ F, 15 volts, electrolytic
- C2—0.1  $\mu$ F, 16 volts, disc
- C3-C6—0.01  $\mu$ F, 16 volts, disc
- D1, D2, D6—1N914 signal diode
- D3, D4—1N949 germanium diode (no substitutes)
- D5—1N4733A 5.1-volt, 1-watt Zener
- RECT1—VM08 50 PIV 1-amp bridge rectifier (Varo or equiv.)
- IC1—Fairchild 3817 (A or D) digital alarm clock (no substitutes)
- T1—11.5-volt, 175-mA Class II wall-plug transformer, 117-VAC, 50- to 60-Hz primary (Dormeyer PS-8514—no substitutes)
- DIS1-DIS4—Fairchild FND-500 7-segment LED display, brightness code 08 or 09 or FND-560, any brightness code (no substitutes)
- S1—4PDT alternate-action switch (IEE/Schadow F4U-EE)
- S2-S4—2PDT momentary-action switch (IEE/Schadow F2U-OA)
- Misc.—two 9-pin right-angle header strips (AP Products 929835-01); switch button tops; PC boards; enclosure with end caps and screws; data plate; foam feet; antireflection display filter (Panelgraphic

electrolytic capacitor C1. Extra spurious high-frequency filtering is provided by capacitor C2. Resistor R1 and capacitor C3 shape and feed the AC-input frequency to the clock IC counter circuitry. Capacitor C6, which is connected to the metal case by a PC board trace, helps keep external static discharges (such as that built up from walking on a rug) from affecting the clock IC when you touch the case. Zener diode D5 and a 2-watt resistor, R6, stabilize the variable output from the Class II transformer to keep  $V_{ss}$

*Chromafilter* Type CF-133 Color: Red 63); hookup wire for jumpers.

**The following kits are available from Cervco, Inc., 211 Mill Creek Drive, Youngstown, OH 44512:**

**KIT DT-1K: Complete kit consisting of all components, PC boards, case, header-pin bending tool, and step-by-step assembly and applications manual, \$49.95.**

**KIT DT-P: Partial kit consisting of all components, including graded displays, switches, transformer and header strips, \$29.95.**

**KIT DT-B: Partial kit consisting of both PC boards; precision-milled, drilled, plated-through (PCB-B), solder-plated and reflown on black substrate, \$14.95.**

**KIT DT-C: Partial kit consisting of case with hardware, data plate and Panelgraphic display lens, \$9.95.**

**The following assembled and tested units are also available from Cervco, Inc.:**

**DT-1A: Standard *Digi:Toll*, \$79.95.**

**DT-1A/T, L, W: Modified *Digi:Toll*, \$89.95.**

**Quantity pricing available on kits and assembled units.**

**All prices are postpaid in the U.S. Ohio residents add state and local taxes as applicable. For BankAmericard and Master Charge orders, include complete card number and expiration date.**

(positive voltage) at approximately 12 volts. Also, D5 and R6 form a voltage divider that clamps the voltage drop across the IC internal segment drivers and display segments at 5.1 volts. This allows for maximum display-segment drive current without overheating the IC. Without a carefully balanced combination of T1, D5 and R6, the IC could overheat, or the digit displays could flicker with different digit combinations, since a different number of segments would be lighted. Although D5 and IC1 run warm and R6 becomes hot, they all operate within specifications.

Switches S3 and S4 set the time-of-day display (when switch S1 is in the up position) by connecting  $V_{ss}$  to pins 33 and 34 of the clock IC in the conventional manner.

The design lets you use the IC's alarm register as an elapsed timer. This is done by "clocking" the alarm display with the 1-Hz slow time-advance command. Depressing switch S1 locks it down in the ELAPSED TIME position until it is pressed again. When this switch is in the down position, positive voltage  $V_{ss}$  at switch terminal 11 flows through terminal 12 and diode D1 to pins 31 and 38 of IC1. This commands the display to show alarm time in the 24-hour mode. Simultaneously, terminal 12 of S1 (through resistor R3 and diode D2) also provides positive voltage to pin 33 of IC1. This advances the display one count-per-sec-

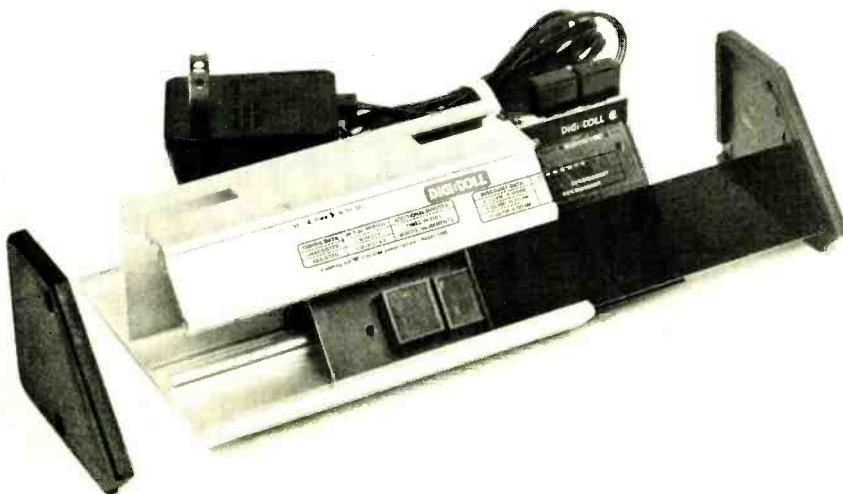

THE PC BOARD SUB-ASSEMBLY slides into specially designed extruded aluminum cabinet with non-reflective front panel and molded end caps. Data plate slides into sloping track.



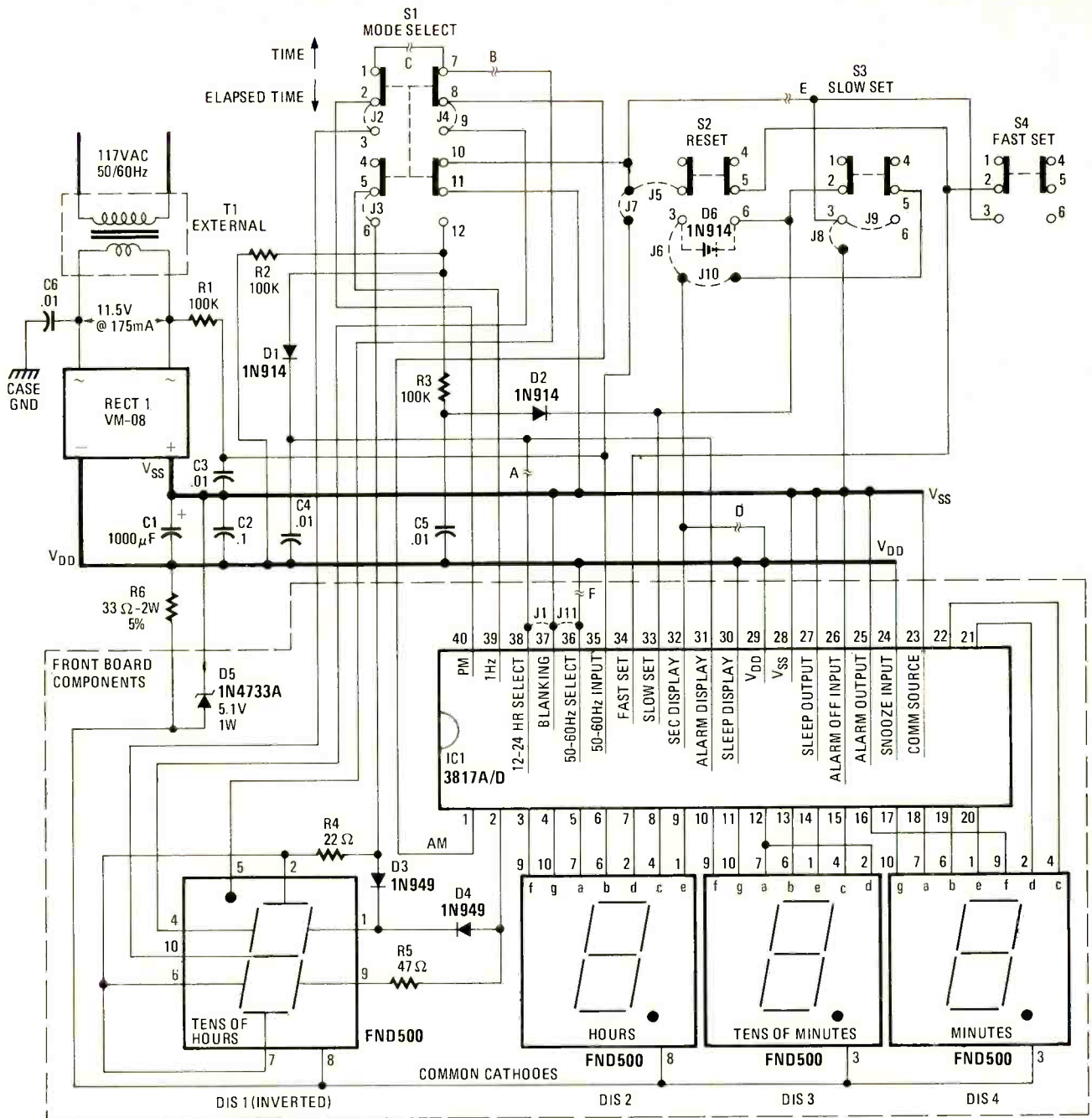

**NOTES**

- 1 - CIRCUIT MODIFICATIONS:
- A. BREAKS IN EXISTING PC BOARD TRACES ARE INDICATED BY THE SYMBOL ≈ PLUS A LETTER DESIGNATION.
  - B. HAROWIRE JUMPERS ARE INDICATED BY A DOTTED LINE PLUS A J DESIGNATION.
  - C. MODIFICATION DESIGNATIONS:
    1. 24 HR CLOCK/24 MIN TIMER - T
    2. 24 HR CLOCK-TIMER/24 MIN TIMER - L
    3. 24 HR TOTALIZING TIMER/24 MIN TIMER - W
    4. 50Hz OPERATION - P
  - D. ALL FOIL BREAKS EXCEPT D & F ARE ON THE BACK PC BOARD.
  - E. ALL JUMPERS & D6 ARE ON THE BACK PC BOARD

**MODIFICATION TABLE**

MOD	FOIL BREAKS						JUMPERS (J)											
	A	B	C	D	E	F	1	2	3	4	5	6	7	8	9	10	11	D6
T	×	×	×	×	×	×												
L	×	×	×	×	×	×												
W	×	×	×	×	×	×												
P	×	×	×	×	×	×												

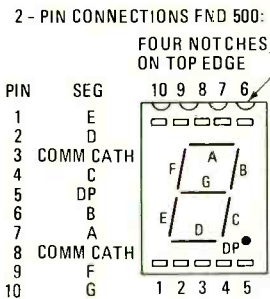

**FIG. 2—SCHEMATIC DIAGRAM OF THE DIGI-TOLL. A single clock IC does all the timekeeping and drives the four seven-segment displays. One display is intentionally mounted up-side down. Several versions are made possible by making changes in the circuitry as in the table.**

ond. Furthermore, when the last two digits reach "59," the next count advances the preceding digit by one.

Although this display is intended to show the alarm-time hours and minutes in a 24-hour format, it is being used here

to represent elapsed time in minutes and seconds up to 23 minutes and 59 seconds. On the next count, it goes to 00 00 and continues counting. when switch S1 is pressed again and pops up, this elapsed (alarm) time is held in the clock IC's

alarm register. To recall this time, depress S1 to display the last count and the sequence starts advancing again one count-per-second.

To "zero" the elapsed-time display, depress spring-loaded pushbutton RESET

switch S2; this feeds a positive voltage to pin 34. Since a positive voltage is already being applied to pin 33, the clock IC is commanded by the internal logic to reset the display to 00 00. Table II shows the operating modes for IC1 in order to clarify the interaction of mode and set functions.

Switch S1 performs another important function. Display DIS1 (the tens-of-hours digit) is normally blank during the time-of-day display (except when it shows a "1" from 10 00 to 12 59) in the 12-hour format. However, for the elapsed-time display, display digit DIS1 must show a "0," "1," or "2" as required. Switch S1's other terminals program this digit with the IC segment-driver outputs.

example, D1, D2, R2, R3, C4 and C5 prevent the time-of-day display from being altered if switches S1 and S2 are operated together to simultaneously start *and* zero the elapsed timer. Circuit-shift time within the IC and contact-bounce of the switches could cause the time-of-day circuitry to "see" a fast-forward command before the display is changed to the elapsed-time mode. Time-delay circuits formed by R3-C5 and D1-C4 prevent this from happening. When switches S1 and S2 are pressed together, diode D1's low forward resistance allows capacitor C4 to charge rapidly, quickly commanding the display to show elapsed time. However, the relatively high resistance of R3 slows the charging of capacitor C5, so

creating foil breaks on the PC board and adding jumpers, as shown in the Fig. 2 table. For example, for modification "T," the 24-hour version, you make foil breaks A, B and C, and add jumpers J1, J2, J3 and J4. Foil break A isolates IC1 pin 38, the 12- to 24-hour select pin, from the switching circuit, and jumper J1 permanently connects it to  $V_{ss}$ . Similarly, foil breaks B and C disconnect the decimal-point indicator, and jumpers J2, J3 and J4 permanently wire switch S1 for a 24-hour display. No other functions are affected. This "T" modification is also required as part of the "L" (legal) or "W" (WATS) modifications of the clock/timer.

The "L" version requires one more foil break and two more jumpers, plus adding another diode, D6. Foil break D disconnects pin 32 (the seconds display) from  $V_{dd}$  (ground). Jumpers J5 and J6 allow  $V_{ss}$  to be applied to pins 32, 33 and 34 simultaneously by pressing switch S2, with switch S1 in the up (time-of-day) mode. Table II shows this resets the time display to 00 00, allowing the unit to be used as a 24-hour elapsed timer. Diode D6 prevents unwanted hold mode when push-button switch S3 is used to slow-set the time.

The "W" version can be chosen instead of the "L" version, but you cannot have both together. The "W" version allows you to totalize or accumulate separate time periods up to 24 hours. The counting is inhibited while S1 is in the time mode (up position) by adding jumper J7, which connects pin 35, the 50- to 60-Hz counting input of IC1, to  $V_{ss}$  through terminal 10 of S1. When S1 is in the 24-minute elapsed-time mode (down position),  $V_{ss}$  is removed from pin 35, and counting resumes from where it had been stopped. To insure that resetting the 24-hour accumulators to 00 00 is done intentionally and not accidentally, *both* SLOW SET and FAST SET switches S3 and S4 must be pressed. This is done by foil breaks D and E, and by jumpers J8, J9 and J10. When S3 and S4 are *both* pushed, pins 32, 33 and 34 are all connected to  $V_{ss}$  and resetting to 00 00 occurs (see Table II).

The power modification to 50 Hz (P) can be done independently of the other options by foil break F and jumper J11. This disconnects IC1 pin 36 from voltage  $V_{dd}$  and connects it to voltage  $V_{ss}$ . The specified transformer operates at an input of 117 volts, 50 Hz, although it runs warmer than at a 60-Hz input. If your power input is 220 volts, you will need a converter or a different transformer.

In the next article, we'll show the PC boards and discuss construction, testing and *Digi:Toll* applications. **R-E**

TABLE II—DIGI: TOLL OPERATING MODES

Unit Designation	Display Control Pin Connected To $V_{ss}$	Display Mode	Set Control Pin Connected To $V_{ss}$			
			None	33 (slow)	34 (fast)	Both
Standard, T, L, P	None	Time of day	Time of day	Slow time advance	Fast time advance	Fast time advance
L, W, P	32	24-hour elapsed-time (reset)	N/A <sup>1</sup>	N/A <sup>1</sup>	N/A <sup>1</sup>	24-hour display resets to 00 00
All	31	24-minute elapsed time	N/A <sup>1</sup>	Elapsed time run	N/A <sup>1</sup>	24-minute display resets to 00 00

**Note:**

1. N/A = Not applicable to *Digi:Toll*.

When S1 is in the up (TIME) position, IC1 pins 1 and 40 operate the time-of-day/power-failure indicator dot at the upper left-hand corner of DIS1—a steady "on" display means the clock is showing time in the 12-hour format, while a flashing dot means a power interruption has occurred and the clock may be incorrect. However, when switch S1 is in the down (ELAPSED TIME) position it applies the output voltages of pins 1, 40 and 39 to various segments of DIS1. The 3817 clock IC is designed to display the 24-hour format by wiring these pins to the segments shown in Fig. 2.

Two unusual features are worth noting here. First, the dot referred to is simply the decimal point of DIS1, which is mounted in inverted fashion on the PC board for this reason. Second, you may wonder whether pin 39 (the 1-Hz output used as a 24-hour segment driver) would make the segment blink continuously. The answer is (although this information would not be found on the data sheets for the 3817 or MM5316) pin 39 is a 1-Hz output *only* when the clock IC is in the 12-hour mode; in the 24-hour mode, it is a segment driver!

If you've followed the explanation thus far, you may be wondering about some of the extra components in the circuitry. For

the positive voltage at the cathode of D2 is delayed at time-advancing command pins 33 and 34 of IC1. Similarly, if S1 and S2 are pressed simultaneously, going from the elapsed-time mode to the time-of-day mode, capacitor C5 discharges rapidly through resistors R3 and R2, while C4 (blocked by D1) is forced to discharge more slowly through the high internal pulldown resistance of the clock IC at pin 31. This removes  $V_{ss}$  from pins 33 and 34, (the time-advancing command pins) before the time-of-day is displayed. Diode D2 blocks positive voltage from reaching this whole network when MODE SELECT switch S1 is up (in the time-of-day mode).

Another circuit trick is accomplished by D3, D4, R4 and R5. Diodes D3 and D4 are *special* low-forward-voltage-drop germanium diodes that balance with 5% resistors R4 and R5 to provide uniform brightness to DIS1. Since either a "0," "1," or "2" may be displayed (two, five or six segments are on simultaneously) and the IC-driver outputs are limited to 8 mA on most outputs (16 mA on pins 2 and 12; 24 mA on pin 39), the resistor value and diodes have been carefully selected to minimize segment brightness differences.

You can make circuit modifications by



# ROUNDUP

# Cases And Cabinets For Your Projects

ONE OF THE MAJOR CONSIDERATIONS FACING THE amateur electronic experimenter and constructor is the physical layout and appearance of the finished project. In the days of vacuum tube and 12 by 16 in. chassis, most projects could be finished off nicely by adding a front panel and slipping the whole thing into a cabinet that could be hand-crafted from wood or readily available sheet metals. Today, most electronic projects are assembled on printed-circuit boards or similar materials and are sometimes only one-tenth the size of its old vacuum-tube equivalent.

To select a case or enclosure that is most suitable for your project, you must have a pretty good idea as to what is available. Too, if your make and model specified in a magazine article is not available through your usual supplier, you should be aware of equivalents and possible substitutes. These charts list off-the-shelf enclosures, cases and chassis boxes in various material combinations, colors and sizes.

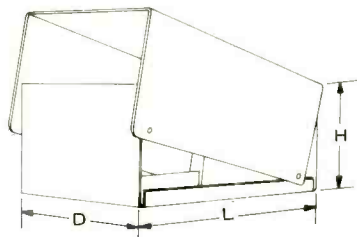

## INTERLOCKING "U" STYLE

Simple aluminum case available in a wide variety of sizes. Screws that hold the case together are located along the lower edge.

To find out more about the products or distributors, a list of addresses of each manufacturer follows.

- Apollo** – Industrial Park, Hauppauge, NY
- Buckeye** – 555G Marion Road, Columbus, OH 43207 (614) 445-8433.
- Bud Electronics** – Dept. G., 4605 East 355 Street, Willoughby, OH 44094. (216) 946-3200.
- GC Electronics** – Division of Hydrometals, Inc., Rockford, IL 61101.
- Lafayette Electronics** – 111 Jericho Turnpike, Syosset, NY 11791. (516) 921-7700.
- LMB Products** – 725 Ceres Avenue, Los Angeles, CA 90021. (213) 627-9310.
- Premier Metals** – C/O Sunshine Mining Co., 337 Manida St., Bronx, NY 10474. (212) 993-9200.
- Radio Shack** – 2617 West 7th Street, Ft. Worth, TX 76107. (817) 390-3272.
- Rose/Stahlin** – 500 Maple Street, Belding, MI 48809. (616) 794-0700.
- Scientific-Atlanta** – Optima Enclosures-2166 Mountain Industrial Road, Tucker, GA 30084. (404) 939-6340.
- TenTec, Inc.** – Dept. G., Industrial Park, Sevierville, TN 37862. (615) 453-7172.
- Vector Electronics Co.** – 12460 Gladstone Ave., Sylmar, CA 91342. (213) 365-9661.
- Zero Mfg.** – 777 Front Street, Burbank, CA 91503. (213) 846-4191.

Length	Height	Depth	Mfr.	Model No.	Case Material	Comments	Options	Color
2-1/4	1-3/8	1-1/2	LMB	C-R-211	Al	—	—	blue
2-1/4	1-3/4	2-1/8	LMB	C-R-221	Al	—	—	blue
2-3/4	2-1/8	2-1/8	LMB	C-R-234	Al	—	—	blue
2-3/4	2-5/8	2-1/8	LMB	C-R-275	Al	—	—	blue
3	5	4	LMB	C-R-345	Al	—	—	blue
3-1/4	1-5/8	2-1/8	LMB	C-R-321	Al	—	—	blue
3-3/4	2-1/8	3	LMB	C-R-332	Al	—	—	blue
4	1-5/8	2-1/8	LMB	C-R-421	Al	—	—	blue
4	2-1/4	2-1/4	LMB	C-R-422	Al	—	—	blue
4	2-3/4	2	LMB	C-R-400	Al	—	—	blue
4	2	4	LMB	C-R-442	Al	—	—	blue
4-1/4	1-1/4	2-1/4	LMB	C-R-425	Al	—	—	blue
5	2-1/4	2-1/4	LMB	C-R-522	Al	—	—	blue
5-1/4	2-1/8	3	LMB	C-R-531	Al	—	—	blue
5-1/2	1-5/8	3	LMB	C-R-532	Al	—	—	blue
6	3	4	LMB	C-R-643	Al	—	—	blue
6	5	4	LMB	C-R-645	Al	—	—	blue
6-1/4	2-1/8	3-1/2	LMB	C-R-632	Al	—	—	blue
7	3	5	LMB	C-R-753	Al	—	—	blue
8	2-3/4	3	LMB	C-R-800	Al	—	—	blue
8	4-1/2	6	LMB	C-R-864	Al	—	—	blue
10	2-1/2	4	LMB	C-R-1042	Al	—	—	blue
12	1-3/4	2	LMB	C-R-1247	Al	—	—	blue

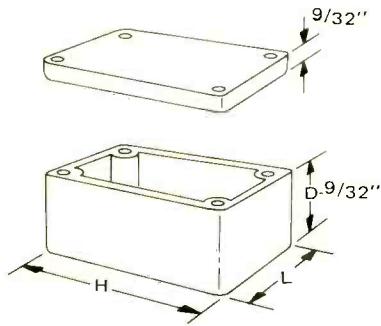

### BOX WITH COVER

Rectangular case with front cover available in a variety of materials ranging from plastic, to aluminum to steel. In some units both the front and rear panels can be removed. A few have louvers.

Length	Height	Depth	Mfr.	Model No.	Case Material	Comments	Options	Color
1-31/32	2-3/64	1-3/8	Rose	90	Lexan	—	90 K for clear cover	grey
2	3-1/8	1	GC	H4-723	Styrene	Al lid; break resistant	—	black
2	3-7/8	1-1/2	GC	H4-724	Styrene	Al lid; break resistant	—	black
2-7/16	4-7/8	1-3/8	GC	H4-722	Styrene	Al lid; break resistant	—	black
2-1/2	2-9/32	1-5/16	Rose	10	Al	die cast body	—	grey
2-1/2	3-55/64	1-5/16	Rose	11	Al	die cast body	—	grey
2-1/2	5-29/32	1-5/16	Rose	12	Al	die cast body	—	grey
2-5/8	3-3/4	1-3/8	GC	H4-725	Phenolic	plastic recessed lid	—	black
2-7/8	5-5/8	2	GC	H4-727	Phenolic	plastic recessed lid	—	black
2-61/64	3-5/32	1-31/32	Rose	305/31	Polyester	impact resistant, flame resistant	—	grey
2-61/64	3-15/16	1-31/32	Rose	305/32	Polyester	impact resistant, flame resistant	—	grey
3-5/32	2-61/64	2-3/64	Rose	25	Al	die cast body	—	grey
3-5/32	3-15/64	2-11/64	Rose	91	Lexan	—	90K for clear cover	grey
3-5/32	4-23/32	2-11/64	Rose	92	Lexan	—	90K for clear cover	grey
3-5/32	4-59/64	2-3/64	Rose	26	Al	die cast body	—	grey
3-5/32	6-19/64	2-11/64	Rose	93	Lexan	—	93K for clear cover	grey
3-5/32	6-57/64	2-3/64	Rose	27	Al	die cast body	—	grey
3-1/8	3-1/4	3-3/8	Rose	911	—	—	—	grey
3-1/8	4-3/4	3-3/8	Rose	M230/921	Lexan	—	—	grey
3-1/8	6-5/16	3-3/8	Rose	M235/931	Lexan	—	—	grey
3-1/4	2-1/8	1-1/8	Lafayette	99-P-80772	Bakelite & Al	recessed inserts	—	black/grey
3-1/2	6	1-7/8	GC	H4-726	Phenolic	plastic recessed lid	—	black
4	2-1/8	1-5/8	Lafayette	99-P-80780	Bakelite & Al	recessed inserts	—	black/grey
4	4	2	Bud	CU-883	Steel	removable front & back panels	—	black/grey
4	4	2	Bud	AU-1083	Al alloy	removable front & back panels	ALL-1083-HG for grey	grey
4-23/32	4-13/16	2-11/64	Rose	82	Lexan	—	82K for clear cover	grey
4-23/32	4-13/16	3-11/64	Rose	821	Lexan	—	821K for clear cover	grey
4-23/32	4-59/64	2-3/64	Rose	26	Al	die cast body	—	grey
4-23/32	6-57/64	2-3/64	Rose	27	Al	die cast body	—	grey
4-23/32	7-7/8	2-61/64	Rose	84	Lexan	—	84K for clear cover	grey
4-23/32	9-29/64	3-15/64	Rose	85	Lexan	—	85K for clear cover	grey



Length	Height	Depth	Mfr.	Model No.	Case Material	Comments	Options	Color
5-1/8	2-1/8	1-5/8	Lafayette	99-P-80758	Bakelite & Al	recessed Inserts	—	black/grey
6	6	6	Bud	CU-1098	Steel	removable front & back panels	black	grey
6	6	6	Bud	AU-1039	Al alloy	removable front & back panels	AU-1039-HG for grey	natural
6	—	5	Bud	CU-1099	Steel	removable front & back panels	black	grey
6	9	5	Bud	AU-1040	Al alloy	removable front & back panels	AU-1040-HG for grey	natural
6-1/4	3-3/4	2	Lafayette	19-P-20016	Bakelite	panel sold separately	—	black
6-1/4	3-3/4	4-1/4	Bud	CU-463	Steel	contoured, louvered rear panel	—	grey
6-1/4	5-3/4	4-1/4	Bud	CU-465	Steel	contoured, louvered rear panel	—	grey
6-3/8	3-3/4	1-7/8	Lafayette	99-P-62721	Bakelite/Al	recessed end panel inserts	—	black/grey
6-19/64	6-19/64	3-35/64	Rose	46	Polyester	flame & impact resistant	—	gray
6-19/64	6-19/64	3-35/64	Rose	56	Al	die cast body	—	—
6-19/64	9-29/64	3-35/64	Rose	87	Lexan	—	87K for clear cover	gray
6-19/64	10-1/32	3-35/64	Rose	47	Polyester	flame & impact resistant	—	gray
6-19/64	10-15/64	3-35/64	Rose	57	Al	die cast body	—	gray
6-19/64	14-11/64	3-35/64	Rose	58	Al	die cast body	—	gray
6-3/4	5-1/4	2-1/4	Lafayette	19-P-20024	Bakelite	panel sold separately	—	black
7-3/4	4-7/16	2-3/8	Lafayette	99-P-80764	Bakelite/Al	recessed inserts	—	black/grey
8-1/4	5-3/4	5-1/4	Bud	CU-585	Steel	louvered rear panel, contoured	black	grey
8-1/4	7-3/4	5-1/4	Bud	CU-587	Steel	louvered rear panel, contoured	black	grey
8-3/8	7-3/8	3	Lafayette	19-20032	Bakelite	panel sold separately	—	black
9-1/16	7-7/8	4-11/32	Rose	60	Al	die cast body	—	grey
9-1/16	13	4-11/32	Rose	62	Al	die cast body	—	grey
9-1/16	13-1/16	7-1/8	Rose	621	Al	die cast body	—	grey
9-27/32	10-1/32	4-23/32	Rose	141	Polyester	impact & flame resistant	—	grey
9-27/32	15-3/4	4-23/32	Rose	143	Polyester	impact & flame resistant	—	grey
10	10	8	Bud	CU-880	Steel	removable front & rear panels	black	grey
11	12	8	Bud	CU-881	Steel	removable front & rear panels	—	grey
12-1/4	5-3/4	7-1/4	Bud	CU-7125	Steel	louvered rear panel, contoured	black	grey
12-1/4	7-3/4	7-1/4	Bud	CU-7127	Steel	louvered rear panel, contoured	—	grey
15	9	7	Bud	CU-882	Steel	removable front & rear panels	—	grey

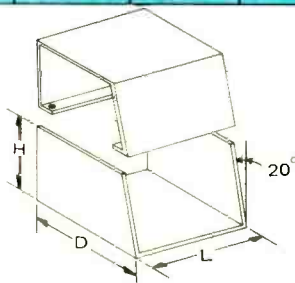

#### INTERLOCKING "U" WITH SLOPING FRONT

An interesting case where a sloping panel is desired. Aluminum is the material.

Length	Height	Depth	Mfr.	Model No.	Case Material	Comments	Options	Color
5	4-1/4	5	Bud	SC-12100	Al	single knock-out, 20° slope; 1 piece cover, feet	—	black/white
12	3-1/4	10	Bud	SC-12101	Al	1 piece cover, 20° slope, footed	—	black/white

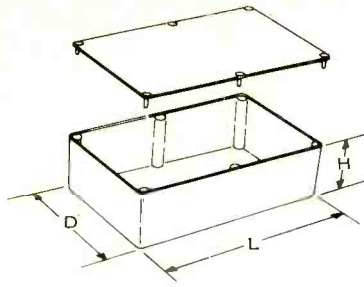

### BOX WITH COVER

These cases are all cast aluminum for applications where durability is important.

Length	Height	Depth	Mfr.	Model No.	Case Material	Comments	Options	Color
3-5/8	1-1/16	1-1/2	Bud	CU-123	Cast al alloy	1/2 lb.		grey
4-3/8	1-1/16	2-3/8	Bud	CU-124	Cast al alloy	1/2 lb.		grey
4-11/16	2-1/16	3-11/16	Bud	CU-234	Cast al alloy	3/4 lb.		grey
7-3/8	2-1/16	4-11/16	Bud	CU-247	Cast al alloy	1-1/4 lb.		grey
7-3/8	3-1/16	4-11/16	Bud	CU-347	Cast of alloy	1-1/2 lb.		grey

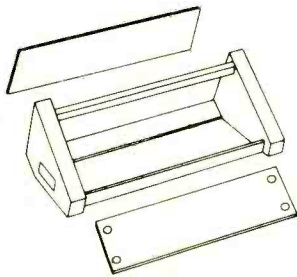

### TRIANGULAR SHAPE

An unusual shape for a case but ideal when an unusual appearance for a project is desired. Very pretty when multiple digit readouts are used.

Length	Panel or rear door area	Mfr.	Model No.	Case Material	Comments	Options	Color
16	5-3/4	Bud	MT-214	Steel	9-3/4 lbs; spring latch; handles	Extra door or panel	1—grey
21	5-3/4	Bud	MT-219	Steel	12-1/4 lbs; spring latch; handles	Extra door or panel	1—grey
26	5-3/4	Bud	MT-224	Steel	14-1/4 lbs; spring latch; handles	Extra door or panel	1—grey

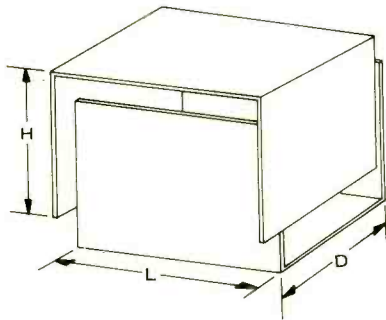

### ANOTHER INTERLOCKING "U"

One of the most popular types of experimenter cases, overlapping lips on the ends secure the lid.

Length	Height	Depth	Mfr.	Model No.	Case Material	Comments	Options	Color
4-1/4	1-7/8	4-1/8	Ten-Tec	TG-24	Al	—	—	grey/black
4-1/4	1-7/8	4-1/8	Ten-Tec	TW-24	Al	—	—	walnut/white
4-1/4	3	4-1/8	Ten-Tec	TG-34	Al	—	—	grey/black
4-1/4	3	4-1/8	Ten-Tec	TW-34	Al	—	—	walnut/white
6	2-3/4	4	Radio Shack	270-260	Al	Rubber feet	—	walnut grain
6-1/4	1-7/8	4-1/8	Ten-Tec	TG-26	Al	—	—	grey/black
6-1/4	1-7/8	4-1/8	Ten-Tec	TW-26	Al	—	—	walnut/white
6-1/4	3	4-1/8	Ten-Tec	TG-36	Al	—	—	grey/black
6-1/4	3	4-1/8	Ten-Tec	TW-36	Al	—	—	walnut/white
9	3-1/2	6	Radio Shack	270-261	Al	Rubber feet	—	walnut grain
11	4	8	Vector	WA1-4V	Al body/plastic	10° slope panel	—	dk. blue/grey
11	4	8	Vector	WA1-12V	Al body/plastic	10° slope panel	—	white/walnut
11	4	8	Vector	WA1-1A	Al body/plastic	10° slope panel	—	clear anodized color
14	4	11	Vector	WA2-4V	Al body/plastic	10° slope panel	—	white/dk blue
14	4	11	Vector	WA2-12V	Al body/plastic	10° slope panel	—	walnut/white
14	4	11	Vector	WA2-1A	Al body/plastic	10° slope panel	—	clear/anodize



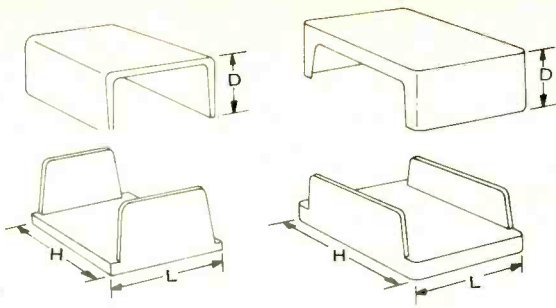

### INTERLOCKING "U"

Another variation, but one that produces a good looking smooth-seamed case, no case parts overlap.

Length	Height	Depth	Mfr.	Model No.	Case Material	Comments	Options	Color
1-31/32	3-15/16	63/64	Rosé	410	polystyol	impact resistant dust proof	410-K for clear cover	grey
1-31/32	3-15/16	1-37/64	Rose	420	polystyol	impact resistant dust proof	420-K for clear cover	grey
2-9/16	4-23/32	1-37/64	Rose	430	polystyol	impact resistant dust proof	430-K for clear cover	grey
3-5/32	4-23/32	2-23/64	Rose	512	Al	insensitive to heat & cold	512-D0 for front screw mounting	grey & blue
3-5/32	5-29/32	2-11/64	Rose	440	polystyrol	impact resistant dust proof	440-K for clear cover; 440-H for handle	grey
3-5/32	5-29/32	3-5/32	Rosé	445	polystyrol	impact resistant dust proof	445-H for handle	grey
4-23/32	7-7/8	2-61/64	Rose	520	Al	insensitive to heat & cold	520-D0 for front screw mount	grey & blue
4-21/64	7-13/32	2-3/4	Rose	450	polystyrol	impact resistant dust proof	450-K for clear cover; 450-H handle	grey
4-21/64	7-13/32	3-15/16	Rose	460	polystyrol	impact resistant dust proof	460-H-handle	grey
6-19/64	9-29/64	3-35/64	Rose	524	Al	dust proof	524-D0 for front screw mount	grey & blue

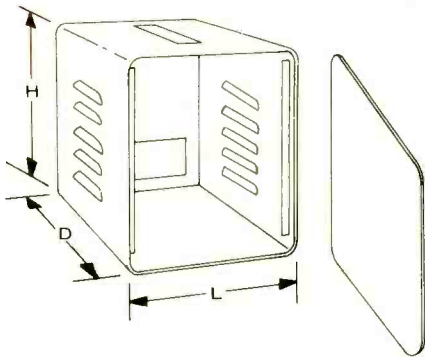

### INSTRUMENT CASE WITH REMOVABLE FRONT PANEL

The kind of case that has been commonly used for all kinds of test instruments. Available in aluminum with louvers.

Length	Height	Depth	Mfr.	Model No.	Case Material	Comments	Options	Color
6-1/8	8	8	Bud	WA-1540	Al	1/2" recessed ft. panel rubber feet, louvered	—	grey
7	4	5	Zero	ZIC-407	Al	rubber feet	unfinished & unassembled	blue
7-3/4	4-1/2	7	Zero	ZTC-408	Al	rubber feet	unfinished & unassembled	blue
8-1/8	9	12	Bud	WA-1541	Al	1/2" recessed ft. panel rubber feet, louvered	—	grey
9	6	5	Zero	ZIC-409	Al	rubber feet	unfinished & unassembled	blue
11	7	7	Zero	ZIC-411	Al	rubber feet	unfinished & unassembled	blue
11-1/8	11	18	Bud	WA-1543	Al	1/2" recessed ft. panel rubber feet, louvered	—	grey
14-1/8	12	18	Bud	WA-1544	Al	1/2" recessed ft. panel rubber feet, louvered	—	grey

# LED Bar Graph Universal Indicator

Bar graphs are replacing analog meters as voltage-level indicators in many instances. Here's how the basic LED bar graph works.

MARTIN BRADLEY WEINSTEIN  
WB8LBV, KDT5787\*

THE FIRST APPLICATION YOU MIGHT THINK of for the new SN75489 IC (renamed TL489) from Texas Instruments would be as a 0-1-volt LED bar graph. This is because when the IC's five internally biased comparators are fed a 0-1-volt input signal, they will turn on a string of 5 LED's at 200-mV intervals.

Figure 1 shows what's inside of the SN75489. A series of five voltage comparators compare the analog input signal (the input of pin 8, buffered by an

The comparators feature a built-in hysteresis of about 10 mV to prevent oscillations at the outputs, even with slowly varying inputs. When the input is driven from a high-impedance source, a capacitor should be connected between the high-impedance analog input (pin 8) and ground to prevent undue noise interference.

Figure 2 is the schematic of the simple demonstrator shown in the photo. Resistor R1 varies the voltage at pin 8 and causes the string of LED's, which are arranged as a bar graph, to light up in lines that are successively longer and shorter.

The demonstrator is built on a solderless breadboard (the model EXP350

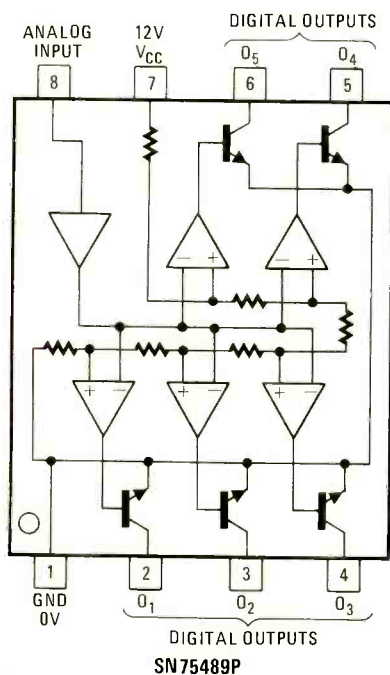
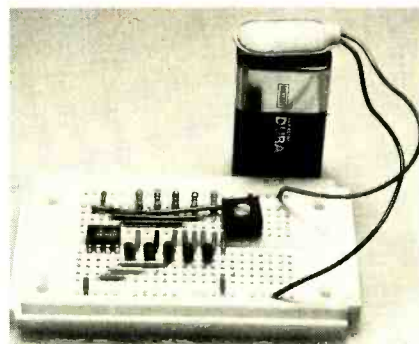
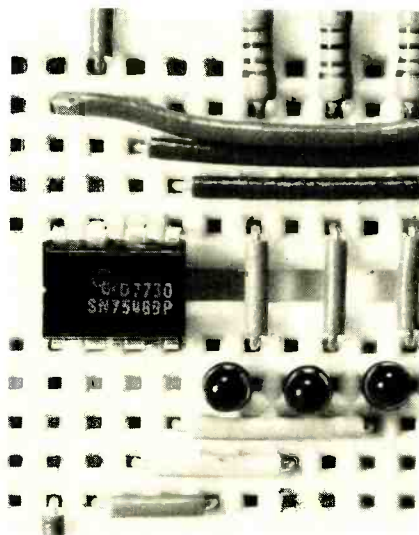

FIG. 1—INSIDE THE SN75489—just renamed the TL489 by the manufacturer.

internal amplifier with a typical 100K input impedance) with a string of resistors between V<sub>CC</sub> (pin 7) and ground (pin 1). The resistive ladder turns on comparators 01-05 at 200 mV, 400 mV, 600 mV, 800 mV and 1000 mV, respectively. The comparators turn on open collector transistors at each output (pins 2-6), each capable of sinking up to 80 mA and of handling up to 18 volts. The circuit is intended for use on 10-18-volt supplies, although 9-volt batteries work well.



THE DEMONSTRATOR uses Continental Specialties Experimenter 350 breadboarding socket.



CLOSEUP shows board construction and how IC's, LED's and other parts plug right in.

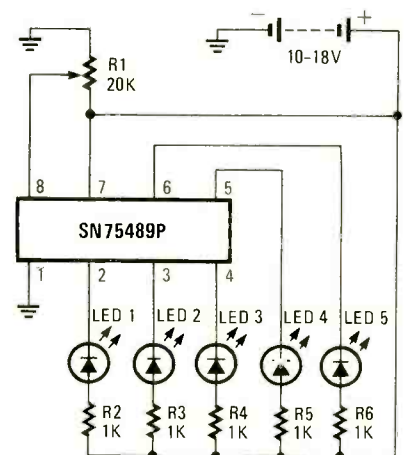

FIG. 2—SCHEMATIC OF DEMONSTRATOR in photo. Number of lit LED's depends on R1.

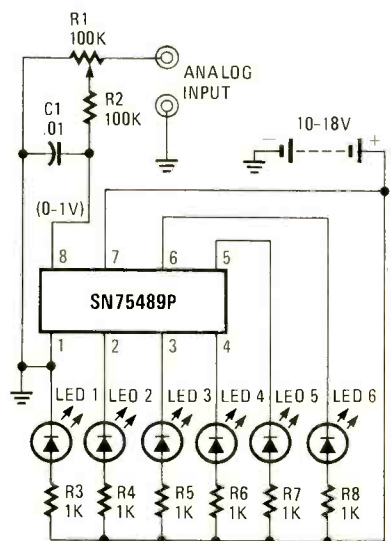

FIG. 3—THE LED ADDED ON LEFT acts as pilot light and lengthens light bar.

Experimenter Socket, Continental Specialties Corp., 44 Kendall St., New Haven, CT 06509; the breadboard is available for about \$5.50). It took about the same amount of time to build the demonstrator as to draw the schematic, about a month later.

Figure 3 shows a circuit modification: The first LED in the string of six LED's



**TABLE 1. SPECIFICATIONS FOR TEXAS INSTRUMENTS TL489-CP  
Five-Step Analog Level Detector/Indicator**

TL489-CP ABSOLUTE MAXIMUM RATINGS				
Supply voltage	18 volts (max)			
Positive voltage at analog input	8 volts (max)			
Negative current at analog input	10 mA (max)			
Current into each output, high level	1 mA (max)			
Current into each output, low level	80 mA (max)			
RECOMMENDED OPERATING CONDITIONS				
Supply voltage $V_{CC}$	MIN	TYP	MAX	
Voltage on any output, $O_{1-5}$	10	12	16.5 V	18 V
ELECTRICAL CHARACTERISTICS $T_A = 25^\circ\text{C}$ , $V_{CC} = 12\text{ V}$				
PARAMETER	MIN	TYP	MAX	UNIT
(positive-going threshold voltage at input for switching outputs:)				
$O_1$	160	200	240	mV
$O_1, O_2$	350	400	450	mV
$O_1, O_2, O_3$	540	600	660	mV
$O_1, O_2, O_3, O_4$	730	800	870	mV
$O_1, O_2, O_3, O_4, O_5$	920	1000	1080	mV
Hysteresis for switching any output	10			mV
Low-level output voltage:				
$I_{\text{sink}} = 16\text{ mA}$		0.1	0.4	V
$= 40\text{ mA}$		0.2	0.7	V
High-level output current, $V_{OH} = 18\text{ V}$		5	20	$\mu\text{A}$
Supply current:				
all outputs high		8	12	mA
all outputs low		15	25	mA
Positive input current ( $V_{in} = 1\text{ V}$ )		0.5		$\mu\text{A}$

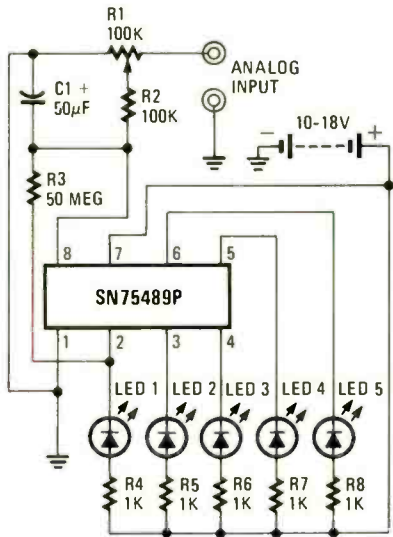
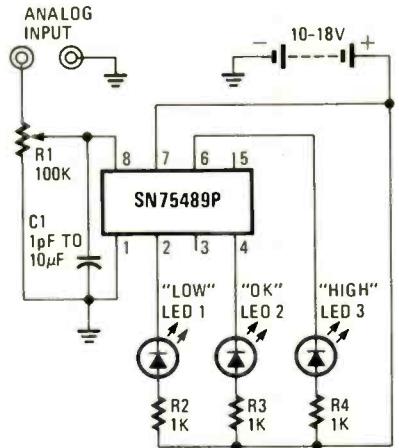

**FIG. 4—THE TIME CONSTANT of R3 and C1 cause LED1 to flash with inputs below 200 mV.**

can double as a bar-graph-lengthener and a pilot light. This scheme is similar to that seen in the solid-state S-meters on some newer CB transceivers. Resistors R1 and R2 scale the input signal to the SN75489's 0-1-volt input range while maintaining high impedance, and capacitor C1 acts as a noise-preventing bypass.

Figure 4 shows the R-C timing action of R3 and C1. With an input signal at pin 8 of less than 200 mV, R3 and C1 cause LED1 to flash.

In Fig. 5 only three outputs are used, but this scheme is very useful for many

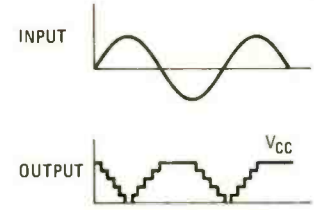
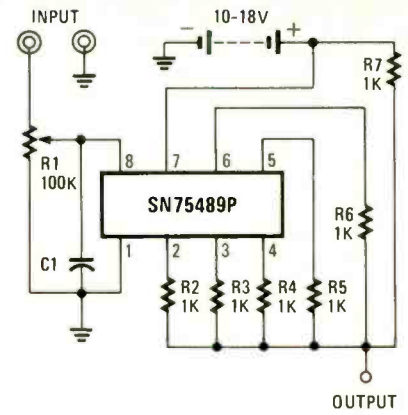

**FIG. 5—A THREE-STAGE LEVEL INDICATOR useful in alarm and monitoring systems.**

monitoring and alarm applications. Input voltages greater than 200 mV (representing a low alarm state or alarm release) cause LED1 to turn on; LED2 turns on at input voltages greater than 600 mV (representing correct operation); and LED3 turns on at 1 volt or more (representing a high alarm state or alarm release).

The circuit shown in Fig. 6 can change a sinewave input signal to a stepped triangular output signal through using appropriate values in the pulse-shape resistor network, R2-R6.

Figure 7 shows how the risetime and falltime of an input signal can be used to determine sequential delays at the outputs. This also helps explain the operation of the circuit in Fig. 6.



STEP SIZE IS VARIED BY VARYING R2 - R6

**FIG. 6—A STEPPED OUTPUT waveform is developed from a sinewave input signal.**

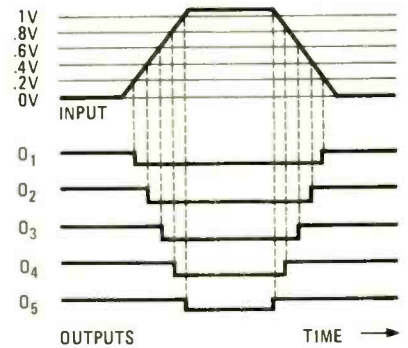

**FIG. 7—THE DELAYS between the five outputs depends on the rise and fall times of input**

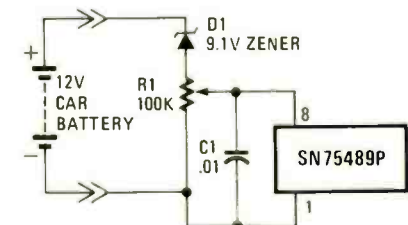

**FIG. 8—AUTOMOBILE BATTERY MONITOR. Diode and R1 match voltage to IC's input level.**

Some suggested SN75489P applications might include low-resolution metering (in a car, for example, with red, amber and green LED's indicating low, normal and high pressure or temperature); or expanded monitoring a car's battery voltage, as shown in Fig. 8. Instead of LED readouts, LED's contained in opto-isolators could be used to switch on various loads to respond to temperature changes.

Although the SN75489P is relatively new, many TI semiconductor distributors and dealers should have it in stock soon. You should expect the price to be between 60¢ and \$1.00 per unit. **R-E**

## All About Audio Oscillators

*Part 2—The audio oscillator most-often-used today is a sophisticated instrument that is a far cry from the simple AF signal source.*

*This is a continuation of the story on the latest types.*

THIS STORY OPENED IN THE APRIL ISSUE. We began with a discussion of the basic oscillator and basic circuits and followed through into accessories, such as attenuators, into this continuing discussion of pertinent specifications and features.

### Frequency stability

The frequency stability specification indicates the ability to maintain an original frequency under various electrical and environmental conditions. Frequency stability and frequency accuracy should not be confused. To measure frequency stability, setting accuracy is ignored, and the actual operating frequency is measured directly with an external frequency meter. Variations from this measured frequency caused by environmental or electrical variations are measurements of the frequency stability.

On extremely low-cost units, frequency stability may not be specified. On the more expensive audio oscillators, this specification is divided among a number of environmental and electrical variations.

The most common variation is that of time, and two time intervals are used: The first is short-term stability, which is the drift expected (after warmup) over a ten-minute period or other short time span. The second is long-term stability, which is the stability expected over a 12- to 24-hour period. An alternate method is for an intermediate period, such as an hour.

In addition to time, the expected variations for line-voltage changes, variations at the oscillator output (usually no load to full load) and temperature can be given. All specifications are given as a percent change for the indicated environmental or electrical variation, nominally a few tenths of a percent or less for any variation. Frequency stability, like frequency

### CHARLES M. GILMORE\*

accuracy, is a major consideration only when the measurement depends upon the generated frequency remaining a constant. All stability specifications are usually given after a warmup period of an least one hour.

### Output voltage

The output voltage specification indicates the maximum voltage available from the audio oscillator. This voltage is generally indicated for two situations: One indicates the oscillator output voltage with no load (open circuit). The other indicates maximum output voltage when the output load is equal to the source impedance of the generator. This voltage is one-half the open circuit voltage. Maximum outputs of 5 to 10 volts RMS are usual.

### Amplitude flatness

The consistency of the audio oscillator output amplitude with frequency changes is called amplitude flatness. This specification may be given either as a percentage or as a variation in decibels. There may be a division in amplitude flatness specifications with frequency, with the better flatness specification confined to the center frequencies. Considerable degeneration of the specification can be expected at the frequency extremes. Amplitude flatness is also termed the frequency response, and can be given graphically. Low-cost audio oscillators typically specify  $\pm 1$ -dB flatness, which is equivalent to a  $\pm 10\%$  variation. The better audio oscillators specify  $\pm 0.05$  dB or  $\pm 0.5\%$ . Audio oscillators with metered outputs sometimes delete this specification because it is assumed the user can readjust the output level for any frequency change.

### Amplitude stability

Amplitude stability is much like frequency stability. It indicates the oscillator's ability to maintain a constant output amplitude under varying environmental and electrical conditions. Amplitude stability specifications, like those for frequency stability, are frequently given for variations in time, line voltage and temperature. Changes of a few tenths of a percent or less can be expected for any particular effect.

### Output impedance

Output impedance indicates the value of resistance that appears to be in series with the audio oscillator if the oscillator is presumed to be of zero impedance. The most common output impedance specification is 600 ohms; however, 50 ohms is used on some oscillators.

### Output balance

Output balance is the impedance ratio to earth ground between the output terminals. There are three variations available with audio oscillators. The first is the full-floating or ungrounded oscillator. The impedance from either output terminal to earth ground is high and relatively equal. On these oscillators there is a specification indicating the maximum DC potential that can be applied between either terminal and earth ground. Common ranges for this voltage are  $\pm 300$  to  $\pm 500$ . Note that impedance balance between output terminals may degenerate for higher oscillator frequencies as the capacitive effect of wiring within the oscillator becomes appreciable.

A second variation on output balance also yields a floating output that can be raised to a high DC voltage level with respect to earth. This indicates a high and equal value of resistance from either terminal to earth ground. However, one of the terminals, normally called the low

\* Manager, Design Engineering, Heath Co., Benton Harbor, MI.



or common side, has a large capacitor (between 0.04 and 0.1  $\mu\text{F}$ ) connected to earth ground. For all but the lowest of audio frequencies and direct current, this terminal is effectively connected to earth ground. It cannot be connected into a circuit where the floating voltage has an AC component.

The third variation connects one side of the output directly to earth ground at all times. No floating is possible. In either of the first two configurations, a strap or a switch can be provided to connect the common terminal to earth ground, if desired.

### Distortion

One of the more important and expensive specifications on the high-quality audio oscillator is the percentage of THD in the sinewave output. The theoretical definition of THD is the ratio—expressed as a percentage—of the square root of the square of the amplitudes of all harmonics to the amplitude of the fundamental signal. It is not practical to measure this, and usually is measured with an instrument that determines the ratio of the harmonics to the sum of the harmonics plus the fundamental. The error between this measurement and the theoretical THD specification is less than one-half of one percent. Total harmonic distortion values in the area of 0.2% to 0.1% are common for low- and medium-cost generators. On the extremely good generators, THD specifications can be in the area of 0.05% to 0.005%.

Usually, the THD specification is supplied with frequency-limiting data, often in the form of a graph. The curve of Fig. 9 is typical. Some oscillators offer a special low-distortion mode. In such cases, the graphs of THD-versus-frequency may have two response curves, according to the mode of use.

Depending on the measurement meth-

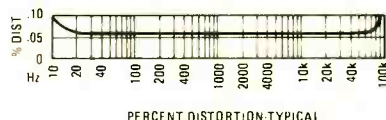

**FIG. 9—HARMONIC DISTORTION CURVE for Heathkit IG-18 indicates little distortion in the audible range, with sharp upcurves at the high- and low-frequency extremes.**

od used when the manufacturer defines the audio oscillator THD, other signals can be included within that specification. Hum and noise both can contribute to the amplitude of all signals not at the fundamental frequency. Hum and noise can also be specified separately, and are indicated as a percentage of the maximum output, most typically in the area of 0.01%. No attempt is made to separate line-frequency hum from broadband noise.

### Output attenuator

An output attenuator can come in three forms: a small variable control, a

stepped attenuator, or a combination of the two. Specifications include the step amplitude, expressed as a ratio or a change in decibels, as well as the accuracy of each step. In a similar form, range is given for the variable control. The most common attenuator has 10-dB steps, which give a 1–3–10 voltage sequence. The associated variable control commonly has a 10-dB range to provide continuous settings. Simple vernier controls have 20-dB to 40-dB (10:1 to 100:1 voltage) ranges.

### Squarewave output

Many audio oscillators include—in addition to the sinewave output—a squarewave output. This output usually is somewhat less unusual in attenuation and impedance.

Squarewave-output specifications are very similar to those of the sinewave output. The output voltage indicates the maximum voltage obtainable; the output impedance indicates the source resistance in series with the generator; and the output balance indicates the type of output connection.

Attenuator specifications are the same as those for the sinewave output; however, with a more limited range and accuracy. The output amplitude symmetry specification indicates the relationship between the positive and negative portions of the squarewave. Symmetry is usually within a few millivolts. An output time-symmetry specification indicates the relative widths of the positive and negative squarewave pulses. Theoretically, these widths should be equal but shaping circuits often limit the time symmetry to the  $\pm 5\%$  area. Risetime indicates the time required for the output squarewave to rise from 10% to 90% of the desired amplitude. The risetime on squarewaves supplied by audio oscillators is generally in the range of 50 to 100 nanoseconds.

### Output connectors

The generally accepted output connector is a pair of  $\frac{3}{4}$ -inch 5-way binding posts. An alternate to the dual 5-way binding post is a triple 5-way binding post configuration to permit strapping either of the two binding posts to the third one (connected to earth). Binding posts are usually confined to 600-ohm generators.

Fifty-ohm generators tend to use the BNC connector because it offers certain advantages. First, it is fully shielded and, when ultra-low-distortion sinewaves are desired, it is mandatory to have shielded connections between the audio oscillator and the input to the equipment under test to avoid an increase in the hum and noise level. Second, when a generator is used in the squarewave mode, the 50-ohm BNC connector limits the number of reflections on the transmission line caused by impedance mismatches.

### Frequency adjustment

The method of frequency adjustment varies considerably from generator to generator. As noted, there are two major types: First, switch-selected decades that are continuously tunable throughout the decade; second, switched incremental tuning that may or may not have a variable control to permit frequency selections between the incremental frequency positions. Each system, of course, has its advantages.

The continuously variable control within one decade is probably used most to manually sweep through the decade to observe the response of a particular device under test. It is the oldest and most common frequency control method. To some extent, the need for the continuously tuned dial is now rendered unnecessary by sweep generators, such as the swept-function variety, which are designed to perform this service.

Switched-frequency selection permits rapid changes and eliminates any required dial interpolation. Such a system is excellent for production-line or service situations in which the only requirement is to test at specific frequencies as rapidly as possible. As it is occasionally necessary to set an audio oscillator to an exact frequency, instruments with incremental frequency selection often have a continuously adjustable vernier control. This method permits the frequency to be set between any two switch-selected steps. Exact frequency calibration is given with this control in a calibrated position.

The other frequency control feature that should be analyzed is that of extended frequency range. Although the human ear ceases to perform in the 20-kHz area, virtually all audio oscillators extend at least to 100 kHz. With today's solid-state technology, many audio amplifiers have some response to nearly 1 MHz. If design work on audio amplifiers is contemplated, it is often necessary to observe the frequency response characteristics of the amplifier to 1 MHz. In such a case, a generator with extended frequency response is desirable.

Most audio amplifiers today are specified with a low-frequency cutoff in the 5-Hz to 10-Hz range. But if design work is contemplated, the audio oscillator should probably extend to at least 1 Hz and lower. Other applications, such as general laboratory work, usually dictate the widest frequency range possible, since other instruments and electronic systems may not have the limited frequency response of audio components.

In a future continuation of this series, we will go immediately into frequency synchronization and what is required when the audio oscillator is to be locked to an external frequency source. We think that you'll find it interesting. Watch for it.

R-E

# BUILD

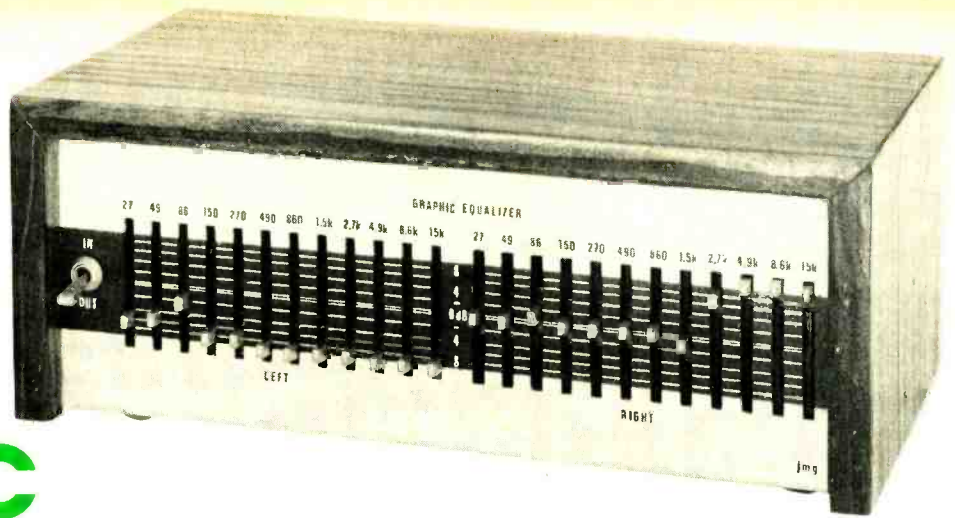

## Graphic Equalizer For Your Stereo System

*Part 2—A versatile and useful addition to your hi-fi system. This concludes theoretical and construction details begun last month.*

JOE GORIN

LAST MONTH WE INTRODUCED THE GRAPHIC equalizer, both as a handy tool for the audio expert and discriminating high-fidelity buff. Now we are going to complete the technical discussion and get into construction and installation.

The strength of this design lies in the fact that the components that determine the filter response are independent of the control potentiometers. Thus, the twelve bandpass filters can all be built with only three different capacitor values and eight different resistor values, while using only one potentiometer value. Other designs use from twelve to twenty-four different capacitor values, making parts hard to find.

The signal fed into the equalizer is attenuated by voltage divider R1 and R2 (Fig. 1) and then AC-coupled into IC1-c. The attenuation keeps the unit's dynamic range very large so that it can be used in a tape-monitor circuit. Amplifiers IC1-a and IC1-b bring the average gain up to 0 dB. The output of IC1-b is AC-coupled; R33 keeps the op-amp from having to drive a capacitive cable and provides the 600-ohm output impedance. Resistor R34 absorbs any leakage through C27 so that the DC output is zero and switching the unit in and out for comparison will not cause any clicks.

Resistors R71, R72 and R73 and capacitors C28 and C29 filter the bias voltage,  $V_B$ , for the op-amps. (In a normal dual supply circuit,  $V_B$  would be called

ground.) The two-section filter removes almost all the noise on the bias. Op-amp IC2-c reduces the ripple in positive supply to IC1. Since IC1 is a low-noise amplifier with low-noise power and bias supplies, the unit has an excellent S/N ratio despite the attenuation of the signal at the front end.

Rectifier diodes D201-D204 and capacitor C201 are a standard fullwave bridge circuit. The transformer is a wall-plug type. Since the unit draws less than 2 watts, it can be left on all the time or plugged into the switched outlet of a receiver or preamp.

Switch S1 can be wired as shown in the schematic or as shown in the inset in Fig. 1. In the tape-monitor application, the switch replaces the TAPE-MONITOR switch on the amplifier, which can be used to switch the equalizer in and out. In the inset drawing where the equalizer is connected between a preamp and power amplifier, S1 is wired to switch the unit in and out for comparison purposes—a tape-monitor function is unnecessary. In this application, R1 can be shorted, R2 can be removed, and R32 can be changed to 16K. This reduces the maximum input signal but increases the S/N ratio to 100 dB below 2V, so that it will be inaudible with even high-gain amplifiers and very efficient speakers.

The equalizer can also be used as the tone controls in a high-quality preamp. In this case, leave R32 at 39K, and eliminate

R1 and R2. Wire the output of the volume control directly to C1, add a phono preamp (the supply voltage is perfect for this application), a selector switch and anything else you want, and you have the equivalent of a very expensive preamp. To provide an equalizer in/out switch for this application, wire a 4PST switch in series with the leads connecting pins 13 and 14 on the two boards.

### Construction

The compactness of the unit is partially due to the use of two PC boards: the amplifier board and the control board that contains the slide potentiometers and associated resistors. Figures 5 and 6 are the foil patterns of the amplifier and control boards, respectively. Figure 7 shows placement of parts on the amplifier board. The twenty-four slide pots and forty-eight resistors positioned on the control board as shown in Fig. 8.

Install the resistors first, then the capacitors. Be sure to observe the polarity of the electrolytic devices.

Lay the two boards flat 1 inch from each other with their bottom edges facing. Connect the points numbered 1 to 14 from each channel to corresponding points on the other board. Flat ribbon cable will make for neater wiring, or just color-coding the wires will reduce the probability of errors.

Estimate the required wire lengths for the input, output, ground, and power



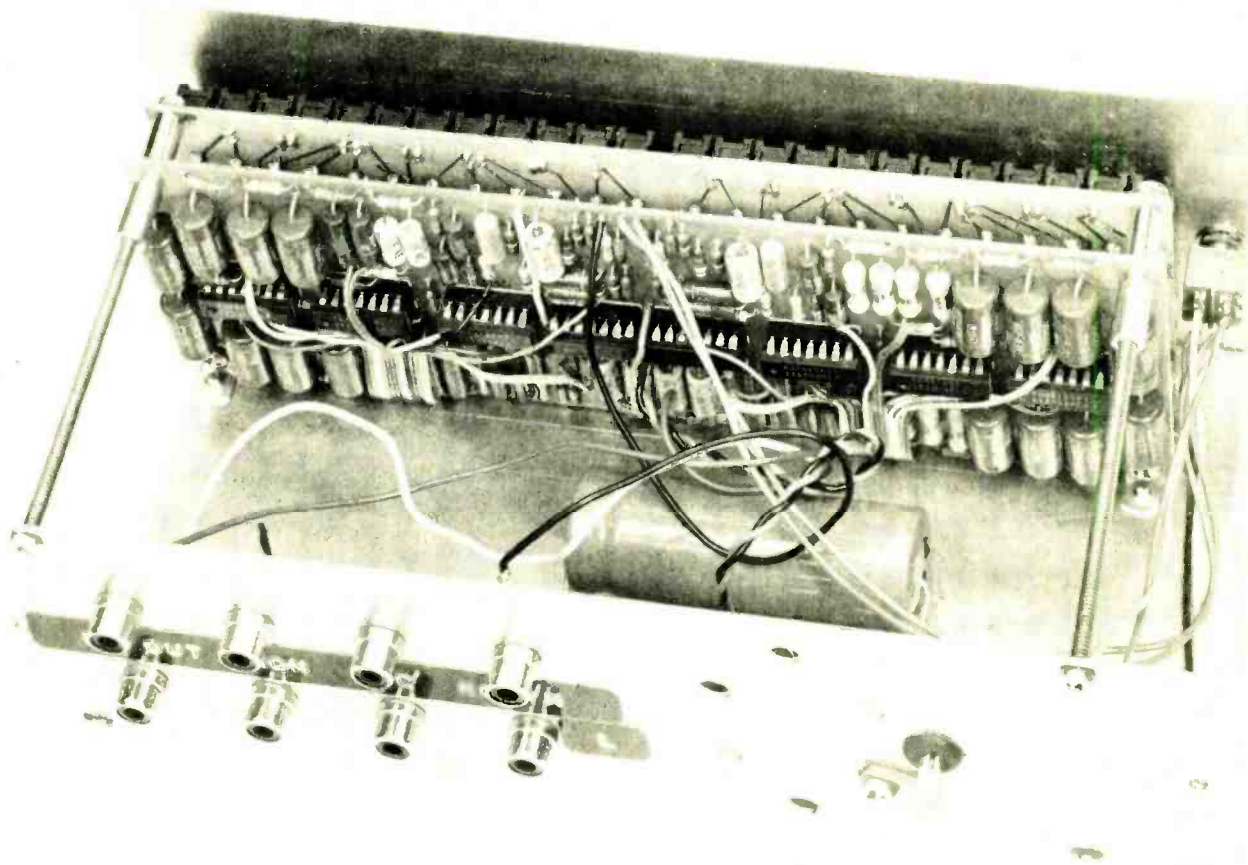

**INTERIOR VIEW OF THE EQUALIZER** showing the positioning of the two printed-circuit boards. The right and left halves of the two boards are practically mirror-images of each other.

supply wires, and solder one end of each to the amplifier board. Bolt the boards together back-to-back with 1/2-inch spacers and install them in a suitable chassis. In the prototype shown, the mounting holes in the bottom of the chassis are slightly oversized to help line up the slide pots with the slots in the front panel, and the tops of the boards are supported from the rear panel with long screws that allow adjustment of the depth behind the front panel. Construction details can be seen in the interior photograph shown in Fig. 9.

Install the switch and phono sockets in the chassis. Assemble the power supply on a terminal strip and solder connections C and D from the amplifier board and the wires from the power transformer; then install the strip in the chassis.

Wire the switch and phono sockets according to the mode of operation you plan to use (see Fig. 1 and the inset drawing) and wire the ground lead (E) to the chassis lug on one of the phono sockets.

Check your work: be particularly careful about the diode, capacitor and wiring to the amplifier board of the power supply. A mistake here could wipe out *all* of the IC's. Check that the inputs and outputs are wired to the correct sockets, switch terminals and channels. Recheck the IC and electrolytic polarities.



**LOOKING DOWN ON THE EQUALIZER** from overhead.

#### Installation

For a tape-monitor installation, connect the **TAPE RECORD** terminals of your receiver/amp to the **EQUALIZER IN** terminals and the **EQUALIZER OUT** to the **TAPE MONITOR** inputs. Wire the tape recorder to the equalizer as though it were the receiver. The **TAPE MONITOR** switch on the amplifier will then switch the equalizer in and out of circuit; the switch on the equalizer will control the tape monitoring. The tape recorder cannot be used without the equalizer in this setup, but the only reason to switch it out is for comparison when first setting it up.

In a preamp/power amplifier connection (which is superior if possible), wire the preamp output to the **EQUALIZER IN** and **EQUALIZER OUT** to the power ampli-

fier inputs.

The equalizer power transformer can be plugged into the switched sockets on the receiver if it is mechanically compatible. If not, the transformer can be plugged in through an extension cord or plugged directly into the wall.

#### Operation

To use the equalizer as a super tone control, adjust the bands and trust your ears! You may want to experiment to see what all sorts of strange response curves can sound like. To equalize your system, purchase a stereo test record and adjust your system for a flat response. The *Altec Acousta-Voicette* test record is particularly good for this purpose. Your local audio shop may own a sound-level meter you can rent or borrow to equalize perfectly. After you have equalized for a flat response, reduce the gain slowly above 2 khz to compensate for boosts. **R-E**

#### ERRATA

In the parts list under resistors, change tolerance from 10% to 5% and change R135 to R136. Under miscellaneous, following J1—J4, change phono to phono and delete the reference to knobs. Delete the 3/32-inch reference to board thickness.

ANNOUNCING  
... A New  
CREI Program:  
Minicomputer &  
Microprocessor  
Technology  
Including A  
Microprocessor  
Laboratory

Now you can learn at home  
the new technology that is  
revolutionizing electronics

The microprocessor has ushered in the age of microtechnology and electronics will never again be the same. The microprocessor has made possible the placing of an entire computer on a silicon chip one quarter inch square. The microprocessor "miracle chip" is in the process of changing the world. Soon all technical personnel in electronics will have to understand and work with the microprocessor. It is invading virtually every area of electronics. And it is profoundly affecting your electronics career.

**Brand New Program**

CREI has a brand new program to help you learn how to work effectively with this revolutionary electronics development. CREI's new program in Minicomputer and Microprocessor Technology is designed to prepare you for this field by giving you the education and practical experience you need.

The program provides solid preparation in electronics engineering technology with a specialization in minicomputers and microprocessors. In addition, it includes a microprocessor laboratory which features a fully programmable microcomputer which utilizes the Motorola 6802 microprocessor chip. This is an extremely important element of your program.

**Programming Essential**

As you may well know, you must learn how to *program* the microprocessor in order to design, service or troubleshoot microprocessor electronic systems. There is only one effective way to learn this all-important skill of programming, and that is by actually *doing it*. CREI's new program gives you this opportunity as you work with the exciting microprocessor laboratory.

**Programming Is Easy**

With CREI's new program, learning the skill of programming is simple. Within a few hours you'll be programming the microprocessor and in a short time you'll learn how to program it in three languages: BASIC, assembly and machine languages. In addition, you will learn how to interface the microprocessor with other systems and to test and debug specialized programs.



# Preparation at Home

## Wide Choice of Programs

Please note, however, that CREI's new program is only one of 16 state-of-the-art programs in advanced electronic technology offered by CREI. So even if you choose not to specialize in micro-processor technology, CREI has an advanced electronics program to meet your needs.

With CREI, you may choose from any of the following areas of specialization in advanced electronics:

- Microprocessor Technology
- Computer Engineering
- Communications Engineering
- Digital Communications
- Electronic Systems
- Automatic Controls
- Industrial Electronics
- Television Engineering
- Microwave Engineering
- Cable Television
- Radar and Sonar
- Nuclear Instrumentation
- Satellite Communications
- Aeronautical and Navigational
- Solid State Theory
- Nuclear Engineering

## Unique Lab Program

An exclusive option available with CREI programs in electronic engineering technology is CREI's unique Electronic Design Laboratory program. It gives you actual experience in designing practical electronic circuits. It also helps you to understand the theories of advanced electronics and gives you extensive experience in such areas as tests and measurements, breadboarding, prototype construction, circuit operation and behavior, characteristics of electronics components and how to apply integrated circuits. Only CREI offers this unique Lab Program.

## Practical Engineering

CREI programs give you a practical engineering knowledge of electronics. That is, each part of your training is planned for your "use on the job." By using your training, you reinforce the learning process. And by demonstrating your increased knowledge to your employer, you may qualify for faster career advancement.

## Free Book

There isn't room here to give you all of the facts about career opportunities in advanced electronics and how CREI prepares you for them. So we invite you to send for our free catalog. This fully illustrated, 56 page book describes in detail the programs, equipment and services of CREI.

## Qualifications

You may be eligible to take a CREI college-level program in electronics if you are a high school graduate (or the true equivalent) and have previous training or experience in electronics. Program arrangements are available depending upon whether you have extensive or minimum experience in electronics.

**Send for this FREE Book**  
describing your opportunities  
and CREI college-level  
programs in electronics

CREI Home Study Programs in  
**ELECTRONIC  
ENGINEERING TECHNOLOGY**

CREI Introduces  
Program 680:  
**MINICOMPUTER &  
MICROPROCESSOR  
TECHNOLOGY**  
INCLUDING MICROPROCESSOR  
LABORATORY PROGRAM

CAPITOL  
RADIO  
ENGINEERING  
INSTITUTE

McGraw-Hill  
Continuing  
Education Center  
Washington, D. C.  
20016

Mail card or write describing qualifications to

**CREI** **CAPITOL  
RADIO  
ENGINEERING  
INSTITUTE**

McGraw-Hill Continuing Education Center  
3939 Wisconsin Avenue Northwest  
Washington, D.C. 20016

Accredited Member National Home Study Council

## GI Bill

CREI programs are approved for training of veterans and servicemen under the G.I. Bill.



# New Directions In MATV Switching Systems

*Installing, connecting and disconnecting individual subscribers to TV signal distribution systems is revolutionized by new switching matrix.*

RAYMOND ST. LOUIS\*

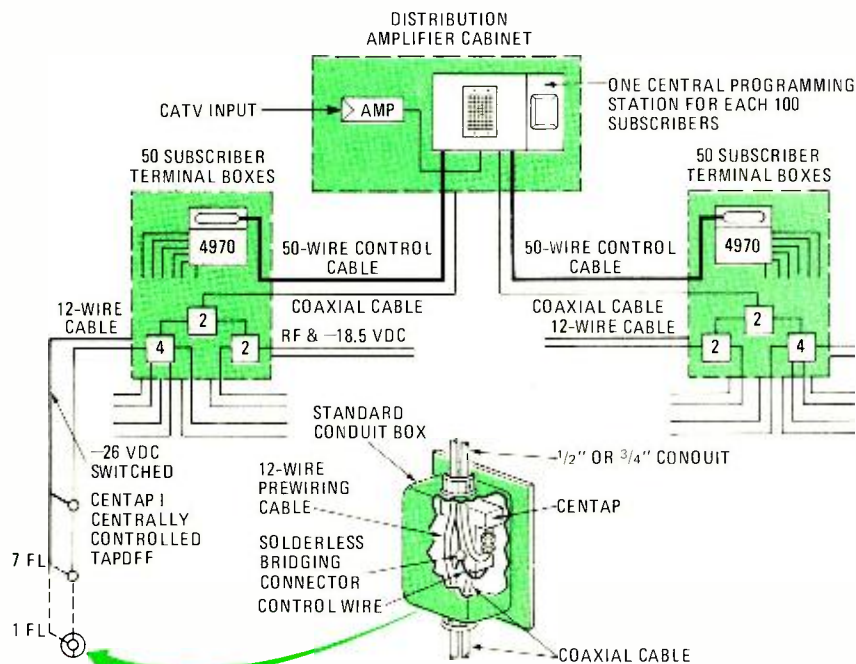

SYSTEM WIRING FOR CENTAP CONTROLLED TAP-OFFS, with an internal view of the tapoff itself.

A NEW CENTRALIZED SWITCHING SYSTEM to interconnect MATV, CCTV and CATV subscribers has been especially designed for use in high-rise apartment houses, hotels, condominiums, hospitals, schools and office buildings. This switching system is called *Centap*. It is manufactured by Blonder-Tongue Laboratories, Inc., 1 Jake Brown Road, Old

\*Product Manager, Blonder-Tongue Laboratories, Inc.

Bridge, NJ 08857.

## What the system does

This MATV subscriber tap-off system can turn individual TV outlets on or off from a central location and can handle blocks of up to 100 TV system tap-offs. For example, when individual subscribers in a multiple dwelling have paid for TV service, their particular antenna outlets can be activated. On the other hand, TV

service to individual antenna outlets can be turned off when desired from one central location without having to enter the apartment, hotel room, condominium unit, etc. The central-control unit is the *model 8201 Centrol*, while the individual subscriber tap-offs are called the *model 8200 Centaps*.

The system is compatible with all MATV and CATV installations. It can be added to existing systems that have been installed using conduit. The *Centap* system is wired similar to a conventional MATV tap-off scheme except that one additional 24-gauge prewire conductor is connected to each tap-off.

## Special features

Some of the special features of the *Centap* system are:

- Simple wiring.
- Much lower labor costs (as little as one-seventh that of home-run systems).
- All connections are made at a single location.
- The system is permanently wired and there is no need to make individual hookups or disconnection.
- It lends itself to high-rise buildings that use vertical risers.
- The central-control unit can be situated anywhere.
- The system offers complete supervisory control over individual tap-offs.
- Self-testing of the system is provided.
- There is instant accountability of which tap-offs are in use, and tap-off condition lists are provided.
- Extensive technical knowledge is not required to connect or disconnect subscribers.
- The system is tamper-proof.

## How it works

The new system operates as follows: The individual subscriber taps are biased electrically in the off condition by a negative DC voltage (-18.5) that is impressed on the coaxial cable along with the RF signals (see diagram). The prewire control cable carries the -26-volt DC turn-on potential when a connection pin is inserted in the appropriate hole on the central-control unit's front panel.

The tap-offs use three special PIN diodes to handle the actual switching. The circuitry provides over 60 dB of isolation in the turn-off mode and three fixed amounts of attenuation (15 dB, 20 dB, or 25 dB) in the turn-on mode. The 60-dB isolation is more than adequate to insure that no visible TV picture occurs at turn-off, even in a system that delivers a strong local TV signal.

Built-in facilities in the central-control unit panel allows a service technician to monitor the condition of each subscriber's tap-off. In this way it is possible to detect opens, shorts, or other unauthorized misuse of the outlet. No switches or electrical connections are required to turn



the TV service on or off. All that is necessary to instantly determine the status of any tap-off is to insert or remove a pin in the appropriate hole on the front-panel matrix board of the central-control unit.

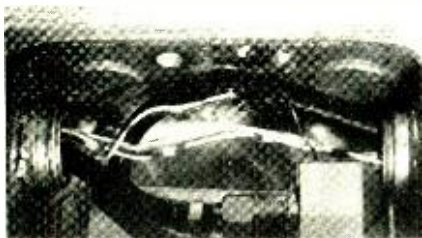

INTERIOR OF BLONDER-TONGUE CENTAP BOX.

### Cost comparison

Assume you wish to install a CATV or MATV system in a 12-floor apartment house with eight apartments per floor. Let's compare the cost of material and labor for a home-run system and for the *Centap* system.

Comparing material and labor costs for the two systems using 1/2-in. conduit shows that the materials cost about \$50 more with the *Centap* system. If 3/4-inch conduit is used, then the materials for the home-run system cost about \$425 more than for the *Centap* system. However, the *Centap* system uses one-seventh as much coaxial cable and one-seventh the amount of conduit. When you add the cost of labor for installing seven times as much cable and conduit required for the home-run system, the home-run system is far more costly than the *Centap* system in either case.

Another advantage of the *Centap* system is that tap-offs can be wired in the normal vertical-riser fashion used in high-rise buildings. Although the home-run method is economical for low-density (4- to 24-outlet) systems, it is not compatible with construction methods used for telephone and electrical wiring and plumbing, heating and ventilating services used in high-rise construction.

### Installation

The RF portion of the *Centap* system is wired in the normal tap-off riser fashion. A maximum of 12 tap-offs per riser is recommended. Each distribution riser requires one RF coaxial cable (Nos. RG-59 or RG-6) and one telephone prewiring cable obtainable from the manufacturer. Each tap-off on a riser requires one conductor of the prewire cable.

To install the system, pull the prewiring cable through the TV system conduit along with the coaxial cable. At each tap-off conduit box leave a loop of coaxial cable, but allow the prewire cable to pass straight through the box. (The prewire cable need not be cut to connect it.)

After the cables have been pulled, install the *Centap*. The control wire of the *Centap* must be connected to one wire of the prewiring cable. Connect the control wire of the first tap-off on the riser to wire No. 1 of the prewire cable.

Next, prepare the coaxial cables and attach the standard F-connectors. Connect the cable to the tap-off and secure the cover plate, using the F-connector nut. Next, fasten the *Centap* tap-off to the conduit box with the tamper-proof screws supplied. The last tap-off on the riser should be terminated with a resistor.

A terminal block and RF splitters are then mounted in an electrical box measuring at least 12 × 12 × 6 inches. The quick-connect clips of the terminal block eliminate the necessity to strip the conductor insulation when making terminations. A special tool is available that simultaneously cuts away the wire insulation and makes a good electrical connection with the conductor. The tool also simultaneously seats the conductor and trims off the excess wire.

Now connect wire No. 1 of the first tap-off riser to the upper-left terminal of the terminal block. Wire No. 1 will connect later to the proper terminal on the central-control unit. Connect all wires in order, starting at the top left and working down to the bottom left, and then to the top of the next column of terminals. After connecting one complete riser, write down the wire destinations on a chart affixed to the terminal-block cover. This step is most important since it will save much time in later identifying the proper subscriber-wire locations.

Next, connect the terminal block to the central-control unit. For this connection, a special running cable is used that contains 50 wires with prewired plugs attached and is available in 5-ft., 25-ft., 50-ft., 100-ft., and 200-ft. lengths. The running cable has a plug on one end and a connector on the other end so that different cable lengths can be connected together for longer distances. The end of the running cable that must be connected to the terminal block is identified by a

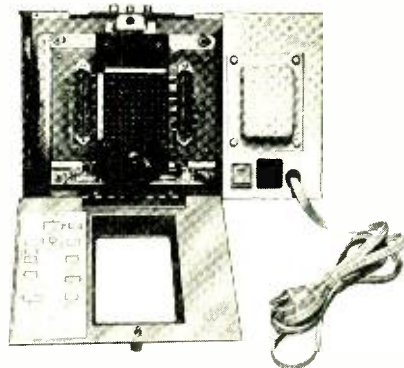

BLONDER-TONGUE CENTRAL-CONTROL UNIT with front panel opened.

small "2D" in the lower portion of the plug's plastic housing. The cable end that connects to the central-programming station carries a "1D" identification in the matching location.

Running cables can be pulled through conduits measuring 1 1/2 inches and more. If a conduit measuring at least 1 1/2 inches has not been provided, running cables can be pulled through conduits as small as 1 1/4 inches by removing the plug cover and carefully wrapping the wiring in several layers of electrical tape. Installing a running cable in a smaller conduit, say, one that measures 3/4 inch, requires removing and reinstalling one plug.

Finally, connect the running cable to the proper central-control terminal to conform with the "2D" designation at the terminal block. Then, connect the coaxial cables, which feed the splitter at the terminal block, to the power-adding splitter in the control unit. Connect the output of the system distribution amplifier to the input of this splitter.

### Testing the system

Insert the central-control-unit test cord in a matrix hole position that is connected

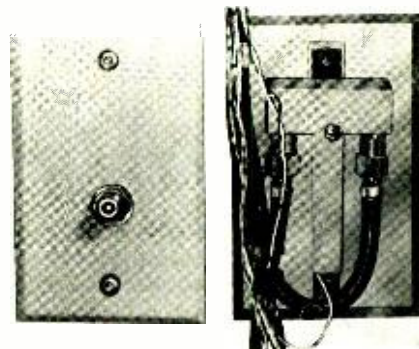

FRONT AND REAR VIEWS OF A CENTAP BOX.

to a *Centap* tap-off. As the plug is inserted, the red LED glows brightly. This indicates that the station's power supply is delivering voltage to the matrix. When the plug is fully inserted, the red LED grows dimmer. This indicates that a tap-off is properly connected to that matrix position, and that the DC power supply added at the central-control unit's RF splitter/DC adder is passing through the coaxial cable and splitter, through the system.

After installing the system, record the subscriber location on the large adhesive-backed label supplied with the *Centap* equipment. Affix this label permanently to the door of the central unit's high-security housing. Write down the apartment numbers (in numerical order) to correspond to the station's terminal positions on the bottom half of the label. Just make a copy of the completed first half of the label and cut it up so that each location can be sorted by apartment number. Then, record this information on the bottom half of the label. This will save time on service calls.

R-E

# hobby corner

*Most active experimenters and constructors develop a cache of useful short-cuts. Here are some you can use.*

**EARL "DOC" SAVAGE, K4SDS, HOBBY EDITOR**

EVERY FEW MONTHS IT SEEMS NECESSARY to stop and gather up a bunch of short but useful tips and ideas. So, here is another collection of ideas for your workbench.

## Keeping records

Do you make a record of the circuits you design? And how about drawing schematics for the equipment you build? Even when you construct something from a circuit, do you file away a copy of the schematic? Do you note on the schematic any and all changes made both in the original construction and in later modifications?

If you do not do any or all of these things, you are asking for trouble. My file system leaves a lot to be desired but *somewhere* in there I keep all schematics and pertinent notes on every piece of equipment I own, every past item constructed, and every circuit ever designed (I hope!). A lot of time and work was involved in assembling those files, but in the long run it has been worth it.

At first, my file system was a hit-and-miss affair. I only became serious when problems began to arise. The straw that broke the camel's back was a homebrew ham transmitter that started acting up. Lengthy searches produced no notes on the many modifications I had made or even the original schematic of the unit. Before repairs could be made, I had to trace out and draw the entire circuit—a tremendous waste of time. I swore, *never again!*

It is very difficult to trace out and draw the circuit of a piece of complex equipment. I have done it since then but not on my own equipment. Students and friends who have asked for help occasionally have received along with it a strong lecture on properly documenting their work.

Documentation is even more important with modern breadboarding systems. It is especially easy to become curious about a circuit, put it on a breadboard, modify it in a dozen ways, and then throw the parts back in the cabinet. If you do it that way and omit the record-making step, you can be sure that somewhere, sometime you're going to need that circuit again. So, you have to start all over from the beginning.

If you don't keep records, start now. Your documentation doesn't have to be

complete in every detail, but just enough so you won't have to repeat your work later. Rough sketches and abbreviated notes are sufficient. Keep a road map of where you have been just in case you have to go back.

## Tool holders

I have never known a hobbyist who had not accumulated a sock full of tools. And I've never known one who wasn't continually adding new tools as they struck his fancy, or as he found one to perform a new task or an old task better. Also hobbyists store their tools in a variety of ways.

Some store tools in a jumbled mess on the workbench. Some use a tool box and have to search for everything. Others apparently do use socks! And still others have their tools arrayed on a wall board with nails for holders or on a pegboard.

I prefer a pegboard because it has movable holders. The tools are easier to find, remove and replace, and they can be rearranged readily whenever a new tool must be inserted among its fellows.

If you use a pegboard for tools (or other items), you can make your own holders, and thereby also save a lot of money! The number of holder shapes that can be bought is limited. The number of shapes you can create is limited only by your imagination. The tools and materials needed are quite elementary.

I make my holders and brackets of aluminum clothesline wire (about 10 gauge). Other types of wire can be used, of course, but the aluminum wire is easily obtained, inexpensive, easily bent and very satisfactory. If you can locate some lighter-gauge aluminum, you can use it for hanging miniature tools.

The only essential tool for making the holders is a pair of sturdy yet narrow pliers. Long-nose pliers will not do the job as they are not strong enough to repeatedly bend the heavy wire. I have found the best pliers for the job to be small (about 5 inches) battery pliers—they are also called utility and pump pliers.

The two most critical bends in any holder are at the top where the wire must be inserted and attached to the pegboard—you must use the narrow pliers

here. These bends are close together and each one is angled at 90 degrees. They must be made as perfect as possible so that the holder will hang from the board properly. Other larger pliers can be used for the other holder bends.

By the way, you can use these same holders on plain boards instead of pegboards. Just omit making the "pegboard bends" at the end and create a small loop to accommodate a screw or nail.

While you can do the entire job with pliers, I would not recommend it; especially if you plan to make more than a half-dozen holders. I use a small and inexpensive wire-bending jig (Radio Shack No. 64-1960). Using this tool, I can make a simple hook in a few seconds and a pliers holder in a minute or less. A bonus is that the aluminum wire is not gouged and rough when the jig is used.

The jig consists of a metal base (about 1 inch by 5 inches) and four short metal rods. The base has slots of several sizes for holding the wire being bent and five holes for the rods. Two (or more) rods are placed in the holes to hold the wire when you make unusual bends—circles, spirals, zig-zags, arcs and the like. The jig can be clamped in a vise, or screwed or bolted to the top of your workbench through the holes provided.

By planning your wire bending carefully, you can make hooks, holders and brackets similar to the commercial types. Without welding you can even duplicate the welded types by judicious wire routing. You can make custom hooks, holders, etc., to fit an infinite number of different size tools, for example, screwdrivers from jeweler's size to 15-inch monsters, or pliers measuring from 3½ inches to 12 inches. You can design and make holders for needle oilers, epoxy tubes, rolls of hook-up wire, spray cans, wiring pencils, etc.

The first step in the procedure is to make the pegboard hanger end using pliers. Then, form the business end on the bending jig. If the holder is a dual-hanger type, the second hanger is fashioned last.

When the holder is complete and you are ready to cut the aluminum wire—*don't*. Most wire cutters leave a sharp edge on the wire. You will find it more satisfactory to notch the wire two or three times with the wire cutters. The wire will then break easily and be less sharp.

## Thread files

What do you do when you damage the



threads on a potentiometer? I've found dozens of ways to mess up the threads on bolts, shafts, pots, switches, lamp housings and all kinds of devices. Cross-threading, sawing off excess lengths, slipping pliers, using a wrong-size nut, etc., can really cause problems, especially when working with something that cannot be replaced easily.

You, too, have probably tried using a triangular file but the angle was wrong and it wouldn't reach down into the thread. Usually you can make a repair with a die of the proper size and thread. However, I have never been fortunate enough to have complete sets of all the English and metric, coarse, fine, extra fine, etc., threads that one runs into. And now I don't need them!

The *Fitz-All* screw thread files (M & B Special Purpose Hand Files, Box 306, Oak Ridge, NJ 07438) are available in two sizes. Each one can be used with any V-thread screw. The difference is in the maximum size (diameter) they fit. Since the *V. P. Mini File* (\$2.50) can be used with threads that are over 1/8-inch in diameter, it will probably meet your needs. Just run the file along the mangled thread and it will clean it up nicely.

#### Grinding PC boards

Now and then we all would like to be able to turn out a simple "quick and  
*continued on page 119*



**8700 Processor:** 6503 MPU. Wear free "Active Keyboard", Micro-Diagnostic. Extensive documentation. Fully Socketed.

**Piebug Monitor:** User Subroutines, Relative address calculator. Pointer High-low, Back-step key.

**Cassette Interface:** Load & Dump by file #. Positive indication of operation. Tape motion control.

Applications systems from \$90 (10 unit quantity)  
Development systems from \$149 (single unit)

**TELL ME MORE** I want to see for myself that the 8700 is The Answer.

( ) Please send documentation \$10 enclosed.

( ) send price lists & FREE Catalog of other PAIA kits.

name: \_\_\_\_\_

Address: \_\_\_\_\_

City: \_\_\_\_\_ State: \_\_\_\_\_ zip \_\_\_\_\_

**PAIA ELECTRONICS** DEPT. 6R • 1020 W. Wilshire Blvd. • Oklahoma City, OK 73116 •

CIRCLE 21 ON FREE INFORMATION CARD

# You can be sure

more times in more circuits in more places  
than with any other multimeters on the market today

Each Sencore DVM is backed with 15 Megohm input impedance for one third less circuit loading on every measurement. That means 50% higher accuracy than other DVMs.

**DVM38** \$395  
3½ DIGIT .1% DCV ACCURACY  
AUTO-RANGING DVM

A "prime" standard at your fingertips for measurements you can trust. Auto-ranging for extended low-level range and ease of operation. 15 Megohm input impedance assures .1% reading accuracy is maintained in solid state circuits. Highly sensitive, yet fully protected to 2000 VDC overloads. Hi-Lo Power Ohms circuit simplifies in-circuit resistance measurements.

**DVM37** *New* \$268  
3½ DIGIT .1% DCV ACCURACY  
PORTABLE DVM

Prime standard .1% accuracy on the bench or in the field for less than \$250. The DVM37 is the most accurate portable DVM you can buy, with 15 Megohm input impedance for 50% more accuracy. Includes automatic features—Auto Zero, Polarity, Decimal, Overrange. Fully protected inside to over 2000V on all functions, including Ohms, and protected outside with super-rugged case. Full ranges for every test. Fingertip "Push-On" switch in probe saves batteries as power is applied only when needed.



*New* DVM37



DVM32

**DVM32** \$225  
3½ DIGIT .5% DCV ACCURACY  
PORTABLE DIGITAL MULTIMETER

Bench and field master for digital accuracy measurements anywhere. 0.5% DCV accuracy, backed with 15 Megohm input impedance. Exclusive battery-saving Auto-Display turns the display on automatically when you make a measurement. 2000V input protection on all functions and ranges—including Ohms.

**DVM36** \$158  
3½ DIGIT .5% DCV ACCURACY  
POCKET PORTABLE DVM

Pocket portable lab accurate performance that fits every budget with highest performance-to-price benefits of any meter. .5% DCV accuracy, backed with 15 Megohm input impedance for lowest circuit loading. Full protection to 1000 V on all functions and ranges—including ohms. Drop-proof case. Battery-saving "Push On" button in probe.

**DVM35** \$134  
3 DIGIT 1% DCV ACCURACY  
POCKET PORTABLE DVM

Fast, direct reading digital accuracy for the man on the go. Same features as DVM36, except 3-digit, 1% DCV accuracy, backed by 15 Megohm input impedance that is ten times more accurate than analog meters.



DVM38



DVM36

In stock at your favorite local  
Sencore Full Line Distributor.

**SENCORE**  
DIGITAL MULTIMETER SPECIALISTS

3200 SENCORE DRIVE, SUITE 1, FALLS SQ. 57107 16051 339 0100

CIRCLE 37 ON FREE INFORMATION CARD

# state of solid state

*A single IC from National Semiconductor adds true RMS measurements of voltage to a multimeter.*

KARL SAVON, SEMICONDUCTOR EDITOR

THE MEASUREMENT OF TRUE RMS VOLTAGE and current, the technique against which other AC methods are weighed, has only recently been used in compact, low-cost instruments.

The importance of an RMS measurement is that it stems from the fundamental concepts of energy and power. The root-mean-square voltage, when squared and divided by the value of the resistance across which it is impressed, results in the power being dissipated in the resistor. This happens whether the waveforms are pure sinewaves, square-waves or any other form.

RMS measurements are fundamental to measuring noise, harmonic analysis, intermodulation distortion, SCR waveform and mechanical vibration.

The final step to a numerical readout of the measured value is invariably an analog or digital DC meter. Therefore, the key component of an RMS measurement system is an RMS-to-DC converter.

Most conventional multimeters respond to the *average* value of the rectified AC input known as the mean absolute value. These instruments usually have an RMS scale, calibrated with a scale factor that is 1.11 times the DC scale. The average value of a fullwave rectified sine-wave is  $2/\pi$  times its peak value, and the RMS value is  $\sqrt{2}/2$  of the peak. The scale factor is the ratio of these two constants, or

$$\frac{\sqrt{2}/2}{2/\pi} = 1.11072.$$

For many common measurements with known waveforms, such simple corrections are adequate. However, when a waveform becomes complicated or unpredictable, better methods must be used. The RMS value of a DC voltage is equal to its DC value; so, in this case, multiplying by 1.11 for RMS causes a reading that is 11% high. The RMS value of a squarewave is equal to its peak voltage; therefore, the same error applies. Noise measurement errors, on the other hand, tend to be negative.

For RMS reading meters, the ratio of the peak to the RMS value of the input waveform is important. It is quite possible for signal peaks to overload the input

circuitry even though the reading may be less than full scale. The term given to this ratio is *crest factor*.

Bandwidth is another important parameter, since pulsed waveforms can be decomposed into a Fourier series of discrete-frequency sinewaves that are harmonics of the basic signal repetition rate. If the harmonic spectrum is wider than the instrument bandwidth, part of the input energy is lost and the meter reads low.

For many years, RMS-to-DC conversion was performed thermally; the thermal methods are still used in modernized form.

Figure 1 shows a type of dual-thermocouple system. In the simplified diagram,

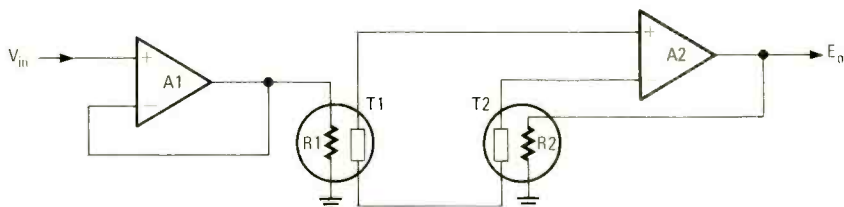

FIG. 1—DUAL THERMOCOUPLE RMS-TO-DC converter.

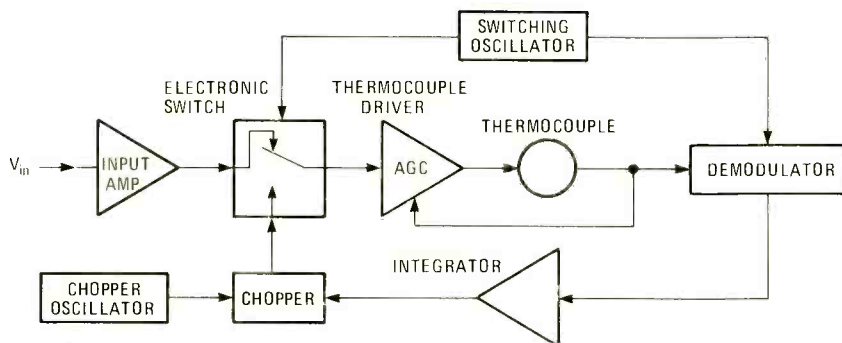

FIG. 2—SINGLE THERMOCOUPLE RMS-TO-DC converter.

the input signal is buffered by active follower A1, and the voltage is transferred across the resistive element of thermocouple T1. Amplifier A2 has a second thermocouple in its feedback loop that balances its inverting and noninverting inputs until they are equal. This condition is reached when the outputs of both thermocouples are identical, so that their resistive elements dissipate the same power. The power in R1 is  $V_{rms}^2/R1$  and in R2, it is  $E_o^2/R2$ . Setting the two equal

to each other and solving for  $E_o$  gives

$$E_o = \frac{\sqrt{V_{rms}^2 R^2}}{R1}$$

If R1 is equal to R2, this reduces to simply  $E_o = V_{rms}$ .

Matching errors between two thermocouples is a problem because of their natural sensitivity to temperature. Figure 2 shows an example of a single thermocouple design; it demonstrates that a thermocouple is an expensive complicated method that has led to its luxury classification.

Other techniques calculate the RMS value by performing the actual computation dictated by the mathematical expression for RMS  $\sqrt{\bar{v}^2}$ , where the bar stands for mean or average. Perform the computation as follows: Square the voltage instant by instant; take the mean by integrating the squared voltage over a period of time T and dividing by T; then,

take the square root.

The RMS value is constant, which is convenient for repetitive (stationary) waveforms. Step 2 can be replaced with a simpler DC-averaging process—an R-C low-pass filter.

Figure 3 shows the circuit used in explicit or direct computation methods. The problem with this type of circuit is that the squarer circuit takes an input signal with a dynamic range of, say, 100 to 1 at the input, and ends up with a



10,000-to-1 dynamic range at its output. Multiplier errors can reduce the useful

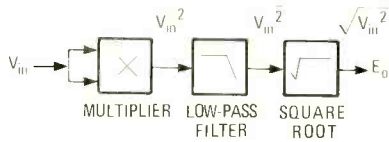

FIG. 3—EXPLICIT METHOD of RMS-to-DC conversion.

dynamic range to 10 to 1.

Implicit methods use feedback to solve problems of cost, resolution and dynamic range. The implicit method is used by National Semiconductor in their single-IC LH0091 True RMS-to-DC Converter and is shown in Fig. 4 on page 106.

In calculating the square of a waveform, it is immaterial whether the signal is positive or negative. The square of a negative number is still positive. It is easier and more accurate to work with voltages and currents that vary in only one direction. The input circuit of the LM0091 is an absolute-value circuit, or an active fullwave rectifier. The job can't be done with just a couple of diodes since it is important to be as precise as possible. The two vertical lines enclosing  $V_{in}$  in the first block is the mathematical way of indicating absolute value.

continued on page 106



**NATCAM**  
**catalog**  
Shopping center for small and precision tools

A fine selection of small tools, measuring instruments, hard-to-find items for shop, home and lab. Convenient one-stop shopping for technicians, engineers, craftsmen, hobbyists. Major credit cards accepted, satisfaction assured. Get your NATCAM catalog today.

**National Camera, Inc.**  
2000 West Union Ave., Dept. GBF  
Englewood CO 80110 USA

CIRCLE 15 ON FREE INFORMATION CARD

# Q • How close can hi-fi get to an authentic musical experience?

## A • Slip on new Audio-Technica Stereophones and hear for yourself.

If you want to find out how good the new Audio-Technica Stereophones really are, don't just compare them with other headphones. Put them up against the very finest *speaker* systems. But don't just listen to the equipment. Listen to the *music*. And be ready for a surprise!

Judged on the basis of flatness of response, freedom from distortion, transient response, sensitivity, and independence from room acoustics, these new dynamic and electret condenser models are perceptibly better sounding than speaker systems costing hundreds of dollars more.

And if you think that great performance can only come from heavy, bulky stereophones, get ready for another surprise. Our heaviest model is less than 7½ ozs. and our lightest is an incredible 4¾ ounces light. Comfort that lasts an entire opera if you wish.

For all the facts, send for our catalog. But for the revealing truth about stereophone performance, listen and compare at your nearby Audio-Technica showroom. It will be a great *musical* experience.



**Model ATH-7**  
Our finest Electret Condenser with LED peak level indicators  
\$149.95

**Model ATH-1**  
The moving coil dynamic stereophone that weighs just 4¾ oz.  
\$29.95

**audio-technica**  
INNOVATION □ PRECISION □ INTEGRITY

AUDIO-TECHNICA U.S., INC., Dept. 68E, 33 Shiawassee Avenue, Fairlawn, Ohio 44313  
Available in Canada from Superior Electronics, Inc.

# micra

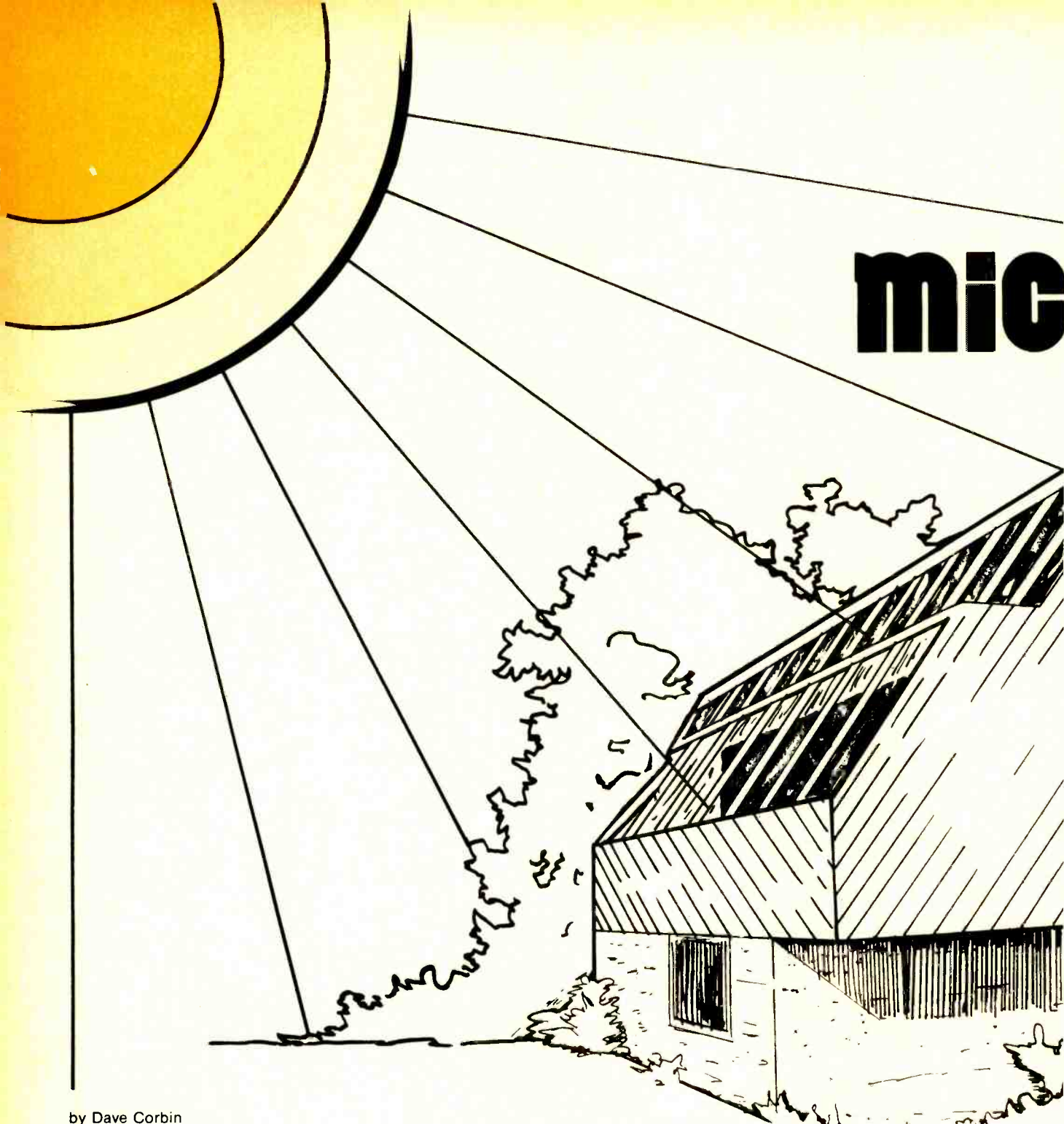

by Dave Corbin

Energy is being consumed today in greater quantities than ever; at the same time, yesterday's seemingly unlimited resources are now seen to be quite finite. As a result, energy conservation has assumed a new importance, and the search for alternative energy sources has begun in earnest. One of the more promising possibilities is harnessing the sun as a direct source of heat.

The solar heating systems now being installed in homes, apartment complexes, and businesses contain heat collecting and storing devices from which resources are drawn during non- and low-sunlight periods. Although there are many types of such systems, the most common circulate water or some other liquid through solar heating panels, or collectors, during the day and store the heated fluid in tanks. When required, this fluid is pumped through radiators or

radiant coils to provide area heating. To maintain comfort and make the best use of the available energy, the user must continuously monitor the temperature of every area to be heated, as well as the temperatures of the collectors and the storage tanks. Valves must then be opened or closed and pumps turned on or off to maintain the desired relationship among the system components. A computerized energy management system, or solar controller, can perform all of the monitor and control functions with optimum efficiency.

A microprocessor-based solar controller designed by Fairchild for Rho Sigma, Inc., a major manufacturer of solar controls, is specifically intended to accept the low voltages produced by thermistor temperature sensors, process and display the data, and provide outputs for relay and switch opening and closing. The solar controller contains a single-



# PROCESSOR-BASED SOLAR CONTROLLER

board F8™ microprocessor, two input and two output cards, an A/D converter control card, a display control card, two 4K EPROM program storage cards, and a 1K RAM and memory address card (Figure 1).

Also included in the unit are an A/D converter, a 5-digit LED display, and a 16-key keyboard. The display automatically sequences through all input channels, displaying the number and temperature of each channel for one second before cycling to the next. The keyboard can be used to halt this sequencing and either make the display continuously moni-

tor only one channel or convert it to a clock-only display that shows time of day.

## CONTROLLER OPERATION

The microprocessor is programmed to solve a set of logic/arithmetic equations. These equations are contained in the EPROM program storage, with the associated constants being held in the 1K RAM. The keyboard can be used to change a number of the equation constants, permitting system changes to be made without hardware modification.

In normal operation, the A/D converter receives analog temperature information from as many as 16 thermistors and presents the converted data to the microprocessor. Digital data, such as that produced by switch closures and teletype signals, can be presented directly to the microprocessor through the 16 digital inputs of the input cards. These data are used to solve the system functional equations and produce two types of microprocessor outputs.

In the channel-monitor modes, temperature information is output to the display in degrees Fahrenheit or Celsius, depending upon resident program. In the time-display mode, a timekeeping routine program assumes control of the display circuitry and the temperature information is not provided.

The other microprocessor output consists of control signals that are suitable for opening and closing relays and activating solid state switches. These signals perform such functions as turning on pumps and opening valves to let water run into the storage tank or circulate through radiators.

Since program storage is in ROM, power failure does not cause catastrophic loss of memory. When power is restored, a resetting sequence begins, with the controller ensuring that all valves and controls are turned off so that stored energy is not lost. The controller then cycles through all of the inputs, decides what the system operating conditions should be, and generates the necessary output signals. This analysis takes approximately five seconds. To indicate to the user that power has been off, the display flashes until manually reset.

Originally designed for use in solar heating applications, the intelligent microprocessor-based controller is applicable to any system in which the ability to deal with multiple sensor inputs and generate control outputs is required.

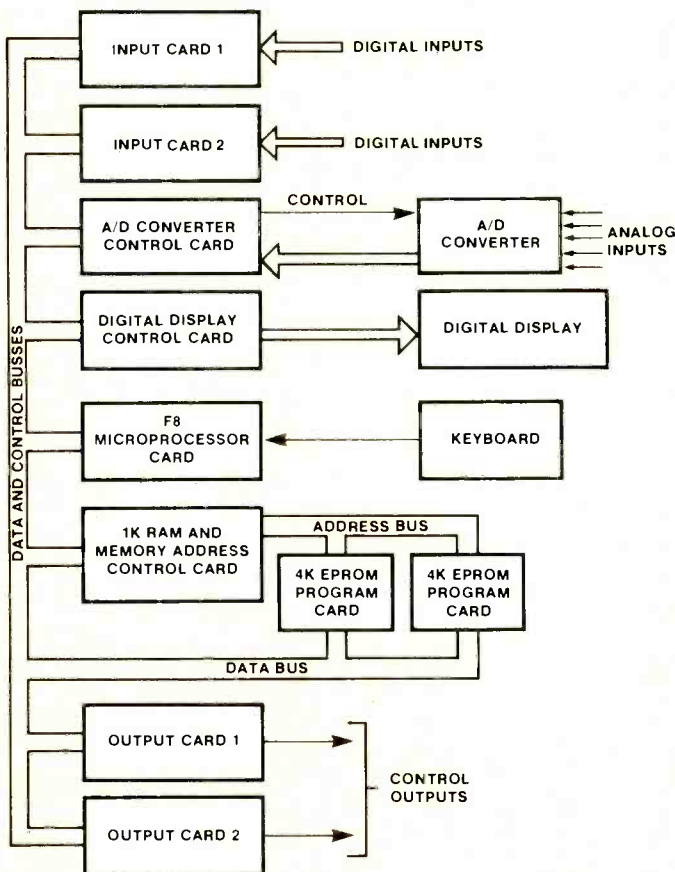

Fig. 1 Solar Controller Functional Block Diagram

# service clinic

## Attacking the fault with a systematic troubleshooting approach.

JACK DARR, SERVICE EDITOR

I'M NOW GOING TO GIVE AWAY ONE OF MY professional secrets! Actually, it's not all that secret. It requires only one piece of non-bench equipment that'll help you make diagnoses of tough dogs in the least possible time. Next time you think you're stuck, "try it—you'll like it!"

The equipment: one clip-board with paper; one pencil or pen; and last of all, one head (yours) that knows how electronic circuits work.

Now, the method: Sit down and *look* at the subject. What symptoms do you see? Write them down at the top of the page, and be sure to get them all down. Next, what do you *think* is the cause? Write this down. This is your first assumption. ("Assumption"—a guess based on observed reactions.) Now, prove it. Take test readings, voltages, signals, etc., and write down *each* test and its result.

Read your results and see what you have. In other words, you've assumed that a certain part or parts in a particular circuit is the cause of a problem. You'll know if you've been thorough in making the tests. Is resistor Rx in tolerance, open or what? Are all DC voltages in the ballpark? Are signals getting through the circuit? These tests will indicate whether the cause *is* in this circuit or not. If it is not, don't consider this is "wrong." On the contrary, you've just eliminated *one* possible cause. Find another cause and check that out too. By writing down the reasons and the results of each test, you can always tell where you are and where you should proceed. You just eliminate one possibility after another until you find the one causing the problem.

There's only one limitation—never make a test without a valid reason. This just wastes time and confuses you. By logging the reason for each test and its results, you'll see the whole problem much more clearly.

For example, if you suspect AGC (Automatic Gain Control) trouble in a tube set, check each DC voltage on the tube and log them. Now, if one DC voltage is off, it'll stick out like a sore thumb. Compare the voltage values you obtain with those shown on the schematic. With transistors, you do the same thing.

The first thing is to *eliminate* as many possible causes in the least time. You can therefore eliminate stages that are working and pin the problem down to only one

or two stages. For instance, you have a set with no picture, and the set has eight stages. Feed a test signal into the input and follow it with your scope to see where it stops. Let's say you read a signal at the output of the second IF transistor, but not at the output of the third IF transistor. Check all DC voltages on the transistor. If you get collector voltage and the emitter voltage is zero but should read +2.65, there you are.

There are now three possible causes. First, an open transistor, which can be checked with an ohmmeter. Second, a transistor could be cut off by too much reverse bias on the base. Use a DC voltmeter for this check. Third, you could have an open emitter resistor or a bad solder joint; use your ohmmeter again. Writing all this down as you perform the tests makes it a lot easier to keep track of everything and to arrive at the final conclusion. ("Conclusion"—the *end* of a process.)

Look for shortcuts. The eight-stage set can be divided into sections very quickly. Read the video signal at the output of the video detector. If the reading is normal, the trouble is not in the tuner, the IF, the AGC, the video detector, or the DC power supply. The trouble lies in the circuits after this point. Of course, if you do not see the normal signal at the video-detector output, you can eliminate the circuits after this stage, because you know that the problem lies in the IF, the tuner, the AGC, etc. A tuner-subber can quickly check the IF and confirm or eliminate that as a source of the problem.

### Multiple symptoms

Let's suppose that you see multiple symptoms: loss of both syncs, pale video, hum-bars in the picture, and so forth. It is very likely that these symptoms have a *common cause*. You might find, say, two different problems, but it's rare to find more at the same time. The best place to look for the cause is in the DC power supply. A defective filter capacitor can allow multiple feedback loops and all kinds of trouble to develop at once. The quickest check is to scope the DC power lines for any kind of signals. In many solid-state sets, the DC power supplies are tightly regulated. These supplies are critical and should be checked first thing. Most of the DC power lines have at least

one shutdown circuit and some of these circuits can overreact! I know of one set with a +118-volt DC line that shuts down instantly when the DC voltage reaches +125 volts!

At this point, someone usually asks: "Yes, but what if it's an intermittent?" The answer is *do not* just sit there and wait for it to quit. The typical intermittent may play for a couple of weeks. In the September 1977 Service Clinic called "Attacking The Intermittent" I wrote that intermittents can be classified very quickly. There are two major causes: *heat*, which causes a shift in part value, or *physical*, meaning bad solder joints, hair-line cracks in PC board conductors, intermittent plug-socket contacts, etc. There are also so-called "combinations": for example, a hairline crack in a PC board may not open until the chassis warms up and expands. Some physicals can be found by bending or tapping the board, parts, or wiring. To attack a "thermal," apply heat from a heat-gun, or cold from a spray can. Move the wiring, tap the board, as you apply heat or spray.

There is one final cause for an intermittent: *voltage*. In certain sets if the line voltage goes high or low, it will cut out. (Don't forget the shutdown circuits.) The answer: vary the line voltage with a variable-voltage transformer. (Note—in sets with voltage-regulating power transformers having saturated cores, this technique cannot be used; these transformers hold the DC voltages too tightly.) Sets that cut out on high line voltage are often really thermals; some stage is taking too much current and overheating some component. By taking detailed notes on each test and its results you can get a better idea of what's happening.

### IC troubleshooting

This definitely also applies to IC's. Here's an illustration: A stereo tape-recorder went dead at irregular intervals on both channels. After writing out the list of reactions, we monitored the signals out of the heads and the output signal. When the line voltage did cut out, it could be brought back by cooling the boards. So, we monitored the signal out of the preamplifier, which was a dual IC op-amp with separate outputs. We warmed up the IC, monitoring one output on the scope and the other with a digital DC voltmeter. Sure enough, when the IC became warm, the DC voltage on the output terminal began to drop. (The

*continued on page 98*



# Understanding Digital Electronics

## New teach-yourself courses

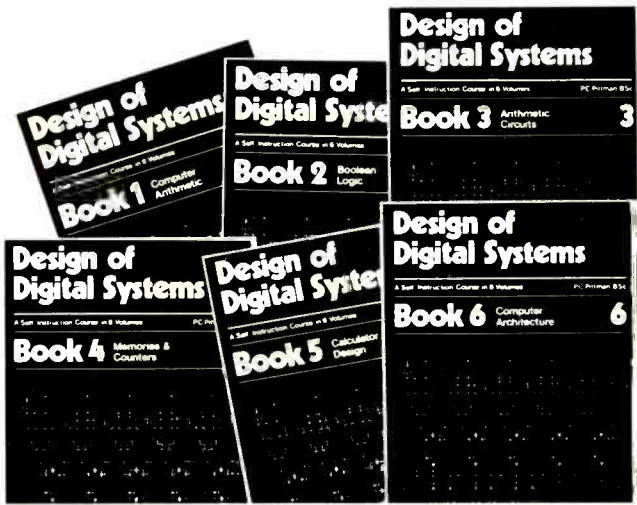

Design of Digital Systems is written for the engineer seeking to learn more about digital electronics. Its six volumes — each 11-1/2" x 8-1/4" are packed with information, diagrams and questions designed to lead you step-by-step through number systems and Boolean algebra to memories, counters and simple arithmetic circuits, and finally to a complete understanding of the design and operation of calculators and computers.

### The contents of Design of Digital Systems include:

- Book 1** Octal, hexadecimal and binary number systems; conversion between number systems; representation of negative numbers; complementary systems; binary multiplication and division.
- Book 2** OR and AND functions; logic gates; NOT, exclusive-OR, NAND, NOR and exclusive-NOR functions; multiple input gates; truth tables; De Morgans Laws; canonical forms; logic conventions; Karnaugh mapping; three-state and wired logic.
- Book 3** Half adders and full adders; subtractors; serial and parallel adders; processors and arithmetic logic units (ALUs); multiplication and division systems.
- Book 4** Flip flops; shift registers; asynchronous and synchronous counters; ring, Johnson and exclusive-OR feedback counters; random access memories (RAMs) and read only memories (ROMs).
- Book 5** Structure of calculators; keyboard encoding; decoding display data; register systems; control unit; program ROM; address decoding; instruction sets; instruction decoding; control program structure.
- Book 6** Central processing unit (CPU); memory organization; character representation; program storage; address modes; input/output systems; program interrupts; interrupt priorities; programming; assemblers; computers; executive programs; operating systems and time sharing.

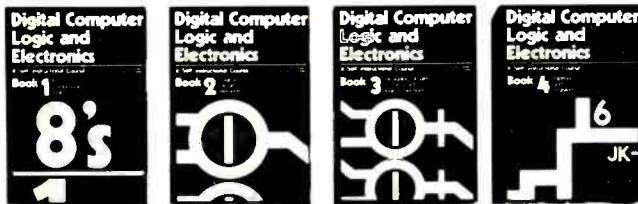

Digital Computer Logic and Electronics is designed for the beginner. No mathematical knowledge other than simple arithmetic is assumed, though the student should have an aptitude for logical thought. It consists of four volumes — each 11-1/2" x 8-1/4" — and serves as an introduction to the subject of digital electronics. Everyone can learn from it — designer, executive, scientist, student, engineer.

Contents include: Binary, octal and decimal number systems; conversion between number systems; AND, OR, NOR and NAND gates and inverters; Boolean algebra and truth tables; De Morgans Laws; design of logic circuits using NOR gates; R-S and J-K flip flops; binary counters, shift registers and half adders.

In the years ahead the products of digital electronics technology will play an important part in your life. Calculators and digital watches are already commonplace. Tomorrow a digital display could show your automobile speed and gas consumption; you could be calling people by entering their name into a telephone which would automatically look up their number and dial it for you.

These courses were written by experts in electronics and learning systems so that you could teach yourself the theory and application of digital logic. Learning by self-instruction has the advantages of being faster and more thorough than classroom learning. You work at your own pace and must respond by answering questions on each new piece of information before proceeding.

After completing these courses you will have broadened your career prospects and increased your fundamental understanding of the rapidly changing technological world around you.

The six volumes of Design of Digital Systems cost only: **\$19<sup>88</sup>**

And the four volumes of Digital Computer Logic and Electronics cost only: **\$14<sup>88</sup>**

But if you buy both courses, the total cost is only: **\$29<sup>90</sup>**

a saving of over: **\$5<sup>00</sup>**

**SEVEN-DAY MONEY-BACK GUARANTEE:** If you are not satisfied with your Cambridge course, return it within 7 days for a full refund.

To order your books, complete the order form below and send it together with your check or money order to GFN Industries, Inc., 6 Commercial Street, Hicksville, N.Y. 11801.

### To: GFN INDUSTRIES, INC.

6 COMMERCIAL STREET, HICKSVILLE, NY 11801

Please send me:

\_\_\_ Sets of Design of Digital Systems \$19.88 \_\_\_\_\_

\_\_\_ Sets of Digital Computer Logic & Electronics \$14.88 \_\_\_\_\_

\_\_\_ Sets of both courses \$29.90 \_\_\_\_\_

Sales tax (N.Y. residents) \_\_\_\_\_

Shipping and handling \$2.50 per set \_\_\_\_\_

Enclosed is check / mo (payable to GFN Industries, Inc.)

Total \$ \_\_\_\_\_

Name \_\_\_\_\_

Address \_\_\_\_\_

City/State/Zip \_\_\_\_\_

Prices include overseas surface mail postage.

RE6B

# IT'S NEW. IT'S DIGITAL. IT'S PUSHBUTTON.



## CB/RF GENERATOR.

- Keyboard entry for instant fingertip selection of all 40 channels.
- Phase-locked-loop frequency control for crystal stability  $\pm 5$  ppm ( $\pm .0005\%$ ).
- LED channel display.
- 455Hz IF output—with front panel socket for extra IF crystals.
- Double shielded for ultra low RF leakage.
- Metered precision attenuator for signals down to 0.3 $\mu$ V.
- Metered modulation for precise output adjustment.
- SSB test function pushbutton operated.
- Noise generator for ANL and noise blanker tests built-in.
- RF protected up to 5 watts for 1 minute.
- 2 year warranty.
- Modern compact size (8 $\frac{1}{4}$ "w X 7"h X 9 $\frac{1}{2}$ "d).

In stock at your Hickok distributor.

MODEL 266 **\$495<sup>00</sup>**

For location of your nearest Hickok distributor, call us, toll free, at 800-321-4664 if you're outside of Ohio.

# HICKOK

the value innovator

INSTRUMENTATION & CONTROLS DIVISION  
THE HICKOK ELECTRICAL INSTRUMENT CO  
10514 Dupont Avenue • Cleveland, Ohio 44108  
(216) 541-8060 • TWX 810-421-8286

CIRCLE 6 ON FREE INFORMATION CARD

## SERVICE CLINIC

continued from page 80

log showed this drop was normal at first, at -6.4 volts.) When it went down to about -0.4 volts, the signal disappeared. When the IC was cooled, the signal suddenly popped in again. The DC supply voltage to the IC was also being monitored, as was the input signal. There was no change in either voltage supply. So it was possible to isolate the problem between these two points: the IC. When any of the DC voltages that come from inside the IC change, this is an almost sure sign that the IC is defective. You should check all external parts, of course.

The important thing to remember in this method is your *attitude* toward the equipment you are checking. You should not view it as a mysterious box full of things. It is only a piece of electronic apparatus that has a bad part somewhere inside that you *can* find! Be completely impartial as to what you hope to find. A completely open mind is the most valuable asset you can have. Write everything down; it'll help keep track of what you're doing and it'll also give you a few good laughs when you get through! **R-E**

## service questions

### CHASSIS ALWAYS HOT

*While working on a Magnavox T982, I found that the chassis was hot to ground. I reversed the AC line plug but it was still hot. Something in there is shorted, but I can't find it.—G.O., Wickes, AR*

This is normal in this model and in the T981! Both types use a full-wave bridge rectifier tied directly to the line. No matter which way the plug is inserted, you'll read about 70-volt AC to an earth ground. Magnavox explains it in their *Service News*, January, 1974 (see circuit diagram). An isolation transformer should always be used when *servicing*; it's safe if all insulators are in place.

### ROLLING ON CHANNEL 7 ONLY

*We get Channel 13, locally, and Channels 7, 10 and 15 from about 60 miles away. All the channels are good, but Channel 7 rolls. I can't figure it out.—H.W., Lynchburg, VA*

We once had a similar case on our CATV. One channel rolled on all sets. We finally checked sync amplitude on all stations and found that the bad one showed something like a 10% sync level, 90% video! The normal levels are 75% video, 25% sync. Calls to the station produced no instant response, but we finally learned that their console monitor was badly out of calibration! If this is fixed there should be no more trouble. You might try calling or writing the station.

(Feedback: "Thank you for the letter. It was very effective. Channel 7 stopped rolling the day the letter arrived and hasn't rolled since. If it starts again, I will wave your letter in front of the screen and stop it!")

### DIMMER PROBLEMS

Lamp dimmers make two kinds of noise—RFI and a "singing," which can be heard if the lamp is near enough. I've found the best cure for the singing effect is to change the bulb. Try screwing it in tighter or loosening it.

Some commercial dimmers apparently do not contain RFI filters. I've found that a 0.05 of 0.1- $\mu$ f capacitor, 600 volts across the line cord, will take the hash out of these. Oddly enough, this capacitor must be connected across the line at a point about 18 inches from the dimmer. I have no idea why this happens, but it does. Do you?

(No, frankly I don't. Possibly this acts as a resonant circuit. Thanks to Carl F. Hartman, Newport Beach, CA, for the hints and experiments.)

continued on page 100

**PROFESSIONAL AIDS  
SHELF FILES**

KEEP MAGAZINES,  
CATALOGS, MANUALS,  
JOURNALS, AND REPORTS  
NEAT, ORGANIZED



Eliminate the clutter of loose magazines, catalogs, etc. Find what you want, when you want it by utilizing these handy shelf or desk top files. Available in 6 sizes from Reader's Digest to newspaper size. Constructed of heavy duty fibreboard. Attractive front panel. Adhesive identification labels included. Popular letter size: 11 $\frac{1}{2}$  x 9 x 3 $\frac{3}{4}$ .



Store on Shelves  
Organize Your Desk

**ORDER DIRECT**  
10 for \$15.89 — 25 for \$28.97  
Other sizes available — Request Catalog  
Shipped pre-paid, Canada, add \$1.00

**PROFESSIONAL AIDS CO.**  
1 S. WACKER DR., SUITE RE6  
CHICAGO, ILL. 60606

CIRCLE 22 ON FREE INFORMATION CARD



# AUTOCOMP

## The GAS SAVER!

### AN IMPORTANT AUTOMOTIVE BREAKTHROUGH!

Microprocessors, the electronic devices of the future, assist our daily living in a multitude of ways. This advanced technology has now been combined with SpaceKom-AUTOCOMP's exclusive fuel and flow sensors, to provide an important automotive breakthrough. The AUTOCOMP mounts in or on your dash, and by pushbutton control provides LED readouts of the following driving functions: Instantaneous MPG, Average MPG, Fuel Used, Distance Traveled, and Correct Time. With this valuable data at your fingertips, you can drive your vehicle more efficiently and derive the following important benefits:

#### REDUCE YOUR FUEL COSTS

By monitoring fuel consumption you can improve your driving habits and significantly cut fuel bills. You will know precisely how changes in acceleration, speed, wind, weight, hills, etc., are affecting fuel economy. AUTOCOMP gives you a true and continuously updating readout of Instantaneous MPG as you drive, allowing you to adjust your driving for safer and more economical conditions on a minute by minute basis. By alerting you when fuel consumption increases, AUTOCOMP can easily save enough money to pay for itself in the first year it is installed!

#### MONITOR YOUR ENGINE'S PERFORMANCE

AUTOCOMP's Average MPG feature lets you monitor fuel consumption on a day by day or week by week basis. You can tell when your engine is causing you to burn extra gas by not running at peak performance. This information cues you when it's time for a tuneup, and helps you avoid the costly repairs of a major breakdown.

#### ENHANCE THE VALUE OF YOUR VEHICLE

AUTOCOMP is a modern electronic instrument which will give your dash the look and functionality of a true instrument panel. Its microcircuit electronic design will provide trouble-free operation to enhance the beauty and value of your vehicle for as long as you drive it.

#### ADD EXCITEMENT TO YOUR DRIVING

AUTOCOMP is today's most exciting automotive accessory. In addition to saving you money and giving you greater command of your driving, AUTOCOMP will enhance your driving fun and pleasure. Checking the readout of its various functions as you drive is a sure-fire method of breaking up the monotony of long trips.

#### INSTALL AUTOCOMP YOURSELF!

\*AUTOCOMP can be installed on most American and Japanese make autos and vans except those with fuel injection. Because of their non-standard speedometer gears, AUTOCOMP is not recommended for European imports. Complete step-by-step illustrated instructions make AUTOCOMP a most rewarding fun experience for the do-it-yourselfer. Equipment supplied include the Speedsensor which simply screws onto the speedometer cable and digital Flowsensor which easily installs onto the fuel line. Free consultation is offered by mail or telephone if any problems are encountered. Installation by an independent mechanic will of course add to the cost. No responsibility for any additional costs can be accepted by SpaceKom-AUTOCOMP.

#### SPECIFICATIONS:

Fuel Used ± 5% typical    Inst. MPG ± 5%  
Distance ± 2%            Clock 1 Min / Mo typical  
Avg. MPG ± 5%            Size 3 1/4" H x 6" W x 1 1/2"



PRICED AT JUST **\$129<sup>50</sup>**

FOR ORDERS ONLY  
**CALL TOLL FREE ANYTIME!**

1-800-423-2355 Ext. 601  
In California 1-800-232-2175 Ext. 601  
For more information call 805-965-1015



## ELECTRONIC MICROPROCESSOR COMPUTES TRUE MPG AS YOU DRIVE.

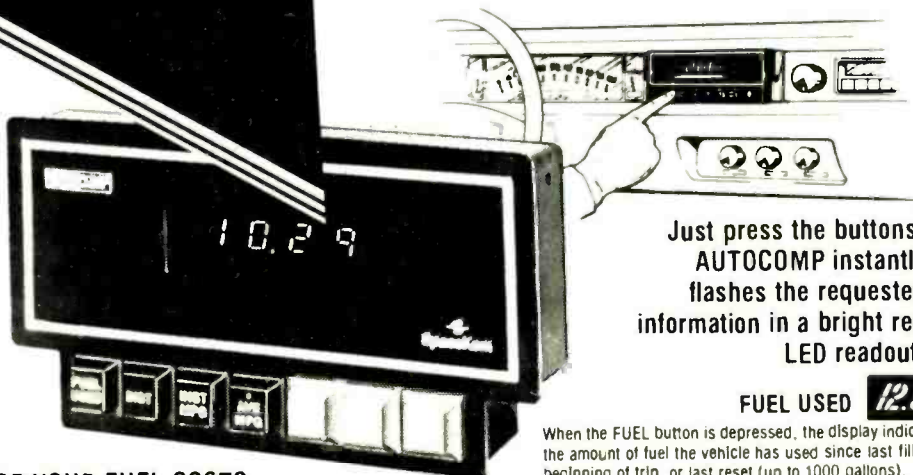

Just press the buttons! AUTOCOMP instantly flashes the requested information in a bright red LED readout!

**FUEL USED 12.9**

When the FUEL button is depressed, the display indicates the amount of fuel the vehicle has used since last fill-up, beginning of trip, or last reset (up to 1000 gallons).

**DISTANCE TRAVELED 85.2**

When the DIST button is depressed, the display indicates the distance the vehicle has traveled since the last reset (up to 1000 miles).

**INSTANTANEOUS MILES/GALLON 23.7**

When the INST MPG button is depressed, the display indicates how many miles per gallon the vehicle is attaining at each moment (up to 200 mpg).

**AVERAGE MILES/GALLON 20.9**

When the AVE MPG button is depressed, the display indicates the average miles per gallon the vehicle has attained since the last reset (up to 200 mpg).

**TIME 11.26**

When the TIME button is depressed, the display indicates the correct time (in hours and minutes). The clock may instead be used to display ELAPSED TIME.

#### SPACEKOM-AUTOCOMP

212 E. Gutierrez Street  
Santa Barbara, CA 93101

Please send me \_\_\_\_\_ AUTOCOMP(s) at \$129.50 each. (California residents must add 6% sales tax.)

Car on which AUTOCOMP will be installed\*

Make \_\_\_\_\_ Model \_\_\_\_\_ Year \_\_\_\_\_

Factory Cruise Control? Yes  No

Total enclosed (Cal. res. add tax) \$ \_\_\_\_\_

#### USE YOUR CHARGE CARD!

BankAmericard (VISA) \_\_\_\_\_

Master Charge (Interbank #) \_\_\_\_\_

Charge # \_\_\_\_\_

Signature \_\_\_\_\_ Exp. Date \_\_\_\_\_

PRINT NAME \_\_\_\_\_

ADDRESS \_\_\_\_\_

CITY \_\_\_\_\_

STATE \_\_\_\_\_ ZIP \_\_\_\_\_

CIRCLE 30 ON FREE INFORMATION CARD

www.americanradiohistory.com

## MATHEMATICS ELECTRONICS ENGINEERING MATHEMATICS ADVANCED MATHEMATICS

These unusual courses are the result of many years of study and thought by the President of Indiana Home Study, who has *personally* lectured in the classroom to *thousands* of men, from all walks of life, on mathematics, and electrical and electronic engineering.

You will have to see the lessons to appreciate them!

NOW you can master mathematics and electronics and actually *enjoy* doing it!

WE ARE THIS SURE:—you order your lessons on a money-back guarantee.

In plain language, *if you aren't satisfied you don't pay*, and there are no strings attached.

Write today for more information and your outline of courses.

You have nothing to lose, and everything to gain!

**The INDIANA  
HOME STUDY INSTITUTE**

P.O. BOX 1189

PANAMA CITY, FLA 32401

CIRCLE 40 ON FREE INFORMATION CARD

### SERVICE QUESTIONS

*continued from page 98*

#### FUSE BLOWS FAST

*I've checked almost everything, but I can't find out why the fuse blows in this Magnavox T982-12. It pops inside of 30 seconds.—B.H., Decatur, GA*

As a last resort, try replacing the "four-legged capacitor" in the collector circuit of the horizontal output transistor.

(Feedback: "Got it! Thanks.")

#### CONSTANT FUSE BLOWOUTS

*I've just repaired a Magnavox T940. It quit, and the owner replaced a 20-amp fuse with a bigger one! Blew all the rectifier diodes and burned up the PC board. I fixed this; now it plays OK for 5-10 minutes, and then the 20-amp fuse goes out again. Any suggestions?—W.I., Salt Lake City, UT*

Well, it took me quite a time to find that 20-amp fuse and then to find out where it went. It kept getting lost. This fuse is in the *heater* circuit for all tubes except the picture tube and 6BK4 high-voltage regulator.

You have one of two problems: An intermittent wiring short, where a lead goes around a sharp corner of a metal *continued on page 102*

## 9 reasons why the real pros prefer Endeco desoldering irons



1. Operates at 120v. 40w. Idles at 20w for longer tip life
2. Flexible, burn resistant Neoprene cord set
3. Cool, unbreakable polycarbonate handle
4. Exclusive bracket insures alignment, prevents damage
5. Safety light in handle tells when it's on
6. Stainless steel construction
7. Temperature control. Low, high or off.
8. Eight tip sizes. Comes with .063 I.D.
9. Converts to soldering iron with ¼" shank type tip

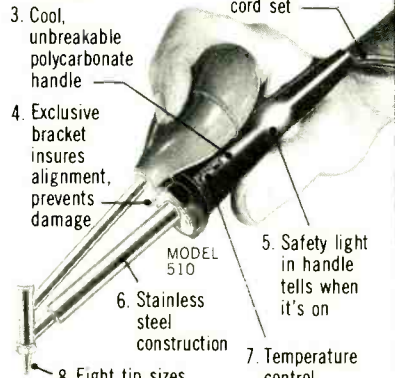

See your distributor or write . . .

### Enterprise Development Corp.

5127 E. 65th St. • Indianapolis IN 46220  
PHONE (317) 251-1231

CIRCLE 1 ON FREE INFORMATION CARD

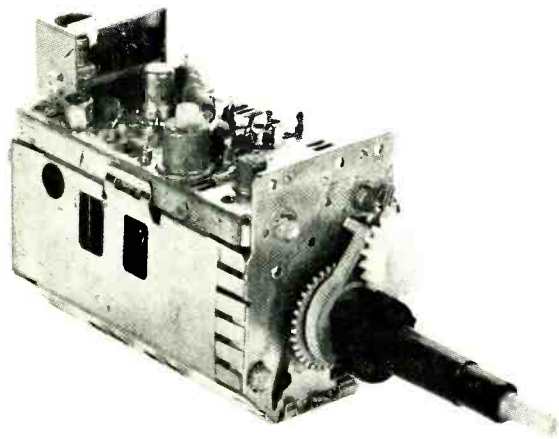

# The Best of Everything Has Its Price

Even tuner service. From the beginning our goal has been to provide the best tuner service, not the cheapest. The extra dollar you might pay at PTS is peanuts when you consider the reliability and standards of excellence we apply to every job. Thousands of PTS customers must agree or we wouldn't be the world's largest tuner service company.

See The Yellow Pages For The PTS Servicenter Nearest You Or Contact:



**PTS ELECTRONICS, INC.**

P.O. BOX 272 BLOOMINGTON, IN 47401 812-824-9331



# Jim-pak<sup>®</sup>

Electronic components

# One-Stop Component Center

## NEW!! EXPANDED PRODUCT LINE...

<p><b>TTL</b></p> <p>7400 7480 7402 7482 7404 7484 7408 74107 7410 7412 7420 74122 7430 74123 7432 74125 (DM8093) 7442 74154 7447 74151 (DM9316) 7473 74176 (DM9280) 7474 74177 (DM9281) 7475 74192 7476 74193 7485 74367 (DM8097)</p> <p><b>Low Power TTL Schottky</b></p> <p>74LS00 74LS73 74LS109 74LS02 74LS74 74LS123 74LS04 74LS75 74LS136 74LS08 74LS83 74LS138 74LS10 74LS85 74LS151 74LS20 74LS86 74LS175 74LS30 74LS90 74LS367 74LS52</p> <p><b>C/MOS</b></p> <p>4000 4020 4050 4001 4023 4051 4010 4024 4059 4011 4029 4071 4013 4044 4081 4016 4046 4051 4017 4049</p> <p><b>Display LEDs Discrete</b></p> <p>MAN2 XCS56 Red DL104 XCS56 Green DL101 XCS56 Yellow DL147 CLPL1ES Red DL150 Green Yellow</p>	<p><b>LINEAR</b></p> <p>LM301V LM567V LM303V LM723N LM309K LM733N LM311V LM741V LM320K 5 (7905) LM747N LM320T 5 (7905) LM1458V (5558V) LM3201 (217912) LM1488N LM3201 (517915) LM1489N LM339N LM1556V LM340T 5 (7805) XR7206 LM340T 12 (8812) CA3080 LM340T 151 (7815) CA3130 LM355V CA3140 LM565N LM3900N (CA3401)</p> <p><b>MICROPROCESSOR</b></p> <p>Z 80 2101 8080A 2102 8212 2102 8224 7489 8228 MM5262 8804 1102A 6810 8252J 6830L 2710B AY 5 1013 DM8835N 2913 0140 NR197 MM5A14 (Clock Chip)</p> <p><b>SOCKETS</b></p> <p>8 pin low profile 14 pin wire wrap 14 pin low profile 16 pin wire wrap 16 pin low profile 24 pin wire wrap 24 pin low profile 40 pin wire wrap 40 pin low profile TO 3 Socket 14 pin plug 16 pin plug Male Pins</p> <p><b>SWITCHES</b></p> <p>Discontinues Slide Toggle Push Button Subminiature Push Button</p>	<p><b>CAPACITORS</b></p> <p><b>Aluminum Electrolytic</b></p> <p>1mf 50V 100mf 50V 4.7mf 50V 220mf 50V 10mf 50V 470mf 50V 22mf 50V 1000mf 25V 47mf 50V 2200mf 16V</p> <p><b>Ceramic Disc</b></p> <p>10pf 50V 001mf 50V 47pf 50V 0047mf 50V 100pf 50V 0.1mf 50V 220pf 50V 0.22mf 50V 330pf 50V 0.47mf 50V 470pf 50V 1mf 50V</p> <p><b>Dipped Tantalum</b></p> <p>1mf 35V 2.2mf 35V 22mf 35V 3.3mf 35V 33mf 35V 4.7mf 35V 47mf 35V 6.8mf 35V 68mf 35V 10mf 25V 1mf 35V 15mf 25V 1.5mf 25V 33mf 25V</p> <p><b>Polyester Mylar</b></p> <p>001mf 100V 0.022mf 100V 0015mf 100V 0.047mf 100V 0.022mf 100V 1mf 100V 0.047mf 100V 22mf 100V 0.1mf 100V</p> <p><b>CRYSTALS</b></p> <p>CY1A CY2A CY12A</p> <p><b>TEST CLIPS</b></p> <p>14 pin clip 16 pin clip</p> <p><b>FUSE HOLDERS</b></p> <p>HKP 3AB</p>	<p><b>P.C. POTENTIOMETERS</b></p> <p>Single Turn 15-Turn</p> <p>840P1K 830P1K 840P5K 830P5K 840P10K 830P10K 840P50K 830P50K 840P100K 830P100K 840P1mg 830P1mg</p> <p><b>DIODES</b></p> <p>IN751 IN4158 IN9141 IN4733 IN4001 IN4734 IN4004 IN4742 IN4007 IN4744 MDA-9803</p> <p><b>TRANSISTORS</b></p> <p>C106R1 2N3055 2N2222A 2N3904 2N2807A 2N3906 MJE2955 2N5129 MJE3055 2N4339</p> <p><b>CONNECTORS</b></p> <p>D825P Plug D825S Socket</p> <p><b>DATA BOOKS*</b></p> <p>7400/74LS Data Book CMOS Linear Data Book Microprocessor LEO Data Book *JIMPAK Products only</p> <p><b>HEAT SINKS</b></p> <p>1 Watt 5% 50 Pp. Assortments</p> <p><b>1/4 W RESISTOR ASST.</b></p> <p>1 Watt 5% 50 Pp. Assortments</p>
--	--	---	--

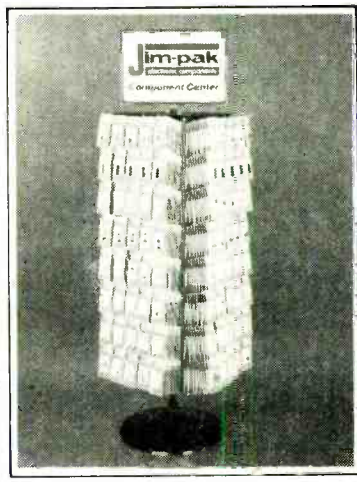

A new component product line of over 260 items developed for the independent dealer. Guaranteed nationally advertised products. Complete JIM-PAK program includes national advertising, direct mail programs, store display racks, stock rotation plan and return policy. For dealer information, write or call JIM-PAK, 1021 Howard Avenue, San Carlos, CA 94070 (415) 592-8097.

## SEE YOUR LOCAL Jim-pak<sup>®</sup> DEALER TODAY...

- |  |  |  |
|--|--|--|
| <p><b>ALABAMA</b></p> <p>Mobile Lafayette Radio Electronics</p> <p><b>ALASKA</b></p> <p>Anchorage Electronics Corp of Alaska</p> <p><b>ARIZONA</b></p> <p>Fountain Hills P &amp; C Communications<br/>Tempe Computerworld Inc.<br/>Yuma Yuma Electronics</p> <p><b>CALIFORNIA</b></p> <p>Bellflower Earl's Hobby Shop<br/>Berkeley Al Lasher Electronics<br/>Buena Park SJ Electronics<br/>Fontana Fontana Electronics<br/>Fullerton Orvac Electronics Inc.<br/>Long Beach Scott Radio Supply<br/>Mission Viejo Tower Electronics Corp.<br/>Monterey Zackit<br/>Oceanside Electronic Center<br/>Oxnard Dow Radio Inc.<br/>Palo Alto Zack Electronics<br/>Pasadena Dow Radio Inc.<br/>Sacramento The Radio Place<br/>Sacramento Zackit<br/>San Carlos J &amp; H Outlet Store<br/>San Diego Radio Shack A.S.C. Mira Mesa<br/>San Fernando San Fernando Electronics<br/>San Francisco Zack Electronics<br/>San Jose Quermeter Electronics<br/>San Luis Obispo Mid State Electronics<br/>Santa Cruz Santa Cruz Electronics<br/>Santa Monica Mission Control<br/>Sunnyvale Sunnyvale Electronics<br/>Vallejo Zackit<br/>Walnut Creek Byte Shop Computer Store</p> <p><b>CANADA</b></p> <p>Alberta (Calgary) The Computer Shop<br/>Montreal (Quebec) Wang's Microcenter<br/>Ontario (Windsor) Home Computer Centre</p> <p><b>COLORADO</b></p> <p>Aurora Com Co Electronics<br/>Steamboat Springs Norm's TV &amp; Electronics</p> <p><b>CONNECTICUT</b></p> <p>Bridgeport Bridgeport Computer</p> <p><b>FLORIDA</b></p> <p> Ft. Lauderdale Computers For You<br/>Lakeland Lakeland Specialty Electronics<br/>Orlando Altair Computer Center of Orlando<br/>Tampa AMF Electronics<br/>Tampa Microcomputer Systems</p> <p><b>FRANCE</b></p> <p>Paris Computer Boutique</p> <p><b>GEORGIA</b></p> <p>Atlanta Atlanta Computer Mart</p> <p><b>HAWAII</b></p> <p>Aiea Delcoms Hawaii<br/>Honolulu Integrated Circuit Supply</p> <p><b>IDAHO</b></p> <p>Idaho Falls Auditoriums</p> | <p><b>ILLINOIS</b></p> <p>Evanston Tri-State Electronics<br/>Evanston Itty Bitty Machine Co.<br/>Groveland Moyer Electronics<br/>Mount Prospect Tri-State Electronics<br/>Oak Park Spectronics<br/>Schaumburg Data Domain</p> <p><b>INDIANA</b></p> <p>East Chicago Acio Electronics<br/>Hammond Quantum Computer Works</p> <p><b>IOWA</b></p> <p>Indianola Electronix Limited</p> <p><b>KANSAS</b></p> <p>Wichita Amateur Radio Equipment Co.</p> <p><b>KENTUCKY</b></p> <p>Lexington Radio-Electronic Equipment Co.</p> <p><b>LOUISIANA</b></p> <p>Baton Rouge Davis Electronics Supply</p> <p><b>MARYLAND</b></p> <p>Baltimore Computer Workshop of Baltimore<br/>Baltimore Everything Electronic<br/>Lavage I &amp; M Electronics<br/>Rockville Computers Workshop<br/>Towson Baynesville Electronics<br/>Towson Computers, Etc.</p> <p><b>MASSACHUSETTS</b></p> <p>Medford Tufts Electronics<br/>North Adams Electronics Supply Center<br/>Walham Computer Mart Inc.</p> <p><b>MICHIGAN</b></p> <p>Flint Hobby Electronic Center<br/>Grand Rapids Micro Computer World<br/>Lansing Fulton Radio Supply<br/>Mt. Clemens The Computer Store</p> <p><b>MINNESOTA</b></p> <p>Duluth Northwest Radio of Duluth<br/>Eagan Computer Room Inc.</p> <p><b>MISSOURI</b></p> <p>El Dorado Springs Beckman Electronics<br/>Parkville Computer Workshop of Kansas City</p> <p><b>MONTANA</b></p> <p>Billings Conley Radio Supply</p> <p><b>NEBRASKA</b></p> <p>Lincoln Altair Computer Center<br/>Omaha Omaha Computer Store</p> <p><b>NEVADA</b></p> <p>Las Vegas Century 23</p> <p><b>NEW JERSEY</b></p> <p>Bayville A. R. S. Communications Services<br/>Cherry Hill Computer Emporium<br/>Hoboken Hoboken Computer Works<br/>Pompton Lakes Computer Corner of New Jersey</p> <p><b>NEW YORK</b></p> <p>Ramsey Typetronic Computer Store<br/>Albany Fort Orange Electronics<br/>New York Computer Mart of New York<br/>Troy Trojan Electronics<br/>White Plains The Computer Corner</p> | <p><b>NORTH CAROLINA</b></p> <p>Durham Futureworld<br/>Greensboro Byte Shop of Greensboro<br/>Raleigh Byte Shop of Raleigh</p> <p><b>OHIO</b></p> <p>Bucyrus Mead Electronics<br/>Cincinnati Digital Design<br/>Dayton Altair Computer Center<br/>Reynoldsburg Reynoldsburg Radio<br/>Steubenville Hostelt Electronics</p> <p><b>OKLAHOMA</b></p> <p>Guyton Sound Service<br/>Oklahoma City Bits, Bytes &amp; Micros</p> <p><b>OREGON</b></p> <p>Beaverton Altair Computer Center<br/>Coos Bay Herrick Electronics<br/>Ontario Miller Electronics<br/>Salem Computer Pathways</p> <p><b>PANAMA</b></p> <p>Panama City Sonitel, S.A.</p> <p><b>PENNSYLVANIA</b></p> <p>Hershey Microcomputer Systems Inc.<br/>Murrysville Computer Workshop of Pittsburgh</p> <p><b>RHODE ISLAND</b></p> <p>Cranston Jabbour Electronics City<br/>Pawtucket Jabbour Electronics City<br/>Providence Interserve (PTE) Ltd.</p> <p><b>SINGAPORE</b></p> <p>Technical Services Inc.</p> <p><b>SOUTH CAROLINA</b></p> <p>Charleston</p> <p><b>TENNESSEE</b></p> <p>Clarksville Classivronics<br/>Knoxville Byte Shop of Knoxville<br/>Memphis Sere-Rou &amp; Co. Electronics<br/>Oak Ridge Computer Denn</p> <p><b>TEXAS</b></p> <p>Amarillo Computer Encounters Inc.<br/>Dallas CompuShop<br/>Houston Altair Computer Center<br/>Houston Interactive Computers<br/>San Antonio Herman Electronics Supply</p> <p><b>UTAH</b></p> <p>Provo Alpine Electronic Supply Co.</p> <p><b>VIRGINIA</b></p> <p>Alexandria Computer Hardware Store<br/>Alexandria Computers Plus<br/>Charlottesville Lafayette Electronics<br/>Richmond Computers To Go<br/>Springfield Computer Workshop of North Virginia<br/>Virginia Beach Heathkit Electronics Center</p> <p><b>WASHINGTON</b></p> <p>Bellevue Altair Computer Center<br/>Longview Progress Electronics<br/>Pasco Riverview Electronics<br/>Seattle C.Com<br/>Seattle Empire Electronics<br/>Spokane Personal Computers</p> <p><b>WEST VIRGINIA</b></p> <p>Morgantown The Computer Corner<br/>Morgantown Electro Distributors</p> |
|--|--|--|

CIRCLE 8 ON FREE INFORMATION CARD

www.americanradiohistory.com

# Try this exciting new hobby!

Build your own electronic concert organ. It's easy. No technical knowledge required. Just follow the clearly pictured instructions of the famous Wersi do-it-yourself system. Choose from seven different models. Send \$2.00 (refundable) with coupon for colorful 104 page catalog.

**WERSI**



Wersi Electronics, Inc.  
Dept. 24, Box 5318  
1720 Hempstead Road  
Lancaster, PA 17601

Enclosed is \$2.00 for my copy of your 104 page catalog.

Name \_\_\_\_\_  
Address \_\_\_\_\_  
City \_\_\_\_\_ State \_\_\_\_\_ Zip \_\_\_\_\_

CIRCLE 54 ON FREE INFORMATION CARD

## SERVICE QUESTIONS

*continued from page 100*

object, or a possible heater-to-cathode short in a tube that does *not* have a cathode resistor. (If it does, the resistor burns up and tells us where the problem is.) Even small tubes can do this; it would be a "hot short." The tube has to get pretty hot to expand enough to make it happen. Since this apparently blew up the rectifiers, check the damper or horizontal output.

### HALF VERTICAL SCAN

If you see about half the normal vertical scan, with heavy retrace lines at the top of the screen, in the Magnavox T995 chassis, check the vertical output *choke*. It may be shorted. The normal resistance is 9-10 ohms; some have been found with only about 3 ohms.

*(Magnavox Service News Letter.)*

### TWO CORRECTION NOTICES

In the March issue of **Radio-Electronics** (page 82), I said (referring to an Aims amplifier) that "6550 tubes are rated at 20 watts, etc., etc."

John Dalnes, service manager of Ace Music, North Miami, FL, wrote me that in his RCA tube manual *No. RC-30* these tubes are rated at 100 watts each. He's

right! I found them in my own copy of *RC-29*, too . . . I just didn't look far enough down the page. I'm glad you told me, John. Thanks.

The second mistake is one that is not due to stupidity, but to just plain ignorance. In the same issue on page 81, I told the technician complaining of a speed loss at high volume levels in a Panasonic SG-635 to check the DC power supply.

George Weiss (Patis-Bell TV, Chicago, IL) informs me that this is a common problem in this unit. It is due to high-resistance contacts in the on-off switch in series with the motor. This information should be helpful, and I thank George for letting me in on it. It's now duly filed for future reference.

### HIGH DC VOLTAGES

*I can't get a handle on this one—a Sylvania model EO-8 that has no sound or raster; and the breaker trips. The B+ voltages are all too high. Take a look in the crystal ball and tell me a good way to get hold of this.—F. L., San Diego, CA.*

You've got a dandy "typical symptom" that appears in almost all solid-state TV sets. If your DC voltages are *too high*, the chances are there's a problem in the voltage regulator. In most you'll find one or more *shutdown* circuits that trip instantly if the high voltage or the B+ volt-  
*continued on page 104*

# NEW

## AN INTRODUCTION TO PERSONAL AND BUSINESS COMPUTING

AN INTRODUCTION TO PERSONAL AND BUSINESS COMPUTING

RODNEY ZAKS



Rodney Zaks - Austin Lesea Ref C200 **\$6.95**

This introductory text is aimed at answering the basic question: "What do I need in order to...?" It covers applications, peripherals, existing systems, how to assemble them. How to choose. The real cost of a system. The software. Is a floppy sufficient for a mailing list? Build or buy?

## MICROPROCESSOR LEXICON

**\$2.95**

110 pp., pocket-size, ref X1  
ALL THE DEFINITIONS AND ACRONYMS  
A complete dictionary, PLUS: part numbers, signals, for S100, RS232, IEEE 488, addresses.

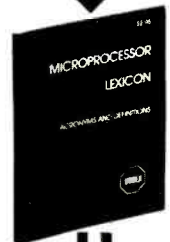

## SELF-STUDY COURSES

Each course includes a book plus 2 cassettes (can be played on any cassette recorder at home, in the car, at the office.)

**S1-INTRODUCTION TO MICROPROCESSORS** **\$29.95**  
2½ hours. Basic introductory course.

**S2-PROGRAMMING MICROPROCESSORS** **\$29.95**  
2½ hours. Basic introduction to programming.

## A MICROPROGRAMMED APL IMPLEMENTATION

**\$25.00**

Rodney Zaks 320 pp., ref Z-10  
The complete design of a real APL interpreter, including theory, parsing, operators, dynamic block management, actual listing.



USED WORLDWIDE IN TEACHING AND EDUCATION

## MICROPROCESSORS

Rodney Zaks 416 pp., ref C201 **\$9.95**

## MICROPROCESSOR INTERFACING TECHNIQUES

Austin Lesea - Rodney Zaks 416 pp., ref C207 **\$9.95**

### TO ORDER

- **BY PHONE:** call (415)848-8233  
BankAmericard/Mastercharge accepted
- **SHIPPING:** no charge when payment included.  
ADD: \$1.00/book for fast shipping.
- **TAX:** in California, add sales tax.
- **OVERSEAS:**  
SYBEX-EUROPE, 313 rue Lecourbe,  
75015 - PARIS, France Tel: (1)8282502



2020 Milvia St.  
Berkeley,  
Calif 94704

NAME \_\_\_\_\_ POSITION \_\_\_\_\_  
COMPANY \_\_\_\_\_  
ADDRESS \_\_\_\_\_  
CITY \_\_\_\_\_ STATE/ZIP \_\_\_\_\_  
 C201  C207  C200  X1  Z10  OTHER \_\_\_\_\_  
 Payment enclosed  Bill company  Bill me  
ADD \$1.00 / BOOK FOR FAST SHIPPING  
 charge my  Visa  Master charge  
 Number \_\_\_\_\_ Exp date \_\_\_\_\_  
Signature \_\_\_\_\_  Send catalog.  
 FREE CATALOG/ ORDER FORM

CIRCLE 95 ON FREE INFORMATION CARD



# NEW for Professional Technicians

## Forest Belt's TRAINING WORKSHOPS 1978

- THREE-DAY
- INTENSIVE
- UP-TO-DATE
- PERSONAL
- UNIQUE
- Includes lodging
- Breakfasts, lunches, and coffee breaks during WORKSHOPS
- Grand AWARDS BANQUET
- FREE Extra SEMINAR

### ADVANCED VIDEO SERVICING

Featuring VCRs, Digital Controls, VIR . . .  
and much more

Intensive Forest Belt teaching techniques and exclusive, proven training aids bring you right up-to-date in the troubleshooting and repair of today's video equipment for home or industry.

Special emphasis on solid-state and integrated circuits. See new IF and color alignment methods you probably never thought of. Learn about Vertical Interval Reference (VIR) automatic color control in newly introduced TV receivers. Understand digital and solid-state tuning systems. Participate in live equipment demonstrations. Sit in on the industry's first look at practical, **Easi-Way™** repair of video cassette recorders.

DON'T BE LEFT BEHIND in your own industry! Be the one technician in your region who not only keeps up but stays AHEAD of new technology and servicing methods. ENROLL NOW to be sure you do not miss this vital and unique Advanced Video Servicing WORKSHOP.

FREE Price and Profit SEMINAR Tuesday evening.

**September**  
**11-13 (Communications)**  
**or 18-20 (Video)**

**Hospitality Inn East**  
**Interstate 70 at Post Road**  
**Indianapolis, INDIANA**

Centrally placed for convenient travel from anywhere in the mainland U.S. Also timed earlier in the year, in case you should not be away from your shop during the pre-Christmas season. You can attend in time to prepare you for the year-end service rush and the new sets being sold.

Comfortable, pleasant accommodations: two people to a room (two beds). Indoor pool. Shopping downtown by freeway. Bring your spouse if you wish, at the nominal No-WORKSHOP fee (she joins the WORKSHOP group for breakfasts and lunches). If you prefer to room with a specific other WORKSHOP attendee, tell us.

Enrollments close August 4, 1978, or when capacity is reached.

Per Workshop **\$495**



### ADVANCED COMMUNICATIONS SERVICING

Featuring FM Two-Way, PLL, Single Sideband . . .  
and much more

Here, too, intensive Forest Belt teaching methods and exclusive, tested learning aids assure you up-to-the-minute training in troubleshooting and maintaining communications systems.

Special emphasis on solid-state and integrated circuits. Observe professional alignment and tuneup methods. Deal profitably with Business and Land Mobile Radio—and the growing General Mobile Radio on UHF wavelengths. Learn of new developments in Marine and Aircraft Radio. Study the latest phase-locked loops, including their digital programming. Take part in live equipment demonstrations. See **Easi-Way™** techniques applied to communications.

GROW AS A REAL EXPERT in your specialty. Grab this exceptional opportunity to polish up your diagnosis and repair skills. Become familiar with new technology and money-saving instruments. ENROLL NOW in Advanced Communications . . . a giant step beyond our popular CB Servicing WORKSHOPS.

FREE Math and Formulas SEMINAR Tuesday evening.

**November**  
**6-10 (Communications)**  
**or 13-17 (Video)**

**South Seas Plantation**  
**Captiva Island, FLORIDA**  
**(near Sanibel and Ft. Myers)**

For technicians who could use a bit of get-away time as part of this unique training package. Two days of consulting or on-your-own follow each WORKSHOP. Make your own airline reservations, well in advance; but we take care of placing you in our luxury cottage lodging.

Exceptional resort accommodations: four people (two bedrooms, four beds, two baths) or six people (three bedrooms, six beds, three baths) in fancy beach cottages. Bring your spouse, if you wish, at the nominal No-WORKSHOP fee (she joins the WORKSHOP group for breakfasts and lunches). If you prefer to share a room with a specific other WORKSHOP attendee, tell us. Cottages have kitchen facilities. An unusual winter-season bargain.

Enrollments close Sept. 15, 1978, or when capacity is reached.

Per Workshop **\$595**

----- FIRST COME, FIRST SERVED ----- ENROLLMENT DEADLINES ABOVE -----

Yes, enroll me promptly for TRAINING WORKSHOP at right.

Advanced Communications Servicing

Advanced Video Servicing

I enclose check or money order for \$ \_\_\_\_\_ U.S. dollars.

- \$495 per WORKSHOP in Indianapolis
- \$595 per WORKSHOP in Florida
- \$175 for spouse
- \$250 for spouse (includes lodging, same meals as for WORKSHOP enrollee)
- \$475 for CB Service WORKSHOP (same as 1977, and includes lodging) at Indianapolis August 21-23, 1978.

Name \_\_\_\_\_ Age \_\_\_\_\_

Company \_\_\_\_\_

Address \_\_\_\_\_ Phone \_\_\_\_\_

City \_\_\_\_\_ State \_\_\_\_\_ Zip \_\_\_\_\_

NOTE: You need 2 years electronics training or experience to gain proper benefit from these Advanced TRAINING WORKSHOPS. NOT FOR BEGINNERS.

Mail to: Forest Belt's TRAINING WORKSHOPS,  
Box 68120, Indianapolis IN 46268

**SERVICE QUESTIONS**  
continued from page 102

ages exceed certain limits.

Plug the set into a variable-voltage line transformer. Now, monitor the B+ source, and bring the line voltage slowly up to the point where B+ is correct. If the set now starts to work normally, then this is where your problem lies. Check out that entire voltage-regulator circuit, including all Zeners, transistors, diodes, etc. Something is not doing its job.

**NEW TUBES, SAME SYMPTOM!**  
Here's a zinger for you. Zenith model

**12A12C52 had a dark, about 1½-inch-wide vertical band on the left-hand side of the screen. Said to myself, this is a problem in the damper stage, and put in a new normally reliable 6CJ3 tube. It went away for five minutes, then came back! I tried another new tube of the same brand. Same thing happened. I tried a third time—no change! Then I found an old but good 6CJ3 tube of a different make on my bench. I put this new tube in and the set has operated properly ever since! Can you think of an obscure reason why this happened?—S. M., Bloomfield, CT.**

Nope. The same thing happened to me. Apparently you managed to get hold of three new tubes of a reliable brand that

had some kind of screwball fault! We have run across similar problems in several different tube types, from horizontal outputs to triode-pentodes. This is the first time I've ever heard of this problem in the 6CJ3's, but I'll remember it! Thanks.

**COLOR, PICTURE VERY DIM**

**I asked about a Zenith model 14A10C19 with dim color and picture. You steered me right: The plate voltage on the video output was fluctuating and dropping to 50 to 60 volts instead of maintaining the normal +308 volts. The answer turned out to be an intermittently open resistor, R208 (R77, Sams 1108-3). The original resistor was 7 watts; I replaced it with a 10-watt resistor and a new tube. The set has been working perfectly for quite a while! Thanks.—J. K., Pine Bush, NY.**

Don't mention it. Even a blind pig gets an acorn now and then. Here's a coincidence: I ran into the same problem in another make of set about three weeks ago! I used the same cure; one of the two feed paths to the video-output plate was opening.

**CONTROL AND BOOST-DIODE BURNING UP**

This Magnavox model U920 chassis was burning up vertical-linearity controls

**DUAL TRACE 30MHz OSCILLOSCOPE WITH DELAY**



MODEL 1474



**NOW IN STOCK - IMMEDIATE DELIVERY**

- Rise time 11.7 nS or less
- Built-in signal delay line permits view of leading edge of high frequency pulse rise time
- Triggers on signals up to 50 MHz
- 5mV/cm vertical sensitivity
- Mode automatically shifts between CHOP and ALTERNATE as you change sweep time
- Checks most digital logic circuitry, including ECL
- High accuracy ten position vertical input attenuator
- Flat response with smooth rolloff past 30 MHz
- PDA CRT with P31 phosphor
- Built-in high- and low-pass filters
- Maintains calibration accuracy over 105-130 VAC and 205-260VAC range
- 20 calibrated sweeps—0.2 μS/cm—0.5 S/cm
- Differential input capability
- Algebraic addition and subtraction

**SPECIFICATIONS**

**VERTICAL AMPLIFIER (Channel A and Channel B):**  
Detection Factor: 5mV/cm to 5V/cm, ±3% in 10 ranges, each with fine adjustment.  
Frequency Response: DC, DC-30MHz (-3dB). AC: 10Hz-30MHz (-3dB).  
Rise Time: 11.7 nS or less  
Overshoot: 3% or less  
Input Impedance: 1MΩ±2%, 22 pF (±3 pF).  
Tilt: less than 5%  
Non-Distorted Maximum Amplitude: more than 40mm at 30MHz; more than 80mm at 10MHz  
Maximum Input Voltage: 300V DC + AC peak or 600 V p-p.  
Operating Modes: CH-A, CH-B, Dual, Add and subtract (using CH B INVERT), ALT 0.2 μS/cm—0.5 mS/cm, CHOP 1 mS/cm—0.5 S/cm. Dual Trace—trace automatically chopped at all sweep times of 1mSEC/cm and slower, alternate mode automatically selected for all faster sweep times.  
Coup. Frequency: 200 KHz±20%  
Signal Delay: Fixed, 12 nS minimum visible delay  
CH B Polarity: NORM, INV (Provides CH A minus CH B function)  
Channel Separation: Better than 70dB at 1 KHz.  
**SWEEP SYSTEM (Common to Channel A and Channel B):**  
Type: Automatic and triggered (NORM) Mode (X-Y operation) CH A - Y, CH B - X  
Sweep Time: 0.2 μS/cm—0.5 S/cm ±3% in 20 calibrated steps in a 1:2.5 sequence with vernier adjustment  
Sweep Magnification: x5 (five times) ±5%. Externals maximum sweep rate to 40S/cm

**TRIGGERING**

Source: CH-A, CH-B, EXT, and EXT10  
Automatic: Sweep is triggered at the average amplitude of the displayed signal.  
Normal: Sweep is obtained with a displayed signal amplitude of one cm, or less. The point on the displayed waveform at which the sweep starts is determined by the SLOPE and LEVEL controls.  
Slope: Sweep can be set to trigger on the positive or negative going slope of the trigger waveform.  
Coupling: AC, DC, LF reject, HF reject, (AC) 30Hz-30MHz, (LF reject) signals below 10kHz are attenuated, (HF reject) signals higher than 30kHz are attenuated.  
Level: Continuously variable. Pull for AUTO (Sweep is obtained without an input signal)  
**HORIZONTAL AMPLIFIER (X-AXIS):** Input through Channel B vertical input.  
Detection Factor: 5mV/cm to 5V/cm, ±9% in ten ranges, each with fine adjustment.  
Frequency Response: DC-1 MHz (-3dB)  
Input Impedance: 1 megohm (nominal), shunted by 22 pF (±3 pF).  
Input Protection: 300 VDC + AC peak, or 600V p-p.  
**X-Y Operation:** With SWEEP TIME-CM switch in CH B position, the CH B input becomes the X input (horizontal) and the CH B position control becomes the horizontal position control.  
**Z-AXIS INPUT (Intensity Modulation):**  
Sensitivity: 5V/TTL compatible.  
Usable Frequency Range: DC to 5MHz.

RADIO-ELECTRONICS

212-687-2224

**THE TEST EQUIPMENT SPECIALISTS**

Mastercharge, BankAmericard,

Check our ad on page 106 for our special.

**TOLL FREE HOT LINE**  
**800-223-0474**

54 West 45 Street, New York, N.Y. 10036

**ADVANCE ELECTRONICS**

**PROFESSIONAL DISCOUNTS**

**Texas Instruments electronic calculator**

TI-1750 LCD	\$19.35	SR-40	\$23.25
TI-2550 III	23.25	TI-55	NEW 49.95
Little Prof	12.55	TI-57	NEW 63.00
Dataman	NEW 19.95	TI-58	NEW 95.75
TI-5100	38.75	TI-59	NEW 219.95
TI-5015	NEW 63.00	PC-100A	147.00
TI-5050 M	77.55	MBA	63.00
TI-5040 PD	95.00	Bus Anylist	26.95
TI-30 SP	16.98	TI Programmer	NEW 49.95
Datapac	28.09	TI-1790	NEW 39.95

Ask for TI Digital Watches

**HEWLETT PACKARD**

HP-10	NEW \$139.00	HP-80	235.00
HP-19C	NEW 275.00	HP-67	360.00
HP-21	59.95	HP-31E	NEW 55.00
HP-22	89.95	HP-32E	NEW 75.00
HP-25	89.95	HP-33E	NEW 92.00
HP-25C	128.00	HP-37E	NEW 75.00
HP-27	119.95	HP-38E	NEW 110.00
HP-29C	NEW 156.00	HP-92	NEW 500.00
		HP-97	599.00

We're HP's authorized franchise dealer — all accessories are professionally discounted.

Also SCM, Olivetti, Casio, Canon, APF, Sharp, Craig, Sanyo, Record-A-Call, Norelco-Phillips and more. All at great prices!

Norelco NT-1	\$164.00	Sanyo 9908	\$249.95
Norelco 186	245.00	Sanyo 8000A	199.95

**WE WILL BEAT OR MEET ANY COMPETITOR'S PRICE IF HE HAS MERCHANDISE ON HAND.** All units shipped in original factory cartons with accessories according to manufacturers' specifications. In Calif. call (213) 370-5795 or CALL (800) 421-0367 (other than CA) Above prices are for cash only. BankAmericard/Visa & Master Charge prices differ. Send money order. Pers. ck (2 wks to clear). In CA add 6% sales tax. Add \$3.50 min. shipping charges. WE SHIP AIR on request. Subject to availability. Send mail orders to DEPT. EM-J  
**WRITE OR CALL FOR FREE CATALOG.**

**tk Enterprises**  
WRITE OR CALL FOR FREE CATALOG  
WILSHIRE - 2 STORES - HAWTHORNE  
CALL  
16611 HAWTHORNE BLVD. LAWNDALE, CA 90260  
(213) 370-5795 • (800) 421-0367



and boost-rectifier diodes as fast as I could put them in! Following your suggestions, I rechecked the wiring. I discovered that there should be a B+ supply

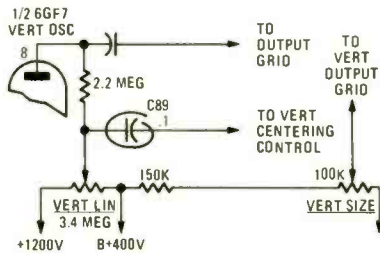

400-volt connection to the end of the vertical-linearity control. The boost goes to the other end, the +1200 volt B++. The cause of this problem was a shorted 0.1- $\mu$ F capacitor, Sams C89 (C160 in Magnavox 7288) that goes from here to the vertical centering control. Thanks again!—Rex Gray, Garland, TX.

### REPLACEMENT POWER TRANSFORMER

*I need a replacement power transformer for an old Emerson TV, Sams 858-1. I tried to get one from the company, but they don't have them any more. Nobody lists a replacement. Otherwise, the set worked fine before the transformer went out.—A. W., Parkersburg, WV.*

I did a doubletake when I looked at the schematic! Actually, this isn't much of a "power transformer" at all. It does not-

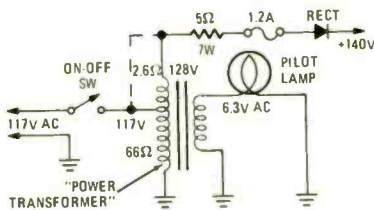

ing but light the *pilot light!* The primary is tapped; the tap is marked "tapped at 117 volts" (see diagram). However, there doesn't seem to be any useful step-up; the DC output is about normal at +140 volts.

I'd replace it with a stock 6.3-volt filament transformer and connect the AC input to the DC power supply right to the line. This should work. Apparently they're doing this to keep the escutcheon from shock hazard, since this is a hot-chassis set.

### SWEEP GENERATOR TIP

*Here's a helpful hint I discovered when I was working on my Eico model 369 Sweep Generator. I couldn't get a marker response at 45 or 50 MHz; the harmonics were too low. I couldn't find any actual circuit faults. Finally, I tacked a small 3-to 5-pF capacitor across capacitor C18, and it works fine!—S. G., Hayward, CA.*

Thank you. This hint might come in handy for others. R-E

## THERM DIGITAL HEAT SENSORS



\*THERM I: 3 digit .3" LED display; 4AA alkaline batteries; 25-30 hour continuous operation; battery recharger and NiCads optional.

\*THERM II: 3 digit .5" LCD display, 9v alkaline battery; 300 hour continuous operation.

\*MINI-THERM: plugs directly into DVM for reading on DVM display; 9v alkaline battery; 500 hour continuous operation.

- Rugged, handheld aluminum case.
- Accuracy .2%  $\pm$  1 LSD.
- Resolution: 1° F, K, or C.
- Probe: Comes with 5' teflon cable (replaceable).
- Range: -50°C (-58°F) to +150°C (302°F)
- Battery-operated.

(415) 941-2764

P.O. Box 4477 Mtn. View CA 94040



CIRCLE 63 ON FREE INFORMATION CARD

## 5 GREAT New Books on Microprocessors!

### BEGINNER'S GUIDE TO MICROPROCESSORS

Everything you need to know to get started with microprocessors and personal computers, from the very basics to their internal architecture, from programming to interfacing with the outside world, including how to select your own computer system. Assumes absolutely no prior knowledge of the subject. Includes a point-by-point comparison of the Motorola 6800 and the Intel 8080 chips. 182 p., 106 ill. Paper \$5.95; Hardbound \$8.95

Order No. 995

### 57 PRACTICAL PROGRAMS AND GAMES IN BASIC

57 of the hardest working, most enjoyable BASIC programs you've ever seen...everything from space war games to blackjack, from craps to I Ching, from arithmetic progression to statistical permutations to one-arm bandits! It's an easy-to-use manual that gives you 57 different Simplified BASIC programs. You can program your minibrain for all kinds of fun and games, for figuring compound interest, calculating depreciation, etc. 210p., 64 ill. Paper \$7.95; Hardbound \$10.95

Order No. 1000

### MICROPROGRAMMING FOR COMPUTER HOBBYISTS

A unique programming manual that takes you right from the very basics up to state-of-the-art capabilities with enough detail on intermediate and advanced techniques of programming and data structuring to satisfy a working professional programmer. Anyone, no matter how inexperienced, can easily follow it. Covers stacks, queues, deques, strings, trees, graphs, right up through the most supercomplex multiple-linked chains. 378p., 219 ill. Paper \$8.95; Hardbound \$12.95

Order No. 952

### MINIPROCESSORS: FROM CALCULATORS TO COMPUTERS

The computer hobbyist's machine-language hybrid calculator/computer book, shows you how to use, build, design, repair, troubleshoot, program, and customize your own calculators! Bridges the gap between calculator and computer technology; shows you how to start with a few easy-to-obtain calculator chips and gradually construct any kind of superbrained, specialized calculator you want. 192 p., 67 ill. Paper \$5.95; Hardbound \$9.95

Order No. 971

### THE "COMPUTATOR" BOOK

An imaginative new project book that shows you how to mate the COMPUTER with the CALCULATOR...to build, design, and customize calculators for all kinds of "brainwork"—counting, storing data, measuring times, dialing phones, generating random numbers...even lying one into a Teletype for a tape-controlled calculator with virtually an infinite memory...plus how to build displays several feet high. Includes full-size printed-circuit layouts to make your own PC boards! 322 p., 224 ill. Paper \$7.95; Hardbound \$10.95

Order No. 975

SEND NO MONEY! We'll invoice you on 10-DAY FREE TRIAL. Clip entire ad to order. 100% guaranteed or your money refunded.

TAB BOOKS DEPT RE-58 BLUE RIDGE SUMMIT, PA. 17214

CIRCLE 33 ON FREE INFORMATION CARD

## Fascinated By Home Computers And Video Games?

*Creative Computing* is the Number 1 applications and software magazine because we offer you ways to get the most out of your computer.

We bring you things like data base and file systems, text editing, graphics and animation, artificial intelligence, communications and networks, small business functions, investment analysis, building control and music synthesis. Complete programs, too, with thorough documentations, listings and sample runs.

Just getting started? Then turn to our technology tutorials, learning activities, short programs and problem-

solving pages. No-nonsense book reviews, too.

Buying a system or adding on to one? Then you need *Creative Computing's* in-depth equipment and software evaluations.

We cover the whole gamut from smart electronic and video games to mini and micro computers. Terminals, floppy disks, displays, software—there's something for everyone in each issue of *Creative Computing*.

Can't wait? Use your bankcard and call our toll-free number.

800-631-8112

(In NJ call 201-540-0445)

I want to get the most out of my computer. Please enter my subscription to:

## creative computing

	1-year	2-year	3-year	Lifetime	Vol. 1 Bound	Vol. 2 Bound
USA	<input type="checkbox"/> \$ 8	<input type="checkbox"/> \$15	<input type="checkbox"/> \$21	<input type="checkbox"/> \$300	<input type="checkbox"/> \$10	<input type="checkbox"/> \$10
Foreign Surface	<input type="checkbox"/> 12	<input type="checkbox"/> 23	<input type="checkbox"/> 33	<input type="checkbox"/> 400	<input type="checkbox"/> 12	<input type="checkbox"/> 12
Foreign Air	<input type="checkbox"/> 20	<input type="checkbox"/> 39	<input type="checkbox"/> 57	<input type="checkbox"/> 600	<input type="checkbox"/> 15	<input type="checkbox"/> 15
<input type="checkbox"/> Payment Enclosed <input type="checkbox"/> Bill me (\$1 billing fee will be added; foreign and book orders must be prepaid)						

Visa/BankAmerica  Master Charge no \_\_\_\_\_ Exp. date \_\_\_\_\_

Name \_\_\_\_\_ Address \_\_\_\_\_

City \_\_\_\_\_ State \_\_\_\_\_ Zip \_\_\_\_\_

Send to Creative Computing, P.O. Box 789-M, Morristown, NJ, 07960.

8 K



Next, to square the waveform you can use either the straightforward multiplier technique or the explicit method. However, there are distinct advantages to using a logarithmic method for squaring because of its ability to handle wide dynamic range inputs.

As you remember from high-school math, if you take the logarithm of two numbers, add them together and take the antilog, you end up with the product of the original numbers. The block in Fig. 4

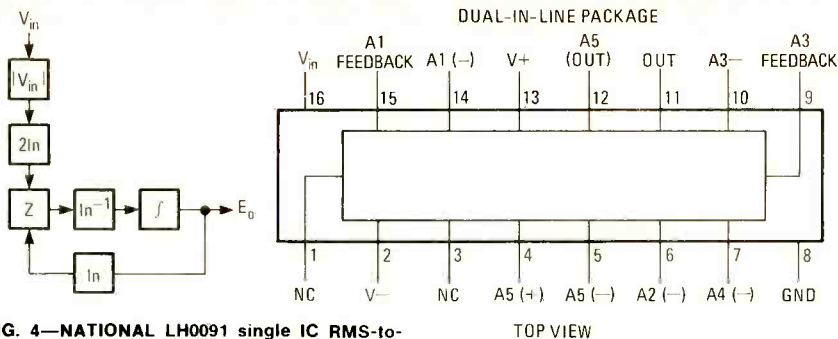

FIG. 4—NATIONAL LH0091 single IC RMS-to-DC converter.

marked "2 ln" represents the adding of the two logarithms; ln stands for natural

logarithm, which uses base epsilon or 2.718, compared with log, which uses base 10. Semiconductor junctions by natural law follow a ln-relationship. Squaring the input means multiplying the same number by itself, so that the log of the input is added to itself, which accounts for the 2 in front of the ln function.

The signal then proceeds through the summation block to the antilog circuit where the square is extracted. Antilogs are calculated by raising the number base to a power equal to the signal.

The next block with the integral sign is the averaging circuit that takes the mean of the squared signal.

The feedback block marked "ln" is the implicit method used to perform the final square-root function. Just as adding logarithms is equivalent to multiplication,

**PHILIPS**

**BK PRECISION**

**HICKOK**

**LEADER**

**NLS Non-Linear Systems**

**FLUKE**

**DATA PRECISION**

**TRIPLETT VIZ formerly RCA**

**Bak Precision Model 1474**

**Dual-Trace 5" 30MHz Triggered Scope With Signal Delay \$699.<sup>95</sup>**

SALE ENDS JULY 31, 1978 PROBES NOT INCLUDED IN PRICE

We give you immediate off the shelf delivery on Oscilloscopes, Power Supplies, Audio & R.F. Generators, Digital Multimeters, Frequency Counters, Logic Probes, Tube & Transistor Testers, Wow & Flutter Meters, Distortion Analyzers, Bridges, and Accessories. For more information call us Toll Free: 800-223-0474.

212-687-2224 **THE TEST EQUIPMENT SPECIALISTS**

**TOLL FREE HOT LINE 800-223-0474**

54 West 45 Street, New York, N.Y. 10036

ADVANCE ELECTRONICS

RADIO-ELECTRONICS

**Our new Bearcat® 250** has all the fantastic space age features of our super popular Bearcat® 210, but **now we've added:**

- 50 synthesized crystalless channels
- User selectable scanning speeds
- Priority channel
- Digital time clock—accurate to seconds
- Automatic or user controlled squelch
- Search Direction—Search "up" or "down" for quicker return to desired frequencies
- Transmission activity counter—tells you how busy each frequency has been
- Search & Store—Will find and "remember" up to 64 active frequencies for later recall
- Direct channel select—Advance directly to a channel without stepping through interim channels
- Non volatile memory—No batteries required to retain memory, even when scanner is unplugged
- Auxiliary—On/Off control of equipment (tape deck, alarms, lights, etc.) when transmissions occur on programmed channels

To reserve your space-age Bearcat® 250 and receive your order priority number for spring-summer delivery, send \$389.00 plus \$5.00 for U.S. U.P.S. shipping. Foreign orders invited at slightly higher cost. Visa and Master Charge card holders may call toll free 800-521-4414 to order. Outside the U.S. and Michigan dial 313-994-4441. To order by mail or for a free catalog completely describing the fantastic crystalless Bearcat® 250 write: COMMUNICATIONS ELECTRONICS, Box 1002—Dept. 6, Ann Arbor, Michigan 48106 U.S.A.

©1978 Communications Electronics

CIRCLE 89 ON FREE INFORMATION CARD



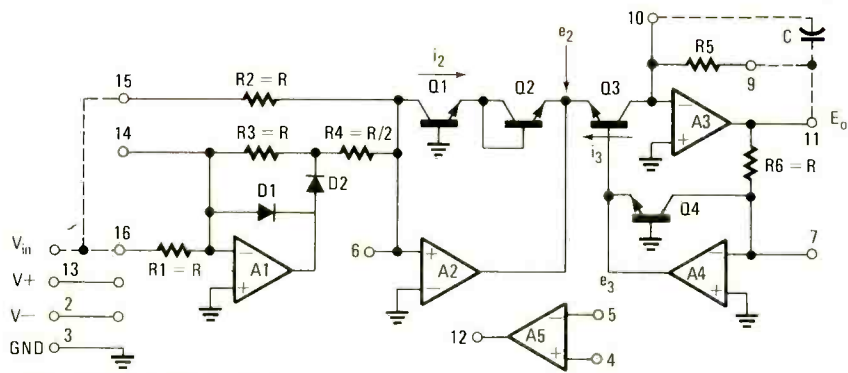

NOTE: DOTTED LINES DENOTE EXTERNAL CONNECTIONS.  
**FIG. 5—SIMPLIFIED SCHEMATIC of National's LH0091.**

ground, and, because of the negative feedback around the amplifier, the inverting input is also negative. Any voltage on the input terminal is then impressed across R1 so that the input current through pin 16 is  $V_{in}/R$ . When the input terminal goes above ground, current flows into pin 16 to turn on D1. The voltage drop across the forward-biased junction of D1 subtracts from the ground potential on the noninverting input of A1, biasing the output of the amplifier at about 0.7 volt below ground. This negative potential reverse-biases D2, keeping it off.

Figure 6-a shows the equivalent circuit for positive inputs. The input of A2 is also a virtual ground, so there is no voltage across R3 and R4 and no current through them. Input current arrives at the noninverting input of A2 only through R2, and the current is  $V_{in}/R$ . Amplifier A1 has acted as a sensitive detector of where the input signal goes positive, and then it acts as a switch to reduce the circuit to one resistor!

Negative-input swings cause the current in R1 to flow from right to left; D1 is biased off and D2 turns on. Because R1 is equal to R3 and their junction is at zero volts, the cathode D2 voltage is positive and has the same magnitude as the input voltage. Figure 6-b shows the two current paths—the first is identical to that for

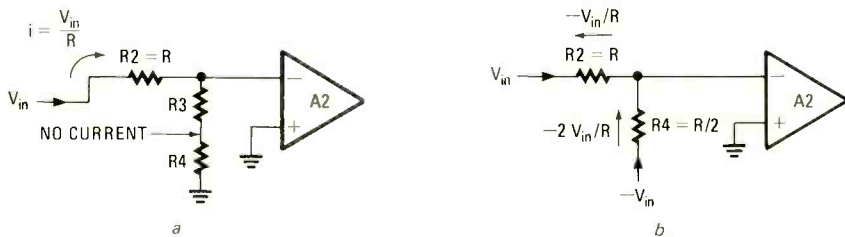

**FIG. 6—ABSOLUTE VALUE input circuit of LH0091. Equivalent circuit for positive inputs is shown in a and equivalent circuit for negative inputs is shown in b.**

tional to the average of  $V_{in}^2/E_o$ ,  $E_o$  will be the square root of the average value of  $V_{in}^2$ .

In Fig. 5, A1 with its associated diodes and resistors is the absolute value circuit. The noninverting input of A1 is tied to

subtracting them is the same as division. By producing an output that is propor-



# MORE FOR LESS!

EC-2 POWER SUPPLY 0-16 VDC, 0-5 ADC. Continuously variable.

Unmatched filtering, reliability, low price. Continuous voltage adjustment.

Compare with others for reliable, hum-free auto and portable radio DC servicing. Extra features, including overload capacity, enable the EC-2 to handle varied R/D and test jobs in industry, laboratories and schools. Only 0.5% ripple at 5 amps continuous DC output. Patented cooling. One year warranty. See **Gold Book & EEM** for data on full line. *FREE BULLETIN EC-2*

**EPSCO, Inc. 920-R Westwood, Addison, IL 60101**



Performance-Proven DC Power Supplies Since 1936

WHAT WOULD YOUR PERSONAL COMPUTER SAY IF IT COULD TALK?

---

GET SPEECH POWER WITH THE **COMPUTALKER SPEECH SYNTHESIZER**

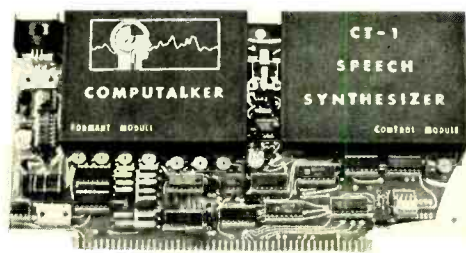

S-100 BUS

ASSEMBLED CIRCUIT BOARD COMPLETE WITH SOFTWARE FOR PHONETIC INPUT 430.00

CALIF. RESIDENTS ADD 6% SALES TAX

---

WRITE FOR INFORMATIVE LITERATURE

COMPUTALKER CONSULTANTS

P.O. BOX 1951, DEPT. R, SANTA MONICA, CA 90406

# You Can Count On DAVIS!



## NEW CTR-2A 500 MHz & 1 GHz COUNTERS

NOW WITH  
PERIOD MEASUREMENT (Optional)  
AND BUILT-IN PREAMP

- 8 Digit .3" LED Display
- High Stability TCXO Time Base
- Built-in VHF-UHF Prescaler & Preamp
- Period 1us to 1 sec. (optional)
- TCXO Std.  $\pm 2$  ppm
- Input Diode Protected
- 12V-DC Operation (optional)
- Oven Crystal  $\pm .5$  ppm (optional)
- Selectable Gate Times .1 sec. & 1 sec.

500 MHz kit CTR-2A-500K	\$249.95
500 MHz assembled CTR-2A-500A	349.95
1 GHz kit CTR-2A-1000K	399.95
1 GHz assembled CTR-2A-1000A	549.95

### OPTIONS:

(02) Oven Crystal	\$49.95
(03) .43" LED	10.00
(04) 12 V-DC	10.00
(05) 10 sec. Time Base	10.00
(06) Period Option	15.00



DAVIS ELECTRONICS  
636 Sheridan Drive  
Tonawanda, NY 14150  
716/874-5848



CIRCLE 87 ON FREE INFORMATION CARD

positive inputs through R2; the second is through R4. Summing the currents in the two resistors yields  $i_2 = V_{in}/R - V_{in}/(R/2) = -V_{in}/R$ . Taking the negative of the negative input makes this current positive. This is exactly the same as the positive input, so the sign of the input is ignored by the circuit!

Next (see Fig. 5), A2 with Q1 and Q2 is the 2 In-circuit that does the first part of the squaring function. Again, the amplifier has the noninverting input connected to ground. The output voltage is equal to the voltage on the base of Q1, which is zero, plus the negative drops across the base-to-emitter junctions of the two transistors. The logarithmic characteristic of the transistor junctions are used to perform the very useful logarithmic operation on the absolute input current, which is proportional to the absolute value of the input voltage.

The next operation is a summation or, more precisely, a subtraction to take care of the In-feedback, and then an exponential or inverse logarithm function. Both functions are done in a single process by Q3. Back in A2, an input current was fed into the collector circuit of a transistor, and its junction voltage was used as the output. The opposite is done to take the inverse log by applying the input voltage across a transistor junction and using the collector current as the output. By put-

ting the feedback voltage on the transistor base and the output of the 2 In-circuit on the emitter, the base-to-emitter voltage on Q3 becomes the difference,  $e_3 - e_2$ . Solving the equations yields:

$$E_o = \sqrt{V_{in}^2}$$

Amplifier A5 remains unused in the IC and can be used to allow the system to

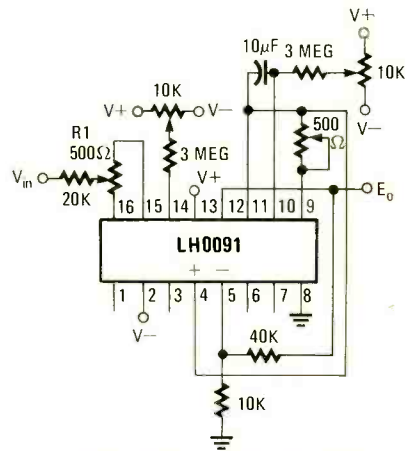

FIG. 7—HIGH CREST-FACTOR CIRCUIT is used with crest factors greater than 2.

work with high crest factors. Figure 7 shows the recommended circuit for crest factors greater than 2. An external resis-

# RCA pays you to win!

## Enter our fabulous RCA SK Rebate/Contest that pays you cash for every time you enter.

- Win one of ten RCA SelectaVision Video Cassette Recorders.
- Get cash rebates from RCA for 20, or more, RCA SK bags.

# WIN!

**RCA**  
**SelectaVision**  
VIDEO CASSETTE RECORDER

Contest starts April 1, and expires June 30, 1978.



tor drops the input current by a factor of 5 in order that input peaks do not overload the circuit. Amplifier A5 is set up with 40K and 10K resistors to get back the gain.

### Matched transistors

Some precision DC amplifier applications are adversely affected by the input offsets of conventional operational amplifiers. Balance potentiometers null out the initial offset but temperature and aging drifts must be considered. In power-supply and thermometer circuits, these errors may be significant.

Precision Monolithics Inc.'s MAT-01 Ultra Matched Monolithic Dual Transistor series has outstanding specifications for offset voltage, offset, current and offset temperature coefficients. Improvements compared to other monolithic devices is on the order of 10 times. Both devices must be placed on the same monolithic IC, geometrically interwoven so that they share virtually identical thermal environments.

The  $V_{be}$  match for the MAT-01 is 40- $\mu$ V typical, 110- $\mu$ V maximum, which compares favorably with numbers that would normally be on the order of 5 mV. The temperature coefficients of this offset are 0.5  $\mu$ V/ $^{\circ}$ C maximum.

Two fully packed pages of specifications make it fairly obvious that PMI is

proud of these circuits. Included are not only the usual offset voltage-versus-temperature plots, but also offset drift-versus-time. These curves remain essentially flat out to the 13-month limit of the abscissa.

The PMI data sheet points out that during circuit turn-on, reverse-bias voltages can be applied to the transistor base-to-emitter junctions. If these voltages exceed 5, degradation in  $h_{fe}$  (current gain) and  $h_{fe}$  matching may occur. Although essential when using devices such as the MAT-01 series where matching is what it's all about, it's important to remember that all circuits should be checked for excessive reverse bias during turn-on and modified if necessary. Protection may take the form of the diodes that are used across transistor junctions and are poled opposite to the junction.

Prices for the commercial versions of the MAT-01 range from \$2.75 to \$3.50 each in 100 quantities. Precision Monolithics Incorporated, 1500 Space Park Drive, Santa Clara, CA 95050.

### Signetics-Motorola agreement

As the result of an agreement between the two companies, Signetics will manufacture Motorola's MC1399 color-processing IC and Motorola will make Signetics' TCA440 five-stage AM radio IC.

The MC1399 IC has unmatched lin-

earity for DC chromatic control and uses a phase-locked-loop subcarrier regenerator that is more accurate than injection lock systems.

The TCA440 IC has a 100-dB dynamic range and can be used in both AM and CB applications.

### 8080 assembler

RO-CHE System's Assem 1.0 8080-assembler works with their multi-cassette controller. It can assemble source-code programs that are larger than the computer memory.

The first of two passes reads the source code from the tape and builds a symbol table. The tape is read again in the second pass, and the object program (machine language) is created and stored in memory. The assembled program can then either be run or stored on cassette tape.

The Assem 1.0 can be purchased from RO-CHE Systems, 7101 Mammoth Avenue, Van Nuys, CA 91405, for \$10. Also provided are a line editor, the assembler on cassette tape and instructions. **R-E**



### Here's a contest where you can't lose!

Because you earn generous cash rebates for RCA SK bags, and you can enter every time you send in at least 20 RCA SK bags. Your entry can win one of ten RCA SelectaVisions we are awarding. All you have to do is complete this statement, in 25 words or less: "I prefer RCA SK's because . . ." *It's that easy!*



### You can win an unsurpassed home video recording system.

RCA SelectaVision gives you 4 full hours of record/playback in a

single cassette. A built-in digital timer. A remote pause for chair-side editing. Record one channel while you watch another, or record while you're asleep or away. You and your family will love it.



### You get generous cash rebates.

Save your RCA SK plastic bags for cash rebates, as follows:

- \$2 rebate for 20 bags
- \$5 rebate for 45 bags
- \$10 rebate for 80 bags
- \$15 rebate for 115 bags
- 13¢ rebate for each bag over 115

With each purchase of RCA SKs from your RCA Distributor you get an official entry blank. All entries will be judged by a panel of independent judges. Prizes will be awarded on the basis of dealer's expression of demonstrated and proven usefulness of RCA SKs.



### See your RCA Distributor for full information.

He will have all the details on RCA's complete line of replacement semiconductors and RCA SK Rebate/Contest rules. Or write to: RCA Distributor and Special Products Division, PO Box 250, Deptford, NJ 08096.

This contest is open to all electronic service technicians except RCA employees or members of their immediate families, RCA's affiliates or subsidiaries, its advertising agencies, and the judging organization. Void where prohibited or restricted by law. This contest subject to all federal, state and local laws. All prizes will be awarded.

**RCA**  
SK Replacement  
Solid State

NEW VERSATILITY ADDED

# Xcelite<sup>®</sup> Service Master Kits

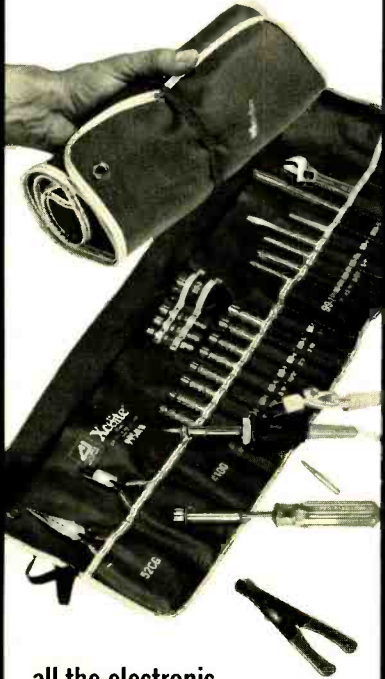

all the electronic  
service tools you need  
99% of the time

Model 99SMW adds new dimensions to the serviceability of Xcelite's famous and still available 24-piece 99SM Service Master Set

Housed handily in the same type of roll-up, plastic-coated, canvas case, the 27-piece 99SMW adds a Weller WP25 professional, pencil-style soldering iron with an extra, wider tip, and a No. 100 wire stripper/cutter. These plus the traditional 99SM tools that thousands of servicemen and technicians have liked so much so long: 20 Xcelite Series 99 quick-change, interchangeable blade tools—popular size nutdrivers, slotted and Phillips type screwdrivers, extension, reamer, regular and stubby handles; diagonal and long nose pliers, thin-pattern, adjustable wrench. *The handiest handful of service tools you've ever laid your hands on!*

in stock at leading electronic distributors . . . nationwide



**The Cooper Group**  
Electronics Division

WELLER<sup>®</sup> • WISS<sup>®</sup> • XCELITE<sup>®</sup>

PO. BOX 728, APEX, NORTH CAROLINA 27502, 919/362-7511

CIRCLE 12 ON FREE INFORMATION CARD

# new products

More information on new products is available from manufacturers of items identified by a Free Information number. Free Information Card is inside back cover.

**COMPUTER LEARNING SYSTEM, Cardiac**, is a simple manually operated computer training device plus 53-page manual for a complete "hands-on" teaching aid. *Cardiac* operates by manipu-

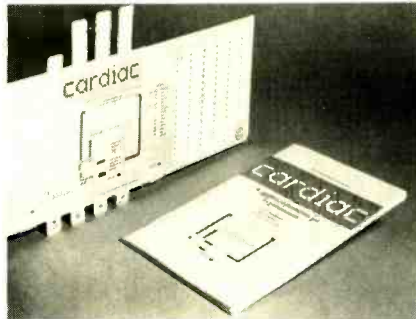

lating cardboard slides to display register contents through windows. A series of 10 different programs range from the simple to more complex formats. Loops, indexing, bootstrapping, double-precision techniques and subroutines are all demonstrated. Price: \$4.95, plus \$1.50 shipping and handling.—**Comspace Corp.**, 350 Great Neck Rd., Farmingdale, NY 11735.

CIRCLE 106 ON FREE INFORMATION CARD

**SOLDER/SOLDERING ACCESSORIES**, a complete line of products designed for many professional and home uses. Included are Multicore



solders in a variety of alloys and/or fluxes; solid-wire solders; creams, pastes and wicks; an emergency solder; and special formulation for soldering stainless steel and silver jewelry.—**Multicore Solders**, Westbury, NY 11590.

CIRCLE 107 ON FREE INFORMATION CARD

**INTERFACE/MOTHERBOARD, Kimsi**, comes in kit form or assembled. Attaches to any KIM-1 computer to provide, on a single board, both interface and motherboard with eight 100-pin slots. *Kimsi* allows S-100 compatible boards to be plug-compatible with KIM. Instructions are executed at top speed, with no extra instructions or software needed. The board includes complete

address decoding and power regulation for KIM, as well as facilities for DMA and multiprocessing on the S-100 bus.

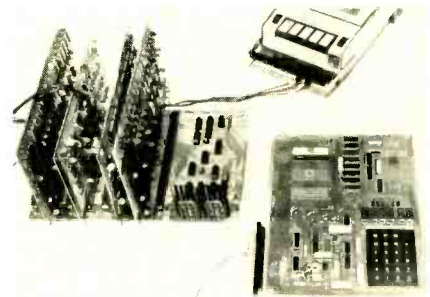

Kit comes with double-sided circuit board with soldermask and owner's manual; all parts, IC sockets and 100-pin connector are included. Prices: kit, \$125; assembled, \$165.—**Forethought Products**, Box 386, Coburg, OR 97401.

CIRCLE 108 ON FREE INFORMATION CARD

**CABLE TIES AND CLAMPS, EZ Fasteners**, come in reusable display package (*Re-Use-A-Pac*). Removable card enables refilling heavy-gauge plas-



tic bubble when necessary. Point-of-purchase rack available. Clamps and ties are also available in bulk.—**South Shore Trading Corp.**, 422 S. Franklin St., Hempstead, NY 11550.

CIRCLE 109 ON FREE INFORMATION CARD

**PROJECTION TV SYSTEM, Projectapix II**, uses superfast f/1.85 optic lens for sharper image and brilliant color. Featuring solid-state electronics, system contains a video tape recorder and a built-in digital clock/timer with LED readout that can be used to control and record one program as you watch another; unit can also record radio music or perform as a tape recorder; even home movies can be created (with the use of a video



camera). A stop-action pushbutton is provided for either instant replay or erase. A four-foot screen is also available. Optional accessories

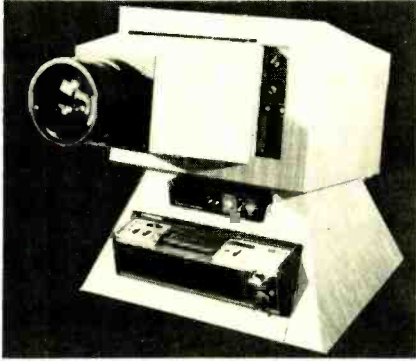

include remote controls; video games; mikes and mike mixers; cameras; a special control accessory that projects smaller image in corner of the screen, for dual-program monitoring; plus a video disc. The *Projectapix II* sells for \$2790; the four-foot screen, \$1495.—**Projectapix, Ltd.**, Suite 1L, 300 West 53rd St., New York, NY 10019.

**CIRCLE 110 ON FREE INFORMATION CARD**

**40-CHANNEL CB TRANSCEIVER, Sidebander IV**, is an SSB/AM unit that uses digitally synthesized circuitry, with an RF output of 4 watts and 12 watts SSB PEP. Controls include squelch,



volume, clarifier, RF gain, and switchable noise blanker and limiter. Also included are PA provision and mike. Suggested list price: \$379.95.—**SBE, Inc.**, Dept. P, 220 Airport Blvd., Watsonville, CA 95076.

**CIRCLE 111 ON FREE INFORMATION CARD**

**PHONO CARTRIDGE, model 2000T**, is designed for stereo and matrix 4-channel (SQ, QS, RM) playback. Specifications include: frequency re-

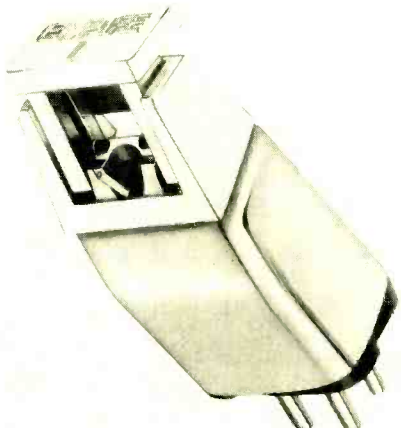

sponse of 20 Hz–20 kHz  $\pm 1\frac{1}{2}$  dB; tracking force range of  $\frac{3}{4}$ –1 $\frac{1}{4}$  grams; lateral and vertical compliance of  $30 \times 10^{-6}$  cm/dyne; tracking ability of 38 cm/sec at 1 kHz at 1 gram; channel balance within 1 dB at 1 kHz; a rated input load of 47,000

ohms/channel; an output of 3 mV/channel at 3.54 cm/sec. Price: \$90.—**Empire Scientific Corp.**, 1055 Stewart Ave, Garden City, NY 11530.

**CIRCLE 112 ON FREE INFORMATION CARD**

**CB BASE STATION, Golden Eagle Mark IV SSB/AM**, uses *Transcan* system to sweep all transmit frequencies. Circuitry is phase-locked loop with

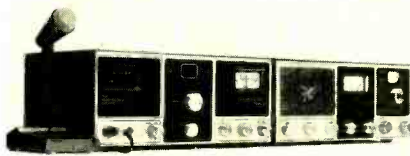

full 4-watt power and 100% modulation. Transmitter RF output, up to 12 watts PEP (SSB); carrier suppression is better than  $-70$  dB. Re-

ceiver sensitivity is  $0.32 \mu\text{V}$  for a 10 dB signal-to-noise ratio.

Transmitter features include LED readout, RF amplifier for AM operation, automatic level control for SSB, channel reset and lock detector. Receiver has fine tune control, AGC on-off switch, beat-frequency oscillator, noise blanker. *Model 776* high-impedance mike is included with unit; the *Astatic model GD-104* mike is available as an option. Unit measures  $6\frac{1}{2} \times 15\frac{1}{2} \times 10$  inches. Two-year warranty. Price: \$950.—**Browning Laboratories, Inc.**, O'Shea Industrial Park, Laconia, NH 03246.

**CIRCLE 113 ON FREE INFORMATION CARD**

**CB HEADSET MIKE, SpeakEasy**, is voice-activated via miniaturized preamp for hands-free operation. Features separate amplifier with red/green LED readout for transmit/receive modes and built-in mini-microphones. Made of light-



**NLS LEADS AGAIN!!**

**NEW**

**MS-215 DUAL TRACE MINISCOPE**



**15MHz PORTABLE OSCILLOSCOPE**

- 15 megahertz bandwidth.
- External and internal trigger.
- Time Base—0.1 microseconds to 0.5 Sec/div—21 settings.
- Battery or line operation.
- Automatic and line sync modes
- Power consumption less than 15 W.
- Vertical Gain—0.01 to 50 volts/div—12 settings.
- Weight is only 3 pounds.

**RECHARGEABLE DUAL TRACE**

PORTABLE

2.7"H x 6.4"W x 7.5"D

**AVAILABLE NOW**

**\$395**

With Rechargeable Batteries & Charger Unit



**FREE PROBE**

**BUY ONE GET ONE FREE**  
With the purchase of the MS-215 you get two deluxe 10:1 and direct switchable probes. Price 2 for \$30.

OFFER EXPIRES AUG. 31, 1978



212-687-2224

**THE TEST EQUIPMENT SPECIALISTS**

**TOLL FREE HOT LINE**  
**800-223-0474**  
54 West 45 Street, New York, N.Y. 10036

**ADVANCE ELECTRONICS**

JUNE 1978

111

INTERNATIONAL FM-2400CH

# FREQUENCY METER FOR TESTING MOBILE TRANSMITTERS AND RECEIVERS

• Portable • Solid State • Rechargeable Batteries

The **FM-2400CH** provides an accurate frequency standard for testing and adjustment of mobile transmitters and receivers at predetermined frequencies.

The FM-2400CH with its extended range covers 25 to 1000 MHz.

The frequencies can be those of the radio frequency channels of operation and/or the intermediate frequencies of the receiver between 5 MHz and 40 MHz.

Frequency stability:  $\pm 0.0005\%$  from  $+50^\circ$  to  $+104^\circ\text{F}$ .

Frequency stability with built-in thermometer and temperature corrected charts:  $\pm 0.00025\%$  from  $+25^\circ$  to  $+125^\circ$  (.000125% special 450 MHz crystals available).

- Tests Predetermined Frequencies 25 to 1000 MHz
- Extended Range Covers 950 MHz Band
- Pin Diode Attenuator for Full Range Coverage as Signal Generator
- Measures FM Deviation

<b>FM-2400CH</b> (meter only) Cat. No. 035320 .....	<b>\$595.00</b>
<b>RF crystals</b> (with temperature correction) .....	<b>24.90 ea.</b>
<b>RF crystals</b> (less temperature correction) .....	<b>18.90 ea.</b>
<b>IF crystals</b> .....	<b>catalog price</b>

Write for catalog



INTERNATIONAL CRYSTAL MFG. CO., INC.  
10 North Lee / Oklahoma City, Okla. 73102

CIRCLE 91 ON FREE INFORMATION CARD

weight aluminum, *SpeakEasy* can be powered from any 12-volt supply. Suggested retail price,

For  
faster  
service

USE  
ZIP  
CODE

on  
all  
mail



\$79.95.—Chase Western Product Sales Division, 11526 Burbank Blvd., North Hollywood, CA 91601.

CIRCLE 114 ON FREE INFORMATION CARD

**MICROCOMPUTER CARD CASES.** *Vector-Pak* models *VP1*, *VP2*, accommodate IMSAI, ALTAIR and other 5.31- by 10-in. cards. Fully assembled cases are compatible with IMSAI and ALTAIR systems, *model VP1* having front-to-back orientation, *model VP2*, with side-to-side orientation. Cases have space for 21 cards, and adjustable slots that permit receptacle or motherboard mounting. Plastic card guides are supplied sepa-

## FCC LICENSE STUDY GUIDE

If you have experience or training in electronics, but need help in preparing for FCC license exams, get *Grantham's FCC License Study Guide* — not a Q & A book, not a correspondence course, but simply an authoritative, down-to-earth presentation of what you should know to pass FCC exams for 3rd, 2nd, and 1st class radiotelephone licenses. Included are four information sections, 1465 FCC-type multiple-choice questions, with more than 65,000 words "explaining" the correct answers. Self-study presentation. Order by letter, or check box below.

Grantham's FCC License Study Guide.

Size, 7 x 10½, 377 pages ..... \$12.75

**OTHER BOOKS written in home-study style by Donald J. Grantham:**

Fundamental Properties of AC Circuits.

Size, 7 x 10½, 267 pages ..... \$12.75

Mathematics for Basic Circuit Analysis.

Size, 7 x 10½, 352 pages ..... \$12.75

Basic Electronic Devices and Circuits.

Size, 7 x 10½, 378 pages ..... \$12.75

**TO ORDER** any of the books listed above, check off the ones you want, compute the total price, *add only 75¢ (regardless of the number of books ordered) for postage and handling*, and mail this ad (or order by letter). Be sure to include your name and address and payment. Mail your order to:

**GSE Publishing Company**

(2000 Stoner Avenue)

**P. O. Box 25992, Los Angeles, CA 90025**

CIRCLE 4 ON FREE INFORMATION CARD



rately. Both cases have sturdy aluminum chassis and measure 17.85 X 9.01 X 17.1 in. and weigh 5 lbs. Optional accessories include prepunched 10-hole rear panel for 25-pin D-type connectors.

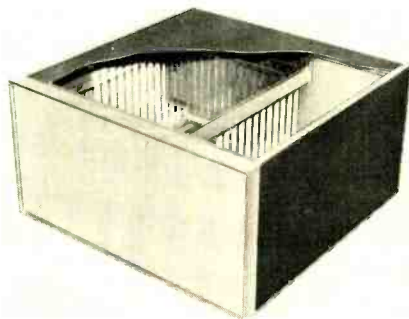

Vector Series 8800 prototyping cards, and sockets, connectors, pins and tools. Prices: model VP1, \$128.30; model VP2, \$134.30.—Vector Electronic Co., Inc., 12460 Gladstone Ave., Sylmar, CA 91342.

CIRCLE 115 ON FREE INFORMATION CARD

EXTENDER BOARD, model VTE-100. The Exter-

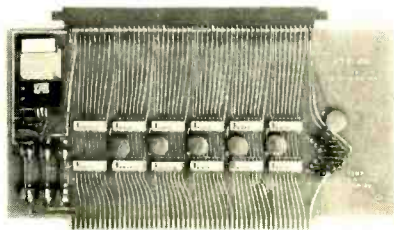

minator, is an S-100 bus compatible card that occupies one slot on the motherboard. It serves as a terminator for the entire bus, using bridge terminating networks that do away with crosstalk and extraneous noises. The model VTE-100 can be used with any memory or I/O card without interference from adjacent boards. Fused power buses protect against accidental damage and provide easy access for current monitoring. Unit comes assembled and tested and costs \$49.95, plus \$2 shipping and handling (\$4 for foreign orders).—VAMP Inc., Box 29315, Los Angeles, CA 90029.

CIRCLE 116 ON FREE INFORMATION CARD

EARLY WARNING SMOKE DETECTOR, model S29, is a self-contained ionization home unit designed to detect early stages of a fire, thus making it ideal for home, mobile homes, apartments, vacation houses, etc. No wires are



**HIGH BLOOD PRESSURE.**  
Treat it...and live.

The National High Blood Pressure Education Program,  
U.S. Department of Health, Education, and Welfare.

**BETTER  
THAN A  
THIRD HAND!**

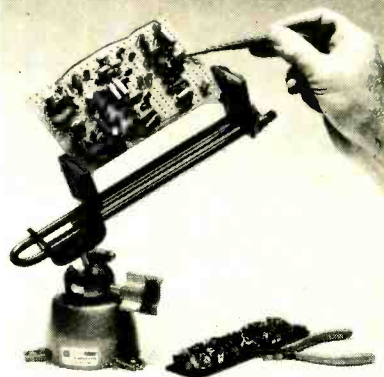

**PANA VISE TILTS, TURNS, AND  
ROTATES TO ANY POSITION.  
IT HOLDS YOUR WORK  
EXACTLY WHERE YOU WANT IT.**

**PanaVise has great strength yet is gentle  
enough to firmly hold delicate objects.**

Quite possibly the finest new tool you will buy this year, PanaVise is built to exacting professional standards. We guarantee it!

Illustrated is the Electronics Vise Model 396. Three other bases and a wide variety of heads are available. All interchangeable! Buy a basic unit, then add on to create your system.

Available through your dealer.  
Write for a free catalog.

**PANA VISE** Dept. 5E

10107 Adella Ave., South Gate, CA 90280  
In Canada: 25 Toro Rd., Downsview, Ont. M3J 2A6



A Division of Colbert Industries

CIRCLE 78 ON FREE INFORMATION CARD

## A 20MHz OSCILLOSCOPE UNDER \$500?



**YES !!**

**LBO - 507** by

**LEADER  
Instruments Corp.**

### FEATURES:

- 20 MHz bandwidth
- Unique trigger circuit for maximum display stability
- 10 MV sensitivity
- Bright display
- TV trigger
- Built-in calibration signal
- Triggered and automatic sweep
- Built-in TV vertical and horizontal sync separation circuits
- Check most digital logic circuitry, including CMOS
- 18 sweep range selections
- Sweep to 1 μSEC/cm

### SPECIFICATIONS

VERTICAL AMPLIFIER	SENSITIVITY	10mV/cm - 20V/cm CALIBRATED IN 11 STEPS (1:2.5 SEQUENCE UP TO 30V/cm WITH VARIANCE CONTROL)
	ACCURACY	±3%
	BANDWIDTH	(DC) DC - 20MHz (3dB, 4 cm) (AC) 20 - 20MHz (3dB, 4 cm) 17.5dB
	RISE TIME	1N-DHM SHUNTED BY 35pf (1.5pf)
TIME BASE	SWEEP SPEED	0.5 MICRO SECOND/cm - 200M/cm, 18 STEP, 1:2.5 SEQUENCE UP TO 500M/cm WITH VARIABLE CONTROL
	ACCURACY	±5%
	MAGNIFICATION	x5 - 5X (MAX SPEED 100X/cm)
SYNCHRONIZATION	MODE	TRIGGERED & AUTOMATIC
	SIGNAL SOURCE	INTERNAL OR EXTERNAL - OR - SLOPE
	SENSITIVITY	TRIGGERED INT 1.2V - 15MHz AT 1cm (EXT) 2V - 15MHz AT 100mVpp AUTOMATIC INT 1.50V - 15MHz AT 1cm (EXT) 1.50V - 15MHz AT 100mVpp
	HORIZONTAL AMPLIFIER	SENSITIVITY

These new LEADER OSCILLOSCOPES are available for IMMEDIATE DELIVERY.  
To order or for more information call 800-223-0474 for our

**SUPER SPECIALS**

**LBO-508**  
DUAL TRACE 20 MHz.

**LBO-520**  
DUAL TRACE 30 MHz.  
with Delay

**LBO-515**  
DUAL TRACE 25MHz.  
with Dual Time Base

212-687-2224

THE TEST EQUIPMENT SPECIALISTS

TOLL FREE HOT LINE  
800-223-0474

54 West 45 Street, New York, N.Y. 10036

**ADVANCE  
ELECTRONICS**

JUNE 1978

113



# Grab the book for Grabbers.

Our big 90-page catalog of electronic test accessories is up for grabs.

In it, you'll find a complete line of Grabber™ test clips, designed to simplify testing of everything from conventional components to maximum density DIP's.

Unlike some test clips, Grabbers provide a positive connection that won't pop off. And its gold plated hook has no sharp teeth to damage wires.

Plunger type action makes the Grabber easy to operate. And

the spring is stainless steel for extra long life.

Grabbers are available in a wide range of sizes. You can choose between various other-end connectors, such as banana and pin plugs, or you can wire your own test leads using our simplified assembly procedure. Models accepting 6-32 threaded leads are also offered.

Send for free catalog or see your favorite electronic parts distributor. See our pages in EEM.

AVAILABLE THROUGH YOUR FAVORITE ELECTRONIC PARTS DISTRIBUTOR

## ITT POMONA ELECTRONICS

1500 East Ninth St., Pomona, Calif. 91766  
Telephone (714) 623-3463 • TWX: 910-581-3822



CIRCLE 62 ON FREE INFORMATION CARD



needed; simply screw the detector into the ceiling. AA batteries are included. Can operate remote equipment such as a bell, siren, light, monitor panel or telephone dialer by using built-in relay with 0.125-amp, 115-volt rated contacts. The model S29 measures 5 1/2 in. square and is 3 in. high. Price: \$79.—Mountain West Alarm Supply Co., Box 10780, Phoenix, AZ 85064.

CIRCLE 117 ON FREE INFORMATION CARD

MICROWAVE LEAKAGE DETECTOR, model 245M, is a self-powered, hand-held instrument that needs no batteries or outside power source.

### burglar-fire alarm catalog

# FREE!



MORE THAN 900 PRODUCTS

detectors,  
controls,  
sunders,  
locks,  
tools

### EVERYTHING NEEDED TO PROTECT HOME, BUSINESS, INSTITUTION

Huge selection of high quality professional alarm products. 64 fact-filled pages with detailed specs, diagrams, technical notes. Products range from basic switches, controls, bells, sirens to most sophisticated detectors — radar, modulated or passive infrared, microwave, ultrasonics, ion, data links using pulse code multiplex, FSK radio, automatic phone dialers, leased line connections and display panels. Full selection of tools, relays, wire, foil, terminals, books.

WRITE FOR FREE CATALOG TODAY!

(Outside U.S., send \$1.00.)



mountain west alarm  
box 10780 • phoenix, az 85064  
(602) 263-8831

CIRCLE 14 ON FREE INFORMATION CARD



Designed for home, industry and commercial applications, instrument checks for 2450-MHz microwave leakage. The meter is calibrated to



0-5 mW/cm<sup>2</sup>, with a maximum of 5 mW/cm<sup>2</sup> from oven as a safe limit. Mounted in a high-impact case, the model 245M measures 2 X 4 X 0.5-in., and sells for \$49.95.—UCE, Inc., 20 N. Main St., Norwalk, CT 06854.

**CIRCLE 118 ON FREE INFORMATION CARD**

**DIGITAL PANEL METER, Series B500**, succeeds manufacturer's earlier Series 500 unit. The DPM consists of a single IC, 7 passive components and a 0.5-inch red 3½-digit LED readout. Features auto-zeroing, with a 200 mV-1000-volt input range, and operates from either 5 volts DC or

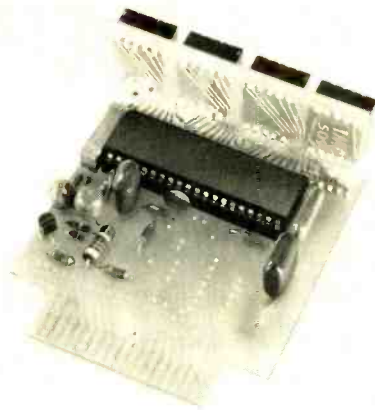

115-230 volts AC, 47-400 Hz. Single unit price, \$59; 100 quantity, \$39.—International Microtronics Corp., 4016 E. Tennessee St., Tucson, AZ 85714.

**CIRCLE 119 ON FREE INFORMATION CARD**

**SAMPLE SOLDER KIT**, dispenser-packed kit includes five different solders for the following uses: stainless-steel and jewelry; plumbing, sheet



metal and general metal joining; electrical wiring; electronic assemblies and PC boards; and alumi-

num soldering. Multiple cores provide proper flux to metal ratio, let you work faster and use less solder. Kit comes with *Solder User's Guide*, and costs \$8.95 (introductory price, includes shipping/handling). For detailed information on solders in sampler kit and how to order, write the manufacturer.—Multicore Solders, Westbury, NY 11590.

**STATIC ELIMINATOR GUN** is the first in a line of *Audio Groome* products designed to improve sterec record performance. Double-barrel gun



releases a flow of negative and positive ions to remove static from records. No batteries or outside power source are needed.—Empire Scientific Corp., 1055 Stewart Ave., Garden City, NY 11530.

**CIRCLE 120 ON FREE INFORMATION CARD**

## Bugworks® & Breadboards.

E&L's Complete Bugworks Catalog: Products, instruments and educational materials (like our famous Bugbook® volumes) that teach you circuit design and microcomputer operation.

Save time designing your own circuits with E&L's SK series breadboarding sockets and the Breadbox IV. For both digital and analog designs, Breadbox IV, like all our solderless breadboards, enables instant circuit construction. It's the best priced instrument in the field.

From simple solderless breadboards to complete design systems, master the great new world of electronics.

Send for your Complete Bugworks. It's free.



E&L INSTRUMENTS, INC.  
61 First Street, Derby, Conn. 06418  
(203) 735-8774 Telex No. 96 3536

TM

**CIRCLE 55 ON FREE INFORMATION CARD**

For  
faster  
service

USE  
ZIP  
CODE

on  
all  
mail



**FLUKE**

3½ DIGIT  
MULTIMETER

**Fluke 8020A DMM**

You get unbelievable field versatility with the 8020A, and it's sized to slip easily into your pocket or service kit. Compact, with big features—like 0.25% dc accuracy and 26 ranges. Conductance ranges for measuring leakage to 10,000 MΩ, or transistor beta. Ten megohm input resistance, ac and dc. Battery powered, with a large liquid crystal display.

FOR MORE INFORMATION TOLL FREE HOT LINE  
OR TO ORDER CALL 800-223-0474

**ADVANCE  
ELECTRONICS**

54 West 45 Street, New York, N.Y. 10036 212-687-2224

**THE TEST EQUIPMENT SPECIALISTS**

JUNE 1978

115

for an  
experience  
in electronics,

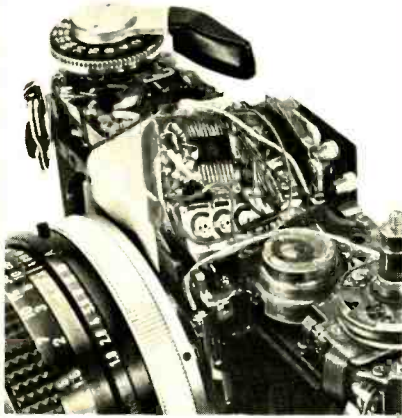

## get into cameras

Improve your income by acquiring additional skills as a camera repair technician. Increasing use of electronics in cameras is creating still more opportunities for camera repair specialists. Take advantage.

### Performance Training

National Camera developed the first comprehensive technical training for camera repair technicians in the '50's. More practicing technicians have received training from us than from any other single source. Now this better-than-ever professional program is as close to you as your mailbox. Learn at home!

### Complete Package

You get texts, tools, practice equipment — a complete program including the latest additions in photographic electronics — not available anywhere else.

### Free catalog

Find out about great training programs in camera repair technology. You can learn at home, keeping your present job, or at our one-year resident school in Colorful Colorado. For free information, use the card in this publication or write us today.



**National Camera**

Technical Training Division, Dept. GBD  
2000 West Union Ave.,  
Englewood, Colorado 80110

Accredited member: NHSC, NATIS

# next month

## ■ Build A Darkroom Timer

Great addition to your darkroom. Has an LED readout and keyboard entry of exposure time. Automatically turns off your safelight when exposing a print.

## ■ All About Disposable Batteries

Ever wonder what the differences between alkaline, carbon zinc and mercury batteries are. Here's an in-depth explanation plus what you should expect in terms of performance from each type.

## ■ Digital Hi-Fi Recording

Your hi-fi tape recorder will never be the same. Here's a look at where the industry is going and what may happen to your tape recorder in the near future.

### Plus:

**Hi-Fi Lab Test Reports**

**Computer Corner**

**Jack Darr's Service Clinic**

**Hobby Corner**

**State-Of-Solid-State**

**and more**

**THE BOOK YOU'VE  
WAITED FOR  
IS HERE!**

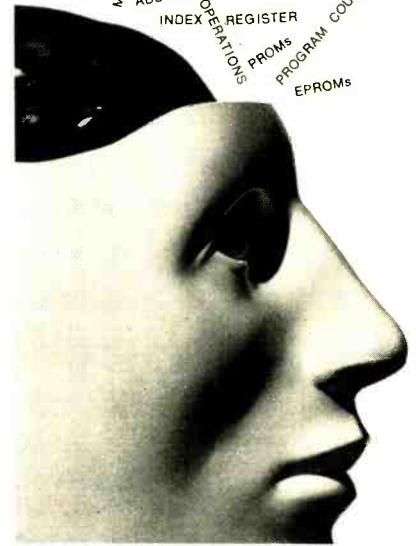

## UNDERSTANDING MICRO COMPUTERS AND SMALL COMPUTER SYSTEMS

Here, at last, is a profusely illustrated, easy-reading, "must" book explaining fundamental concepts behind operation of almost all microcomputers... in simple English... giving you that extra knowledge to read and *understand* computer magazines and manufacturer's literature... and feel "at home" around computers. Things like:

- How a CPU is organized; how it follows sequences of orders to solve problems
- Illustrates basic instructions from almost every microcomputer
- Discusses common memory addressing modes — illustrates typical uses
- What to know to tell a computer what to do when using machine language programming
- Use of flow charts; program worksheets; hand assembly of source codes into object codes; memory maps; purpose of Editor, Assembler, Monitor.

**Hardcover \$14.95. Paperback \$9.95**

- How a computer communicates
- Commonly used I/O devices and operational concepts
- Practical aspects of selecting a small computer system
- Plus, hundreds of other practical facts and information! If you're curious about small computers, you must own this 300 page no-nonsense easy-reading text. Includes easy-to-use glossary of key microcomputer-oriented words.

**UNDERSTANDING MICROCOMPUTERS.** The name says it all! Only \$9.95 ppd. Order your copy today!



**SCELBI COMPUTER  
CONSULTING INC.**

P.O. Box 133 — PP STN, Dept. RE-6  
Milford, CT 06460

Prices shown for North American customers. Master Charge, VISA, Postal and Bank Money Orders preferred. Personal checks delay shipping up to 4 weeks. Pricing, specifications, availability subject to change without notice. **IMPORTANT!** Include 75¢ postage/handling for each book delivered by U.S. Mail; or \$2 for each book shipped via UPS.

**CIRCLE 23 ON FREE INFORMATION CARD**



# books

**SERVICING SONY COLOR TV FOR 1969-1972**, by Stan Prentiss. Theodore Audel & Co., Div. of Howard W. Sams & Co., Inc., 4300 W. 62nd St., Indianapolis, IN 46268. 304 pp. 8 1/2 x 11 in. Softcover \$49.95.

This service guide contains adjustment and alignment specifications, troubleshooting information, schematics, parts lists, disassembly instructions and operational theory. Chapter 1 gives the reader a basic understanding of the barrier AGC system used in today's TV receivers. Other chapters deal with specific troubleshooting methods for the models covered in this book. Foldout schematics are included in the back of the book.

**RADIOMAN'S GUIDE, Fourth Edition**, by Robert G. Middleton. Theodore Audel & Co., Div. of Howard W. Sams & Co., Inc., 4300 W. 62nd St., Indianapolis, IN 46268. 470 pp. 5 1/2 x 8 1/4 in. Hardcover \$7.50.

When radio was first developed, it was greeted as the miracle of the age, but no one could have predicted its many present-day uses in such diverse fields as industry, navigation, space exploration, surveillance—the list is endless. This book provides the layman with a sound understanding of the basic principles of radio. It presents its material clearly and simply. Some of the chapter titles are: "Elements of Radio," "Magnetism," "Inductors," "Capacitors," "Basic Electronic Circuits," "Radio Transmitters," and "Radio Testing."

**THE 8080A BUGBOOK, MICROCOMPUTER INTERFACING AND PROGRAMMING**, by Peter R. Rony, David G. Larsen and Jonathan Titus. Howard W. Sams & Co., Inc., 4300 W. 62nd St., Indianapolis, IN 46268. 416 pp. 5 1/2 x 8 1/2 in. Softcover \$9.95.

This latest in the *Bugbook* series contains the basic interfacing concepts of the Intel 8080 IC along with a discussion of I/O programming so that you can then develop your own interfaces to other devices such as teletypes, panel meters, A/D and D/A converters, etc.

The first three chapters introduce you to the microcomputer, describe a small 8080 device and how to program it. Later chapters deal with device select-pulse generation, clock cycles, the international operation of 8080 IC; subroutines, interrupts, external flags and stacks are discussed in Chapter 7. The appendixes contain references, and instruction set summaries for both the 8080 and 8080A microcomputers.

**ELECTRONIC COMMUNICATIONS SYSTEMS, Second Edition**, by George Kennedy. Gregg/McGraw-Hill Book Co., 1221 Ave. of the Americas, New York, NY 10020. 774 pp. 6 1/2 x 9 1/4 in. Hardcover \$16.95.

This book is written for postsecondary-level engineering students having a basic familiarity with electronics communications and who have completed algebra, trigonometry and binary arithmetic. This volume includes all the latest developments in the field, and chapter sequence has been reorganized. Two new chapters have been added: Broadband Communications Systems and Television Fundamentals. Each communications system is described in logical progression—what it does and how, where it is applicable and what its future applications could be. An instructor's manual with exercises and solutions is contained in the back. R-E

# Why buy a multi-capability counter for frequency-only measurements?



The 1911A multicounter makes accurate field transmitter frequency checks easy with the optional battery-pack and whip antenna.

For accurate readings in the presence of noise. Our new 1911/12A multi-counters have both trigger-level and attenuator controls.

For high resolution measurement of low frequency control tones in the period or period-average mode.

For economy. They're priced about the same as many frequency-only models, with totalize, autozero, autoranging, manual and automatic range selection, and more. Standard.

- 1911A for 250 MHz applications: \$495\*
- 1912A for measurements to 520 MHz: \$620\*

Call (800)426-0361, toll free, or write: John Fluke Mfg. Co., P.O. Box 43210, Mountlake Terrace, WA 98043.

\*(U.S. price)



1912A 520 MHz model

## Fluke Multicounters for Communications Service



2110-8001

CIRCLE 76 ON FREE INFORMATION CARD

## HOBBYISTS! ENGINEERS! TECHNICIANS! STUDENTS!

Write and run machine language programs at home, display video graphics on your TV set and design microprocessor circuits — the very first night — even if you've never used a computer before!

## RCA COSMAC microprocessor/mini-computer

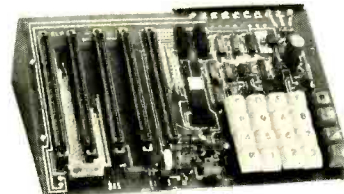

A THOUGHTFUL GIFT FOR ANYONE WHO MUST STAY UP TO DATE IN COMPUTERS AND ELECTRONICS!

ELF II \$99<sup>95</sup>

### SPECIFICATIONS

ELF II features an RCA COSMAC COS/MOS 8-bit microprocessor addressable to 64k bytes with DMA, interrupt, 16 registers, ALU, 256 byte RAM, full hex keyboard, two digit hex output display, 3 slot plug-in expansion bus, stable crystal clock for timing purposes and a double-sided plated-through PC board plus RCA 1861 video IC to display any segment of memory on a video monitor or TV screen.

Use ELF II to ... **PLAY GAMES** using your TV for a video display ... **CREATE GRAPHICS** pictures, alphanumeric, animated effects ... learn how to **DESIGN CIRCUITS** using a microprocessor ... the possibilities are infinite!

**NOW AVAILABLE**

ELF II explodes into a giant when you plug the **GIANT BOARD™** into ELF's expansion bus. This powerful board includes cassette I/O, RS 232-C/TTY, 8-bit P I/O and system monitor/ editor... meaning your ELF II is now the heart of a full-size system with unlimited computing power! \$39.95 kit. \$2 p&h.  
 • 4k Static RAM addressable to any 4k page to 64k. \$89.95 kit. \$3 p&h.  
 • Prototype (Kluge) Board accepts up to 32 I.C.'s of various sizes. \$17.00 kit. \$1 p&h.  
 • Expansion Power Supply. \$34.95 kit. \$2 p&h.  
 • Gold plated 86-pin connector. \$5.70 postpaid.

Coming Soon! **Tiny Basic**

ASCII KEYBOARD\* CONTROLLER BOARD\* D-A, A-D CONVERTER\* CABINET

### SEND TODAY

**NETRONICS R&D LTD.**, Dept. RE-6, 333 Litchfield Road, New Milford, CT 06776 Phone (203) 354-9375

Yes! I want to run programs at home and have enclosed:

\$99.95 plus \$3 p&h for **RCA COSMAC ELF II kit**. Featured in **POPULAR ELECTRONICS**.

Includes all components plus everything you need to write and run machine language programs plus the new Pixie chip that lets you display video graphics on your TV screen. Designed to give engineers practice in computer programming and microprocessor circuit design. ELF II is also perfect for college and college-bound students (who must understand computers for any engineering, scientific or business career). Easy instructions get you started right away, even if you've never used a computer before!

I want mine wired and tested with the power transformer and **RCA 1802 User's Manual** for \$149.95 plus \$3 p&h. Conn. res. add sales tax.

NAME \_\_\_\_\_

ADDRESS \_\_\_\_\_

CITY \_\_\_\_\_

STATE \_\_\_\_\_ ZIP \_\_\_\_\_

Send info on other kits!

PROM. ASCII keyboard inputs. Dealer Inquiries Invited

CIRCLE 88 ON FREE INFORMATION CARD

# FULL SIZE DISK SYSTEM \$895



For just \$895 your DISCUS I™ system is complete. Complete with software. Completely assembled.

It's full-size floppy format gives you a quarter of a million bytes per diskette. And twice the speed of mini-floppies. Plus, DISCUS I™ is both S-100 and IBM compatible.

And unlike other disk systems, DISCUS I™ comes assembled and tested — a Disk Jockey I™ controller, cables, and a free-standing Shugart disk drive in a handsome cabinet complete with power supply.

And you get the software you need, ready to self-load and run: DOS, ATE™ assembler/editor, patches for CPM, and Advanced BASIC (delivered mid-1978). CPM (\$70) and Micro-soft Extended Disk BASIC (\$199) are options.

Ask your local computer store to order DISCUS I™ today at our special \$100-off introductory price: \$895 only until June 30, 1978. Or send your check or money order to THINKER TOYS™, 1201 10th Street, Berkeley, CA 94710. Or call (415) 527-7548, 10-4 pm PST. Add \$3.00 handling; California residents add tax.

A PRODUCT OF  
MORROW'S MICRO-STUFF FOR

# Thinker Toys™

CIRCLE 85 ON FREE INFORMATION CARD

# Organize Your Junkbox

FRED BLECHMAN

A SIMPLE INEXPENSIVE WAY TO FIND small parts easily and quickly is to use match boxes. Parts cabinets can be made from pocket-size match boxes available in supermarkets, the brand used here is Ohio Blue Tip Matches (Ohio Match Company, Wadsworth, OH 44281). Each box is approximately 2-long, 1½-wide and ½-inches high. A 10-box package only costs around 20¢!

To make small-parts storage cabinets, glue, self-adhesive plastic and labels are needed. Rubber cement is ideal since it doesn't "set" immediately. The self-adhesive plastic comes in various designs and colors, and is available in most five-and-ten-cent and variety stores for about 70¢ a yard in the 18-inch width. The Avery Label Company (Azusa, CA 91702) makes No. S-620, ¾ × 1¼-inch self-adhesive labels sold in stationery stores in boxes of 1,000 labels for around \$2.

To make a parts cabinet, empty the

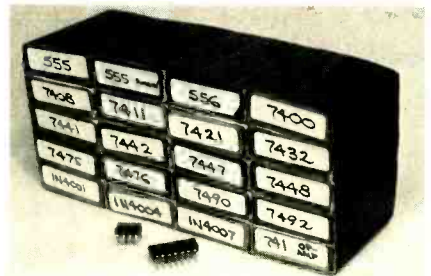

matches out of the individual boxes and glue them together in a convenient arrangement. Four-boxes-wide by five-boxes-high makes a cabinet about 6 × 3 × 2-inches, with 20 drawers. Before the cement has dried thoroughly, cut a 2½-inch-wide strip of self-adhesive plastic long enough to band the tops and sides of the assembled boxes. (A walnut-grain design makes the finished cabinet look like wood.) Peel off the paper backing and carefully apply the plastic around the boxes so that it holds them together securely. Trim with scissors or a razor blade and the cabinet is finished. **R-E**

## For faster service

## USE ZIP CODE

## on all mail

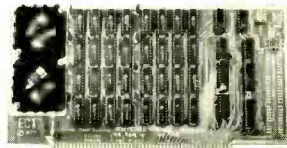

## 16K RAM

FULLY STATIC

\$450

INTRODUCTORY  
KIT PRICE

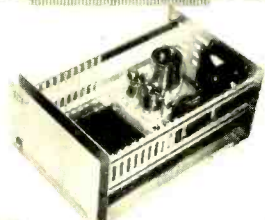

10 SLOT TABLE TOP  
MICROCOMPUTERS  
TT-8080 KIT \$440

SYSTEM W/16K & I/O  
TT-8080-S KIT \$1050

10-SLOT MAIN FRAME  
TT-10 KIT \$325

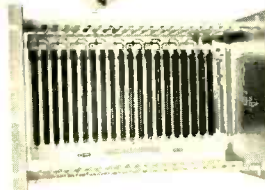

CARD CAGE &  
MOTHER BOARD  
ECT-100 KIT \$100  
CCMB-10 KIT \$75

WITH CONNECTORS  
& GUIDES

ECT-100-F KIT \$200  
CCMB-10-F KIT \$125

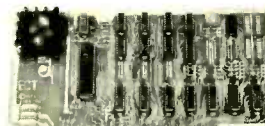

CPU'S, MEMORY  
MOTHER BOARDS  
PROTOTYPING BOARDS  
EXTENDER CARDS  
POWER SUPPLIES

DEALER INQUIRIES INVITED

## ELECTRONIC CONTROL TECHNOLOGY

FACTORY ADDRESS

763 Ramsey Avenue

Hillside, NJ 07205

(201) 686-8080

MAILING ADDRESS

P.O. Box 6

Union, NJ 07083

SHIPPING EXTRA

CIRCLE 69 ON FREE INFORMATION CARD



dirty" PC board, perhaps for a circuit that uses only a couple of transistors and a few other parts. It hardly seems worthwhile to draw with resist and then etch such a small board. You don't have to if you have a hand-held grinder or a flexible shaft tool.

If the pattern is not too small and/or complex, you can *grind* away the copper that you would have etched away. You can isolate pads of copper to receive two, three or more leads. Transistor sockets are not difficult to make, except for DIP sockets for IC's which are very difficult to construct. It can be done but it requires patience and a *very* steady hand.

The unwanted copper can be ground away with any of the small steel cutters that are normally used with a flexible shaft or hand-held tool. I have discovered that the round end cutters are less satisfactory than those with square and pointed ends. Some of the grinding bits used by dentists are excellent for PC board use. Ask your dentist to save his dull ones for you—they have a lot of copper-grinding life left in them.

When cutting away copper, try not to dig too deep into the board. Cutting away too much of the base material will weaken the board mechanically. If the tool slips and you cut across a copper run (and you will do this at first), don't discard the board because you can always jump the cut with wire. Finally, **always wear safety goggles** to protect your eyes—those fast-spinning cutters really throw out very fine slivers of material.

You now have a quick and easy way to construct PC boards that should speed up your prototype and one-of-a-kind construction.

**Reader suggestions**

From time to time we have invited readers to send in ideas and suggestions for this column. We have especially welcomed circuits that you would like to share with other readers. Numerous ideas and suggestions have been received, and we appreciate every one of them.

We've also received letters about circuits, but most of the letters begin, "I need a circuit that will . . ." Well, sometimes I have such a circuit, but most often I can only suggest how it can be developed.

However, some of you must be *building* circuits, too. Just what kinds of things are you constructing? How about sharing your projects and ideas with others?

All you have to do is sketch a schematic diagram, attach a parts list and a short description of the project, and mail it to **Radio-Electronics**. We will examine each entry carefully and publish the best in future "Hobby Corner" articles. Of

course, your name will be listed as the contributor.

Here are a few items that others have asked for:

- A reader in New York wants an add-on for his model rocket launcher that would provide a digital readout, automatic countdown and close the launch circuit at time zero.
- Someone in Ohio wants to discourage burglars. He needs a timer that will turn lights on and off in different parts of the house at different times.
- A Florida reader needs a simple circuit to put numbers on a digital readout from a keyboard the way

it is done in calculators.

- A model railroad club in New York would like to have a layout running-time counter that would be cumulative from one session to another yet continue to operate under derail conditions.
- A reader in Connecticut wants a rate counter for motor RPM, a wind-speed indicator and similar devices.

Those are only a few ideas. Electronics is present in every field of human endeavor. If you've developed a circuit to perform a task, why not consider sharing it? Send it along to Hobby Corner, **Radio-Electronics**, 200 Park Avenue South, New York, NY 10003. **R-E**

## Are You still using an Audio Generator that has a Crank?



IF SO, THEN LOOK AT THE **270 FUNCTION GENERATOR**

by **HICKOK**

**Sines, Squares, Triangles to 500 kHz — and much, much more**

A new, versatile service and lab instrument — the feature packed Model 270 Function Generator — gives you much more waveform generating capability than you'd expect for its low price. This compact, precision unit puts stable, calibrated, high quality sine, square and triangle waveforms from 1Hz to 500kHz at your fingertips. But that's not all. With external connections you can produce logic pulses, sweeps and ramps, amplitude and frequency modulated outputs, phase and frequency shift keying signals, tone bursts, and a host of mixed signal outputs. It's even a stand-alone wideband inverting amplifier!

REG. \$199.

**SAVE \$20**

**\$179.00**

Complete with Deluxe Carrying Case

Offer expires **Aug. 31, 1978**

**Basic Output Waveforms:**  
Sine, Square, Triangle

**Frequency Range:**  
1 Hz to 1MHz\* in six pushbutton-selected decade ranges.  
\* Typical: 500 kHz guaranteed minimum upper frequency

**Frequency Accuracy:**  
± 3% of F.S. up to 200 kHz

**Amplitude Flatness:**  
± 0.1 dB from 20 Hz to 20 kHz; ± 0.3 dB from 1 Hz to 100 kHz

**Output Level:**  
0 to 24 volts peak to peak (8.5 volts RMS) open circuit — protected against short circuits

**Output Impedance:**  
500 ohms ± 5%, constant regardless of attenuator setting

**Attenuators:**  
Total dynamic range of step and continuous attenuators is 80 dB minimum. Step (pushbutton) attenuators provide 0 dB, -20 dB and -40 dB attenuation (± 0.5 dB accuracy). Continuous (AMPLITUDE) control provides at least 40 dB additional control.

**Amplitude Stability**  
(After 12 hour warm-up):  
With Line Voltage: ± 0.5% with 10% line voltage change  
With Temperature: ± 0.5% per °C from 0°C to +50°C

**Sine Wave Distortion:**  
Max. total harmonic distortion (THD) is 1% from 20 Hz to 20 kHz

**Square Wave Rise/Fall Time:**  
0.5% minimum (5% maximum asymmetry)

**Triangle Wave Linearity:**  
98% minimum (2% maximum nonlinearity) to 100 kHz

**Rear Panel Inputs:**  
AM input, FM input, Frequency Shift Keying (FSK) control, FSK resistor, FSK Sync (pulse) remote control, Mixer input

**Rear Panel Input Protection:**  
Another Model 270 (or other unit with ± 15 volt/500 ohm output) may be connected to rear inputs without damage.

**DC Offset:**  
Output DC level on all waveforms is variable from -6V to +6V (at 0 dB ATTENUATION)

**Frequency Stability**  
(After 12 hour warm-up):  
With Line Voltage: ± 0.1% with 10% line voltage change  
With Temperature: ± 0.1% per °C from 0°C to +50°C

**Power Required:**  
105-125 VAC/210-250 VAC, 50-400 Hz, 5 watts

**Size & Weight:**  
(Not including feet) 8 1/2" w x 3 1/2" h x 6" d (21.6 cm x 8.9 cm x 15.2 cm); 4 pounds (1.8 kg)

**Accessories:**  
Rear dials connector and detailed instruction manual.

212-687-2224

**THE TEST EQUIPMENT SPECIALISTS**

**TOLL FREE HOT LINE**  
**800-223-0474**

45 West 45 Street, New York, N.Y. 10036



# Solid-State Update

## NEW EICO 480 TRIGGERED SWEEP 10 MHz SCOPE

100% Solid State • Includes 10:1 Probe

More Professional scope performance for your money! DC to 10 MHz bandwidth, AC and DC coupling, 11 position calibrated attenuator, 10 mV/cm sensitivity, push-button operation. Outstanding features: Built-in TV Sync Separator; Digitally controlled trigger circuits; reference baseline display; calibrated 21 step sweep speed; Fully regulated power supply; Custom Bezel for standard camera mounting. **Assembled \$425.00**

### FREE '78 EICO CATALOG

Check reader service card or send 50¢ for first class mail. See your local EICO Dealer or call (516) 681-9300, 9:00 a.m.-5:00 p.m. EST. Major credit cards accepted.

EICO-108 New South Rd.  
Hicksville, N.Y. 11801



CIRCLE 70 ON FREE INFORMATION CARD

### Schottky rectifiers

Schottky rectifiers are ideal for power rectification because of their lower forward voltage and the resulting lower power dissipation. The 17-device MBR7520 family from Motorola has a greater transient capacity than other rectifiers on the market. The diodes have a forward-current rating from 25 to 75 amp and

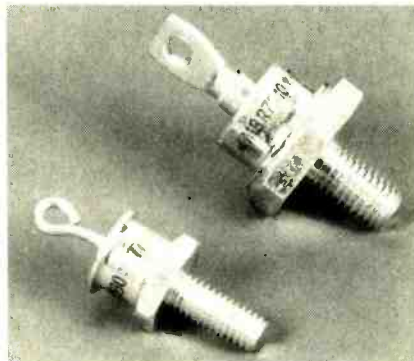

SCHOTTKY RECTIFIERS FROM MOTOROLA

have reverse voltage ratings up to 45 volts. Most devices in the series have dV/dt ratings of 100 volts-per- $\mu$ s.

At a 100°C case temperature, 70-amp

forward current and 45 volts, test units have been subjected to 8.3-ms, 1300-amp pulses once-per-minute, with no failures. The diodes recover from transients above the operating voltage specifications that drive them into temporary avalanche breakdown.

The rectifiers are mounted in DO-4 and DO-5 stud packages. Additional data is available from Motorola Semiconductor Products, Inc., Box 20912, Phoenix, AZ 85036.

### Operational amplifiers

Signetics' SE/NE5534 operational amplifier has a 10-MHz small-signal bandwidth and a 200-kHz power bandwidth. It can drive 600 ohms to 10 volts RMS. The operational amplifier is internally compensated for gains equal to or higher than 3, and can be used in high-quality audio equipment, instrumentation and control circuits and telephone channel amplifiers.

The DC gain is 100,000 volts, the AC gain is 6000 volts at 10 kHz and the supply range is  $\pm 3$  to  $\pm 20$  volts. The amplifiers are available in 8-pin mini-DIP and TO-5 packages, cost between \$1.50

## GET ALL THE FACTS ON THE NEW GTS-10 GENERAL TELEVISION SERVICER - the concept that is changing the course of TV servicing!

### SEND FOR A FREE GTS-10 TWO-VOLUME OWNER'S MANUAL!

In addition to a free two-volume set of the GTS-10 owner's manuals you will receive a comprehensive 6-page full color brochure - describing its profit making potential and its many unique patterns as well as information on our 30-day Shop Trial offer of the GTS-10 General Television Servicer.

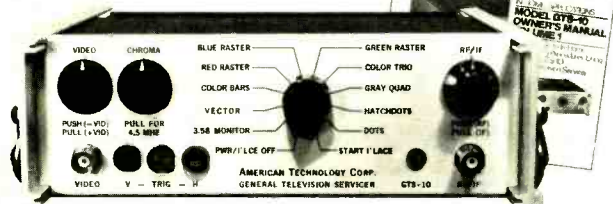

Patents Pending on many unique features.

The GTS-10, with in-home portability, replaces an ordinary color bar pattern generator and includes the most used functions of a substitute tuner and an analyst. It also provides capabilities that none of these other instruments can match. Advanced yet sensibly priced at \$349.00 the GTS-10 is the ultimate instrument for increasing servicing profits.

**FOR IMMEDIATE REPLY TO THIS OFFER SEND COUPON OR WRITE DIRECT TO**

For VISA and MASTER CHARGE orders call (303) 275-8991.

**ATC**

AMERICAN TECHNOLOGY CORP.  
225 Main Street,  
Canon City, Colorado 81212 RE06

Send \$1.00 if First Class delivery is desired.

Name \_\_\_\_\_ Phone \_\_\_\_\_

Company \_\_\_\_\_

Address \_\_\_\_\_

City \_\_\_\_\_ State \_\_\_\_\_ Zip \_\_\_\_\_

CIRCLE 75 ON FREE INFORMATION CARD



## A Platt tool case won't fall apart at the seams because there are no seams.

Unlike other tool cases, the pockets on a Platt Pallet are molded without any seams, stitches or rivets to form a one-piece unit. It's practically indestructible.

The case itself has that same rugged construction. It comes in either tough, lightweight ABS Thermoplastic, rich looking expanded vinyl or a combination of both.

Platt also has rugged hardware. Like an aluminum rim for extra strength. Steel core handles. And tough brass locks.

Inside there are compartments for larger tools, parts boxes and testing equipment. And multiple lid pockets for paper and order books.

Besides having a tough case Platt has a tough 5-year guarantee on both the case and pallet.

**platt**

\* Pat. No. 3,880,285

Cases for business and industry.

2301 S. Prairie Ave., Chicago, Ill. 60616 (312) 225-6670

CIRCLE 65 ON FREE INFORMATION CARD



and \$2.00 in quantities of 100. Details are available from Signetics, 811 East Avenue, Box 9052, Sunnyvale, CA 94086.

Texas Instruments has expanded their BIFET (Bipolar Field-Effect Transistor) operational-amplifier line to 12 circuits. The TL061 and TL071 series combine JFET's (Junction Field-Effect Transistor) and bipolar transistors, which results in low input-bias current requirements with higher internal current levels for higher performance levels.

The TL061 has a 3.5-volt-per- $\mu$ s slew rate and a 0.2-mA current drain that makes it suitable for battery operation. Specifications for the TL071 are a 13-volt-per- $\mu$ s slew rate and a 2.5-mA maximum current drain. The low noise and distortion levels for the TL071 makes it suitable for use in preamplifiers. Inquiries should be sent to Texas Instruments Incorporated, Inquiry Answering Service, Box 5012, M/S 308 (Attn: TL061 and TL071), Dallas, TX 75222.

#### Voltage regulator

Silicon General's SG1532, SG2532 and SG3532 precision general-purpose regulators are substantially improved versions of the industry standard SG723. The SG1532 has a minimum required

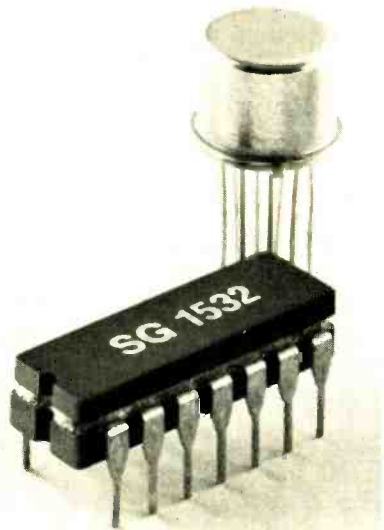

SILICON GENERAL'S SG1532 VOLTAGE REGULATOR

input voltage of 4.5 compared with the SG723's 9-volt specification. Lower voltages can be sustained across common 5-volt regulators, reducing the dissipation.

The SG1532 has thermal shutdown and current-limit protection. The IC is protected even if an external pass transistor fails. A sense voltage of only 89 mV is needed to current-limit the SG1532 compared with 650 mV for the SG723. A series-current sense resistor is inserted in the output current path to trigger the current-limit protection circuit. At 650 mV and, for example, 10 amps, the sense resistor dissipates  $0.65 \times 10$  or 6.5 watts—a lot of wasted energy.

turn page

## Technicians— RCA Flameproof Film Resistors simplify your replacement problems.



More and more technicians are switching to RCA Flameproof Film Resistors. Here are 5 important reasons why:

- Many of today's circuits require flameproof resistors.
- Simplified inventory: RCA's 2% tolerance flameproof resistors replace many conventional types having 5% and 10% ratings.
- High quality service demands high quality replacement parts.
- They're available in the popular wattage ratings — 1/4, 1/2, 1 and 2 watts.
- Values run from 1.0 Ohm to 1.5 Megohms. Altogether there are 523 film resistors to choose from.

And, RCA's convenient, preloaded and prelabeled Flameproof Resistor Kit makes it easy to store and locate your resistors.

See your RCA Distributor for details or write to RCA Distributor and Special Products Division, 2000 Clements Bridge Road, Deptford, NJ 08096.

**RCA** Flameproof  
Film Resistors

## "My father built this Schober Organ for me!"

You'd be proud to buy her an organ this good...but how would you feel if you'd also built it? It's a special kind of satisfaction. The gift of a lifetime of magnificent music, crafted with your own hands!

And you can do it! You need no prior electronic or mechanical abilities. Just the capacity to follow instructions. Every step is clearly detailed, every component is supplied. You'll find the assembly process as enjoyable as the music which follows!

And what music! For this is a truly fine instrument you will build. Far superior to most

"ready-made" organs...easily comparable to others at twice the price. Kit costs range from \$650 to \$2850 for all basic components, and you can purchase it in sections to spread costs out...or have two-year time payments.

When you've completed the basic organ, Schober offers a full complement of accessories...plus complete organ playing courses! People have been building Schober Electronic Organs for their daughters, sons, wives, husbands...for themselves...for 20 years now. Join the thousands of delighted Schober people.

You can have all the details, without cost or obligation. Just send the coupon for the fascinating Schober color catalog (or enclose \$1 for a record that lets you hear as well as see the quality of Schober). Why not clip it right now, before you forget?

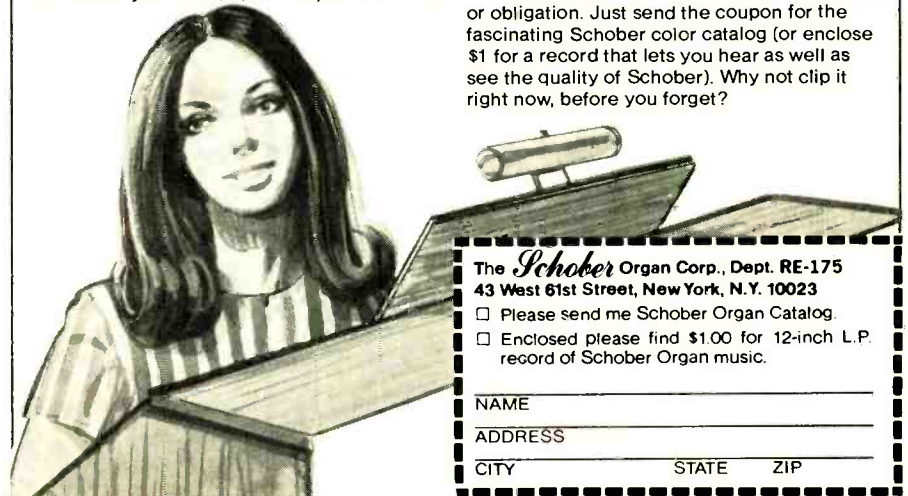

The Schober Organ Corp., Dept. RE-175  
43 West 61st Street, New York, N.Y. 10023

- Please send me Schober Organ Catalog.  
 Enclosed please find \$1.00 for 12-inch L.P. record of Schober Organ music.

NAME \_\_\_\_\_

ADDRESS \_\_\_\_\_

CITY \_\_\_\_\_

STATE \_\_\_\_\_

ZIP \_\_\_\_\_

CIRCLE 53 ON FREE INFORMATION CARD

# JUST \$495 GETS YOU THIS DUAL TRACE GOULD SCOPE PLUS TWO X10 PROBES.

You know that's a great price. Especially when you consider the outstanding performance you get with this Gould OS245A oscilloscope.

And you get clear, bright displays. 5mV/div. sensitivity and exceptionally versatile trigger performance. It's ideal for TV or general electronic service work; perfect for hobbyists and educational institutions. You can rely on Gould to live up to these specs:

- DC to 10 MHz; dual trace
- Trigger performance in excess of 15 MHz
- TV trigger facilitates solid synchronization with TV signals

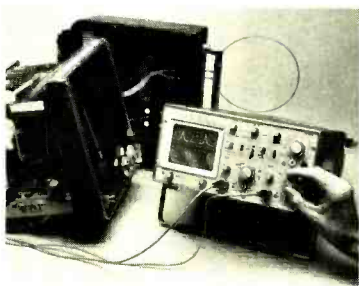

- Portable; weighs just 11 lbs.
  - Carries full two year warranty on all parts and labor excluding normal calibration, fuses and minor maintenance.
- Just one phone call gets you action.**

Don't miss out on this bargain. Pick up the phone now and call us toll-free at 800-325-6400. (In Missouri call 800-342-6600). We'll rush you free literature and ordering information on the OS245A as well as other Gould oscilloscopes applicable to your needs. Gould Inc., Instrument Systems Division, 3631 Perkins Avenue, Cleveland, Ohio 44114.



**GOULD**

CIRCLE 81 ON FREE INFORMATION CARD

The older SG723 design uses a Zener diode reference, while the SG1532 has a lower noise band-gap reference.

Line regulation is 0.01%-per-volt maximum, and the output current capacity is a minimum of 100 mA. The price is \$1.10 per unit in quantities of 100. Silicon General, Inc., 7382 Bolsa Avenue, Westminster, CA 92683.

## Another radio circuit

SGS-ATES Semiconductor Corp. also has AM/FM integrated circuits—the TDA1220 and TDA1230. The TDA1220 has an FM IF amplifier-limiter, an FM detector, and an AM RF amplifier, mixer, oscillator, IF amplifier and detector. The FM limiting sensitivity is 30  $\mu$ V, the amplitude modulation rejection (AMR) is 50 dB and the S/N ratio is better than 60 dB.

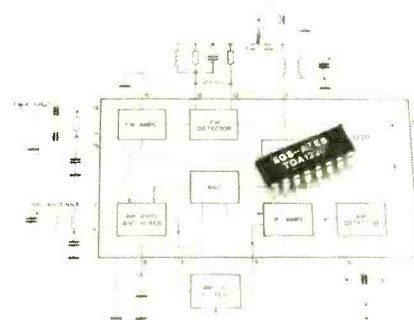

SGS-ATES FM/IF amplifier

The TDA1230 goes further with an AF power amplifier that is driven from the on-chip FM detector or from an external audio source. **R-E**

## CROSSTALK IN ORGAN

*I wrote about a crosstalk problem in a home-made electronic organ I am building. You said it was out of your line but made some helpful suggestions! One suggestion was to reduce the signal level at the point where the problem started.*

*I also found a lot of good data in some articles written by John S. Simonton, especially the article in which he wrote that, in some cases, too many grounding points would actually be a drawback. Thanks to you both.—H. B., Lancaster, PA.*

You're welcome!

## LONG-TERM INTERMITTENT

*I wonder if you can give me some clue on this RCA model CTC-16X. It works for quite a while, then goes out of focus. The picture turns red, then it blacks out. The worst part is it's MY set!—L. S., Oak Park, IL.*

Oh, you've got one of the later models; mine's a model CTC-15! Anyway, I remember a model CTC-10 that showed exactly these symptoms. After watching



it in vain for some time. I finally caught the symptom. A quick check in the back of the set showed that the damper tube heater was slowly going out! In this case, it was not the damper tube, but a bad contact on one of the heater pins in the socket. You already changed the damper tube, but you should clean up the contacts on that socket. (I still haven't figured out why the picture turned red as it went out, but I saw it.)

**NO VERTICAL HOLD**

*This Philco model 21KT40 has a unique problem: The height and linearity are good, the vertical sync is very critical, and, the unique part, the vertical hold control has no effect whatsoever! I replaced the plate-load resistor, the multiplier grid resistor, etc., nothing. I changed capacitor C62, nothing. Everything else seems to check OK. I'm just scratching my head!—K. S., Seymour, IN.*

What can mess up this circuit is a leakage in the capacitors in the feedback loop, especially capacitor C59. Somehow, the time constant in the input-grid circuit is way off. As a last resort, get out your shotgun and change them all at once.

(Feedback: "You're right. I loaded up the shotgun and the third capacitor was the one—C59, the coupling capacitor from the end of the feedback loop to the input grid. Thanks a million.") R-E

**For faster service**

**USE ZIP CODE**

**on all mail**

**Clever Kleps**

Test probes designed by your needs—Push to seize, push to release (all Kleps spring loaded).

- Kleps 10.** Boathook clamp grips wires, lugs, terminals. Accepts banana plug or bare wire lead. 4¾" long. \$1.39
  - Kleps 20.** Same, but 7" long. \$1.49
  - Kleps 30.** Completely flexible. Forked-tongue gripper. Accepts banana plug or bare lead. 6" long. \$1.79
  - Kleps 40.** Completely flexible. 3-segment automatic collet firmly grips wire ends, PC-board terminals, connector pins. Accepts banana plug or plain wire. 6¼" long. \$2.59
  - Kleps 1.** Economy Kleps for light line work (not lab quality). Meshing claws. 4½" long. \$ .99
  - Pruf 10.** Versatile test prod. Solder connection. Molded phenolic. Doubles as scribing tool. "Bunch" pin fits banana jack. Phone tip. 5½" long. \$ .89
- All in red or black - specify. (Add 50¢ postage and handling). Write for complete catalog of - test probes, plugs, sockets, connectors, earphones, headsets, miniature components.

Available through your local distributor, or write to:  
**RYE INDUSTRIES INC.**  
 126 Spencer Place, Mamaroneck, N.Y. 10543  
 In Canada: Rye Industries (Canada) Ltd.  
 CIRCLE 43 ON FREE INFORMATION CARD



**WORLD'S MOST PRACTICAL SOLDER HANDLING TOOLS**

**SOLDERING + DESOLDERING + RESOLDERING = SOLDER Ability ELEMENTARY TO ELITE**

ESPECIALLY DESIGNED FOR YOU!

**Vacuum Impulse Products**

**ENSIST NOW** on The Civilian Air Force of Electronic Tools!

**EDSYN** 144 PAGE TRAINING MANUAL **NEW! OVER 1,000 ILLUSTRATIONS**

1558 ARMINIA ST., VAN NUYS, CALIF. 91406  
 24 HR. PHONES (818) 719-2224 L.A. (818) 717-5115  
 CABLE: EDSYNEX VAN TEL EX 05-1469

**Accuracy like a VTVM... Convenience like a VOM...**

**NEW BATTERY-OPERATED FET SOLID-STATE VOLT-OHMMETER #116**

Easy-to-build KIT \$41.85 =116K

Factory-Wired & Tested \$56.12 =116W

Now you can get all the benefits of a VTVM (laboratory accuracy, stability and wide range) but with its drawbacks gone: no plugging into an AC outlet, no waiting for warm-up, no bulkiness. New Field Effect Transistor (FET) design makes possible low loading, instant-on battery-operation and small size. Excellent for both bench and field work.

**Compare these valuable features:**

- High impedance low loading: 11 meg-ohms input on DC, 1 megohm on AC
- 500-times more sensitive than a standard 20,000 ohms-per-volt VOM
- Wide-range versatility: 4 P-P AC voltage ranges: 0-3.3, 33, 330, 1200V; 4 RMS AC voltage ranges: 0-1.2, 12, 120, 1200V; 4 DC voltage ranges: 0-1.2, 12, 120, 1200V; 4 Resistance ranges: 0-1K, 0-100K, 0-10 meg., 0-1000 meg.; 4DB ranges -24 to +56DB.
- Sensitive easy-to-read 4½" 200 micro-amp meter. Zero center position available. Comprises FET transistor, 4 silicon transistors, 2 diodes. Meter and transistors protected against burnout. Etched panel for durability. High-impact bakelite case with handle useable as instrument stand. Kit has simplified step-by-step assembly instructions. Both kit and factory-wired versions shipped complete with batteries and test leads. 5¼" H x 6¾" W x 2¾" D. 3 lbs.

Send FREE catalog of complete EMC line and name of nearest distributor. RE-6

Name \_\_\_\_\_  
 Address \_\_\_\_\_  
 City \_\_\_\_\_  
 State \_\_\_\_\_ Zip \_\_\_\_\_

**EMC**  
 ELECTRONIC MEASUREMENTS CORP.  
 625 Broadway, New York, N.Y. 10012

# What is an LCD?

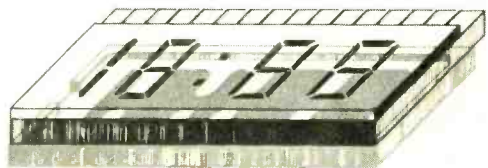

BY KEITH RIORDAN

LIQUID CRYSTAL DISPLAYS (LCD'S) DIFFER FROM OTHER types of displays in that they scatter, rather than generate, light. Two basic types are available: reflective, which require front illumination, and transmissive, which require rear illumination. Both types use a field-effect cell that is filled with liquid crystal material.

A liquid crystal material is an organic compound – that is, a compound containing carbon, hydrogen, oxygen, and nitrogen – that has the optical properties of solids and the fluidity of liquids. In the liquid crystal state, which is exhibited over a specific temperature range, the compound has a milky, yellow appearance. At the high end of the temperature range, the milky appearance gives way to a clear liquid. At the low end of the range, the compound turns to a crystalline solid.

The molecules of a liquid crystal compound are in the form of long, cigar-shaped rods. Because of the special grouping of the atoms that form these molecules, the rods act as dipoles in the presence of an electrical field. This characteristic enables the molecules to be aligned in the direction of the electrical field and provides the basis for operation of a liquid crystal display.

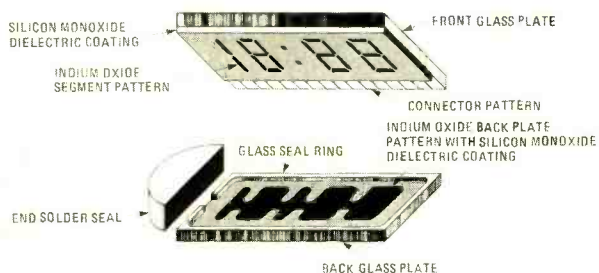

FIG. 1 - FIELD-EFFECT CELL STRUCTURE

## FIELD-EFFECT CELL STRUCTURE

A field-effect liquid crystal cell consists of two glass plates, each with a transparent conductive coating, between which the liquid crystal material is sandwiched (Figure 1). A thin film of indium oxide – a transparent electrical conductor – is deposited on the top, or front, glass plate. This oxide is patterned to produce a series of 7-segment characters. Each segment has a lead that extends to the long edge of the glass. The bottom, or back, glass plate also has an indium oxide coating, but the pattern is designed as a common electrode that, when the plates are fused, registers to the top glass pattern. The oxide-coated side of both the top and bottom glass plates is entirely covered by an evaporated layer of silicon monoxide dielectric, which produces the desired alignment of the liquid crystal molecules.

After the conductive and dielectric coatings have been applied, the top and bottom plates are fused to within 0.0005 inch by a glass ring that has a 0.05-inch opening on

one side. Both plates have a strip of solderable metal – gold over copper over chrome – on the side with the opening. This opening is used to introduce the liquid crystal material into the display envelope, after which the metal strips are soldered to seal the opening.

## REFLECTIVE LCD OPERATION

A reflective LCD consists of a vertical polarizer, liquid crystal field-effect cell, horizontal polarizer, and reflector (Figure 2). With no voltage applied, the treatment of the

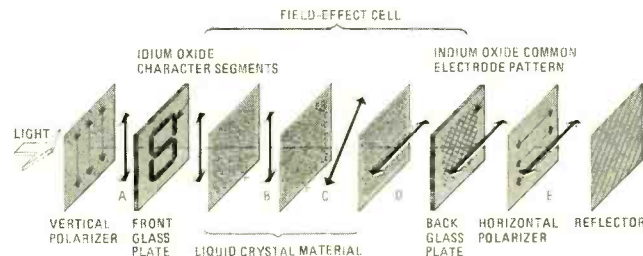

FIG. 2 - UNENERGIZED REFLECTIVE LCD

liquid crystal cell plates produces a uniform alignment of the crystal molecules. If the front and back plates are mounted at right angles to one another – according to the way in which the crystal molecules line up – a 90-degree rotation, or twist, of the alignment occurs. Vertically polarized light entering the front of the cell (A) follows the rotation of the crystal alignment as it passes through the cell (B, C, D). Having been rotated 90 degrees, the polarized light passes through the horizontal polarizer to the reflector (E). The light is then returned through the cell, again rotating 90 degrees, and passes out of the LCD through the vertical polarizer.

When voltage is applied across one or more of the character segments (Figure 3), the crystal molecules in the area

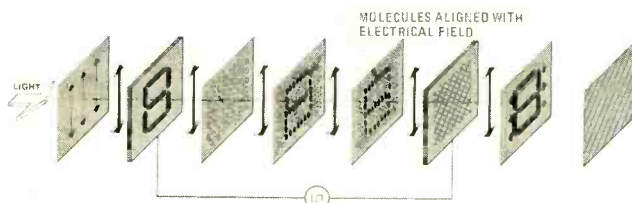

FIG. 3 - ENERGIZED REFLECTIVE LCD

of the segments align themselves with the electrical field. Rotation therefore does not occur in the region of the energized pattern elements. The vertically polarized light conforming to the image produced by these elements cannot pass through the horizontal polarizer but is, rather, absorbed by it. The energized display elements therefore appear as black images against a light background.

## TRANSMISSIVE LCD OPERATION

A transmissive LCD consists of a vertical polarizer, field-effect cell, horizontal polarizer, and light source. The light source, which may be of any suitable type, is in the same position as the reflector in a reflective display.

With no voltage applied to the cell, light from the source passes through the horizontal polarizer, is twisted by the cell, and passes out of the LCD through the vertical polarizer at the front of the display. When voltage is applied to the cell, the twist is destroyed in the region of the energized pattern segments. The horizontally polarized light emitted by the source is absorbed by the vertical polarizer, forming the black-on-white image of the energized pattern segments.

A white-on-black effect can be achieved by using two horizontal (or two vertical) polarizers. In this case, light in the area of the energized pattern elements passes through both polarizers while light in the surrounding area is absorbed. R-E

Reprinted from "Progress", © copyright 1978 Fairchild Camera & Instrument Corp.



# Radio-Electronics Tests Lux

## R-1120 Stereo AM/FM Receiver



CIRCLE 101 ON FREE INFORMATION CARD

LEN FELDMAN  
CONTRIBUTING HI-FI EDITOR

LUX AUDIO OF AMERICA, LTD., THE AMERICAN subsidiary of Lux Corporation of Japan, has labeled their three receivers as tuner-amplifiers in the advertising campaigns introducing the products to the U.S. market. After three years establishing its reputation as a maker of top-quality separate components, the firm now seeks to capture some of the high-volume sales potential of the all-in-one receiver market.

The *Luxman model R-1120* stereophonic AM/FM receiver is shown in Fig. 1. It is clear from this photo that Luxman receivers (all of which bear a family resemblance) are not merely carbon copies of other better-known integrated units. The front panel contains a large bronze-colored dial area opening camouflaging less-used controls and switches while the most-used controls are neatly positioned below them, creating a distinctly uncluttered rich look.

Major controls are arranged along the bottom of the panel. They include an input program selector switch (with two phono settings, AM, FM and AUX); BASS and TREBLE controls, which, when gently pulled forward, offer alternate crossover or turnover frequencies; a large central tuning knob; dual-concentric volume/balance controls; and a SPEAKER selector switch. The headphone jack is located to the right of this last switch.

Secondary controls and switches blend neatly into the dark-colored area above the dial

scales. These controls include a Dolby FM switch (active only if you purchase an optional extra Dolby decoder board that plugs into the chassis via an otherwise empty multiple-pin connector), a tape-monitor switch, a tape-selector switch (up to two tape decks can be handled by the *model R-1120*), a tape dubbing switch (one-to-two or two-to-one), a mono/stereo mode switch, a LOUDNESS switch, a SUBSONIC switch, low- and high-cut filter switches, a selector switch that governs the sensitivity of two series of peak indicator power switches and a main POWER on-off switch.

Linear FM and AM dial scales positioned just below these controls illuminate softly when power is applied. Below the dial scales, at the left, are indicator lights for the Dolby switch and for stereo FM reception, plus illuminated signal-strength and center-of-channel tuning meters. The lower right-hand side of the dial area includes two symmetrically placed groups of LED indicators, calibrated at -18, -15, -12, -9, -6 and 0 dB. The 0-dB calibration corresponds either to the rated power output of 120 watts (into 8-ohm loads) or, when the sensitivity button is depressed, to an output of 7.5 watts. This arrangement extends the usefulness of the LED indicators so that power output can be read instantaneously even when you listen at low levels (down to 120 milliwatts-per-channel). An additional LED serves as a power-on indicator and, when power is first applied, flashes intermittently for a few seconds as voltage in

the receiver become stabilized. The light remains continuously lit when this process is completed, and only then is sound fed to the speaker systems.

The rear panel of the *model R-1120* is shown in Fig. 2. Three sets of spring-loaded speaker terminals are located to the left,

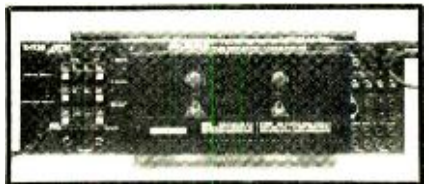

together with switched and unswitched convenience AC receptacles. Two sets of speaker terminals are used for connecting two pairs of conventional dynamic speaker systems, while the third set of terminals is specifically for connecting electrostatic wide-range speakers that often require (or present) different amplifier impedances. Speaker-line fuses for each channel are located below the three sets of speaker terminals.

A metal grill in the center of the rear panel covers and protects the four output transistors that are mounted directly to projecting heat sinks. In the right-hand section of the panel are four antenna input terminals (for connection to external AM, 75-ohm and 300-ohm FM antennas), a chassis ground terminal, two sets of phono input terminals, auxiliary input terminals, two sets of tape input and output terminals and a DIN connector that parallels the pin-jack tape-l terminals. An antenna attenuator switch is located in this area for use during reception of overly strong incoming FM signals. A large AM ferrite-bar antenna can be rotated away from the metal chassis surface and oriented for best reception.

A wide variety of equipment can be connected to and used with the *model R-1120* receiver (see Fig. 3). Rather surprisingly, there are no jacks for separate operation of the two sections of the receiver (preamplifier-out/main amplifier-in jacks), despite the emphasis Lux places on the tuner/amplifier characteristics of this receiver. There is no FM detector output jack (for possible future use with four-channel FM adapters) nor any jacks for connection to an oscilloscope to observe multipath interference and antenna orientation.

### Circuit highlights

The preamplifier section of the *model R-1120* uses a three-stage, direct-coupled circuit using PNP transistors, followed by a two-stage direct-coupled voltage amplifier, a buffer stage using NPN transistors and a two-stage direct-coupled control amplifier section using PNP devices. In the power amplifier section, a difference amplifier using low-noise transistors

### MANUFACTURER'S PUBLISHED SPECIFICATIONS

#### FM TUNER:

**IHF Sensitivity:** mono, 1.8  $\mu\text{V}$  (10.3 dBf); stereo, 4.0  $\mu\text{V}$  (17.2 dBf). **50-dB Quieting:** mono, 2.8  $\mu\text{V}$  (14.1 dBf); stereo, 38  $\mu\text{V}$  (36.8 dBf). **S/N Ratio:** mono, 74 dB; stereo, 70 dB. **Selectivity:** 80 dB. **Frequency Response:** 20 Hz to 15 kHz, +0.2, -1.5 dB. **Distortion:** mono, 0.1% at 1 kHz, 0.3% at 6 kHz; stereo, 0.2% at 100 and 1000 Hz, 0.4% at 6 kHz. **Capture Ratio:** 1.3 dB. **Image Rejection:** 80 dB. **IF Rejection:** 85 dB. **AM Suppression:** 55 dB. **Stereo Separation:** 48 dB at 1 kHz, 45 dB at 100 Hz, 42 dB at 10 kHz. **Subcarrier Rejection:** 60 dB. **SCA Rejection:** 60 dB.

#### AM TUNER:

**Sensitivity:** 200  $\mu\text{V}$ -per-meter (internal antenna). **Image Rejection:** 75 dB. **IF Rejection:** 80 dB. **S/N Ratio:** 52 dB. **THD:** 0.5% (30% modulation). **Selectivity:** 32 dB.

#### AMPLIFIER & PREAMPLIFIER:

**Power Output:** 120 watts-continuous-per-channel into 8-ohm loads, 20 Hz to 20 kHz. **Rated THD:** 0.03%. **Rated IM:** 0.03%. **Frequency Response:** 15 Hz to 60 kHz,  $\pm 1.0$  dB. **Residual Noise:** 1.3 mV. **Input Sensitivity:** phono, 2.6 mV; high level, 160 mV. **Phono Overload:** 160 mV. **S/N Ratio:** phono, 72 dB (94 dB referenced to 10 mV, A-weighted); high level, 88 dB (95 dB referenced to full output, A-weighted). **Bass Control Range:**  $\pm 6$  dB or  $\pm 11$  dB at 100 Hz. **Treble Control Range:**  $\pm 8$  dB or  $\pm 13$  dB at 10 kHz. **High- and Low-Filter Cutoff Frequencies:** subsonic, 15 Hz; low, 70 Hz; high, 7 kHz (all at -12 dB per octave).

#### GENERAL:

**Power Consumption:** 500 watts maximum, 120 volts, 60 Hz. **Dimensions:** 19 $\frac{3}{16}$  W  $\times$  7 $\frac{3}{32}$  H  $\times$  16 $\frac{1}{32}$  D. **Weight:** 37.4 lbs. net. **Suggested Retail Price:** \$895.

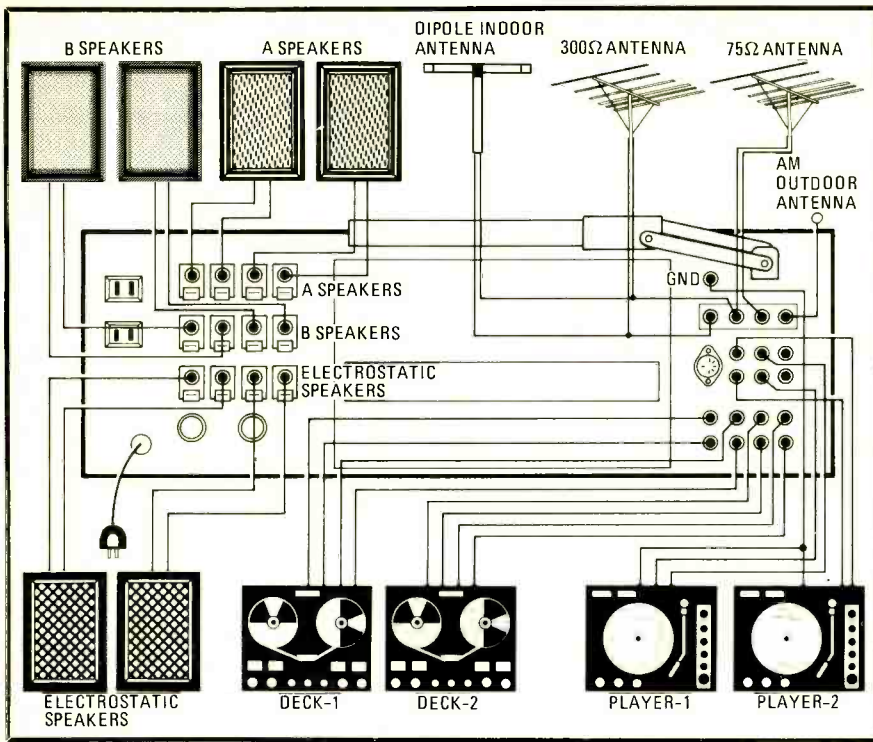

suppresses any possible DC drift. A constant current-drive system loads the predriver stages. A power limiter circuit protects the output transistors from excessive current, and a time-delay muting circuit safeguards the speakers.

The FM section uses a four-gang tuning capacitor and a dual-gate MOSFET RF stage in its front end. The IF section uses linear phase ceramic filters to achieve sharp skirt selectivity while maintaining adequate bandwidth for low distortion mono and stereo reception. A quadrature detector/limiter circuit in the form of an IC is used to recover the composite signal that is fed to a phase-locked-loop multiplex decoder IC stage, followed by an IC low-pass filter that suppresses subcarrier products. A modified form of AFC circuitry that Lux terms its *closed-lock-loop tuning system* locks received signals but, unlike conventional AFC circuits, is limited to a locking range of only  $\pm 100$  kHz to prevent pulling in adjacent strong-signal channels.

The AM tuner uses a three-gang tuning capacitor and amplified AGC circuitry as well as a ceramic filter in its IF section. The front-panel signal-strength meter can be used both in the AM and FM modes.

### FM measurements

Table I summarizes FM tuner lab measurements made on the *model R-1120*. While the receiver either equaled or exceeded most of the published specifications, particularly noteworthy were the incredibly low harmonic distortion figures that were obtained in both mono and stereo modes and the unusually high stereo FM separation figures obtained at 100 Hz and 10 kHz.

Figure 4 is a sweep-frequency analysis of FM audio response (including 75- $\mu$ s de-emphasis) of a desired output signal (shown in

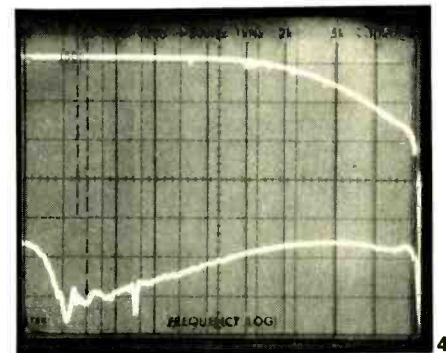

the upper trace) and an undesired opposite-channel output signal, which confirms higher separation at low audio frequencies. Note, too, the steep filtering action at 19 kHz that virtually eliminates any high-frequency subcarrier output signals at the output of the tuner or of the complete receiver. The AM suppression ratio was less impressive. Although this figure was better than specified, it seemed rather low for a set of this quality and price. Stereo threshold, sensitivity and overall muting threshold were ideally set by the factory to provide the best possible results in mono and stereo.

Table II summarizes amplifier and preamplifier performance, and a comparison with the manufacturer's published specifications shown elsewhere in this report shows that the amplifier is very conservatively rated.

Both the available phono inputs have identical input sensitivities (2.8 mV) and identical high overload capabilities (200 mV as

**TABLE I**  
**RADIO-ELECTRONICS PRODUCT TEST REPORT**

Manufacturer: Lux Audio of America, Ltd.

Model: R-1120

### FM PERFORMANCE MEASUREMENTS

	R-E Measurement	R-E Evaluation
<b>SENSITIVITY, NOISE AND FREEDOM FROM INTERFERENCE</b>		
IHF sensitivity, mono: ( $\mu$ V) (dBf)	1.7 (9.8)	Excellent
Sensitivity, stereo ( $\mu$ V) (dBf)	3.7 (16.6)	Excellent
50-dB quieting signal, mono ( $\mu$ V) (dBf)	2.7 (13.8)	Very good
50-dB quieting signal, stereo ( $\mu$ V) (dBf)	30 (34.8)	Very good
Maximum S/N ratio, mono (dB)	76	Excellent
Maximum S/N ratio, stereo (dB)	71	Excellent
Capture ratio (dB)	1.2	Very good
AM suppression (dB)	57	Good
Image rejection (dB)	80	Very good
IF rejection (dB)	88	Very good
Spurious rejection (dB)	90	Very good
Alternate channel selectivity (dB)	82	Excellent
<b>FIDELITY AND DISTORTION MEASUREMENTS</b>		
Frequency response, 50 Hz to 15 kHz ( $\pm$ dB)	0.5	Excellent
Harmonic distortion, 1 kHz, mono (%)	0.07	Superb
Harmonic distortion, 1 kHz, stereo (%)	0.08	Superb
Harmonic distortion, 100 Hz, mono (%)	0.085	Superb
Harmonic distortion, 100 Hz, stereo (%)	0.10	Excellent
Harmonic distortion, 6 kHz, mono (%)	0.09	Excellent
Harmonic distortion, 6 kHz, stereo (%)	0.12	Superb
Distortion at 50-dB quieting, mono (%)	0.7	Very good
Distortion at 50-dB quieting, stereo (%)	0.5	Good
<b>STEREO PERFORMANCE MEASUREMENTS</b>		
Stereo threshold ( $\mu$ V) (dBf)	3.3 (15.6)	Excellent
Separation, 1 kHz (dB)	54	Superb
Separation, 100 Hz (dB)	60	Superb
Separation, 10 kHz (dB)	33	Good
<b>MISCELLANEOUS MEASUREMENTS</b>		
Muting threshold ( $\mu$ V) (dBf)	3.3 (15.6)	Excellent
Dial calibration accuracy ( $\pm$ kHz at MHz)	40 at 98	Excellent
<b>EVALUATION OF CONTROLS, DESIGN, CONSTRUCTION</b>		
Control layout		Superb
Ease of tuning		Very good
Accuracy of meters or other tuning aids		Excellent
Usefulness of other controls		Excellent
Construction and internal layout		Very good
Ease of servicing		Good
Evaluation of extra features, if any		Very good
<b>OVERALL FM PERFORMANCE RATING</b>		<b>Excellent</b>



compared with the 160 mV claimed). While we prefer to measure signal-to-noise ratios based upon rated input sensitivities, it should be noted that if the reported 75-dB figure were referred to a 10-mV input, it would be equivalent to 87 dB—still without the benefit of any weighting curve. RIAA equalization was found to be accurate to within 0.2 dB from 30 Hz to 15 kHz.

Figure 5 is a scope photo showing the range of control of the BASS and TREBLE controls. With the control knobs in their depressed or normal positions, turnover frequencies are 200 Hz and 10 kHz; with the control knobs pulled out, the turnover frequencies shift to 400 Hz (for the BASS control) and 2 kHz (for the TREBLE control) for additional tone-control flexibility. In Fig. 6, it is not possible to observe the action of the steep subsonic filter since it begins to roll off well below the 20-Hz

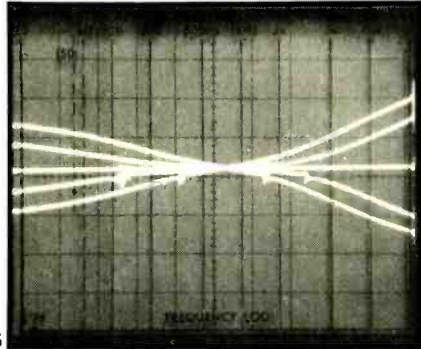

5

lower limit of the spectrum analyzer's log sweep range. The 12 dB-per-octave roll-off of the low-cut and high-cut filters is shown clearly in Fig. 6, however, and the -3-dB cutoff points correspond closely to the 70-Hz and 7-kHz frequencies specified by Lux.

### Summary

In order to arrive at the summary conclusions in Table III (along with our overall

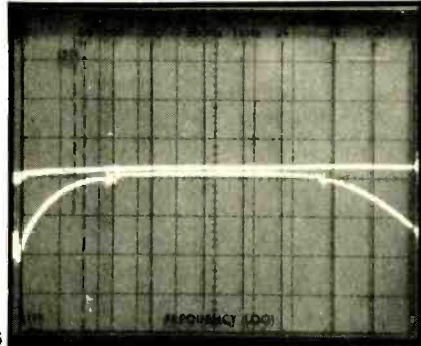

6

product evaluations), we listened to a great deal of recorded and broadcast material using the *model R-1120*. More than one pair of speakers was used so that we could characterize the sound produced by the receiver itself rather than judge the sound reproduction solely on the basis of the speakers used. Our experience with conventional dynamic speakers (both low- and high-efficiency types) leads us to believe that serious audiophiles will be willing to pay just a bit more for Lux equipment. As far as power output is concerned, there are only a few—a very few—loudspeakers that would ever demand more power than that provided by the *model R-1120* in any home listening situation. If, as Lux's brochures maintain, their engineers spend as much time listening as they do designing circuits, then the extra effort has paid off in the *model R-1120*.

R-E

**TABLE II**  
**RADIO-ELECTRONICS PRODUCT TEST REPORT**

Manufacturer: Lux Audio of America, Ltd.

Model: R-1120

### AMPLIFIER PERFORMANCE MEASUREMENTS

	R-E Measurement	R-E Evaluation
<b>POWER OUTPUT CAPABILITY</b>		
RMS power/channel, 8-ohms, 1 kHz (watts)	137	Excellent
RMS power/channel, 8-ohms, 20 Hz (watts)	130	Superb
RMS power/channel, 8-ohms, 20 kHz (watts)	130	Excellent
RMS power/channel, 4-ohms, 1 kHz (watts)	N/A	
RMS power/channel, 4-ohms, 20 Hz (watts)	N/A	
RMS power/channel, 4-ohms, 20 kHz (watts)	N/A	
Frequency limits for rated output (Hz-kHz)	13-23	Very good
<b>DISTORTION MEASUREMENTS</b>		
Harmonic distortion at rated output, 1 kHz (%)	0.0095	Superb
Intermodulation distortion, rated output (%)	0.025	Good
Harmonic distortion at 1-watt output, 1 kHz (%)	0.03	Good
Intermodulation distortion at 1-watt output (%)	0.02	Very good
<b>DAMPING FACTOR, AT 8 OHMS</b>		
	40	Very good
<b>PHONO PREAMPLIFIER MEASUREMENTS</b>		
Frequency response (RIAA ± dB)	0.2	Excellent
Maximum input before overload (mV)	200	Excellent
Hum/noise referred to full output (dB)		
(at rated input sensitivity)	75	Excellent
<b>HIGH LEVEL INPUT MEASUREMENTS</b>		
Frequency response (Hz-kHz, ± dB)	8-44, 1.0	Very good
Hum/noise referred to full output (dB)	95	Excellent
Residual hum/noise (minimum volume) (dB)	97	Very good
<b>TONAL COMPENSATION MEASUREMENTS</b>		
Action of bass and treble controls	See Fig. 5	Excellent
Action of secondary tone controls		N/A
Action of low frequency filter(s)	See Fig. 6	Excellent
Action of high frequency filter(s)	See Fig. 6	Very good
<b>COMPONENT MATCHING MEASUREMENTS</b>		
Input sensitivity, phono 1/phono 2 (mV)	2.8/2.8	
Input sensitivity, auxiliary input(s) (mV)	175	
Input sensitivity, tape input(s) (mV)	175	
Output level, tape output(s) (mV)	175	
Output level, headphone jack(s) (V or mW)	460 mV/8 ohms	
<b>EVALUATION OF CONTROLS, CONSTRUCTION AND DESIGN</b>		
Adequacy of program source and monitor switching		Excellent
Adequacy of input facilities		Very good
Arrangement of controls (panel layout)		Superb
Action of controls and switches		Very good
Design and construction		Very good
Ease of servicing		Good
<b>OVERALL AMPLIFIER PERFORMANCE RATING</b>		Excellent

**TABLE III**  
**OVERALL PRODUCT ANALYSIS**

Retail price	\$895
Price category	High
Price/performance ratio	Good
Styling and appearance	Excellent
Sound quality	Superb
Mechanical performance	Very good

Comments: The Lux Corporation's emphasis on listening quality (as opposed to just power output and measurable specifications) is as evident in this, their most powerful receiver, as it is in their separate components. The *model R-1120* sounds good—and its audible superiority is evident even if you connect relatively inexpensive loudspeakers (although its true potential is best realized when accurate-sounding, more costly speakers are used with it). A good deal of human engineering has obviously gone into the layout, and all controls have been positioned for the easiest, most logical operation. The idea of a separately available Dolby decoder board makes good sense, since many areas do not as yet have Dolby FM broadcasts and to have penalized all purchasers of the receiver with the added built-in cost of a Dolby decoder would have been unfair. Lux's description of this receiver (as well as of their lower-powered, lower-priced *models R-1050* and *R-1040*) as a tuner/amplifier is justified in some ways and not in others. The implication is, of course, that the unit offers the same sort of reproduction provided by a separate tuner and amplifier. The *model R-1120* does just that. However, the absence of separate access to its preamplifier output and its main amplifier inputs (a feature found on many less-costly receivers) limits its flexibility to that of an all-in-one integrated receiver. Like other Lux products we have seen, the receiver cannot be judged on power output alone, for if so its price would be on the high side. This component must be seen and heard at a properly equipped audio shop, with a bit of hands-on operation. There is a sense of handcrafted detail about this receiver that offers positive aesthetic advantages but also makes for a slightly crowded internal layout that is not the easiest to service. Still, if superb sound in an all-in-one receiver is what you crave and 120-watts-per-channel plus are what you need to drive your speakers, the *model R-1120* may well be for you.

### Electronic Warning Flasher Kit

This battery operated device continuously emits bursts of intense light. Great safety device for bicycle riders, skiers, hikers, boaters & campers. Comes complete w/ all electronic parts, quality glass-epoxy P.C. board & easy to understand instructions. Uses high-output xenon flash tube which flashes 2 times per second when batteries are fresh. Operates continuously for 12 hours on 2 alkaline "C" batteries. You need only to supply the batteries and, if desired, a battery holder & case.

C23207 \$6.95  
(3 for \$18.00)



#### Strobe Light Kit

5000V EFT xenon tube strobe light. Contains all parts including the case. Board and instructions. Operates on 117 Volt.

6 MV TRIGGER COILS 2 for \$1

Green Neon Same as NE2 but glows GREEN. Operates on 120V. 6 for \$1.00

LIQUID CRYSTAL WATCH DISPLAY WITH SPECS \$1.25

SLIDE SWITCH ASSORTMENT 20 for \$1.00

MV109 TUNING DIODE 2 for \$1.00

LASCR 200 VOLT .3 AMP. C23203 4 for \$1.00

MICRO-MINIATURE ROTARY SWITCH 8 POSITION 79¢

HONEYWELL STROBE 14" SHUTTER CORD \$1.00

### Electronic Flash Unit

These were to be installed in cases but the final assembly was never completed. You get a complete working flash unit. Operates on 2 AA flashlight batteries. You need only supply a shutter cord, battery holder & batteries. & if desired, some sort of case. Approx. overall size of circuit board, reflector & capacitor 3" x 2 1/2" x 1 1/2".

PHOTOFLA/H CAPS/ REFLECTOR  
350 mf 330V 100 \$2.00  
720 mf 360V 150 \$2.00  
520 mf 500V 2.00 \$2.00

Metal mirror finish round reflector for electronic flash strobes, slave lights, etc. 3 3/4" Dia. x 1 7/8" \$2.00

STROBE TUBE ASST. Brand new factory prime strobe tubes. Assortment of 5 strobe tubes w/ schematics. C23280 \$2.00

5V REED RELAY SPST \$1.00  
5V REED RELAY SPDT 1.50  
JUMBO YELLOW LED 5 \$1.00  
7el.05 5V REG. 5 \$1.00  
100V 5AMP SCR #SE# 3 1/2 1.00

Minimum order: \$5.00  
Please include \$1 for postage  
Visa, MC and COD accepted.  
Phone orders are welcome.



PO BOX 27038, DENVER, CO. 80227 Ph: (303) 973-1052  
Send for our FREE GIANT CATALOG of unique items !!!  
CIRCLE 48 ON FREE INFORMATION CARD

# market center

**CLASSIFIED COMMERCIAL RATE** (for firms or individuals offering commercial products or services). **\$1.50 per word** (no charge for zip code) . . . minimum 15 words.

**NONCOMMERCIAL RATE** (for individuals who want to buy or sell personal items) **85¢ per word** . . . no minimum.

**ONLY FIRST WORD AND NAME** set in bold caps. Additional bold face (not available as all caps) at 10¢ per word. Payment must accompany all ads except those placed by accredited advertising agencies. 5% discount for 6 issues, 10% for 12 issues within one year, if paid in advance. All copy subject to publisher's approval. Advertisements using P.O. Box address will not be accepted until advertiser supplies publisher with permanent address and phone number. Copy to be in our hands on the 26th of the third month preceding the date of the issue (i.e., August issue closes May 26). When normal closing date falls on Saturday, Sunday or a holiday, issue closes on preceding working day.

### PLANS & KITS

**CONSTRUCTION plans;** over 100. From TV to telephone, from broadcasting to computers. Catalog air mailed \$1.00; includes year's subscription to Electronic Newsletter. **DON BRITTON ENTERPRISES**, PO Box G, Waikiki, HI 96815

**MINI-laser plans** \$1.00. Science project catalog 25¢. **MOTEN**, 323 S. Franklin, #804, Chicago, IL 60606

**HOBBYIST** give your project the professional look. Printed circuit boards from your sketch or artwork. Affordable prices. Also fur kit projects. Rush free details. **DANOCINTHS**, Box 261, Westland, MI 48185

**MANUALS** for Govt. surplus radios, test sets, scopes. List 50¢ (coin). **BOOKS**, 7218 Roanoke Drive, Washington, D.C. 20021

**LINEAR Amplifier:** Ham only 2-30 MHz, 100 watt, solid-state. **Frequency Counter:** 300 MHz, miniportable/mobile, memory! **VOX-Compressor:** Splatter-free modulation booster. Construction plans \$3.00 each. All \$7.50! Kits, others, catalog available. **PANAXIS PRODUCTIONS**, Box 5516-F6, Walnut Creek, CA 94596

### EDUCATION & INSTRUCTION

**GRANTHAM's** FCC License Study Guide—377 pages, 1465 questions with answers/discussions—covering third, second, first radiotelephone examinations. \$13.45 postpaid. **GSE PUBLICATIONS**, 2000 Stoner, Los Angeles, CA 90025

**UNIVERSITY** degrees by mail! Bachelors, Masters, Ph.D.'s . . . Free revealing details. **COUNSELING**, Box 317-RE6 Tustin, CA 92680

**899** PUSHBUTTON AM AUTO RADIO  
All Are Brand New  
Reg. 10<sup>99</sup> AU-500 •Mounts In Or Under Dash  
•12 VDC Negative Ground

**1999** 8-TRACK AUTO STEREO PLAYER  
Enjoy Your Favorite Music In Car Van, Etc.  
Reg. 24<sup>99</sup> AU-428

- AC Adapt. 117V to 6, 7.5 & 9VDC. BA-159 . . . . . 3.99
- CB Gutter Mount Antenna. AA-929 . . . . . 6.99
- CB Trunk Mount Antenna. AA-999 . . . . . 5.99
- "Message Minder" Tape Recorder. As-Is. RA-731 . . . . . 7.99
- "Bib" Groove Klean Record Cleaner. HF-604 . . . . . 1.99
- 500" Hook-Up Wire Kit. WW-579 . . . . . 1.99
- Cassette Tape. Pkg of 3-30 Minute TA-879 . . . . . 79¢
- 8-Track Tape. 40 Minute TA-907 . . . . . 49¢
- Earphones. 8 Ohm. Less Cord. Pkg of 4 PH-405 . . . . . 49¢
- Singer 12 Digit MOS Calculator Chip With Data XM-635 . . . . . 1.79
- Ceramic Capacitors. Pkg of 100 CC-211 . . . . . 1.00
- RED LED. 2 Volt. 10mA. Pkg of 5 PL-233 . . . . . 59¢
- 709 High Gain OP AMP. RE-131 . . . . . 79¢
- Cassette Lapel Mike. 3.5mm Plug. MM-174 . . . . . 1.00
- Slidemount For Auto Stereo or CB. AU-149 . . . . . 1.99
- 6 to 12 Volt DC Converter. 6V. Acc. On 12V. Batt. AU-297 . . . . . 4.99

OFFER GOOD ONLY IN THE CONTINENTAL U.S.

**Olson.** electronics  
260 S. Forge St.  
Dept. LC Akron, Ohio 44327

NAME \_\_\_\_\_  
ADDRESS \_\_\_\_\_  
CITY \_\_\_\_\_ STATE \_\_\_\_\_ ZIP \_\_\_\_\_  
Qty. Stk. # Description Price Ea. Total \_\_\_\_\_  
\_\_\_\_\_

Please Send Catalog  Tax Postage TOTAL \_\_\_\_\_

To run your own classified ad, put one word on each of the lines below and send this form along with your check for \$1.50 per word (minimum \$15.00) to:

Radio-Electronics, 200 Park Avenue South, N.Y., N.Y. 10003

16.50	18.00	19.50	21.00	22.50
24.00	25.50	27.00	28.50	30.00
31.50	33.00	34.50	36.00	37.50
39.00	40.50	42.00	43.50	45.00

RADIO-ELECTRONICS



# 600 MHZ. FREQUENCY COUNTER ±0.1 PPM TCXO

## OPTO-8000.1



This new instrument has taken a giant step in front of the multitude of counters now available. The Opto-8000.1 boasts a combination of features and specifications not found in units costing several times its price. Accuracy of  $\pm 0.1$  PPM or better — *Guaranteed* — with a factory-adjusted, sealed TCXO (Temperature Compensated Xtal Oscillator). **Even kits require no adjustment for guaranteed accuracy!** Built-in, selectable-step attenuator, rugged and attractive, black anodized aluminum case (.090" thick aluminum) with tilt bail. 50 Ohm and 1 Megohm inputs, both with amplifier circuits for super sensitivity and both diode/overload protected. Front panel includes "Lead Zero Blanking Control" and a gate period indicator LED. AC and DC power cords with plugs included.

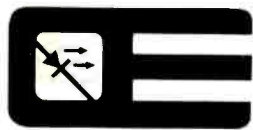

### OPTOELECTRONICS, INC.

5821 NE 14 Avenue  
Ft. Lauderdale, FL 33334  
Phones: (305) 771-2050 771-2051  
Phone orders accepted 6 days, until 7 p.m.



#### SPECIFICATIONS:

Time Base—TCXO  $\pm 0.1$  PPM GUARANTEED!  
Frequency Range—10 Hz to 600 MHz  
Resolution—1 Hz to 60 MHz; 10 Hz to 600 MHz  
Decimal Point—Automatic  
All IC's socketed (kits and factory-wired)  
Display—8 digit LED  
Gate Times—1 second and 1/10 second  
Selectable Input Attenuation—X1, X10, X100  
Input Connectors Type —BNC  
Approximate Size—3" h x 7 1/2" w x 6 1/2" d  
Approximate Weight—2 1/2 pounds  
Cabinet—black anodized aluminum (.090" thickness)  
Input Power—9-15 VDC, 115 VAC 50/60 Hz  
or internal batteries  
OPTO-8000.1 Factory Wired **\$299.95**  
OPTO-8000.1K Kit **\$249.95**

#### ACCESSORIES:

Battery-Pack Option—Internal Ni-Cad Batteries and charging unit **\$19.95**  
Probes: P-100—DC Probe, may also be used with scope **\$13.95**  
P-101—LO-Pass Probe, very useful at audio frequencies **\$16.95**  
P-102—High Impedance Probe, ideal general purpose usage **\$16.95**  
VHF RF Pick-Up Antenna—Rubber Duck w/BNC #Duck-4H **\$12.50**  
Right Angle BNC adapter #RA-BNC **\$ 2.95**

#### FC-50 — Opto-8000 Conversion Kits:

Owners of FC-50 counters with #PSL-650 Prescaler can use this kit to convert their units to the Opto-8000 style case, including most of the features.  
FC-50 — Opto-8000 **Kit \$59.95**  
\*FC-50 — Opto-8000F **Factory Update \$99.95**  
FC-50 — Opto-8000.1 (w/TCXO) **Kit \$109.95**  
\*FC-50 — Opto-8000.1F **Factory Update \$149.95**  
\*Units returned for factory update must be completely assembled and operational

**TERMS:** Orders to U.S. and Canada, add 5% to maximum of \$10.00 per order for shipping, handling and insurance. To all other countries, add 10% of total order. Florida residents add 4% state tax. C.O.D. fee: \$1.00. Personal checks must clear before merchandise is shipped.

CIRCLE 18 ON FREE INFORMATION CARD

www.americanradiohistory.com

# BEST BUYS

## OUR BEST SELLER: ECONORAM II™

S-100 compatible 8Kx8 in a cost-effective package. All lines buffered, fast, low power, unique configuration as two 4K blocks, handles DMA, and many other features... packed on a high quality board and using high quality parts (all sockets included). Totally static design.

See the 1/78 issue of KiloBaud for an in-depth evaluation, or send SASE to "KB Reprint" and we'll send you a copy... or better yet, talk to somebody who owns one.

Kit: \$135.00; 3 kits: \$375.00;  
Assembled: \$155.00



## H8 COMPATIBLE ECONORAM VI™ KIT

12Kx8 for the H8, with the same features that have made Econoram the name in S-100 buss memory. Static design, buffering, plus all sockets and bypass caps are already soldered in place so you can get right into the best part of kit building.

Kit form: \$235.00



## NEW! 16K ECONORAM IV™ KIT

S-100 compatible 16Kx8 memory. Static design, current under 2000 mA, manual write protect switches for 4K blocks, can be used with or without phantom line... and it actually costs less than dynamic equivalents!



## COMING SOON: 24K ECONORAM VII™ KIT

Just around the corner for the S-100 buss... we think you'll like it. All the regular features of our static Econorams, plus some extras. It's static, it's 24K, it's an Econoram... watch for it!

**PLUG FROM BILL:** There's more to life than computers... like music. Craig Anderton, noted author and designer of our Musikit products, has produced a cassette tape of original music that is distributed by our friends at PAIA Electronics (1020 W. Wishnie, Oklahoma City, OK 73116, \$6.45 ppd) in addition to hearing our Musikits in action, you get to hear some really good modern music. We like it... you probably will too.

**TERMS:** Please allow up to 5% for shipping, excess refunded. California add tax. COD orders accepted with street address for UPS. For VISA/Mastercharge orders call our 24 hour order desk at (415) 562-0636. Prices good through cover month of magazine.

**FREE FLYER:** These are just a few of the items we carry for the computer enthusiast. We also stock a broad line of semiconductors, passive components, and hobbyist items. We will gladly send you a flyer describing our products upon receipt of your name and address.

# GODBOUT

BILL GODBOUT ELECTRONICS  
BOX 2355, OAKLAND AIRPORT, CA 94614

TELEPHONE bugged? Don't be Watergated! Countermeasures brochure \$1.00. NEGEVE LABORATORIES, Box 547-RE, Pennsboro, WV 26415

## F.C.C. EXAM MANUAL

PASS FCC EXAMS! Memorize, study—Tests—Answers for FCC 1st and 2nd class Radio-telephone licenses. Newly revised multiple choice questions and diagrams cover all areas tested in FCC exams, plus Self-Study Ability Test. \$9.95 postpaid. Money-back guarantee.



COMMAND PRODUCTIONS P.O. BOX 26348 E  
RADIO ENGINEERING DIV SAN FRANCISCO, CAL 94126

WIN an electronics workshop! Plus instant prizes! R.T.T.'s new accelerated radio & TV course. RADIO TELEVISION TRAINING, P.O. Box 279-R68, Syracuse, NY 13206

## BUSINESS OPPORTUNITIES

**CABLE FM STATION.** No experience required, excellent spare-time income, others operate for you. Details free. BROADCASTING, Box 5516—F6, Walnut Creek, CA 94596

## HIGHLY PROFITABLE ONE-MAN ELECTRONIC FACTORY

Investment unnecessary, knowledge not required, sales handled by professionals. Ideal home business. Write today for facts! Postcard will do. Barta-RE-F, Box 248, Walnut Creek, CA 94597.

MECHANICALLY inclined individuals desiring ownership of Small Electronics Manufacturing Business—without investment. Write: BUSINESSES, 92-R, Brighton 11th, Brooklyn, NY 11235

CIRCLE 47 ON FREE INFORMATION CARD

### UNIVERSAL 4Kx8 MEMORY BOARD KIT \$69.95

32-2102 1 fully buffered, 16 address lines, on board decoding for any 4 of 64 pages, standard 44 pin bus, may be used with F-8 & KIM

### EXPANDABLE F8 CPU BOARD KIT \$99.00

Featuring Fairbug PSU 1K of static ram, RS 232 interface, documentation, 64 BYTE tests etc.

### 4K BASIC FOR FAIRBUG F8 \$25.00

on paper tape

### C/MOS (DIODE CLAMPED)

4012	16	4023	16	4046	1.45		
4013	29	4024	66	4047	1.50		
4001	16	4015	74	4025	16	4050	34
4002	16	4016	29	4027	37	4055	1.25
4006	95	4017	78	4028	72	4066	38
4007	16	4018	78	4029	37	4071	24
4009	37	4019	37	4030	33	4076	89
4010	37	4020	84	4035	97	40C10	22
4011	16	4022	85	4042	58	74C193	1.50

2788-8K EPROM (450 ns)	\$10.95
2922 STATIC SHIFT REG	\$1.95
2513 CHARACTER GEN	\$6.75
2518 HEX 32 BIT SR	\$3.50
5203-2K EPROM	\$4.50
21L021 (500 ns)	\$1.95
MK 4008P	\$1.45
MM5270-3KX1 DYN	\$3.45
2111-1256 X4 STATIC	\$3.45
2112-256 X4 STATIC	\$3.45
5260/2107 4K DYNAMIC RAM	\$2.75
1702A UV PROM	\$1.95
2204 4K PROM	\$10.95
8252	\$1.95
A751013 UART	\$6.95
8703C TELETYPE 3 STAGE	\$13.50
BINARY 8 BIT A/D CONVERTER	\$11.95
8080A	\$11.95

### AP PHOTO BOARDS USED FOR SOLDERLESS BREADBOARDING

26-L	128 FIVE-TIL POINT TERMINALS	\$12.75	
212R	POWER BOARD	\$2.50	
224R	96 FIVE-TIL POINT TERMINALS	\$9.75	
209R	POWER BOARD	\$2.25	
IC TEST CLIPS			
TC-14	\$4.50	TC-16	\$4.75

CTS 206 8 night position on dip switch \$1.90  
CTS 206 4 low position on dip switch \$1.45  
LIGHT ACTIVATED SCR'S TO 18 200V 1A \$1.10

### SILICON SOLAR CELLS

2 1/2" diameter 4V at 500 ma \$4.00

### RS232 CONNECTORS

DB 25P male	\$2.95
DB 25S female	\$3.50

### LED READOUTS

FND 357 C.C. 4 digit	\$5.95
FCS 8024 4 digit	\$5.95
CC 8" display	\$5.95
FND 503 C.C. 5 digit	\$8.95
FND 510 C.A. 5 digit	\$5.95
DL 704 3" C.C.	\$8.95

### PRINTED CIRCUIT BOARD

4 1/2" x 16 1/2" SINGLE SIDED EXPOSURE BOARD \$16.00 ea  
5 \$2.60

### 7 WATT LD-65 LASER DIODE IR \$8.95

2N 3820 P FET	\$4.45
2N 5457 N FET	\$4.45
2N2546 UJT	\$4.45
ER 900 TRIGGER DIODES	4 \$1.00
2N 6028 PHOG. UJT	\$4.65

MINIATURE MULTI-TURN TRIM POT'S 100, 500, 1K, 2K, 5K, 10K, 25K, 50K, 100K, 200K, 500K, 1Meg, 2Meg, \$75 each \$32.00

WSU 30 Hard wire wrap tool used to wrap, un-wrap & strip #30 wire \$5.30

### VERIPAX PC BOARD

This board is a 16K x 8 bit computer board with 1.4 x 6" DRILLED AND ETCHED which will hold up to 21 single 14 pin IC's or 8 16 or 18 pin DIP IC's with buses for power supply connector \$4.00

MV 5691 YELLOW GREEN BIPOLAR LED \$9.00

RED, YELLOW, GREEN or AMBER LARGE LED'S 2" \$61.00

1L-5 (IMCT 2) OPTO-ISOLATOR \$7.75

MOLEX PINS 1000 \$1.00

10 WATT ZENERS 3.9, 4.7, 5.6, 8.2, 18, 22, 100, 150 or 200V ea \$6.00

1 WATT ZENERS 4.7, 5.6, 10, 12, 15, 18 or 22V ea \$5.25

MC6860 MODEM CHIP \$9.95

MCM 6577 A 7 x 9 character gen \$10.75

### Silicon Power Rectifiers

PRV 1A	3A	12A	50A	125A	240A
100	06	14	30	80	370
200	07	20	35	115	475
400	09	25	50	140	650
600	11	30	70	180	850
800	15	35	90	230	1050
1000	20	45	110	275	1250

SAD 1024 a REDICOM 1024 stage analog "Bucknet Brigade" shift register \$18.95

IN 4148 1N914 \$15 \$1.50

ACA 81 OPTICAL LIMIT SWITCH \$1.50

### REGULATORS

309K	\$9.35	340K	12.15
723	\$5.00	or 24V	\$9.95
LM 376	\$6.00	340T 5, 6, 8, 12	
320K 5, 12	\$1.00	or 24V 5, 95	
320T 5, 15	\$1.00	78 MG	\$1.35
or 24V	\$9.95	79 MG	\$1.35

### TRANSISTOR SPECIALS

2N6233-NPN SWITCHING POWER	\$1.95
MRF-8004 A CB RF Transistor NPN	\$1.50
2N1377 NPN Si TO 3	\$1.00
2N1546 PNP GE TO-3	\$1.75
2N4006 PNP Si TO 3	\$1.50
2N6056 NPN Si TO 3	\$1.70
2N5086 PNP Si TO 92	\$4.10
2N3137 NPN Si RF	\$1.85
2N404 PNP GE TO 5	\$1.00
2N3919 NPN Si TO 3 HF	\$1.50
2N3904 NPN Si TO 92	\$3.10
2N3767 NPN Si TO 66	\$1.70
2N2272 NPN Si TO 18	\$1.00
2N3055 NPN Si TO 3	\$1.50
2N3904 NPN Si TO 92	\$1.00
2N3906 PNP Si TO 92	\$1.00
2N5296 NPN Si TO 220	\$1.50
2N6109 PNP Si TO 220	\$1.50
2N3638 PNP Si TO 5	\$1.00

### TTL IC SERIES

7400	13	7445	65	74151	61
7401	13	7446	68	74153	61
7402	13	7447	58	74154	94
7403	13	7448	68	74155	58
7404	15	7450	15	74157	55
7405	13	7472	25	74161	55
7406	16	7473	28	74163	38
7407	20	7474	28	74164	85
7408	18	7475	45	74165	95
7409	18	7476	30	74170	168
7410	13	7480	31	74173	120
7411	18	7483	65	74174	95
7412	13	7485	87	74175	85
7413	36	7486	28	74176	75
7414	60	7490	42	74177	75
7416	22	7491	58	74180	85
7417	25	7492	43	74181	180
7420	13	7493	43	74180	100
7421	22	7496	67	74181	100
7422	22	7495	65	74192	79
7427	19	7496	65	74193	79
7430	13	74107	28	74194	80
7432	22	74121	29	74195	85
7437	21	74122	38	74196	86
7438	21	74123	46	74279	55
7440	13	74126	40	74367	65
7441	70	74126	40	75491	50
7442	37	74150	94	75492	50

### DATA CASSETTES

44 Pin Solder Tail 156" Connector \$2.20

MM 5387AA new clock chip which will directly drive LED'S 12/24 hrs, 1 supply & alarm \$5.95

NO. 24 8 CONDUCTOR SPECTRA FLAT CABLE 10' \$1.50 100' \$13.50

NO. 30 WIRE WRAP WIRE SINGLE STRAND 100' \$1.40

### ALCO MINATURE TOGGLE SWITCHES

MTA 106 SPDT	\$1.05
MTA 206 DPDT	\$1.70
MTA 206 P DPDT CENTER OFF	\$1.85
MTA 206 P DPDT CENTER OFF WITH SWITCH	\$1.85

### Full Wave Bridges

PRV 1A	2A	6A	25A	8 PIN	22	24 PIN	30
100			1.30	14 PIN	25	28 PIN	50
200	.75	1.25	2.00	16 PIN	28	40 PIN	60
400	.95	1.50	3.00	18 PIN	30		
600	1.20	1.75	4.00				

### SANKEN AUDIO POWER AMPS

SA 1010 G 10 WATTS	\$5.80
SA 1020 G 20 WATTS	\$13.70
SA 1050 G 50 WATTS	\$25.90

### TANTALUM CAPACITORS

22UF 35V 5 S1 00	6.8UF 35V 4 S1 00
47UF 35V 5 S1 00	10UF 10V
68UF 35V 5 S1 00	22UF 25V
10UF 35V 5 S1 00	15UF 35V 3 S1 00
2.2 UF 20V 5 S1 00	30UF 6V 5 S1 00
3.3UF 35V 4 S1 00	47UF 20V
4.7UF 15V 5 S1 00	68UF 15V

### 74LS SERIES

74LS00	21	74LS126	47	LM 101	75
74LS02	21	74LS132	60	LM 301PA8	29
74LS03	21	74LS136	39	LM307	30
74LS04	28	74LS138	70	LM 308	75
74LS05	28	74LS139	70	LM 311	75
74LS08	21	74LS151	70	LM 318	120
74LS09	28	74LS153	70	LM 319	95
74LS10	21	74LS155	70	LM 324	105
74LS11	21	74LS156	70	LM 339	110
74LS12	28	74LS157	72	LM 358	140
74LS15	25	74LS160	88	LM 370	115
74LS20	24	74LS161	85	LM 377	250
74LS21	26	74LS162	85	LM 380	95
74LS22	26	74LS163	85	LM 381	125
74LS26	32	74LS169	88	LM 382	125
74LS27	32	74LS169	85	LM 537	250
74LS30	26	74LS170	168	LM 553	250
74LS32	32	74LS173	110	LM 556	39
74LS33	32	74LS174	100	LM 558	85
74LS38	32	74LS175	80	NE540L	235
74LS40	26	74LS190	95	560	200
74LS42	65	74LS191	95	565	95
74LS47	19	74LS192	95	566	125
74LS48	26	74LS193	95	567	130
74LS49	26	74LS195	95	703	90
74LS50	95	74LS196	95	709	25
74LS74	35	74LS197	95	710	35
74LS76	35	74LS221	125	741C or V 31	
74LS85	130	74LS225	70	747	65
74LS86	65	74LS258			







## FOR SALE

FREE catalog. IC's, Semi's. **CORNET ELECTRONICS**, 649A Notre Dame W., Montreal, Que., Canada, H3C-1H8. US Inquiries.

RECONDITIONED test equipment. \$0.50 for catalog. **WALTER'S TEST EQUIPMENT**, 2697 Nickel, San Pablo, CA 94806

**VERSATILE LOGIC ANALYZER**



VIA - 1000 \$575.00

**DATA DOMAIN, WAVE-SHAPE, AND MAP MODE - 16 BITS X 16 WORDS - POS, NEG OR NEGATIVE TIME DISPLAY - 10 MHZ - 0.9999 CLK OR EVENT DELAY. MANY MORE FEATURES. WRITE FOR MORE INFORMATION.**

**lab science**

PO BOX 1972  
BOULDER, CO 80306

COMPUTER, peripheral, technical reports; project supplies; kits. Send \$1 for **THE CPU HOBBYIST**, Box 738-RE, College Park, MD 20740

**RECORDS-TAPES!** Discounts to 73%; all labels; no purchase obligations; newsletter; discount dividend certificates; 100% guarantees. Free details. **DISCOUNT MUSIC CLUB**, 650 Main St., Dept. 3-0678, New Rochelle, NY 10801

**PICTURE TUBE MACHINE**

We buy and sell NEW and USED CRT rebuilding machinery. COMPLETE TRAINING. Buy with CONFIDENCE from the ORIGINAL MFRG.

For complete details send name, address, zip to:

**LAKESIDE INDUSTRIES**  
3520 W. Fullerton Ave.  
Chicago, Ill. 60647  
Phone: 312-342-3399



**NAME brand test equipment.** Up to 50% discount. Free catalog and price list. **SALEN ELECTRONICS**, P.O. Box 82, Skokie, IL 60076

**ELECTRONIC parts!** Refundable \$1 gets you 1978 catalog. Send to: **B.C. ELECTRONICS**, P.O. Box 226, West Lynn, MA 01905

**YES, YOU CAN BUILD AN ELECTRONIC ORGAN**



That has a PIPE ORGAN SOUND

With **DEVTRONIX** easy to build assemblies. Own the ultimate in organ design & sound at 1/2 the cost of commercial organs.

Several models to choose from.

BROCHURE AND DEMO RECORD \$1.00



Dept. B  
5872 Amapola Dr.  
San Jose, CA 95129

## INTO TV ANTENNA SYSTEMS? YOU'LL BE INTO TASCO!

Below wholesale prices on a full line of antenna installation surplus shipped from stock. Unbelievable prices on connectors, wall plates, splitters, transformers, amplifiers, etc. Write for free catalogue. Order now & compare. **TASCO**. PO Box 30143 Houston Tex 77009

**RADIO & TV tubes 36¢ each.** One year guaranteed. Plus many unusual electronic bargains. Free catalog. **CORNELL**, 4217-E University, San Diego, Calif. 92105

**SERVICEMEN**—Cleaners, lubricants, adhesives for all electronic repairs. Write for free catalog. **PROJECTOR-RECORDER BELT CORP.**, Box 176, Whitewater, WI 53190 800-558-9572 ex. WI

# Govt. SURPLUS ELECTRONIC EQUIPMENT CATALOG

New ITEMS . . . New BARGAINS! **FREE UPON REQUEST!**

if you haven't received our new Catalog, write for free copy today. Address: Dept. RE

**FAIR RADIO SALES**

1016 E. EUREKA • Box 1105 • LIMA, OHIO • 45802

**CARBON film resistors**—1/2W, 5% (1-4M7 ohms) 3.5¢ each. 50/value—\$0.85. Postage, handling \$1.00. Other components. Free catalog, resistor sample. **COMPONENTS CENTER**, Box 295R, West Islip, NY 11795

## BREATHE BETTER AIR WITH AMAZING NEGATIVE ION GENERATOR

Scientists have long known that negative ions can be beneficial to man's health. These tiny but potent atmospheric particles abound in nature. Now, through the magic of science, you can duplicate this delightful phenomenon in the privacy and convenience of your own home or office.

Output: 9 x 10<sup>9</sup> ions/sec  
Size: 19" x 14" x 8"  
Weight: 18 pounds

DEALERS WANTED

**GOLDEN ENTERPRISES**  
P.O. Box 1283-RE  
Glendale, Arizona 85311

(Please send \$1.00 for fascinating details)

**TUBES, receiving and Industrial, semiconductors, factory boxed, low prices, free price list.** **TRANSLERONIC INC.**, 1365 — 39th Street, Brooklyn, NY 11218 212-633-2800

## NO-ETCH

Duplicate or make additions to, modifications of Any Etched Board. Ideal for point-to-point or wire wrap breadboards.

Complete set of (3) tools IP6003 \$25.00 ppd. A. F. Stahler Co., P.O. Box 354R, Cupertino, CA 95014 - (408) 252-4219.



**B&K test equipment.** Free catalog. Free shipping. Dinosaur discounts. **SPACETRON-DF**, 948 Prospect, Elmhurst, IL 60126

## Why is this the LARGEST SELLING low cost COUNTER KIT?

This counter is such a great seller because people like you have found that, feature for feature, the CT-50 gives you more for your money. Advanced LSI and CMOS circuitry has; lowered power consumption, increased performance, and reduced cost. Complete push button operation makes using the CT-50 a snap, and automatic decimal point positioning gives you quick, reliable readings. Battery operation is also possible because the CT-50 runs equally as well on 12VDC as it does on 110VAC. For ultra-accuracy we offer the CB-1 color burst adapter, it locks the CT-50's internal crystal to the television networks color standard for .001 ppm accuracy! Why sacrifice performance by using another counter when you can get professional quality at the unheard of price of \$89.95? Order yours today!



**SPECIFICATIONS**  
Sensitivity: less than 10 mv.  
Frequency range: 5 Hz to 60 MHz, typically 65 MHz  
Gate time: 1 second, 1/10 second, with automatic decimal point positioning on both direct and prescale  
Display: 8 digit red LED .4" height  
Accuracy: 2 ppm, internal TCXO standard  
Input: BNC, 1 megohm direct, 50 Ohm with prescale option  
Power: 110 V ac 5 Watts or 12 V dc @ 300-400 ma  
Size: Approx 6" x 4" x 2", high quality aluminum case

CT 50, 60 MHz Counter Kit ..... \$89.95  
CT-50 wt 60 MHz Counter Wired & Tested ..... \$159.95  
CT-600, 600 MHz prescaler option for CT-50, add. .... \$29.95

## MINI-KITS

**FM WIRELESS MIKE KIT**  
Transmit up to 300' to any FM broadcast radio, uses any type of mike. Runs on 3 to 9V. Type FM-2 has added super-sensitive mike preamp.  
FM-1 — \$2.95 FM-2 — \$4.95

**SUPER-SLEUTH AMPLIFIER**  
A super-sensitive amplifier which will pick up a pin drop at 15 feet! Great for monitoring baby's room or a general purpose test amplifier. Full 2 watts of output, runs on 6 to 12 volts, uses any type of mike. Requires 8-45 ohm speaker.  
Complete Kit, BN-9 ..... \$4.95

**COLOR ORGAN/MUSIC LIGHTS**  
See music come alive! 3 different lights flicker with music or voice. One light for low, one for the mid-range and one for the highs. Each channel individually adjustable, and drives up to 300 watts. Great for parties, band music, nite clubs and more.  
Complete Kit, ML-1 ..... \$7.95

**tone DECODER KIT**  
A complete tone decoder on a single PC Board. Features: 400-5000 Hz adjustable frequency range, voltage regulation, 567 IC. Use-ful for touch-tone decoding, tone burst detection, FSK demod, signaling, and many other uses. Use 7 for 12 button touchtone decoding. Runs on 5 to 12 volts.  
Complete Kit, TD-1 ..... \$4.95

**LED BLINKY KIT**  
A great attention getter which alternately flashes 2 Jumbo LEDs. Use for name badges, buttons, or warning type panel lights. Runs on 3 to 9 volts.  
Complete Kit, BL-1 ..... \$2.95

**POWER SUPPLY KIT**  
Complete triple regulated power supply provides variable +15 volts at 200 mA and ±5 volts at 1 Amp. 50 mV load regulation good filtering and small size. Kit less transformers. Requires 6-8V at 1 Amp and 18 to 30 VCT.  
Complete Kit, PS-3LT ..... \$6.95

**SIREN KIT**  
Produces upward and downward wail characteristic of police siren. 5 watts audio output, runs on 3-9 volts, uses 8-45 ohm speaker.  
Complete Kit, SM-3 ..... \$2.95

**VIDEO MODULATOR KIT**  
Converts any TV to video Monitor. Super stable tunable over Ch. 4-6. Runs on 1-5V, accepts std video signal. Best unit on the market.  
Complete Kit, VD-1 ..... \$6.95

## SIX DIGIT 12/24 HOUR CLOCK KIT

Here's a clock you can be proud of. The best looking, most complete kit on the market! Features include: time set push-buttons, jumbo .4" readouts, and extruded aluminum case available in 5 colors. All parts included. Colors: gold, silver, bronze, black, blue (specify)



Clock Kit, DC-5 ..... \$22.95 Alarm Clock, 12 Hr., DC-8 ..... 24.95  
Mobile Clock, DC-7 ..... 25.95 Clock with HAM ID timer DC-10 ..... 25.95

Assembled and tested clocks available, add \$10.00 to Kit price.

## 600 MHz PRESCALER

Extend the range of your counter to 600 MHz. Works with all counters. Less than 150 mv sensitivity. Specify -10 or -100. Wired, tested,  
PS-1 B ..... \$59.95  
Kit, PS-1 B ..... \$44.95

## CALENDAR ALARM CLOCK

Has every feature one could ever ask for. Kit includes everything except case, build it into wall, station or even car!

**FEATURES:**  
• 6 Digits, 5" High LED • 12/24 Hour Format  
• High Accuracy (1 minute/month)  
• Calendar shows mo./day • Snooze button  
• True 24 Hour Alarm • 5001 chip does all!  
• Battery back up with built-in on chip time base

Complete Kit, less case  
DC-9 ..... \$34.95

## TV TYPEWRITER KIT

A compact 5 x 10 inch PC card that requires only an ASCII keyboard and a TV set to become a complete interactive terminal for connection to your microprocessor asynchronous interface. Its many features are single 5-volt supply, crystal controlled sync and baud rates (up to 9600 baud), 2 pages of 32 characters by 16 lines, read to and from memory, computer and keyboard operated cursor and page control, power-on initialization, full 64-character ASCII display, built-in cursor, keyboard, computer control backspaces, forward spaces, line feeds, rev. line feeds, home, returns cursor. Also clears page, clears to end of line, selects page 1 or 2, reads from to memory. The card requires 5 volts at approx. 900 ma and outputs standard 75 ohm composite video.

TH3216 Kit ..... \$149.50  
TH3216, Assembled and Tested ..... 239.95  
VD 1 Video to RF Modulator Kit ..... 6.95

## CAR CLOCK KIT

12/24 Hour 12-Volt AC or DC  
• High Accuracy (1 minute/month)  
• 6 Jumbo .4" LED readouts  
• Easy, no-polarity hookup  
• Display blanks with ignition  
• Case mounting bracket included  
• Super instructions  
Complete Kit, DC-11 ..... \$27.95  
Auto dimmer for DC-11 ..... \$2.50

**741 OP AMP SPECIAL**  
Prime, Mini-dip 10/\$2.00

ICs	LINEAR	REGULATOR	TRANSISTORS
5314 Clock \$2.95	555 \$5.00	78MG \$1.49	MRF-238 30W VHF \$11.95
7001 Clock 6.95	556 \$.75	309K .89	NPN 2N3904 type 10/\$1.00
5369 Cmos 1.95	566 1.49	309H .99	PNP 2N3906 type 10/\$1.00
7447 .79	567 1.49	340K 12 .99	NPN Power Tab 40W 3/\$1.00
7473 .35	1458 .50	7805 .89	PNP Power Tab 40W 3/\$2.00
7475 .50	LED DRIVER 7812 .89	FET MRF-102 type 3/\$2.00	
7490A .55	7549-1 50 7815 .89	UJT 2N2646 type 3/\$2.00	
74143 3.50	7549-2 50 7818 .89	2N3055 NPN Power 75	

**ORDER BY PHONE OR MAIL**  
Satisfaction guaranteed or money refunded. Add 5% for shipping and insurance. COD add \$1.00. Orders under \$10.00 add \$3.75. NY residents add 8% sales tax. Minimum order \$6.00

**ramsey electronics**

BOX 4072B ROCHESTER, NY 14610 (716) 271-6487



**AVAILABLE NOW! ONLY \$ 5.90**  
**JAPANESE TRANSISTOR SUBSTITUTION MANUAL**



An invaluable Japanese to Japanese substitution guide for approximately 3000 transistors.

\* Covers the 2SA, 2SB, 2SC, and 2SD series.

\* Introduction includes a guide to understanding Japanese transistors.

\* A 90-page, 8 1/2" by 11", soft cover book.

# MAY SPECIAL

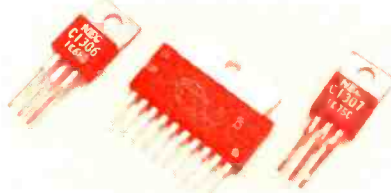

**ORDER NOW**

LIMITED Q'TY

2SC1306 **\$1.90** REG \$ 3.90  
 2SC1307 **\$2.90** REG \$ 4.90  
 TA7205P **\$1.90** REG \$ 3.50

NO FURTHER DISCOUNT  
 ON SPECIAL OFFER

## Seeking Original Japanese Replacement Parts for CB, TV and Stereo Repair Use?

2SA 49	2SA 744	2SB 528D	1.60	2SC 642A	5.90	2SC 1051	4.40	2SC 1569	1.40	2SD 235	1.00	AN 315	3.70	TA 7108P	1.90
2SA 52	2SA 745R	2SB 529	.90	2SC 644	.45	2SC 1060	1.40	2SC 1584	1.40	2SD 261	.60	AN 328	3.90	TA 7109P	3.40
2SA 53	2SA 747	2SB 530		2SC 645	.70	2SC 1061	1.40	2SC 1586	7.60	2SD 287	3.70	AN 348	3.70	TA 7120P	1.90
2SA 70	2SA 748	SUB 2SB 541		2SC 650	1.30	2SC 1079	5.90	2SC 1624	1.30	2SD 288	1.40	AN 362	3.00	TA 7120PC	2.15
2SA 101	2SA 750	2SB 531	3.40	2SC 665H	8.50	2SC 1080	4.40	2SC 1626	1.10	2SD 300	5.60	BA 511	3.40	TA 7122AP	1.90
2SA 102	2SA 755	2SB 536	1.60	2SC 668	.45	2SC 1096	1.00	2SC 1628	1.30	2SD 313	1.10	BA 521	3.70	TA 7124P	1.60
2SA 234	2SA 756	2SB 537	1.60	2SC 680	2.80	2SC 1098	1.10	2SC 1647	1.00	2SD 314	1.20	HA 1137	4.90	TA 7129P	1.90
2SA 235	2SA 758	2SB 539	4.90	2SC 681A	1.80	2SC 1111	3.40	2SC 1669	1.60	2SD 315	1.20	HA 1138	4.40	TA 7130P	2.80
2SA 240	2SA 764	2SB 541	4.40	2SC 684	1.10	2SC 1114	3.70	2SC 1674	.59	2SD 325	1.10	HA 1149	5.60	TA 7136P	1.30
2SA 329	2SA 774	2SB 554	10.00	2SC 693B	.59	2SC 1115	4.40	2SC 1675	.59	2SD 330	1.00	HA 1151	4.40	TA 7146P	4.20
2SA 342	2SA 777	2SB 556	4.90	2SC 696	1.95	2SC 1116	4.90	2SC 1678	2.25	2SD 341	5.60	HA 1156	3.00	TA 7159P	2.50
2SA 353	2SA 794A	2SC 708	1.90	2SC 708	1.90	2SC 1116A	6.60	2SC 1679	4.25	2SD 350	5.90	HA 1158	5.00	TA 7200P	4.60
2SA 377	2SA 798	2SB 561B	.70	2SC 710	.45	2SC 1124	1.30	2SC 1681	7.00	2SD 352	.90	HA 1159	5.80	TA 7201P	4.60
2SA 440	2SA 810	2SB 564	.70	2SC 711	.45	2SC 1127	1.40	2SC 1682	4.5	2SD 356D	1.10	HA 1196	4.90	TA 7203P	3.70
2SA 473	2SA 814	2SB 566	2.80	2SC 712	.59	2SC 1161	1.90	2SC 1684	.59	2SD 357D	1.00	HA 1197	3.90	TA 7204P	3.40
2SA 483	2SA 815	2SB 595	1.90	2SC 717	.59	2SC 1162	1.10	2SC 1687	.70	2SD 358	1.30	HA 1201	1.50	TA 7205P	3.50
2SA 484	2SA 816	2SB 596	.70	2SC 727	1.90	2SC 1166	.59	2SC 1688	.70	2SD 359	1.00	HA 1202	2.25	TA 7310P	3.95
2SA 485	2SA 818	SUB 2SB 507		2SC 730	4.40	2SC 1167	6.60	2SC 1708	.59	2SD 360	1.20	HA 1211	1.50	TA 78005M	5.80
2SA 489	2SA 839	SUB 2SC 600A	7.00	2SC 731	5.80	2SC 1170B	6.60	2SC 1728	1.90	2SD 361	1.00	HA 1306W	3.70	TA 8005P	5.80
2SA 490	2SA 841	2SC 732	.59	2SC 732	.59	2SC 1172B	8.50	2SC 1730	.59	2SD 370		HA 1312	3.90	TA 8012M	6.60
2SA 493	2SA 844	2SC 733	.59	2SC 733	.59	2SC 1173	.90	2SC 1756	1.40	SUB 2SD 427		HA 1322	4.40	TA 8012P	5.80
2SA 495	2SA 847	2SC 734	.59	2SC 734	.59	2SC 1175	.90	2SC 1760	1.90	2SD 371S	2.80	HA 1339	4.40	TA 8015M	6.50
2SA 496	2SA 850	2SC 735	.59	2SC 735	.59	2SC 1177	14.00	2SC 1765	8.80	2SD 380	7.60	HA 1339A	4.40	TBA 810SH	3.70
2SA 497	2SA 872A	2SC 738	.59	2SC 738	.59	2SC 1189	1.20	2SC 1775	4.5	2SD 382	1.40	HA 1342A	4.40		
2SA 505	2SA 885	2SC 756	2.80	2SC 756	2.80	2SC 1209	.70	2SC 1816	3.90	2SD 388	3.40	HA 1452	3.40		
2SA 509	2SA 908	SUB 2SC 458		2SC 756A	3.00	2SC 1211D	.59	2SC 1846	.70	2SD 388A	4.40	LA 1111P	2.50		
2SA 525	2SA 913	2SC 284	1.20	2SC 763	.59	2SC 1212A	1.40	2SC 1885	7.00	2SD 389	.90	LA 1201	2.50		
2SA 530		2SC 317	1.20	2SC 772	.45	2SC 1213	.70	2SC 1908	.59	2SD 390	1.00	LA 1221	2.80		
2SA 537A	2SB 22	2SC 352A	2.50	2SC 773	.70	2SC 1215	.70	2SC 1909	3.90	2SD 424	8.50	LA 1364	4.40		
2SA 539	2SB 54	2SC 353A	2.50	2SC 774	2.00	2SC 1222	.45	2SC 1913	1.20	2SD 425	6.50	LA 3300	3.00		
2SA 545	2SB 55	2SC 367	.90	2SC 775	1.95	2SC 1226A	.90	2SC 1945	5.60	2SD 426	4.60	LA 3301	3.00		
2SA 561	2SB 55	2SC 369	.59	2SC 776	2.65	2SC 1237	4.25	2SC 1951	1.10	2SD 427	3.00	LA 4030P	3.40		
2SA 562	2SB 75	2SC 371	.59	2SC 777	3.50	2SC 1239	3.90	2SC 1957	1.20	2SD 525	1.60	LA 4031P	3.00		
2SA 564A	2SB 77	2SC 372	.45	2SC 778	3.60	2SC 1279	.70	2SC 1969	4.90	2SD 526	1.10	LA 4032P	3.40		
2SA 565	2SB 173	2SC 373	.45	2SC 781	2.65	2SC 1306	3.90	2SC 1973	1.10	2SD 555A	6.60	LA 4051P	3.70		
2SA 565	2SB 175	2SC 374	.59	2SC 783R	3.60	2SC 1307	4.90	2SC 1974	1.90	2SD 610	1.90	LA 4400	3.70		
2SA 566	2SB 176	2SC 377	.70	2SC 784	.59	2SC 1310	.59	2SC 1975	4.40	SG 613 (TV)	5.95	LD 3120	2.50		
2SA 606	2SB 178	2SC 380	.59	2SC 785	.59	2SC 1312	.59	2SC 2028	.90			M 5111A	2.80		
2SA 607	2SB 186	2SC 381	.59	2SC 789	1.00	2SC 1313G	.59	2SC 2029	3.90			M 5111B	7.00		
2SA 624	2SB 187	2SC 382	.59	2SC 793	2.80	2SC 1317	.45	2SC 2076	.59			M 5115PR	4.90		
2SA 627	2SB 202	2SC 383	.90	2SC 799	3.60	2SC 1318	.45	2SC 2091	2.80			M 5151L	4.90		
2SA 628	2SB 220	2SC 387A	.59	2SC 802		2SC 1325A	7.60	2SC 2092	3.90			M 5152L	2.50		
2SA 634	2SB 237	2SC 388A	1.00	SUB 2SC 799		2SC 1327	.59	2SC 2098	4.90			M 51841P	2.80		
2SA 640	2SB 324	2SC 394	.59	2SC 815	.59	2SC 1330	.70					M 5320 DP	2.25		
2SA 643	2SB 337	2SC 403	.59	2SC 828	.45	2SC 1335	.70					M 5327 3P	2.80		
2SA 653	2SB 346	2SC 429	.90	2SC 829	.45	2SC 1342	.59					M 53274P	2.50		
2SA 659	2SB 367	2SC 454	.59	2SC 838	5.90	2SC 1344	.59					M 54730 P	8.80		
2SA 661	2SB 368	2SC 458	.59	2SC 838	5.90	2SC 1345D	.59					M 53393	7.60		
2SA 663	2SB 379	2SC 460	.59	2SC 839	.59	2SC 1346	.70					STK 011	7.60		
2SA 666	2SB 381	2SC 461	.59	2SC 867	4.25	2SC 1347	.70					STK 014	9.50		
2SA 672	SUB 2SB 415	2SC 478	1.10	2SC 870	.59	2SC 1358	5.90					STK 015	6.60		
2SA 673	2SB 400	2SC 481	1.60	2SC 871	.59	2SC 1359	.59					STK 016B	8.50		
2SA 678	2SB 405	2SC 482	1.50	2SC 897	3.40	2SC 1360	1.00					STK 022	11.00		
2SA 679	2SB 407	2SC 484		2SC 898	4.40	2SC 1362	.59					STK 032	14.00		
SUB 2SA 744	2SB 411	SUB 2SC 485		2SC 900	4.5	2SC 1364	.70					STK 035	8.50		
2SA 680	DISC. BY MFR.	2SC 485	1.60	2SC 923	.45	2SC 1377	4.90					STK 037	9.80		
SUB 2SA 744	2SB 415	2SC 486	1.60	2SC 929	.45	2SC 1383	.59					STK 045	11.00		
2SA 682	2SB 434	2SC 493	3.90	2SC 930	.45	2SC 1384	.59					STK 408	5.90		
2SA 683	2SB 435	2SC 495	.90	2SC 941	.59	2SC 1396	.70					STK 409	2.50		
2SA 684	2SB 440	2SC 497	1.60	2SC 943	.70	2SC 1400	.59					STK 502	8.80		
2SA 695	2SB 449	2SC 509	.70	2SC 945	.45	2SC 1400	.59					STK 503	9.60		
2SA 697	2SB 461	2SC 515A	1.40	2SC 959	1.50	2SC 1402	4.90					TA 7027M	3.70		
2SA 699A	2SB 463	2SC 517	3.95	2SC 971	1.00	2SC 1403	4.90					TA 7045M	3.00		
2SA 705	2SB 471	2SC 535	.59	2SC 982	.90	2SC 1407	.90					TA 7054P	2.50		
2SA 706	2SB 472	2SC 536	.59	2SC 983	1.00	2SC 1419	1.10					TA 7055P	3.00		
2SA 715	2SB 473	2SC 537	.59	2SC 984	.90	2SC 1444	2.80					TA 7060P	1.60		
2SA 719	2SB 474	2SC 538A	.70	2SC 994	3.90	2SC 1447	1.60					TA 7061AF	1.90		
2SA 720	2SB 481	2SC 562	.70	2SC 996	3.40	2SC 1448	1.60					TA 7062P	1.90		
2SA 721	2SB 492	2SC 563	1.10	2SC 1000BL	.59	2SC 1449	1.00					TA 7063P	1.60		
2SA 725	2SB 507	2SC 605	.70	2SC 1012	1.50	2SC 1451	2.25					TA 7064P	1.90		
2SA 726	2SB 509	2SC 619	.59	2SC 1013	1.10	2SC 1452	1.60					TA 7066P	2.00		
2SA 733	2SB 511	2SC 620	.59	2SC 1014	1.10	2SC 1475	1.40					TA 7074P	4.90		
2SA 738	2SB 514	2SC 627	2.25	2SC 1017	1.40	2SC 1478S	.70					TA 7075P	4.90		
2SA 740	2SB 523	2SC 631	.90	2SC 1018	1.20	2SC 1509	1.10					TA 7076P	4.90		
2SA 743A	2SB 526C	2SC 632A	.45	2SC 1030C	2.80	2SC 1567	1.10					TA 7088P	3.00		
2SA 743A	2SB 527	2SC 634A	.59	2SC 1047	.70	2SC 1567A	1.10					TA 7102	5.80		
												TA 7106P	4.90		
												WZ 050	4.5		
												WZ 061	4.5		

## BULLET ELECTRONICS

**PHONE ORDERS ON MASTERCHARGE/VISA**

**6 GOOD REASONS TO BUY FROM BULLET**

- We are an established company, in business since 1976
- Mail order is our only business. Full Time
- Components & un assembled kits may be returned for full refund.
- Full repair service on any kit we sell.
- Our customers are important. We are always available for help.

**MOBILE CLOCK CALENDAR KIT**  
Seems like everybody tells digital clocks kits however we have the only low cost **DIGITAL CLOCK / CALENDAR** for mobile operation. We provide battery powered, through hole boards and step by step instructions. parts overflows and schematics. The clock has many features and we supply all the parts out a small speaker. Fantastic for car, boat or Van.  
\*Integral Timebase \*5.1W 15x2V (0.1% ACC)  
\*Large 4 DIGIT LED display with AM/PM indicators  
\*Flashing color at 1/2 rate  
\*Special radio end overvoltage protection for mobile use  
\*Auxiliary output will drive relay or TRIAC to control external equipment  
**23.50 NO CASE**  
12 VAC XFMR for 110 VAC to control external equipment  
24 Hour format add 1.00

**MG-01 ELECTRONIC GRANDFATHER CLOCK**  
While we are talking about clocks check out the MINI GRAND FATHER CLOCK. Reviewed in April 1978 RADIO ELECTRONICS. We have the only kit in the world with all the below listed features. The biggest problem is to describe how unique and fascinating this compex really is! The LED "Singing" Pendulum and Marching Tick-Tock Sound are available only on our clock. In addition the electronic "bell" notes each hour (ie 3 times for 3 o'clock). Housed in the optional Solid Hardwood Case, the unit makes a beautiful addition to any room.  
\*4 DIGIT LED READOUT  
\*Adjustable tone & duration on chime  
\*Simulated swinging LED Pendulum  
\*All CMOS Construction  
\*Quality plated boards  
\*all electronic switches and XPMR included  
**39.95 KIT 59.95 A5EM8**

**THE SMALL PRINT**  
No COD's All orders add 5% for shipping  
CHECK or MD 5% for shipping  
M/C/VISA  
TX residence • Orders over \$50 add \$3.00 S&H 10% inc. discount tax  
Foreign address add 10% for \$10 and 75 shipping handling

**WE STOCK A COMPLETE LINE OF QUALITY LOW COST PANEL METERS. SEND FOR FREE CATALOG TODAY**

➔ **ULTRASONIC SENDER RECEIVER KIT US 02** ➔

**TOTAL SECURITY!** Completely invisible ultrasonic (23KHZ) sound beam works like a Doppler's beam but is unaffected by light, heat or noise. Separate Transmitter and Receiver can be used from 6 inches to 25 feet! A solid object breaking the beam causes an output to go low that will sink up to 150 MA. Use it for a Relay, TRIAC etc. Complete electronics are provided. Works on 12VDC (unregulated) and draws less than 100 MA. Use it for burglar alarms, object counters, automatic door openers, automatic door bells, electric rat traps! and more.  
Optional entry delay and Alarm Timeout Circuit 3.95  
will source or sink up to 200 MA OC

**COMPLETE KIT LESS CASES 21.50**

**10 WATT WARBLE ALARM KIT 2.50**  
It's hard to believe this little gem puts out 10 Watts of alternating (just like streams) A real great attention getter. Great for alarms, games, toys, etc. **2.50** includes 12VDC 1A

**OTHER GREAT KITS!** We have 15A power supplies, COILS, DVP's, mini mobile clocks, clock-timers, sound circuits and many more. It's all in our latest catalog. **FREE ON REQUEST**

**PARTS** (many more listed in catalog)

MC1469N	1/4A positive Voltage Reg	House	1.25
MC1351P	FM IF and Sound System		.50
CA3011	Wideband IF Amp IC	House	.50
NM5315	8 Digit Alarm Clock Chip		2.95
555	Timer & Pulse Gen Chip		.29
741	Op amps 8 pin MINI DIP		.49
LM3900	QUAD OP AMP		.45
723	Pos Voltage Reg DIP		.65
725	Ultra low noise high gain Op amp	House	.99
NE565A	PLL DIP		.50
TC4430	Quad Audio Oscillator Dip		.69

**CAPS**  
1000VDC Mylar 8/100  
50VDC Mylar 8/100  
400VDC Mylar 4/100  
35V Tant Axial 6/100  
25V Tant Axial 6/100  
35V Tant Axl 5/100  
20V Dip Tant 4/100  
10V Dip Tant 4/100  
25V Alum Axial 7/100  
35V Alum Axial 5/100  
35V Alum Axial 4/100

**HEATSHRINK TUBING**  
A very good amt of 3/32" 1/8" 3/16" & 1/4" in. Etm lengths 12 pieces total 75  
This item FREE with purchase of 15.00 or more

**MJ900, MJ1000 Matched Pair 8A Darlingtons Pair/3.00**  
IN4148 Switching Diodes 25/1.00  
2N3559 NPN Silicon Switching 8/1.00  
2N2712 NPN Small Signal 8/1.00  
2N4343 P Channel JFET 4/1.00  
2N6028 Programmable Unijunction 2/1.00  
2N6111 PNP Med Power 30W 10/2.00

**ZENER GRAB BAG** A very nice assortment of 10 different voltages between 2.7v and 30 VDC in 400 MW, 1/4W and 1W. All are prime units but must have Mfg's numbers. We supply a cross reference sheet to standard numbers. **1.00 SPECIAL PRICE 10 pieces**

**Miniature 7a Pot w/switch Pin Mount or panel mount 1/8" shaft 49 Black plastic knob for above FREE**

**LIMITED QTY Computer Grade FILTER CAP Screw Terminals 2 x 5x 9500 mfd@75V 2.95 or 4.95**

**SPECIAL SALE TIL 3/12 LED Common Anode 3 Segment Red/Grn 3 Character Pinout while last 65 6/3.00**

# 1 out of 2 who have it don't know it...

## Do you?

21 million Americans have high blood pressure. But 50 percent of those who have it, don't know it!

When blood pressure goes higher than it should, and stays high, it sets the stage for heart attack or stroke.

Most cases of high blood pressure can be controlled with drugs and other advances in treatment. That's why you should see your doctor regularly. Only he can tell if you need help.

A public service message from your Heart Association

### TELEPHONE recording equipment and other "unusual" electronic devices. Free info: GARRISON, Box 128-B, Kew Gardens, NY 11415

**BLITZ ZOINK ZATT: UNSCRAMBLE** these fascinating police communications with our CODE-BREAKER and keep informed. Tunes all scramble frequencies, works with all scanners, and is factory built and guaranteed. **\$34.95PP. UNSCRAMBLER KIT.** Latest Technology, 2 1/2"x2 1/2"x1/2"-inch, complete instructions, only **\$19.95PP.** Thousands of satisfied customers. Catalog 50c Order from **KRYSTAL KITS, BOX 445, BENTONVILLE, ARK. 72712.** COD orders. 501-273-5340.



## PRINTED CIRCUIT

Positive Acting Photo Resist; Carbide bits; Bubble etchers; Artwork; Epoxy Glass Boards.  
**Send stamp & address label for flyer**  
**TRUMBULL**  
833 Balra Dr., El Cerrito, CA 94530

**TAPE head cleaner. 8" oz.—\$2.30.** Includes postage and handling. Write: **"CLEANER,"** Box 176, Whitewater, WI 53190

### BUILD YOUR OWN TV CAMERA!

**Ideal for home & business**



**THE ECONOMICAL ANSWER TO HOME MONITORING OF NUMEROUS ENTRANCES, DRIVEWAYS, BUSINESS AND INDUSTRIAL SURVEILLANCE. TV AMATEUR PLUS HUNDREDS OF OTHER APPLICATIONS. MODEL XT-1A, SERIES D - KIT FORM \$185 ASSEMBLED \$275. SOLID-STATE. WORKS ON ANY TV SET. OPTIONAL SOUND KIT \$28.95. PHONE or WRITE for catalog. Dial 402-987-3771**  
**BOX 453-RE ATV Research DAKOTA CITY, NE 68731**

**OPTO-ISOLATORS GE H11A2, 25/\$10, 100/\$35. RCA zero voltage switch CA 3079 25/\$12.50, 100/\$45. All prime & 100% guarantee. AMAN KHAN, 2355 Burch Cir., Atlanta, GA 30319**

# Special Functions

**3050 VALMONT ROAD BOULDER, COLORADO 80301**

**Terms**

- Prices, specifications and availability subject to change without notice.
- U.S. & Canadian orders minimum \$10.00
- All other foreign orders \$20.00 minimum.
- Please add \$1.00 postage and handling.
- Foreign orders (exc. Canada) add 15% for postage
- Colorado residents add 3 1/2% sales tax.
- No C.O.D.'s please.
- Foreign orders send U.S. funds ONLY.

<b>Slide Switch</b> Smooth action, 4-pole, triple throw. J-5100 <b>80¢</b>	<b>Toggle Switch</b> Heavy duty, SPST toggle, rated @ 15A/125 volts. J-5004 <b>95¢</b>	<b>1N4148 Diode</b> Miniature glass type high speed switching diode. Case AA. J-1002 <b>12 for \$1.00</b>	<b>Connector</b> spade connector w/ unique teflon-unique interconnect price. J-7100 <b>15/\$1.00</b>	<b>Transformer</b> 8V @ 500 ma or 12V @ 190ma. J-5005 <b>\$1.50</b>	<b>Wire Special</b> 22 ga. magnet wire w/ solder through insulation. Appx. 500'. J-7003 <b>\$2.50</b>	<b>Strobe</b> Xenon strobe tube & 4kv trigger transformer. Beat our price!! J-4001 <b>1.75¢</b>
<b>Jumbo LED</b> 200" factory prime LED's for experimenters. J4004 5 for <b>\$1.</b>	<b>LED Panel Clip</b> Black plastic clip for mounting LED in panels. J-4002 <b>12/\$1.</b>	<b>28 Pin Socket</b> Standard, solder-type, low profile 28 pin IC socket. J-7101 <b>40¢</b>	<b>PC Board</b> glass-epoxy PC board blanks. .062" thick. 4 x 6 (J-8016) 5 for \$3.00 3 x 6 (J-8017) 5 for \$2.25 6 x 6 (J-8018) 5 for \$3.60 2 x 8 (J-8019) 5 for \$2.00	<b>Trimmer Cap</b> 1-3pin miniature PC trimmer cap for crystal circuits, etc. J-3000 <b>75¢</b>	<b>2N3055</b> Popular audio-type power transistor. J-1001 <b>50¢</b>	<b>Lamp Socket</b> Double contact automotive type, bayonet-base. J-4003 <b>20¢</b>
<b>Reed Relay</b> Sensitive 12 VDC reed relay, DPST, 1 1/2" long, with P-C leads. J-5047 <b>\$1.50</b>	<b>Hex Nuts</b> Standard size hex nuts for use on pots, switches, etc. 3/8" I.D. J-7006 <b>\$1.00</b>	<b>Felt Feet</b> 3/8" diameter felt feet in peel-off strips of 25 feet per strip. Prevent scratches! J-8010 <b>25¢</b>	<b>PC Trimmer</b> 20 turn miniature PC mount trimmer pot. 3/4" long, 5K ohm. J-2013 <b>\$1.10</b>	<b>BNC Connector</b> 3/8" female BNC type shielded connector with jacketed 6" leads. J-7102 <b>\$1.00</b>	<b>Rubber Edging</b> For up to 1/16" material. Soft & J-8008 pliable. 10/\$1.60 100/\$12.00	
<b>Transformer</b> Unique split primary allows two outputs, 9 or 18 volts at 1.5 amps. W/ specs & data. J-5012 <b>\$2.50</b>	<b>Opto Isolator</b> Type 4N27 Motorola 6 pin DIP, w/ specs. 1500V isolation, freq. resp. to 300khz. J-4000 <b>\$1.00</b> 10 for \$9.00	<b>RO170 Diode</b> The famous RO-170 general replacement diode, rated 1000 piv at 2.5 amps. J-1000 <b>20¢</b> 100 for \$14.50	<b>Photoflash Cap</b> Brand new by Rubycon, 600 uF @ 360 VDC. Use w/ our strobe tube & transformer for a strobe light!!! J-3002 <b>\$1.95</b>			
<b>N-MOS Random Access Memories:</b>	<b>4801-U</b> 650 Ns cycle time, 250 Mw typical operating power, single 5 volt power supply. <b>\$1.20 EA</b> 4K(8pcs) \$90.00	<b>4804-U</b> 650 Ns cycle time, 250 Mw typical operating power, single 5 volt power supply. <b>1K(2pcs) \$28.00</b> 4K \$106.00	<b>V.O.X.</b> Solid state Voice Operated Switch. Complete and assembled. With schematic. J-5003 <b>\$1.50</b>	<b>Potentiometer</b> Miniature 1/8" shaft, 1/4" mount potentiometer. 100 ohm value. J-2100 <b>70¢</b>	<b>PC Trimmer Pot</b> Horizontal type, 1K-ohm PC trimmer. J-2101 <b>25¢</b>	<b>Keyboard</b> High quality, black plastic calculator keyboard assemblies, with all "point closure" (non-matrix) switches. Includes 2 miniature slide switches and 17 momentary action (SPST) pushbutton keytop switches. With a little imagination, you can find literally hundreds of uses for this item. We give you complete specifications and a data sheet that even shows you how to make an alphanumeric keyboard using three of these units!!! J-5001 <b>\$1.95</b> 3/55 00
<b>AA Nicad</b> Brand new, prime quality AA nicads made by Sanyo. These won't last long!!! J-8005 <b>\$1.50</b>	<b>AA Battery Holder</b> All metal, size AA, 4 batteries. J-8006 <b>40¢</b>	<b>Heat Shrink</b> Much easier and faster than electrical tape. Twelve 6" pieces, ass't'd. J-7004 <b>\$1.45</b>				

RADIO-ELECTRONICS



# ELECTRONIC SYSTEMS

P.O. Box 9641 San Jose, CA 95157 (408) 374-5984

FOR CATALOG INCLUDING PARTS LISTS AND SCHEMATICS,  
SEND A SELF ADDRESSED ENVELOPE WITH 24¢ POSTAGE.

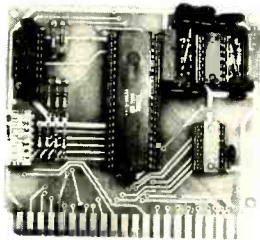

## UART & BAUD RATE GENERATOR\*

- Part no. 101
- Converts serial to parallel and parallel to serial
  - Low cost on board baud rate generator
  - Baud rates: 110, 150, 300, 600, 1200, and 2400
  - Low power drain +5 volts and -12 volts required
  - TTL compatible
  - All characters contain a start bit, 5 to 8 data bits, 1 or 2 stop bits, and either odd or even parity.
  - All connections go to a 44 pin gold plated edge connector
  - Board only \$12.00; with parts \$35.00

## 8K STATIC RAM



- Part no. 300
- 8K Altair bus memory
  - Uses 2102 Static memory chips
  - Memory protect
  - Gold contacts
  - Wait states
  - On board regulator
  - S-100 bus compatible
  - Vector input option
  - TRI state buffered
  - Board only \$22.50; with parts \$160.00

## RS-232/TTL INTERFACE\*



- Part no. 232
- Converts TTL to RS-232, and converts RS-232 to TTL
  - Two separate circuits
  - Requires -12 and +12 volts
  - All connections go to a 10 pin gold plated edge connector
  - Board only \$4.50; with parts \$7.00

## DC POWER SUPPLY\*



- Part no. 6085
- Board supplies a regulated +5 volts at 3 amps., +12, -12, and -5 volts at 1 amp.
  - Power required is 8 volts AC at 3 amps., and 24 volts AC C.T. at 1.5 amps.
  - Board only \$12.50; with parts \$42.50 excluding transformers

## TIDMA\*



- Part no. 112
- Tape Interface Direct Memory Access
  - Record and play programs without bootstrap loader (no prom) has FSK encoder/decoder for direct connections to low cost recorder at 1200 baud rate, and direct connections for inputs and outputs to a digital recorder at any baud rate.
  - S-100 bus compatible
  - Board only \$35.00; with parts \$110.00

Part no. 111

## TAPE INTERFACE\*

- Play and record Kansas City Standard tapes
- Converts a low cost tape recorder to a digital recorder
- Works up to 1200 baud
- Digital in and out are TTL-serial
- Output of board connects to mic. in of recorder
- Earphone of recorder connects to input on board
- Requires +5 volts, low power drain
- Board \$7.60; with parts \$27.50
- No coils

Part no. 107

## RF MODULATOR\*

- Converts video to AM modulated RF, Channels 2 or 3
- Power required is 12 volts AC C.T., or +5 volts DC
- Board \$7.60; with parts \$13.50

## Apple II Serial I/O Interface\*

- Part No. 2
- Baud rates up to 30,000
  - Plugs into Apple Peripheral connector
  - Low-current drain
  - RS-232 Input and Output
- SOFTWARE
- Input and Output routine from monitor or BASIC to teletype or other serial printer.
  - Program for using an Apple II for a video or an intelligent terminal. Board only - \$15.00; with parts - \$42.00; assembled and tested - \$62.00.

## RS-232/TTY\* INTERFACE NEW

- Part no. 600
- Converts RS-232 to 20mA current loop, and 20mA current loop to RS-232
  - Two separate circuits
  - Requires +12 and -12 volts
  - Board only \$4.50, with parts \$7.00

## TELEVISION TYPEWRITER

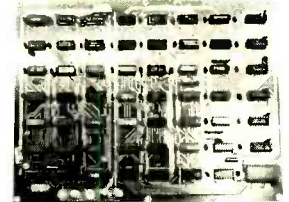

- Part no. 106
- Stand alone TVT
  - 32 char/line, 16 lines, modifications for 64 char/line included
  - Parallel ASCII (TTL) input
  - Video output
  - 1K on board memory
  - Output for computer controlled cursor
  - Auto scroll
  - Non-destructive cursor
  - Cursor inputs: up, down, left, right, home, EOL, EOS
  - Scroll up, down
  - Requires +5 volts at 1.5 amps, and -12 volts at 30 mA
  - All 7400, TTL chips
  - Char. gen. 2513
  - Upper case only
  - Board only \$39.00; with parts \$145.00

## MODEM\*



- Part no. 109
- Type 103
  - Full or half duplex
  - Works up to 300 baud
  - Originate or Answer
  - No coils, only low cost components
  - TTL input and output-serial
  - Connect 8 ohm speaker and crystal mic. directly to board
  - Uses XR FSK demodulator
  - Requires +5 volts
  - Board \$7.60; with parts \$27.50

### To Order:



Mention part number and description. For parts kits add "A" to part number. Shipping paid for orders accompanied by check, money order, or Master Charge, BankAmericard, or VISA number, expiration date and signature. Shipping charges added to C.O.D. orders. California residents add 6.5% for tax. Parts kits include sockets for all ICs, components, and circuit board. Documentation is included with all products. Dealer inquiries invited. 24 Hour Order Line: (408) 374-5984.\* Designed by John Bell.





# Radio Shack: No. 1 Parts Place Buy Off-the-Shelf! Low Prices! Huge Selection!

Top-quality devices, fully functional, carefully inspected. Guaranteed to meet all specifications, both electrically and mechanically. All are made by well-known American manufacturers, and all have to pass manufacturer's quality control procedures. These are not rejects, not fallouts, not seconds. In fact, there are none better on the market! Always count on Radio Shack for the finest quality electronic parts.

## Linear ICs

By National Semiconductor and Motorola — first quality

Type	Cat. No.	ONLY
301CN	276-017	49¢
324N	276-1711	1.49
339N	276-1712	1.49
386CN	276-1731	99¢
555CN	276-1723	79¢
556CN	276-1728	1.39
566CN	276-1724	1.69
567CN	276-1721	1.99
723CN	276-1740	69¢
741CN	276-007	49¢
741H	276-010	49¢
3900N	276-1713	99¢
3909N	276-1705	99¢
3911N	276-1706	1.99
4558CN	276-038	79¢
75491	276-1701	99¢
75492	276-1702	99¢
7805	276-1770	1.29
7812	276-1771	1.29
7815	276-1772	1.29

## Computer Chips



Prime Devices

8080A Microprocessor. 8-bit. NMOS. 276-2510 Reg. 17.95 Sale 12.95  
2102 1K Static RAM. Under 450 ns. 276-2501 2.49 Ea. or 8/14.95

## NEW 1978 Edition



**BONUS OFFER**  
Only 99¢  
With Any \$5  
Parts Purchase

REGULARLY \$1.95. Archer® Semiconductor Reference and Application Handbook. Complete specs and application data on every Archer semiconductor — display devices, too! 46,000 cross-reference/substitution listings plus glossary of words, symbols, abbreviations. 276-4002. With Any \$5 Parts Purchase, Only 99¢

Offer good at participating Radio Shack stores and dealers

## Wire Wrapping Accessories

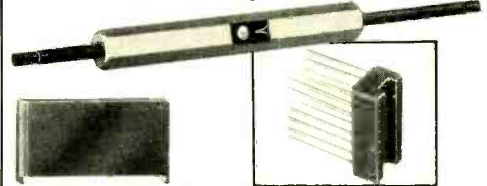

IC Socket Wrapping Tool. Strips and wraps 30-gauge wire. 276-1570 6.95  
14-Pin Wire Wrapping Sockets. 276-1993 2/1.29  
16-Pin Wire Wrapping Sockets. 276-1994 2/1.29  
DIP Header. 16 pins. 276-1980 1.29  
50 Red 30-ga. Kynar® Wire. 278-501 1.99  
50 White 30-ga. Kynar Wire. 278-502 1.99  
50 Blue 30-ga. Kynar Wire. 278-503 1.99

## Trim Multi-Purpose Cabinets

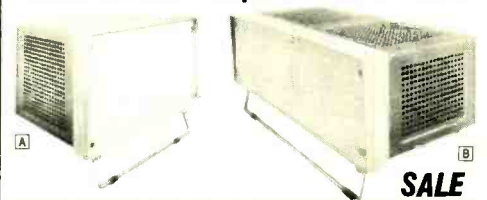

**A** Compact. Makes even your small projects look professional. 5 1/2"x9"x4 1/4" 270-281 10.95  
**B** Low-Profile. Slim-design — only 5 1/2"x11 1/2"x3 1/2" 270-282. Reg. 14.95 Sale 12.95

## TTL and CMOS Logic ICs

Full-Spec Devices Direct from Motorola and National Semiconductor

Type	Cat. No.	ONLY
7400	276-1801	35¢
7402	276-1811	39¢
7404	276-1802	35¢
7406	276-1821	49¢
7410	276-1807	39¢
7413	276-1815	79¢
7420	276-1809	39¢
7427	276-1823	49¢
7432	276-1824	49¢
7441	276-1804	99¢
7447	276-1805	99¢
7448	276-1816	99¢
7451	276-1825	49¢
7473	276-1803	49¢
7474	276-1818	49¢
7475	276-1806	79¢
7476	276-1813	59¢
7485	276-1826	1.19
7486	276-1827	49¢
7490	276-1808	79¢
7492	276-1819	69¢
74123	276-1817	99¢
74145	276-1828	1.19
74150	276-1829	1.39
74154	276-1834	1.29
74192	276-1831	1.19
74193	276-1820	1.19
74194	276-1832	1.19
74196	276-1833	1.29
74C00	276-2301	SALE 29¢
74C02	276-2302	SALE 29¢
74C04	276-2303	SALE 29¢
74C08	276-2305	SALE 29¢
74C74	276-2310	SALE 49¢
74C76	276-2312	SALE 49¢
74C90	276-2315	SALE 89¢
74C192	276-2321	SALE 1.00
74C193	276-2322	SALE 1.00
4001	276-2401	49¢
4011	276-2411	49¢
4013	276-2413	89¢
4017	276-2417	1.49
4020	276-2420	1.49
4027	276-2427	89¢
4049	276-2449	69¢
4050	276-2450	69¢
4511	276-2447	1.69
4518	276-2490	1.49

## LED Digital Displays

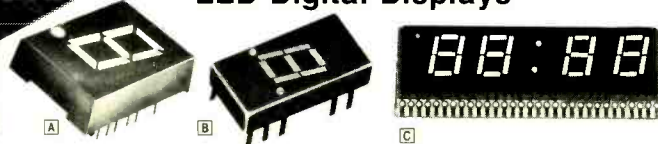

Digits	Size	Drive	Cat. No.	Reg.	SALE	Digits	Size	Drive	Cat. No.	Reg.	SALE
1	0.6"	Anod.	276-055	2.99	2.29	1	0.3"	Anod.	276-1210	4.69	4/5.49
1	0.6"	Cath.	276-066	2.99	2.29	1	0.3"	Cath.	276-1211	4.69	4/5.49
1	0.3"	Anod.	276-053	1.99	1.49	4	0.5"	Anod.	276-1201	6.95	5.99
1	0.3"	Cath.	276-062	1.99	1.49	4	0.5"	Cath.	276-1202	6.95	5.99

## IC Accessories

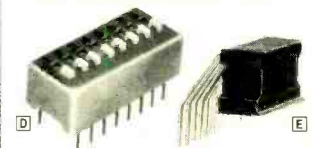

**D** DIP Switch. For changing preset logic states. 275-1301 1.99  
**E** Right-Angle 16-Pin Socket. 276-1985 1.49

## MA1003 Automotive Clock Module

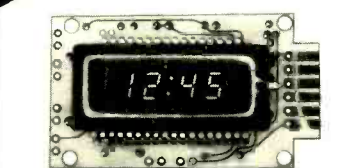

Just add switches and install! Q2-hour readout. 0.3" digits. ±0.5 sec./day accuracy. 12VDC. 277-1003. Reg. 24.95 Sale 19.95

## Archer® Project-Boards — Predrilled PCB's

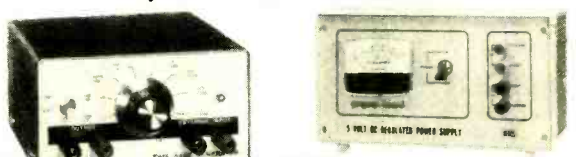

**SALE**  
Time Base Generator. Built-in 10 MHz xtal or ext. input. Decade selector. switch. TTL output. Requires 5VDC. Reg. \$5.99. 277-115 (PCB less parts) Sale 4.99

**NEW**  
5V, 3-Amp Power Supply. Metered output current, foldback limiting. Remote sensing. For all SSI, TTL projects. 277-119 (PCB less parts) 7.95

Shown Built with Recommended Parts and Cases

## Full-Wave Bridge Rectifiers



**NEW**  
**A** 1-Amp, 50 PIV. Mini DIP fits PCB or 8 and 14-pin sockets. 276-1161 69¢  
**B** 6-Amp, 50 PIV. Heavy-duty leads. heat sink mtg. hole. 276-1180 1.99

## Mike Elements



Dynamic. Tiny yet delivers 80-10,000 Hz response -65 dB. 200 ohms. 3/4x1/8" 270-093 1.69  
Hi-Z Crystal. 50-8000 Hz response -55 dB. 1 1/2x1 1/2" 270-095 1.39

## 2-Foot Mini Test Clips



Red. Reg. 1.99 278-1158 Sale 1.49  
Black. Reg. 1.99 278-1159 Sale 1.49

## 35VDC Electrolytic Pak

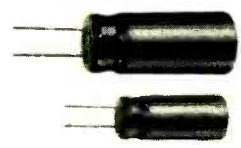

Package of 10 with two of each value: 4.7 10, 25, 50 and 100 µF. PC mounting. 272-1035 2.99

WHY WAIT FOR MAIL ORDER DELIVERY?  
IN STOCK NOW AT OUR STORE NEAR YOU!

Prices may vary at individual stores and dealers

# Radio Shack®

A DIVISION OF TANDY CORPORATION • FORT WORTH, TEXAS 76102  
OVER 6000 LOCATIONS IN NINE COUNTRIES

## DIGITAL CASSETTE TAPE C-60



FOR DIGITAL  
COMPUTER RECORDING  
All these tapes made in U.S.A.  
Never Recorded—Reg. \$6.80 each  
**OUR PRICE 3 for \$5.00**

\* without B.O.T., E.O.T.  
\* 60 minutes recording time  
\* Write enable tap  
\* ANSI Notch  
\* ANSI Audio Port plane

## MICROPROCESSOR CRYSTALS

FREQUENCY	MICROPROCESSOR OR CLOCK IC	Price
1.0 MHz	6800/S6860	\$5.95
1.8432 MHz	MC14411 Baud Rate Generator	\$9.80
2.0 MHz	F-8/CPU 3850	\$5.95
2.097152 MHz	MM5378 MM5379 Auto Clock	\$8.50
2.4576 MHz	34702 Bit Rate Generator	\$8.50
2.667 MHz	Pace	\$8.50
3.00 MHz	MCS 48	\$8.50
3.20 MHz	RCA 1803	\$8.50
3.2768 MHz	Intersil ICM 7205	\$8.50
3.579545 MHz	NSC MM5369 (TV Color Burst)	\$1.25
4.0 MHz	Intel 4040/4004/4201	\$4.95
4.0 MHz	Pace	\$4.95
4.194304 MHz	Intersil ICM 7038A	\$4.95
4.91520 MHz	Standard Clock Frequency	\$4.95
5.0 MHz	Non-standard MPU Frequency	\$4.95
5.0688 MHz	COM 5016 Dual Baud Rate Generator COM 5016T Dual Baud Rate Generator	\$4.95
5.185 MHz	Intel 4040/4004/4201	\$4.95
5.7143 MHz	National Semiconductor	\$4.95
6.00 MHz	MCS 48	\$4.95
6.144 MHz	Intel 8085	\$4.95
6.40 MHz	RCA 1803	\$4.95
6.5536	Intersil Precision Timer Crystal ICM 7045	\$4.95
8.0 MHz	Signetics	\$4.95
10.0 MHz	Non-standard MPU Frequency	\$4.95
14.318 MHz	Processor Tech	\$4.95
18.00 MHz	Intel 8080/8008/8224	\$4.95
18.432 MHz	Intel 8080/8008/8224	\$4.95
20.0 MHz	Non-standard MPU Frequency	\$4.95
22.1184 MHz	Intel 8080A	\$4.95
27.0 MHz	Intel 8080A Series	\$4.95
36.0 MHz	Intel 8080A Series	\$4.95
48.0 MHz	T.I. Mod. TIM9904 P.N. SNLS362	\$4.95

## COMPUTER GRADE CAPACITORS



All capacitors are Brand New  
U.S. made in standard size

5600MFD	60V	\$2.20 EA.
8500MFD	35V	\$2.75 EA.
9000MFD	50V	\$3.25 EA.
4200MFD	150V	\$2.50 EA.
3000MFD	15V	\$1.50 EA.
11000MFD	35V	\$3.20 EA.
20000MFD	55V	\$3.50 EA.
23000MFD	20V	\$3.00 EA.
58000MFD	20V	\$3.20 EA.
100,000MFD	6V	\$2.50 EA.



## VHF MODULATOR

(Size of a  
Match Box)

This unit converts the video  
signal to RF signal. Ideal for  
computer terminal or TV  
games.

Video input: 1V DC RF  
output: 1.5MV  
Preset at 61.25 MHz  
(channel 3)  
Frq. adjustable  $\pm$  3 MHz  
Power Supply 5~8V DC 10 MA

**\$4.50 EACH**

## DIP SWITCHES



(On-Off Contacts)

4 positions	\$1.50
5 positions	\$1.60
6 positions	\$1.70
7 positions	\$1.70
8 positions	\$1.80
10 positions	\$2.00

## 8K STATIC RAM MEMORY BOARD (BARE) \$24.50 PER BOARD

Memory Chips: 21L02 X 64 pcs.

Fully buffered; all support chips are LS type; total of 26 bypass capacitors on the board; four 340T-S voltage regulators give more than enough power to the board.

## 16K STATIC RAM MEMORY BOARD (BARE) \$24.50 PER BOARD

MEM-2 uses 2114 any speed any power

Start address and stop address selected on board so board can be used portionally populated; capable of block address, can be used in SOL<sub>TM</sub> and systems without front panel.

## The MQ-1 QUIET MOTHER BOARD 13 SLOT \$29.50 BARE

This Quiet Mother is standard 2-100 BUS with 13 slots; Kluge area; extensive ground plane; passive terminal for all lines; double solder mask; silk screen parts layout.

## 8080A CPU BOARD \$29.50 BARE

With 8 level vector interrupt. CPU chip 8080A; clock chip: 8224; X'tal freq.: 18 MHz; vector interrupt chip: 8214.

## RTC-1 REAL TIME CLOCK BOARD for 5-100 BUS \$24.50 BARE

On Board Oscillator: 1 MHz Crystal

Number of Interrupt: 2, one is decade; it steps from 100 $\mu$  Sec to 100 Sec. Second is 16 bit counter, it is selectable from 10 $\mu$  Sec to 655, 360 $\mu$  Sec in 10 $\mu$  Sec step.

All above boards include all documents  
and detailed parts list and instructions.

MINIMUM ORDER \$10.00. California residents add 6% sales tax and 10% shipping.  
Out of state add 15% of total purchase for shipping charges, out of USA and Overseas add 25% of total purchase.  
SEND CHECK OR MONEY ORDER TO:



**FORMULA INTERNATIONAL INC.**

12603 CRENSHAW BOULEVARD • HAWTHORNE, CALIFORNIA 90250

For more information please call (213) 973-1921, (213) 679-5162

STORE HOURS 10-7 Monday - Saturday

## DON'T MISS ANY

Get every single issue of Radio-Electronics delivered right to your door, and before it appears on the newsstand. Use this coupon and subscribe now.

Mail to: Radio-Electronics  
SUBSCRIPTION DEPT., P.O. BOX 2520,  
BOULDER, CO., 80322

name (please print)

address

city state zip code

### check offer preferred

- 1 Year—12 issues **ONLY \$9.98**
- 2 Years—24 issues **SAVE MORE \$19.00**  
(You save \$5.00 over newsstand)
- 3 Years—36 issues **GREATER SAVINGS \$27.00**  
(You save \$9.00 over newsstand prices)
- Payment enclosed  Bill Me
- Check here if this is a new subscription
- Check here if you are extending or renewing  
your subscription

Extra Shipping: Canada \$3.00 per  
year, all other countries \$5.00 per  
year.

**40F8**

## NEW TV CAMERA with ZOOM LENS

9 TO 30 mm f:1.9 Lens



• USE WITH  
ANY V.T.R.  
ATV, SSTV,  
HOME SECURITY

• USE INDOORS  
OR OUTDOORS

• ALL SOLID  
STATE

15 FOOT CABLE AND  
PISTOL GRIP

NOT A KIT  
Fully Guaranteed

**\$195.00  
Complete**

## DIGITAL AUTO INSTRUMENTS

#1 TACHOMETER SEVEN MODELS!

- #2 WATER TEMP.
- #3 FUEL LEVEL
- #4 SPEEDOMETER\*
- #5 OIL PRESSURE
- #6 OIL TEMP.
- #7 BATTERY MONITOR

KIT INCLUDES:

- CASE & ALL HARDWARE
- PRESSURE & TEMP SENDERS
- ASSEMBLED MAIN PC BOARD

FEATURES:

- 4" ORANGE LED'S
- 4" x 5" x 7 ABS CASE

\*ADD \$10 FOR REQUIRED SPEED SENDER \$15 FOR SPEED SENDER ALONE  
KIT: \$49.95. . . . . ASSEMBLED: \$59.95

SPECIFY  
12 OR 24  
HOURS

## 3 1/2 DIGITAL CLOCK

• 4 DIGIT KIT \$49.95 • 4 DIGIT ASSEMBLED \$59.95  
• 6 DIGIT KIT \$69.95 • 6 DIGIT ASSEMBLED \$79.95

117 VAC 12 OR 24 HR MODE . . . . . KIT COMES COMPLETE!  
6 DIGIT VERSION: 27" x 5" x 1 1/2" 4 DIGIT VERSION: 18" x 5" x 1 1/2"



MARK FOSKETT'S

SOLID STATE TIME

P.O. BOX 2159

DUBLIN, CALIF. 94566

ORDERS (415) 828-1923



PLEASE ADD \$1.50  
OR POSTAGE  
& HANDLING



CALIFORNIA RESIDENTS - ADD 6% SALES TAX



## SUPER 15 WATT AUDIO AMP KIT



**ONLY \$23.50 each**

Uses STK-015 Hybrid Power Amp Kit includes: STK-015 Hybrid IC, power supply with power transformer, front AMP with tone control, all electronic parts as well as PC Board. Less than 0.5% harmonic distortion at full power 1/2dB response from 20-100,000 Hz. This amplifier has QUASI-Complementary class B output. Output max is watt (10 watt RMS) at 4Ω.

## 30MHZ FREQUENCY COUNTER KIT



Model 250-30A

**Only \$59.50**

Includes all parts, PC Board and Transformer

Take advantage of this new state-of-the-art counter featuring the many benefits of custom LSI circuitry. This new technology approach to instrumentation yields enhanced performance, smaller physical size, drastically reduced power consumption (portable battery operation is now practical), dependability, easy assembly and revolutionary lower pricing!

- 0.5" red LED 6 digit display
- Resolution: 1 Hz at 1 sec. 10 Hz at 1/10 sec.
- Sensitivity: 10 Mv RMS to 30 Hz
- Internal power supply: 5.2V at 1 amp regulated
- Input connector: BNC type
- Input power required: 117V AC 50/60 Hz
- Diode protected for over voltage input



## FM WIRELESS MIC KIT

This new model FM wireless MIC kit uses 3 high freq. transistors, works in the FM range (88-108 MHz). It transmits the sound wave fidelity clearly over long distances (up to 2500 ft.). Kit comes with all electronic parts, P.C. Board and mini microphone!

**\$6.95**

**EACH KIT**



## SOUND ACTIVATED SWITCH

All parts completed on a PC Board SCR will turn on relay, buzzer or trigger other circuit for 2-10 sec. (adjustable) Ideal for use as door alarm, sound controlled toys and many other projects Supply voltage 4.5V-9V D.C. \$1.75 ea./2 for \$3.00

**Sub-Mini Size Condenser Microphone \$2.50 each**  
FET Transistor Built-in



## FLUORESCENT LIGHT DRIVER KIT

12V DC POWERED

Lights up 8-15 Watt Fluorescent Light Tubes Ideal for camper, outdoor Auto or Boat



Kit includes high voltage coil, power transistor, heat sink, all other electronic parts and PC Board, light tube not included!

**ONLY \$5.50 PER KIT**

## CALCULATOR with STOPWATCH

6 Functions with % and memory 8 Digits big green display \*Built-in X'tal controlled stop watch count to 1/10 of a second.

Special Price Only **\$16.50 Ea.**

BATTERIES NOT INCLUDED



## MECHANICAL DIGITAL CLOCK

WITH DAY AND DATE OF THE WEEK



This clock is beautifully designed. Case is made from high quality die cast alloy. Movement is the popular flip type with a back up light.

Supply Voltage 110V AC. limited quantity **\$15.50 ea.**

## 1Watt AUDIO AMP

All parts are pre assembled on a mini PC Board Supply Voltage 6-9V D.C. **SPECIAL PRICE \$1.95 ea.**



## "FISHER" 30 WATT STEREO AMP

(15W X 2)



Kit includes 2 pcs Fisher PA 301 Hybrid IC all electronic parts with PC Board, power supply, 1 16V DC (not included). Power band with (KF 1% ± 3dB). Voltage gain: 33dB, 20Hz-20KHz

Super Buy Only **\$22.50 each kit**

## 5W AUDIO AMP KIT

2 LM 380 with Volume Control Power Supply 6-18V DC

**only \$5.00 ea.**



## TIMER KIT

Time Controlled from 1-100sec.



Ideal to be used as time delay unit for burglar alarm, photo service, and other purposes. Max. loading 110V, 2 AMP Supply voltage 12 18V D.C. **\$11.50 each**

## ELECTRONIC ALARM SIREN

COMPLETE UNIT

Ideal for use as an Alarm Unit, or hookup to your car back up to make a reverse indicator Light Output up to 130 dB. Voltage Supply 6-12V **\$7.50**



## 19 KEY HEXADECIMAL KEY PAD

• 1-0 • Homekey  
• ABCDEF • ← Key  
**SPECIAL \$10.50 ea.**



Low Cost Hexadecimal 16 Key Pad



Designed for Calculator. Can be used for Computer Data Entry Pad or Digital Lock All key tops blank with super good touch feeling **\$0.95 ea.**

## DIGITAL ELECTRONIC LOCK KIT



for auto ignition, entry door, burglar, alarm, etc. CMOS I.C. 4 Digits Programmable to suit your needs. IN COMBINATION WITH 400R RELAY AND KEY PAD NOT INCLUDED

**\$6.50 ea.**

Designed for Calculator. Can be used for Computer Data Entry Pad or Digital Lock All key tops blank with super good touch feeling **\$0.95 ea.**

Designed for Calculator. Can be used for Computer Data Entry Pad or Digital Lock All key tops blank with super good touch feeling **\$0.95 ea.**

Designed for Calculator. Can be used for Computer Data Entry Pad or Digital Lock All key tops blank with super good touch feeling **\$0.95 ea.**

Designed for Calculator. Can be used for Computer Data Entry Pad or Digital Lock All key tops blank with super good touch feeling **\$0.95 ea.**

Designed for Calculator. Can be used for Computer Data Entry Pad or Digital Lock All key tops blank with super good touch feeling **\$0.95 ea.**

Designed for Calculator. Can be used for Computer Data Entry Pad or Digital Lock All key tops blank with super good touch feeling **\$0.95 ea.**

Designed for Calculator. Can be used for Computer Data Entry Pad or Digital Lock All key tops blank with super good touch feeling **\$0.95 ea.**

Designed for Calculator. Can be used for Computer Data Entry Pad or Digital Lock All key tops blank with super good touch feeling **\$0.95 ea.**

Designed for Calculator. Can be used for Computer Data Entry Pad or Digital Lock All key tops blank with super good touch feeling **\$0.95 ea.**

Designed for Calculator. Can be used for Computer Data Entry Pad or Digital Lock All key tops blank with super good touch feeling **\$0.95 ea.**

Designed for Calculator. Can be used for Computer Data Entry Pad or Digital Lock All key tops blank with super good touch feeling **\$0.95 ea.**

Designed for Calculator. Can be used for Computer Data Entry Pad or Digital Lock All key tops blank with super good touch feeling **\$0.95 ea.**

Designed for Calculator. Can be used for Computer Data Entry Pad or Digital Lock All key tops blank with super good touch feeling **\$0.95 ea.**

Designed for Calculator. Can be used for Computer Data Entry Pad or Digital Lock All key tops blank with super good touch feeling **\$0.95 ea.**

Designed for Calculator. Can be used for Computer Data Entry Pad or Digital Lock All key tops blank with super good touch feeling **\$0.95 ea.**

Designed for Calculator. Can be used for Computer Data Entry Pad or Digital Lock All key tops blank with super good touch feeling **\$0.95 ea.**

Designed for Calculator. Can be used for Computer Data Entry Pad or Digital Lock All key tops blank with super good touch feeling **\$0.95 ea.**

Designed for Calculator. Can be used for Computer Data Entry Pad or Digital Lock All key tops blank with super good touch feeling **\$0.95 ea.**

Designed for Calculator. Can be used for Computer Data Entry Pad or Digital Lock All key tops blank with super good touch feeling **\$0.95 ea.**

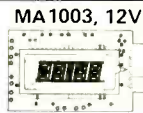

## MA1003, 12V DC CLOCK MODULE

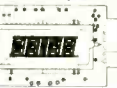

Built in X'TAL controlled time base. Protected against automotive volt transients. Automatic brightness control with 0-3 green color display. Display turnoff with ignition "OFF".

**\$19.50**

## 12V DC MINI RELAY

P.C. Board Solder Type

2AMP Contact SPDT \$1.30 EA  
2AMP Contact DPDT \$1.75 EA  
5AMP Contact 4PDT \$2.20 EA



## ELECTRONIC SWITCH KIT

CONDENSER TYPE



Touch on Touch Off use 7473 I.C. and 12V relay **\$5.50 each**



## 12V D.C. AUTO DIGITAL CLOCK

Complete Unit

Not a Kit!

0.4" blue color 4 digits display. Turn off readouts when car is not running. X'tal controlled time base for time accuracy. Special designed case for easy mounting on top of your dashboard. Ideal for car, boat and campers.

**ONLY \$28.50 ea.**



## HEAVY DUTY CLIP LEADS

10 pairs - 5 colors Alligator clips on a 22" long lead. Ideal for any testing.

**\$1.85/pack**

## MINI-SIZED I.C. AM RADIO

Size smaller than a box of matches!! Receives all AM stations Batteries and ear phone included

**Only \$8.50**



## NEW! 4 EASY-TO-BUILD KIT

LED PROJECTS ON ONE BOARD

- HO-Gauge railroad crossing blinker
- Variable LED flasher
- Six-bit binary counter
- Wheel of fortune

Kit includes all electronic components and PC Board

Especially designed for experimenters

Guaranteed - they all work!!

(Battery not included)

**\$12.50 PER KIT**



## LED ALARM CLOCK

COMPLETE UNIT

NOT A KIT

- 0.5" RED LED READ OUT
- 24 HRS. ALARM SET
- 10 MINS. SNOOZE SET
- AM/PM ALARM INDICATORS
- SECOND DISPLAY SWITCH
- AUTOMATIC BRIGHTNESS CONTROL
- COMPACT AND HANDSOME PACKAGING
- 110V AC 60HZ INPUT

**\$17.50 EACH**

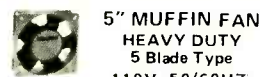

## 5" MUFFIN FAN

HEAVY DUTY

5 Blade Type

110V 50/60HZ

Case made of Die-Cast metal used but almost brand new **SPECIAL PRICE \$9.60 ea.**

## BIPOLAR LED

Jumbo Size red/green change color when reverse polarity of voltage. Ideal for go/no-go indicator.

Two for **\$1.50**

## I.C. TEST CLIPS

Same as the E Z clips With 20" Long Leads In Black and Red Colors **\$2.75 per pair**



## NI-CD RECHARGEABLE BATTERIES

AA SIZE \$1.25 EA  
C SIZE \$1.50 EA  
D SIZE \$2.50 EA  
5 Sub C pack SIZE \$4.90 EA

\*12V Mini Size Motorcycle rechargeable wet battery 6AMP/Hour Brand new, but ltd. quantity **\$12.50 EA.**



## Sub Mini Size PANEL METER

500 U.A.

**ONLY \$1.20 ea**

PANEL METER (D.C. Type) Size 60MM X 60MM White Face Type  
0.50 U.A. 0.30V  
0.1MA 0.50V  
0.5MA 0.100V  
0.100MA

## TRANSFORMERS

ALL 117 VOLT INPUT  
30V CT 4AMP \$7.50 EA.  
35V CT 3AMP \$6.50 EA.  
48V CT 3AMP \$6.50 EA.  
24V CT 3AMP \$6.50 EA.  
12 or 24V 2AMP \$3.90 EA.  
24V CT 0.8AMP \$1.80 EA.  
12V CT 0.8AMP \$1.80 EA.

## AC POWER SUPPLY

Wall Type Transformer  
12V AC Output 200MA \$2.75 EA.  
16V CT AC Output 100MA \$2.10 EA.  
6V DC Output 120MA \$1.90 EA.  
12V DC Output 100MA \$1.90 EA.

## 150UA METER

only **\$1.50 ea.**

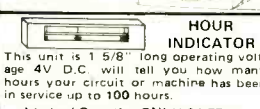

## HOUR INDICATOR

This unit is 1 5/8" long operating voltage 4V D.C. will tell you how many hours your circuit or machine has been in service up to 100 hours. Limited Quantity **ONLY \$1.75 ea.**



## MINI-MINI

## TOGGLE SWITCH

Half size of submini toggle switch rated 3amp 125V AC contact  
1 9 10 99  
2432P SPST 090 080  
M1 245 DPDT 120 110  
**LARGE QUANTITY AVAIL FOR OEM**

## SUBMINIATURES TOGGLE SWITCHES

SPDT On Off \$1.30 ea.  
DPDT On Off \$1.50 ea.  
3PDT On Off \$1.75 ea.  
Mini Size Reel Type Also Available at the Same Price

## MINI SIZE REED RELAY

Approx. 1" square SPST Normal Open Contact rated 1AMP Coil 6-12V DC All brand new by AMF 3 for \$2.00

## PUSH-BUTTON SWITCH

N/Open Contact Color: Red, White, Blue, Green, Black. 4/\$1.00 N/Close also Available 50c ea. **LARGE QTY AVAILABLE**

## SOLID STATE ELECTRONIC BUZZER

1/2" x 1/2" x 1/4" Supply voltage 1.5V 12V Ideal for Alarm or Tone Indicator **\$1.50 each**



# FORMULA INTERNATIONAL INC.

12603 CRENSHAW BOULEVARD • HAWTHORNE CALIFORNIA 90250

For more information please call (213) 973-1921, (213) 679-5162

STORE HOURS 10-7 Monday - Saturday





### SOCKET JUMPERS

Mates with two rows of .025" sq. or dia. posts on patterns of .100" centers and shielded receptacles. Probe access holes in back. Choice of 6" or 18" length.

Part No.	No. of Contacts	Length	Price
924003-18R	26	18"	\$ 5.38 ea.
924003-06R	26	6"	4.78 ea.
924005-18R	40	18"	8.27 ea.
924005-06R	40	6"	7.33 ea.
924006-18P	50	18"	10.31 ea.
924006-06R	50	6"	9.15 ea.

### JUMPER HEADERS

Solder to PC boards for instant plug-in access via socket-connector jumpers. .025" sq. posts. Choice of straight or right angle.

Part No.	No. of Posts	Angle	Price
923863-R	26	straight	\$1.28 ea.
923873-R	26	right angle	1.52 ea.
923865-R	40	straight	1.94 ea.
923875-R	40	right angle	2.30 ea.
923866-R	50	straight	2.36 ea.
923876-R	50	right angle	2.82 ea.

### INTRA-CONNECTOR

Provides both straight and right angle functions. Mates with standard 10" x 10" dual row connectors (i.e. 3M, Ainsley, etc.) Permits quick testing of inaccessible lines.

Part No.	No. of contacts: 26	Price \$6.90 ea.
922576-26		

### INTRA-SWITCH

Permits instant line-by-line switching for diagnostic or QA testing. Switches actuated with pencil or probe tip. Mates with standard 10" x 10" dual-row connectors. Low profile design. Switch buttons recessed to eliminate accidental switching.

Part No.	IS-26	No. of contacts: 26	Price \$13.80 ea.
----------	-------	---------------------	-------------------

### CRYSTALS

THESE FREQUENCIES ONLY

PART NO.	FREQUENCY	CASE	PRICE
CY1A	1.000MHz	HC33	5.95
CY1.84	1.8432MHz	HC33	5.95
CY2A	2.000MHz	HC33	5.95
CY2.01	2.010MHz	HC33	1.95
CY2.50	2.500MHz	HC33	4.95
CY2.27	2.2768MHz	HC33	4.95
CY3.57	3.579545MHz	HC33	4.95
CY3A	4.000MHz	HC18	4.95
CY4.91	4.916MHz	HC18	4.95
CY7A	5.000MHz	HC18	4.95
CY5.18	5.1854MHz	HC18	4.95
CY6.14	6.144MHz	HC18	4.95
CY6.40	6.400MHz	HC18	4.95
CY6.55	6.5536MHz	HC18	4.95
CY12A	10.000MHz	HC18	4.95
CY14A	14.31818MHz	HC18	4.95
CY19A	18.000MHz	HC18	4.95
CY18.43	18.432MHz	HC18	4.95
CY22A	20.000MHz	HC18	4.95
CY30A	32.000MHz	HC18	4.95

### SWITCHES

Part No.	Mounting holes	Price
JMT121	1.9	\$1.95
JMT123	1.9	1.21
JMT221	1.9	2.55
JMT223	1.9	1.58
MPC121	1.9	\$2.05
MPC123	1.9	1.75
MPC221	1.9	2.65
MPC223	1.9	2.25
PB123	1.9	1.95
PB126	1.9	1.47
MS102	3.5	35
MS103	3.5	30
206-4	1.75	1.65
206-7	1.85	1.85
206-8	2.25	2.15

### 1/16 VECTOR BOARD

Part No.	Material	Price
PHENOLIC	64P4 062XRP	6.50
169P4 062XRP	17.00	3.69
EPDXY	64P4 062WE	6.50
GLASS	64P4 062WE	8.50
169P4 062WE	17.00	5.04
169P4 062WE	17.00	9.23
169P4 062WEC1	17.00	6.80

### ELLY-WRAP

Model P180 Includes 2-100' spools #28 AWG wire wrap wire

Supplies insulated wire from spool to wrap-posts without prestrapping and precutting using "daisy chain" method.

**Model P180 \$24.50**

Replacement wrap bit for P180 slit N wrap (pkg. of 3) \$2.75 each

No. P180A \$12.95 each

W28-2-A green W28-2-B red W28-2-C clear W28-2-D blue

### INSTRUMENT/CLOCK CASE

Injection molded unit. Complete with red bezel. 4 1/2" x 4" x 1-9/16"

**\$3.49**

### MICROPROCESSOR COMPONENTS

Part No.	Price	Part No.	Price
8088 CPU	\$19.95	Z80 CPU	\$24.95
8088A CPU	29.95	2650 MPU	26.50
8080A CPU	10.95	MC6800 MPU	19.95
8212 8-Bit Input/Output	4.95	MC6810A1 128 K 8 Static Ram	5.95
8214 Priority Interrupt Control	7.95	MC6820 Periph Interface Adapter	7.95
8216 8-Directional Bus Driver	4.95	MC6821 Periph Interface Adapter	11.50
8224 Clock Generator/Driver	5.95	MC6830L8 1024 X 8 Bit ROM	14.95
8228 System Controller/Bus Driver	5.95	MC6850 Asynchronous Comm. Adapter	14.95

### USER MANUALS

Part No.	Price	Part No.	Price
1802M 8080 Manual	\$ 7.50	1101 256 X 1 Static	\$ 1.49
780 Manual	11.03	2111 256 X 4 Static	5.95
2650M 2650 Manual	7.50	2101 256 X 4 Static	5.95

### SHIFT REGISTERS

Part No.	Price	Part No.	Price
MM500H Dual 25 Bit Dynamic	.50	2107/5280 4096 X 1 Dynamic	4.95
MM503H Dual 50 Bit Dynamic	.50	2114 4K X 1 Static 450ms	9.95
MM504H Dual 16 Bit Static	.50	2114L 4K X 1 Static 450ms Low Power	10.95
MM505H Dual 100 Bit Static	.50	2114-3 4K X 1 Static 300ms	10.95
MM507H Dual 100 Bit Static	.50	2114-3 4K X 1 Static 300ms Low Power	11.95
MM510H Dual 64 Bit Accumulator	.50	7489 16 X 4 Static	1.75
MM5013H 1024 Bit Accumulator Dynamic	2.95	8101 256 X 4 Static	5.95
MM5019H 500/512 Bit Dynamic	.99	8111 256 X 4 Static	6.95
MM5017H 1024 Dynamic	3.95	8199 16 X 4 Static	3.49
2504T Hex 32 Bit Static	4.00	21102 1024 X 1 Static	1.95
2518 Hex 40 Bit Static	7.95	74700 256 X 1 Static	6.95
2519 Hex 40 Bit Static	9.95	9421 256 X 1 Static	2.95
2522 Dual 132 Bit Static	2.95	MM5252 2K X 1 Dynamic	4.95
2524 512 Dynamic	.99	MM4027 (UP041) 4K DYNAMIC 16 PIN	5.95
2525 1024 Dynamic	2.95	MM4116 (UP0416) 16K DYNAMIC 16 PIN	29.95
2527 Dual 250 Static	2.95	MS4044-45HL 4K STATIC	14.95
2528 Dual 240 Bit Static	4.00	1702A 2048 Famous	\$ 5.95
2532 Quad 80 Bit Static	2.95	2048 Famous	14.95
2533 1024 Static	2.95	82523 32 X 8 Open C	5.00
3341 4 X 4 Register	6.95	82515 4096 Bipolar	19.95
74LS670	1.95	825123 32 X 8 Tri-state	5.00

### ROM'S

Part No.	Price	Part No.	Price
2513(2140) Character Generator (upper case)	\$ 9.95	2708 8K EPROM	10.95
2513(3021) Character Generator (lower case)	9.95	2716 T.1 16K EPROM	29.95
2516 Character Generator	10.95	2716 16K EPROM	59.95
MM5230N 2048 Bit Read Only Memory	1.95	6301-1 1024 16 Pin State Buffer	3.49
AY-5-1013 30K BAUD UART'S	\$ 5.95	6330-1 256 Open C Buffer	2.95
		74186 512 TTL Open Collector	9.95
		74188 256 TTL Open Collector	3.95

### SPECIAL REQUESTED ITEMS

Part No.	Price	Part No.	Price
KEYBOARD CHIPS		ICM7045	\$24.95
AV-5-9100	\$14.95	ICM7205	19.95
AV-5-9200	14.95	ICM7207	7.50
AV-5-9500	14.95	ICM7208	19.95
AV-5-2376	14.95	ICM7209	6.95
HD0165	7.95		
74C922	9.95		
ICM CHIPS		NMOS READ ONLY	
11C80	\$19.95	11C80	\$17.50
MC3061P	11.95	MC3061P	11.95
MC138L17	4.95	MC138L17	3.75
MC1401B	5.75	MC1401B	5.75
LD110111	\$25.00	LD110111	7.50
MC016744161	6.95	MC016744161	6.95
4K33	3.95		
TV GAME CHIP SET			
AY-3-9900-1 Chip and 2-1010 MHz Crystals	\$7.95		

### PARATRONICS Logic Analyzer Kit Model 100A \$229.00/kit

Analyzes any type of digital system. Checks data rates in excess of 8 million words per second. Trouble shoot TTL, CMOS, DTL, RTL, Schottky and MOS families. Displays 16 logic states up to 8 digits wide. See ones and zeros displayed on your CRT, octal or hexadecimal format. Tests circuits under actual operating conditions. Easy to assemble — comes with step-by-step construction manual which includes 80 pages on logic analyzer operation. (Model 100A Manual - \$4.95)

Model 100A Model 10

### PARATRONICS TRIGGER EXPANDER - Model 10

Adds 16 additional bits. Provides digital delay and qualification of input clock and 24-bit trigger word — Connects direct to Model 100A for integrated unit.

Model 10 Kit - \$229.00 Baseplate — \$9.95 Model 10 Manual — \$4.95

### BK PRECISION 3 1/2-Digit Portable DMM

Overload Protected. 3 1/2 High LED Display. Battery or AC operation. Auto Zeroing. True RMS 0.1 ohm resolution. Overrange reading. 10 meg input impedance. DC Accuracy 1% typical. Ranges: DC Voltage - 0-1000V; AC Voltage - 0-1000V; DC AC Current - 0-100mA; Resistance - 0-10 meg ohm. Size 6 1/2 x 4 1/2"

Model 2800 \$99.95

Accessories: AC Adapter BC-28 \$9.00 Rechargeable Batteries BP-26 20.00 Carrying Case LC-28 7.50

### 100 MHz 8-Digit Counter

20 to 100 MHz Range. 6 LED Display. Crystal-controlled timebase charger 12V with auto lighter adapter and external 7.2-10V power supply. Portable — completely self contained. Size — 1.75" x 7.38" x 5.63"

MAX-100 \$134.95

Accessories for MAX 100: Mobile Charger Eliminator use power from car battery Model 100 — CLA \$3.95 Charger/Eliminator use 110 V AC Model 100 — CAI \$9.95

### 63-Key Unencoded KEYBOARDS Hexadecimal Encoder

This is a 63-key terminal keyboard newly manufactured by a large computer manufacturer. It is unencoded with SPST keys, unattached to any kind of PC board. A very solid molded plastic 13 x 4" base suits most application. IN STOCK \$29.95/each

19-key pad includes 1-10 keys, ABCDEF and 2 optional keys and a shift key. \$10.95/each

\$5.00 Minimum Order — U.S. Funds Only California Residents — Add 6% Sales Tax Spec Sheets — 25¢ 1978A Catalog Available — Send 35¢ stamp

### Jameco ELECTRONICS

PHONE ORDERS WELCOME (415) 592-8097

MAIL ORDER ELECTRONICS — WORLDWIDE 1021 HOWARD AVENUE, SAN CARLOS, CA 94070 Advertisers Prices Good Thru June

### The Incredible "Pennywhistle 103" \$129.95 Kit Only

The Pennywhistle 103 is capable of recording data to and from audio tape without critical speed requirements for the recorder and it is able to communicate directly with another modern terminal for telephone, teletype, and communications for the deaf. In addition, it is free of critical adjustments and is built with non-precision readily available parts.

Data Transmission Method — Frequency Shift Keying, full duplex (half-duplex selectable)

Maximum Data Rate — 300 Baud

Data Format — Asynchronous Serial (return to mark level required between each character)

Receive Channel Frequencies — 2025 Hz for space 2225 Hz for mark

Transmit Channel Frequencies — Switch selectable Low (normal) 1070 space, 1270 mark, High — 025 space 2225 mark, 46 dbm acoustically coupled

Receive Sensitivity — 15 dbm nominal, Adjustable from 6 dbm to -20 dbm

Receive Frequency Tolerance — Frequency reference automatically adjusts to allow for variation between 1800 Hz and 2100 Hz

Digital Data Interface — EIA RS-232C or 20-mA current loop (receiver is optoisolated and non-polar)

Power Requirements — 120 VAC, single phase, 10 Watts

Physical — All components mount on a single 5 1/2" x 9" printed circuit board. All components included.

Requires a VOM, Audio Oscillator, Frequency Counter and/or Oscilloscope to align

### The Original the 3rd Hand \$9.95 each

Leaves two hands free for working. Clamps on edge of bench, table or work bench. Position board on angle or flat position for soldering or clipping. Sturdy, aluminum construction for hobbyist, manufacturer or school rooms.

### DIGITAL STOPWATCH

Bright 6-Digit LED Display. Times to 59 minutes, 59.99 seconds. Crystal Controlled Time Base. Three Stopwatches in One. Times Single Events — Split & Taylor. Size 4.5" x 2.15" x .90" (4 1/2 ounces). Uses 3 Penrite Cells.

Kit — \$39.95 Assembled — \$49.95 Heavy Duty Carry Case \$5.95

Stop Watch Chip Only (7205) \$19.95

### EMC 3 1/2 DIGIT DPM KIT

New Bipolar Unit. Auto Zeroing. 5" LED. Auto Polarity. Low Power. Single IC Unit.

Model KB500 DPM Kit \$49.00 Model KB503 5V Power Kit \$17.50

### JE700 CLOCK

The JE700 is a low cost digital clock but is a very high quality unit. The unit features a simulated walnut case with dimensions of 8" x 7 1/2" x 1 1/2". It utilizes a MAX102 high brightness readout, and the MM5314 clock chip.

115 VAC 17 or 24 Hour KIT ONLY \$16.95

### JE803 PROBE

The Logic Probe is a unit which is for the most part indispensable in trouble shooting logic families TTL, DTL, RTL, CMOS. It derives the power it needs to operate directly off of the circuit under test drawing a scant 10-mA max. It uses a MAX102 readout to indicate any of the following states: these symbols (H) 1 (LOW) 0 (PULSE) P (The Probe can detect high frequency pulses to 45 MHz. It can't be used at MOS levels or circuit damage will result)

\$9.95 Per Kit printed circuit board

### T'L 5V 1A Supply

This is a standard TTL power supply using the well known LM309K regulator. It provides a solid 1 AMP of current at 5 volts. We try to make things easy for you by providing everything you need — one package, including the hardware for only

JE225 \$9.95 Per Kit

### PROTO BOARDS

PROTO BOARD 6 \$15.95 (6 long X 4 wide)

PB100 - 4.5" x 6" \$ 19.95  
PB101 - 5.8" x 4.5" 29.95  
PB102 - 7" x 4.5" 39.95  
PB103 - 9" x 6" 59.95  
PB104 - 9.5" x 8" 79.95  
PB203 - 9.75" x 6 1/2" x 2 1/2" 80.00  
PB203A - 9.75" x 6 1/2" x 2 1/2" 129.95 (includes power supply)

PROTO CLIPS  
14 PIN \$4.50  
16 PIN 4.75  
24 PIN 8.50  
40 PIN 13.75







## TRANSFORMER HINT

Steve P. Dow, Gibsons, BC, Canada, writes:

"Low-end stereos which need unavailable OEM transformers can be replaced with standard brands, as you said in the Service Clinic, January 1978 issue. Many of the originals fail because a thermal fuse was used in the primary circuit. The UL and CSA safety tests on these receivers are based upon this intrinsic energy-limiting device. However, many of the standard low-voltage transformers in replacement lines do not have this protective device. So, when these are used, a fuse should be added, if the original part isn't used.

"This thermal fusing seems to be the result of tightened transformer standards since 1973. Manufacturers had to guarantee that when a transformer burned out it could not short any primary terminal to the core. Since this burnout test was made with the primary energized and the secondary shorted, the simple solution was to use thermal links. Burnout then terminated with the open primary circuit, and the insulation did not overheat."

(Thank you very much, Steve. To be honest, I didn't know that! However, I had wondered about the rash of cases with open primary winding. You may remember that the older power transformers rarely, if ever, opened the prima-

ry; they just overheated and burnt up.

Thermal fusing is a very good idea, and I should have added that. Also, if the replacement transformer is well derated, as suggested, there won't be as much risk of overloading it, as the original obviously was.)

## THIN BLUE LINE

*I'm having a time with this J.C. Penney model 2874. All I get is a thin blue horizontal line on the screen! I've checked several things and come up dry.—M. B., Pearl, MS.*

There are several possible causes for this. One, make sure that the service switch is good. The ohmmeter must show zero resistance between the vertical-output base and the bottom end of the 39-ohm resistor to the vertical driver's collector circuit. Also, read the emitter voltage of the vertical-output transistor. If this reads normal (+5.2V volts), then the output stage is working, and there should be an open circuit in the secondary of the vertical-output transformer or vertical-deflection yoke. Check all yoke plug contacts.

If all these seem to be OK, check the 220- $\mu$ F electrolytic capacitor in the yoke circuit. This is the yoke-return capacitor, and if it's open there will be no sweep.

For the blue line, check the red and green screen-control settings.

P.O. Box 4430E Santa Clara, CA 95054

For will call only: (408) 988-1640  
2996 Scott Blvd.

**QUEST**

**ELECTRONICS**

Same day shipment. First line parts only. Factory tested. Guaranteed money back. Quality IC's and other components at factory prices.

### INTEGRATED CIRCUITS

74001T	74LS28N	41	LM3401-12	1.10	CMOS	04511	94	2117	4.00
7400N	74LS30N	15	LM3401-15	1.10	CMOS	04516	10	2118	4.00
7400P	74LS30P	15	LM3401-15	1.10	CMOS	04520	100	2119	4.00
7400Q	74LS30Q	15	LM3401-15	1.10	CMOS	04520	100	2120	4.00
7400R	74LS30R	15	LM3401-15	1.10	CMOS	04520	100	2121	4.00
7400S	74LS30S	15	LM3401-15	1.10	CMOS	04520	100	2122	4.00
7400T	74LS30T	15	LM3401-15	1.10	CMOS	04520	100	2123	4.00
7400U	74LS30U	15	LM3401-15	1.10	CMOS	04520	100	2124	4.00
7400V	74LS30V	15	LM3401-15	1.10	CMOS	04520	100	2125	4.00
7400W	74LS30W	15	LM3401-15	1.10	CMOS	04520	100	2126	4.00
7400X	74LS30X	15	LM3401-15	1.10	CMOS	04520	100	2127	4.00
7400Y	74LS30Y	15	LM3401-15	1.10	CMOS	04520	100	2128	4.00
7400Z	74LS30Z	15	LM3401-15	1.10	CMOS	04520	100	2129	4.00
7401N	74LS10N	47	LM3401-12	1.10	CMOS	04516	10	2130	4.00
7401P	74LS10P	47	LM3401-12	1.10	CMOS	04516	10	2131	4.00
7401Q	74LS10Q	47	LM3401-12	1.10	CMOS	04516	10	2132	4.00
7401R	74LS10R	47	LM3401-12	1.10	CMOS	04516	10	2133	4.00
7401S	74LS10S	47	LM3401-12	1.10	CMOS	04516	10	2134	4.00
7401T	74LS10T	47	LM3401-12	1.10	CMOS	04516	10	2135	4.00
7401U	74LS10U	47	LM3401-12	1.10	CMOS	04516	10	2136	4.00
7401V	74LS10V	47	LM3401-12	1.10	CMOS	04516	10	2137	4.00
7401W	74LS10W	47	LM3401-12	1.10	CMOS	04516	10	2138	4.00
7401X	74LS10X	47	LM3401-12	1.10	CMOS	04516	10	2139	4.00
7401Y	74LS10Y	47	LM3401-12	1.10	CMOS	04516	10	2140	4.00
7401Z	74LS10Z	47	LM3401-12	1.10	CMOS	04516	10	2141	4.00
7402N	74LS20N	50	LM3401-12	1.10	CMOS	04516	10	2142	4.00
7402P	74LS20P	50	LM3401-12	1.10	CMOS	04516	10	2143	4.00
7402Q	74LS20Q	50	LM3401-12	1.10	CMOS	04516	10	2144	4.00
7402R	74LS20R	50	LM3401-12	1.10	CMOS	04516	10	2145	4.00
7402S	74LS20S	50	LM3401-12	1.10	CMOS	04516	10	2146	4.00
7402T	74LS20T	50	LM3401-12	1.10	CMOS	04516	10	2147	4.00
7402U	74LS20U	50	LM3401-12	1.10	CMOS	04516	10	2148	4.00
7402V	74LS20V	50	LM3401-12	1.10	CMOS	04516	10	2149	4.00
7402W	74LS20W	50	LM3401-12	1.10	CMOS	04516	10	2150	4.00
7402X	74LS20X	50	LM3401-12	1.10	CMOS	04516	10	2151	4.00
7402Y	74LS20Y	50	LM3401-12	1.10	CMOS	04516	10	2152	4.00
7402Z	74LS20Z	50	LM3401-12	1.10	CMOS	04516	10	2153	4.00
7403N	74LS00N	10	LM3401-12	1.10	CMOS	04516	10	2154	4.00
7403P	74LS00P	10	LM3401-12	1.10	CMOS	04516	10	2155	4.00
7403Q	74LS00Q	10	LM3401-12	1.10	CMOS	04516	10	2156	4.00
7403R	74LS00R	10	LM3401-12	1.10	CMOS	04516	10	2157	4.00
7403S	74LS00S	10	LM3401-12	1.10	CMOS	04516	10	2158	4.00
7403T	74LS00T	10	LM3401-12	1.10	CMOS	04516	10	2159	4.00
7403U	74LS00U	10	LM3401-12	1.10	CMOS	04516	10	2160	4.00
7403V	74LS00V	10	LM3401-12	1.10	CMOS	04516	10	2161	4.00
7403W	74LS00W	10	LM3401-12	1.10	CMOS	04516	10	2162	4.00
7403X	74LS00X	10	LM3401-12	1.10	CMOS	04516	10	2163	4.00
7403Y	74LS00Y	10	LM3401-12	1.10	CMOS	04516	10	2164	4.00
7403Z	74LS00Z	10	LM3401-12	1.10	CMOS	04516	10	2165	4.00
7404N	74LS04N	10	LM3401-12	1.10	CMOS	04516	10	2166	4.00
7404P	74LS04P	10	LM3401-12	1.10	CMOS	04516	10	2167	4.00
7404Q	74LS04Q	10	LM3401-12	1.10	CMOS	04516	10	2168	4.00
7404R	74LS04R	10	LM3401-12	1.10	CMOS	04516	10	2169	4.00
7404S	74LS04S	10	LM3401-12	1.10	CMOS	04516	10	2170	4.00
7404T	74LS04T	10	LM3401-12	1.10	CMOS	04516	10	2171	4.00
7404U	74LS04U	10	LM3401-12	1.10	CMOS	04516	10	2172	4.00
7404V	74LS04V	10	LM3401-12	1.10	CMOS	04516	10	2173	4.00
7404W	74LS04W	10	LM3401-12	1.10	CMOS	04516	10	2174	4.00
7404X	74LS04X	10	LM3401-12	1.10	CMOS	04516	10	2175	4.00
7404Y	74LS04Y	10	LM3401-12	1.10	CMOS	04516	10	2176	4.00
7404Z	74LS04Z	10	LM3401-12	1.10	CMOS	04516	10	2177	4.00
7405N	74LS08N	10	LM3401-12	1.10	CMOS	04516	10	2178	4.00
7405P	74LS08P	10	LM3401-12	1.10	CMOS	04516	10	2179	4.00
7405Q	74LS08Q	10	LM3401-12	1.10	CMOS	04516	10	2180	4.00
7405R	74LS08R	10	LM3401-12	1.10	CMOS	04516	10	2181	4.00
7405S	74LS08S	10	LM3401-12	1.10	CMOS	04516	10	2182	4.00
7405T	74LS08T	10	LM3401-12	1.10	CMOS	04516	10	2183	4.00
7405U	74LS08U	10	LM3401-12	1.10	CMOS	04516	10	2184	4.00
7405V	74LS08V	10	LM3401-12	1.10	CMOS	04516	10	2185	4.00
7405W	74LS08W	10	LM3401-12	1.10	CMOS	04516	10	2186	4.00
7405X	74LS08X	10	LM3401-12	1.10	CMOS	04516	10	2187	4.00
7405Y	74LS08Y	10	LM3401-12	1.10	CMOS	04516	10	2188	4.00
7405Z	74LS08Z	10	LM3401-12	1.10	CMOS	04516	10	2189	4.00
7406N	74LS16N	10	LM3401-12	1.10	CMOS	04516	10	2190	4.00
7406P	74LS16P	10	LM3401-12	1.10	CMOS	04516	10	2191	4.00
7406Q	74LS16Q	10	LM3401-12	1.10	CMOS	04516	10	2192	4.00
7406R	74LS16R	10	LM3401-12	1.10	CMOS	04516	10	2193	4.00
7406S	74LS16S	10	LM3401-12	1.10	CMOS	04516	10	2194	4.00
7406T	74LS16T	10	LM3401-12	1.10	CMOS	04516	10	2195	4.00
7406U	74LS16U	10	LM3401-12	1.10	CMOS	04516	10	2196	4.00
7406V	74LS16V	10	LM3401-12	1.10	CMOS	04516	10	2197	4.00
7406W	74LS16W	10	LM3401-12	1.10	CMOS	04516	10	2198	4.00
7406X	74LS16X	10	LM3401-12	1.10	CMOS	04516	10	2199	4.00
7406Y	74LS16Y	10	LM3401-12	1.10	CMOS	04516	10	2200	4.00
7406Z	74LS16Z	10	LM3401-12	1.10	CMOS	04516	10	2201	4.00
7407N	74LS24N	10	LM3401-12	1.10	CMOS	04516	10	2202	4.00
7407P	74LS24P	10	LM3401-12	1.10	CMOS	04516	10	2203	4.00
7407Q	74LS24Q	10	LM3401-12	1.10	CMOS	04516	10	2204	4.00
7407R	74LS24R	10	LM3401-12	1.10	CMOS	04516	10	2205	4.00
7407S	74LS24S	10	LM3401-12	1.10	CMOS	04516	10	2206	4.00
7407T	74LS24T	10	LM3401-12	1.10	CMOS	04516	10	2207	4.00
7407U	74LS24U	10	LM3401-12	1.10	CMOS	04516	10	2208	4.00
7407V	74LS24V	10	LM3401-12	1.10	CMOS	04516	10	2209	4.00
7407W	74LS24W	10	LM3401-12	1.10	CMOS	04516	10	2210	4.00
7407X	74LS24X	10	LM3401-12	1.10	CMOS	04516	10	2211	4.00
7407Y	74LS24Y	10	LM3401-12	1.10	CMOS	04516	10	2212	4.00
7407Z	74LS24Z	10	LM3401-12	1.10	CMOS	04516	10	2213	4.00
7408N	74LS32N	10	LM3401-12	1.10	CMOS	04516	10	2214	4.00
7408P	74LS32P	10	LM3401-12	1.10	CMOS	04516	10	2215	4.00
7408Q	74LS32Q	10	LM3401-12	1.10	CMOS	04516	10	2216	4.00
7408R	74LS32R	10	LM3401-12	1.10	CMOS	04516	10	2217	4.00
7408S	74LS32S	1							



# INTERNATIONAL ELECTRONICS UNLIMITED

## IC LED SALE

### LED DISPLAYS

MAN 1	.27"	Red CA LHD	.99
MAN 2	.30"	Red 5x7 LHD	3.95
MAN 5	.27"	Green CA LHD	.99
MAN 7	.27"	Yellow CA LHD	.49
MAN 54	.30"	Green CC RHO	1.19
MAN 66	.60"	Red CA LHD	1.19
MAN 72	.30"	Red CA LHD	.59
MAN 82	.30"	Red CA LHD	.99
MAN 3610	.30"	Orange CA RHO	.69
MAN 3640	.30"	Orange CC RHO	.69
MAN 4610	.40"	Orange CC RHO	.59
MAN 6660	.56"	Orange CA RHO	.59
DL 10A	.27"	Red CA LHD	.99
DL 702	.30"	Red CC LHD	.79
DL 707	.30"	Red CA RHO	.79
DL 747	.60"	Red CA LHD	1.19
FND 359	.375"	Red CC RHO	.59
FND 500	.50"	Red CC RHO	.69
FND 507/510	.50"	Red CA RHO	.69
NSN 74R	.30"	Red CC RHO	.69
MAN 6610	2 Dig .56"	Orng CA RHO	.69
MAN 6630	1-1/2 Dig .56"	Orng CA RHO	.59
MAN 6640	2 Dig .56"	Orng CC RHO	.69
MAN 6650	1-1/2 Dig .56"	Orng CC RHO	.59
MAN 6710	2 Dig .56"	Red CA RHO	.69
MAN 6730	1-1/2 Dig .56"	Red CA RHO	.59
MAN 6740	2 Dig .56"	Red CA RHO	.69
MAN 6750	1-1/2 Dig .56"	Red CC RHO	.59
DL 338	3 Dig .17"	Red CC	.29
DL 338	2 Dig .17"	Red CC	.49
NSN 33	3 Dig .17"	Red CC	.39
HP 5082	4 Dig .11"	Mag. RHO	.39
HP 5082	5 Dig .11"	Mag. RHO	.49
SP425-09	9 Dig Gas Discharge		.69
Calc Disp	9 MAN 3s on board Red		.79
TJ 434	9 Dig Red		.49

Jumbo Red LEDs	12/\$1.00	140/\$10.00
Jumbo Green LEDs	8/\$1.00	100/\$10.00
Jumbo Yellow LEDs	8/\$1.00	100/\$10.00
Jumbo Clear LEDs	12/\$1.00	140/\$10.00

### UNIVERSAL BREADBOARD



Silver plated copper circuits fits any IC and related components. 2 triple rows of 27 holes for DIP. 3-3/16"x5-1/16" \$1.00

### IC BREADBOARD

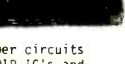

Silver plated copper circuits holds 5 - 16 pin DIP IC's and interconnection holes. \$1.00

### PLASTIC CASES



VERO - dark and light gray nominal 0.0.	
2514F 2"x4"x1"	\$4.34
2516G 2"x4"x1.6"	4.90
2518H 2.6"x4.7"x1.6"	5.48
2520J 3.2"x6"x2"	6.24
2522K 4.3"x7.4"x2.4"	8.28
2755G 2.6"x4.7"x2.6"	6.74
27600 4.3"x7.4"x2.4"	
(w/ handle/stand)	10.78
2525F 2.8"x5.4"x2.4"	
(ventilated)	5.40
HAMMOND - blue	
1591C 2.6"x4.8"x1.6"	2.65

### KEYBOARD



20 Keys - 2 slide switches 3" x 3-3/4" ..... \$1.00/3

### BEZELS - with red filters

140-2 cut-out 1.125" x 2.375" max .062" panel thickness \$1.75

### BIMBOARD - BREADBOARD KIT



Solderless breadboard section has 94 breadboard strips of 50 sockets each. 2 bus strips of 40 sockets each. Component bracket for switches lamps etc., accepts leads .01" to .035" diameter. \$11.95 ea.

2708	8K EROM	\$8.95
2b13(caps)	Char. Gen.	2.95
2513(L.C.)	Char. Gen.	2.95
MM1101	256 bit RAM	.65
MM1103	1K RAM	.75
1702A	EROM	4.75
MM5261	1K RAM	.55
MM5262	1K RAM	.95
F93410	256 bit RAM	.95
MM5314	Clock Chip	2.95
MM5316	Clock Chip	2.95
MM5370	Clock Chip	3.95
MM5375AA	Clock Chip	2.95
CT7001	Clock Chip	4.95
2510	Dual 50 bit Shift Reg.	.95
2511	Dual 100 bit Shift Reg.	.95
2518	Hex 32 bit Shift Reg.	1.25
2522	Dual 132 bit Shift Reg.	.95
MM5016	500/512 bit Shift Reg.	.95
SL-5-4025	Quad 25 bit Shift Reg.	.59
CT5002	Calc. Chip	.35
CT5005	Calc. Chip	.75
MM5725	Calc. Chip	.35
MM5736	Calc. Chip	.65
MM5738	Calc. Chip	.95
MM5739	Calc. Chip	.95

EXAR 320	1.19	4136	.69
2206	3.90	4202	.69
2207	1.49	4212	.69
2567	1.49	4739	.69

SIGNAL DIODES 400mw 100/\$1.00
MV10B T0-18 Clear 15/\$1.00

### IASIS MICROCOMPUTER APPLICATIONS HANDBOOK

301m Prec. Op Amp	\$1.19
302H Volt Follower	.39
308H Prec Op Amp	.49
311N Hi Perf V Comp.	.59
34016V Pos. V Reg.	.59
540H Power Amp	1.59
565N Genl Purp PLL	.99
723N Volt Reg	.45
739N Diff Video Amp	.49
739N Dual Audio Preamp	.69
1414N Dual Diff Comp.	.99

### LINEAR ASSORTMENT

1 each of following - all functional  
301M, 302H, 307M, 311N, 340T-5, 340T-6, 340T-15, 380-8, 385K, 723N, 739N, 741M, 748M, 75453M \$4.75

### TRIMPOT - Single Turn

Mepeco - Cermet 8014  
.5w, + 100 PPM/°C + 20%  
500 ohm, 2K, 10K, 25K, 50K, 100K, 500K, 1M. \$3.75 ea .69/10-

### TRIMPOT - 25 turn

Bourns - Cermet 3299W  
PC Mount, vert. adj.  
2K, 10K, 20K \$1.75 ea

### METAL FILM RESISTORS

± 1%, 1/4w, + 50 PPM/°C  
Standard Decade Values 10.5 - 464K  
Qty. Ea. Min 10/value Min 100/value  
1-99 \$2.20 \$1.35  
100-999 .20 .10 \$9.00/100  
1000- .20 8.00/100

### Carbon Film Resistors ± 5% 1/4w, 1/2w

Qty. Ea. Min 10/value Min 100/value  
1-99 \$1.10 \$0.50  
100-999 .10 .04 \$3.00/100  
1000- .20 2.50/100

### RESISTOR PACKAGE

Carbon Film ± 5% 1/4 w or 1/2 w  
15 ea. of 12 values:  
100, 220, 470, 1K, 1.5K, 3.3K  
4.7K 6.8K, 10K, 33K, 100K, 1M.  
\$5.45

### Carbon Film ± 5% 1/4w or 1/2w

Usage Evaluated Assortment  
5 to 20 ea of 44 values.  
\$12.95  
Supplied in 15 Drawer 60 Comp. Cabinet. \$22.95 + \$2.00 Sh.

### IC SOCKETS

Low Profile Solder Tail		Wire Wrap	
8 pin \$1.6	24 pin \$3.6	8 pin \$4.5	
14 pin \$1.9	28 pin \$4.4	14 pin \$4.9	
16 pin \$2.1	40 pin \$6.1	16 pin \$5.5	
18 pin \$2.8			

### PC BOARDS - for use with ELEKTOR MAGAZINE PROJECTS

ELEKTOR #27/28 Jul-Aug 77	3.00
LED peak indicator	9525 2.70
knotted handkerchief	9830 .45
phaser	77001 2.50
distortion meter	77005 4.10
TV car preamp	77020 2.45
time switch	77021 3.50
0-10V supply	77059 2.10
11 - qualiser	77071 1.50
automatic Ni Cad charger	77075 1.45
TV games	77084 4.50
4w car radio amp	77101 1.40
3-1/2 digit DVM	77109 4.70
ELEKTOR #26 June 77	1.50
Precision time base	9448 3.40
power supply for time base	9448-1 1.30
music synthesiser	9721-1 5.75
keyboard interface (E25)	9763 5.20
levitator	9763 5.20
loudspeaker cross-over filters (E25)	9768 4.30
model car track (E24,25)	
servo amp	9803 .80
ELEKTOR #25 May 77	1.50
music cleaner	9785 3.90
model car track (E24)	
multitex encoder	9796-1 6.85
infrared transmitter	9796-2 3.55
ultrasonic alarm (E19)	
single transducer/recvr	9815-1 2.80
transmitter	9815-2 .85
ELEKTOR #24 April 77	1.50
display (E13)	9376 6.90
LED volume unit meter	
rectifier section	9419-1 5.15
display section	9419-2 9.95
FM tuner (E23)	
i.f. converter	9447-2 3.40
stereo decoder	9447-3 2.55
auto slide changer	9743 1.45
mosc decoder	9759 16.25
signal injector	9765 1.10

### 5 BACK ISSUES OF ELEKTOR MAGAZINE

containing a variety of electronic projects, with schematics, PC layouts, parts list. PC boards are available. Regular \$1.50/copy \$4.00/5 issues

25 26 29 30 31

### REGULATED POWER SUPPLY

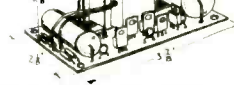

Plus & minus 5V, 12V and 15V. Uses 3 LM340T and 3 LM302T regulators, 115V/29V CT transformer plus PC board capacitors & diodes. All parts, schematic, instructions PS-29 ..... \$12.95 + \$1.00 Shpping.

### CLOCK KIT - Mark I

5 digit clock kit with one PC board. Accommodates MM5314 clock chip and 6 FND 359 displays contains all components except transformer. Includes 3 switches. Board has terminals for remote displays. \$10.95

with 12V/300 ma transformer \$13.95

### PRECISION RESISTOR PACKAGE

Metal Film ± 1% 1/4 watt  
Starliner Kit - 2ea. 60 values  
120 Resistors 10.5 ohm- 464K  
\$14.95  
Supplied in 15 Drawer 60 Comp. Cabinet - \$26.50 + \$2.00 Sh.

### TYL

7400	11	7451	20	74155	75
7401	18	7452	20	74156	75
7402	14	7453	20	74157	85
7403	14	7460	20	74158	39
7404	16	7464	35	74160	123
7405	19	7465	35	74161	95
7406	29	7466	35	74162	139
7407	28	7467	35	74163	15
7408	22	7473	35	74164	95
7409	17	7474	35	74165	95
7410	16	7475	49	74166	15
7411	25	7476	34	74170	90
7412	43	7483	68	74173	149
7413	65	7485	88	74174	159
7414	65	7486	88	74174	159
7415	25	7488	38	74175	95
7416	35	7489	225	74176	84
7417	35	7493	48	74182	85
7420	16	7491	75	74180	95
7423	37	7492	48	74181	230
7426	25	7497	75	74184	15
7428	22	7494	75	74185	220
7427	35	7495	75	74190	125
7430	20	7498	75	74191	115
7432	23	74100	15	74192	88
7437	25	74107	37	74193	85
7436	25	74121	37	74194	15
7439	50	74122	38	74195	74
7440	15	74123	45	74196	98
7441	19	74124	54	74197	55
7442	59	74126	58	74198	169
7443	65	74132	75	74199	169
7444	70	74137	85	74200	393
7445	65	74145	90	74279	79
7446	61	74150	90		
7447	59	74151	68		
7448	79	74153	60		
7450	17	74154	120		

### ELECTRONIC BUZZER

Miniature, Solid State  
6V 15ma (4-9V oper.) \$1.29 ea.  
12V 15ma (8-20V oper.) \$1.29 ea.

### ELECTRONIC DOOR CHIME KIT

WITH T1 TMS 1000  
MICROPROCESSOR CHIP  
PROGRAMMED TO PLAY  
24 DIFFERENT TUNES

INTERNATIONAL ELECTRONICS UNLIMITED, AN INDUSTRY OF U.S. BUSINESS GROUP, INC. (A DIVISION OF INTERNATIONAL ELECTRONICS UNLIMITED) IS A U.S. COMPANY. ALL PARTS ARE U.S. MADE. PLEASE CONTACT US FOR A COMPLETE LIST OF PRODUCTS AND PRICES. WE WILL BE GLAD TO ASSIST YOU IN YOUR PURCHASES. WE WILL BE GLAD TO ASSIST YOU IN YOUR PURCHASES. WE WILL BE GLAD TO ASSIST YOU IN YOUR PURCHASES.

PROGRAMMED TO PLAY IN PERFECT TUNE  
PERMANENTLY PROGRAMMED TO PLAY IN PERFECT TUNE  
PROGRAMMED TO PLAY IN PERFECT TUNE

**\$39.50** SHIPPING \$1.00

### TANTALUM CAPACITOR KIT

solid dipped, 12 values, 5 each

.1uf/35V	2.2/35	10/25	33/10
.33/35	4.7/16	15/20	47/25
1/35	6.8/12	22/16	56/6

capacitors only.....\$14.95  
supplied in styrene utility box.....\$19.95

### CAPACITOR KIT - ceramic disc

50V, 24 values, 10 capacitors each

1pf	33pf	82pf	220pf	820pf	.022uf
5pf	47pf	100pf	270pf	.001uf	.030uf
10pf	56pf	150pf	470pf	.0047uf	.050uf
22pf	68pf	180pf	600pf	.01uf	.1uf

capacitors only.....\$11.95  
Packaged in 15 drawer, 60 compartment cabinet.....\$19.95 plus \$2.00 shipping

### CERAMIC DISC CAPACITORS - 50V

1pf	22pf	56pf	120pf	270pf	820pf	.022uf
5pf	27pf	68pf	150pf	390pf	.001uf	.030uf
7pf	33pf	82pf	180pf	470pf	.0047uf	.050uf
10pf	47pf	100pf	220pf	600pf	.01uf	

0-10 per value.....\$.10ea 10-up per value \$.05ea  
10-up per value \$.05ea

### TANTALUM CAPACITORS - solid dipped

.1u/35V	\$2.0	6.8/6	\$2.5	15/50	\$4.40
.22/35	\$2.0	6.8/16	.25	22/16	\$4.40
.33/35	\$2.0	6.8/50	.30	33/10	\$4.50
1/35	.20	10/16	.30	47/6	.50
2.2/20	.25	10/25	.35	47/25	.55
2.2/35	.25	10/50	.35	56/6	.65
3.3/35	.25	15/10	.35	150/15	1.25
4.7/16	.25	15/20	.35		

### DIODES

Silicon SW diode assorted 400 mw \$5.00ea

1M4148 (1N414) Silicon diode 400 mw	.10
1N3064 Silicon SW diode 400 mw	.10
1N4006 Silicon rect. - 2.4V, 3.6V, 5.1V, Zener diode 400 mw	.10
Germanium diode 400 mw	.08

### TRANSISTORS

2N1132	PNP Gen Purp. Ampl T0
--------	-----------------------

**LEADER**  
Instruments Corp.

# OSCILLOSCOPES



Model LBO-507

**20 MHz, TRIGGERED**  
 ■ Single trace, automatic trigger for highly stable, bright display.  
 ■ 17.5nSec rise time. ■ 10mV/cm to 20V/cm Vertical Sensitivity; 11 steps. ■ Displays signals to 27 MHz with ease.



Model LBO-508

**20 MHz, DUAL TRACE**  
 ■ Add, subtract modes on CH-1 & CH-2 facilitate easy checkout for simultaneous pulses, signal levels, distortion & noise canceling. ■ Front panel X-Y operation for phase shift measuring, sweep alignment, vector scope service. ■ 17.5nSec rise time.



Model LBO-515

**25 MHz, DELAYED SWEEP, DUAL TRACE**  
 ■ Built in variable delay circuitry — 1µSec to 5 Sec. ■ 5mV/Div. Vertical Sensitivity. ■ Rectangular, 8 x 10Div CRT with internal graticule.  
 ■ Selectable synchronization, automatic, normal, single trace and reset modes. ■ 14nSec rise time.

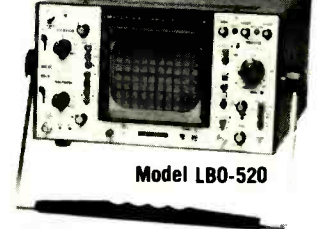

Model LBO-520

**30 MHz, FIXED DELAY, DUAL TRACE**  
 ■ Dual trace, 30 MHz bandwidth. ■ 5mV/cm Vertical Sensitivity. ■ Fixed delay facilitates hi-speed readings of the leading edge of a pulse or pulse train. ■ Add, subtract, alternate selection, chopped, and front panel X-Y modes

**Before you buy, check our prices...**

**FREE**  
20 KΩ/V VOM  
Multimeter

**\$29.95 VALUE**

With any order from this ad. Ad must accompany order.



**Call TOLL FREE (800) 645-9518**

N.Y. State call (516) 752-0050

**FORDHAM**

RADIO SUPPLY CO., INC.  
855R Conklin St.  
Farmingdale, N.Y. 11735

Mastercharge,  
BankAmericard,  
VISA and  
C.O.D.'s accepted

**YOUR ONE STOP DISCOUNT CENTER**

Send for new 1978 catalog of over 3,000 items ... 164 pages of test equipment. CB, tools, tubes, components and electronic supplies.

ADD \$3.00 TO COVER SHIPPING, HANDLING & INSURANCE. N.Y. Res. add approx. sales tax

CIRCLE 64 ON FREE INFORMATION CARD

**more than  
20,000 different  
components**

**RECTIFIERS**

	10	100
	For	For
1N4001	.60	5.00
1N4002	.70	6.00
1N4003	.80	7.00
1N4004	1.00	9.00
1N4005	1.00	9.00
1N4006	1.10	10.00
1N4007	1.20	11.00

**JAPANESE TRANSISTORS**

2SA484	2.44	2SC482	1.40	2SC1226A	.85	2SD170	1.50
2SA495	.60	2SC495	.85	2SC1237	4.00	2SD180	2.50
2SA497	1.44	2SC517	3.60	2SC1239	3.50	2SD188	2.70
2SA634	1.00	2SC634A	.60	2SC1306	3.50	2SD234	.85
2SA636	1.25	2SC710	.49	2SC1307	4.75	2SD235	.85
2SA673	.70	2SC711	.49	2SC1377	4.80	2SD313	1.05
2SA678	.65	2SC735	.49	2SC1388	.50	2SD314	1.50
2SA682	1.49	2SC756A	2.40	2SC1448	1.00	2SD315	1.20
2SA683	.60	2SC778	3.50	2SC1449	.85	2SD358	1.10
2SA699	1.30	2SC781	2.50	2SC1678	2.00	2SD360	1.05
2SA699A	1.45	2SC789	1.00	2SC1728	1.85	2SD427	2.55
2SA733	.49	2SC798	3.95	2SC1760	1.60	2SD525	1.50
2SA777	.99	2SC799	3.25	2SC1816	3.50	2SK19	1.25
2SB54	.49	2SC1000	.49	2SC1908	.49	2SK30A	.75
2SB56	.95	2SC1013	.95	2SC1909	3.75	2SK33	.90
2SB186	.49	2SC1014	.95	2SC1957	1.00	2SK55	1.00
2SB187	.55	2SC1017	1.20	2SC1973	.90		
2SB324	.65	2SC1018	1.00	2SC1975	3.50	3SK22Y	2.20
2SB370	.65	2SC1061	1.25	2SC2028	.80	3SK40	2.00
2SB405	.60	2SC1079	3.95	2SC2029	3.40	3SK45	2.20
2SB415	.65	2SC1096	.80	2SC2029	3.40	3SK49	2.20
2SB461	1.60	2SC1098	1.00	2SC2092	3.25		
2SB463	1.40	2SC1115	3.00				
2SB507	1.40	2SC1170B	4.95	2SD72	.80	4004	3.00
2SC371	.49	2SC1172	5.25	2SD77	1.50	4005	3.00
2SC372	.49	2SC1173	.75	2SD88	4.80	40081	1.50
2SC481	1.50	2SC1209	.75	2SD118	3.00	40082	3.00

**JAPANESE CIRCUITS**

AN136	2.90	LA4400FS	3.40	TA7055P	3.00	UPC20C	3.75
AN214	3.35	LA4400FR	3.40	TA7060P	1.40	UPC41C	2.80
AN239	6.50	LD3120	2.40	TA7061P	1.50	UPC563H2	8.00
AN241	2.40	M5115PR	7.80	TA7063P	1.50	UPC566H	1.25
AN315	3.50	PLL01A	13.50	TA7075P	3.75	UPC575C	2.60
BA511	3.00	PLL02A	8.50	TA7089P	2.90	UPC595C	2.95
BA521	3.40	PLL02A-G	8.50	TA7120P	1.50	UPC1001H2	3.50
HA1202	2.90	SG613	6.75	TA7150P	3.75	UPC1008C	5.75
HA1306	4.50	STK011	7.50	TA7153P	6.90	UPC1020H	3.25
HA1308	4.50	STK015	6.50	TA7203P	4.25	UPC1025H	3.50
HA1322	4.20	STK032	14.20	TA7204P	3.70	UPC1166H	4.50
LA1201	4.25	STK050	24.50	TA7205P	3.60	UPD277C	4.50
LA4031P	3.20	UH1C056	11.35	UH1C003	6.50	UPD857C	15.50
LA4032P	4.20	STK415	8.50	UH1C004	6.50	UPD858C	9.50
LA4051P	3.20	TA7045M	3.25	UPC16C	2.50	UPD861C	18.50

**CHECK OUR NEW LOWER PRICES**



**NEW-TONE  
ELECTRONICS**

PO Box 1738A Bloomfield, N.J. 07003  
Phone (201) 748-6171, 6172, 6173

N.J. residents add 5% sales tax.  
All orders add \$1.00 Postage \$1.50 Canada  
minimum order \$5.00

PARTIAL LISTING — WRITE FOR FREE CATALOG

CIRCLE 51 ON FREE INFORMATION CARD



# hobbi house

Send for Free Hobbi House Catalog  
**969 BALL AVE., UNION, N.J. 07083**  
 Retail Store Open Mon.—Sat., 9 to 6

## TERMS AND CONDITIONS

Add \$1.50 postage and handling for all orders within U.S.. COD orders -- add \$2.00 for postage and handling.

\$7. Min. order. Phone orders accepted. \$15 Min B.A./Visa, Master Charge orders. N.J. Residents add 5% Sales Tax

Outside Continental U.S. send U.S.funds only, and include sufficient postage for first class mail.

## OPTO SPECIALS

Cat. #	Order by Cat. # & Type #	
01	7 seg. Display	
	33' 707 MAN 1 C.A. or C.C.	59 ea. or 10/\$5.00
03	Diffused Jumbo Red Leds 0.2"	7/\$1.00, 100/\$11.00
04	DL741 Jumbo Displays C.A.	\$1.35
05	25PK LEDS ASSTD Sizes & Colors	\$2.50
06	Jumbo Red Leds	10/\$1.00, 100/\$9.00
07	9 digit display by National	\$1.00



**MA1003  
MOBILE CLOCK  
MODULE (National)**  
 \$18<sup>95</sup> complete

Attaches directly to 9-12V Battery. Automatic Nighttime Dimming. Fluorescent Display gives Color Choice (Red, Blue, Green or Yellow) when used w/corresponding Color Filter. Includes — Module, Switches, & Filter

**ALUMINUM CASE WITH FILTER. \$5.75**  
 (switches included with clock kit). In Silver, Black and Gold. Filter colors — red, blue, green, or yellow.

LM555 TIMERS .....3/.99

## SWITCHES

Cat. #	Order by Cat. # & Type #	
M9	Sound Actuated Switch	.85
M10	Dry Reed Switch, 5 AMP, 115 VAC	25/\$1.98
M13	250 K Slide Volume Control By Mallory	4/\$1.00
M51	DPDT Momentary Slide Switch	10/\$1.00
M52	DPDT Slide Switch Low Profile	10/\$1.00
M53	DPDT Slide Switch Long Button	10/\$1.00
M56	DP4T Slide Switch	10/\$1.00

## ADAPTORS

Cat. #	Order by Cat. # & Type #	
M16	AC DC 120 V input 6 UDC 130 MA output	\$1.00
M65	AC Input 120 VAC, 3.7w/output 9 UDC, 100 MA	\$1.50

## SPECIALS

Cat. #	Order by Cat. # & Type #	
M12	6" Pioneer Pincusion speakers, 3.2 OHMS, 7½ watts	\$3.95 a pair
M17	8 FT. Stereo Extension Cord, RCA plugs at both ends.	2/\$1.99
M33	16 Pin Strip sockets, By AMP	10/\$1.00
M41	6 FT. Line Cords	6/\$1.00
M49	6 DC Battery Holder	3/\$1.00
M29	SPDT 12 Volt Relay, 5 AMP contact, Plug in style	\$1.00
M35	Variable Trimmer Cap 3-18 PF, 50 volt	5/\$1.00
M48	2.5 MEG Trimmer Pot	5/\$1.00
M69	50K Trim Pot, Pc mount thum wheel	10/\$1.00

Your Store for Prime Components — Money Back Guarantee on all Orders!  
 Toll-Free Wats Line — 800-631-7485 • Open Saturdays  
 In New Jersey Call (201) 964-5206

# lowest prices

## Zener Diodes

Cat. #	Order by Cat. # & Type #	
D1	5.1V 1 watt	10/\$1.00
D4	22V 1 watt	10/\$1.00
D5	3.9V 400MW	10/\$1.00
D7	6.8V 400MW	10/\$1.00
D8	8.2V 400MW	10/\$1.00
D10	30V 400MW	10/\$1.00
D11	10V 1 Watt	10/\$1.00

## Rectifiers

Cat. #	Order by Cat. # & Type #	
D2	IN1084	4/\$1.00
D3	IN4384	10/\$1.00
D6	IN645	10/\$1.00
D13	35AMP 50V DO-5 Case	2/\$1.00
D14	25AMP 200V Bridge Rect	\$1.75
D23	IN4148 Switching Diode	50/\$1.00
D16	IN4001	10/.55
D17	IN4002	10/.65
D18	IN4003	10/.75
D19	IN4004	10/.85
D20	IN4005	10/.95
D21	IN4006	10/\$1.00
D22	IN4007	10/\$1.00

## DISC Caps

Cat. #	Order by Cat. # & Type #	
C1	680 MMF 500V - 10%	20/\$1.00
C2	200 MMF 500V - 10% P.C.	20/\$1.00
C3	390 MMF 400V - 10%	20/\$1.00
C4	220 µF 500V - 10% P.C.	20/\$1.00
C5	820 PF 1000V - 10% P.C.	20/\$1.00
C6	27 PF 500V - 10%	20/\$1.00
C7	470 µF 2kV - 20%	20/\$1.00
C8	470 PF 2kV - 20%	20/\$1.00
C34	.03 µF 100V - 20% P.C.	20/\$1.00
C41	16 µF 500V - 5% P.C.	20/\$1.00
C42	.001 PF 100V - 10% P.C.	20/\$1.00
C45	.1 MF 50V - 10%	20/\$1.00
C47	15 PF 100V - 10% P.C.	20/\$1.00
C49	22 µF 750V - 10% P.C.	20/\$1.00
C52	22 PF 500V - 10%	20/\$1.00
C54	100 PF 100V - 10%	20/\$1.00
C57	16 PF 500V - 5% P.C.	20/\$1.00
C59	22 PF 150V - 10% P.C.	20/\$1.00
C61	22 PF 200V - 10%	20/\$1.00
C62	33 PF 100V - 5%	20/\$1.00

## IC SOCKETS.

Cat. #	Order by Cat. # & Type #	
M1	Grain of Wheat Display Lamps	10/\$1.00
M2	8 PIN	5/\$1.00
M3	14 PIN	5/\$1.00
M4	16 PIN	5/\$1.00
M5	18 PIN	5/\$1.00
M6	24 PIN	2/\$1.00
M7	28 PIN	2/\$1.00
M8	40 PIN	2/\$1.00

## Transformers

Cat. #	Order by Cat. # & Type #	
M22	Mini Audio 1" square	10/\$1.99
M32	70 Volt Line Transformer, 10 watts	\$2.90
M40	6.3 Volts 1.2 amp	\$1.49

## Transistors

CAT #	Order by Catalog # & Type #	
T1	2N918 ITT	5/\$1.00
T2	2N2904 ITT	5/\$1.00
T3	2N2219 ITT	5/\$1.00
T4	2N4949 House #	2/\$1.00
T5	MPS5172 MOTO	10/\$1.00
T6	2N3638 S.S.	10/\$1.00
T7	2N2102 House #	5/\$1.00
T8	3N140 Fet N Channel	2/\$1.00
T9	2N2907 ITT	5/\$1.00
T10	2N914 ITT	5/\$1.00
T11	2N2369A ITT	10/\$1.00
T12	2N2368 ITT	10/\$1.00
T13	2N706 MOTO	10/\$1.00
T15	D41E1 Ge P.C.	10/\$1.00
T16	2N3416 Sprague	5/\$1.00
T17	MPS2369 ITT	10/\$1.00
T18	MPS3704 ITT	10/\$1.00
T19	2N708 MOTO	5/\$1.00
T20	2N3055 S.S.	2/\$1.00

## Electrolytics — all Axial Leads

CAT. #	Order by Cat. # & Type #	
C15	15µF 400 V	5/\$1.00
C16	1µF 50 V	5/\$1.00
C17	10µF 50 V	5/\$1.00
C18	1.0µF 200 V	5/\$1.00
C19	25µF 25 V	5/\$1.00
C20	5/F 25 V	5/\$1.00
C21	500µF 15 V	5/\$1.00
C22	1500µF 3V	5/\$1.00
C24	1000µF 6V	5/\$1.00
C25	2000µF 2.5V	5/\$1.00
C40	500µF 50V	4/\$1.00
C46	4.7µF 50V	4/\$1.00
C53	4.7µF 35V	4/\$1.00
C56	220µF 16V	4/\$1.00
C63	1000MFD 35V	4/\$1.00

## Tantalum, Axial Leads

Cat. #	Order by Cat. # & Type #	
C13	047µF 200 V	10/\$1.00
C44	1MF 35V	10/\$1.00
C48	15µF 35V	10/\$1.00

## Voltage Regulators

Cat. #	Order by Cat. # & Type #	
1C1	7805 Pos.	\$1.00
1C2	7815 Pos.	\$1.00
1C3	7806 Pos.	\$1.00
1C4	7905 Neg.	\$1.25
1C5	7812 Pos.	\$1.00
1C6	7824 Pos.	\$1.00
1C7	7915 Neg.	\$1.25

## Mylar Caps

Cat.	Order by Cat. # & Type #	
C9	1.0 100V ± 5%	10/\$1.00
C11	.018MF 400V ± 10%	10/\$1.00
C12	.47µF 100V ± 10%	10/\$1.00

## SPECIAL

### WESTINGHOUSE TUBES — BOXED AND BRANDED

1V2	1.50	6CG3/W3/Q3	2.50	6HB7	2.40	6LQ6/6JE6C	4.85
2AV2	2.00	6CJ3/6CH3	2.50	6HM5/6HA5	2.30	6Z10/6J10	4.30
3A3C	3.10	6DW4B	2.50	6HZ6	2.00	8FQ7/8C67	2.00
3AT2B	3.00	6EA8	2.50	6JC6A	2.65	12AT7/ECC81	2.00
3CU3A	3.75	6EJ7/EF184	2.20	6JS6C	4.50	12A-7/ECC82	2.00
3DB3/3CY3	3.30	6EW6	2.20	6JL8A	2.60	12AX7/ECC83	2.00
3HM5/3HA5	2.50	6FQ7/6CG7	1.85	6KD6	4.90	12BY7A/V/O	2.20
5GH8A	2.75	6GF7A	3.20	6KE8	3.60	12H37/6N7A	3.30
6AQ5A	2.00	6GH8A	2.00	6KT8	3.25	17JZ8	2.50
6AU6A	2.00	6GJ7/ECF801	2.25	6KZ8	2.40	23Z9	3.00
6BK4C/EL4A	4.50	6GM6	2.50	6L6GC	3.60	33GY7A	3.75
8BL8/ECF80	1.75	6GU7	2.50	6LE6	4.75	36MC6	5.00
						38HE7	3.85

# ADVANCED COMPUTER PRODUCTS

## \$100 PRODUCTS

### LOGOS 16K STATIC RAM

- ★ Low Power
- ★ Selectable Memory Protect
- ★ Totally Buffered
- ★ Phantom
- ★ Battery Backup on Address
- ★ Address on 1K boundary
- ★ Requires no front panel
- ★ No wait states



### ASSEMBLED & TESTED

250ns. 199.95  
450ns. 179.95

### KIT

250ns. 149.95  
450ns. 125.95

Bare PC Board w/Data ..... \$21.95  
Now over 1 year successful field experience  
"Special Offer" Buy (4) 8K 450ns. Kits \$117.00 ea.

### IMS 16K STATIC RAM

- ★ Memory mapping
- ★ Phantom
- ★ Address 16K Bound
- ★ Use with or w/o front panel
- ★ Power 2.1 amps typ.
- ★ Uses 2114

ASSEMBLED & TESTED ONLY  
450ns \$439.95 250ns \$495.95

### S-100 32K STATIC RAM

- ★ Address 32K Boundary
- ★ Power 450ns. 2.8 amps typ.
- ★ No wait states on 2MHz
- ★ Fully Buffered
- ★ Phantom can be added
- ★ 2114/TMS4045 or 9135

ASSEMBLED & TESTED KIT  
250ns \$849.00 250ns \$790.00  
450ns \$799.00 450ns \$740.00  
Bare PC Board w/Data ..... \$59.95

SPECIAL OFFER  
Kit without Memory only \$99.95. Add  
2114 Memory for \$160.00 per 8K

### MICROBYTE 32K STATIC RAM

- ★ Phantom
- ★ Addressable 4K Blks
- ★ Independent reg.

ASSEMBLED & TESTED ONLY  
450ns. \$775.00  
250ns. \$875.00  
(Special offer 16K version (expandable)  
450ns. \$435.00)

### DC HAYES DATA COMMUNICATIONS ADAPTER

- ★ Telephone/TWX
- ★ S-100 compatible
- ★ Bell 103 freq.
- ★ Originate & answer mode

Assembled & Tested ..... \$279.95  
Bare PC Board w/data ..... \$ 49.95

### DATABOOKS & MANUALS

N5C TTL Data	3.95	AMI MOS/LSI Data	3.95	Met Vol 4 Mecc Data	3.95
N5C Linear Data	4.95	GI MOS/LSI Data	4.95	Met Vol 5 CMOS Data	2.95
N5C Linear APP>Note #1	3.95	Osborne Intro to Micro Vol 0	7.50	Met Vol 6 Linear Data	2.95
N5C Linear APP>Note #2	3.95	Osborne Intro to Micro Vol 1	7.50	Met Vol 7 Schottky TTL	2.95
N5C CMOS Data	2.95	Osborne Intro to Micro Vol 2	7.50	Met MPU Applications	25.00
N5C Audio Data	3.95	Osborne 8080 Programming	7.50	Met MPU Prog. Ref. Manual	3.95
N5C VHF-High Data	2.95	Osborne 8080 Programming	7.50	Met Power Data	2.95
N5C Memory Data	3.95	Osborne Z80 Programming	7.50	Met Rectifier Data	2.95
N5C MOS/LSI Data	3.95	Ti Power Semis Data	7.50	Met Switching Tran	2.95
N5C Power Transistors	2.95	Ti TTL Data	6.95	Met Zeners	2.95
Intel Databook	3.95	Ti Transistors & Diodes	8.50	Basic Software SRI Vol I or II	24.95
Intel MCS85 Manual	7.50	Ti Memory Data	3.95	Basic Software SRI Vol III	39.95
Intel MCS80 Manual	7.95	Ti Optoelectronics	3.95	Basic Software SRI Vol IV or V	39.95
Intel MCS40 Manual	4.95	Ti Linear Data	3.95	Basic Software SRI Vol VI	49.95
AMD 8080 Handbook	9.95	Ti Bipolar Memory	3.95	Basic Software SRI Vol VII	39.95
AMD Linear Data	4.95	Ti Interface Data	4.95	1978 IC Master	47.50
AMD Schottky Data	4.95	Motorola Semi Data 1, 2, 3	9.95		

## 6800 DESIGNER BOARDS MODULES PROTO BOARDS

★ Motorola Compatible Modules*		AMI EVK 200 Kit	449.95
MEK 6800 D2 Kit	\$235.00	AMI EVK 300 Assembled	649.00
9600 6800 MPU Module	495.00	EVK Kluge Board	95.00
9601 16 slot Mother Bd.	175.00	EVK 16K Byte Ram Board	75.00
9602 16 slot Card Cage	75.00	EVK 6 Slot Motherboard	35.00
9603 8 slot Mother Bd.	99.00	EVK Extender Board	45.00
9604 System Power Supply	250.00	EVK Solid Frame Chassis	129.00
9610 Prototype Board	36.00	EVK Connectors	6.50
9615 4KEprom Module	250.00	AMI 6800 Proto Rom	30.00
9620 16 port parallel I/O	375.00	AMI 6800 Micro Assembler Rom	30.00
9626 8K Static RAM	295.00	6800 Tiny Basic Paper Tape	20.00
9626K 8K Static RAM Kit	225.00	6800 Tiny Basic Eprom	125.00
9630 Extender Card	60.00		
9640 Multiple Tuner Prog.	395.00		
9650 8 port Duplex Asyn. I/O	395.00		
Mod 43/86 Connectors w/w or s/t	5.95		
AMI EVK 900 - 6800 sub Kit	145.00		
AMI EVK 100 Kit	269.95		

### Z-80/Z-80A CPU BOARD

- ★ On board 2708
- ★ Power on jump
- ★ 2708 included (450ns.)
- ★ completely socketed

Assembled and tested ..... \$185.00  
Kit ..... \$129.95  
Bare PC Board ..... \$ 34.95  
★ For 4MHz Speed Add \$15.00

### TDL COMPATIBLE Z-80 CPU

- ★ Compatible to TDL
- ★ Can be upgraded software & hardware
- ★ For 4MHz operation

Assembled and tested ..... \$139.95  
Kit ..... \$139.95  
Bare PC Board ..... \$ 34.95

### BYTE USER 8K EPROM BOARD

- ★ Power on Jump
- ★ Reset Jump

Assembled & Tested ..... 94.95  
Kit ..... 64.95  
Bare PC Board ..... 21.95  
Special Offer: Buy 4 kits only \$59.95 each

### 8080A CPU BOARD

- ★ S100 compatible with 8 level Vector Interrupt fully socketed.

Assembled & Tested ..... \$149.95  
Kit ..... \$ 99.95  
Bare PC Board w/data ..... \$ 34.95

### TARBELL FLOPPY INTERFACE

- ★ S100 Compatible
- ★ Uses CPM
- ★ Jumper Selectable
- ★ Percsi, Shugart, etc

Assembled and tested ..... \$269.95  
Kit ..... \$179.95  
Bare PC Board ..... \$ 39.95  
NOTE: For CPM Add \$70.00  
Documentation Add \$20.00

### WMC REAL TIME CLOCK

- ★ S100 Compatible
- ★ Two interrupts
- ★ Software programmable
- ★ 1MHz Crystal Oscillator

Assembled and tested ..... \$179.95  
Kit ..... \$124.95  
Bare PC Board w/data ..... \$ 29.95

### MICRODESIGN MR-16 20716 EPROM BOARD

- ★ Individual Prom Address
- ★ Uses Low cost 16K TI EPROMS
- ★ Optional 1K RAM
- ★ Phantom control

Assembled and Tested ..... 174.95  
Kit ..... 99.50

THE FIRST TO OFFER PRIME PRODUCTS TO THE HOBBYIST AT FAIR PRICES NOW LOWERS PRICES EVEN FURTHER!

- 1. Proven Quality** Factory tested products only, no re-tests or fallouts. Guaranteed money back. We stand behind our products.
- 2. Same Day Shipment** All prepaid orders with cashiers check, money order or charge card will be shipped same day as received.

### SUPPORT DEVICES

3881 (280 Pin)	11.25
3881 (4 MHz)	14.95
3882 (Z-80 C/C)	11.25
3882 (4 MHz)	14.95
8205/745 138 Decoder	2.95
8212 8 bit I/O	3.25
8214 Priority Int	7.95
8216 Bus Driver	3.25
8224 Clock Gen	3.95
8224 (4MHz)	12.95
8226 Bus Driver	3.95
8226 Sys Control	2.39
8228 Sys Cont	6.95
8228 Sys Cont Kit	7.95
8251 Prog I/O	11.50
8251 Prog I/O Kit	27.95
8257 Prog DMA	11.50
8259 Prog Int	19.95
8279 Prog Keyboard	27.95
8810 128 x 8 RAM	4.75
8820 PIA	7.95
8828 Priority Int	11.95
8828 131 x 8 Eprom	12.95
6850 ACIA	7.95
6852 Serial Adapter	9.95
6852 Floppy	14.50
6862 Modulator	27.50
9811A 10MHz OSC	9.50
9812 USRT	15.95
6880 Bus Driver	2.39
8128 256 x 1 RAM	16.95
8128 CD 32 x 8 RAM	9.95
8150 1024 x 8 RAM	10.95
1856 CD I/O	8.95
8557 CD I/O	8.95
6824 Floppy	12.95
6522 Mod	15.50
6530-002	15.50
6530-004	15.50
6530-006	15.50
3851 FB Prog Store	14.95
3853 FB Memory I/O	14.95

### MICROPROCESSORS

240	\$21.95
240A	29.95
F-8 (3850)	18.95
21L02 450ns	24.95
21L02 250ns	19.95
21L02 15ns	11.95
91L02AFC	1.75
21L11-1	4.10
21L11-2	3.25
21L12-1	4.25
21L11-1	3.95
21L11-1	3.95
2101-1	2.90
214-3 300ns	12.95
2114 4.450ns	10.25
TMS4044	11.25
TMS4045	3.75
EMM4200A	12.50
EMM4202	9.95
5101CE	10.95
u044 10 14200	10.95
AMD10241	19.95
AMD130-31	12.95
FSC 480-46416K CCD	118.95
101	1.95

### STATIC RAM HEADQUARTERS

1-24	25-99	100
1.30	1.25	1.15
1.59	1.55	1.45
3.25	3.15	2.95
7.75	1.65	1.50
4.10	3.95	3.75
3.95	2.85	2.65
4.25	4.10	3.95
3.75	3.65	3.55
2.90	2.70	2.55
12.95	10.95	9.95
12.50	11.95	9.95
11.25	10.25	9.50
3.75	3.25	3.05
12.50	11.95	9.95
9.95	9.95	9.25
10.95	10.95	9.25
10.95	10.25	9.25
10.95	10.25	9.25
11.95	11.95	10.25
1.95	1.75	1.25

### SOCKETS

8 Pin w/w	32	14 Pin S/T	20
14 Pin S/T	22	16 Pin S/T	22
18 Pin w/w	38	18 Pin S/T	31
18 Pin w/w	22	22 Pin S/T	35
20 Pin w/w	50	24 Pin S/T	41
22 Pin w/w	83	28 Pin S/T	49
8 Pin S/T	17	40 Pin S/T	63

### CONNECTORS

6 Pin Single S/E	1.49
15-20 Pin S/T	3.95
18-36 Dual S/E	2.35
22-44 Dual S/E	2.95
43-60 Pin S/T	6.50
43-88 Dual W/W	6.50
50-100 IMSAI W/W	4.75
50-100 IMSAI S/T	4.75
50-100 Altair W/W	5.95
50-100 Altair S/T	5.95

25 Pin D Subminiature	2.75
D825P	3.75
Head	1.25

IMSAI Card Guides 4/1 00



### NEW CTS DIPSWITCHES

CTS206-4	\$1.75	CTS208-8	\$1.95
CTS208-8	\$1.75	CTS209-9	\$1.95
CTS206-6	\$1.75	CTS209-10	\$1.95
CTS207-7	\$1.75		

We also stock full of 7400, 74LS, 74L Linear and CMOS. Find for pricing or use our competitors STD catalog pricing.

### NAKED PC BOARD SALE \$-100

2.80 CPU (ITHACA)	34.95
Z-80 CPU (TDL comp)	34.95
8080A CPU	34.95
8K Static Logic	21.95
32 Static S-100	59.95
Tarbelle Floppy I/O	39.95
Tarbelle Cassette	29.95
Vector 8080 Proto	19.95
ACP Proto Bd	27.95
ACP Extender w/cann	15.95
Realtime Clock	34.95
WMC 13 Slot Mother Bd	33.00
S-100 8 Slot Mother Bd	34.95
Vector 8803 11 Slot M. Bd	29.95
SSA Video I/O	25.95
SSM 102 Parallel I/O	25.95

### KEYBOARD ENCODERS

UV "Eprom" Eraser	\$50.50
Model Live-11E	\$50.50
Model 21E	\$50.50
Model 31E	\$50.50
Model 41E	\$50.50
Model 5-52	\$219.95

### KIMSAI

Expand your KIM-1 to S-100  
Kit \$125.00 Assembled \$165.00

### BAUD RATE GENERATORS

MC14411	11.25
4702	14.95
WD1941	97.95

### TV CHIPS

MMS320 TV Synchron	7.95
8100 8 bit Binary	3.50
8701 10 bit Binary	22.00
8702 12 bit Binary	26.95
8703 12 bit Binary	42.95
9400 Vcr to Freq Conv	7.25
8750 3-1/2 Digit BCD	13.95
8036 Multifunction	9.95
1408L 8 bit	5.95
1408L 8 bit	3.95

### MPU & COMPUTER KITS

MEK 6800 D2 Kit	235.00
KIM 16502	245.00
TEC 6800 Kit	281.00
Technic 9800 Kit	299.00
RCA VIF Cosmos	275.00
AMI EVK 99	145.00

### TV INTERFACES

Pave-Verter	8.50
TV Video Interface	8.95
Pipes & Trout TV Mod Kit	20.00

### NOTICE

We are looking for software support packages to offer in our new catalogue. Please write or call if you want to participate.



### WAVEFORM GENERATORS

8038 Function Gen	3.95



# 30 MHZ LOW COST FREQUENCY COUNTER KIT

**Features:**

- Frequency Range—100Hz to 30MHz min., resolution 100 Hz
- All TTL Circuitry—No tears in the eyes when replacing ICs
- FET Input Stage—Offers high input impedance
- High Sensitivity—15mV typical
- Xyal Time Base—0.001% 10MHz for better accuracy
- On Board Regulator—No external power supply needed
- All ICs Socketed—Easy to service
- Easy to Operate—No switches to flip
- Tin Plated & Screened Board—For easy assembly



**COMPARE and SAVE!**

**\$54.95**  
KIT # T-230-30-A

**KIT INCLUDES:** Detailed Instructions (22 pages). All parts including transformer

## Now Low Cost Instrument Case for Kit

H. 2 7/16" W. 8 1/2" D. 9 1/4"

and in 6 varying heights also compatible as other instrument housing

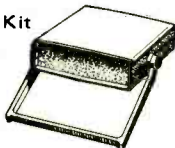

Mod. # CH200

PRICE: \$17.50

## WOW! LOOK AT THIS!

### 5V 10A Power Supply Kit for your TTL Circuits!

Kit includes: Extra Large Heat Sink, Power Tr., IC Regulator, P.C. Board, with OVP Circuitry. KIT # T-200

**\$11.95**

With Optional Rectifiers and Filtering Capacitor.

**\$14.95**

(X' former not available)



## HERE'S A MUST FOR THE EXPERIMENTER!



2.20V @ 1.3A Continuously Variable Power Supply Kit. Kit Includes: P.C. Board, Transformer, Power Transistor, Heat Sink, IC Regulator & all the parts with detailed instruction. KIT # T-450

**\$12.95**

## 0.8" 4 Digit Jumbo Display Alarm Clock Kit

**Features:**

- A. Fairchild 0.8" FSC8000 Display Array
- B. Fairchild Super-Chip — F-3B17PC
- C. P.C. Board, Transformer, Speaker and all parts included (less case)
- D. Detailed Instructions

**THIS IS A BIG ONE!**

**\$19.50**

## 6-DIGIT AUTO CLOCK KIT WITH ALARM

**Features:**

- A. Fairchild 0.5" FND 500 Series Display
- B. Display Board may be remote
- C. X'yal time base
- D. P.C. Boards, speaker, IC's and all parts
- E. Detailed Instructions

**\$19.95**

KIT # T-130Z

# Z80 KIT

IMSAI/ALTAIR S-100 COMPATIBLE

On board 2708 EPROM addressable to any 4K boundary above 32K. Power-on-Jump to any 4K boundary above 32K, or the on-board 2708. A wait state may be added to any:

- 1) M1 cycle
- 2) Memory request cycle
- 3) On-board ROM cycle (for use at 4 MHz)
- 4) Input cycle
- 5) Out-put cycle

On-board run-stop flip-flop and optional generation of MEMORY WRITE allow front panel-less operation. Selectable 10 addressing mode: 1) 8080 Mode where peripheral address byte is duplicated on high and low order address bytes. 2) Z-80 mode where the peripheral byte appears on the low order address, and the contents of the accumulator appears on the high order byte, allowing simultaneous I/O. DMA Grant tri-states all signals from the processor board. 8224 clock generator provides 8080 look-alike  $\phi 1$  and  $\phi 2$  for the S-100 bus. Status signals SINP, SOUT, SMEMR, & SWO are latched per S-100 bus specs.

**\$135.00 EA. (2MHZ)**

**\$149.95 EA. (4MHZ)**

**BARE BOARD \$35.00**

ASSEMBLED & TESTED: ADD \$50 to each KIT PRICE

KITS INCLUDE ALL PARTS AND 2708 UNPROGRAMMED

## PUT YOUR HAM GEAR OR CB IN YOUR HOUSE WITH THIS SPECIALLY DESIGNED POWER SUPPLY KIT!

**KIT INCLUDES:** Transformer, PC Board, Large heat sink, Large filtering capacitor and all parts with detailed instruction.

- Output Voltage = 13.5V
- Output Current = 3.5A Min.
- Load Regulation = 0.01%
- Line Regulation = 0.02%
- Internal Current Limiting
- Over-voltage Protected

**ONLY \$16.95**  
KIT # T-700

## T-8K/ Static Ram Memory Kits

### Memory Chips

2102 low power chips. Boards operate with the fastest 2102 on the market (250ns).

### Buffering Support Chips

Input and output data lines fully buffered. All possible support chips are low power schottky. Support chips at bottom of board for strong drive signals to bus.

### Bypass

26 bypass capacitors on the board.

### Voltage Regulation

Four 340T-5 five volt regulators give power even if all chips on board are regular power devices.

### Protect

Protect/Unprotect is selected on board so board can be used in systems without a front panel.

### Address Select Delay

Can be set in 8K increments. Delays can be selected on board that any speed 2102 memory chip can be used.

450ns 350ns 250ns  
T-8K Kit \$129.95 \$139.95 \$169.95  
Assembled & Tested \$129.00 \$159.95 \$189.95  
Bareboard (without parts): \$25.00

## CRYSTALS ±0.002%

**LOWEST PRICE EVER! HIGHEST ACCURACY!**

Frequency	Price	Frequency	Price	Frequency	Price
MHZ		MHZ		MHZ	
1.0000	@ 4.90	4.0000		10.0000	
1.8432		4.1943		14.318	
		4.9152		14.391	
		5.0000		18.0000	
2.0000		6.0668	@ 3.65	18.4220	
2.0100		5.1850		20.0000	
2.097152	@ 4.50	5.7143		22.1184	
2.4576		6.0000		27.0000	
2.667		6.1444		32.0000	
3.0000		6.4000		36.0000	
3.2768		6.6536		48.0000	
3.5795		8.0000			

# TRINICO INTERNATIONAL

(Formerly Trico)

2795 W. Lincoln Ave., Suite L  
Anaheim, CA 92801  
Tel: (714) 821-0234

Terms: Money Back Guarantee

Calif. residence add 6% sales tax.  
Please add \$1.00 for postage inside Calif., \$2.00 for out of state, overseas add 10% of order.  
Minimum order \$5.00, C.O.D. \$20.00 (\$1.00 handling)  
STORE HOURS: MON. SAT., 10-7  
BANKAMERICARD MASTERCHARGE

## 7400 Series

SN7400N	15	SN7472N	39	SN74160N	1.25
SN7401N	18	SN7473N	39	SN74161N	.99
SN7402N	20	SN7474N	35	SN74162N	1.95
SN7403N	20	SN7475N	50	SN74163N	3.25
SN7404N	20	SN7476N	35	SN74164N	.99
SN7405N	20	SN7477N	5.00	SN74165N	.99
SN7406N	35	SN7480N	50	SN74166N	1.25
SN7407N	35	SN7481N	99	SN74167N	3.25
SN7408N	20	SN7482N	70	SN74170N	6.00
SN7409N	25	SN7485N	.89	SN74171N	2.10
SN7410N	20	SN7486N	.39	SN74173N	1.50
SN7411N	30	SN7488N	3.50	SN74174N	1.25
SN7412N	35	SN7489N	2.49	SN74175N	.89
SN7413N	69	SN7490N	.45	SN74176N	.79
SN7414N	70	SN7491N	.75	SN74177N	.79
SN7415N	35	SN7492N	.49	SN74179N	2.49
SN7417N	35	SN7493N	.49	SN74180N	.99
SN7420N	20	SN7494N	.79	SN74181N	2.49
SN7421N	.39	SN7495N	.79	SN74182N	.95
SN7422N	.49	SN7496N	.79	SN74184N	1.95
SN7423N	.37	SN7497N	3.00	SN74185N	1.95
SN7425N	.29		1.25	SN74188N	15.00
SN7426N	.29	SN74107N	.39	SN74187N	6.00
SN7427N	.37	SN74109N	.95	SN74188N	3.95
SN7429N	.42	SN74109N	.95	SN74189N	1.79
SN7430N	25	SN74121N	.39	SN74191N	1.25
SN7432N	25	SN74122N	.39	SN74192N	.89
SN7437N	35	SN74123N	.50	SN74193N	.89
SN7438N	35	SN74125N	.60	SN74194N	1.25
SN7439N	25	SN74125N	.60	SN74195N	1.25
SN7440N	21	SN74132N	1.25	SN74196N	1.00
SN7441N	89	SN74136N	.95	SN74197N	1.00
SN7442N	.69	SN74141N	1.15	SN74198N	1.75
SN7443N	.75	SN74142N	.89	SN74199N	1.25
SN7444N	.75	SN74143N	3.25	SN74200N	5.59
SN7445N	.75	SN74144N	3.00	SN74251N	1.79
SN7446N	.89	SN74145N	1.15	SN74279N	.90
SN7447N	.69	SN74147N	2.30	SN74284N	6.00
SN7448N	.89	SN74148N	2.00	SN74284N	6.00
SN7449N	.89	SN74150N	1.25	SN74285N	6.00
SN7450N	25	SN74151N	.79	SN74365N	7.50
SN7451N	25	SN74152N	.89	SN74366N	7.50
SN7452N	25	SN74153N	1.25	SN74367N	7.50
SN7454N	25	SN74154N	1.25	SN74368N	7.50
SN7455A	25	SN74155N	.89	SN74390N	2.25
SN7460N	25	SN74156N	.89	SN74390N	2.25
SN7470N	45	SN74157N	.89	SN74393N	2.25

CMOS					
CD4000	23	CD4027	69	CD4069	45
CD4001	23	CD4028	69	CD4070	55
CD4002	23	CD4029	1.19	CD4071	23
CD4006	1.19	CD4030	49	CD4072	49
CD4007	25	CD4031	1.19	CD4076	1.39
CD4009	49	CD4032	99	CD4081	.23
CD4010	49	CD4033	99	CD4082	.23
CD4011	23	CD4034	1.19	CD4086	2.49
CD4012	25	CD4041	1.25	MC14409	14.95
CD4013	39	CD4042	.99	MC14410	14.95
CD4014	1.39	CD4044	.89	MC14411	14.95
CD4015	1.19	CD4046	1.79	MC14419	4.95
CD4016	49	CD4047	1.19	MC14506	.75
CD4017	1.19	CD4048	1.35	MC14507	.99
CD4018	.99	CD4049	.49	CD4508	3.99
CD4019	.49	CD4050	.49	CD4510	1.39
CD4020	1.19	CD4051	1.19	CD4511	1.29
CD4021	1.39	CD4053	1.19	CD4515	2.95
CD4022	1.19	CD4056	1.49	CD4518	1.29
CD4023	23	CD4059	9.95	CD4520	1.29
CD4024	70	CD4062	7.99	MC14562	14.50
CD4025	23	CD4065	7.99	CD4566	2.25
CD4026	2.25	CD4068	.39	MC14583	3.50

## 74C00 Series

74C00	39	74C74	1.15	74C180	3.25
74C02	55	74C80	4.00	74C181	1.25
74C04	75	74C90	3.00	74C183	3.00
74C10	65	74C93	2.00	74C164	3.25
74C14	3.00	74C95	2.00	74C173	2.60
74C15	65	74C107	1.25	74C193	2.75
74C30	65	74C151	2.90	74C195	2.75
74C42	2.15	74C154	3.00	80C95	1.50
74C73	1.50	74C157	2.15	80C97	1.50

## LINEAR

LM300H	80	LM340T-8	1.25	LM741CH	35
LM301H	35	LM340T-12	1.25	LM741CN	.35
LM301CN	35	LM340T-15	1.25	LM741-14N	39
LM302	75	LM340T-18	1.25	LM741-17N	.79
LM304H	1.00	LM340T-24	1.25	LM747N	.79
LM305H	.60	LM350N	1.00	LM748N	.39
LM307CN	35	LM351CN	.65	LM748N	.99
LM308H	1.00	78M6	1.75	LM1303N	.99
LM308CN	1.00	LM370N	1.15	LM1304N	1.19
LM309H	1.10	LM373N	3.25	LM1305N	1.40
LM309K	1.25	LM377A	4.00	LM1307N	85
LM310CN	1.15	LM380N	1.25	LM1310N	2.95
LM311H	.90	LM380CN	1.25	LM1351N	1.85
LM311N	.90	LM381N	1.79	LM1414N	1.79
LM317K	1.79	LM382N	1.79	LM1458CN	.99
LM318CN	7.50	NE501A	8.00	LM1496N	.99
LM319N	1.30	NE501B	1.25	LM1549N	1.75
LM320K-5	1.35	NE529A	4.95	LM2211N	1.95
LM320K-5-2	1.35	NE531H	3.00	LM2901N	2.95
LM320T-12	1.35	NE536T	6.00	LM3065	1.00
LM320T-15	1.35	NE540T	6.00	LM3090N(3401)	.69
LM320T-5	1.25	NE550N	1.30	LM3900N(3401)	.49
LM320T-5-2	1.25	NE555V	.39	LM3905N	.89
LM320T-8	1.25	NE560B	5.00	LM3909	1.25
LM320T-12	1.25	NE561B	5.00	LM5556N	1.85
LM320T-15	1.25	NE562B	5.00	MC1558N	1.00
LM320T-18	1.25	NE565H	1.75	LM7525N	.90
LM320T-24	1.25	NE565N	1.25	LM7534N	.75
LM323K-5	5.95	NE566CN	1.75	80C86	4.95
LM323N	1.80	NE567H	1.95	LM7540N	.49
LM339N	.99	NE567V	1.49	754	

# Tarbell Floppy Disc Interface

Designed for Hobbyists and Systems Developers

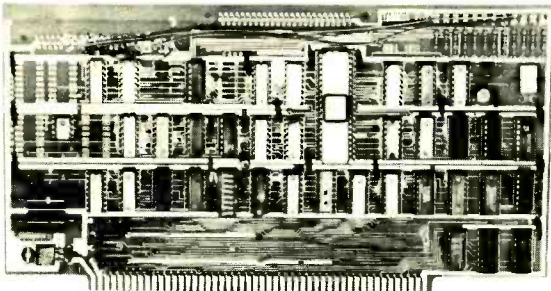

- Plugs directly into your IMSAI or ALTAIR\* and handles up to 4 standard single drives in daisy-chain.
- Operates at standard 250K bits per second on normal disc format capacity of 243K bytes.
- Works with modified CP/M Operating System and BASIC-E Compiler.
- Hardware includes 4 extra IC slots, built-in phantom bootstrap and on-board crystal clock. Uses WD 1771 LSI Chip.
- 6-month warranty and extensive documentation.
- **PRICE:** Kit \$190 ..... Assembled \$265  
\* ALTAIR is a trademark/tradename of MITS, INC.

**Tarbell Electronics**  
20620 South Leapwood Avenue, Suite P  
Carson, California 90746  
(213) 538-4251

CIRCLE 34 ON FREE INFORMATION CARD

# SOCKET SALE

## WIRE WRAP SOCKETS

14 Pin Wire Wrap	.30	.27/400
16 Pin Wire Wrap	.32	.29/350

## EDGE CARD CONNECTORS

44 Pin ST Edge Card Connector	1.75	1.50/10
100 Pin ST Edge Card Connector	3.50	3.00/10
100 Pin WW Edge Card Connector	3.50	3.00/10

All Sockets & Connectors Include Gold.

## SOLDERLESS BREADBOARDS SK 10 \$16.50

### INCLUDING:

Over 100 pieces of precut wire in assorted lengths — free!  
Choose 1 color: Red, Black, Blue, Yellow, Green, White, Orange Or Assortment.

2.2" x 6.5"

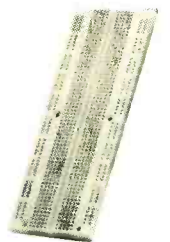

## PAGE DIGITAL ELECTRONICS

135 E. Chestnut Street 4A  
Monrovia, California 91016  
Phone (213) 357-5005

### ORDERING INFORMATION

- Orders under \$25 and COD's add \$2.
  - All others, shipped Ppd in U.S. via UPS
  - For Blue Label (Air) or 1st Class, add \$1
  - We accept Visa & Master Charge
  - Most orders shipped same day
- Dealer Inquiries Invited**

CIRCLE 20 ON FREE INFORMATION CARD

## JUMBO LED READOUT ARRAY



**\$1.95 LIMITED STOCK**

By Bowmar. .5 in. character common cathode. Designed for use with multiplexed clock chips 4 digits in 1 pack!

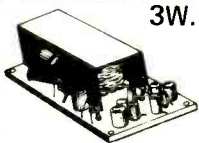

## 3W. AUDIO AMP

**\$3.95**  
2 1/2" x 3"

Assembled & tested. Not a kit. Has tapped output for either 4, 8 or 16 OHMS. With schematic.

## NATIONAL SEMICONDUCTOR

### SIX DIGIT ALARM CLOCK CHIP

National's second generation clock chip  
24 Pin Dip. Super easy to use

#### FEATURES:

12 HOUR DISPLAY • 24 HOUR ALARM  
4 OR 8 DIGITS • ALARM TONE OUTPUT  
SNOOZE ALARM • EASY LED INTERFACE  
POWER FAIL IND. • BRIGHTNESS CONTROL  
AM/PM INDICATION • SINGLE POWER SUPPLY  
FAST AND SLOW SET • LOW POWER

WE SUPPLY FULL DATA. SPECS

**MM5375AA**

**\$1.95 each**

COMPARE AT TWO OR THREE TIMES OUR PRICE!

**HUGE SPECIAL PURCHASE!**

### SPECIAL OFFER!

With purchase of Clock Chip at left.  
T1. COMMON ANODE LED READOUTS  
# T1L 312 33 INCH

**59¢ ea.**

HIGH EFFICIENCY!  
A PERFECT MATE

BUILD YOUR OWN CLOCK!  
WE SUPPLY DATA!

## MOTOROLA 7805R

### Voltage Regulator

Same as standard 7805 except 750 MA output.  
**TO-220. 5VDC output. 44¢ each 10/\$3.95**

## MOTOROLA 4K RAM's — 99¢ EACH (WITH DATA)

A major U.S. computer mfg. removed these parts from PC boards, then retested them to full specs. Best Memory Buy in the U.S.A.! 4096 x 1 Bits. One of the easiest Dynamic RAM's to use. A complete memory board design using these chips is detailed in the MOTOROLA M6800 APPLICATIONS MANUAL starting on page 4-70. The 6605 is the popular 22 Pin Dip.

**8 FOR \$6.95**

(4096 WORDS OF RAM!)

**SURPLUS BUY OF THE DECADE!**

**MCM6605**  
470 NS  
GUARANTEED!

## EXPERIMENTER'S CRYSTAL



262 144KHZ This frequency is 2 to the 18th power. Easily divided down to any power of 2, and even to 1HZ. New by CTS-Knight. A \$5 value!

**\$1.25 each**

## LED IC Counter Kit

You Get: 1—7490; 1—7475; 1—7447; 1—Led Readout. All this for **\$1.99** (Led Readout is famous SLA-1. .33 in. By Opcoa.)

**FAIRCHILD JUMBO READOUTS**  
.5 Inch Char. High Efficiency!  
FND-503-Common Cathode  
FND-510-Common Anode  
**YOUR CHOICE 69¢**  
10 FOR \$5.75

**DISC CAPACITORS**  
.1 MFD 16V. P.C. leads. Most popular value! By Sprague.  
**20 for \$1.00**

**Full Wave Bridge**  
**4 Amp 200 PIV**  
**69¢ea. 10/\$5.75**

**MALLORY POWER SUPPLY CAPACITOR**  
1500 MFD 16 WVDC  
**3/\$1.10 10/\$2.95**  
FACTORY FRESH! SMALL SIZE

**2N3904-House No.**  
TO-92. NPN.  
VCEO-45.  
HFE 100 to 300  
**10 for \$1.00**

**Jumbo Red Leds**  
New by G.E. Like MV5024. Number SSL-22.  
**6/\$1. 25/\$3.75**

**Motorola PNP Power!**  
2N4905 TO-3 case. 90W  
VCEO-60. HFE-100 max. at 2.5A. Good mate for the 2N3055. PRIME!  
**75¢ ea. 4/\$2.50**

**GE POWER TRIAC**  
SC 146D. House #.  
10 AMPS 400 PIV  
TO-220 CASE 75¢ea.  
**4 FOR 2.50**

**LS SERIES TTL**  
74LS00-33c 74LS74-49c  
74LS02-35c 74LS90-69c  
74LS04-35c 74LS138-89c  
74LS08-35c 74LS154-1.49  
74LS10-33c 74LS175-1.10  
74LS20-33c 74LS367-75c  
74LS73-49c 74LS368-85c

**Motorola Quad Op-Amp MC3401. Pin for Pin Sub for popular LM3900.**  
**3/\$1.00**

# Digital Research Corporation

(OF TEXAS)  
P. O. BOX 401247 B GARLAND, TEXAS 75040 • (214) 271-2461

TERMS: Orders under \$15. add 75¢. No COD's. We accept VISA, MasterCard and American Express Cards. Money Back Guarantee on all items! Texas Residents add 5% Sales Tax. **WE PAY POSTAGE!**

CIRCLE 90 ON FREE INFORMATION CARD

www.americanradiohistory.com



NEW LSI TECHNOLOGY  
**FREQUENCY COUNTER**

TAKE ADVANTAGE OF THIS NEW STATE-OF-THE-ART COUNTER FEATURING THE MANY BENEFITS OF CUSTOM LSI CIRCUITRY. THIS NEW TECHNOLOGY APPROACH TO INSTRUMENTATION YIELDS ENHANCED PERFORMANCE, SMALLER PHYSICAL SIZE, DRASTICALLY REDUCED POWER CONSUMPTION [PORTABLE BATTERY OPERATION IS NOW PRACTICAL], DEPENDABILITY, EASY ASSEMBLY AND REVOLUTIONARY LOWER PRICING!

- KIT #FC-50C ..... 60 MHZ COUNTER WITH CABINET & P.S. .... **\$119<sup>95</sup>** COMPLETE!
- KIT #PSL-650 ..... 650 MHZ PRESCALER [NOT SHOWN] ..... 29.95
- MODEL #FC-50WT ..... 60 MHZ COUNTER WIRED, TESTED & CAL. .... 165.95
- MODEL #FC-50/600 WT. .... 600 MHZ COUNTER WIRED, TESTED & CAL. .... 199.95

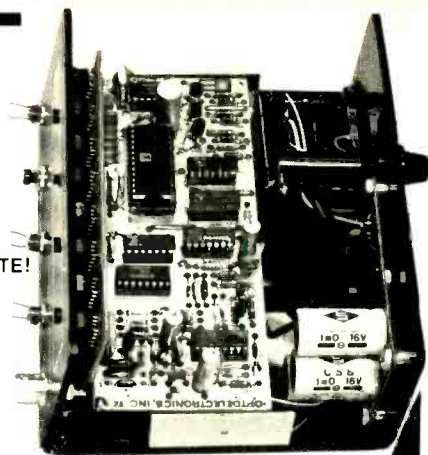

SIZE:  
3" High  
6" Wide  
5 1/2" Deep

**FEATURES AND SPECIFICATIONS:**

DISPLAY: 8 RED LED DIGITS .4" CHARACTER HEIGHT  
GATE TIMES: 1 SECOND AND 1/10 SECOND  
PRESCALER WILL FIT INSIDE COUNTER CABINET  
RESOLUTION: 1 HZ AT 1 SECOND, 10 HZ AT 1/10 SECOND.  
FREQUENCY RANGE: 10 HZ TO 60 MHZ. [65 MHZ TYPICAL].  
SENSITIVITY: 10 MV RMS TO 50 MHZ, 20 MV RMS TO 60 MHZ TYP.  
INPUT IMPEDANCE: 1 MEGOHM AND 20 PF.  
[DIODE PROTECTED INPUT FOR OVER VOLTAGE PROTECTION.]  
ACCURACY: ± 1 PPM [± .0001%]; AFTER CALIBRATION TYPICAL.  
STABILITY: WITHIN 1 PPM PER HOUR AFTER WARM UP [1.001% XTAL]  
IC PACKAGE COUNT: 8 [ALL SOCKETED]  
INTERNAL POWER SUPPLY: 5 V DC REGULATED.  
INPUT POWER REQUIRED: 8-12 VDC OR 115 VAC AT 50/60 HZ.  
POWER CONSUMPTION: 4 WATTS



KIT #FC-50C IS COMPLETE WITH PREDRILLED CHASSIS ALL HARDWARE AND STEP-BY-STEP INSTRUCTIONS. WIRED & TESTED UNITS ARE CALIBRATED AND GUARANTEED.

**PLEXIGLAS CABINETS**

Great for Clocks or any LED Digital project Clear-Red Chassis serves as Bezel to increase contrast of digital displays.

- CABINET I**  
3"H, 6 1/2"W, 5 1/2"D Black, White or Clear Cover
  - CABINET II**  
2 1/2"H, 5"W, 4"D \$6.50 ea.
- RED OR GREY PLEXIGLAS FOR DIGITAL BEZELS  
3"x6"x1/8" 95¢ ea 4/13

**SEE THE WORKS Clock Kit**  
Clear Plexiglas Stand

- 6 Big .4" digits
- 12 or 24 hr. time
- 3 set switches
- Plug transformer
- all parts included

Plexiglas is Pre-cut & drilled  
Kit #B50-4 CP

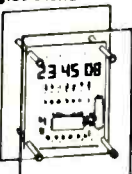

Size: 6"H, 4 1/2"W, 3"D Assembled  
\$23<sup>50</sup> ea. 2/45. \$29<sup>95</sup>

**60 HZ.**

XTAL TIME BASE:  
Will enable Digital Clock Kits or Clock-Calendar Kits to operate from 12V DC.  
1"x2" PC Board  
Power Req: 5-15V (2.5 MA TYP.)  
Easy 3 wire hookup  
Accuracy ± 2PPM  
#TB-1 (Adjustable)  
Complete Kit \$4<sup>95</sup>  
Wir & Cal \$9.95

**SPECIAL PRICING!**  
PRIME - HIGH SPEED RAM

**21L02-3** 400 NS  
LOW POWER - FACTORY FRESH

1-24	\$1.75 ea.	100-199	\$1.45 ea.
25-99	1.60 ea.	200-999	1.39 ea.
1000 AND OVER	<b>\$1.29 ea.</b>		

**8-DIGIT LED CLOCK CALENDAR KIT**  
DATE-TIME-SNOOZE ALARM & MORE... KIT 7001

FOR THE BUILDER THAT WANTS THE BEST. FEATURING 12 OR 24 HOUR TIME — 29-30-31 DAY CALENDAR. ALARM, SNOOZE AND AUX. TIMER CIRCUITS

Will alternate time (8 seconds) and date (2 seconds) or may be wired for time or date display only, with other functions on demand. Has built-in oscillator for battery back-up. A loud 24 hour alarm with a repeatable 10 minute snooze alarm, alarm set & timer set indicators. Includes 110 VAC/60Hz power pack with cord and top quality components through-out.

- KIT - 7001B WITH 6 - 5" DIGITS ..... \$39.95
- KIT - 7001C WITH 4 - 6" DIGITS & 2 - 3" DIGITS FOR SECONDS ..... \$42.95
- KIT - 7001X WITH 6 - 6" DIGITS ..... \$45.95

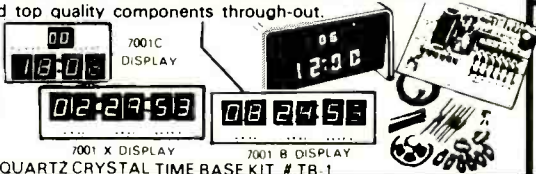

KITS ARE COMPLETE (LESS CABINET)  
ALL 7001 KITS FIT CABINET I AND ACCEPT QUARTZ CRYSTAL TIME BASE KIT #TB-1

PRINTED CIRCUIT BOARDS for CT 7001 Kits sold separately with assembly info. PC Boards are drilled Fiberglass, solder plated and screened with component layout.

Specify for 7001

B, Cor X - \$7.95

**AUTO BURGLAR ALARM KIT**

AN EASY TO ASSEMBLE AND EASY TO INSTALL ALARM PROVIDING MANY FEATURES NOT NORMALLY FOUND KEYLESS ALARM HAS PROVISION FOR POTS & GROUNDING SWITCHES OR SENSORS WILL PULSE HORN RELAY AT 1/2 RATE OR DRIVE SIREN. KIT PROVIDES PROGRAMMABLE TIME DELAYS FOR EXIT, ENTRY & ALARM PERIOD. UNIT MOUNTS UNDER DASH. REMOTE SWITCH CAN BE MOUNTED WHERE DESIRED CMOS RELIABILITY RESISTS FALSE ALARMS & PROVIDES FOR ULTRA DEPENDABLE ALARM. DO NOT BE FOOLED BY LOW PRICES! THIS IS A TOP QUALITY COMPLETE KIT WITH ALL PARTS INCLUDING DETAILED DRAWINGS AND INSTRUCTIONS OR AVAILABLE WIRED AND TESTED.



KIT #ALR-1 \$9.95  
#ALR-1WT WIRED & TESTED \$19.95

**VARIABLE REGULATED 1 AMP POWER SUPPLY KIT**

- VARIABLE FROM 4 TO 14V
  - SHORT CIRCUIT PROOF
  - 723 IC REGULATOR
  - 2N3055 PASS TRANSISTOR
  - CURRENT LIMITING AT 1 Amp
- KIT IS COMPLETE INCLUDING DRILLED & SOLDER PLATED FIBERGLASS PC BOARD AND ALL PARTS (LESS TRANS. FORMER) KIT #PS-01 \$8.95  
TRANSFORMER 24V CT will provide 300MA at 12V and 1 Amp at 5V. \$3.50

**MOBILE LED CLOCK**

12/24 HR .4" DIGITS!

MODEL 12 VOLT AC or #2001 DC POWERED

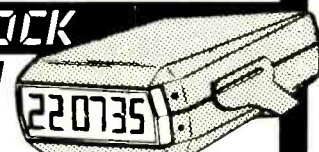

- 6 JUMBO .4" RED LED'S BEHIND RED FILTER LENS WITH CHROME RIM
  - SET TIME FROM FRONT VIA HIDDEN SWITCHES • 12/24-Hr. TIME FORMAT
  - STYLISH CHARCOAL GRAY CASE OF MOLDED HIGH TEMP. PLASTIC
  - BRIDGE POWER INPUT CIRCUITRY — TWO WIRE NO POLARITY HOOK-UP
  - OPTIONAL CONNECTION TO BLANK DISPLAY [Use When Key Off in Car. Etc.]
  - TOP QUALITY PC BOARDS & COMPONENTS - INSTRUCTIONS.
  - MOUNTING BRACKET INCLUDED
- KIT #2UG: COMPLETE KIT \$27<sup>95</sup> 3 OR MORE \$25<sup>95</sup> ea. 115 VAC Power Pack #AC-1 \$2<sup>50</sup> ea.

ASSEMBLED UNITS WIRED & TESTED ORDER #2001 WT (LESS 9V. BATTERY) \$37<sup>95</sup> ea. 3 OR MORE \$35<sup>95</sup> ea. Wired for 12-Hr. Op. if not otherwise specified.

ORDER BY PHONE OR MAIL  
COD ORDERS WELCOME

**OPTOELECTRONICS, INC.**

5821 N.E. 14th AVENUE,  
FORT LAUDERDALE, FLA. 33334  
PHONE (305) 771-2050 / 771-2051

ORDERS TO USA & CANADA ADD 5% FOR SHIPPING, HANDLING & INSURANCE. ALL OTHERS ADD 10%. ADDITIONAL \$1.00 CHARGE FOR ORDERS UNDER \$15.00 - COD FEE \$1.00. FLA. RES. ADD 4% STATE TAX.







# RADIO HUT

## 1-800-527-2304

Use Our Toll Free Watts Line  
For Master Charge and BankAmericard Orders



### Jumbo LED Car Clock Kit

#### FEATURES:

- A. Bowmar Jumbo 5 inch LED array
  - B. MOSTEK - 50250 - Super clock chip
  - C. On board precision crystal time base
  - D. 12 or 24 hour Real Time format.
  - E. Perfect for cars, boats, vans, etc.
  - F. PC board and all parts (less case) inc.
- Alarm option - \$1.50  
AC XFMR - \$1.50



**\$16.95**

### MUSICAL HORN

One tune supplied with each kit. Additional tunes - \$6.95 each. Special tunes available. Standard tunes now available -  
Dixie - Eyes of Texas - On Wisconsin - Yankee Doodle Dandy - Notre Dame - Pink Panther - Aggie War Song - Anchors Away - Never on Sunday - Yellow Rose of Texas - Deep in the Heart of Texas - Boomer Sooner - Bridge over River Kwai  
Special Design Assembled  
CAR & BOAT KIT HOME KIT Case \$3.50 & Tested  
34.95 29.95 Add \$10.00

### TELEPHONE RELAY

Assembled & Tested **\$29.95**

**Automatically Starts & Stops Tape Recorders**  
Surreptitious interception of telephone conversation is a violation of Federal Law and this device is not intended for such use.

### 6 DIGIT ALARM CLOCK KIT

Features: Litronix dual 1/2" displays. Mostek 50250 super clock chip, single I.C. segment driver, SCR digit drivers. Kit includes all necessary parts (except case). Xfmr optional. Eliminate the hassle.

AC XFMR - \$1.50 Case \$3.50

**\$12.95**



Plugs into earphone or external speaker of any Scanner or Monitor. Guaranteed to unscramble any 1085 call

### NEW IMPROVED UNSCRAMBLER!

**\$25.00**

Punched and Printed Case

- Easily tuned
- Full instruction included
- Drilled fiberglass P.C. Board
- One Hour Assembly

### 12V 1 AMP POWER SUPPLY

INPUT VOLTAGE 25V MAX. OUTPUT CURRENT 1 AMP. MAX. LOAD REGULATION 50mV. OUTPUT VOLTAGE 12V. LINE REGULATION 0.01%. KIT CONTAINS ALL PARTS EXCEPT FOR LINE CORD AND TRANSFORMER.

**ONLY \$4.50**

### 7400 TTL DIGITAL CIRCUITS

7400	11	7442	47	7490	65	74156	89
7401	13	7443	59	7491	61	74157	55
7402	13	7444	59	7492	43	74160	50
7403	13	7447	68	7493	43	74161	65
7404	15	7448	71	7494	67	74163	65
7404	29	7450	13	7495	67	74164	85
7450	44	7451	13	7496	67	74165	89
7406	16	7453	13	74100	30	74165	89
7408	19	7460	19	74104	49	74175	85
7410	13	7470	27	74107	28	74181	93
7411	18	7472	25	74109	31	74181	93
7412	26	7473	29	74121	29	74182	68
7416	15	7474	29	74123	48	74191	98
7420	13	7475	47	74132	98	74192	79
7423	25	7476	31	74136	99	74193	75
7425	29	7480	31	7451381	95	74194	81
7433	26	7481	55	74141	75	74195	69
7437	23	7482	57	74151	61	74196	85
7438	23	7483	61	74153	61	9601	351
7440	13	7485	89	74154	98	9604	35
7441	76	7489	125	74155	89		

### LINEARS

709	Operational Amplifier	25
710	Differential Comparators	40
711	Dual Differential Comp	35
712	Half Adder	25
749	Stereo Pre-Amp by Fairchild	2/51
LM 301	Operational Amplifier	30
LM 307	Operational Amplifier	30
LM 308	Operational Amplifier	95
LM 309K	5V Lamp Regulator	1.49
LM 710	Voltage Comparator	25
LM 311	Voltage Comparator	85
LM 318	Operational Amplifier	1.15
LM 723	Voltage Comparator	69
LM 324	Quad Operational Amplifier	1.20
LM 377	Dual 2W Amplifier	1.85
LM 9300	Quad Op. Amplifier	2.00
LM 741	Operational Amplifier	25
LM 748	Operational Amplifier	25
NE 553	Quad Timer	1.95
NE 555	Timer	1.50
NE 556	Dual Timer	95
NE 567	Tone Decoder	1.25
1458	Dual Op. Amplifier	1.25
75491	Quad Segment Driver	35
75492	Hex Digit Driver	35
3043	IF Amplifier	35
8038	Voltage Cont. Osc	3.95

### MICROPROCESSOR SUPPORT CHIPS

8212	- I/O port	3.50
8214	- P.C. C	12.95
8216	- Non Invert Bus	4.95
8224	- Clock Gen	4.95
8226	- Invert Bus	3.95
8228	- PIO for Z-80	14.95
8229	- PIO for Z-80	14.95
8228	Sys. Controller	8.20
8255	Prog. comm. interface	10.95
8255	Prog. per. interface	13.50
8820	Dual Line Recr.	1.75
8830	Dual Line Dr.	1.75
2513	Char. Gen.	7.50
9538	Quad Bus Recv.	2.00
74LS138N	1:8 decoder	99
8197	Hex Tri-State Buffer	1.25
1488/1489	RS232	1.50
TR1602B	uart	3.95
TR1863	uart	8.50

### CLOCK & COUNTER CHIPS

MK50252	Clock Chip	\$4.99
MK50250	Alarm Clock	3.75
MK50380	Alarm Chip	2.95
FCM7010	Direct Drive Clock Chip	4.95
MK5005	4 Digit Counter w/ Latch	8.50
MK5002	4 Digit Counter	8.95
MK50395	6 Digit UP/Down Counter	12.95
MK50397	6 Digit Elapsed Timer	8.95
CTS5005	Calculator Chip w/ Specs	1.25
MK5021	Cal. Chip w/ I.C.	2.50

**SOCKET SPECIAL!**  
28 PIN IC SOCKET  
9 FOR \$1  
WHEN PURCHASED  
W/ICLOCK IC

### 74LS00 LOW POWER SCHOTTKY

74LS00	21	74LS47	73	74LS136	37	74LS256	71
74LS02	21	74LS51	26	74LS138	71	74LS260	26
74LS03	21	74LS54	26	74LS139	71	74LS266	26
74LS04	28	74LS55	26	74LS145	100	74LS279	55
74LS05	28	74LS57	35	74LS151	65	74LS293	61
74LS08	21	74LS77	35	74LS153	70	74LS293	61
74LS09	28	74LS76	49	74LS155	69	74LS295	95
74LS10	21	74LS83	73	74LS156	70	74LS298	95
74LS11	21	74LS85	135	74LS157	75	74LS365	55
74LS13	45	74LS86	68	74LS158	71	74LS366	55
74LS14	99	74LS90	55	74LS160	85	74LS367	55
74LS15	26	74LS92	55	74LS161	85	74LS368	55
74LS20	24	74LS93	55	74LS162	85	74LS330	175
74LS21	28	74LS109	38	74LS164	49	74LS330	175
74LS22	28	74LS112	38	74LS164	49	74LS670	230
74LS26	32	74LS113	38	74LS168	85	74LS192	95
74LS27	32	74LS114	38	74LS169	85	74LS193	95
74LS30	26	74LS122	49	74LS170	69	74LS194	95
74LS32	32	74LS124	99	74LS173	110	74LS195	85
74LS37	32	74LS125	47	74LS174	100	74LS196	85
74LS38	32	74LS126	47	74LS175	81	74LS197	85
74LS40	36	74LS132	79	74LS190	95	74LS251	85
74LS42	65	74LS133	35	74LS191	95	74LS253	81
				74LS195	85	74LS257	71

### TTL SPECIAL!

9002/7400	10/1/00	9000 series parts prime from ITT Pin for PNP compatible with 7400 series
9003/7410	10/1/00	
9004/7420	10/1/00	
9006/7460	6/1/00	
9007/7430	10/1/00	
9009/7440	10/1/00	
9016/7404	8/1/00	
9024/7409	3/1/00	
9300/74195	3/1/00	
NE 557	1/0/00	

### PROMS

1702A	- 1K - 1.5us	3.95 or 10/35
2708	- 8K Intel - 450ns	14.95
5204	- 4K	7.95
825129	- 1K	2.50
2708S	- 8K signetics	650ns 9.95

### DIODES

IN 4002	1 Amp 100 PIV	40/\$1
IN 4004	1 Amp 400V	15/\$1
IN 4007	1 Amp 1000V	10/\$1

### GERMANIUM DIODES

IN 54A		\$8/\$1
IN 270		10/\$1

### ZENER DIODES

IN 746	3.3V 400M	4/\$1
IN 752	5.6V 400M	4/\$1
IN 1958	8.2V 400M	4/\$1
IN 5259	39V 500M	10/\$1
IN 5271	100V 500M	10/\$1
IN 5280	180V 500M	10/\$1

### HOUSE # ZENER

4.7V	500 MW	10/\$1
9V	500 MW	10/\$1
10V	1 Watt	8/\$1
15V	500 MW	10/\$1
22V	5 Watt	6/\$1

### SWITCHING DIODES

IN 4148/IN914	Long Leads	20/\$1
IN 4148/IN914	Cut Leads	40/\$1
IN 4148/IN914	PC Leads	100/\$2

### CMOS

CD4000	19	CD4017	95	CD4040	100	CD4071	19
CD4001	19	CD4018	95	CD4041	69	CD4081	19
CD4002	19	CD4019	95	CD4042	69	CD4057	35
CD4006	120	CD4020	97	CD4043	60		
CD4007	19	CD4021	97	CD4044	60	CD4510	100
CD4009	47	CD4022	97	CD4045	60	CD4512	110
CD4010	39	CD4023	19	CD4047	150	CD4516	70
CD4011	19	CD4024	75	CD4049	35	CD4518	110
CD4012	29	CD4025	19	CD4050	39	CD4520	89
CD4013	32	CD4027	39	CD4051	119	CD4528	85
CD4014	78	CD4028	85	CD4053	119	74C02	45
CD4015	78	CD4029	99	CD4056	115	74C04	32
CD4016	32	CD4030	35	CD4066	78	74C107	79

### ITT LED DRIVERS

ITT 501	Quad Seg. Dr.	35	We have 100's of thousands of listed parts are These parts are 100% prime
ITT 502	Hex Digit Dr.	49	
ITT 503	Quad Seg. Dr.	49	
ITT 506	Hex Digit Dr.	49	
ITT 508	8 Digit Dr.	49	
ITT 509	8 Seg. Dr.	49	
ITT 511	Quad Seg. Dr.	55	
ITT 514	8 Digit Dr.	59	

### FAIRCHILD RTL's

The most popular digital IC's ever Produced. Very hard to find!  
UL914 DUAL 2 INPUT NOR 99  
UL923 JK FLIP FLOP \$1.19

### SOCKETS

• 8 Pin Low Profile	20	• 18 Pin Low Profile	30
• 14 Pin Low Profile	22	• 28 Pin Low Profile	69
• 16 Pin Low Profile	25	• 40 Pin Low Profile	89

### Bowmar 4 Digit LED Readout Array Full 1/2" Litronix Jumbo Dual Digit LED Displays

4 JUMBO .50" DIGITS ON ONE STICK! WITH COLONS & AM/PM INDICATOR  
**\$3.95**

DL 722 - C.C.	DL 728 - C.C
DL 721 B C.A.	DL 727 - C.A
99c	\$1.29

**UNMARKED**  
**1702A EPROMS**  
3.50 Ea. or 10/\$32.00  
LIMITED SUPPLY

IMSAI SPECIAL  
**S-100 Connector**  
**\$3.95 Ea.**

### CAPACITORS

AXIAL TYPE		ELECTROLYTIC		RADIAL TYPE	
20MFD	250V	5S1	47MFD	35V	PC Leads 10/\$1
35MFD	25V	15S1	68MFD	25V	PC Leads 8/\$1
500MFD	35V	5S1	330MFD	50V	PC Leads 5/\$1
			1000MFD	25V	PC Leads 4/\$1
			150PF MICA	5%	10/\$1
COMPUTER GRADE					
1.900MFD	35WVDC (Mini)	95 cents each	3S2		
8.000MFD	40WVDC	\$4.00 Each			
TANTALUM					
1MFD	20WVDC	PC Leads 15/\$1	68PF	50V	001MFD 50V
4.7MFD	10WVDC	PC Leads 5/\$1	100PF	100V	002FMD 200V
33MFD	10WVDC	6/\$1	150PF	50V	01MFD 200V
22PF	10	10/\$1	220PF	50V	02MFD 200V
			330PF	50V	33PF 500V
			001MFD	50V	100PF 500V
			PC Leads	25/89	cents No Mix

### JOY STICKS

FOUR 100 K-OHMS POTS  
Ideal for electronic games  
**\$3.95**

### MICRO-DIP \$1.95

New - Series 2300  
The World's Smallest Coded BCD Dual-In-Line Switch! PC Mount  
2300 02G BCD 1-2-4-8  
2300 12G BCD 1-2-4-8  
Compliment

### BRIDGE RECTIFIERS

1 Amp 200V	6/\$1	2
------------	-------	---





# Active Electronic Sales Corp.

## May We Introduce Ourselves

# \$30.00

### INTRODUCTORY PACKAGE

With any order valued at **\$30.00** or more

Post marked prior to July 31, 1978

You receive **AT NO EXTRA CHARGE**

- A 1978 ACTIVE ELECTRONICS Catalogue
- Your choice of any of the following packages -

#### PACKAGE NO. 1

**UNB0400 Unitorde Semiconductor Data Book.** 500 pages on rectifiers, fullwave bridges, transient voltage suppressors, zeners, programmable unijunction transistors, etc.

**LCC4162 TTL Supplement.** The most recent TTL functions are included in this supplement to the 2nd edition of the TTL Data Book.

**RAB0606 Raytheon Selection Guide.** A full line condensed quick reference source on all Raytheon Components.

**LCC4151 T.I. Linear and Interface Circuits Data Book.** 688 pages. Complete specifications on the 75 series of MOS interface peripheral driver, memory sense amplifiers, display interface circuits etc.

**Value \$16.90**

#### PACKAGE NO. 2

**FSB0104 Fairchild Bipolar Memory Data Book.** Bipolar memories, ECL static memories, TTL static memories, TTL dynamic memories and macrologic.

**FSB0105 Macrologic Bipolar Microprocessor Data Book.** Microprogramming for implementing as many system functions as possible in one centralized logic block.

**FSB0112 Fairchild Hybrid.** Custom and standard product as well as reliability and design considerations.

**GSB0100 Zener, Transistor and Transorb Catalogue.** Discrete devices and pertinent data and complete device characterization.

**FSB0103 Fairchild Power Data Book.** Basic parameter and data information as well as information on technology, safe operating area, reliability etc.

**Value \$14.35**

#### PACKAGE NO. 3

##### ADVANCED MICRO DEVICES

**AMB0203 8080A/9080A MOS Microprocessor Hand Book.** Detailed descriptions of the 8080A and associated CPU components.

**AMB0205 MOS/LSI Data Book.** Static RAM's dynamic 4K RAM's, 2K EROM, shift registers, FIFO memories and complete microprocessor and support circuits.

**AMB0206 Linear and Interface Data Book.** Comparators, data conversion products, Line drivers/receivers, MOS memory and microprocessor interface, Op Amps, Voltage Regulators etc.

**Value \$17.85**

#### PACKAGE NO. 4

**LCC4041 T.I. Power Semiconductor Data Book.** 816 pages germanium and silicon power transistors, SCR's, Triacs, darlington's, silicon power high voltage and low voltage types etc.

**SIB0303 Siliconix High Speed Analog Switches.** Complete specifications, characteristics and applications of the DG300 series.

**SIB0304 Siliconix FET Data Book.** Complete data on selecting the right FET for your application, characteristics and PC board layout.

**SIB0305 VMOS Power FET's.** Technical information, application and design aids, characteristics and device / application selection for this latest in technology.

**Value \$16.30**

#### PACKAGE NO 5

**SIB0300 Analog Switches and their Applications.** Introduction to FET Analog Switches and the way the switch control or driver circuit affect performance.

**LCC4280 T.I. Peripheral Driver Data Book.** Total information and typical application of complete peripheral drivers and interface.

**LCC4290 T.I. Line Driver and Line Receiver Data Book.** Complete data on line circuits and application information.

**GIM0100 General Instrument Microelectronics.** Complete specifications and data on calculator, clock and T.V. game chips, microprocessors, industrial devices, static RAM's, EAROM's and ROM's.

**Value \$19.30**

We reserve the right to ship a package of our choice, if one or more items of a requested package is out of stock. This offer available in the United States only.



P.O. BOX 1035 FRAMINGHAM, MASSACHUSETTS 01701

Over-the-counter sales,  
12 Mercer Rd., Natick, Mass. 01760  
Behind Zayres on Rte. 9  
Telephone Orders & Enquires (617) 879-0077

IN CANADA 2 LOCATIONS  
QUEBEC & ONTARIO

MINIMUM ORDER \$10.00 • ADD \$2.00 TO COVER POSTAGE & HANDLING • Canadian customers add 30% for exchange and handling. All federal and provincial taxes extra.  
Foreign customers please remit payment on an international bank draft or international postal money order in American dollars.

**MINI MINI TOGGLE**  
EXTRA SMALL D.P.D.T.  
3A 125VAC CONTACTS  
each \$1.50  
8 - 10.  
100 - \$105.



actual size

**ACTUAL SIZE**



**\$1.35 10-\$12**  
C & K #7103  
Single pole double throw  
center off (3 position)  
toggle switch.....

**LOOK new**  
**RC1 40374**  
250V - 2A NPN T066



POWER TRANSISTOR MOUNTED ON A  
FACTORY ASSEMBLED HEAT SINK -  
5.8 WATTS @ AMBIENT OF 25C  
\$.75 ea. 10 for \$6

**1/8 WATT RESISTORS**  
10 ea. - 390, 1.8k, 3.9k, 6.8k, 11k  
43k, 68k, 240k - 5 percent tol.  
**80 FOR \$4**

**BISTABLE RELAY**  
SPDT 6VDC 200 OHM COILS  
1 AMP 20 WATT DC CONTACTS  
LONG LIFE (1 X 10<sup>9</sup>) OPER.  
HIGH SPEED (500 HZ)  
HERMETICALLY SEALED 3/8X3/8X3/4"



**\$2.95 ea.**

**2A, 50V bridge 39¢ ea**

**ultra sensitive relay**



Single pole normally  
open dry reed relay.  
Unbelievable sensi-  
tivity, 1800 amp coil  
with 3 volt pull-in  
(that's less than 3  
ma.) A TTL gate  
will drive many of  
these. A CMOS buffer  
will directly actuate  
this nifty relay....  
MFG. unknown, but I was  
told they came from IBM.  
600 available

**\$2.95 ea.**

**ELEC-TROL 12 vdc**  
**REED RELAY 440 Ω**  
coil  
4 dpst  
n.o.

**sale**  
1.1"

PICTURE IS APPROXIMATION, RELAY HAS  
FOUR PINS ON ONE END AND TWO ON OTHER.  
PINS ARE SPACED .1" X 1". 1/2A CONTACTS.

**79¢ ea. 10 - \$6**

**-SUPER SPECIALS-**

DIAC 27 TRIGGER DIODE . . . . .20  
PULSE XFMR. 1/1 TOROID-ENCASED .25  
600MFD. 360VDC PHOTO FLASH CAP. .90  
1702A 2K, lus, EPROM . . . . .7.95  
SP425 SPERRY 9 digit 4" HV  
multiplexed 7 seg. . . . .1.25  
MM5369 time base osc. chip . . . . .1.75  
T.V. crystal for above..... 1.75  
1101A 256 x 1 MOS RAM . . . . .59  
93410 256 x 1 45NS RAM . . . . .85  
75451 peripheral driver . . . . .40  
7402 TTL nor gate . . . . .16  
7430 TTL nand gate . . . . .14  
CERAMIC FILTER 10.7 Mhz. . . . .1.20  
MM5058 1024 bit static SR . . . . .1.50  
UA715 60Mhz. op-amp . . . . .1.20  
74S206 256 x 1 45NS RAM . . . . .90  
78L2.6 2.6V T092 .1A +regul. . . . .29  
78L05 5.0V " " " " . . . . .29  
78L6.2 6.2V " " " " . . . . .29  
78L12 12V " " " " . . . . .29  
78L15 15V " " " " . . . . .29  
78M05 5V tab .5A + regul. . . . .59  
78MG 4 term. adj. .5A + reg. 1.29  
79MG " " " - reg. 1.39  
7805T tab 1A 5v regul . . . . .89  
7812 to-3 1A +12V regul. . . . .59

**POTTER BRUMFIELD**

Type KHP Relay  
4 PDT 3A Contacts

24VDC COIL  
650 ohms

120VAC  
10.5MA



**\$1.60 ea.**

**DELTA ELECTRONICS**  
P.O. Box 2, 7 Oakland St.,  
Amesbury, Mass. 01913  
617-388-4705

**RETAIL OUTLET**  
ATLANTA, GA. DELTA ELECTRONIC HOBBIES  
5151 Buford Hwy. Doaraville, (Atlanta) Ga. 30340

CIRCLE 44 ON FREE INFORMATION CARD

**DIP TRIMMER**

12 TURN 1/4" x 1/4" x 1/4"  
5K or 200K only  
mfg. DALE



**\$1.50 TEN FOR \$4**

**FANTASTIC**  
**RC1 40536**  
2A 400V TRIAC



FACTORY ASSEMBLED ON  
HEAT SINK READY TO  
PUT IN YOUR CIRCUIT BD.

**T05**  
**\$1.50 BOTH \$2.75 \$0.90 ea. 10 for \$7.50**

**SPERRY 9 DIGIT PLASMA DISPLAY, COMMON CATHODES, 1/4" HIGH DIGITS--**  
DM8880 IC DRIVER FOR "NIXIE" ABOVE  
DISPLAYS 0123456789ABCDEF WITH 0-15 BINARY INPUT.....

**DISPLAY or IC \$1.50 BOTH \$2.75 \$0.90 ea. 10 for \$7.50**

**VARO SEMICONDUCTOR**

**SUPER SAVER**

**EPOXY BRIDGE RECTIFIERS**  
10 AMP 50V VJ048



**\$1.39 ea. - 10 for \$12 100- \$99**

**PO BOX 41778**  
**Sacramento, Ca.**  
95841  
916 334 2161

**Money back guarantee - \$5 minimum order.**  
we pay post on orders for \$10 or more. All  
payment must be in U.S. funds. Foreign  
orders must include post BAC & MC are  
not prepaid orders and shipping is added

4811 MYRTLE AVE

**BABYLON ELECTRONICS**

**your BANKAMERICARD welcome to us**

CIRCLE 61 ON FREE INFORMATION CARD

**TV HOCKEY SOCCER GAME PLUS VIDEOCUBE-TV INTERFACE**

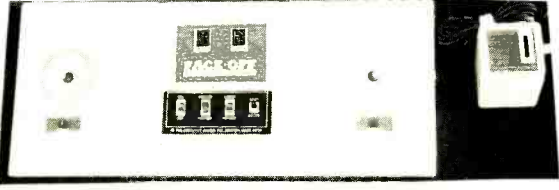

The game we have been selling for \$27.50 in kit form. NOW complete, ready to go including VIDEOCUBE, the TV interface, used for interfacing minicomputers and cameras, as described in August RADIO-ELECTRONICS. Games have 2 levels of skill, LED read-outs for scoring, 2 joysticks which move players in all planes, not just vertical & horizontal. Game sold for \$79.50 in Boston stores.  
**STOCK NO.5495R Complete TV game & VIDEOCUBE \$18.95**

**NEW TRANSFORMERS**

115 V primary. Sec.1—12.6V@1.0 A. ct. Sec.2—33.5V, tapped @ 13.1 V @1.0A. Sec.3—140V @100 ma. 2Lbs. 4"x2"x2 3/4".  
**STOCK NO.6772R \$2.95 ea. 2/5.00**

Two 115 volt primaries,(can be used on 230V). 4 secondaries. 11.5V @ 4.8 A, 23V @ 9.0 A., 14 V. @ 20 A. and 125 V 1.5 A.  
13 lbs. 4 1/2"x4 3/4"x3 3/4"  
**STOCK NO.6554R \$16.95 ea. 2/30.00**

TRIAD—N67A ISOLATION transformer. 115 or 230 VAC to 115 AC. 150 VA. Limited quantity. 7 lbs. 4"x4"x3 1/2".  
**STOCK NO.6788 \$7.95 ea. 2/15.00**

**DELTA ELECTRONICS**  
P.O. Box 2, 7 Oakland St.,  
Amesbury, Mass. 01913  
617-388-4705

**RETAIL OUTLET**  
ATLANTA, GA. DELTA ELECTRONIC HOBBIES  
5151 Buford Hwy. Doaraville, (Atlanta) Ga. 30340

CIRCLE 44 ON FREE INFORMATION CARD

**INTEGRATED ELECTRONICS**

5100 El Camino Real, Los Altos, CA 94022. (415) 969-7827

74LS00 .25	TTL 74LSXX	74LS253 1.70
74LS01 .25	JUNE SPECIAL - guaranteed prime parts	74LS257 1.70
74LS02 .25	74LS74 .45	74LS258 1.75
74LS03 .25	74LS75 .63	74LS259 2.00
74LS04 .32	74LS76 .47	74LS261 3.25
74LS05 .32	74LS78 .40	74LS266 .75
74LS08 .30	74LS83 1.65	74LS273 2.75
74LS09 .36	74LS85 1.90	74LS279 .75
74LS10 .30	74LS86 .47	74LS283 1.60
74LS11 .33	74LS90 .86	74LS290 1.60
74LS12 .35	74LS91 1.30	74LS293 1.60
74LS13 .65	74LS92 1.10	74LS295 2.00
74LS14 1.50	74LS95 1.45	74LS298 2.00
74LS15 .33	74LS96 1.85	74LS299 7.00
74LS20 .27	74LS107 .56	74LS324 2.25
74LS21 .33	74LS109 .56	74LS352 1.85
74LS22 .33	74LS112 .56	74LS365 .95
74LS26 .37	74LS113 .54	74LS366 .95
74LS27 .35	74LS114 .54	74LS367 .95
74LS28 .38	74LS122 .90	74LS368 .95
74LS30 .30	74LS123 1.20	74LS374 2.25
74LS32 .35	74LS124 2.00	74LS375 1.25
74LS33 .39	74LS125 1.00	74LS377 3.25
74LS37 .39	74LS126 1.00	74LS378 2.35
74LS38 .39	74LS132 1.20	74LS379 2.25
74LS40 .37	74LS136 .56	74LS386 .95
74LS42 1.20	74LS138 1.20	74LS390 3.75
74LS47 1.25	74LS139 1.20	74LS393 2.75
74LS48 1.45	74LS148 1.60	74LS395 2.85
74LS49 1.45	74LS151 1.20	74LS399 2.60
74LS51 .28	74LS153 1.20	74LS490 3.75
74LS54 .33	74LS155 1.25	74LS668 2.25
74LS55 .28	74LS156 1.60	74LS669 1.85
74LS73 .47	74LS157 1.40	74LS670 3.95

21L02 - Guaranteed prime \$1.50, 10 up  
±3 digit A/D LD 130 \$6.50

Minimum order \$5.00 US currency. Check or money order only.  
Add 5% to cover shipping and handling charges. Calif. residents  
add 6% sales tax. Santa Clara Co. residents add 6.5% sales tax.

RADIO-ELECTRONICS



**SC-5**  
With Rechargeable Batteries & Charger Unit **\$89** Unit **\$195**

**FM-7**  
With Rechargeable Batteries & Charger Unit **\$195**

Features Include: • By using the new NLS SC-5 Prescaler, the range of the FM-7 Frequency Meter, which is 10 Hz to 50 MHz, may be extended to 570 MHz (the upper VHF & UHF frequency bands) • The FM-7 utilizes an LED readout, providing 7-digit resolution • The FM-7 can be calibrated to an accuracy of 0.00001% • The SC-5 is accurate to one part per million • Each unit has 30 millivolts sensitivity, is battery powered and has a charger unit included • Dimensions of each are 1.9" H x 2.7" W x 3.9" D • The units may be obtained separately or as a Frequency Duo • Parts & Labor guaranteed 1 year.

Tilt stand option **\$ 3.50**  
Leather case **\$16.00**

**MS-15 MINISCOPE \$289**  
With Rechargeable Batteries & Charger Unit

• 15 megahertz bandwidth.  
• External and internal trigger.  
• Time base — .1 microsec. to 0.5 Sec/div - 21 settings ± 3%.  
• Battery or line operation.  
• Automatic & line sync modes.  
• Power consumption < 15 watts.  
• Vertical Gain — .01 to 50 V/div - 12 settings ± 3%.  
• Viewing area 1.1" x 1.35"  
• Case size 2.7" H x 6.4" W x 7.5" D, 3 pounds.  
• Parts & Labor guaranteed 1 year  
• 10 to 1, 10 meg probe **\$24.50**  
• Leather carrying case **\$30.00**

**NEW VOLKSMETERS!**  
With LCD Display—  
Excellent Readability in Direct Sunlight!

**NEW**

**1010**  
**LM-300**  
Full three digits  
**\$99.50**

**0.5%  
LM-350**  
3 1/2 digits  
**\$125.00**

**SPECIFICATIONS**

METER	RANGE	ACCURACY (LINEarity)	ACCURACY (FUNCTION)	MEASUREMENT	INPUT RESISTANCE	TEST CURRENT
VOLTS DC	10 100 1000	±1 Reading	±0.5 Reading	1 mV 10 mV 100 mV 1 V	10 MΩ	
VOLTS AC	1 10 100 1000	±1 Reading	±0.5 Reading	1 mV 10 mV 100 mV 1 V	16 MΩ, 25 pF	
RESISTANCE	10 100 1000 10000	±1 Reading	±0.5 Reading	1 Ω 10 Ω 100 Ω 1 KΩ		1 mA 100 μA 10 μA 1 mA
CURRENT	1 mA 10 mA 100 mA 1 A	±1 Reading	±0.5 Reading	1 mA 10 mA 100 mA 1 A	1 MΩ	100 μA 10 μA 1 mA 10 mA

**FEATURES**

- Measures DC volts, AC volts, ohms and current
- Automatic polarity decimal and overload indication
- No zero adjustment and no full scale ohms adjust
- Large LCD display for easy reading without interpolation
- Size 1.9" H x 2.7" W x 4.0" D
- Parts and labor guaranteed for one year

**SPECIAL!!**

Batteries & Charger **\$1.00**  
with the purchase of Meter and the mention of this magazine

Tilt Stand Option, add **\$3.50**  
Leather Case **\$16.00**  
3AA Ni-Cad Batts. & Charger **\$12.00**

Standard AA size batteries provide up to 20 hours of operation. Rechargeable Ni-Cad batteries and charger unit available as optional equipment. Batteries not included.

**LEDU MG 10A**  
List **\$72.00**

Perfectly balanced, fluorescent lighting with precision magnifier lens for prof., techn. & hobbyist. Has one cast protective shade, inst. start 3 diopter lens, 42" reach.

**\$44.95**  
with 19 fluorescent lamp (lamp required) colors Gray or Black (Optional, Brown) 17 inches deep

**SPECIAL**

• 15 megahertz bandwidth.  
• External and internal trigger.  
• Time base — .1 microsec. to 0.5 Sec/div - 21 settings ± 3%.  
• Battery or line operation.  
• Automatic & line sync modes.  
• Power consumption < 15 watts.  
• Vertical Gain — .01 to 50 V/div - 12 settings ± 3%.  
• Viewing area 1.1" x 1.35"  
• Case size 2.7" H x 6.4" W x 7.5" D, 3 pounds.  
• Parts & Labor guaranteed 1 year  
• 10 to 1, 10 meg probe **\$24.50**  
• Leather carrying case **\$30.00**

• **MS-215 Dual Trace Version of MS-15 \$395.00**  
**PROBE 1¢** with the purchase of SCOPE and

the MENTION of this MAGAZINE

**8803 MOTHER BOARD FOR \$100 BUS MICRO-COMPUTERS**

• Kit includes 12 tantalum capacitors for +5, +12 — 12 buses and inter-wired mounting sockets.  
• Wiring guide shown. Component side bare epoxy glass with white markings for component locations.  
• 610 epoxy glass board with 2 ounce copper solder plating and 038 ounce tin-niis top leads.  
• Solder mask with solder windows on etched circuits to avoid accidental short circuits.  
• Meets 11 receptacles with 100 contacts (2 rows) on 125 centers with 250 row spacing. Vector part number 8881-2 or mounts 100 receptacles plus interconnections to insure mother board for expansion.  
• Includes etched circuits and instructions for option of active, pull-up, or floating terminations.  
• Large holes — .035 and .050 (10 AMP). Current ratings are per MIL-STD-275 with 10C 15A.  
• Fits in Vector gas enclosures.  
• Fits in IMSAI 8380 microcomputer as an expandable board.

**Price: \$29.50**

**Vector Plugboards**

**8800V** Universal Microcomputer/processor plugboard, use with S-100 bus. Complete with heat sink & hardware. 5.3" x 10" x 1/16"

1-4	5-9	10-24
\$19.95	\$17.95	\$15.95

**8801-1** Same as 8800V except plain less power buses & heat sink.

1-4	5-9	10-24
\$14.95	\$13.45	\$11.95

**3682 9.6" x 4.5"** **\$10.97**  
**3682-2 6.5" x 4.5"** **\$9.81**

**Hi-Density Dual-In-Line Plugboard for Wire Wrap with Power & Grid Bus Epoxy Glass 1/16" 44 pin con. spaced .156**

**3677 9.6" x 4.5"** **\$10.90**  
**3677-2 6.5" x 4.5"** **\$9.74**

**Gen. Purpose D.I.P. Boards with Bus Pattern for Solder or Wire Wrap Epoxy Glass 1/16" 44 pin con. spaced .156**

**3662 6.5" x 4.5"** **\$7.65**  
**3662-2 9.6" x 4.5"** **\$11.45**

**P pattern plugboards for IC's Epoxy Glass 1/16" 44 pin con. spaced .156**

**R 644**

**R644 P C receptacle 22/44 cont. 150 ctrs. pierced solder eyelets tails gold** **\$2.95**  
**R644-3 P C receptacle 22/44 cont. 150 ctrs. Wire Wrap tails gold** **\$4.49**

**S-100 Bus P.C. Edge Connectors**

**R681 DIP solder tails on 140 spaced rows for ALTAIR mother boards. Fits 047 dia holes gold** **\$7.35**  
**R681-1 025 sq 3 wrap lengths posts (62 long) on 250 spaced rows, gold** **\$5.00**  
**R681-2 025 sq 1 wrap length posts (22 long) on 250 spaced rows for wrapping or DIP solder for IMSAI mother boards, gold** **\$5.85**  
**R681-3 pierced solder eyelet tails, gold** **\$7.35**

**1/16" Vector BOARD**  
.042 dia holes on 0.1 spacing for IC's

**Phenolic**

PART NO.	SIZE	PRICE
64P44-062XXP	4.5 x 6.5"	\$ 1.49
169P44-062XXP	4.5 x 17"	\$ 3.51

**Epoxy Glass**

PART NO.	SIZE	PRICE
64P44-062	4.5 x 6.5"	\$ 1.70
84P44-062	4.5 x 8.5"	\$ 2.10
169P44-062	4.5 x 17"	\$ 4.30
169P84-062	8.5 x 17"	\$ 6.39

**ELLY-WRAP**  
Wraps insulated wire on .025 square posts **FOUR TIMES FASTER** than regular manual wrap post tools.

**\$24.50**

**P180** with two 100' spools of 28 ga. wire

**P160-4T** includes charger, wire **\$75.00**

**SLIT-N-WRAP WIRE** 12" Package  
W28 2 A Pkg. 3 Green W28 2 C Pkg. 3 Gray W28 2 B Pkg. 3 Red W28 2 D Pkg. 3 Blue

**2708 8K 450 ns**

**EPROM FACTORY PRIME \$10.00 EA.**  
**25 + Call For Price**

**14 & 16 PIN 3 LEVEL WIRE WRAP SOCKETS**

14-T3 100 for	<b>\$30.00</b>
16-T3 100 for	<b>\$30.00</b>
50 of ea. for	<b>\$32.00</b>

**ACE • All- for fast, solderless, Circuit plug-in circuit building Evaluator and testing**

Just plug in any components with leads to .032" dia. Interconnect with solid wire up to 20 ga. Assembled models tool

ACE Model No.	Pin	Capacity	Buttons	Board Size (Inches)	Price Each
206-K (Kit)	726	8 (16 x 3)	2	4.9/15 x 5.9/16	\$18.95
208 (assem)	872	8 (16 x 3)	2	4.9/15 x 5.9/16	28.95
201-K (Kit)	1032	12 (14 x 3)	2	2 1/2 x 7	24.95
212 (assem)	1224	12 (14 x 3)	2	4.9/15 x 7	34.95
218 (assem)	1760	18 (14 x 3)	10	6-1/2 x 7-1/8	46.95
221 (assem)	2712	27 (14 x 3)	28	8 x 9-1/4	59.95
236 (assem)	3648	36 (14 x 3)	36	10 1/4 x 9-1/4	79.95

**SALE**

**LIQUID CRYSTAL DIGITAL CLOCK-CALENDAR**

- For Auto, Home, Office
- Small in size (2x2 1/2 x 1/2)
- Push button for seconds release for date
- Clocks mount anywhere with either 3M double-sided tape or VELCRO, included.
- 2 MODELS AVAILABLE
- LCD-101, portable model runs on self-contained batteries for better than a year.
- LCD-102, runs on 12 Volt system and is back-lighted.
- LCD-101 or LCD-102 your choice **\$34.95..**
- Clear desk stand for **\$2.00**

**3 LEVEL GOLD WIRE WRAP SOCKETS**

1-24	25-49	50-99
8 pin	47	42
10 pin	45	41
14 pin	39	38
16 pin	43	42
18 pin	75	68
20 pin	84	77
22 pin	100	97
24 pin	100	94
28 pin	109	98
36 pin	159	145
40 pin	149	139

**MICRO-KLIP** for .042 dia. holes (all boards on this page)

T42-1 pkg. 100	\$ 1.50
T42-1 pkg. 1000	\$11.00
P-149 hand installing tool	\$ 2.03

**12:28 .8" LED ALARM CLOCK**

12 hr LED Alarm Clock uses 3 1/2 digit 8 LED Display with AM/PM indicators and colors. Direct drive PIN to PIN interface with **\$19.98A** IC. Just add switches, AC Supply Alarm Display and I.C. only.

**\$7.95 or 2/\$15.00**

**Price Breakthrough! \$17.95**

**MA1003 CAR CLOCK**

Bright Green Fluorescent Display Crystal Time Base Assembled, just add switches and 12 VDC.

**SPECIAL**

**14CS2 100 for \$14.00**  
**16CS2 100 for \$16.00**  
**14 pin CS2 10 for \$2.11**  
**16 pin CS2 8 for \$2.11**

These low cost DIP sockets will accept both standard width plugs and chips. For use with chips, the sockets offer a low profile height of only .125" above the board. These sockets are not stackable.

**Vector**

**WRAP POST** for .042 dia. holes (all boards on this page)

T-44 pkg. 100	\$ 2.28
T-44 pkg. 1000	\$14.00
A-13 hand installing tool	\$ 2.80

**Priority ONE ELECTRONICS**

10031 S. Woodley Ave. Sepulveda CA. 91343

Terms: VISA, MC, BAC, check, Money Order, C.O.D., U.S. Funds Only. CA residents add 6% sales tax. Minimum order \$10.00. Orders less than \$75.00 include 10% shipping and handling, excess refunded. Just in case please include your phone no. **"Sorry, no over the counter sales"** Good thru July 15, 1978

phone orders welcome (213) 893-8202 OEM and Institutional inquiries invited.

**24 PIN DIP PLUGS WITH COVERS**

**3 / \$1.00**  
**40 / \$10.00**



# WAREHOUSE CLEARANCE

## ETCO

### GREAT BUYS

EVERY ONE A BARGAIN!

- K242SU 110 VAC solenoid water valve (6 oz.).....\$3.95, 10/\$34.95
- K054EK Eico Blacklite strobe (5 lb.).....\$39.95
- K197KT Educational electric motor kit (5 Oz.).....\$1.99, 10/\$15.95
- K233HP 12V-2 A. (4A. surge) CB/car stereo power supply (1 lb.).....\$9.95
- K150TR 1200' 5" reel Philips recording tape (6 oz.)\$2.95, 10/\$19.95
- K338PT 1 lb. asst. 2 sided glass epoxy PC boards.....\$2.95
- K339PT 1 lb. asst. 1 sided glass epoxy PC boards.....\$2.95
- K112MP New electret shotgun microphone (2 lb.).....\$59.95
- K088DS Hamlin 3 1/2 digit liquid crystal watch display.....\$4.95 (2 Oz.)
- K2630P 5 assorted optical lenses.....\$1.98
- K308SU Surprise relay board (4 oz.).....\$2.95, 10/\$24.95
- K604TR Popular 8 track stereo head (4 oz.).....\$2.89, 10/\$24.95
- K180AE 10 section 50" whip antenna (5 oz.).....99c
- 5Y4G tubes (3 oz.).....\$1.29
- 6AQ6 tubes (3 oz.) 99c, 10/\$8.95, 100/\$79.95.

### FREE!

WITH EACH ORDER OF \$10.00 OR MORE —  
2 of these 12 vdc DPST PC BOARD RELAYS!  
Request 2 No. K066RL.



**UNUSUAL 4 - CHANNEL VLF FM RECEIVER!**

Brand new. Originally used in wireless classroom systems. Picks up transmitted frequencies from a closed-loop antenna (40 x 40 ft.) surrounding an area up to 1600 square feet. 4 channels: 185, 230, 285, 350 KHz. Operates on 1.4 V mercury cell (Mallory RM-12) not included. 4 push-button channel selector switches, 2 headphone jacks, volume control. Automatic "on" when head phone is plugged in. Bears Sylvania No. STU - 41031. Fascinating application possibilities. 1 1/2 lb. K310SU.

### CLOSE-OUT SALE!



MONEY BACK GUARANTEE— You have to be pleased or return it within 10 days for refund.

ETCO scoops the industry - buys up closeout inventory of fine, sophisticated X-band radar detectors - and brings them to you at the lowest price ever! Sealed factory display cartons (excellent dealer item). Audio/visual warning. Sensitivity control. Dual brackets. Picks up radar signals at twice the distance that radar operator is able to "sight" you! Easily worth 3 times our low price. Order today while inventory lasts. (1 lb.) K013HM.

SPECTACULAR PURCHASE I

HAWKEYE

RADAR WARNING SYSTEM

PRICE CUT  
NOW ONLY—  
**29.95**  
3/\$79.95  
WORTH THREE TIMES OUR AMAZINGLY LOW PRICE!

### BUILD YOUR OWN DUMMY TV CAMERAS!

BANKRUPTCY PURCHASE!

**2.95**  
10/\$24.95

We bought up thousands of these dummy TV camera lenses. Originally manufactured for "Foto-Vu" security equipment. Professional appearance. Black plastic with clear lucite lens. 2 1/2" diameter x 3" long. 6 oz. K292SU.

### POTTER & BRUMFIELD 4PDT 24 VDC RELAYS!

VALUE

2500 in stock!

**1.99**  
3/\$5.49  
10/\$14.95  
50/\$59.95

4 amp contact rating. Sensational value. Add diode rectifier for AC use. A thousand applications. 1 1/2" x 1" x 3/4". 2 oz. K010RL.

### MAIL YOUR ORDER TODAY

### FIVE POUND SURPRISE BOX!

5 pounds of pure pleasure! Parts, gadgets, assemblies, hardware - easily worth 5 to 10 times our low price. A box of goodies specially prepared by ETCO to endure us to our customers forever. Each kit is different - order several. A super money saver for servicemen. P.S. Don't tell your wife where you got it - she'll shoot us! 5 lb. K097PT.



**1.29**  
THE MAGIC SOUND SWITCH  
DIAGRAM INCLUDED  
10/\$9.95  
100/\$79.95

Originally used in the manufacture of an electronic turtle! Sensitive crystal mike picks up sound which is amplified to trigger an SCR. Operates on 3-6 VDC. A great experimental item. Clap hands to operate motors, lights, alarms. A factory surplus assembly. 2 oz. K210SU.

### SPECIAL PURCHASE

### HOME CONVERTER FOR CAR STEREO!

400 in stock!

SALE

**24.95**

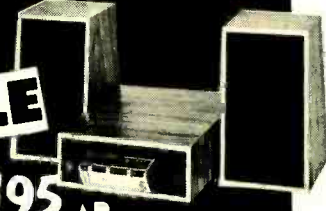

AR AUTOMATIC RADIO

3/\$79.95

A sensational ETCO purchase! Designed to accept and power AR Automatic Radio Car stereo models SPC-5002 & SPE-5004, but can be adapted to just about any car stereo or car radio! (could power CB sets and scanners, too!) 2 speakers included. Exactly as pictured. Less car stereo unit. AR No. HCC-5103 Walnut woodgrain finish. Built in 110 VAC power supply. Pilot light. On-off switch. Stereo headphone jack. Original factory sealed cartons. An excellent dealer item. (9 lb.). K725HP

### RCA 40374 POWER TRANSISTOR WITH HEATSINK!

10/\$10.88 BRAND NEW

**1.39**

TO-66 case. Complete with heat sink as pictured. NPN silicon, AF high voltage 6W power transistor very similar to SK3021. 1 oz. K169DS

### RCA 40536 TRIAC WITH HEATSINK!

**1.29**  
10/\$9.95

TO-5 case, in heat sink as in photo. Similar to SK3506. Off-state voltage - 400 Forward current: 2.5 A RMS (surge 25 A.) Brand new Factory surplus. 2 oz. K168DS.

# SURPLUS WANTED

TELEPHONE YOUR ORDERS — Phone in your charge. card orders at low station-to-station rates!  
CALL: 1-518-561-8700.

SURPLUS WANTED — Contact our buying office at 1-514-695-0400 or send list and samples to Plattsburgh address below.

CANADIANS — Ordering from this ad is simple. Please remit in U.S. funds (or add 10% to overall total and remit in Canadian funds). (Chargex and Mastercard welcome). We do the paperwork and ship to you direct from the U.S.A. at low American prices. You pay duty and tax to Canadian Customs (Canadian schools are exempt). We have stores in Canada, too! Write for Canadian catalogs. We invite you to visit our Plattsburgh store - just 50 minutes from Montreal on U.S. 87!



**Rush Your Order Today** — Shipped to you direct from our new mailorder headquarters and warehouse store!  
**MERCHANDISE SUBJECT TO PRIOR SALE.** Full remittance with each order, please. Money Order, Certified check, BANKAMERICARD, VISA, MASTERCARD or CHARGEX. Add 20% for UPS (or postage) and handling (we refund excess). Please try to bring your order total to \$10 or more. Worldwide export orders solicited. Open account to Government agencies, schools, institutions and triple "A" rated industrial & commercial accounts. Special quotes for quantities. N.Y. state residents: add 7% sales tax.

**ETCO ELECTRONICS CORP. U.S.A.**  
North Country Shopping Center,  
Route No. 9, Plattsburgh, N.Y. 12901.

RADIO-ELECTRONICS



### S-100 32K STATIC MEMORY BOARD

**features:**

1. FULLY STATIC - usable with all DMA devices.
2. BUFFERED - with noise suppressed control inputs.
3. MODULAR - populated in 1k increments.
4. RELIABLE - single source +5V regulator
5. PROM COMPATIBLE - monitors available on request.

AVAILABLE EITHER IN COMPLETE KITS OR ALREADY ASSEMBLED UNITS WHICH HAVE BEEN FULLY TESTED AND BURNED IN.

**BARE BOARD \$38<sup>00</sup>**

	KIT	ASSEMBLED
8K	\$270 <sup>00</sup>	\$296 <sup>00</sup>
16K	\$440 <sup>00</sup>	\$465 <sup>00</sup>
24K	\$580 <sup>00</sup>	\$612 <sup>00</sup>
32K	\$695 <sup>00</sup>	\$740 <sup>00</sup>

PRICES QUOTED ARE FOR 300ns MEMORIES KITS AND ASSEMBLED UNITS INCLUDE DOCUMENTATION

### DEC® LSI-11 16K MEMORY BOARD

- Q-BUS—FULLY STATIC
- MODULAR
- ADDRESSABLE TO 128K WORDS
- MAPPABLE IN 4K INCREMENTS
- BUFFERED AND NOISE SUPPRESSED
- PROM COMPATIBLE

ASSEMBLED, TESTED & BURNED IN **\$1249<sup>00</sup>** COMPLETE KIT **\$1159<sup>00</sup>**

LARGEST & FASTEST STATIC MEMORY AVAILABLE

### S-100 EXPANDABLE MOTHER BOARD

- 8-SLOT EXPANDABLE BACKPLANE—in line male and female connectors enable backplanes to be plugged together, or the female may be used in place of an extender board.

QUIET—ground plane decouples all signal lines.

RELIABLE—SAE 8100 phenolic body, gold contact connectors.

COMPLETE KIT **\$66<sup>00</sup>** ASSEMBLED **\$89<sup>00</sup>**

### UNIVERSAL "U DESIGN" WIRE WRAP BOARDS

ALL BOARDS ARE G-10 GLASS EPOXY, HAVE Vcc AND GROUND PLANES, PLATED THROUGH HOLES, & GOLD PLATED EDGE CONNECTORS

**No. 1 "BEST ON THE MARKET" MICRO CPU CARD WITH S 100 BUS, 3 ON BOARD REGULATORS, FITS ALL STANDARD I.C. SOCKET CONFIGURATIONS 1700+ HOLES. SIZE 5"x10"**  
**\$23<sup>95</sup>**

**No. 2 UNIVERSAL BOARD FITS 86 PIN SOCKET WITH 0.10" CONTACT SPACING. MADE BY LEADING COMPUTER MANUFACTURER AS "IN HOUSE" BOARD. 1600+ HOLES. SIZE 4.78"x7.58"**  
**\$7<sup>95</sup>**

### S-100 EXTENDER BOARD

with connector  
**A MUST for trouble-shooting your Computer boards \$17<sup>95</sup>**

### BUILD YOUR OWN LOGIC PROBE

24 TO 92 SMALL SIGNAL DARLINGTONS AND 24 LEDS—ALL FUNCTIONAL **only \$4<sup>95</sup>**

### MAXI SWITCH KEYBOARDS

UNENCODED-MOUNTED ON G-10 GLASS EPOXY BOARDS-A BLACK METAL FRAME KEEPS KEY SWITCHES SECURELY IN PLACE.

**No. 1**  
-53 key main keyboard  
-10 auxiliary & cursor control keys  
-11 key numeric pad  
-Bank of 5 auxiliary power and control, rocker arm switches—one of them lights up.  
**\$39<sup>95</sup>**

**No. 2**  
-53 key keyboard  
-1 auxiliary power/control DPDT rocker arm switch  
**\$29<sup>95</sup>**

BEIGE METAL FRAME MOUNT FOR NO. 2 KEYBOARD **\$9<sup>95</sup>**

SOCKET CONNECTOR FOR NO. 2 KEYBOARD **\$2<sup>95</sup>**

WIRE WRAP SOCKET CONNECTOR FOR NO. 1 KEYBOARD **\$2<sup>95</sup>**

### OUR NEW ASCII KEYBOARD

HAS ON BOARD UV PROM, A MAIN KEYBOARD SECTION OF 58 KEYS, A HEX PAD OF 15 KEYS AND 16 MORE PERIPHERAL KEYS. 89 KEYS TOTAL & ASCII ENCODED for only **\$99<sup>95</sup>**

### EDGE VIEW METER

CHARGE DISCHARGE SCALE READS .20, 0, .40 MOVEMENT +60, -120mA  
0.135 OHMS **\$24<sup>9</sup>**

### POWER SUPPLY PARTS

#### DIODES

IN4001	50V at 1A	6c
IN4003	200V at 1A	8c
IN4007	1000V at 1A	12c
IN250	60V at 20A	95c
IN3909	50V at 30A	\$1.25

#### BRIDGES

FAST RECOVERY AVALANCHE BRIDGE		
IN4436/T	200V at 10A	\$4.25
FULL WAVE "MINI BRIDGE" WITH TAB TERMINALS		
PR -10F	100V at 12A	\$3.75

#### 5% ZENERS

IN4733A	5.1V	1w	39c
IN4739A	9.1V	1w	39c
IN4744A	15V	1w	39c

#### VOLTAGE REGULATORS

uA723-VARIABLE 2V to 3.7V	PLASTIC	METAL
	38c	69c
78L05 5V at 100mA	TO-92	3/98c
3401-6 6V at 1 AMP	TO-220	2/98c

#### PASS TRANSISTORS

MJE3055	10A PLASTIC	89c
2N3055	10A TO-3	95c
2N5301	30A TO-3	\$1.95

PROTECT YOURSELF. INSTALL AN ELECTRONIC CROWBAR CIRCUIT IN YOUR POWER SUPPLY.  
**CROWBAR SCR C220D 400V at 10A \$1.75**

### BUILD YOUR OWN PAPER TAPE READER

1/10" CENTER STACKABLE

### PHOTO TRANSISTERS 10/\$9<sup>60</sup>

### TTL COMPATIBLE REED RELAY

400 OHMS **\$14<sup>9</sup>** **7/\$9<sup>75</sup>**

### 4K STATIC RAMS

2114	650ns	600mw	\$6.25
TMS-4045-4	450ns	300mw	\$10.95
HM 472114	300ns	200mw	\$11.95

### MINIATURE 16 BUTTON PADS

4x4 MATRIX ENCODED **\$19<sup>5</sup>**

### I.C. SOCKETS LOW PROFILE-SOLDERTAIL

for that professional touch CARBIDE DRILL BITS for P.C. BOARD WORK  
ASSORTMENT OF SIZES FROM NO. 55 TO NO. 70  
5 MIX/\$7<sup>49</sup> 10 MIX/\$12<sup>49</sup> 100 MIX/\$99<sup>00</sup>

### GOLD WIRE WRAP SOCKET STRIPS

MAKE UNIVERSAL END AND SIDE STACKABLE WIRE WRAP BOARDS  
7 PIN STRIP  
TOP VIEW  
SIDE VIEW  
12 PIN 3 LEVEL 48c  
14 PIN 2 LEVEL 48c  
3 LEVEL 56c

### GOLD INLAID TIN

8 PIN	10/\$1.59	10/\$1.35
14 PIN	10/\$1.89	10/\$1.49
16 PIN	10/\$1.99	10/\$1.59
22 PIN	5/\$1.69	5/\$1.49
24 PIN	5/\$1.89	5/\$1.59
28 PIN	5/\$1.99	5/\$1.69
40 PIN	4/\$1.99	4/\$1.69

### OPTO DEVICES

**PHOTO TRANSISTORS** ULTRA HIGH SPEED  
SIMILAR TO FPT 100  
4/98c  
EXTREMELY SENSITIVE LIGHT ACTIVATED SCR  
triggerable by flashlight at several hundred yards  
\$2<sup>95</sup>

**PHOTO DETECTOR**  
0.5ns RISE TIME  
\$3<sup>75</sup>

**PHOTO DARLINGTONS** MOTOROLA  
4/98c

### INFRA RED DETECTOR

ULTRA LOW LEVEL  
PIV 7V  
1 on 1ma  
**\$4<sup>95</sup>**

### SOLAR CELLS

2x2cm 130ma  
**\$1<sup>99</sup> ea. 10/\$99<sup>00</sup>**

### HEWLETT-PACKARD JUMBO-RED HIGH EFFICIENCY LED

ON BOARD STATUS INDICATOR  
**6/\$1<sup>00</sup>**

### HIGH INTENSITY RED LED LAMP

EXTREME WIDE ANGLE VIEWING  
**3/98c 10/\$24<sup>5</sup>**

### GOLD EDGE CARD CONNECTORS

<b>No. 1</b> SAC185/2-2 SINGLE ROW, 18 PIN CONNECTOR WITH 0.156" CONTACT SPACING. <b>99c</b>	<b>No. 2</b> SAC225/2-2 SINGLE ROW, 22 PIN CONNECTOR WITH 0.156" CONTACT SPACING. <b>99c</b>	<b>No. 3</b> 2VH31/ICB6 31 SOLDER LUG CONNECTOR WITH 0.125" CONTACT SPACING. <b>99c</b>
---	---	--

### WIRE WRAP POST

2 LEVEL 10/98c  
100/\$7.40  
1000/\$64.00  
3 LEVEL 10/\$1.25  
100/\$8.50  
1000/\$72.00

### HI-REL GOLD WIRE WRAP SOCKET PIN

10/\$1<sup>75</sup>  
100/\$9<sup>00</sup>  
1000/\$79<sup>00</sup>  
LIST PRICE 29c

### OP AMPS

SINGLE	
709	10c
741	12c
DUAL	
MC1458	39c
QUAD	
LM3900	49c

### DIODES

IN91	15c
IN270	12c
IN914	15c
IN3600	15c
IN4148	10c

### TRANSISTORS

2N2222	12c
2N3904	12c
2N3906	12c
2N3053	49c

### D/A CONVERTER

SIGNETICS NES008  
**\$9<sup>95</sup>**

### SUB MINIATURE CRYSTAL FILTER

455 KHZ WITH DATA  
**\$2<sup>95</sup>**

### LEDS

YELLOW, GREEN, OR AMBER (SPECIFY COLOR)  
**3/88c**

### 3-1/2 DIGIT L.C.D.'s LIQUID CRYSTAL DISPLAY

<b>No. 1</b> 0.4" CHARACTER WITH CONNECTOR <b>\$6<sup>95</sup></b>	<b>No. 2</b> THIS MINIATURE L.C.D. IS IDEAL FOR POCKET SIZED INSTRUMENTS <b>\$3<sup>95</sup></b>
--	--

### NO BACK ORDERS

YOUR PARTS OR IMMEDIATE REFUND

### WE PAY POSTAGE & HANDLING

ON U.S. ORDERS ONLY - CALIF. RES ADD 6% SALES TAX

### MONEY BACK GUARANTEE (MOS AND LED DEVICES EXCLUDED) \$20 MINIMUM

FOR UNDER 8 HOUR PROCESSING SEND MONEY ORDER, CERTIFIED OR CASHIERS CHECK. SORRY! WE CANNOT ACCEPT PURCHASE ORDERS, COD'S, PHONE ORDERS OR CREDIT CARDS.

### F. Reichert Sales

1110 E. GARVEY AVE.  
W. COVINA, CA 91790

### FOREIGN ORDERS

CANADA PUERTO RICO, U.S. POSSESSIONS ADD U.S. \$3.50. ALL OTHER ADD U.S. \$7.00  
IMMEDIATE SHIPPING ON CHASE MANHATTAN, FIRST CITIZENS, CASHIERS CHECKS & CANADIAN POSTAL MONEY ORDERS.

### DROP INTO ONE OF OUR LOCATIONS

#### LOS ANGELES

(213) 967-4611

#### LMN ELECTRONICS

1042 E. GARVEY AV., W. COVINA, CA (VINCENT & SAN BERDO Fwy.)  
TEL. to SAT. 10-8-CLOSED SUN. & MON

#### PORTLAND

(503) 646-4044

#### WIZARD OF PARTS

8225 SW CIRIUS DR. BEAVERTON, ORE. (ROLL BUS CNTR. WASHINGTON SQUARE)

#### DENVER

(303) 573-5214

#### ELECTRONIC LOLLIPOP

5643 N. BROADWAY, DENVER, CO. (425 & 58th AVE.)







**ONE CENT IC SALE**



# POLY PAKS' PENNY REVOLUTION

THESE ONE-CENTERS ARE THE CENT-CIBLE WAY TO SHOP AND SAVE!  
BUY ONE AT SALE PRICE.  
GET 2ND FOR ONLY 1¢ MORE



**THIS NEW LIST OF "ONE-CENTERS" HELPS FIGHT INFLATION!**

## TTL'S & OP AMPS!

Order By Cat. No. 6R1981 & Type No.

Type	Each	2 for	Type	Each	2 for	Type	Each	2 for
SN7400	\$1.19	\$2.20	SN7465	.19	.20	SN74145	1.25	1.26
SN7401	.19	.20	SN7470	.25	.26	SN74148	1.75	1.76
SN7403	.19	.20	SN7471	.25	.26	SN74150	.99	1.00
SN7404	.25	.26	SN7472	.25	.26	SN74151	.99	1.00
SN7405	.19	.20	SN7473	.55	.56	SN74153	.99	1.00
SN7406	.19	.20	SN7474	.29	.30	SN74154	1.75	1.76
SN7408	.21	.22	SN7475	.79	.80	SN74155	.79	.80
SN7410	.19	.20	SN7476	.39	.40	SN74156	.69	.70
SN7413	.39	.40	SN7477	.59	.60	SN74157	.99	1.00
SN7414	.65	.66	SN7480	.29	.30	SN74158	.99	1.00
SN7416	.29	.30	SN7481	.29	.30	SN74159	1.25	1.26
SN7420	.19	.20	SN7483	.99	1.00	SN74161	1.25	1.26
SN7423	.29	.30	SN7485	1.49	1.50	SN74163	1.19	1.20
SN7426	.25	.26	SN7486	.39	.40	SN74164	.99	1.00
SN7427	.25	.26	SN7489	.95	1.96	SN74165	1.25	1.26
SN7430	.29	.30	SN7490	.69	.70	SN74166	1.25	1.26
SN7432	.25	.26	SN7491	.79	.80	SN74173	1.25	1.26
SN7437	.25	.26	SN7492	.45	.46	SN74174	1.49	1.50
SN7439	.29	.30	SN7493	.49	.50	SN74175	.99	1.00
SN7440	.19	.20	SN7494	.69	.70	SN74177	.79	.80
SN7442	.69	.70	SN7495	.69	.70	SN74179	1.49	1.50
SN7443	.69	.70	SN7496	.69	.70	SN74180	.49	.50
SN7444	.65	.66	SN7498	.69	.70	SN74182	.69	.70
SN7445	.99	1.00	SN74100	1.49	1.50	SN74189	1.75	1.76
SN7446	1.35	1.36	SN74107	.39	.40	SN74191	.85	.86
SN7447	1.25	1.26	SN74112	.25	.26	SN74192	.85	.86
SN7448	1.35	1.36	SN74113	.19	.20	SN74193	.85	.86
SN7450	.19	.20	SN74117	.25	.26	SN74194	.85	.86
SN7451	.19	.20	SN74121	.49	.50	SN74195	.49	.50
SN7453	.19	.20	SN74123	.69	.70	SN74197	.75	.76
SN7454	.19	.20	SN74125	.69	.70	SN74198	1.75	1.76
SN7455	.19	.20	SN74128	.99	1.00	SN74200	5.50	5.51
SN7460	.19	.20	SN74132	1.25	1.26	SN74251	1.75	1.76
SN7462	.19	.20	SN74141	1.49	1.50	SN74284	4.25	4.26
SN7464	.19	.20				SN74285	4.25	4.26

### POP-AMPS AT "CENT-CIBLE" PRICES

Case code: T=TO-220 Power Tab, V=Mini dip, K=TO-3, H=TO-5, N=DIP

Type	Each	2 for	Type	Each	2 for	Type	Each	2 for
LM300H	\$4.59	\$5.50	LM3370N-H	1.79	1.80	LM741V-H	.29	.30
LM301H-V	.45	.46	LM3376V	.29	.30	LM1304	.79	.80
LM308V-H	.79	.80	LM3377N	2.25	2.26	LM1310	.99	1.00
LM309K	.79	.80	LM3381N	1.69	1.70	LM1312	1.99	2.00
LM311H-V	.79	.80	LM3381N	1.69	1.70	LM1458V	.69	.70
LM318V	1.29	1.30	LM3313H	1.49	1.50	LM1800N	.99	1.00
LM320H-5, 12, 15	1.29	1.30	LM332H-N	.29	.30	LM3028H	.65	.66
LM320K-15	1.29	1.30	LM3507N	.79	.80	LM3900N	.49	.50
LM320T-6, 5	1.29	1.30	LM3558V	.79	.80	LM3909V	1.75	1.76
LM322N	1.19	1.20	LM3561N	1.00	1.01	LM4195	1.95	1.96
LM324N	1.75	1.76	LM3561N	1.00	1.01	LM4250	1.19	1.20
LM333N	1.09	1.10	LM703H	.49	.50	LM75451	.39	.40
LM340K-5, 6, 8, 12, 15, 18, 24	1.29	1.30	LM704H	.29	.30	LM75453	.39	.40
LM340T-5, 6, 8, 12, 15, 18, 24	1.29	1.30	LM709N-H	.25	.26	LM75491	.79	.80
LM350N	.59	.60	LM733N	.79	.80	LM75492	.79	.80
			LM739N	.89	.90	LM75494	.59	.60

### YOU GET 120-DAY MONEY BACK GUARANTEE

**10 AMP - POWER TABS! SCRS! TRIACS! QUADRACS!**

Order by Cat. No. and voltage!

Order: #R1448 TRIACS #R1730 - SCR #R1590 - QUADRACS

PRV	Sale	2 for
50	\$ .55	\$ .56
100	.69	.89
200	.88	.89
400	1.19	1.20
600	1.59	1.60

### HI-POWER STUD RECTIFIERS

Cat. No. 6R3567 - 150 amp			Cat. No. 6R7UG65 - 250 amp		
V.	1c	1c SALE	V.	1c	1c SALE
50	\$ 2.95	2 for \$ 2.96	50	\$ 4.95	2 for \$ 4.96
100	3.95	2 for 3.96	100	6.50	2 for 6.51
200	4.95	2 for 4.96	200	7.50	2 for 7.51
400	7.50	2 for 7.51	400	8.50	2 for 8.51
600	9.00	2 for 9.01	600	10.50	2 for 10.51
800	10.50	2 for 10.51	800	13.00	2 for 13.01
1000	12.50	2 for 12.51	1000	14.50	2 for 14.51

Order by Cat. No. & Voltage

### 25 AMP BRIDGE RECTIFIERS

Order by Cat. No. 6R2273 & voltage

V	Each	1c SALE
50	\$1.95	2 for \$1.96
100	1.49	2 for 1.50
200	1.69	2 for 1.70
400	1.99	2 for 2.00
600	2.25	2 for 2.26
800	2.25	2 for 2.26
1000	2.25	2 for 2.26

### 25 AMP POWER STUD SCRS, TRIACS

Order by Cat. No. 6R-14A147 (SCRS)

Order by Cat. No. 6R-60886A (Triacs)

V.	Each	1c SALE
50	\$ 1.95	2 for \$ 1.96
100	1.25	2 for 1.26
200	1.95	2 for 1.96
400	2.50	2 for 2.51
600	2.95	2 for 2.96

### IN4000 Epoxy Rectifiers

Order by Cat. No. and Type No.

Cat. No.	Type No.	PIV	Price	1c MORE!
6R2377	1N4001	50	10 for \$.65	20 for .76
6R2378	1N4002	100	10 for .75	20 for .86
6R2379	1N4003	200	10 for .85	20 for 1.00
6R2380	1N4004	400	10 for .99	20 for 1.00
6R2381	1N4005	600	10 for 1.29	20 for 1.30
6R2382	1N4006	800	10 for 1.39	20 for 1.40
6R2383	1N4007	1000	10 for 1.49	20 for 1.50

### BULLET RECTIFIERS!

Order by Cat. No. 6R6084 & voltage

PRV	10 for	20 for
50V	\$ .59	\$ .60
100V	.79	.80
200V	.89	.90
400V	1.09	1.10
600V	1.09	1.10
800V	1.19	1.20

### MICRO MINI TOGGLE SWITCHES!

3 Amps, 125 VAC contacts with chrome handles, complete with mounting hardware.

Cat. No.	Type	Sale	2 for
6R3936	SPDT	\$1.29	\$1.30
6R5085	SPDT	1.39	1.40
6R4037	DPDT	1.45	1.46
6R4037	DPDT	1.45	1.46
6R4037	DPDT	1.45	1.46

**SALE**

BUY 1 AT OUR SALE PRICE GET 2 FOR 1¢ MORE

### LYTIC KLINIC

Order by Cat. No. 6R3269 and value

UF	V. Style	Sale	1c SALE
10	15 P.C.	10 for \$1.00	20 for \$1.01
50	15 P.C.	8 for 1.00	16 for 1.01
15	25 P.C.	8 for 1.00	16 for 1.01
50	25 P.C.	6 for 1.00	12 for 1.01
20	15 Axial	10 for 1.00	20 for 1.01
20	15 P.C.	10 for 1.00	20 for 1.01

### 6 AMP CARTWHEEL RECTIFIERS

Order by Cat. No. 6R3584

V.	Each	1c SALE
50	\$ .36	2 for \$ .37
100	.45	2 for .46
200	.61	2 for .62
400	.79	2 for .80
600	.90	2 for .91
800	1.19	2 for 1.20
1000	1.39	2 for 1.40

### LEDS!

YOUR CHOICE 5 for \$1.00 1c SALE 10 for \$1.01

Order by Cat. No.

- #R2135 JUMBO RED LEDS
- #R2137 MICRO RED LEDS
- #R2190 JUMBO RED CLEAR LEDS
- #R2192 JUMBO RED AMBER LEDS
- #R2140 MICRO GREEN LEDS

### ZENERS!

Order by Cat. No. 6R5210 & voltage & wattage:

Watt	Sale	1c SALE
1	5 for \$1.10 for \$1.01	10 for \$1.01
5	2 for 1.10 for 1.01	10 for 1.01
9.1	5 for 1.10 for 1.01	10 for 1.01
11.5	5 for 1.10 for 1.01	10 for 1.01
11.5	5 for 1.10 for 1.01	10 for 1.01
15.5	5 for 1.10 for 1.01	10 for 1.01

Qty.	Description (Order by Cat. No. in parenthesis)	Sale	1c SALE
1	WOODGRAN CABINET, 3 1/2 x 10 x 4" deep, apks, alarms. (#R5201)	\$1.49	2 for \$1.50
2	LCD THERMAL INDICATORS, 88-108°F, 7x1", flexible (#R5195)	1.00	4 for 1.01
1	JOYSTICK, four 100K pots, with knob (#R3808A)	4.95	2 for 4.96
5	REC'D THUMBWHEEL SWITCH, BCD, 0-7 (#R2870A)	1.49	2 for 1.50
1	8-TRACK TAPE TRANSPORT, with preamp (#R3010)	9.95	2 for 9.96
1	PLESSEY TV SIDEBAND FILTER, for chan. 3 or 4 (#R3975)	1.95	2 for 1.96
5	TRANSISTORS, 2N3904 comp. NPN, switching (#R5209)	10.00	10 for 10.10
1	METER, 50uA, 1 1/2" square, 0-200uA (#R3705)	1.19	2 for 1.20
1	SPST RELAY, norm. open 12-24 VDC, 1250 ohms, dip style (#R5175)	1.00	2 for 1.01
1	VEEDER ROTARY COUNTER, 000-999, resettable, panel mt. (#R5081)	1.49	2 for 1.50
2	DUAL GATE MOSFET, sim. to 3N200, 3N187, for RF & Mixer (#R5101)	1.00	4 for 1.01
1	8-TRACK TAPE HEAD, with plug, n' cord (#R3468)	2.50	2 for 2.51
10	CALCULATOR KEYBOARDS, 20 keys and more (#R3625)	\$2.00	20 for \$2.01
15	SLIDE VOLUME CONTROLS, asstd values (#R3057)	2.00	30 for 2.01
10	CRYSTALS, may include CB, Ham or more (#R3250)	2.00	20 for 2.01
150	MOLEX IC SOCKETS, 1/2" strip, cut to length (#R3144)	2.00	300 for 2.01
100	TERMINAL STRIPS, from 2 lugs up (#R3136)	2.00	200 for 2.01
30	NE-ZEON LAMPS, all 100% good (#R2613)	2.00	60 for 2.01
40	H. SHIELDED CABLE, 1 cond, mikes, phones, (#R3577)	2.00	80 for 2.01
100	TRANSISTOR LEADS, 1/2" long, 1/16" dia (#R2747)	2.00	200 for 2.01
30	SOUND TRIGGERS, sound triggers scr w/amp (#R3625)	2.00	6 for 2.01
15	6V TEST INDICATORS, leads, grain-o-wheat (#R3526)	2.00	30 for 2.01
30	MINI TRIMPOTS, 1/4" dia, mica, 10K, 100K (#R2738)	2.00	200 for 2.10
10	VOLTAGE REGULATORS, hobby LM320, 340, TO-3 (#R3330)	2.00	20 for 2.01
30	PANEL SWITCHES, slides, rotaries, mod. etc (#R3268)	2.00	60 for 2.01
200	RESISTOR SPECIAL, 1/4" to 1W, carbon, metal (#R4089)	2.00	400 for 2.01
100	NATIONAL IC BONANZA, 7400s, ROMS (#R2860)	2.00	200 for 2.01
40	HOBBY LEDS, asstd types, mostly yellow (#R2859)	2.00	80 for 2.01
15	LM340T VOLTAGE REGULATORS, 5 to 24V, TO-220 (#R2635)	2.00	30 for 2.01
100	TWO WATERS, resistors, carbon-bonded (#R2735)	2.00	200 for 2.01
100	POLYSTYRENE CAPS, asstd values, voltage, hi-Q (#R2729)	2.00	200 for 2.01
50	THERMISTORS, resistors that change with temp (#R4089)	2.00	100 for 2.01
25	WMPIN SOCKET SETS, micro, 1/2" dia (#R3577)	2.00	400 for 2.01
15	MIXED READOUTS, hobby, untested, 127, 3, 5, etc (#R3619)	2.00	30 for 2.01
150	QUARTER WATERS, resistors, metal film, marked (#R3413)	2.00	300 for 2.01
200	BRIDGES, untested, 2, 4, 6, 10, amp, full wave (#R4022)	2.00	200 for 2.01
200	PREFORMED RESISTORS, 1/4", 1W, marked, asstd (#R2608)	2.00	400 for 2.01
200	PRECISION RESISTORS, 1/4", 1W, 1%, 2%, marked (#R2428)	2.00	400 for 2.01
50	DIPPED MYLARS, shiny finish, asstd values (#R2597)	2.00	120 for 2.01
30	VOLUME CONTROLS, audio, linear, asstd values (#R2421)	2.00	60 for 2.01
7	7.5 VOLT ZENER DIODES, 1 watt (#R5187)	1.00	10 for 1.01
9	9.1 VOLT ZENER DIODE		



## MESHNA SPECIALS

PHOTO FLASH complete on PC board w/flash tube in reflector, 2 ni-cads & camera connecting cable. Cycles In 3 seconds \$6.00

8 SWITCHES in MINI DIP 1.80

10 SWITCHES in MINI DIP 2.00

AA NI-CADS fast charge 1.25

5 WAY BINDING POST US made .35

U-FIX-EM TV games, w/power pack & video Cube in original boxes (sold for \$50) 11.00

JUMBO LED .187 diam. long leads 6/1.00

TV CHEATER CORDS 6 ft .75

LIQUID CRYSTAL thermometer, reads 86 to 108 degrees F 4/1.00

MULTI USE xfmr puts out 140 volts, 12.6, 6, 33.5 volts Many home projects 1.50

SEISMIC DETECTOR radio transmitter, used in Viet Nam for troop detection. 4.00

COPY LENS FROM ZEROX in mount. 8 1/2 focal length irfs f4.5 to f8 10.50

U-FIX-EM hand calculator 4 function 3.00

LAMBDA solid state regulated slim line power supply 12 volts DC 8 amps 50.00

ULTRA SONIC transducer 37 or 40 Khz \$2.00

The above includes data on alarm system

PL 259 coax connector .75

SO-239 coax socket .60

TOUCH TONE ENCODER KIT, pad, chip & instructions 12.95

IR NIGHT VIEWER, new ready to use, see in the dark 199.00

All above FOB LYNN MASS (you pay shipping)  
Amazing 64 page catalog free

JOHN MESHNA JR, INC. PO Box 62, E. Lynn Mass. 91904

CIRCLE 49 ON FREE INFORMATION CARD

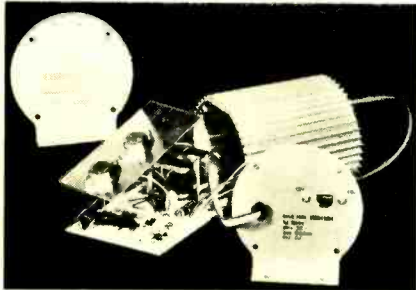

### FROM KIT TO CAR IN 80 MINUTES!

Electronic ignition is "in." Update your car with the TOPS in power, efficiency and reliability — the TIGER SST capacitive discharge ignition (CD).

The TIGER delivers everything other CD's promise — and more: quicker starting, more power, more gas mileage, tune-ups eliminated, lifetime plugs and points, reduced repairs and pollution.

The TIGER can be built and installed in your car in 80 minutes. The TIGER is unique!

The TIGER comes with a switch for TIGER or standard ignition for 12V negative ground only.

Simpli-Kit \$21.95  
POST PAID U.S.A.

WE ACCEPT:

Mastercharge or BankAmericard.  
Send check or money order with order to:

**Tri-Star Corporation**

DEPT. FF, P.O. Box 1727  
Grand Junction, Colorado 81501

CIRCLE 41 ON FREE INFORMATION CARD

## ADVERTISING INDEX

RADIO-ELECTRONICS does not assume any responsibility for errors that may appear in the index below.

### Free Information Number Page

66	Ace Electronics	136
	Active Electronics	151
	Advance Electronics	104,106,111,113,115,119
9	Advanced Computer Products	146
10	Aldelco	142
	A M C Sales	136
75	American Technology	120
	A T V Research	134
	Audio-Technica	93
79	Avanti Research & Development	26
61	Babylon Electronics	152
	Karel Barta	130
	Forest Belt's Training Workshop	103
80	B & K Precision Dynascan Co.	34
	Bullett Electronics	134
67	Central Data	35
	C F R Associates	136
48	Chaney Electronics	128
	C I E—Cleveland Institute of Electronics	18-21
	Command Productions	130
89	Communications Electronics	106
	Computalk Consultants	107
11	Continental Specialties	Cov. 3
36	Creative Computing	105
	C R E I—Div. of McGraw Hill Continuing Education	84-87
	Dage Scientific Instruments	136
87	Davis Electronics	108
44	Delta Electronics	152
	Devtronix Organ Products	132
68	Digi-Key	156
90	Digital Research Corporation	148
71	D R I Industries	31
59	Edsyn	123
70	E I C O	120
55	E & L Instruments	115
69	Electronic Control Technology	118
	Electronic Systems	135
38	Electronics & Control Engineer's Book Club—McGraw Hill Book Division	1
	E M C—Electronics Measurements	123
63	Energy Control Systems	105
1	Enterprise Development	100
56	Epsco	107
46	Etco Electronics	154
	Fair Radio Sales	132
76	Fluke	117
64	Fordham Radio Supply	144
60,3	Formula International	138,139
2	Fuji-Svea	133
	G F N	97
47	Godbout Electronics	130
	Golden Enterprises	132
81	Gould	122
4	Grantham College of Engineering	112
5	G.T.E. Sylvania—Consumer Renewal	29
100	Heath	5,36
6	Hickok Electrical Instruments	98
19	Hobby House	145
96	Hobby World	131
77	IMSAI Manufacturing Corp.	Cov. 4
40	Indiana Home Study	100
	Information Unlimited	136
83	Integrated Electronics	152
91	International Crystal Mfg. Co.	112
7	International Electronics	143
94	International Peripheral	Cov. 2
8,57,58	James Electronics	101,140,141
	J & E Electronics	136
	Krystal Kits	134
	Lab Science	132
	Lakeside Industries	132
74	Leader	22
84	LMN Electronics	155
	Logical Services	136
24	Mallory	2
49	Meshna	158
85	Morrow's Micro Stuff	118
14	Mountain West Alarm Supply	114

15,16	National Camera Supply	93,116
	National Radio Institute (NRI)—Div. of McGraw Hill Continuing Education Center	8-11
	National Technical Schools	15
88	Netronics	117
51	New-Tone Electronics	144
42	O.K. Machine & Tool	17
82	Olson	128
18,17	Optoelectronics	129,149
20	Page Digital	148
21	P A I A	91
78	Panavise	113
65	Platt Luggage	120
	Plus Electronics	136
	Poly Paks	157
62	Pomona	114
	Priority 1 Electronics	23,153
22	Professional Aids	98
97	P T S Electronics	100
13	Quest	142
92	Radio Hut	150
	Radio Shack	137
39	Ramsey Electronics	132
	R C A	16,108,109,121
43	Rye Industries	123
93	Sabtronics	7
	H.W. Sams	32-33
73	Sansui	25
23	Scelbi Computer	116
53	Schober Organ	121
28,37	Sencore	28,91
26	Solid State Sales	130
29	Solid State Time	138
27	Southwest Technical Products	13
30	Spacekom	99
	Special Functions	134
	A.F. Stahler Co.	132
95	Sybox	102
33	Tab Books	105
34	Tarbell Electronics	148
	Tasco	132
	TK Enterprises	104
32	Trinico International	147
41	Tri-Star	158
	Trumbull	134
72	Vaco	27
86	Vector	20
35	VIZ Mfg.	34
12	Weller-Xcelite Div. of Cooper Industries	110
54	Wersi Electronics	102

### MOVING?

Don't miss a single copy of **Radio-Electronics**. Give us:

Six weeks' notice

Your old address and zip code

Your new address and zip code

ATTACH  
LABEL  
HERE

name (please print)

address

city state zip code

Mall to: Radio-Electronics  
SUBSCRIPTION DEPT., P.O. BOX 2520,  
BOULDER, COLO. 80322



# FREQ OUT. FOR LESS.



100 Hz to 50 MHz.  
**\$89.95\***

Introducing CSC's new Mini-Max. It brings down the cost of counting up the frequency for CB-ers, hams, computer enthusiasts, audiophiles... just about any engineer, technician or hobbyist will find it indispensable. It's "mini"-sized, too — a pocketable 3 x 6 x 1½ inches.

But when it comes to performance, Mini-Max means maximum value. Measuring signals as low as 30 mV from 100 Hz to a *guaranteed* 50 MHz, with  $\pm 3$  ppm timebase accuracy and better than 0.2 ppm/°C stability from 0 to 50°C. *Completely automatically.* Advanced LSI circuitry with a crystal controlled timebase provides precise frequency readings on a bright, six-digit LED display, with automatic KHz/MHz indications. Mini-Max is versatile, too. You can connect it directly to the circuit under

test, or use its matching mini antenna for easy RF checking. Either way, the input is protected against overload to 50V (100V below 1 KHz).

Mini-Max is as inexpensive to use as it is to own. An ordinary 9 volt alkaline battery gives up to 8 hours of intermittent operation, and you have the flexibility of a battery eliminator for AC operation. For increased versatility, there's a complete line of accessories, including standard clip-lead cable and mini antenna — eliminator and carrying case are optional.

CSC's new, all-American made Mini-Max is everything you need for highly-accurate checking of frequencies up to 50 MHz. At a price that will Freq you out. *Order today.* Call 203-624-3103, 9 a.m. — 5 p.m. Eastern Standard Time. Major credit cards accepted. Or see your CSC dealer. Prices slightly higher outside U.S.A.

CONTINENTAL SPECIALTIES CORPORATION



\*Manufacturer's suggested retail price  
© 1978 Continental Specialties Corporation

70 Fulton Terrace, Box 1942, New Haven, CT. 06508, 203-624-3103 TWX 710-465-1227  
WEST COAST 351 California St., San Francisco, CA 94104, 415-421-8872 TWX 910-372-7992  
GREAT BRITAIN: CSC UK LTD., Spur Road, North Feltham Trading Estate, Feltham, Middlesex, England. 01-890-0782 Int'l Telex. 851-890-0782  
CANADA: Len Finkler Ltd., Ontario

CIRCLE 11 ON FREE INFORMATION CARD

FREE INFO

# Price/Performance no one else has put together.

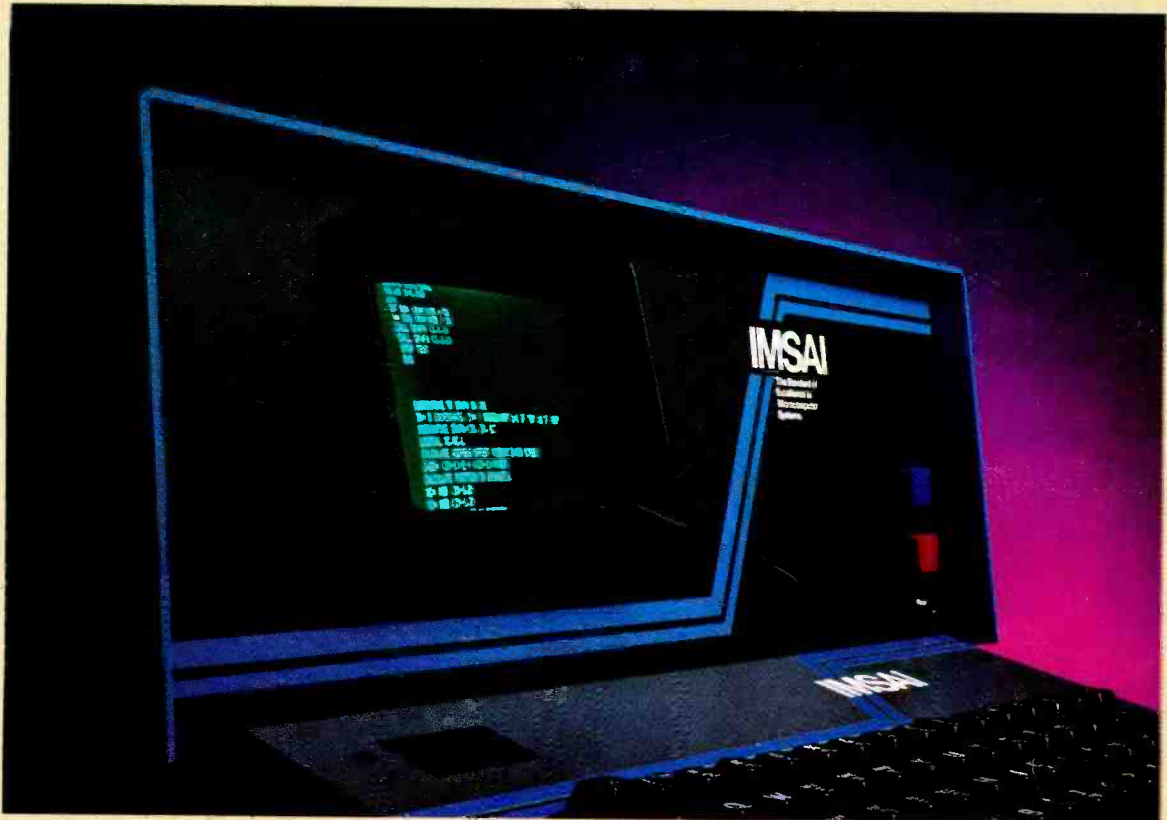

## IMSAI Introduces the PCS-80/30 Integrated Video Computer

- 3 MHz microcomputer
- 3K ROM monitor
- 2K RAM
- 8 expansion slots
- 14 MHz integrated intelligent CRT (24 x 80)
- Intelligent Keyboard
- Parallel interface
- 2 serial interfaces
- Graphic and edit CRT functions
- 28 amp power supply
- All for \$1499\* assembled and tested.

### Software:

ASSEMBLER, DOS, TTY and ACR BASIC, Commercial/Scientific BASIC, FORTRAN IV and more.

### Memory Options:

1 64K RAM memory boards.

### Peripherals:

Printers, floppies—mix and match; standard, mini and high performance double density floppy disks on the same system (an industry first), 1/2" magnetic tape drive, CRT and TV monitors.

Send today for your copy of the 250-page IMSAI PCS-80/30 User Manual. Price \$5.00. The cost of the manual may be applied towards your purchase of a PCS-80/30 Integrated Video Computer. Use the coupon provided.



### Gentlemen:

Send me the IMSAI PCS-80/30 User Manual, price \$5.00. I understand that the \$5.00 may be applied towards the purchase of a PCS-80/30 Video computer System.

Check/Money Order enclosed. Amt. \$ \_\_\_\_\_  
Charge my  BAC  M/C

# \_\_\_\_\_ Exp. Date: \_\_\_\_\_

Sig. \_\_\_\_\_

Name \_\_\_\_\_

Address \_\_\_\_\_

City \_\_\_\_\_

State/Zip \_\_\_\_\_

IMSAI 14860 Wicks Blvd. San Leandro, CA 94577

# IMSAI®

**The Standard of Excellence  
in Microcomputer Systems**

IMSAI Manufacturing Corporation  
14860 Wicks Blvd. San Leandro, CA 94577  
(415) 483-2093 TWX 910-366 7287

\*U.S. domestic price only. PCS-80/30 kit available. Other PCS-80 kits start at \$699. Prices and specifications subject to change without notice.

INFORMATION CARD