

**SPECIAL SECTION—How To Service CB Radios**

\$1.00 ■ MARCH 1978

# Radio-Electronics

THE MAGAZINE FOR NEW IDEAS IN ELECTRONICS

**Make A Panel Meter  
A DIGITAL VOM  
It's Easy To Do**

**What's New In  
POLICE-RADAR DETECTORS  
A Picture Story**

**More Build-It Info  
PROGRAMMABLE DRUMS  
Are Fun To Play**

**ALSO:**

- Z-80 Computer Corner**
- R-E Lab Tests BIC Beam Box**
- Jack Darr's Service Clinic**
- Hobby Corner**
- State Of Solid State**
- More Hobby Computer Listings**
- Equipment Reports—**
  - ★ **Sabtronics Digital Meter**
  - ★ **Motorola HEP  
Microcomputer Kit**
  - ★ **Tenna Mindb...**



**Build This Portable  
FREQUENCY COUNTER  
With 4-Digit Readout**

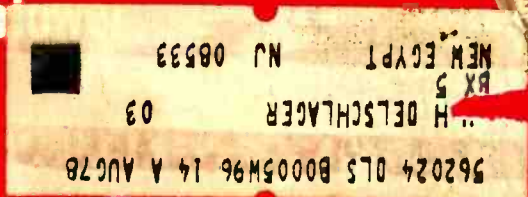

PUBLICATION



# Gould Oscilloscopes They have a name for reliability

Ask electronics people what the Gould name means to them and most would agree that reliability stands high on the list. In fact we are sure enough of our reliability to give you a 2-year warranty on our entire line of oscilloscopes.

Of course, performance is also important, so we offer you four oscilloscopes covering a frequency range from DC to 50MHz, plus a unique digital storage model with options for hard copy and binary output.

There's a Gould scope to suit your needs. Economy is also a consideration. Gould oscilloscopes are competitively priced. But because we build them for the long haul, your instrument pays dividends through years of trouble-free service. Reliability says it all and that's what the Gould name is all about. So when you're looking for reliability, look for our name. For oscilloscopes and other fine instruments, you can rely on Gould.

For details write Gould Inc., Instrument Systems Division, 3631 Perkins Avenue, Cleveland, Ohio 44114. Or call the number below.

**FOR BROCHURE CALL  
TOLL FREE AT  
(800) 325-6400.  
EXTENSION 77.  
In Missouri: (800) 342-6600**

 **GOULD**



CIRCLE 90 ON FREE INFORMATION CARD

# VERSATILITY - UNMATCHED

*by any other  
micro-computer  
system*



COMPUTERS  
TERMINALS  
PRINTERS  
SOFTWARE

TAPE SYSTEMS  
DISK SYSTEMS  
GRAPHICS  
PROM PROGRAMMER

MEMORY - 4K, 8K, 16K & 32K  
PROGRAMMABLE REAL TIME CLOCK  
CALCULATOR INTERFACE  
A - D CONVERTER

Write, or circle our reader reply number for a catalog describing our complete line of computer hardware and software.

---

NOW AVAILABLE IN BOTH KIT AND ASSEMBLED FORM.

---



SOUTHWEST TECHNICAL PRODUCTS CORPORATION  
219 W. RHAPSODY  
SAN ANTONIO, TEXAS 78216

CIRCLE 21 ON FREE INFORMATION CARD

# fact: you can choose your microphone to enhance your sound system.

Shure makes microphones for every imaginable use. Like musical instruments, each different type of Shure microphone has a distinctive "sound," or physical characteristic that optimizes it for particular applications, voices, or effects. Take, for example, the Shure SM58 and SM59 microphones:

## SM59

**Mellow, smooth,  
silent...**

The SM59 is a relatively new, dynamic cardioid microphone. Yet it is already widely accepted as a standard for distinguished studio productions. In fact, you'll often see it on TV... especially on musical shows where perfection of sound quality is a major consideration. This revolutionary cardioid microphone has an exceptionally flat frequency response and neutral sound that reproduces exactly what it hears. It's designed to give good bass response when miking at a distance. Remarkably rugged — it's built to shrug off rough handling. And, it is superb in rejecting mechanical stand noise such as floor and desk vibrations because of a unique, patented built-in shock mount. It also features a special hum-bucking coil for superior noise reduction!

**Some like it essentially flat...**

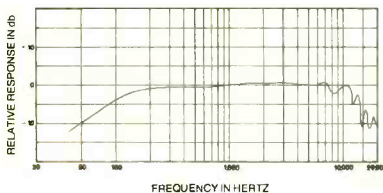

## SM58

**Crisp, bright  
"abuse proof"**

Probably the most widely used on-stage, hand-held cardioid dynamic microphone. The SM58 dynamic microphone is preferred for its punch in live vocal applications... especially where close-up miking is important. It is THE world-standard professional stage microphone with the distinctive Shure upper mid-range presence peak for an intelligible, lively sound. World-renowned for its ability to withstand the kind of abuse that would destroy many other microphones. Designed to minimize the boominess you'd expect from close miking. Rugged, efficient spherical windscreen eliminates pops. Lightweight (15 ounces!) hand-sized. The first choice among rock, pop, R & B, country, gospel, and jazz vocalists.

**...some like a "presence" peak.**

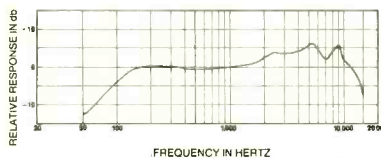

**professional microphones...by**

**SHURE®**

Shure Brothers Inc., 222 Hartrey Ave., Evanston, IL 60204, In Canada: A. C. Simmonds & Son Limited  
Manufacturers of high fidelity components, microphones, sound systems and related circuitry.

CIRCLE 18 ON FREE INFORMATION CARD

# Radio-Electronics®

THE MAGAZINE FOR NEW IDEAS IN ELECTRONICS

Electronics publishers since 1908

MARCH 1978 Vol. 49 No. 3

## SPECIAL SECTION

- 49 **What You Need To Know About Servicing CB Radios**  
by Forest Belt
- 50. **Repair Low Cost CB's Profitably**
- 52. **Efficiency in CB Service Estimates**
- 53. **DC Trouble Up Front**
- 58. **Transmitter Keying**
- 61. **Servicing Synthesizers**
- 63. **23-Channel PLL**

## BUILD ONE OF THESE

- 35 **Portable Frequency Counter**  
Palm-sized 30 MHz counter with a 4-digit LED display that delivers 6-digit resolution. **by Gary McClellan**
- 40 **Digital Multimeter**  
Start by building a 3½-digit panel meter; add a few shunts and range switches, and end up with a digital multimeter.  
**by Dr. E. H. Borneman and Robert Benward**
- 45 **Programmable Drums—Part II**  
Conclusion of a 2 part series for a hi-fi add-on that lets you tap out a beat with your fingertips. **by John S. Simonton, Jr.**

## COMPUTERS

- 68 **Z-80 Computer Corner**  
A look at the different interrupts available with the Z-80 CPU.  
**by William Barden, Jr.**
- 70 **Mainframe Roundup—Part II**  
Conclusion of who makes what and what it is they make.  
**by Chester H. Lawrence**

## GENERAL ELECTRONICS

- 4 **Looking Ahead**  
Tomorrows news today. **by David Lachenbruch**
- 76 **Hobby Corner**  
A game circuit you can play with. **by Earl "Doc" Savage**
- 88 **Police Radar Detectors**  
A look at the latest equipment.
- 100 **Teaching Digital Counters To Count**  
How to make a decade counter IC count by some number other than 10. **by Fred Blechman**

## TELEVISION

- 80 **Service Clinic**  
Vertical OTL (Output Transformerless) output stages. **by Jack Darr**
- 81 **Service Questions**  
R-E's Service Editor solves reader problems.

## EQUIPMENT REPORTS

- 24 **Motorola HEP Educator II Microcomputer kit.**
- 26 **Tenna PS69RD Mindblower stereo speaker/amplifier for your car**
- 32 **Sabtronics 2000 Digital Multimeter**
- 66 **Hi-Fi Lab Tests B.I.C. Beam Box indoor FM antenna**
- 108 **Sencore CB42 CB Analyzer**

## DEPARTMENTS

- |                                     |                                 |
|-------------------------------------|---------------------------------|
| 140 <b>Advertising Index</b>        | 98 <b>New Literature</b>        |
| 14 <b>Advertising Sales Offices</b> | 94 <b>New Products</b>          |
| 16 <b>Letters</b>                   | 104 <b>New Books</b>            |
| 111 <b>Market Center</b>            | 110 <b>Next Month</b>           |
| 6 <b>New &amp; Timely</b>           | 141 <b>Readers Service Card</b> |

## ON THE COVER

This month's feature construction project is a hand-held portable frequency counter. The unit measures to 30 MHz with a 90 mV sensitivity. The readout is a 4-digit LED display that provides 6-digit resolution. A must for any workbench. The complete construction details start on page 35.

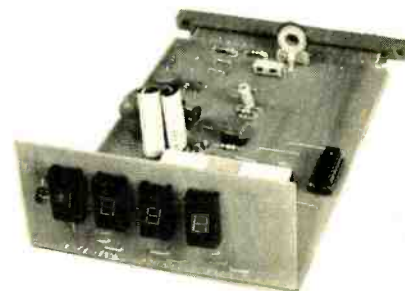

**A BASIC DIGITAL PANEL METER.** Turn to page 40 to see how to build this and then turn it into a complete digital multimeter.

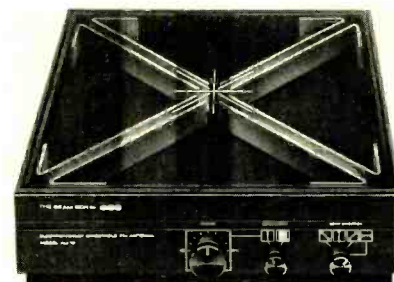

**B.I.C.'s MODEL FM-10 BEAM BOX indoor FM antenna.** R-E's Hi-Fi Lab puts it through its paces. For a complete report, turn to page 66.

Radio-Electronics, Published monthly by Gernsback Publications, Inc., 200 Park Avenue South, New York, NY 10003. Phone: 212-777-6400. Second-class postage paid at New York, NY and additional mailing offices. One-year subscription rate: U.S.A. and U.S. possessions, \$9.98, Canada, \$12.98. Other countries, \$14.98. Single copies \$1.00. © 1978 by Gernsback Publications, Inc. All rights reserved. Printed in U.S.A.

**Subscription Service:** Mail all subscription orders, changes, correspondence and Postmaster Notices of undelivered copies (Form 3579) to Radio-Electronics Subscription Service, Box 2520, Boulder, CO 80322.

A stamped self-addressed envelope must accompany all submitted manuscripts and/or artwork or photographs if their return is desired should they be rejected. We disclaim any responsibility for the loss or damage of manuscripts and/or artwork or photographs while in our possession or otherwise.

As a service to readers, Radio-Electronics publishes available plans or information relating to newsworthy products, techniques and scientific and technological developments. Because of possible variances in the quality and condition of materials and workmanship used by readers, Radio-Electronics disclaims any responsibility for the safe and proper functioning of reader-built projects based upon or from plans or information published in this magazine.

# looking ahead

**Another videodisc:** Matsushita Electric of Japan, the world's largest manufacturer of television sets and parent company of Panasonic and Quasar, has demonstrated a new videodisc system that uses discs strongly resembling standard LP audio records, and made with standard record-pressing equipment and materials. It is a mechanical system with grooves recorded in the "hill-and-dale" method. A twist stylus system uses a piezoelectric material to convert mechanical vibrations into voltage fluctuations.

Matsushita calls its system *Visc* and has developed two variations—both use two-sided 12-inch vinyl records, but one plays for 30 minutes per side, the other for one hour per side. In either variation, the disc revolves at 450 rpm and contains two high-fidelity audio channels as well as a color video program. Matsushita is targeting the player to sell for \$480 to \$600 on the Japanese market, and discs themselves to sell 20% to 50% more than an audio LP record. The diamond stylus is said to be capable of more than 1,000 hours life.

Matsushita says marketing schedules will depend upon the support of programming companies throughout the world. The specs and parameters of the *Visc* system appear to be so close to those of the RCA capacitance system that the question of potential compatibility was certain to arise—and did. An RCA disc spokesman was asked this question; his reply was that, except for the fact that the center holes on the two discs are different sizes (RCA's is large, Matsushita's is audio-disc size), there should be no reason why Matsushita and RCA discs couldn't be played interchangeably, given some other minor modifications. Both sides insisted their development work was completely independent of each other.

**AM stereo closer:** An AM stereo system now seems inevitable, and some authorities predict that the parameters of the chosen system could be available before the end of '78. The industry-wide National AM Stereo Radio Committee completed its field-test report as 1977 ended and submitted it to the FCC. The document covered three systems that were submitted for testing (by Belar, Magnavox and Motorola). Although the report made no recommendations, it noted that all three systems were capable of providing good stereo with fidelity close to that of FM, that they all used economically feasible transmitters and receivers, and required little more bandwidth than mono AM and were compatible with existing AM receivers. Two other AM stereo systems, not submitted to the committee for testing, have also been proposed to the FCC by Harris Corporation and by Kahn Communications.

**FTC and video games:** After a year's investigation, the Federal Trade Commission has tentatively cleared most video games of responsibility for causing injury to TV sets. Based on its inquiry, the FTC stated that "reasonable" use of video games should not damage TV screens. It added the warning, however, that prolonged use of some sets might imprint patterns on some screens, particularly on black-and-white sets. The FTC conceded it had received no consumer complaints, but some special

tests conducted by the National Bureau of Standards found that some games with high modulation settings could imprint a pattern on a monochrome set after 100 to 200 hours of use, but these games would not affect color sets until at least 350 hours of use.

The Commission recommended that consumers purchase games with low-modulation video signals, and those that create constantly changing patterns, colors and brightness levels when turned on but not being used in play. Players are urged to adjust the TV for a normal broadcast picture before turning the game on, and to turn the game off when not in use. The FCC said it would continue to monitor TV games—with special emphasis on the new programmable types—for possible imprint problems.

**FM car radio costs:** Why does the cheapest auto manufacturer's FM-AM radio cost around \$140 or \$150 when you can buy a portable FM-AM radio for \$10 or \$15? Why does a monophonic FM-AM car radio cost about twice as much as a standard AM car radio? The National Association of Broadcasters and the Corporation for Public Broadcasting admitted they didn't know the answers, but decided to find out whether there was any hanky-panky involved. Because both of these groups endorse legislation that requires that all radios sold in the U.S. contain both FM and AM bands, they were also interested in determining whether large-scale production could reduce FM car radio prices.

Booz, Allen Applied Research made the study for them. The final report specifically studied original-equipment radios that were supplied with three domestic and two import-band autos. The sticker price for the AM-only radios ran \$66 to \$80, while the low-end FM-AM radios for the same cars ran \$135 to \$154. It was discovered that the difference in price between the FM-AM radios and the AM radios didn't represent just profit, but, indeed, the FM section added substantially to the cost. The investigation determined that the markup on an FM-AM radio was about 15% better than that on a low-end AM radio, but that most of the price differential "is directly related to manufacturing cost."

The study didn't offer much hope for any substantial reductions in prices, even if AM-only radios suddenly were outlawed. Additional economies of scale in producing FM-AM radios "are not expected to be significant," said the report, "since AM-FM radio production is currently well over 6 million units per year."

The report did hold out the prospect of price reductions for mono FM-AM radios of from \$15 to \$30, or an average of 15%, if all radios were FM-AM. The logic was that FM-AM radios would then occupy the bottom of the line and would carry the bottom-of-the-line profit ratios currently experienced by AM-only radios. The eventual increased use of IC's should chop off another \$11 to \$30, the report forecast.

DAVID LACHENBRUCH  
CONTRIBUTING EDITOR

# Tuner Service Corporation

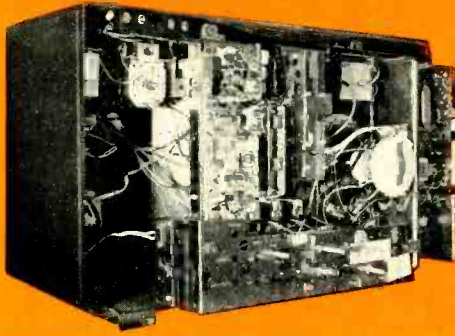

**\$10.95**  
U.S.A. ONLY

Major Parts and Shipping Charged at Cost

One Year Guarantee

## MODULE REPAIRS

TSC has been repairing private brand TV modules for over 3 years.

Expanded facilities now include modules for

- RCA
- GE
- ZENITH
- W. T. GRANT
- J. C. PENNEY
- WESTERN AUTO
- GAMBLES

as well as Zenith IF subchassis.

For free Price List and complete information write or phone; TSC HEADQUARTERS, BLOOMINGTON, IND. or any of the TSC locations listed below.

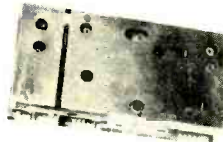
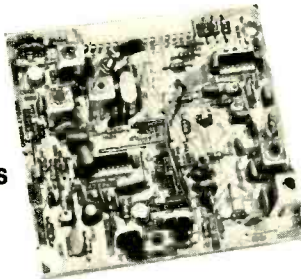

PROVIDES YOU WITH A COMPLETE SERVICE FOR ALL YOUR TELEVISION TUNER REQUIREMENTS.

### TUNER REPAIRS

VHF OR UHF ANY TYPE.....(U.S.A.) \$10.95  
UHF/VHF COMBINATION.....(U.S.A.) \$17.95  
MAJOR PARTS AND SHIPPING CHARGED AT COST

- FAST, EFFICIENT SERVICE AT ANY OF THE CONVENIENTLY LOCATED SERVICE CENTERS LISTED BELOW.
- ONLY ORIGINAL FACTORY PARTS USED
- All tuners ultrasonically cleaned, repaired and realigned.

### EXACT REPLACEMENT

- Exact Replacement Tuners are available at a cost of \$14.95 and up. ....(U.S.A. Only)
- Send in your original tuner for comparison purposes to any of the Centers listed below.

### UNIVERSAL REPLACEMENT

- UNIVERSAL REPLACEMENT TUNER \$13.95.....(U.S.A. Only)
- This price buys you a complete new tuner built specifically for this purpose.
- All shafts have a maximum length of 10 1/2" which can be cut to 1 1/2".
- Specify heater type parallel and series 450 mA or 600 mA.

FLASH

**NOW AVAILABLE—TUNER SERVICE PARTS CATALOG**  
OF ALL SARKES TARZIAN VHF AND UHF TUNERS, INCLUDING EXPLODED VIEW DRAWINGS. OVER 200 PAGES. ORDER YOUR COPY TODAY.  
SEND \$2.50 WITH ORDER TO BLOOMINGTON HEAD OFFICE.

## SAME DAY SERVICE — ONLY ORIGINAL FACTORY PARTS USED



|                |                                  |                                     |                   |
|----------------|----------------------------------|-------------------------------------|-------------------|
| HEADQUARTERS   | BLOOMINGTON, INDIANA 47401       | 537 South Walnut Street             | Tel. 812/334-0411 |
| ARKANSAS       | LITTLE ROCK, ARKANSAS 72204      | 4200-C Asher Ave.                   | Tel. 501/661-0393 |
| ALABAMA        | BIRMINGHAM, ALABAMA 35212        | 5623 1st Avenue, North              | Tel. 205/592-9150 |
| CALIFORNIA     | NORTH HOLLYWOOD, CALIF. 91601    | 10654 Magnolia Boulevard            | Tel. 213/769-2720 |
|                | SAN MATEO, CALIF. 94402          | 600 S. Amphlett Boulevard           | Tel. 415/346-3292 |
|                | MODESTO, CALIF. 95351            | 123 Phoenix Avenue                  | Tel. 209/521-8051 |
| FLORIDA        | TAMPA, FLORIDA 33606             | 1505 Cypress Street                 | Tel. 813/253-0324 |
|                | FT. LAUDERDALE, FLORIDA 33309    | 3518 N.W. 10th Avenue               | Tel. 305/566-4882 |
| GEORGIA        | ATLANTA, GEORGIA 30310           | 646 Evans Street S.W.               | Tel. 404/758-2232 |
| ILLINOIS       | URBANA, ILLINOIS 61801           | 908 E. Main Street                  | Tel. 217/384-2052 |
|                | SKOKIE, ILLINOIS 60076           | 5110 West Brown Street              | Tel. 312/675-0230 |
| INDIANA        | INDIANAPOLIS, INDIANA 46204      | 112 West St. Clair Street           | Tel. 317/632-3493 |
| KENTUCKY       | LOUISVILLE, KENTUCKY 40205       | 2244 Taylorsville Road              | Tel. 502/452-1191 |
| LOUISIANA      | SHREVEPORT, LOUISIANA 71104      | 2423 Southern Ave.                  | Tel. 318/221-3027 |
| MASSACHUSETTS  | SPRINGFIELD, MASSACHUSETTS 01108 | 405 Dickinson Street                | Tel. 413/788-8206 |
| MISSOURI       | ST. LOUIS, MISSOURI 63132        | 9577 Page Avenue                    | Tel. 314/429-0633 |
| NEVADA         | LAS VEGAS, NEVADA 89102          | 1114 South Casino Center Blvd.      | Tel. 702/384-4235 |
| NEW JERSEY     | TRENTON, NEW JERSEY 08638        | 1139 Pennsylvania Avenue            | Tel. 609/393-0999 |
|                | JERSEY CITY, NEW JERSEY 07307    | 454 Central Avenue                  | Tel. 201/792-3730 |
| NEW YORK       | ROCHESTER, NEW YORK 14615        | 37 Pullman Avenue                   | Tel. 716/647-9180 |
| NORTH CAROLINA | GREENSBORO, NORTH CAROLINA 27405 | 2914 East Market Street             | Tel. 919/273-6276 |
| OHIO           | CLEVELAND, OHIO 44139            | 4525 Pearl Road                     | Tel. 216/741-2314 |
| OREGON         | PORTLAND, OREGON 97210           | 1732 N.W. 25th Ave., P.O. Box 10141 | Tel. 503/222-9059 |
| PENNSYLVANIA   | PITTSBURGH, PENNSYLVANIA 15209   | 515 Grant Avenue                    | Tel. 412/821-4004 |
| TENNESSEE      | MEMPHIS, TENNESSEE 38111         | 3158 Barron Avenue                  | Tel. 901/458-2355 |
| TEXAS          | DALLAS, TEXAS 75218              | 11540 Garland Road                  | Tel. 214/327-8413 |
| CANADA         | ST. LAURENT, QUEBEC H4N-2L7      | 305 Decarie Boulevard               | Tel. 514/748-8803 |
|                | CALGARY, ALBERTA T2H-1Y3         | P.O. Box 5823, Stn. "A"             | Tel. 403/243-0971 |

If you want to branch out into the TV Tuner Repair Business write to the Bloomington Headquarters about a franchise.

CIRCLE 23 ON FREE INFORMATION CARD

WATCH US GROW

## RCA receives patent to manufacture amorphous silicon solar cells

Dr. David E. Carlson, head of the Photovoltaic Device Section of the RCA Corporation Energy Systems Research Laboratory, recently was granted a U.S. patent for "a semiconductor device having a body of amorphous silicon." Based on initial lab tests, it is believed that hydrogenated amorphous silicon solar cells will be able to produce electricity at costs competitive with conventional power sources by the mid to late 1980's.

RCA envisions that amorphous silicon cells could be used by developing nations lacking more sophisticated power distribution capabilities. Solar cell power supplies could be adapted to small village areas that



**AMORPHOUS SILICON SOLAR CELLS** can be produced less expensively than conventional crystalline cells, and are expected to be a cost-effective answer to future power requirements. Shown is Dr. David E. Carlson of RCA laboratories operating the glow-discharge equipment used in manufacturing hydrogenated amorphous silicon solar cells.

receive adequate sunlight but whose electricity requirements are modest. After the technology is improved, amorphous solar cells could be used by more developed nations, particularly where large amounts of DC power are required.

The chief advantage of amorphous silicon cells is their low cost. The material used (a sand derivative) is easily available; a glow-discharge fabrication process is used similar to that used in conventional fluorescent lights; and very thin layers of the material can be spread on large substrates of inexpensive glass or steel sheeting. And because the arrangement of amorphous silicon atoms is not as orderly as that in crystalline solar cells, the material is easier to grow and deposit on inexpensive substrates.

Although conventional silicon cells work more effectively, they are more expensive to fabricate than amorphous silicon cells. Crystalline silicon requires higher process-

ing temperatures (1100°C), compared with the lower 300°C required by amorphous silicon cells. Crystalline cells are also thicker. Amorphous cells can be manufactured in 1-foot-square entities, compared with conventional cells that use 3-inch-diameter wafers.

## Last "Radio Central" antenna tower demolished

In 1921, President Harding threw a switch that officially opened "Radio Central," the world's most powerful radio station, and ushered in a colorful era in radio communications. In December, 1977, the last of the 12 giant antenna towers erected in Rocky Point, N.Y., for "Radio Central" by RCA came crashing down . . . the 410-foot tower had become a dinosaur in an age of advanced communications technology.

The Rocky Point facility was the principal station that linked the U.S. with the rest of the world, transmitting messages to Europe, Central and South America. In the early 1920's, longwaves were necessary for such long-distance transmission, and the state-of-the-art mandated the erection of high steel towers to support the antenna structures. The Rocky Point facility had 12 such towers that stretched over a three-

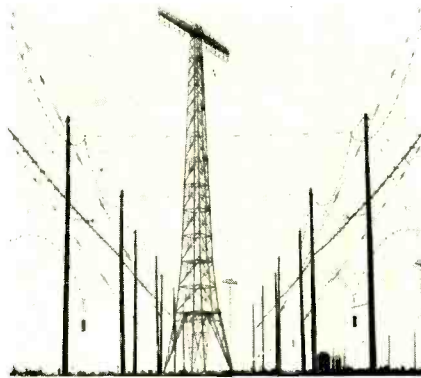

**ROCKY POINT, NY, FACILITY** as it appeared in the early 1920's.

mile area on the eastern end of Long Island. Each tower was 410 feet high and weighed 150 tons.

When shortwave transmission rendered the towers obsolete, they were all taken down except for one, which was used for a while to support aviation beacon lights and high-frequency radio antennas. When this no longer became necessary, the order went out to demolish "the last of the giants," thus closing a chapter in communications history.

## TI to have 16K EAROM by mid-1978

Texas Instruments has announced to its customers that it plans to make available in

sample quantities by mid-1978, the first American-made Famos-type 16K EAROM (Electrically Alterable Read Only Memory). The device is reported to have an access time of 450 ns. The EAROM differs from an EPROM in that it can be erased and reprogrammed entirely by electrical signals, whereas an EPROM is erased by ultraviolet light.

Nippon Electric Company presently manufactures an 8K EAROM, but it is not yet available in quantity; and General Instrument Corporation makes EAROM's in the nitride family—the fastest device having an access time of 600 ns. Intel is also reported to be working on an 8K device that is erased by ultraviolet light.

The TI EAROM is organized as 2048 words by 8 bits and requires three power supplies—one each for read, write and erase.

## Computerized system used in road testing

Performance-testing wheeled vehicles normally consists of someone sitting on the passenger side taking down data manually under sometimes nerve-racking and uncomfortable conditions.

Lamar Instruments has now produced an automated computerized road test system that eliminates the necessity for a data-taker. It also reduces costs and simplifies data collection for single-seat vehicles such as motorcycles and race cars.

The Lamar road test system weighs only 25 lbs, and consists of a microcomputer, keyboard, cassette tape recorder for program inputs, a fifth wheel for feeding basic speed and distance data to the computer, and a printer. The LCD display reads out speed in mph, time in seconds, distance in feet and the engine's rpm.

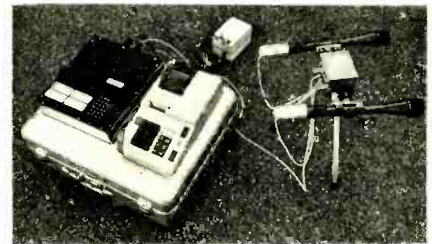

**COMPUTERIZED ROAD TEST SYSTEM** from Lamar Instruments. Also shown is the optional VHS-THT tester consisting of two telescopes with photocells. As the vehicle passes the line of sight of each telescope, the computer is triggered. When used on a slalom run (a weaving course marked by pylons), the computer prints out the elapsed time to pass both photocells and the average speed.

A decided improvement over the old method of data gathering is provided by the printer, which produces a permanent

*continued on page 12*



# Chances are, someone you know just bought a professional 3½ digit DMM kit for less than \$70.



Thousands of people have already bought the Sabtronics Model 2000 . . . for two main reasons. First, its incredible accuracy, range and professional features. And second, the incredibly low price of \$69.95

People everywhere appreciate this bench/portable multi-meter. They depend on its basic DCV accuracy of 0.1% ± 1 digit, its readings to ±1999 and its five functions giving 28 ranges, overload protection and 100% overrange.

The 2000 is automatically appealing to hobbyist and professional alike. With automatic overrange indication, automatic polarity, even automatic zeroing.

Best of all, it's easy to assemble. All the parts you'll need, including the high-impact case, come right along with the clear, step-by-step instructions.

The result is a professional quality 3½ digit DMM that you could have paid a lot more than \$69.95 for . . . possibly receiving a lot less. But this one's from Sabtronics, specialists in digital technology.

Maybe you should order yours before you turn the page.



Made in U.S.A.

**sabtronics**   
INTERNATIONAL INC.

P.O. Box 64683 Dallas, Texas 75206 (214) 369-7310

## GUARANTEE:

Our guarantee to you; examine the 2000 DMM kit for 10 days. If you're not satisfied, return it unassembled for a full refund of purchase price.

## SPECIFICATIONS:

DC volts in 5 ranges: 100µV to 1000V  
AC volts in 5 ranges: 100µV to 1000V  
DC current in 6 ranges: 100nA to 2A  
AC current in 6 ranges: 100nA to 2A  
Resistance: 0.1Ω to 20MΩ in 6 ranges  
AC frequency response: 40Hz to 50KHz  
9mm (.36") LED display  
Input impedance: 10MΩ  
Size: 8"W x 6.5"D x 3"H  
(203W x 165D x 76H mm)

Power requirements: 4 "C" cells (not included)

To: Sabtronics International, Inc.  
P.O. Box 64683, Dallas, TX 75206

R-E-378

Please send me \_\_\_\_\_ Sabtronics Model 2000 DMM kit(s) at \$69.95 each. \_\_\_\_\_ subtotal

Shipping and handling, \$5.00 per unit\* \_\_\_\_\_ subtotal

Texas Residents Add Sales Tax \_\_\_\_\_

TOTAL enclosed \_\_\_\_\_

Name \_\_\_\_\_

Street Address \_\_\_\_\_

City \_\_\_\_\_

State \_\_\_\_\_ Zip \_\_\_\_\_

\*USA only. Canada \$6.50 All other countries, \$10.00 (surface mail)

MARCH 1978

7

# Only NRI

# 25" designed-

DIAGONAL

# Color TV



# Quadraphonic



Two home training schools give you a hobby-kit Color TV to assemble. Two others give you a commercial set right off the shelf. Neither was designed to teach you how to repair Color TV's. Only NRI invested the time and money to design equipment with learning in mind!

No other home training school gives you both a solid state Color TV and SQ™ Quadraphonic Receiver complete with four speakers . . . all in one course. In fact, to even match this kind of thorough training at another school, you'd have to take an extra

course costing hundreds of dollars more. And only NRI courses in Color TV/Audio servicing let you learn on equipment designed specifically for training.

It's the only way you can (1) get the feel of typical commercial circuitry, (2) learn bench techniques while building complete units from the "ground" up, (3) perform over 35 "in-set" experiments during construction, and (4) end up with a 25" diagonal solid state Color TV with cabinet and a 4-channel Audio Center.

#### **NRI passes the savings on to you**

NRI engineering eliminates the cost of buying from an outside source. We pay no salesman's commission. Students are enrolled by mail only. The savings are passed on to you in the form of low tuition fees, extras like the TV's console cabinet and the Quadraphonic System; professional test instruments like a 5" triggered sweep oscilloscope, CMOS digital frequency counter, and integrated circuit Color TV pattern generator. You can pay hundreds of dollars more for similar courses and not

™ Trademark of CBS, Inc.

# gives you this for-learning ...plus complete Audio Center.

get a nickel's worth more in training and equipment.

#### More know-how per dollar

It all boils down to the quality of training you get for your money. In our 62-year history, more than a million students have come to NRI and we're fully approved for career training under the G.I. Bill. We know the right way to make home training pay dividends for you.

Some of those "right" things are bite-size lessons to ease understanding and speed learning . . . personal consultation, and prompt grading of all tests . . . a full-time staff of engineer/instructors to help if you need it . . . the right kind of kits and experiments to give you hands-on training . . . and fully professional programs oriented to full or part-time career needs.

#### Also CB, Computer, & Other Courses

NRI offers not one, but five TV/Audio servicing courses so you can tailor your training to your budget. Or you can study other opportunity fields like Digital Computer Electronics, Citizens Band Radio, Communications, Aircraft or



Marine Electronics, Mobile Radio and more. Send for your free catalog and see for yourself that no one gives you more training and equipment for your dollar. There's no obligation and no salesman will call.

If card is missing, write to:

**NRI**  
**McGraw-Hill**  
NRI SCHOOLS  
McGraw-Hill Continuing  
Education Center  
3939 Wisconsin Avenue,  
Washington, D.C. 20016

#### MASTER HANDBOOK OF 1001 PRACTICAL ELECTRONIC CIRCUITS

Here are IC and transistor circuits for practically anything and everything—with ALL the data needed to put them to work. It's the ideal schematic sourcebook for all active technicians, engineers, experimenters, amateurs—for anyone who must occasionally or regularly construct or adapt electronic circuits for any purpose whatsoever. Each circuit diagram has every component carefully labeled, and every schematic is accompanied by all the info you need to construct the circuit for use in your own individual application. If there are coils to be wound, you'll find full and complete coil-winding details right there on the spot. If special parts are required, you won't have to invest a lot of time and effort before the fact, for it's all there before you in condensed captions. The circuits included are completely up-to-date, and have been designed, built, tested, reworked as necessary, and perfected. You'll find any circuit you're ever likely to need in the pages of this rich volume. Includes an ultracomplete 22 page cross-reference index so you can quickly find the circuit you need. The schematics are classified according to general application. If you're in the business of servicing/repairing commercially built electronic equipment, you're going to especially appreciate the comprehensive Appendix of IC substitutions, which includes base diagrams for most popular ICs, and gives you all the info you need to adapt the IC packages of one manufacturer to the circuit applications of another. 602 pps., over 1250 illus. List Price \$12.95.

Selection. Alternates and other offerings, every 4 weeks (13 times a year)

- If you want the Selection, do nothing—it will be sent to you automatically. If you do not wish to receive the Selection, or if you want to order one of the many Alternates offered, you simply give instructions on the reply form (and in the envelope) provided, and return it to us by the date specified. This date allows you at least 10 days in which to return the form if, because of late mail delivery, you do not have 10 days to make a decision and so receive an unwanted Selection, you may return it at Club expense.

- Personal service for your account—no computers used!
- To complete your Trial Membership, you need buy only four additional monthly selections or alternates during the next 12 months. You may cancel your Membership any time after you purchase these four books.

- All books—including the Introductory Offer—are fully returnable after 10 days if you're not completely satisfied.
- All books are offered at low Member prices plus a small postage and handling charge.

- **Continuing Bonus:** If you continue after this Trial Membership, you will earn a Dividend Certificate for every book you purchase. Three Certificates, plus payment of the nominal sum of \$1.99 will entitle you to a valuable Book Dividend of your choice which you may choose from a list provided Members.

CIRCLE 5 ON FREE INFORMATION CARD

TRONICS BOOK CLUB and send my 4-volume Electronics Circuits Library, invoicing me for only \$1.99 plus shipping. If not delighted, I may return the books within 10 days and owe nothing, and have my Trial Membership cancelled. I agree to purchase at least four additional books during the next 12 months, after which I may cancel my Membership at any time.

Name \_\_\_\_\_ Phone \_\_\_\_\_  
Address \_\_\_\_\_  
City \_\_\_\_\_  
State \_\_\_\_\_ Zip \_\_\_\_\_  
(Valid for new Members only. Foreign and Canada add 10%) RE-38

- Microprocessor Course and Trainer (ET-3400) \$299.95 (+\$3.06 shipping & handling)
- Microprocessor Course only (EE-3401) \$89.95 (+\$2.23 shipping & handling)
- Microprocessor Trainer kit only (ET-3400) \$189.95 (+\$1.69 shipping & handling)
- Digital Techniques Course and Trainer kit (EES-3201) \$119.95 (+\$3.64 shipping & handling)

Prices subject to change without notice

Account # \_\_\_\_\_ Exp. Date \_\_\_\_\_  
Master Charge Code # \_\_\_\_\_  
Signature \_\_\_\_\_  
NAME \_\_\_\_\_  
ADDRESS \_\_\_\_\_  
CITY \_\_\_\_\_ STATE \_\_\_\_\_ ZIP \_\_\_\_\_

CIRCLE 100 ON FREE INFORMATION CARD

record of reduced and formatted data that can be compared on the spot with other data or printed directly on a report, thus eliminating many hours (sometimes days) of reducing raw data to a comprehensible state.

The basic system sells for \$4995, with all the necessary hardware and software for

## TRAINING WORKSHOPS FOR MAGNAVOX FIELD-SERVICE PERSONNEL



## editorial

## Radio-Electronics®

**Hugo Gernsback** (1884-1967) founder  
**M. Harvey Gernsback**, editor-in-chief and publisher  
**Larry Steckler**, KTX-3644, CET, editor  
**Arthur Kleiman**, KTZ-3288, managing editor

## letters

### CHALLENGE TO CIRCULAR POLARIZATION

The November 1977 article on the benefits of circular polarization (CP) as a means of exorcizing TV ghosts made interesting reading. However, the CP systems will not go unchallenged as sole contenders for ghost-free viewing.

A new LSI circuit, recently codeveloped by Toshiba and NHK and ultimately intended for installation in new receivers, has been proved capable of attenuating ghosts of up to 27  $\mu$ s delay by a reduction of 30 dB. These figures compare quite favorably with CP transmitting/receiving antenna systems.

Basically, the circuit examines the ordinarily stable intervals between equalizing pulses in the composite video signal to determine the presence of ghost images that would show up here as smaller trailing pulses. Through multiplexing and analog memory techniques, voltages accurately derived from the amplitude and amount of delay of the ghost pulses are applied to vary the gain on each of 64 MOSFET

weighting circuits fed in parallel with a sample of the video signal. The outputs of the weighting circuits in turn feed 64 CCD delay lines, each having a predetermined delay time. The outputs of the delay lines are added and then applied as negative feedback to the composite video signal in a form having sufficient amplitude and delay to cancel the ghosts.

Although practical mass fabrication of the discrete device is still many months off, its implementation could radically alter the outlook for widespread use of the CP system.

**JAMES DAMON**  
 Kincaid Electronics Corp.  
 Alexandria, VA

### BIORHYTHM CLOCK

Concerning the article on page 33 of the November 1977 issue ("Biorhythm Clock") many people feel that things seem to run in cycles. However, the concept that these cycles start at the exact moment of birth and hold constant throughout life is some-

what fantastic. For instance, the internal "clock" of a 30-year-old adult would have to be absolutely accurate to within 0.0533% for the shortest biorhythm to even predict between peak and "switching" days at all.

Does the human Biorhythm Clock always start the same whether a child is born prematurely or late? Why does the clock always start at a neutral or "switching" point as implied by the chart? One would think that evolution would tend to all the biorhythms starting at a *peak* for maximum survival of an otherwise helpless infant. Might it not be possible that biorhythms start at conception? Or how about their even being inherited? It seems logical that such rhythms could synchronize with the mother's.

It is hard to imagine that illness, accidents, etc., have no effect on the Biorhythm Clock. How could the curves peak exactly as predicted no matter how badly one felt? Somehow, it all sounds like astrology.

If one believes in biorhythms, it would seem much more logical to keep a diary of

*continued on page 22*

## ok® wire wrapping center ok®

### NEW HOBBY WRAP MODEL BW 630



Battery wire wrapping tool

**\$34.95**

ONLY COMPLETE WITH BIT AND SLEEVE

### STRIP/WRAP/UNWRAP TOOL MODEL WSU-30



**\$6.95\***

### RIBBON CABLE ASSEMBLY

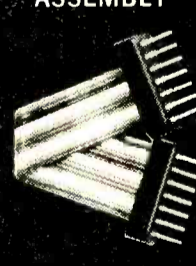

### DIP SOCKETS

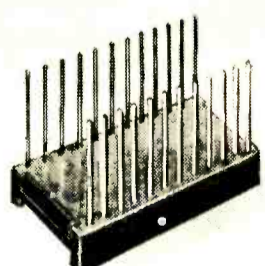

### DIP IC INSERTION TOOL WITH PIN STRAIGHTENER

MODEL INS-1416



**\$3.49\***

### WIRE DISPENSER MODEL WD-30-B



**\$3.95\***

### PRE-CUT PRE-STRIPPED WIRE

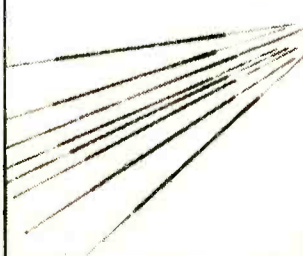

### WIRE WRAPPING KIT

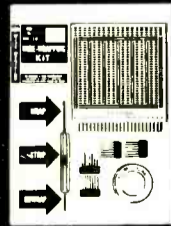

**\$15.45\***

\*MINIMUM ORDER \$25.00, SHIPPING CHARGE \$1.00, N.Y. CITY AND STATE RESIDENTS ADD TAX

## OK MACHINE AND TOOL CORPORATION

3455 CONNER STREET, BRONX, NEW YORK, N.Y. 10475 U.S.A.  
 PHONE (212) 994-6600 TELEX NO. 125091

# gives you this for-learning ...plus complete Audio Center.

get a nickel's worth more in training and equipment.

#### More know-how per dollar

It all boils down to the quality of training you get for your money. In our 62-year history, more than a million students have come to NRI and we're fully approved for career training under the G.I. Bill. We know the right way to make home training pay dividends for you.

Some of those "right" things are bite-size lessons to ease understanding and speed learning . . . personal consultation, and prompt grading of all tests . . . a full-time staff of engineer/instructors to help if you need it . . . the right kind of kits and experiments to give you hands-on training . . . and fully professional programs oriented to full or part-time career needs.

#### Also CB, Computer, & Other Courses

NRI offers not one, but five TV/Audio servicing courses so you can tailor your training to your budget. Or you can study other opportunity fields like Digital Computer Electronics, Citizens Band Radio, Communications, Aircraft or



Marine Electronics,  
Mobile Radio and more.  
Send for your free catalog and  
see for yourself that no one gives you  
more training and equipment for your  
dollar. There's no obligation and no  
salesman will call.

If card is missing, write to:



**NRI SCHOOLS**  
McGraw-Hill Continuing  
Education Center  
3939 Wisconsin Avenue,  
Washington, D.C. 20016

record of reduced and formatted data that can be compared on the spot with other data or printed directly on a report, thus eliminating many hours (sometimes days) of reducing raw data to a comprehensible state.

The basic system sells for \$4995, with all the necessary hardware and software for acceleration and braking tests. Additional software for aerodynamic drag, road horsepower and other vehicle handling and driver performance parameters are being developed. For further information, write Lamar Instruments, 1024 17th Street, Hermosa Beach, CA 90254.

### LED's developed for daytime display

As everyone knows, conventional LED displays are difficult, if not impossible, to read in bright light or in the sun. Now, however, Hewlett-Packard has designed a discrete light-emitting diode that it claims can compete with LCD's, incandescent, gas discharge and other displays used for daytime applications.

The red and yellow 7-segment LED displays can be viewed in direct sunlight or in ambient lighting up to 10,000 foot-candles in intensity. To achieve that performance, a high-contrast gray package was developed along with high-efficiency chips having large, active pn junctions.

For direct viewing in sunlight, a commercially available acrylic neutral-density gray filter blocks out the sun's rays. The LED displays are expected to have many automotive, avionic, instrument and measurement applications.

### Casio introduces compact new mini-calculators

At a recent media conference, Casio, Inc., manufacturers of electronic calculators, displayed three new compact, fully



**CASIO LC-78 MINI-CARD CALCULATOR** is no bigger than a credit card, yet offers four math functions, percent and memory.

functional mini-calculators: the *model LC-78*, the *model MQ-2* and the *model AQ-810*.

The simplest, and smallest, calculator is

### TRAINING WORKSHOPS FOR MAGNAVOX FIELD-SERVICE PERSONNEL

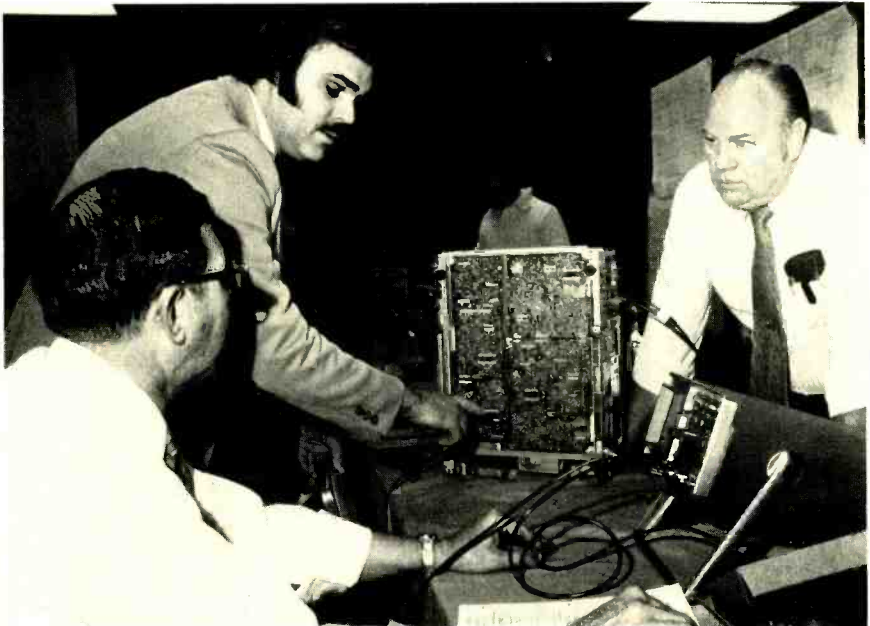

**IN DECEMBER, MAGNAVOX** held a series of four, week-long service workshops at its Fort Wayne division headquarters. These seminars were aimed at giving field service personnel "hands-on" experience with Magnavox's new videocassette recorder. Here, Howard Shoudy (rear), service training specialist, shows VCR circuitry to Jim Fritsche (left), Cleveland division and Bill Nurge (right), Dallas division. A January series is planned for dealers and independent service technicians at selected sites throughout the country.

the *model LC-78* (shown) which is about the size of an ordinary business card and weighs 1.4 ounces. It features an 8-digit LCD readout, four basic math functions, plus percent and memory.

The *model MQ-2* is slightly larger and weighs 1.6 ounces. Its capabilities include an 8-digit calculator and watch/calendar that displays the year, month, date and day; its time memory can show the exact time in two time zones, and its calculator includes four math functions and percent.

The *model AQ-810* consists of a calculator complete with memory, percent and square root. This unit can perform time calculations. The timer function contains two "beep" reminders. The eight-digit readout displays hours, minutes, seconds and AM-PM. It is powered by two silver oxide batteries that give the user 3000 hours of continuous use.

### Focusing system uses linear IC

Honeywell, Inc., has recently designed an automatic-focus system for cameras. This focusing system, called the *Visitronic* module, will doubtless find increasing applications in the camera field, particularly in view of the increasing demand for home videotape TV cameras and in automated equipment. The module will be incorpo-

rated into the Konica C35AF camera that will be introduced next spring.

The process resembles conventional split-image focusing. In the automatic-focus linear IC, two separate images are focused on a pair of photodiode sensor arrays placed at opposite ends of the body of the IC. Each array receives the image via a separate mirror—one mirror is fixed on one array, the other is linked to the camera lens and scans down the scene. At the point at which the output signals from the detector arrays nearly match, the camera lens moves into focus position.

For this match to take place, each sensor array is divided into four quadrants, each producing a separate current output signal that is fed into one of eight logarithmic amplifiers (which are sensitive to voltage mismatch). The amplifiers feed each signal to four absolute-value circuits, at which point each signal is fed to a summing circuit. The latter then inverts the signal so that when the two images match, a summing circuit output signal known as a correlation signal reaches a peak.

The correlation signal is fed into a peak detector, whose output signal then turns on a solenoid that moves the lens to focus at the best point. The entire process takes place in the instant it takes to press the shutter button.

# ELECTRONICS BOOK CLUB

invites you to take this  
1,626-page electronics circuits  
library for only

\$ **1.99**

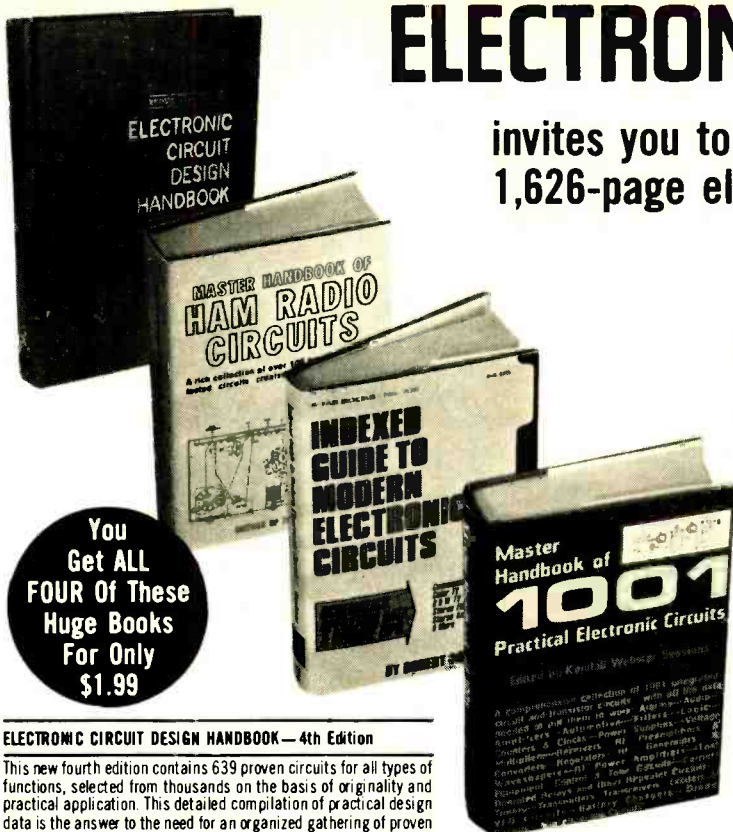

You  
Get ALL  
FOUR of These  
Huge Books  
For Only  
\$1.99

- ✓ Only \$1.99 for all four!
- ✓ Regular List Price \$51.80
- ✓ Top-Quality Binding
- ✓ Contains Thousands of Circuits
- ✓ Over 2,600 illustrations
- ✓ Contains over 600,000 words
- ✓ 1,626 data-packed pages

with a Trial  
Membership in  
the Book Club  
that Saves you  
25% to 75% on  
a wide selection of  
electronics books

## ELECTRONIC CIRCUIT DESIGN HANDBOOK — 4th Edition

This new fourth edition contains 639 proven circuits for all types of functions, selected from thousands on the basis of originality and practical application. This detailed compilation of practical design data is the answer to the need for an organized gathering of proven circuits that can easily serve as stepping stones to almost any kind of circuit you might want to build...adapted or modified to suit your own specific needs. Here is a GIANT of a book—an 8 1/2 x 11" hardbound volume of 416 pages, with 19 BIG sections of tried and tested circuits, which will serve as "imagination triggers" for anyone who has an interest in electronic circuit design and construction. 416 pgs., 8 1/2 x 11", 966 ill. List Price \$17.95.

## MASTER HANDBOOK OF HAM RADIO CIRCUITS

A rich collection—a super collection—of over 100 practical, unique, tested circuits created by hams for hams! Contains some of the most usable, most ingenious ham radio circuits around—all have been built and tested by hams—some are brand new, some are oldies but goodies that are well worth remembering, and some are souped-up versions of the tried and true—but they're all useful...to the novice operator and to the extra-class licensee. There are circuits for voice communications, for CW, for radioteletype, for SSTV...for just about anything and everything you want. If there's a new circuit that hams are hooked on, if there's an innovation that operators are excited about, chances are it's in this book! 392 pgs., 301 illus. List Price \$12.95.

## INDEXED GUIDE TO MODERN ELECTRONIC CIRCUITS

Composed entirely of electronic circuits and descriptions of how they work and how they sometimes fail, including essential theory, troubleshooting tips, signal flow info, and other data designed to help you better understand and more quickly repair the great majority of those tricky electronic circuits seen every day. The material is categorized according to the equipment in which you're most apt to find the circuits described. And an extraordinarily large index lists and cross-references each circuit, subcircuit, circuit element, and circuit function so you can find it in seconds! 216 pgs., 92 illus. List Price \$7.95.

## MASTER HANDBOOK OF 1001 PRACTICAL ELECTRONIC CIRCUITS

Here are IC and transistor circuits for practically anything and everything—with ALL the data needed to put them to work. It's the ideal schematic sourcebook for all active technicians, engineers, experimenters, amateurs—for anyone who must occasionally or regularly construct or adapt electronic circuits for any purpose whatsoever. Each circuit diagram has every component carefully labeled, and every schematic is accompanied by all the info you need to construct the circuit for use in your own individual application. If there are coils to be wound, you'll find full and complete coil-winding details right there on the spot. If special parts are required, you won't have to invest a lot of time and effort before the fact, for it's all there before you in condensed captions. The circuits included are completely up-to-date, and have been designed, built, tested, reworked as necessary, and perfected. You'll find any circuit you're ever likely to need in the pages of this rich volume. Includes an ultracomplete 22 page cross-reference index so you can quickly find the circuit you need. The schematics are classified according to general application. If you're in the business of servicing/repairing commercially built electronic equipment, you're going to especially appreciate the comprehensive Appendix of IC substitutions, which includes base diagrams for most popular ICs, and gives you all the info you need to adapt the IC packages of one manufacturer to the circuit applications of another. 602 pgs., over 1250 illus. List Price \$12.95.

Let us send you these four practical, time- and money-saving books as part of an unusual offer of a Trial Membership in Electronics Book Club.

Here are quality hardbound volumes, each especially designed to help you increase your know-how, earning power, and enjoyment of electronics.

These handsome hardbound books are indicative of the many other fine offerings made to Members...important books to read and keep...volumes with your specialized interests in mind.

Whatever your interest in electronics—computers and microprocessors, radio and TV servicing, audio and hi-fi, industrial electronics, communications, broadcasting, electronics as a hobby—you will find Electronics Book Club will help you get the job you want, keep it, improve it or make your leisure hours more enjoyable. With the Club providing you with top quality books, you may broaden your knowledge and skills to build your income and increase your enjoyment of electronics, too.

This Special Offer is just a sample of the help

and generous savings the Club offers you. For here is a Club devoted exclusively to seeking out only those titles of direct interest to you. Members are annually offered over 50 authoritative books on all phases of electronics.

This extraordinary offer is intended to prove to you, through your own experience, that these very real advantages can be yours...that it is possible to keep up with the literature published in your areas of interest...and to save substantially while so doing. As part of your Trial Membership, you need purchase as few as four books during the coming 12 months. You would probably buy at least this many anyway...without the savings offered through Club Membership.

To start your Membership on these attractive terms, simply fill out and mail the coupon today. You will receive the 4-volume Electronics Circuits Library for 10-day inspection. YOU NEED SEND NO MONEY! If you are not delighted, return them within 10 days and your Trial Membership will be cancelled without cost or obligation.

ELECTRONICS BOOK CLUB, Blue Ridge Summit, Pa. 17214

### Facts About Club Membership

- The 4 introductory books carry a publishers retail price of \$51.80. They are yours for only \$1.99 (plus postage and handling) with your Trial Membership
- You will receive the Club News describing the current Selection. Alternates and other offerings, every 4 weeks (13 times a year)
- If you want the Selection, do nothing, it will be sent to you automatically. If you do not wish to receive the Selection, or if you want to order one of the many Alternates offered, you simply give instructions on the reply form (and in the envelope) provided, and return it to us by the date specified. This date allows you at least 10 days in which to return the form. If, because of late mail delivery, you do not have 10 days to make a decision and so receive an unwanted Selection, you may return it at Club expense.
- Personal service for your account—no computers used!
- To complete your Trial Membership, you need buy only four additional monthly selections or alternates during the next 12 months. You may cancel your Membership any time after you purchase these four books
- All books—including the Introductory Offer—are fully returnable after 10 days if you're not completely satisfied.
- All books are offered at low Member prices plus a small postage and handling charge.
- Continuing Bonus: If you continue after this Trial Membership, you will earn a Dividend Certificate for every book you purchase. Three Certificates, plus payment of the nominal sum of \$1.99 will entitle you to a valuable Book Dividend of your choice which you may choose from a list provided Members.

CIRCLE 5 ON FREE INFORMATION CARD

## ELECTRONICS BOOK CLUB

Blue Ridge Summit, Pa., 17214

Please open my Trial Membership in ELECTRONICS BOOK CLUB and send my 4-volume Electronics Circuits Library, invoicing me for only \$1.99 plus shipping. If not delighted, I may return the books within 10 days and owe nothing, and have my Trial Membership cancelled. I agree to purchase at least four additional books during the next 12 months, after which I may cancel my Membership at any time.

Name \_\_\_\_\_ Phone \_\_\_\_\_

Address \_\_\_\_\_

City \_\_\_\_\_

State \_\_\_\_\_ Zip \_\_\_\_\_

(Valid for new Members only. Foreign and Canada add 10%) RE-38

## Report From The Winter CES

Having just returned from the 1978 Winter Consumer Electronics Show, I should be brimming with news of the wonderful new consumer electronics products to appear this year. But I was disappointed. There were lots of electronics at what turned out to be the largest show of its kind, but very little that was really new.

Video tape recorders are a boom market. More manufacturers are announcing new models and fantastic sales. Projection TV is another boom area, but the price tag keeps the total numbers down. However, Panasonic has joined this race and several other major brands are expected to climb on the bandwagon shortly.

The home computer is alive and well. Even more new units are appearing and each has its own built-in attractions. However, there is one point that seems to be escaping some buyers. If you want a TV game, *don't buy a home computer*. It's true that you can play some rather elaborate games with a computer, but programmable TV games remain under \$200 while home computers start at \$595.

There were no flat-screen TV's; no 3-D TV's; very little 4-channel stereo; and no startling breakthroughs. There were smaller calculators; cheaper calculators; more new TV manufacturers; lots of new companies offering me-too products; and hundreds of add-on telephone products.

To summarize, the electronics business is alive and well. Perhaps exciting, really new products will appear this June at the Summer Consumer Electronics Show. Meanwhile, the manufacturers and dealers seem to believe that they are going to sell a bundle of consumer electronics this year, and I think that they are right.

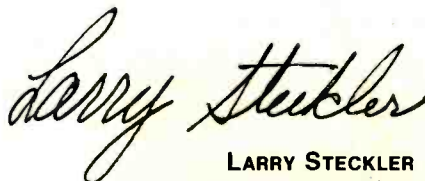
  
LARRY STECKLER  
Editor

## Radio-Electronics®

**Hugo Gernsback** (1884-1967) founder  
**M. Harvey Gernsback**, editor-in-chief and publisher  
**Larry Steckler**, KTX-3644, CET, editor  
**Arthur Kleiman**, KTZ-3288, managing editor  
**Robert F. Scott**, CET, W2PWG, KXK-8533, technical editor  
**Sonia Greenbaum**, copy editor  
**Jack Darr**, CET service editor  
**Leonard Feldman**, contributing high-fidelity editor  
**Karl Savon**, semiconductor editor  
**David Lachenbruch**, contributing editor  
**Earl "Doc" Savage**, K4SDS, hobby editor  
**Vincent P. Cicenia**, production manager  
**Harriet I. Matysko**, circulation director  
**Sheila Wertling**, circulation assistant  
**Arline R. Bailey**, advertising coordinator

Cover design by Louis G. Rubsamen  
Cover photo by Michael Wilson

**Radio Electronics** is a member of the *Institute of High Fidelity* and is indexed in *Applied Science & Technology Index* and *Readers Guide to Periodical Literature*.

Gernsback Publications, Inc.  
200 Park Ave. S., New York, NY 10003  
(212) 777-6400  
President: M. Harvey Gernsback  
Vice President: Larry Steckler  
Treasurer: Carol A. Gernsback  
Secretary: Bertina Baer

### ADVERTISING SALES

Paul McGinnis  
Director of Marketing

### EAST

Stanley Levitan  
Radio-Electronics  
200 Park Ave. South  
New York, NY 10003  
(212) 777-6400

### MIDWEST/Texas/Arkansas/Okla.

Ralph Bergen  
The Ralph Bergen Co.  
6319 N. Central Ave.  
Chicago, IL 60646  
(312) 792-3646

### PACIFIC COAST Mountain States

Jay Eisenberg  
J.E. Publishers Representative Co.,  
8732 Sunset Blvd.,  
4th Floor,  
Los Angeles, CA 90069  
(213) 659-3810  
Sales Mart Building  
1485 Bayshore Blvd., Box 140  
San Francisco, CA 94124  
(415) 467-0125

### SOUTHEAST

J.E. Publishers Representative Co.,  
214-387-2424





# LEARN Microprocessor Operation, Interfacing and Programming with

## The New **HEATHKIT** Microprocessor Course!

*Explore the fascinating field of computer technology!*

Here's the newest, easiest and lowest-cost self-instruction microprocessor course ever! What's more, it's the fastest way to really learn about this fascinating field with applications in every phase of our everyday lives. From automotive diagnostics to the microwave oven in the kitchen to the computers that are taking on more jobs in the home, schools, government, business and industry!

Working with the popular 6800 microprocessor, you'll explore this exciting field in 3 easy steps! In step 1, using proven self-instruction text materials, you'll learn about micro-computer basics, number systems and codes, computer arithmetic, programming, 6800 capabilities and interfacing and more. In step 2, with the aid of audio visuals included, you'll go deeper into programming, designing with microprocessors and semiconductor memories. Then, in step 3, you'll actually perform 19 "hands on" experiments with the optional trainer designed to reinforce the theory you've mastered to that point!

The ET-3400 Trainer kit, designed to accompany your course, features the popular 6800 microprocessor. It is actually a miniature digital computer in itself, complete with a: 1K ROM monitor program; 6 digit LED display for address and data readout; 17-key hexadecimal keyboard for entering programs, data and control; 256 bytes of RAM (expandable to 512 bytes with the chips supplied in the course); breadboarding socket; 8 buffered LED's for display of logic states; 8 SPST switches for binary input plus an on-board power supply with +5, +12 and -12 volt outputs.

The Course comes complete with 62 electronic components, including a 6280 PIA, two 2112 RAM's, a 1406 digital-to-analog converter, 741 and 301 op amps and more. Includes audio visual aids such as an audio cassette, colorful flip charts and programmed learning text material in two deluxe permanent binders.

Complete the optional exam and receive a Certificate of Achievement and 8.0 Continuing Education Units (CEU's) — a nationally accepted means of recognizing participation in non-credit adult education. (Note: Microprocessor Course requires completion of Digital Techniques Course or equivalent knowledge.)

ORDER ETS-3400 (Course and Trainer kit) ..... **\$269<sup>95</sup>**  
(Add \$3.06 shipping and handling)



### FREE SOLDERING IRON!

Included with your Course at no extra cost — this pencil-style soldering iron that's perfect for printed circuit work — a \$7.95 comparable value — yours FREE!



### MONEY-BACK GUARANTEE!

If you are not 100% satisfied with your Heathkit Course, we will refund the full purchase price of the course text material, less trainer.

### NEED DIGITAL TECHNIQUES TRAINING?

**Comprehensive Digital Techniques Course** — the background you need to understand computer and modern electronics technology! Digital fundamentals, semi-conductor devices for digital applications. Boolean algebra, flip-flops and registers, sequential and combinational logic circuits, digital design and an introduction to computers and more! The course includes programmed instruction text, audio-visual aids, parts for experiments and more.

Digital Design Experimenter/Trainer lets you perform all the experiments in your course, then develop and test your own projects.

Features solderless breadboard sockets, 4 binary data switches, 2 "no bounce" switches to pulse logic circuits, 3-frequency pulse clock generators, 4 LED's for visual indication of logic states plus 3 regulated power supplies. Upon completion of the optional final exam, you receive a Certificate of Achievement and 4.0 Continuing Education Units.

ORDER EES-3201 (Course and Trainer Kit) ..... **\$119<sup>95</sup>**  
(Add \$3.64 shipping and handling)

**SAVE TIME--ORDER BY PHONE Call (616) 982-3411**

|  |   |  |
|--|---|--|
| HEATH<br><b>Schlumberger</b>   | Heath Company, Dept. 020-392<br>Benton Harbor, Michigan 49022 | <b>OR, MAIL COUPON TODAY!</b>  |
| Gentlemen: Please send me the item(s) checked below and include my FREE Soldering Iron.<br><input type="checkbox"/> Microprocessor Course and Trainer (ETS-3400) \$269.95 (+\$3.06 shipping & handling)<br><input type="checkbox"/> Microprocessor Course only (EE-3401) ..... \$89.95 (+\$2.23 shipping & handling)<br><input type="checkbox"/> Microprocessor Trainer kit only (ET-3400) ..... \$189.95 (+\$1.69 shipping & handling)<br><input type="checkbox"/> Digital Techniques Course and Trainer kit (EES-3201) ..... \$119.95 (+\$3.64 shipping & handling)<br>Prices subject to change without notice |   | I enclose <input type="checkbox"/> check <input type="checkbox"/> money order for \$ _____; OR,<br>(Michigan residents, add 4% sales tax)<br>CHARGE to my <input type="checkbox"/> VISA/BankAmericard <input type="checkbox"/> Master Charge<br>Account # _____ Exp. Date _____<br>Master Charge Code # _____<br>Signature _____<br>NAME _____<br>ADDRESS _____<br>CITY _____ STATE _____ ZIP _____<br>Necessary to send merchandise<br>Please print |

CIRCLE 100 ON FREE INFORMATION CARD

# letters

## CHALLENGE TO CIRCULAR POLARIZATION

The November 1977 article on the benefits of circular polarization (CP) as a means of exorcizing TV ghosts made interesting reading. However, the CP systems will not go unchallenged as sole contenders for ghost-free viewing.

A new LSI circuit, recently codeveloped by Toshiba and NHK and ultimately intended for installation in new receivers, has been proved capable of attenuating ghosts of up to 27  $\mu$ s delay by a reduction of 30 dB. These figures compare quite favorably with CP transmitting/receiving antenna systems.

Basically, the circuit examines the ordinarily stable intervals between equalizing pulses in the composite video signal to determine the presence of ghost images that would show up here as smaller trailing pulses. Through multiplexing and analog memory techniques, voltages accurately derived from the amplitude and amount of delay of the ghost pulses are applied to vary the gain on each of 64 MOSFET

weighting circuits fed in parallel with a sample of the video signal. The outputs of the weighting circuits in turn feed 64 CCD delay lines, each having a predetermined delay time. The outputs of the delay lines are added and then applied as negative feedback to the composite video signal in a form having sufficient amplitude and delay to cancel the ghosts.

Although practical mass fabrication of the discrete device is still many months off, its implementation could radically alter the outlook for widespread use of the CP system.

JAMES DAMON  
Kincaid Electronics Corp.  
Alexandria, VA

## BIORHYTHM CLOCK

Concerning the article on page 33 of the November 1977 issue ("Biorhythm Clock") many people feel that things seem to run in cycles. However, the concept that these cycles start at the exact moment of birth and hold constant throughout life is some-

what fantastic. For instance, the internal "clock" of a 30-year-old adult would have to be absolutely accurate to within 0.0533% for the shortest biorhythm to even predict between peak and "switching" days at all.

Does the human Biorhythm Clock always start the same whether a child is born prematurely or late? Why does the clock always start at a neutral or "switching" point as implied by the chart? One would think that evolution would tend to all the biorhythms starting at a *peak* for maximum survival of an otherwise helpless infant. Might it not be possible that biorhythms start at conception? Or how about their even being inherited? It seems logical that such rhythms could synchronize with the mother's.

It is hard to imagine that illness, accidents, etc., have no effect on the Biorhythm Clock. How could the curves peak exactly as predicted no matter how badly one felt? Somehow, it all sounds like astrology.

If one believes in biorhythms, it would seem much more logical to keep a diary of *continued on page 22*

# ok® wire wrapping center ok®

## NEW HOBBY WRAP MODEL BW 630



Battery  
wire  
wrapping  
tool  
**\$34.95**  
ONLY  
COMPLETE WITH BIT  
AND SLEEVE

## STRIP/WRAP/UNWRAP TOOL MODEL WSU-30



**\$6.95\***

## RIBBON CABLE ASSEMBLY

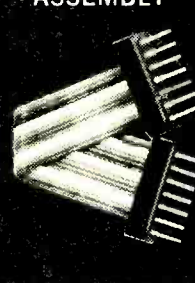

## DIP SOCKETS

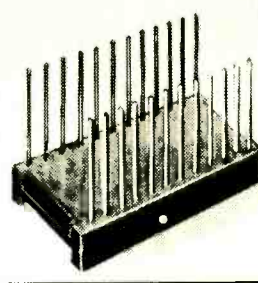

## DIP IC INSERTION TOOL WITH PIN STRAIGHTENER

MODEL  
INS-1416



**\$3.49\***

## WIRE DISPENSER MODEL WD-30-B



**\$3.95\***

## PRE-CUT PRE-STRIPPED WIRE

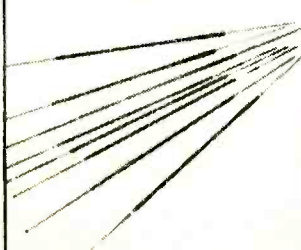

## WIRE WRAPPING KIT

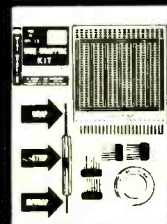

**\$15.45\***

\*MINIMUM ORDER \$25.00, SHIPPING CHARGE \$1.00, N.Y. CITY AND STATE RESIDENTS ADD TAX

# OK MACHINE AND TOOL CORPORATION

3455 CONNER STREET, BRONX, NEW YORK, N.Y. 10475 U.S.A.  
PHONE (212) 994-6600 TELEX NO. 125091

**The most important piece of electronic equipment you'll ever own.**

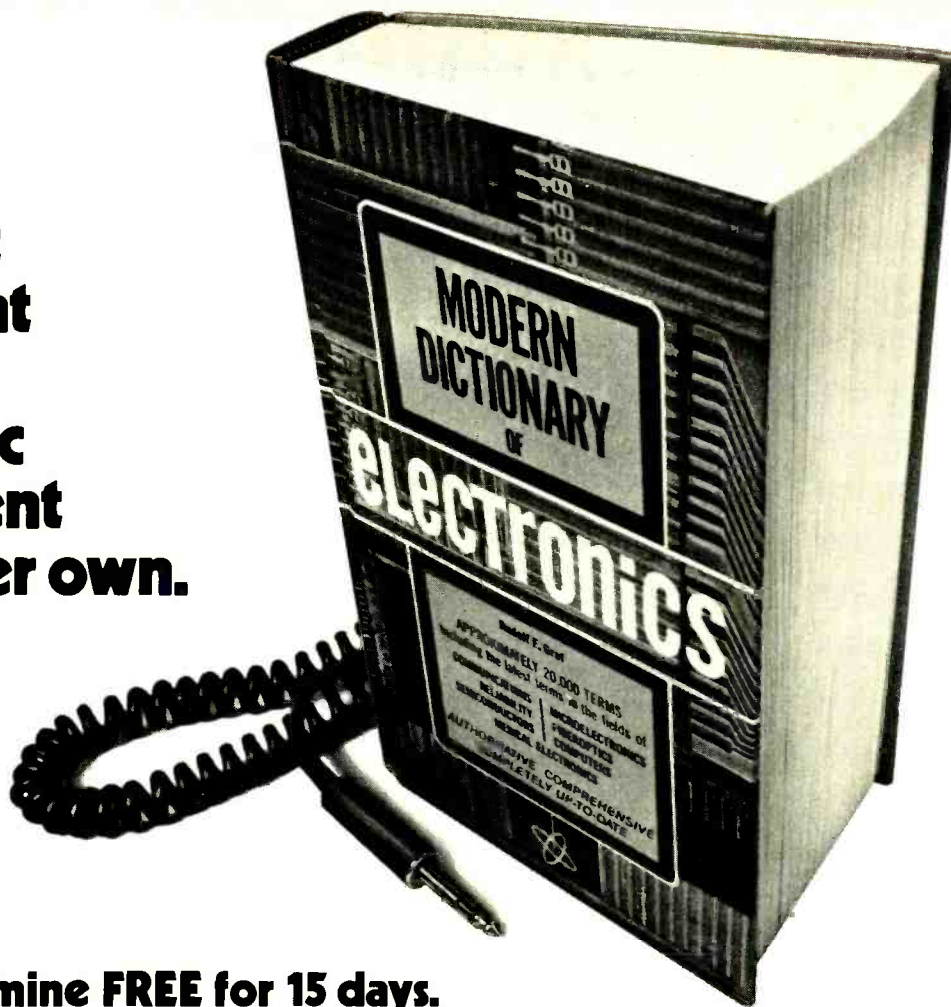

**Yours to examine FREE for 15 days.**

245

**INCLUDES ALL THE LATEST TERMINOLOGY FOR SUCH FIELDS AS:**

- Communications
- Microelectronics
- Fiberoptics
- Semi-conductors
- Reliability
- Computers
- Medical
- Electronics

LOOK at all the valuable "extras" this one handy reference volume contains:

- Hundreds of easy-to-grasp ILLUSTRATIONS AND DIAGRAMS—positioned with the terms they depict—and clearly captioned for quick understanding.
- CROSS-REFERENCED to aid you in locating those terms which you might look for in more than one place. Example: When looking up "Esaki diode" you'll be referred to "tunnel diode."
- Helpful PRONUNCIATION GUIDE of more than 1100 often-mispronounced electronic terms showing syllabic division as well as the newest, most-accepted pronunciation of each term.
- A newly-revised list of SEMI-CONDUCTOR SYMBOLS AND ABBREVIATIONS for use in semiconductor device data sheets and specifications.
- Clearly-illustrated SCHEMATIC SYMBOLS.
- GREEK ALPHABET. A special table lists the letters along with technical terms for which these letters are used as symbols (Name and Designates).

819 Pages of crystal-clear definitions. Over 18,500 terms defined and alphabetically arranged. Size: 5-1/2 x 8-1/2.

• Authoritative • Comprehensive • Completely up-to-date

**BE OUR GUEST.** Examine the MODERN DICTIONARY OF ELECTRONICS free for 15 days. Discover why book reviewers and some of the most demanding electronics experts around are calling it the most complete, up-to-date, authoritative dictionary ever compiled for this exacting field. And get a FREE \$4.95 bonus book.

Since rolling off the presses this giant reference is already being hailed as *THE* dictionary of the industry by thousands of electronic engineers, technicians, experimenters and hobbyists from coast to coast. So don't be surprised if it becomes one of the

most dogeared, coffee-stained books on your reference shelf.

Users tell us that one of the things that sets it head and shoulders above other electronic dictionaries is all the valuable *extra information* it contains. But see for yourself. Send for the MODERN DICTIONARY OF ELECTRONICS today. If you don't agree it's one of the most important pieces of electronic "equipment" you could own, simply return it within 15 days and owe nothing. And no matter what you decide, you'll get a free copy of "How to Read Schematic Diagrams" to keep...as our "thank you" gift.

**FREE TRIAL COUPON**

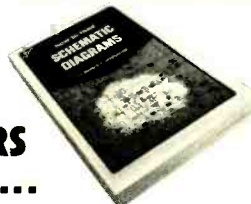

**YOURS FREE...**

"How to Read Schematic Diagrams" A \$4.95 value... *keep it*—even if you decide to return the DICTIONARY. **SAVE postage and handling costs. Full payment enclosed (plus tax where applicable). 15-day return privilege still applies.** (Prices subject to change without notice)

Yes, Please rush me the MODERN DICTIONARY OF ELECTRONICS (#21488\*) for my free trial. I understand if not completely satisfied I may return it within 15 days and owe nothing. Otherwise, it's mine to keep for only \$18.95 plus postage and handling and local taxes (where applicable).

Name \_\_\_\_\_  
 Address \_\_\_\_\_  
 City \_\_\_\_\_  
 State \_\_\_\_\_ Zip \_\_\_\_\_

Mail to: EC39  
 Howard W. Sams & Co., Inc.  
 4300 W. 62nd St.,  
 Indianapolis, Ind. 46202



# A new introductory Electronics

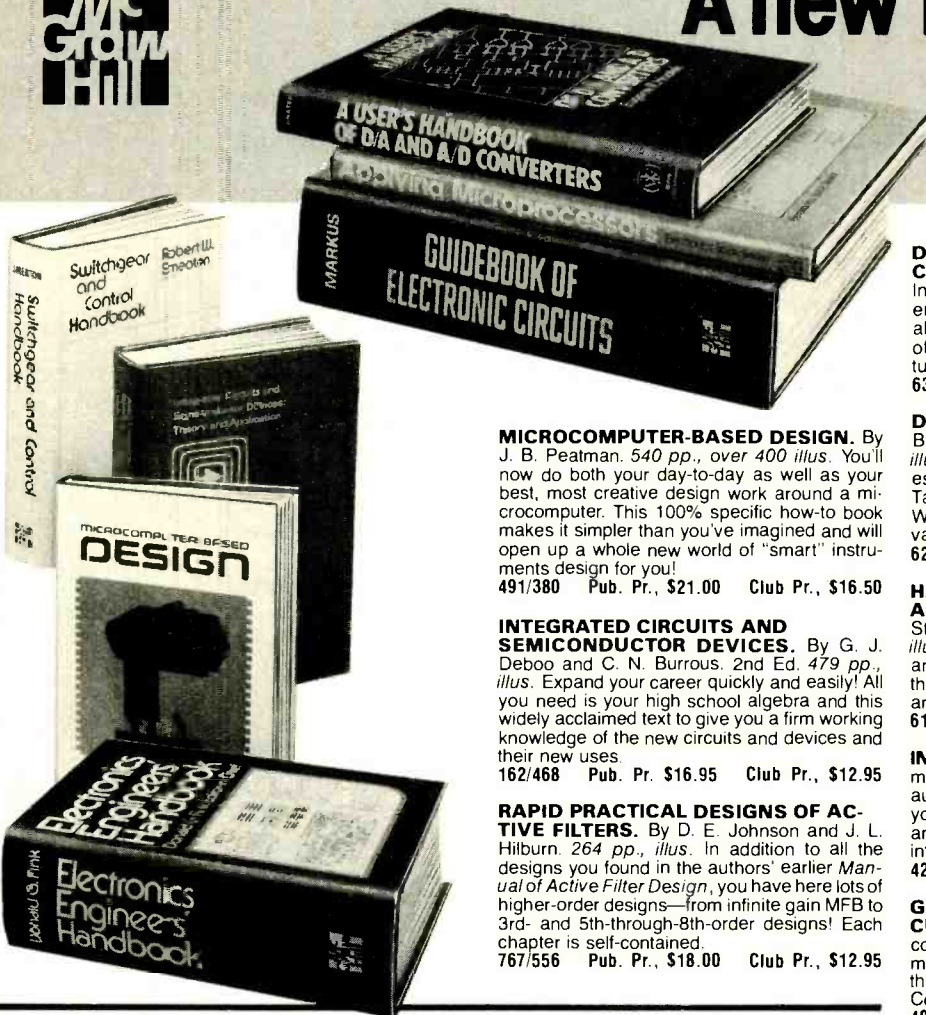

**DESIGNING WITH TTL INTEGRATED CIRCUITS.** By IC Applications Staff of Texas Instruments, Inc. 322 pp., 399 illus. For general, technical, and non-engineer managers, all the information you need to get the most out of TTL devices—their design, economics, features, performance, applications. 637/458 Pub. Pr., \$28.50 Club Pr., \$19.50

**DIGITAL INTEGRATED ELECTRONICS.** By H. Taub and D. Schilling. 650 pp., profusely illus. Ideal for self-study and self-testing, this essential textbook picks up where Millman and Taub's "Pulse, Digital and Switching Waveforms" left off and gives you every advance in the field. Solve the 400 problems! 629/218 Pub. Pr., \$21.95 Club Pr., \$16.95

**HANDBOOK OF OPERATIONAL AMPLIFIER CIRCUIT DESIGN.** By D. F. Stout. Edited by M. Kaufman. 434 pp., 223 illus. Compact, concise, highly concentrated, and containing a storehouse of information, this one-stop volume will help you solve any op amp circuit problem! 617/97X Pub. Pr., \$29.65 Club Pr., \$17.50

**INTEGRATED ELECTRONICS.** By J. Millman and C. C. Halkias. 850 pp., illus. Two top authorities give you the information and data you want on the design and analysis of both analog and digital circuits, plus systems using integrated circuits as basic building blocks. 423/156 Pub. Pr., \$22.50 Club Pr., \$15.95

**GUIDEBOOK OF ELECTRONIC CIRCUITS.** By J. Markus. 1,018 pp., illus. Are you constantly on the lookout for circuits that will meet your needs? Here's a giant collection of them to use "as is" or to adapt to your own ideas. Complete with values. 404/453 Pub. Pr., \$29.50 Club Pr., \$21.50

**MICROCOMPUTER-BASED DESIGN.** By J. B. Peatman. 540 pp., over 400 illus. You'll now do both your day-to-day as well as your best, most creative design work around a microcomputer. This 100% specific how-to book makes it simpler than you've imagined and will open up a whole new world of "smart" instruments design for you! 491/380 Pub. Pr., \$21.00 Club Pr., \$16.50

**INTEGRATED CIRCUITS AND SEMICONDUCTOR DEVICES.** By G. J. Deboo and C. N. Burrous. 2nd Ed. 479 pp., illus. Expand your career quickly and easily! All you need is your high school algebra and this widely acclaimed text to give you a firm working knowledge of the new circuits and devices and their new uses. 162/468 Pub. Pr. \$16.95 Club Pr., \$12.95

**RAPID PRACTICAL DESIGNS OF ACTIVE FILTERS.** By D. E. Johnson and J. L. Hilburn. 264 pp., illus. In addition to all the designs you found in the authors' earlier *Manual of Active Filter Design*, you have here lots of higher-order designs—from infinite gain MFB to 3rd- and 5th-through-8th-order designs! Each chapter is self-contained. 767/556 Pub. Pr., \$18.00 Club Pr., \$12.95

**DICTIONARY OF SCIENTIFIC & TECHNICAL TERMS.** McGraw-Hill. 452/571 Pub. Pr., \$39.50 Club Pr., \$29.50

**CALCULUS FOR ELECTRONICS.** 2nd Ed. By A. Richmond. 523/517 Pub. Pr., \$13.95 Club Pr., \$9.95

**OPERATIONAL AMPLIFIERS: Theory & Practice.** By J. K. Roberge. 772/371 Pub. Pr., \$21.95 Club Pr., \$16.95

**SWITCHGEAR AND CONTROL HANDEOOK.** By R. W. Smeaton. 584/397 Pub. Pr., \$32.50 Club Pr., \$24.95

**STANDARD HANDBOOK FOR ELECTRICAL ENGINEERS.** 10th Ed. By D. J. Fink and J. M. Carroll. 209/731 Pub. Pr., \$44.50 Club Pr., \$28.50

**THE POTENTIOMETER HANDBOOK.** By Bourns, Inc. 066/906 Pub. Pr., \$21.50 Club Pr., \$16.95

**BUCHSBAUM'S COMPLETE HANDBOOK OF PRACTICAL ELECTRONIC REFERENCE DATA.** By W. J. Buchsbaum. 770/271 Pub. Pr., \$16.95 Club Pr., \$13.50

**OPTOELECTRONICS APPLICATIONS MANUAL.** By Hewlett-Packard. 286/051 Pub. Pr., \$19.25 Club Pr., \$14.50

**STANDARD HANDBOOK OF ENGINEERING CALCULATIONS.** T. G. Hicks. 287/341 Pub. Pr., \$24.95 Club Pr., \$17.95

**A USER'S HANDBOOK OF D/A and A/D CONVERTERS.** By E. R. Hnatek. 767/149 Pub. Pr., \$24.95 Club Pr., \$18.50

**ELECTRONIC COMMUNICATION.** By R. L. Shrader. 3rd Ed. 798 pp., 810 illus. Check-up quizzes throughout and FCC test questions, plus up-to-date coverage of solid-state, microwave, and digital data communications give the electronic technician authoritative concrete help. 571/384 Pub. Pr., \$15.95 Club Pr., \$11.50

**DIGITAL COMPUTER ELECTRONICS.** By A. P. Malvino. 404 pp., illus. Use your dc-ac theory and elementary knowledge of diodes and transistors to take full advantage of every diagram, circuit, table, posed problem, and given answer in this 100% clarifying guide to computers and microprocessors! 398/615 Pub. Pr., \$13.95 Club Pr., \$10.95

**ELECTRICAL ENGINEERING FOR PROFESSIONAL ENGINEERS' EXAMINATIONS.** By J. Constance, 3rd Ed. 537 pp., illus. Pass your P.E. exam the very first time! Yes, this ever-popular book has helped tens of thousands of engineers to do just that. The updated, expanded material, the facts, know-how, and answers are all here to make passing easier! 124/485 Pub. Pr., \$19.50 Club Pr., \$13.95

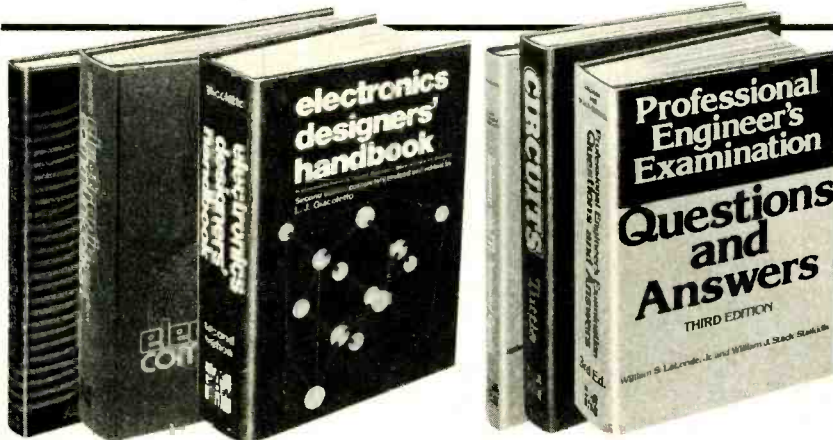

# offer to new members of the and Control Engineers' Book Club

**ELECTRONICS ENGINEER'S HANDBOOK.** Editor-in-Chief, D. G. Fink. 2,104 pp., 2,026 illus. Huge in every sense, this instant-reference volume gives you every latest essential in the field, 2,100 formulas and equations, a 2,500-item bibliography, and every illustration you need to clarify all of modern electronics! 209/804 Pub. Pr., \$45.50 Club Pr., \$33.50

**CIRCUITS.** By D. F. Tuttle, Jr. 820 pp., 1,148 illus. It's all here—complete coverage of circuits, what they are, their true nature, and how to analyze them! Topics range from RD and RLC circuits to networks and Laplace transformations. 655/91X Pub. Pr., \$21.50 Club Pr., \$16.95

**PROFESSIONAL ENGINEERS' EXAMINATION QUESTIONS AND ANSWERS.** By W. S. LaLonde, Jr., and W. J. Stack-Staikidis. 3rd Ed. 601 pp., 276 illus. Over 500 questions and complete answers—suitable for all states—prepare you for passing your exams for the E.I.T. certificate and your P.E. license. 360/936 Pub. Pr., \$16.50 Club Pr., \$13.75

**APPLICATIONS OF OPERATIONAL AMPLIFIERS.** By J. G. Graeme. 256 pp., illus. Written with your needs as a designer in mind, this guide on new op-amp technology and its applications was prepared by the Burr-Brown people. This alone would make it one of your most valuable working aids! 238/901 Pub. Pr., \$19.50 Club Pr., \$11.95

**HANDBOOK FOR ELECTRONICS ENGINEERING TECHNICIANS.** By M. Kaufman and A. H. Seidman. 520 pp., 695 illus. Rely on this technician's godsend for all your work with analog and digital integrated and discrete circuits. Here are the stiff brush-up you want and the solutions to every possible problem. 334/013 Pub. Pr., \$21.50 Club Pr., \$15.95

**APPLYING MICROPROCESSORS.** Edited by L. Altman and S.E. Scrupski. 200 pp., 8½ x 11, illus. Keep yourself constantly abreast with the new hardware, the new software, and the new applications with this *Electronics* magazine book that advances your technology beyond the previous book *Microprocessors*. You're now into second and third generation devices and their almost unlimited uses! 191/603 Pub. Pr., \$15.00 Club Pr., \$12.50

**DIGITAL INTEGRATED CIRCUITS AND OPERATIONAL AMPLIFIER AND OPTOELECTRONIC CIRCUIT DESIGN.** Edited by B. Norris. 206 pp., 400 illus. Having this vast amount of case-tested data, proven shortcuts, worked-out circuit designs, and circuit diagrams handy saves you valuable time for your other, more vital, areas of creative design—and cuts down costs in all areas! 637/539 Pub. Pr., \$16.50 Club Pr., \$12.50

**ELECTRONICS DESIGNERS' HANDBOOK.** Edited by L. J. Giacoletto. 2nd Ed. 2,344 pp., 1,686 illus. Now doubled in size and with 90% of its material new, this famous classic (first edition by Landee, Davis, Albrecht) has been thoroughly revised and updated to give you not only the *how* and the *why* of all your design work but also the *how much* of every design step you take! 231/494 Pub. Pr., \$47.50 Club Pr., \$37.50

**HANDBOOK OF ENGINEERING FUNDAMENTALS.** By a team of specialists headed by O.W. Eshbach (deceased) and M. Souders. 3rd Ed. 1,562 pp., illus. Yes, this is the famous Eshbach classic, ready in its present edition to save you untold time and work by giving you the latest facts, techniques, drawings, and data needed to solve problems faster than ever! 769/842 Pub. Pr., \$31.50 Club Pr., \$24.95

any one  
of these great  
professional books

for only **\$1.89**

values up  
to \$47.50

Special \$1.89 bonus  
book comes to you  
with your first  
club selection

## ELECTRONICS AND CONTROL ENGINEERS' BOOK CLUB saves you both time and money!

Here is a professional book club designed to meet your on-the-job engineering needs by providing practical books in your field on a regular basis at below publisher prices. If you're missing out on important technical literature—if today's high cost of reading curbs the growth of your library—here's the solution to your problem.

The *Electronics and Control Engineers' Book Club* was organized for you, to provide an economical reading program that cannot fail to be of value. Administered by the McGraw-Hill Book Company, all books are chosen by qualified editors and consultants. Their understanding of the standards and values of the literature in your field guarantees the appropriateness of the selections.

How the club operates: Every month you receive free of charge *The Electronics and Control Engineers' Book Club Bulletin*. This announces and describes the Club's featured book of the month as well as alternate selections available at special members' prices. If you want to examine the Club's feature of the month, you do nothing. If you prefer one of the alternate selections—or if you want no book at all—you notify the Club by returning the card enclosed with each Bulletin.

As a Club member, you agree only to the purchase of four books (including your first selection) over a two-year period. Considering the many books published annually, there will surely be at least four you would want to own anyway. By joining the Club, you save both money and the trouble of searching for the best books.

### MAIL COUPON TODAY

ELECTRONICS AND CONTROL ENGINEERS' BOOK CLUB  
P.O. Box 582, Princeton Road, Hightstown, New Jersey 08520

Please enroll me as a member and send me the two books indicated. I am to receive the bonus book at the introductory price of \$1.89 plus my first selection, plus tax, postage and handling. If not completely satisfied, I may return the books within 10 days and request that my membership be cancelled. If I keep the books, I agree to take a minimum of three additional books during the next two years at special Club prices (guaranteed 15% discount, often more). I will receive the Club Bulletin 13 times a year. If I want to examine the featured selection, I need take no action. It will be shipped automatically. If, however, I want an alternate selection—or no book at all—I simply notify the Club by returning the convenient card always enclosed. I will always have a minimum of ten days in which to return the card and you will credit my account fully, including postage, if this is not the case. Membership in the Club is continuous but cancellable by me at any time after the four-book purchase requirement has been filled. This order subject to acceptance by McGraw-Hill. Orders from outside the continental U.S. must be prepaid. All prices subject to change without notice. Offer good for new members only.

#### WRITE BELOW:

Code No. of \$1.89 book

Code # of 1st selection



NAME \_\_\_\_\_

ADDRESS \_\_\_\_\_

CITY \_\_\_\_\_

STATE \_\_\_\_\_ ZIP \_\_\_\_\_

EXTRA SAVINGS: Remit in full with your order, plus any local and state tax, and McGraw-Hill will pay all regular postage and handling charges.

E33342

CIRCLE 12 ON FREE INFORMATION CARD

www.americanradiohistory.com

# ARROW AUTOMATIC STAPLE GUNS

## CUT WIRE & CABLE INSTALLATION COSTS

... without cutting into insulation!

**SAFE!** Grooved Guide positions wire for proper staple envelopment! Grooved Driving Blade stops staple at right depth of penetration, to prevent cutting into wire or cable insulation!



**No. T-18—Fits wires up to 3/16" in diameter.**

BELL, TELEPHONE, THERMOSTAT, INTERCOM, BURGLAR ALARM and other low voltage wiring.

Uses T-18 staples with 3/16" round crown in 3/8" and 7/16" leg lengths.



**No. T-25—Fits wires up to 1/4" in diameter.**

Same basic construction and fastens same wires as No. T-18.

Also used for RADIANT HEAT WIRE

Uses T-25 staples with 1/4" round crown in 9/32", 3/8", 7/16" and 9/16" leg lengths



**NEW! Intermediate No. T-37—Fits wires and cables up to 5/16" in diameter.**

Same basic construction as Nos. T-18 & T-25.

Also used for CATV and DRIVE RINGS in stringing wires.

Uses T-37 staples with 5/16" round crown in 3/8", 1/2" and 9/16" leg lengths.

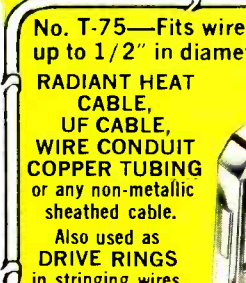

**No. T-75—Fits wires and cables up to 1/2" in diameter.**

RADIANT HEAT CABLE, UF CABLE, WIRE CONDUIT COPPER TUBING or any non-metallic sheathed cable.

Also used as DRIVE RINGS in stringing wires.

Uses T-75 staples with 1/2" flat crown in 9/16", 5/8" and 7/8" leg lengths.

**ARROW FASTENER COMPANY, INC.**  
271 Mayhall Street, Saddle Brook, N. J. 07663

### LETTERS continued from page 16

one's feelings, moments of efficiency, successes, etc., for several months. This would tend to show where the real peaks occurred. Then the clock could be set on a more rational basis. After all, we are all a little different. It would be truly amazing if the most consistent human trait (within a fraction of a percent) would be these Biorhythm Clock cycles.

PETER LEFFERTS  
San Martin, CA

Your letter indicates a general lack of enthusiasm for the biorhythm concept, which may be due to your not having been able to investigate the overwhelming amount of material on the subject. Of the 14 books I've run across, I recommend two. They are: *Is This Your Day?* by George S. Thommen (Avon paperback) and *The Complete Book of Biorhythm Life Cycles* by Dr. Robert E. Smith (Ardvark Publishers, New York). Both books are available at most bookstores.

Your comment regarding the extreme accuracy implied in life cycles that start at birth and stay on-schedule throughout one's lifetime is not so "fantastic" when one considers the "accuracy" of the universe, solar system, earth rotation, seasons, endocrine rhythms, etc. The swallows leave and come back to Capistrano on definite days each year. With the overwhelming influence of "rhythms," or cycles, on everything from the infinity of the universe to the tiny atom, it would certainly be surprising if all living things did not exhibit similar effects.

It was not the intention of the article to prove the existence of biorhythm cycles, just to provide an electronic device to display this information without constant calculation or reference to tables.

FRED BLECHMAN

I'll go along with the last paragraph in your letter and acknowledge that you have an interesting electronic project . . . lots of other applications too. Furthermore, I won't credit you with or complain about your "inventing" biorhythms.

Just for discussion, let's consider that most of the cycles in birds, animals, plants, etc., are *not* tied to the DAY they are born (if the swallows at Capistrano came back based on a rhythm starting the day they were *born*, the return would be spaced but over a month or so and wouldn't excite anyone. We have those very same swallows building nests in the eaves of our houses. They come back two to three days after Capistrano . . . but their family-raising is nowhere near that predictable!) According to the *American Scientist* (and other sources), such cycles are "corrected" by the actual daily or seasonal cycles.

Now, how about human cycles? There is no way of predicting the day five years from now when a female will start her "monthly" cycle. Emotion, health, etc., have a big effect. The age of maturity is not predictable. The nine-month gestation period is rather erratic.

Here's another thought. Many times "predictions" tend to become self-fulfilling. If a fortune teller, "the stars," or a comput-

er says today is an individual's *good* day, often he gets hyped up . . . and sure enough, he has a good day. (This has been proven with experiments involving teachers' attitudes towards their students.) But . . . fortune tellers (for obvious reasons) emphasize the good possibilities.

It is true I did not research the literature on biorhythms, but commonsense has some place, too.

PETER LEFFERTS  
San Martin, CA

### AMPAK ERROR

Thank you for featuring Pacer's *Ampak* in the December 1977 issue ("New Products"). But apparently an error was made in setting up the feature. The first line reads: "measures 1-8 amps DC." However, this should read "1-800 amps DC."

MICHAEL HUBER  
General Manager, Pacer Industries, Inc.  
Chippewa Falls, WI

### OOOOPS!

There are errors in the schematic of the digital capacitance meter on page 38 of the December 1977 issue. Capacitor C3 is .001  $\mu$ F as in the parts list; not .01  $\mu$ F. The number 6 pins of displays DIS1, DIS3 and DIS4 should go to R42, R43 and R44, respectively, instead of to the points indicated in the diagram.

### BRICKLAYING TECHNIQUES

Walter Cardwell's IC bricklaying techniques (December 1977 issue) lend themselves particularly well to an application no one mentioned in the article—computer memory construction.

Memory IC's are usually connected to each other in parallel, except for the input, the output and, sometimes, the chip select pins. To make a 1K  $\times$  8 memory using eight 2102's, for example, trim only the input and output pins, as in the article. Stack the IC's one on top of the other, and solder the common leads together.

For nK  $\times$  8, trim the IC select pin on the bottom of each 1K  $\times$  8 block, and stack the blocks. If you must have sockets, you can use Molex pins soldered to each IC to hold the one above it. However, this technique will not be as sturdy as direct soldering, and the stacks will be taller. On the plus side, this method allows easier cooling. Of course, the heat-sinking methods described in the article should be used where necessary. For memory expansion, Mr. Cardwell's method saves the cost of a rather expensive PC board.

EVERETT B. OGDEN  
Delmar, NY

### VIDEO MODULATOR

Please advise any of your readers who plan on building the video modulator (*Radio-Electronics*, August, 1977, page 33) that the "complete" kit of parts does not include the printed circuit board for the switch nor the bottom RF shield.

In addition, Delta Electronics also charges postage and handling. This is not mentioned in the parts list on page 34.

ELMER P. VANDENBURGH  
La Grange, IL

RADIO-ELECTRONICS

# A dollar says Sound Guard<sup>®</sup> keeps your Bach, Blues and Boogie perfectly preserved.

Audio experts have called our Record Preservation Kit "the best thing for records since vinyl!"

Now Sound Guard will pay you \$1 to prove the strength of their judgement. Simply purchase the Preservation Kit from your audio or record dealer and send us the coupon below with proof of purchase. We'll send you your dollar.

Independent tests prove records played 100 times show the same absence of surface noise and distortion, when regularly treated with Sound Guard, as a new record played once in "mint condition." Sound Guard protection lasts. However, this offer ends July 31, 1978. So don't delay.

## Sound Guard<sup>®</sup> keeps your good sounds sounding good.

Ball Sound Guard preservative—Sound Guard cleaner—Sound Guard Total Record Care System. Sound Guard is Ball Corporation's registered trademark. Copyright © Ball Corporation, 1978. Muncie, IN 47302



**SOUND GUARD RECORD PRESERVATION KIT**

Good for one dollar refund if accompanied by proof of purchase from a Sound Guard Record Preservation Kit. To redeem, clip the contents photo, etc., of a Sound Guard Record Preservation Kit outer package and mail, with this coupon, to Sound Guard Refund Offer, P.O. Box 5003, Muncie, IN 47302. Offer expires July 31, 1978. Good in U.S. and Canada only. Void where taxed, prohibited or otherwise restricted.

**COUPON**

NAME \_\_\_\_\_  
 ADDRESS \_\_\_\_\_  
 CITY \_\_\_\_\_  
 STATE/ZIP \_\_\_\_\_

**ONE DOLLAR REFUND**

RE-1

CIRCLE 71 ON FREE INFORMATION CARD

www.americanradiohistory.com

# equipment reports

## Motorola Educator II Microcomputer Kit



CIRCLE 101 ON FREE INFORMATION CARD

THE MOTOROLA EDUCATOR II HEP KIT IS AN M6800 microcomputer system learning tool designed with future expansion in mind. Data is entered through eight toggle switches, and the system is controlled by three additional center-off, spring-loaded toggle switches. The binary data-output display consists of eight discrete LED's. A ninth LED is extinguished when the processor is running. To power the unit an external 5-volt, 1-amp supply such as

the Motorola *HK1001* is required. A beginner should start out by confronting data and instructions on a bit-by-bit basis with the toggle switches. As he advances, the computerist will seek more convenient modes of operation, and can add more sophisticated keyboard and display systems through two 44-pin edge connectors.

The *Educator II* microcomputer board uses a HEP version of the M6800 (HEP C4801), two IC's with 512 words of RAM that contain utility programs, 128 words of user RAM and a C4821 peripheral interface adapter (PIA) with 16 inputs and outputs, and some hand-shaking leads.

The M6800 is a popular microprocessor with a versatile architecture that uses two 8-bit accumulators, a 16-bit index register, a 16-bit program counter, a 16-bit stack pointer and an 8-bit condition code register (CCR).

The ROM firmware, DBUG, has routines for loading, reading and running user programs. It also contains a cassette tape routine. This produces an audio output and deposits specified portions of RAM into an external cassette tape recorder. A complementary read routine is intelligent enough to search a tape

for a file number indicated by the data-switch settings.

The M6800 microprocessor recognizes the software interrupt instruction (SWI) code 3F. When the microprocessor encounters this instruction, a vectored jump to DBUG saves the status of the accumulators, index register, program counter and CCR in RAM locations 00F4 through 00FA. This is an invaluable troubleshooting aid. You can, by inserting SWI instructions in crucial locations in the program, interrupt program execution at those places so that you can inspect the registers and memory contents.

The 128 words of RAM provided with the kit are assigned addresses from 0080 to 00FF, with the last 14 locations, F2 through FF, reserved for use by the DBUG firmware. There is enough board space for an additional 128 words from 0000 to 007F. Larger blocks of memory can be added externally using one of the 44-pin connectors and proper address decoding.

To read memory, the upper and lower bytes of the address to be inspected are entered with the data switches and the LOAD LEAST SIGNIFICANT and LOAD MOST SIGNIFICANT switches.

Finding the right semiconductor replacement is easy with....

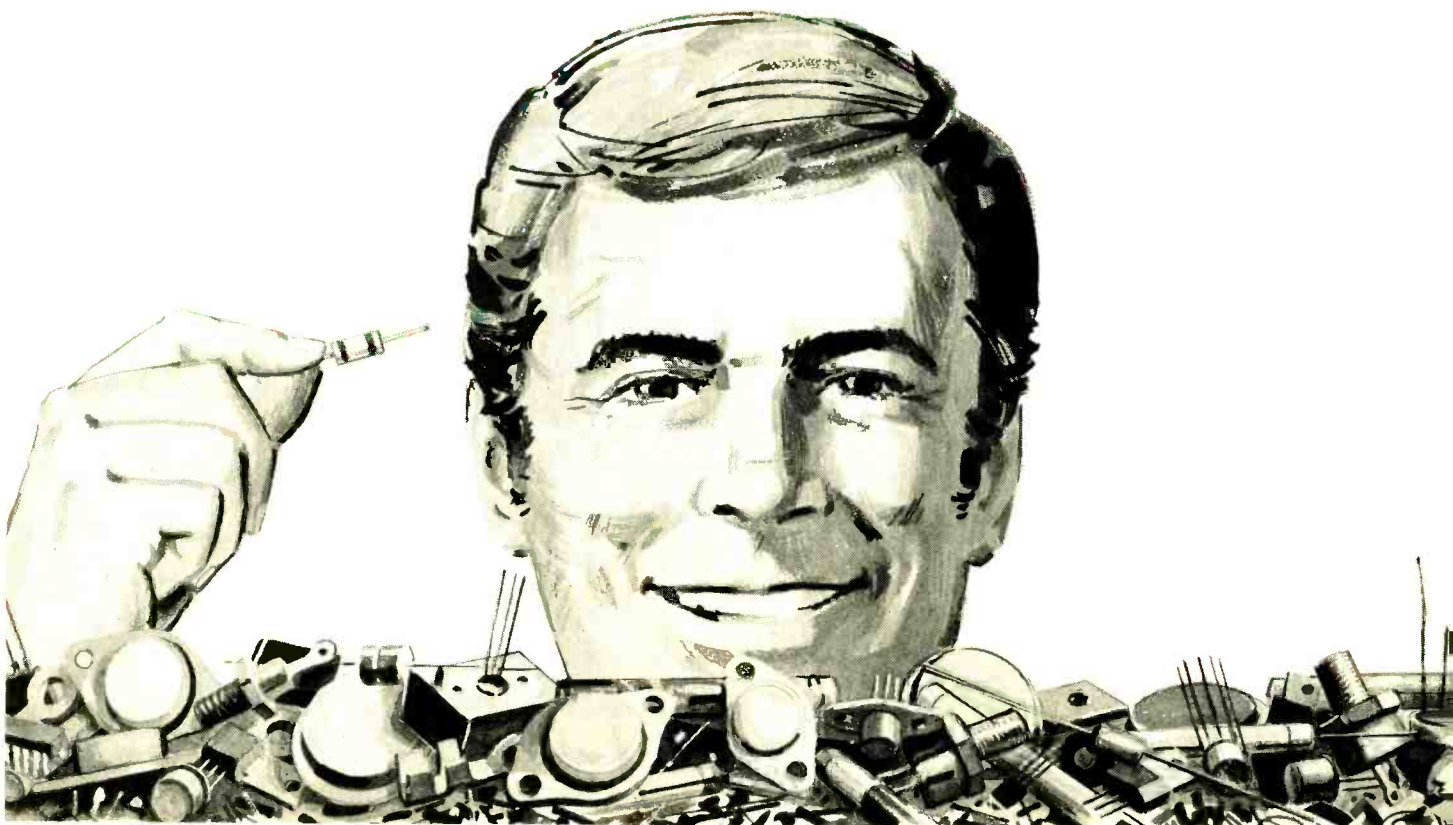



**LEADER**  
Instruments Corp.

LCR-740 TRANSISTORIZED LCR BRIDGE

40 = = 40

REG. \$299.95

**SAVE \$40.**

SPECIAL  
**\$259.95**



Offer expires

**40** May 30, 1978 **40**



The EXAMINE switch is then used to sequentially inspect memory locations starting at that address. Memory contents are read out in binary by the 8 data LED's. Each time you depress the EXAMINE switch, the lower byte of the address being examined is displayed on the LED readout. Releasing the switch displays the memory contents. Storing programs or data into memory is similar except that the STORE switch is used and data is entered by the data switches. Running a program is a bit more complicated since the program starting address must first be stored in the DEBUG program counter storage locations 00F9 and 00FA. Then the GO/HALT switch is toggled to initiate processing.

The manual includes kit assembly instructions, an explanation of the microcomputer hardware, some theory of number systems, suggestions on writing programs, operating instructions and application programs. A schematic and a firmware listing are included. However, only one of the two pages of firmware is listed, but this may be due to the early edition of the manual. The other page is easily read out using the EXAMINE facility.

*turn page*

**SPECIFICATIONS**

|                                |  |
|--------------------------------|--|
| <b>Resistance Measurement</b>  |  |
| Range                          | 0.001 ohm - 11M ohm<br>0.1 ohm, 1 ohm, 10 ohms, 100 ohms,<br>10kOhms, 100kOhms, 1Mohm 8 ranges   |
| Over-Range                     | 10%  |
| Resolution                     | 1m ohm   |
| Accuracy                       | 1 ohm - 100kOhm range $\pm(0.5\% + 0.1\% \text{ F.S.})$<br>1Mohm range $\pm(1\% + 0.1\% \text{ F.S.})$<br>0.1ohm range $\pm(2\% + 0.1\% \text{ F.S.})$ |
| Residual Resistance            |  |
|                                | approximately 3m ohm   |
| <b>Capacitance Measurement</b> |  |
| Range                          | 1pF - 11,000 uF<br>100pF, 1000pF, 0.01uF, 0.1uF, 10uF,<br>100uF, 100uF 8 ranges  |
| Over-range                     | 10%  |
| Resolution                     | 1pF  |
| Accuracy                       | 100pF - 100uF range $\pm(0.5\% + 0.1\% \text{ F.S.})$<br>100pF range $\pm(1\% + 0.1\% \text{ F.S.})$<br>1000uF range $\pm(3\% + 0.1\% \text{ F.S.})$   |
| Residual                       |  |
|                                | approximately 3pF  |

- Highly accurate 3 unit digital readout.
- Measures inductance (L), Capacitance (C), and Resistance (R), within  $\pm 0.5\%$  accuracy.

|                               |   |
|-------------------------------|---|
| <b>Inductance Measurement</b> |   |
| Range                         | 0.1uHenry - 1100H<br>10uH, 100uH, 1mH, 10mH, 100mH, 1H,<br>10H, 100H 8 ranges   |
| Over-range                    | 10%   |
| Resolution                    | 0.1uH   |
| Accuracy                      | 100uH - 10H range $\pm(0.5\% + 0.1\% \text{ F.S.})$<br>100H range $\pm(1\% + 0.1\% \text{ F.S.})$<br>10uH range $\pm(3\% + 0.1\% \text{ F.S.})$ |
| Loss Factor Ranges (D)        |   |
|                               | 0.01 - 30.2 ranges<br>Accuracy $\pm(10\%$ of reading + 3 minor divisions of scale) 1KHz:  |
| Frequency                     |   |
|                               | Int. 1KHz $\pm 50\text{Hz}$<br>Ext. 50Hz - 40KHz  |
| Power Supply                  |   |
|                               | 1-9VBatt'y (006p) or AC adapter   |
| Size and Weight               |   |
|                               | 3 7/8"H x 9 1/2"W x 6 3/4"D; 5 lbs.   |

212-687-2224

**THE TEST EQUIPMENT SPECIALISTS**

**TOLL FREE HOT LINE**  
**800-223-0474**

54 West 45 Street, New York, N.Y. 10036

**ADVANCE**  
**ELECTRONICS**

# RCA's all new 1978 Replacement Guide!

**RCA's biggest and most complete Guide, ever.** Our comprehensive line of replacement transistors, rectifiers, thyristors, integrated circuits, and high voltage triplers has now grown to over 750 SKs that replace 143,000 domestic or foreign semiconductors. *And it's all under one cover.*

**It's an encyclopedia of solid state replacements.** The new Guide includes 387 SKs which have been added to the line since February 1977. It contains 240 pages that represent thousands of hours of engineering know-how.

**Everything you need to stay up-to-date.** The new Guide covers consumer, TV, Hi-Fi, CB and industrial applications. And more importantly, they're available from your RCA SK distributor. And remember, too, that every RCA SK is backed up by RCA. They're Top-of-the-Line quality.

**Ask your RCA Distributor for a copy** of the 1978 SK Replacement Guide. Or write, enclosing \$1.50, (check or money order) to: RCA Distributor and Special Products Division, PO Box 85, Runnemede, NJ 07078.

**RCA** SK Replacement  
Solid State



Kit assembly is straightforward, but, as with all computer kits, it requires meticulous soldering technique. The PIA with its complex control and data-direction register structure is described adequately. Each microprocessor instruction and the six addressing modes are described in detail.

Inevitably, when you debug programs, you must add or delete instructions. Assuming there is sufficient memory space, deleting instructions can be as simple as overwriting with no-operation commands. Adding instructions, though, means moving every instruction following the added instruction. The alternate technique of inserting patches or jumps to other parts of memory is both slow and wasteful of memory. The manual presents one short application program that moves all the instruc-

tions down one memory location, starting at the location where the addition is to be made, and inserts the added instruction at that point. The program can be executed repeatedly so multiple word instructions or a series of instructions can be inserted sequentially by depressing GO as many times as required. A delete-data program works similarly, taking out one word at a time by moving all subsequent program steps up one byte and overwriting the instruction being removed. (It's a big help.)

*Educator II* looks like a good way to get going with a capable microprocessor that has the capability to grow. The *HEP Kit* is priced at \$169.95. For more information, write Motorola HEP/MRO Operations, 705 West 22nd Street, Tempe, AZ 85282. **R-E**

## Mindblower Model PS-69RD Stereo Speaker/Amplifier

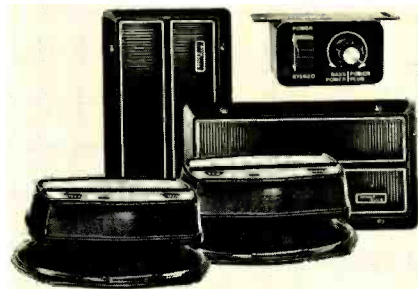

**CIRCLE 102 ON FREE INFORMATION CARD**

WHEN I WAS ASKED TO TEST TENNA CORPORATION'S *Mindblower*, model PS-69RD, car stereo speaker/amplifier system, I took one look at the spec sheet and flinched. At that time, the mere thought of 60 watts of audio—30 watts rms-per-channel—in a car that I would be driving was indeed mindblowing. I couldn't conceive of anyone using, or even wanting, 60 watts of audio for a car stereo setup.

I reluctantly agreed to test the *Mindblower* when I realized that I could install it at the same time as the model XTAL XA-909 FM stereo radio/cassette player I had just bought to go in my 1973 Gas Guzzler. I had not yet selected the stereo speakers for the rear-deck installation, so why not use the *Mindblower* instead? It could be installed with the same amount of labor.

When the amplifier/speaker system arrived from the factory, I was impressed with its appearance. The system consists of two heavy wide-range 6 × 9-inch speakers, chrome-trimmed black plastic grilles and a small control unit.

The back of each speaker (see photo) has an oblong case that covers and protects the 30-watt amplifier that is arranged around the heavy ceramic speaker magnet. A glance at the owners' instructions showed that the installation would be fairly simple. I'd need help at only one point—someone had to crawl into the trunk and hold the speakers in place while I inserted the mounting screws from inside the car.

### Installation was a breeze

Everything went smoothly. The FM radio/cassette player was hung under the dashboard on a *Mount 'n Lock* CB installation bracket. (The bracket is fastened to the dashboard with four heavy bolts. The car stereo is held in the *Mount 'n Lock* bracket by two locking nuts that must be unlocked with a key before the radio can be removed.) The *Mindblower* control box was mounted close by. Each speaker/amplifier unit has four leads. Two leads are for power—one fused for the 12-volt positive supply and one for the power ground; the other leads are for audio. Only three wires run back to the speakers—the +12-volt line and the two hot speaker leads. The negative power lead and the audio return leads are grounded to the car's chassis close to one of the speakers.

The three leads from the control box were tucked up behind the dashboard and run across to one side, down behind one of the kick panels, inside the channel under the door sills and under the rear seat into the trunk area. My car, like many others today, has cutouts for 6 × 9-inch speakers in the metal underside of

# DR22 Receiver

## Fully Synthesized General Coverage Receiver from McKAY DYMEK



### FEATURES

- Shortwave, CB, ham radio, ships at sea, overseas phone calls, etc.
- Hi Fi, SWL, commercial, industrial and government uses.
- High level RF front end for excellent intermodulation rejection and sensitivity.
- Crystal filters in first and second IF amplifiers, ceramic filter in third IF.
- Quartz crystal tuning accuracy at all frequencies, no crystals to buy.
- Built in power supply for 110-120 or 220-240 VAC switchable, 50-60 Hz.
- Low Phase Noise Synthesizer
- Solid state, phase locked, digital synthesis tuning.
- Extreme ease of tuning at all frequencies.
- No mechanical tuning dial error or backlash.
- Switch selectable 4 or 8 kHz RF bandwidth.
- Built in monitor speaker with external speaker connectors.
- Switchable impulse noise limiters for AM and SSB.

### SPECIFICATIONS

|                                  |   |                |                  |                  |               |
|----------------------------------|---|----------------|------------------|------------------|---------------|
| ■ Frequency coverage:            | 50 kHz to 29.7 MHz, continuous. Digital synthesis in 5 kHz steps, fine tune for ±5 kHz.   |                |                  |                  |               |
| ■ Reception modes:               | AM, upper sideband, lower sideband, CW.   |                |                  |                  |               |
| ■ Sensitivity for 10 dB S + N/N: | 100 kHz   | 200 kHz        | 300 kHz-29.7MHz  |                  |               |
|                                  | CW, SSB<br>AM   | 10 μV<br>30 μV | 2.0 μV<br>6.0 μV | 0.5 μV<br>1.0 μV | CW, SSB<br>AM |
| ■ Selectivity:                   | -3dB @ ±2 kHz or ±4 kHz and -60dB @ ±5 kHz or ±6 kHz                                      |                |                  |                  |               |
| ■ Dimensions & Wt.:              | (W x D x H) 17.5 x 14.5 x 5.1 inches. Shpg. Wt. 19 lbs. (8.7 Kg)                          |                |                  |                  |               |
| ■ Frequency stability:           | Within ±40 Hz in any 8 hour period at a constant ambient of 25C, after 30 minute warm up. |                |                  |                  |               |
| ■ Circuitry:                     | 43 integrated circuits, 18 transistors, 16 FETs and 54 diodes.                            |                |                  |                  |               |

Order factory direct.  
Exclusive rent/own plan  
available in U.S.



**McKay Dymek Co.**  
111 South College Ave  
Claremont, CA 91711



**Nationwide**  
800/854-7769  
**California**  
800/472-1783

In Canada  
**WSI Sales Company**  
18 Sheldon Avenue North  
Kitchener, Ontario. N2H 3M2

**Great Metropolitan  
Sound Co. Ltd.**  
120 Eglinton Avenue East  
Toronto, Canada M4P 1E2

**CIRCLE 31 ON FREE INFORMATION CARD**

the rear deck. All I had to do was crawl into the trunk and use an icpick to punch up through the speaker mounting holes into the car. The holes are guides for positioning the grille and for cutting away the pressed board and leatherette finish on the rear deck. With my son in the trunk holding the speakers, I was able to get the four mounting screws for each speaker through the grilles and into the speed nuts on the speaker frames. Tightening the screws was a problem.

(The rear window on my car has a very sharp slope and is quite rounded on the sides. This feature, along with the positions of the speaker cutouts, made it impossible to use any of the standard screwdrivers that I owned.) A borrowed 3-inch stubby Phillips screwdriver enabled me to tighten two screws in each speaker. The other two screws were left loose while I spent several weeks finding and buying an offset (right-angle) screwdriver.

### Great sound

The control box has a two-position slide switch to select the output mode and a potentiometer to control bass boost and volume level. The switch, when in the STEREO position, lets you hear your stereo radio or tape player output at about the volume level that would be available minus the *Mindblower*. The output voltage of the radio or tape player is attenuated so that when the signal passes through the *Mindblower*, it emerges at about the normal level. The switch placed in the POWER position lets the full radio or tape deck output voltage drive the *Mindblower* amplifiers up to maximum power output. This voltage is tapped off a frequency-selective network by the poten-

tiometer.

At first, on drives around town, I listened to FM radio and tapes with the switch in the STEREO position. The car-filling sound was great. The sensation was similar to listening through stereo headphones. The bass was solid and the highs crisp—a credit to the *Mindblower* and the FM radio.

On a long drive at highway speeds, road and wind noises intruded on the radio's sound. I was annoyed when I found that outside noises were still interfering even with the volume control set at maximum. Then, I remembered the *Mindblower* mode switch and threw it to POWER. Wow! What a difference. I now had the volume to override outside noises. Maximum power was available with the potentiometer fully clockwise in the POWER PLUS position. Bass boost is added to the output when the control is in its fully counterclockwise BASS POWER position.

The sound is clean at all levels. The maximum volume level can be set with the potentiometer on the control box. You can set intermediate levels with the radio's volume control. I was surprised to find the *Mindblower* very tolerant of audio input driving power. Overload distortion was not noticeable until the set's volume control and the level control on the *Mindblower* were both advanced to maximum. Backing off either control reduced the distortion without appreciably reducing the volume level.

### I'm convinced

There is a place for high-power audio in car radio systems. It is a must if you want to listen to music with the same ease and freedom from

distractions that you have in your living room. On the road, you seldom realize just how loud you are playing the radio until you stop at a light or toll booth. The sound now is often overpowering. This gives a good indication of the sound level you need to overcome outside noises.

### Is high-power audio for you?

If you should ask if high-power stereo in your car is for you, I'd say yes! For no matter how you feel about loud music in the quiet of your listening room, you need more power if you want the same ratio of signal to outside noise that you enjoy at home.

There are other audio power boosters available, but the *Mindblower* is the only one I know of that combines the amplifiers with especially tailored hi-fi speakers. So, if you want boosted audio, consider this system. It goes in real easy and the sound is mighty good. The price is also right at \$69.95 from Tenna Corporation, 19201 Cranwood Parkway, Cleveland, OH 44128, or available at your local car stereo dealer.

(Note: If you go for the *Mindblower* or any other audio power booster that requires placing the amplifiers under the seat or in the trunk, **do not** rely solely on the fuse in the car's accessory circuit and the fuse at or in the amplifier. Use an independent fuse just for the amplifier and connect it to the hot supply lead as closely as possible to the car's fuse block. Select a fuse that is just heavy enough to hold up under maximum-volume power drain.)

The *Mindblower* has two fuses: one in the hot line about 6 inches from each speaker/  
*continued on page 32*

## A P BROUGHT YOU SOLDERLESS BREADBOARDING. NOW WE'VE ADDED POWER.

### Introducing POWERACE, the new line of ACE All Circuit Evaluators.

POWERACE—for fast, solderless circuit building and testing. All models will accept all DIP sizes—plus TO-5's and discretes with leads to .032" diameter. POWERACE 101 has a variable 5-15 VDC 600 ma Power supply. POWERACE 102 features a fixed 5VDC 1 amp power supply; and POWERACE 103 has a fixed 5VDC 750 ma power supply, a fixed +15VDC 250 ma power supply, and a fixed -15VDC power supply at 250 ma.

Order from your A P distributor today. For the name of the distributor nearest you call Toll-Free 800-321-9668.

**Faster and Easier is what we're all about.**



**A P PRODUCTS INCORPORATED**

Box 110 • 72 Corwin Drive, Painesville OH 44077  
(216) 354-2101 TWX: 810-425-2250



MODEL #103  
\$124.95

MODEL #101 \$84.95

MODEL #102  
\$114.95

CIRCLE 3 ON FREE INFORMATION CARD

www.americanradiohistory.com

“If you’re going to learn electronics, you might as well learn it right!”

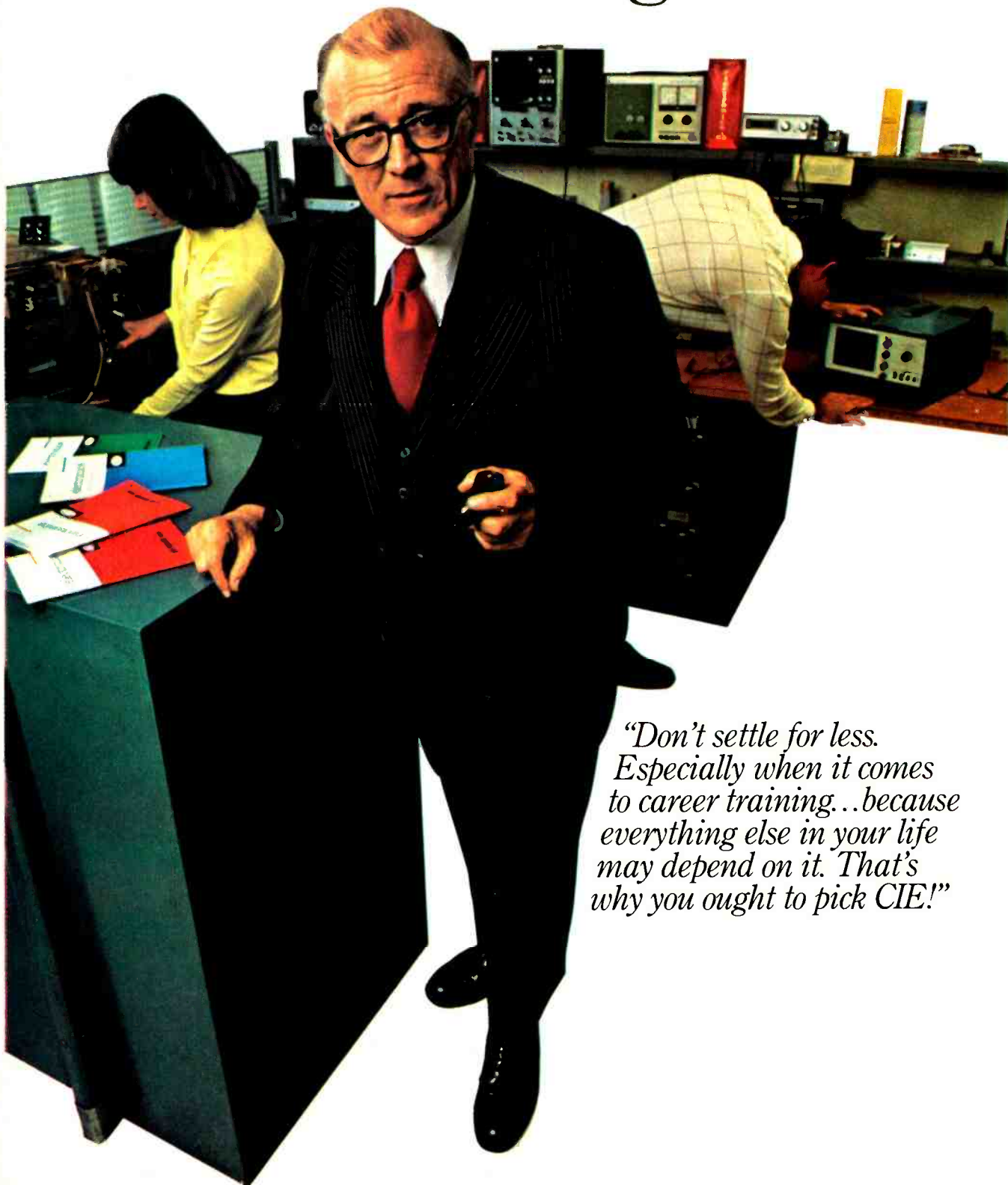

*“Don’t settle for less. Especially when it comes to career training...because everything else in your life may depend on it. That’s why you ought to pick CIE!”*

**You've probably seen advertisements from other electronics schools. Maybe you think they're all the same. They're not!**

**CIE is the largest independent home study school in the world that specializes exclusively in electronics.**

...

**Meet the Electronics Specialists.**

When you pick an electronics school, you're getting ready to invest some time and money. And your whole future depends on the education you get in return.

That's why it makes so much sense to go with number one...with the specialists...with CIE!

**There's no such thing as bargain education.**

If you talked with some of our graduates, chances are you'd find a lot of them shopped around for their training. Not for the lowest priced but for the best. They pretty much knew what was available when they picked CIE as number one.

We don't promise you the moon. We do promise you a proven way to build valuable career skills. The CIE faculty and staff are dedicated to that. When you graduate, your diploma shows employers you know what you're about. Today, it's pretty hard to put a price on that.

**Because we're specialists, we have to stay ahead.**

At CIE, we've got a position of leadership to maintain. Here are some of the ways we hang onto it...

**Our step-by-step learning includes "hands-on" training.**

At CIE, we believe theory is important. And our famous Auto-Programmed® Lessons teach you the principles in logical steps.

But professionals need more than theory. That's why some of our courses train you to use tools of the trade like a 5 MHz triggered-sweep, solid-state oscilloscope you build yourself—and use to practice troubleshooting. Or a beauty of a 19-inch diagonal Zenith solid-state color TV you use to perform actual service operations.

**Our specialists offer you personal attention.**

Sometimes, you may even have a question about a specific lesson. Fine. Write it down and mail it in. Our experts will answer you promptly in writing. You may even get the specialized knowledge of all the CIE specialists. And the answer you get becomes a part of your permanent reference file. You may find this even better than having a classroom teacher.

**Pick the pace that's right for you.**

CIE understands people need to learn at their own pace. There's no pressure to keep up...no slow learners hold you back. If you're a beginner, you start with the basics. If you already know some electronics, you move ahead to your own level.

**Enjoy the promptness of CIE's "same day" grading cycle.**

When we receive your lesson before noon Monday through Saturday, we grade it and mail it back—the same day. You find out quickly how well you're doing!

**CIE can prepare you for your FCC License.**

For some electronics jobs, you must have your FCC License. For others, employers often consider it a mark in your favor. Either way, it's government-certified proof of your specific knowledge and skills!

More than half of CIE's courses prepare you to pass the government-administered exam. In continuing surveys, nearly 4 out of 5 CIE graduates who take the exam get their Licenses!

**For professionals only.**

CIE training is not for the hobbyist. It's for people who are willing to roll up their sleeves and go to work...to build a career. The work can be hard, sure. But the benefits are worth it.

**Send for more details and a FREE school catalog.**

Mail the card today. If it's gone, cut out and mail the coupon. You'll get a FREE school catalog plus complete information on independent home study. For your convenience, we'll try to have a CIE representative contact you to answer any questions you may have.

Mail the card or the coupon or write CIE (mentioning name and date of this magazine) at: 1776 East 17th Street, Cleveland, Ohio 44114.



Patterns shown on TV and oscilloscope screens are simulated.

**CIE** **Cleveland Institute of Electronics, Inc.**  
 1776 East 17th Street, Cleveland, Ohio 44114  
 Accredited Member National Home Study Council

**YES...** I want the best of everything! Send me my FREE CIE school catalog—including details about troubleshooting courses—plus my FREE package of home study information. RE-30

Print Name \_\_\_\_\_

Address \_\_\_\_\_ Apt. \_\_\_\_\_

City \_\_\_\_\_

State \_\_\_\_\_ Zip \_\_\_\_\_

Age \_\_\_\_\_ Phone (area code) \_\_\_\_\_

Check box for G.I. Bill information:  Veteran  Active Duty

**MAIL TODAY!**

**EQUIPMENT REPORTS**

*continued from page 27*

amplifier. A few days after I installed the system in the car, some rip-off artist broke into the car and tried to steal the FM radio/cassette player. He would have made it if he could have defeated the *Mount 'n Lock* bracket. In his attempt, he yanked on the cabled wires running back from the *Mindblower* control box. The power cable insulation was cut on a sharp metal edge in the channel under the rear door so the 12-volt lead shorted to the chassis. When I turned on the ignition, the current drawn was high enough to melt and ignite the wire insulation for its entire length between the fuse block and the short, but it was not

high enough to blow the fuse until after the fire gained headway. An 8-amp fuse in the line directly at the fuse block would have prevented the fire and a costly replacement of much of the wiring behind the dashboard. **R-E**

**Sabtronics Model 2000  
Digital Multimeter**

IF YOU DON'T ALREADY OWN A DMM, OR IF YOU own a bulky bench type and are looking for a battery-powered portable, take a serious look at the Sabtronics *model 2000*. (Sabtronics International Inc., Box 64683, Dallas, TX 75206.) It has impressive specifications and many features that a few years ago could be found only in expensive lab instruments. These



**CIRCLE 114 ON FREE INFORMATION CARD**

include a basic DC accuracy of 0.1%, a 3 1/2-digit readout, automatic polarity, automatic zeroing and automatic overrange indication. The *model 2000* is available only as a kit at \$69.95.

The front panel of the *model 2000* is uncluttered and easy to understand. In the upper center-half is the 3 1/2-digit 0.36-inch-high LED display. Directly below this are 9 push-buttons. The POWER on-off switch is red and located to the far left. Next, from left to right, are the AC, VOLT, AMP and OHM function switches. These switches are grey. The VOLT, AMP and OHM switches are interlocked so only one can be depressed at any one time. The AC pushbutton is not interlocked and selects either AC or DC measurements (AC when depressed). You use the AC pushbutton in conjunction with the VOLT, AMP and OHM pushbuttons to select AC volts, DC volts, AC current, DC current and resistance. (The AC pushbutton has no effect on the ohms function.)

To the right of the function pushbuttons are four range pushbuttons that are white. Three select the full-scale reading and the fourth is a X10 multiplier. The basic full-scale resistance ranges are 100, 10K and 1M. Using the X10 multiplier expands the number of resistance ranges to six—100, 1K, 10K, 100K, 1M and 10MEG. There is a 100% overrange capability on all ranges. So, for the 10-megohm resistance range, the upper measurement limit is 19.99 megohms.

The basic full-scale current ranges are 10  $\mu$ A, 1 mA and 100 mA. The X10 multiplier extends the number of ranges to six—10  $\mu$ A, 100  $\mu$ A, 1 mA, 10 mA, 100 mA and 1 amp. With the 100% overrange capability on all ranges, the 1 amp scale will read to 1.999 amps. Two amperes is also the maximum allowable input current. The ranges and upper measurement limit holds true for both the AC and DC current scales.

Voltage ranges are selected just like the current and resistance ranges, with the basic full-scale ranges being 100 mV, 10 volts and 1 kV. No, the X10 multiplier won't extend the upper measurement limit to 10 kV. The maximum allowable input voltage is 1 kV. In fact, the 100% overrange capability on the 1 kV scale is academic. Using the X10 multiplier permits you to select full-scale voltage ranges of 100 mV, 1 volt, 10 volts, 100 volts and 1 kV. This holds true for both the DC and AC voltage ranges.

At the far right of the front panel are the input jacks. The COMMON input jack is black and the volt-ohm-amp input jack is directly above it and red. Both of these jacks accept banana-type plugs. Test leads are extra. An optional set of 36-inch black and red test leads are available from Sabtronics for \$3.50, part No. TL-36P. The probes that come with the optional test leads are the standard barrel-type.

*continued on page 102*

**INTRODUCING THE NEW LEADER**

**40-Ch PLL CB  
Signal Generator**

40-Ch. Digital Readout in FCC Sequence.

$\pm$ 1KHz Program Freq. Shift for SSB.

Modulation Meter.

Calibrated RF Meter.

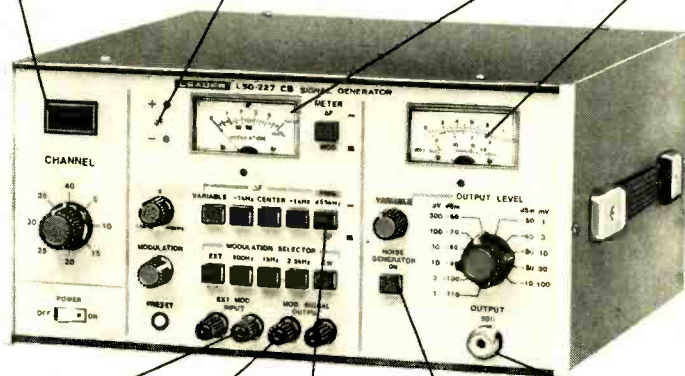

External Mod. Capability

Audio Output

455KHz IF Output.

Built-in Noise Generator

Blow-out Proof.

**Now, service CB with speed and accuracy.**

**Model LSG-227 . . . \$549.<sup>95</sup>**

See your distributor or write direct for details.

When Quality Counts . . .

**LEADER  
Instruments Corp.**

151 Dupont Street, Plainview, N.Y. 11803  
(516) 822-9300

In Canada: Omnitronix Ltd., Montreal, Quebec

**CIRCLE 45 ON FREE INFORMATION CARD**





# We've got the longest running feature on TV.

Our Color Bright 85® picture tube warranty is the longest in the industry. We can offer it because we're confident that a Color Bright 85 picture tube will probably last longer than five years.

The warranty is a great selling tool that builds customer confidence in your quality work. Plus, it lets you form a long-term customer relationship with each picture tube you replace.

\*Limited warranty, naturally. It does not cover labor for replacing a tube.

The Color Bright 85 picture tube offers economy with the high quality standards you expect from Sylvania. Couple that with the new 5-year warranty\* and you'll find the Color Bright 85 is an easy sale. And it can be better for you in the long run.

**GTE SYLVANIA**

CIRCLE 74 ON FREE INFORMATION CARD



# **BUILD**

# Portable 30-MHz Frequency Counter

*You can hold it in the palm of your hand. Yet it reads to 28-Mhz and better, has a 70-mV sensitivity and a 4-digit readout that delivers 6-digit resolution.*

**GARY McCLELLAN**

HOW WOULD YOU LIKE TO HAVE A frequency counter that measures frequencies to 30 MHz, and is small enough to fit in your coat pocket! Sure you would, and for good reason; counters are becoming more popular every day.

Our pocket counter may be small, but it has grown-up features. The maximum frequency it will measure is 23 MHz typical, with 70-mV sensitivity. However, you can go as high as 30 MHz with 90-mV sensitivity. The input impedance is the standard 1 megohm, meaning you can use scope probes on this counter for easier circuit checking. Oh yes, overloads can happen and this counter is protected from most of them. It will take 120 volts AC right from the wall outlet without harm! The unit is powered by four rechargeable NiCad batteries, and since the current drain is low, they will last a long time. The batteries also help make this counter portable, like a calculator.

The heart of any counter is its timebase, and this one has a crystal-controlled timebase, just like the big counters. We use a color TV burst crystal (3.58 MHz) in our unit and this gives good accuracy. You can normally expect better than  $\pm 0.005\%$  accuracy with  $\pm 0.003\%$  typical, depending upon the frequency being measured. Like other counters, the higher the frequency you measure, the better the accuracy. The display is all LED—4

digits of 0.112-inch-high display. Don't let that display fool you either! With just a flip of the three-position range switch you can get up to two digits more, for a total of six digits with the power consumption of four digits! Quite a counter!

The pocket counter is easy to build. It has nine IC's, most of which are CMOS and the rest are low-power Schottky. So all of a sudden the counter is easier to build and the power drain is reduced to about a half watt. You should be able to build this project in about three evenings or less. A PC board makes the job easy. And all parts mount on this board, except for a few switches, jacks and the battery that must go on the case. Special arrangements have been made to bring you a low-cost kit to make the construction task easier. Or, if you prefer, the PC layouts are shown so you can roll your own. Nearly all of the parts are available through mail order houses, and the few harder to get parts are available either from the author or from several suppliers mentioned later on.

### **How it works**

The counter uses the classic "window counting" technique that is the basis for almost all frequency counters in use today. Figure 1 is a block diagram of a counter based on this technique. This basic counter has four sections; input

amplifier, gate, timebase and decade counter/display section. Here's how it works. Input signals are squared up by the input amplifier and are applied to the gate section. It is necessary to square up the input signals because digital circuitry does not respond too well to analog-type signals such as sinewaves. The *timebase* circuit puts out three synchronized signals in this order: gate-enable, data transfer (latch) and reset. The gate-enable signal is applied to the gate section, causing the signal from the input amplifier to pass through it. This is called the *window*, and the time the gate allows the input signal to pass through is precisely determined.

The gated signal is then counted up by a string of of decade counters, wired in series. Usually, there are at least 4 decades total, with 6 decades being typical. The signals from these counters are then applied to a display latch that transfers the output from the counters to the displays upon command from the transfer line from the timebase. This reading is frozen at the displays while the decade counters are reset to zero and the count sequence is repeated. The latches are very important, because without them you would see the decade counters count up, stop briefly at the correct count, then reset to zero and repeat. This is the basic frequency counter, and there are few

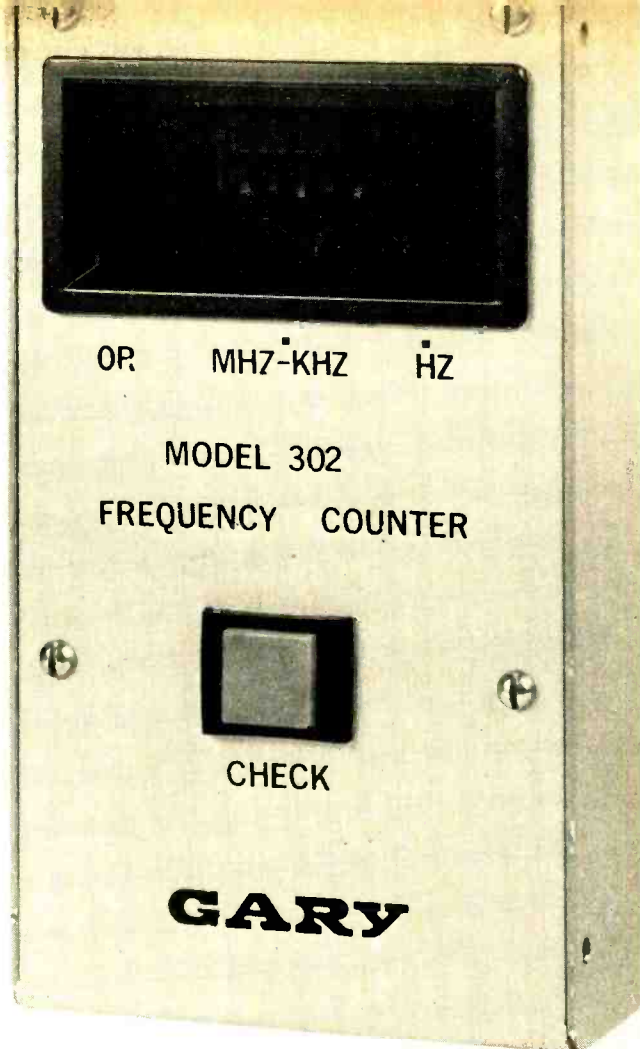

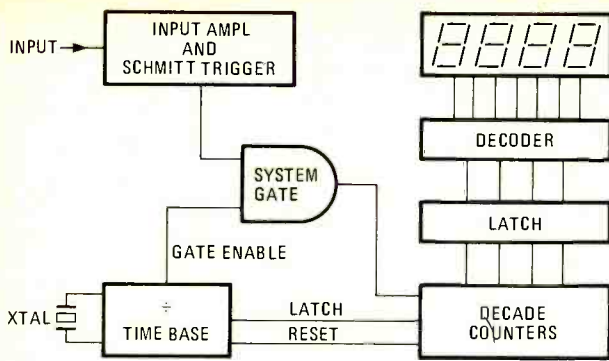

**FIG. 1—BLOCK DIAGRAM** shows the four sections of the basic counter: input amplifier, gate, timebase, and decade counter display.

designs that are very different.

Now let's take a look at our counter. It is just like the basic counter. Figure 2 is a block diagram of the unit. You should be able to identify the input amplifier, the counter/display and the timebase, but the gate will be difficult. The gate section is part of the input amplifier and will be discussed further on. There are some divider sections following the input amplifier. Their purpose is to divide the input signal so that it will run the counter/display section. A CMOS LSI IC (IC5) handles the counting at this point. Its maximum frequency range is about 2 MHz, so with the dividers (normally called *prescalers*) it is easy for a 2-MHz IC to count over 20 MHz. By the way, that CMOS counter saves you twelve TTL IC's or about 184 soldered connections! This is the secret of a successful counter that anyone can build.

Operation of our counter is just like the window counting method first described. The only difference is the frequency dividers that scale down the input frequency for the CMOS counter/display IC. Normally you don't find them in other counters; instead you change the the timebase frequency by tapping off dividers there to get the different ranges. Our counter provides Hz, kHz and MHz ranges just like the big counters, but with fewer parts and low power drain.

### The circuit

Now let's dig deeper into the circuitry. Checking the schematic (Fig. 3) you'll find that the input signal appears at Q1, a FET source follower. Diodes D1 and D2

form the overload protection network. The signal passes from the follower, which is there to give a high-Z input, to IC1, a quad NAND gate. The first section is biased for amplifier operation by R4 and the stage provides about 10X gain or so. Surprisingly, TTL gates make stable amplifiers. Not hi-fi but fine for counters. The next two stages (gates, really) act as the Schmitt trigger, squaring up the signal to proper TTL levels. Resistor R6 sets hysteresis or trigger point. The final section, IC1-d, is the gate, with transistor Q7 and resistor R19 controlling its on and off times. These two parts convert the CMOS (think low current) timebase output to the low-power Schottky TTL (think higher current) gate input. From there, the signal is divided down by 10 in IC2, by 10 again in IC3 and by 100 in IC4. Low-power Schottky 74LS90's in

the first two spots insure high-frequency operation and low power drain. A typical 74LS90 will go to 35-40 MHz and draw about 5 mA.

Compare that to a standard 7490 that goes to 20-25 MHz and draws 25 mA! Switch S1 is the RANGE switch. It selects the proper range by switching different places in the divider network. From there, the selected signal goes to IC5, a National Semiconductor MM74C926 counter array that counts the signal, latches it and drives an LED display. This IC houses 4 decade counters, 4 latches, a display driver and multiplex logic.

Now let's take a look at the rest of the counter. The timebase consists of IC6, IC7-a, IC8-a and IC9. A color-TV crystal, XTAL1, generates the reference frequency, with IC6 providing the associated oscillator and counting down to 60 Hz. This signal drives IC7, a divide-by-60 counter, to get the necessary 1-second timebase. IC7 also provides part of the reset and latch signals as well. The 1-Hz output drives IC8, which converts it into a 1-second-on and 1-second-off pulse for the gate section. Finally, the IC9 gates create the reset and latch (or transfer) pulses necessary for proper operation of the counter. Sections IC7-b and IC8-b are wired to form an overrange indicator—that's the circuitry you see wired to LED1. IC7-b acts as an inverter, causing the SR flip-flop of IC8-b to energize on negative edge of the waveform that ap-

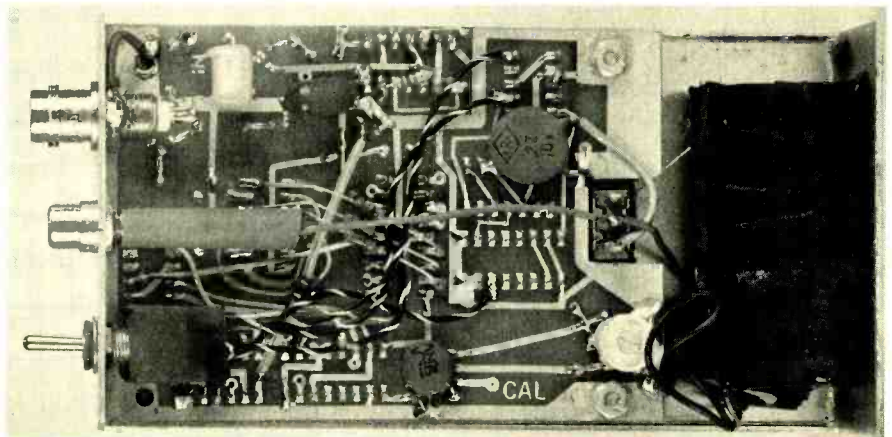

**INSIDE VIEW OF BASIC COUNTER** shows just how easy a construction job it is. Most components go right on the circuit board.

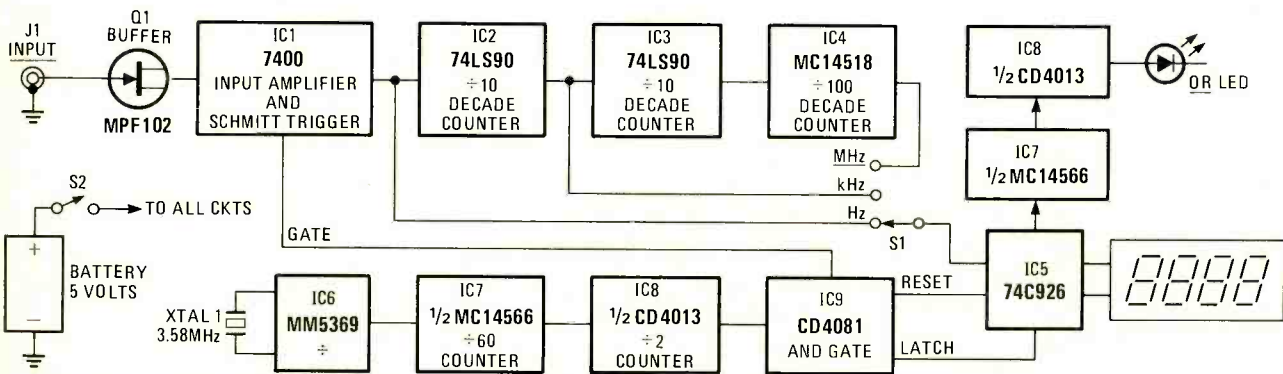

**FIG. 2—BLOCK DIAGRAM OF THE COUNTER** described in this article. The gate section is different than that shown in Fig. 1 and there are some additional divider stages.

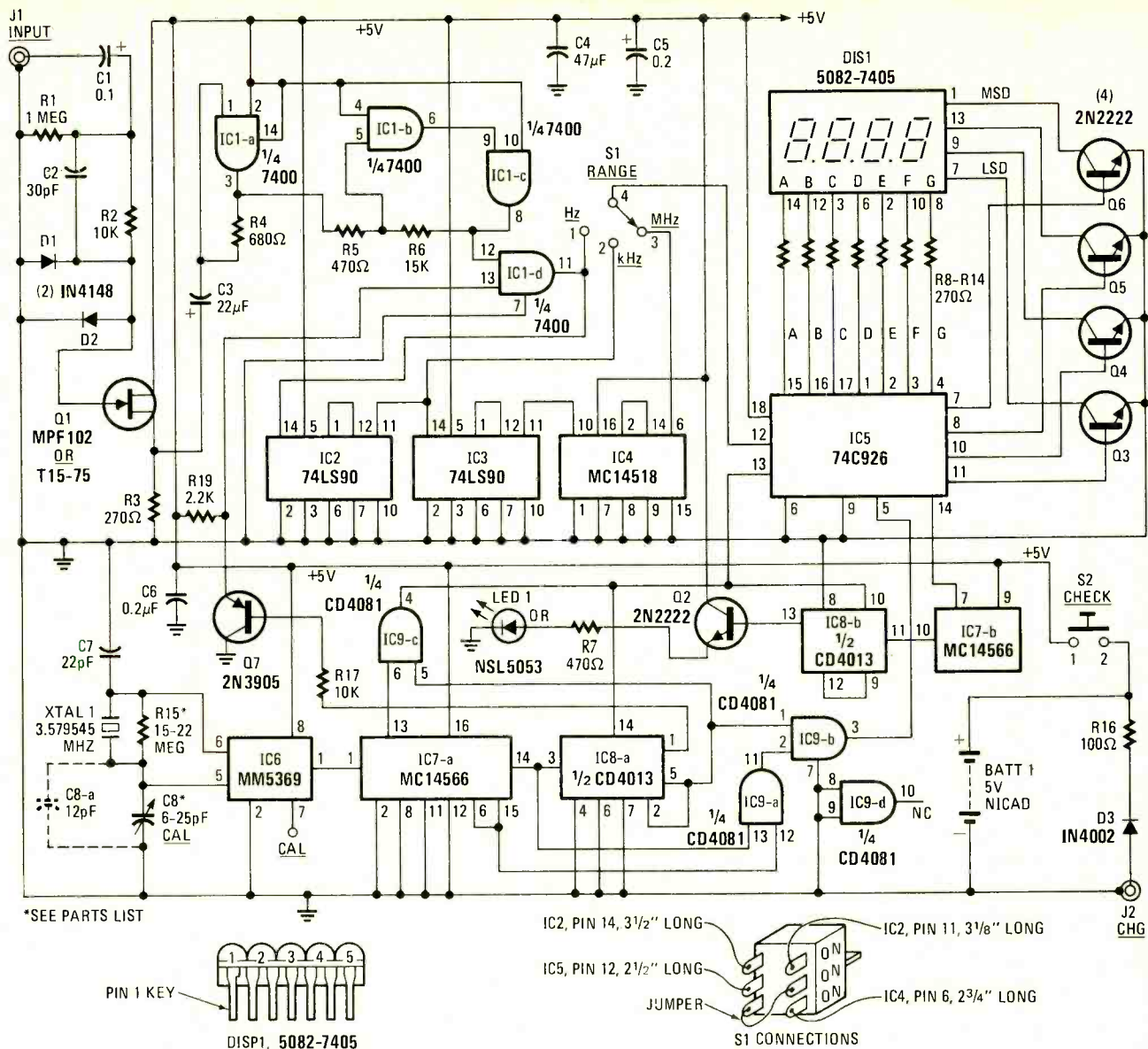

FIG. 3—FULL SCHEMATIC OF THE COUNTER makes it easy to follow the circuit description. Resistor R18 (10K) was inadvertently omitted. It connects between Q2's base and pin 13 of IC8-b.

**All resistors 1/4-watt carbon film type unless noted.**

- R1—1 megohm
- R2, R17, R18—10,000-ohm resistors
- R3, R8-R14—270-ohm resistors
- R4—680 ohms
- R5, R7—470 ohms
- R6—15,000 ohms
- R15—15 to 22 megohms
- R16—100 ohms, 1/2 watt
- R19—2200 ohms
- C1—0.1 μF, 200-volt tubular
- C2—30 pF disc
- C3—22 μF, 6-volt tantalum
- C4—47 μF, 6-volt tantalum
- C5, C6—0.2 μF, 10-volt disc (0.1 μF OK)
- C7—22 pF mica
- C8—either a 6-25-pF trimmer or a 6-18-pF trimmer plus 12-pF mica cap (C8-a)
- D1, D2—1N4148
- D3—1N4002
- DIS1—5082-7405 display (Hewlett-Packard). Poly Paks 92CU3199
- LED1—NSL5053 LED National or similar
- Q1—MPF102 FET
- Q2-Q6—2N2222 transistors
- Q7—2N3905 PNP transistor or similar

- IC1—SN7400 IC, Active Electronics
  - IC2, IC3—SN74LS90 IC, Active Electr.
  - IC4—MC14518P CMOS IC dual BCD up-counter
  - IC5—MM74C926N CMOS IC (National) Tri-Tek or Liberty Electronics
  - IC6—MM5369N CMOS IC (National)
  - IC7—MC14566CP CMOS IC timebase generator (Motorola) or HEP C4055P
  - IC8—CD4013 CMOS IC
  - IC9—CD4081 CMOS IC
  - J1—BNC female coax connector
  - J2—RCA phono socket
  - S1—single-pole, 3-position toggle switch, C&K 7211 (Poly Paks 92CU3016)
  - S2—SPST, normally open pushbutton switch, C&K 8121-J81-3-2 or similar
  - BATT1—5-volt NiCad battery pack; 4-size AA cells in holder
  - XTAL1—3.579545-MHz color TV crystal
  - Misc.—LMB CR531 case, model 302 PC board, display bezel, 12-volt wall plug transformer with RCA plug (battery charger), 3/8-in. threaded spacers, etc.
- Note: A kit of all above parts is available from Gary McClellan and Co., Box 2085, 1001 West Imperial Hwy., La**

Habra, CA 90631. Complete kit of all parts and unpunched case, \$39.95 postpaid. California residents add state and local taxes as applicable. PC board only, \$5.95 postpaid. Write for prices on other parts.

**ADDRESSES OF SUPPLIERS LISTED**

- Poly Paks** PO Box 942  
South Lynnfield,  
MA 01940
- Optoelectronics** PO Box 219  
Hollywood, FL  
33022
- Tri-Tek Electronics** 6522 North 43rd  
Ave.  
Glendale, AZ  
85301
- Liberty Electronics** 124 Maryland St.  
(Indust. Dist'r) El Segundo, CA  
90245
- Active Electronics** PO Box 1035  
Framingham, MA  
01701

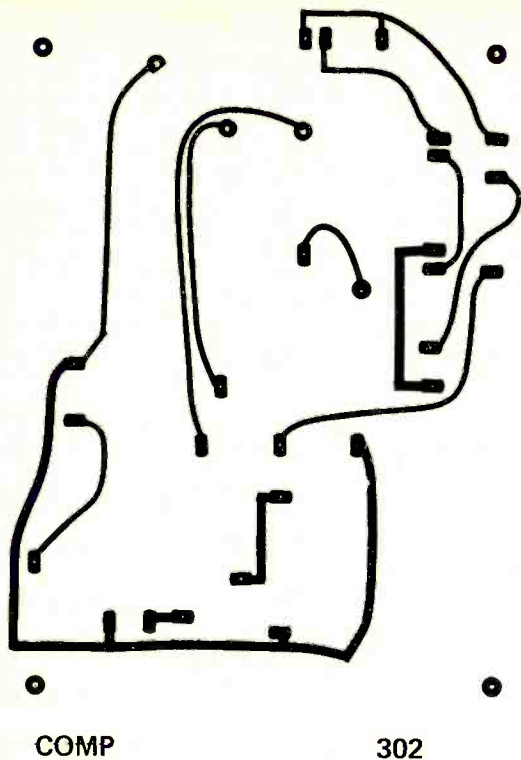

FIG. 4—FULL-SIZE FOIL PATTERN of one side of the 2-sided circuit board. Used with Fig. 5 you can make your own circuit board.

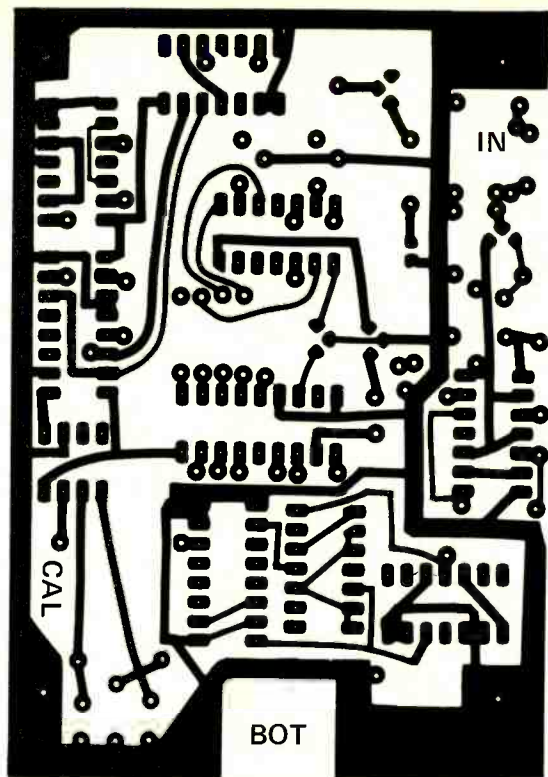

FIG. 5—THE OTHER SIDE OF THE CIRCUIT BOARD. This full-size pattern used with the one on Fig. 4 can be used to make your own circuit board for this instrument.

pears at the overrange output (pin 14) of IC5.

Now that you know how it works, let's get started on the construction!

### Put one together

Construction of this counter is pretty easy if you take your time. Also, use of a PC board is strongly recommended. If you wish, you can duplicate one from the patterns in Figs. 4 and 5, or buy one from the author.

The first step is to locate the parts. Sources are given in the parts list for the tougher ones to help you get the components without a lot of problems. Write the sources for more information and prices if you desire. One thing that's important here: *you must use quality parts. That means NO JUNK! Cheap reject "retested" type parts will cause you more problems than you can believe when it's time to check out this counter!* A word to the wise is sufficient.

Start construction by stuffing the PC board. It contains nearly all of the parts, and when you finish stuffing, you can test it prior to putting it into the case.

Study Figs. 6 and 7 before you start. Probably the best way to begin is to install the diodes, D1 and D2. Place the board in the position shown with the side saying "COMP" in the corner face up. Install the two diodes as shown and solder. The next step is to install the transistors. This will require a little extra care, as the holes do not exactly match the leads coming out of the transistors. That means you will have to bend a lead

on most of the transistors—an easy task. Install FET Q1 first. Notice how the flat side faces. Next, add the PNP transistor, Q7. This one plugs directly into the three holes with no bending. The same is true of Q2. It mounts near the top of the board. Finish up by installing the four transistors near the center of the board. Bend the emitter lead on two transistors so that it goes between the base and collector leads, then place each transistor in the Q4 and Q5 spots on the board. The emitter leads go to the foil bus on the other side of the board, the collector leads point toward the center of the board and the base leads point toward the top edge of the board. Transistors Q3 and Q6 are installed last. They go in place without bending. The base leads face the exact center of the board, and the collectors face the top edge. So much for the transistors.

The next step is to install the display. Do LED1 first, noting that the flat spot faces the center of the board. You can substitute almost any LED here, so don't feel stuck with the one specified. Then add DIS1. This is a rather tricky part, and there should be a dot showing pin 1 on the reverse side. If not, you may have to try it and reverse it later if you get strange readings. To make life easier *all readouts supplied with the kit* have an unused pin (pin 4) cut and you simply orient the readout as shown. *(If you use the Hewlett-Packard display specified, pin 1 is notched as shown on the inset in Fig. 3.—Editor)*

Next, you can install the resistors.

Stick them in as shown. Leave about  $\frac{1}{8}$  inch on the 22-megohm resistor leads because the crystal will mount on them. Oh yes, this resistor is part of a \$5.95 kit offered by Optoelectronics and others. It is called a "clock timebase" kit and features many other parts you will be using. Keep the rest of the leads short.

Continue with the capacitors. Since only four mount on the component side, no comment is necessary! If your clock timebase kit included a 12-pF mica capacitor, install this transistor at the place marked C8.

Then install the crystal, XTAL1. Bend its leads over so that they can touch R15 (22 megohms). Make sure the plastic body of the crystal is snug against the resistor, then solder the leads. Take a piece of bare wire and *quickly* solder it to the metal case of the crystal. Bend the wire over the end of the board and solder it to the foil. See the illustrations.

The next step is to install the IC's. Use *Molex* pins for IC5, and don't install this part until just before testing the board. Use a low-power grounded-tip soldering iron for all work here; this is especially important. Remember you are working with CMOS! Double-check for proper placement and proper orientation when you are done.

Now turn the board over as there are some components to be installed on the reverse side. See Fig. 7. Start with the capacitors. Install C4 first, with the positive lead on pin 14 of IC1 and the minus lead on the large foil running near this IC. This capacitor is a 47- $\mu$ F unit. Be sure

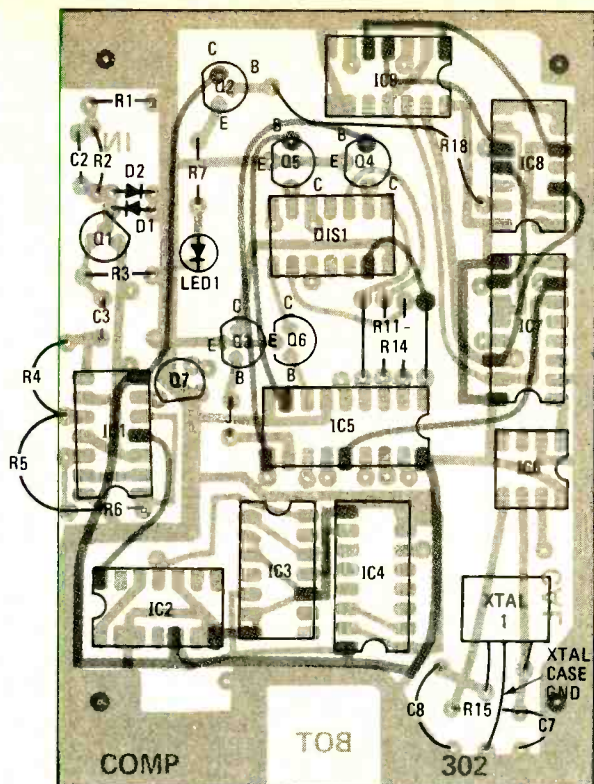

FIG. 6—PARTS PLACEMENT DIAGRAM shows exactly where all the parts mount on the topside of the circuit board. Diagram also shows how the two foil patterns overlap. View is from the top side of the circuit board with the bottom foil pattern shown in the lighter shade of grey.

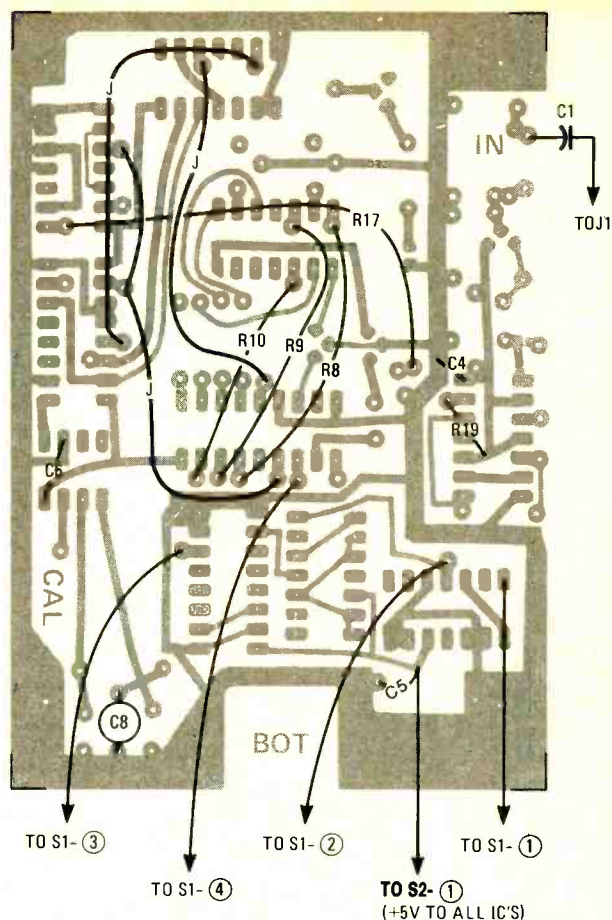

FIG. 7—PARTS PLACEMENT DIAGRAM for the bottom side of the circuit board.

to keep those leads short! Then install C5 (0.2- $\mu$ F disc) between pin 5 of IC2 and the large foil running near the IC's. Remember that the large foil running around the edge of the board is ground! Last, add C6 (0.2- $\mu$ F disc) between pins 8 and 2 of IC6 (MM5369). Then add trimmer C8 to complete the job.

Now add the jumpers. Even though the board is double-sided, some jumpers are unavoidable. Use insulated wire. Check Fig. 7 carefully.

Next, add the remaining five resistors. Install the three 270-ohm resistors first, from display to IC5 (MM74C926). Then add R19 (2.2K) between pin 4 and pin 13 of IC1. Cut two lengths 1 inch long of spaghetti tubing and slip them over the leads of R17 (10K). Then connect it between pin 1 of IC8 (CD-4013) and the base pad of transistor Q7.

Set the module aside temporarily and turn to switch S1. Check Fig. 3 for details and then attach leads cut to the lengths indicated. Add the jumper. Solder the switch leads to the places indicated. Check over your wiring at this point around the switch, and if everything's OK, proceed to the last step.

Finish up the module by adding a 1½-inch piece of insulated wire to pin 5 of IC2. This is the power lead and it goes to S2. Then add a 2-inch piece of wire from the large foil (ground, remember) near-

by. This is the negative battery lead.

That's it for the bulk of the construction. Check your wiring at this point for the usual things—errors and shorts, and correct them if necessary. You may want to proceed to checkout at this point to test the module, then return to finish the box.

Get out the box and lay out the front for the various parts. Use the module you built to determine sizes, etc. Note the cutout in the board. Switch S2 fits in this spot, so don't forget. Turn to the top of the box and lay out the two jacks and switch. Place them as far from the front of the box as you can. This will allow more clearance between the parts and the module when it is installed. Clean up the box and label it.

Install the four ¼-inch spacers in the box with 4-40 × ¼-inch screws. Then add the display bezel, jacks J1 and J2 and switch S2. Drill holes to match the mounting screws in the module and then drop it in, display facing the box. Secure it with lockwashers and 4-40 nuts. Install S1, noting that the jumper faces the adjacent edge of the box. Then add C1, the 0.1- $\mu$ F, 200-volt tubular capacitor between J1 and the pad marked IN on the circuit board.

Next, wire switch S2. Attach the short wire that comes from pin 5, IC2 to it. Also, add resistor R16 (100 ohms) and

diode D3 (IN4002) between the other switch contact and J2. Cover these parts with a short length of spaghetti tubing. This will prevent problems later! Finish up by installing the four-battery pack between ground on the module and S2. The switch is positive, of course; don't forget!

### Checkout and calibration

The checkout part is easy and takes little time. If you have the module only, connect it to a 0-250-mA meter and 5-volt power supply. If all's well, the meter will read about 100 mA and the display will light. It will first show a jumble of numbers and then in a few seconds read 00-00. This is normal and the next step is to touch the pad marked IN with your finger. You will probably get a jumble of numbers and the LED will blink. If not, flip S1 until you get results. Next, connect a signal generator set to around 10 MHz to the IN pad and advance the output level. Flip S1 through its three ranges and you will get a reading close to what the generator is set to. Even without calibration, this counter is surprisingly accurate! If all is well at this point, install the module in the box and proceed to "calibration."

If you already installed your module in the box, you can still perform the simple

*continued on page 124*

# **BUILD**

## **3½-Digit DMM**

*The digital panel meter has the same relationship to the DMM as the D'Arsonval panel meter has to the analog multimeter. Build your own multimeter using a DPM*

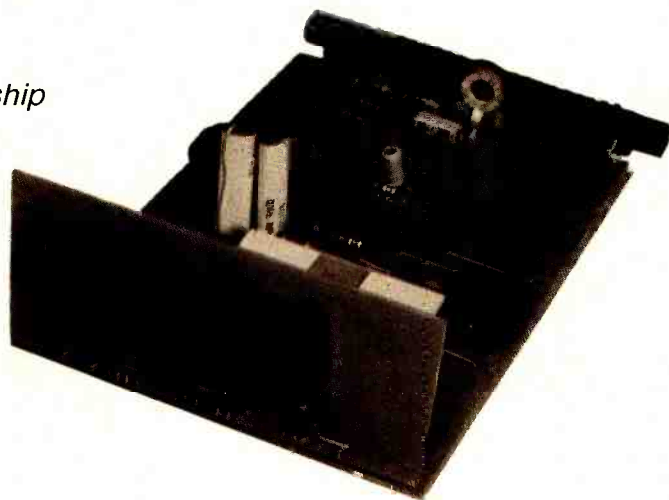

**DR. E. H. BORNEMAN AND ROBERT BENWARD**

A DIGITAL PANEL METER IS THE HEART OF every digital multimeter. This article describes a relatively simple circuit for a 2-volt DPM (Digital Panel Meter) using readily available IC's that can be easily converted into a digital multimeter (DMM) by adding some voltage-divider and current-shunting circuits. The resulting instrument, including power supply, can be simply packaged to become a very functional and rather attractive digital multimeter.

### **DPM circuit and operation**

The basic DPM circuit is shown in Fig. 1. It uses a minimum number of parts, with most of the circuitry in two IC's; one a signal conditioner, the other a digital processor. These IC's include an on-board clock and a medium quality internal reference (40 ppm/°C). The measuring system uses dual-slope integration with its advantages of noncritical clock frequency, high rejection of AC signals and use of noncritical components.

The 8052 signal conditioner has three phases of signal conversion, these being auto-zero, integrate input and integrate reference. At the end of a measurement the system automatically reverts to auto-zero mode until a new measurement is started. If no overload has occurred in the previous measurement, it takes 10 milliseconds for the auto-zero to null. At power-on or after an overload it takes 100

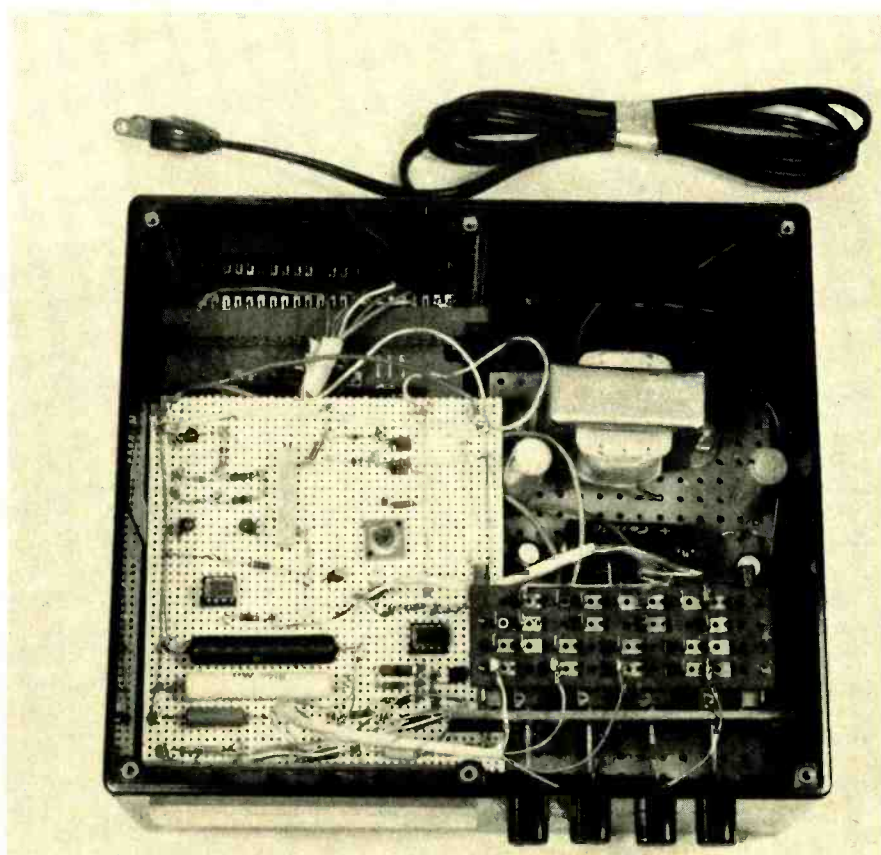

**INTERIOR OF A DIGITAL MULTIMETER** based on a version of the digital panel meter in the head photo above. The DPM (at left) used point-to-point wiring on perforated board. See Fig. 8 for layout drawing.

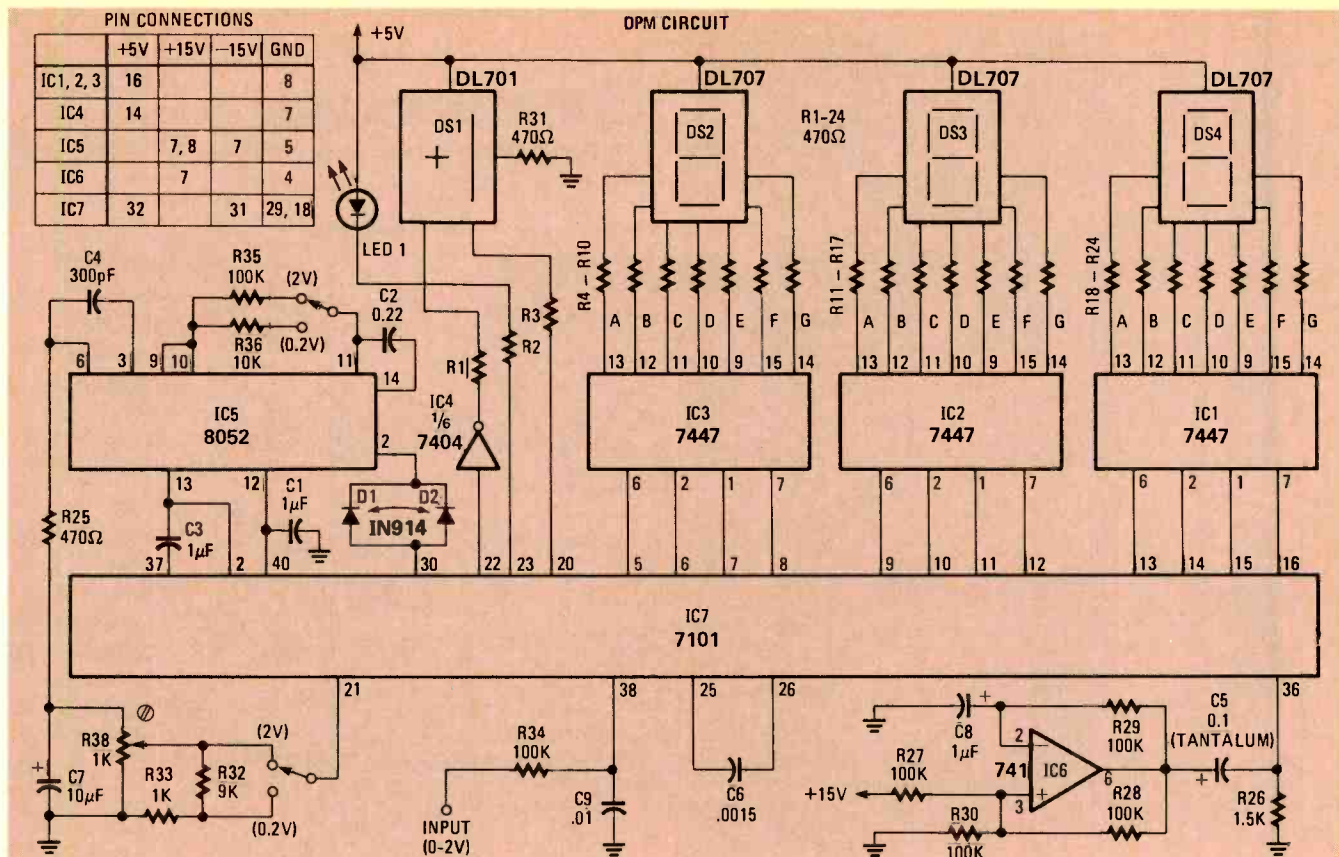

FIG. 1—DIGITAL PANEL METER SCHEMATIC. The unit is simple and easy to construct; using either point-to-point wiring or a couple of PC boards.

### DPM PARTS LIST

All resistors 1/4 watt, 10% or better

- R1, R2, R4-R25, R31—470 ohms
- R26—1500 ohms
- R27-R30, R34, R35—100,000 ohms
- R32—9000 ohms
- R33—1000 ohms
- R36—10,000 ohms
- R38—1000 ohms, miniature potentiometer

All capacitors 10 volts DC or higher

- C1, C3—1  $\mu$ F, Mylar

- C2—0.22  $\mu$ F, polypropylene
  - C4—300 pF, disc
  - C5—0.1  $\mu$ F, tantalum or metallized film
  - C6—.0015  $\mu$ F, disc
  - C7—10  $\mu$ F, electrolytic
  - C8—1  $\mu$ F, electrolytic
  - C9—0.01  $\mu$ F, disc
- Semiconductors**
- D1, D2—1N914 diode
  - DS1—+1 LED digit, Litronix DL701 or equal
  - DS2-DS4—7-segment LED digit, Litronix DL707 or equal

- Integrated circuits**
- IC1-IC3—7447 BCD/7-segment decoder/driver
  - IC4—7404 hex inverter
  - IC5—8052 signal conditioner
  - IC6—741 op-amp
  - IC7—7101 digital processor

milliseconds to null.

None of the circuit component values are critical in determining the accuracy of the instrument. For example, the reference capacitor and auto-zero capacitor (C1 and C3) are both shown as 1.0  $\mu$ F. These rather large values minimize the effect of PC board leakage. The 0.22- $\mu$ F value of the integration capacitor C2 is selected for PC board considerations alone, since the very small leakage at the integration input is nulled at auto-zero. It

is very important that this capacitor have very low dielectric absorption.

The DPM is calibrated by putting a standard mercury cell across the input (any convenient reference source less than 2 volts can be used) and adjusting the 1K pot until the reference voltage is correctly displayed on the readout.

Initially the DPM circuit was built on a perf board, but the later models were constructed on two PC boards with one board containing the displays and the second, with a 15-pin edge connector, containing all the circuitry.

The foil pattern for the main PC board is in Fig. 2. The parts are positioned as shown in Fig. 3. Figure 4 is the pattern for the display board. Figure 5-a shows the jumpers that are installed from the front side of the board. Figure 5-b shows the locations of three jumpers connected to the 7-segment displays. The drawings in Fig. 5-c show how the jumpers can be added. The main and display boards are

joined by 26 jumpers as detailed in Fig. 3 and Fig. 5-d.

Start with scraps of leads clipped off the resistors and other components that have been installed. Insert the leads from the foil side of the display board and solder in place. Insert the unattached lead ends in the holes in the main board, adjust the boards so they are close together and at right angles. Solder one end, check board alignment and then solder the other. Solder the connections between the ends.

Electrical characteristics of the DPM are as follows:

- Power supply:** +5 V @ 200 mA; +15 V @ 25 mA; -15 V @ 25 mA.
- Linearity (full scale):** 0.1 count typ.; +1 count max.
- Rollover [differential in equal (+V = -V = 2V)]:** 0.1 count typ.; +1 count max.
- Noise (full scale):** -0.05 counts
- Leakage current into input:** 5 pA typ.; 30 pA max.

The following are available from Hobbi House, 969 Ball Ave., Union, NJ 07083 (800-631-7485).

Digital Panel Meter, includes all parts listed in the DPM Parts List plus PC boards, \$29.95.

Set of PC boards for DPM (2 boards), \$6.95.

Digital Multimeter, includes all parts listed in DMM, DPM and Power Supply Parts Lists, \$49.95.

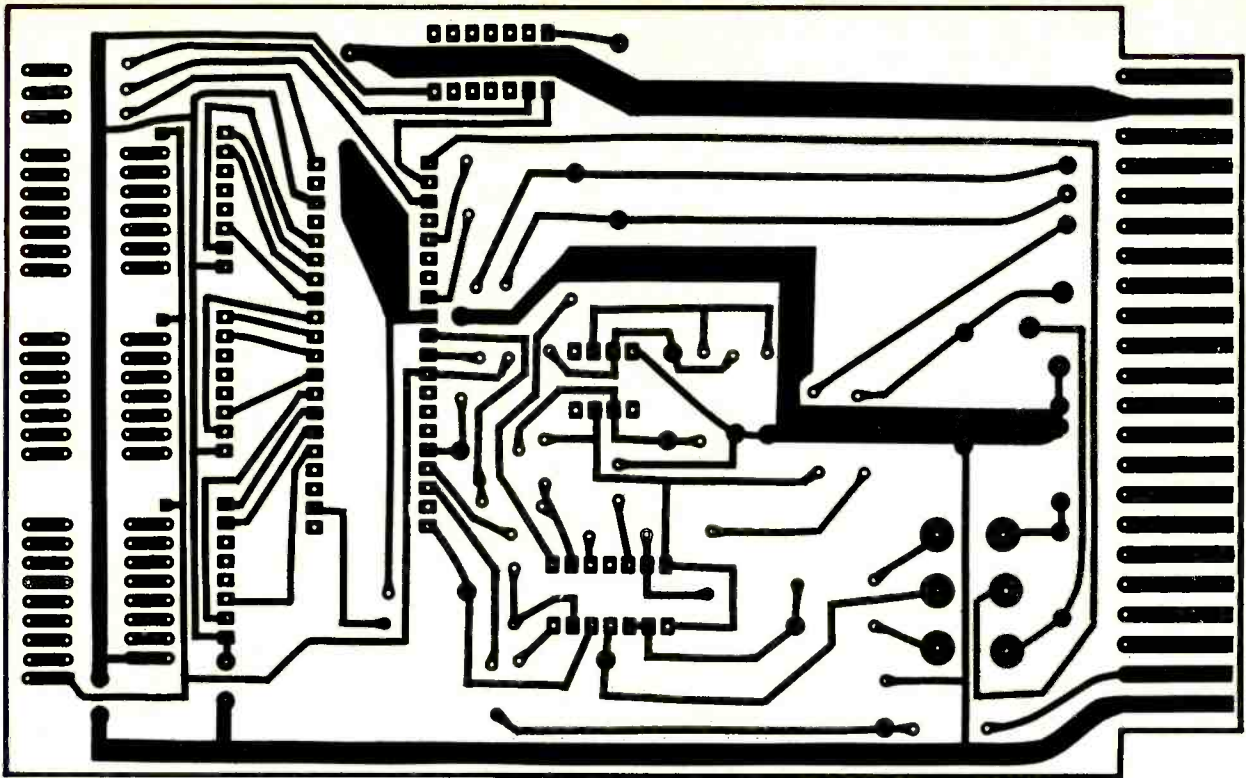

FIG. 2—FULL-SIZE FOIL PATTERN for the main board. The "fingers" on the right fit into a female PC board connector for connections to the DMM switching circuitry.

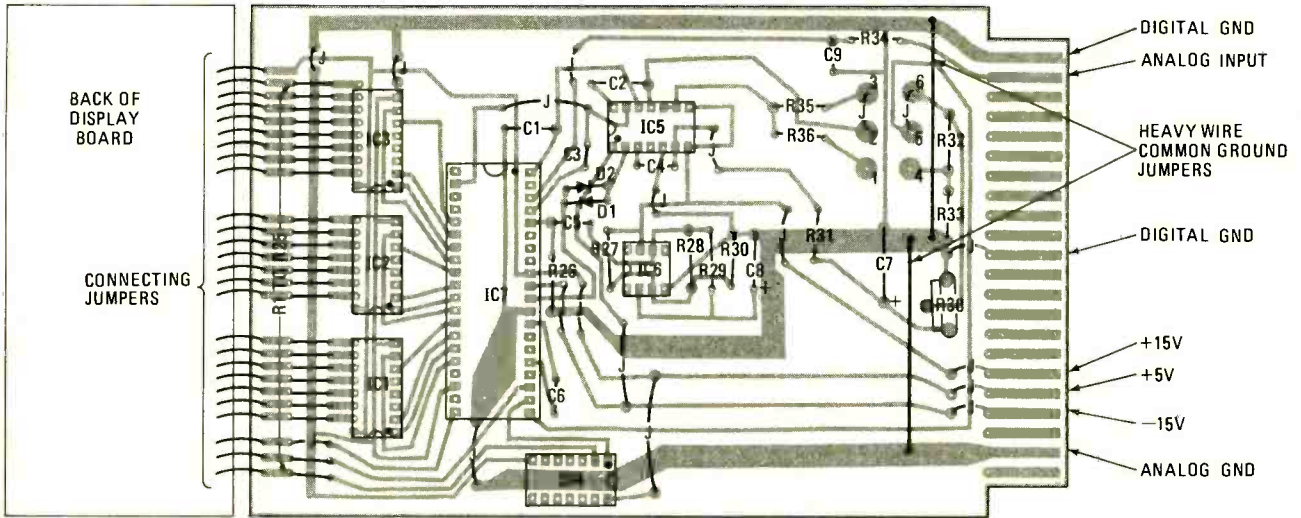

FIG. 3—HOW COMPONENTS ARE PLACED on the main board. Note the location of jumpers, IC positioning and electrolytic capacitor lead polarity.

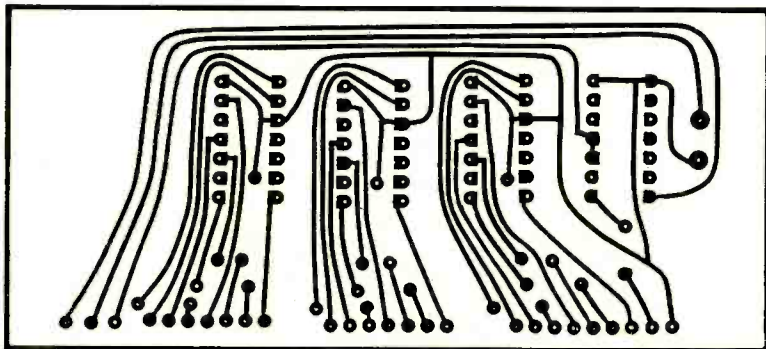

FIG. 4—DISPLAY BOARD foil pattern is full-size. Jumpers must be installed on both sides of the board as detailed in another figure.

The power supply for the DPM must deliver regulated outputs of +5 volts, +15 volts, and -15 volts DC. A circuit diagram for the power supply is shown in Fig. 6.

Although rather low currents are required for the DPM, the output currents supplied by this circuit will operate all the additional functions of the multimeter circuitry to be described. Good regulation is required (0.1%), so three voltage regulator IC's are used.

#### Conversion of DPM into digital multimeter

The basic DPM can be converted into a



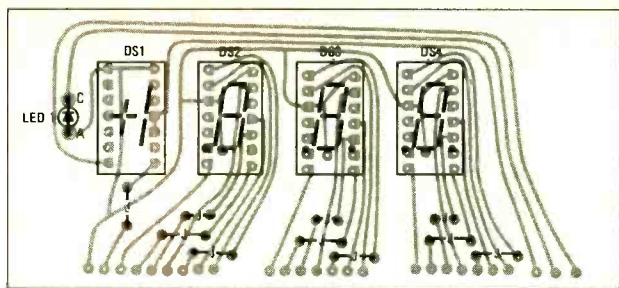

a DISPLAY BOARD FRONT

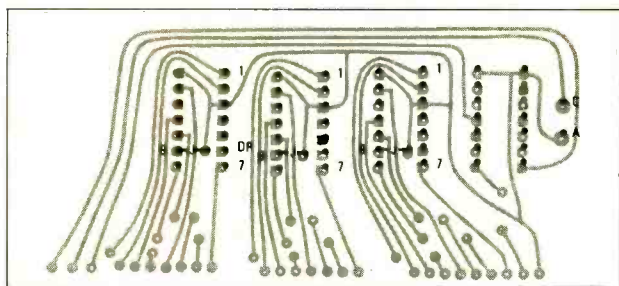

b DISPLAY BOARD BACK

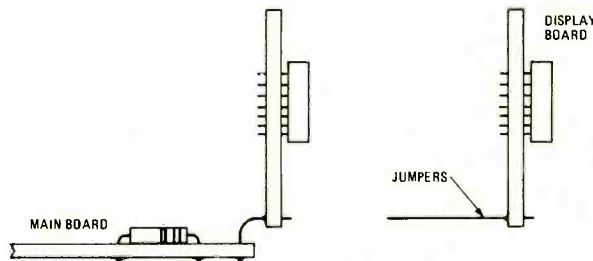
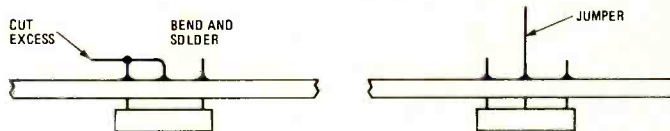
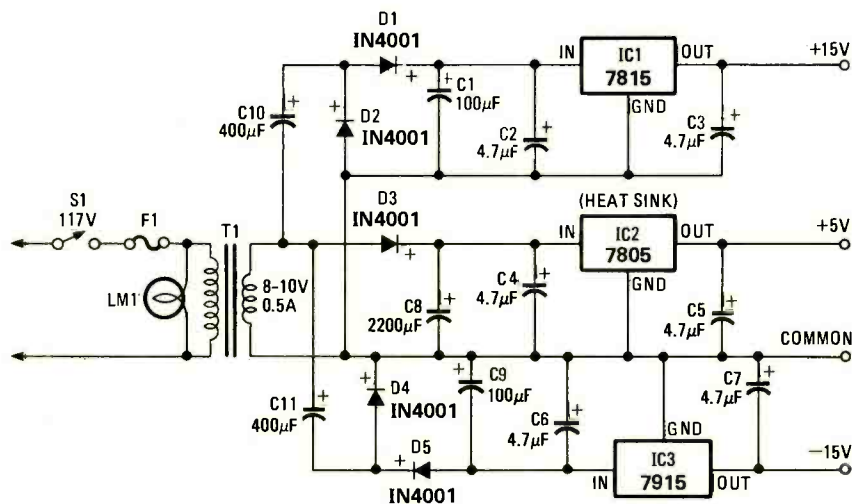

FIG. 5—MOUNTING AND JUMPER DETAILS for display board. Drawing c shows how back-of-board jumpers are formed while d, along with Fig. 3 shows how boards are joined by jumpers.



**POWER SUPPLY PARTS LIST**

**Capacitors 25 volts DC or higher**

- C1, C9—100  $\mu$ F, electrolytic
- C2—C7—4.7  $\mu$ F, tantalum
- C8—2200  $\mu$ F, electrolytic
- C10, C11—400  $\mu$ F, electrolytic

**Semiconductors**

- D1—D5—1N4001 diodes
- IC1—7815 positive 15-volt regulator
- IC2—7805 positive 5-volt regulator
- IC3—7915 negative 15-volt regulator
- S1—SPST switch
- T1—power transformer, 8-10-volt, 0.5-A secondary
- LM1—117-volt pilot lamp
- F1—0.25-ampere fuse

FIG. 6—POWER SUPPLY DIAGRAM. Three solid-state voltage regulators set the levels of voltages needed to operate the multimeter.

digital multimeter by adding the circuitry shown in Fig. 7. This circuit uses pushbutton DPDT switches. However, these can be replaced with a multisection rotary switch. Functions performed by the digital multimeter are listed in the following table.

**DC volts:** 2, 20, 200, 2000

- AC volts:** 2, 20, 200, 2000 (RMS)
- Ohms:** 2K, 20K, 200K, 2 megohms, 20 megohms
- Direct current:** 200 mA, 2A, 10A
- Alternating current:** 200 mA, 2A, 10A (RMS)

The circuit shown in Fig. 7 connects directly into the input of the 2-volt DPM.

Accuracy of the multimeter functions depends on the precision resistors used in the voltage-divider and current-shunt circuits. I recommend 1% or better, to take advantage of the inherent high accuracy of the DPM. Unless otherwise indicated, all other resistors in the circuit are 1/4 watt, 10%.

**All resistors 1/4 watt, 5% unless noted**

- R1—9 megohms, 1/2 watt, 1% or better
- R2—900,000 ohms, 1/4 watt, 1% or better
- R3—90,000 ohms, 1/4 watt, 1% or better
- R4—9000 ohms, 1/4 watt, 1% or better
- R5—1000 ohms, 1/4 watt, 1% or better
- R6—0.1 ohm, 10 watts (20 watts optional) 1% or better
- R7—1.0 ohm, 10 watts, 1% or better
- R8—10 ohms, 1 watt, 1% or better
- R9—100 ohms, 1/2 watt
- R10, R30—30,000 ohms
- R11, R21—1 megohm
- R12—10 megohms

**ADD-ON MULTIMETER PARTS**

- R13—6200 ohms
- R14—750 ohms
- R15—4300 ohms
- R16—910 ohms
- R17—1000 ohms, miniature potentiometer
- R18—4700 ohms
- R19, R23—3300 ohms
- R20, R22—9100 ohms
- R24—470,000 ohms
- R25, R26—10,000 ohms
- R27, R29—5100 ohms
- R28—2500 ohms, miniature potentiometer

**All capacitors 25-volts DC or higher**

- C1—.01  $\mu$ F, ceramic
  - C2—150 pF, ceramic
  - C3—C5—4.7  $\mu$ F, tantalum
- Semiconductors**
- D1, D2—1N914
  - D3—D6—1N4003
  - D7—6.2-volt Zener diode
  - Q1, Q2—2N3904
  - IC1, IC2—LM308 op-amps

**Miscellaneous**

- S1, S3—S9—DPDT pushbutton switch or equivalent
- S2—4-pole DT pushbutton switch or equivalent

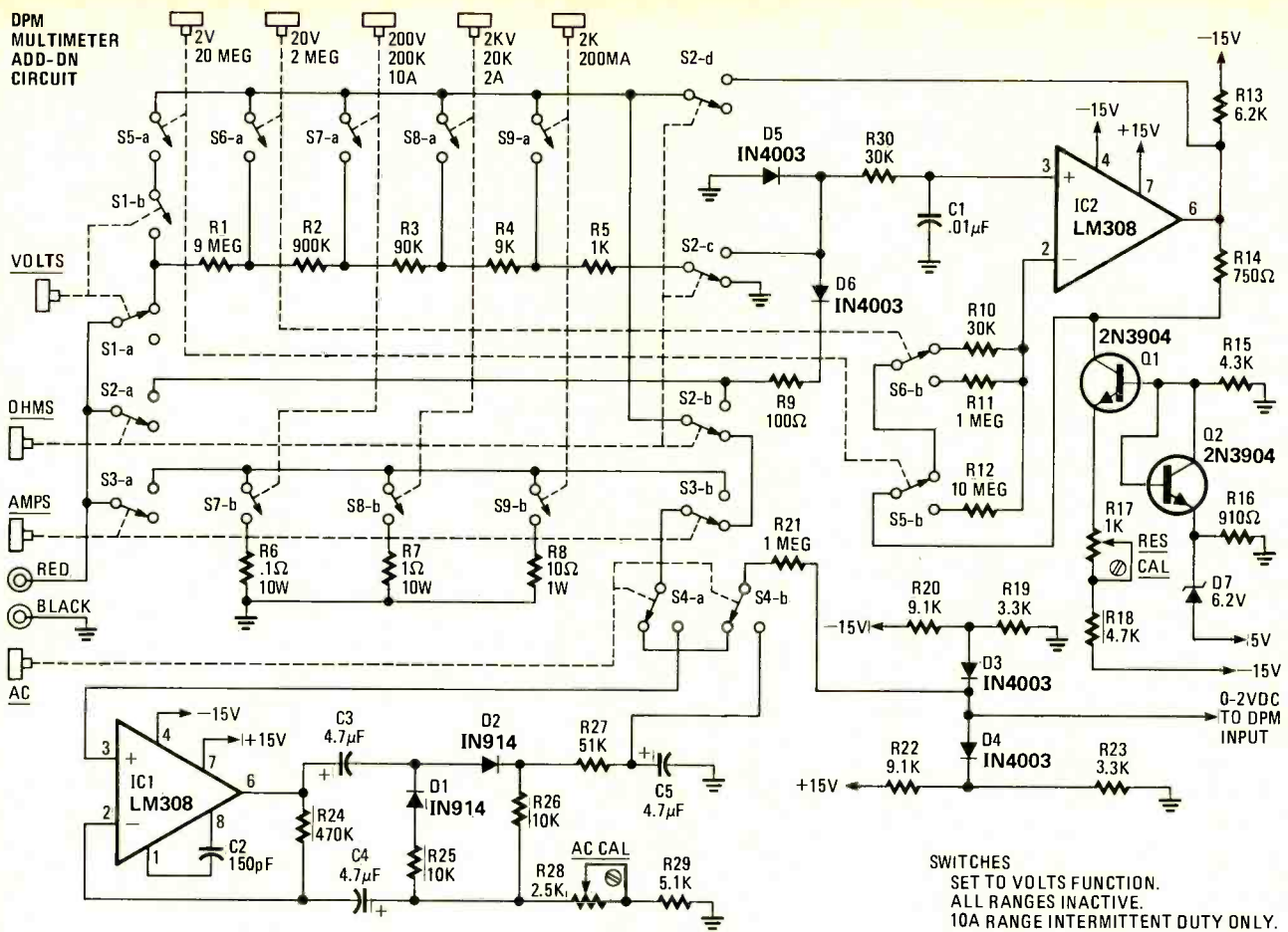

SWITCHES  
SET TO VOLTS FUNCTION.  
ALL RANGES INACTIVE.  
10A RANGE INTERMITTENT DUTY ONLY.

FIG. 7—CIRCUITRY TO CONVERT DPM TO DMM includes function selector switching, multiplier and shunt resistor networks and a few active components.

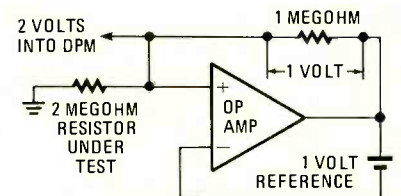
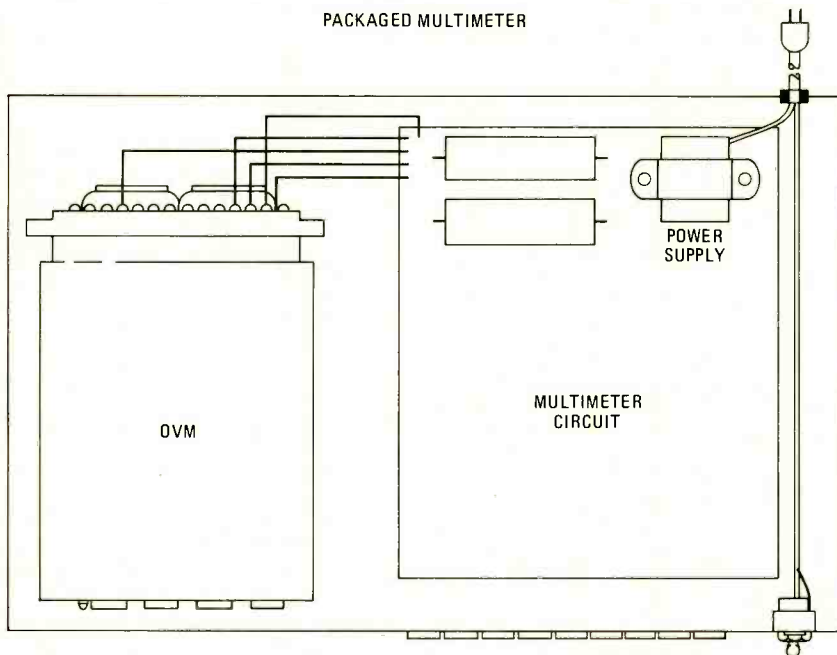

FIG. 9—SIMPLIFIED OHMMETER CIRCUIT. Equal voltages at op-amp inputs are essential to proper ohmmeter operation.

The multimeter can now be made into a finished packaged instrument by housing it in a chassis case similar to that shown in Fig. 8 and the photograph. Here the basic DPM is mounted on the left side of the chassis with the display showing through a tinted red or gray acrylic plastic window, the power supply plus multimeter circuitry being housed in the right side. On-off and function switches are mounted in the right front panel. Such a packaged instrument, though home built, can offer a very attractive and useful meter for both amateur and professional use.

**DMM operation**

The DMM circuit is built around relatively simple and well-proven circuit principles. The circuit diagram in Fig. 7 shows all functions are fed into the DPM on the 0-2-volt scale. The DC voltage input to the DMM feeds into a precision resistor voltage divider, with the scale

*continued on page 103*

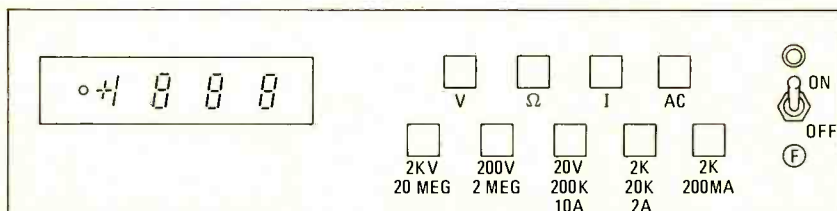
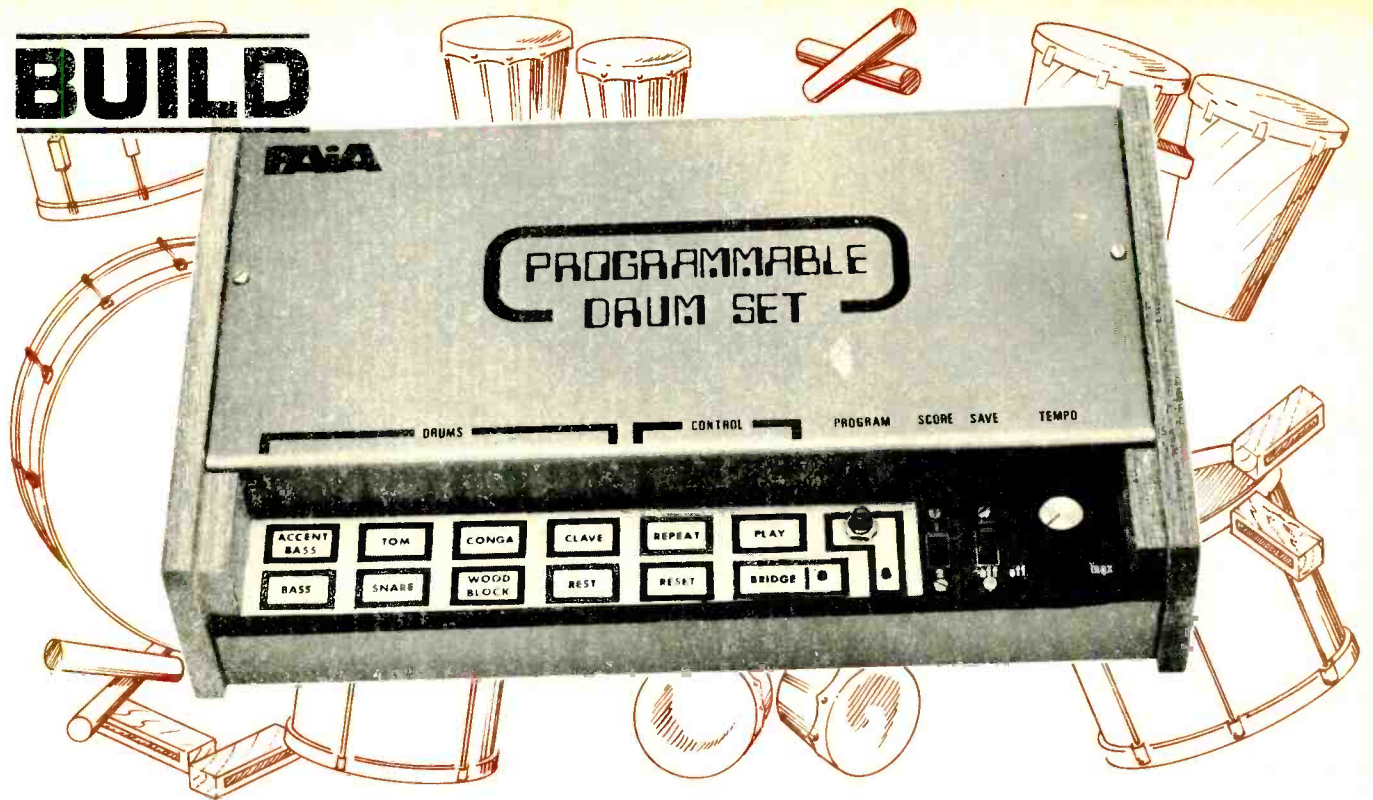

FIG. 8—HOW BASIC PARTS ARE LAID OUT in a typical instrument case. The DPM connects to the multimeter circuit through an edge connector and a short length of cable.

# BUILD



Part II—An electronic musical instrument accessory with a difference. Novel programming capabilities give you unusual time signatures along with bridges and introductions.

LAST MONTH, AS WE BEGAN THE STORY ON this unique musical instrument accessory, we covered its applications, circuitry and theoretical operation. Now, we'll go forward with construction details. A PC board simplifies construction.

## Assembly

For easy assembly, the drum set has been designed so that *everything*, except for the audio output jack and the sync input tip jack, mount directly on the circuit board. This minimizes point-to-point wiring (although there is still some) and produces an exceptionally easy unit to work on. For all practical purposes there are no wires tying the circuit board to panel-mounted controls; in fact, the case is simply a shell to hide the components.

A circuit board is mandatory. You can etch your own PC board using Fig. 5 as a guide. Boards are also available commercially, as are complete kits (see parts list.)

Note that the touch-switch pads that form the bulk of the unit controls are a part of the PC board. In the commercial version of this board, the touch pads are covered with a colored ink; contrasting color designates the control areas. If you make this board at home, transfer lettering can be applied directly to the touch pads and a strip of thin transparent tape applied over that. Since the touch switch-

## JOHN S. SIMONTON, JR.

es do not require direct contact to operate, the insulating layer provided by the tape will suffice but it must be kept as thin as possible.

Once you have the board the way you want it, mount the parts: Resistors and capacitors first; then solid wire jumpers (note there are several of these, as indicated by the solid lines connecting points in Fig. 6); then semiconductors, diodes, transistors, IC's, etc. Observe the orienta-

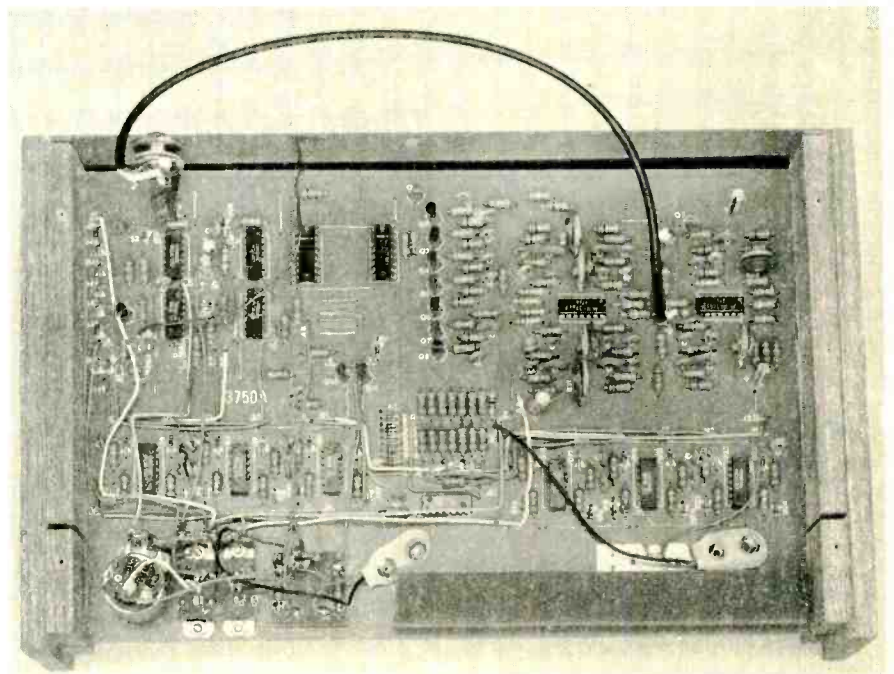

INSIDE VIEW OF THE UNIT shows how parts are positioned on the circuit board. Note that this is a one-sided board.

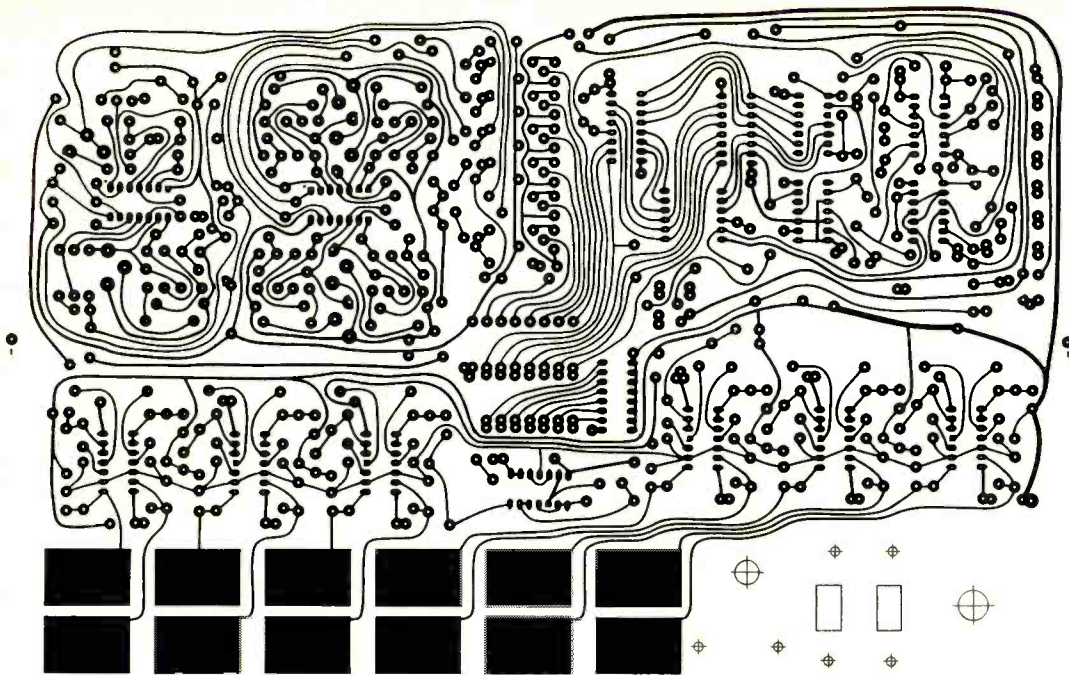

FIG. 5—MAIN PC BOARD foil pattern shown half-size.

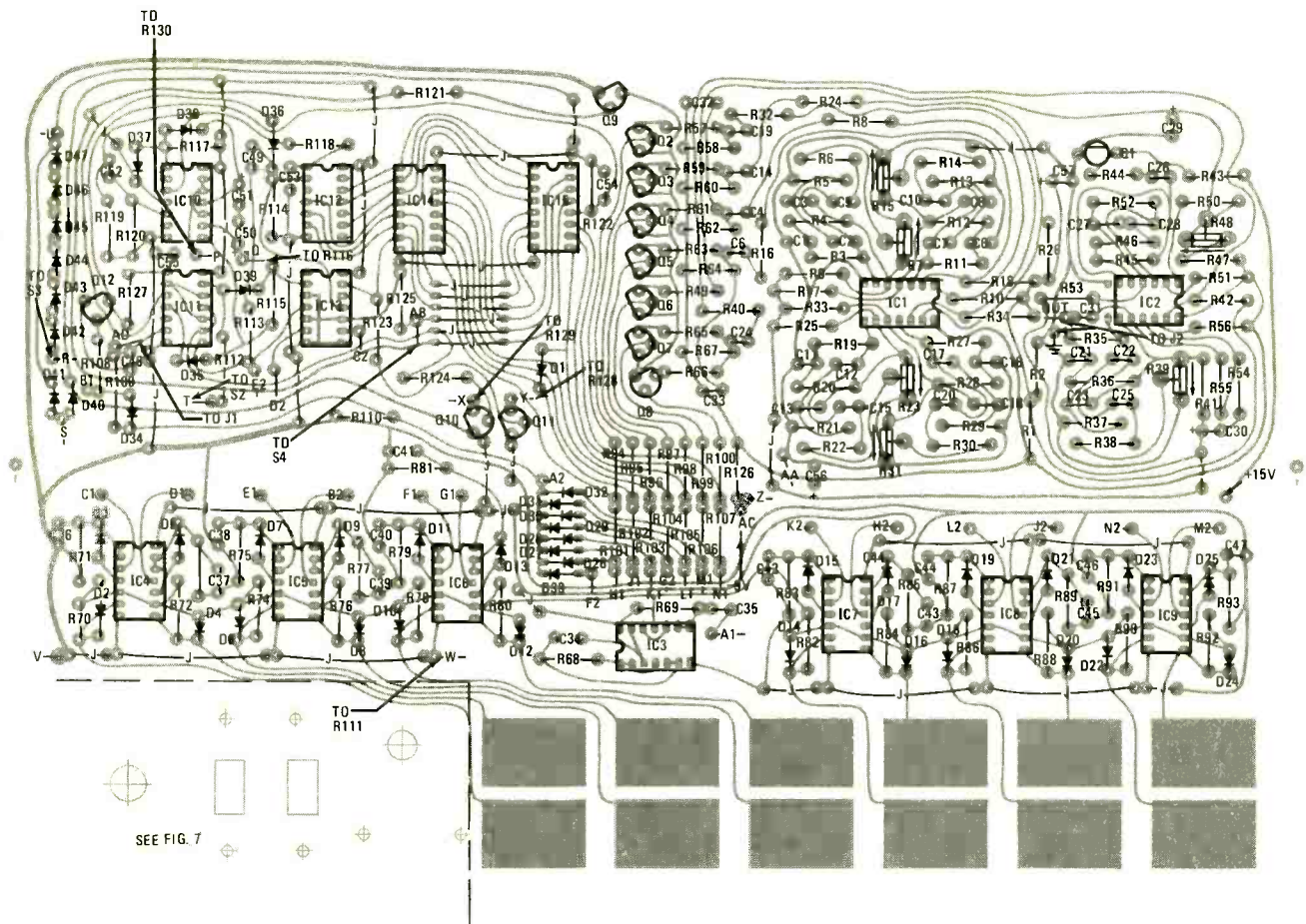

FIG. 6—COMPONENT PLACEMENT DIAGRAM. Wiring of the PC mounted controls and switches are shown in Fig. 7.

tion of electrolytic capacitors, semiconductors and IC's.

Because CMOS logic is used, the common rules of good practice must be followed when installing these parts. In general, avoid static build-up—Do not wear nylon clothes, use a grounded soldering iron and don't run across the carpet before picking up the parts.

After mounting all the electronic components, mount potentiometer R130 and slide switches S3 and S4. Mount a 3-lug tie strip somewhere in the vicinity of these controls (such as under one of the S4 mounting screws as shown in Fig. 7). Note that the two PROGRAM and BRIDGE LED's are mounted on their own circuit board. The foil pattern for the LED board

is shown in Fig. 8. This board also mounts resistors R128 and R129 and is held in place by the mounting shaft of PROGRAM pushbutton S2, as shown in Fig. 9.

There are numerous connections that are made with stranded, insulated wire on the component side of the circuit board. Points with the same letter prefix are connected together (A1 to A2, etc.).

**All resistors 1/2 watt, 10% or better, unless noted.**

R1, R5, R41, R46, R58, R60, R62, R64, R67, R121, R127—10,000 ohms  
 R2, R65—6800 ohms  
 R3, R4, R11, R12, R19, R20, R27, R28, R35, R36, R51—2.2 megohms  
 R6, R8, R14, R22, R30, R38, R43, R52—1 megohm  
 R7, R15, R23, R31, R39, R48—50,000-ohm trimmer, PC mount  
 R9, R17, R25, R33—18,000 ohms  
 R10, R18, R26, R34, R42—3.9 megohms  
 R13, R108, R110, R112, R115, R117, R122—R125—33,000 ohms  
 R16, R24, R32, R56—330,000 ohms  
 R21—39,000 ohms  
 R29, R57, R61, R63—68,000 ohms  
 R37, R101—R104, R106, R107, R118—15,000 ohms  
 R40, R45, R114—220,000 ohms  
 R44, R113, R128, R129—2200 ohms  
 R47, R116—82,000 ohms  
 R49—100 ohms  
 R50, R54, R55, R119—150,000 ohms  
 R53—27,000 ohms  
 R66, R94—R100—47,000 ohms

R68, R105—4700 ohms  
 R69—R93—680,000 ohms  
 R109, R120—470,000 ohms  
 R126—47 ohms  
 R130—500,000-ohm log-taper potentiometer with SPST switch  
 C1, C11, C16, C21, C33, C48, C54, C55—.01μF, 50 volt, ceramic disc  
 C2, C3, C12, C13, C17, C18, C34, C52—.001μF, 50 volt, ceramic disc  
 C4, C9, C14, C19, C22, C23, C32, C35—C47, C49—.005μF, 50 volt, ceramic disc  
 C5, C10, C15, C20, C24—C26, C31—.05μF, 50 volt, ceramic disc  
 C6—C8, C27, C28—500 pF, 50 volt, ceramic disc  
 C29, C57—2.2μF, 10 volt, electrolytic  
 C30, C50, C51—1μF, 10 volt, electrolytic  
 C53—100 pF, 50 volt, ceramic disc  
 C56—33μF, 10 volt, electrolytic  
 D1—D47—1N914 or 1N4148  
 LED1, LED2—light-emitting diodes (Texas Instruments TIL209B or equal)  
 Q1—2N2712 specially selected noise transistor  
 Q2—Q8, Q11, Q12—2N5129

Q9, Q10—2N5139  
 IC1, IC2—LM3900 or CA3401  
 IC3—IC11—CD4001 quad NOR gate  
 IC12—CD4024 seven-stage counter  
 IC13—CD4013 dual-D flip-flop  
 IC14, IC15—2112 256×4 RAM  
 S1—SPST switch ONR130  
 S2—SPST momentary-contact pushbutton  
 S3, S4—SPST slide switches  
 J1—insulated tip jack, red  
 J2—2-conductor phone jack  
 Misc.—two 9-volt battery clips, one battery holder for 4 penlight cells (Keystone type-182 or equiv.), one lug-type terminal strip (one lug grounded, two insulated).

**The following are available from Paia Electronics, 1020 Wilshire, Oklahoma City, OK 73116:**

**Order No. 3750—Complete kit including all parts, case, step-by-step instructions. \$79.95 plus \$3.00 shipping.**

**Order No. 3750PC—Set of two etched, drilled and silkscreened circuit boards. \$15.00 plus \$1.00 shipping.**

**Oklahoma residents add state and local taxes as applicable.**

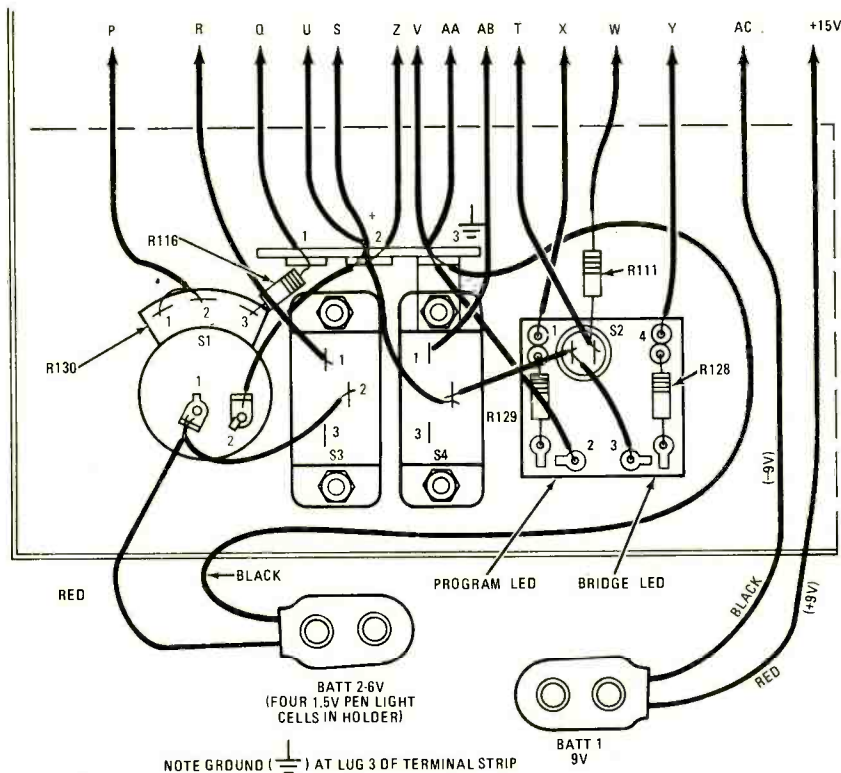

**FIG. 7—CONTROLS AND SWITCHES are mounted on the main PC board. Point-to-point wiring to the main board is shown in Fig. 6.**

There are 13 pairs of these points, designated from A to N (except for I).

Finally, perform the wiring between the controls and the remaining designated points on the circuit board and install the battery snaps, as shown in Fig. 7.

### Testing and calibration

The capacitive touch switches used in the programmable drum set require a moderate-quality earth ground to operate properly. In most cases, the ground established to the amplifier through the audio output cable will suffice.

After carefully checking for misplaced components, solder bridges and cold solder joints, turn the TEMPO control fully counterclockwise past the "click" and turn all six internal trimmer potentiometers (R7, R15, R23, R31, R39 and R48) to their minimum sustain position (*opposite* the direction of the arrows in Fig. 6). Place the SCORE switch in the 1 position and turn the SAVE switch off.

Load the 6-volt battery pack with four AA penlight cells, making sure to observe the orientation of the batteries. Connect this battery pack to the snap attached to

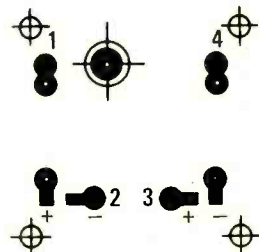

**FIG. 8—LED BOARD foil pattern shown full size.**

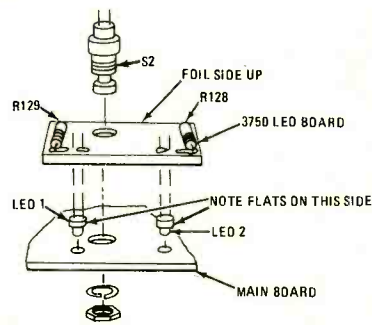

**FIG. 9—LED BOARD is mounted directly to the main PC board. Point-to-point wiring to main PC board is shown in Fig. 7. Components are mounted on foil side of board.**



**FIG. 10—FOX TROT is used as a programming example in text.**

the on-off switch on the TEMPO control. Connect another 9-volt transistor radio battery to the remaining snap (see Fig. 7).

Using a jumper cable, connect the phone-jack output of the drum set to an instrument amplifier or the auxiliary input of a hi-fi amplifier.

Turn the power on by advancing the TEMPO control clockwise. When the unit is first turned on, you may (if the volume

of the amplifier is set high enough) hear a burst of noise lasting about one second. This is normal.

One or both LED's may also come on when power is first applied. Touching the RESET pad should extinguish these LED's.

To test the drum oscillator circuits sustained-oscillation capability, advance the internal trimmers one at a time in the sustain direction (the direction of the arrows) until the drum circuits start oscillating. Once you have established that an oscillator is capable of sustained operation, retard its trimmer control fully (*opposite* the direction of the arrow) before testing the next oscillator. *Note* that trimmer R48 is an adjustment of the noise source used in the snare drum circuits; it does not produce a tone but rather a steady hiss as it is advanced.

To adjust the drum sound oscillators, touch RESET and then press the PROGRAM button. The PROGRAM LED then indicates that you are in the program mode. Advance the TEMPO control clockwise approximately three-fourths of its total rotation.

At this point, pressing any of the drum sound pads should produce a repeating percussion sound in the amplifier's speaker. Adjust the rate at which this sound repeats with the TEMPO control.

With a finger on the WOOD BLOCK pad, adjust trimmer R7 in the sustain direction (the direction of the arrow) until the sound approximates that of a wood block.

Similarly, touch CLAVE and adjust R15; touch TOM and adjust R23; and touch CONGA and adjust R31. Touch ACCENT BASS and adjust R39; then touch BASS and confirm that the bass drum sound is heard, although at a lower volume level than ACCENT BASS.

Touch the SNARE pad and adjust R48 until the noise source approximates that of a snare drum. It may be necessary to adjust TOM control R23 to obtain the maximum realism from the SNARE generator.

Touch RESET and the PROGRAM LED goes off (this resets the unit's internal event counter to zero); then press PROGRAM again to reactivate the PROGRAM LED. Tap each drum sound control pads in turn, ACCENT BASS, TOM, CONGA, CLAVE, BASS, SNARE, WOOD BLOCK and REST. Do not hold these pads down long enough for the sound to repeat, only long enough for a single drum sound to be generated. Finally, touch the REPEAT pad (to indicate the point at which the pattern is to repeat) and, finally, the PLAY pad. At this point the drum set should begin playing back the entered pattern.

Having verified the unit's ability to store a program, you are ready to test the bridge pattern. Reset the unit, and while resting a finger on the BRIDGE pad, touch RESET again. (Note: The activation of the

bridge circuit is sequence-sensitive; this can only be activated by touching RESET *while* the BRIDGE pad is being touched). The BRIDGE LED will come on, indicating that you are in the bridge mode. Push the PROGRAM button (observing that the PROGRAM LED lights), and you are ready to program the bridge.

Program some easily recognized pattern (such as four clave beats) then touch REPEAT and RESET.

Touch PLAY, and the test pattern of all drum sounds programmed previously should be heard. Allow this pattern to play for a couple of cycles, then touch BRIDGE. When the pattern playing reaches the repeat stage, the unit should switch to the bridge pattern (as indicated by the BRIDGE LED lighting) and, as long as the pad is touched, should continue to play. Release the BRIDGE pad. The BRIDGE LED may not immediately extinguish, and the unit may not immediately shift back to the main pattern. This shift should only occur at the point in the bridge pattern where it would ordinarily repeat.

### Using the drum set

Before discussing the operation and use of the controls, the following points need mentioning:

1. Battery current drain is a significant 100 mA in full operation and 30 mA in the SAVE mode. Therefore, use the SAVE sparingly and turn the unit off when not in operation. The penlight batteries should be good for ten hours of intermittent operation, and the 9-volt transistor radio battery should have essentially shelf life.

2. There is a natural tendency to enter patterns "in tempo" by beating out the rhythm on the touch switches. *This is not the way that it is done.* Any pattern must have REST's entered with it for proper drum-beat spacing.

The operation of the controls is as follows:

- TEMPO—This knob, at the right-hand edge of the control panel, sets the tempo at which a programmed rhythm pattern plays back. Clockwise rotation of the control increases the tempo.

The power switch is a part of this control, and rotating the control fully counterclockwise past the "click" turns off the power. The power should be turned off any time that the unit is not being played or programmed.

The TEMPO control also sets the rate at which drum sounds are repeated during programming. In the program mode, continuously activating a drum pad will cause that sound to be repeated at a rate set by the TEMPO control. Each drum sound heard will also be entered into memory.

- SAVE—The SAVE switch holds a programmed pattern for short periods of time. Sliding the SAVE switch to the on position allows the TEMPO control to be rotated to

the full-power off position without losing the scores currently programmed into memory. The SAVE switch should be left off any time it is not being used to actually save a score.

- SCORE—The SCORE switch allows two independent rhythm patterns (each with its own bridge pattern) to be programmed and selected for playback.
- PROGRAM—Pressing the PROGRAM pushbutton puts the unit into the programming mode for pattern entry or modification. The PROGRAM LED will light anytime the unit is in the programming mode.
- CONTROL—There are four touch pads: RESET, REPEAT, PLAY and BRIDGE. Get in the habit of touching the RESET pad every time before anything else is activated. This control resets the internal event counter that determines the next programmed event; it also takes the unit out of the program or bridge modes.

The primary function of the REPEAT pad is to enter into memory the point at which the currently programmed pattern is to repeat. This pad can also be used during playback to go back to the beginning of a pattern without stopping the unit entirely. This is useful for special effects, introductions, etc.

Touching the PLAY pad reproduces the programmed pattern selected by the SCORE switch at a rate set by the TEMPO control. This control pad latches so that a single tap will start the unit, which will then continue to play until stopped by touching the RESET pad.

The BRIDGE pad is used one of two ways, depending on whether you are programming a score or playing one back. To program the bridge, the following sequence must be followed: RESET (*always* reset before anything else), then while touching the BRIDGE pad, tap the RESET again (the BRIDGE LED should light, indicating the bridge mode); then push PROGRAM (the BRIDGE LED should still be on) and now the PROGRAM LED should light indicating the program mode. The bridge pattern can then be programmed in the same manner as a main score.

During playback, touching the BRIDGE pad *at the time of the repeat* will cause the drum circuitry to begin playing the bridge rather than the main score. The BRIDGE key does not latch, and you must touch it at the time of the repeat in order for the unit to shift to the bridge pattern. When the repeat point of the bridge pattern is reached, the unit will shift back to the main score unless the BRIDGE pad is still being touched, in which case the bridge pattern will be repeated.

- DRUMS—The eight touch pads on the left side of the panel control the drum sounds: BASS, ACCENT BASS (down-beat, etc.), TOM, SNARE, CONGA, WOOD BLOCK, CLAVE and, most important, REST.

*continued on page 107*

# Forest Belt tells...

# What You Need To Know About Servicing Citizens Band Radios

## TABLE OF CONTENTS

|  |    |
|--|----|
| Repair Low-Cost CBs<br>Profitably . . . . .    | 50 |
| Efficiency in CB Service<br>Estimate . . . . . | 52 |
| DC Trouble<br>Up Front . . . . .               | 53 |
| Transmitter Keying . . .                       | 58 |
| Servicing<br>Synthesizers . . . . .            | 61 |
| 23-Channel PLL . . . . .                       | 63 |

What happened to CB radio? Nothing you need worry much about. Sales dragged for a while, but most signs indicate there will be a significant improvement by Spring this year.

Servicing dwindled hardly at all. Those dealers who backed up their sales with service have suffered very little. They don't sell as many CB radios as during boom times, but they do move plenty of accessories. And they certainly attract their share of repairs among the 25 million CB radios already in use.

The number of radios is growing, too. More than 200,000 new CB license applications reach the FCC every month—even in so-called bad times. This means that service needs are also growing. If you already repair CB radios, or plan to, or even wonder if you should, you must be aware of certain factors that affect the business now. This special section should help you meet some of the new circumstances in CB servicing.

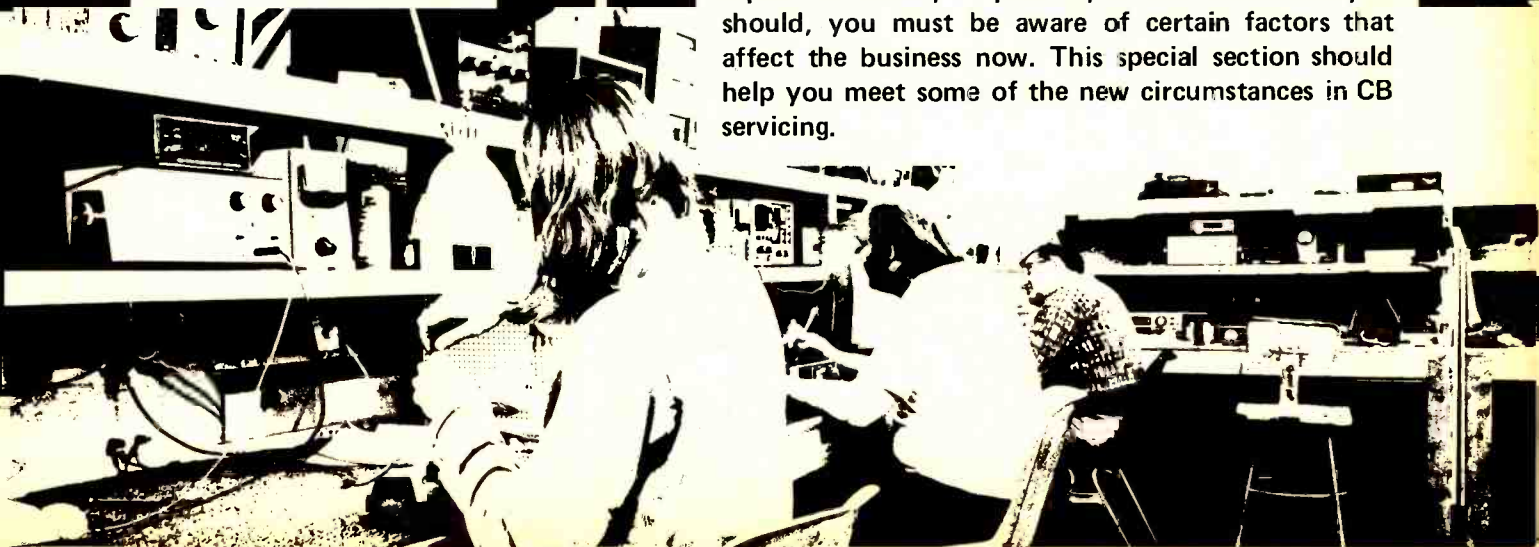

# The New Heathkit Catalog has everything from Personal

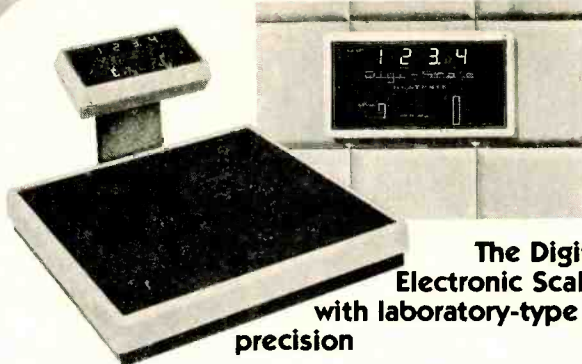

**The Digital Electronic Scale with laboratory-type precision**

Unique and functional truly describe the new Digi-Scale electronic "weighing machine". Big, bright LED's show your weight with more precision than normal scales and there are no springs or weights to compromise performance. Unlike cheaper digital scales, this one uses a precision strain gauge for the utmost in accuracy. The digital readout may be mounted on the wall or just about anywhere.

GD-1186, only \$99.95

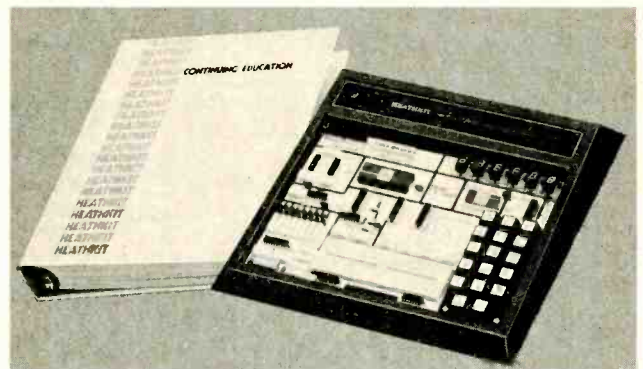

## Learn all about the Microprocessor with this new Self-Instruction Course

Our EE-3401 Microprocessor Course (\$89.95) is your key to learning about microprocessors. Features Heath's famous individualized learning techniques to provide you with a thorough background in microprocessor operation, interfacing and programming. Accompanying software and hardware experiments provide "hands-on" experience with the companion ET-3400 6800 Microprocessor-based trainer (\$189.95).

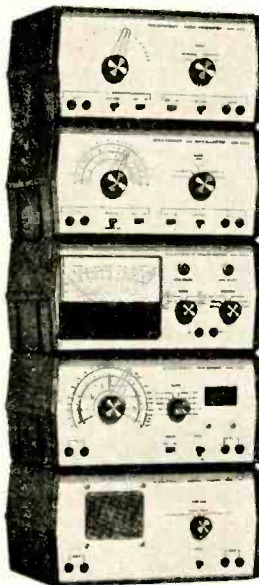

## Low-Cost Starter Series Test Bench

These five starter instruments are an economical low cost way to your first bench. They're intended for (but not limited to) the beginner and you'll be surprised at the features and performance these new instruments have to offer! There's the IG-5280 RF Oscillator with 320 kHz to 220 MHz frequency range, the IM-5284 high performance multimeter that reads volts, ohms and DC current, the IT-5283 Signal Tracer for RF, AF and logic tracing, the IB-5281 RCL Bridge for design and experimentation and the IG-5282 Audio Oscillator with a 10 Hz to 100 kHz frequency range. And to power the 5280 series, you can build the IPA-5280-1 power supply. Only \$37.95 each, \$24.95 for the power supply.

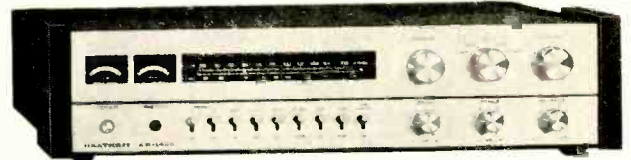

## Build this new Stereo Hi-Fi Receiver for top performance and value

Experience the subtle shadings of the symphony, cool jazz, and the driving beat of rock all with this stereo performer from Heath. 35 watts, minimum RMS, per channel into 8 ohms with less than 0.1% total harmonic distortion from 20-20,000 Hz. The AR-1429 is perfect for the budget conscious stereo buff who requires a high quality system. It has all the features of a high-priced receiver and the performance too. Phono hum and noise are -65 dB. FM sensitivity is 1.8  $\mu$ V. Has provision for optional Dolby™ FM module. AR-1429, only \$319.95

## Heathkit/Dana Electronic Speed Control Fits Most Cars

Long distance drivers will really appreciate the CS-1048. It makes the most of famous Dana Corp. technology and a crystal clear Heath instruction manual for easy installation. Electronically maintains your auto's speed uphill or downhill.

CS-1048, only \$64.95



## Super-Value Digital Alarm Clock

A perfect kit for the first time kitbuilder. This super-accurate timepiece has an attractive blue four-digit display that dims automatically according to ambient light. It also has the features you need in a clock; 24-hour "smart" alarm, snooze switch, alarm-on indicator and power failure indicator. GC-1107, only \$27.95

Read more about these and nearly 400 other unique and exciting kit products – all in the big, NEW, Heathkit Catalog.



# Entertainment to Personal Computing

## AVAILABLE LOCALLY IN THESE MARKETS

**ARIZONA:** Phoenix, 85017, 2727 W. Indian School Rd., Phone: 602-279-6247; **CALIFORNIA:** Anaheim, 92805, 330 E. Ball Rd., Phone: 714-776-9420; El Cerrito, 94530, 6000 Potrero Ave., Phone: 415-236-8870; Los Angeles, 90007, 2309 S. Flower St., Phone: 213-749-0261; Pomona, 91767, 1555 Orange Grove Ave. N., Phone: 714-623-3543; Redwood City, 94063, 2001 Middlefield Rd., Phone: 415-365-8155; Sacramento, 95825, 1860 Fulton Ave., Phone: 916-486-1575; San Diego (La Mesa, 92041), 8363 Center Dr., Phone: 714-461-0110; San Jose (Campbell, 95008), 2350 S. Bascom Ave., Phone: 408-377-8920; Woodland Hills, 91364, 22504 Ventura Blvd., Phone: 213-883-0531; **COLORADO:** Denver, 80212, 5940 W. 38th Ave., Phone: 303-422-3408; **CONNECTICUT:** Hartford (Avon, 06001), 395 W. Main St. (Rte. 44), Phone: 203-678-0323; **FLORIDA:** Miami (Hialeah, 33012), 4705 W. 16th Ave., Phone: 305-823-2280; Tampa, 33614, 4019 West Hillsborough Ave., Phone: 813-886-2541; **GEORGIA:** Atlanta, 30342, 5285 Roswell Rd., Phone: 404-252-4341; **ILLINOIS:** Chicago, 60645, 3462-66 W. Devon Ave., Phone: 312-583-3920; Chicago (Downers Grove, 60515), 224 Ogden Ave., Phone: 312-852-1304; **INDIANA:** Indianapolis, 46220, 2112 E. 62nd St., Phone: 317-257-4321; **KANSAS:** Kansas City (Mission, 66202), 5960 Lamar Ave., Phone: 913-362-4486; **KENTUCKY:** Louisville, 40243, 12401 Shelbyville Rd., Phone: 502-245-7811; **LOUISIANA:** New Orleans (Kenner, 70062), 1900 Veterans Memorial Hwy., Phone: 504-722-6321; **MARYLAND:** Baltimore, 21234, 1713 E. Joppa Rd., Phone: 301-661-4446; Rockville, 20852, 5542 Nicholson Lane, Phone: 301-881-5420; **MASSACHUSETTS:** Boston (Peabody, 01960), 242 Andover St., Phone: 617-531-9330; Boston (Wellesley, 02181), 165 Worcester Ave. (Rt. 9 just west of Rt. 128), Phone: 617-237-1510; **MICHIGAN:** Detroit, 48219, 18645 W. Eight Mile Rd., Phone: 313-535-6480; E. Detroit, 48021, 18149 E. Eight Mile Rd., Phone: 313-772-0416; **MINNESOTA:** Minneapolis (Hopkins, 55343), 101 Shady Oak Rd., Phone: 612-938-6371; **MISSOURI:** St. Louis (Bridgeton), 63044, 3794 McKelvey Rd., Phone: 314-291-1850; **NEBRASKA:** Omaha, 68134, 9207 Maple St., Phone: 402-391-2071; **NEW JERSEY:** Fair Lawn, 07410, 35-07 Broadway (Rte. 4), Phone: 201-791-6935; Ocean, 07712, 1013 State Hwy. 35, Phone: 201-775-1231; **NEW YORK:** Buffalo (Amherst, 14226), 3476 Sheridan Dr., Phone: 716-835-3090; Jericho, Long Island, 11753, 15 Jericho Turnpike, Phone: 516-334-8181; Rochester, 14623, 937 Jefferson Rd., Phone: 716-244-5470; White Plains (North White Plains, 10603), 7 Reservoir Rd., Phone: 914-761-7690; **OHIO:** Cincinnati (Woodlawn, 45215), 10133 Springfield Pike, Phone: 513-771-8850; Cleveland, 44129, 5444 Pearl Rd., Phone: 216-886-2590; Columbus, 43229, 2500 Morse Rd., Phone: 614-475-7200; Toledo, 43615, 48 S. Byrne Rd., Phone: 419-537-1887; **PENNSYLVANIA:** Philadelphia, 19149, 6318 Roosevelt Blvd., Phone: 215-288-0180; Frazer (Chester Co.), 19355, 630 Lancaster Pike (Rt. 30), Phone: 215-647-5555; Pittsburgh, 15235, 3482 Wm. Penn Hwy., Phone: 412-824-3564; **RHODE ISLAND:** Providence (Warwick, 02886), 558 Greenwich Ave., Phone: 401-738-5150; **TEXAS:** Dallas, 75201, 2715 Ross Ave., Phone: 214-826-4053; Houston, 77027, 3705 Westheimer, Phone: 713-623-2090; **VIRGINIA:** Alexandria, 22303, 6201 Richmond Hwy., Phone: 703-765-5515; Norfolk (Virginia Beach, 23455), 1055 Independence Blvd., Phone: 804-460-0997; **WASHINGTON:** Seattle, 98121, 2221 Third Ave., Phone: 206-682-2172; **WISCONSIN:** Milwaukee, 53216, 5215 W. Fond du Lac, Phone: 414-873-8250.



H8 Computer

H11 Computer

LA36 DEC Writer II

H9 Video Terminal

H10 Paper Tape Reader/Punch

## Complete "Total Concept" Personal Computer Systems and Systems Software: Economy, power and service backup from a single source!

Heathkit Computers and System Software are designed for complete continuity from top to bottom. The 8080A based H8 computer is a good example. It features a front panel ROM monitor program readout, 8-bit operation, a heavy duty power supply and a host of other user benefits. Like all Heathkit Computers, it's easily expanded. Includes BASIC, assembler, editor and debug software for only \$375. Our most sophisticated computer, the H11, utilizes the famous DEC LSI-11 CPU for 16-bit operation. Has a 4096 x 16 read/write MOS semiconductor memory and 38 high speed data, address, control and synchronization lines. Executes and includes the powerful 400+PDP-11/40 instruction set. It also includes a complete software package for only \$1295.

Heathkit Peripheral Devices follow the same total concept philosophy. Our H9 12" CRT ASCII Video Terminal has all standard serial interfaces, auto scrolling, erase mode, long and short form and plot mode displays and ASCII 67-key keyboard for just \$530. If you need hard copy, the LA36 DEC Writer II is perfect. Fully compatible with the H8 and H11, this incredible terminal has a 7 x 7 dot matrix print head, selectable 10, 15 and 30 CPS print speeds, half or full duplex operation and much more for a low \$1495. Our low cost mass storage peripheral is the H10 Paper Tape Reader/Punch. Precise ratchet/solenoid drive, 50 CPS max read rate, 10 CPS max punch rate and the features of similar units that cost far more than \$350.

# FREE!

Get your copy of the latest **HEATHKIT CATALOG**  
Nearly 400 exciting electronic kits

### MAIL COUPON TODAY

or bring it in person to any of the 50 Heathkit Electronic Centers (Units of Schlumberger Products Corporation) listed at right, where Heathkit products are displayed, sold and serviced. (Retail prices on some products may be slightly higher.) Prices are mail order net F.O.B., Benton Harbor, Michigan. Prices and specifications subject to change without notice.

Heath Company, Dept. 020-390



|  |   |
|--|---|
| HEATH<br>Schlumberger  | Heath Company, Dept. 020-390<br>Benton Harbor, Michigan 49022 |
| Please send me my FREE Heathkit Catalog.<br>I am not on your mailing list. |   |
| Name _____   |   |
| Address _____  |   |
| City _____   | State _____   |
| GX-340 _____ Zip _____   |   |

CIRCLE 100 ON FREE INFORMATION CARD

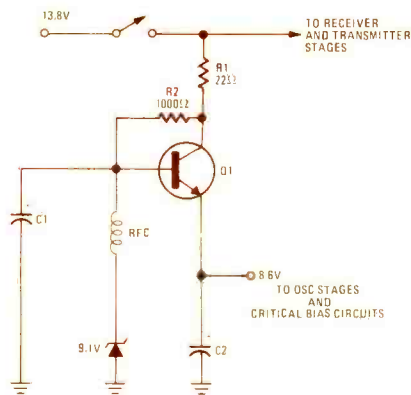

**FIG. 3—TRANSISTOR REGULATOR IS rare for inexpensive CB radios, and usually includes a Zener diode.**

it's only a half-watt resistor, the heat may change its value. Eventually, the resistor chars or, if the resistance decreases, the current may rise high enough for the fuse to blow.

Second, Zener diodes open. It may not be noticeable unless some critical stage malfunctions because of varying voltage. Hence, in any set with Zener diodes, it is wise to include some

measuring voltage across each diode. . . within 5 percent of the Zener rating. Schematic diagrams usually list the voltage to expect across each Zener.

### Transistor voltage regulator

Enough low-cost sets use transistor regulators that you should know what to expect of them. Figure 3 is a diagram of the usual transistor circuitry. Actually, the regulating action begins with the Zener diode in the transistor base circuit.

Transistor Q1 operates as a series regulator. The output, which stabilizes at about 8.6 volts, depends on the voltage drops across Q1 and R1. The internal resistance of Q1 is determined, of course, by the emitter-base bias.

Suppose that more current is being drawn at the Q1 output. Emitter voltage tends to become slightly less positive. The Zener holds the base voltage steady so that the net bias on NPN transistor Q1 becomes greater in the forward direction. This, in turn, lowers the series resistance of Q1, bringing the output voltage back up to 8.6.

Now, suppose less current is drawn. The voltage at the Q1 emitter rises, thus reducing the forward bias on transistor Q1. Less conduction in Q1 is the equivalent of increasing its effective resistance. Less current can flow and the output voltage drops back to equilibrium at 8.6.

Equally important, this regulator cures input-voltage fluctuations. Even if the input voltage alters, the Zener diode prevents the base bias from varying. The output voltage would tend to follow the input-voltage variation up or down, but it cannot do so because of the regulating action described above.

To troubleshoot, measure the voltage across the Zener diode. If the voltage is high, replace the diode; if low, open the emitter lead of the transistor. If the voltage then rises back to normal across the Zener, the fault may be in the transistor; test it while the lead is loose. Or, you may have to trace a short along the regulated DC supply line.

That about covers what you might find in the DC supply sections of a low-cost transceiver. **R-E**

# Transmitter Keying

SWITCHING FROM RECEIVE TO transmit modes (called transmitter *keying*) is relatively simple in low-cost CB transceivers. There are three switching methods: relay switching, simple electronic switching and transistor electronic switching.

Changing from the receive to transmit modes involves four basic operations:

1. Disabling the receiver. Usually, this is done most simply by removing the DC voltage supply from the receive stages. That's how a relay does it. But there are also other means, as discussed later on in this article.

2. Activating the transmitter. A relay can simply apply the DC voltage to the transmit stages. Electronic switching uses other ways to activate the stages.

3. Disconnecting the speaker. The audio stages and output transformer double as modulator components for AM transmitting. And if the speaker were on, it would cause acoustic feedback to the mike.

4. Transferring the antenna connection from the receiver input to the transmitter output. This switchover is simple with a relay. Electronic keying requires a different approach.

These are the fundamental alterations that switch the receive mode to the transmit mode. The CB operator initiates them by pressing the mike button. Figure 1-a shows how this is done when a relay system is used.

Roughly one-fourth of low-cost CB transceivers incorporate relay keying.

Most mike push-to-talk (PTT) buttons have two sections. Figure 3-a

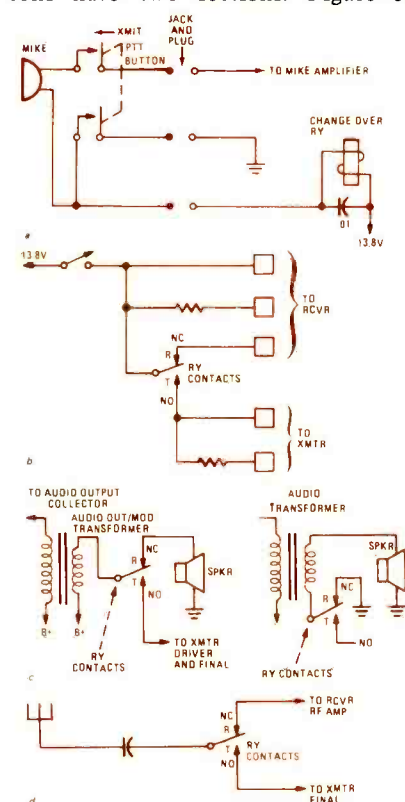

**FIG. 1—THREE SETS OF CONTACTS ON relay accomplish the four receive-to-transmit switchover operations.**

shows a double-pole single-throw (DPST) version. One set of contacts feeds the mike's output voltage to the mike amplifier stage; the others are *keying contacts*. They ground one end of the keying-relay coil. Since the other end connects to the 13.8-volt DC supply line, closing the mike-switch contacts energizes the relay coil.

The keying relay contains at least three sets of contacts. One contact set (shown in Fig. 1-b), transfers the DC supply voltage from the receiver to transmitter stages; this takes care of the first two changeover operations in our list of four. Another set of contacts disables the speaker (Fig. 1-c). In some designs, the relay transfers the output of the audio power stage from the speaker to the transmitter RF section, changing the audio function to modulator. In other schemes, the contacts merely unground the speaker or one transformer winding to eliminate speaker sound.

And finally, Fig. 1-d shows that one set of contacts moves the antenna connection from the receiver input to the transmitter output.

There's a specific procedure you use to troubleshoot different keying troubles. For relay keying, you start by pushing the relay armature, using your finger or an insulated rod. If the transceiver shifts to transmit, the contacts are working; concentrate on the keying circuit.

The coil cord causes more keying trouble than any other component. Open the mike and check the voltage on the relay side of the mike switch. Is it missing? The coil cord or plug may be open. Or the relay or its connection to the DC voltage line are open. Try keying with a jumper lead: First jumper the keying contacts at the coil cord, at the plug and finally right at the relay.

Occasionally, you may find a relay that pulls in OK when you press the mike button; the receiver stops, but the transmitter doesn't start. Yet, pressing the relay with your finger does start the transmitter. Either the relay contacts are dirty and need burnishing, the relay coil is partially shorted or the relay is misadjusted. A new relay proves the surest cure for any of these defects.

### Electronic keying

Keying without a relay saves the cost of an expensive component—the relay. Actually, all four changes can be accomplished with one set of switch contacts—in the mike. Figure 2 is a diagram of one design that incorporates a number of techniques found in other models although not always together.

Two principles allow the electronic keying arrangement shown in Fig. 2 to turn the receiver off and the transmitter on: (1) Apply proper DC operating voltage to the transistors in a stage, and the stage operates. Remove the voltages, and the stage stops. (2) In typical circuitry, you can turn off any NPN transistor by applying a high positive voltage to its emitter circuit. This is termed a *kill voltage*. Return the emitter circuit to ground potential, and the stage turns on again.

Figure 2 shows how this happens. This keying design uses one DC voltage bus in two ways. The same voltage serves both as a kill voltage and as a supply voltage. Source point 4 in the Fig. 2 diagram marks the voltage (6.1)



**SOME MICROPHONES USE A LEAF switch (right), while others use a plunger-type DPDT switch.**

used for transmit-receive keying.

Study the supply line bus first. This DC branch supplies voltage to the collector of the receive mixer, as well as bias for the base. It is not necessary to show the other receiver stages on the diagram; the 6.1-volt supply goes to each of them. Note that the emitters of these receiver stages go to ground through the usual resistor.

Pressing the mike switch to its transmit position grounds point 4. The voltage drops to zero. Resistor R4 limits the current so the short doesn't overload the DC input. Of course, the receiver stages can't operate with zero voltage fed to their collectors and bases. Releasing the mike button restores the voltage, and the receiver works.

Turn your attention now to the connections along the bus labeled the "kill line." First, look at the transmit buffer stage. The collector voltage on this transistor comes from source point 1. The bias voltage develops through self-bias. But the stage can't operate—with 6.1 volts positive on the emitter, the stage is dead.

But move that mike-switch contact from the receive mode to the transmit mode, and the voltage goes to zero. Grounding the emitter circuit this way brings the stage to life.

The same operating principle controls

the transmit oscillator IC. This IC turns on when the mike switch grounds one of its pins. The rest of the time, during the receive mode, the positive kill-line voltage deactivates the transmit oscillator IC.

Generally, only two or three transmitter stages need to be kept off during the receive mode. The driver and final stages can stay idle and draw a bit of current from their DC voltage supplies with no harm done. These stages do not really operate until driven by the RF drive signal from the transmit oscillator and buffer stage. The mike amplifier is usually included among the switched stages, kept off during the receive mode so that no mike sound can reach the audio stages.

Cutting off the receiver and turning on the transmitter takes care of switchover operations Nos. 1 and 2 listed earlier. Now let's consider a third operation: the antenna.

There's really no need to transfer the antenna. You can connect the transmitter's RF output to the same point as the receiver input, and leave it. However, the receiver input needs protection from the transmitter's RF power. Diode D2 and the kill line (see Fig. 2) provide such protection.

With 6.1 volts on its cathode, diode D2 is reverse-biased and exerts no effect on the base circuit to which it's connected. Closing the mike switch grounds the cathode, and D2 becomes conductive.

The last transfer operation concerns the speaker switchoff. Figure 2 shows how this is done: Pressing the mike switch to the transmit position ungrounds the speaker or the audio transformer.

### Switching other stages

The keying setup shown in Fig. 3 probably needs little explanation. You know that applying a positive voltage to the NPN transistor emitters holds them cut off. So, in this system the mike switch grounds the emitters of

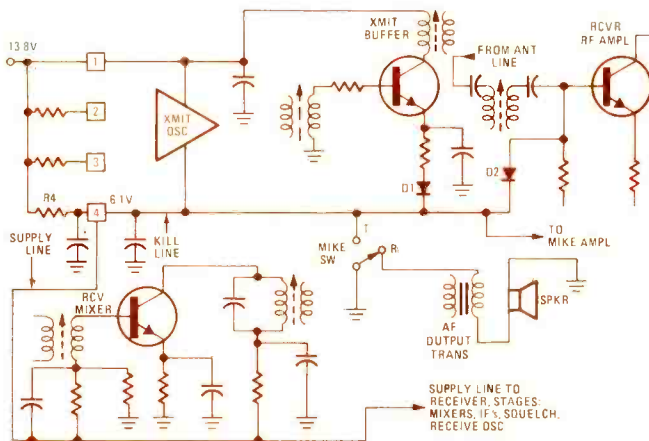

**FIG. 2—MIKE SWITCH GROUNDS A COMBINATION SUPPLY and kill bus to change set to transmit mode.**

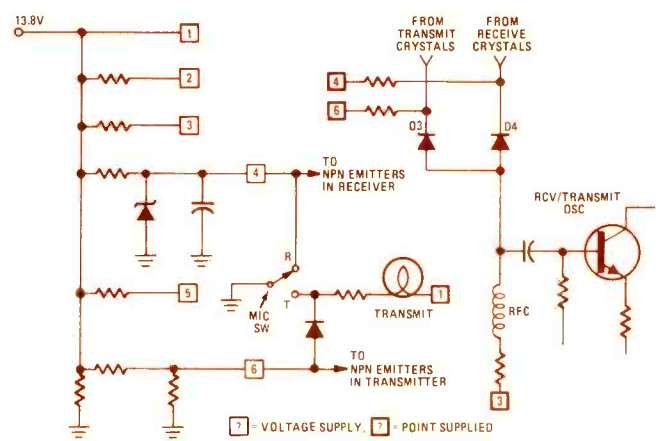

**FIG. 3—KILL LINES FOR TRANSMIT OR RECEIVE ARE grounded by mike switch. Same lines connect crystals through diodes.**



# Servicing Synthesizers

How to troubleshoot both the PLL and the multi-crystal types.

THERE IS ONE SECTION IN A CB transceiver that operates whether you are transmitting or receiving—the frequency synthesizer. This section initiates internal RF signals for both receiver and transmitter.

Inexpensive CB radios are predominantly 23-channel sets. Very few use a phase-locked loop. Some 80 percent incorporate frequency synthesizers, by

far the most popular being the 6-4-4 type of synthesizer. This version consists of a master oscillator with six crystals, a receive oscillator with four crystals and a transmit oscillator with another four crystals. A few low-priced transceivers use a 6-4-2 synthesizer, having six and four crystals in two synthesizer oscillators, and one each in the receive and transmit oscillators.

## How synthesis works

Synthesizer operation is easy to understand, no matter in what kind of CB radio. It involves simple heterodyning.

The block diagram of Fig. 1 shows the type of synthesizer used by a majority of low-cost 23-channel CB radios; the most common crystals for this type of radio are shown. You are safe in stocking up on these crystals. . . you'll use them.

First, study the operation of this synthesizer during the transmit function; the receive oscillator is off, and the transmit oscillator is on.

For example, assume the channel selector is set for CB Channel 9. To discover which crystals are activated, consult the crystal combination chart in Fig. 1. (Each Sams *PhotoFact* Schematic contains a similar chart.)

In our example, crystals X3 and X11 are the ones involved in transmitting the Channel 9 signals. (Remember, the receive oscillator is off.) The signals generated by the synthesis oscillator and the transmit oscillator meet in the transmit mixer, where they heterodyne. Subtracting the crystal X11 frequency from the crystal X3 frequency, (37.700 minus 10.635) gives 27.065 MHz—the output of the transmit mixer.

Release the mike button and the set returns to the receive condition. This cuts off the transmit oscillator and activates the receive oscillator. The synthesis oscillator continues to operate. The Channel 9 crystal combination for receive is crystals X3 and X7.

However, the Fig. 1 block diagram shows that the signals from these two crystals do not heterodyne together directly. Instead, the synthesis oscillator signal goes to the first receive mixer, where it heterodynes with whatever incoming CB signals are present. Since the channel selector is set at Channel 9, here's what happens if there is a Channel 9 signal present.

Crystal X3 produces a 37.700-MHz signal. If that signal heterodynes in the first receive mixer with a 27.065-MHz signal the resulting high IF signal is 10.635 MHz. This high IF signal mixes in the second receive mixer with a signal from the receive oscillator. Since crystal X7 is selected when the switch is at Channel 9, the 10.635-MHz signal heterodynes with a 10.180-MHz signal.

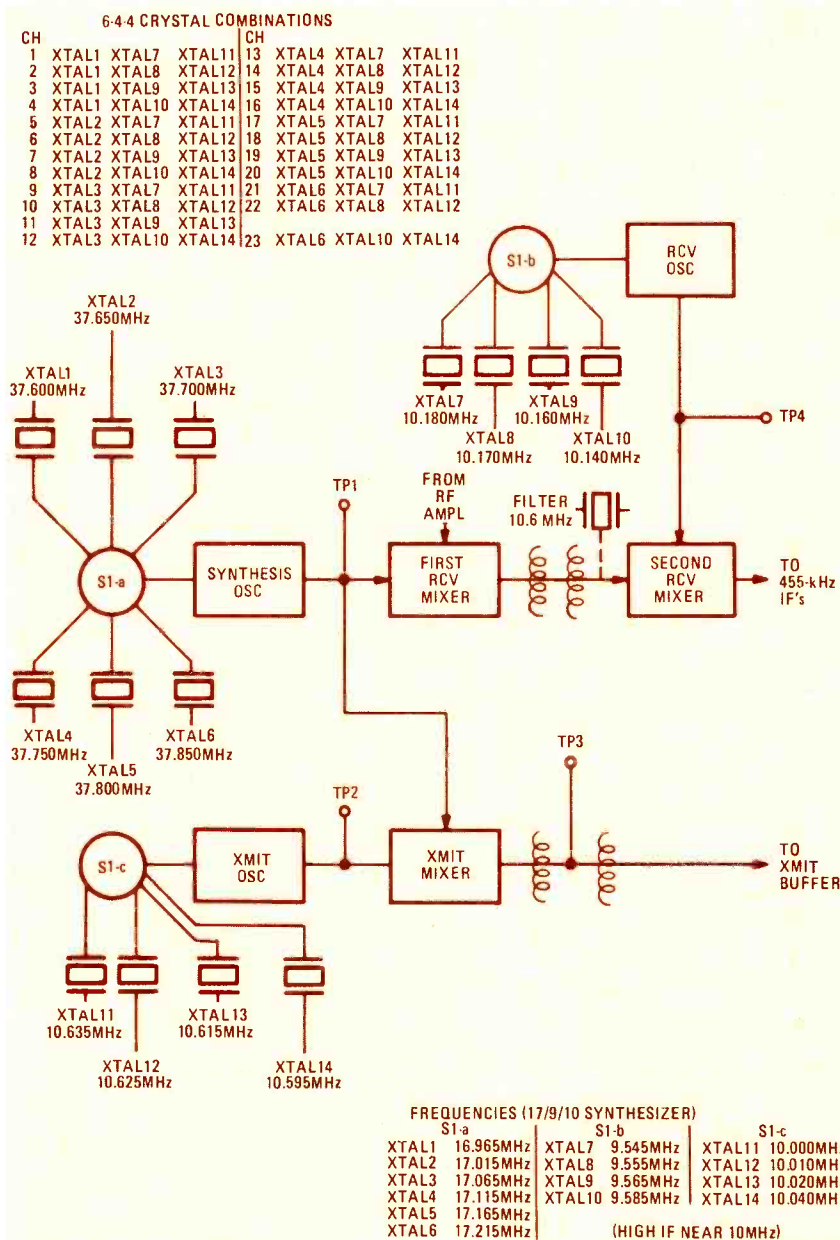

FIG. 1—THE 6-4-4 SYNTHESIZER FALLS MAINLY IN TWO FREQUENCY GROUPINGS: 37/10/10 (the most popular) and 17/9/10, using a 10-MHz high IF signal.

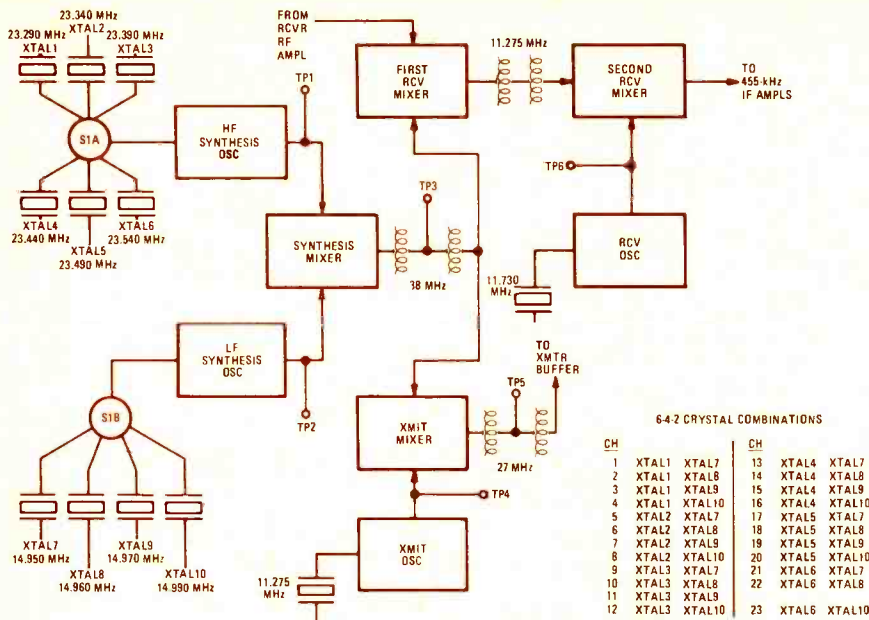

FIG. 2—THE 6-4-2 SYNTHESIZER HAS HIGH- AND LOW-FREQUENCY SYNTHESIS oscillators, and separate single-frequency receive and transmit oscillators.

The difference is 0.455 MHz—of 455 kHz, the low intermediate frequency.

Using the same method, you can figure out how any other channel operates. The crystal combinations chart will show you which crystals are used in any channel position. The 37/10/10 crystal frequency arrangement shown in Fig. 1 is typical and the most common. However, there is another set of frequencies that is used fairly often—17/9/10. Frequencies for each of these crystals are listed in the box in Fig. 1. Crystals in the vicinity of 17 MHz control the synthesis oscillator; crystals near 10 MHz operate the transmit oscillator; and those near 9 MHz control the receive oscillator. If you see many of these sets, it's probably a good idea to carry one each of these crystals also.

Most of these receivers are double-conversion units. On schematic diagrams, the high IF is labeled either 10 MHz or 10.7 MHz, depending on the synthesizer crystals. Either way, the receive oscillator then heterodynes that high IF signal down to the second or low IF, which is always 455 kHz.

The so-called 10.7-MHz high IF signals are actually at 10.6 MHz, but they are listed that way because 10.7-MHz IF coils are common. The coils can be aligned at whatever frequency the synthesizer crystals beat the incoming CB signal down to: Slightly above 10.6 MHz in 37/10/10 combinations and barely above 10 MHz in the 17/9/10 arrangement. Occasionally, 37/10/10 models will have a ceramic-tuned filter instead of coils between the two mixers. Almost always, it is listed as a 10.7-MHz filter, but it actually centers a bit below that frequency.

To be sure you understand the synthesizer system shown in Fig. 1, use your

calculator to go through the following 17/9/10 example: Assume the channel switch is set to Channel 19. Crystals X5 and X9 control the synthesis and receive oscillators, respectively.

Incoming signals mix with the 17.165-MHz synthesis signal to create high IF signals. Only a 27.185-MHz (Channel 19) signal places a 10.020-MHz signal into the second receive mixer. And that's the only high IF signal that can heterodyne 9.565 MHz (from crystal X9) and produce the correct low IF signal of 455 kHz. Any other incoming CB signal produces the wrong intermediate frequencies and is rejected.

In the transmit mode, crystals X5 and X13 heterodyne in the transmit mixer. Together their 17.165-MHz and 10.020-MHz signals produce a 27.185-MHz signal, the carrier for Channel 19.

### Another synthesizer

Figure 2 shows a type of frequency synthesizer found in some low-cost CB's. I call it a 6-4-2 synthesizer. But you might also call it a 23/14 system because of the approximate number of crystal frequencies in the two synthesis oscillators. Again, it pays to keep this dozen crystals on hand. (Two crystals belong in the transmit and receive oscillators.)

Both synthesizer oscillators operate continuously when the set is on, for both transmit and receive functions. Let's choose Channel 23 for example. I recommend you run through the heterodyne calculations to see how this synthesizer operates in the transmitter. Fire up your calculator.

For Channel 23, the Fig. 2 chart names crystals X6 and X10. Crystal X6 holds the high-frequency synthesis

oscillator at 23.540 MHz. Crystal X10 holds the low-frequency synthesis oscillator at 14.990 MHz. This synthesizer mixer is additive; its output signal is 38.530 MHz.

In the transmit mode, the receiver mixer and oscillator are disabled. The transmit stages are all turned on. An 11.275-MHz signal mixes with the 38.530-MHz signal in the subtractive transmit mixer. Subtracting 11.275 MHz from 38.530 MHz gives 27.255 MHz, the carrier frequency for Channel 23.

In the receive mode, the transmit stages are off and the receive stages are on. As in the other systems, the synthesizer frequency beats in the first receive mixer signal with incoming CB signals from the receiver's input RF amplifier. The only CB signal that produces the correct 11.275-MHz high IF is the 27.255-MHz signal. You can check it on your calculator. Just subtract 27.255 MHz from the 38.530-MHz synthesizer signal.

Next, the 11.275-MHz IF signal heterodynes in the second receive mixer stage with an 11.730-MHz signal from the receive oscillator. Your calculator will show the difference is 0.455 MHz—which is the 455-kHz low IF signal.

Just as an exercise in understanding double-superhet receivers, use your calculator to see what happens to any other incoming signal, beating with the Channel 23 synthesizer signal. Suppose that the antenna is receiving signals from Channels 2, 4, 8, 9, 12, 17, 19 and 23. Choose any one of these signals and run it through the two mixers.

For example, try channel 9. Subtracting 27.065 from 38.530 (with the synthesizer set for Channel 23) gives an IF signal of 11.465 MHz. The high IF signal transformer, since it is tuned to 11.275 MHz, tries to reject this signal, but a small portion probably gets through to the second mixer.

In the second mixer, whatever is left of this 11.465-MHz IF signal mixes with the 11.730-MHz signal from the receive oscillator. The difference frequency is 0.265 MHz, or 265 kHz. That's a long, long way from 455 kHz. There is no way a 265-kHz signal can make it through the low IF amplifiers. Thus, the set has rejected the original Channel 9 signal.

If you work out any of the other signals except Channel 23, you'll see that the same thing happens to them. On the other hand, if you change the channel selector switch to choose a new combination of synthesizer crystals, the incoming signal frequency for that channel will heterodyne ultimately to exactly 455 kHz.

### Troubleshooting synthesizers

Three instruments are all you need

to troubleshoot, diagnose or analyze synthesizer faults: a digital multimeter (DMM), a frequency counter and a calculator.

With synthesizers, only two kinds of components give the most trouble. The worst offenders are transistors; the second most troublesome are crystals. In an oscillator that is running off-frequency, the fault is probably a crystal. If the output voltage is too weak or missing, you can usually blame the transistor. Occasionally, a switch or other component can cause the voltage problem.

Your frequency counter is the first instrument to reach for. Figures 1 and 2 show test points. In some CB models, these test points are brought to test-point posts on the PC board. In other models, you might have to hunt the base of a transistor for the test connection. Be sure your frequency counter is sensitive enough to be locked by the signal, which in some oscillators may not exceed 20 to 40 volts P-P.

Use the crystal combinations chart in Fig. 1 to find the proper arrangement for the 6-4-4 synthesizer. Connect the frequency counter to test point 1. Set the channel selector to enough different channels to verify all six crystal frequencies in the synthesis oscillator. None should vary more than 1000 Hz from the indicated frequency. A crystal with a marginal frequency might leave the transmitter legal but not received well by other CB stations. Likewise, it might make the receiver operate marginally, even while testing OK for sensitivity.

Furthermore, anytime a crystal varies by 1000 Hz, you can expect it to shift more. Replacing such a crystal is your best insurance against a quick callback.

Second, use your frequency counter to test the output of the transmit oscillator (TP2). If no test point is provided, go to the base of the transmit mixer. If the mixer input point is the same for both signals, one may override the other, and the result may confuse the counter. You might conclude that one oscillator is running and the other isn't.

You have two alternatives. Some technicians keep a 0.1  $\mu$ F capacitor,



**FOURTEEN CRYSTALS** are a sign that the synthesizer is 6-4-4; the 6-4-2 synthesizer needs only twelve crystals.

with test leads attached, for killing an oscillator. You just clip the capacitor jumper from the oscillator base to ground. That lets only the signal from the other oscillator show up at the mixer input.

The other alternative is to move the frequency counter to test point 3. If all six synthesis oscillator crystals are OK, any discrepancy in the 27-MHz output voltage from the transmit mixer must be caused by either a bad mixer or a faulty crystal in the transmit oscillator. If the signal is merely off-frequency, blame the crystal. If the mixer transistor is defective, you might find either no output voltage at all or only from one or the other oscillator.

In any case, these three fast frequency checks show you the condition of the synthesis oscillator, transmit oscillator and mixer.

Test point 4 lets you verify the frequency of the receive oscillator. If it's wrong, the proper low IF cannot be developed by signals in the first mixer.

With a strong input signal and a sensitive frequency counter, you can check the high IF at the first-mixer input. If you don't know what the exact frequency should be, get out your calculator. From the frequency of whatever synthesis crystal the channel selector switch has chosen (see Fig. 1), you subtract the assigned frequency for that CB channel. The difference is the IF you should expect. In a 37/10/10 synthesizer, a normal

high IF signal ranges from 10.595 MHz to 10.635 MHz. In the 17/9/10 configuration, the IF frequency is from 10.0 MHz to 10.04 MHz.

If you suspect a transistor is causing the problem, you can check it quickly by analyzing voltages with your DMM or by taking the base lead loose and measuring forward and backward with the ohmmeter. You also save time if you use a quick-check type of in-circuit transistor tester.

Troubleshooting a 6-4-2 synthesizer (see Fig. 2) differs only slightly. First, you check all the crystals in the HF oscillator by connecting the frequency counter at test point 1. Then, check the IF oscillator crystals at test point 2. Finally, verify that these crystals are heterodyning to the right frequencies, by connecting the frequency counter at test point 3. If all crystals are OK in both oscillators, all you have to do is check one combination just to be sure the mixer is working properly. Here's where your calculator comes in handy, because service schematic diagrams seldom list synthesis-mixer outputs.

For example, suppose the channel selector is set at Channel 12. The switch connects crystals X3 and X10 to their respective oscillators. Since the mixer is additive, your frequency counter at test point 3 should read close to 38,380 MHz.

Then, move to test point 4. Any discrepancy in frequency here, with the synthesizer frequency at test point 3 being correct, indicates there is a fault in the transmit-oscillator frequency. Or, perhaps the same 38-MHz frequency shows up at test point 4; that means the oscillator isn't working.

Ordinarily, the best place to start testing the receiver side is at the receive oscillator, in both 6-4-4 and 6-4-2 synthesizers. In Fig. 1, the receive oscillator test point is No. 4; in Fig. 2, it's test point 5. Use a frequency counter to find out whether or not the oscillator is working accurately.

If your frequency counter is not sensitive enough to check the oscillator output directly, try checking at a mixer output. In the receiver, this may still not suffice, because there may be less signal following the mixer than out of the oscillator.

## 23-Channel PLL

YOU MAY RUN INTO SOME TROUBLE trying to understand how low-cost sets with a phase-locked loop (PLL) work. Many diagrams are misleading. They don't really indicate the way a PLL operates. A block diagram shows

separated portions of an integrated circuit, without ever showing the internal connections that interrelate the separate sections. The block diagram shown here will try to circumvent this problem.

You may already know how a PLL operates, but here's an explanation. This circuit is common in low-cost 23-channel sets; it uses either the PLL-01A integrated circuit or the PLL-02A IC. A few other PLL IC's are used;

they work about the same.

The heart of any PLL system is a DC-tuned oscillator, called a *voltage-controlled oscillator* (VCO). The main job of a VCO is to provide the internal signal for the receive and transmit mixers. In 23-channel sets, the same VCO frequency is used for both transmit and receive modes. Only resetting the channel selector switch changes the VCO's output frequency.

A phase-locked loop tuning system takes its name from the loop formed by the stages controlling the VCO frequency. A sample signal from the VCO is fed to a loop mixer and heterodyned against the signal from an overtone oscillator. The overtone oscillator runs on the third overtone of an 11.8066-MHz crystal; its output is therefore nominally 35.42 MHz.

The VCO can run at almost any frequency. But for the sake of example, let it run at 37.66 MHz. This frequency, mixed with the signal from the overtone oscillator, produces a loop signal at 2.24 MHz.

This 2.24-MHz signal is fed through a buffer amplifier, to a programmed downcounter or divider, which is part of a TTL-type IC.

A specially designed channel selector switch connects a particular combination of high and low voltages to certain pins in the IC. In our example, suppose the channel selector is set at CB Channel 1. High and low voltages program the divider to down-count by a factor of 224.

A 2.24-MHz loop signal fed into this 224 down-counter produces an output signal at 0.01 MHz, or 10 kHz. And that output signal is fed to a phase detector.

Meanwhile, a reference signal is being developed by a reference oscillator that is controlled by a 10.24-MHz crystal. Passing through a buffer stage, this signal is fed to another divider, inside the IC, which produces a fixed 1024 down-count. Hence, the reference oscillator and the 1024 divider produce a tightly controlled reference signal at 10 kHz.

This 10-kHz reference signal proceeds—still inside the IC—to the same phase detector that receives the down-counted loop signal. The phase detector checks to see if both signals match precisely in frequency and phase. If they do, as in the example just described, the DC voltage output DC of the phase detector stabilizes. Do not make the mistake of thinking that the voltage output goes to zero; it does not. The phase detector simply holds a ramp voltage at some specific value. This DC voltage is applied to the voltage-controlled oscillator, and determines its frequency.

To understand how this PLL system

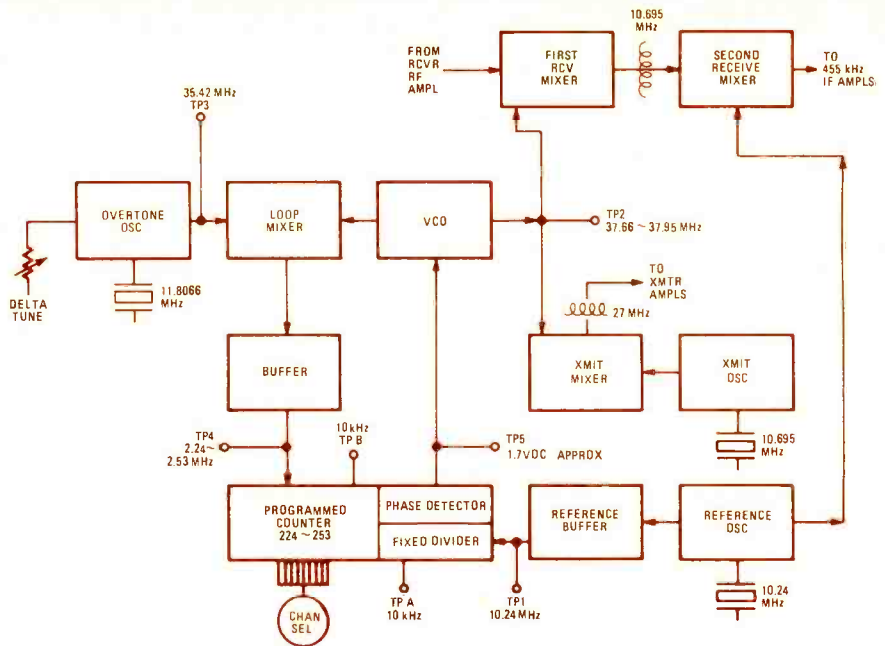

**TYPICAL 23-CHANNEL PHASE-LOCKED LOOP CAN BE TESTED WITH DC CLAMP voltage connected to test point 5, so you can control the voltage-controlled oscillator (VCO) manually.**

controls the VCO frequency, let's turn the channel selector switch to Channel 9. As you know, the channel selector switch chooses the high and low voltages that are applied to the programmed divider inside the IC. Rearranging the high and low voltages reprograms the variable divider to a new down-count factor. For Channel 9, because of the divider's inner design this down-count factor is 234.

You know immediately that the 37.66-MHz VCO frequency will not provide the right loop signal. In order for the phase detector to receive a 10-kHz signal from the programmed counter, a 2.34-MHz signal must come down the loop from the loop mixer. Mixing a 37.66-MHz signal from the VCO with a 35.42-MHz signal from the overtone oscillator results in a signal of 2.24-MHz, not 2.34 MHz.

The 2.24-MHz signal on the loop line is now divided by 234 instead of 224. Obviously, this cannot produce a 10-kHz signal for comparison with the reference. The phase detector senses this discrepancy. It sets its ramp voltage in motion, which then starts swinging the VCO frequency. Only when the VCO frequency reaches 37.76 MHz does the phase detector stabilize the ramp voltage.

Why a VCO frequency of 37.76 MHz? Because this is the frequency which, when it is beat against the overtone oscillator signal of 35.42 MHz produces a 2.34-MHz loop signal. And this is the only loop-signal frequency that will divide perfectly to 10 kHz in the programmed down-counter. In addition, the phase detector can lock *only* at that frequency. Any slight shift in the VCO frequency throws the

phase detector off, and its ramp voltage automatically corrects the VCO frequency.

The PLL diagram shows where the VCO output goes. When the transmitter is keyed, the output mixes with the transmit oscillator. In the case of Channel 9, in which the VCO is stabilized at 37.76 MHz, the subtractive transmit mixer heterodynes 37.76 MHz and 10.695 MHz to produce a frequency of 27.065 MHz, which is the Channel 9 carrier frequency.

When the receiver is operating, the VCO output mixes with incoming signals from the receiver RF amplifier. From here on, operation is similar to CB receivers using synthesizers. In this case, only a frequency of 27.065 MHz will mix with the 37.76-MHz signal from the VCO to produce a 10.695-MHz high IF signal. And that is the only signal that can beat in the second mixer with a 10.24-MHz signal and produce a 455-kHz low IF signal. You may have noticed, a sample of the 10.24-MHz reference signal is fed to the second mixer instead of a receive oscillator signal.

### Troubleshooting in PLL

That's how a 23-channel PLL system works. Now, how do you troubleshoot it? Here's a step-by-step procedure that uncovers virtually any defect you are likely to encounter in a PLL.

First, here's a point to remember. Suppose you narrow down a trouble to the inside sections of an IC. This means replacing the entire IC. Some sections are contained in more than one IC, and some discrete stages use transistors. Adapt your techniques to suit.

Start measuring DC voltage at test



point 4. The service schematic should indicate the voltage there within a few tenths of a volt. If this voltage is wrong, the VCO can be far off-frequency or even pushed to the point where it stops oscillating. The PLL system shown in the block diagram states that 1.7 volts is nearly correct. So, the voltage should fall somewhere between 1.3 and 2.1. Much voltage outside that range indicates trouble, but this does not necessarily show where the trouble is.

Next, clamp the DC voltage line at test point 4. Choose a well-filtered and well-regulated DC power supply. Connect its output to test point 4. If there is no test-point post, clip this output to the DC voltage line that feeds the capacitive diode controlling the VCO frequency. Clip your multimeter to the same point and adjust the DC supply to approximately 1.7 volts, or whatever value the schematic calls for.

Now connect a frequency counter to the VCO output (test point 2). The frequency should fall somewhere within the limits specified for that VCO. Sets having PLL-01A IC's run the VCO at a frequency of 21 MHz, and the discrete-reference oscillator operates at 6.4 MHz. The PLL-02A and most other 23-channel systems operate the VCO near a 38-MHz frequency, with a 10.24-MHz frequency reference.

Actually, the VCO shown here operates from 37.66 MHz to 37.95 MHz. If the proper voltage does not bring the VCO into this frequency range or very close, the VCO needs servicing or adjustment.

Next, if the frequency is almost correct, adjust the clamp voltage—without regard to its specific value—to make the VCO operate at some steady frequency. The precise frequency doesn't matter much as long as you can measure it and it holds steady.

For example, assume your counter reads 36.710 MHz. Move the counter to test point 3, the overtone oscillator output. If the loop-mixer input is missing or is not precisely at 35.42 MHz, there's your trouble; cure it.

Take out your calculator; it's an important servicing tool. Keep it handy because you'll be doing several calculations.

Whatever frequency comes from the overtone oscillator, subtract that from the measured frequency of the clamped VCO. Suppose, for example, that the DC-clamp voltage has set the frequency of the VCO oscillator at 37.705 MHz. Simultaneously, your frequency counter shows the overtone oscillator output at 35.422 MHz. Your calculator tells you that the difference between the two frequencies, which is or should be the output of the loop mixer, is 2.283 MHz.

Your frequency counter ought to find that 2.283-MHz frequency at the mixer output or at test point 3 following the buffer stage. If it doesn't, there's trouble in the mixer or buffer stages. If this signal is wrong or missing, you'll have to cure the trouble before you proceed.

Next, check the dividing action of the programmed divider or down-counter in the IC. But, you say, the output goes to the phase detector, which is also inside the IC. How can you check this? Most monolithic PLL IC's include internal test points that are brought out to blank pins. Therefore, you can check the divider action with your frequency counter.

Remember that the 2.283-MHz (2283-kHz) frequency is the signal that enters the programmed down-counter. Set the channel selector to any channel you wish. The system is disabled, because of the DC clamp voltage on the VCO control line, so dialing the switch does not affect the VCO. Just for example, set the switch for Channel 1. The divider factor there is 224 for Channel 1. Therefore, the divider should divide by 224 whatever frequency enters.

With your calculator, divide 2283 kHz by the factor the channel switch has selected, which is 224. Your calculator tells you that the output of the programmed divider should be 10.192 kHz. If you had chosen some other channel, the divider factor would be different, and the frequency at test point B would also be different. However, your calculator would tell you *what* it should be. For instance, with Channel 9 and a divider factor of 234, the output frequency should be 2283 kHz divided by 234, or 9.756 kHz.

Now let your frequency counter verify whether or not the programmed down-counter produces the correct frequency (in this case 10.192 kHz). Connect the counter to whichever IC pin corresponds to test point B on the IC you're working with. If the frequency is within a couple of Hz, the programmed divider is working correctly. If the symptom complaint has been that one or two channels are incorrect, verify the down-count for those channels.

When your frequency counter verifies everything your calculator has told you around to this point in the loop, then everything so far is working OK. Now, check out the reference side of the PLL. The frequency counter at test point 1 indicates whether the reference crystal is on-frequency and if the oscillator and buffer are working. Most systems in low-cost 23-channel CB's operate with a 10.24-MHz reference frequency. (An exception is those

using the PLL-01A IC, which operates with a 6.4-MHz reference frequency.)

Then, if the reference stages are working, check the fixed divider inside the IC. Again, there is a no-connection pin that forms the output test point (test point A) for the fixed divider. Your frequency counter should verify the exact down-count, whether from 6.4 MHz or 10.24 MHz, always to exactly 10.0 kHz. If this frequency deviates more than 1 or 2 Hz, find the trouble.

Incidentally, if your frequency counter shows the fixed-divider output test point is 16 kHz, either the wrong IC or a wrong-frequency reference crystal have been installed. By the same token, if the counter reads almost exactly 6.25 kHz, you have the same trouble.

Finally, check the phase detector by first connecting the clamp voltage close to the VCO. Then, break the DC line voltage somewhere between the clamp voltage and the DC voltage output of the IC's phase detector section. Now, with the VCO still held stable by the clamp voltage, connect your DC voltmeter to the phase-detector output; the DC voltage here should be steady, and close to the value shown on the set's schematic.

If everything checks out OK around the PLL, the phase detector should pull the VCO right onto frequency and lock it there when you remove the clamp voltage. If it doesn't, the fault is in the phase detector or ramp-voltage section of the IC. In either case, the IC must be replaced.

However, suppose that earlier troubleshooting found that dividers were defective. It is important that you check both of them if you find one bad. Why? Because the DC voltage input, (Vcc input) might be at fault. Usually, normal voltage is somewhere on the order of 5 or 6. It must be close to correct, or the IC cannot operate normally. If you find that IC action is defective and replace the IC when actually the only trouble was in the Vcc input, the new IC wouldn't work either.

R-E

# Radio-Electronics

## Tests

# Model FM-10 Beam Box Antenna

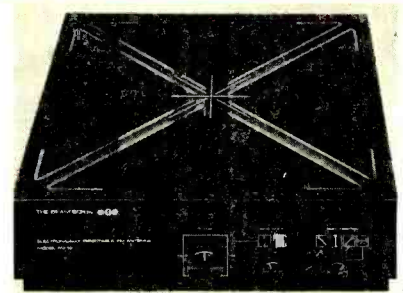

CIRCLE 95 ON FREE INFORMATION CARD

LEN FELDMAN  
CONTRIBUTING HI-FI EDITOR

I HAVE FOR MANY YEARS BEMOANED THE FACT that most purchasers of good FM tuners and receivers seldom realize the full potential from their investment. That's because they do not, or cannot, install an adequate directional outdoor antenna specifically designed for FM signal reception. The usual 300-ohm T-wire packed with most hi-fi tuners and receivers, while theoretically suitable for proper FM signal reception, generally suffers in performance because it is seldom positioned for best reception and often ends up casually tossed behind the tuner or under a rug. The so-called "rabbit ear" antennas, although they *can* be oriented for best signal reception, are cumbersome and inconvenient to place properly.

Several FM radio manufacturers have attempted to design and market indoor antennas that incorporate booster RF amplifiers and other electronic schemes. The trouble with most of these schemes is that along with amplifying the desired signal, they amplify background noise as well. Most FM front ends have about as good a noise figure as can be obtained, and increased signal strength is hardly ever a problem unless you live many, many miles from an FM station.

The real problem in FM reception, especially stereo FM reception, lies in trying to feed a proper signal to the antenna terminals—one that is free of interfering reflections, known as multipath. TV viewers are all too familiar with signal reflections, since they cause multiple images to the right of the main picture. In FM reception, such signal reflections cause distortion, loss of stereo separation and, in extreme cases, increased background noise. The solution, of course, is a directional antenna.

B.I.C.'s new model FM-10, Beam Box, is, as far as we know, the first indoor FM antenna of its kind. Figure 1 shows it is physically designed to look like other high-fidelity components. In fact, it can be positioned alongside, under or above the rest of the components in

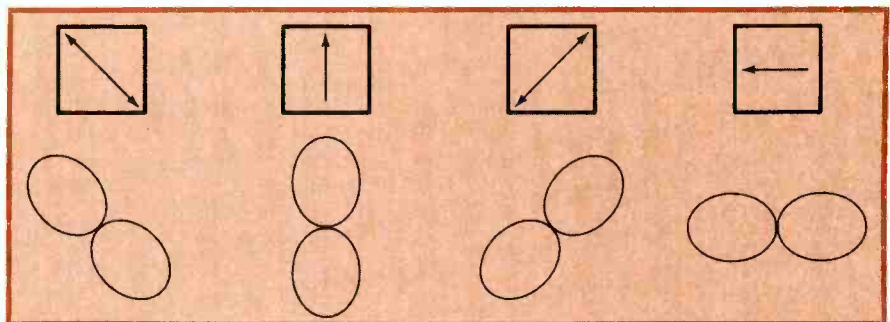

your system. One of the key features of this new indoor FM antenna is that its reception patterns can be altered without physically rotating the entire unit. A BEAM DIRECTION switch at the right of the front panel hooks up to pairs of antenna elements so that four Figure 8 reception patterns can be obtained, each displaced from the next by 45 degrees. The reception patterns generated by the different switch settings are shown in Fig. 2.

To use *The Beam Box*, connect its rear-panel output terminals to the tuner or receiver antenna terminals either by using the 300-ohm transmission line supplied, or, if 75-ohm coaxial operation is desired, by a suitable length of this type of cable terminated in a standard connector that must be purchased separately. If your tuner is equipped with a signal strength meter, first tune to the desired frequency and then use the BEAM DIRECTION switch to choose the beam pattern that results in the greatest deflection of the signal strength meter. Next, the BANDWIDTH control, next to the BEAM DIRECTION switch, is turned from its broadband position to its narrowband or sharp position. When this is done, a four-section variable-tuning capacitor, with its associated coils and other passive front end parts, is introduced as part of the antenna circuitry.

When the BEAM DIRECTION switch is set to the narrowband position, *The Beam Box* acts, in effect, as a front end in front of your tuner's own front end, and therefore contributes significantly to image rejection, spurious response rejection and, to a lesser degree, selectivity. You simply turn the TUNING control until

signal reception is optimized, observing the signal strength meter or, if none is available, listening for the cleanest, least noisy FM reception. The owner's manual suggests that after the initial optimization, it is advisable to recheck using the BEAM DIRECTION switch, since occasionally a different directional pattern can further improve reception once the other controls have been set.

### Lab measurements

Two sets of experiments were conducted to determine the usefulness of *The Beam Box*. Our laboratory is equipped with a precision field-strength meter, the Blonder-Tongue model 4127 that reads directly in microvolts. This meter was first hooked up to a standard 300-ohm wire dipole antenna of the type normally supplied with most tuners or receivers. The dipole antenna was placed in a fixed position and not reoriented during the tests (much as it would be used in a typical installation). Several received signals were tuned to on the field-strength meter and readings were recorded.

Next, *The Beam Box* was connected to the field-strength meter and tuned to the same signal frequencies. The received signal strength was again recorded. Results of these tests are listed in Table I and, as can be seen, in most instances, signal strengths received using an optimally adjusted and tuned *Beam Box* were greater than those received using the nominally positioned standard dipole antenna—despite the fact that *The Beam Box* (by virtue of its 8th-wavelength elements) actually has less theoretical gain than a half-wave dipole antenna. Even in the few instances where signal strengths were greater using the dipole antenna, subsequent listening tests revealed that *reception quality* was superior when *The Beam Box* was used, once again proving that the signal quality counts more than actual signal strength.

Our second experiment involved measuring the residual background noise of an FM received signal. FM noise reduction is not

### MANUFACTURER'S PUBLISHED SPECIFICATIONS:

**Frequency Range:** 88 MHz to 108 MHz. **Antenna Gain:** -5 dB (narrowband); -12 dB (broadband). **Receiving Elements:** four 8th-wavelength extruded aluminum elements. **Output Impedance:** 300-ohm balanced or 75-ohm unbalanced (coaxial) connection. **Standing-Wave Ratio (VSWR):** less than 1.5:1, narrowband. **Bandwidth,** in narrowband position, 3 MHz at -3-dB points. **Dimensions:** 14½ W × 4½ H × 14¼ inches D. **Net Weight:** 8.5 lbs. **Accessories:** 44-inch length of 300-ohm transmission line, terminated at each end with spade-lug connectors. **Suggested Retail Price:** \$89.95.

| Station Frequency (MHz) | Signal Strength ( $\mu$ V) Using B.I.C. Beam Box Tuned And Set For Best Reception | Signal Strength ( $\mu$ V) Using Fixed Wire-Dipole Tacked To A Wall |
|-------------------------|---|---|
| 89.1                    | 125   | 50  |
| 89.9                    | 62  | 48*   |
| 92.1                    | 60  | 60*   |
| 96.3                    | 100   | 45*   |
| 97.1                    | 250   | 125   |
| 99.9                    | 160   | 30  |
| 101.1                   | 160   | 70  |
| 102.7                   | 80  | 100   |
| 104.3                   | 115   | 90  |
| 106.7                   | 250   | 30*   |
| 107.9                   | 35  | 5*  |

\* These stations exhibited severe multipath reception problems when the fixed-position dipole antenna was used.

| RADIO-ELECTRONICS PRODUCT TEST REPORT   |                                |
|---|--------------------------------|
| Manufacturer: B.I.C.  | Model: FM-10 Beam Box Antenna  |
| OVERALL PRODUCT ANALYSIS  |                                |
| Retail price  | \$89.95                        |
| Price category  | Unique, no comparison possible |
| Price/performance ratio   | Excellent                      |
| Styling and appearance  | Superb                         |
| Sound quality   | Not applicable                 |
| Mechanical performance  | Excellent                      |
| <p>Comments: This unique product will probably be the answer to many FM enthusiasts' prayers. It is the first indoor FM antenna that really does a good job and is not an eyesore in your listening room. The combination of directionality switching and tuned circuits actually can and does improve FM performance of any tuner or receiver, regardless of its price, since it enables the user who is prohibited from installing a proper directional outdoor FM antenna to receive the least amount of multipath interference and optimum signal quality. It takes a bit of getting used to, since it is necessary to tune <i>The Beam Box</i> each time you listen to a new station. But the effort is worthwhile, since each received signal is truly optimized if you use <i>The Beam Box</i> properly and the procedure becomes habitual. B.I.C. includes a station log sheet that can be filled in with your favorite station call letters, their frequency and the correct BEAM DIRECTION switch setting for each station. This cuts down the antenna tuning time the next occasion you want to listen to one of the logged stations.</p> <p>If the desired signal strengths are just too low to provide adequate limiting in your tuner, <i>The Beam Box</i> won't help. But if you are plagued with poor FM reception even from nearby signals (because of reflections, etc.) <i>The Beam Box</i> could be the next best thing to an expensive directional outdoor antenna array/rotator combination. If installing an outdoor antenna is either prohibited or prohibitive, the B.I.C. <i>Beam Box</i> seems to be a viable alternative.</p> |                                |

always a function of signal strength. There are a few FM tuners and receivers around (notably, those manufactured by Harman Kardon) that do provide what is called a *quieting* meter instead of the usual signal strength meter. To simulate this kind of indication, we connected a bandpass filter (tuned to around 100 kHz) to the detector output of a tuner. The output of the filter was connected to the vertical input of an oscilloscope. Since the filter allows only noise components in the 100-kHz region to pass through, the audio modulation of the received signal does not affect the display. This sort of display gives a good indication of quieting or noise content in a received FM signal.

We tuned to a relatively weak signal, using *The Beam Box*, with the BEAM DIRECTION switch and tuning controls set arbitrarily. Figure 3 shows the high level of background noise (lack of quieting) that resulted. We then opti-



mized the BEAM DIRECTION, switched to the narrowband position, and tuned the tuning control on *The Beam Box* and the noise quickly diminished, as shown in Fig. 4. By way of comparison, we then connected a standard dipole antenna to the same tuner, which

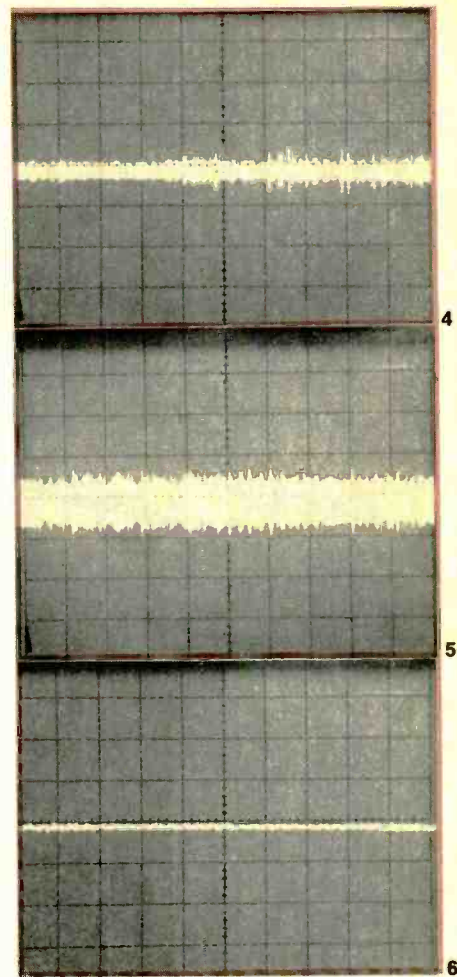

remained tuned to the same frequency. Figure 5 shows the noise pattern that resulted, which was considerably greater than the noise pattern obtained when the properly tuned *Beam Box* was used. We then connected a six-element outdoor antenna, properly oriented by a rotator, and observed the noise pattern shown in Fig. 6. Obviously, if money is no object, such an installation would still outperform *The Beam Box*, as you might have guessed.

Our overall product summary is found in Table 2, together with summary comments concerning *The Beam Box*. For those who might wonder why we rated the price-performance ratio as excellent, the only thing that beats the performance of *The Beam Box* is a carefully installed, highly directional outdoor antenna. However, the cost of such an installation (including the price of the antenna and accessory parts, cable, mast and, likely a rotator if all your station signals originate from points about the compass) might well be double or triple that of *The Beam Box*. R-E

# computer corner

## Z-80 *A close look at the three different interrupts available in the Z-80*

WILLIAM BARDEN, JR.

LAST MONTH, WE LOOKED AT THE VARIOUS addressing modes of the Z-80. This month, we'll examine three different ways the Z-80 can be interrupted.

### Interrupts

The Z-80 has two interrupt inputs—INT, which typically comes from an external device requesting I/O (Input/Output) service; and a nonmaskable interrupt, NMI. The nonmaskable interrupt is the least sophisticated of the two; so, NMI will be examined first.

The NMI interrupt *cannot* be disabled by the DI (Disable Interrupt) instruction. This means that even if the NMI line to the Z-80 is brought to a logic 0 level, the CPU will *always* act on the interrupt. The NMI signals important system conditions that must be acted on immediately, such as system power failure or system reset. Whenever the NMI line is brought to a logic-low level by external circuitry, the CPU executes a RESTART instruction to memory location 0066H. You will recall that a RESTART instruction automatically saves the contents of the program counter by pushing it into the stack, and the RESTART instruction initiated by the NMI interrupt performs the same action. The NMI is not implemented in the 8080 microprocessor.

The INT interrupt operates in three modes, selected by prior execution of one of three special mode instructions—IMO, IM1 or IM2. For this type of interrupt to occur, the interrupt enable flip-flop must be set. The interrupt enable flip-flop is set or reset by two interrupt control instructions, EI and DI (Enable Interrupts and Disable Interrupts). As in the 8080-based and other microcomputers, there are times when interrupts are permitted and other times when interrupts must be inhibited. An obvious example of a time when interrupts must be disabled is when a previous interrupt has *just* occurred and is in the first stages of being processed. If a second interrupt was to occur while the status of CPU flags and registers is being saved in the stack, the second interrupt might destroy the previous contents of the CPU registers and status flags. Another example of an interrupt-disable period is when the system is first initialized. If an interrupt were allowed to occur before system devices were reset and

initialized, a spurious or unexpected interrupt might result and be erroneously processed.

If an IMO instruction has been executed, the Z-80 is in mode 0 which is identical to the 8080 interrupt mode. If the interrupt enable flip-flop is set and signal  $\overline{\text{INT}}$  is brought down to a logic 0 level, the CPU enters an interrupt state and signals the interrupting external device by the  $\overline{\text{IORQ}}$  signal together with the  $\overline{\text{MI}}$  signal. When the interrupting device receives these two signals, it responds and the Z-80 behaves in a fashion identical to the 8080. A RESTART instruction is jammed onto the data bus. Encoded within the one-byte RESTART instruction is a three-bit field with a value of 0 through 7 and the CPU transfers control to memory location 0, 8, 10H, 18H, 20H, 28H, 30H, or 38H, depending upon the value of the field (0, 1, 2, 3, 4, 5,

6, or 7). At the same time, the CPU saves the contents of the program counter in the stack. The eight locations typically contain jumps to interrupt processing routines elsewhere in memory, since eight bytes is not really enough memory to process most interrupts. At the end of interrupt processing, a Return (RET) instruction pops the address of the interrupted instruction from the stack and transfers control back to the main program at the point of interruption.

When interrupt mode 1 has been initiated by execution of an IM1 instruction, an interrupt on the  $\overline{\text{INT}}$  input pin while the interrupt enable flip-flop is set causes a RESTART to location 38H. Why is this mode convenient? Because mode 1 needs no external hardware to jam the RESTART instruction onto the data bus at the proper time. The CPU automatically transfers control to the proper location, as in the case of the NMI interrupt. This mode is not implemented in the 8080 microprocessor.

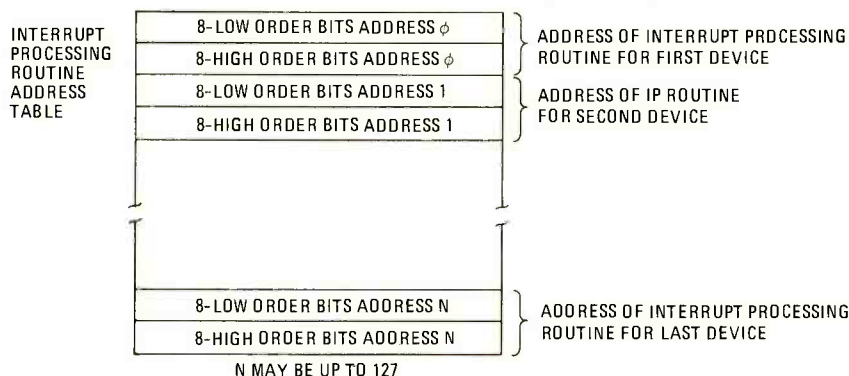

FIG. 1

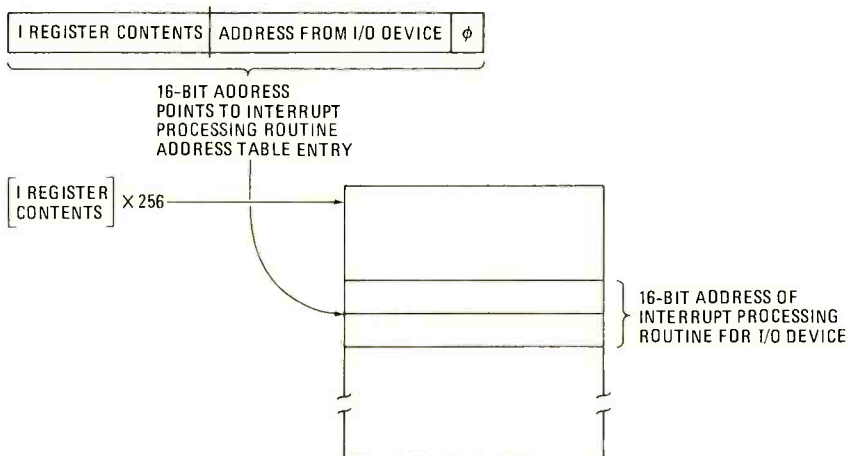
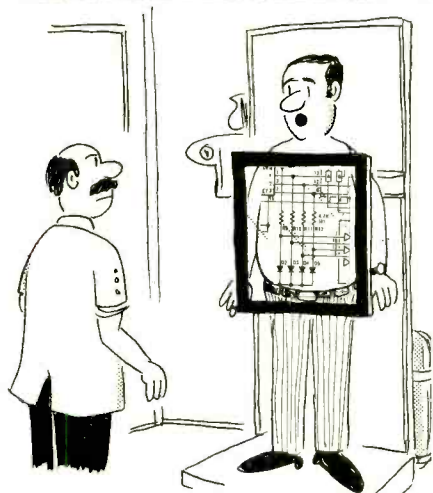

FIG. 2

The remaining interrupt mode, mode 2, is the most powerful interrupt mode of the three. Using this mode, up to 128 interrupt levels can be used in the Z-80 system. A table of addresses representing up to 128 interrupt processing routines is stored anywhere in memory. Figure 1 shows this table, in which each entry consists of two bytes representing the address of the interrupt processing routine. Register I is previously loaded with an eight-bit value representing the address of the start of the table divided by  $256_{10}$ . For example if the table started at 2000H, register I would be loaded with 20H.

With mode 2 previously set by an IM2 instruction and the interrupt enable flip-flop set, an interrupt on the INT pin causes the same IORQ and M1 response as mode 1. The difference is that the interrupting device supplies an eight-bit value representing the lower-order eight bits of the interrupt vector, while register I supplies the eight higher-order bits of the interrupt vector as shown in Fig. 2. The CPU treats the two bytes as a 16-bit memory address and puts the contents of that memory address and that memory address plus one into the program counter, thus effectively transferring control to the interrupt vector address retrieved from the table. Note that the least significant bit of the address from the I/O device must always be a logical 0, so that the resulting address points to the first word of the interrupt vector table entry. Using mode 2, up to 128 external I/O devices could cause 128 unique interrupts with a subsequent transfer of control to 128 different interrupt processing locations. Obviously, external logic is required to properly establish the priority of these devices so that only one interrupt can occur at a time. Mode 2, of course, is not implemented in the 8080.

Next month, we'll discuss how to interface the Z-80 to I/O devices and to additional memory. **R-E**



"That's remarkable, Doc!—How'd you know that I'm an electronics technician?"

HELP US FIGHT FOR YOUR LIFE

# Exercise Regularly

American Heart Association 

WE'RE FIGHTING FOR YOUR LIFE

## Are You still using an Audio Generator that has a Crank?



IF SO, THEN LOOK AT THE **270 FUNCTION GENERATOR**

by **HICKOK**

**Sines, Squares, Triangles to 500 kHz — and much, much more**

A new, versatile service and lab instrument — the feature packed Model 270 Function Generator — gives you much more waveform generating capability than you'd expect for its low price. This compact, precision unit puts stable, calibrated, high quality sine, square and triangle waveforms from 1Hz to 500kHz at your fingertips. But that's not all. With external connections you can produce logic pulses, sweeps and ramps, amplitude and frequency modulated outputs, phase and frequency shift keying signals, tone bursts, and a host of mixed signal outputs. It's even a stand-alone wideband inverting amplifier!

REG. \$199.

**SAVE \$20**

**\$179.00**

Complete with Deluxe Carrying Case

Offer expires May 30, 1978

|   |   |  |
|---|---|--|
| <p><b>Basic Output Waveforms:</b><br/>Sine, Square, Triangle</p> <p><b>Frequency Range:</b><br/>1 Hz to 1MHz in six pushbutton selected decade ranges<br/>Typical: 500 kHz guaranteed minimum upper frequency.</p> <p><b>Frequency Accuracy:</b><br/>± 3% of F.S. up to 200 kHz</p> <p><b>Amplitude Flatness:</b><br/>± 0.1 dB from 20 Hz to 20 kHz; ± 0.3 dB from 1 Hz to 100 kHz.</p> <p><b>Output Level:</b><br/>0 to 24 volts peak to peak (8.5 volts RMS) open circuit — protected against short circuits.</p> <p><b>Output Impedance:</b><br/>600 ohms ± 5%, constant regardless of attenuator setting.</p> <p><b>Attenuators:</b><br/>Total dynamic range of step and continuous attenuators is 80 dB minimum. Step (pushbutton) attenuators provide 0 dB, -20 dB and -40 dB attenuation (± 0.5 dB accuracy). Continuous (AMPLITUDE) control provides at least 40 dB additional control.</p> | <p><b>Amplitude Stability</b><br/>(After 1/2 hour warm-up):<br/>With Line Voltage: ± 0.5% with 10% line voltage change<br/>With Temperature: ± 0.5% per °C from 0°C to +50°C.</p> <p><b>Sine Wave Distortion:</b><br/>Max. total harmonic distortion (THD) is 1% from 20 Hz to 20 kHz.</p> <p><b>Square Wave Rise/Fall Time:</b><br/>0.5 usec or less.</p> <p><b>Square Wave Symmetry:</b><br/>95% minimum (5% maximum asymmetry).</p> <p><b>Triangle Wave Linearity:</b><br/>98% minimum (2% maximum nonlinearity) to 100 kHz.</p> <p><b>Rear Panel Inputs:</b><br/>AM input, FM input, Frequency Shift Keying (FSK) control, FSK resistor, FSK Sync (Pulse/Ramp control), Mixer input.</p> <p><b>Rear Panel Input Protection:</b><br/>Another Model 270 (or other unit with ± 15 volt/600 ohm output) may be connected to rear inputs without damage.</p> | <p><b>DC Offset:</b><br/>Output DC level on all waveforms is variable from 6V to +6V (at 0 dB ATTENUATION).</p> <p><b>Frequency Stability</b><br/>(After 1/2 hour warm-up):<br/>With Line Voltage: ± 0.1% with 10% line voltage change.<br/>With Temperature: ± 0.1% per °C from 0°C to +50°C.</p> <p><b>Power Required:</b><br/>105—125 VAC/210—250 VAC, 50—400 Hz, 5 watts.</p> <p><b>Size &amp; Weight:</b><br/>(Not including feet) 8 1/2" w x 3 1/2" h x 6" d (21.6 cm x 8.9 cm x 15.2 cm), 4 pounds (1.8 kg).</p> <p><b>Accessories:</b><br/>Rear panel connector and detailed instruction manual.</p> |
|---|---|--|

212-687-2224

THE TEST EQUIPMENT SPECIALISTS

TOLL FREE HOT LINE  
**800-223-0474**

54 West 45 Street, New York, N.Y. 10036

**ADVANCE ELECTRONICS** 

# Hobby Computer Mainframes

THIS DIRECTORY GREW TOO LARGE TO FIT INTO A SINGLE ISSUE. So this concluding section had to be held over for this month. Before starting this section we have one correction and one addition to last month's section. The address for the Mits Division of Pertec was incorrect; the proper address is PCC Microsystems, 21111 Erwin St., Woodland Hills, CA 91367.

Also, some gremlins resulted in the listing for ECD not appearing in alphabetical order. So here it is now, at the top of this month's list.

## ECD

Makes *Micromind*, an assembled ready-to-use machine with 8K of memory built around a 6500A microprocessor. Comes complete with an 80-key software definable keyboard; I/O interface board; high-detail graphics and character display processor; power supply, RF modulator and connections for up to four tape recorders plus TV or monitor. Price, \$987.54. Available from ECD Corp., 196 Broadway, Cambridge, MA

## Southwest Technical Products

Complete line of hobby computer equipment. Includes 6800 computer complete with 4K of memory. Kit, \$395. Additional memory, \$100 for 4K; \$250 for 8K. Terminal monitor CT-64 features 64-character lines, upper-and-lower-case letters, switchable control character printing, word highlighting, full cursor control, 110-1200 Baud serial interface. Kit, \$325; 12-MHz monitor, \$175.

MF-60 dual mini-floppy kit with controller, chassis, cover, power supply, two disc drives, \$995. MF-6X kit expands unit to four drives, \$850. Other peripherals include PR-40 alphanumeric line printer that prints 40 characters per line at 75 lines-per-minute. Price, \$250. Southwest Technical Products Corp., 219 W. Rhapsody, San Antonio, TX 78216

## Space Byte

A single-card self-contained 8085 CPU for the S-100 bus. Operates at 3 MHz using 450-nS memory. Two on-board RS-232C serial I/O ports with software-selectable Baud rates. Also 16K RAM boards with on-board voltage regulators for S-100 systems. Prices not available. Space Byte Corp., 1720 Pontius Ave., Suite 201, Los Angeles, CA 90025

## Spectrum 8

Complete in one cabinet, this computer system includes 8085 microprocessor, video terminal that produces 80 characters by 24 lines, cassette drive unit, keyboard and software and 16K RAM. Price, \$2195. Spectrum 8, 3750 E. Foothill Blvd., Pasadena, CA 91107

## STM Systems

*Baby I* microcomputer you can fit into an attache case. 6502-based system with 2K of RAM \$850, assembled only. With 4K RAM, \$1000. 4K RAM add-on, \$205. Floppy diskette drive with power supply and controller, \$750. STM Systems Inc., P.O. Box 248, Mont Vernon, NH 03057

## Szerlip Enterprises

No main frame here, only a PROM setter for 1702A and 2708 PROM's. Plugs into S-100 computer. Complete kit, \$210; assembled, \$375. Szerlip Enterprises, 1414 West 259 St., Harbor City, CA 90710

## Technical Design Labs

ZPU card for S-100 bus machine features Z-80 microprocessor with two on-board clocks. Kit, \$269; assembled, \$345. Z16 memory module with 16K on board, but can be purchased in 4K increments. Uses 4200 memory IC's. 4K kit, \$169; 8K, \$295; 12K, \$435; 16K, \$574; 4K expansion kits, \$140. Systems monitor board, \$295 for kit, \$395 assembled. *Xitan* microcomputer systems. *Xitan Alpha 1* mainframe with ZPU board, system monitor board \$769 for kit, \$1039 assembled. *Alpha 2* expands *Alpha 1* by including Z16 memory module and software package. Kit, \$1369; assembled, \$1749. Technical Design Labs, Research Park, Building H, 1101 State Rd., Princeton, NJ 08540

## Technico I

Single board 16-bit 9900 microprocessor. Just hook up power supply and terminal. Kit, \$299; assembled, \$399. Comes with 1K of PROM, 512 bytes of RAM. Expands on-board to 6K, can address up to 32K words. Technico, Inc., 9130 Red Branch Rd., Columbia, MD 21045

## Telpar

*Model PS-40* printer offered as a silent Teletype alternative. Offered with multifunction interface (F-8 microprocessor). Assembled only, \$400. Power supply, \$100; case, \$100. Telpar, Inc., 4132A Billy Mitchell Rd., P.O. Box 796, Addison, TX 75001

## Thinker Toys

Developers of the *WunderBuss*, a 20-slot S-100 busboard that includes a *Noiseguard* noise-squelching system. Kit, \$76, with 10 edge connectors, \$120; with 20 edge connectors, \$154. Also available: an 8080 CPU/front panel kit, \$250. Speakeasy I/O board kit (three cassette channels, parallel and serial ports), \$120. 8K dynamic RAM kit, \$159; assembled, \$188. 4K static memory kit, \$109. Thinker Toys, 1201 10th, Berkeley, CA 94710

## TLF

Assembled microcomputer with 8K of memory, 2K of control PROM, tape controller, buffered external bus and 110 Baud serial interface. Fully assembled and tested for the *Mini 12*, a 12-bit machine, \$895. A 24-line parallel interface also available. Digital cassette storage system complete with two tape drives, \$795. TLF, P.O. Box 2298, Littleton, CO 80161

## Vector Graphic

Hobby computer systems and accessories, including *Vector I* computer consisting of custom cabinet, 18-slot motherboard S-100 bus, power supply, 8080 CPU board, PROM/RAM board with 1K RAM, room for 2K ROM. Kit, \$619; assembled, \$849. 8K memory boards assembled, \$265 and \$275. Vector Graphic, Inc., 790 Hamshire Rd., Westlake Village, CA 91361

## Xybek

*A Prammer* memory board on an S-100 bus card. Contains up to 1792 bytes of EPROM, 256 bytes of RAM, an integral EPROM programmer. Kit, \$209; assembled, \$289. Extension kit, \$15. Xybek, P.O. Box 4925, Stanford, CA 94305 **R-E**

# Now you can save money and get the counter you want— immediately

A frequency counter should deliver all the performance you expected when you placed the order. If the counter is a B&K-PRECISION you'll be getting that plus some equally important benefits—a price that you can easily afford and off-the-shelf delivery.

B&K-PRECISION has engineered a line of full-feature frequency counters to suit most

applications. All have been conceived as cost-effective answers to frequency measurement needs in communications, lab, field and plant applications. Every B&K-PRECISION counter features: autoranging, liberal input overload protection, a minimum of 1Hz resolution, conservative specifications, and easy-to-read LED displays.

#### MODEL 1850

- 520MHz guaranteed;  
500MHz typical
- 8 digit accuracy
- 1000000 measurement



#### MODEL 1801

- 40MHz guaranteed;  
60MHz typical
- Reliable discrete TTL logic



#### MODEL 1827

- 30MHz guaranteed;  
50MHz typical
- Compact size; portable
- 8 digit accuracy with 6 digit readout



#### MODEL 1820

- 80MHz guaranteed;  
100MHz typical
- Period, event and time measurements



At the top end of our line is the new Model 1850, very conservatively rated at 520MHz. Features include: TCXO time base...Period measurements from 5Hz to 1MHz...Leading zero suppression...Bright .43" LED display... Gate times from 10 ms to 10 seconds...\$450.

The 1820 Universal Counter is one of the most versatile counters available at any price. Frequency measurement typically extends beyond 100MHz...Period measurements from 5Hz to 1MHz... Period average, auto and manual positions... Elapsed time measurements to 9999.99 seconds (plus overflow)... Totalizes event counts to 999999 (plus overflow)... \$260.

At only \$120, the 1827 portable frequency counter is slightly larger than a pocket calculator. 30MHz guaranteed; 50MHz typical... Battery saver for all-day field use... Full range of optional accessories available.

The 1801 is a rugged frequency counter designed for production line and maintenance applications. Readings to 40MHz guaranteed; 60MHz typical... Easy to use and read...Wide range input eliminates the need for level adjustments...\$200.

Isn't it time you stopped sacrificing features and performance for price? See your local distributor for immediate delivery.

**BK PRECISION** **DYNASCAN CORPORATION**

6460 W. Cortland Avenue, Chicago, IL 60635 312/889-9087

In Canada: Atlas Electronics, Ontario

International Sales: Empire Exporters, Inc., 270 Newtown Road, Plainview, L.I., NY 11803

CIRCLE 84 ON FREE INFORMATION CARD

www.americanradiohistory.com

# Train with NTS for the MicroComputers, digital the first name

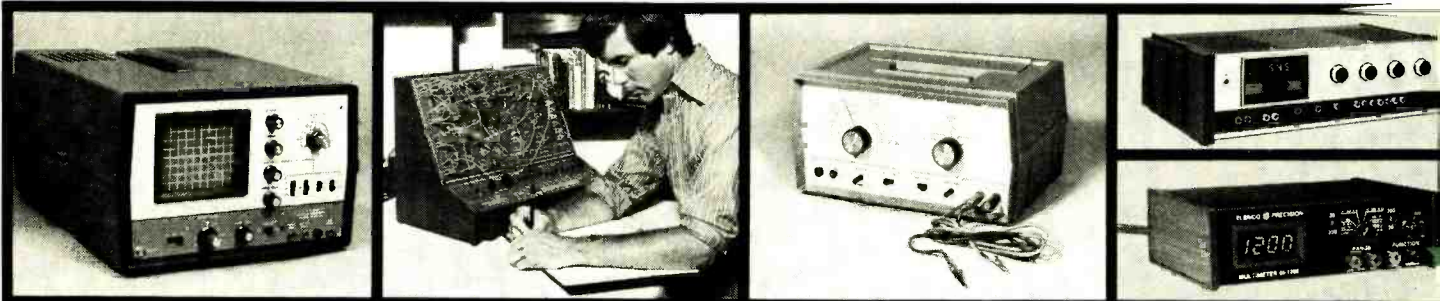

## MicroComputers



The world of electronics is daily becoming more challenging. Technology is growing more specialized, and the importance of digital systems increases every day. Test instruments, home entertainment units and industrial control systems are all going digital. And now, NTS training programs include a wider choice of solid-state and digital equipment than ever before offered in any home study course: Advanced NTS/Heath digital color TV (25" diagonal with optional programming capability), NTS/Heath microcomputer, digital test equipment, digital stereo receiver (70 watts per channel), NTS compu-trainer, plus much more state-of-the-art equipment to make your training exciting and relevant.

The equipment you receive with NTS training programs is selected to provide you with a solid

background in electronic systems. Kits and lessons are designed to work together to demonstrate electronic principles and applications. The kit-building not only shows you how electronic hardware functions, but how various circuit designs accomplish different purposes. Your lessons guide you through any number of experiments associated with many projects. This is the Project-Method, and it works. Step-by-step, you learn how and why digital electronics has become a part of our world, and the even bigger role it is sure to play in the future.

Whether you are looking for training in Consumer, Commercial, or Industrial electronics, NTS offers fourteen courses, some basic, many advanced, in several areas of electronics. An all-new full-color NTS catalog shows you what each course covers,



# electronics of the future.

systems and more...from  
in home study.

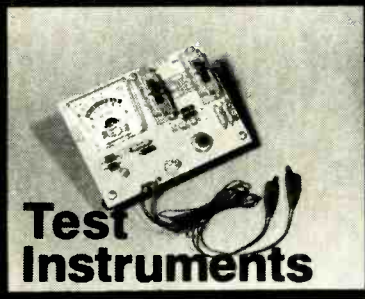

**Test Instruments**



*Simulated TV Reception*



**Digital  
Color TV**



**Basic  
Electronics**

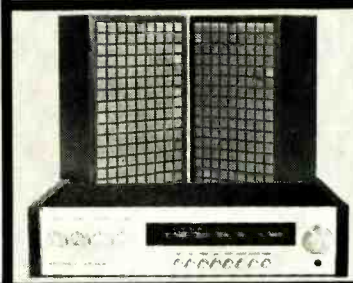

and every piece of equipment included.  
Send for it today, and see for yourself what's really happening in electronics training technology at NTS. Find out how much has changed, and what new directions the field is taking. You'll probably want to be a part of it.  
It's free. Just mail the card or coupon. Today.

**NO OBLIGATION. NO SALESMAN WILL CALL.  
APPROVED FOR VETERAN TRAINING.**

**NATIONAL TECHNICAL SCHOOLS**

TECHNICAL-TRADE TRAINING SINCE 1905  
Resident and Home-Study Schools  
4000 South Figueroa St., Los Angeles, Calif. 90037

**NATIONAL TECHNICAL SCHOOLS** Dept. 206-038  
4000 South Figueroa Street, Los Angeles, California 90037

Please send FREE Color Catalog and Sample Lesson.

- Color TV Servicing
- B & W TV and Radio Servicing
- FCC License Course
- Electronic Communications
- Electronics Technology
- Audio Electronics Servicing
- Digital Electronics
- MicroComputers/MicroProcessors

Name \_\_\_\_\_

Address \_\_\_\_\_

Apartment Number \_\_\_\_\_ Age \_\_\_\_\_

City \_\_\_\_\_

State \_\_\_\_\_ Zip \_\_\_\_\_

- Check if interested in G.I. Bill information.
- Check if interested ONLY in classroom training in Los Angeles.

# hobby corner

*A basic game roller or chase circuit that's the basis for many games. Plus some simple modifications to change the odds.*

EARL "DOC" SAVAGE, K4SDS, HOBBY EDITOR

YOU KNOW, HALF THE FUN OF THIS ELECTRONICS hobby is building a circuit and then seeing what else you can make it do. This month's circuit can be changed in a number of ways.

Many games require a spin of a counter or a toss of the dice to determine the order of play and/or the number of moves per turn. Here is a circuit that will do that job at the push of a button. The parts are few and inexpensive and construction is within the capability of virtually anyone. We'll start with a basic circuit and then change it around.

## Game circuit

The basic game roller circuit shown in Fig. 1 uses only three IC's. The 555 timer, an astable multivibrator, produces a very rapid series of pulses whenever switch S1 is open. These pulses are counted in groups of 16 and converted into binary form by the 7493.

Now if you have the facility of reading binary numbers quickly, you could stop with the 7493 and simply put an LED on each output line. Most of us, however, take too much time to convert mentally from binary to decimal numbers, so an electronic converter is added. The 74154 is a 1-of-16 decoder/demultiplexer that is wired here so that each of its 16 output

lines goes low sequentially and in step with the binary count delivered by the 7493. When the switch is closed, only one LED remains on. It is only necessary, then, to determine which line is low by noting which of the 16 LED's is glowing. Notice in the schematic that only one current limiting resistor (R3) is used for all the LED's since only one is on at any one time.

Thus, Fig. 1 is a spin counter that indicates any number from 1 to 16. The clock is designed to be fast enough so that the number on which the count stops is quite random. In fact, the LED's are switching on and off so fast that they all appear to be glowing dully. For this reason, the player cannot make the count stop where he would like.

The speed of the clock can be changed easily. Reducing the value of C1, R1 or R2 will *increase* the rate. Increasing one of these values will decrease the rate. You may wish to substitute a pot for R2 to make it easier to change the frequency (a 250K pot will provide a wide adjustment range).

## Adaptations

Another interesting use for this circuit is to make a "traveling light" sign. If you line up all 16 LED's and slow the clock, it

appears that the light is traveling down the line. Additional LED's would make the device even more eye-catching.

Fortunately, it happens that each output pin of the 74154 will carry a number of LED's. Since each LED you add will increase the current only about 0.1 mA, you don't even need more limiting resistors. Use two or more LED's on each output and connect them as shown in Fig. 2. (Figure 2 shows the connection for output pin No. 1 only. The other output

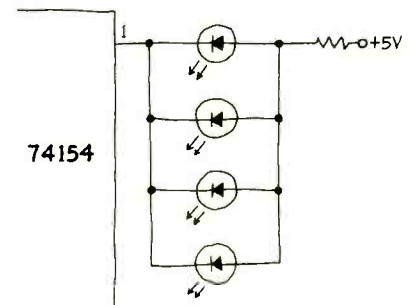

FIG. 2

pins are connected similarly.) The only caution is that you may have to match the LED's on each output. If one LED draws all the current (and light) from the other LED's on the same output, put it on another pin where it is more evenly matched.

Now arrange your LED's in a 1-16, 1-16, 1-16, etc., order. If you have 4 LED's on each pin, it will appear that 4 lights are traveling down the line. Of course, the display is made more interesting if you form a circle or rectangle or some other shape. By turning the pot you've substituted for R2, you can vary the speed with which the lights move.

So far, we have done nothing to change the probabilities or odds that one number (LED) will come up any more often than another. There has been an equal chance for every number. The following modifications will change that.

First, let's connect two outputs together as shown in Fig. 3. A low level at *either*

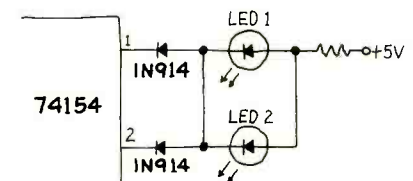

FIG. 3

output pin No. 1 or No. 2 will light *both* LED's. If both of the LED's represent numbers, your rule of play could call for

*continued on page 79*

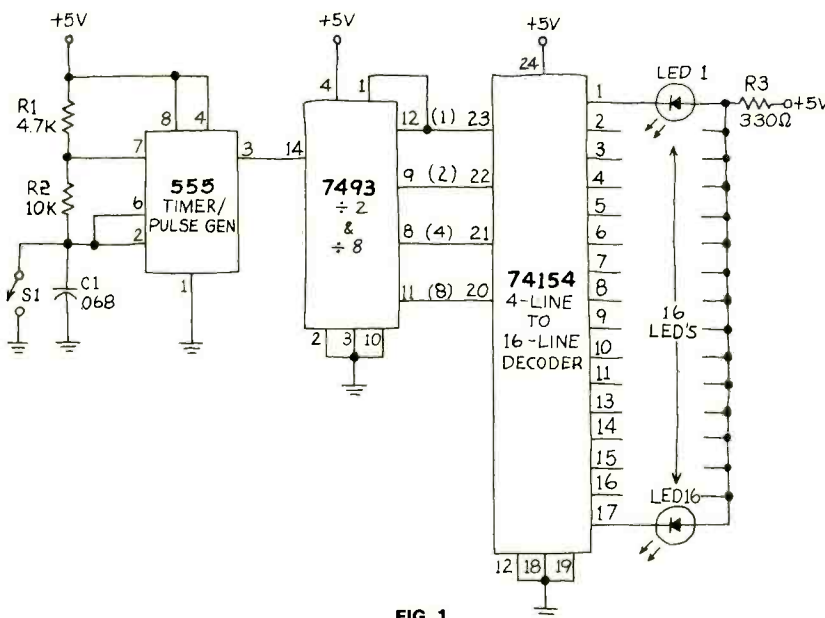

FIG. 1

# A major advance in cassette deck design. The new Sansui SC-5100.

If you're looking for a cassette deck that combines the convenience of the traditional cassette deck with the tonal excellence of open reel, you needn't look any further. Because the Sansui SC-5100 gives you both. And more.

Here's why. Performance meets the standards of today's most advanced component systems. All musical signals are reproduced clearly and without distortion because of the wide frequency response (20-17,000-Hz, chromium), excellent signal-to-noise ratio (67dB, with Dolby\*), and unusually low wow and flutter (0.05%, WRMS).

The SC-5100 is ultra-convenient to use. Solenoid operation permits controls that easily respond to your lightest touch. And with the electronically-controlled tape transport you get automatic play and repeat. The illuminated memory counter is also automatic.

For added convenience the SC-5100, when used with a timer, will record off your tuner or receiver unattended. Or it will wake you gently in the morning with your favorite music.

The SC-5100 offers all the features you'd

expect in a superior cassette deck. Such as large VU meters, a peak level indicator, line input, mic mixing capability, and bias and equalization controls for every tape. We've also added something you didn't expect, Sansui's exclusive Tape Lead-in\*\*. Just touch the control and the tape advances past the leader to the first point suitable for recording. You need never miss or spoil the start of a recording again.

Direct-O-Matic loading is another Sansui exclusive. It makes loading and unloading a snap, gives you access to the tape well for instant insertion and easy cleaning of the heads, and lets you see the direction of the tape and how much is left.

Now you have it, cassette deck convenience with open reel performance. All for less than \$600†. Hear the new SC-5100 at your franchised Sansui dealer. We think you'll agree you've never heard anything like it.



\*Trade mark of Dolby Laboratories, Inc.  
\*\*Patent pending.  
†Approximate nationally advertised value. Actual retail prices set at the option of the individual dealers.

**A whole new world of musical pleasure.**



**SANSUI ELECTRONICS CORP.**

Woodside, New York 11377 • Gardena, California 90247

SANSUI ELECTRIC CO., LTD., Tokyo, Japan

SANSUI AUDIO EUROPE S.A., Antwerp, Belgium — In Canada Electronic Distributors

**Sansui**

**CIRCLE 76 ON FREE INFORMATION CARD**

is increased by 50%.

edge of a workbench or surface up to 4

all work guaranteed 30 days!"

# service clinic

## Vertical OTL (Output TransformerLess) output stages adapted from audio amplifier technology—how they work and how to troubleshoot them. JACK DARR, SERVICE EDITOR

MANY SOLID-STATE TV SETS USE COMPLEMENTARY-symmetry and stacked ("totem-pole" or quasi-complementary-symmetry) vertical output stages. Basically, these stages are alike, but in the complementary-symmetry stages, transistors of opposite polarity are used. There are variations in the DC power supply, but the circuit operates the same. The advantages are obvious. The circuits don't need a big, expensive vertical output transformer, because they're all OTL (Output TransformerLess) circuits.

These simple circuits can develop some peculiar symptoms. For instance, how about a vertical sweep that covers only the top or bottom half of the raster, yet is perfectly linear?

The OTL circuits are the same as the output circuit used in so many audio amplifiers, with minor differences. They work in Class B. Each transistor conducts on only one half-cycle of the input signal, and cuts off completely on the reverse-polarity half. One transistor sweeps the top half of the raster and the other transistor, the bottom half. Therefore, the reason it is possible to have a linear half-raster is that one transistor isn't conducting at all! This is usually due to an open transistor or a bad connection.

### How it works

A typical example of this comes from the Admiral M45 chassis and is shown in Fig. 1. Note the waveforms in the upper right-hand corner. The top and bottom waveforms (waveforms *a* and *c*) taken across the emitter resistors show very clearly how first one then the other transistor conducts. The center waveform (waveform *b*) is the combination of the top and bottom waveforms, taken to ground from the junction of the emitter resistors where the vertical yoke is connected.

Since the first two signals were taken across a resistor, the voltage peaks are directly proportional to the current through the resistor and yoke winding. These transistors are termed the top ramp and bottom ramp vertical output transistors because they generate a ramp voltage (linearly rising sawtooth), and the two together give the complete sawtooth that is needed to scan the whole screen.

During the top half of the scan, the top transistor is turned on, and the bottom transistor is cut off completely. In the middle of the screen, the top transistor is turned off, and the bottom transistor finishes the job.

The following question has puzzled many technicians, present company included: The top transistor is connected to B+ (145 volts). Current flows through it and the yoke. If this current is cut off during the bottom half of the scan, from what source does the bottom-half transistor get its DC voltage supply?

The answer is simple. Note capacitor C606 (220  $\mu$ F) in series with the vertical yoke return to ground. While the current flows through the top transistor, capacitor C606 charges. When the top transistor cuts off, capacitor C606 discharges through the bottom transistor, and away we go.

This is only one valuable clue in finding problems. If the DC power supply is normal, both transistors are good, but you still have no vertical sweep, check the capacitor to see if it is open. Not only will you lose the DC voltage at the midpoint,

but the vertical yoke winding will have no return to ground. In normal operation, you will read about +59 volts DC at the junction of the output-transistor emitter resistors. The middle waveform (waveform *b*) in Fig. 1 is a pulse sawtooth waveform with a voltage of about 100 P-P. Your meter reads this voltage as the charge on the capacitor, therefore it is lower.

As in the audio circuit, the crossover (the midpoint in the cycle where the transistors switch conduction) is very important. In audio, you can have a little crossover distortion and maybe not hear it, but you can see it in a raster. Several different networks are used in these circuits just for this purpose. Figure 1 shows a familiar circuit: the two series diodes between the output bases correct the bias ratio and provide turn-on and turn-off at just the right time.

A feedback loop taken from the yoke connection (junction of the emitter resistors) is fed back into the first stages for S-correction. This corrects any tendency of the predriver stages to be nonlinear or show a droop in the rising part of the sawtooth. Note also that the vertical yoke winding does not go directly to ground through the return capacitor. A small sawtooth voltage is picked off across a small resistor (R615 and R616 in paral-

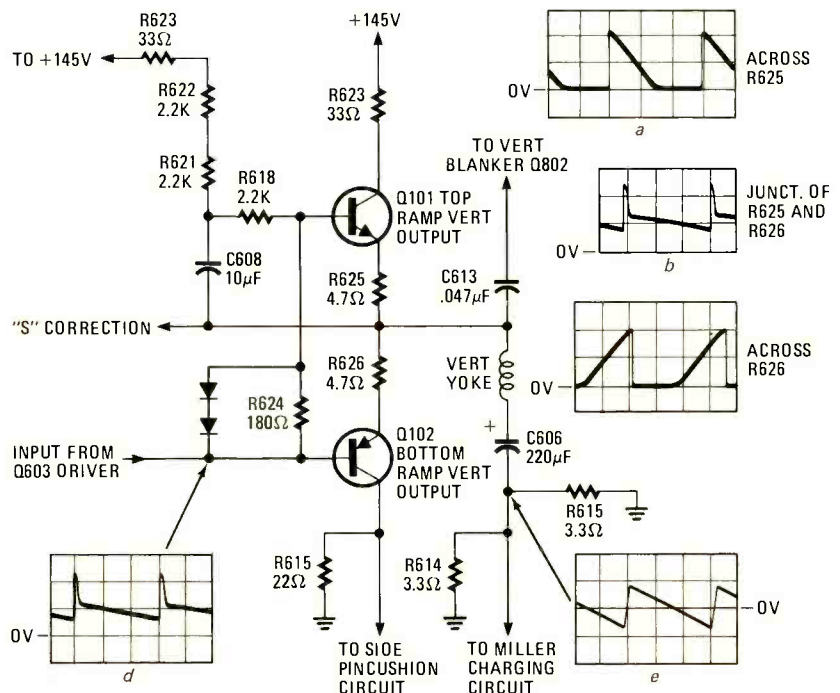

FIG. 1

lel); this is fed back into the Miller charging circuit used in the vertical oscillator circuit, which is not shown in the Fig. 1 diagram.

This circuit develops a very linear sawtooth waveform. The correct signal, shown in waveform *e* of Fig. 1, is a voltage waveform taken across a resistor again so that it is directly proportional to the yoke current.

DC voltage readings plus raster observations help greatly in finding circuit troubles. Check all of them, especially the DC voltage at the junction of the output-transistor emitters. This voltage will read about +59 DC. If this reading approaches normal, the output stages are probably working.

Another odd problem affecting linearity occurs if bootstrap capacitor C608 in the base of the top transistor (Q101) is open. Capacitor C608 provides a little regenerative feedback to raise the gain of transistor Q101. Other linearity problems can be caused by a drift in the value of resistors in the feedback loops or by open bypass capacitors, etc.

You can use a scope to check the waveforms for amplitude and distortion and determine just where the trouble lies. Follow the feedback loops back to where they are used, and you can pin down the cause of any distortion very quickly.

The OTL circuit uses a single-ended DC power supply; the clue is that one of the output transistors always goes to ground. Another clue is the big coupling capacitor (C606) in series with the yoke winding. This will hold true whether the circuit is complementary-symmetry, a "totem pole" using identical NPN or PNP transistors, or a quasi-complementary-symmetry circuit using identical output transistors and complementary-symmetry drivers.

You will also find the same circuit using dual-polarity DC power supplies, which is almost always used with complementary-symmetry transistors. This circuit will *not* have a big yoke-coupling capacitor; the yoke returns directly to ground. Equal and opposite DC voltages are supplied to the output transistors. A circuit similar to the one shown in Fig. 1 would probably show something like +60 volts on the top (NPN) transistor collector, and -60 volts on the bottom (PNP) transistor. These are ballpark figures, or course, since the actual voltages depend on the design, type of transistor, screen size, etc. What is important to remember is the *ratio* between the DC voltages, bias voltage and so forth. Another handy hint is to check all the controls for *reaction*. If you find one that has no reaction at all or an incorrect reaction, check the circuitry around this control thoroughly and find out why.

An OTL is a good circuit, and one in which it is not at all hard to diagnose problems, if you know how it works and what it does when it isn't working! **R-E**

## service questions

### NO BOOST VOLTAGE

*I can't get any boost voltage on this Admiral H1-1A portable. The tubes are good and supply voltage is normal. Any idea?—G.V., E. Hartford, CT*

Check the deflection yoke. If it has a light blue plastic mount and is marked "Made In Taiwan," it could be bad as many of these have been.

(Confirmed by reader!)

### HIGH-VOLUME SPEED LOSS

*When the record is first started on this Panasonic SG-635, everything is fine. When a loud passage comes in, the turntable slows away down! I don't get it!—H.K., Garrettville, OH*

I didn't either until I looked at the schematic. The turntable motor is not driven from the AC line, but from the DC power supply. Apparently it has enough output to keep the turntable running until the amplifier starts to draw more current. This is normal; this type of amplifier takes only small currents no-signal, but current drain goes up drastically on loud passages.

# WE PUT THE WICK WHERE IT BELONGS

**IN A UNIQUE, BUILT-IN DESOLDERING TOOL — YOURS FREE, AS A LIMITED-TIME INTRODUCTORY OFFER TO SD5.**

Imagine having desoldering wick, right where you can get at it fastest, when you need it most... while you're soldering. It's our new patent-pending, refillable SD5 solder/desolder system with 2½ inch heat-resistant, telescoping Teflon\* probe.

Snapped right into the center of a pound spool of our high quality 16, 18 or 21 gauge MIL-spec solder is D5—our easy-to-use desoldering tool. D5 contains 5 feet of pure copper wick that lets you see the absorption of solder... so you never overheat boards or components by working with a used portion of wick. Its non-activated, pure water-white rosin flux coating quickly removes all solder, without corrosive residue.

Nothing beats the D5 dispenser tool for easy desoldering without

burnt fingers. Its 2½ inch probe reaches right into tight areas. And by applying tension to the probe, you can shape or "web" the wick to provide a greater absorption surface. You also use less wick, dispensing the right amount as you need it.

SD5 is the total system for maximum soldering/desoldering efficiency. Alone, the D5 tool is perfect for times when you want to pocket the wick and leave the solder behind. And D5 is also refillable... just snap out the Teflon\* probe and plug in a D5 refill, available in two gauges—.10 inch and .06 inch.

The Chemtronics modular solder/desolder system can be purchased separately as half or one-pound spools of solder, D5 desoldering tool and D5 wick refill. Or as a complete SD5 unit with free D5 desoldering tool. Take advantage of this limited-time offer at your Chemtronics distributor now.



Precision application even in high density circuits



Snap out, pocket D5

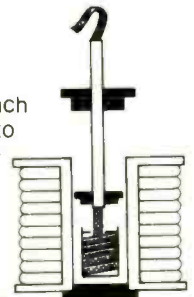

Modular construction—D5 tool is removable. 2½" probe snaps into wick refill



**FREE!**  
\$2.45 VALUE!



**CHEMTRONICS INC.**

WHERE CHEMISTRY MAKES ELECTRONICS WORK BETTER

45 Hoffman Avenue, Hauppauge, N.Y. 11787 (516) 582-3322/(212) 895-1930

CIRCLE 75 ON FREE INFORMATION CARD.

Check the DC power-supply output and motor voltages. They are regulated. You should read 9.1 volts at the power-supply output (at all times) and +3.25 volts across the motor and on the regulator-transistor collector. There may be very low or open input filter capacitor in the DC power supply.

### SUDDEN COLOR CHANGE

*This Truetone WEG-4419A-47 will intermittently change color to a reddish, bluish, etc., raster. It's never shown the same color twice. The voltage-regulating transistor runs hot, and the DC voltages are off. The +30.7 volt line is only about 20.*

*Also, while checking, my probe slipped and I blew the Zener diode ZD601. Since I can't find a replacement, I could use help.—M.D.O., Mena, AR*

Get those DC voltages back up to normal, and your problem will probably go away. The Zener diode is shown as a 31-volt type, but an RCA SK-3095 will replace it. Check the regulator transistor. This can be replaced by an RCA SK-3054. Also, don't overlook the "Regulator Protector" (error-amp) transistor Q602; an SK-3124 will replace this.

The 30.7-volt line feeds the color amplifier transistors. If this voltage is quite low, these transistors will clip the signal

badly and distort the colors. Heat-related shifts in the regulated DC voltage cause changes.

### TUBE HEATER OUT

*Although I have high voltage, sound and so on, I can't get the screen to light on this Sony TV-500U. The picture-tube heater doesn't show any glow; is it supposed to?—C.V., Jessup, PA*

This isn't one of those tubes with "dark heaters." I'd say it should definitely show a light. The circuit uses a small tertiary winding on the horizontal driver transformer to supply the picture-tube heater. Since you have high voltage, this transformer ought to be good. Check that winding for the voltage, which will be AC. Check the continuity on the picture-tube base, from pin 1 to pin 3, the heater terminals. Try hooking a small 12-volt bulb across the driver transformer tertiary; if the bulb lights up, then the picture tube is open.

### POWER TRANSFORMER NEEDED

*I need a substitute power transformer for an amplifier made by Aims Amplifiers, Inc., which is not in business any more. This model "Dual Twelve" has two 12AT7's, four 7025's, and two 6550's, and is rated at 120 watts into 4 ohms.—W.M., Newark, DE*

From the schematic you sent, plus the ratings on the tube manual, this should be fairly easy. It seems to have a bias winding on the high-voltage secondary, which would be normal for a high-power amplifier using 6550's. I'd recommend using a Thordarson 24R38.

However, the 6550 tubes listed in GE's tube manual are rated at 20 watts *per tube*. This should be about 40 watts push-pull, not 120 watts! Sounds like someone was being a touch optimistic with power ratings. (If so, no wonder the power transformer blew out.)

### TRACE PROBLEM

*I have a trace problem in a Precision ES-550 scope. After about half an hour, it broadens until the intensity and focus controls won't correct it. What's doing this?—A.M., Lowell, IN*

Look at the network of high-value resistors from the high negative voltage supply, to the intensity, focus and astigmatism controls, to ground. Some of these resistors are probably off value. If the 1.0-megohm resistor between the slider of the INTENSITY control and the CRT cathode has gone away up in value, it will cause the symptom you describe.

This is obviously a thermal; you can speed up the process by heating up each resistor with a soldering iron, after a cold start. Alternate: Cool each one after the trouble shows up.

### CHECKING OLD TUBES

*I'd like to know how you can check the older tube types, like Nos. 80, 43, 45, etc.,*



**This Nosey Helper Gets You Into (and out of) Tight Spots**

When you have to nose into tight places for small objects, here's the helper that will do the job. Precisely matched fine teeth and jaws. Jaw-opener coiled spring, a big help on repetitive work. Hand honed, perfectly mated, specially hardened cutting edges. Fine polished, drop forged steel. Blue dipped plastic cushion grips. The expert craftsmanship you expect—and get—from CHANNELLOCK.

CHANNELLOCK, INC., • Meadville, Pa. 16335

**CHAN NEL LOCK**

No. 326 GS Long Nose Plier



MEET THE FAMILY

Send For Our Free Catalog

CIRCLE 88 ON FREE INFORMATION CARD

in a late-model tube tester.—K.F., Raleigh, NC

With great difficulty! It is true that these are "only tubes," pentodes, etc. But you'd have to make up a socket panel and then connect it to your present tube tester. You'll have to identify the plate, grid, cathode, etc.

An easier way is to check them in-circuit. For example, if there are 250 volts AC on the plates of an No. 80 tube, but only about 100-volts DC output, the tube is weak or the input filter capacitor is open.

The same thing applies to any amplifier tubes. If the plate voltage is 100 high (supply voltages and load resistors normal), the tube is low in emission. Check the grid voltage to make sure the tube isn't biased-off. (Watch out for tubes like the 45's, which used a very high bias, up to 30-40 volts negative on the grids!)

### HORIZONTAL OSCILLATOR

**This GE FS-chassis portable won't light up every time it's turned on. However, once you touch anything in the horizontal oscillator circuit, it starts. After it's going, it never stops. What is causing this?—M.M., Chicago, IL**

The schematic shows this is the same Colpitts circuit used in several other portable makes. The most common cause of this symptom is the two capacitors across the oscillator coil: C262/C263, .0027  $\mu$ f and .0068  $\mu$ f. Try new ones in here.

(Feedback: "These capacitors were both good on the test. However, an eyelet in the PC board at one end of C263 wasn't very good! Same results. Thanks.")

### NO VERTICAL SWEEP

**This T935 Magnavox came in with no vertical sweep. A new tube didn't help. The DC voltage was very low on the input half-plate. I can inject a signal to the half-plate and get full sweep, floating. All resistance readings look good.—L.N., Philadelphia, PA**

All vertical multivibrator sweep circuits are basically the same: A two-stage RC-coupled audio amplifier with its tail in its mouth. Translation: A very heavy feedback from output to input to make it oscillate. Since the "amplifier" is obviously working, the problem is one of the parts in the feedback loop.

(Feedback on the feedback: "Yep. Capacitor C410, 0.001  $\mu$ f to ground, had shorted.")

### OUTPUT TRANSFORMER SUB

**I need a substitute for the output transformer in an old Motorola record-player console. The part number is 25C60394A03-E. I've checked with the local distributor and parts houses; no luck. Can you help?—L.B., Narragansett, RI**

A Triad S-55X is an exact duplicate for that part number.

## Presenting your portable automatic solid state

# "JOB HOPPER"



BACKED BY SENCORE'S  
100% MADE RIGHT  
LIFETIME GUARANTEE

Now, nobody likes to be called a Job Hopper, but the new, patented TF46 Portable Super Cricket can literally help you hop from job to job through solid state circuits faster than any other transistor tester on the market today. For the first time you can automatically analyze 162,000 different transistors and FETs, in or out of circuit at any job location in the world. Here are four reasons why.



### It's 100% automatic.

Connect the test leads any way you want right in circuit and rotate the large permutator knob until the Cricket "chirps". Read any transistor or FET as Good or Bad on the meter with the patented phase-inversion automatic Cricket test. It even identifies the transistor leads! It virtually thinks for you.



### It takes no set-up information.

None at all. It tests over 162,000 transistors and FETs with the same, simple test, and can easily be used by a non-technical maintenance person.



### It provides Leakage & Gain tests to completely analyze any transistor or FET.

The only portable tester that includes transistor Beta, FET Gm, and full leakage checks to totally check all parameters, and catch troubles other miss.



### You can now test solid state circuits anywhere.

The TF46 is fully battery operated for the field, or AC operated for the bench with the optional 39G90 Power Adapter. You know what else? The TF46 automatically turns itself off after 10 minutes of testing in the field to save the batteries.

Hop to it. Call your local Sencore Full Line Promotional Distributor, or order your TF46 Job Hopper with the coupon below.

**SENCORE** 3200 Sencore Drive, Sioux Falls, So. Dak. 57107 (605) 339-0100  
In Canada: Superior Electronics

I WANT TO BUY IT. Send \_\_\_\_\_ TF46s to me at \$225 each.  
 Check/MO enclosed.  Send C.O.D.  
 Also send:  
 \_\_\_ PA208 Power Adapter ..... \$9.95  
 \_\_\_ 39G85 Touch-Test Probe ..... \$10.00  
 I WANT TO TRY IT. Have my nearest Sencore distributor bring the TF46 to me.  
 SEND FULL SPECIFICATIONS.

NAME: \_\_\_\_\_  
 COMPANY: \_\_\_\_\_  
 STREET: \_\_\_\_\_  
 CITY: \_\_\_\_\_  
 STATE: \_\_\_\_\_ ZIP: \_\_\_\_\_  
 PHONE: \_\_\_\_\_

CIRCLE 20 ON FREE INFORMATION CARD

# Solid-State Update

## Microcomputers

Microkit has produced the M8-40 *Microemulator* and M8-41 Debug and EPROM programmer as a \$1,250 package.

The *Microemulator* plugs into a CPU socket. It can be used for debugging development systems, production testing and maintenance of microprocessor systems in their own environments. The

system has a monitor; emulator mode; single step and trace execution; hardware breakpoints; and 2708/2704 EPROM programming.

The programmer is available for 8080, 6800 and Z-80 microprocessors. Microkit, Inc., 11205 S. La Cienega Blvd., Los Angeles, CA 90045.

The Signetics 2651 Programmable Communications Interface (PCI) is a

combination Universal Synchronous/Asynchronous Receiver/Transmitter (USART) and baud rate generator that is compatible with the 2650, 8080, Z-80 and 6800 microprocessors.

The USART function takes the parallel output data of a microprocessor and converts it into a serial bit stream. Received serial data is converted into a 5- to 8-bit word for entry through the microprocessor's data bus. Asynchronous false starts caused by noise are detected, and the number of start bits, and odd, even or no parity selection is implemented. Baud rates from 50 to 19.2 kilobits-per-second can be program-selected.

The 2651 interface should prove useful in intelligent terminals, communication controllers, data concentrators and front-end processors.

Texas Instruments' TL505 is an A/D converter designed to work with microprocessors such as the TMS1000 in such applications as high-impedance sources, weight scales, and thermal, light and moisture sensors.

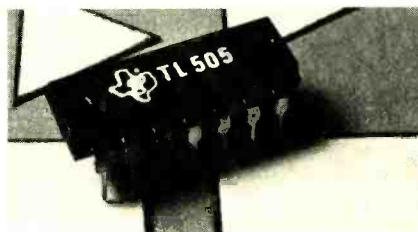

The TL505 has 0.1% accuracy, on-chip reference voltage, auto zero and high-impedance MOS inputs. Three-digit BCD conversions are completed in 500 ms by the TL505/TMS1000 combination.

## Microprocessors

There have been some recent developments in National Semiconductor's SC/MP 8-bit and PACE 16-bit microprocessors. First, for those who cannot see the logic of hooking a \$3000 terminal to a \$100 evaluation/development board, a new low-cost SC/MP keyboard kit has been developed. The calculator-like device has a keyboard with hexadecimal and system control keys, and a built-in six-digit hex display. The buffer, decoder and driver circuits mount on the empty portion of the SC/MP kit board. A new ROM replaces the original kit bug ROM.

The ABT (abort) key terminates the command in process and returns the system to a wait loop. The MEM key displays the next memory address and its contents. The TERM key terminates the present mode and then enters data at specified addresses. And the GO key followed by



**Simpson**

CONTINENTAL SPECIALTIES CORPORATION





# PHILIPS



# HICKOK

# LEADER



Non-Linear Systems



TRIPLETT VIZ formerly RCA





**SUPER SPECIAL**

**BK PRECISION**

**New 3-1/2 Digit Portable DMM**

REG. \$99.95

**\$79.95**

Resistor - fully shielded protection  
3 1/2 digit read to read LED  
display  
Completely portable - uses  
4 AA batteries  
Auto-ranging  
High-impedance inputs for  
AC/DC voltage

• Very low & 1/2 ohm resolution  
• 10 meg-ohm impedance  
• Industry standard  
• Excellent temperature coefficient  
• DC accuracy 1% typical

MODEL 2800

OFFER EXPIRES APRIL 30, 1978





We give you immediate off the shelf delivery on Oscilloscopes, Power Supplies, Audio & R.F. Generators, Digital Multimeters, Frequency Counters, Logic Probes, Tube & Transistor Testers, Wow & Flutter Meters, Distortion Analyzers, Bridges, and Accessories. For more information call us Toll Free: 800-223-0474.

212-687-2224 THE TEST EQUIPMENT SPECIALISTS

TOLL FREE HOT LINE  
800-223-0474

54 West 45 Street, New York, N.Y. 10036

ADVANCE  
ELECTRONICS



TERM begins program execution at the last referenced address.

The price of the ISP-8K/400 keyboard kit is \$95, including a hand-held wire-wrap tool.

National has also released the \$499 ISP-8P/301 low cost development system for the SC/MP microprocessor. The basic LCDS system comes with a 16-key hex keyboard, three control switches and a six-digit hex display. The CPU card supplied with the system plugs into one of four available sockets.

Programs can be entered, examined and run in continuous or single instruction modes, and can operate through a teletype using SC/MP DEBUG.

National's SC/MP II, which is an N-channel version of the older P-channel microprocessor, is twice as fast and uses only one-fourth the power of the earlier type. Only a single +5-volt supply is needed as compared with the +5- and -7-volt supplies used by the PMOS microprocessor. Typical instruction execution time is 5  $\mu$ s.

The PACE 16-bit microprocessor costs \$20 ordered in quantities of 100, and \$13 in 5000 lots. These prices represent a 50% price reduction, and prices are expected to drop even more in 1977. The cost of the PACE microprocessor is now one-half that of the General Instruments microprocessor and one-fourth that of the Texas Instruments device.

National Semiconductor Corporation, 2900 Semiconductor Drive, Santa Clara, CA 95051.

#### Watch circuits

RCA has three new CMOS timing circuits for liquid-crystal watches, the CD22001H, CD22002H and CD22003H.

The first two are two-button, five-function circuits that display hours, minutes, month, date and seconds on a 3 $\frac{1}{2}$ -digit display. The CD22002H can be reset by pressing both switches simultaneously. This resets the watch and disables the high-voltage (4.5 volts) display supply for minimum current drain during storage. The CD22003H also includes a 15-minute stopwatch.

The RUN II mode displays alternating hour/minute and month/date. Thirty and 31-day months are corrected automatically, but February is fixed at 28 days so that resetting is necessary only during leap year.

#### Schottky TTL's

Motorola has signed a second-source agreement with Fairchild Camera and Instrument Company that provides for a technology exchange.

Motorola plans to produce low-power Schottky TTL products; while Fairchild will second-source Motorola's M6800 microprocessor.

Motorola has been successfully making  
*Turn page*



Model AT15Sa/H Dual Magnet Stereo Cartridge pre-mounted in Universal tone arm head shell.

## To find out how much better our cartridge sounds, play their demonstration record!

There are some very good test and demonstration records available. Some are designed to show off the capabilities of better-than-average cartridges... and reveal the weaknesses of inferior models. We love them all.

Because the tougher the record, the better our Dual Magnet™ cartridges perform. Bring on the most stringent test record you can find. Or a demanding direct-to-disc recording if you will. Choose the

Audio-Technica cartridge that meets your cost and performance objectives. Then listen.

Find out for yourself that when it comes to a duel between our cartridge and theirs... we're ready. Even when *they* choose the weapons!

What you'll hear is the best kind of proof that our Dual Magnet design and uncompromising craftsmanship is one of the most attractive values in high fidelity. For their records... and yours!



**audio-technica**  
INNOVATION □ PRECISION □ INTEGRITY

AUDIO-TECHNICA U.S., INC.  
Dept. 38E, 33 Shiawassée Avenue, Fairlawn, Ohio 44313  
In Canada: Superior Electronics, Inc.

CIRCLE 38 ON FREE INFORMATION CARD

**FREE!**



**MORE THAN 900 PRODUCTS**

detectors, controls, sounders, locks, tools

**EVERYTHING NEEDED TO PROTECT HOME, BUSINESS, INSTITUTION**

Huge selection of high quality professional alarm products. 64 fact-filled pages with detailed specs, diagrams, technical notes. Products range from basic switches, controls, bells, sirens to most sophisticated detectors — radar, modulated or passive infrared, microwave, ultrasonics, ion, data links using pulse code multiplex, FSK radio, automatic phone dialers, leased line connections and display panels. Full selection of tools, relays, wire, foil, terminals, books.

**WRITE FOR FREE CATALOG TODAY!**

(Outside U.S., send \$1.00.)



**mountain west alarm**  
 box 10780 • phoenix, az 85064  
 (602) 263-8831

**CIRCLE 13 ON FREE INFORMATION CARD**

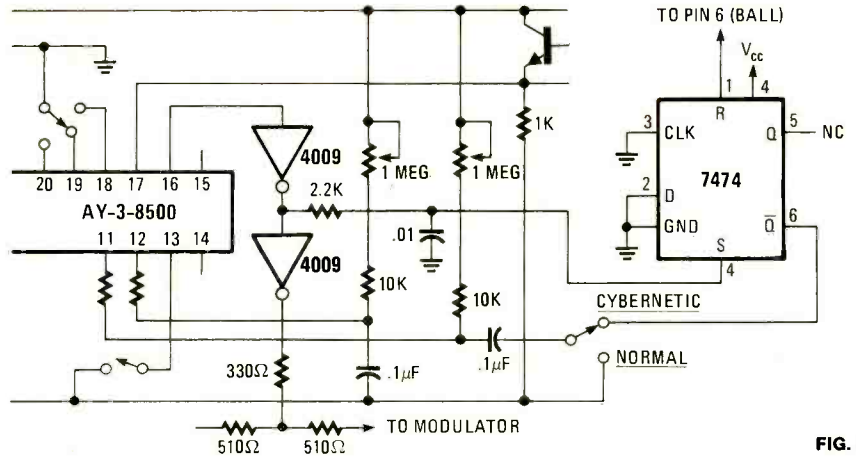

**FIG. 1**

selected Schottky devices to prove compatibility with Fairchild's LS process, and now plan to produce all Schottky LS products offered by the industry as well as introducing new devices.

**BIFET op-amps**

Texas Instruments has added four new devices for a full line of five BIFET operational amplifiers. The devices have a high slew rate, low input bias and offset current and offset voltage selection.

The TL080 and TL081 are single amplifiers, that have offset-voltage null capability. The TL081 includes internal frequency compensation.

The dual TL082 and TL083 types have internal compensation, and the TL083 has offset voltage nulling.

The devices add to the previously announced TL084 quadruple operational amplifier. Commercial prices range from 52¢ to \$1.30 each in 100 quantity.

**Game modification**

Those who have been following game circuit developments are no doubt aware of the General Instrument AY-3-8500 TV games IC. Figure 1 shows a modification (courtesy of R. Dowden, Ashland, VA) that lets you play against the machine in the so-called "cybernetic mode." With the switch in the cybernetic position, the ball output on pin 6 of the AY-3-8500 is connected to the reset input of the D-type flip-flop and the filtered junction of the two 4009 inverters is connected to the set input of the flip-flop. The flip-flop is set on each vertical sync pulse and reset by the ball pulse. The output then has a pulse width that is proportional to the vertical deflection of the ball. The complemented output of the flip-flop connects to the return side of the paddle position capacitor and switches it to ground whenever the flip-flop is set. This automatically controls the right-hand paddle to keep it in the same vertical position as the ball.

Using the capacitor connected to the right-hand paddle on pin 11 permits initial adjustment by using "Pelota," one of the IC's six games.

The paddle potentiometer varies the skill of the machine and creates a weak left-side handicap.

**R-E**

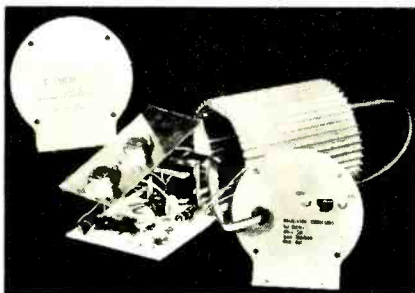

**FROM KIT TO CAR IN 80 MINUTES!**

Electronic ignition is "in." Update your car with the TOPS in power, efficiency and reliability — the TIGER SST capacitive discharge ignition (CD).

The TIGER delivers everything other CD's promise — and more: quicker starting, more power, more gas mileage, tune-ups eliminated, lifetime plugs and points, reduced repairs and pollution.

The TIGER can be built and installed in your car in 80 minutes. The TIGER is unique!

The TIGER comes with a switch for TIGER or standard ignition for 12V negative ground only.

**Simpli-Kit \$21.95**  
 POST PAID U.S.A.

WE ACCEPT:  
 Mastercharge or BankAmericard.  
 Send check or money order with order to:

**Tri-Star Corporation**  
 DEPT. FF, P.O. Box 1727  
 Grand Junction, Colorado 81501

**CIRCLE 24 ON FREE INFORMATION CARD**

**ALDELCO ELECTRONICS COMPANY**

**NEW IMPROVED DIGITAL ALARM CLOCK KIT**  
 0.5 LED Display 12 hour format  
 Snooze Feature  
 Elapsed Timer  
 Simulated Wood Grain or Black Leather Cabinet \$24.95  
 12 or 24 Hour Clock Kit. Similar to above but without Alarm or Timer features \$39.95  
 8 Size AA Nicad Batteries Only \$23.95  
 Crystal Time Base Kit for 12 Volt DC use 4.95

**COMBINATION FREQUENCY COUNTER & CLOCK.** 0.4 LED Display. .00005% accuracy. 12 or 24 Hour Clock uses 8 AA Nicad batteries (not supplied). Assembled Unit \$39.95  
 8 Size AA Nicad Batteries 17.50  
 110 Volt AC Power Supply & Battery Charger 5.95

| VOLTAGE REGULATORS |          | NEW—Internal DVM Kit 0-200 mV, expandable. PC Board part and instructions. liquid crystal display \$39.95 |
|--------------------|----------|---|
| TO220 Package      | Negative |   |
| Positive           |          | LOGIC PROBE KIT DIGIPEAKE-A \$9.95  |
| \$1.00             | \$1.25   |   |
| 7805               | 7905     |   |
| 7806               | 7906     |   |
| 7808               | 7912     |   |
| 7812               | 7915     |   |
| 7815               | 7918     |   |
| LM309H             | \$1.10   |   |
| LM309K             | 1.10     | Kit of parts for power supply. Includes schematic 5 Volt, 6 Amp \$17.95<br>+15 and -15 2 Amp \$16.95      |
| LM723              | .55      |   |

**FETS** 40673 1.55 We have transistors.  
 MPF102 .55 Send stamp for catalog.

**MA 1003 National Car Clock Module**  
 With 3 push button switches and filters \$19.95  
 New aluminum cabinet for MA 1003 \$6.95

| WOW LOOK AT THIS JUMBO RED LEDS |              | AMATEUR TV CONVERTER Covers 420 to 450 AM TV BAND. Works on unused Commercial TV Channel KIT ONLY \$39.95<br>ASSEMBLED \$49.95 |
|---------------------------------|--------------|--|
| Green, Yellow or Orange LEDs    | 5 for \$1.00 |  |
| FND 70 CC 0.3 Display LED .49   |              | BLINKY-FLASHER-TIMER KIT Includes 555. PC Board Parts & Instructions \$2.50  |
| FND 500 CC 0.5 Display LED .89  |              |  |
| CLOCK FILTERS 2 1/4 x 5 1/4"    | .80 ea       |  |
| Red, Blue, Green or Amber       |              |  |

**ACCUKEYER KIT.** Uses TTL. Includes IC's, sockets, Speaker, PC Board, Instructions and all parts ONLY \$19.95  
**MEMORY KIT.** Matches above & other accukeyer kits ONLY \$19.95

**VARIABLE POWER SUPPLY KITS.** .5 Amps 5-15 Volt DC \$6.95  
 add \$1.00 per kit shipping .5 Amps 12-28 Volt DC 6.95

Visit Our Store. Hours 9:00 AM to 8:00 PM Mon. to Fri. Sat. 9:00 AM to 2:00 P.M. Phone Orders accepted. Visa & Master Charge. ADD 5% FOR SHIPPING. ORDERS UNDER \$10.00 add \$1.00. Foreign Orders add 15% shipping (Except Canada & Mexico) send Certified Check or Money Order in USA funds.

**ALDELCO**  
 2281R BABYLON TURNPIKE, MERRICK, N.Y. 11566  
 (516) 378 4555

**CIRCLE 2 ON FREE INFORMATION CARD**

**"Maybe it will go away."**

The five most dangerous words in the English language.

American Cancer Society  
 We want to cure cancer in your lifetime.

## FOCUS PROBLEM

*The picture tube in this Magnavox T935-04 was replaced with an 18VAKP22. Now I can't get any focus. There are three taps on the chassis: +550 volts, +280 volts and ground. It won't focus on any of them!—L.N., Philadelphia, PA*

There are two different types of picture tubes used in this Magnavox series. Some use the "standard" bipotential tube (25kV high voltage, 5kV of focus), but others use a low-focus voltage Einzel-lens tube.

The 18VAKP22 is a bipotential tube and needs 4 to 5 kV for focus. If you add the stock focus-dropping network it should work. Use the flyback modification kit, No. 171321-1, which uses a voltage tripler.

## FM INTERFERENCE TV

I'm an engineer at an FM stereo station operating at 3.2 kilowatts on 97.7 MHz. We were getting complaints from residents that we were upsetting Channel 10 with our second harmonic. We took the station off the air until we could get this checked. The measured second harmonic at the transmitter was something like 100-dB down!

After much searching, the cause of the problem was found. Broadband TV antenna boosters were being overloaded. The input stages were actually being driven into Class C and doubling our carrier! This not only created problems for the user but it radiated into neighbors' sets.

The cure was to install FM traps between the antenna and the booster input; boosters with built-in FM traps also worked well.

(Many thanks to Tim Metzger, Jewett City, CT, for this information.—Ed.)

## SUB FOR TRANSISTOR

*This Sears 518.41960357 chassis blows the 1.5-amp fuse. Transistor Q500 seems to be bad. I can't find a listing for it. I ordered one from Sears but haven't heard from them yet. Can't find any shorts in the DC voltage supply.—W.G., Kingston*

Transistor Q500 is not bipolar! It's a PUT (Programmable Unijunction Transistor). Sylvania shows it under the OEM part number and says to use an ECG-6402 (which is a PUT.) The key is that the gate goes to the anode, not to the cathode as in an SCR (Silicon Controlled Rectifier).

There is another PUT in the DC regulator circuit. It gates on the SCR to control the +114-volt supply line. I suggest you monitor the +114-volt line. If it goes too high, this will make all the circuits fed from it take too much current, thus possibly causing the blown fuse. We have heard from other technicians who have run into PUT's; one said he had checked it every way he could think of, but when he changed it, that fixed it!

# How do you really use a multimeter?

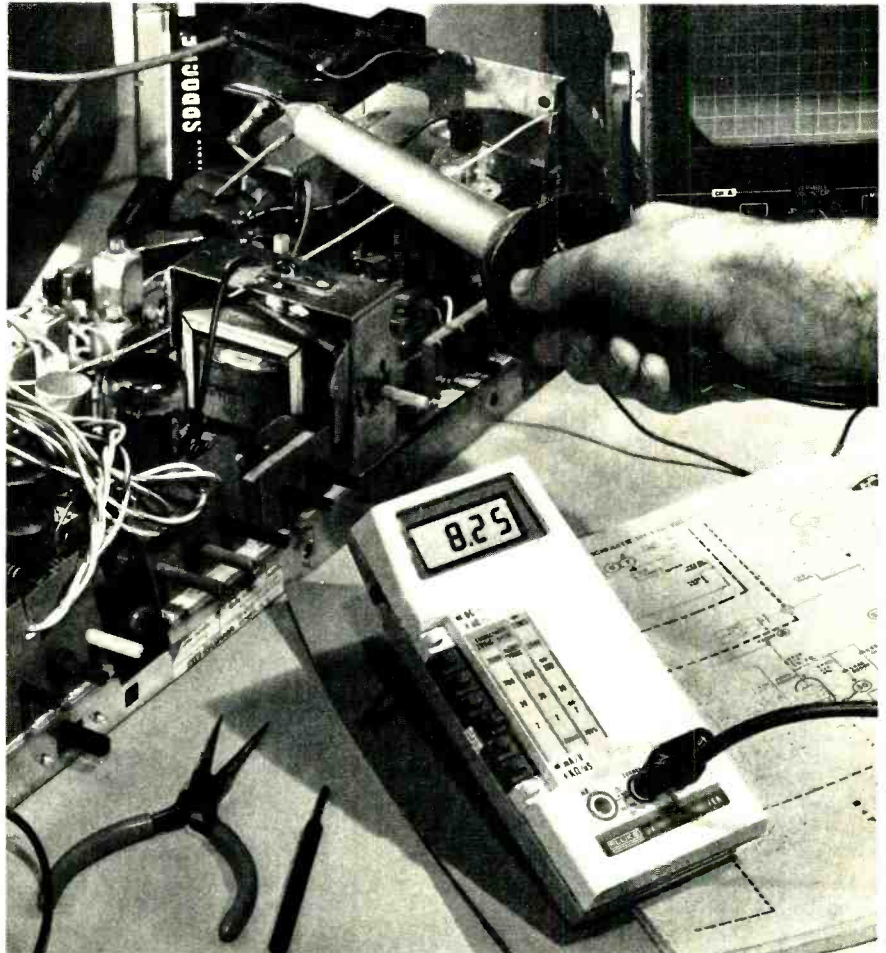

Usually at your bench, in the shop, shared with others. And, if it's a Fluke multimeter, you use it with confidence.

Now you can carry that same bench precision on the job. Introducing the new Fluke 8020A DMM for only \$169.\*

This rugged beauty packs more field-valuable features than any other DMM available, at any price. And that means field versatility when you need it most.

The 8020A has six resistance ranges, including a 20 megohm range for those special high-resistance TV components. Plus, you can measure focus dividers, pcb and capacitor leakage clear up to 10,000 megohms with the new conductance function. And conductance allows you to measure transistor beta—unique

with the 8020A.

Ever damaged your meter in the flyback circuit? Rest easy. The 8020A is MOV-protected to 6000V against hidden spikes and transients.

Your 8020A comes with a full-year warranty, with worldwide service backup. Regardless of what happens to it, we'll fix it inexpensively and quickly, making the 8020A a truly cost-effective investment.

Call (800) 426-0361, toll free. Give us your chargecard number for immediate delivery. Or, we'll tell you the location of the closest Fluke office or distributor. (Buy ten 8020As for only \$1521!\*)

\*U.S. price only.

**Command Performance: Demand the Fluke 8020A.**

1807-7007



CIRCLE 64 ON FREE INFORMATION CARD

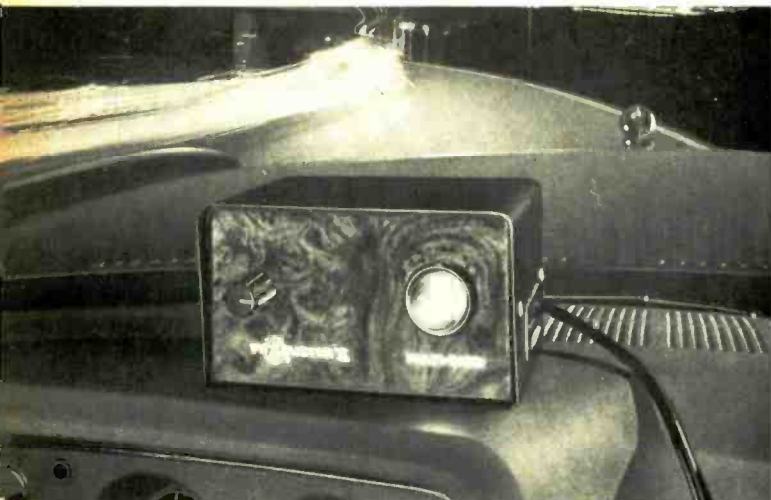

**ELECTROLERT FUZZBUSTER II** is a multiband detector that covers both the X and K bands. It sells for \$129.95, mounts on the dash and plugs into your car's cigarette lighter.

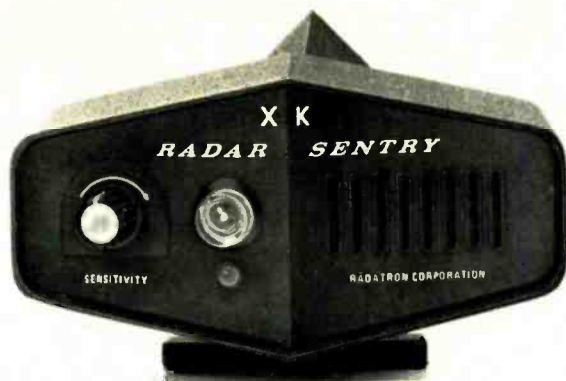

**RADATRON XK RADAR SENTRY** is two-band unit. Offers both visual and audio warnings; has front-panel sensitivity control.



**TYPICAL POLICE RADAR UNIT.** The antenna can be remotely positioned when necessary. It reads out directly in MPH.

**ARTHUR FULMER SUPER SCOUT** also covers both K and X bands. Plugs into lighter or permanently wired in with supplied connectors. Red light and beep alarms.

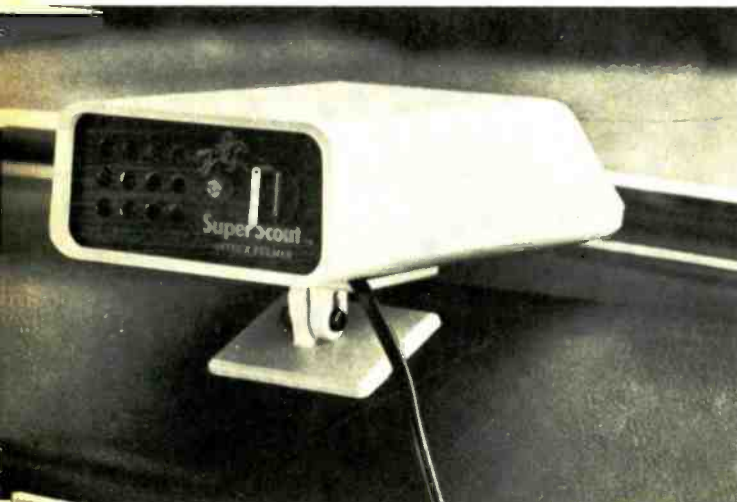

# Police-Radar Detectors

**WHISTLER RADAR EYE** multi-band detector. The closer the radar the faster the alarm light blinks and the faster the audio beep. Price is \$159.95.





**BEARFINDER TWO + TWO** uses two separate antennas—one for K band, one for X band to provide maximum sensitivity. Both audio and visual alarms are provided.

**WHISTLER RADAR EYE** blocks false triggering from 2-way radio, CB and microwave transmissions. It will set you back \$99.99.

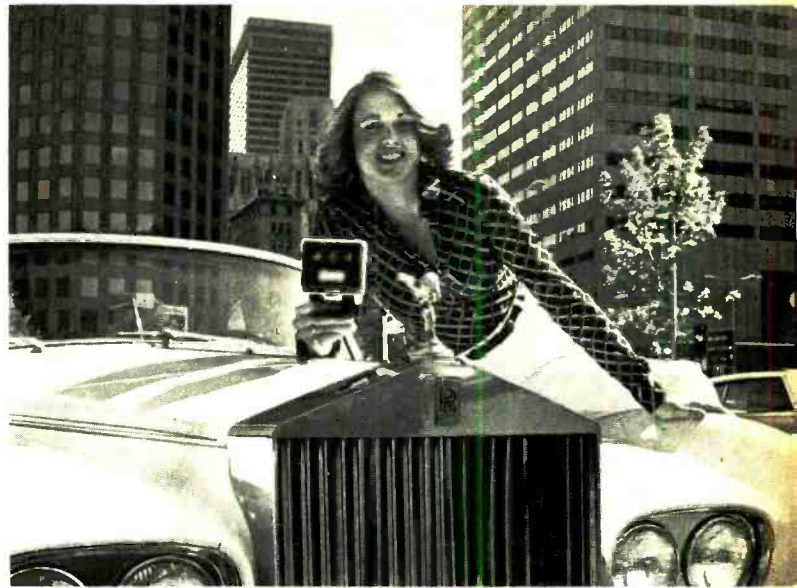

*These radar-sensing devices are intended to warn you of the locations of police-radar. They are not a substitute for staying below the posted speed limit.*



**AUTOTRONICS SUPER SNOOPER** detects all types of police-radar. Automatic sensitivity control and audio alarm with volume control.

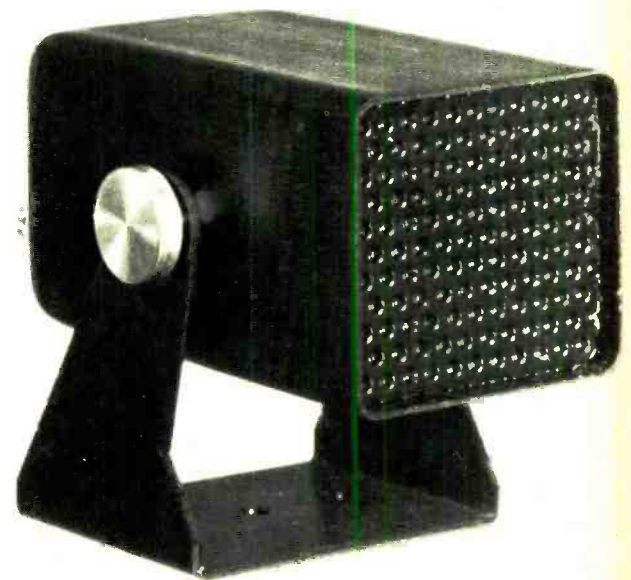

**RIGEL SIDEWINDER** warns of radar either ahead of or behind your vehicle. Price is \$129.95. The unit detects both X and K band radar.

# Should your career in electronics go beyond TV repair?

**CREI prepares you at home  
for broader and more advanced  
opportunities in electronics—  
plus offers you special arrangements  
for engineering degrees**

There is no doubt television repair can be an interesting and profitable career field. TV repair, however, is only one of the many career areas in the fast growing field of electronics.

As an indication of how career areas compare, the consumer area of electronics (of which TV is a part) makes up less than one-fourth of all electronic equipment manufactured today. Nearly twice as much equipment is manufactured for the communications and industrial fields. Still another area larger than consumer electronics is the government area. That is the uses of electronics in such areas as research and development, the space program, and others.

Just as television is only one part of the consumer field, these other fields of electronics are made up of many career areas. For example, there are computer electronics, microwave and satellite communications, cable television, even the broadcast systems that bring programs to home television sets.

As you may realize, career opportunities in these other areas of electronics are mostly for advanced technical personnel. To qualify for these higher level positions, you need college-level training in electronics. Of course, while it takes extra preparation to qualify for these career areas, the rewards are greater both in the interesting nature of the work and in higher pay. Furthermore, there is a growing demand for personnel in these areas.

Unlike most other home study schools, CREI programs are devoted exclusively to preparing you for careers in advanced electronics. All of CREI programs are college level. And CREI gives you both theory and practical experience in advanced electronics.

## **Unique Design Lab**

A unique feature of CREI training is its Electronic Design Laboratory Program, which trains you to actually design circuits. It also helps you understand the theories of advanced electronics and gives you extensive practical experience in such areas as tests and measurements, breadboarding, prototype construction, circuit operation and behavior, characteristics of electronic components and how to apply integrated circuits.

## Career Training at Home

Only CREI offers this unique Lab Program. It is a complete college lab and, we believe, better than you will find in most colleges. The "Lab" is one of the factors that makes CREI training interesting and effective. And the professional equipment in this program becomes yours to keep and use throughout your professional career after you complete the training.

### Engineering Degree

CREI offers you special arrangements for earning credit for engineering degrees at certain colleges and universities as part of your home study training program. An important advantage in these arrangements is that you can continue your full time job while "going to college" with CREI. This also means you can apply your CREI training in your work and get practical experience to qualify for career advancement.

### Wide Choice of Programs

CREI gives you a choice of specialization in 14 areas of electronics. You can select exactly the area of electronics best for your career field. You can specialize in such areas as computer electronics, communications engineering, microwave, CATV, television (broadcast) engineering and many other areas of modern electronics.

### FREE Book

In the brief space here, there isn't room to give you all of the facts about CREI college-level, home study programs in electronics. So we invite you to send for our free catalog (if you are qualified to take a CREI program). The catalog has over 80, fully illustrated pages describing your opportunities in advanced electronics and the details of CREI home study programs.

### Qualifications

You may be eligible to take a CREI college-level program in electronics if you are a high school graduate (or the true equivalent) and have previous training or experience in electronics. Program arrangements are available depending upon whether you have extensive or minimum experience in electronics.

Send for this **FREE** Book describing your opportunities and CREI college-level programs in electronics



Mail card or write describing qualifications to

**CREI** **CAPITOL  
RADIO  
ENGINEERING  
INSTITUTE**

McGraw-Hill Continuing Education Center  
3939 Wisconsin Avenue Northwest  
Washington, D.C. 20016

Accredited Member National Home Study Council

### GI Bill

*CREI programs are approved for training of veterans and servicemen under the G.I. Bill.*



# DIGITAL PERFORMANCE YOU CAN RELY ON.



The Hickok Model 334 DMM is a rugged, non-temperamental, hardworking tool that's easy to use and easy on your eyes. Hickok has established a unique reputation in digital electronics during the past 10 years. The Model 334 is another example of our engineering expertise — an economical lab quality instrument with exceptional durability and accuracy.

- Easy reading, green fluorescent display
- 3½ digit — auto polarity
- 26 ranges including 200 mV AC & DC ranges
- Fast response — 2.5 readings/sec

Basic Accuracies (% of reading)  
 DC Volts; ±0.2% (±0.5% on 200V, 1200V ranges)  
 AC Volts; ±0.5% (±2.0% on 200 mV, 2V ranges)  
 OHMS; ±0.5%  
 DC Current; ±1.5%  
 AC Current; ±2.0%

Ask to see the Model 334 at your Hickok distributor. It's a no compromise DMM at a price you can afford.

**\$189<sup>00</sup>**

## HICKOK

the value innovator

INSTRUMENTATION & CONTROLS DIVISION  
 THE HICKOK ELECTRICAL INSTRUMENT CO.  
 10514 Dupont Avenue • Cleveland, Ohio 44108  
 (216) 541-8060 • TWX: 810-421-8286

CIRCLE 83 ON FREE INFORMATION CARD

# new products

More information on new products is available from manufacturers of items identified by a Free Information number. Free Information Card is inside back cover.

**HIGH-FIDELITY SPEAKERS, models AR-17, AR-18.** Both speaker systems contain an 8-inch acoustic-suspension woofer and 1¼-in. ring-radiator tweeter with a crossover frequency at 2000 Hz. The *model AR-17* has a low-frequency response of -3 dB at 50 Hz and the *model AR-18* is -3 dB at 62 Hz. Power handling capability is 100 watts continuous per channel being driven to



clipping 10% of the time. Cabinets each measure 10 X 18½ X 8¼ in. The *model AR-17* comes in oiled walnut veneer and the *model AR-18* (shown) comes in walnut grain vinyl veneer. Manufacturers' suggested retail price for *model AR-17*, \$95; *model AR-18*, \$65. Speakers are sold only in pairs.—**Teledyne Acoustic Research**, 10 American Dr., Norwood, MA 02062.

CIRCLE 116 ON FREE INFORMATION CARD

**PAPER TAPE READER, Byte Reader,** is designed for the home computer hobbyist. A *Lite Optimizer* circuit senses intensity of external light source and adjusts photo transistor sensitivity levels. LED's visually indicate data being sent to the

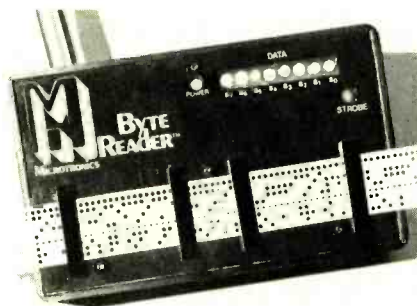

computer. Kit sells for \$69.95; assembled: \$84.50. Add \$3 shipping and handling; California residents include state or local taxes as applicable.—**Microtronics**, Box 7454N, Menlo Park, CA 94025.

CIRCLE 117 ON FREE INFORMATION CARD

**15-FUNCTION TOOL KIT, model 96006,** comes in a heavy-duty vinyl case imprinted to simplify tool identification. The kit includes an interchangeable screw- and nutdriver series and the *Plika*—a 4-in-1 electrical tool that performs all plier, crimp-



er, stripper and cutter functions. Included in the screwdriver-nutdriver series are a handle, a 4-in. extension, 3/16-in. and ¼-in. slotted screwdrivers, No. 1 and No. 2 Phillips screwdrivers and 3/16-in. through ¼-in. nutdrivers. Kit measures 6 X 8½ X 1 in. Suggested retail price: \$21.19.—**Hunter Tools**, 9674 Telstar Ave., El Monte, CA 91731.

CIRCLE 118 ON FREE INFORMATION CARD

**DIP JUMPERS,** flat cable/conductors for jumpering within a PC board, making interconnections, interfacing I/O signals, etc. Available in 14-, 16-, 24-, and 40-pin single-ended or double-ended assemblies and in 6-, 12-, 24-, and 36-inch

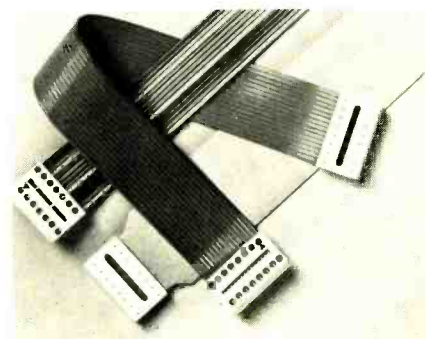

lengths. Copper alloy jumpers mate with standard IC sockets, cable is grooved top and bottom and conductors are made of No. 28 AWG tin-



coated copper.—**A P Products, Inc.**, Ken Braund, 72 Corwin Dr., Box 110, Painesville, OH 44077.

**CIRCLE 94 ON FREE INFORMATION CARD**

**METAL DETECTOR**, *TR Earth Challenger* (stock No. 80,262) is a fully transistorized, balanced instrument that combines quality and power with low cost. Made of rugged aluminum and weighing

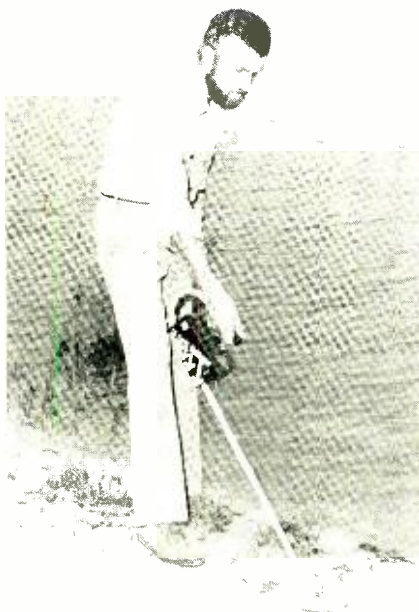

2 lb., 6 oz., unit features electronic housing and 6-in. waterproofed search coil. Nine-volt transistor battery included. Deluxe version of *TR Earth Challenger* (stock No. 80,251) comes with tele-

scopic shaft and 10-turn metal/mineral tuner. *TR Earth Challenger*, \$39.95; *Deluxe TR Earth Challenger*, \$59.95.—**Edmund Scientific**, 7782 Edscorp Bldg., Barrington, NJ 08007.

**CIRCLE 119 ON FREE INFORMATION CARD**

**POWER AMPLIFIERS**, models *CP120*, *CP500* and *CP500M*, are dual-channel units that can be operated independently or as a bridged unit. The model *CP120* (shown) is rated at 61 watts-per-channel, 122 watts in the bridged mode. The model *CP500* and model *CP500M* are both rated at 255 watts-per-channel, 510 watts bridged. The model *CP500M* also contains peak-reading meters, a blown-fuse indicator and a thermal protection indicator.



Three *PowerLock* threshold settings (full, half and quarter power) protect against overload and reduce clipping. Other features include 1/4-in. phono jack inputs and rugged all-steel construction for on-the-road use. Prices: model *CP120*, \$339; model *CP500*, \$649; and model *CP500M*, \$779.—**Technical Audio Products Corp.**, 3810 148th Ave. N.E., Redmond, WA 98052.

**CIRCLE 120 ON FREE INFORMATION CARD**

**MULTIFAMILY LOGIC PROBE**, model *LP-2*, is designed to test and troubleshoot digital circuits such as gates, clocks, CPU's, UART's, etc. Pulse detection and pulse stretching provides instant readout of logic levels, positive and negative transitions, pulse symmetry (duty cycle), and abnormal circuit conditions for major logic families, including TTL, DTL, HTL and CMOS. Gives pre-

cise measurements (within 0.15 V) of logic levels and transitions, with positive go/no-go conditions. No adjustments are necessary; just set a single switch for logic family, attach clip leads and touch probe to circuit in question.



Built-in pulse stretcher can be used to detect pulses as short as 300 ns. Unit probe features plug-in connector system and phono jack, and space is provided in front of the model *LP-2* for interchangeable tips. The unit measures 5.8 × 1.0 × 0.7 inches and bears a manufacturer's resale price of \$24.95.—**Continental Specialties Corp.**, 44 Kendall St., Box 1942, New Haven, CT 06509.

**CIRCLE 50 ON FREE INFORMATION CARD**

**MICROCOMPUTER**, *Horizon 1*, is a single floppy disc drive mainframe featuring the Z-80A microprocessor and includes 16K bytes of memory and 12-slot mother-board with serial terminal interface. (With a second disc drive, unit is called

# Everything you've dreamed of in a scope...including a sensible price.



**WO-527A \$479.00**

See them at your VIZ distributor.

Whether it be for servicing or scientific research, the new WO-527A 15MHz 5" triggered-sweep oscilloscope is designed for a wide range of applications. With its host of useful functions and its advanced solid-state integrated circuits, it's hard to believe it's so reasonably priced.

- Easy-to-use pushbutton controls
- Triggered or automatic sweep; ac or dc triggered
- Unique trigger level control with LED polarity indicators
- 10mV to 20V/cm in 11 ranges
- 19 calibrated sweep ranges
- Preset, automatic TV sync separation circuits
- Built-in calibrated time-base
- Special line selector for TV line-by-line display
- 10 times sweep magnifier

**VIZ Test Instruments Group**  
of VIZ Mfg. Co.

335 E. Price St., Philadelphia, PA 19144

Formerly  
Instruments

© VIZ  
6883

**CIRCLE 32 ON FREE INFORMATION CARD**

www.americanradiohistory.com

MARCH 1978

95

# MATHEMATICS ELECTRONICS ENGINEERING MATHEMATICS ADVANCED MATHEMATICS

These unusual courses are the result of many years of study and thought by the President of Indiana Home Study, who has *personally* lectured in the classroom to *thousands* of men, from all walks of life, on mathematics, and electrical and electronic engineering.

You will have to see the lessons to appreciate them!

NOW you can master mathematics and electronics and actually *enjoy* doing it!

WE ARE THIS SURE:—you order your lessons on a money-back guarantee.

In plain language, *if you aren't satisfied you don't pay*, and there are no strings attached.

Write today for more information and your outline of courses.

You have nothing to lose, and everything to gain!

**The INDIANA  
HOME STUDY INSTITUTE**  
P.O. BOX 1189  
PANAMA CITY, FLA 32401

CIRCLE 10 ON FREE INFORMATION CARD

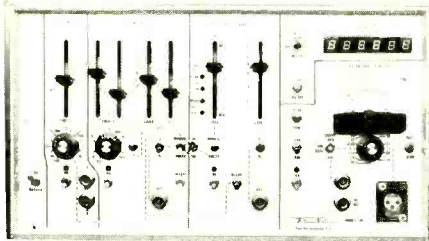

MODEL 101 AUDIO TEST SYSTEM consists of two sine/square/triangle function generators, pulse generator, frequency counter and AC voltmeter. As a system it will generate a frequency response plot on an X-Y recorder or scope.

Time base generator offers symmetrical or independent control of the positive and negative sides of the ramp providing a duty cycle of 1% to 99%. Frequency range is .002 Hz to 100k Hz. Amplitude is 16 Vpp into 500 ohms with  $\pm 5$  VDC offset. The time base output drives the X axis of an X-Y recorder. Manual mode provided for setup.

Audio sweep generator provides manual frequency adjustment or log or linear sweep of 20 Hz to 20k Hz. Blanking mode provides zero reference line on an X-Y recorder or tone burst. Amplitude is 16 Vpp into 500 ohms or 10 Vpp into 8 ohms.

Pulse generator frequency range is .002 Hz to 800k Hz. Pulse width is adjusted independent of frequency from 4 seconds to 40 nanoseconds. Outputs are complementary TTL.

AC voltmeter has full scale sensitivities from 1 mV to 250 V. Fast or slow, peak or true RMS and log or linear modes are provided. Output drives Y axis of X-Y recorder.

Frequency counter is 6 digit, 50 or 60 Hz line triggered, and reads either internal or external. Sensitivity is 10% of voltmeter full scale at 20k Hz. 1 or 1/2 second update.

Dimensions: 8 x 14 x 3. Shipping weight: 9 lbs. \$695. Stock to 30 days. Warranty: 1 year, 3 year \$70. Master Charge and Visa. Specs and operating information on request.

1894 Commercial W. #105  
San Bernardino, CA 92408  
(714) 889-7623

FIDELITY SOUND

Horizon 2.) System is also S-100 bus-compatible for use with a wide variety of peripheral boards. System includes full extended BASIC, with sequential and random disc files, formatted output, line editor, strings and machine language CALL.

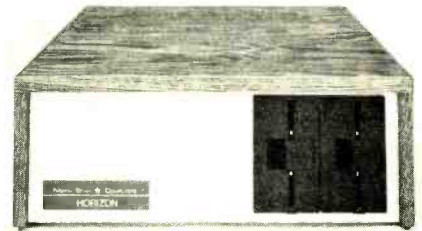

Options for the Horizon computer include additional disc drives, floating point arithmetic boards, 24-line by 80-character upper and lower case VDC board, and 16K memory board with parity option. Choice of blue metal or wood chassis cover. *Horizon 1* kit, \$1599; assembled, \$1899. *Horizon 2* kit, \$1999; assembled, \$2349. Options: 16K RAM kit, \$399; assembled, \$459. Parity option kit, \$39; assembled, \$59. Floating point board kit, \$259; assembled, \$359. Z80 board kit, \$199; assembled, \$259.—North Star Computers, Inc., 2465 Fourth St., Berkeley, CA 94710.

CIRCLE 82 ON FREE INFORMATION CARD

HANDLES, BLADES, KITS, Series 99. Complement of five handles accommodate 85 nutdriver, screwdriver and special-use shafts. Series also includes multitool and handy-roll kits and sets in plastic cases, plus high-carbon steel blades and

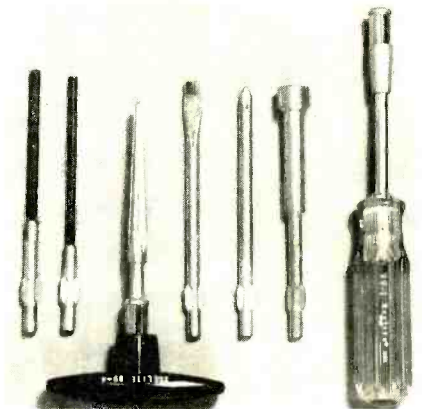

precision-formed steel head sockets. Patented spring device in handle holds blades firmly for easy insertion and removal.—Weller Xcelite Electronics Div., The Cooper Group, Apex, NC 27502.

CIRCLE 98 ON FREE INFORMATION CARD

FREQUENCY COUNTER, model 7208, offers full 8-digit LED display and operation to 60 MHz with 1-Hz resolution. Model 7208A, with optional scaler, can operate to 600 MHz. Unit features selectable gate times (1 sec and .1 sec), and 115



VAC or 12 VDC operation (jack included). Housed in metal cabinet, the instrument measures 5 1/2 x 6 x 2 inches. Model 7208 (60 MHz) assembled: \$169.95; kit: \$119.95. Model 7208A (600 MHz)

## DE FOREST ELECTRONICS



### MM200 SPECIAL FEATURES

**FUSED INPUT PROTECTION** A 1 amp fuse protects DC and AC currents circuits while a 50 milliamp fuse protects the resistance circuit from damage. The two fuses, easy to replace, avoids the components breakdown when wrong or overranging signals are applied.

**FULLY BATTERY OPERATED** A battery gives you eight hours of operation and is rechargeable in 16 hours. The AC/DC converter will also recharge the battery while using the instrument (recharging time in this case is longer).

**BRIGHT LED DISPLAY** A 0.3" bright LED display allows you to use the instrument in the field or in the laboratory in any type of light condition.

**FULL 2000 COUNT PLUS OVERRANGE** Direct readout up to 1999 counts. Two flashing bars on the first LED indicates an overrange condition in the measurement.

**LOW COST** The cost of the MM200 is \$119.95 which includes two test leads and an AC/DC converter. The rechargeable battery is optional and its cost is \$15.00.

A Subsidiary of DUMONT OSCILLOSCOPE LABORATORIES, INC. (A Carter Company)

**40 FAIRFIELD PLACE WEST CALDWELL, NEW JERSEY 07006  
PHONE (201) 575-8670**

CIRCLE 68 ON FREE INFORMATION CARD

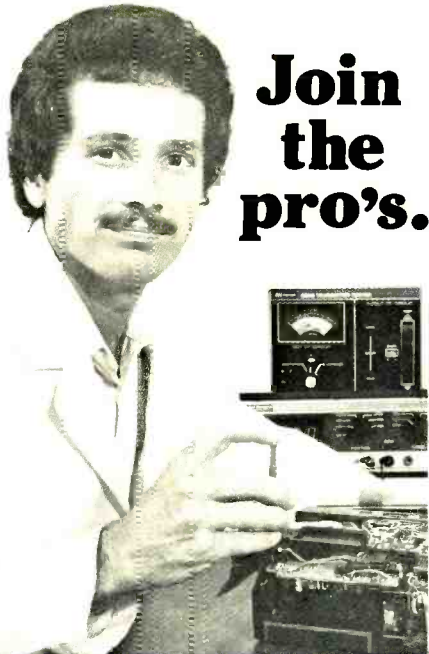

## Join the pro's.

For technical specialists career prospects are good. Forecasts show that job openings in many technical areas are increasing.

In photography a high skill level as a camera repair technician commands a good salary and opens doors to advancement. As with other fields where the jobs are, good training is the key to success. National Camera has successfully trained photo equipment technicians for 25 years. And popular interest in new electronically controlled cameras is helping to create more opportunities than ever for you as a camera technician.

Expand your talents into a new area—work full time or part time, independently or for a wide variety of employers. Learn at home in spare time, or attend intensive training program in Colorado.

Founded 1952  
Accredited member NHSC, NATTS.  
Approved for Veterans' training.  
Eligible institution,  
Federal financial aid programs.  
Resident training also available.



### National Camera Technical Training Division

2000 West Union Avenue Dept. GBC  
Englewood, Colorado, 80110 U.S.A.

Return coupon today for free booklet. No salesman will call.

I am interested in  classroom

home study  Check here if veteran

Please print:

Name \_\_\_\_\_

Address \_\_\_\_\_

City \_\_\_\_\_

State \_\_\_\_\_ Zip \_\_\_\_\_

Send to: National Camera  
2000 West Union Ave., Dept. GBC  
Englewood, Colorado 80110

CIRCLE 25 ON FREE INFORMATION CARD

assembled: \$199.95; kit: \$149.95.—Davis Electronics, 636 Sheridan Drive, Tonawanda, NY 14150.

CIRCLE 121 ON FREE INFORMATION CARD

**DUAL-TRACE 25-MHz SCOPE, model LBO 515,** offers continuously variable delay from 1  $\mu$ s to 5 seconds. Sensitivity is 5 mV per-division and risetime is 14 ns. Unit features rectangular CRT with internal graticule; high accelerating voltages; selectable sync; automatic, normal, single-trace and reset modes with 20-Hz to 10-kHz frequency



rejection. Overall accuracy for both channels is  $\pm 3\%$ .

Includes beam rotator, trigger for both channels and polarity-inversion switch for Channel 2, front-panel astigmatic control, and X10 magnification. Priced less than \$1400 and is complete with probes and accessories.—Leader Instruments Corp., 151 Dupont St., Plainview, NY 11803. R-E

CIRCLE 99 ON FREE INFORMATION CARD

## Bearcat<sup>®</sup> 210 Scanner



# \$289.

The Bearcat 210 super synthesized receiver scans and searches over 16,000 different frequencies without expensive crystals. The Bearcat 210 covers 32-50, 146-174 & 416-512 Mhz., and has AC/DC operation. Save over \$60.00 now by ordering on our 24 hour toll-free credit card order line 800-521-4414. In Michigan and outside the U.S. call 313-994-4441. Add \$5.00 for shipping in the U.S. or \$9.00 for air UPS to the west coast. Charge cards or money orders only. Foreign orders invited. Mail your order to: **Communications Electronics, P.O. Box 1003, Dept. 505, Ann Arbor, Michigan 48106.**



Just say charge it! Which card?



CIRCLE 91 ON FREE INFORMATION CARD

## Now you can safely plug away without the problems of overload or coming up short.

# SGL WABER<sup>®</sup> Multiple Outlet Strips

You can do it thanks to SGL WABER<sup>®</sup>—the finest quality multiple outlet strip available! There are 240 versatile models—each unit exceeds National Electrical Code standards and is safety tested. Ideal for organizing your work area and having extra outlets when and where you need them. Over 2000 electronic distributors carry the SGL WABER line. Send for your free 24 page catalog today!

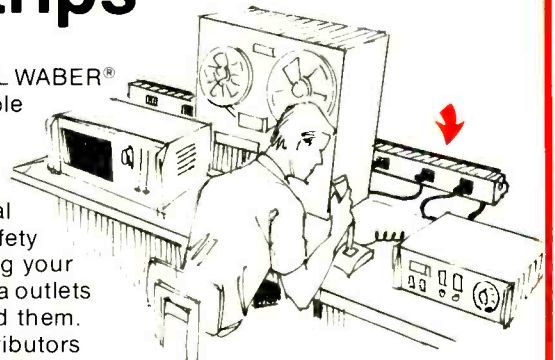

**SGL WABER Electric**  
A division of SGL INDUSTRIES, INC.  
DEPT. H—300 Harvard Avenue  
Westville, NJ 08093 (609) 456-5400

CIRCLE 8 ON FREE INFORMATION CARD

# new lit

More information on new products is available from manufacturers of items identified by a Free Information number. Free Information Card is inside back cover.

**PARTS CATALOG, Quality Semiconductors And Electronic Parts, Catalog No. 10,** contains 14 pages of transistors, linear IC's, CMOS units, plugs, test accessories, frequency counters (kit and assembled), clocks (kit and assembled) and many different tools and replacement parts. A handy order form is included.—**Aldelco**, 2281 Babylon Turnpike, Merrick, NY 11566.

**CIRCLE 103 ON FREE INFORMATION CARD**

**CONDENSER MICROPHONES, MS2420,** brochure describes three condenser replacement mikes specifically designed to cover 97% of today's cassette requirements. Full details and specifications are included.—**Workman**, Box 3828, Sarasota, FL 33578.

**CIRCLE 104 ON FREE INFORMATION CARD**

**COMPUTER PRODUCTS,** 30 pages, contains complete descriptions of computer kits, including manufacturer's 6800 system, software, terminal system, audio cassette interface, alphanumeric

printer, joystick, etc. All products are designed to be compatible with all computer systems for maximum flexibility.—**Southwest Technical Products Corp.**, 219 W. Rhapsody, San Antonio, TX 78216.

**CIRCLE 105 ON FREE INFORMATION CARD**

**SPEAKERS, Truth In Listening,** 14-page full-color catalog that defines the characteristics of accurate sound reproduction as well as describing manufacturer's line of hi-fi speakers. Complete specs, charts, photos and drawings accompany the text. Catalog is available from manufacturer or AR dealers.—**Teledyne Acoustic Research**, 10 American Dr., Norwood, MA 02062.

**CIRCLE 106 ON FREE INFORMATION CARD**

**TEST EQUIPMENT "WISH BOOK,"** 1977-78 Edition, 23 pages, features five new instruments on the front cover: a CB analyzer, video analyzer, DMM, 230-mHz frequency counter and portable tester. Full descriptions of these and other test

units are accompanied by large clear photos and complete specs.—**Sencore**, 3200 Sencore Dr., Sioux Falls, SD 57107.

**CIRCLE 107 ON FREE INFORMATION CARD**

**WORD PROCESSING SYSTEMS, The Micro-computer and Word Processing—A Cost Effective Analysis,** is an article analyzing the cost effectiveness of various microcomputer word-processing systems and compares several popular IBM systems with an MITS microcomputer-based system using a Selectric terminal output. It is estimated that current microcomputer word processing is cost-effective at a correspondence level of from 300 to 400 letters per month. Send a 24¢ SASE.—**Center for the Study of the Future**, Dept. B, 4110 N.E. Alameda, Portland, OR 97212.

**AUDIBLE SIGNAL DEVICE BROCHURE** describes the *Sonalert* line of signalers that has a wide variety of applications such as in automot-

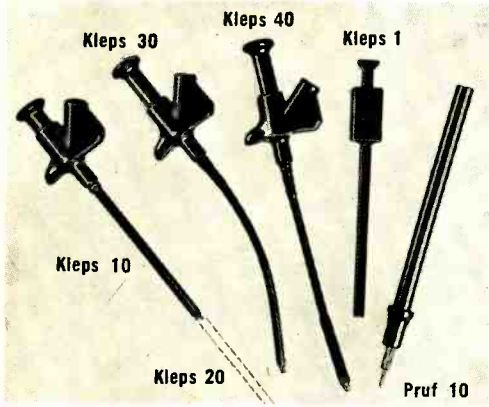

## Clever Kleps

Test probes designed by your needs — Push to seize, push to release (all Kleps spring loaded).  
**Kleps 10.** Boathook clamp grips wires, lugs, terminals. Accepts banana plug or bare wire lead. 4¾" long. **\$1.39**  
**Kleps 20.** Same, but 7" long. **\$1.49**  
**Kleps 30.** Completely flexible. Forked-tongue gripper. Accepts banana plug or bare lead. 6" long. **\$1.79**  
**Kleps 40.** Completely flexible. 3-segment automatic collet firmly grips wire ends, PC-board terminals, connector pins. Accepts banana plug or plain wire. 6¼" long. **\$2.59**  
**Kleps 1.** Economy Kleps for light line work (not lab quality). Meshing claws. 4½" long. **\$.99**  
**Prof 10.** Versatile test prod. Solder connection. Molded phenolic. Doubles as scribing tool. "Bunch" pin fits banana jack. Phone tip. 5½" long. **\$.89**  
 All in red or black - specify. (Add 50¢ postage and handling). Write for complete catalog of - test probes, plugs, sockets, connectors, earphones, headsets, miniature components.

Available through your local distributor, or write to:  
**RYE INDUSTRIES INC.**  
 125 Spencer Place, Mamaroneck, N.Y. 10543  
 In Canada: Rye Industries (Canada) Ltd.

**CIRCLE 47 ON FREE INFORMATION CARD**

## ALL TOGETHER NOW!

The acclaimed Equinox 100™ mainframe kit (\$799) is now a complete S-100 system.  
 Because now there is an Equinox 100™ I/O interface kit (\$120) that handles the hard work of interfacing all your peripherals.  
 And Equinox 100™ 4K memory kits (\$109). Assembled 8K memory boards (\$188). EQU/ATE™ editor/assembler and BASIC-EQ™ software on cassettes.  
 It all goes together. It all works together. It's all together now at special system prices.  
 See The Equinox System™ at your local computer shop. Call toll-free to 800-648-5311. BAC/MC accepted. Or write Equinox Division, Parasitic Engineering, P.O. Box 6314, Albany California 94706.

**THE EQUINOX SYSTEM™** When you put it together, it's really together.

**CIRCLE 67 ON FREE INFORMATION CARD**

bile, aircraft, and marine warning systems, airport metal detectors and medical instruments.

*Sonalert* signalers produce either a soothing pleasant tone or chime, or a more strident blast in cases of emergency. Four tone frequencies, three loudness levels and seven modes or rhythms can be combined to produce more than 30 distinct sound variations. Power requirements are low—a low-power transistor, SCR or integrated circuit can do the trick. The devices are also solid-state, thus ensuring many years of trouble-free service.—**Mallory Capacitor Co.**, Div. P.R. Mallory & Co., Inc., Box 1284, Indianapolis, IN 46206.

**CIRCLE 108 ON FREE INFORMATION CARD**

**1978 ENGINEERING MANUAL AND PURCHASING GUIDE NO. 780** is a 234-page catalog crammed with electronic parts and equipment. It contains such essentials as wire, cable, test equipment, trimmers and pots, switches, timers—even a low-cost microcomputer system. Also included are cross-references and complete manufacturer indexes. Price: \$1.—**Allied Electronics**, Dept. C-78, 401 E. 8th St., Fort Worth, TX 76102.

**MINI-CATALOG No. MC-477** shows a full line of silicon rectifier bridges, diodes, high-voltage rectifiers, assemblies and TV high-voltage diodes. Also featured are high-voltage devices, industrial multipliers and X-ray assemblies.—**Electronic Devices, Inc.**, 21 Gray Oaks Ave., Yonkers, NY 10710.

**CIRCLE 109 ON FREE INFORMATION CARD**

**TEST INSTRUMENTS Catalog No. BK 78** contains 40 illustrated pages of DMM's, frequency counters, high-voltage probes, oscilloscopes and many other test instruments. Each device is thoroughly described and complete specifications are given.—**B&K-Precision**, Dynascan Corporation, 6460 W. Cortland Ave., Chicago, IL 60635.

**CIRCLE 110 ON FREE INFORMATION CARD**

**HEATH/SCHLUMBERGER INSTRUMENTS Catalog No. 811-23** contains 32 pages of test devices for hobbyists and service personnel. Among new products listed are frequency counters, an FET multimeter, a lin/log swept-function generator and a low-cost voltage-controlled function generator. Oscilloscopes, distortion analyzers, VOM's and VTVM's and color TV service equipment are just some of the many devices described.—**Heath/Schlumberger Instruments**, Dept. 570-010, Benton Harbor, MI 49022.

**CIRCLE 111 ON FREE INFORMATION CARD**

**CATALOG SHEET** describes the Kager *KL 3000 Soldering Pistol*, a lightweight, easy-to-operate instrument that permits single-handed operation. The solder is incorporated in the gun and is fed to the tip by squeezing the trigger. The rate of feed and the amount of solder necessary for a particular joint are automatically selected for precision work. The problem of dry joints is almost completely eliminated because the object to be soldered is heated first by the tip prior to applying the solder. Many different brands of solder can be used with this instrument, and nonscaling tips are provided in different sizes and shapes. This pistol is adaptable to both fine soldering and continuous production-line work.—**KAGER International**, 1180 S. Beverly Drive, Los Angeles, CA 90035.

**CIRCLE 112 ON FREE INFORMATION CARD**

**FIVE BROCHURES** describing complete test-instrument product lines are designed for point-of-sale and direct mail. Each brochure contains six pages of product benefits, uses and applications, photos and specifications. Titles include: "Digital Multimeters," "Communications & CB," "Oscilloscopes & Power Supplies," "Transistor & Tube Testers," and "TV & Radio Test Equipment."—**Sencore, Inc.**, Promotion Mailing Dept., 3200 Sencore Drive, Sioux Falls, SD 57107. R-E

**CIRCLE 113 ON FREE INFORMATION CARD**

## SUBBER®

### MARK IV-CUV A TIMESAVING INSTRUMENT BY CASTLE



VHF-UHF TV tuner and i-f signal analyst  
Incorporates these important features:

- Tunes all VHF & UHF Channels
- Electronic Fine Tuning
- Dual 40 MHz IF Output Jacks
- Battery Condition Indicator

MARK IV-CUV

Net \$74.95



## CASTLE ELECTRONICS

5233 Old South Highway 37 • Bloomington, Indiana 47401

For More Details and Specifications Contact Your Nearest Distributor

**CIRCLE 41 ON FREE INFORMATION CARD**



Non-Linear Systems, Inc.



SC-5

FM-7

## DYNAMIC DUO

512 MHz  
PRESCALER

60 MHz  
FREQUENCY  
COUNTER

PORTABLE  
BATTERY OPERATED

- Extends range of FM-7 Frequency Meter to 512 MHz.
- Can be interfaced with almost any 50 MHz frequency meter
- 30 mV sensitivity.

- Large 7-digit LED display.
- 1 Hz resolution on low range.
- Overload protection.
- C-MOS construction.
- 30 mV sensitivity

Size: 1.9" H x 2.7" W x 4.0" D.

212-687-2224

THE TEST EQUIPMENT SPECIALISTS

TOLL FREE HOT LINE  
800-223-0474

54 West 45 Street, New York, N.Y. 10036

**ADVANCE  
ELECTRONICS**

# Teaching Digital Counters To Count

Digital displays have uses in most facets of our lives; ranging from watches to home appliances and test instruments. They are all basically counters. Here's a way to make a decade counter count by some number other than 10.

FRED BLECHMAN, K6UGT

DIGITAL COUNTING CIRCUITS ARE BECOMING the standard means for measuring almost any variable, such as time, frequency, voltage, current, resistance, temperature and events. The conventional readouts used with digital devices normally display in decimal format. However, the counting circuits themselves usually count in binary code, a system that is based on powers of 2. Since the count is displayed decimally, typical IC counters automatically reset to 0 after the decimal count of 9, running from 0 to 9 and then repeating. Also, the counter outputs trigger the next highest digit, (whenever more than one digit is used) to carry the count. Thus, 09 becomes 10 on the next count, and 199 becomes 200.

However, if you want the count to go back to 0 at some point other than 9, how do you program the counter to do this? While this is "duck-soup" for the digital engineer, most experimenters and newcomers to digital electronics find this confusing, and there is little information available in recent literature. The explanation and examples that follow should lift the veil of mystery from digital counting circuits and allow you to apply these principles to your own special needs. Just bear in mind that the following explanation is not intended to be all-inclusive.

## IC counters

Although different IC counters are available for special purposes, the most popular is the 7490 decade counter. Actually, it contains divide-by-2 and divide-by-5 sections in one package; these sections can be wired, as shown in Fig. 1, to form a divide-by-10. Note that pins 2, 3, 6, 7 and 10 are grounded for normal counting. (Actually, either pin 2 or pin 3, and either pin 6 or pin 7 must be grounded; but it's best to ground them all for decade counting.) A logical-high (about 5 volts) output at pin 12 represents a decimal count of 1; pin 9 is a decimal count of 2; pin 8 is a decimal count of 4; and pin 11 is a decimal count of 8. Normally, these pins are a logical low—nearly at ground potential—when off. Now, as the 7490 is triggered at pin 14 with a negative-going pulse, a high output appears at pin 12 on the first count, at pin 9 on the second count, and on both pin 12 and pin 9 on the third count. On the fourth count, only pin 8 is high; pin 9, pin 11 and pin 12 are low. On the fifth count, pin 8 and pin 12 are high. On the sixth count, pins 8 and 9 are high. What is happening is that the counter is "adding" decimally with a single output or combinations of outputs. Figure 2 shows this counting sequence.

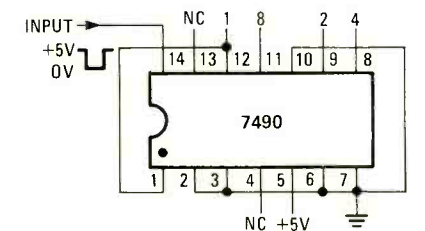
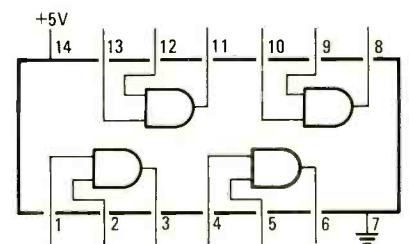

FIG. 1—7490 IC connected as a divide-by-10 counter.

| DECIMAL NUMBER | PIN NUMBER |   |   |    |
|----------------|------------|---|---|----|
|                | 11         | 8 | 9 | 12 |
| 0              | L          | L | L | L  |
| 1              | L          | L | L | H  |
| 2              | L          | L | H | L  |
| 3              | L          | L | H | H  |
| 4              | L          | H | L | L  |
| 5              | L          | H | L | H  |
| 6              | L          | H | H | L  |
| 7              | L          | H | H | H  |
| 8              | H          | L | L | L  |
| 9              | H          | L | L | H  |

FIG. 2—BCD OUTPUTS from 7490 IC when connected as a divide-by-10 counter as shown in Fig. 1.

The 7490 resets to 0 at the next count



a

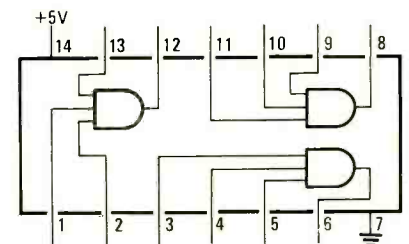

b

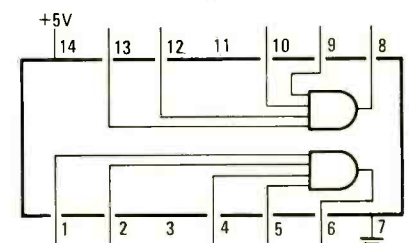

c

FIG. 3—TYPICAL AND-GATE IC's. The 7408 Quad 2-input AND gate IC is shown in a. The 7411 Triple 3-input AND gate IC is shown in b, and c shows the 7421 Dual 4-input AND gate IC.

after 9 when wired as shown in Fig. 1. Pins 2 and 3 are two reset pins that are normally used to set the counter to 0 when the counter is first turned on. The internal reset circuitry is designed so that when both pins 2 and 3 go high, the 7490 resets to 0. For normal counting, either (or both) pins 2 or 3 must be low.

It now becomes simple to reset the 7490 at the desired count. To reset to 0 at

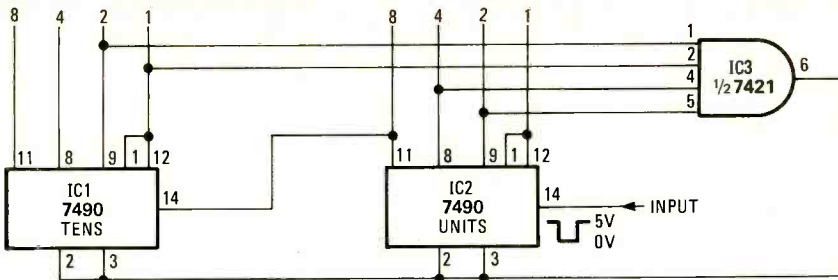

FIG. 4—DIVIDE-BY-36 counter. The 7490's count from 00 to 35 and are then reset to 00.

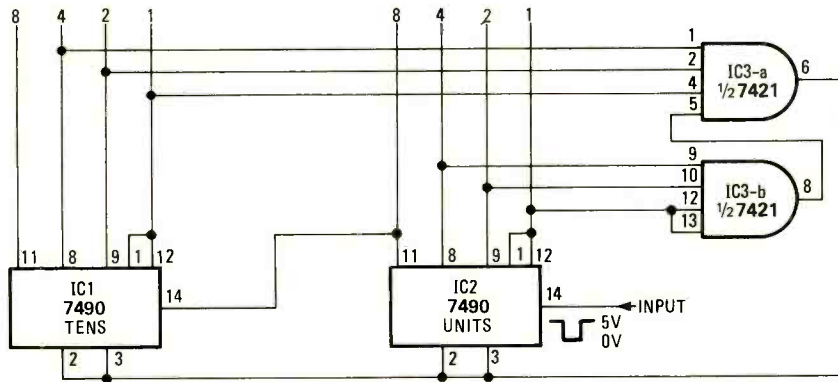

FIG. 5—DIVIDE-BY-77 counter. The counters are reset by the AND gate after they reach a count of 76.

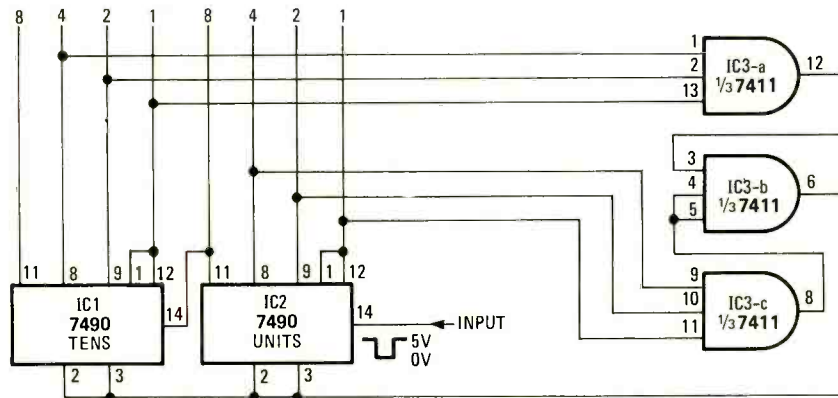

FIG. 6—DIVIDE-BY-77 counter. Same circuit as Fig. 5 except with a different arrangement of AND gates.

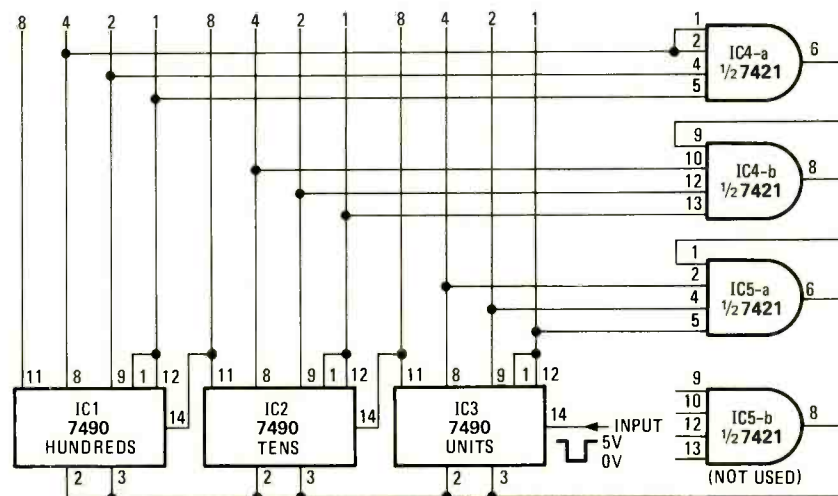

FIG. 7—ANY NUMBER of decade counters can be programmed. Here, three decade counters are connected to divide-by-777.

the second count (so that the 7490 counts 0 to 1 and back to 0), simply connect a jumper from pin 9 to pin 2, and remove the ground from both pins 2 and 3.

(Leaving a pin unconnected is the same as connecting it to a high level). For a count of 3 (0 to 2), connect pin 2 to pin 9 and pin 3 to pin 12. For a count of 4,

connect pin 2 or pin 3 to pin 8, and leave the other reset pin unconnected. For a count of 5, connect one reset pin to pin 8 and the other reset pin to pin 12. For a count of 6, connect the reset pins to pins 8 and 9.

When you want the decade counter to reset after a count of 7, you need to have some way to sense when *three* pins (pins 8, 9 and 12) are all high at the same time. Although other circuitry could be used, it is easier to use standard AND gates to trigger the reset terminals with a high output when all inputs to the AND gate are high. Figure 3 shows several typical AND gates. You could, for example, connect pins 8, 9 and 12 to the three inputs of one 7411 AND gate (Fig. 3-b), and then use the output from the AND gate to trigger reset pin 2 of the 7490, leaving pin 3 unconnected. This would give you a count from the 7490 of 0 to 6 and back to 0 on the seventh count.

When there is more than one digit, logic gates are a necessity, since you may have to sense the state of several counter-output lines. For example, suppose you wanted to reset to 0 after 35 counts—that is, from 00 to 35 and back to 00. The reset would occur at the 36th count. Figure 4 shows one way to do this. Here's what happens. With each *negative*-going pulse into pin 14 of the units counter, the count advances one count. At the count of 09, output 8 and output 1 (pins 11 and 12) are high. On the very next count, all outputs go low. The *negative*-going output at pin 11 is directly coupled to pin 14 of the tens counter, and it advances one count to 10. This happens again at 20 and 30. A 7421 four-input AND gate is connected to sense when the tens counter is at 3 and the units counter reaches 6. At that instant, all four inputs to the AND gate are high, so the output goes high and directs the reset pins on each counter to return the count to 0. Only at the count of 36 are all four inputs to the 7421 gate high; until then, the 7421 output is low and the 7490's count normally.

Figure 5 shows another example, this time using both sections of the 7421 IC. Here, at the count of 77, the high output on pin 6 of the 7421 resets the counters to 00, so that they count from 00 to 76. Here's how it works: The 4-2-1 outputs of each 7490 are connected to the 7421 inputs, as shown in Fig. 5. When the tens counter is at a count of 7, three inputs of IC3-a are high, but the output at pin 6 is still low since the fourth input (the output of IC 3-b) is still low. When the units counter reaches a count of 7, all the inputs to AND gate IC3-b are high (note that IC3-b pin 13 must be jumpered to any of the other input pins of IC3-b); output pin goes high, providing the last needed high input for IC3-a to output a high on pin 6, thus resetting the 7490's.

This could also be done by using all three AND gates of the 7411 IC. (See Fig.

*continued on page 106*

Put Professional Knowledge and a  
**COLLEGE DEGREE**  
in your Electronics Career through

**HOME  
STUDY**

**Earn Your  
DEGREE**

by correspondence, while continuing your present job. No commuting to class. Study at your own pace. Learn from complete and explicit lesson materials, with additional assistance from our home-study instructors. Advance as fast as you wish, but take all the time you need to master each topic. Profit from, and enjoy, the advantages of directed but self-paced home study.

The Grantham electronics degree program begins with basics, leads first to the A.S.E.T. degree, and then to the B.S.E.E. degree. Our free bulletin gives complete details of the program itself, the degrees awarded, the requirements for each degree, and how to enroll. Write for *Bulletin R-78*.

**Grantham College of Engineering**  
2000 Stoner Avenue  
P. O. Box 25992  
Los Angeles, CA 90025

Worldwide Career Training thru Home Study

CIRCLE 9 ON FREE INFORMATION CARD

**You Can Count  
On DAVIS!**



**500 MHz & 1 GHz COUNTERS**

If you need a reliable counter at an affordable price, the CTR 2 is the answer.

- 8 Digit .3" LED Display
- High Stability TCXO Time Base
- Built-in VHF-UHF Prescaler
- Automatic Dp Placement
- TCXO Std.  $\pm 2$  ppm
- Input Diode Protected
- 12V-DC Operation (Optional)
- Oven Controlled Crystal (Optional)  $\pm .5$  ppm
- Selectible Gate Times

CTR-2-500 (range-10 Hz to 512 MHz)

CTR-2-1000 (range-10 Hz to > 1000 MHz)

|                              |          |
|------------------------------|----------|
| 500 MHz Kit CTR-2-500K       | \$249.95 |
| 500 MHz Assembled CTR-2-500A | 349.95   |
| 1 GHz Kit CTR-2-1000K        | 399.95   |
| 1 GHz Assembled CTR-2-1000A  | 549.95   |

**OPTIONS:**

|                        |         |
|------------------------|---------|
| (02) Oven Crystal      | \$49.95 |
| (03) .43" LED          | 10.00   |
| (04) 12V-DC            | 10.00   |
| (05) 10 sec. Time Base | 10.00   |



DAVIS ELECTRONICS  
636 Sheridan Drive  
Tonawanda, NY 14150  
716/874-5848



**EQUIPMENT REPORTS**

*continued from page 32*

The front panel itself is black with white legends, and it's well designed with the human operator in mind. There are just enough legends to know what you've selected without confusing the issue. The ranges are "keyed" to the function switches by white lines, so you can tell instantly which set of ranges goes with each function.

The case is a light blue and measures 8 X 6 1/2 X 3 inches. There's a tilt stand on the underside of the case. When set, the stand raises the front of the instrument for easy viewing on a workbench. With the stand retracted, the instrument lies flat on the work surface.

Power is supplied either by batteries or from an external power supply kit. A plastic battery holder is provided that accepts four C-cells. The model 2000 draws about 120 mA from a 4 to 6 1/2 volt DC source. This translates into an operating time for standard zinc carbon batteries of 8 hours. Switching to alkaline batteries increases the operating time to 25 hours. If you desire, you can also use a NiCad battery pack. Sabtronics offers two different size NiCad battery packs as optional accessories. The NB-1200 is a sub-C size NiCad pack that sells for \$12.95 and will power the model 2000 for 10 hours. The NB-500 pack is made up of AA size NiCad batteries that will power the model 2000 for 4 hours. The NB-500 sells for \$7.75.

To recharge the batteries, the EP-12V External Power Kit is required. It consists of a separate PC board with a voltage regulator, charging circuit and external power jack. The assembly mounts on the inside of the rear panel of the model 2000. Access to the external power jack is provided through a hole in the rear panel. External power comes from an AC power adapter. This is one of those calculator-type plug-and-transformer modules with a long wire that has a plug on the end of it. The AC power adapter must supply 8.5 to 15 VDC at 150 mA. Sabtronics offers two AC power adapters as optional accessories: The AC-115 for 115 VAC and the AC-230 for 230 VAC. With the External Power Kit and the AC Power Adapter, the sub-C size NiCad battery pack can be recharged in 16 hours. This combination also supplies enough to power the model 2000 directly from the line voltage.

**Specifications**

For those readers who like specifications (and who doesn't), here goes: The 100 mV and 1 volt DC ranges have a 100  $\mu$ V and 1 mV resolution, respectively, and both have a  $\pm 0.1\% \pm 1$  digit accuracy. At the opposite end of the DC voltage range is the 1000V range with a 1 volt resolution and a  $\pm 0.5\% \pm 2$  digit accuracy. The input impedance for the DC voltage ranges is 10 megohms and the response time is 0.5 seconds.

The lowest AC voltage range is 100 mV with an accuracy of 0.3%  $\pm 2$  digits at 60 Hz and a frequency range of 40 Hz to 50 kHz. The highest AC voltage range, 1000 VAC, has an accuracy of 1%  $\pm 2$  digits at 60 Hz and a frequency range of 40 Hz to 50 Hz. At the two ends of the DC current ranges, 10  $\mu$ A and 1 amp, the resolution is 10 nA and 1 mA, respectively, while the accuracy is 0.1%  $\pm 2$  digits and 1%  $\pm 1$  digit, respectively. The 10  $\mu$ A AC current range has an accuracy at 60 Hz of 1%  $\pm 5$  digits and a frequency range of 40

Hz to 500 Hz. The 1 amp range has a 60 Hz accuracy of 0.8%  $\pm 2$  digits and a frequency range of 40 Hz to 20 kHz. Response time on the AC current ranges is 5 seconds maximum. Maximum input current on all ranges is 2 amps, overcurrent protection provided by a fuse.

Now for the ohms ranges. The lowest ohms range, 100 ohms, has a resolution of 0.1 ohms with an accuracy of 0.1%  $\pm 1$  digit. This accuracy also holds for the 1K, 10K, 100K ranges. The 100-ohm range uses a measuring current of 1 mA. At the opposite end of the scale is the 10-megohm range with a resolution of 10K ohms and an accuracy of 0.5%  $\pm 5$  digits. The 10-megohm range uses a measuring current of 100 nA. Open circuit voltage for the X1 ranges (100, 10K, and 1MEG) is 100 mV. For the X10 ranges (1K, 100K and 10MEG), the open circuit voltage is 1 volt. All the resistance ranges are protected against a maximum input voltage of 250 VDC and 250 VAC RMS. Input protection is provided by a 2-amp fuse.

Did I forget anything? Oh yes, the input  
*continued on page 108*

**BETTER  
THAN A  
THIRD HAND!**

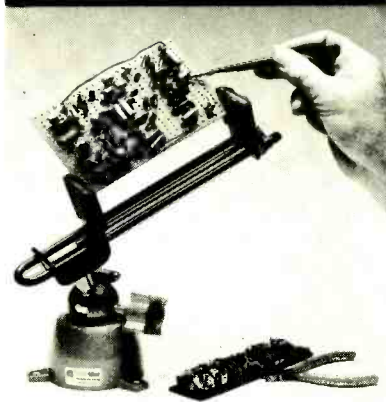

**PANAVISE TILTS, TURNS, AND  
ROTATES TO ANY POSITION.  
IT HOLDS YOUR WORK  
EXACTLY WHERE YOU WANT IT.**

**PanaVise has great strength yet is gentle enough to firmly hold delicate objects.**

Quite possibly the finest new tool you will buy this year, PanaVise is built to exacting professional standards. We guarantee it!

Illustrated is the Electronics Vise Model 396. Three other bases and a wide variety of heads are available. All interchangeable! Buy a basic unit, then add on to create your system.

Available through your dealer.  
Write for a free catalog.

**PANAVISE®**

Dept. 5E

10107 Adella Ave., South Gate, CA 90280  
In Canada: 25 Toro Rd., Downsview, Ont. M3J 2A6



A Division of Colbert Industries  
**CIRCLE 87 ON FREE INFORMATION CARD**



switches arranged so that the maximum coming off the divider into the DPM input is always 2 volts.

The AC volts input goes through the same voltage divider and then into a "precision rectifier circuit" that converts the signal into DC to feed the input to the DPM. The 2.5K pot in this circuit lets you calibrate the output of the precision rectifier on a one-time basis against a standard AC input signal.

The ohmmeter circuit is shown in simplified form in Fig. 9. Here, one leg of the op-amp contains a standard reference voltage that is adjustable through the 1K pot to exactly 1 volt. The other leg contains the portion of the voltage divider that is active for measuring a particular resistance range. In the illustration the 1-meg resistor shown is used to measure 2 megohms full scale. Since the op-amp operation dictates that the inputs to both legs must be equal, and since the outputs are common, exactly 1 volt must also appear across the 1-meg resistance. This constant voltage forces a constant current through the resistance being measured; in this particular case 2 megohms. The 2 volts developed across the 2-megohm resistor is then fed into the DPM, registering a full-scale reading. Other resistance values for the unknown will, of course, produce proportional voltages feeding into the DPM.

The resistance circuit is calibrated on a one-time basis by adjusting the 1K pot with a standard resistor across the input. When the DPM registers the correct reading of resistance, it has been calibrated. An alternate method is to adjust the pot so that exactly 1 volt appears across the 750-ohm resistor (R14) at the output of the op-amp.

The direct current input is taken off the three shunt resistors, R6, R7 and R8. Each resistor develops exactly 2 volts across it for maximum scale readings. Note that the high current scale is limited to 10 amps only because of the low wattage (10 watts) of the 0.1-ohm resistor (R6). If you make this a 20-watt resistor, you can read 20 A full scale. These resistors should be at least 1 percent tolerance or better for good measurement accuracy.

The multicontact pushbutton switches shown in the circuit diagram are of course the easiest to wire, although layered rotary switches can also be used. The correct decimal point for each scale can be displayed by connecting pin 6 of the appropriate display number (DS-2, 3 or 4) through the appropriate scale switch to ground through a 470-ohm resistor.

The entire DMM circuit can easily be laid out and assembled on a 4½ X 6-inch piece of perforated circuit board with 0.1-inch hole spacings. **R-E**

For  
faster  
service

USE  
ZIP  
CODE

on  
all  
mail

## 60 YEARS AGO, YOU DIDN'T NEED A COLLEGE EDUCATION

In fact, you didn't need much of anything except a willingness to work 16 hours a day. For 8¢ an hour. Under brutal conditions.

But times have changed drastically. Life for the working man is more

challenging. Safer. More stimulating. And far more rewarding.

Why?

Many things have helped. Especially an endless flow of technological improvements and discoveries. Many of which came from college campuses, and from college-trained men and women.

We must sustain this flow of ideas. Only in this way, can we increase the productivity that will maintain and increase our standard of living.

America's colleges need your help. They are in deep financial trouble.

**GIVE TO THE COLLEGE OF YOUR CHOICE. NOW.**

Council for Financial Aid to Education, Inc. **CF AE**  
680 Fifth Avenue, New York, N.Y. 10019

**AO** A Public Service Of This Magazine And  
Council The Advertising Council.



**"Our whole family helped assemble this wonderful Schober Organ... now we all play it!"**

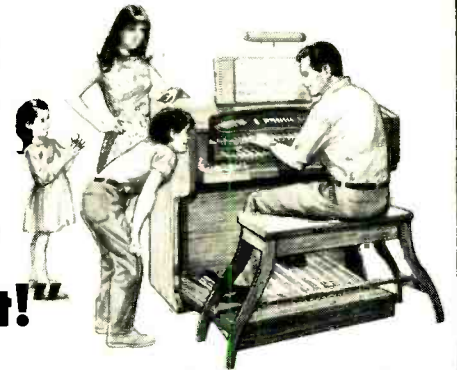

Talk about real *family* fun! We all worked together, for a few hours almost every day. Almost too soon, our Schober Organ was finished. Our keen-eyed daughter sorted resistors. Mom soldered transistor sockets, although she'd never soldered anything before. And it did our hearts good to see the care with which our son—he's only 12—installed the transistors. Me? I was the quality control inspector—they let me do the final wiring. And when it came time to finish the beautiful walnut cabinet the easy Schober way, we all worked at it!

Now, we gather around our Schober Organ every evening to play and sing together. Some of us play better than the others, but we're all learning—with the help of the easy Schober Organ playing courses. I might add that I'm especially pleased with all the money we saved. Our completed Schober Organ compares favorably with a "ready-made" one costing twice as much! (The five models range from \$650 to \$2850.) And we didn't even need to pay the whole amount all at once, because we were able

to buy Schober Kits a component at a time, to spread costs out. Or we could have had two-year time payments!

Families like ours have been building Schober Organs for 20 years. How about your family? You can have all the details, without cost or obligation. Just send the coupon for the fascinating Schober color catalog (or enclose \$1 for a 12-inch LP record that lets you hear as well as see Schober quality). Clip the coupon right now—and mail it **TODAY!**

The *Schober* Organ Corp., Dept. RE-172  
43 West 61st Street, New York, N.Y. 10023

- Please send me Schober Organ Catalog
- Enclosed please find \$1.00 for 12-inch L P record of Schober Organ music

NAME \_\_\_\_\_

ADDRESS \_\_\_\_\_

CITY \_\_\_\_\_ STATE \_\_\_\_\_ ZIP \_\_\_\_\_

**CIRCLE 36 ON FREE INFORMATION CARD**

**NEW**

from Polaris

# CADDY-PROBE

40 KV DUAL RANGE

Measures  
**VOLTAGE**  
And  
**CURRENT**

RANGE  
40,000 VOLTS DC  
400 MA DC

**34.95**

Fits Your Caddy



# 851

## UNIVERSAL TEST RIG



\$229.95

PJS-298

C.R.T. Included

- 33KV Leaded Glass CRT
- 40KV Meter
- Build-In Speaker
- Obsolete-Proof

The PJS-298 Universal Test Rig for tube and Solid State TVs designed for servicing high voltage chassis. Built-in speaker for convenient audio checking, 40KV-50Ua sensitivity meter constant monitoring of the anode voltage. Up-dating is accomplished by means of plug-in modules. (Extension cables included).

FOR FAST TROUBLE SHOOTING . . .

## TeleMatic TV MINI-ANALYZER



\$99.95

SG-785

- VHF/UHF Subber
- I.F. - Video Troubleshooter
- Convergence Generator
- Oots and Cross-Hatch Patterns

The "SG-785" is a multi-functional instrument for fast, efficient trouble-shooting and adjustment of all Color and B&W tvs. It is ideal for both shop and field work. (Cables included.)

**TeleMatic**

108-02 OTIS AVENUE, CORONA, N.Y. 11368

# new books

**COUPLING OF EXTERNAL ELECTROMAGNETIC FIELDS TO TRANSMISSION LINES**, by Albert A. Smith, Jr. Wiley-Interscience, Div. of John Wiley & Sons, 605 Third Ave., New York, NY 10016. 132 pp. 6 x 9 inches. Hardcover \$14.50.

Electromagnetic radiation causes not only disruption in communications but can pose a very real hazard to humans and equipment. This book examines some of the problems involved in coupling electromagnetic fields to transmission lines and offers application data in the form of solved examples and spectrum profiles. The material presented is applicable to coupling problems in communications, data processing, and in power, telephone and control systems. Teachers will find the book useful in graduate or advanced undergraduate classroom work. Several appendices, bibliography and an index make up the back of the book.

**CMOS COOKBOOK**, by Don Lancaster. Howard W. Sams & Co., Inc., 4300 W. 62nd St., Indianapolis, IN 46268. 416 pp. 5 1/2 x 8 1/2 in. Softcover \$9.95.

This is another in the "Cookbook" series that presents the reader with all the nuts-and-bolts material needed to understand and use CMOS integrated circuits. The material presented is long on real-world applications, is detail-oriented and the easy-to-read style is not overloaded with mathematical formulas and theory.

Chapter 1 discusses CMOS circuitry basics: how it works, how to power it, how to use it. Chapter 2 presents an index of 100 CMOS devices, complete with schematics and detailed descriptions. Other chapters cover logic, multivibrators, clocked logic and JK flip-flops. These IC's can be used in a wide variety of applications, including TVT's, digital instruments, logic trainers, digital watches and frequency counters.



D-612T  
DC  
POWER  
SUPPLY

## LOWEST PRICE/WATT + these other exclusives:

- 1) Variable dc output.
- 2) Full 10-amp rating over 0-12 v range.
- 3) Super filtering over entire output.
- 4) Dual range.
- 5) Heavy overload capacity.
- 6) Fully enclosed steel cabinet.
- 7) Large, easy-to-read meters.
- 8) Full year warranty.

21 Stock Models from 6 to 125 vdc. See Your Distributor. Custom OEM Power Supplies Engineered to Your Requirements.

FREE BULLETINS! See Gold Book & EEM for Full Line Data.

EPSCO, Inc. 920-R Westwood, Addison, IL 60101-312/543-0410



Performance-Proven Regulated & Semi-Regulated DC Power Supplies

7-15

**A QUICK LOOK AT BASIC**, by Donald D. Spencer. Camelot Publishing Co., Box 1317, Ormond Beach, FL 32074. 64 pp. 5 1/4 × 8 1/4 inches. Softcover \$4.95.

This book presents the BASIC programming language. Written in easy nontechnical style, the material offers those with little or no computer background an opportunity to learn BASIC in just a few hours. Exercises and examples are given to supplement and reinforce the text.

**TAPE RECORDING FOR THE HOBBYIST**, Fourth Edition, by Art Zimmerman. Howard W. Sams & Co., Inc., 4300 W. 62nd St., Indianapolis, IN 46268. 160 pp. 5 1/4 × 8 1/4 in. Softcover \$4.95.

This book uses nontechnical language to explain the ABC's of how to select and use a tape recorder, add special effects (including instructions on how to create your own effects from everyday household objects), and edit tapes. The reader is instructed in what to look for in the controls and special features of an instrument, and how to match tape with the machine. Chapters also include suggestions on using a recorder to tape parties and special events, and to create sound-track accompaniment for film. The final chapter tells you how to care for your recorder.

**COMPUTER DICTIONARY**, by Donald D. Spencer. Camelot Publishing Co., Box 1317, Ormond Beach, FL 32074. 160 pp. 5 1/4 × 8 1/4 inches. Softcover \$5.95; hardcover \$9.95.

All students of computer science/data processing in schools and colleges, teachers, businessmen, programmers, systems analysts and other computer users will find this dictionary a handy addition to their reference library. Simple clear, nontechnical language is used to define terms. **R-E**



INTERNATIONAL FM 2400CH

# FREQUENCY METER for testing mobile transmitters and receivers



- Tests Predetermined Frequencies 25 to 1000 MHz
- Extended Range Covers 950 MHz Band
- Pin Diode Attenuator for Full Range Coverage as Signal Generator
- Measures FM Deviation

The **FM-2400CH** provides an accurate frequency standard for testing and adjustment of mobile transmitters and receivers at predetermined frequencies.

The FM-2400CH with its extended range covers 25 to 1000 MHz. The frequencies can be those of the radio frequency channels of operation and/or the intermediate frequencies of the receiver between 5 MHz and 40 MHz.

Frequency Stability: ±.0005% from +50° to +104°F.

Frequency stability with built-in thermometer and temperature corrected charts: ±.00025% from +25° to +125° (.000125% special 450 MHz crystals available).

Self-contained in small portable case. Complete solid state circuitry. Rechargeable batteries.

**FM-2400CH** (meter only) ..... \$595.00  
**RF crystals** (with temperature correction) ..... 24.00 ea.  
**RF crystals** (less temperature correction) ..... 18.00 ea.  
**IF crystals** ..... catalog price

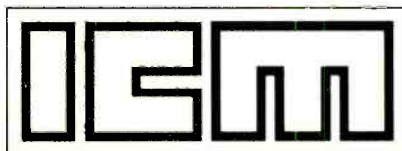

International Crystal Manufacturing Company, Inc.

10 North Lee Oklahoma City Oklahoma 73102

**CIRCLE 89 ON FREE INFORMATION CARD**

MARCH 1978

105

## "POOR BOY" TUNER SUB ONLY \$19.95

Since all tuner subs that we know of are modified TV Tuners, we decided to market an excellent performing yet very low cost sub for the technician who has to get all he can for his money... a "Poor Boy's Sub" for *only* \$19.95.

This was not an easy task since cabinets, knobs and controls would push the price far above \$19.95... We searched for a tuner that needed no cabinet and no controls... one that the tech could scrounge the knobs from most any old TV...

It took over two years but we finally found it. The gain is excellent... Battery drain is very low (only 18 mils). It's self biasing so there is no R.F. gain control to fiddle with... It works equally well on tube or transistor sets... b/w or color... and is as easy to use as starting a fight with your wife (well, almost). All you need do is hook the set's IF cable to the "Poor Boy" and view the picture... That's it... no set up controls to confuse you.

We compared the "Poor Boy" with other subs costing over twice the price and found it to work just as well on *all* the comparison tests we made... and often a lot easier to use... Even though instructions aren't needed... you get those too.

The "Poor Boy" is small enough to easily hold in one hand... no wires or controls dangling around. It comes completely wired and tested *including batteries and ready to use*. Send a check for only \$19.95, and we even pay the shipping (how about that?) or we will ship COD. (\$1.85 C.O.D. Fee)

**Try it for 10 days... If not completely satisfied... return for full refund.**

**Call us toll free 1-800-433-7124.**

**ALL ORDERS SHIPPED THE SAME DAY RECEIVED!!**

### TEXAS TUNER SERVICE

4210 N.E. 28TH STREET, FORT WORTH, TEXAS 76117

TEXAS CUSTOMERS PHONE (817) 834-8201

Please rush me the "Poor Boy" Substitute Tuner.

I understand that I can return it within 10 days for a full refund if I'm not completely satisfied... with no questions asked.

I am enclosing full amount of \$19.95 and will not be charged shipping.

Ship C.O.D. and I will pay an extra \$1.85 shipping and C.O.D.

RE-3/78

Name: \_\_\_\_\_

Street Address: \_\_\_\_\_

City: \_\_\_\_\_

State: \_\_\_\_\_

Zip: \_\_\_\_\_

**CIRCLE 55 ON FREE INFORMATION CARD**



## ELECTRONIC DRUMS

continued from page 48

### A programming example

For example, Fig. 10 (See page 47.) shows a simple shuffle/fox trot tablature. The most basic principle is that since the shortest note that is used is an eighth note, and since the tempo clock, once set, pulls events out of memory as a constant tempo, each event from memory will represent an eighth note. The quarter-note accented bass will actually be entered into memory as an ACCENT BASS followed by a REST.

To prepare for programming, first touch RESET, press the PROGRAM button (acknowledged by PROGRAM LED), then enter the score on the drum pads like this:

ACCENT BASS / REST / SNARE / REST / BASS / REST / REST / SNARE and, since this line must be repeated again and again, finish off by touching REPEAT.

### Tricks & things

There is more versatility and power in the drum set than the control labeling tends to indicate. Here are some discoveries that we've made; other possibilities are only limited by the imagination of the user.

**Using the bridge as an intro**—You can begin playing with the bridge rather than the main score by placing the unit in the bridge mode then touching PLAY.

**Playing a manual tempo**—You can play a score to a manual tempo by tapping on the REST pad in the tempo that you want. Each tap advances the event counter and causes any programmed drum sounds to play. The REST pad can also be used as a nonlatching play key. Simply touch this pad continuously and the unit will play at the rate set by the TEMPO control.

**Playing only a portion of a score**—The REPEAT pad can be used in the PLAY mode to cause a pattern to begin again before the programmed repeat point is reached. Simply tap the pad. If you are touching the BRIDGE pad at the same time, the unit will switch to the beginning of the bridge.

**Editing**—Some limited editing is possible by single-stepping to the point to be changed using the REST pad. When you get to the event that is to be changed, put the unit in the program mode (in this case, *do not reset*—simply press the PROGRAM button) and alter the events desired.

**External synchronization/manual play**—The pin jack on the rear of the case provides a means of either foot-switch controlling the unit or synchronizing to external events. A 5-volt trigger applied to this input causes the clock to run at the rate set by the TEMPO control. If the triggers applied to this input are short, the event counter will advance one event for each pulse.

R-E

U.S. & foreign patents

## SAY GOODBYE to old manual wire wrapping tools!



NEW P184 SLIT-N-WRAP tool with Tefzel wire makes connections as reliable as other wrap tools.

Now you can wrap thick insulated wire 4 TIMES FASTER with NO pre-cutting NO pre-stripping DAISY CHAIN RUNS.

F184, with 100' of 28 gage Tefzel wire, \$29.50.

Insulation is slit open before wrapping on post, not between posts. No unwanted cut-thru.

P184-4T with batteries and recharger, \$80.00 (includes P184). P184-4T1 110V AC, \$89.00 (includes P184). Tefzel wire, 28 gage, various colors, \$4.18/100 ft. If not available locally, factory order—add \$2 handling charge.

**Vector**

ELECTRONIC COMPANY, INC., 12460 Gladstone Av., Sylmar, CA 91342  
phone (213) 365-9661, twx 910-496-1539  
571177

CIRCLE 79 ON FREE INFORMATION CARD

# FREE catalog

of over **2000** small tools, measuring instruments, and supplies

ELT-COL... DRILLS... FILM LOADERS... PS... PAGES... GRAVERS... GRINDERS... HAMMERS... INCLINOMETERS... JACKS... KNIVES... LATHES... LEATHER-ETTES... LOUPES... MINIATURE TOOLS... METRIC TOOLS... MULTI-TESTERS... NEGATIVE FILES... NIPPERS... OILERS... PIN VISES... PLIERS... PROBES... RIFFLERS... SCISSORS... SNARES... SOLDERING SUPPLIES... TEST INSTRUMENTS... TWEEZERS... VIEWERS... VISES... WRENCHES... ADH... ABRASIVES... G... BOOKS... LIMATORS... EPOXIES... CALIPERS.

**National Camera**  
2000 West Union Ave., Dept. GBC  
Englewood, Colo., U.S.A. 80110

25th Anniversary 1952-1977

CIRCLE 14 ON FREE INFORMATION CARD

## Try this exciting new hobby!

Build your own electronic concert organ. It's easy. No technical knowledge required. Just follow the clearly pictured instructions of the famous Wersi do-it-yourself system. Choose from seven different models. Send \$2.00 (refundable) with coupon for colorful 104 page catalog.

**WERSI**



Wersi Electronics, Inc.  
Dept. 24, Box 5318  
1720 Hempstead Road  
Lancaster, PA 17601

Enclosed is \$2.00 for my copy of your 104 page catalog.

Name \_\_\_\_\_  
Address \_\_\_\_\_  
City \_\_\_\_\_ State \_\_\_\_\_ Zip \_\_\_\_\_

CIRCLE 60 ON FREE INFORMATION CARD

MARCH 1978

107

## Don't cut yourself out of a career as a two-way radio technician...

MTI offers the only training for professional FM two-way radio available. Qualified technicians are employed in government, industry, and public service. But training is your key.

You could cut out a career as a two-way radio technician by cutting out this coupon. We'll send you information on how you can learn more about this specialized field, at home.

Name \_\_\_\_\_

Address \_\_\_\_\_

City \_\_\_\_\_

State/Zip \_\_\_\_\_

003



formerly

**MOTOROLA TRAINING INSTITUTE**

Summerdale, Pennsylvania 17093

CIRCLE 46 ON FREE INFORMATION CARD

## EQUIPMENT REPORTS

continued from page 102

impedance on the AC voltage ranges is 10 megohms shunted by 25 pF. Also, the sample rate is 4 per second.

### Assembly and use

Assembling the *model 2000* was a breeze. The instruction manual contains step-by-step procedures with plenty of illustrations. Little is left in the way of guesswork. It took me about 9 hours to assemble the unit. However, you should accept this figure with a grain of salt, since I'm not sure whether my ability with a soldering iron compares with that of the tortoise or the hare.

After the assembly procedures have been completed, the unit must be calibrated. The instruction manual contains two separate calibration procedures. The first calibration procedure is prepared for the kit builder who has no other test equipment other than the *model 2000*. The procedure uses data supplied by Sabtronics on four resistors and a voltage reference. There is also an AC peak detector circuit consisting of a diode and a capacitor that must be built for calibrating the AC voltage scales.

To calibrate the *model 2000* to within published specifications, the second calibration procedure must be followed. This procedure requires a meter calibrator such as the Fluke *model 760*, a 4 1/2-digit DMM such as the Hewlett-Packard *model HP3465A*, and an AC signal generator.

Anytime you acquire a new test instrument, it takes time to get used to it. With the simple

front panel layout of the *model 2000*, it took almost no time to become familiar with it. I've used the *model 2000* to troubleshoot numerous circuits and it performed perfectly. The *model 2000* now occupies a permanent corner on my workbench and its sleek blue case adds a little decor. If you're thinking of acquiring a new DMM, take a look at the *model 2000*. R-E

## Sencore Model CB42 CB Analyzer



CIRCLE 115 ON FREE INFORMATION CARD

EVER SINCE I WAS A TEEN-AGED TECHNICIAN, I've been crazy about "analyzers"—instruments that could make all kinds of tests. Of course, when I was a teen-ager, the sets were simpler and so were the analyzers. I still have several different types on my bench. These versatile instruments can be real timesavers.

The Sencore people have come out with an Analyzer for CB radios, the *model CB42*. This instrument has an RF signal generator that

## SPECIAL REPORT:

Jack Darr, Service Editor of *Radio-Electronics* writes: **Oneida's Nu-Color Picture Tube Restorer 'Lives up to its name'**

This device is designed to restore color to old picture tubes with one or more weak guns.

I had a trade-in Wards TV, with a picture tube so bad it had to be seen to be believed. The blue gun read almost normal emission; the green gun would come up to the bottom end of the BAD sector on the meter; and the red gun just barely wiggled the needle.

The *Nu-Color model 90A* is a plug-in device that is inserted between the picture tube and socket, like a brightener. However, it is *not* a brightener, at least in the usual sense of the word. Between its plug and socket is a little box with three color-coded slide controls, one for each color.

Starting with all controls at the OFF position, I plugged the *Nu-Color* in and turned the set on. As expected, the raster was a bright blue. I adjusted the controls of the *Nu-Color* and came up with a good-looking color-bar pattern. Twiddling the grey scale and the *Nu-Color* controls gave an excellent color picture. Reds saturated normally, with the color control all the way up and all other things looked very good! This device lives up to its claims and its name: it certainly did "restore the color" to this old dog.

As Oneida is careful to explain, the *Nu-Color* is not intended as a "cure-all" for color troubles, but it will help correct problems due to unbalanced picture-tube emission. The device can be installed and adjusted in the home with very little trouble.

For details write: Dalton Smith, President, Oneida Electronic Mfg. Co., Box 678, Meadville, Pa. 16335



CIRCLE 34 ON FREE INFORMATION CARD

## WHAT WOULD YOUR PERSONAL COMPUTER SAY IF IT COULD TALK?

## GET SPEECH POWER WITH THE COMPUTALKER SPEECH SYNTHESIZER

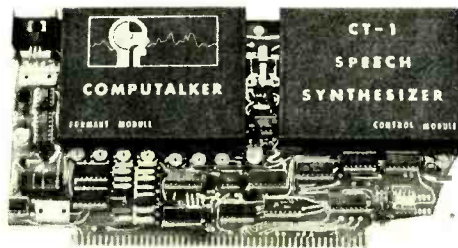

S-100 BUS

ASSEMBLED CIRCUIT BOARD  
COMPLETE WITH SOFTWARE  
FOR PHONETIC INPUT

430.00

CALIF. RESIDENTS ADD 6% SALES TAX

WRITE FOR INFORMATIVE LITERATURE

**COMPUTALKER CONSULTANTS**  
P.O. BOX 1951, DEPT. R, SANTA MONICA, CA 90406

covers from 375 kHz to 12 MHz for IF's and a CB RF signal generator that covers all 40 channels with provisions for five more channels. Both of these generators can be modulated by 400 or 1000 Hz AM, or zero. Or external modulation or a dual-frequency special audio signal (500/2400 Hz). The modulation percentage of both can be set to zero, 30% or 100%. The attenuator will drop the signal level from 1.0 volt to a minimum of 0.1  $\mu$ V.

There is also a 7-digit frequency counter with dual inputs, one has a 50-ohm impedance (built-in 12-watt dummy load) and the other has a 1.0-megohm impedance for high sensitivity. The counter also indicates the RF or IF output frequency. An RF wattmeter with digital readout, a digital readout plug-in crystal-checker that shows the fundamental frequency of any crystal from 1.0 MHz to 20.0 MHz. A modulation-percentage readout, for both positive and negative modulation percentages and a special readout on any channel that displays the percentage of error of the transmitter frequency. A microphone-tester that doubles as a substitute speaker; a built-in oscillator/mixer circuit that beats the 27-MHz CB frequencies down to about 1.0 MHz. The oscillator/mixer circuit permits you to use just about any narrowband scope. The *model CB42* also features a very simple receiver sensitivity test and an equally simple signal-to-noise ratio receiver test. A switch-selected speaker-load 4, 8 or 16 ohms with an audio wattmeter readout that can read up to 20 watts. I hope I haven't left any out, although I might!

Imagine each of these instruments in its own case. You'd have a stack of boxes that would cover up the average service bench. Sencore has managed to put them all in one 11x14 inch box! The only instrument you would need beside the *model CB42* would be a scope for looking at modulation waveforms. Any scope will do.

Every function and test on the *model CB42* can be selected individually by the controls, which are very plainly marked. Input-output jacks are in a row along the bottom of the panel. The RF signal generator is a crystal-controlled digitally programmed phase-locked-loop with a crystal accuracy of 1.0 ppm. It has a knob that selects either of two bands, Channels 1-23 and 24-40. Actually 45 since there are five spare positions not hooked up, but can be easily connected if they're ever needed. The IF generator covers from 375 kHz to 12.0 MHz in five ranges; the frequency of these are read out on the display. The IF tuning knob is a three-turn pot, for easier setting of exact frequencies. The RF/IF output has its own jack, with 50-ohm output impedance.

For transmitter frequency tests, the CB rig is connected to the 50-ohm input, and the switch set to external frequency/50-ohm load. In the next position of the switch, the 1.0 megohm high sensitivity input of the frequency counter is connected to the jack on the panel. If you set the CB tuning knob of the RF generator to the same frequency as the CB set and turn to the next position of the switch, the readout will give you a direct reading of the percentage off-frequency. The signal generator's PLL is accurate to within 1.0 ppm, and the readout has a rated accuracy of .001%. Since FCC specs call for only .005% tolerance, these are well within limits. These tests work in the same way for SSB transmitters.

A very versatile test instrument that can certainly speed up any kind of CB radio work and pay for itself in the number of jobs you can get out in a day. **R-E**

## HOBBYISTS! ENGINEERS! TECHNICIANS! STUDENTS!

Write and run machine language programs at home, display video graphics on your TV set and design microprocessor circuits — the very first night — even if you've never used a computer before!

### RCA COSMAC microprocessor/mini-computer

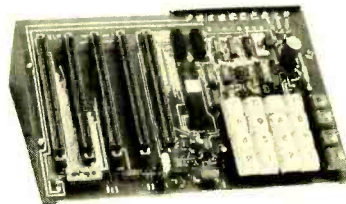

A THOUGHTFUL GIFT FOR ANYONE WHO MUST STAY UP TO DATE IN COMPUTERS AND ELECTRONICS!

ELF II \$99<sup>95</sup>

#### SPECIFICATIONS

ELF II features an RCA COSMAC COS MOS 8-bit microprocessor addressable to 64k bytes with DMA, interrupt, 16 registers, ALU, 256 byte RAM, full hex keyboard, two digit hex output display, 5 slot plug-in expansion bus, stable crystal clock for timing purposes and a double-sided plated-through PC board plus RCA 1861 video IC to display any segment of memory on a video monitor or TV screen.

Use ELF II to ... **PLAY GAMES** using your TV for a video display ... **CREATE GRAPHICS** pictures, alphanumeric, animated effects ... learn how to **DESIGN CIRCUITS** using a microprocessor ... the possibilities are infinite!

#### NOW AVAILABLE

ELF II explodes into a giant when you plug the **GIANT BOARD™** into ELF's expansion bus. This powerful board includes cassette I/O, RS 232-C/TTY, 8-bit P I/O and system monitor/editor... meaning your ELF II is now the heart of a full-size system with unlimited computing power! \$39.95 kit. \$2 p&h.

- 4k Static RAM addressable to any 4k page to 64k. \$89.95 kit. \$3 p&h.
- Prototype (Klug) Board accepts up to 32 I.C.'s of various sizes. \$17.00 kit. \$1 p&h.
- Expansion Power Supply. \$34.95 kit. \$2 p&h.
- Gold plated 86-pin connector. \$5.70 postpaid.

Coming Soon!

#### Tiny Basic

ASCII KEYBOARD\* CONTROLLER BOARD\* D-A, A-D CONVERTER\* CABINET

#### SEND TODAY

NETRONICS R&D LTD., Dept. RE3

333 Litchfield Road, New Milford, CT 06776 Phone (203) 354-9375

Yes! I want to run programs at home and have enclosed:

\$99.95 plus \$3 p&h for RCA COSMAC ELF II kit. Featured in POPULAR ELECTRONICS.

Includes all components plus everything you need to write and run machine language programs plus the new Pixie chip that lets you display video graphics on your TV screen. Designed to give engineers practice in computer programming and microprocessor circuit design. ELF II is also perfect for college and college-bound students (who must understand computers for any engineering, scientific or business career). Easy instructions get you started right away, even if you've never used a computer before!

As your need for computing power grows, five card expansion bus (less connectors) allows memory expansion, program debugger/monitor, cassette I/O, A to D and D to A converters, PROM, ASCII keyboard inputs.

controllers, etc. (soon to be available as kits). Manual includes instructions for assembly, testing, programming, video graphics and games plus how you can get ELF II User's Club bulletins. Kit can be assembled in a single evening and you'll still have time to run programs, including games, video graphics, controllers, etc., before going to bed!  \$4.95 for 1.5 amp 6.3 VAC power supply, required for ELF II kit.  \$5.00 for RCA 1802 User's Manual.

I want mine wired and tested with the power transformer and RCA 1802 User's Manual for \$149.95 plus \$3 p&h. Conn. res. add sales tax.

NAME \_\_\_\_\_

ADDRESS \_\_\_\_\_

CITY \_\_\_\_\_

STATE \_\_\_\_\_ ZIP \_\_\_\_\_

Send info on other kits!

Dealer Inquiries Invited

CIRCLE 69 ON FREE INFORMATION CARD

Includes Functional Tilt Stand!

## NEW EICO 270 3 1/2 DIGIT DMM KIT ONLY \$79<sup>95</sup>

Introductory Offer—FREE AC ADAPTOR

The first and only lab accuracy portable DMM Kit featuring MOS/LSI IC economy and reliability. Measures DC/AC Volts, Kilohms, DC/AC milliamps in 21 ranges. Polarity indicators and overload protection are provided, and 0.5 inch LED displays give easiest-to-read digital readout to 9999. The 270 features a basic 0.5% DC accuracy, 10 Megohm input impedance, low voltage drop in all current ranges and automatically-flashing overrange indicator. **Assembled \$109.95**

### FREE '78 EICO CATALOG

Check reader service card or send 50c for first class mail. See your local EICO Dealer or call (516) 681-9300, 9:00 a.m.-5:00 p.m. EST. Major credit cards accepted.

EICO-108 New South Rd. Hicksville, N.Y. 11801

**EICO**

CIRCLE 6 ON FREE INFORMATION CARD

## RAIA 8700 Computer Controller

The Answer For... Student Hobbyist Manufacturer

8700 Processor: 6503 MPU. Wear free "ActiveKeyboard", Micro-Diagnostic. Extensive documentation, Fully Socketed.

Piebug Monitor: User Subroutines, Relative address calculator. Pointer High-low, Back-step key.

Cassette Interface: Load & Dump by file #. Positive indication of operation. Tape motion control.

Applications systems from \$90 (10 unit quantity) Development systems from \$149 (single unit)

### TELL ME MORE

I want to see for myself that the 8700 is The Answer.

Please send documentation \$10 enclosed.

send price lists & FREE Catalog of other PAIA kits.

name: \_\_\_\_\_

Address: \_\_\_\_\_

City: \_\_\_\_\_ State: \_\_\_\_\_ zip \_\_\_\_\_

**RAIA** DEPT. 3-R • 1020 W. Wilshire Blvd. ELECTRONICS • Oklahoma City, OK 73116 •

CIRCLE 15 ON FREE INFORMATION CARD

MARCH 1978

109

# WANTED.

Courageous people to work for no pay. Frequently the hours and conditions are inconvenient or difficult. Occasionally even dangerous. No reward, beyond the gratitude of the people you help. Apply at your local Red Cross Chapter.



P.O. Box 4430E Santa Clara, CA 95054

For will call only: (408) 988-1640  
2996 Scott Blvd.

Same day shipment. First line parts only. Factory tested. Guaranteed money back. Quality IC's and other components at factory prices.

### INTEGRATED CIRCUITS

|        |         |           |           |         |        |        |        |        |        |        |      |
|--------|---------|-----------|-----------|---------|--------|--------|--------|--------|--------|--------|------|
| 7400TL | 74LS30N | 25        | LM340T-15 | 110     | CD4001 | 21     | CD4553 | 5.75   | MM5320 | 5.95   |      |
| 7400N  | 74LS33N | 17        | LM340T-18 | 110     | CD4002 | 21     | CD4553 | 5.75   | MM5330 | 5.95   |      |
| 7402N  | 74LS38N | 30        | LM340T-24 | 110     | CD4006 | 10     | CD4583 | 4.50   | MM5330 | 5.95   |      |
| 7424N  | 74LS39N | 35        | LM337     | 4.50    | CD4007 | 21     | CD4583 | 4.50   | MM5330 | 5.95   |      |
| 7409N  | 23      | 74LS175N  | 47        | LM370   | 1.15   | CD4008 | 21     | CD4019 | 3.00   | MM5330 | 5.95 |
| 7410N  | 17      | 74LS39N   | 51        | LM379   | 4.50   | CD4010 | 38     | 74C04  | 25     | MM5330 | 5.95 |
| 7414N  | 63      | 74LS39N   | 51        | LM379   | 4.50   | CD4010 | 38     | 74C04  | 25     | MM5330 | 5.95 |
| 7420N  | 17      | 74LS39N   | 1.89      | LM380N  | 1.00   | CD4011 | 21     | 74C10  | 28     | MM5330 | 5.95 |
| 7422N  | 138     | 74LS107N  | 55        | LM381   | 1.60   | CD4012 | 21     | 74C14  | 44     | MM5330 | 5.95 |
| 7430N  | 20      | 74LS112N  | 35        | LM382   | 1.60   | CD4013 | 38     | 74C20  | 28     | MM5330 | 5.95 |
| 7442N  | 50      | 74LS113N  | 35        | LM3703H | 40     | CD4014 | 88     | 74C20  | 28     | MM5330 | 5.95 |
| 7445N  | 69      | 74LS113N  | 72        | LM709H  | 28     | CD4015 | 86     | 74C48  | 2.95   | MM5330 | 5.95 |
| 7447N  | 60      | 74LS113N  | 55        | LM729N  | 50     | CD4016 | 39     | 74C74  | 7.5    | MM5330 | 5.95 |
| 7448N  | 69      | 74LS113N  | 67        | LM733N  | 67     | CD4017 | 94     | 74C76  | 1.40   | MM5330 | 5.95 |
| 7450N  | 17      | 74LS115N  | 67        | LM741CH | 35     | CD4018 | 94     | 74C80  | 1.15   | MM5330 | 5.95 |
| 7474N  | 29      | 74LS117N  | 67        | LM741N  | 29     | CD4019 | 21     | 74C93  | 1.40   | MM5330 | 5.95 |
| 7475N  | 49      | 74LS117N  | 91        | LM747N  | 62     | CD4020 | 102    | 74C154 | 3.00   | MM5330 | 5.95 |
| 7485N  | 38      | 74LS117N  | 91        | LM747N  | 35     | CD4021 | 102    | 74C160 | 1.44   | MM5330 | 5.95 |
| 7489N  | 200     | 74LS174N  | 91        | LM7489N | 32     | CD4022 | 86     | 74C175 | 2.00   | MM5330 | 5.95 |
| 7490N  | 43      | 74LS190N  | 106       | LM1304  | 110    | CD4023 | 21     | 74C192 | 2.40   | MM5330 | 5.95 |
| 7492N  | 43      | 74LS227N  | 1.95      | LM1305  | 1.27   | CD4024 | 78     | 74C251 | 2.75   | MM5330 | 5.95 |
| 7493N  | 43      | 74LS227N  | 67        | LM1307  | 2.00   | CD4025 | 21     | 74C265 | 3.00   | MM5330 | 5.95 |
| 7498N  | 69      | 74LS267N  | 89        | LM1310  | 2.75   | CD4026 | 131    | 74C265 | 3.00   | MM5330 | 5.95 |
| 74100N | 90      | LINEAR    | LM1458    | 47      | CD4027 | 35     | 74C314 | 1.95   | MM5330 | 5.95   |      |
| 74101N | 24      | CD348     | LM1812    | 7.50    | CD4028 | 102    | 74C323 | 7.50   | MM5330 | 5.95   |      |
| 7412N  | 59      | CD349     | LM1889    | 3.00    | CD4030 | 21     | 74C323 | 10.50  | MM5330 | 5.95   |      |
| 74122N | 59      | CD349     | LM2111    | 1.75    | CD4035 | 102    | 74C323 | 10.50  | MM5330 | 5.95   |      |
| 74143N | 69      | CD382     | LM2902    | 1.50    | CD4040 | 102    | 74C377 | 10.50  | MM5330 | 5.95   |      |
| 74150N | 95      | CD382     | LM3009N   | 60      | CD4042 | 71     | 74C382 | 1.75   | MM5330 | 5.95   |      |
| 74151N | 69      | CD382     | LM3905    | 1.75    | CD4043 | 63     | 74C382 | 1.75   | MM5330 | 5.95   |      |
| 74154N | 60      | LM3009    | LM3909N   | 61      | CD4044 | 83     | 8098   | 65     | MM5330 | 5.95   |      |
| 74157N | 69      | LM3009    | LM3909N   | 55      | CD4046 | 191    | 8098   | 65     | MM5330 | 5.95   |      |
| 74161N | 87      | LM307N    | NE540L    | 2.89    | CD4049 | 39     | 8098   | 65     | MM5330 | 5.95   |      |
| 74162N | 87      | LM307N    | NE540N    | 50      | CD4049 | 39     | 8098   | 65     | MM5330 | 5.95   |      |
| 74163N | 87      | LM307N    | NE555V    | 43      | CD4051 | 113    | 8109   | 127    | MM5330 | 5.95   |      |
| 74174N | 96      | LM309A    | NE555V    | 96      | CD4052 | 113    | 8113   | 3.00   | MM5330 | 5.95   |      |
| 74175N | 96      | LM309A    | NE555A    | 100     | CD4053 | 113    | 8113   | 3.00   | MM5330 | 5.95   |      |
| 74190N | 15      | LM317N    | NE569V    | 115     | CD4058 | 40     | 8123   | 3.20   | MM5330 | 5.95   |      |
| 74192N | 87      | LM317N    | NE569V    | 110     | CD4059 | 40     | 8123   | 3.20   | MM5330 | 5.95   |      |
| 74193N | 85      | LM320A-5  | 78L05     | 60      | CD4070 | 21     | 8123   | 3.20   | MM5330 | 5.95   |      |
| 74221N | 55      | LM320A-5  | 78L06     | 60      | CD4071 | 21     | 8123   | 3.20   | MM5330 | 5.95   |      |
| 74298N | 55      | LM320A-12 | 75L05     | 70      | CD4072 | 21     | 8127   | 2.75   | MM5330 | 5.95   |      |
| 74303N | 56      | LM320A-15 | 75L06     | 65      | CD4073 | 21     | 8127   | 2.75   | MM5330 | 5.95   |      |
| 74366N | 56      | LM320A-15 | 75L05     | 1.75    | CD4075 | 21     | 8198   | 1.69   | MM5330 | 5.95   |      |
| 74376N | 66      | LM320T-8  | 75A91CN   | 50      | CD4076 | 21     | 8198   | 1.69   | MM5330 | 5.95   |      |
| 74381N | 77      | LM320T-8  | 75A92CN   | 59      | CD4081 | 21     | 2101-1 | 4.50   | MM5330 | 5.95   |      |
| 74382N | 77      | LM320T-8  | 75A92CN   | 59      | CD4081 | 21     | 2101-1 | 4.50   | MM5330 | 5.95   |      |
| 74383N | 77      | LM320T-8  | 75A92CN   | 59      | CD4081 | 21     | 2101-1 | 4.50   | MM5330 | 5.95   |      |
| 74384N | 77      | LM320T-8  | 75A92CN   | 59      | CD4081 | 21     | 2101-1 | 4.50   | MM5330 | 5.95   |      |
| 74385N | 77      | LM320T-8  | 75A92CN   | 59      | CD4081 | 21     | 2101-1 | 4.50   | MM5330 | 5.95   |      |
| 74386N | 77      | LM320T-8  | 75A92CN   | 59      | CD4081 | 21     | 2101-1 | 4.50   | MM5330 | 5.95   |      |
| 74387N | 77      | LM320T-8  | 75A92CN   | 59      | CD4081 | 21     | 2101-1 | 4.50   | MM5330 | 5.95   |      |
| 74388N | 77      | LM320T-8  | 75A92CN   | 59      | CD4081 | 21     | 2101-1 | 4.50   | MM5330 | 5.95   |      |
| 74389N | 77      | LM320T-8  | 75A92CN   | 59      | CD4081 | 21     | 2101-1 | 4.50   | MM5330 | 5.95   |      |
| 74390N | 77      | LM320T-8  | 75A92CN   | 59      | CD4081 | 21     | 2101-1 | 4.50   | MM5330 | 5.95   |      |
| 74391N | 77      | LM320T-8  | 75A92CN   | 59      | CD4081 | 21     | 2101-1 | 4.50   | MM5330 | 5.95   |      |
| 74392N | 77      | LM320T-8  | 75A92CN   | 59      | CD4081 | 21     | 2101-1 | 4.50   | MM5330 | 5.95   |      |
| 74393N | 77      | LM320T-8  | 75A92CN   | 59      | CD4081 | 21     | 2101-1 | 4.50   | MM5330 | 5.95   |      |
| 74394N | 77      | LM320T-8  | 75A92CN   | 59      | CD4081 | 21     | 2101-1 | 4.50   | MM5330 | 5.95   |      |
| 74395N | 77      | LM320T-8  | 75A92CN   | 59      | CD4081 | 21     | 2101-1 | 4.50   | MM5330 | 5.95   |      |
| 74396N | 77      | LM320T-8  | 75A92CN   | 59      | CD4081 | 21     | 2101-1 | 4.50   | MM5330 | 5.95   |      |
| 74397N | 77      | LM320T-8  | 75A92CN   | 59      | CD4081 | 21     | 2101-1 | 4.50   | MM5330 | 5.95   |      |
| 74398N | 77      | LM320T-8  | 75A92CN   | 59      | CD4081 | 21     | 2101-1 | 4.50   | MM5330 | 5.95   |      |
| 74399N | 77      | LM320T-8  | 75A92CN   | 59      | CD4081 | 21     | 2101-1 | 4.50   | MM5330 | 5.95   |      |
| 74400N | 77      | LM320T-8  | 75A92CN   | 59      | CD4081 | 21     | 2101-1 | 4.50   | MM5330 | 5.95   |      |
| 74401N | 77      | LM320T-8  | 75A92CN   | 59      | CD4081 | 21     | 2101-1 | 4.50   | MM5330 | 5.95   |      |
| 74402N | 77      | LM320T-8  | 75A92CN   | 59      | CD4081 | 21     | 2101-1 | 4.50   | MM5330 | 5.95   |      |
| 74403N | 77      | LM320T-8  | 75A92CN   | 59      | CD4081 | 21     | 2101-1 | 4.50   | MM5330 | 5.95   |      |
| 74404N | 77      | LM320T-8  | 75A92CN   | 59      | CD4081 | 21     | 2101-1 | 4.50   | MM5330 | 5.95   |      |
| 74405N | 77      | LM320T-8  | 75A92CN   | 59      | CD4081 | 21     | 2101-1 | 4.50   | MM5330 | 5.95   |      |
| 74406N | 77      | LM320T-8  | 75A92CN   | 59      | CD4081 | 21     | 2101-1 | 4.50   | MM5330 | 5.95   |      |
| 74407N | 77      | LM320T-8  | 75A92CN   | 59      | CD4081 | 21     | 2101-1 | 4.50   | MM5330 | 5.95   |      |
| 74408N | 77      | LM320T-8  | 75A92CN   | 59      | CD4081 | 21     | 2101-1 | 4.50   | MM5330 | 5.95   |      |
| 74409N | 77      | LM320T-8  | 75A92CN   | 59      | CD4081 | 21     | 2101-1 | 4.50   | MM5330 | 5.95   |      |
| 74410N | 77      | LM320T-8  | 75A92CN   | 59      | CD4081 | 21     | 2101-1 | 4.50   | MM5330 | 5.95   |      |
| 74411N | 77      | LM320T-8  | 75A92CN   | 59      | CD4081 | 21     | 2101-1 | 4.50   | MM5330 | 5.95   |      |
| 74412N | 77      | LM320T-8  | 75A92CN   | 59      | CD4081 | 21     | 2101-1 | 4.50   | MM5330 | 5.95   |      |
| 74413N | 77      | LM320T-8  | 75A92CN   | 59      | CD4081 | 21     | 2101-1 | 4.50   | MM5330 | 5.95   |      |
| 74414N | 77      | LM320T-8  | 75A92CN   | 59      | CD4081 | 21     | 2101-1 | 4.50   | MM5330 | 5.95   |      |
| 74415N | 77      | LM320T-8  | 75A92CN   | 59      | CD4081 | 21     | 2101-1 | 4.50   | MM5330 | 5.95   |      |
| 74416N | 77      | LM320T-8  | 75A92CN   | 59      | CD4081 | 21     | 2101-1 | 4.50   | MM5330 | 5.95   |      |
| 74417N | 77      | LM320T-8  | 75A92CN   | 59      | CD4081 | 21     | 2101-1 | 4.50   | MM5330 | 5.95   |      |
| 74418N | 77      | LM320T-8  | 75A92CN   | 59      | CD4081 | 21     | 2101-1 | 4.50   | MM5330 | 5.95   |      |
| 74419N | 77      | LM320T-8  | 75A92CN   | 59      | CD4081 | 21     | 2101-1 | 4.50   | MM5330 | 5.95   |      |
| 74420N | 77      | LM320T-8  | 75A92CN   | 59      | CD4081 | 21     | 2101-1 | 4.50   | MM5330 | 5.95   |      |
| 74421N | 77      | LM320T-8  | 75A92CN   | 59      | CD4081 | 21     | 2101-1 | 4.50   | MM5330 | 5.95   |      |
| 74422N | 77      | LM320T-8  | 75A92CN   | 59      | CD4081 | 21     | 2101-1 | 4.50   | MM5330 | 5.95   |      |
| 74423N | 77      | LM320T-8  | 75A92CN   | 59      | CD4081 | 21     | 2101-1 | 4.50   | MM5330 | 5.95   |      |
| 74424N | 77      | LM320T-8  | 75A92CN   | 59      | CD4081 | 21     | 2101-1 | 4.50   | MM5330 | 5.95   |      |
| 74425N | 77      | LM320T-8  | 75A92CN   | 59      | CD4081 | 21     | 2101-1 | 4.50   | MM5330 | 5.95   |      |
| 74426N | 77      | LM320T-8  | 75A92CN   | 59      | CD4081 | 21     | 2101-1 | 4.50   | MM5330 | 5.95   |      |
| 74427N | 77      | LM320T-8  | 75A92CN   | 59      | CD4081 | 21     | 2101-1 | 4.50   | MM5330 | 5.95   |      |
| 74428N | 77      | LM320T-8  | 75A92CN   | 59      | CD4081 | 21     | 2101-1 | 4.50   | MM5330 | 5.95   |      |
| 74429N | 77      | LM320T-8  | 75A92CN   | 59      | CD4081 | 21     | 2101-1 | 4.50   | MM5330 | 5.95   |      |
| 74430N | 77      | LM320T-8  | 75A92CN   | 59      | CD4081 | 21     | 2101-1 | 4.50   | MM5330 | 5.95   |      |
| 74431N | 77      | LM320T-8  | 75A92CN   | 59      | CD4081 | 21     | 2101-1 | 4.50   | MM5330 | 5.95   |      |
| 74432N | 77      | LM320T-8  | 75A92CN   | 59      | CD4081 | 21     | 2101-1 | 4.50   | MM5330 | 5.95   |      |
| 74433N | 77      | LM320T-8  |           |         |        |        |        |        |        |        |      |





### JUMBO LED READOUT ARRAY



By Bowmar. .5 in. character common cathode. Designed for use with multiplexed clock chips 4 digits in 1 pack!

**\$1.95 LIMITED STOCK**

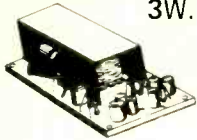

### 3W. AUDIO AMP

**\$3.95**  
2 1/4 x 3"

Assembled & tested. Not a kit. Has tapped output for either 4, 8 or 16 OHMS. With schematic.

### CMOS SPECIAL!

CD4001-5/\$1. CD4011-5/\$1.  
CD4013-3/\$1. CD4040-\$1. each  
CD4042-2/\$1. CD4049-3/\$1.

### FILTER CAP

Mini Size. Axial. 1,000  
MFD. 16 WVDC. 4/\$1.00

**RED LED READOUT FILTER**  
Very handy. Can be used with our calculator displays.  
2 1/4 x 1/2" 6/\$1.

2708 1Kx8 EPROMS 2708  
Prime new units from a major mfg. 450 N.S. access time. Equivalent to 4-1702 A's in 1 package! **450 ns**  
**\$15.75 each**

### MOTOROLA 7805R Voltage Regulator

Same as standard 7805 except 750 MA output.  
TO-220. 5VDC output. **44c each** 10/\$3.95

### 4K STATIC RAM'S

2114. The new industry standard. Arranged as 1K x 4. Equivalent to 4-21 L02's in 1 package! 18 pin DIP. 2 chips give 1Kx8.

2 for \$24. 8 for \$85.

### OPCOA LED READOUT

SLA-1 Common Anode. .33 inch character size. The original high efficiency LED display.

75c ea. 4/\$2.50

### TRANSFORMER

12 Vac. 60 MA. PRI-115 VAC 60 HZ. Perfect for clocks or power supplies!

Small Size. **\$1.95**

### LED IC Counter Kit

You Get: 1-7490; 1-7475; 1-7447; 1- Led Readout. All this for **\$1.99** (Led Readout is famous SLA-1. .33 in. By Opcoa.)

### 741C OP AMPS

Mini Dip. Prime new units. Has computer Mfg's house number. 12/\$2. 100 for \$15.

### DISC CAPACITORS

1 MFD 16V. P.C. leads. Most popular value! By Sprague. 20 for \$1.00

### Full Wave Bridge

4 Amp 200 PIV  
69c ea. 10/5.75

### 5V. NI-CAD Battery

4 cell Pack. Rated 500 MAH. **NEW!**  
**\$3.95 pack**

### 2N3904-House No.

TO-92. NPN. VCEO-45. HFE 100 to 300  
10 for \$1.00

### Jumbo Red Leds

New by G.E. Like MV5024. Number SSL-22.  
6/\$1. 25/\$3.75

### Motorola PNP Power!

2N4905. TO-3 case. 90W. VCEO-60; HFE-100 max. at 2.5A. Good mate for the 2N3055. 75c each. 4/\$2.50 **PRIME!**

### TI POWER TRANSISTORS

TO-220. VCEO-60V. 30W.  
TIP29A-NPN 44c  
TIP30A-PNP 44c

### CMOS QUAD Bilateral Switch

CM4116. By Solitron. An improved CD4016. 3/\$1.

### Motorola Quad Op-Amp MC3401. Pin for Pin Sub for popular LM3900.

3/\$1.00

## Digital Research Corporation

(OF TEXAS)

P. O. BOX 401247 • GARLAND, TEXAS 75040 • (214) 271-2461

TERMS: Orders under \$15. add 75c. No COD's. We accept VISA, MasterCard and American Express Cards. Money Back Guarantee on all items! Texas Residents add 5% Sales Tax. **WE PAY POSTAGE!**

CIRCLE 42 ON FREE INFORMATION CARD

### UNIVERSAL 4Kx8 MEMORY BOARD KIT

\$69.95  
32:2102 1 fully buffered, 16 address lines, on board decoding for any 4 of 64 pages, standard 44 pin buss

### EXPANDABLE F8 CPU BOARD KIT

\$99.00  
featuring Fairbug PSU 1K of static ram, RS 232 interface, documentation, 64 BYTE register

### 4K BASIC FOR FAIRBUG F8

on paper tape \$25.00

### C/MOS (DIODE CLAMPED)

|        |      |      |      |      |      |      |      |
|--------|------|------|------|------|------|------|------|
| 74C10  | -.22 | 4012 | -.22 | 4023 | -.22 | 4046 | 2.25 |
| 74C193 | 1.50 | 4013 | -.40 | 4024 | -.75 | 4049 | -.40 |
| 4001   | -.22 | 4015 | -.95 | 4025 | -.22 | 4050 | -.40 |
| 4002   | -.22 | 4016 | -.40 | 4027 | -.40 | 4055 | 1.50 |
| 4006   | 1.20 | 4017 | 1.05 | 4028 | -.88 | 4066 | -.80 |
| 4007   | -.22 | 4018 | 1.00 | 4029 | 1.10 | 4071 | -.27 |
| 4009   | -.42 | 4019 | -.25 | 4030 | -.22 | 4076 | 1.05 |
| 4010   | -.42 | 4020 | 1.05 | 4035 | 1.10 |      |      |
| 4011   | -.22 | 4022 | -.95 | 4042 | -.78 |      |      |

WSU-30 Hand wire wrap tool used to wrap, un-wrap & strip #30 wire **\$5.30**

### #24, EIGHT CONDUCTOR SPECTRA FLAT CABLE

|      |         |
|------|---------|
| 10'  | \$1.50  |
| 100' | \$13.50 |

### DIP SOCKETS

|        |    |        |    |
|--------|----|--------|----|
| 8 PIN  | 22 | 24 PIN | 40 |
| 14 PIN | 25 | 28 PIN | 50 |
| 16 PIN | 28 | 40 PIN | 60 |
| 18 PIN | 30 |        |    |

### 2708 8K EPROM 1450 nst

|                                       |        |
|---------------------------------------|--------|
| 2527 STATE SHIF T REL                 | \$1.95 |
| 2513 CHARACTER GEN                    | \$6.75 |
| 2512 HEX 12 BIT SR                    | \$3.50 |
| TMS4050N14K dvs RAM                   | \$4.95 |
| 5203 2K EPROM                         | \$4.50 |
| 2102 1024 BT RAM (450 nst)            | \$1.19 |
| 2107B                                 | \$3.50 |
| MK4008P                               | \$1.95 |
| 5280 4K DYNAMIC RAM                   | \$4.75 |
| MTA 206 PDPDT CENTER OFF              | \$1.85 |
| MTA 206 PDPDT CENTER OFF LEVER SWITCH | \$1.85 |
| 1702A UV PROM                         | \$4.95 |
| 5204 4K PROM                          | \$1.95 |
| 82523                                 | \$1.95 |
| AY5 1013 UART                         | \$6.95 |

### LIGHT ACTIVATED SOLAR'S

TO 18. 200V 1A \$1.10

### SILICON SOLAR CELLS

2 1/2" diameter 4V at 500 ma \$4.00

### LED READOUTS

|                 |     |                   |        |
|-----------------|-----|-------------------|--------|
| FND 359 C.C. 4" | \$5 | DL 704 3" C.C.    | \$9.95 |
| FND 70 C.C. 4"  | \$5 | MAN 7 3" C.A.     | \$8    |
| FND 503 C.C. 5" | \$5 | NS 33 3 dig array | \$7.75 |
| FND 510 C.A. 5" | \$5 | DL 747 C.A. 6"    | \$1.95 |

Terms: FOB Cambridge, Mass. Send Check or Money Order. Include Postage. Minimum Order \$5.00, COD'S \$20.00

Send 25¢ for our catalog featuring Transistors and Rectifiers 145 Hampshire St., Cambridge, Mass.

### PRINTED CIRCUIT BOARD

4 1/2" x 6 1/2" SINGLE SIDED EPOXY BOARD 1/16" thick unetched \$5.60 ea. 5/\$2.60

### 7 WATT LD-65 LASER DIODE IR \$8.95

|                       |          |
|-----------------------|----------|
| 2N 3820 P FET         | \$4.45   |
| 2N 5457 N FET         | \$4.45   |
| 2N2646                | \$4.45   |
| ER 900 TRIGGER DIODES | 4 \$1.00 |
| 2N 6028 PROG UJT      | \$6.00   |

### MINIATURE MULTI-TURN TRIM POTS

100, 500, 1K, 2K, 5K, 10K, 25K, 50K, 100K, 200K, 500K 1 Meg. \$75 each \$32.00

### CCD202 charge coupled device 100 x 100 image sensor.

\$145.00

### VERIPAX PC BOARD

This board is a 1116" single sided paper epoxy board, 4 1/2" x 6 1/2" DRILLED and ETCHED which will hold up to 21 single 14 pin IC's or 8, 16 or LSI DIP IC's with busses for power supply connector. \$4.00

### MV 5691 YELLOW GREEN

|                             |            |
|-----------------------------|------------|
| BIPOlar LED                 | \$ .90     |
| FP 100 PHOTO TRANS          | \$ .50     |
| RED, YELLOW, GREEN or AMBER |            |
| LARGE LED's                 | 6/\$1.00   |
| 1L-5 (MCT-2)                | \$ .75     |
| MOLEX PINS                  | 100/\$1.00 |

### 10 WATT ZENERS 3.9, 4.7, 5.6, 8.2, 12, 18, 22, 100, 150 or 200V ea.

\$ .60

### 1 WATT ZENERS 4.7, 5.6, 10, 12, 15, 18 or 22V ea.

\$ .25

### MC6860 MODEM CHIP

\$9.95

### Silicon Power Rectifiers

|        |    |     |     |      |
|--------|----|-----|-----|------|
| PRV 1A | 3A | 12A | 50A | 125A |
| 100    | 06 | 14  | 30  | 80   |
| 200    | 07 | 20  | 35  | 115  |
| 400    | 09 | 25  | 50  | 140  |
| 600    | 11 | 30  | 70  | 180  |
| 800    | 15 | 35  | 90  | 220  |
| 1000   | 20 | 45  | 110 | 275  |

SAD 1024 a REDICOM 1024 stage analog "Bucket Brigade" shift register. **\$18.95**

IN 4148 IN9141 \$15.50

MCA 81 OPTICAL LIMIT SWITCH \$1.50

### REGULATORS

|               |        |                    |        |
|---------------|--------|--------------------|--------|
| 309K          | \$ .95 | 340K 12.15         |        |
| 723           | \$ .50 | or 24V             | \$ .85 |
| LM 376        | \$ .60 | 340T-5, 6, 8, 12   |        |
| 320K 5 or 15V | \$1.40 | 15, 18 or 24V/1.10 |        |
| 320T-5, 15    |        | 78 MG              | \$1.35 |
| or 24V        | \$1.15 | 79 MG              | \$1.35 |

### RS232 DB 25P male \$2.95

CONNECTORS DB 25S female \$3.50

### TRANSISTOR SPECIALS

|                                 |          |
|---------------------------------|----------|
| 2N6233-NPN RF POWER             | \$1.95   |
| MRF-8004 a CB RF Transistor NPN | \$1.50   |
| 2N3772 NPN Si TO-3              | \$1.00   |
| 2N1546 PNP GE TO-3              | \$ .75   |
| 2N4908 PNP Si TO-3              | \$1.00   |
| 2N6056 NPN Si TO-3 Darlington   | \$1.70   |
| 2N5086 PNP Si TO-92             | 4/\$1.00 |
| 2N4888 PNP TO-66                | \$ .60   |
| 2N404 PNP GE TO-5               | 5/\$1.00 |
| 2N3919 NPN Si TO-3 RF           | \$1.50   |
| MPSA-13 NPN Si TO-92            | 3/\$1.00 |
| 2N3767 NPN Si TO-66             | \$ .70   |
| 2N2222 NPN Si TO-18             | 5/\$1.00 |
| 2N3055 NPN Si TO-3              | \$ .50   |
| 2N3904 NPN Si TO-92             | 5/\$1.00 |
| 2N5296 NPN Si TO-220            | \$ .50   |
| 2N6109 PNP Si TO-220            | \$ .55   |
| 2N3638 PNP Si TO-5              | 5/\$1.00 |

### TTL IC SERIES

|      |    |       |     |       |     |
|------|----|-------|-----|-------|-----|
| 7400 | 16 | 7445  | 65  | 74151 | 65  |
| 7401 | 16 | 7446  | 70  | 74152 | 65  |
| 7402 | 16 | 7447  | 65  | 74154 | 100 |
| 7403 | 16 | 7448  | 70  | 74155 | 70  |
| 7404 | 20 | 7449  | 15  | 74157 | 65  |
| 7405 | 20 | 7450  | 32  | 74161 | 85  |
| 7406 | 25 | 7451  | 32  | 74163 | 80  |
| 7407 | 25 | 7452  | 32  | 74164 | 80  |
| 7408 | 20 | 7453  | 45  | 74165 | 95  |
| 7409 | 20 | 7454  | 30  | 74170 | 225 |
| 7410 | 16 | 7480  | 45  | 74173 | 135 |
| 7411 | 20 | 7482  | 70  | 74174 | 95  |
| 7412 | 20 | 7485  | 87  | 74175 | 90  |
| 7413 | 39 | 7486  | 30  | 74176 | 75  |
| 7414 | 85 | 7490  | 45  | 74177 | 75  |
| 7416 | 25 | 7491  | 65  | 74180 | 65  |
| 7417 | 25 | 7492  | 43  | 74181 | 290 |
| 7420 | 16 | 7493  | 45  | 74190 | 120 |
| 7425 | 25 | 7494  | 70  | 74191 | 120 |
| 7426 | 25 | 7495  | 65  | 74192 | 83  |
| 7427 | 25 | 7496  | 65  | 74193 | 83  |
| 7430 | 16 | 7497  | 28  | 74195 | 85  |
| 7432 | 25 | 74121 | 33  | 74195 | 85  |
| 7437 | 24 | 74122 | 38  | 74196 | 86  |
| 7438 | 74 | 74123 | 40  | 74279 | 87  |
| 7440 | 16 | 74124 | 40  | 75491 | 50  |
| 7441 | 70 | 74126 | 40  |       |     |
| 7442 | 52 | 74150 | 110 |       |     |

### 1/2 hr. DATA CASSETTS \$1.25

44 Pin Solder Tail 156" Spacing \$2.20

### MM587AA with FC8204 readouts. This new National clock chip will directly drive LED displays. Four 8" high readouts supplied. \$10.95

MCM 6571A 7 x 9 upper & lower case character gen. \$10.75

CTS 206-8 eight position dip switch \$1.90

CTS 206-4 four position dip switch \$1.45

### ALCO MINIATURE TOGGLE SWITCHES

|               |        |
|---------------|--------|
| MTA 106 SPDT  | \$1.05 |
| MTA 206 PDPDT | \$1.70 |

### Full Wave Bridges

|     |      |      |      |
|-----|------|------|------|
| PRV | 2A   | 6A   | 25A  |
| 100 |      |      | 1.30 |
| 200 | 75   | 1.25 | 2.00 |
| 400 | 95   | 1.50 | 3.00 |
| 600 | 1.20 | 1.75 | 4.00 |

### SANKEN AUDIO POWER AMPS

|                    |         |
|--------------------|---------|
| Si 1010 G 10 WATTS | \$ 6.80 |
| Si 1020 G 20 WATTS | \$13.70 |
| Si 1050 G 50 WATTS | \$25.90 |

### TANTALUM CAPACITORS

|                 |                  |
|-----------------|------------------|
| 22UF 35V 5/100  | 6.80UF 35V 4/150 |
| 47UF 35V 5/100  | 10UF 10V \$ 2.50 |
| 68UF 35V 5/100  | 22UF 25V \$ 4.00 |
| 1UF 35V 5/100   | 15UF 35V 3/100   |
| 2.2 UF 20V5/100 | 30UF 6V 5/100    |
| 3.3UF 35V 4/150 | 47UF 20V \$ 35   |
| 4.7UF 15V 5/100 | 68UF 15V \$ 35   |

### 74LS SERIES 74LS125 65 LINEAR CIRCUITS

|        |    |        |     |               |
|--------|----|--------|-----|---------------|
| 74LS00 | 26 | 74LS32 | 80  | LM 301/748 29 |
| 74LS02 | 26 | 74LS33 | 39  | LM 307        |
| 74LS03 | 26 | 74LS36 | 39  | LM 308        |
| 74LS04 | 28 | 74LS38 | 72  | LM 308        |
| 74LS05 | 28 | 74LS39 | 72  | LM 311        |
| 74LS08 | 28 | 74LS41 | 98  | LM 312        |
| 74LS09 | 28 | 74LS43 | 93  | LM 319        |
| 74LS10 | 26 | 74LS45 | 200 | LM 324        |
| 74LS11 | 26 | 74LS46 | 95  | LM 339        |
| 74LS12 | 50 | 74LS47 | 98  | LM 358        |
| 74LS13 | 28 | 74LS48 | 102 | LM 370        |
| 74LS14 | 26 | 74LS49 | 102 | LM            |

| DIODES/ZENERS |       |      |     | SOCKETS/BRIDGES |              |    |      | TRANSISTORS, LEDS, etc. |                           |               |      |
|---------------|-------|------|-----|-----------------|--------------|----|------|-------------------------|---------------------------|---------------|------|
| 1N914         | 100v  | 10mA | .05 | 8-pin pcb       | .25          | ww | .45  | 2N2222                  | NPN                       | (Plastic .10) | .15  |
| 1N4005        | 600v  | 1A   | .08 | 14-pin pcb      | .25          | ww | .40  | 2N2907                  | PNP                       |               | .15  |
| 1N4007        | 1000v | 1A   | .15 | 16-pin pcb      | .25          | ww | .40  | 2N3906                  | PNP                       |               | .10  |
| 1N4148        | 75v   | 10mA | .05 | 18-pin pcb      | .25          | ww | .75  | 2N3054                  | NPN                       |               | .35  |
| 1N753A        | 6.2v  | z    | .25 | 22-pin pcb      | .45          | ww | 1.25 | 2N3055                  | NPN                       | 15A 60v       | .50  |
| 1N758A        | 10v   | z    | .25 | 24-pin pcb      | .35          | ww | 1.10 | T1P125                  | PNP                       | Darlington    | .35  |
| 1N759A        | 12v   | z    | .25 | 28-pin pcb      | .35          | ww | 1.45 | LED Green, Red, Clear   |                           |               | .15  |
| 1N4733        | 5.1v  | z    | .25 | 40-pin pcb      | .50          | ww | 1.25 | D.L.747                 | 7 seg 5/8" high com-anode |               | 1.95 |
| 1N5243        | 13v   | z    | .25 | Molex pins .01  | To-3 Sockets |    | .45  | XAN72                   | 7 seg com-anode           |               | 1.50 |
| 1N5244B       | 14v   | z    | .25 | 2 Amp Bridge    | 100-prv      |    | 1.20 | FND 359                 | Red 7 seg com-cathode     |               | 1.25 |
| 1N5245B       | 15v   | z    | .25 | 25 Amp Bridge   | 200-prv      |    | 1.95 |                         |                           |               |      |

| C MOS |      | - T T L - |      |       |      |        |      |        |      |               |      |
|-------|------|-----------|------|-------|------|--------|------|--------|------|---------------|------|
| 4000  | .15  | 7400      | .15  | 7473  | .25  | 74176  | 1.25 | 74H72  | .55  | 74S133        | .45  |
| 4001  | .20  | 7401      | .15  | 7474  | .35  | 74180  | .85  | 74H101 | .75  | 74S140        | .75  |
| 4002  | .20  | 7402      | .20  | 7475  | .35  | 74181  | 2.25 | 74H103 | .75  | 74S151        | .35  |
| 4004  | 3.95 | 7403      | .20  | 7476  | .30  | 74182  | .95  | 74H106 | .95  | 74S153        | .35  |
| 4006  | 1.20 | 7404      | .15  | 7480  | .55  | 74190  | 1.75 |        |      | 74S157        | .80  |
| 4007  | .35  | 7405      | .25  | 7481  | .75  | 74191  | 1.35 | 74L00  | .35  | 74S158        | .35  |
| 4008  | .95  | 7406      | .35  | 7483  | .95  | 74192  | 1.65 | 74L02  | .35  | 74S194        | 1.05 |
| 4009  | .30  | 7407      | .55  | 7485  | .95  | 74193  | .85  | 74L03  | .30  | 74S257 (8123) | .25  |
| 4010  | .45  | 7408      | .25  | 7486  | .30  | 74194  | 1.25 | 74L04  | .35  |               |      |
| 4011  | .20  | 7409      | .15  | 7489  | 1.35 | 74195  | .95  | 74L10  | .35  | 74LS00        | .35  |
| 4012  | .20  | 7410      | .10  | 7490  | .55  | 74196  | 1.25 | 74L20  | .35  | 74LS01        | .35  |
| 4013  | .40  | 7411      | .25  | 7491  | .95  | 74197  | 1.25 | 74L30  | .45  | 74LS02        | .35  |
| 4014  | 1.10 | 7412      | .30  | 7492  | .95  | 74198  | 2.35 | 74L47  | 1.95 | 74LS04        | .35  |
| 4015  | .95  | 7413      | .45  | 7493  | .40  | 74221  | 1.00 | 74L51  | .45  | 74LS05        | .45  |
| 4016  | .35  | 7414      | 1.10 | 7494  | 1.25 | 74367  | .85  | 74L55  | .65  | 74LS08        | .35  |
| 4017  | 1.10 | 7416      | .25  | 7495  | .60  |        |      | 74L72  | .45  | 74LS09        | .35  |
| 4018  | 1.10 | 7417      | .40  | 7496  | .80  | 75108A | .35  | 74L73  | .40  | 74LS10        | .35  |
| 4019  | .60  | 7420      | .15  | 74100 | 1.85 | 75110  | .35  | 74L74  | .45  | 74LS11        | .35  |
| 4020  | .85  | 7426      | .30  | 74107 | .35  | 75491  | .50  | 74L75  | .55  | 74LS20        | .35  |
| 4021  | 1.35 | 7427      | .45  | 74121 | .35  | 75492  | .50  | 74L93  | .55  | 74LS21        | .25  |
| 4022  | .95  | 7430      | .15  | 74122 | .55  |        |      | 74L123 | .55  | 74LS22        | .25  |
| 4023  | .25  | 7432      | .30  | 74123 | .55  | 74H00  | .25  |        |      | 74LS32        | .40  |
| 4024  | .75  | 7437      | .35  | 74125 | .45  | 74H01  | .25  | 74S00  | .55  | 74LS37        | .35  |
| 4025  | .35  | 7438      | .35  | 74126 | .35  | 74H04  | .25  | 74S02  | .55  | 74LS40        | .45  |
| 4026  | 1.95 | 7440      | .25  | 74132 | 1.35 | 74H05  | .25  | 74S03  | .30  | 74LS42        | 1.10 |
| 4027  | .50  | 7441      | 1.15 | 74141 | 1.00 | 74H08  | .35  | 74S04  | .35  | 74LS51        | .50  |
| 4028  | .95  | 7442      | .45  | 74150 | .85  | 74H10  | .35  | 74S05  | .35  | 74LS74        | .65  |
| 4030  | .35  | 7443      | .85  | 74151 | .75  | 74H11  | .25  | 74S08  | .35  | 74LS86        | .65  |
| 4033  | 1.50 | 7444      | .45  | 74153 | .95  | 74H15  | .30  | 74S10  | .35  | 74LS90        | .95  |
| 4034  | 2.45 | 7445      | .65  | 74154 | 1.05 | 74H20  | .30  | 74S11  | .35  | 74LS93        | .95  |
| 4035  | 1.25 | 7446      | .95  | 74156 | .95  | 74H21  | .25  | 74S20  | .35  | 74LS107       | .85  |
| 4040  | 1.35 | 7447      | .95  | 74157 | .65  | 74H22  | .40  | 74S40  | .25  | 74LS123       | 1.00 |
| 4041  | .69  | 7448      | .70  | 74161 | .85  | 74H30  | .25  | 74S50  | .25  | 74LS151       | .95  |
| 4042  | .95  | 7450      | .25  | 74163 | .95  | 74H40  | .25  | 74S51  | .45  | 74LS153       | 1.20 |
| 4043  | .95  | 7451      | .25  | 74164 | .60  | 74H50  | .25  | 74S64  | .25  | 74LS157       | .85  |
| 4044  | .95  | 7453      | .20  | 74165 | 1.50 | 74H51  | .25  | 74S74  | .40  | 74LS164       | 1.90 |
| 4046  | 1.75 | 7454      | .25  | 74166 | 1.35 | 74H52  | .15  | 74S112 | .90  | 74LS367       | .85  |
| 4049  | .70  | 7460      | .40  | 74175 | .80  | 74H53J | .25  | 74S114 | 1.30 | 74LS368       | .85  |
| 4050  | .50  | 7470      | .45  |       |      | 74H55  | .25  |        |      |               |      |
| 4066  | .95  | 7472      | .40  |       |      |        |      |        |      |               |      |
| 4069  | .40  |           |      |       |      |        |      |        |      |               |      |
| 4071  | .35  |           |      |       |      |        |      |        |      |               |      |
| 4081  | .70  |           |      |       |      |        |      |        |      |               |      |
| 4082  | .45  |           |      |       |      |        |      |        |      |               |      |

| 9000 SERIES |     | LINEARS, REGULATORS, etc. |      |                |      |                  |      |              |      |  |  |
|-------------|-----|---------------------------|------|----------------|------|------------------|------|--------------|------|--|--|
| 9301        | .85 | 8266                      | .35  | LM320K5 (7905) | 1.65 | LM340T24         | .95  | LM723        | .50  |  |  |
| 9309        | .35 | MCT2                      | .95  | LM320K12       | 1.65 | LM340K12         | 2.15 | LM725        | 1.75 |  |  |
| 9322        | .85 | 8038                      | 3.95 | LM320T5        | 1.65 | LM340K15         | 1.25 | LM739        | 1.50 |  |  |
| 95H03       | .55 | LM201                     | .75  | LM320T12       | 1.65 | LM340K18         | 1.25 | LM741 (8-14) | .25  |  |  |
| 9601        | .75 | LM301                     | .25  | LM320T15       | 1.65 | LM340K24         | .95  | LM747        | 1.10 |  |  |
| 9602        | .50 | LM308 (Mini)              | .75  | LM339          | .95  | LM373            | 2.95 | LM1307       | 1.25 |  |  |
|             |     | LM309H                    | .65  | 7805 (340T5)   | .95  | LM380            | .95  | LM1458       | .95  |  |  |
|             |     | LM309K (340K-5)           | .85  | LM340T12       | 1.00 | LM709 (8,14 PIN) | .25  | LM3900       | .50  |  |  |
|             |     | LM310                     | 1.15 | LM340T15       | 1.00 | LM711            | .45  | LM75451      | .65  |  |  |
|             |     | LM311D (Mini)             | .75  | LM340T18       | 1.00 |                  |      | NE555        | .50  |  |  |
|             |     | LM318 (Mini)              | .65  |                |      |                  |      | NE556        | .95  |  |  |
|             |     |                           |      |                |      |                  |      | NE565        | .95  |  |  |
|             |     |                           |      |                |      |                  |      | NE566        | 1.75 |  |  |
|             |     |                           |      |                |      |                  |      | NE567        | 1.35 |  |  |

## INTEGRATED CIRCUITS UNLIMITED

7889 Clairemont Mesa Boulevard, San Diego, California 92111  
(714) 278-4394 (Calif. Res.)

All orders shipped prepaid      No minimum  
Open accounts invited      COD orders accepted

Discounts available at OEM Quantities      California Residents add 6% Sales Tax  
All IC's Prime/Guaranteed. All orders shipped same day received.

**24 Hour Toll Free Phone 1-800-854-2211      MasterCharge / BankAmericard / AE**

**SPECIAL DISCOUNTS**

|                |        |
|----------------|--------|
| Total Order    | Deduct |
| \$35 - \$99    | 5%     |
| \$100 - \$300  | 10%    |
| \$301 - \$1000 | 15%    |
| \$1000 - Up    | 20%    |

more than  
20,000 different  
components

**RECTIFIERS**

|        | 10 For | 100 For |
|--------|--------|---------|
| 1N4001 | .80    | 5.00    |
| 1N4002 | .70    | 6.00    |
| 1N4003 | .80    | 7.00    |
| 1N4004 | .90    | 8.00    |
| 1N4005 | 1.00   | 9.00    |
| 1N4006 | 1.10   | 10.00   |
| 1N4007 | 1.20   | 11.00   |

**JAPANESE TRANSISTORS**

|         |      |          |      |          |      |        |      |
|---------|------|----------|------|----------|------|--------|------|
| 2SA484  | 2.44 | 2SC482   | 1.40 | 2SC1226A | .85  | 2SD170 | 1.50 |
| 2SA495  | .60  | 2SC495   | .85  | 2SC1237  | 4.00 | 2SD180 | 2.50 |
| 2SA497  | 1.44 | 2SC517   | 3.60 | 2SC1239  | 3.50 | 2SD188 | 2.70 |
| 2SA634  | 1.00 | 2SC634A  | .60  | 2SC1306  | 3.50 | 2SD234 | .85  |
| 2SA636  | 1.25 | 2SC710   | .49  | 2SC1307  | 4.75 | 2SD235 | .85  |
| 2SA673  | .70  | 2SC711   | .49  | 2SC1377  | 4.80 | 2SD313 | 1.05 |
| 2SA678  | .65  | 2SC735   | .49  | 2SC1383  | .50  | 2SD314 | 1.50 |
| 2SA682  | 1.49 | 2SC756A  | 2.40 | 2SC1448  | 1.00 | 2SD315 | 1.20 |
| 2SA683  | .60  | 2SC778   | 3.50 | 2SC1449  | .85  | 2SD358 | 1.40 |
| 2SA699  | 1.30 | 2SC781   | 2.50 | 2SC1678  | 2.00 | 2SD360 | 1.05 |
| 2SA699A | 1.45 | 2SC789   | 1.00 | 2SC1728  | 1.85 | 2SD427 | 2.55 |
| 2SA733  | .49  | 2SC798   | 3.95 | 2SC1760  | 1.60 | 2SD525 | 1.50 |
| 2SA777  | .99  | 2SC799   | 3.25 | 2SC1816  | 3.50 | 2SK19  | 1.25 |
| 2SB54   | .49  | 2SC1000  | .49  | 2SC1908  | .49  | 2SK30A | .75  |
| 2SB56   | .95  | 2SC1013  | .95  | 2SC1909  | 3.75 | 2SK33  | .90  |
| 2SB186  | .49  | 2SC1014  | .95  | 2SC1957  | 1.00 | 2SK55  | 1.00 |
| 2SB187  | .55  | 2SC1017  | 1.20 | 2SC1973  | .90  |        |      |
| 2SB324  | .60  | 2SC1018  | 1.00 | 2SC1975  | 3.50 | 3SK22Y | 2.20 |
| 2SB370  | .65  | 2SC1061  | 1.25 | 2SC2028  | .80  | 3SK40  | 2.00 |
| 2SB405  | .60  | 2SC1079  | 3.95 | 2SC2029  | 3.40 | 3SK45  | 2.20 |
| 2SB415  | .65  | 2SC1096  | .80  | 2SC2091  | 2.50 | 3SK49  | 2.20 |
| 2SB461  | 1.60 | 2SC1098  | 1.00 | 2SC2092  | 3.25 |        |      |
| 2SB463  | 1.40 | 2SC1115  | 3.00 |          |      |        |      |
| 2SB507  | 1.40 | 2SC1170B | 4.95 | 2SD72    | .80  | 4004   | 3.00 |
| 2SC371  | .49  | 2SC1172  | 5.25 | 2SD77    | 1.50 | 4005   | 3.00 |
| 2SC372  | .49  | 2SC1173  | .75  | 2SD88    | 4.80 | 40081  | 1.50 |
| 2SC481  | 1.50 | 2SC1209  | .75  | 2SD118   | 3.00 | 40082  | 3.00 |

**VOLT. REG**

|           |      |
|-----------|------|
| LM340K-5  | 1.70 |
| LM340K-6  | 1.70 |
| LM340K-8  | 1.70 |
| LM340K-12 | 1.70 |
| LM340K-15 | 1.70 |
| LM340K-24 | 1.70 |
| LM340T-5  | 1.50 |
| LM340T-6  | 1.50 |
| LM340T-8  | 1.50 |
| LM340T-12 | 1.50 |
| LM340T-15 | 1.50 |
| LM340T-18 | 1.50 |
| LM340T-24 | 1.50 |

**5400 SERIES**

|        |      |
|--------|------|
| 5400   | 1.00 |
| 5404   | 1.25 |
| 5410   | 1.00 |
| 5426   | 1.25 |
| 5473   | 1.50 |
| 5475   | 1.50 |
| 5486   | 1.90 |
| 5493   | 2.00 |
| 54100  | 1.80 |
| 54LS04 | 1.00 |

**OEM SPECIALS**

|         |      |         |      |         |      |
|---------|------|---------|------|---------|------|
| 1N34    | .25  | 2N2905A | .30  | 2N3903  | .16  |
| 1N60    | .25  | 2N2906  | .25  | 2N3904  | .16  |
|         |      | 2N2906A | .30  | 2N3905  | .16  |
| 1N270   | .25  | 2N2907  | .25  | 2N3906  | .16  |
| 1N914   | .10  | 2N2907A | .70  | 2N3956A | 3.75 |
| 2N173   | 1.75 | 2N2913  | .75  | 2N3955  | 2.45 |
| 2N404   | .75  | 2N2914  | 1.20 | 2N3957  | 1.25 |
| 2N443   | 2.50 | 2N3019  | 1.00 | 2N3958  | 1.20 |
| 2N508A  | .45  | 2N3053  | .30  | 2N4037  | .60  |
| 2N718   | .25  | 2N3054  | .70  | 2N4093  | .85  |
| 2N930   | .25  | 2N3055  | .75  | 2N4124  | .16  |
| 2N956   | .30  | 2N3221  | 1.00 | 2N4126  | .16  |
| 2N1302  | 1.25 | 2N3247  | 3.40 | 2N4141  | .20  |
| 2N1305  | .75  | 2N3250  | .50  | 2N4142  | .20  |
| 2N1540  | .90  | 2N3393  | .20  | 2N4143  | .20  |
| 2N1544  | .80  | 2N3394  | .17  | 2N4220A | .45  |
| 2N1560  | 2.80 | 2N3414  | .17  | 2N4234  | .95  |
| 2N1605  | 1.75 | 2N3415  | .18  | 2N4400  | .16  |
| 2N1813  | .50  | 2N3416  | .19  | 2N4401  | .16  |
| 2N1711  | .50  | 2N3417  | .20  | 2N4402  | .16  |
| 2N2102  | .70  | 2N3442  | 1.85 | 2N4403  | .20  |
| 2N2160  | .70  | 2N3553  | 1.50 | 2N4409  | .16  |
| 2N2218  | .25  | 2N3563  | .20  | 2N4410  | .16  |
| 2N2218A | .30  | 2N3565  | .20  | 2N4441  | 1.00 |
| 2N2219  | .25  | 2N3638  | .20  | 2N4442  | 1.15 |
| 2N2219A | .30  | 2N3642  | .20  | 2N4443  | 1.35 |
| 2N2221  | .25  | 2N3643  | .20  | 2N4852  | .55  |
| 2N2221A | .30  | 2N3645  | .20  | 2N5061  | .30  |
| 2N2222  | .25  | 2N3646  | .14  | 2N5064  | .50  |
| 2N2222A | .30  | 2N3731  | 3.75 | 2N5130  | .20  |
| 2N2270  | .40  | 2N3740  | 1.00 | 2N5138  | .15  |
| 2N2369  | .25  | 2N3771  | 1.75 | 2N5296  | .50  |
| 2N2484  | .32  | 2N3772  | 1.90 | 2N5306  | .20  |
| 2N2712  | .18  | 2N3773  | 3.00 | 2N5400  | .40  |
| 2N2904  | .25  | 2N3819  | .40  | 2N5401  | .50  |
| 2N2904A | .30  | 2N3823  | .70  | 2N5457  | .35  |
| 2N2905  | .25  | 2N3866  | 1.25 | 2N5458  | .30  |

**7400 TTL**

|      |      |       |      |       |      |
|------|------|-------|------|-------|------|
| 7400 | .18  | 7442  | 1.08 | 74107 | .49  |
| 7401 | .21  | 7448  | 1.15 | 74121 | .55  |
| 7402 | .21  | 7450  | .26  | 74122 | .49  |
| 7404 | .21  | 7451  | .27  | 74123 | 1.05 |
| 7405 | .24  | 7453  | .27  | 74125 | .60  |
| 7407 | .45  | 7454  | .41  | 74126 | .81  |
| 7408 | .25  | 7460  | .22  | 74132 | 3.00 |
| 7409 | .25  | 7472  | .39  | 74141 | 1.15 |
| 7410 | .20  | 7473  | .45  | 74150 | 1.10 |
| 7411 | .30  | 7474  | .45  | 74151 | 1.25 |
| 7413 | .85  | 7475  | .80  | 74153 | 1.35 |
| 7416 | .43  | 7482  | 1.75 | 74154 | 1.54 |
| 7417 | .43  | 7483  | 1.15 | 74157 | 1.30 |
| 7420 | .21  | 7485  | 1.12 | 74161 | 1.45 |
| 7422 | 1.50 | 7486  | .45  | 74164 | 1.65 |
| 7425 | .43  | 7489  | 2.49 | 74165 | 1.65 |
| 7427 | .37  | 7490  | .69  | 74166 | 1.70 |
| 7428 | .35  | 7491  | 1.20 | 74174 | 1.95 |
| 7430 | .26  | 7492  | .82  | 74175 | 1.95 |
| 7432 | .31  | 7493  | .82  | 74180 | 1.05 |
| 7437 | .47  | 7494  | .91  | 74181 | 3.55 |
| 7438 | .40  | 7495  | .91  | 74191 | 1.50 |
| 7440 | .21  | 7496  | .91  | 74195 | 1.50 |
| 7441 | 1.10 | 74100 | 1.25 | 74197 | 1.00 |

PARTIAL LISTING — WRITE FOR FREE CATALOG

**JAPANESE CIRCUITS**

|         |      |          |       |         |      |           |       |
|---------|------|----------|-------|---------|------|-----------|-------|
| AN136   | 2.90 | LA4400FS | 3.40  | TA7055P | 3.00 | UPC20C    | 3.75  |
| AN214   | 3.35 | LA4400FR | 3.40  | TA7060P | 1.40 | UPC41C    | 2.00  |
| AN239   | 6.50 | LD3120   | 2.40  | TA7061P | 1.50 | UPC563H2  | 8.80  |
| AN241   | 2.40 | M5115PR  | 7.80  | TA7063P | 1.50 | UPC566H   | 1.25  |
| AN315   | 3.50 | PLL01A   | 13.50 | TA7075P | 3.75 | UPC575C   | 2.60  |
| BA511   | 3.00 | PLL02A   | 8.50  | TA7089P | 2.90 | UPC595C   | 2.95  |
| BA521   | 3.40 | PLL02A-G | 8.50  | TA7120P | 1.50 | UPC1001H2 | 3.50  |
| HA1202  | 2.20 | SG613    | 6.75  | TA7150P | 3.75 | UPC1008C  | 5.75  |
| HA1306  | 4.90 | STK011   | 7.50  | TA7153P | 6.90 | UPC1020H  | 3.25  |
| HA1308  | 4.50 | STK015   | 6.50  | TA7203P | 4.25 | UPC1025H  | 3.50  |
| HA1322  | 4.20 | STK032   | 14.20 | TA7204P | 3.70 | UPC1166H  | 4.50  |
| LA1201  | 4.25 | STK050   | 24.50 | TA7205P | 3.50 | UPD277C   | 4.50  |
| LA4031P | 3.20 | STK056   | 11.35 | UH1C003 | 6.50 | UPD857C   | 15.50 |
| LA4032P | 4.20 | STK415   | 8.50  | UH1C004 | 6.50 | UPD858C   | 9.50  |
| LA4051P | 3.20 | TA7045M  | 3.25  | UPC16C  | 2.50 | UPD861C   | 18.50 |

CHECK OUR NEW LOWER PRICES



**NEW-TONE  
ELECTRONICS**

PO Box 1738A Bloomfield, N.J. 07003  
Phone (201) 748-6171, 6172, 6173

CIRCLE 43 ON FREE INFORMATION CARD

**PLAYMASTER 40W + 40W PROFESSIONAL AMPLIFIER KIT**

The PLAYMASTER 4040 is a sophisticated, advanced design incorporating the latest developments, yet uses reliable, rugged, easily available components. The 2N3055 power transistors, for example, are the most popular power transistors in the world. If disaster strikes and they need to be replaced, you'll have no trouble buying spares.

**ONLY \$105.**

**each  
kit**

|                    | MODEL 25W/40W   | MODEL 35W/50W                                  | MODEL 27W/43W | MODEL 22W/36W | MODEL 15W/24W | MODEL 13W/21W |
|--------------------|---|--|---------------|---------------|---------------|---------------|
| POWER OUTPUT       | One Channel<br>4 ohms<br>8 ohms<br>16 ohms  | Both Channels<br>27W/43W<br>22W/36W<br>15W/24W |               |               |               |               |
| FREQUENCY RESPONSE | Phono inputs<br>RIAA equalization within<br>1dB from 30 Hz to 20 kHz<br>25 Hz to 20 kHz = 1 dB<br>High level inputs |  |               |               |               |               |
| CHANNEL SEPARATION | (low respect to 25W)<br>10kHz -33dB<br>1kHz -46dB<br>100 Hz -40dB   |  |               |               |               |               |

**SPECIFICATIONS**

**HUM & NOISE**  
Phono (with respect to 10mV)  
Other inputs  
70dB unweighted with typical cartridge  
70dB unweighted with inputs open circuit

**TOTAL HARMONIC DISTORTION**  
At full power with both channels operating from 25 to 20kHz less than 0.2%  
Typically less than 0.05% at normal listening levels

**INPUT SENSITIVITY**  
Phono at 1kHz 2mV 56k  
Overload at 1kHz 120mV  
High level inputs 150mV 35k (minimum)

**DAMPING FACTOR**

at 1kHz > 60  
at 30Hz > 30  
**STABILITY**  
Unconditional  
**STONE CONTROLS**  
Bass  
+12, -13dB at 50Hz  
Tone  
± 10dB at 10kHz

**SPECIALS OF THE MONTH  
I.C. SOCKETS ON SALE !!**

|            |        |        |
|------------|--------|--------|
| 14 PIN S/T | 10 FOR | \$2.00 |
| 16 PIN S/T | 10 FOR | \$2.40 |
| 14 PIN W/W | 10 FOR | \$3.50 |
| 16 PIN W/W | 10 FOR | \$4.00 |
| 28 PIN S/T | 5 FOR  | \$3.50 |
| 28 PIN W/W | 5 FOR  | \$4.50 |

**T.I. LED DISPLAY SPECIAL**

|  |                           |            |
|--|---------------------------|------------|
| TIL 305  | 5 X 7<br>Alphanumeric     | \$3.50 ea. |
| TIL 311  | Hexadecimal<br>with Logic | \$4.50 ea. |
| TIL 306  | 7 Seg<br>with Logic       | \$6.70 ea. |
| (Counter, Latch, Decoder, and Driver built-in) |                           |            |
| TIL 308  | 7 Seg<br>with Logic       | \$4.75 ea. |
| (Latch, Decoder, and Driver built-in)          |                           |            |



**SUPER 15 WATT  
AUDIO  
AMP KIT**

Uses STK-015 Hybrid Power Amp

Kit includes: STK-015 Hybrid IC, power supply with power transformer, front Amp with tone control, all electronic parts as well as PC Board. Less than 0.5% harmonic distortion at full power 1/2dB response from 20-100,000 Hz. This amplifier has QUASI-Complementary class B output. Output max is watt (10 watt RMS) at 4 Ω.

**ONLY \$23.50 each**

**"FISHER" 30 WATTS STEREO  
AMP KIT (15W x 2)**

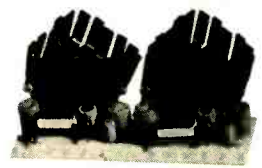

Kit includes: 2 pcs. Fisher PA301 Hybrid IC all electronic parts with PC Board. Power supply: + 16V DC (not included). Power band with (KF = 1% ± 3dB). Voltage gain: 33dB, 20Hz-20KHz.

**ONLY \$22.50 each kit**

MINIMUM ORDER \$10.00. California residents add 6% sales tax.  
All orders add 10% postage for out of state. Overseas countries add 15% of total order for postage.  
SEND CHECK OR MONEY ORDER TO:



**FORMULA INTERNATIONAL INC.**

12603 CRENSHAW BOULEVARD • HAWTHORNE, CALIFORNIA 90250

For more information please call (213) 679-5162

STORE HOURS 10-7 Monday - Saturday

CIRCLE 27 ON FREE INFORMATION CARD

www.americanradiohistory.com

# SHOP YOUR NEARBY RADIO SHACK FOR QUALITY PARTS AT LOW PRICES!

Top quality devices, fully functional, carefully inspected. Guaranteed to meet all specifications, both electrically and mechanically. All are made by well known American manufacturers, and all have to pass

manufacturer's quality control procedures. These are not rejects, not fallouts, not seconds. In fact, there are none better on the market! Count on Radio Shack for the finest quality electronic parts.

## TTL Digital ICs

First Quality

Made by National Semiconductor and Motorola

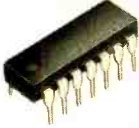

| Type  | Cat. No. | ONLY |
|-------|----------|------|
| 7400  | 276-1801 | 35¢  |
| 7402  | 276-1811 | 39¢  |
| 7404  | 276-1802 | 35¢  |
| 7406  | 276-1821 | 49¢  |
| 7410  | 276-1807 | 39¢  |
| 7413  | 276-1815 | 79¢  |
| 7420  | 276-1809 | 39¢  |
| 7427  | 276-1823 | 49¢  |
| 7432  | 276-1824 | 49¢  |
| 7441  | 276-1804 | 99¢  |
| 7447  | 276-1805 | 99¢  |
| 7448  | 276-1816 | 99¢  |
| 7451  | 276-1825 | 39¢  |
| 7473  | 276-1803 | 49¢  |
| 7474  | 276-1818 | 49¢  |
| 7475  | 276-1806 | 79¢  |
| 7476  | 276-1813 | 59¢  |
| 7485  | 276-1826 | 1.19 |
| 7486  | 276-1827 | 49¢  |
| 7490  | 276-1808 | 79¢  |
| 7492  | 276-1819 | 69¢  |
| 74123 | 276-1817 | 99¢  |
| 74145 | 276-1828 | 1.39 |
| 74150 | 276-1829 | 1.39 |
| 74154 | 276-1834 | 1.29 |
| 74192 | 276-1831 | 1.19 |
| 74193 | 276-1820 | 1.19 |
| 74194 | 276-1832 | 1.19 |
| 74196 | 276-1833 | 1.29 |

## Resistor and Capacitor Packs

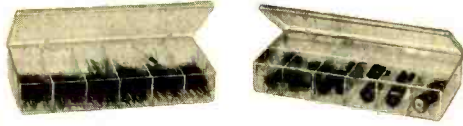

Resistor and capacitor kits in handy plastic storage boxes you can use over and over again. Stock up!  
 1/2 Watt, 10% Tolerance Resistors. 271-601 ..... Pkg. of 350/9.95  
 1/2 Watt, 5% Tolerance Resistors. 271-602 ..... Pkg. of 350/9.95  
 50WVDC Ceramic Disc Capacitors. 272-601 ..... Pkg. of 175/9.95  
 35WVDC Radial Lead Capacitors. 272-602 ..... Pkg. of 35/9.95  
 35WVDC Axial Lead Capacitors. 272-603 ..... Pkg. of 36/9.95

## Tantalum Capacitors

Maximum capacity in smallest size. Low ESR, highly stable electrical characteristics and low leakage. Radial leads.

| Cat. No. | μF   | Each | Cat. No. | μF   | Each |
|----------|------|------|----------|------|------|
| 272-1401 | 0.1  | 39¢  | 272-1407 | 2.2  | 45¢  |
| 272-1402 | 0.22 | 39¢  | 272-1408 | 3.3  | 45¢  |
| 272-1403 | 0.33 | 39¢  | 272-1409 | 4.7  | 49¢  |
| 272-1404 | 0.47 | 39¢  | 272-1410 | 6.8  | 49¢  |
| 272-1405 | 0.68 | 39¢  | 272-1411 | 10.0 | 49¢  |
| 272-1406 | 1.0  | 39¢  |          |      |      |

Nos. 1401-1408, 35WVDC; 1409-1411, 16WVDC.



## PC Board Accessories



8-piece photographic PC board processing kit — fastest, easiest way to produce perfect printed circuit projects.  
 276-1560 ..... 12.95  
 Etch-Resist Marking Pen. 276-1530 ..... 1.19  
 Etchant Solution. 276-1535 ..... 1.89  
 PC Board Assortment. 276-1573 ..... 1.98

## Build an LED Digital Clock



12-HR LED Clock Module. Just add a transformer and switches for a complete clock with 0.5" LED display. 277-1001 ..... 14.95  
 Transformer for above. 120VAC 60 Hz. 273-1520 ..... 3.99  
 SPST Miniature Pushbutton Switch. 275-1547 ..... 5/1.99  
 Display Case. 1 1/8" x 3 7/8" x 4 7/16". 270-285 ..... 3.95

## CMOS ICs

100% guaranteed electrically and mechanically

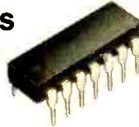

| Type   | Cat. No. | ONLY |
|--------|----------|------|
| 74C00  | 276-2301 | 49¢  |
| 74C02  | 276-2302 | 49¢  |
| 74C04  | 276-2303 | 49¢  |
| 74C08  | 276-2305 | 49¢  |
| 74C74  | 276-2310 | 89¢  |
| 74C76  | 276-2312 | 89¢  |
| 74C90  | 276-2315 | 1.49 |
| 74C192 | 276-2321 | 1.69 |
| 74C193 | 276-2322 | 1.69 |
| 4001   | 276-2401 | 49¢  |
| 4011   | 276-2411 | 49¢  |
| 4013   | 276-2413 | 89¢  |
| 4017   | 276-2417 | 1.49 |
| 4020   | 276-2420 | 1.49 |
| 4027   | 276-2427 | 89¢  |
| 4049   | 276-2449 | 69¢  |
| 4050   | 276-2450 | 69¢  |
| 4511   | 276-2447 | 1.69 |
| 4518   | 276-2490 | 1.49 |

## LED Digital Displays

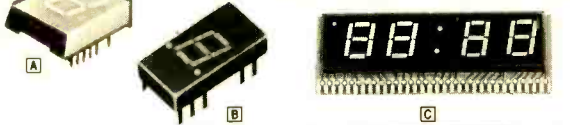

| Digits | Size   | Drive | Cat. No. | ONLY   |
|--------|--------|-------|----------|--------|
| A      | 1 0.6" | Anod. | 276-056  | 2.99   |
| A      | 1 0.6" | Cath. | 276-066  | 2.99   |
| B      | 1 0.3" | Anod. | 276-053  | 1.99   |
| B      | 1 0.3" | Cath. | 276-062  | 1.99   |
| C      | 1 0.3" | Anod. | 276-1210 | 4/6.99 |
| C      | 1 0.3" | Cath. | 276-1211 | 4/6.99 |
| C      | 4 0.5" | Anod. | 276-1201 | 6/9.95 |
| C      | 4 0.5" | Cath. | 276-1202 | 6/9.95 |

## IC Accessories

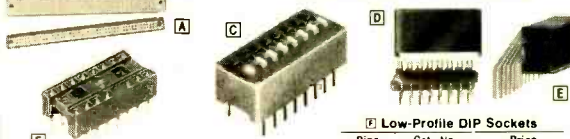

- A Bus Strip. 276-173 ..... 1.99
- B Experimenter Socket. 276-172 ..... 9.95
- C DIP Switch. 275-1301 ..... 1.99
- D DIP Header. 276-1980 ..... 1.29
- E Right Angle 16-Pin Socket. 276-1985 ..... 1.49

### Low-Profile DIP Sockets

| Pins | Cat. No. | Price   |
|------|----------|---------|
| 8    | 276-1995 | 2/59¢   |
| 14   | 276-1999 | 2/89¢   |
| 16   | 276-1998 | 2/89¢   |
| 28   | 276-1997 | Ea. 89¢ |
| 40   | 276-1996 | Ea. 99¢ |

## Power Supply Parts

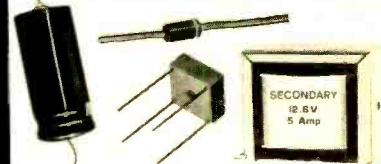

6-Amp Full-Wave Bridge Rectifier. 50 PIV. 276-1180 ..... 1.99  
 50V 3-Amp Power Rectifier. 300-A surge. 276-1141 ..... Pkg. 2/69¢  
 Electrolytic Capacitors  
 3300 μF at 35V. 272-1021 ..... 2.99  
 5000 μF at 35V. 272-1022 ..... 3.49  
 Heavy-Duty Transformers. All for 120VAC. 60 Hz.  

| Cat. No. | Volts   | Current | Size            | Each |
|----------|---------|---------|-----------------|------|
| 273-1512 | 25 2 CT | 2A      | 2 3/4" x 2 1/4" | 4.99 |
| 273-1513 | 12      | 5A      | 4x2x2 1/2"      | 8.95 |
| 273-1514 | 18 CT   | 4A      | 4x2x2 1/2"      | 8.95 |

## Linear ICs

By National Semiconductor and Motorola — first quality

| Type   | Cat. No. | ONLY |
|--------|----------|------|
| 301CN  | 276-017  | 49¢  |
| 324N   | 276-1711 | 1.49 |
| 339N   | 276-1712 | 1.49 |
| 386CN  | 276-1731 | 99¢  |
| 555CN  | 276-1723 | 79¢  |
| 556CN  | 276-1728 | 1.39 |
| 566CN  | 276-1724 | 1.69 |
| 567CN  | 276-1721 | 1.99 |
| 723CN  | 276-1740 | 69¢  |
| 741CN  | 276-007  | 49¢  |
| 741H   | 276-010  | 49¢  |
| 3900N  | 276-1713 | 99¢  |
| 3909N  | 276-1705 | 99¢  |
| 3911N  | 276-1706 | 1.99 |
| 4558CN | 276-038  | 79¢  |
| 75491  | 276-1701 | 99¢  |
| 75492  | 276-1702 | 99¢  |
| 7805   | 276-1770 | 1.29 |
| 7812   | 276-1771 | 1.29 |
| 7815   | 276-1772 | 1.29 |

## Computer Chips



8080A Microprocessor. An 8-bit National Semiconductor chip in a 40-pin DIP. 100% Prime. 276-2510 ..... 17.95

The CPU and Memory IC's you need for building your own personal computer.

2102 Static RAM. 1024-word by one bit read/write memory. Under 600 nS access time. 276-2501 ..... 2.49 Ea. or 8/14.95

## Silicon Solar Cells

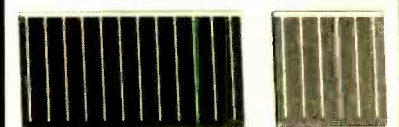

Produce Power from Light!  
 2cmx4cm. 0.5V at 100mA. 276-120 ..... 2.99  
 2cmx2cm. 0.5V at 60mA. 276-128 ..... 1.99

## Clock Chips

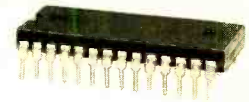

50252. 12-hour clock, 24-hour alarm chip. With full specifications. 276-1751 ..... 6.99  
 7001. 12-hour calendar alarm clock IC. With all data. 276-1756 ..... 10.95

WHY WAIT FOR MAIL ORDER DELIVERY? IN STOCK NOW AT OUR STORE NEAR YOU!

# Radio Shack®

Prices may vary at individual stores and dealers

A TANDY COMPANY • FORT WORTH, TEXAS 76102  
 OVER 6000 LOCATIONS IN NINE COUNTRIES

### 8K ECONORAM II™: kit \$135, 3 kits for \$375, assembled and tested \$155.

This is the board that thousands of owners swear on, not at. There are lots of reasons, such as unique addressing options, reliability, full buffering, fast access time, a full set of sockets... but probably the most popular feature is the price, which is all the more remarkable because of the high level of quality. One owner reviewed this board in the 1/77 issue of *Kilobaud*, closing with the words "If you're not convinced by now that the Econoram II is one of the best memory buys on the market today, you really have to be one tough cookie—either that or you work for someone else who makes memory boards."



### 12K ECONORAM VI™: \$235

We proudly welcome our newest memory board family member, designed from the ground up for full compatibility with the Heath Company H8. Organized as two independent blocks, one 8K block and one 4K. Has the same basic features as our ECONORAM II™—all static design, switch selected protect and phantom sockets for all ICs, full buffering—plus the required hardware and edge connector to mate mechanically with the H8. You can have our 12K board for the price of the Heath Company's 8K... with the performance you have come to expect from products carrying the ECONORAM trade mark.



### 8K ECONORAM III™: \$149

The first 8K X 8 dynamic RAM that performs well enough to merit the ECONORAM™ name. Not a kit, it's assembled, tested, and ready to run in your S-100 machine (Altair, etc.). Low power. Configuration as 2 separate 4K blocks. Zero wait states with 8080 CPU. Includes 1 year warranty.



- CPU POWER SUPPLY ..... \$50  
5V at 4A, +12V at 1/2A, -12V at 1/2A, bias supply.
- 10 SLOT MOTHERBOARD ..... \$90
- 18 SLOT MOTHERBOARD ..... \$124
- These S-100 buss motherboards come with edge connectors and active termination circuitry.
- ACTIVE TERMINATOR ..... \$29.50  
Plugs into S-100 buss motherboards lacking active termination to clean up the glitches associated with unterminated lines.

### MORE COMPUTER ITEMS

"Altair/MSAI Extender Board Kit." We are proud to distribute this Muller Computer Boards product for the S-100 buss. A must for servicing, taking measurements, burning in, etc. Integral logic probe, with needle point non-skid tip and special edge connector for easy probing; \*CK-006, \$35.00. Also available: "Relay/Opto-Isolator Control Board Kit." 8 reed relays respond to 8 bit word; 8 optoisolators accept inputs for handshaking or further control. With applications notes: \*CK-011, \$117.00.

### DB-25 RS-232 SUBMINI-D CONNECTORS:

Male plug, \*CK-1004, \$3.95; female jack, \*CK-1005, \$3.95; plastic hood for male connector, \*CK-1006, \$0.90.

### EDGE CONNECTORS:

\*CK-1001: 100 pin edge connector with gold plated 3 level wrap posts. Mates with Altair/MSAI peripherals \$5 each or 5/\$22.  
\*CK-1002: Same as above, but with soldertail pins on .025" centers (mates with IMSAI motherboard) \$5 each or 5/\$22.  
\*CK-1003: Same as above, but with soldertail pins on .014" centers (mates with Altair motherboard) \$6 each or 5/\$27.50.

### BOOKS

"Some Common BASIC Programs" by Lon Poole and Mary Borchers. If you've got BASIC, here are some programs to play with. \*BK-21002, \$7.50.

The Adam Osborne and Associates Books. We offer "An Introduction to Microcomputers," volumes 1 and 2, plus "8080 Programming for Logic Design" at a special combination price of \$25.00 (order #BK-1001). Also available: "6800 Programming for Logic Design." \*BK-5001, \$7.50.

Send for our flyer

**GODBOUT**  
BILL GODBOUT ELECTRONICS  
BOX 2355, OAKLAND AIRPORT, CA 94614

Terms: Cal res add tax. Allow 5% shipping, excess refunded. Mastercharge® /VISA® orders (\$15 min) call (415) 562-0636, 24 hrs COD OK with street address.

CIRCLE 35 ON FREE INFORMATION CARD

### SN7400 SERIES IC BENT PIN SPECIAL

We have a large lot of SN7400 series ICs, and some linears, that have been removed from wire wrap boards. The only defect we have been able to find are bent pins. The lot includes the entire series of SN7400s, gates, MSI and LSI. We are selling them in lots of 125 for \$10.00, mixed, (no choice), but guarantee a satisfactory mixture that must please you or your money back.

STOCK NO.4591R 125 pc. lot of ICs \$10.00 3/25.00

### GATES RECHARGEABLE BATTERIES



GATES RECHARGEABLE ENERGY CELLS, in banks to give the following ratings: 6 V 10 AH, 8 V 5 AH, 12 V 2.5 AH, and 12 V 5 AH. These units were used in computers as back up supplies in case of power line failures. The batteries were periodically replaced, regardless of usage. Manufacturers specs say cells are good for up to 2000 charge cycles. We supply application and charging data. May come in plastic case, or cells, as per photo.

- STOCK NO.5572R 6 Volt 10 Amp.Hour battery 22.50 2/40.00
- STOCK NO.5573R 8 Volt 5 Amp.Hour battery 19.50 2/37.00
- STOCK NO.5574R 12 Volt 2.5 Amp. hour battery 12.50 2/23.00
- STOCK NO.5575R 12 Volt 5 Amp. hour battery 22.50 2/40.00

MAIL ORDER

### DELTA ELECTRONICS

P.O. Box 2, 7 Oakland St.  
Amesbury, Mass. 01913  
617-388-4705



OVER THE COUNTER SALES ROOMS  
ATLANTA, GA. DELTA ELECTRONIC HOBBIES  
5151 Buford Hwy. Doarville, (Atlanta) Ga. 30340  
BOSTON, Mass. DELTA ELECTRONICS WAREHOUSE OUTLET  
590 Commonwealth Ave. Boston, Mass.02215

CIRCLE 49 ON FREE INFORMATION CARD

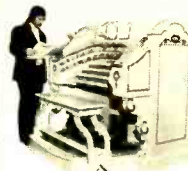

### YES, YOU CAN BUILD AN ELECTRONIC ORGAN

That has a PIPE ORGAN SOUND

With **DEVTRONIX** easy to build assemblies. Own the ultimate in organ design & sound at 1/4 the cost of commercial organs.

Several models to choose from.

BROCHURE AND DEMO RECORD \$1.00



Dept. B  
5872 Ampola Dr.  
San Jose, CA 95129

**CARBON film resistors**—1/4W, 5% (1-4M7 ohms) 3.5¢ each. 50/value—\$0.85. Postage, handling \$1.00. Other components. Free catalog, resistor sample. **COMPONENTS CENTER**, Box 295R, West Islip, NY 11795

**BUILDING?** Try our top quality electronic parts in your circuits. No CB'S, TV'S, or Ham sets—just parts. **BRAND X**, Rt. 3, Box 223, Ontario, OR 97914

**SEEKING Japanese Transistors for CB and stereo repair?** Request complete list. Compare 1 to 9 prices: 2SC710 .59, 2SC517 3.95, 2SC799 3.60, 2SC1306 4.40, 2SC1678 2.25, TA7205P 3.90, BA521 3.70, BA511 3.40. **FUJI-SVEA ENTERPRISE**, Dept. RE, P. O. Box 40325, Cincinnati, OH 45240

**PARTS! CORNELL TUBES!**

FREE Send for FREE  
CORNELL'S New Color Catalog  
48 Pgs. New Items IN LOTS OF 100

**33¢** per tube  
**36¢** per tube  
ORDER FREE IF NOT SHIPPED IN 4 HOURS

4215 E. UNIVERSITY AVE. SAN DIEGO, CALIF. 92105

### Electronic Warning Flasher Kit

This battery operated device continuously emits bursts of intense light. Great safety device for bicycle riders, skiers, hikers, boaters & campers. Comes complete w/ all electronic parts, quality glass-epoxy P-C board & easy to understand instructions. Uses high-output xenon flash tube which flashes 2 times per second when batteries are fresh. Operates continuously for 12 hours on 2 alkaline "C" batteries. You need only to supply the batteries and, if desired, a battery holder & case.



C23207 \$6.95  
(3 for \$18.00)

### Strobe Light Kit

COMPLETE variable-rate strobe light kit. Contains all parts, including time control PC board and instructions. Operates on 117 VAC. \$7.50 each

**6 HV TRIGGER CONU 2 for \$1**  
required to "fire" xenon flash tubes.

**Green Neon**  
Same as NE2 but glows GREEN. Operates on 120V.  
6 for \$1.00

### PHOTOFLASH CAPS

- 350 mf 330V 1.00
- 720 mf 360V 1.50
- 1000 mf 360V 1.75



### Metal matte finish round REFLECTOR

reflector for electronic flash, strobes, slave lights, etc. 3-3/4" Dia. x 1-7/8"



### STROBE TUBE ASST.

Brand new factory prime strobe tubes. Assortment of 5 strobe tubes, w/ schematics \$2.00



- 5V REED RELAY SPST \$1.00
- 5V REED RELAY SPDT 1.50
- JUMBO YELLOW LED 5/\$1.00
- 78L05 5V REG. 5/\$1.00
- 400V 8AMP SCR HSE# 3/1.00



- Minimum order \$5.00
- Please include \$1 for postage
- Visa, MC and COD accepted.
- Phone orders are welcome.

P.O. BOX 27038, DENVER, CO. 80227 Ph: (303) 973-1052

Send for our FREE GIANT CATALOG of unique items

CIRCLE 57 ON FREE INFORMATION CARD

# J.B. Saunders Co.

**3050 VALMONT ROAD  
BOULDER, COLORADO 80301  
Ph: (303) 442-1212**

## Terms:

- All prices subject to change without notice.
- All items change subject to prior sale.
- Please add \$1.00 postage and handling.
- Colorado residents add 3% state sales tax.
- No COD's, please.
- Foreign Orders: send U.S. Funds ONLY.

MINIMUM ORDER \$10.00

### GIANT CATALOG

The best bargain on this page!!!—Our brand new 1977 giant catalog packed with dozens and dozens of super buys on electronic components. Contains such unique components as: Pneumatic switches, electric motors, Caps, wire, resistors, diodes, switches, LED's, transformers, transistors, and much, much more. Perhaps we have just the item you've been looking for!!



### REED RELAY

High quality, ultra-sensitive 5VDC SPST reed relay. Use in a variety of applications where transistors or SCR's are not quite suitable. May be driven directly from TTL. RRY-510 \$1.50

### DIGITAL READOUTS

Hewlett-Packard prime units HP #7730, .3" character (RED) Common Anode.....\$1.70  
4 for \$4.95

### FAN MOTOR

117VAC fan motor for use in cooling insides of test equipment, operating models, cooling yourself off, etc. A fantastic buy at this price! MOT-115 \$2.25

### LOGI-CASE

Universal instrument enclosure with a wide variety of applications. Unique interior plexiglass rack assembly will hold up to 6-1.5" by 4" PC boards. Great for packing a lot of components into a very small space. Adds a very professional touch to any project. Made from 1/8" thick anodized, extruded aluminum. So tough that you can run over it without damaging it!!!! The Logi-Case comes with a reversible front filter allowing you to choose between transparent red or smoke grey. Now available in two popular sizes:  
Small: 4 1/2" x 3 3/4" x 1 3/8"  
Large: 6" x 4 3/4" x 2"  
\$7.95  
SMALL (LCS 100) .....  
LARGE (LCS 200) ..... 9.95

### 4N27 OPTO ISOLATOR

NPN phototransistor & PN infra red light emitting diode. 1500 volt isolation. 3ma coil output current. Excellent frequency response to 300 kHz. Brand new Motorola 6 pin DIP with full specs & data. \$1.00 10 for \$9

### 12V RELAY

Brand new 12VDC relay by Cornell-Dubilier. Has N.O. and N.C. contacts. Measures approx. 1 x 1 1/2". CRY-012 \$1.50

### P.C. TRIMMER POTS

| TYPE                 | PART NO. | PRICE |
|----------------------|----------|-------|
| 470 ohm, vertical    | PCV-471  | 25    |
| 1K ohm, vertical     | PCV-102  | 20    |
| 2.5K ohm, vertical   | PCV-252  | 20    |
| 5K ohm, vertical     | PCV-502  | 20    |
| 22K ohm, horizontal  | PCV-223  | 25    |
| 50K ohm, vertical    | PCV-503  | 20    |
| 470K ohm, horizontal | PCV-473  | 25    |

### 9/18v 1.5a Trans.

SPLIT PRIMARY WINDING GREAT TRANSFORMER FOR 9 OR 18V UNREG. OR 5, 6, 12, OR 15V REG. ALSO ALLOWS 220V OPERATION. \$2.95

### RO170 DIODE

The famous Motorola HEP170 universal replacement diode. Rated 1000 PIV @ 2.5 Amps. HEP-170 ..... 20 cents ea. 100 for only ..... \$14.50

### STROBE TUBE

Experimenter's delight! New xenon strobe tube & trigger transformer. Tube op. from 150-300V. FFT-100 1.75

### TELEPHONE WIRE

26 AWG Telephone wire; hook-up wire; single strand, twisted pair & 20 pair. Single Cond. 100ft/90¢ 1 pr-100/1.40 20pr-1ft/20¢

### TRANSFORMER

Mini transformers for clocks, etc. Outputs 8V @ 500ma or 12V @ 190ma. With specs. CMX-812 \$1.50

### HEAT SHRINK

Much easier to use than electrical tape. Slip over solder joint & heat. Tube will shrink to form tight seal. 12-6" prices, assorted sizes. HST-120 \$1.45

### 1-3pf TRIM CAP

Mini trim cap. Great for crystal circuits, hand probes, etc. Measures 3/16" diameter. PCT-130 95¢ for \$3.50

### VOX

Solid state Voice Operated switch. Complete w/ all parts and completely assembled. SCR output. W/ schematic. VOX-900 ..... \$1.50

### Insulating Washer

A MUST FOR TO-3 TRANSISTOR APPLICATIONS w/HIGH HEAT TRANSFER. 10 FOR 75¢

### .1uf, 6000V CAP

New by Sprague. Great for experimenting w/ high voltage. AX-160 ..... 70¢

### 2N3055

The king of audio power transistors now at an unbelievable price!!! Brand new. BNC-055 ..... 50¢

### TOGGLE SWITCH

Heavy duty, SPST high quality. Rated 15A @ 125 VDC. TSW-111 95¢

### POWER RELAY

Potter & Brumfield 20V. SPDT, 25 Amp. CRY-012 \$4.00

### SNAP SWITCH

Mini SPDT snap switch by Cherry. Rated 5 amps, 125-250 VAC. MSW-523 45¢

### RIBBON CABLE

Cond. Part No. 1' 10' 6 RIB-006 25 2.00 12 RIB-012 45 3.95 24 RIB-024 85 7.95

### WIRED SWITCH

Strange, but useful reverse-action snap switch w/ level, NC & NO connection. LSW-100 ..... 75¢

### WIRE SPECIAL

22 ga. magnet wire. Unique solder-thru insulation. Buy by the pound and save! (Approx. 500 feet). LBW-220 \$2.50

### RUBBER FEET

Molded, adhesive back rubber feet in peel-off sheets from 3M. Round: (RRF-120) 12 for 75¢ Square: (SRF-120) 12 for 55¢

### POT w/ SWITCH

New by Allen-Bradley. 100K mini 1/8" shaft, 1/2" mount. with SPST switch. CVR-104 65¢

### MICRO SWITCH

Miniature SPDT momentary contact pushbutton. Rated 5 amps @ 125VAC. MSP-111 95¢

### TTL DATA BOOK

The newest edition of the TTL data book for design engineers. Detailed specs on over 900 TTL devices including standard and high-technology Schottky Clamped TTL. Pin assignment drawings of all TTL types. The most complete book ever written on TTL. —By Texas Instruments. TDB-254 \$4.95

### VACUUM SWITCH

SPST pneumatic switch. Enclosed diaphragm activates with vacuum or pressure. Extremely sensitive. Brand new. VPS-195 ..... \$1.95

### 10a POWER CORD

High quality power cord. New from Belden, 10a, 125v 3 connector, approx. 5ft. 75¢

### 5 MEG H.V. POTS

High voltage pots w/ insulated shaft for protection against high voltage. 1/4" shaft (TVR-505) 75¢

### 1.5V DC MOTOR

Great for toys, experimenting, etc. 6" leads, 1/16" shaft. MOT-015 ..... 50¢ 10 for only ..... \$4.00

### MINI-SWITCH

Brand new by C & K. Very high quality SPDT toggle, rated 5Amps @ 125 VAC. MST-111 \$1.10

### RUBBER EDGING

Protection from unsightly metal edges. Contours to any shape... For mat'll up to 1/16" thick. 10' for \$1.60 100' for \$12

### PHOTOFLASH CAP

Brand new Rubycon. 600 uf at 360 volt. Use with our flash tube & trigger transformer to make a very high quality strobe light!!! PFC-360 \$1.95

### Switch

SPDT momentary, center-off! (on off-on). Rated 15A @ 125VAC, 10A @ 250VAC. New Units. 55¢

### COMPUTER CAPS

Quality computer grade caps. 12000mf @ 25VDC CGC-122 ..... 3.95 5000mf @ 30VDC CGC-503 ..... 1.95 2700mf @ 25VDC CGC-272 ..... 1.75

### MOD-POT

High quality dual concentric pot. 1/8 and 1/4 inch shafts. New by Allen Bradley. Measures 5/8" square. Front pot is 25K linear. rear pot is 50K log. MVR-255 \$1.75

### AA Battery Clip

DIET AA BATTERY CLIP. ALL METAL. 25¢

### 1N4448

Case AA, 75v., high speed diode. New from Texas Instruments. 12 for \$1.00

### SLIDE SWITCH

Standard DPDT Long shaft for deep panel mounting. 3A @ 125VDC. SSW-221 25¢

### POT NUTS

Standard size pot hex nuts. 2 sizes: 3/8" ..... PTN-380 1/4" ..... PTN-140 your choice, 25 for ..... 1.00

### FELT FEET

3/8" diameter. Comes in peel-off strips of 25 felt feet per strip. FFT-015 25¢ strip

### .01uf DISC

.01 uf disc ceramic capacitor. We have thousands!!! Buy while they last DCP-010 5¢

### IOK POT

New from CTS mini 1/8" shaft, 1/4" mounting dia. QVR-103 65¢

### DIKIE BELL

Enclosed, aluminum signal bell. 6.8VAC or 3.6V D.V. New units. DBL-720 \$2.00

### .02uf DISC

.02 uf disc ceramic capacitor. We have thousands!!! Buy while they last DCP-020 5¢/20 for 80¢

### 6CM4

We somehow managed to get hold of hundreds of these. Very popular number for replacement in radios, TV's, etc. New and unused. 50¢

### STAND-OFF

Insulated stand off terminal, 1/4" dia., 5/8" long. With 1/4" mounting screw. SOT-210 10/S1.49

### Hi-Voltage Cap

CERAMIC DISC .001 MFD @ 10kv 35¢ 10/\$2.50

### .1/50V CAP

TRW dipped mylar capacitor. 1 uf at 50 VDC. DCP-150 15¢

### ROCKER SW.

PC mount, 2 pole 3 position. Used, but in very good condition. RSW-231 25¢

### BARRIER BLOK

Black molded bakelite barrier block, 5 position. BTS-250 25¢

### 5uf, 150V

5 uf, 150VDC cap. Great for audio crossover networks. Non-polarized. NPC-515 60¢

### 5200uf CAP

New by STM 5200 uf @ 50VDC. Brand new. PCL-522 75¢

### 1800uf CAP

1800 uf at 40VDC. Brand new. PCL-184 55¢

### TERMINAL

Single solder terminal strip. Bakelite mount. STS-010 6 for ..... 25¢

### .01uf MINI CAP

Ultra-miniature .01 uf ceramic chip capacitor, axial lead. Appx. 1/4" long. High quality. 15¢

### 47pf MINI CAP

Ultra-miniature ceramic capacitor for crystal circuits, etc. UMC-047 10¢

### TYPE MKM

Extremely stable metallized polycarbonate .01 uf at 150 VDC. 4" lead spacing. MKM-010

### 760 HC COMPARATOR

TTL compatible. 8 lead TO-5 case. CMP-760 50¢

### 60 AMP (!)

Power terminator strip. Sell's new for over \$11.00. Mfg. by Curtiss. PTS-060 \$4.00

CIRCLE 19 ON FREE INFORMATION CARD

www.americanradiohistory.com

**BIG SAVINGS ON TOP QUALITY PARTS AND SURPLUS**

**110 VAC SOLENOID WATER VALVE**

**Surplus!**

Brand new factory surplus - as used in dishwashers, etc. Great for building automated garden watering system, lab work, service and industrial applications. While they last. G242SU.

**3<sup>95</sup>**  
10/\$34.95

**FREE**



**Silicone Treated RECORD CLEANING CLOTH WITH EACH ORDER!**

**IF YOUR ORDER TOTALS \$10.00 OR MORE, ASK US FOR THREE OF THESE! G117MS.**

**10 SECTION 50" WHIP ANTENNA!**

**99¢**

**SURPLUS**

2000 available

A nice surplus 10-section telescopic whip antenna for general replacement or for the builder. 6 1/2" collapsed - 50" extended. Base diameter 3/8". Our normal price \$1.69. G180AE.

**EICO'S GRAND OPENING SALE**

**OF OUR NEW PLATTSBURGH, N.Y. MAILORDER CENTER AND WAREHOUSE STORE! NOW - MUCH IMPROVED MAILORDER SERVICE DIRECT FROM OUR GIANT U.S.A. WAREHOUSE! PERSONAL SHOPPERS ARE WELCOME!**

THOUSANDS SOLD TO SCHOOLS

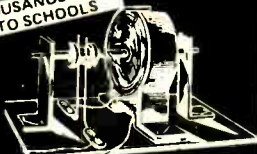

**DEK EDUCATIONAL ELECTRIC MOTOR KIT**

**\$1.99**  
10/\$15.95  
**EXPERIMENTERS! SPECIAL!**  
**INSTRUCTIONS IN FRENCH & ENGLISH**

Follow the instructions and from bits and pieces of wire and metal, it springs to life. The instructions teach basic electrical theory. Includes every thing necessary except flashlight battery. G197KT.



2000 in stock! low price!

**99¢**

10/\$7.88  
100/\$59.95

**TRIGGER TYPE SWITCHES!**

Brand new Factory Surplus, of a type very commonly used on power drills and other pistol-type electric tools. Rated 4 amps, 110 vac. "Press-pin-to-lock-on". While they last. G044SW.

**EICO**

**HIGH INTENSITY**



**Black-Lite Strobe**  
**WEIRD EFFECTS**

**INCREDIBLE EICO VALUE!**

**\$39<sup>95</sup>**  
**SALE**

Creates a sensational sensory experience. Posters which merely glow with blacklite, dance with illumination when using a blacklite strobe. This instant-starting 15 watt bulb in polished chrome reflector, almost equals 75 watts of ordinary blacklight. Easy mounts over paintings, in windows, etc., with multi-position "keyhole" slots. Throws its mystifying illumination as far as 25 feet or more. Solid state strobe circuit. Adjustable on/off rate allows you to synchronize illumination with the rhythm of your music for extraordinary effects. Strobe action turns off for use as regular blacklite. Black cabinet. Size 4 1/2" x 18" x 4". G054EK.

**CANADIANS:**

ORDERING FROM THIS AD IS SIMPLE - Please remit in U.S. funds, CHARGE X or MASTERCHARGE. We do the paperwork and ship direct to you from the U.S.A. at low American prices. You pay duty and tax to Canadian Customs (Canadian schools are exempt). We have stores in Canada, too! Write for Canadian catalogs. We also invite you to visit our Plattsburgh, N.Y. Store. (just 55 minutes from Montreal)

**TELEPHONE YOUR ORDERS**

Phone in your Chargecard orders at low station-to-station rates: Call: 1-518-561-8700.

**SURPLUS WANTED!**

CONTACT OUR BUYING OFFICE IN PLATTSBURGH, NEW YORK.



# LOOK AT THESE SPECIALS!

**Interesting 24 VDC INCREMENTAL STEPPER MOTOR!**

**BRAND NEW \$8.95 FACTORY SURPLUS!**

10/\$69.95

Every time you apply 24 VDC, this HAYDON Gearhead motor rotates 3.6°. Apply 100 pulses and you have completed one shaft rotation. Gearing way down for high output torque. Haydon No. 350400, R-36. Brand New! \$020RP.



**Radiotelephone DECODER ESCAPEMENT**

Removed from West... Electric Radiotelephones-Unusual, excellent for experimenters. This precision electromechanical device accepts electrical impulses and through a ratchet and pawl action advances a code wheel. The proper sequence of pulses will cause the code wheel to complete a circuit and thus ring a bell or other device. Improper pulse sequence is ignored. Changeable code. Excellent condition, glass cover. G016SU.

**\$19.95**



**BARGAIN SCOOP**

40 ohm Speaker

**\$9.95**

12/\$89.95



**Sold Out to ETCO**

**1,000 POUNDS OF GLASS EPOXY PC BOARD!**

Beautiful double and single sided copper clad glass epoxy board. (not fibre). Ready for etching. Neatly cut in convenient rectangular angles of various sizes. Suitable for most popular projects.

**2.95**

G339PT - 1 pound of Single-Sided Boards - \$2.95  
G338PT - 1 pound of Double-Sided Boards - \$2.95



**1200 ft. PHILIPS RECORDING TAPE!**

**\$2.95**

10/\$19.95

Fine quality Philips tape at a very special ETCO price. 5" reel. Each box cello-wrapped. Ideal for dealer resale. Polyester. No more after these 600 rolls sold. G150TR.



**SPECIAL PURCHASE**

**"In-Wall" Intercom Sub Station**

We scooped up 300 of these brand new individually cartoned units. Manufactured by Bern's Air King Corp. of Chicago. 9 1/2" x 11" white plastic face. 8" - 40 ohm speaker. Front panel includes volume control, DPDT spring return slide switch and multipole rotary switch. Ideal for custom intercom and background music installations for home, office or hospital. An unusual factory surplus item. Stock up now while we have 'em. G257SP.

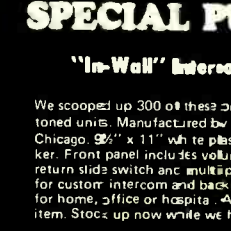

**Special Purchase!**

**GE RTV124 BLACK SILICONE RUBBER SEALANT!**

**Compare!**

**2.95**

Another ETCO buyout! 13.7 oz. spouted "gun cartridge" of GE RTV124 black silicone rubber adhesive/sealant so popular for industrial applications and home handyman use. A multitude of applications. Stock is limited. G056CH.

**BARGAIN SCOOP**



**6AQ6 TUBES!**

**SURPLUS SALE!**

**99¢**

10/\$8.95  
100/\$79.95

WHILE THEY LAST! Dual Diode. High-mu Triode. 6.3V Heater.

**FACTORY SURPLUS!**



**AS PICTURED**

**99¢**

**12-DIGIT READOUT!**

**PRICE BREAK!**

Brand new Factory Surplus Burroughs No. BR13451 - exactly as pictured. 4" 7 segment characters. MOS compatibility. Designed for multiplex mode operation. G599DR.



**Special Scoop Purchase**

**POWER SUPPLY PS 1202U**

**\$9.95**

**ATTENTION DEALERS!**

12 VOLT, 2 AMP

Easily capable of 3-4 Amp Surges! Excellent for CB, car stereo and general hobby applications. A sensational purchase allows us to offer these at this low, low price while inventory lasts! Dealers - STOCK UP NOW! G233HP.



**5Y4 RECTIFIER TUBE!**

It will soon be impossible to find at any price! Hard working Power Supply tube for antique radios, juke boxes, phonographs, etc. Stock up now while we have 'em.

**AN OLDIE BUT A GOODIE!**

**1.29**

**FACTORY SURPLUS!**



**Burroughs**

**Burroughs "Panaplex" 16 DIGIT READOUT PANEL!**

**CLOSE-OUT \$2.95**

10/\$24.95

Brand new Factory Surplus Burroughs No. BR16401 (K85). Exactly as pictured. G156DS.



**2 1/2" PLASTIC CONE HI FI TWEETER!**

**49¢**

10/\$4.49  
100/\$39.95

**U.S. GOV'T SURPLUS**

A fabulous buy! Originally designed to U.S. Gov't spec as a dynamic mike cartridge, these units turn out to have super specs as ultra-hi fi tweeters. Impedance 8-16 ohms, Response 3.5 to 21.5 KHz. Power: 10 watts peak, over 1 watt continuous. Each comes with an 8000 ohm transformer which is easily disassembled. G024SP.



**AIRPAX DC CIRCUIT BREAKERS!**

**AIRPAX ELECTRONICS SURPLUS \$1.95**

Brand new factory surplus. Both models have built in SPDT switch for "tattletale" pilot light. Quantities limited.

G079MS - No. UPL1-1R0-588-01-25 Amp Trip ..... \$1.95  
G086MS - No. UPL1-1R0-266-07-18.8 Amp Trip ..... \$1.65

**5 AMP - 3AG PIGTAIL FUSES!**

**LITTELFUSE \$1.29**

BOX OF 5.

**SPECIAL PURCHASE of Brand-New Littelfuse No 318005 INVENTORY. Box of 5. G078FU.**



**HERE'S LOOKING AT YA!**

**69¢ SURPLUS**

10/\$5.95

Fascinating little photographic surplus item! Photoresistive cell senses light level, feeding signal to IC controlled flip-flop circuit that selectively lights mini incandescent "go" or "no-go" lamps. Adjustable threshold control. Operates on 1/2 to 6 volt DC @ 150 mA. Can drive EV-150 mA relay. Size 27mm x 12mm. Brand New camera Factory Surplus. G309SU.



**41 CONTROL "NAKED" KEYBOARD!**

**SURPLUS \$2.95**

12 1/2" x 5 1/2" PC board with 41 "Keytronic" momentary contact keyboard switches and 41 diodes. Totally accessible for easy modification for computer teletype, or controller applications. G297SU.



**ETCO ELECTRONICS**

Rush Your Order Today To... **ETCO ELECTRONICS CORP. U.S.A.**  
North Country Shopping Center,  
Route No. 9, Prattsburgh, N.Y. 12901.

Merchandise subject to prior sale. Prices subject to change without notice. Full remittance with each order, please. Money Order, Certified Check, BANKAMERICARD, VISA, MASTERCARD or CHARGE. Add 15% for UPS (postage), and handling (we refund excess). N.Y. State residents add 7% sales tax. Please try to bring your order total to \$10.00 or more. Worldwide export orders solicited. Special quotes for large quantities.

# SENCORE VALUE FROM FORDHAM

FOR PRICING AND TO ORDER

CALL TOLL FREE  
**(800) 645-9518**

For N.Y. State call (516) 752-0050

**FREE** 164 page catalog of over 3000 items ... test equipment, CB, tools, tubes, components and electronic supplies



**FORDHAM**  
YOUR ONE STOP DISCOUNT CENTER

RADIO SUPPLY CO., INC.  
855R Conklin St.  
Farmingdale, N.Y. 11735

**TRANSISTOR & FET TESTER**  
**Model TF 46 Portable Super Cricket**  
■ Completely portable ■ Automatic ■ Simple to use  
■ Automatic power shut-off after 10 minutes



**FREQUENCY COUNTER**  
**Model FC 45**

■ Frequency range coverage for every use from audio through VHF  
■ Better than FCC accuracy.  
■ High sensitivity for circuit testing ■ Easy-to-use pushbuttons.  
■ Direct readout.



**AUTOMATIC CB ANALYZER**  
**Model CB 42**

■ The total CB service bench ... simplified.  
■ Combines 5 units in one for complete testing:  
1) Frequency Counter; 2) RF-IF Generator; 3) Audio Generator; 4) Digital RF Wattmeter; and 5) Special CB Tester



**TV-VTR-MATV & VIDEO ANALYZER**  
**Model VA 48**

■ New patented Bar Sweep patterns for simplified speed alignment ■ All RF & IF signals for injection before the detector from one cable ■ All drive signals for every stage after the detector — tube and solid state ■ Uses standard color bars and patterns ■ 100% accurate Ringer yoke and flyback test ■ Accurate drive signal monitoring ■ Video sweep generator ■ Bias and B+ substitute power supply.

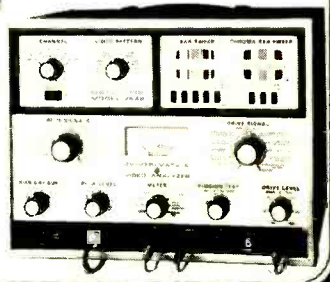

CIRCLE 58 ON FREE INFORMATION CARD

**EDGE CONNECTORS**

156 CENTERS, FIT 1/16" BOARDS  
GOLD CONTACTS, POP-UP MFRS.,  
SINGLE READOUT

- 6 pin C-3101 .49  
SOLDER TERMS
- 15 pin C-3108 .49  
SOLDER TERMS
- 18 pin .59  
WIREWRAPE POSTS  
C-3112
- 22 pin C-3104 .99  
SOLDER TERMS

WOW!  
22 pin 3110 .99  
WITH BUILT IN CARDS  
GUIDES FOR STD A-172  
BOARDS

ROCKER SWITCHES—  
ASST'D SPST. 10  
SPST & COLORS FOR  
A-2002 \$1

PC SLIDE SWITCH—  
MINI SPOT 20/51

59c  
SOUND  
ACTUATED  
SWITCH

PRIME NATIONAL  
8080A \$12.50 ea  
21L02-1 \$1.80 ea  
PRIME FAIRCHILD 8/\$12.50

—REGULATORS—  
1 AMP TO-220  
7812 69c ea  
7815 10/6.50

78L05 100 MA TO-92  
78L12 38c ea  
78L15 10/3.50

S-2008 SCR 6 AMP 200V 55c ea  
10/3.50  
T-2008 TRIAC 6 AMP 200V 55c ea  
10/3.50

0.35" HIGH NUMERICAL COMMON CATHODE  
YOUR CHOICE  
69c  
10/5.6

FND 357  
3" PM SPEAKER  
32 OHM VC FOR BEEPERS, INTERCOMS, ETC.

2N3055  
115V 60V 15A

DIP SOCKETS  
LOW PROFILE  
14 PIN 186  
16 PIN 204  
24 PIN 384  
28 PIN 454

WIRE WRAP SPECIAL  
14 PIN GOLD 2 LEVEL  
294 ea, 10/\$2.50

CRYSTALS  
TUNE WITH 18 PF  
3.579545 MHz \$1.25  
4.000000 MHz \$1.50  
4.194304 MHz \$1.50

MM5369  
3.58 MHz TO 80 MHz OSC & DIVIDER IC  
\$2.29

.. SEND FOR OUR CATALOG ..

**74LS00**

|        |    |         |      |
|--------|----|---------|------|
| 74LS00 | 28 | 74LS136 | .39  |
| 74LS02 | 28 | 74LS138 | .79  |
| 74LS03 | 28 | 74LS139 | .79  |
| 74LS04 | 28 | 74LS145 | 1.50 |
| 74LS05 | 28 | 74LS152 | .75  |
| 74LS08 | 28 | 74LS153 | .75  |
| 74LS09 | 28 | 74LS155 | .75  |
| 74LS10 | 28 | 74LS156 | .75  |
| 74LS11 | 28 | 74LS157 | .75  |
| 74LS12 | 28 | 74LS158 | .75  |
| 74LS13 | 28 | 74LS160 | 1.02 |
| 74LS14 | 28 | 74LS161 | 1.02 |
| 74LS15 | 28 | 74LS162 | 1.02 |
| 74LS16 | 28 | 74LS163 | 1.02 |
| 74LS17 | 28 | 74LS164 | 1.02 |
| 74LS18 | 28 | 74LS165 | 1.02 |
| 74LS19 | 28 | 74LS166 | 1.10 |
| 74LS20 | 28 | 74LS167 | 1.10 |
| 74LS21 | 28 | 74LS168 | 1.10 |
| 74LS22 | 28 | 74LS169 | 1.10 |
| 74LS23 | 28 | 74LS170 | 1.70 |
| 74LS24 | 28 | 74LS171 | 1.20 |
| 74LS25 | 28 | 74LS172 | 1.20 |
| 74LS26 | 28 | 74LS173 | 1.20 |
| 74LS27 | 28 | 74LS174 | .99  |
| 74LS28 | 28 | 74LS175 | .99  |
| 74LS29 | 28 | 74LS176 | .99  |
| 74LS30 | 28 | 74LS177 | .99  |
| 74LS31 | 28 | 74LS178 | .99  |
| 74LS32 | 28 | 74LS179 | .99  |
| 74LS33 | 28 | 74LS180 | .99  |
| 74LS34 | 28 | 74LS181 | .99  |
| 74LS35 | 28 | 74LS182 | .99  |
| 74LS36 | 28 | 74LS183 | .99  |
| 74LS37 | 28 | 74LS184 | .99  |
| 74LS38 | 28 | 74LS185 | .99  |
| 74LS39 | 28 | 74LS186 | .99  |
| 74LS40 | 28 | 74LS187 | .99  |
| 74LS41 | 28 | 74LS188 | .99  |
| 74LS42 | 28 | 74LS189 | .99  |
| 74LS43 | 28 | 74LS190 | .99  |
| 74LS44 | 28 | 74LS191 | .99  |
| 74LS45 | 28 | 74LS192 | .99  |
| 74LS46 | 28 | 74LS193 | .99  |
| 74LS47 | 28 | 74LS194 | .99  |
| 74LS48 | 28 | 74LS195 | .99  |
| 74LS49 | 28 | 74LS196 | .99  |
| 74LS50 | 28 | 74LS197 | .99  |
| 74LS51 | 28 | 74LS198 | .99  |
| 74LS52 | 28 | 74LS199 | .99  |
| 74LS53 | 28 | 74LS200 | .99  |
| 74LS54 | 28 | 74LS201 | .99  |
| 74LS55 | 28 | 74LS202 | .99  |
| 74LS56 | 28 | 74LS203 | .99  |
| 74LS57 | 28 | 74LS204 | .99  |
| 74LS58 | 28 | 74LS205 | .99  |
| 74LS59 | 28 | 74LS206 | .99  |
| 74LS60 | 28 | 74LS207 | .99  |
| 74LS61 | 28 | 74LS208 | .99  |
| 74LS62 | 28 | 74LS209 | .99  |
| 74LS63 | 28 | 74LS210 | .99  |
| 74LS64 | 28 | 74LS211 | .99  |
| 74LS65 | 28 | 74LS212 | .99  |
| 74LS66 | 28 | 74LS213 | .99  |
| 74LS67 | 28 | 74LS214 | .99  |
| 74LS68 | 28 | 74LS215 | .99  |
| 74LS69 | 28 | 74LS216 | .99  |
| 74LS70 | 28 | 74LS217 | .99  |
| 74LS71 | 28 | 74LS218 | .99  |
| 74LS72 | 28 | 74LS219 | .99  |
| 74LS73 | 28 | 74LS220 | .99  |
| 74LS74 | 28 | 74LS221 | .99  |
| 74LS75 | 28 | 74LS222 | .99  |
| 74LS76 | 28 | 74LS223 | .99  |
| 74LS77 | 28 | 74LS224 | .99  |
| 74LS78 | 28 | 74LS225 | .99  |
| 74LS79 | 28 | 74LS226 | .99  |
| 74LS80 | 28 | 74LS227 | .99  |
| 74LS81 | 28 | 74LS228 | .99  |
| 74LS82 | 28 | 74LS229 | .99  |
| 74LS83 | 28 | 74LS230 | .99  |
| 74LS84 | 28 | 74LS231 | .99  |
| 74LS85 | 28 | 74LS232 | .99  |
| 74LS86 | 28 | 74LS233 | .99  |
| 74LS87 | 28 | 74LS234 | .99  |
| 74LS88 | 28 | 74LS235 | .99  |
| 74LS89 | 28 | 74LS236 | .99  |
| 74LS90 | 28 | 74LS237 | .99  |
| 74LS91 | 28 | 74LS238 | .99  |
| 74LS92 | 28 | 74LS239 | .99  |
| 74LS93 | 28 | 74LS240 | .99  |
| 74LS94 | 28 | 74LS241 | .99  |
| 74LS95 | 28 | 74LS242 | .99  |
| 74LS96 | 28 | 74LS243 | .99  |
| 74LS97 | 28 | 74LS244 | .99  |
| 74LS98 | 28 | 74LS245 | .99  |
| 74LS99 | 28 | 74LS246 | .99  |

**TUBES**, receiving and Industrial, semiconductor, factory boxed, low prices, free price list.  
**TRANSLETORNIC INC.**, 1365 — 39th Street, Brooklyn, NY 11218 212-633-2800

CA 3140 MOS op amp: 95c. CA 3080: 95c. CA 3401 quad: 45c.  
TAU SYSTEMS model 1010 Volt. cont'd. active LOW PASS filter kit, 10 Hz-30kHz, 10Vp-P, 1 volt per octave, -15V @ 30mA. Variable "Q" ..... only \$47. each

Serial Analog Delay 1024 STAGE DELAY IC. U.S. made, same as RETICONS: SAD 1024a. W/data etc... \$17. each

Voltage Controlled Oscillator Module: TAU SYSTEMS model 1230. 1v/oct, 10 Hz-10kHz, 10 vP-P output, sawtooth & pulse outs, ready to use. W/data \$24.50

HYBRID STATE VARIABLE FILTER. Features: HP, BP, LP, Stimul. outs + xtra op amp. Same as Nat'l's AF-100. DC-10kHz, 2 resistors set Fc. With Data: \$7.30 each

UA 796 Bal Mod: \$1.50 M-156B .15 volt trkg reg 95c

**CFR ASSOCIATES**  
**Box F**  
Newton NH 03858  
TO ORDER: add \$1.75 for Shpg. & Hdg. That's all it takes.

WRITE FOR OUR LATEST FLYER

**POWER** booster, in car, 25 watts stereo, transformerless. Guitar amplifier, up to 250 watts. Schematic, parts list, \$5.00 each, \$7.50 both.  
**BURMON, P.O. Box 2483, Dearborn, MI 48123**

**TAPE** head cleaner, 8 oz. — \$2.30. Includes postage and handling. Write: "CLEANER," Box 176, Whitewater, WI 53190

**EC-101 CURVE TRACER**  
STILL BY FAR THE LOWEST COST FULL FUNCTION CURVE TRACER ON THE MARKET. ATTACHES TO YOUR SCOPE IN SECONDS. USED BY EDUCATORS, PROFESSIONALS AND HOBBYISTS ALL OVER THE WORLD. 30 DAY MONEYBACK GUARANTEE.

**lab science** \$49.50  
ADD \$2 P&H  
COLO. RES. ADD 3% SALES TAX

PO BOX 1972, BOULDER, COLO. 80306

**RECORDS-TAPES!** Discounts to 73%; all labels; no purchase obligations; newsletter; discount dividend certificates; 100% guarantees. Free details. **DISCOUNT MUSIC CLUB**, 650 Main St., Dept. 3-0378, New Rochelle, NY 10801

CIRCLE 40 ON FREE INFORMATION CARD

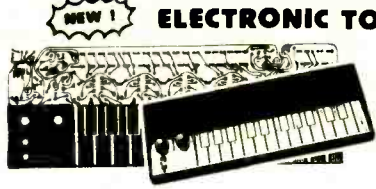

**ELECTRONIC TOUCH ORGAN KIT**

Fantastic new design uses CMOS I.C. and a total of 39 semi-conductors to give a touch control keyboard, all the electronic parts in one PC Board. This organ is easy to build, yet has features like a full two-octave range touch keyboard, variable tremolo; two voices; built-in I.C. amplifier with volume control, complete with speaker and a specially designed plexi-glass case.

BATTERIES NOT INCLUDED \*Ideal kit for beginner or gift for children **\$24.50 ea.**

**DIGITAL CASSETTE TAPE C-60**



**COMPUTER RECORDING**  
All these tapes made in U.S.A. by a top cassette tape Co. Never Recorded - Reg. \$6.80 ea. **3 packs/\$5.00**  
Can be used in Audio Recording as well.

**SOUND ACTIVATED SWITCH**



All parts completed on a PC Board SCR will turn on relay, buzzer or trigger other circuit for 2 ~ 10 sec. (adjustable) Ideal for use as door alarm, sound controlled toys and many other projects.  
Supply voltage 4.5V ~ 9V D.C. \$1.75 ea./2 for \$3.00

**Sub-Mini Size Condenser Microphone \$2.50 each**  
FET Transistor Built-in

**SIGMA 78RE1, 12DC RELAY 400R COIL SPDT**  
\$1.30 ea. or 10 for \$10.00  
ALL BRAND NEW UNITS

**COMPUTER GRADE CAPACITORS**

|                |            |
|----------------|------------|
| 5,600 MFD 60V  | \$2.20 ea. |
| 10,000 MFD 50V | \$3.25 ea. |
| 11,500 MFD 75V | \$3.95 ea. |
| 34,800 MFD 50V | \$4.25 ea. |
| 85,000 MFD 25V | \$4.10 ea. |
| 100,000 MFD 6V | \$3.50 ea. |



**30MHZ FREQUENCY COUNTER KIT**

Take advantage of this new state-of-the-art counter featuring the many benefits of custom LSI circuitry. This new technology approach to instrumentation yields enhanced performance, smaller physical size, drastically reduced power consumption (portable battery operation is now practical), dependability, easy assembly and revolutionary lower pricing!

Only **\$59.50**

Model 250-30A Includes all parts, PC Board and Transformer

- \* 0.5" red LED 6 digits display
- \* Resolution: 1 Hz at 1 sec. 10 Hz at 1/10 sec.
- \* Sensitivity: 10 Mv RMS to 30 Hz
- \* Internal power supply: 5.2V at 1 amp regulated
- \* Input connector: BNC type
- \* Input power required: 117V AC 50/60 Hz
- \* Diode protected for over voltage input

**CALCULATOR with STOPWATCH**  
6 Functions with % and memory  
8 Digits big green display  
\*Built-in X'tal controlled stop watch count to 1/10 of a second.  
Special Price Only **\$16.50 Ea.**  
BATTERIES NOT INCLUDED



**MECHANICAL DIGITAL CLOCK**



WITH DAY AND DATE OF THE WEEK

This clock is beautifully designed. Case is made from high quality die cast alloy. Movement is the popular flip type with a back up light.  
Supply Voltage 110V AC. limited quantity **\$15.50 ea.**

**1Watt AUDIO AMP**  
All parts are pre assembled on a mini PC Board  
Supply Voltage 6 ~ 9V D.C.  
**SPECIAL PRICE \$1.95 ea.**

**"FISHER" 30 WATT STEREO AMP (15W X 2)**  
Kit includes: 2 pcs. Fisher PA 301 Hybrid IC all electronic parts with PC Board, Power supply: ± 16V DC (not included), Power band with (K.F. = 1% ± 3dB) Voltage gain: 33dB, 20Hz - 20KHz.  
Super Buy Only **\$22.50 each kit.**

**5W AUDIO AMP KIT**  
2 LM 380 with Volume Control  
Power Supply 6 ~ 18V DC  
**only \$5.00 ea.**

**TIMER KIT**  
Time Controlled from 1-100sec.  
Ideal to be used as time delay unit for burglar alarm, photo service, and other purposes.  
Max. loading 110V, 2 AMP  
Supply voltage 12-18V D.C.  
**\$11.50 each**

**ELECTRONIC ALARM SIREN**  
COMPLETE UNIT  
Ideal for use as an Alarm Unit, or hookup to your car back up to make a reverse indicator.  
Light Output up to 130 dB  
Voltage Supply 6 ~ 12V **\$7.50**

**19 KEY HEXADECIMAL KEY PAD**  
• 1-0 • Homekey  
• ABCDEF • ← → Key  
**SPECIAL \$10.50 ea.**  
Low Cost Hexadecimal 16 Key Pad

**DIGITAL ELECTRONIC LOCK KIT**  
for auto ignition, entry door, burglar, alarm, etc.  
CMOS I.C. 4 Digits Programmable to IN CIRCUIT Any Combination  
400R RELAY AND KEY PAD NOT INCLUDED  
**\$6.50 ea.**

**POWER SUPPLY KIT**  
0-30V D.C. REGULATED  
Uses UA723 and ZN3055 Power TR output can be adjusted from 0.30V, 2 AMP. Complete with PC board and all electronic parts.  
0-10 POWER SUPPLY **\$9.50 each**  
Transformer for Power Supply, 2 AMP 24V x 2 **\$4.50 ea.**  
30V DC Panel Meter **\$4.20**

**MA1003, 12V DC CLOCK MODULE**  
Built in X'TAL controlled time base. Protected against automotive volt transients.  
Automatic brightness control with 0.3" green color display. Display turnoff with ignition "OFF".  
**\$19.50**

**QUARTZ CRYSTALS**

|           |        |
|-----------|--------|
| 1 MHz     | \$4.95 |
| 2 MHz     | \$5.25 |
| 4 MHz     | \$5.25 |
| 10 MHz    | \$5.25 |
| 3.579 MHz | \$1.25 |

Color TV Type

**ELECTRONIC SWITCH KIT**  
COINSENER TYPE  
Touch or Touch Off  
use 7473 IC and 12V relay  
**\$5.50 each**

**VHF MODULATOR**  
For TV Game or Computer  
This unit converts the Video Signal to RF Signal  
Video Input: VHS/CRF Output: 1.5 MV  
61.25 MHz (channel 3)  
Frg. Adjustable - 3 MHz  
**ONLY \$4.50**

**LED ALARM CLOCK**  
COMPLETE UNIT NOT A KIT  
• 0.5" RED LED READ OUT  
• 24 HRS. ALARM SET  
• 10 MINS. SNOOZE SET  
• AM/PM ALARM INDICATORS  
• SECOND DISPLAY SWITCH  
• AUTOMATIC BRIGHTNESS CONTROL  
• COMPACT AND HANDSOME PACKING  
• 110V AC 60HZ INPUT  
**\$17.50 EACH**

**5" MUFFIN FAN HEAVY DUTY**  
5 Blade Type  
110V 50/60HZ  
Case made of Die-Cast metal used but almost brand new  
**SPECIAL PRICE \$9.60 ea.**

**BIPOLAR LED**  
Jumbo Size red/green color when reverse polarity of voltage. Ideal for go/no-go indicator.  
Two for **\$1.00**

**I.C. TEST CLIPS**  
Same as the E 2 clips With 20" Long Leads In Black and Red Colors  
**\$2.75 per pair**

**12V D.C. AUTO DIGITAL CLOCK**  
Complete Unit Not a Kit!  
0.4" blue color 4 digits display. Turn off readouts when car is not running. X'tal controlled time base for time accuracy. Special designed case for easy mounting on top of your dashboard. Ideal for car, boat and campers.  
**ONLY \$28.50 ea.**

**WIRE WRAPPING TOOL**  
\$29.50  
Wire Wrapping In Bulk  
100' **\$2.00**  
500' **\$8.50**

**Sub Mini Size PANEL METER**  
500 U.A.  
**ONLY \$1.20 ea.**

**PANEL METER (D.C. Type)**  
Size 60mm x 60mm  
White Face Type  
0.50 U.A. 0-30V  
0.1MA 0-50V  
0.5MA 0-100V  
0-100MA  
**\$5.50 ea.**

**TRANSFORMERS**  
ALL 117 VOLT INPUT

|            |               |             |
|------------|---------------|-------------|
| 30V        | at 15 amp     | \$30.00 ea. |
| 36V        | CT at 3 amp   | \$ 4.50 ea. |
| 50V        | CT at 2.5 amp | \$ 4.50 ea. |
| 48V        | CT at 2.5 amp | \$ 4.50 ea. |
| 12V or 24V | at 2 amp      | \$ 3.90 ea. |
| 24V        | CT at 800MA   | \$ 1.80 ea. |
| 0.8V - 12V | at 400MA      | \$ 1.80 ea. |

**AC POWER SUPPLY**  
Adapter Type Transformer  
12V AC Output 200 MA  
**\$2.75 each**

|         |        |       |            |
|---------|--------|-------|------------|
| 6V DC   | Output | 130MA | \$1.90 ea. |
| 8.7V DC | Output | 130MA | \$1.90 ea. |
| 12V DC  | Output | 100MA | \$1.90 ea. |

**150UA METER**  
only  
**\$1.50 ea.**

**HOUR INDICATOR**  
This unit is 1 5/8" long operating voltage 4V D.C. will tell you how many hours your circuit or machine has been in service up to 100 hours.  
Limited Quantity **ONLY \$1.75 ea.**

**HEAVY DUTY CLIP LEADS**  
10 pairs - 5 colors  
Alligator clips on a 22" long lead. Ideal for any testing.  
**\$1.85/pack**

**MINI-SIZED I.C. AM RADIO**  
Size smaller than a box of matches!  
Receives all AM stations  
Batteries and ear phone included  
**Only \$8.50**

**MINI-MINI TOGGLE SWITCH**  
Half size of submini toggle switch rated 3 amp 125V AC contact  
1-9 10-99  
MS 2432 SPST 0.90 0.80  
MS 244 SPDT 1.00 0.90  
MS 245 DPDT 1.20 1.10  
LARGE QUANTITY AVAIL FOR OEM

**SUBMINIATURES TOGGLE SWITCHES**  
SPDT On/Off \$1.30 ea.  
DPDT On/Off \$1.50 ea.  
3PDT On/Off \$1.75 ea.  
Mini Size Router Type. Also Available at the Same Price

**JOY STICK**  
4 100K Volume pot in one unit, vary resistance proportional to the angle of the stick. Perfect for electronic games or model remote control.  
**only \$5.50**

**PUSH-BUTTON SWITCH**  
N/Open Contact  
Color: Red, White, Blue, Green, Black. **4/\$1.00**  
N/Close also  
Available 50c ea.  
LARGE QTY AVAILABLE

**SOLID STATE ELECTRONIC BUZZER**  
Mini Size 1 1/2" x 3/4"  
Supply voltage 1.5V 12V  
Ideal for Alarm or Tone Indicator  
**\$1.50 each**

MINIMUM ORDER \$10.00 California residents add 6% sales tax. All orders add 10% postage for out of state. Overseas countries add 15% of total order for postage. SEND CHECK OR MONEY ORDER TO

**FORMULA INTERNATIONAL INC.**  
12603 CRENSHAW BOULEVARD • HAWTHORNE CALIFORNIA 90250  
For more information please call (213) 679-5162  
STORE HOURS 10-7 Monday Saturday

YOUR BANKAMERICAN web.com



### VARIABLE POWER SUPPLY KIT NO. 1 ONLY \$10.95

- Continuously variable from 5V to 20V
- Excellent regulation up to 1/2 Amp
- Kit includes all components
- Drilled fiberglass P.C. Board
- Case included
- 4400 Mfd of filtering
- One hour assembly

### VARIABLE POWER SUPPLY KIT NO. 2

Same as above but with a 1 Amp output, also with case ONLY \$13.95

This model will power a 5 watt transistorized CB Radio

## LOOK AT THIS SPECIAL FROM RADIO HUT

• Power Supply Kit, 5V1 amp req.  
• Line regulation 005%  
• Load regulation 50mV

Kit includes components, PC board, transformer, fuses and pilot light. Line cord not included.

### Only \$6.50

### 60 Hz. Crystal Time Base for Digital Clocks

\$4.50  
Buy 2 for \$8.



- A 60 Hz. output with accuracy comparable to a digital watch.
  - B Directly interfaces with all MOS clock chips
  - C Super low power consumption (1.5 ma typ.)
  - D Uses latest MOS 17 stage divider IC
  - E Eliminates forever the Problem of AC line glitches
  - F Perfect for cars, boats, campers, or even for portable clocks at ham field days
  - G Small size can be used in existing enclosures
- KIT INCLUDES CRYSTAL, DIVIDER IC, P.C. BOARD PLUS ALL NECESSARY PARTS & SPECS

### UNSCRAMBLER \$19.95



Plugs into earphone or external speaker of any Scanner or Monitor. Guaranteed to unscramble any 1085 call.

- Easily tuned
- Full instruction included
- Drilled fiberglass P.C. Board
- One Hour Assembly
- Punched Case

### 7400 TTL DIGITAL CIRCUITS

|       |    |      |    |       |     |       |       |
|-------|----|------|----|-------|-----|-------|-------|
| 7400  | 11 | 7430 | 13 | 7480  | 31  | 74153 | 61    |
| 7401  | 13 | 7432 | 23 | 7481  | 55  | 74154 | 98    |
| 7402  | 13 | 7433 | 26 | 7482  | 57  | 74155 | 89    |
| 7403  | 13 | 7437 | 23 | 7483  | 67  | 74156 | 89    |
| 7404  | 15 | 7438 | 23 | 7485  | 89  | 74157 | 55    |
| 7404A | 29 | 7440 | 13 | 7489  | 125 | 74160 | 55    |
| 74504 | 44 | 7441 | 76 | 7490  | 65  | 74161 | 85    |
| 7405  | 13 | 7442 | 47 | 7491  | 61  | 74163 | 65    |
| 7406  | 16 | 7443 | 59 | 7492  | 43  | 74164 | 85    |
| 7407  | 16 | 7444 | 59 | 7493  | 43  | 74165 | 89    |
| 7408  | 19 | 7446 | 68 | 7494  | 43  | 74171 | 85    |
| 7409  | 19 | 7447 | 68 | 7495  | 67  | 74173 | 85    |
| 7410  | 13 | 7448 | 71 | 7496  | 67  | 74180 | 67    |
| 7411  | 18 | 7450 | 13 | 74100 | 30  | 74181 | 93    |
| 7412  | 26 | 7451 | 13 | 74104 | 49  | 74182 | 68    |
| 7413  | 37 | 7453 | 13 | 74107 | 26  | 74191 | 98    |
| 7416  | 15 | 7454 | 13 | 74109 | 31  | 74192 | 79    |
| 7420  | 13 | 7456 | 19 | 74121 | 29  | 74193 | 81    |
| 7421  | 13 | 7470 | 21 | 74123 | 48  | 74194 | 81    |
| 7423  | 25 | 7472 | 25 | 74132 | 99  | 74195 | 69    |
| 7425  | 29 | 7473 | 29 | 74136 | 99  | 9316  | 85    |
| 7426  | 24 | 7474 | 29 | 74138 | 195 | 9601  | 31/51 |
| 7427  | 19 | 7475 | 47 | 74141 | 75  | 9L04  | 35    |
| 7428  | 26 | 7476 | 31 | 74151 | 61  |       |       |

### TTL SPECIAL!

9000 series parts  
prime from ITT  
Pin for Pin  
compatible with  
7400 series

### DTL

|      |                             |       |
|------|-----------------------------|-------|
| 932  | Dual 4 Input Buffer         | 8/51  |
| 934  | Dual 5 Input NAND Gate      | 10/51 |
| 934  | One Shot Multivibrator      | 5/51  |
| 945  | JK F/F                      | 8/51  |
| 946  | Quad 11 Input Gate NAND/NOR | 8/51  |
| 948  | JK F/F                      | 8/51  |
| 950  | F/F                         | 10/51 |
| 951  | One Shot Multivibrator      | 5/51  |
| 1800 | (See 934 above)             | 10/51 |
| 1806 | Quad 2 Input NAND Gate      | 10/51 |
| 9093 | Dual JK F/F                 | 8/51  |
| 9094 | Dual JK F/F                 | 8/51  |
| 9097 | Dual JK F/F                 | 8/51  |
| 9099 | Dual JK F/F                 | 8/51  |
| 9109 | Hex Inverter                | 7/51  |
| 9110 | Hex Inverter                | 7/51  |
| 9112 | Hex Inverter                | 7/51  |
| 9601 | One Shot                    | 3/51  |
| 9930 | Quad 4 Input Ext. NAND      | 8/51  |
| 9932 | Quad 2 Input NAND Buffer    | 8/51  |
| 9945 | RS F/F                      | 8/51  |
| 9946 | Quad 2 Input NAND           | 8/51  |
| 9949 | Quad 2 Input NAND           | 8/51  |
| 9951 | Monostable Multivibrator    | 8/51  |
| 9962 | Triple 3 Input NAND         | 8/51  |

### 74LS00 LOW POWER SCHOTTKY

|        |    |         |     |         |     |         |     |
|--------|----|---------|-----|---------|-----|---------|-----|
| 74LS00 | 21 | 74LS47  | 73  | 74LS136 | 37  | 74LS258 | 71  |
| 74LS02 | 21 | 74LS51  | 26  | 74LS138 | 71  | 74LS260 | 26  |
| 74LS03 | 21 | 74LS54  | 26  | 74LS139 | 71  | 74LS266 | 26  |
| 74LS04 | 28 | 74LS55  | 26  | 74LS145 | 100 | 74LS279 | 55  |
| 74LS05 | 28 | 74LS73  | 35  | 74LS151 | 70  | 74LS290 | 75  |
| 74LS06 | 21 | 74LS74  | 35  | 74LS153 | 70  | 74LS293 | 61  |
| 74LS09 | 28 | 74LS76  | 49  | 74LS155 | 69  | 74LS296 | 95  |
| 74LS10 | 21 | 74LS83  | 73  | 74LS156 | 70  | 74LS298 | 95  |
| 74LS11 | 21 | 74LS85  | 135 | 74LS157 | 75  | 74LS305 | 65  |
| 74LS13 | 45 | 74LS86  | 36  | 74LS158 | 71  | 74LS366 | 55  |
| 74LS14 | 26 | 74LS90  | 55  | 74LS160 | 85  | 74LS367 | 55  |
| 74LS15 | 26 | 74LS92  | 55  | 74LS161 | 85  | 74LS368 | 55  |
| 74LS20 | 24 | 74LS93  | 55  | 74LS162 | 85  | 74LS390 | 175 |
| 74LS21 | 28 | 74LS109 | 38  | 74LS163 | 85  | 74LS393 | 145 |
| 74LS22 | 28 | 74LS112 | 38  | 74LS164 | 49  | 74LS670 | 230 |
| 74LS26 | 32 | 74LS113 | 38  | 74LS168 | 85  | 74LS192 | 95  |
| 74LS27 | 32 | 74LS114 | 38  | 74LS169 | 85  | 74LS193 | 95  |
| 74LS30 | 26 | 74LS122 | 49  | 74LS170 | 69  | 74LS194 | 95  |
| 74LS32 | 32 | 74LS124 | 99  | 74LS173 | 110 | 74LS195 | 85  |
| 74LS37 | 32 | 74LS125 | 47  | 74LS174 | 100 | 74LS196 | 85  |
| 74LS38 | 32 | 74LS126 | 47  | 74LS175 | 81  | 74LS197 | 85  |
| 74LS40 | 26 | 74LS132 | 79  | 74LS190 | 95  | 74LS251 | 85  |
| 74LS42 | 65 | 74LS133 | 35  | 74LS191 | 95  | 74LS253 | 81  |
|        |    |         |     |         |     | 74LS257 | 71  |

### ITT HIGH LEVEL LOGIC

|     |                                    |    |
|-----|------------------------------------|----|
| 301 | Dual 5 Input NAND Gate             | 15 |
| 302 | Quad 2 Input Buffer open collector | 18 |
| 303 | Quad 2 Input NAND Buffer           | 15 |
| 311 | Master Slave F/F                   | 15 |
| 312 | Dual JK Flip Flop                  | 18 |
| 321 | Quad 2 Input NAND Gate             | 18 |
| 322 | Dual 5 Input NAND Gate             | 15 |
| 323 | Quad 2 Input NAND Gate             | 18 |
| 324 | Quad 2 Input NAND Gate             | 18 |
| 325 | Dual 2 Dual 3 Input NAND Gate      | 13 |
| 326 | Dual 2 Dual 3 Input NAND Gate      | 13 |
| 331 | Dual 5 Input Expander              | 13 |
| 332 | Hex Inverter                       | 18 |
| 333 | Hex Inverter                       | 18 |
| 334 | Hex Inverter                       | 18 |
| 335 | Hex Inverter                       | 18 |
| 342 | Dual One Shot Multivibrator        | 25 |
| 343 | Dual 4 Bit Comparator              | 22 |
| 370 | Quad D Flip Flop                   | 27 |
| 371 | Decade Counter                     | 30 |
| 372 | Quad Ripple Counter                | 30 |
| 380 | BCE to Decimal Decoder             | 39 |
| 381 | BCE to Decimal Decoder             | 39 |

### ITT LED DRIVERS

|         |               |    |
|---------|---------------|----|
| ITT 501 | Quad Seg. Dr. | 35 |
| ITT 502 | Hex Digit Dr. | 49 |
| ITT 503 | Quad Seg. Dr. | 49 |
| ITT 506 | Hex Digit Dr. | 49 |
| ITT 508 | 8 Digit Dr.   | 49 |
| ITT 509 | 8 Seg. Dr.    | 49 |
| ITT 511 | Quad Seg. Dr. | 55 |
| ITT 514 | 8 Digit Dr.   | 59 |

### DIODES

|         |               |        |
|---------|---------------|--------|
| IN 4002 | 1 Amp 100 PIV | 40/\$1 |
| IN 4004 | 1 Amp 400V    | 15/\$1 |
| IN 4007 | 1 Amp 1000V   | 10/\$1 |

### GERMANIUM DIODES

|        |  |         |
|--------|--|---------|
| IN 54A |  | \$8/\$1 |
| IN 270 |  | 10/\$1  |

### ZENER DIODES

|         |           |        |
|---------|-----------|--------|
| IN 746  | 3.3V 400M | 4/\$1  |
| IN 752  | 5.6V 400M | 4/\$1  |
| IN 1958 | 8.2V 400M | 4/\$1  |
| IN 5259 | 39V 500M  | 10/\$1 |
| IN 5271 | 100V 500M | 10/\$1 |
| IN 5280 | 180V 500M | 10/\$1 |

### HOUSE # ZENER

|      |        |        |
|------|--------|--------|
| 4.7V | 500 MW | 10/\$1 |
| 9.1V | 500 MW | 10/\$1 |
| 10V  | 1 Watt | 8/\$1  |
| 15V  | 500 MW | 10/\$1 |
| 22V  | 5 Watt | 6/\$1  |

### SWITCHING DIODES

|               |            |         |
|---------------|------------|---------|
| IN 4148/IN914 | Long Leads | 20/\$1  |
| IN 4148/IN914 | Cut Leads  | 100/\$2 |

### IMSAI SPECIAL

## S-100 Connector

\$3.95 Ea.

LIMITED SUPPLY

### BRIDGE RECTIFIERS

|        |      |       |
|--------|------|-------|
| 1 Amp  | 200V | 6/\$1 |
| 6 Amp  | 50V  | 1.10  |
| 10 Amp | 50V  | 1.25  |
| 25 Amp | 50V  | 1.39  |

### SOCKETS

- 8 Pin Low Profile 20
- 14 Pin Low Profile 22
- 16 Pin Low Profile 25
- 18 Pin Low Profile 30
- 28 Pin Low Profile 69
- 40 Pin Low Profile 89

### 74H SERIES TTL

|       |    |       |    |       |    |       |    |
|-------|----|-------|----|-------|----|-------|----|
| 74H00 | 18 | 74H21 | 29 | 74H53 | 29 | 74H73 | 39 |
| 74H05 | 29 | 74H40 | 29 | 74H61 | 25 | 74H74 | 39 |
| 74H20 | 29 | 74H50 | 20 | 74H72 | 45 |       |    |

### CMOS

|        |     |        |    |        |     |        |     |
|--------|-----|--------|----|--------|-----|--------|-----|
| CD4000 | 19  | CD4017 | 95 | CD4040 | 100 | CD4071 | 19  |
| CD4001 | 19  | CD4018 | 95 | CD4041 | 69  | CD4081 | 19  |
| CD4002 | 19  | CD4019 | 19 | CD4042 | 69  | CD4087 | 35  |
| CD4006 | 120 | CD4020 | 97 | CD4043 | 60  | CD4508 | 280 |
| CD4007 | 19  | CD4021 | 97 | CD4044 | 60  | CD4510 | 100 |
| CD4009 | 47  | CD4022 | 97 | CD4046 | 39  | CD4512 | 110 |
| CD4010 | 38  | CD4023 | 19 | CD4047 | 50  | CD4516 | 79  |
| CD4011 | 19  | CD4024 | 75 | CD4048 | 110 | CD4518 | 110 |
| CD4012 | 29  | CD4025 | 19 | CD4050 | 39  | CD4520 | 69  |
| CD4013 | 32  | CD4027 | 39 | CD4051 | 119 | CD4528 | 85  |
| CD4014 | 78  | CD4028 | 85 | CD4053 | 119 | 74C02  | 45  |
| CD4015 | 78  | CD4029 | 39 | CD4055 | 115 | 74C04  | 32  |
| CD4016 | 32  | CD4030 | 35 | CD4066 | 78  | 74C107 | 79  |

### VOLTAGE REGULATORS

|           |           |    |           |           |     |
|-----------|-----------|----|-----------|-----------|-----|
| 7805 Pos. | 5V 1 Amp  | 99 | 7818 Pos. | 18V 1 Amp | 99  |
| 7806 Pos. | 6V 1 Amp  | 99 | 7820 Pos. | 24V 1 Amp | 99  |
| 7808 Pos. | 8V 1 Amp  | 99 | 7905 Neg. | 5V 1 Amp  | 110 |
| 7812 Pos. | 12V 1 Amp | 99 | 7912 Neg. | 12V 1 Amp | 110 |
| 7815 Pos. | 15V 1 Amp | 99 | 7915 Neg. | 15V 1 Amp | 110 |

723 VOLTAGE REGULATORS  
Output voltages variable from 2 volts to 37 volts.  
A very versatile and popular device.—14 PIN DIP  
89c

MOTOROLA VOLTAGE REGULATOR  
MC1469R TO-66 9 lead package for 3 to 30V outputs.  
Provides 600 mA direct output or more by using an external power transistor. Regular catalog price—\$4.00 each. With specs. \$1.95 each

### TO-5 HEATSINKS

Similar to Thermalloy 225G  
Finned with insert. 5/\$1.

### TO-5 HEATSINKS

STANDARD SLIP-ON 6/\$1.  
HEATSINKS FOR VOLTAGE REGULATORS

Black anodized aluminum "U" shaped.  
Fits TO-220 cases.  
4 FOR \$1.00

## UNMARKED 1702A EPROMS

3.50 Ea. or 10/\$32.00  
LIMITED SUPPLY

## 12V 1 AMP POWER SUPPLY

INPUT VOLTAGE 25V MAX. OUTPUT CURRENT 1 AMP. MAX. LOAD REGULATION 50mV. OUTPUT VOLTAGE 12V. LINE REGULATION 0.01%. KIT CONTAINS ALL PARTS EXCEPT FOR LINE CORD AND TRANSFORMER.

ONLY \$4.50

### HOUSE # TTL IC's

|      |        |                |       |       |         |        |
|------|--------|----------------|-------|-------|---------|--------|
| 7400 | 10/100 | Please specify | 7437  | 6/100 | 300 KHz | \$1 50 |
| 7404 | 10/100 | that you       | 7438  | 6/100 | 357945  | 1 25   |
| 7408 | 10/100 |                | 74141 | 3/100 |         |        |
| 7420 | 10/100 | are ordering   | 74153 | 3/100 |         |        |

House Number TTL

### COUNTER AND CLOCK CHIPS

|         |                         |        |
|---------|-------------------------|--------|
| MK50252 | Clock Chip              | \$4 99 |
| MK5316  | Clock Chip              | 3 75   |
| MK50250 | Alarm Clock             | 3 75   |
| MK50380 | Alarm Chip              | 2 95   |
| FCM7010 | Direct Drive Clock Chip | 4 95   |
| MK5005  | 4 Digit Counter w/Latch | 8 50   |
| MK5002  | 4 Digit Counter         | 8 95   |
| MK50395 | 6 Digit UP/Down Counter | 12 95  |
| MK50397 | 6 Digit Elapsed Timer   | 8 95   |
| OT3005  | Calculator Chip w/Specs | 1 25   |
| MK5021  | Cal. Chip w/eq. rt      | 2 50   |

### TRANSISTORS

|                           |        |                          |          |
|---------------------------|--------|--------------------------|----------|
| INTERVAL DUAL TRANSISTORS |        | Originally Cost \$3 each |          |
| Similar to 2N913          |        | 2/51                     |          |
| GENERAL PURPOSE           |        |                          |          |
| 2N 2905 PNP               | 4 \$1  | 115 W 200V               | PNP 95   |
| 2N 3904 NPN               | 8 \$1  | TIP 29 (E967)            | PNP 4/51 |
| 2N 3906 PNP               | 8 \$1  | TIP 30 (E929)            | PNP 4/51 |
| 2N 470 MFD Pre-Amp        | 25 \$1 | TIP 31 C Leads           | PNP 5/51 |
| 2N 4400 NPN               | 10 \$1 | MJE 2370                 | 3/51     |
| 2N 4402 PNP               | 10 \$1 | 2N 3055                  | 75       |
| EN 2222 NPN               | 8 \$1  | TN 2021 B RCA            | 95       |
| EN 2907 PNP               | 8 \$1  | FET TIS 75 House #       | 5/51     |

### CAPACITORS

|             |        |              |              |             |  |
|-------------|--------|--------------|--------------|-------------|--|
| AXIAL TYPE  |        | ELECTROLYTIC |              | RADIAL TYPE |  |
| 20 MFD 250V | 5/\$1  | 47 MFD       | 35V PC Leads | 10/\$1      |  |
| 35 MFD 25V  | 15/\$1 | 68 MFD       | 25V PC Leads | 8/51        |  |
| 200 MFD 25V | 5/\$1  | 330 MFD      |              |             |  |



**S. D. SALES NEW EXPANDABLE EPROM BOARD**

16K or 32K EPROM \$49.95 w/out EPROM  
Allows you to use either 2708's for 16K of  
Eprom or 2716's for 32K of Eprom.

**KIT FEATURES:**

1. All address lines & data lines buffered.
2. Quality plated through P.C. Board, including solder mask and silk screen.
3. Selectable wait states.
4. On board regulation provided.
5. All sockets provided w/board.

WE CAN SUPPLY 450ns 2708's AT \$11.95  
WHEN PURCHASED WITH BOARD.

**32K FOR \$475 EXPANDORAM KIT 24K FOR \$367.00**

MEMORY CAPACITY  
MEMORY ADDRESSING  
MEMORY WRITE  
PROTECTION

8K, 16K, 24K, 32K using Mostek MK4115 with 8K boundaries and protection. Utilizes DIP switches. PC board comes with sockets for 32K operation. Orders now being accepted. Allow 6 to 8 weeks for delivery.

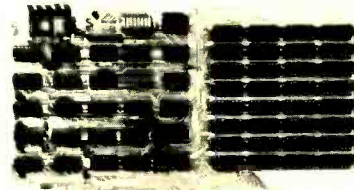

INTERFACE CAPABILITY  
Control, data and address inputs utilizes low power Schottky devices.

POWER REQUIREMENTS  
+8VDC 400MA DC  
+18VDC 400MA DC  
-18VDC 30MA DC

on board regulation is provided. On board (invisible) refresh is provided with no wait states or cycle stealing required.

MEMORY ACCESS TIME IS 375ns.  
Memory Cycle Time is 500ns.

Buy an \$100 compatible 8K Ram Board and upgrade the same board to a maximum of 32K in steps of 8K at your option by merely purchasing more ram chips from S.D. Sales! At a guaranteed price — Look at the features we have built into the board.

**16K FOR \$259.00**

**8K FOR \$151.00**

**Z-80 CPU BOARD KIT — \$139.**

CHECK THE ADVANCED FEATURES OF OUR Z-80 CPU BOARD. Expanded set of 158 instructions. 8080A software capability, operation from a single 5VDC power supply, always stops on an M1 state, true sync generated on card (a real plus feature!), dynamic refresh and NMI available, either 2MHz or 4MHz operation, quality double sided plated through PC board, parts plus sockets priced for all IC's. \*Add \$10 extra for Z-80A chip which allows 4MHz operation.  
Z-80 chip with Manual — 29.95



NEW FROM S.D.  
**"VERSAFLOPPY"™ KIT**  
THE VERSATILE FLOPPY DISK CONTROLLER  
**ONLY \$149.00**

Features: IBM 3740 Soft Sectored Compatible, S-100 BNS Compatible for Z-80 or 8080. Controls up to 4 Drives (single or double sided). Directly controls the following drives:

1. Shugart SA400/450 Mini Floppy.
2. Shugart SA800/850 Standard Floppy.
3. PERSCI 70 and 277.
4. MFE 700/750.
5. CDC 9404/9406.

34 Pin Connector for Mini Floppy. 50 Pin Connector for Standard Floppy. Operates with modified CP/M operating system and C-Basic Compiler.

The new "Versafloppy" from S.D. Computer Products provides complete control for many of the available Floppy Disk Drives. Both Mini and Full Size. At the heart of "Versafloppy" is the powerful Western Digital FD1771B-1 Single Density Controller Chip. This allows a great flexibility via Control Software. Listings for Control Software are included in the price.

FD 1771B-1 CHIP ALONE \$39.95

**4K LOW POWER RAM KIT**

Fully Buffered — on board regulated — reduced power consumption utilizing low power 21L02 — 1 500ns RAMS — Sockets provided for all IC's. Quality plated through PC board. \*Add \$10 for 250ns PAM operation.



**The Whole Works - \$79.95**

**Low Cost Cassette Interface Kit**



Features: Play and record K.C. Standard 2400/1200 Hz tapes. 300 Baud, TTL I/O Compatible, Phase Lock Loop. Both 22 Pin Connector and 8 Pin Molex Connector. Comes partially assembled. Oscillator and phase lock loop pre-tuned to K.C. Standard. Selector switch reads cassette data or auxiliary input data to microprocessor. LED indicates logic 1 level.

**\$19.95**

**6 DIGIT ALARM CLOCK KIT**

Features: Litronix dual 1/2" displays, Mostek 50250 super clock chip, single I.C. segment driver, SCR digit drivers. Kit includes all necessary parts (except case). Xfmr optional. Eliminate the hassle.

AC XFMR — \$1.50 Case \$3.50 **\$12.95**

**8K LOW POWER RAM — \$159.95**

Fully assembled and tested. Not a kit. Insaal — Altair — S-100 Bus compatible, uses low power static 21L02-500ns fully buffered on board regulated, quality plated through PC board, including solder mask 8 pos. dip switches for address select.



**DIGITAL LED READOUT THERMOMETER — \$29.95**

Features: Litronix dual 1/2" displays. Uses Siliconix LD131 single chip CMOS A/D converter. Kit includes all necessary parts (except case). AC line cord and power supply included. 0-149° F.



**Bowmar 4 Digit LED Readout Array Full 1/2" Litronix Jumbo Dual Digit LED Displays**

4 JUMBO .50" DIGITS ON ONE STICK!  
WITH COLONS & AM/PM INDICATOR  
\$3.95

DL 722 - C.C. DL 728 - C.C.  
DL 721 B C.A. DL 727 - C.A.  
99c \$1.29

**MUSICAL HORN**

One tune supplied with each kit. Additional tunes — \$6.95 each. Special tunes available. Standard tunes now available: Dixie — Eyes of Texas — On Wisconsin — Yankee Doodle Dandy — Notre Dame — Pink Panther — Aggie War Song — Anchors Away — Never on Sunday — Yellow Rose of Texas — Deep in the Heart of Texas — Boomer Sooner — Bridge over River Kwai.

CAR & BOAT KIT HOME KIT Special Design Case \$3.50  
\$34.95 \$26.90

**Jumbo LED Car Clock Kit**

FEATURES:  
A. Bowmar Jumbo 5 inch LED array.  
B. MOSTEK — 50250 — Super clock chip.  
C. On board precision crystal time base.  
D. 12 or 24 hour Real Time format.  
E. Perfect for cars, boats, vans, etc.  
F. PC board and all parts (less case) inc.  
Alarm option — \$1.50  
AC XFMR — \$1.50



**\$16.95**

**RAMS**

|               |         |
|---------------|---------|
| 21L02 - 500NS | 8/11 50 |
| 21L02 - 250NS | 8/15 95 |
| 2114 - 4K     | 14 95   |
| 1101A - 256   | 8/14 00 |
| 1103 - 1K     | 35      |
| MK 4115 - 8K  | 15 45   |
| 745 200 - 256 | 3 95    |

**CPU's**

|                       |       |
|-----------------------|-------|
| Z-80 includes manual  | 29.95 |
| Z-80A includes manual | 34.95 |
| 8080A CPU 8 BIT       | 11.95 |
| 8008 CPU 8 BIT        | 6.95  |

**PROMS**

|                          |                |
|--------------------------|----------------|
| 1702A - 1K - 1.5us       | 3.95 or 10/35. |
| 2708 - 8K - 450ns        | 14.95          |
| 5204 - 4K                | 7.95           |
| 825129 - 1K              | 2.50           |
| 2708U 8K signetics 650ns | 9.95           |

**COUNTER CHIPS**

|                               |       |
|-------------------------------|-------|
| MK50397 6 Digit elapsed timer | 8.95  |
| MK50250 Alarm clock           | 4.99  |
| MK50380 Alarm chip            | 2.95  |
| MK50395 6 digit up/dn. count. | 12.95 |
| MK5002 4 digit counter        | 8.95  |
| MK5021-Cal. chip sq. root     | 2.50  |

★ ★ ★ ★ SUPER FLOPPY SPECIAL ★ ★ ★ ★  
S. D. SALES' VERSAFLOPPY S-100 CONTROLLER BOARD PLUS  
SHUGART SA 400 FLOPPY DISK DRIVE INCLUDING CABLE FOR ONLY  
**\$479.00**

**MICRO-DIP \$1.95**

New — Series 2300  
The World's Smallest  
Coded BCD Dual-In-Line  
Switch! PC Mount  
2300 02G BCD 1-2-4-8  
2300 12G BCD 1-2-4-8  
Compliment

★ ★ JOY STICKS ★ ★

FOUR 100 K-OHMS  
POTS  
Ideal for  
electronic  
games **\$3.95**

**Z-80**

Programming Manual  
IN DEPTH DETAIL OF  
THE Z-80 CPU  
MICRO-COMPUTER  
S. D. SALES SPECIAL  
**\$9.95**

|                            |           |
|----------------------------|-----------|
| Thermistors 1.5K ohm       | 5/\$1.00  |
| Tantalum Caps 1 mfd. 20VOC |           |
| P.C. Leads                 | 15/\$1.00 |
| Flat Pack IC Assort.       | 20/\$1.00 |
| Electrical Coil            |           |
| 13T Type C - 10T Type C    | 12/\$1.00 |
| 2 Transistor Audio         | 8/\$1.00  |
| Trimmer Pots               |           |
| 10K, 20K, 25K, Mini        | 10/\$1.00 |
| Disc Caps For Bypass       |           |
| .01 mfg - 100 WUDC         |           |
| PC Leads                   | 40/\$1.00 |
| New Cambion Jacks          |           |
| Part #450-4352             |           |
| Gold Plated                | 50/\$1.00 |

|                                   |            |
|-----------------------------------|------------|
| Silicon Rectifier Special 1N4007. |            |
| 1 amp 1000 PN.                    | 10/\$1.00  |
| Photocell Assortment              | 12/\$1.00  |
| Plastic Readout Filters           |            |
| Amber                             | 6/\$1.00   |
| Disc Cap Assortment               | 60/\$1.00  |
| P.C. Lead Diodes                  |            |
| 1N4148 1N 914                     | 100/\$2.00 |
| 1N4002-1A-100 PN                  | 40/\$1.00  |
| MICA Trimmer                      |            |
| PC402 Miniature                   |            |
| 1.5-20 P.C. P.C. Mount.           | 4/\$1.00   |
| Resistor Special 22 ohm           |            |
| Carbon Comp.                      | 25/\$1.00  |
| Resistor Assortment 1/4 W 5% &    |            |
| 10% PC leads                      | 200/\$1.50 |

CHOOSE \$1. FREE MERCHANDISE FROM ASTERISK ITEMS ON EACH \$15 ORDER

**MICROPROCESSOR CHIPS**

|                             |       |
|-----------------------------|-------|
| 8212 - I/O port             | 3.50  |
| 8214 - P.I.C.               | 12.95 |
| 8216 - Non Invert Bus       | 4.95  |
| 8224 - Clock Gen.           | 4.95  |
| 8226 - Invert Bus           | 3.95  |
| P10 for Z-80                | 14.95 |
| CTC for Z-80                | 14.95 |
| 8228 Sys. Controller        | 8.20  |
| 8251 Prog. comm. interface. | 10.95 |
| 8255 prog. prep. interface. | 13.50 |
| 8820 Dual Line Recr         | 1.75  |
| 8830 Dual Line Dr.          | 1.75  |
| 2513 Char. Gen.             | 7.50  |
| 8838 Quad Bus. Recvr.       | 2.00  |
| 74LS138N - 1/8 decoder      | .99   |
| 8797-Hex Tri-State Buffer   | 1.25  |
| 1488/1489 RS232             | 1.50  |
| TR 1602B Uart               | 3.95  |
| TR 1863 Uart                | 8.50  |
| FD 1771B-1                  | 39.95 |

**CMOS**

|      |    |       |      |
|------|----|-------|------|
| 4001 | 19 | 4029  | 99   |
| 4002 | 19 | 4042  | 69   |
| 4011 | 19 | 4047  | 1.50 |
| 4013 | 32 | 4049  | 35   |
| 4016 | 32 | 4069  | 23   |
| 4017 | 95 | 4071  | 19   |
| 4020 | 97 | 4076  | 97   |
| 4022 | 97 | 14518 | 1.10 |
| 4024 | 75 | 14528 | 8.50 |
| 4027 | 39 | 14529 | 85   |

CALL IN YOUR BANKAMERICARD (VISA) OR MASTER CHARGE ORDER IN ON OUR CONTINENTAL TOLL FREE WATTS LINE:  
**1-800-527-3460**

Texas Residents Call Collect:  
**214/271-0022**

DEALER INQUIRIES INVITED



NO COD'S. TEXAS RESIDENTS ADD 5% SALES TAX. ADD 5% OF ORDER FOR POSTAGE & HANDLING. ORDERS UNDER \$10. ADD 75c HANDLING. FOREIGN ORDERS — U. S. FUNDS ONLY!

**PORTABLE FREQUENCY COUNTER**  
continued from page 39

checkout. Make sure that the batteries are fully charged, then connect a 0-250-mA meter across S2 and perform the test as described.

There are two ways you can calibrate your counter. Both are pretty easy, but they do require quality equipment that is in calibration. Try to beg or borrow the best equipment to be mentioned you can if you don't have it already. The accuracy of your counter will depend on it!

The first method is probably the best. You'll need a counter that has an accuracy to at least  $\pm 0.001\%$ . Let it warm up

for a few minutes (the calibration counter) and attach a X10 scope probe to its input. Ground the probe ground to the case of your counter, and touch the probe tip to the large pad on the board marked CAL. Press S2 and hold it for about a minute. Note that the batteries should be fully charged! Then adjust the trimmer (C8) for a reading of 3,579, 545 Hz. There will be some jitter in the last digit, but try to get it close to a "5" as you can. You must be within  $\pm 179$  Hz to meet the accuracy spec. That's it!

The other method is to connect a known signal to the input of the counter and adjust the trimmer until you get a proper reading. Take a signal generator/

counter combination and attach it to the input jack J1. Then set the generator to 10,000,000 Hz or exactly 10 MHz. Next, set S1 to the MHZ position, and press S2. The display will show a jumble of numbers and then two seconds later show a reading close to 10 MHz. If not, adjust the output level on the signal generator until it does. Adjust trimmer C8 for a reading of 10-00. Flip S1 to KHZ and you should get 00-00 with the overrange lamp lit. If not, adjust C8 until you do.

**Now put it to work**

Using this counter is a snap! Simply unsnap it from your belt (get a surplus calculator case) or take it out of your toolbox and connect it to the signal you want to check. Press S2 and hold it for at least six seconds for two readings. Meanwhile, set S1 to MHZ to get a reading, flipping it to KHZ or Hz for a reading if necessary. Presto! In seconds you have a reading of four digits!

If your frequency is 1 MHz or greater, you can get up to six digits of resolution by combining two ranges. Here's how to do it: Say you are measuring a frequency of 10.125 MHz. On the MHZ position of S2 you will get 10-13, with the dash mark indicating the decimal point printed on the case. On the KHZ position you will get a reading of 25-00 plus overrange (OR). Here's how to combine the readings:

$$\begin{array}{r}
 10-13 \\
 + \quad 25-00 \\
 \hline
 10-125-00
 \end{array}$$

That's all there is to it. But remember to always drop the least-significant digit from the MHz range (that's the "3") when combining the two ranges. As you can see, we actually got seven digits of resolution in this digit. But actually, there will be some jitter in this digit during the measurement, making its usefulness rather limited. You can perform the same stunt of combining readings on the kHz and Hz ranges, too. But in this case three numbers will overlap.

A few last words concerning the display of this counter. Decimal points were left out of the display to save power, and as a result, were printed on the case. Also, a digit was blanked in the readout to emphasize a decimal on the MHz and KHz ranges. On the Hz range, the decimal is at the far right end of the display, so you ignore the gap. With a little practice you will get used to this arrangement.

R-E



**Original Japanese Transistors, FET, IC, Diodes**  
**CHECK OUR LOW PRICES!**

| TRANSISTORS |      | FET      |       | IC       |      | DIODES     |       |
|-------------|------|----------|-------|----------|------|------------|-------|
| 2SA 49      | .59  | 2SA 816  | .70   | 2SC 403  | .59  | 2SC 897    | 2.65  |
| 2SA 70      | 1.10 | 2SA 818  | 1.40  | 2SC 430  | 1.10 | 2SC 898    | 4.40  |
| 2SA 101     | .59  | 2SA 839  | 2.15  | 2SC 454  | .59  | 2SC 900    | .59   |
| 2SA 102     | .59  | 2SA 847  | .59   | 2SC 458  | .59  | 2SC 929    | .59   |
| 2SA 234     | .59  | 2SA 850  | .70   | 2SC 461  | .59  | 2SC 930    | .59   |
| 2SA 342     | .90  | 2SA 872A | .59   | 2SC 481  | 1.60 | 2SC 943    | 1.20  |
| 2SA 353     | .70  | 2SA 908  | 11.00 | 2SC 482  | 1.50 | 2SC 945    | .59   |
| 2SA 377     | 2.00 | 2SB 54   | .59   | 2SC 485  | 1.60 | 2SC 959    | 1.50  |
| 2SA 440     | .90  | 2SB 55   | 1.10  | 2SC 486  | 1.60 | 2SC 971    | 1.00  |
| 2SA 483     | 3.00 | 2SB 75   | .59   | 2SC 495  | 1.00 | 2SC 983    | 1.00  |
| 2SA 484     | 2.50 | 2SB 77   | .59   | 2SC 497  | 1.60 | 2SC 984    | .90   |
| 2SA 485     | 2.00 | 2SB 186  | .59   | 2SC 498  | 1.60 | 2SC 1000BL | .59   |
| 2SA 489     | 1.60 | 2SB 187  | .59   | 2SC 517  | 3.95 | 2SC 1014   | 1.20  |
| 2SA 495     | .70  | 2SB 202  | 1.60  | 2SC 535  | .70  | 2SC 1017   | 1.40  |
| 2SA 496     | 1.10 | 2SB 220  | .70   | 2SC 536  | .59  | 2SC 1018   | 1.20  |
| 2SA 497     | 1.60 | 2SB 303  | .59   | 2SC 537  | .59  | 2SC 1020   | 2.80  |
| 2SA 509     | .70  | 2SB 324  | .70   | 2SC 538A | .70  | 2SC 1024   | 1.40  |
| 2SA 525     | 2.50 | 2SB 337  | 1.80  | 2SC 562  | 2.15 | 2SC 1060   | 2.25  |
| 2SA 537     | 2.25 | 2SB 367  | 1.50  | 2SC 563  | 1.10 | 2SC 1061   | 1.40  |
| 2SA 539     | .70  | 2SB 368B | 2.15  | 2SC 619  | .59  | 2SC 1089   | 1.40  |
| 2SA 561     | .59  | 2SB 379  | 1.10  | 2SC 620  | .59  | 2SC 1096   | 1.00  |
| 2SA 562     | .59  | 2SB 400  | .59   | 2SC 632A | .70  | 2SC 1111   | 3.40  |
| 2SA 564A    | .59  | 2SB 405  | .70   | 2SC 644  | .59  | 2SC 1115   | 3.40  |
| 2SA 565     | 1.10 | 2SB 407  | 1.40  | 2SC 645  | .70  | 2SC 1116   | 4.90  |
| 2SA 566     | 3.40 | 2SB 415  | .70   | 2SC 650  | 1.30 | 2SC 1124   | 1.30  |
| 2SA 606     | 1.90 | 2SB 434  | 1.20  | 2SC 668  | .59  | 2SC 1162   | 1.10  |
| 2SA 624     | 1.10 | 2SB 440  | .70   | 2SC 680  | 2.80 | 2SC 1166   | .59   |
| 2SA 627     | 3.60 | 2SB 483  | 1.50  | 2SC 684  | 1.40 | 2SC 1173   | .90   |
| 2SA 628     | .59  | 2SB 471  | 1.90  | 2SC 693B | .59  | 2SC 1175   | .90   |
| 2SA 634     | .59  | 2SB 472  | 2.80  | 2SC 696  | 1.95 | 2SC 1177   | 14.00 |
| 2SA 640     | .59  | 2SB 474  | 1.20  | 2SC 708A | 1.90 | 2SC 1189   | 1.40  |
| 2SA 643     | .70  | 2SB 492  | 1.00  | 2SC 710  | .59  | 2SC 1211D  | .70   |
| 2SA 659     | .59  | 2SB 507  | 1.60  | 2SC 711  | .59  | 2SC 1213   | .70   |
| 2SA 663     | 4.90 | 2SB 509  | 1.90  | 2SC 712  | .59  | 2SC 1222   | .45   |
| 2SA 666     | .70  | 2SB 514  | 1.90  | 2SC 717  | .59  | 2SC 1226   | 1.00  |
| 2SA 672     | .70  | 2SB 526C | 1.30  | 2SC 730  | 4.40 | 2SC 1237   | 4.25  |
| 2SA 673     | .70  | 2SB 527  | 1.90  | 2SC 732  | .59  | 2SC 1239   | 3.50  |
| 2SA 678     | .70  | 2SB 528D | 1.60  | 2SC 733  | .59  | 2SC 1259   | 7.00  |
| 2SA 683     | .70  | 2SB 536  | 1.60  | 2SC 734  | .59  | 2SC 1306   | 4.40  |
| 2SA 684     | .70  | 2SB 539  | 4.90  | 2SC 735  | .59  | 2SC 1307   | 4.90  |
| 2SA 685     | .70  | 2SB 541  | 4.40  | 2SC 738  | .59  | 2SC 1312   | .59   |
| 2SA 697     | .70  | 2SB 554  | 10.00 | 2SC 756  | 2.80 | 2SC 1313G  | .59   |
| 2SA 706     | 1.60 | 2SB 561B | 1.90  | 2SC 763  | .59  | 2SC 1317   | .59   |
| 2SA 715     | 1.40 | 2SB 564  | .90   | 2SC 773  | .70  | 2SC 1400   | .59   |
| 2SA 719     | .70  | 2SB 595  | 1.90  | 2SC 774  | 1.60 | 2SC 1327   | .59   |
| 2SA 720     | .70  | 2SB 600A | 7.00  | 2SC 776  | 2.65 | 2SC 1330   | 1.50  |
| 2SA 721     | .70  | 2SC 183  | .59   | 2SC 778  | 3.60 | 2SC 1342   | .59   |
| 2SA 725     | .59  | 2SC 184  | .59   | 2SC 781  | 2.65 | 2SC 1344   | .59   |
| 2SA 726     | .59  | 2SC 181  | .59   | 2SC 783R | 3.60 | 2SC 1345D  | .59   |
| 2SA 733     | .59  | 2SC 284  | 1.40  | 2SC 784  | .59  | 2SC 1359   | 1.40  |
| 2SA 740     | 2.65 | 2SC 367  | .90   | 2SC 785  | .70  | 2SC 1360   | 1.00  |
| 2SA 744     | 3.70 | 2SC 369  | .70   | 2SC 789  | 1.00 | 2SC 1362   | .59   |
| 2SA 745R    | 4.40 | 2SC 371  | .59   | 2SC 793  | 2.80 | 2SC 1364   | 1.40  |
| 2SA 747     | 5.80 | 2SC 372  | .59   | 2SC 799  | 3.80 | 2SC 1377   | 4.90  |
| 2SA 750     | .59  | 2SC 373  | .59   | 2SC 815  | .59  | 2SC 1383   | .59   |
| 2SA 756     | 3.40 | 2SC 374  | .59   | 2SC 828  | .59  | 2SC 1403   | .70   |
| 2SA 758     | 5.80 | 2SC 380  | .59   | 2SC 829  | .59  | 2SC 1402   | 3.70  |
| 2SA 774     | .59  | 2SC 381  | .59   | 2SC 838  | .59  | 2SC 1403   | 3.70  |
| 2SA 777     | 1.10 | 2SC 382  | .59   | 2SC 839  | .59  | 2SC 1419   | 1.10  |
| 2SA 798     | .70  | 2SC 387  | .59   | 2SC 870  | .59  | 2SC 1444   | 2.80  |
| 2SA 814     | 1.90 | 2SC 394  | .59   | 2SC 871  | .59  | 2SC 1448   | 1.10  |

PRICES MAY CHANGE WITHOUT NOTICE COD ORDERS WELCOMED

**IMMEDIATE DELIVERY WITHIN 48 HOURS**  
**ON ALL TRANSISTORS IN STOCK**

Minimum order \$5.00 Ohio residents add 4% sales tax.  
Add \$1.00 postage and handling. Quantity discount prices.

**ASK FOR OUR COMPLETE PRICE LIST**  
**MANUFACTURER INQUIRIES WELCOMED**  
All Parts Guaranteed Against Factory Defects

**FUJI-SVEA ENTERPRISE**

Dept. Radio Electronics

P.O. Box 40325

Cincinnati, OH 45240

(513)874-0220

874-0223

**A**  
**HIGH BLOOD PRESSURE**  
**Treat it...and live.**  
The National High Blood Pressure Education Program,  
U.S. Department of Health, Education, and Welfare.

# DIGI-KEY CORPORATION

Quality Electronic Components

# TOLL FREE 1-800-346-5144

MINNESOTA RESIDENTS 218-681-6674

**DON'T FORGET OUR DISCOUNTS WHEN COMPARING PRICES** I.C.'S • RESISTORS • TRANSISTORS • CAPACITORS • DIODES • I.C. SOCKETS & PINS • SWITCHES  
CLOCK MODULES • OPTOELECTRONICS • BREADBOARDING & TESTING DEVICES • DRAFTING SUPPLIES  
DATA BOOKS • HEAT SINKS • WIRE • TOOLS... AND MORE... WRITE FOR FREE CATALOG...

## INTEGRATED CIRCUITS

|      |       |      |         |      |       |      |
|------|-------|------|---------|------|-------|------|
| 7400 | 74198 | 1.49 | 74LS261 | 2.00 | LS377 | 1.90 |
| 7401 | 74201 | 1.49 | 74LS262 | 2.00 | LS378 | 1.90 |
| 7402 | 74202 | 1.49 | 74LS263 | 2.00 | LS379 | 1.90 |
| 7403 | 74203 | 1.49 | 74LS264 | 2.00 | LS380 | 1.90 |
| 7404 | 74204 | 1.49 | 74LS265 | 2.00 | LS381 | 1.90 |
| 7405 | 74205 | 1.49 | 74LS266 | 2.00 | LS382 | 1.90 |
| 7406 | 74206 | 1.49 | 74LS267 | 2.00 | LS383 | 1.90 |
| 7407 | 74207 | 1.49 | 74LS268 | 2.00 | LS384 | 1.90 |
| 7408 | 74208 | 1.49 | 74LS269 | 2.00 | LS385 | 1.90 |
| 7409 | 74209 | 1.49 | 74LS270 | 2.00 | LS386 | 1.90 |
| 7410 | 74210 | 1.49 | 74LS271 | 2.00 | LS387 | 1.90 |
| 7411 | 74211 | 1.49 | 74LS272 | 2.00 | LS388 | 1.90 |
| 7412 | 74212 | 1.49 | 74LS273 | 2.00 | LS389 | 1.90 |
| 7413 | 74213 | 1.49 | 74LS274 | 2.00 | LS390 | 1.90 |
| 7414 | 74214 | 1.49 | 74LS275 | 2.00 | LS391 | 1.90 |
| 7415 | 74215 | 1.49 | 74LS276 | 2.00 | LS392 | 1.90 |
| 7416 | 74216 | 1.49 | 74LS277 | 2.00 | LS393 | 1.90 |
| 7417 | 74217 | 1.49 | 74LS278 | 2.00 | LS394 | 1.90 |
| 7418 | 74218 | 1.49 | 74LS279 | 2.00 | LS395 | 1.90 |
| 7419 | 74219 | 1.49 | 74LS280 | 2.00 | LS396 | 1.90 |
| 7420 | 74220 | 1.49 | 74LS281 | 2.00 | LS397 | 1.90 |
| 7421 | 74221 | 1.49 | 74LS282 | 2.00 | LS398 | 1.90 |
| 7422 | 74222 | 1.49 | 74LS283 | 2.00 | LS399 | 1.90 |
| 7423 | 74223 | 1.49 | 74LS284 | 2.00 | LS400 | 1.90 |
| 7424 | 74224 | 1.49 | 74LS285 | 2.00 | LS401 | 1.90 |
| 7425 | 74225 | 1.49 | 74LS286 | 2.00 | LS402 | 1.90 |
| 7426 | 74226 | 1.49 | 74LS287 | 2.00 | LS403 | 1.90 |
| 7427 | 74227 | 1.49 | 74LS288 | 2.00 | LS404 | 1.90 |
| 7428 | 74228 | 1.49 | 74LS289 | 2.00 | LS405 | 1.90 |
| 7429 | 74229 | 1.49 | 74LS290 | 2.00 | LS406 | 1.90 |
| 7430 | 74230 | 1.49 | 74LS291 | 2.00 | LS407 | 1.90 |
| 7431 | 74231 | 1.49 | 74LS292 | 2.00 | LS408 | 1.90 |
| 7432 | 74232 | 1.49 | 74LS293 | 2.00 | LS409 | 1.90 |
| 7433 | 74233 | 1.49 | 74LS294 | 2.00 | LS410 | 1.90 |
| 7434 | 74234 | 1.49 | 74LS295 | 2.00 | LS411 | 1.90 |
| 7435 | 74235 | 1.49 | 74LS296 | 2.00 | LS412 | 1.90 |
| 7436 | 74236 | 1.49 | 74LS297 | 2.00 | LS413 | 1.90 |
| 7437 | 74237 | 1.49 | 74LS298 | 2.00 | LS414 | 1.90 |
| 7438 | 74238 | 1.49 | 74LS299 | 2.00 | LS415 | 1.90 |
| 7439 | 74239 | 1.49 | 74LS300 | 2.00 | LS416 | 1.90 |
| 7440 | 74240 | 1.49 | 74LS301 | 2.00 | LS417 | 1.90 |
| 7441 | 74241 | 1.49 | 74LS302 | 2.00 | LS418 | 1.90 |
| 7442 | 74242 | 1.49 | 74LS303 | 2.00 | LS419 | 1.90 |
| 7443 | 74243 | 1.49 | 74LS304 | 2.00 | LS420 | 1.90 |
| 7444 | 74244 | 1.49 | 74LS305 | 2.00 | LS421 | 1.90 |
| 7445 | 74245 | 1.49 | 74LS306 | 2.00 | LS422 | 1.90 |
| 7446 | 74246 | 1.49 | 74LS307 | 2.00 | LS423 | 1.90 |
| 7447 | 74247 | 1.49 | 74LS308 | 2.00 | LS424 | 1.90 |
| 7448 | 74248 | 1.49 | 74LS309 | 2.00 | LS425 | 1.90 |
| 7449 | 74249 | 1.49 | 74LS310 | 2.00 | LS426 | 1.90 |
| 7450 | 74250 | 1.49 | 74LS311 | 2.00 | LS427 | 1.90 |
| 7451 | 74251 | 1.49 | 74LS312 | 2.00 | LS428 | 1.90 |
| 7452 | 74252 | 1.49 | 74LS313 | 2.00 | LS429 | 1.90 |
| 7453 | 74253 | 1.49 | 74LS314 | 2.00 | LS430 | 1.90 |
| 7454 | 74254 | 1.49 | 74LS315 | 2.00 | LS431 | 1.90 |
| 7455 | 74255 | 1.49 | 74LS316 | 2.00 | LS432 | 1.90 |
| 7456 | 74256 | 1.49 | 74LS317 | 2.00 | LS433 | 1.90 |
| 7457 | 74257 | 1.49 | 74LS318 | 2.00 | LS434 | 1.90 |
| 7458 | 74258 | 1.49 | 74LS319 | 2.00 | LS435 | 1.90 |
| 7459 | 74259 | 1.49 | 74LS320 | 2.00 | LS436 | 1.90 |
| 7460 | 74260 | 1.49 | 74LS321 | 2.00 | LS437 | 1.90 |
| 7461 | 74261 | 1.49 | 74LS322 | 2.00 | LS438 | 1.90 |
| 7462 | 74262 | 1.49 | 74LS323 | 2.00 | LS439 | 1.90 |
| 7463 | 74263 | 1.49 | 74LS324 | 2.00 | LS440 | 1.90 |
| 7464 | 74264 | 1.49 | 74LS325 | 2.00 | LS441 | 1.90 |
| 7465 | 74265 | 1.49 | 74LS326 | 2.00 | LS442 | 1.90 |
| 7466 | 74266 | 1.49 | 74LS327 | 2.00 | LS443 | 1.90 |
| 7467 | 74267 | 1.49 | 74LS328 | 2.00 | LS444 | 1.90 |
| 7468 | 74268 | 1.49 | 74LS329 | 2.00 | LS445 | 1.90 |
| 7469 | 74269 | 1.49 | 74LS330 | 2.00 | LS446 | 1.90 |
| 7470 | 74270 | 1.49 | 74LS331 | 2.00 | LS447 | 1.90 |
| 7471 | 74271 | 1.49 | 74LS332 | 2.00 | LS448 | 1.90 |
| 7472 | 74272 | 1.49 | 74LS333 | 2.00 | LS449 | 1.90 |
| 7473 | 74273 | 1.49 | 74LS334 | 2.00 | LS450 | 1.90 |
| 7474 | 74274 | 1.49 | 74LS335 | 2.00 | LS451 | 1.90 |
| 7475 | 74275 | 1.49 | 74LS336 | 2.00 | LS452 | 1.90 |
| 7476 | 74276 | 1.49 | 74LS337 | 2.00 | LS453 | 1.90 |
| 7477 | 74277 | 1.49 | 74LS338 | 2.00 | LS454 | 1.90 |
| 7478 | 74278 | 1.49 | 74LS339 | 2.00 | LS455 | 1.90 |
| 7479 | 74279 | 1.49 | 74LS340 | 2.00 | LS456 | 1.90 |
| 7480 | 74280 | 1.49 | 74LS341 | 2.00 | LS457 | 1.90 |
| 7481 | 74281 | 1.49 | 74LS342 | 2.00 | LS458 | 1.90 |
| 7482 | 74282 | 1.49 | 74LS343 | 2.00 | LS459 | 1.90 |
| 7483 | 74283 | 1.49 | 74LS344 | 2.00 | LS460 | 1.90 |
| 7484 | 74284 | 1.49 | 74LS345 | 2.00 | LS461 | 1.90 |
| 7485 | 74285 | 1.49 | 74LS346 | 2.00 | LS462 | 1.90 |
| 7486 | 74286 | 1.49 | 74LS347 | 2.00 | LS463 | 1.90 |
| 7487 | 74287 | 1.49 | 74LS348 | 2.00 | LS464 | 1.90 |
| 7488 | 74288 | 1.49 | 74LS349 | 2.00 | LS465 | 1.90 |
| 7489 | 74289 | 1.49 | 74LS350 | 2.00 | LS466 | 1.90 |
| 7490 | 74290 | 1.49 | 74LS351 | 2.00 | LS467 | 1.90 |
| 7491 | 74291 | 1.49 | 74LS352 | 2.00 | LS468 | 1.90 |
| 7492 | 74292 | 1.49 | 74LS353 | 2.00 | LS469 | 1.90 |
| 7493 | 74293 | 1.49 | 74LS354 | 2.00 | LS470 | 1.90 |
| 7494 | 74294 | 1.49 | 74LS355 | 2.00 | LS471 | 1.90 |
| 7495 | 74295 | 1.49 | 74LS356 | 2.00 | LS472 | 1.90 |
| 7496 | 74296 | 1.49 | 74LS357 | 2.00 | LS473 | 1.90 |
| 7497 | 74297 | 1.49 | 74LS358 | 2.00 | LS474 | 1.90 |
| 7498 | 74298 | 1.49 | 74LS359 | 2.00 | LS475 | 1.90 |
| 7499 | 74299 | 1.49 | 74LS360 | 2.00 | LS476 | 1.90 |
| 7500 | 74300 | 1.49 | 74LS361 | 2.00 | LS477 | 1.90 |
| 7501 | 74301 | 1.49 | 74LS362 | 2.00 | LS478 | 1.90 |
| 7502 | 74302 | 1.49 | 74LS363 | 2.00 | LS479 | 1.90 |
| 7503 | 74303 | 1.49 | 74LS364 | 2.00 | LS480 | 1.90 |
| 7504 | 74304 | 1.49 | 74LS365 | 2.00 | LS481 | 1.90 |
| 7505 | 74305 | 1.49 | 74LS366 | 2.00 | LS482 | 1.90 |
| 7506 | 74306 | 1.49 | 74LS367 | 2.00 | LS483 | 1.90 |
| 7507 | 74307 | 1.49 | 74LS368 | 2.00 | LS484 | 1.90 |
| 7508 | 74308 | 1.49 | 74LS369 | 2.00 | LS485 | 1.90 |
| 7509 | 74309 | 1.49 | 74LS370 | 2.00 | LS486 | 1.90 |
| 7510 | 74310 | 1.49 | 74LS371 | 2.00 | LS487 | 1.90 |
| 7511 | 74311 | 1.49 | 74LS372 | 2.00 | LS488 | 1.90 |
| 7512 | 74312 | 1.49 | 74LS373 | 2.00 | LS489 | 1.90 |
| 7513 | 74313 | 1.49 | 74LS374 | 2.00 | LS490 | 1.90 |
| 7514 | 74314 | 1.49 | 74LS375 | 2.00 | LS491 | 1.90 |
| 7515 | 74315 | 1.49 | 74LS376 | 2.00 | LS492 | 1.90 |
| 7516 | 74316 | 1.49 | 74LS377 | 2.00 | LS493 | 1.90 |
| 7517 | 74317 | 1.49 | 74LS378 | 2.00 | LS494 | 1.90 |
| 7518 | 74318 | 1.49 | 74LS379 | 2.00 | LS495 | 1.90 |
| 7519 | 74319 | 1.49 | 74LS380 | 2.00 | LS496 | 1.90 |
| 7520 | 74320 | 1.49 | 74LS381 | 2.00 | LS497 | 1.90 |
| 7521 | 74321 | 1.49 | 74LS382 | 2.00 | LS498 | 1.90 |
| 7522 | 74322 | 1.49 | 74LS383 | 2.00 | LS499 | 1.90 |
| 7523 | 74323 | 1.49 | 74LS384 | 2.00 | LS500 | 1.90 |
| 7524 | 74324 | 1.49 | 74LS385 | 2.00 | LS501 | 1.90 |
| 7525 | 74325 | 1.49 | 74LS386 | 2.00 | LS502 | 1.90 |
| 7526 | 74326 | 1.49 | 74LS387 | 2.00 | LS503 | 1.90 |
| 7527 | 74327 | 1.49 | 74LS388 | 2.00 | LS504 | 1.90 |
| 7528 | 74328 | 1.49 | 74LS389 | 2.00 | LS505 | 1.90 |
| 7529 | 74329 | 1.49 | 74LS390 | 2.00 | LS506 | 1.90 |
| 7530 | 74330 | 1.49 | 74LS391 | 2.00 | LS507 | 1.90 |
| 7531 | 74331 | 1.49 | 74LS392 | 2.00 | LS508 | 1.90 |
| 7532 | 74332 | 1.49 | 74LS393 | 2.00 | LS509 | 1.90 |
| 7533 | 74333 | 1.49 | 74LS394 | 2.00 | LS510 | 1.90 |
| 7534 | 74334 | 1.49 | 74LS395 | 2.00 | LS511 | 1.90 |
| 7535 | 74335 | 1.49 | 74LS396 | 2.00 | LS512 | 1.90 |
| 7536 | 74336 | 1.49 | 74LS397 | 2.00 | LS513 | 1.90 |
| 7537 | 74337 | 1.49 | 74LS398 | 2.00 | LS514 | 1.90 |
| 7538 | 74338 | 1.49 | 74LS399 | 2.00 | LS515 | 1.90 |
| 7539 | 74339 | 1.49 | 74LS400 | 2.00 | LS516 | 1.90 |
| 7540 | 74340 | 1.49 | 74LS401 | 2.00 | LS517 | 1.90 |
| 7541 | 74341 | 1.49 | 74LS402 | 2.00 | LS518 | 1.90 |
| 7542 | 74342 | 1.49 | 74LS403 | 2.00 | LS519 | 1.90 |
| 7543 | 74343 | 1.49 | 74LS404 | 2.00 | LS520 | 1.90 |
| 7544 | 74344 | 1.49 | 74LS405 | 2.00 | LS521 | 1.90 |
| 7545 | 74345 | 1.49 | 74LS406 | 2.00 | LS522 | 1.90 |
| 7546 | 74346 | 1.49 | 74LS407 | 2.00 | LS523 | 1.90 |
| 7547 | 74347 | 1.49 | 74LS408 | 2.00 | LS524 | 1.90 |
| 7548 | 74348 | 1.49 | 74LS409 | 2.00 | LS525 | 1.90 |
| 7549 | 74349 | 1.49 | 74LS410 |      |       |      |

\$2.50

1978

**THE WORLD'S LARGEST  
INTERNATIONAL SEMICONDUCTOR  
DISTRIBUTOR**

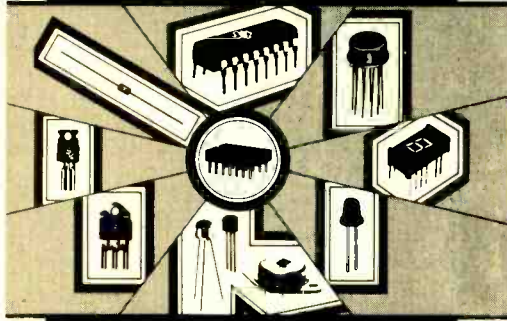

**Active Electronic Sales Corp.**

P.O. BOX 1035

FRAMINGHAM, MASSACHUSETTS 01701

TELEPHONE ORDERS (617) 879-0077

Over The Counter Sales

12 Mercer Rd.  
NATICK, MASS. 01760  
(Behind Zayres on Route 9)

Our New and Expanded  
Comprehensive  
1978 Catalogue  
(144 pages) is finally  
available.

Please write for your  
complimentary copy.

**Active Electronic Sales Corp.**

P.O. BOX 1035 FRAMINGHAM, MASSACHUSETTS 01701

OVER-THE-COUNTER SALES, 12 Mercer Rd., Natick, Mass. 01760 Behind Zayres on Rte. 9

Telephone Orders & Enquiries (617) 879-0077

**IN CANADA  
2 Locations**

**5651 Ferrier st.  
Montreal, Quebec  
Tel. (514) 735-6425**

**44 Fasken Dr-Unit 25  
Rexdale, Ontario  
Tel. (416) 675-3311**

MINIMUM ORDER \$10.00 \* ADD \$2.00 TO COVER POSTAGE & HANDLING \* Canadian customers add 15% for exchange and handling. All federal and provincial taxes extra. Foreign customers please remit payment on an international bank draft or international postal money order in American dollars.

CIRCLE 86 ON FREE INFORMATION CARD

**VARIABLE POWER SUPPLY KIT \$11<sup>95</sup>**

- Continuously Variable from 2V to over 15V
- Short-Circuit Proof
- Typical Regulation of 0.1%
- Electronic Current Limiting at 300mA
- Very Low Output Ripple
- Fiberglass PC Board Mounts All Components
- Assemble in about One Hour
- Makes a Great Bench or Lab Power Supply
- Includes All Components except Case and Meters

ADD \$1.25 FOR POSTAGE/HANDLING

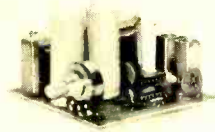

**SPECIALS - THIS MONTH ONLY**

|  |  |        |         |   |            |
|--|--|--------|---------|---|------------|
| 1N34A  | Germanium Diode 50V 10mA   | 10/S1  | LM308H  | Low Bias Current Op Amp-Super 709                                     | \$0.84     |
| 1N270  | Germanium Diode 80V 200mA  | 4/S1   | LM309K  | 5 Volt Regulator  | TO-3 .84   |
| 1N914  | Silicon Diode 100V 10mA  | 25/S1  | LM317K  | Adjustable Voltage Regulator  | 2.37V 3.50 |
| 1N6263   | Hot Carrier Diode (HP2800, etc.)                                     | \$1.00 | LM380N  | 2 Watt Audio Power Amplifier  | DIP .94    |
| F7   | Power Varactor 1-2W Out @ 432MHz (Specs & Circuits included with F7) | \$2.00 | NE585A  | Phase Locked Loop   | DIP .94    |
| <b>DIODE GRAB BAG - Mixed zeners, rectifiers, etc.</b> |  |        |         |   |            |
| 2N706  | NPN High Speed Switch 75ns   | 4/S1   | LM723CN | Precision Voltage Regulator   | DIP 3/S1   |
| 2N918  | UHF Transistor - Osc/ Amp up to 1 GHz                                | 4/S1   | LM747   | Dual 741 Compensated Op Amp   | DIP 2/S1   |
| 2N2909   | P Channel FET Amplifier 2500, mhos                                   | \$1.00 | 2102    | 1024-Bit Static RAM (1024 x 1)  | DIP \$1.75 |
| 2N2920   | NPN Dual Transistor 3mV Match - 2Z5                                  | 2.95   | 2740DE  | FET Input Op Amp - like NE 536/µA740                                  | 1.95       |
| 2N3904   | NPN Amp/Switch 100 40V 200mA   | 8/S1   | CA2018A | 4 Transistor Array/Darlington   | .99        |
| 2N4122   | PNP RF Amplifier & Switch  | 3/S1   | CA3028A | RF/F Amplifier/ Osc to 120MHz   | 1.45       |
| 2N4889E  | N Channel Audio FET Super Low Noise                                  | 2/S1   | CA3075E | FM IF Amp/Limiter/Detector  | DIP 1.45   |
| 2N4888   | 150 Volt PNP Transistor for Keyer                                    | 2/S1   | RC4558  | Dual High Gain Op Amp   | mDIP 3/S1  |
| E112   | N Channel FET VHF RF Amp   | 3/S1   | N5556V  | Precision Fast Op Amp   | mDIP 2/S1  |
| T1574  | N Channel FET High Speed Switch 40ns                                 | 3/S1   | N5558V  | Dual Hi Gain Op Amp Comp.   | mDIP 3/S1  |
| TD 220   | Mounting Kit Mica insulator & bushing                                | 10/S1  | 8038    | Function Generator/VCO with circuits                                  | \$3.75     |
|  |  |        | 8223    | 256-Bit PRDM (32 x 8) 50ns  | 2.89       |
|  |  |        | LP-10   | LOGIC PROBE kit-TTL, CMOS, etc. Machined case included-4 hr. assembly | \$7.85     |

SEND FOR ADVA'S NEW 1978 CATALOG  
OVER 700 SEMICONDUCTORS, KITS, CAPACITORS, ETC.-SEND 13¢ STAMP.

**OTHER ADVA KITS:**

**LOGIC PROBE KIT**-Use with CMOS, TTL, DTL, RTL, HTL, H/ML and most MOS IC's. Built-in protection against polarity reversal and overvoltage. Drives only a few mA from circuit under test. Dual LED readout. Complete kit includes case and clip leads. **ONLY \$7.95**

**FIXED REGULATED POWER SUPPLY KITS**-Short circuit proof with thermal current limiting. Compact size and typical regulation of 0.5% make these ideal for most electronic projects. Available for: 5V @ 500mA, 6V @ 500mA, 9V @ 500mA, 12V @ 400mA, 15V @ 300mA. Slightly voltage when ordering. **\$8.95 ea.**

These easy-to-assemble kits include all components, complete detailed instructions and plated fiberglass PC boards. Power supply kits do not include case or meters. Add \$1.25 per kit for postage and handling.

\*MAIL NOW! FREE DATA SHEETS supplied with many items from this ad FREE ON REQUEST - 741 Op Amp with every order of \$5 or more - 749 Dual Op Amp or two E110 FET's with every order of \$10 or more. Also marked on ad to 12/31/77. One free item per order.

**ORDER TODAY** - All items subject to prior sale and prices subject to change without notice. All items are new surplus parts - 100% functionally tested.

**WRITE FOR FREE CATALOG** offering over 700 semiconductors carried in stock. Send 13¢ stamp.

**TERMS** - Send check or money order (U.S. funds) with order. Add 5% postage for U.S. Canada and Mexico. \$1.00 handling charge on orders under \$10. Calif. residents add 6% sales tax. Foreign orders add 10% postage. COD orders add \$1.00 service charge.

**MORE SPECIALS:**

- RC41950N 1kV @ 50mA VOLTAGE REGULATOR IC. Vary easy to use. Makes a neat High Voltage Regulator - 15V Supply for OP AMP's, etc. Requires only unregulated DC (18-30V) and 2 bypass capacitors. With Data Sheet and Schematics. 8-pin mDIP. **\$1.25**
- RC4136 Quad 741 Low-Noise Op Amp mDIP. **\$0.95**
- LM1304 FM Multiplex Stereo Demodulator DIP. **0.99**
- LM2111 FM IF Subsystem (IF Amp, Det., Limiter) DIP. **0.99**
- 1N6263 Hot Carrier Diode 0.4V @ 1mA 0.1ns DO-35. **1.00**
- ZENERS - Specify Voltage 3.3, 3.9, 4.3, 5.1, 6.8, 8.2, 9.1, 10, 12, 15, 16, 18, 20, 22, 24, 27, or 33V (±10%) 1 Watt 3/S1.00

- **MONEY-BACK GUARANTEE**
- **ALL TESTED AND GUARANTEED**

**ADVA ELECTRONICS**  
BOX 4181 ER, WOODSIDE, CA 94062  
Tel. (415) 851-0455

CIRCLE 82 ON FREE INFORMATION CARD

**FREE** IC or FET's WITH \$5 & \$10 ORDERS.† DATA SHEETS WITH MANY ITEMS.

| DIODES<br>& RECTIFIERS | TRANSISTORS | TRANSISTORS | TRANSISTORS | LINEAR IC's |
|------------------------|-------------|-------------|-------------|-------------|
| 2N706                  | 2N706       | 2N2909      | 2N2909      | LM308K-5    |
| 2N718                  | 2N718       | 2N2907      | 2N2907      | LM308K-5    |
| 2N720                  | 2N720       | 2N2904      | 2N2904      | LM308K-5    |
| 2N918                  | 2N918       | 2N2907      | 2N2907      | LM308K-5    |
| 2N914                  | 2N914       | 2N2904      | 2N2904      | LM308K-5    |
| 2N1711                 | 2N1711      | 2N2907      | 2N2907      | LM308K-5    |
| 2N1890                 | 2N1890      | 2N2904      | 2N2904      | LM308K-5    |
| 2N1893                 | 2N1893      | 2N2907      | 2N2907      | LM308K-5    |
| 2N2219                 | 2N2219      | 2N2904      | 2N2904      | LM308K-5    |
| 2N2222                 | 2N2222      | 2N2907      | 2N2907      | LM308K-5    |
| 2N2222A                | 2N2222A     | 2N2904      | 2N2904      | LM308K-5    |
| 2N2369                 | 2N2369      | 2N2907      | 2N2907      | LM308K-5    |
| 2N2609                 | 2N2609      | 2N2904      | 2N2904      | LM308K-5    |
| 2N2905                 | 2N2905      | 2N2907      | 2N2907      | LM308K-5    |
| 2N2905A                | 2N2905A     | 2N2904      | 2N2904      | LM308K-5    |
| 2N2907                 | 2N2907      | 2N2907      | 2N2907      | LM308K-5    |
| 2N3553                 | 2N3553      | 2N2904      | 2N2904      | LM308K-5    |
| 2N3553                 | 2N3553      | 2N2907      | 2N2907      | LM308K-5    |
| 2N3558                 | 2N3558      | 2N2904      | 2N2904      | LM308K-5    |
| 2N3558                 | 2N3558      | 2N2907      | 2N2907      | LM308K-5    |
| 2N3568                 | 2N3568      | 2N2904      | 2N2904      | LM308K-5    |
| 2N3568                 | 2N3568      | 2N2907      | 2N2907      | LM308K-5    |
| 2N3638                 | 2N3638      | 2N2904      | 2N2904      | LM308K-5    |
| 2N3638                 | 2N3638      | 2N2907      | 2N2907      | LM308K-5    |
| 2N3641                 | 2N3641      | 2N2904      | 2N2904      | LM308K-5    |
| 2N3641                 | 2N3641      | 2N2907      | 2N2907      | LM308K-5    |
| 2N3643                 | 2N3643      | 2N2904      | 2N2904      | LM308K-5    |
| 2N3643                 | 2N3643      | 2N2907      | 2N2907      | LM308K-5    |
| 2N3644                 | 2N3644      | 2N2904      | 2N2904      | LM308K-5    |
| 2N3644                 | 2N3644      | 2N2907      | 2N2907      | LM308K-5    |
| 2N3688                 | 2N3688      | 2N2904      | 2N2904      | LM308K-5    |
| 2N3688                 | 2N3688      | 2N2907      | 2N2907      | LM308K-5    |
| 2N3690                 | 2N3690      | 2N2904      | 2N2904      | LM308K-5    |
| 2N3690                 | 2N3690      | 2N2907      | 2N2907      | LM308K-5    |
| 2N3691                 | 2N3691      | 2N2904      | 2N2904      | LM308K-5    |
| 2N3691                 | 2N3691      | 2N2907      | 2N2907      | LM308K-5    |
| 2N3694                 | 2N3694      | 2N2904      | 2N2904      | LM308K-5    |
| 2N3694                 | 2N3694      | 2N2907      | 2N2907      | LM308K-5    |
| 2N3821                 | 2N3821      | 2N2904      | 2N2904      | LM308K-5    |
| 2N3821                 | 2N3821      | 2N2907      | 2N2907      | LM308K-5    |
| 2N3822                 | 2N3822      | 2N2904      | 2N2904      | LM308K-5    |
| 2N3822                 | 2N3822      | 2N2907      | 2N2907      | LM308K-5    |
| 2N3866                 | 2N3866      | 2N2904      | 2N2904      | LM308K-5    |
| 2N3866                 | 2N3866      | 2N2907      | 2N2907      | LM308K-5    |
| 2N3903                 | 2N3903      | 2N2904      | 2N2904      | LM308K-5    |
| 2N3903                 | 2N3903      | 2N2907      | 2N2907      | LM308K-5    |
| 2N3906                 | 2N3906      | 2N2904      | 2N2904      | LM308K-5    |
| 2N3906                 | 2N3906      | 2N2907      | 2N2907      | LM308K-5    |
| 2N3919                 | 2N3919      | 2N2904      | 2N2904      | LM308K-5    |
| 2N3919                 | 2N3919      | 2N2907      | 2N2907      | LM308K-5    |
| 2N3922                 | 2N3922      | 2N2904      | 2N2904      | LM308K-5    |
| 2N3922                 | 2N3922      | 2N2907      | 2N2907      | LM308K-5    |
| 2N3954                 | 2N3954      | 2N2904      | 2N2904      | LM308K-5    |
| 2N3954                 | 2N3954      | 2N2907      | 2N2907      | LM308K-5    |
| 2N3958                 | 2N3958      | 2N2904      | 2N2904      | LM308K-5    |
| 2N3958                 | 2N3958      | 2N2907      | 2N2907      | LM308K-5    |
| 2N3970                 | 2N3970      | 2N2904      | 2N2904      | LM308K-5    |
| 2N3970                 | 2N3970      | 2N2907      | 2N2907      | LM308K-5    |
| 2N5561                 | 2N5561      | 2N2904      | 2N2904      | LM308K-5    |
| 2N5561                 | 2N5561      | 2N2907      | 2N2907      | LM308K-5    |

**\*SUPER SPECIALS:**

|        |                      |       |                          |        |
|--------|----------------------|-------|--------------------------|--------|
| 1N34   | Germanium Diode      | 10/S1 | FSA2501M Diode Array     | 2/S1   |
| 1N914  | 100V/10mA Rectifier  | 20/S1 | MPF102 200MHz RF Amp     | 3/S1   |
| 1N4001 | 50V/1A Rectifier     | 15/S1 | 40673 MOSFET RF Amp      | \$1.75 |
| 1N4154 | 30V 1N4154           | 25/S1 | LM324 Quad 741 Op Amp    | .94    |
| BR1    | 50V 1/8A Bridge Rect | 4/S1  | LM376 Pos Volt Reg mDIP  | .55    |
| 2N2907 | NPN Transistor       | 6/S1  | NE555 Timer mDIP         | .38    |
| 2N2907 | PNP Transistor       | 6/S1  | LM723 2.37V Reg DIP      | 3/S1   |
| 2N3055 | Power Xistor 10A     | 50/S1 | LM741 Comp Op Amp mDIP   | 3/S1   |
| 2N3904 | NPN Amp/Sw 100       | 6/S1  | LM1458 Dual 741 mDIP     | 3/S1   |
| 2N3906 | PNP Amp/Sw 100       | 6/S1  | CA3086 5 Trans Array DIP | 6/2    |
| CP650  | Power FET 1/2Amp     | 55    | RCA29 Pwr Xistor 1A 30W  | .70    |

RF391 RF Power Op Amp Transistor 10-25W @ 3-30MHz TC-3 \$5.00  
 555X Timer 1us Tr Delay (pinout from 555 (w/data)) 3/S1  
 RC4194TK Dual Tracking Regulator 0.2 to 30V @ 200mA TO 66 \$2.50  
 RC4195TK Dual Tracking Regulator -15V @ 100mA TO 66 \$2.25  
 8038 Waveform Generator 1/2 Wave With Circuits & Data \$3.75



**S-100 EXPANDABLE MOTHER BOARD**

• 8-SLOT EXPANDABLE BACKPLANE—in line male and female connectors enable backplanes to be plugged together, or the female may be used in place of an extender board.

QUIET—ground plane decouples all signal lines.

RELIABLE—SAE 8100 phenolic body, gold contact connectors.

COMPLETE KIT **\$6600** ASSEMBLED **\$8900**

**DEC® LSI-11 16K MEMORY BOARD**

- Q-BUS—FULLY STATIC
- MODULAR
- ADDRESSABLE TO 128K WORDS
- MAPPABLE IN 4K INCREMENTS
- BUFFERED AND NOISE SUPPRESSED
- PROM COMPATIBLE

ASSEMBLED, TESTED & BURNED IN **\$124900** COMPLETE KIT **\$115900**

LARGEST & FASTEST STATIC MEMORY AVAILABLE

**S-100 32K STATIC MEMORY BOARD**

features:

1. FULLY STATIC - usable with all DMA devices
2. BUFFERED - with noise suppressed control inputs
3. MODULAR - populated in 1K increments
4. RELIABLE - single source +5V. regulator
5. PROM COMPATIBLE - monitors available on request

Available:

COMPLETE KITS or ASSEMBLED UNITS which have been fully tested and burned in

BARE BOARD \$39<sup>00</sup>

|     |       |           |
|-----|-------|-----------|
|     | KIT   | ASSEMBLED |
| 8K  | \$278 | \$320     |
| 16K | \$468 | \$515     |
| 24K | \$648 | \$695     |
| 32K | \$800 | \$845     |

**S-100 EXTENDER BOARD**

A MUST for trouble-shooting your Computer boards **\$16<sup>95</sup>**

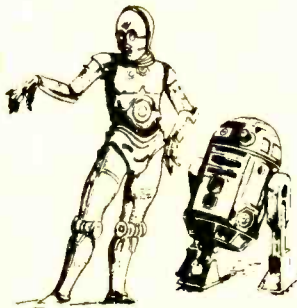

**GOOD GRACIOUS, R-2,** they have spare parts for simply *everything!*

**U.V. PROMS**

|      |     |         |
|------|-----|---------|
| 1702 | 2K  | \$4.75  |
| 2708 | 8K  | \$13.95 |
| 2716 | 16K | \$31.95 |

**1K STATIC RAMS**

|        |        |
|--------|--------|
| 2101   | \$2.45 |
| 2102   | .99    |
| 2102.1 | \$1.25 |

**BIPOLAR PROMS**

|        |              |        |
|--------|--------------|--------|
| 8223   | 256 BIT      | \$2.75 |
| 82523  | 256 BIT      | \$3.50 |
| 6306-1 | 2K TRI-STATE | \$5.95 |

**4K STATIC RAMS**

|           |       |       |         |
|-----------|-------|-------|---------|
| 2114      | 650ns | 600mW | \$9.95  |
| TMS4045 4 | 450ns | 300mW | \$11.95 |
| HM-472114 | 450ns | 200mW | \$13.95 |

**MINIATURE 3-1/2 DIGIT LIQUID CRYSTAL CRYSTAL**

ideal display for pocket sized instruments

**\$3<sup>95</sup>**

**SUB-MINIATURE CRYSTAL FILTER 455 KHz**

**\$2<sup>95</sup>**

**PRECUT & STRIPPED**

**WIRE WRAP WIRE**

No. 30 Kynar available in red, blue, yellow, orange, green, black, white. Length is overall with 1" strip on each end.

AT THESE PRICES A GUY HAS TO BE NUTS TO DO IT BY HAND!

|        |        |        |        |        |        |        |        |
|--------|--------|--------|--------|--------|--------|--------|--------|
|        | 100pcs |        | 100pcs |        | 100pcs |        | 100pcs |
| 2-1/2" | \$1.00 | 4-1/2" | \$1.27 | 6-1/2" | \$1.57 | 8-1/2" | \$1.88 |
| 3"     | 1.08   | 5"     | 1.35   | 7"     | 1.63   | 9"     | 1.97   |
| 3-1/2" | 1.15   | 5-1/2" | 1.41   | 7-1/2" | 1.68   | 9-1/2" | 2.08   |
| 4"     | 1.20   | 6"     | 1.50   | 8"     | 1.75   | 10"    | 2.18   |

**MC1568D ±15V DUAL TRACKING VOLTAGE REGULATOR**

100mA **\$1<sup>95</sup>**

100 PIECES OF EACH LENGTH **\$22<sup>00</sup>**

500 PIECES OF EACH LENGTH **\$98<sup>00</sup>**

1000 PIECES OF EACH LENGTH **\$188<sup>00</sup>**

PREPAID W.W. WIRE ORDERS FOR OVER \$500 QUALIFY FOR SPECIAL DEALER'S DISCOUNT.

**FOREIGN ORDERS—**

We will now accept foreign orders.  
 • Canada, Puerto Rico, U.S. Possessions add \$3.50 postage & handling.  
 • All other countries add \$7.00.  
 • U.S. FUNDS ONLY.

**TO ALL OUR CUSTOMERS**

Because of F. Reichert Sales' new FOREIGN ORDER policy, we will honor all sale items advertised in DEC., JAN. & FEB. issues of R.E. except the following until April 3, 1978: NE 555, 8 pin I.C. Sockets, Jumbo LED's.

We've extended this offer to all our customers both WALK-IN and MAIL ORDERS.

Due to greater than expected MAIL ORDER response, we will not be able to respond to all INFORMATION and CATALOG requests on a "first-come, first-served" basis. We feel people who have placed orders ought to come first. Later, WE'LL CATCH UP!

**CHEAP THRILLS** LIMIT 10 OF EACH ITEM PER ORDER - NO EXCEPTIONS, PLEASE!

|          |        |    |
|----------|--------|----|
| 7400 09  | 7474   | 20 |
| 7401 09  | 7494   | 35 |
| 7404 10  | 74161  | 40 |
| 74S04 12 | DM8880 | 50 |
| 7432 10  | ua709  | 19 |
| 7442 25  | LM301  | 18 |
| 74L73 20 | MC1458 | 39 |

**DIODES & TRANSISTORS**  
 MARKINGS STANDARD. HOUSE & SOME UNMARKED. BUT ALL MEET SPECS.  
 IN 91 .10 IN 4148 05 2N 2222 .10  
 IN 270 .09 IN 4001 05 2N 3904 .10  
 IN 3600 .10 IN 4007 10 2N 3906 .10  
 NE-2 NEON BULB .08

**NPN POWER TRANSISTORS**

**2N 5301 (30A) \$3.95**  
 TO-3 200W 40V  
**BUY69B 10A \$6.95**  
**BUY69C 15A \$5.95**  
 700V 400V

**DIACS**

Specify TO-92 or axial DO-7 pkg  
 28V  
**3/99c**

**A/D CONVERTER**

Signetics NE 5008 **\$13<sup>95</sup>**

**D/A CONVERTER**

DAC-01/SH **\$12<sup>95</sup>**

**MINI KITS** include schematic & component parts—you add the rest.

**MICRO DC TO DC UP CONVERTER**

5V in 20 to 40V out **\$4<sup>95</sup>**

**UNIVERSAL NICAD CHARGER**

0 to 1 AMP CURRENT LIMITED **\$3<sup>95</sup>**

**SEQUENTIAL LED FLASHER KIT**

Includes 10 LEDS **\$4<sup>95</sup>**

**POWER DEVICES SCR'S**

850 A 600 V PUK **\$99<sup>00</sup>**  
 225 A 800 V STUD **\$29<sup>00</sup>**

**DIODES**  
 400 A 400 V PUK **\$19<sup>95</sup>**  
 300 A 300 V STUD **\$14<sup>95</sup>**  
 250 A 1000 V STUD **\$19<sup>95</sup>**

**BRIDGES**  
 500 A 200 V 30 **\$99<sup>00</sup>**  
 25 A 500 V **\$4<sup>95</sup>**  
 1.5 A 400 V **\$1<sup>25</sup>**  
 1.5 A 100 V **.75**

COME INTO ANY ONE OF OUR LOCATIONS

**LOS ANGELES**

(213) 967-4611  
**LMN ELECTRONICS**  
 1042 E. GARVEY AV., W. COVINA, CA. (VINCENT & SAN BERDO FWY.)

**PORTLAND**

(503) 646-4044  
**WIZARD OF PARTS**  
 8225 SW CIRROS DR., BEAVERTON, ORE. (KOLL BUS. CNTR/WASHINGTON SQUARE)

**SEATTLE**

(206) 575-3709  
**SEMION OF SEATTLE**  
 964 INDUSTRY DR., TUKWILA, WA. (KOLL BUS. CNTR./SOUTH CENTER)

**DENVER**

(303) 573-5214  
**ELECTRONIC LOLLIPOP**  
 5643 N. BROADWAY, DENVER, CO. (I-25 & 58th AVE.)

IF AT ALL POSSIBLE TRY TO DROP INTO ONE OF OUR LOCATIONS. BUT IF YOU LIVE TOO FAR AWAY YOU MAY ORDER BY MAIL FROM:

**NO BACK ORDERS WE PAY ALL POSTAGE & HANDLING**

YOUR PARTS OR IMMEDIATE REFUND ON U.S. ORDERS ONLY \$20 MINIMUM CALIF. RES. ADD 6%  
 FOR UNDER 8 HOURS PROCESSING SEND MONEY ORDER, CERTIFIED OR CASHIERS CHECK.  
 SORRY! WE CANNOT ACCEPT PURCHASE ORDERS, COD'S, PHONE ORDERS OR CREDIT CARDS.  
 CANADA, PUERTO RICO, U.S. POSSESSIONS ADD \$3.50, ALL OTHER FOREIGN ORDERS ADD \$7.00 IN U.S. FUNDS

**F. Reichert Sales**  
 1110 E. GARVEY AVE.  
 W. COVINA, CA. 91790

ALL ITEMS SUBJECT TO PRIOR SALE

PRICES GOOD UNTIL APRIL 3, 1978.

CIRCLE 65 ON FREE INFORMATION CARD

**SAVE UP TO 85% GOV'T SURPLUS and NEW EQUIP'T**

**Powerful Battery Motor**

BUILD MOTORIZED BICYCLE, ELECTRIC CAR, ETC.

\$29.95

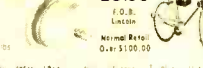

ITEM #1263 New Electric Bicycle Kit...  
Normal Retail Over \$100.00

COMPACT 12 V. BATTERY FOR USE WITH ABOVE MOTOR  
ITEM #2803 New...  
Normal Retail Over \$30.00

**SURPLUS CENTER** P.O. Box 22209 Lincoln, Nebraska Zip Code 68501

**BIG, Equip't. Catalog**

Send 25c Coin or Stamps

LOWEST PRICES ON  
HYDRAULIC COMPRESSORS  
SURVIVAL TOOLS  
WINCHES POWER PLANTS  
CLEAN UP DEVICES  
WELDERS  
ELECTRONIC TEST SPRAYING  
TELEPHONE PLUMBS  
MANY OTHERS

Normal Retail Over \$30.00

\$14.95

**PRINTED CIRCUIT**

Positive Acting Photo Resist; Carbide bits; Bubble etchers; Artwork; Epoxy Glass Boards.

Send stamp & address label for flyer  
**TRUMBULL**  
833 Balra Dr., El Cerrito, CA 94530

**ELECTRONIC** components, communication and test equipment. Stamp for catalog. **E. FRENCH**, Box 249, Aurora, IL 60507

**LEARN MICROCOMPUTER PROGRAMMING**

At home. At your own pace. Complete course consisting of 10 lessons, problems, solutions, practical examples in 8080, 8085 assembly language. \$49.95. Write or call for **FREE BROCHURE**.

**LOGICAL SERVICES, INC.**, 711 Stierlin Road, Mountain View, CA 94043 (415) 965-8365

**NEW INVENTION**

**CAR STOLEN CAR CAN BE LOCATED**

PROTECT AUTOMOBILE, BOAT, TRAILER, AIRPLANE, HOME, OFFICE. LEARN how this FOOL PROOF radio alarm can CORRECT a BIG FAULT in most existing silent alarms-to-day. SEND FOR FREE information on what this BACK UP ALARM SYSTEM can and will do, or send \$15.00 Check or Money Order. 6% tax Calif., for a CONFIDENTIAL BACK UP ALARM REPORT. PLANS INCLUDED on how to make your own FOOL PROOF alarm system for your own needs and protection. PRINT name and address and send to FOWLER ALARMS, P.O. Box 64466 RE-3, Los Angeles, Calif. 90064

Fowler Alarms 1977

**AMAZING ELECTRONIC PROJECTS and PRODUCTS:**

Lasers Super Powered, Burning, Cutting, Rifle, Pistol, Pocket. See in Dark—Shotgun Directional Mike—Unscramblers—Giant Tesla—Stunwand—TV Disrupter—Energy Producing, Surveillance, Detection, Electrifying, Ultrasonic, CB, Auto and Mech. Devices, Hundreds More—All New Plus INFO UNLTD PARTS SERVICE. Catalog \$1. Information Unlimited, Box 626, Lord Jeffery Court, Amherst, N.H. 03031.

**BETAMAX** 2-Hour Video Cassette Recorder. \$200 under list. Cassettes and prerecorded movies at discount prices. **A&D ELECTRONICS**, 5331 Thrasher Drive, Cincinnati, OH 45239

**COMPUTER**, peripheral, technical reports; project supplies; kits. Send \$1 for **THE CPU HOBBYIST**, Box 738-RE, College Park, MD 20740

**IC's**—100 assorted 7400 series—all marked \$12.50 ppd—send stamp for bargain list. **GULL ELECTRONICS**, 12690 Rte. 30, N. Huntingdon, PA 15642

**Why is this the LARGEST SELLING low cost COUNTER KIT?**

This counter is such a great seller because people like you have found that, feature for feature, the CT-50 gives you more for your money. Advanced LSI and CMOS circuitry has; lowered power consumption, increased performance, and reduced cost. Complete push button operation makes using the CT-50 a snap, and automatic decimal point positioning gives you quick, reliable readings. Battery operation is also possible because the CT-50 runs equally as well on 12VDC as it does on 110VAC. For ultra-accuracy we offer the CB-1 color burst adapter, it locks the CT-50's internal crystal to the television networks color standard for .001 ppm accuracy! Why sacrifice performance by using another counter when you can get professional quality at the unheard of price of \$79.95? Order yours today!



**CT-50 FREQUENCY COUNTER**  
Sensitivity: less than 10 mv.  
Frequency range: 5 Hz to 60 MHz, typically 65 MHz  
Gate time: 1 second, 1/10 second, with automatic decimal point positioning on both direct and prescale  
Display: 8 digit red LED .4" height  
Accuracy: 2 ppm, internal TCXO standard  
Input: BNC, 1 megohm direct, 50 Ohm with prescale option  
Power: 110 V ac 5 Watts or 12 V dc @ 300-400 ma  
Size: Approx. 6" x 4" x 2", high quality aluminum case

CT-600, 600 MHz prescaler option for CT-50, add... \$29.95

**MINI-KITS**

**FM WIRELESS MIKE KIT**  
Transmit up to 300' to any FM broadcast radio, uses any type of mike. Runs on 3 to 9V. Type FM-2 has added super-sensitive mike preamp.  
FM-1 - \$2.95 FM-2 - \$4.95

**SUPER-SNOOP AMPLIFIER**  
A super-sensitive amplifier which will pick up a pin drop at 15 feet! Great for monitoring baby's room or a general purpose test amplifier. Full 2 watts of output, runs on 6 to 12 volts, uses any type of mike. Requires 8-45 ohm speaker.  
Complete Kit, BN-9... \$4.95

**COLOR ORGAN/MUSIC LIGHTS**  
See music come alive! 3 different lights flicker with music or voice. One light for lows, one for the mid-range and one for the highs. Each channel individually adjustable, and drives up to 300 watts. Great for parties, band music, nite clubs and more.  
Complete Kit, ML-1... \$7.95

**TOPE DECODER KIT**  
A complete tone decoder on a single PC Board. Features: 400-5000 Hz adjustable frequency range, voltage regulation, 567 IC. Useful for touch-tone decoding, tone burst detection, FSK demod, signaling, and many other uses. Write for 12 button touchtone decoding. Runs on 5 to 12 volts.  
Complete Kit, TD-1... \$4.95

**LED BLINKY KIT**  
A great attention getter which alternately flashes 2 Jumbo LEDs. Use for name badges, buttons, or warning type panel lights. Runs on 3 to 9 volts.  
Complete Kit, BL-1... \$2.95

**POWER SUPPLY KIT**  
Complete triple regulated power supply provides variable +15 volts at 200 mA and ±5 volts at 1 Amp. 50 mV load regulation good filtering and small size. Kit less transformers. Requires 6-8V at 1 Amp and 18 to 30 VCT.  
Complete Kit, PS-3LT... \$6.95

**SIREN KIT**  
Produces upward and downward wail characteristic of police siren. 5 watts audio output, runs on 3-9 volts, uses 8-45 ohm speaker.  
Complete Kit, SM-3... \$2.95

**VIDEO MODULATOR KIT**  
Converts any TV to video Monitor, Super stable tunable over Ch. 4-6. Runs on 5-15V, accepts std. video signal. Best unit on the market.  
Complete Kit, VD-1... \$6.95

**SIX DIGIT 12/24 HOUR CLOCK KIT**

Here's a clock you can be proud of. The best looking, most complete kit on the market! Features include: time set push-buttons, jumbo .4" readouts, and extruded aluminum case available in 5 colors. All parts included. Colors: gold, silver, bronze, black, blue (specify)  
Clock Kit, DC-5... \$22.95  
Alarm Clock, 12 Hr., DC-8... 24.95  
Mobile Clock, DC-7... 25.95  
Clock with HAM ID timer DC-10 25.95



Assembled and tested clocks available, add \$10.00 to Kit price.

**600 MHz PRESCALER**

Extend the range of your counter to 600 MHz. Works with all counters. Less than 150 mv sensitivity. Specify -10 or -100. Wired, tested,  
PS-1 B... \$59.95  
Kit, PS-1 B... \$44.95

**CALENDAR ALARM CLOCK**

Has every feature one could ever ask for. Kit includes everything except case, build it into wall, station or even car!  
**FEATURES:**  
• 6 Digits, 5" High LED • 12/24 Hour Format  
• Calendar shows mo/day • Snooze button  
• True 24 Hour Alarm • 7001 chip does all!  
• Battery back up with built-in on chip time base

Complete Kit, less case DC-9... \$34.95

**TV TYPEWRITER KIT**

A compact 5 x 10 inch PC card that requires only an ASCII keyboard and a TV set to become a complete interactive terminal for connection to your microprocessor asynchronous interface. Its many features are single 5 volt supply, crystal controlled sync and baud rates (up to 9600 baud), 2 pages of 32 characters by 16 lines, read to and from memory, computer and keyboard operated cursor and page control, power-on initialization, full 64-character ASCII display, block-type, see-thru cursor, keyboard/computer control backspaces, forward spaces, line feeds, rev. line feeds, home, returns cursor. Also clears page, clears to end of line, selects page 1 or 2, feeds from or to memory. The card requires 5 volts at approx. 900 ma and outputs standard 75 ohm composite video.

TH3216 Kit \$149.55  
TH3216, Assembled and Tested 239.95  
VD 1 Video to RF Modulator Kit 6.95

**CAR CLOCK KIT**

12/24 Hour 12-Volt AC or DC  
• High Accuracy (1 minute/minute)  
• 6 Jumbo .4" LED readouts  
• Easy, no-polarity hookup  
• Display blanks with Ignition  
• Case mounting bracket Included  
• Super Instructions  
Complete Kit, DC-11... \$27.95  
Auto dimmer for DC-11... \$2.50

741 OP AMP SPECIAL Prime, Mini-dip 10/\$2.00

| ICs        | LINEAR             | REGULATOR    | TRANSISTORS                |
|------------|--------------------|--------------|----------------------------|
| 5314 Clock | 555 \$ .50         | 78MG \$ 1.49 | MRF-238 30W VHF \$11.95    |
| 7001 Clock | 6.95 556 .75       | 309K .89     | NPN 2N3904 type 10/\$1.00  |
| 5369 Cmos  | 1.95 566 1.49      | 309H .89     | PNP 2N3906 type 10/\$1.00  |
| 7447       | .79 567 1.49       | 340K-12 .99  | NPN Power Tab 40W 3/\$1.00 |
| 7473       | .35 1458 .50       | 7805 .89     | PNP Power Tab 40W 3/\$1.00 |
| 7475       | .50 LED DRIVER .75 | 7812 .89     | FET MPF 102 type 3/\$2.00  |
| 7490A      | .55 75491 .50      | 7815 .89     | J2N2646 type 3/\$2.00      |
| 74143      | 3.50 75492 .50     | 7818 .89     | 2N3055 NPN Power .75       |

**ORDER BY PHONE OR MAIL**  
Satisfactory guaranteed or money refunded. Add 5% for shipping and handling. C.O.D. add \$1.00. Orders under \$10.00 add \$.75. NY residents add 7% sales tax. Minimum order \$6.00.

**ramsey electronics**  
BOX 4072B ROCHESTER, NY 14610 (716) 271-6487

**medallion BY MIDLAND**

**PUSHBUTTON COMBINATION AM/FM Stereo-8 Track 40 channel CB**



Reg. List Price \$129.95 Postpaid  
\$399.95

While Supply Lasts Model 63-540

**FULL POWER TOP OF THE LINE**

- L.E.D. Shows Operating Radio Mode, CB Channel, and 8-Track Program
- CB Monitor, Transmit/Receive Light, Adjustable Switch
- Automatic or Manual Tape Programming
- Local Distant Switch for FM
- Midland Nationwide Warranty
- 7" wide x 7" deep x 2 1/2" high w/custom with custom trim plate

**Accessories**  
AM/FM/CB Antenna (mounts like reg. car antenna List \$39.95 now \$29.95)  
Medallion 5 1/2" Co-Axial Speakers 10 oz. magnets List \$39.95 pr. now \$19.95 pr.

**LESLIE EDELMAN**

U.S. Rt. 309, Box 547, Montgomeyville, PA 18936 \*Phone Orders Call (215) 322-8599

Name \_\_\_\_\_  
Address \_\_\_\_\_  
City \_\_\_\_\_ State \_\_\_\_\_ Zip \_\_\_\_\_  
Bank American, Master Charge are accepted  
Card Number \_\_\_\_\_

CIRCLE 56 ON FREE INFORMATION CARD

RADIO-ELECTRONICS

NEW LSI TECHNOLOGY  
**FREQUENCY COUNTER**

TAKE ADVANTAGE OF THIS NEW STATE-OF-THE-ART COUNTER FEATURING THE MANY BENEFITS OF CUSTOM LSI CIRCUITRY. THIS NEW TECHNOLOGY APPROACH TO INSTRUMENTATION YIELDS ENHANCED PERFORMANCE, SMALLER PHYSICAL SIZE, DRASTICALLY REDUCED POWER CONSUMPTION (PORTABLE BATTERY OPERATION IS NOW PRACTICAL), DEPENDABILITY, EASY ASSEMBLY AND REVOLUTIONARY LOWER PRICING!

- KIT #FC-50C ..... 60 MHZ COUNTER WITH CABINET & P.S. .... **\$119<sup>95</sup>** COMPLETE!
- KIT #PSL-650 ..... 650 MHZ PRESCALER (NOT SHOWN) ..... 29.95
- MODEL #FC-50WT ..... 60 MHZ COUNTER WIRED, TESTED & CAL. .... 165.95
- MODEL #FC-50/600 WT. .... 600 MHZ COUNTER WIRED, TESTED & CAL. .... 199.95

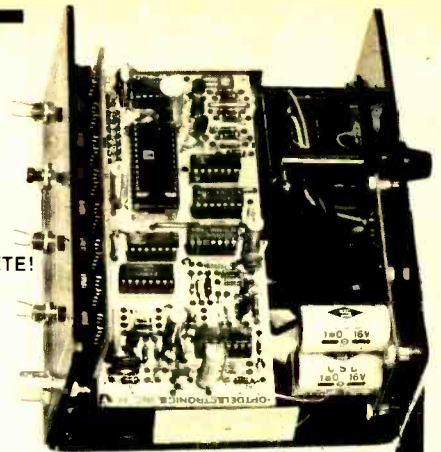

SIZE:  
3" High  
6" Wide  
5 1/2" Deep



**FEATURES AND SPECIFICATIONS:**

DISPLAY: 8 RED LED DIGITS .4" CHARACTER HEIGHT  
GATE TIMES: 1 SECOND AND 1/10 SECOND  
PRESCALER WILL FIT INSIDE COUNTER CABINET  
RESOLUTION: 1 HZ AT 1 SECOND, 10 HZ AT 1/10 SECOND.  
FREQUENCY RANGE: 10 HZ TO 60 MHZ. [65 MHZ TYPICAL].  
SENSITIVITY: 10 MV RMS TO 50 MHZ, 20 MV RMS TO 60 MHZ TYP.  
INPUT IMPEDANCE: 1 MEGOHM AND 20 PF  
[DIODE PROTECTED INPUT FOR OVER VOLTAGE PROTECTION.]  
ACCURACY: ± 1 PPM [± .0001%] AFTER CALIBRATION TYPICAL.  
STABILITY: WITHIN 1 PPM PER HOUR AFTER WARM UP [1.001% XTAL]  
IC PACKAGE COUNT: 8 [ALL SOCKETED]  
INTERNAL POWER SUPPLY: 5 V DC REGULATED.  
INPUT POWER REQUIRED: 8-12 VDC OR 115 VAC AT 50/60 HZ.  
POWER CONSUMPTION: 4 WATTS

KIT #FC-50C IS COMPLETE WITH PREDRILLED CHASSIS ALL HARDWARE AND STEP-BY-STEP INSTRUCTIONS. WIRED & TESTED UNITS ARE CALIBRATED AND GUARANTEED.

**PLEXIGLAS CABINETS**

Great for Clocks or any LED Digital project. Clear-Red Chassis serves as Bezel to increase contrast of digital displays.

- CABINET I**  
3" H, 6 1/4" W, 5 1/2" D Black, White or Clear Cover
  - CABINET II**  
2 1/2" H, 5" W, 4" D \$6.50 ea.
- RED OR GREY PLEXIGLAS FOR DIGITAL BEZELS  
3" x 6" x 1/8" 95¢ ea 4/13

**SEE THE WORKS Clock Kit**  
Clear Plexiglas Stand

- 6 Big 4" digits
- 12 or 24 hr. time
- 3 set switches
- Plug transformer
- All parts included

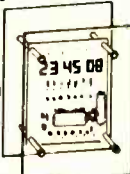

Plexiglas is Pre-cut & drilled  
Kit #850-4 CP  
Size: 6" H, 4 1/2" W, 3" D  
Assembled \$29<sup>95</sup>  
\$23<sup>50</sup> ea 2/45.

**60 HZ.**

XTAL TIME BASE:  
Will enable Digital Clock Kits or Clock-Calendar Kits to operate from 12V DC.  
1" x 2" PC Board  
Power Req: 5-15V (2.5 MA. TYP.)  
Easy 3 wire hook up  
Accuracy: ± 2PPM  
#TB-1 (Adjustable) Complete Kit \$4<sup>95</sup>  
Wir & Cal \$9.95

**SPECIAL PRICING!**  
PRIME - HIGH SPEED RAM

**21L02-3 400 NS**  
LOW POWER - FACTORY FRESH

|               |                   |         |            |
|---------------|-------------------|---------|------------|
| 1-24          | \$1.75 ea.        | 100-199 | \$1.45 ea. |
| 25-99         | 1.60 ea.          | 200-999 | 1.39 ea.   |
| 1000 AND OVER | <b>\$1.29 ea.</b> |         |            |

**6-DIGIT LED CLOCK CALENDAR KIT**  
DATE-TIME-SNOOZE ALARM & MORE... KIT 7001

FOR THE BUILDER THAT WANTS THE BEST. FEATURING 12 OR 24 HOUR TIME - 29-30-31 DAY CALENDAR. ALARM, SNOOZE AND AUX. TIMER CIRCUITS

Will alternate time (8 seconds) and date (2 seconds) or may be wired for time or date display only, with other functions on demand. Has built-in oscillator for battery back-up. A loud 24 hour alarm with a repeatable 10 minute snooze alarm, alarm set & timer set indicators. Includes 110 VAC/60Hz power pack with cord and top quality components through-out.

- KIT 7001B WITH 6 .5" DIGITS ..... \$39.95
- KIT 7001C WITH 4 .6" DIGITS & 2 .3" DIGITS FOR SECONDS ..... \$42.95
- KIT 7001X WITH 6 .6" DIGITS ..... \$45.95

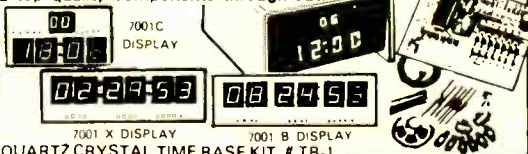

KITS ARE COMPLETE (LESS CABINET)  
ALL 7001 KITS FIT CABINET I AND ACCEPT QUARTZ CRYSTAL TIME BASE KIT # TB-1

PRINTED CIRCUIT BOARDS for CT-7001 Kits sold separately with assembly info. PC Boards are drilled Fiberglass, solder plated and screened with component layout.

Specify for 7001  
B, Cor X - \$7.95

**AUTO BURGLAR ALARM KIT**

AN EASY TO ASSEMBLE AND EASY TO INSTALL ALARM PROVIDING MANY FEATURES NOT NORMALLY FOUND. KEYLESS ALARM HAS PROVISION FOR POS & GROUNDING SWITCHES OR SENSORS WILL PULSE HORN RELAY AT 1/2 RATE OR DRIVE SIREN. KIT PROVIDES PROGRAMMABLE TIME DELAYS FOR EXIT ENTRY & ALARM PERIOD UNIT MOUNTS UNDER DASH - REMOTE SWITCH CAN BE MOUNTED WHERE DESIRED. CMOS RELIABILITY RESISTS FALSE ALARMS & PROVIDES FOR ULTRA DEPENDABLE ALARM. DO NOT BE FOOLED BY LOW PRICES! THIS IS A TOP QUALITY COMPLETE KIT WITH ALL PARTS INCLUDING DETAILED DRAWINGS AND INSTRUCTIONS OR AVAILABLE WIRED AND TESTED.



KIT #ALR-1 \$9.95  
#ALR-1WT WIRED & TESTED \$19.95

**VARIABLE REGULATED 1 AMP POWER SUPPLY KIT**

- VARIABLE FROM 4 TO 14V
  - SHORT CIRCUIT PROOF
  - 723 IC REGULATOR
  - 2N3055 PASS TRANSISTOR
  - CURRENT LIMITING AT 1 AMP
- KIT IS COMPLETE INCLUDING DRILLED & SOLDER PLATED FIBERGLASS PC BOARD AND ALL PARTS (LESS TRANSFORMER) KIT #PS-01 \$8.95  
TRANSFORMER 24V CT will provide 300MA at 12V and 1 Amp at 5V. \$3.50

**MOBILE LED CLOCK**

12/24 HR 4" DIGITS!  
MODEL 12 VOLT AC or DC POWERED #2001

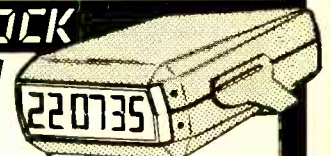

- 6 JUMBO .4" RED LED'S BEHIND RED FILTER LENS WITH CHROME RIM
  - SET TIME FROM FRONT VIA HIDDEN SWITCHES • 12/24-Hr. TIME FORMAT
  - STYLISH CHARCOAL GRAY CASE OF MOLDED HIGH TEMP. PLASTIC
  - BRIDGE POWER INPUT CIRCUITRY - TWO WIRE NO POLARITY HOOK-UP
  - OPTIONAL CONNECTION TO BLANK DISPLAY [Use When Key Off in Car, Etc.]
  - TOP QUALITY PC BOARDS & COMPONENTS - INSTRUCTIONS.
  - MOUNTING BRACKET INCLUDED
- KIT #2001  
COMPLETE KIT \$27<sup>95</sup> 3 OR \$25<sup>95</sup> ea. 115 VAC Power Pack \$25<sup>00</sup> #AC-1 EA.
- ASSEMBLED UNITS WIRED & TESTED \$37<sup>95</sup> 3 OR \$35<sup>95</sup> ea.  
ORDER #2001 WT [LESS 9V. BATTERY] Wired for 12-Hr. Op. if not otherwise specified.

ORDER BY PHONE OR MAIL  
COD ORDERS WELCOME

**OPTOELECTRONICS, INC.**

BOX 219 HOLLYWOOD, FLA. 33022  
PHONE [305] 921-2056 / 921-4425

ORDERS TO USA & CANADA ADD 5% FOR SHIPPING, HANDLING & INSURANCE. ALL OTHERS ADD 10%. ADDITIONAL \$1.00 CHARGE FOR ORDERS UNDER \$15.00 - COD FEE \$1.00. FLA. RES. ADD 4% STATE TAX.



CIRCLE 76 ON FREE INFORMATION CARD

## 7400N TTL

|         |    |          |      |          |       |
|---------|----|----------|------|----------|-------|
| SN7400N | 16 | SN7472N  | 39   | SN74160N | 1.25  |
| SN7401N | 16 | SN7473N  | 39   | SN74161N | 1.25  |
| SN7402N | 20 | SN7474N  | 39   | SN74162N | 1.95  |
| SN7403N | 20 | SN7475N  | 50   | SN74163N | 99    |
| SN7404N | 20 | SN7476N  | 35   | SN74164N | 99    |
| SN7405N | 20 | SN7477N  | 5.00 | SN74165N | 99    |
| SN7406N | 35 | SN7478N  | 39   | SN74166N | 1.25  |
| SN7407N | 35 | SN7479N  | 39   | SN74167N | 3.25  |
| SN7408N | 20 | SN7480N  | 39   | SN74170N | 2.10  |
| SN7409N | 25 | SN7481N  | 89   | SN74172N | 6.00  |
| SN7410N | 20 | SN7482N  | 39   | SN74173N | 1.50  |
| SN7411N | 30 | SN7483N  | 3.00 | SN74174N | 1.25  |
| SN7412N | 35 | SN7484N  | 2.49 | SN74175N | 99    |
| SN7413N | 69 | SN7490N  | 45   | SN74177N | 79    |
| SN7414N | 70 | SN7491N  | 75   | SN74179N | 2.49  |
| SN7415N | 35 | SN7492N  | 49   | SN74180N | 99    |
| SN7417N | 20 | SN7493N  | 49   | SN74181N | 2.49  |
| SN7420N | 20 | SN7494N  | 79   | SN74182N | 99    |
| SN7421N | 39 | SN7495N  | 79   | SN74184N | 1.95  |
| SN7422N | 49 | SN7496N  | 79   | SN74186N | 1.25  |
| SN7423N | 37 | SN7497N  | 3.00 | SN74187N | 15.00 |
| SN7425N | 20 | SN7498N  | 1.25 | SN74188N | 6.00  |
| SN7426N | 20 | SN7499N  | 39   | SN74189N | 3.95  |
| SN7427N | 37 | SN74100N | 95   | SN74190N | 1.79  |
| SN7428N | 37 | SN74101N | 1.95 | SN74191N | 1.25  |
| SN7430N | 35 | SN74102N | 39   | SN74192N | 89    |
| SN7432N | 35 | SN74120N | 39   | SN74193N | 89    |
| SN7433N | 35 | SN74122N | 50   | SN74194N | 1.25  |
| SN7437N | 35 | SN74123N | 60   | SN74195N | 75    |
| SN7438N | 35 | SN74124N | 60   | SN74196N | 1.00  |
| SN7439N | 25 | SN74125N | 60   | SN74197N | 1.00  |
| SN7440N | 21 | SN74127N | 1.25 | SN74198N | 1.75  |
| SN7441N | 89 | SN74130N | 95   | SN74199N | 1.75  |
| SN7442N | 69 | SN74141N | 1.15 | SN74200N | 5.99  |
| SN7443N | 75 | SN74142N | 3.25 | SN74201N | 6.00  |
| SN7444N | 75 | SN74143N | 1.79 | SN74202N | 1.79  |
| SN7445N | 89 | SN74145N | 1.15 | SN74279N | 90    |
| SN7446N | 69 | SN74147N | 2.35 | SN74283N | 2.25  |
| SN7448N | 69 | SN74148N | 2.00 | SN74284N | 6.00  |
| SN7450N | 25 | SN74150N | 1.25 | SN74285N | 6.00  |
| SN7451N | 25 | SN74151N | 79   | SN74365N | 75    |
| SN7453N | 25 | SN74153N | 89   | SN74366N | 75    |
| SN7454N | 25 | SN74154N | 1.25 | SN74367N | 75    |
| SN7455N | 25 | SN74155N | 89   | SN74368N | 75    |
| SN7456N | 25 | SN74156N | 89   | SN74369N | 2.25  |
| SN7457N | 25 | SN74157N | 89   | SN74370N | 2.25  |

20% Discount for 100 Combined 7400's

## CMOS

|        |      |         |       |              |       |
|--------|------|---------|-------|--------------|-------|
| CD4060 | 23   | CD4044  | 89    | CD4520       | 1.29  |
| CD4001 | 23   | CD4045  | 1.79  | MC14562      | 14.50 |
| CD4002 | 23   | CD4046  | 2.25  | CD4566       | 2.25  |
| CD4006 | 1.19 | CD4047  | 1.25  | MC14583      | 3.90  |
| CD4007 | 25   | CD4048  | 1.35  | 74C00 Series |       |
| CD4009 | 49   | CD4049  | 49    | 74C00        | 99    |
| CD4010 | 49   | CD4050  | 49    | 74C02        | 55    |
| CD4011 | 23   | CD4051  | 1.19  | 74C03        | 75    |
| CD4012 | 25   | CD4052  | 1.19  | 74C04        | 65    |
| CD4013 | 39   | CD4053  | 1.49  | 74C14        | 3.00  |
| CD4014 | 1.39 | CD4054  | 9.95  | 74C20        | 85    |
| CD4015 | 1.19 | CD4055  | 1.49  | 74C23        | 65    |
| CD4016 | 99   | CD4056  | 79    | 74C24        | 2.15  |
| CD4017 | 1.19 | CD4057  | 1.49  | 74C25        | 1.50  |
| CD4018 | 99   | CD4058  | 35    | 74C27        | 1.15  |
| CD4019 | 49   | CD4059  | 55    | 74C28        | 4.00  |
| CD4020 | 1.19 | CD4060  | 49    | 74C30        | 3.00  |
| CD4021 | 1.19 | CD4061  | 3.99  | 74C32        | 2.00  |
| CD4022 | 1.19 | CD4062  | 1.39  | 74C33        | 2.00  |
| CD4023 | 23   | CD4063  | 2.3   | 74C35        | 1.25  |
| CD4024 | 79   | CD4064  | 2.49  | 74C37        | 2.90  |
| CD4025 | 23   | MC14049 | 14.95 | 74C54        | 3.00  |
| CD4026 | 6.25 | MC14051 | 19.95 | 74C56        | 3.25  |
| CD4027 | 2.69 | MC14052 | 14.95 | 74C61        | 3.25  |
| CD4028 | 85   | MC14053 | 4.95  | 74C63        | 3.25  |
| CD4029 | 1.19 | MC14054 | 7.75  | 74C64        | 3.25  |
| CD4030 | 1.19 | MC14055 | 9.95  | 74C65        | 3.25  |
| CD4040 | 1.19 | CD4051  | 1.29  | 74C66        | 2.75  |
| CD4041 | 1.25 | CD4052  | 1.29  | 74C67        | 2.75  |
| CD4042 | 99   | CD4053  | 2.95  | 80C95        | 1.50  |
|        |      | CD4054  | 1.29  | 80C97        | 1.50  |

## LINEAR

|           |      |          |        |
|-----------|------|----------|--------|
| LM309H    | 80   | LM739N   | 1.19   |
| LM3010N   | 35   | LM741CN  | 35     |
| LM3011N   | 35   | LM741DN  | 35     |
| LM3020N   | 75   | LM7414N  | 39     |
| LM3021N   | 1.00 | LM7415N  | 79     |
| LM3050H   | 60   | LM7470N  | 79     |
| LM3070N   | 35   | LM7484N  | 39     |
| LM3080H   | 1.00 | LM7488N  | 39     |
| LM3090N   | 1.00 | LM7500N  | 89     |
| LM3090H   | 1.25 | LM1304N  | 1.19   |
| LM3100N   | 1.00 | LM1305N  | 1.40   |
| LM3110N   | 1.00 | LM1307N  | 2.95   |
| LM3110H   | 90   | LM1307N  | 2.95   |
| LM3110N   | 90   | LM1310N  | 85     |
| LM3110H   | 7.50 | LM1311N  | 1.65   |
| LM3110N   | 7.50 | LM1312N  | 1.75   |
| LM3110H   | 1.00 | LM1482CN | 59     |
| LM3110N   | 1.00 | LM1496N  | 95     |
| LM3207K-5 | 1.35 | MC1559A  | 6.00   |
| LM3207K-5 | 1.35 | MC1559B  | 1.75   |
| LM3207K-5 | 1.35 | MC1559C  | 1.95   |
| LM3207K-5 | 1.35 | MC1559D  | 1.95   |
| LM3207K-5 | 1.35 | MC1559E  | 1.95   |
| LM3207K-5 | 1.35 | MC1559F  | 1.95   |
| LM3207K-5 | 1.35 | MC1559G  | 1.95   |
| LM3207K-5 | 1.35 | MC1559H  | 1.95   |
| LM3207K-5 | 1.35 | MC1559I  | 1.95   |
| LM3207K-5 | 1.35 | MC1559J  | 1.95   |
| LM3207K-5 | 1.35 | MC1559K  | 1.95   |
| LM3207K-5 | 1.35 | MC1559L  | 1.95   |
| LM3207K-5 | 1.35 | MC1559M  | 1.95   |
| LM3207K-5 | 1.35 | MC1559N  | 1.95   |
| LM3207K-5 | 1.35 | MC1559O  | 1.95   |
| LM3207K-5 | 1.35 | MC1559P  | 1.95   |
| LM3207K-5 | 1.35 | MC1559Q  | 1.95   |
| LM3207K-5 | 1.35 | MC1559R  | 1.95   |
| LM3207K-5 | 1.35 | MC1559S  | 1.95   |
| LM3207K-5 | 1.35 | MC1559T  | 1.95   |
| LM3207K-5 | 1.35 | MC1559U  | 1.95   |
| LM3207K-5 | 1.35 | MC1559V  | 1.95   |
| LM3207K-5 | 1.35 | MC1559W  | 1.95   |
| LM3207K-5 | 1.35 | MC1559X  | 1.95   |
| LM3207K-5 | 1.35 | MC1559Y  | 1.95   |
| LM3207K-5 | 1.35 | MC1559Z  | 1.95   |
| LM3207K-5 | 1.35 | MC1559AA | 1.95   |
| LM3207K-5 | 1.35 | MC1559AB | 1.95   |
| LM3207K-5 | 1.35 | MC1559AC | 1.95   |
| LM3207K-5 | 1.35 | MC1559AD | 1.95   |
| LM3207K-5 | 1.35 | MC1559AE | 1.95   |
| LM3207K-5 | 1.35 | MC1559AF | 1.95   |
| LM3207K-5 | 1.35 | MC1559AG | 1.95   |
| LM3207K-5 | 1.35 | MC1559AH | 1.95   |
| LM3207K-5 | 1.35 | MC1559AI | 1.95   |
| LM3207K-5 | 1.35 | MC1559AJ | 1.95   |
| LM3207K-5 | 1.35 | MC1559AK | 1.95   |
| LM3207K-5 | 1.35 | MC1559AL | 1.95   |
| LM3207K-5 | 1.35 | MC1559AM | 1.95   |
| LM3207K-5 | 1.35 | MC1559AN | 1.95   |
| LM3207K-5 | 1.35 | MC1559AO | 1.95   |
| LM3207K-5 | 1.35 | MC1559AP | 1.95   |
| LM3207K-5 | 1.35 | MC1559AQ | 1.95   |
| LM3207K-5 | 1.35 | MC1559AR | 1.95   |
| LM3207K-5 | 1.35 | MC1559AS | 1.95   |
| LM3207K-5 | 1.35 | MC1559AT | 1.95   |
| LM3207K-5 | 1.35 | MC1559AU | 1.95   |
| LM3207K-5 | 1.35 | MC1559AV | 1.95   |
| LM3207K-5 | 1.35 | MC1559AW | 1.95   |
| LM3207K-5 | 1.35 | MC1559AX | 1.95   |
| LM3207K-5 | 1.35 | MC1559AY | 1.95   |
| LM3207K-5 | 1.35 | MC1559AZ | 1.95   |
| LM3207K-5 | 1.35 | MC1559BA | 1.95   |
| LM3207K-5 | 1.35 | MC1559BB | 1.95   |
| LM3207K-5 | 1.35 | MC1559BC | 1.95   |
| LM3207K-5 | 1.35 | MC1559BD | 1.95   |
| LM3207K-5 | 1.35 | MC1559BE | 1.95   |
| LM3207K-5 | 1.35 | MC1559BF | 1.95   |
| LM3207K-5 | 1.35 | MC1559BG | 1.95   |
| LM3207K-5 | 1.35 | MC1559BH | 1.95   |
| LM3207K-5 | 1.35 | MC1559BI | 1.95   |
| LM3207K-5 | 1.35 | MC1559BJ | 1.95   |
| LM3207K-5 | 1.35 | MC1559BK | 1.95   |
| LM3207K-5 | 1.35 | MC1559BL | 1.95   |
| LM3207K-5 | 1.35 | MC1559BM | 1.95   |
| LM3207K-5 | 1.35 | MC1559BN | 1.95   |
| LM3207K-5 | 1.35 | MC1559BO | 1.95   |
| LM3207K-5 | 1.35 | MC1559BP | 1.95   |
| LM3207K-5 | 1.35 | MC1559BQ | 1.95   |
| LM3207K-5 | 1.35 | MC1559BR | 1.95   |
| LM3207K-5 | 1.35 | MC1559BS | 1.95   |
| LM3207K-5 | 1.35 | MC1559BT | 1.95   |
| LM3207K-5 | 1.35 | MC1559BU | 1.95   |
| LM3207K-5 | 1.35 | MC1559BV | 1.95   |
| LM3207K-5 | 1.35 | MC1559BW | 1.95   |
| LM3207K-5 | 1.35 | MC1559BX | 1.95   |
| LM3207K-5 | 1.35 | MC1559BY | 1.95   |
| LM3207K-5 | 1.35 | MC1559BZ | 1.95   |
| LM3207K-5 | 1.35 | MC1559CA | 1.95   |
| LM3207K-5 | 1.35 | MC1559CB | 1.95   |
| LM3207K-5 | 1.35 | MC1559CC | 1.95   |
| LM3207K-5 | 1.35 | MC1559CD | 1.95   |
| LM3207K-5 | 1.35 | MC1559CE | 1.95   |
| LM3207K-5 | 1.35 | MC1559CF | 1.95   |
| LM3207K-5 | 1.35 | MC1559CG | 1.95   |
| LM3207K-5 | 1.35 | MC1559CH | 1.95   |
| LM3207K-5 | 1.35 | MC1559CI | 1.95   |
| LM3207K-5 | 1.35 | MC1559CJ | 1.95   |
| LM3207K-5 | 1.35 | MC1559CK | 1.95   |
| LM3207K-5 | 1.35 | MC1559CL | 1.95   |
| LM3207K-5 | 1.35 | MC1559CM | 1.95   |
| LM3207K-5 | 1.35 | MC1559CN | 1.95   |
| LM3207K-5 | 1.35 | MC1559CO | 1.95   |
| LM3207K-5 | 1.35 | MC1559CP | 1.95   |
| LM3207K-5 | 1.35 | MC1559CQ | 1.95   |
| LM3207K-5 | 1.35 | MC1559CR | 1.95   |
| LM3207K-5 | 1.35 | MC1559CS | 1.95   |
| LM3207K-5 | 1.35 | MC1559CT | 1.95   |
| LM3207K-5 | 1.35 | MC1559CU | 1.95   |
| LM3207K-5 | 1.35 | MC1559CV | 1.95   |
| LM3207K-5 | 1.35 | MC1559CW | 1.95   |
| LM3207K-5 | 1.35 | MC1559CX | 1.95   |
| LM3207K-5 | 1.35 | MC1559CY | 1.95   |
| LM3207K-5 | 1.35 | MC1559CZ | 1.95   |
| LM3207K-5 | 1.35 | MC1559DA | 1.95   |
| LM3207K-5 | 1.35 | MC1559DB | 1.95   |
| LM3207K-5 | 1.35 | MC1559DC | 1.95   |
| LM3207K-5 | 1.35 | MC1559DD | 1.95   |
| LM3207K-5 | 1.35 | MC1559DE | 1.95   |
| LM3207K-5 | 1.35 | MC1559DF | 1.95   |
| LM3207K-5 | 1.35 | MC1559DG | 1.95   |
| LM3207K-5 | 1.35 | MC1559DH | 1.95   |
| LM3207K-5 | 1.35 | MC1559DI | 1.95   |
| LM3207K-5 | 1.35 | MC1559DJ | 1.95   |
| LM3207K-5 | 1.35 | MC1559DK | 1.95   |
| LM3207K-5 | 1.35 | MC1559DL | 1.95   |
| LM3207K-5 | 1.35 | MC1559DM | 1.95   |
| LM3207K-5 | 1.35 | MC1559DN | 1.95   |
| LM3207K-5 | 1.35 | MC1559DO | 1.95   |
| LM3207K-5 | 1.35 | MC1559DP | 1.95   |
| LM3207K-5 | 1.35 | MC1559DQ | 1.95   |
| LM3207K-5 | 1.35 | MC1559DR | 1.95   |
| LM3207K-5 | 1.35 | MC1559DS | 1.95   |
| LM3207K-5 | 1.35 | MC1559DT | 1.95   |
| LM3207K-5 | 1.35 | MC1559DU | 1.95   |
| LM3207K-5 | 1.35 | MC1559DV | 1.95   |
| LM3207K-5 | 1.35 | MC1559DW | 1.95   |
| LM3207K-5 | 1.35 | MC1559DX | 1.95   |
| LM3207K-5 | 1.35 | MC1559DY | 1.95   |
| LM3207K-5 | 1.35 | MC1559DZ | 1.95   |
| LM3207K-5 | 1.35 | MC1559EA | 1.95   |
| LM3207K-5 | 1.35 | MC1559EB | 1.95   |
| LM3207K-5 | 1.35 | MC1559EC | 1.95   |
| LM3207K-5 | 1.35 | MC1559ED | 1.95   |
| LM3207K-5 | 1.35 | MC1559EE | 1.95   |
| LM3207K-5 | 1.35 | MC1559EF | 1.95   |
| LM3207K-5 | 1.35 | MC1559EG | 1.95   |
| LM3207K-5 | 1.35 | MC1559EH | 1.95   |
| LM3207K-5 | 1.35 | MC1559EI | 1.95   |
| LM3207K-5 | 1.35 | MC1559EJ | 1.95</ |

### BREAD BOARD JUMPER WIRE KIT

Each kit contains 350 wires cut to 14 different lengths from 0.1" to 5.0". Each wire is stripped and the leads are bent 90° for easy insertion. Wire length is classified by color coding. All wire is solid tinned 22 gauge with PVC insulation. The wires come packed in a convenient plastic box.

**JK1... \$10.00 / kit**

### SOCKET JUMPERS

Mates with two rows of .025" sq. wire posts on patterns of 100+ centers and shielded receptacles. Probe access holes in back. Choice of 6" or 18" length.

| Part No.   | No. of Contacts | Length | Price       |
|------------|-----------------|--------|-------------|
| 924003-18R | 26              | 18"    | \$ 5.38 ea. |
| 924003-06R | 26              | 6"     | 4.78 ea.    |
| 924005-18R | 40              | 18"    | 8.27 ea.    |
| 924005-06R | 40              | 6"     | 7.33 ea.    |
| 924006-18R | 50              | 18"    | 10.31 ea.   |
| 924006-06R | 50              | 6"     | 9.15 ea.    |

### JUMPER HEADERS

Solder to PC boards for instant plug-in access via socket-conductor jumpers. .025" sq. posts. Choice of straight or right angle.

| Part No. | No. of Posts | Angle       | Price      |
|----------|--------------|-------------|------------|
| 923863-R | 26           | straight    | \$1.28 ea. |
| 923873-R | 26           | right angle | 1.52 ea.   |
| 923865-R | 40           | straight    | 1.94 ea.   |
| 923875-R | 40           | right angle | 2.30 ea.   |
| 923866-R | 50           | straight    | 2.36 ea.   |
| 923876-R | 50           | right angle | 2.82 ea.   |

### INTRA-CONNECTOR

Provides both straight and right angle functions. Mates with standard .10" x .10" dual row connectors (i.e. 3M, Ainsley, etc.). Permits quick testing of inaccessible lines.

Part No.: 922576-26 No. of contacts: 26 Price \$6.90 ea.

### INTRA-SWITCH

Permits instant line-by-line switching for diagnostic or QA testing. Switches actuated with pencil or probe tip. Mates with standard .10" x .10" dual-row connectors. Low profile design. Switch buttons recessed to eliminate accidental switching.

Part No.: IS-26 No. of contacts: 26 Price \$13.80 ea.

### CRYSTALS

THESE FREQUENCIES ONLY

| Part No. | Frequency    | Case Style | Price   |
|----------|--------------|------------|---------|
| CV1A     | 1.000 MHz    | HC33-U     | \$5.95  |
| CV2A     | 2.000 MHz    | HC33-U     | \$5.95  |
| CV2.01   | 2.010 MHz    | HC33-U     | \$ 9.99 |
| CV3A     | 4.000 MHz    | HC18-U     | \$4.95  |
| CV7A     | 5.000 MHz    | HC18-U     | \$4.95  |
| CV12A    | 10.000 MHz   | HC18-U     | \$4.95  |
| CV14A    | 14.31818 MHz | HC18-U     | \$4.95  |
| CV19A    | 18.000 MHz   | HC18-U     | \$4.95  |
| CV22A    | 20.000 MHz   | HC18-U     | \$4.95  |
| CV30B    | 32.000 MHz   | HC18-U     | \$4.95  |

### CONNECTORS PRINTED CIRCUIT EDGE-CARD

156 Spacing-Tin-Double Read-Out

Bifurcated Contacts — Fits .054 to .070 P.C. Cards

|                       |                      |        |
|-----------------------|----------------------|--------|
| 15/30                 | PINS (Solder Eyelet) | \$1.95 |
| 18/36                 | PINS (Solder Eyelet) | \$2.49 |
| 22/44                 | PINS (Solder Eyelet) | \$2.95 |
| 50/100                | PINS (Wire Wrap)     | \$6.95 |
| 50/100A (100 Spacing) | PINS (Wire Wrap)     | \$6.95 |

25 PIN-D SUBMINIATURE (RS232)

|       |        |        |
|-------|--------|--------|
| DB25P | PLUG   | \$3.25 |
| DB25S | SOCKET | \$4.95 |

### SWITCHES

| Mounting holes           | 1-9                         | 10+           |
|--------------------------|-----------------------------|---------------|
| TOGGLE (Sub-miniature)   | JMT121 SPDT on-off-on       | \$1.95 \$1.43 |
|                          | JMT123 SPDT on-none-on      | 1.65 1.21     |
|                          | JMT221 DPDT on-off-on       | 2.55 1.87     |
| TOGGLE (Printed Circuit) | MPC121 SPDT on-off-on       | \$2.05 \$1.53 |
|                          | MPC123 SPDT on-none-on      | 1.75 1.31     |
|                          | MPC221 DPDT on-off-on       | 2.65 1.97     |
| PUSH BUTTON              | PB123 SPDT maintained       | 1.95 1.47     |
|                          | PB126 SPDT momentary        | 1.95 1.47     |
| PUSH BUTTON Miniature    | MS102 DPST momentary open   | 35 30         |
|                          | MS103 SPST momentary closed | 35 30         |
| DIPSWITCH SPST           | 206-4 8 pin dip 4 switch    | 1.75 1.65     |
|                          | 206-7 14 pin dip 7 switch   | 1.95 1.85     |
|                          | 206-8 16 pin dip 8 switch   | 2.25 2.15     |

### 1/16 VECTOR BOARD

| 0.1 Hole Spacing Part No. | P-Pattern L    | W    | Price 1-9 10 up |           |
|---------------------------|----------------|------|-----------------|-----------|
| PHENOLIC                  | 64P44 062XXXP  | 4.50 | 6.50            | 1.72 1.54 |
|                           | 169P44 062XXXP | 4.50 | 17.00           | 3.69 3.32 |
| EPOXY                     | 64P44 062WE    | 4.50 | 6.50            | 2.07 1.86 |
|                           | 169P44 062WE   | 4.50 | 9.50            | 2.56 2.31 |
| GLASS                     | 169P44 062WE   | 4.50 | 17.00           | 5.34 4.53 |
|                           | 169P44 062WE   | 8.50 | 17.00           | 9.23 8.26 |
| EPOXY GLASS COPPER CLAD   | 169P44 062WEC1 | 4.50 | 17.00           | 8.80 6.12 |

### INSTRUMENT/CLOCK CASE

Injection molded unit. Complete with red bezel. 4 1/2" x 4 1/2" x 1 9/16"

**\$3.95 ea.**

### MICROPROCESSOR COMPONENTS

|                                   |         |                                  |         |
|-----------------------------------|---------|----------------------------------|---------|
| 8080A CPU                         | \$16.00 | CDP1802 CPU                      | \$19.95 |
| 8214 8 Bit Input/Output           | 4.95    | MC6800 8 Bit MPU                 | 24.95   |
| 8214 Priority Interrupt Control   | 15.95   | MC6820 Periph. Interface Adapter | 15.00   |
| 8216 Bi-Directional Bus Driver    | 6.95    | MC6810A1 128 x 8 Static RAM      | 6.00    |
| 8224 Clock Generator/Driver       | 9.95    | MC6830L8 1024 x 8 Bit ROM        | 15.00   |
| 8228 System Controller Bus Driver | 10.95   | 280 CPU                          | 29.95   |

### CPU S

|                  |       |                              |            |
|------------------|-------|------------------------------|------------|
| 3080A Super 8008 | 16.00 | 1101 256 x 1 Static          | \$ 1.49    |
| 3650 8 Bit MPU   | 26.50 | 2102 256 x 4 Static          | 5.95       |
| 38085 CPU        | 29.95 | 2107 5280 4096 x 1 Dynamic   | 1.75       |
|                  |       | 8111 256 x 4 Static          | 4.95       |
|                  |       | 8599 16 x 4 Static           | 2.49       |
|                  |       | 2112/91102 1024 x 1 Static   | 5.95       |
|                  |       | 1209 256 x 1 Static          | 3.29       |
|                  |       | 93421 256 x 1 Static         | 2.95       |
|                  |       | MM5262 9K x 1 Dynamic        | 3 for 1.00 |
|                  |       | UPD4142/1044K Dynamic 16 Pin | 5.95       |

### SPECIAL REQUESTED ITEMS

|                  |               |               |                     |               |
|------------------|---------------|---------------|---------------------|---------------|
| FCM3817 \$5.00   | 11090 19.95   | 7205 19.95    | 9368 3.95           | MM5309 \$9.95 |
| AY-3-8500-1 9.95 | 4N33 3.95     | ICM7045 24.95 | L2110/11 25.00      | MM5311 4.95   |
| AY-9-9100 17.50  | 8120 7.50     | ICM7207 7.50  | 95H90 11.95         | MM5312 4.95   |
| AY-9-9200 14.95  | 8797 2.00     | ICM7208 22.00 | MC3061P 3.50        | MM5314 4.95   |
| AY-9-9500 4.95   | HD0165 7.95   | ICM7209 7.50  | MC4016 (74416) 7.50 | MM5316 6.95   |
| AY-9-9736 14.95  | MCW6571 13.50 | MC92040 17.50 | MC140817 8.95       | MM5318 9.95   |
| 9374 1.95        | MCW6574 13.50 | DS30265H 3.75 | MC140818 9.95       | MM5369 2.95   |
| 825115 25.00     | MCW6575 13.50 | TLL308 10.50  | 74C922 9.95         | MM5841 9.95   |
|                  |               |               |                     | C7001 8.95    |

### PARATRONICS

Featured on February's Front Cover of Popular Electronics

#### Logic Analyzer Kit Model 100A \$229.00/kit

- Analyzes any type of digital system
- Checks data rates in excess of 8 million words per second
- Trouble shoot TTL, CMOS, DTL, RTL, Schottky and MOS families
- Displays 16 logic states up to 8 digits wide
- See ones and zeros displayed on your CRT, octal or hexadecimal format
- Tests circuits under actual operating conditions
- Easy to assemble — comes with step-by-step construction manual which includes 80 pages on logic analyzer operation.

(Model 100A Manual - \$4.95)

#### PARATRONICS TRIGGER EXPANDER - Model 10

Adds 16 additional bits. Provides digital delay and qualification of input clock and 24-bit trigger word. — Connects direct to Model 100A for integrated unit!

Model 10 Kit - \$229.00  
Baseplate — \$9.95  
Model 10 Manual — \$4.95

### BK PRECISION 3 1/2-Digit Portable DMM

Model 2800 \$99.95

- Overload Protected
- 3 1/2 digit LED Display
- Battery or AC operation
- Auto Zeroing
- 1rm, 1Va, 0.1 ohm resolution
- Overrange reading
- 10 meg input impedance
- DC Accuracy 1% impedance
- Ranges: DC Voltage - 0-1000V/AC Voltage 0-100V/AC Response 50-400 Hz/DC/AC Current 0-100mA/Resistance 0-10 meg ohm Size 6 1/2" x 4 1/2" x 2"

Accessories:  
AC Adapter BC-28 \$9.00  
Batteries BP-26 20.00  
Carrying Case LC-28 7.50

### CSC 100 MHz 8-Digit Counter

MAX-100 \$134.95

- 20 Hz-100 MHz Range
- 6 LED Display
- Crystal controlled timebase
- Fully Automatic
- Portable — completely self contained
- Size — 1.75" x 7.38" x 5.63"

ACCESSORIES FOR MAX 100:  
Mobile Charger/Eliminator \$19.95  
Charger/Eliminator \$19.95  
Use 110 V AC Model 100 — CLA \$3.95  
Model 100 — CAI \$9.95

### CONTINENTAL SPECIALTIES

PROTO BOARD 6 \$15.95 (6" long X 4" wide)

Other CS Proto Boards

|                               |          |
|-------------------------------|----------|
| PB100 - 4.5" x 6"             | \$ 19.95 |
| PB101 - 5.8" x 4.5"           | 29.95    |
| PB102 - 7" x 4.5"             | 39.95    |
| PB103 - 9" x 6"               | 59.95    |
| PB104 - 9.5" x 8"             | 79.95    |
| PB203 - 9.75 x 6 1/2 x 2 1/4  | 80.00    |
| PB203A - 9.75 x 6 1/2 x 2 1/4 | 129.95   |

LOGIC MONITOR for DTL, HTL, TTL or CMOS Devices \$84.95

### QT PROTO STRIPS

|        |        |        |        |        |       |
|--------|--------|--------|--------|--------|-------|
| 01-595 | 01-598 | 01-185 | 01-125 | 01-85  | 01-75 |
| 01-355 | 01-358 | 01-359 | 01-165 | 01-125 | 01-85 |
| 01-356 | 01-357 | 01-358 | 01-166 | 01-126 | 01-86 |
| 01-357 | 01-358 | 01-359 | 01-167 | 01-127 | 01-87 |
| 01-358 | 01-359 | 01-360 | 01-168 | 01-128 | 01-88 |
| 01-359 | 01-360 | 01-361 | 01-169 | 01-129 | 01-89 |
| 01-360 | 01-361 | 01-362 | 01-170 | 01-130 | 01-90 |

Experimentor 300 \$ 9.95  
Experimentor 600 \$19.95

\$5.00 Minimum Order — U.S. Funds Only  
California Residents — Add 6% Sales Tax

Spec Sheets - 25¢ — Send 35¢ Stamp for 1978 Catalog  
Dealer Information Available

### James ELECTRONICS

1021-A HOWARD AVE., SAN CARLOS, CA. 94070  
PHONE ORDERS WELCOME — (415) 592-8097  
Advertised Prices Good Thru March

1978 CATALOG NOW AVAILABLE

### The Incredible "Pennywhistle 103"

\$129.95 Kit Only

The Pennywhistle 103 is capable of recording data to and from audio tape without critical speed requirements for the recorder and it is able to communicate directly with another modern and terminal for telephone, hamming and communications for the deaf. In addition, it is free of critical adjustments and is built with non-precision readily available parts.

Data Transmission Method... Frequency Shift Keying, full-duplex (half-duplex selectable)

Maximum Data Rate... 300 Baud

Data Format... Asynchronous Serial (return to mark level required between each character)

Receive Channel Frequencies... 2025 Hz for space 2225 Hz for mark

Transmit Channel Frequencies... Switch selectable: Low (normal) 1070 space, 1270 mark, High 025 space, 225 mark

Transmit Level... -16 dbm acoustically coupled

Receive Frequency Tolerance... Frequency reference automatically adjusts to allow for operation between 1800 Hz and 2100 Hz

Digital Data Interface... EIA RS-232C or 20 mA current loop (receiver is optoisolated and non-polar)

Power Requirements... 120 VAC single phase, 10 Watts

Physical... All components mount on a single 5" x 9" printed circuit board. All components included

Requires a VOM, Audio Oscillator, Frequency Counter and/or Oscilloscope to align

### NEW! BULB-ENERGY SAVER

BULB-ENERGY SAVERS used for years by major industrial users — now available for home or office use. Bulb Savers cut electrical bills by as much as 3%.

BULB-SAVERS lengthens light life by:

1. Acting as an electrical "shock absorber", turns the bulb on slowly, eliminating the "thermal shock". Bulb life increases 300 percent.
2. Banshees Current "Surges". Cushions line voltage surges when other loads cut power.
3. Reduces Energy Consumption

BES-1 \$1.50 ea. 1.25 ea.

### DIGITAL STOPWATCH

- Bright 6 Digit LED Display
- Times to 99 minutes 59.99 seconds
- Crystal Controlled Time Base
- Three Stopwatches in One
- Times Single Event in Split & Taylor
- Size 4 1/2" x 2 1/4" x 90 (4 1/2" ounces)
- Uses 3 Penrite Cells

Kit — \$39.95  
Assembled — \$49.95  
Heavy Duty Carry Case \$5.95

Stop Watch Chip Only (7205) \$19.95

### IMC 3 1/2 DIGIT DPM KIT

Model KB500 DPM Kit \$49.00  
Model 311D-5C-5V Power Kit \$17.50

### JE700 CLOCK

The JE700 is a low cost digital clock but is a very high quality unit. The unit features a simulated wood-grain case with dimensions of 8 1/2" x 7 1/2" x 1 1/2" inches. A MAN/12 high brightness readout, and the MM5311 clock chip.

115 VAC KIT ONLY \$16.95

### HEXADECIMAL ENCODER 19-KEY PAD

- 10
- ABCDEF
- Shift Key
- 2 Optional Keys

\$10.95 each

### New 63 KEY KEYBOARD \$29.95 IN STOCK

This keyboard features 63 unenclosed SPST keys, unattached to any kind of P.C.B. A very solid molded plastic 13 1/2" x 11 1/2" base fits most applications.

HD165 Encoder Chip (encodes 16 Keys) \$7.95 ea.  
AY-5-2316 Encoder Chip (encodes 88 Keys) \$14.95 ea.

### JE803 PROBE

The Logic Probe is a unit which is for most part inexpensive in terms of shipping logic schemes. TTL, DTL, RTL, CMOS. It gives the power to needs to operate directly off the circuit under test. Drawing a scant 10 mA max. It uses a MAN/12 high brightness readout to indicate any of the following states: High (H), Low (L), PULSE (P), S. The Probe can detect high frequency pulses to 45 MHz. It can't be used at MOS levels or critical damage will result.

\$9.95 Per Kit  
printed circuit board

T-L 5V 1A Supply  
This is a standard TTL power supply using the well known LM309K regulator IC to provide a solid 1 AMP of current at 5 volts. We try to make things easy for you by providing everything you need in one package, including the hardware for only \$9.95 Per Kit

**Everything we know about money-saving, time-saving, energy-saving ride sharing programs is yours for the asking.**

**Free.** Our Double Up kit contains facts, figures, ideas, promotional help and other good things you and your company should know about.

Just write the U.S. Department of Transportation, P.O. Box 1813, Washington, D.C. 20013.

Name \_\_\_\_\_ Title \_\_\_\_\_  
 Company \_\_\_\_\_  
 Address \_\_\_\_\_  
 City \_\_\_\_\_ State \_\_\_\_\_ Zip \_\_\_\_\_



A public service of this magazine, the U.S. Department of Transportation and the Advertising Council.

## FREE KIT Catalog

STOP! Take a minute & let us send our latest kit catalog. If you like, send us the name & address of a friend who may also be interested and we'll include to you our booklet "How to build electronic thermometer".

contains  
**TEST & EXPERT-MENTER'S EQUIP.**

**DAGE** SCIENTIFIC INSTRUMENTS  
 BOX 1054R LIVERMORE CA 94550

**NEW, adjustable, three output, regulated power supply, plus 900 parts worth over \$400.00 in complete cartrivision television electronic assembly. Documentation included. Perfect for microprocessor and all electronic applications. \$17.95 plus \$3.50 S&H. Master Charge, BankAmericard. Free brochure. MADISON ELECTRONICS, 369, Madison, AL 35758. Satisfaction guaranteed**

## INTO TV ANTENNA SYSTEMS? YOU'LL BE INTO TASCOS!

Below wholesale prices on a full line of antenna installation surplus shipped from stock. Unbelievable prices on connectors, wall plates, splitters, transformers, amplifiers, etc. Write for free catalogue. Order now & compare. **TASCO. PO Box 30143 Houston Tex 77009**

**STATE Of The Art test instruments, kits, and plans. Free brochure. Dealer inquiries invited. PENTEC, P.O. Box 148, Whitehall, PA 18052**

**NAME brand test equipment. Up to 50% discount. Free catalog and price list. SALEN ELECTRONICS, P.O. Box 82, Skokie, IL 60076**

**PICTURE TUBE MACHINE**  
 We buy and sell NEW and USED CRT rebuilding machinery. COMPLETE TRAINING. Buy with CONFIDENCE from the ORIGINAL MFRG.  
 For complete details send name, address, zip to:  
**LAKESIDE INDUSTRIES**  
 3520 W. Fullerton Ave.  
 Chicago, Ill. 60647  
 Phone: 312-342-3399



## DON'T MISS ANY

Get every single issue of Radio-Electronics delivered right to your door, and before it appears on the newsstand. Use this coupon and subscribe now.

Mail to: Radio-Electronics  
 SUBSCRIPTION DEPT., P.O. BOX 2520,  
 BOULDER, COLO. 80322

name (please print) \_\_\_\_\_

address \_\_\_\_\_

city state zip code \_\_\_\_\_

### check offer preferred

- 1 Year—12 issues **ONLY \$9.98**
- 2 Years—24 issues **SAVE MORE \$19.00**  
 (You save \$5.00 over newsstand)
- 3 Years—36 issues **GREATER SAVINGS \$27.00**  
 (You save \$9.00 over newsstand prices)
- Payment enclosed  Bill Me
- Check here if this is a new subscription
- Check here if you are extending or renewing your subscription

Extra Shipping: Canada \$3.00 per year, all other countries \$5.00 per year.

40C8

## VMP ELECTRONICS MART

P O BOX 415. — CHAMBERS LN 408-659-3791  
 CARMEL VALLEY CA 93924

### BARGAINS GALORE

MEMORIES, LED'S IC'S AND MORE

### RED LED

12/\$1.00  
 66/ 5.00  
 145/10.00

### MAN 72

RED LED DISPLAY  
 3" COMMON ANODE  
 0—99 \$ .60 ea.  
 100— .50 ea.

### SUPER BARGAIN 2708

8K ERASABLE PROM  
 0—99 \$7.95 ea.  
 100— 6.95 ea.

### 2513

CHARACTER GENERATOR  
 64 x 8 x 5  
 2140 (UPPER CASE)  
 OR 3021 (LOWER CASE)  
 0—99 \$4.95 ea.  
 100— 4.25 ea.

### 1702A

2 K ERASABLE PROM  
 0—99 \$3.50 ea.  
 100— 3.00 ea.

LED'S MFGD BY  
**MONSANTO, LITRONICS,  
 HEWLETT-PACKARD  
 FAIRCHILD**

IC'S MFGB BY  
**MAJOR SUPPLIERS SUCH  
 AS TI, INTEL,  
 SIGNETICS & EXAR**

### SINGLE DIGIT LED DISPLAYS

|         |     |     |    |      |
|---------|-----|-----|----|------|
| MAN72   | .3" | RED | CA | LHDP |
| MAN3620 | .3" | OR  | CA | LHDP |
| MAN4610 | .4" | OR  | CA | RHDP |
| MAN4640 | .4" | OR  | CC | RHDP |
| MAN82A  | .3" | YEL | CA | LHDP |
| MAN3630 | .3" | OR  | CA | RHDP |
| MAN4630 | .4" | OR  | CA | RHDP |

0—99 \$ .70 ea.  
 100— .60 ea.

### 4 & 5 DIGIT LED DISPLAYS

HP5082 — RHDP  
 .11" MAGNIFIED  
 YOUR CHOICE  
 0—99 \$ .50 each.  
 100— .40 ea.

### TTL SPECIALS

80% ARE GUARANTEED FUNCTIONAL

|       |           |
|-------|-----------|
| 7400  | 45/\$1.75 |
| 7403  | 25/\$1.75 |
| 7416  | 20/\$1.75 |
| 7427  | 20/\$1.75 |
| 7437  | 20/\$1.75 |
| 7446  | 5/\$1.75  |
| 7454  | 25/\$1.75 |
| 7483  | 7/\$1.75  |
| 74145 | 3/\$1.75  |

### DOUBLE DIGIT LED DISPLAYS

56" RHDP

|         |           |     |    |
|---------|-----------|-----|----|
| MAN6610 | 2 DIG     | OR  | CA |
| MAN6640 | 2 DIG     | OR  | CC |
| MAN6630 | 1 1/2 DIG | OR  | CA |
| MAN6650 | 1 1/2 DIG | OR  | CC |
| MAN6710 | 2 DIG     | RED | CA |
| MAN6730 | 1 1/2 DIG | RED | CA |
| MAN6740 | 2 DIG     | RED | CC |
| MAN6750 | 1 1/2 DIG | RED | CC |

0—99 \$ .85 ea.  
 100— .75 ea.

### EXTRA SPECIAL

DOUBLE DIGIT LED MIX  
 1 1/2 & 2 DIGIT RED & ORANGE .56"  
 COMMON CATHODE & COMMON ANODE  
**15/\$10.00**

### EXAR IC'S

|        |            |            |
|--------|------------|------------|
|        | 0—99       | 100—       |
| XR320  | \$1.35 ea. | \$1.25 ea. |
| XR2206 | 4.50       | 4.00       |
| XR2207 | 1.75       | 1.55       |
| XR4136 | .95        | .75        |
| XR4202 | .95        | .75        |
| XR4739 | .95        | .75        |

### DISCRET LED ASSORTMENT

JUMBO RED, YELLOW, GREEN,  
 WHITE, AMBER  
 MINI RED, WHITE,  
 PLUS OTHERS  
**GUARANTEED 80% COLORS  
 OTHER THAN RED  
 75/\$10.00**

### LED DISPLAY MIX

SINGLE DIGITS — RED  
 YELLOW & ORANGE .3" & .4"  
 COMMON CATHODE & COMMON ANODE  
**20/\$10.00**



California residents add sales tax.

COMPLETE SATISFACTION GUARANTEED  
 INCLUDE 5% SHIPPING & HANDLING IN U.S.  
 INCLUDE 15% SHIPPING & HANDLING OUTSIDE U.S.

MINIMUM ORDER \$10  
 VISA M.C. BAC ACCEPTED — MIN \$20  
 NO COD'S PLEASE

CIRCLE 96 ON FREE INFORMATION CARD

# hobbi house

Send for Free Hobbi House Catalog  
969 BALL AVE., UNION, N.J. 07083

## lowest prices



**MA1003  
MOBILE CLOCK  
MODULE (National)**  
\$18<sup>95</sup> complete

Attaches directly to 9-12V Battery. Automatic Nighttime Dimming. Fluorescent Display gives Color Choice (Red, Blue, Green or Yellow) when used w/corresponding Color Filter. Includes — Module, Switches, & Filter.

### ALUMINUM CASE WITH FILTER.

(switches included with clock kit). In Silver, Bronze, Black and Gold. Filter colors — red, blue, green, or yellow. **\$5.75**

**Complete Clock Kit \$9.95**  
4 DIGIT 12 24 HOUR

Includes: PC Board, 5316 Clock Chip, all components and Power Supply.

Displays hours and minutes ... Switch to minutes and seconds ... AM-PM Indicator ... Elapsed Timer ... Fluorescent Display

Options: If alarm function desired add \$2.50 (includes speaker and all components)

Plexiglas Case Kit (red or blue) \$2.00

**Big Bright — 5" LED Alarm Clock**  
6 Digit AC or DC or Elapsed Timer Kit  
**\$19.95** Complete

PC Board Drilled and silk screened (includes Xtal Time Base Circuitry) ... 5375 Nat. Clock Chip and Fairchild Displays ... includes EVERY part required for clock and all options except Cabinet and Crystal Time Base components if desired.

- Brightness Control • 24 Alarm with snooze
- Freeze feat on every mode • 12 Hr 60 Hz oper. • Field Tested over 1 yr. • 0.60 Min Elapsed Timer

Complete Instructions — Schematics, pictorials, layouts

Options — XTAL Time Base Components, \$2.95 when purchased with clock. Wood Clock Cabinet, \$4 with clock purchase.

**Regulated Power Supply Kit,**  
**\$14.95** complete

2 Amp @ — 15 and — 15 volts Current Limiting & Thermal Shutdown Protection.

Includes: Transformer ... Bridge Rectifier ... Filter Caps ... 4-way Binding Posts ... Heat Sink & Line Cord ... Voltage Regulators ... Pass Transistor ... Resistors ... Diodes ... etc ... Complete Instructions and Circuit Diagrams.

### Bridges

| VOLT | 2 AMP  | 4 AMP  | 6 AMP  | 25 AMP  |
|------|--------|--------|--------|---------|
| 50   | \$ .60 | \$ .70 | \$ .80 | \$ 1.30 |
| 100  | .70    | .80    | .90    | 1.40    |
| 200  | .80    | .90    | 1.00   | 1.60    |
| 400  | 1.00   | 1.10   | 1.20   |         |
| 600  | 1.25   | 1.35   | 1.40   |         |

**Your Home for Quality Kits, Projects and Components**  
Toll-Free Wats Line — 800-631-7485 • Open Saturdays  
In New Jersey Call (201) 964-5206

**High Power Transistors 2/\$1.00**  
2N3055 NPN (ITT TO 3 Case)  
DTS 410 NPN (GE TO 3 Case) equiv. to ECG 162

**Voltage Regulators.**  
Positive — To 220 Pkg ..... \$1.00  
7805, 7806, 7812, 7815, 7824  
Negative — To 220 Pkg ..... \$1.25  
7905, 7912, 7915  
To — 3 Pkg. — LM309K ..... \$1.25

**Dry Reed Switch Capsules 25/\$1.98**  
Glass Sealed 5 amp 115 VAC

**1C Sockets ..... \$1.00**  
8, 14, 16, 18 Pin ..... 5 \$1.00  
24 & 28 Pin ..... 3 \$1.00  
40 Pin ..... 2 \$1.00

**Clock Chips**  
MM5314 or MM5316 ..... \$3.50  
MM5387 (H. Cur 5316) or  
MM 5375 ..... \$3.95

**Capacitors**  
500 MFD at 50V ..... 4/\$1.00  
500 MFD at 15V ..... 6/\$1.00

**Sound Actuated Switch \$ .85**  
6 Ft. Line Cords 6 for \$1.00

**6 DIGIT LED STOP-WATCH KIT \$29.95 Complete**  
Split Time and Taylor Time  
Features: Reads mins., secs. and 1/100th sec., 6 bright easily readable digits. Needs only one 9V X1STOR battery. Kit includes: Hand-held case for above, PC board, and all components except battery.

**250 K Slide Volume Controls . . . 4/\$1.00**  
By Mallory

**2 Amp Circuit Breaker ..... 2/\$1.00**  
Front Panel Mount through 1/2 dia. hole.  
120 VAC, 32 VDC, Trips at 2.7 amps.

**Grain of Wheat type chic. min. Display Lamp — red or white ..... 10/\$1.00**

**60 Hz. Crystal Time Base Kit . . . \$4.95**  
Use with Digital Clocks for 12 VDC or Portable Operation.  
Kit includes: PC Board, 5369 Divider Chip, 3.5795 MHZ XTAL and all other parts plus complete instructions.

**70 Volt Line Transformer ..... \$2.90**  
Power Rating — 10 watts. Model TR-1  
Primary Volts: 70.7 — Primary Taps: 0.63, 1.25, 2.5, 5, and 10 W. Secondary Impedance: 4 & 8 ohms. Primary and Secondary Terminations: 8" color coded leads. 1 1/2" H, 1 1/2" D, 2" W. Base 2 3/8" W

**6" Pioneer Pincushion Speakers \$3.95 pair**  
3.2 ohms, 7 1/2 watts

**Heavy Duty Alligator Clip Test Lead Set ..... \$2.49**  
Set of 10 color coded leads with insulated alligator clip on each end.

**Jumbo Red LED's ..... 10/\$1.00, 100/\$9.00**

**25 PK. LED's Asstd Sizes & Colors ..... \$2.50**

**Multi-Range Digital Voltmeter Kit \$29.95**  
0 to — .2 Volts DC — 0 to — 2 Volts DC

- Latest technology DVM chip set
- High Noise Rejection
- Non Critical Comp.
- Accuracy to within .001

Contains — P.C. Boards: 4-large 50 Fairchild Readouts: Display Drivers: Op-Amps: Inverter: all electronic comp Switches. Pots: Complete instructions and specs.

Also includes Set/Precision Resistors for increasing Voltage to 200 Volts.

Requirements: Power Supply w — 5V — 15V and — 15V.

**Multi-Meter Kit, \$49.95**  
complete with Power Supply

**AC/DC Wall Plug Adaptor-Charger \$1.00**  
120 volt input 6VDC 130 MA output.

**Transformer, 6.3 volts at 1.2 amps. \$1.49**

**6 Digit LED Alarm Clock Kit and Elapsed Timer Indicator . . . \$13.95**

Red Display  
Complete kit includes: National 5375AB Clock Chip, Transformer, PC Boards, Drilled and Silk Screened: SLA-7 Red .33 High Brightness Displays: All components: Instructions and pictorials.

Features: Hrs., Min., and Sec. . . . 12 Hr format with 24 hr. Alarm . . . Snooz Feature . . . AM PM Indication . . . 60 min. elapsed Timer . . . Freeze Capability . . . Power Fail Indicator.  
Options: Wood grain case \$4.00 when purchased with kit.

**Potentiometer Assortment . . 12/\$1.00**  
Includes 1K to 100K. Tab mounts, printed circuit, duals, push-pulls, nylon and metal shafts (long and short)

**IN 4148 Switching Diodes . . . .50/\$1.00**  
Factory prime, taped and reeled

**5 Volt, 6 Amp Power Supply Kit \$12.95**  
Fixed: 6 Amp, 5 volt 1% Regulation. Adjustable: 5-12 volts Unregulated. Short Circuit Protection, Current Limiting. Complete Kit includes: Transformer, Regulator, Resistors, 4 Way Binding Posts, Heat Sink, Comp. Grade Filter Cap, Output Power Transistors, Capacitors, Bridge Rectifier, Line Cord, complete instructions and Diagrams.

**7 SEG LED Displays \$ .59 ea., 10/\$5.00**  
33' Type 707 MAN-1 14 Pin Dip, Common Anode or Cathode.

### Terms and Conditions

Orders Shipped Within 24 Hours  
\$5.00 Minimum Order.  
Telephone C.O.D.'s accepted.  
\$15.00 Minimum Bank Americard MasterCharge order.  
Add \$1.00 Postage for orders under \$10.00.  
Outside Continental U.S. add postage - U.S. Funds.  
N.J. Residents add 5% Sales Tax.  
Money Back Guarantee.

## Why Wait?

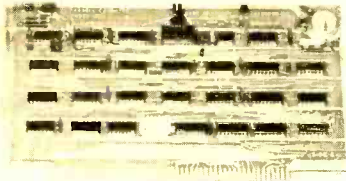

## The Tarbell Cassette Interface

- Plugs directly into your IMSAI or ALTAIR\*
- Fastest transfer rate: 187 (standard) to 540 bytes/second
- Extremely Reliable — Phase encoded (self-clocking)
- 4 Extra Status Lines, 4 Extra Control Lines
- 37-page manual included
- Device Code Selectable by DIP-switch
- Capable of Generating Kansas City tapes also
- No modification required on audio cassette recorder
- Complete kit \$120, Assembled \$175, Manual \$4

## TARBELL ELECTRONICS

20620 S. Leapwood Ave., Suite P, Carson, Ca. 90746  
(213) 538-4251

California residents please add 6% sales tax

\*ALTAIR is a trademark/tradename of MITS, INC.

CIRCLE 22 ON FREE INFORMATION CARD

## WIREWRAP

### PRECUT WIRE

Why buy wire on rolls?

#### PRECUT & STRIPPED WIRE IS:

- Fast - No more cutting & stripping by hand
- Reliable - Good, clean, uniform strip
- Economical - Cheaper than using bulk wire

| Precut Wire                       | Bulk Wire                      |
|-----------------------------------|--------------------------------|
| 100 pcs of 3" at \$82 - 34¢/ft.   | 50 ft. roll at \$1 99 - 4¢/ft. |
| 100 pcs of 6" at 1 06 - 2¢/ft.    | 100 ft. roll at 2 95 - 3¢/ft.  |
| Wire Kit 1 at \$6.95 - 2 1/3¢/ft. |                                |

#30 Kynar stripped 1" on each end. Lengths are overall  
Colors: Red, Blue, Green, Yellow, Black, Orange, White  
Wire packaged in plastic bags. Add 25¢/length for tubes.

|           | 100  | 500  | 1000    | 5000   |
|-----------|------|------|---------|--------|
| 2 1/2 in. | 78   | 2.40 | 4.30/K  | 3.89/K |
| 3 in.     | 82   | 2.60 | 4.71/K  | 4.22/K |
| 3 1/2 in. | 86   | 2.80 | 5.12/K  | 4.55/K |
| 4 in.     | 90   | 3.00 | 5.52/K  | 4.88/K |
| 4 1/2 in. | 94   | 3.21 | 5.93/K  | 5.21/K |
| 5 in.     | 98   | 3.42 | 6.34/K  | 5.52/K |
| 5 1/2 in. | 1.02 | 3.65 | 6.75/K  | 5.86/K |
| 6 in.     | 1.06 | 3.85 | 7.16/K  | 6.19/K |
| 6 1/2 in. | 1.15 | 4.05 | 7.57/K  | 6.52/K |
| 7 in.     | 1.20 | 4.25 | 7.98/K  | 6.85/K |
| 7 1/2 in. | 1.25 | 4.45 | 8.39/K  | 7.18/K |
| 8 in.     | 1.29 | 4.65 | 8.80/K  | 7.53/K |
| 8 1/2 in. | 1.32 | 4.85 | 9.21/K  | 7.84/K |
| 9 in.     | 1.36 | 5.05 | 9.62/K  | 8.17/K |
| 9 1/2 in. | 1.40 | 5.25 | 10.03/K | 8.50/K |
| 10 in.    | 1.45 | 5.51 | 10.44/K | 8.83/K |
| Add. in.  | .10  | .41  | .82/K   | 66/K   |

### WIRE KITS

| # 1        | \$6.95 | # 2        | \$19.95             |
|------------|--------|------------|---------------------|
| 250 3"     | 100 4" | 250 2 1/2" | 250 4 1/2"          |
| 250 3 1/2" | 100 5" | 500 3"     | 250 5"              |
| 100 4"     | 100 6" | 500 3 1/2" | 100 5 1/2"          |
|            |        | 500 4"     | 1 250 ft. Roll Bulk |

Choose One Color or Assortment

### WIRE WRAP SOCKETS

|         | 1-9 | 10-24 | 25-99 | 100-249 | 250-999 | 1K-5K |
|---------|-----|-------|-------|---------|---------|-------|
| 8 pin*  | 41  | 38    | 35    | 31      | 29      | 27    |
| 14 pin* | 42  | 39    | 36    | 32      | 29      | 27    |
| 16 pin* | 46  | 43    | 39    | 35      | 32      | 30    |
| 18 pin* | 63  | 58    | 54    | 47      | 44      | 41    |
| 20 pin  | 84  | 78    | 71    | 63      | 59      | 54    |
| 22 pin* | 130 | 120   | 110   | 95      | 90      | 84    |
| 24 pin  | 91  | 84    | 78    | 68      | 64      | 59    |
| 28 pin  | 125 | 115   | 108   | 95      | 89      | 82    |
| 40 pin  | 165 | 155   | 142   | 125     | 115     | 109   |

\* Gold 3-level Closed Entry Sockets  
\* End & Side Stackable All prices include gold  
Tin sockets and 2-level sockets available

### WIRE WRAP TOOLS



\$34.95

HOBBY WRAP  
Model BW 630

With Free Wire Kit 1  
(\$6.95 Value)

|                                    |         |
|------------------------------------|---------|
| Batteries & Charger                | \$11.00 |
| WSU 30 Hand Wrap-Unwrap Strip Tool | 5.95    |
| WSU 30M, for Modified Wrap         | 6.95    |
| BT 30 Extra Bit                    | 2.95    |

### INTERCONNECT CABLES

Ribbon cable connectors for connecting boards to front panels, or board to board.

|     | SINGLE ENDED |        |        | DOUBLE ENDED |        |        |
|-----|--------------|--------|--------|--------------|--------|--------|
|     | 14 pin       | 16 pin | 24 pin | 14 pin       | 16 pin | 24 pin |
| 6"  | 1.24         | 1.34   | 2.05   | 2.24         | 2.45   | 3.37   |
| 12" | 1.33         | 1.44   | 2.24   | 2.33         | 2.55   | 3.92   |
| 24" | 1.52         | 1.65   | 2.63   | 2.52         | 2.76   | 4.31   |
| 48" | 1.91         | 2.06   | 3.40   | 2.91         | 3.17   | 5.08   |

### Ordering Information:

- Orders under \$25 and COD's, add \$2
- All others, shipped Ppd in U.S. via UPS
- For Blue Label (Air) or 1st Class, add \$1
- We accept Visa & MasterCard
- Most orders shipped same day

Dealer Inquiries Invited

## PAGE DIGITAL ELECTRONICS

135 E. Chestnut Street 4A  
Monrovia, California 91016  
Phone (213) 357-5005

CIRCLE 93 ON FREE INFORMATION CARD

### MINI MINI TOGGLE EXTRA SMALL D.P.D.T. 3A 125VAC CONTACTS

each \$1.50

8 - 10.

100 - \$105.

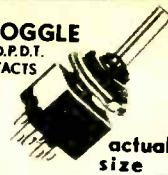

actual size

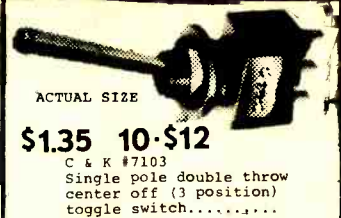

ACTUAL SIZE

\$1.35 10-\$12

C & K #7103

Single pole double throw center off (3 position) toggle switch.....

### BISTABLE RELAY



SPDT 6VDC 200 OHM COILS \$2.95 ea.  
1 AMP 20 WATT DC CONTACTS  
LONG LIFE (1 X 10<sup>9</sup>) OPER.  
HIGH SPEED (500 HZ)  
HERMETICALLY SEALED

### ELEC-TROL 12 vdc REED RELAY 440 Ω coil



4 dpst n.o.  
PICTURE IS APPROXIMATION, RELAY HAS FOUR PINS ON ONE END AND TWO ON OTHER. PINS ARE SPACED .1" X 1". 1/2A CONTACTS.  
\$1.75 ea. - ten \$15

### DIP SWITCH



### DIP TRIMMER

12 TURN 1/4" x 1/4" x 1/4" 5K or 200K only  
mfg. DALE  
\$ .50 TEN FOR \$4

| TRANSISTORS - TRIACS - SCR's            | each   | ten   |
|---|--------|-------|
| MJE1091 PNP Darlington 60V 5A TAB       | \$1.50 | \$14. |
| 2N5559B NPN (HEP707) 400 10 TO-3        | 2.50   | 22.50 |
| TIP31A NPN (HEP245) 60 3 TAB            | .30    | 2.50  |
| 2N6101 NPN (SS004) 80 10 TAB            | .65    | 5.00  |
| D41D1 PNP GE 30 1 TAB                   | .25    | 2.00  |
| 40536 TRIAC 400V 2.5A on 10W heat sink  | .75    | 6.00  |
| 40374 NPN 250V 2A on 6W heat sink TO-66 | .75    | 6.00  |
| C106D1 SCR 400V, 4A, 2ma. gate TAB      | .65    | 5.00  |

## Hal's Goodies

Hal's computer really popped it's stack on these prices. We cannot allow any quantity discounts or bonus credits on these items. Quantities are limited and at these prices - order now.....

|   |             |          |
|---|-------------|----------|
| 2708 8K EPROM Sig., Nat., Intel prime 450NS   | ea. \$14.95 | 8/\$112  |
| 2504T \$1g. 1024 bit dyn. shift register TO-99  | ea. \$7.5   | 10/\$6   |
| 93410 Fairchild 256x1 RAM bipolar 45NS DIP  | ea. .75     | 10/\$6   |
| TR1602B 5V Western Digital UART 40 pin DIP  | ea. 3.00    |          |
| 7402 Nat. quad 2 in NOR gate marked DEC7402   | 10/\$1.50   | 100/\$12 |
| 40 pin gold solder tail IC socket, Augut  | ea. .55     |          |
| Capacitor - .01mf 50V monolithic ceramic, sealed in glass DO-7 diode package                  | 10/\$.90    | 100/\$8  |
| 1/8W carbon comp. resistors ten each of 2.4, 390, 1.8K, 3.9K, 6.8K, 11K, 43K, 68K, 240K, ohms | 90/\$6.     |          |

PO BOX 41778  
Sacramento, Ca.  
95841

916 334 2161

Money back guarantee - \$5 minimum order. We pay post on orders for \$10 or more. All payment must be in U.S. funds. Foreign orders must include post. BAC & MC are not prepaid orders and shipping is added

4811 MYRTLE AVE

## BABYLON ELECTRONICS



CIRCLE 83 ON FREE INFORMATION CARD



# ELECTRONIC SYSTEMS

p.o. box 212 Burlingame CA 94010  
(408) 374-5984

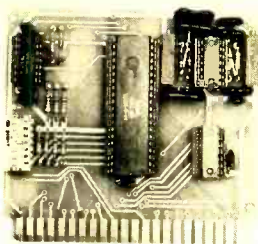

## UART & BAUD RATE GENERATOR

- Part no. 101
- Converts serial to parallel and parallel to serial
  - Low cost on board baud rate generator
  - Baud rates: 110, 150, 300, 600, 1200, and 2400
  - Low power drain +5 volts and -12 volts required
  - TTL compatible
  - All characters contain a start bit, 5 to 8 data bits, 1 or 2 stop bits, and either odd or even parity.
  - All connections go to a 44 pin gold plated edge connector
  - Board only \$12.00; with parts \$35.00

## 8K STATIC RAM



- Part no. 300
- 8K Altair bus memory
  - Uses 2102 Static memory chips
  - Memory protect
  - Gold contacts
  - Wait states
  - On board regulator
  - S-100 bus compatible
  - Vector input option
  - TRI state buffered
  - Board only \$22.50; with parts \$160.00

## RS-232/TTL INTERFACE



- Part no. 232
- Converts TTL to RS-232, and converts RS-232 to TTL
  - Two separate circuits
  - Requires -12 and +12 volts
  - All connections go to a 10 pin gold plated edge connector
  - Board only \$4.50; with parts \$7.00

## DC POWER SUPPLY



- Part no. 6085
- Board supplies a regulated +5 volts at 3 amps., +12, -12, and -5 volts at 1 amp.
  - Board has filters, rectifiers, and regulators
  - Power required is 8 volts AC at 3 amps., and 24 volts AC C.T. at 1.5 amps.
  - Board only \$12.50

## TIDMA

- Part no. 112
- Tape Interface Direct Memory Access
  - Record and play programs without bootstrap loader (no prom) has FSK encoder/decoder for direct connections to low cost recorder at 625 baud rate, and direct connections for inputs and outputs to a digital recorder at any baud rate.
  - S-100 bus compatible
  - Comes assembled and tested for \$160.00

## TAPE INTERFACE



- Part no. 111
- Play and record Kansas City Standard tapes
  - Converts a low cost tape recorder to a digital recorder
  - Works up to 1200 baud
  - Digital in and out are TTL-serial
  - Output of board connects to mic. in of recorder
  - Earphone of recorder connects to input on board
  - Requires +5 volts, low power drain
  - Board \$7.60; with parts \$27.50
  - No coils

## RF MODULATOR



- Part no. 107
- Converts video to AM modulated RF, Channels 2 or 3
  - Power required is 12 volts AC C.T., or +5 volts DC
  - Board \$4.50; with parts \$13.50

## APPLE I MOTHER BOARD



- Part no. 102
- 10 slots - 44 pin (.156) connectors spaced 3/4" apart
  - Connects to edge connector of computer
  - Pin 20 and 22 connects to X & Z for power and ground
  - Board has provisions for bypass capacitors
  - Board cost \$15.00

## TELEVISION TYPEWRITER

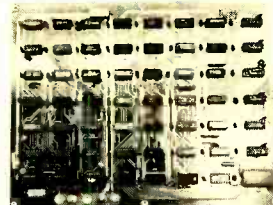

- Part no. 106
- Stand alone TVT
  - 32 char/line, 16 lines, modifications for 64 char/line included
  - Parallel ASCII (TTL) input
  - Video output
  - 1K on board memory
  - Output for computer controlled cursor
  - Auto scroll
  - Non-destructive cursor
  - Cursor inputs: up, down, left, right, home, EOL, EOS
  - Scroll up, down
  - Requires +5 volts at 1.5 amps, and -12 volts at 30 mA
  - Board only \$39.00; with parts \$145.00

## MODEM



- Part no. 109
- Type 103
  - Full or half duplex
  - Works up to 300 baud
  - Originate or Answer
  - No coils, only low cost components
  - TTL input and output-serial
  - Connect 8 ohm speaker and crystal mic. directly to board
  - Uses XR FSK demodulator
  - Requires +5 volts
  - Board \$7.60; with parts \$27.50

### To Order:



Mention part number and description. For parts kits add "A" to part number. Shipping paid for orders accompanied by check, money order, or Master Charge, BankAmericard, or VISA number, expiration date and signature. Shipping charges added to C.O.D. orders. California residents add 6.5% for tax. Parts kits include sockets for all ICs, components, and circuit board. Documentation is included with all products. Dealer inquiries invited. 24 Hour Order Line: (408) 374-5984.

E21

## CATCH-A-PULSE II<sup>®</sup> LOGIC PROBE

10 Nsec SPEED AT 3.5 to 15V  
LEVELS ONLY \$39.95

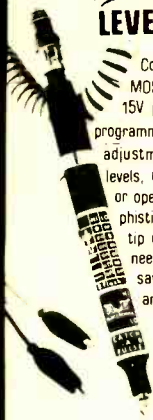

Compatible with RTL, DTL, TTL, CMOS, MOS, and Microprocessors using a 3.5 to 15V power supply. Thresholds automatically programmed. Automatic resetting memory. No adjustment required. Visual indication of logic levels, using LEDs to show high, low, bad level or open circuit logic and pulses. Highly sophisticated, shirt-pocket portable (protective tip cap and removable coil cord). Eliminates need for heavy test equipment. A definite savings in time and money for engineer and technician.

- 10 Nsec pulse response
- Open circuit detection
- Multi-family
- Replaceable tip & cord
- High input impedance
- Pulse stretching

Special PAK-II \$45.95

### CATCH-A-PULSE II

Includes a standard coiled cord  
COILED CORD with E-Z micro hooks  
ADAPTER for using Catch-A-Pulse on  
logic families whose power supply is 15V to 25V

SHIPPING— add \$1.00 per Pak.



Pat. Pend. Dealer inquiries welcome  
**ELECTRONICS**

Box 19299, San Diego, CA 92119, (714) 447-1770

CIRCLE 1 ON FREE INFORMATION CARD

### Mutual radio programs via Westar satellite

The Mutual Broadcasting System and Western Union have recently agreed to allow Mutual's network radio programs be broadcast over Western Union's Westar satellite system. The agreement, which is awaiting FCC approval, will enable Mutual to transmit its radio programs via satellite to more than 500 100-foot receiving antennas, connected directly or indirectly to the broadcast company's 780 affiliate stations.

The advantage of satellite transmission, as opposed to land-line transmission, is that "radio signals will have a 15 kHz quality equalling that of FM stereo," states Gary J. Worth, Mutual's executive vice president in charge of the satellite program. Transmission quality would be substantially improved, since present land transmission typically involves a 5-kHz signal, with some branches receiving only 3.5 kHz signals. The agreement will let Mutual use up to six 15-kHz program audio channels.

Both Mutual and Western Union asked the FCC to allow programs to start being transmitted from Washington, DC, to its nationwide affiliates. If the FCC gives its consent, it is expected that this service could start around mid-1978.

### Future stereo recordings to use digital techniques

Digital techniques will very soon replace analog techniques in stereo recordings. Even now, several Japanese manufacturers are marketing laser-based systems that play back discs whose audio signal has

been pulse-code modulated (PCM).

It is expected that mass-produced PCM-based recordings will use standard 30-cm discs because they can be produced as inexpensively as in analog recordings. However, the key lies in system standardization, and until unanimity is reached on specifications, PCM discs will be impractical and tape will be the medium used.

Alex DeKoster, senior acoustic engineer at Acoustic Research, Inc., Norwood, MA, feels that although mass-market PCM systems will start off being expensive, "demand will force the price down." However, he predicts that it will take about three or four years for the system first to catch on, then another five or six years for the price to come down.

In digital recording systems, frequency response and dynamic range are independent of the characteristics of disc or tape, and there is no channel crosstalk. Signals are retimed during playback, eliminating wow and flutter. In all PCM systems announced thus far, frequency response is flat within a fraction of a dB to 20 kHz, and the dynamic range is at least 85 dB, or better than that of any listening room and 20 dB better than that of most analog systems.

The chief virtue of PCM techniques is that all the necessary components are available. For instance, video tape recorders have reached a stage of development where they can be used as a basic building block; semiconductor lasers appear ready to be mass produced; and phase-locked-loop synthesizers and crystals are in good supply. There is even the possibility of a price reduction on key components. **RE**

## The Speakeasy<sup>™</sup>



Interface all your I/Os with  
one low-cost board!

Talk about easy interfacing for your Altair, IMSAI or Equinox 100! Plug in The Speakeasy<sup>™</sup> interface board and you've got 3 cassette I/O channels with individual motion control ... a bi-directional parallel port for keyboard, paper tape reader or printer ... a serial port for teletype/

RS232 ... and RAM/ROM software to drive it all. \$120 kit by Morrow's Micro-Stuff (\$4 handling; Cal. Res. add tax.) Write for specs.

**Thinker Toys<sup>™</sup>** 1201 10th St.  
Berkeley, CA. 94710

Order it at your local computer shop.  
Or phone BAC/MC orders to (415) 527-7548.  
CIRCLE 66 ON FREE INFORMATION CARD

## Our new test equipment catalog. Free!

With this catalog you can browse through one of the nation's largest electronics warehouses, packed floor to ceiling with the finest test instruments. Everything from probes to dual trace scopes; and everything at sensational savings made possible only by mail order selling. Volume pricing on orders over \$500 gives you even greater

savings. Every item is backed by a big brand name. Shipment is prompt from stock, always freight prepaid and there never is a handling charge on orders over \$200. Write today for the big free catalog of the big brands that offers you the big savings.

**FREE**

**NORTH AMERICAN ELECTRONICS**

**NORTH AMERICAN ELECTRONICS** Dept. RE-178  
1468 West 25th Street  
Cleveland, Ohio 44113  
Yes! Send me your big catalog.

Name \_\_\_\_\_  
Address \_\_\_\_\_  
City \_\_\_\_\_ State \_\_\_\_\_ Zip \_\_\_\_\_

CIRCLE 92 ON FREE INFORMATION CARD

POLY  
PAKS

# COMPUTER PERIPHERAL & PARTS WORKSHOP

MAIL  
ORDER

POLY PAKS INTRODUCES THE FIRST MAGAZINE RETAIL STORE  
FOR THE ELECTRONIC MAIL-ORDER HOBBYIST!

POLY PAKS SPECIAL

BUY \$15 WORTH Take **10%** DISCOUNT

BUY \$100 WORTH Take **25%** DISCOUNT

FROM THIS AD ONLY

## "RED" LED READOUTS!

as low as **20¢ each**

| Cat. No. | Size  | Description   | Sale         |
|----------|-------|---------------|--------------|
| 3R1890   | .127" | MAN-3**       | 5 for \$1.00 |
| 3R1503   | .18"  | MAN-4*        | 2 for \$1.00 |
| 3R1273   | .27"  | MAN-1*        | \$1.00       |
| 3R3093   | .33"  | MAN-72 equal* | \$1.19       |
| 3R3161   | .33"  | MAN-74 equal* | \$1.19       |
| 3R3512   | .35"  | FND350*       | \$1.00       |
| 3R2949   | .5"   | FND500*       | \$1.50       |
| 3R2950   | .5"   | FND507*       | \$1.50       |
| 3R3483   | .5"   | 727-Dual**    | \$2.50       |
| 3R2485   | .5"   | 727-Dual**    | \$2.50       |
| 3R2256   | .6"   | 747*          | \$1.95       |

\*Common Anode \*\*Common Cathode

## HEXADECIMAL MICROPROCESSOR AND CONTROL KEYBOARD KIT! \$29.95

Address microprocessors, control computer operated equipment. 2 key rollover. Has 20 keys. 16 encased, external to be assigned by user. Output 4 bit binary. Also an EXCLUSIVE FEATURE - 4 LEDs display the binary output TTL CMOS compatible. Requires 5, 12VDC. Complete kit. Nothing else to buy! With instructions.

Cat. No. 3R5009 Hexadecimal Kit \$29.95  
Cat. No. 3R5010 Hexadecimal Wired \$34.95



## DISCRETE LED'S 6 for \$1.10

| Order in multiples of 6 each type: | Cat. No. | Description  | Similar to |
|------------------------------------|----------|--------------|------------|
| □ JUMBO .34" h                     | 3R2135   | Jumbo Red    | WV5053     |
| □ MEDIUM .24"                      | 3R1944   | Jumbo Yellow | XC5562     |
| □ MICRO .21"                       | 3R2138   | Jumbo Green  | XC5566     |
|                                    | 3R2785   | Medium Red   | XC222      |
|                                    | 3R2788   | Medium Green | XC226      |
|                                    | 3R2137   | Micro Red    | XC209      |
|                                    | 3R1948   | Micro Yellow | XC209Y     |
|                                    | 3R2140   | Micro Green  | XC290G     |

## COMPUTER GRADE CAPACITORS

| Order by Cat. No. | Mfd    | WVCD | Sale   |
|-------------------|--------|------|--------|
| 3R5112 and value! | 8,000  | 50   | \$2.75 |
|                   | 13,000 | 40   | 2.25   |
|                   | 14,000 | 50   | 2.75   |
|                   | 15,000 | 12   | 1.50   |
|                   | 22,000 | 75   | 3.95   |
|                   | 24,000 | 30   | 2.50   |
|                   | 44,000 | 30   | 3.95   |

## BRIDGE RECTIFIERS:

| Full Wave | 2 AMP      | 6 AMP      | 10 AMP     | 25 AMP     |
|-----------|------------|------------|------------|------------|
| 50        | (\$3R1546) | (\$3R2456) | (\$3R2447) | (\$3R2731) |
| 100       | .85        | .99        | 1.15       | 1.25       |
| 200       | .89        | 1.19       | 1.29       | 1.95       |
| 400       | .89        | 1.40       | 1.79       | 2.95       |
| 600       | .89        | 1.62       | 1.95       | 3.95       |
| 800       | 1.19       | 1.95       | 2.25       | 4.95       |
| 1000      | 1.25       | 2.25       | 2.50       | 5.50       |

Order by Cat. No. Amperage and Voltage

## SPECTRA-TWIST RIBBON CABLE

Twisted pairs of brightly colored cable. 24AWG

□ Cat. No. 3R3680 48 cond. 2 ft. \$1.98  
□ Cat. No. 3R4081 32 cond. 2 ft. \$1.98

## RIBBON CABLE AT THIN PRICES

Cond. Sale

□ 20 8 ft. \$1.98  
□ 26 6 ft. \$1.98  
□ 34 5 ft. \$1.98  
□ 40 4 ft. \$1.98  
□ Single color. Index available. 50 ft. \$1.98

Order by Cat. No. 3R3939 and conductors

## SPECTROL "SKINNY-TRIMS"

8mm 3/8" square screwdriver shaft. Your Choice

□ 100 2% 1/4 watt. Cermet. 1C  
□ 800 leads. Order by Cat. No. and value **2 for \$1**

□ 1K 10K  
□ 2K 20K □ Cat. No. 3R3863 25 turn upright, type 64  
□ 5K 50K □ Cat. No. 3R3866 single turn, flat, type 63

## 10 AMP POWER TAB SCR'S, TRIACS, QUADRACS!

SCR'S Cat. No. 3R1730 500 .88  
3R1730 200 .88  
TRIACS 3R1448 400 1.19  
QUADRACS 3R1590 600 1.59

## MOTHERBOARD EDGE CONNECTOR

106 pins (53 each side). Use with IMSAI & ALTAIR! 0.125" pin ctrs. goldplated 34" wire wrap leads. Open ends fit wide PC boards. 8 oza. Cat. No. 3R3967

**\$3.95**



## GIANT SALE! MICRO-MINI TOGGLE SWITCHES

Cat. No. Contacts Sale

□ 3R3936 SPST \$1.19  
□ 3R4036 SPDT \$1.39  
□ 3R5085 SPDT \$1.39  
□ 3R4037 DPDT 1.45  
□ 3R5087 4PDT 1.95

• Top Quality! • Center off  
• 3A, 125VAC contacts or better  
• Complete with mounting hardware

## "MICRO-TONE" AUTOPATCH ENCODER KIT

Emergency! Family! Friends! Complete in its own mini-cabinet! Only 2 1/8 x 1 5/8 x 1/2" small enough to mount in a mike! Snap action bubble keys control. Features output level, digitally xtal controlled tones, on-chip synthesized tones, on-chip oscillator. Requires 4.5 to 9.5 VDC. Complete kit! Nothing else to buy! Wt. 12 oz.

Cat. No. 3R4086 kit \$28.88  
Cat. No. 3R4087 wired \$34.95



## \$49.95 KEYBOARD & ENCODER KIT

Uses Encoder MOS ROM • 7 LED test feature

Cat. No. 3R5001 Kit \$49.95  
Cat. No. 3R5002 Wired \$59.95

Outputs standard 7 bit ASCII; interfaces with most data systems. Keyboard pre-assembled onto PC board. 2 key rollover. Electronic shift lock and carriage return. 4 modes: Normal, control, shift, shift/control. Additional functions can be assigned by user. -5, -12VDC. 200 ma. Negative or positive logic jumper selectable. Exclusive test feature. 7 LEDs display the ASCII code. Complete kit. Nothing else to buy! Size: 15" x 5 1/2" x 1 1/4". 3 lbs.

• Uses MOS Encoder ROM!  
• 7 LED Test Feature!  
• Encodes 128 ASCII Characters  
• Interfaces with ALTAIR, IMSAI, and more!

## Low Power IC's

| Type    | Sale | Type    | Sale |
|---------|------|---------|------|
| 74LS00  | 5.32 | 74LS132 | 1.19 |
| 74LS02  | 3.32 | 74LS138 | 1.24 |
| 74LS04  | .35  | 74LS139 | 1.24 |
| 74LS08  | .32  | 74LS151 | 1.25 |
| 74LS10  | .32  | 74LS153 | 1.25 |
| 74LS11  | .32  | 74LS155 | 1.25 |
| 74LS13  | .64  | 74LS160 | 1.47 |
| 74LS20  | .32  | 74LS161 | 1.47 |
| 74LS21  | .32  | 74LS162 | 1.47 |
| 74LS22  | .32  | 74LS163 | 1.47 |
| 74LS27  | .39  | 74LS168 | 1.68 |
| 74LS30  | .32  | 74LS169 | 1.68 |
| 74LS32  | .39  | 74LS173 | 1.68 |
| 74LS37  | .45  | 74LS174 | 1.05 |
| 74LS38  | .45  | 74LS190 | 1.77 |
| 74LS42  | 1.19 | 74LS191 | 1.75 |
| 74LS47  | .99  | 74LS192 | 1.75 |
| 74LS74  | .49  | 74LS193 | 1.75 |
| 74LS90  | .49  | 74LS194 | 1.25 |
| 74LS92  | .89  | 74LS197 | 1.25 |
| 74LS93  | .89  | 74LS257 | 1.35 |
| 74LS109 | 1.81 | 74LS269 | 1.68 |
| 74LS112 | .58  | 74LS366 | .66  |
| 74LS113 | .58  | 74LS368 | .69  |
| 74LS114 | .49  | 74LS390 | 2.95 |

## POLY PAKS "CHIPS" AWAY IC AND CRYSTAL PRICES!

| Type       | Description          | Sale    |
|------------|----------------------|---------|
| CM7205     | Stopwatch            | \$14.95 |
| CM73       | 8500-1 6-Tap Games   | 1.95    |
| MS5330     | 4 1/2 Digit DVM      | 4.95    |
| 0B038C     | Volt Control Osc.    | 4.95    |
| KR2376-139 | BCD Encoder Rom      | 6.95    |
| KR2376-57  | ASCII Encoder Rom    | 6.95    |
| 1C1900D    | 60MHz Prescaler      | 14.95   |
| 95H90DC    | 350MHz Prescaler     | 8.88    |
| CMC14410   | Touch Tone Chip      | 9.95    |
| CMC2022    | Char Gen. (4mm 2513) | 1.95    |
| 0720A/7208 | Freq Counter pair    | 24.95   |
| CM7107     | 3 1/2 Digit DVM/DMM  | 12.50   |
| MM5316     | Alarm Clock          | 2.95    |
| MM5368     | 60 Hz Timebase IC    | 1.95    |
| 3.579MHz   | Timebase Xtal        | 1.95    |
| 1.00MHz    | Touchtone Xtal       | 5.95    |
| 03.2768MHz | Stopwatch Xtal       | 4.95    |

## 1N4000 EPOXY RECTIFIERS

| Cat. No. | Type   | PIV | Sale         |
|----------|--------|-----|--------------|
| 3R2377   | 1N4001 | 50  | 10 for \$.65 |
| 3R2378   | 1N4002 | 100 | 10 for .85   |
| 3R2379   | 1N4003 | 200 | 10 for .85   |
| 3R2380   | 1N4004 | 400 | 10 for .99   |
| 3R2381   | 1N4005 | 600 | 10 for 1.39  |
| 3R2382   | 1N4006 | 800 | 10 for 1.39  |

## TRANSFORMER SALE

| Cat. No. | Output V. | Amps  | Price         | Sale   |
|----------|-----------|-------|---------------|--------|
| 3R3399   | 6.3V      | 500ma | Metal encased | \$1.98 |
| 3R3814   | 6.3V      | 1A    | Open frame    | \$2.49 |
| 3R3812   | 12V       | 300ma | Open frame    | \$2.49 |
| 3R4029   | 12V       | 1A    | Metal encased | \$2.95 |
| 3R4028   | 12V       | 1A    | Metal encased | \$2.95 |
| 3R3323   | 24VCT     | 200ma | Open frame    | \$1.95 |
| 3R3324   | 24V       | 1A    | Open frame    | \$1.95 |
| 3R2773   | 48VCT     | 2A    | Metal encased | \$2.95 |
| 3R3875   | 110V      | 300ma | Isolation     | \$1.19 |

## HANDY COMPUTER MULTITESTER

• 1000 ohms per volt 1 1/2" precision movements diode protection against burnout. Measures DC volts 0-15-160-1000; AC volts 0-15-100-1000 DC current 0-150ma; resistance X1000. Sensitivity 1000 ohms/volt AC-DC. Uses penlite cell, not included. Size 2 1/2" x 3 1/2" x 1 3/4". Wt. 5 oza. Cat. No. 3R3921

• IC SOCKETS as low as **17¢ ea.**

• Low profile, solder tail.

□ 3R2123 8 pin midflat .17

□ 3R1308 14 pin dip .19

□ 3R1309 16 pin dip .22

□ 3R2128 18 pin dip .25

## C-MOS

| Type   | Sale | Type   | Sale |
|--------|------|--------|------|
| CD4000 | 5.29 | CD4022 | 1.19 |
| CD4001 | .29  | CD4023 | .29  |
| CD4002 | .29  | CD4024 | .79  |
| CD4006 | 1.19 | CD4025 | .34  |
| CD4007 | .29  | CD4027 | .69  |
| CD4008 | .79  | CD4028 | .89  |
| CD4009 | .59  | CD4029 | 1.19 |
| CD4010 | .59  | CD4030 | .49  |
| CD4011 | .29  | CD4033 | 1.69 |
| CD4012 | .29  | CD4035 | .99  |
| CD4013 | .69  | CD4040 | 1.19 |
| CD4015 | 1.19 | CD4041 | 1.25 |
| CD4016 | .49  | CD4042 | 1.89 |
| CD4017 | 1.19 | CD4046 | 1.79 |
| CD4018 | 1.19 | CD4049 | .49  |
| CD4019 | .49  | CD4056 | .79  |
| CD4020 | .99  | CD4071 | .29  |
| CD4021 | 1.29 |        |      |

## SILICON POWER STUD RECTIFIERS!

| Order by Cat. No. Amperage and voltage. | 12 AMP   | 50 AMP   | 250 AMP  |
|---|----------|----------|----------|
| PIV (#3R727)                            | (#3R727) | (#3R727) | (#3R685) |
| 50                                      | \$29     | \$75     | \$4.95   |
| 100                                     | 36       | 1.10     | 6.50     |
| 200                                     | 45       | 1.35     | 7.50     |
| 400                                     | .61      | 1.75     | 8.50     |
| 600                                     | .79      | 2.25     | 10.50    |
| 800                                     | .90      | 2.75     | 11.50    |

## SOLAR ENERGY DISCS

• All Cells 5V! As low as **\$3.95**

• High efficiency!  
• Gang for higher voltages and amps!

| Cat. No. | Size   | Mils   | Sale   |
|----------|--------|--------|--------|
| 3R5046   | 2"     | 500ma  | \$3.95 |
| 3R3862   | 3"     | 1000ma | 8.88   |
| 3R3783   | 3 1/2" | 1200ma | 12.50  |
| 3R5057   | 4"     | 1500ma | 15.95  |

## DIP SWITCHES

| Cat. No. | Switches | Sale |
|----------|----------|------|
| 3R3668   | 2        | \$7  |
| 3R3621   | 4        | .88  |
| 3R3670   | 5        | 1.19 |
| 3R3671   | 6        | 1.19 |
| 3R2677   | 7        | 1.79 |

## ECCO 10-POSITION BCD THUMBWHEEL SWITCH

1-2-3-4-8 BCD encoding. Positions labeled 0-7, F, L. 3 for (F coded for 8, L coded for 9).

• White numerals on a black background. Ecco 8000 series. 1 1/4" x 1 1/4" x 1/2". Cat. No. 3R3846 **\$1.49**

## MICROPROCESSORS! MEMORIES! SUPPORT!

Order by Cat. No. 3R3459 and type

| Type      | Description             | Sale   |
|-----------|-------------------------|--------|
| MC6800L   | 8 bit CPU               | \$2.85 |
| 8080A     | 8 bit CPU, 2 usec       | 14.95  |
| Z80A      | 8 bit CPU               | 34.95  |
| 8008      | CPU                     | 9.95   |
| 2111      | 256 x 1 stat. RAM       | 5.95   |
| 1103      | 1K Dyn RAM              | 1.29   |
| 1702A     | 256 x 8 EPROM           | 5.95   |
| 2102-11   | 1K x 1 Lo-power RAM     | 1.69   |
| 2111      | 256 x 4 Stat. RAM       | 5.95   |
| 2708      | 8K EPROM                | 19.95  |
| MM4116    | 16K Dyn RAM             | 32.00  |
| MM4200P11 | 4K x 1 Dyn RAM. 350nsec | 3.95   |
| MM5202    | 2K EPROM                | 6.95   |
| MM5203    | 2K EPROM                | 8.95   |
| MM5260    | 1K Dyn RAM              | .99    |
| MM5262    | 2K x 1 Dyn RAM          | 3.95   |
| 8212      | 8 bit IO port           | 3.95   |
| 8216      | Bi-direction bus driver | 3.95   |
| 8224      | Clock Gen               | 4.95   |
| 8228      | System cont.            | 9.95   |
| 8251      | Communicatn int         | 11.50  |
| 8255      | Periph inter            | 11.95  |

## TTL'S

| Type   | Sale   | Type   | Sale |
|--------|--------|--------|------|
| SN7400 | \$0.14 | SN7472 | .26  |
| SN7401 | .14    | SN7473 | .31  |
| SN7402 | .17    | SN7474 | .31  |
| SN7403 | .14    | SN7475 | .48  |
| SN7404 | .17    | SN7476 | .39  |
| SN7405 | .18    | SN7477 | .48  |
| SN7406 | .19    | SN7478 | .69  |
| SN7407 | .24    | SN7479 | .69  |
| SN7408 | .18    | SN7480 | .45  |
| SN7410 | .14    | SN7481 | .45  |
| SN7411 | .19    | SN7482 | .69  |
| SN7413 | .14    | SN7483 | .69  |
| SN7414 | .61    | SN7484 | .69  |
| SN7417 | .24    | SN7485 | .29  |
| SN7420 | .14    | SN7486 | .29  |
| SN7421 | .14    | SN7487 | .29  |
| SN7422 | .14    | SN7488 | .29  |
| SN7423 | .14    | SN7489 | .29  |
| SN7424 | .24    | SN7490 | .69  |
| SN7425 | .24    | SN7491 | .69  |
| SN7426 | .24    | SN7492 | .45  |
| SN7427 | .24    | SN7493 | .45  |
| SN7428 | .24    | SN7494 | .45  |
| SN7429 | .24    | SN7495 | .45  |
| SN7430 | .24    | SN7496 | .45  |
| SN7431 | .24    | SN7497 | .45  |
| SN7432 | .24    | SN7498 | .45  |
| SN7433 | .24    | SN7499 | .45  |
| SN7434 | .24    | SN7500 | .45  |
| SN7435 | .24    | SN7501 | .45  |
| SN7436 | .24    | SN7502 | .45  |
| SN7437 | .24    | SN7503 | .45  |
| SN7438 | .24    | SN7504 | .45  |
| SN7439 | .24    | SN7505 | .45  |
| SN7440 | .24    | SN7506 | .45  |
| SN7441 | .24    | SN7507 | .45  |
| SN7442 | .24    | SN7508 | .45  |
|        |        |        |      |

# INTERNATIONAL ELECTRONICS UNLIMITED

**DISCOUNT ON ALL IC'S AND LED'S**  
**10% OFF ON \$25.00**  
**15% OFF ON \$50.00**

**TTL**

|      |     |       |      |        |      |
|------|-----|-------|------|--------|------|
| 7400 | .11 | 7451  | .20  | 74155  | .75  |
| 7401 | .18 | 7453  | .20  | 74156  | .75  |
| 7402 | .14 | 7454  | .20  | 74157  | .85  |
| 7403 | .14 | 7460  | .20  | 74158  | 1.39 |
| 7404 | .16 | 7464  | .35  | 74160  | 1.23 |
| 7405 | .19 | 7465  | .35  | 74161  | .95  |
| 7406 | .29 | 7470  | .38  | 74162  | 1.39 |
| 7407 | .28 | 7472  | .35  | 74163  | .95  |
| 7408 | .22 | 7473  | .35  | 74164  | .95  |
| 7409 | .17 | 7474  | .31  | 74165  | .95  |
| 7410 | .16 | 7475  | .49  | 74166  | 1.19 |
| 7411 | .25 | 7476  | .34  | 74170  | 1.90 |
| 7413 | .43 | 7483  | .68  | 74173  | 1.49 |
| 7414 | .65 | 7485  | .88  | 74174  | 1.19 |
| 7415 | .25 | 7486  | .38  | 74175  | .95  |
| 7416 | .35 | 7489  | 2.25 | 74176  | .84  |
| 7417 | .35 | 7490  | .43  | 74177  | .84  |
| 7420 | .16 | 7491  | .75  | 74180  | .95  |
| 7423 | .37 | 7492  | .48  | 74181  | 2.30 |
| 7425 | .35 | 7493  | .48  | 74182  | .85  |
| 7426 | .22 | 7494  | .75  | 74185  | 2.20 |
| 7427 | .35 | 7495  | .75  | 74190  | 1.25 |
| 7430 | .20 | 7496  | .75  | 74191  | 1.15 |
| 7432 | .23 | 74100 | 1.15 | 74192  | .89  |
| 7437 | .25 | 74107 | .37  | 74193  | .85  |
| 7438 | .25 | 74121 | .37  | 74194  | 1.15 |
| 7439 | .50 | 74122 | .38  | 74195  | .74  |
| 7440 | .15 | 74123 | .45  | 74196  | .98  |
| 7441 | .85 | 74125 | .54  | 74197  | .98  |
| 7442 | .59 | 74126 | .58  | 74198  | 1.69 |
| 7443 | .65 | 74132 | .75  | 74199  | 1.69 |
| 7444 | .73 | 74141 | .85  | 745200 | .79  |
| 7445 | .65 | 74145 | .90  | 74279  | .95  |
| 7446 | .81 | 74150 | .98  |        |      |
| 7447 | .59 | 74151 | .68  |        |      |
| 7448 | .79 | 74153 | .60  |        |      |
| 7450 | .17 | 74154 | 1.20 |        |      |

**SPECIAL SALE**

**TTL BARGAINS**

|        |       |
|--------|-------|
| 7416   | \$.19 |
| 7430   | .16   |
| 7432   | .19   |
| 7437   | .19   |
| 7438   | .19   |
| 7440   | .13   |
| 7445   | .49   |
| 7495   | .55   |
| 74123  | .25   |
| 74141  | .59   |
| 75LS60 | .99   |

**LINEAR SPECIALS**

|              |       |
|--------------|-------|
| LM300 TO-5   | \$.49 |
| LM302 TO-5   | .39   |
| LM307 mDIP   | .19   |
| LM308 TO-5   | .59   |
| LM311 TO-5   | .49   |
| LM311 mDIP   | .49   |
| 340T-5V      | .79   |
| 340T-6V      | .79   |
| 340T-15V     | .79   |
| LM380-8 mDIP | .69   |
| LM565 DIP    | .89   |
| LM723 DIP    | .39   |
| LM739 DIP    | .79   |

**8038 FUNCTION GENERATOR**  
 Voltage controlled oscillator — sine, square, triangular output. **\$3.95**

**MM 5330**  
 4 1/2 DIGIT DVM LOGIC **\$ 4.95**

**SIGNAL DIODES — 400 MW**  
**20/\$1.00**

**KEYBOARD**

20 KEYS  
 2 SLIDE SW  
 3" x 3" **\$.59**

**LED DISPLAYS**

|         |                    |       |
|---------|--------------------|-------|
| FND358  | RED CC. 375" RHD   | \$.59 |
| FND500  | RED CC. 50" RHD    | .79   |
| FND507  | RED CA. 27" RHD    | .79   |
| DL10A   | RED CA. 27" RHD    | .99   |
| DL702   | RED CC. 30" RHD    | .99   |
| DL707   | RED CA. 30" RHD    | .99   |
| DL747   | RED CA. 50" RHD    | 1.49  |
| MAN5    | GREEN CA. 27" RHD  | .89   |
| MAN8    | YELLOW CA. 27" RHD | .89   |
| MAN82   | YELLOW CA. 30" RHD | .99   |
| MAN8610 | ORANGE DOUBLE DIG. | 1.49  |
| MAN8630 | ORANGE 1 1/2 DIG.  | .99   |
| MAN8740 | RED DOUBLE DIG.    | .99   |
| MAN8750 | RED DOUBLE DIG.    | .99   |
| MAN8630 | RED CC. 56" RHD    | .89   |
| NSN74R  | RED CC. 30" RHD    | .89   |

**MARK II CLOCK KIT**  
 6 DIGIT CLOCK KIT WITH ONE PC BOARD. ACCOMMODATES MM5314 CLOCK CHIP AND 8 FND358 DISPLAYS. CONTAINS ALL COMPONENTS, 3 SWITCHES AND ASSEMBLY INSTRUCTIONS. HAS TERMINALS FOR ADDITIONAL REMOTE DISPLAY. **\$10.95**

WITH 12V/300 MA PC MT. TRANSFORMER **\$13.95**

**SHIFT REGISTERS**

|      |        |
|------|--------|
| 2510 | \$1.75 |
| 2511 | 1.95   |
| 2518 | 2.50   |
| 2522 | 1.95   |
| 2532 | 2.29   |
| 5016 | .89    |

**Jumbo LED'S**  
 green - yellow  
 amber - clear 16¢ ea.

**ZENER DIODE — 400MW**  
 3.6V 5.1V 6.8V 15V  
 4.7V 5.5V 10V **\$.15 EA.**  
**8/\$1.00 ANY MIX**

**CALCULATOR KIT**  
 LITRONIX 1502 MEMORY

**CALC. KIT ONLY \$7.95**  
**ADAPTER -60Hz \$3.95**

**CERAMIC DISC CAPACITOR PACKAGE**  
 10 EA. OF FOLLOWING VALUES — 50 VOLT

|      |      |       |       |         |        |
|------|------|-------|-------|---------|--------|
| 1pf  | 33pf | 82pf  | 220pf | 820pf   | .022uf |
| 5pf  | 47pf | 100pf | 270pf | .001uf  | .030uf |
| 10pf | 56pf | 150pf | 470pf | .0047uf | .050uf |
| 22pf | 68pf | 180pf | 600pf | .01uf   | .1uf   |

24u CAPACITORS **\$10.95**  
 SUPPLIED IN 60 DRAWER CABINET **\$24.50**

**PRECISION RESISTOR PACKAGE**  
 METAL FILM ±1% 1/4 WATT | 240 RESISTORS **\$21.95**  
 4 EA. OF FOLLOWING VALUES SUPPLIED IN 60 DRAWER CABINET **\$39.50**

|      |     |       |       |       |       |       |       |       |       |
|------|-----|-------|-------|-------|-------|-------|-------|-------|-------|
| 10.5 | 100 | 499   | 1.65K | 4.53K | 7.50K | 13.0K | 22.1K | 44.2K | 80.6K |
| 20.0 | 130 | 604   | 2.00K | 5.11K | 8.45K | 14.0K | 24.9K | 48.7K | 90.9K |
| 30.1 | 162 | 750   | 2.49K | 5.49K | 9.09K | 15.2K | 27.4K | 52.3K | 100K  |
| 49.9 | 200 | 1.0K  | 3.01K | 6.04K | 10.0K | 16.2K | 30.1K | 57.6K | 147K  |
| 60.4 | 301 | 1.21K | 3.48K | 6.49K | 11.0K | 17.8K | 34.0K | 63.4K | 210K  |
| 76.8 | 402 | 1.40K | 4.02K | 6.98K | 12.1K | 20.0K | 40.2K | 69.8K | 464K  |

**2708 FULL SPEED ROM**  
**\$10.95**

**5314 6 DIGIT CLOCK CHIP**  
**\$2.95**

**ELECTRONIC DOOR CHIME KIT**  
 WITH TI TMS 1000 MICROPROCESSOR CHIP PROGRAMMED TO PLAY 24 DIFFERENT TUNES

**1702A**  
**\$ 4.75**

**74S200 256 BIT RAM TRI-STATE**  
**\$3.25**

**INTERNATIONAL ELECTRONICS UNLIMITED**  
 1000 VILLAGE SQUARE, P.O. BOX 449, CARMEL VALLEY, CALIFORNIA 93924  
 TEL: (415) 659-3171

**8080A, 8008**  
**\$16.95**

**UART AY51013A**  
**\$6.95**

**COMPLETE INSTRUCTION BOOKS**  
 MICROPROCESSOR CHIP PROGRAMMED TO PLAY 24 DIFFERENT TUNES  
 \$39.50 SHIPPING \$1.00

**LD110, LD111 3 1/2 DIGIT A/D CONVERTER**  
**\$24.75**

**2513 CHARACTER GEN 64 x 8 x 5 ASCII**  
**\$8.95**

**TANTALUM CAPACITORS**  
 Solid dipped +20%

**82S23 256 BIT PROM**  
**\$2.95**

**Clock Kit**  
**\$12.95**

|         |     |       |         |     |       |
|---------|-----|-------|---------|-----|-------|
| .11 mid | 35V | \$.25 | 10 mid  | 16V | \$.40 |
| .33 mid | 35V | .25   | 10 mid  | 25V | .45   |
| 1 mid   | 35V | .25   | 15 mid  | 10V | .40   |
| 2.2 mid | 20V | .25   | 15 mid  | 20V | .45   |
| 3.3 mid | 35V | .30   | 22 mid  | 16V | .45   |
| 2.2 mid | 35V | .30   | 33 mid  | 10V | .40   |
| 4.7 mid | 16V | .30   | 47 mid  | 6V  | .40   |
| 6.8 mid | 6V  | .30   | 56 mid  | 6V  | .45   |
| 6.8 mid | 50V | .40   | 150 mid | 15V | 1.50  |

**MM5314 with 6 NS71 .27" displays 2 P.C. boards — Display board may be remote. Internal or wall transformer can be used. 50-60 Hz, 12-24 hour. Includes all necessary transistors, resistors, capacitors, diodes, 3 switches and complete assembly instructions.**  
**CK6-3 \$12.95**

**REGULATED POWER SUPPLY KIT**

**HAMMOND "BIMBOARD" BREADBOARD KIT**

**PLUS & MINUS 5, 12 & 15 VOLT USES 3 LM340T AND 3 LM320T REGULATORS. 115V/29VCT TRANSFORMER PLUS PC BOARD, CAPACITORS & DIODES + 5V PROVIDED WITH SINK TO SUPPLY 1 AMP. WITH ALL PARTS, SCHEMATIC AND INSTRUCTIONS — PS-29... **\$11.95****

**MINIATURE SOLID STATE ELECTRONIC BUZZER**  
 LONG LIFE — HIGH RELIABILITY  
 LOW CURRENT DRAIN  
 NO MOVING CONTACTS  
 NO ARCING — NO RF NOISE  
 RICH & CLEAR SOUND  
 78 dB min AT 1 FT. — 450 Hz

Accepts DIP packages, without adaptors or damaging component leads.  
 Accepts diodes, transistors, IC's, resistors, capacitors, etc. with leads between 0.01" (0.25 mm) and 0.035" (0.85 mm) diameter on a 0.1" (2.54 mm) matrix.  
 Breadboard Section has 47 horizontal rows of five interconnected sockets set each side of the central channel.  
 Bus Strip Section runs up each side of the Board for carrying ground and Vcc etc.  
 Component Bracket (Included with each Board) will fit on any of the four edges or down the centre.  
**\$11.95**

**EB-106 6V 15mA 4-9 VDC \$1.99**  
**EB-112 12V 15mA 8-20 VDC 1.99**

**METAL FILM RESISTORS 1% STANDARD DECADE VALUES FROM 10.5 OHM TO 464K OHM**

**MM5369 15mA mDIP**  
 Crystal 3.58 MHZ color TV **2.49**  
 Crystal 2.010 MHZ **2.95**

EACH MINIMUM 10 PER VALUE MINIMUM 100 PER VALUE

|          |       |
|----------|-------|
| 0 - 10   | \$.20 |
| 10 - 100 | \$.20 |
| 100 -    | \$.15 |

**ADD SHIPPING & HANDLING AS NOTED IN US & CANADA. OTHER COUNTRIES AS REQUIRED.**

**UNIVERSAL BREADBOARD**  
 Silver plated copper circuit board 3-3/16" x 5-1/16" 2 rows of 27 holes for DIP IC's - space for transistors, resistors & capacitors. Versatile and simple to breadboard IC circuitry **\$1.50 ea.**

**IC SOCKETS**  
 Solder Tail - low profile

|        |       |        |     |
|--------|-------|--------|-----|
| 8 pin  | \$.17 | 24 pin | .42 |
| 14 pin | .20   | 28 pin | .59 |
| 16 pin | .22   | 40 pin | .69 |
| 18 pin | .29   |        |     |

**IC BREADBOARD**  
 Accommodates 5 pin IC's with additional interconnection holes. 1/16" phenolic with silver plated copper circuit. 2 5/16" x 5 9/16" **\$1.60 ea.**

**CERAMIC DISC CAPACITORS**

|      |     |       |     |         |     |        |       |
|------|-----|-------|-----|---------|-----|--------|-------|
| 1pf  | 50V | 56pf  | 50V | 270pf   | 50V | 0.01uf | 1000V |
| 5pf  | 50V | 68pf  | 50V | 390pf   | 50V | 0.02uf | 50V   |
| 7pf  | 50V | 82pf  | 50V | 470pf   | 50V | 0.03uf | 50V   |
| 10pf | 50V | 100pf | 50V | 600pf   | 50V | 0.05uf | 50V   |
| 22pf | 50V | 120pf | 50V | 820pf   | 50V | 1uf    | 50    |
| 27pf | 50V | 150pf | 50V | 0.01uf  | 50V |        |       |
| 33pf | 50V | 180pf | 50V | 0.047uf | 50V |        |       |
| 47pf | 50V | 220pf | 50V | 0.1uf   | 50V |        |       |

(each) (Minimum 10 per value)

|       |          |          |
|-------|----------|----------|
| 0-100 | \$.10 ea | \$.05 ea |
| 100-  |          | \$.04 ea |

Satisfaction guaranteed. Parcels shipped within 3 days after receipt of order. Pay with personal check, charge card or COD. Minimum COD or charge order is \$15.00. Add \$1.00 service charge if order is less than \$10.00. Include 10% of order total to cover shipping and handling outside US or Canada. California residents add sales tax.

**INTERNATIONAL ELECTRONICS UNLIMITED**  
 VILLAGE SQUARE, P.O. BOX 449, CARMEL VALLEY, CA 93924 USA  
 TELEPHONE 408 659-3171



**WARBLE ALARM  
CAR-VAN CLOCK  
WITH HEADLIGHT ALARM**



- ELAPSED TIMER
- SECONDS DISPLAY SWITCH
- 9 MINUTE SNOOZE ALARM
- SIMPLE 4 WIRE HOOK UP
- JUMBO 7" LED DISPLAY
- 1 TO 59 MINUTE COUNTDOWN TIMER RUNS SIMULTANEOUSLY WITH CLOCK!
- RUGGED ABS CASE
- QUARTZ CRYSTAL ACCURACY

COMPLETE KIT \$35.95  
ASSEMBLED \$45.95

**DIGITAL AUTO INSTRUMENTS**

**SEVEN MODELS!**

- #1 TACHOMETER
- #2 WATER TEMP
- #3 FUEL LEVEL
- #4 SPEEDOMETER\*
- #5 OIL PRESSURE
- #6 OIL TEMP
- #7 BATTERY MONITOR



- RIT INCLUDES
- CASE & ALL HARDWARE
- PRESSURE & TEMP SENDERS
- ASSEMBLED MAIN PCB BOARD
- FEATURES
- 4 ORANGE LITES
- 3 - 1 - 2 ABS EASY

\*ADD \$10 FOR REQUIRED SPEED SENDER \$15 FOR SPEED SENDER ALONE  
KIT: \$49.95 . . . . . ASSEMBLED: \$59.95

**ELECTRONIC 'PENDULUM' CLOCK**



- SWING PENDULUM
- 7 HOURS AND MINUTES DISPLAY
- TIME SET PUSH BUTTONS
- ALARM FEATURE

KIT UNFINISHED CASE . . . . . \$59.95  
ASSEMBLED STAINED CASE . . . . . \$69.95

**QUARTZ DIGITAL AUTO CLOCK  
OR ELAPSED TIMER!**

ELAPSED TIMER: HRS, MINS & SECS  
SIMPLE PUSHBUTTON RESET &  
HOLD TOGGLE SWITCH  
RIT INCLUDES 500 PUF 1/4" LED'S  
NOTHING ELSE TO BUY! 1/4" LED'S  
INTERNAL BATTERY BACKUP!  
NON POLAR INPUT  
12 OR 24 HR MODE  
LIMITATIONS: 4 . . . 4 . . .



KIT: \$27.95 . . . . . ASSEMBLED: \$37.95

**NOW WITH  
ELAPSED  
TIME!**



**3 1/2" DIGITAL CLOCK**

• 4 DIGIT KIT \$49.95 • 4 DIGIT ASSEMBLED \$59.95  
• 6 DIGIT KIT \$69.95 • 6 DIGIT ASSEMBLED \$79.95

117 VAC 12 OR 24 HR MODE . . . . . KIT COMES COMPLETE!  
6 DIGIT VERSION: 27 . . . 4 . . . 1 . . . 4 DIGIT VERSION: 19 . . . 4 . . . 1 . . .

**TV-WALL CLOCK**

- 25" VIEWING DISTANCE
- 6" HOURS & MINUTES
- 3" SECONDS
- COMPLETE WITH WOOD CASE



KIT: \$34.95 . . . . . ASSEMBLED: \$39.95

**ECONOMY CAR CLOCK**

- 1/2" LED MODULE!
- COMPLETE WITH CASE, BRACKET & TIME SET PUSHBUTTONS
- ALARM OPTION



KIT: \$19.95 . . . . . ASSEMBLED: \$26.95

**PENOUOLUM**

GIVE YOUR DIGITAL CLOCK A PENDULUM SWING  
9 TO 12V DC 60 HZ INPUT  
SIMPLE HOOK UP TO ANY CLOCK



\$14.95 . . . . . CASE WITH BRACKET \$3.75

**MARK FOSKETS'**

**SOLID STATE TIME**

P.O. BOX 2159  
DUBLIN, CALIF. 94566  
ORDERS (415) 828-1923



CALIFORNIA RESIDENTS ADD 6% SALES TAX

CIRCLE 81 ON FREE INFORMATION CARD

**ADVERTISING INDEX**

**RADIO-ELECTRONICS does not assume any responsibility for errors that may appear in the index below.**

**Free Information Number Page**

|       |  |             |
|-------|--|-------------|
| 86    | Active Electronics   | 126         |
| 62    | ADVA Electronics   | 126         |
|       | Advance Electronics  | 25,69,84,99 |
| 2     | Aldelco  | 86          |
| 3     | AP Products  | 27          |
| 61    | Arrow Fastener   | 22          |
| 38    | Audio-Technica   | 85          |
| 72    | Avanti   | Cov. IV     |
| 1     | AVR Electronics  | 136         |
| 63    | Babylon Electronics  | 134         |
|       | Karel Barta  | 111         |
| 84    | B & K Precision Dynascan   | 71          |
| 41    | Castle Electronics   | 99          |
|       | CFR Associates   | 120         |
| 57    | Chaney Electronics   | 116         |
| 88    | Channelock   | 82          |
| 75    | Chemtronics  | 81          |
|       | CIE—Cleveland Institute of Electronics                               | 28-31       |
|       | Command Productions  | 111         |
| 91    | Communications Electronics   | 97          |
|       | Computalk Consultants  | 108         |
| 29    | Continental Specialties  | Cov. III    |
|       | Cornell Electronics  | 116         |
|       | CREI—Div. of McGraw Hill Continuing Education                        | 90-93       |
|       | Dage Scientific Instruments  | 132         |
| 51    | Davis Electronics  | 102         |
| 68    | Deforest Electronics   | 96          |
| 49    | Delta Electronics  | 116         |
|       | Devtronix Organ Products   | 116         |
| 40    | Diamondback Electronics  | 120         |
| 52    | Digi-Key   | 125         |
| 42    | DRC Electronics  | 112         |
|       | Edmund Scientific  | 33          |
| 6     | Eico   | 109         |
| 5     | Electronics Book Club  | 13          |
| 12    | Electronics & Control Engineer's Book Club—McGraw Hill Book Division | 18-21       |
| 30    | Electronics Systems  | 135         |
|       | EMC—Electronics Measurements   | 106         |
| 39    | Epsco  | 104         |
| 4     | Etco Electronics   | 118,119     |
|       | Fidelity Sound   | 96          |
| 64    | Fluke  | 87          |
| 58    | Fordham Radio Supply   | 120         |
|       | Forest Belt  | 78          |
| 27,26 | Formula International  | 114,121     |
|       | Fowler Alarms  | 128         |
| 7     | Fuji-Svea  | 124         |
| 35    | Godbout Electronics  | 116         |
| 90    | Gould  | Cov. II     |
| 9     | Grantham College of Engineering                                      | 102         |
| 74    | GTE—Sylvania—Consumer Renewal  | 34          |
| 100   | Heath  | 15,54-57    |
| 83    | Hickok Electrical Instruments  | 94          |
| 44    | Hobbi House  | 133         |
| 10    | Indiana Home Study   | 96          |
|       | Information Unlimited  | 128         |
| 11    | Integrated Circuits Unlimited  | 113         |
| 89    | International Crystal  | 105         |
| 96,97 | International Electronics  | 132,138     |
| 77,78 | James Electronics  | 130,131     |
|       | Lab Science  | 120         |
|       | Lakeside Industries  | 132         |
| 45    | Leader   | 32          |
| 56    | Leslie Edelman   | 128         |
|       | Logical Services   | 128         |
| 65    | LMN Electronics  | 127         |
| 31    | McKay Dymek  | 26          |
| 59    | Meshna   | 111         |
| 66    | Morrow's Micro Stuff   | 136         |
| 13    | Mountain West Alarm Supply   | 86          |
| 46    | MTI—Motorola Training Institute                                      | 108         |
| 25,14 | National Camera  | 97,107      |
|       | National Technical Schools   | 72-75       |

National Radio Institute (NRI)—Div. of McGraw Hill Continuing Education Center

|    |                              |      |       |
|----|------------------------------|------|-------|
| 69 | Netronics                    | 8-11 | 109   |
| 43 | New Tone Electronics         |      | 114   |
| 92 | North American Electronics   |      | 136   |
| 28 | O.K. Machine & Tool          |      | 16    |
| 85 | Olson                        |      | 111   |
| 34 | Oneida                       |      | 108   |
| 76 | Optoelectronics              |      | 129   |
| 93 | Page Digital                 |      | 134   |
| 15 | PAIA                         |      | 109   |
| 87 | Panavise                     |      | 102   |
| 67 | Parasitic Engineering        |      | 98    |
| 33 | Poly Paks                    |      | 137   |
| 80 | Priority I Electronics       |      | 139   |
| 16 | Quest                        |      | 110   |
| 53 | Radio Hut                    |      | 122   |
|    | Radio Shack                  |      | 115   |
| 48 | Ramsey Electronics           |      | 128   |
|    | RCA                          |      | 24,25 |
| 47 | Rye Industries               |      | 98    |
|    | Sabtronics                   |      | 7     |
|    | H. W. Sams                   |      | 17    |
| 70 | Sansui                       |      | 77    |
| 19 | J. B. Saunders               |      | 117   |
| 20 | Senore                       |      | 83    |
| 36 | Schober Organ                |      | 103   |
| 54 | SD Sales                     |      | 123   |
| 8  | SGL Waber                    |      | 97    |
| 18 | Shure Brothers               |      | 2     |
| 17 | Solid State Sales            |      | 112   |
| 81 | Solid State Time             |      | 140   |
| 71 | Soundguard                   |      | 23    |
| 21 | Southwest Technical Products |      | 1     |
|    | Surplus Center               |      | 128   |
| 22 | Tarbell Electronics          |      | 134   |
|    | Tasco                        |      | 132   |
| 37 | Techni-Tool                  |      | 106   |
| 73 | Telematic—Div. of UXL        |      | 104   |
| 55 | Texas Tuner Service          |      | 105   |
| 24 | Tri-Star                     |      | 86    |
|    | Trumbull                     |      | 128   |
| 23 | Tuner Service                |      | 5     |
| 79 | Vector                       |      | 107   |
| 32 | VIZ                          |      | 95    |
| 60 | Wersi Electronics            |      | 107   |

**MOVING?**

Don't miss a single copy of **Radio-Electronics**. Give us:

Six weeks' notice

Your old address and zip code

Your new address and zip code

ATTACH LABEL HERE

name (please print) \_\_\_\_\_  
address \_\_\_\_\_  
city state zip code \_\_\_\_\_

Mail to: Radio-Electronics  
SUBSCRIPTION DEPT., P.O. BOX 2520,  
BOULDER, COLO. 80322

RADIO-ELECTRONICS

# IF YOU'RE NOT DESIGNING WITH A CSC PROTO-BOARD, LOOK AT ALL YOU'RE MISSING.

**Utility**—Models are available with or without built-in regulated power supplies (fixed or adjustable).

**Economy**—Eliminate heat and mechanical damage to expensive parts. Save money by re-using components.

**Versatility**—Use with virtually all types of parts, including resistors, capacitors, transistors, DIP's, TO-5's, LED's, transformers, relays, pots, etc. Most plug in directly, in seconds.

**Durability**—All Proto-Board models are carefully constructed of premium materials, designed and tested for long, trouble-free service.

**Expandability**—Proto-Board units can be instantly inter-connected for greater capacity.

**Visibility**—All parts are instantly and easily visible, for quick circuit analysis and diagramming.

**Speed**—Assemble, test and modify circuits as fast as you can push in or pull out a lead. Save hours on every project.



**Accessibility**—All parts are instantly and easily accessible, for quick signal tracing, circuit modifications, etc.

**Variety**—A wide variety of models are available with capacities ranging from 630 to 3060 solderless tie-points (6 to 32 14-pin DIP's), to fit every technical and budget requirement.

**Adaptability**—Use in design, packaging, inspection, QC, etc. Works with most types of circuits, in many, many applications.

**Flexibility**—Use independently, or in conjunction with other accessories, such as scopes, counters, CSC Proto-Clip™ test connectors, Design Mate™ test equipment, etc. One Proto-Board unit can serve a thousand applications.

Whatever type of electronic circuits you work with, you can do more in less time with CSC's solderless Proto-Board systems. As fast and easy as pushing in or pulling out a lead, you can design, test and modify circuits at will. Components plug into rugged 5-point terminals, and jumpers, where needed, are lengths of #22 AWG solid wire. In the same time you took to read this ad, you could be well on your way to assembling a new circuit.

## CSC PROTO-BOARD SOLDERLESS BREADBOARDS

| MODEL NUMBER | NO. OF SOLDERLESS TIE-POINTS | IC CAPACITY (14-PIN DIP'S) | MANUFACTURER'S SUGG. LIST | OTHER FEATURES  |
|--------------|------------------------------|----------------------------|---------------------------|---|
| PB-6         | 630                          | 6                          | \$15.95                   | Kit—10-minute assembly  |
| PB-100       | 760                          | 10                         | 19.95                     | Kit—with larger capacity  |
| PB-101       | 940                          | 10                         | 29.95                     | 8 distribution buses<br>higher capacity   |
| PB-102       | 1240                         | 12                         | 39.95                     | Large capacity, moderate price  |
| PB-103       | 2250                         | 24                         | 59.95                     | Even larger capacity, only 2.7¢ per tie-point   |
| PB-104       | 3060                         | 32                         | 79.95                     | Largest capacity, lowest price per tie-point  |
| PB-203       | 2250                         | 24                         | 80.00                     | Built-in 1% regulated 5V, 1A low-ripple power supply  |
| PB-203A      | 2250                         | 24                         | 129.95                    | As above plus separate 1/2-amp +15V and -15V internally adjustable regulated power supplies |

Order today. Call 203-624-3103 (East Coast) or 415-421-8872 (West Coast); 9 a.m.-5 p.m. local time. Major credit cards accepted. Or see your CSC dealer. Prices slightly higher outside USA.

CONTINENTAL SPECIALTIES CORPORATION

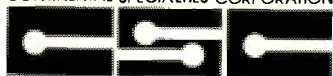

70 Fulton Terrace, Box 1942, New Haven, CT 06509  
203-624-3103 TWX 710-465-1227

WEST COAST: 351 California St., San Francisco, CA 94104,  
415-421-8872 TWX 910-372-7992

GREAT BRITAIN: CSC UK LTD., Spur Road, North Feltham Trading Estate,  
Feltham, Middlesex, England, 01-890-8782 Int'l Telex: 851-881-3669  
CANADA: Len Finkler Ltd., Ontario

© 1978 Continental Specialties Corp.  
Prices and specifications subject to change without notice.

CIRCLE 29 ON FREE INFORMATION CARD

# Revolutionary breakthrough in CB antenna design



Photo courtesy of Edmund Scientific Co.

## AVANTI Invents the Saturn™ Base

The reason the "Saturn" is so revolutionary is that it is absolutely the only **combination vertical and horizontal omni-directional antenna**. That's right, it needs no rotor! You can pick up mobiles (which are vertical) or horizontal and vertical beams.

The "Saturn", invented after years of research by Avanti engineers, is the latest development using AVANTI's unique CO-INDUCTIVE principle to give you the performance of two antennas combined into one.

The "Saturn" not only works on both polarities, but pounds out signals like an air hammer and picks them up like a magnet. Both polarities offer high gain figures.

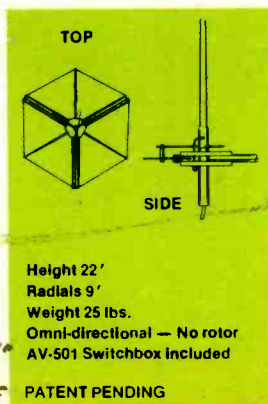

Those of you who are worried about sun spots and "skip" can relax too. This antenna really helps. When the sun spots cause a signal shift, you can often change polarity (just like our P.D.L. or Moonraker) and still pick up the desired channel with no loss of transmission.

The P.D.L. and Moonraker made dual polarity famous as the only antennas to have during the last sun spot cycle, and this time around any serious C.B.'er will want to have the "Saturn."

In fact, having a "Saturn" and a "P.D.L." or "Moonraker" will put you in the elite group of C.B.'ers who "always seem to get out better."

Avanti makes a complete line of high performance base and mobile CB antennas from \$11.95 to \$404.00. Write for free Avanti catalog.

**avanti**®

AVANTI RESEARCH AND DEVELOPMENT, INC.,  
340 Stewart Avenue, Addison, IL 60101

© Copyright 1977. All rights reserved

CIRCLE 72 ON FREE INFORMATION CARD  
[www.americanradiohistory.com](http://www.americanradiohistory.com)

Creators of the famous

