

**CB ANTENNAS-FACTS AND FALLACIES**

\$1.00 ■ OCT. 1977

# Radio-Electronics®

THE MAGAZINE FOR NEW IDEAS IN ELECTRONICS

**CAR CLOCK KITS**

**SUPER ROUNDUP  
CHECKS THEM ALL**

**CLASS-H AMPLIFIER**

**NEW CIRCUIT AND  
HOW IT WORKS**

**BUILD CB METERS**

**3 LOW-COST UNITS  
SWR, POWER, SIGNAL**

**FM ALIGNMENT**

**HI-FI SERVICING  
DO IT YOURSELF**

**SPECIAL-EFFECT FLANGER**

**BUILD HI-FI ADD-ON  
FOR DRAMATIC EFFECTS**



A  
GERNSBACK  
PUBLICATION

**PLUS**

**ALL ABOUT RF SIGNAL GENERATORS ★**

**R-E LAB TESTS HEATH AR-155 RECEIVER &**

**DYNACO SCA-50 AMPLIFIER ★ HOBBY CORNER ★**

**STATE-OF-SO**

**JACK DARR'S**

**REPORTS ★**

**TER CORNER ★**



302196 DRK 6490H090 14 A JUN78  
LLOYD DARKNELL DR.  
450 WYRTLEHDD DR.  
10



**WE'RE OUT OF OUR MINDS!**

**OUR MICROMIND COMPUTER HAS MET  
WITH SUCH CONSUMER ENTHUSIASM  
THAT WE'RE BUSY PARING DOWN  
A SIX MONTH PILE OF ORDERS....**

**PLEASE BE PATIENT.... IT'LL BE WORTH IT!**

**FOR INFORMATION ON MICROMIND CALL (617) 661-4400**



**ECD CORP.  
196 BROADWAY, CAMBRIDGE  
MASS. 02139**

**INNOVATIONS IN ELECTRONICS**

**MicroMind**

*off... and rolling!*

# Burglar Alarm Breakthrough

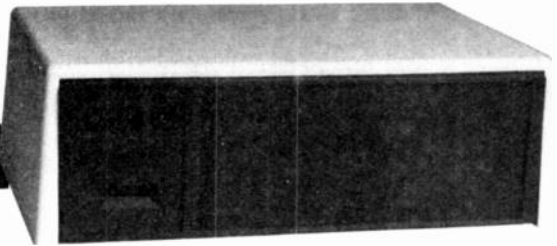

The Midex security computer looks like a handsome stereo system component and measures only 4" x 10½" x 7".

*A new computerized burglar alarm requires no installation and protects your home or business like a thousand dollar professional system.*

It's a security system computer. You can now protect everything—windows, doors, walls, ceilings and floors with a near fail-safe system so advanced that it doesn't require installation.

The Midex 55 is a new motion-sensing computer. Switch it on and you place a harmless invisible energy beam through more than 5,000 cubic feet in your home. Whenever this beam detects motion it sends a signal to the computer which interprets the cause of the motion and triggers an extremely loud alarm.

The system's alarm is so loud that it can cause pain—loud enough to drive an intruder out of your home before anything is stolen or destroyed and loud enough to alert neighbors to call the police.

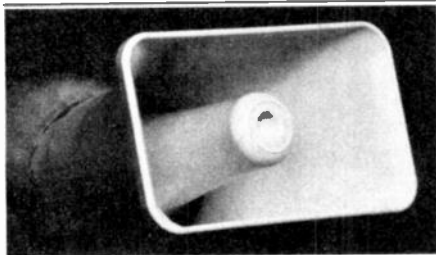

The powerful optional blast horns can also be placed outside your home or office to warn your neighbors.

Unlike the complex and expensive commercial alarms that require sensors wired into every door or window, the Midex requires no sensors nor any other additional equipment other than your stereo speakers or an optional pair of blast horns. Its beam actually penetrates walls to set up an electronic barrier against intrusion.

## NO MORE FALSE ALARMS

The Midex is not triggered by noise or sound, temperature or humidity—just motion, and since a computer interprets the nature of the motion, the chances of a false alarm are very remote.

An experienced burglar can disarm an expensive security system or break into a home or office through a wall. Using a Midex system there is no way a burglar can penetrate the protection beam without triggering the loud alarm. Even if the burglar cuts off your power, the four-hour rechargeable battery pack will keep your unit triggered, ready to sense motion and sound an alarm.

## DEFENSE AGAINST PEEPING TOMS

By pointing your unit towards the outdoors from your bedroom and installing an outside speaker, light, or alarm, your unit can sense a peeping tom, and frighten him off. Pets are no problem for the Midex. Simply put them in one section of the house and concentrate the beam in another.

When the Midex senses an intruder, it remains silent for 20 seconds. It then sounds the alarm until the burglar leaves. One minute after the burglar leaves, the alarm shuts off and resets, once again ready to do its job. This

shut-off feature, not found on many expensive systems, means that your alarm won't go wailing all night long while you're away. When your neighbors hear it, they'll know positively that there's trouble.

## PROFESSIONAL SYSTEM

Midex is portable so it can be placed anywhere in your home. You simply connect it to your stereo speakers or attach the two optional blast horns.

Operating the Midex is as easy as its installation. To arm the unit, you remove a specially coded key. You now have 30 seconds to leave your premises. When you return, you enter and insert your key to disarm the unit. You have 20 seconds to do that. Each key is registered with Midex and that number is kept in their vault should you ever need a duplicate. Three keys are supplied with each unit.

As an extra security measure, you can leave your unit on at night and place an optional panic button by your bed. But with all its optional features, the Midex system is complete, designed to protect you, your home and property just as it arrives in its well-protected carton.

The Midex 55 system is the latest electronic breakthrough by Solfan Systems, Inc.—a company that specializes in sophisticated professional security systems for banks and high security areas. JS&A first became acquainted with Midex after we were burglarized. At the time we owned an excellent security system but the burglars went through a wall that could not have been protected by sensors. We then installed over \$5,000 worth of the Midex commercial equipment in our warehouse. When Solfan Systems announced their intentions to market their units to consumers, we immediately offered our services.

## COMPARED AGAINST OTHERS

In a recent issue of the leading consumer publication there was a complete article written on the tests given security devices which were purchased in New York. The Midex 55 is not available in New York stores but had it been compared it would have been rated tops in space protection and protection against false alarms—two of the top criteria used to evaluate these systems. Don't be confused. There is no system under \$1,000 that provides you with the same protection.

## YOU JUDGE THE QUALITY

Will the Midex system ever fail? No product is perfect but judge for yourself. All components used in the Midex system are of aerospace quality and of such high reliability that they pass the military standard 883 for thermal shock and burn-in. In short, they go through the same rugged tests and controls used on components in manned spaceships.

Each component is first tested at extreme tolerances and then retested after assembly. The entire system is then put under full electrical loads at 150 degrees Fahrenheit for a full week. If there is a defect, these tests will cause it to surface.

## PEOPLE LIKE THE SYSTEM

Wally Schirra, a former astronaut and scientist, says this about the Midex 55, "I know of no system that is as easy to use and provides such solid protection to the home owner as the Midex. I would strongly recommend it to anyone. I am more than pleased with my unit."

Many more people can attest to the quality of this system but the true test is how it performs in your home or office. That is why we provide a one month trial period. We give you the opportunity to personally see how fail-safe and easy the Midex system is to operate and how thoroughly it protects you and your loved ones.

Use the Midex for protection while you sleep, to protect your home while you're away or on vacation. Then after 30 days, if you're not convinced that the Midex is nearly fail-safe, easy to use, and can provide you with a security system that you can trust, return your unit and we'll be happy to send you a prompt and courteous refund. There is absolutely no obligation. JS&A has been serving the consumer for over a decade—further assurance that your investment is well protected.

To order your system, simply send your check in the amount of \$199.95 (Illinois residents add 5% sales tax) to the address shown below. Credit card buyers may call our toll-free number below. There are no postage and handling charges. By return mail you will receive your system complete with all connections, easy to understand instructions and one year limited warranty. If you do not have stereo speakers, you may order the optional blast horns at \$39.95 each and we recommend the purchase of two.

With the Midex 55, JS&A brings you: 1) A system built with such high quality that it complies with the same strict government standards used in the space program, 2) A system so advanced that it uses a computer to determine unauthorized entry, and 3) A way to buy the system, in complete confidence, without even being penalized for postage and handling charges if it's not exactly what you want. We couldn't provide you with a better opportunity to own a security system than right now.

Space-age technology has produced the ultimate personal security system. Order your Midex 55 security computer at no obligation, today.

**JS&A** NATIONAL SALES GROUP  
Dept. RA One JS&A Plaza  
Northbrook, Ill. 60062 (312) 564-9000  
CALL TOLL-FREE... 800 323-6400  
In Illinois call . . . . . (312) 498-6900  
©JS&A Group Inc. 1977

CIRCLE 75 ON FREE INFORMATION CARD

# Vaco.

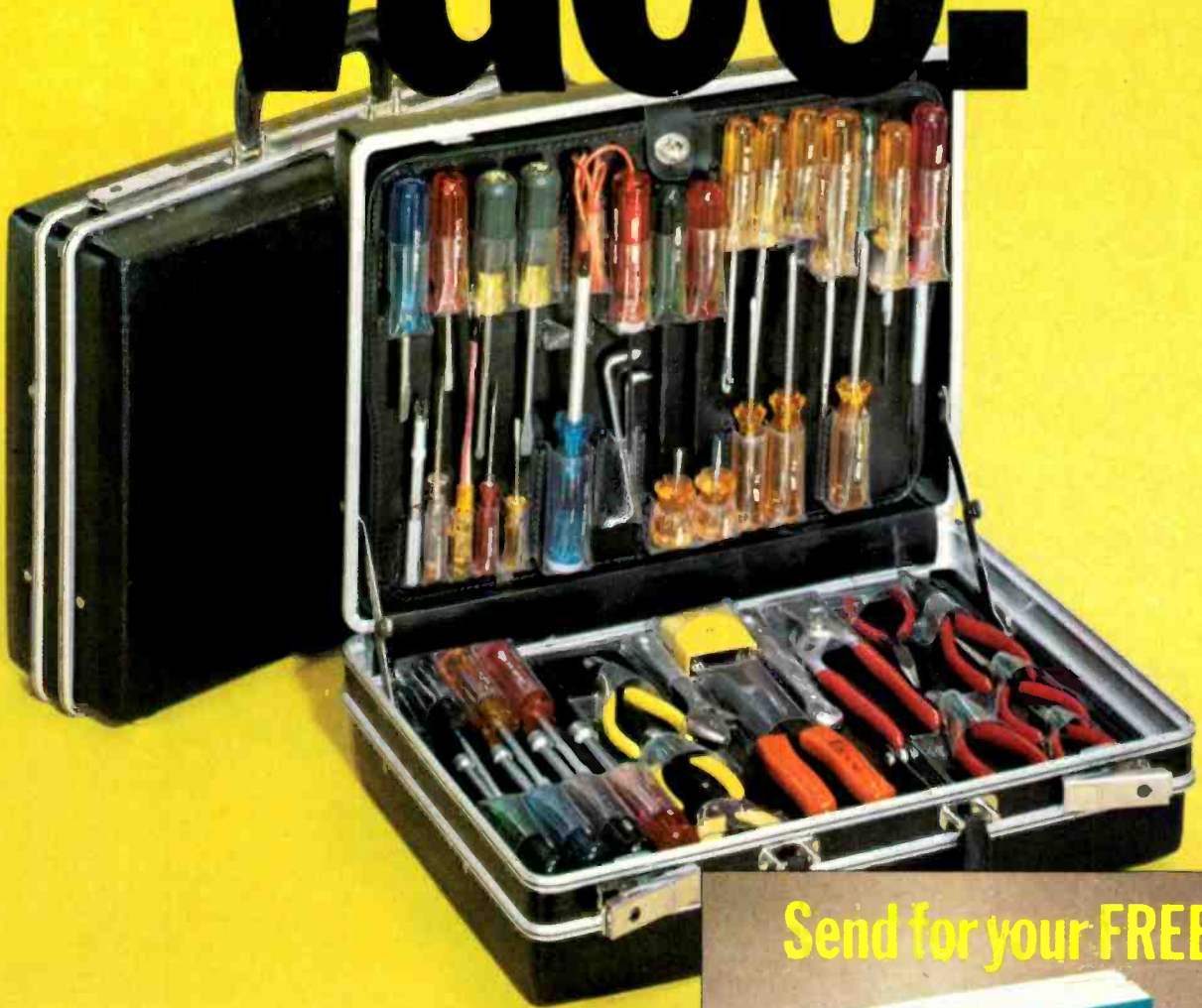

## Super Case

Vaco means value and variety.

Like our Super Case. A great value with great variety. 48 professional problem-solving tools from screwdrivers and nutdrivers to pliers, wrenches, crimping tools, and more! All right at hand. And all unconditionally guaranteed.

You'll find the Super Case and all the other fine Vaco tools in our exciting new 64-page Bicentennial Catalog. FREE for the asking! Just write:

Vaco Products Co., 510 N. Dearborn St., Chicago, Illinois 60610.

Send for your FREE



64 colorful pages with the complete Vaco selection.

1976 VACO catalog!

# Radio-Electronics®

THE MAGAZINE FOR NEW IDEAS IN ELECTRONICS

Electronics publishers since 1908

OCTOBER 1977 Vol. 48 No. 10

<b>BUILD ONE OF THESE</b>	40	<b>3 Low-Cost CB Test Meters</b> Get maximum performance by peaking your CB rig with these easy-to-build low-cost meters. <i>by W.E. Osborne</i>		
	42	<b>Phlanger Creates Dramatic Music Effects</b> Built around an analog delay line, it connects to your hi-fi system. <i>by Marvin Jones</i>		
<b>COMPUTERS</b>	76	<b>Computer Corner</b> Interfacing a microcomputer to a D/A converter. <i>by Jon Titus, David Larsen, Peter R. Rony</i>		
	101	<b>New Radio-Shack Computer</b> A Z-80 machine for the consumer.		
<b>CB RADIO</b>	64	<b>Selecting CB Antennas</b> How to choose and use them effectively. <i>by Milton R. Friedberg</i>		
<b>HIGH FIDELITY STEREO</b>	50	<b>Realign Your FM Receiver</b> Eliminate crosstalk, modulation time errors and phase shift problems. You can do it yourself. <i>by T.J.C. Molle</i>		
	53	<b>Class-H Variproportional Amplifier</b> New approach to audio amplification you'll want to know about. <i>by Len Feldman</i>		
	60	<b>R-E Lab Tests Dynaco SCA-50</b> "Very Good" is how we rate the overall performance. <i>by Len Feldman</i>		
	62	<b>R-E Lab Tests Heath AR-1515</b> Receiver earns "Excellent" for amplifier section; "Very Good" for FM tuner. <i>by Len Feldman</i>		
<b>GENERAL ELECTRONICS</b>	4	<b>Looking Ahead</b> Tomorrow's news today. <i>by David Lachenbruch</i>		
	35	<b>Digital Car Clocks</b> Everything you ever wanted to know about digital clocks for your car. <i>by Fred Blechman</i>		
	70	<b>Hobby Corner</b> SCR's, Friacs, Diacs, Quadracs. <i>by Earl (Doc) Savage, K4SDS</i>		
	72	<b>State of Solid State</b> Tachometer/speed switch IC applications, microcomputer notes, and an alphanumeric display in a DIP. <i>By Karl Savon</i>		
<b>TELEVISION</b>	74	<b>Service Clinic</b> A logical look at digital circuits. <i>by Jack Darr</i>		
	75	<b>Service Questions</b> R-E's Service Editor solves technician problems.		
<b>TEST EQUIPMENT</b>	67	<b>All about RF Signal Generators</b> <i>Part III: A brief look at the more exotic features.</i> <i>by Charles Gilmore</i>		
<b>EQUIPMENT REPORTS</b>	22	<b>Fluke 8020A Digital Multimeter</b>		
	24	<b>Heath SG-1272 Audio Generator</b>		
	26	<b>B&amp;K 530 Semiconductor Tester</b>		
	32	<b>Lunar Electronics DX-555 Signal Generator/Frequency Counter</b>		
	89	<b>Telematic SG 785</b>		
	90	<b>Tri Star Tiger CB Alarm</b>		
<b>DEPARTMENTS</b>	114	<b>Advertising Index</b>	6	<b>New &amp; Timely</b>
	12	<b>Advertising Sales Offices</b>	94	<b>New Products</b>
	14	<b>Letters</b>	103	<b>Next Month</b>
	106	<b>Market Center</b>	115	<b>Reader Service Card</b>
	100	<b>New Books</b>		

## ON THE COVER

Special music effects just your style? Then try building the Phlanger—it's a honey of an effect generator, and you use it with your hi-fi system. Complete details start in this issue on page 42.

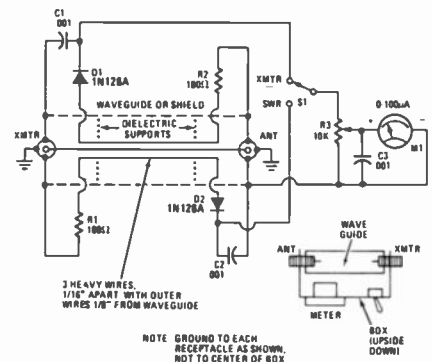

**SWR BRIDGE is only one of 3 inexpensive CB test meters. . . . see page 40**

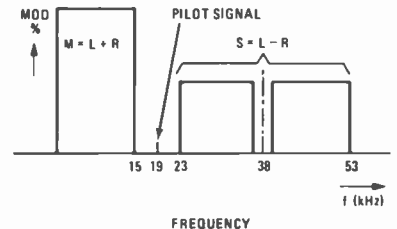

**THIS IS A PROPER FM signal. A misaligned FM tuner will destroy it. Restore the good sound by realignment. . . . see page 50**

Radio-Electronics, Published monthly by Gernsback Publications, Inc., 200 Park Avenue South, New York, NY 10003. Phone: 212-777-6400. Second-class postage paid at New York, NY and additional mailing offices. One-year subscription rate: U.S.A., U.S. possessions and Canada, \$8.75. Pan-American countries, \$10.25. Other countries, \$10.75. Single copies \$1.00. © 1977 by Gernsback Publications, Inc. All rights reserved. Printed in U.S.A.

**Subscription Service:** Mail all subscription orders, changes, correspondence and Postmaster Notices of undelivered copies (Form 3579) to Radio-Electronics Subscription Service, Box 2520, Boulder, CO 80322.

A stamped self-addressed envelope must accompany all submitted manuscripts and/or artwork or photographs if their return is desired should they be rejected. We disclaim any responsibility for the loss or damage of manuscripts and/or artwork or photographs while in our possession or otherwise.

As a service to readers, Radio-Electronics publishes available plans or information relating to newsworthy products, techniques and scientific and technological developments. Because of possible variances in the quality and condition of materials and workmanship used by readers, Radio-Electronics disclaims any responsibility for the safe and proper functioning of reader-built projects based upon or from plans or information published in this magazine.

# looking ahead

**Restricting Japan:** The political tide has begun to turn sharply against electronic imports from Japan, with recent U.S. Government actions now certain to restrict imports and/or increase prices of Japanese goods. The most important move was negotiating voluntary quotas on exporting color sets from Japan to the U.S. after the American International Trade Commission had determined that domestic industry had been injured by Japanese imports. Under the quota agreement, Japan is permitted to export about 1.75 million complete color sets and chassis to the U.S. per year for the next three years—or about 35% less than its 1976 exports.

A second blow to the Japanese was a U.S. Customs court ruling that the Japanese government was subsidizing exports of consumer electronic products by exempting them from commodity taxes. This ruling is being challenged in court by the State Department, but if the ruling is upheld, it could mean imposing additional duties on Japanese electronics. In a third action, five Japanese television manufacturers signed an agreement settling a case brought against them by Sylvania, agreeing to refrain from future price-fixing, market-splitting and predatory price practices. More anti-Japanese actions are pending, including a billion-dollar anti-trust suit brought against Japan's TV manufacturers by Zenith and National Union Electric.

In addition to these actions, the rising value of the Japanese yen is putting the squeeze on importers and Japanese manufacturers doing business with the U.S. By midsummer, Japanese TV and audio brands had posted price increases of about 5%, and there were indications of steeper price hikes to come around the end of the year.

One other aspect of the troubled situation may actually work against audio price increases. Since the quotas are restricting Japanese color TV exports to the U.S., manufacturers are expected to try to compensate for the lost volume with audio gear exports, perhaps flooding the American market with more audio equipment than it can accommodate. The result could be a real disaster, with prices collapsing despite increased costs.

**AM stereo, FM quad:** The FCC is inexorably moving into new areas of radio. It has started two new proceedings to determine whether it should adopt standards for AM stereo and/or FM quadriphonic broadcasting. In the AM stereo case, the National AM Stereophonic Radio Committee, which has tested various systems, will help the FCC select the best parameters for AM stereo. As a matter of fact, AM stereo (distasteful as it may be to some purists) is considered virtually a shoo-in. Radio manufacturers want it. Car manufacturers want it. And AM broadcasters want it (as a weapon against FM). It's expected to sound pretty good (at least reasonably middle-fi), so why not let your AM tuner take advantage of your stereo amplifier?

The quadriphonic FM proceeding has been on the FCC's books for some time, and now the rug has been swept out from under it as a result of the four-channel equipment bomb. But the FCC must follow the rulebooks. Its proceeding asks for comments on the merits of discrete 4-4-4 systems, matrix-discrete 4-3-4 and matrix

4-2-4, which can now be broadcast without any rule changes. However, the Commission had some questions about quadriphonic broadcasting—whether sufficient software was available for four-channel broadcasting, whether existing stereo receivers could be converted to quadriphonic receivers, and how much it would cost to do so. But, it sounds as if the FCC is just going through the motions.

**VTR guide:** You can't tell the players without a program. Well, here's one—showing which manufacturer has which home videocassette system, subject to change. In the table, Beta-2 means the Sony Betamax system with two-hour cassette, VHS-2 means the JVC-Matsushita Video Home System with 2-hour cassette, VHS-4 is the same unit with switchable 2- and 4-hours per cassette.

Brand	Format	Manufacturer
Aiwa*	Beta-2	Sony
Hitachi	VHS-2	Hitachi
JVC	VHS-2	JVC
Magnavox	VHS-4	Matsushita
Curtis Mathes	VHS-4	Matsushita
MGA	VHS-2	JVC
Panasonic	VHS-4	Matsushita
Pioneer*	Beta-2	Sony
Quasar	VX-2000	Matsushita
RCA	VHS-4	Matsushita
Sanyo	V-Cord II	Sanyo
	Beta-2	Sanyo
Sears	Beta-2	Sanyo
Sharp	VHS-2	JVC
Sony	Beta-2	Sony
Sylvania	VHS-4	Matsushita
Toshiba	Beta-2	Toshiba
Zenith	Beta-2	Sony

\* U.S. plans not disclosed.

**New broadcast standard:** Since the development of the videotape recorder in 1956, the two-inch quadruplex VTR has been the TV broadcasting industry's standard for the interchange of tapes for programs and commercials. Time has marched on since Ampex first announced and demonstrated practical video recording—and so has technology. Despite attempts to keep the two-inch quad machine up to the times by upgrading quality and reducing tape speed, new lower-cost, high-quality formats have increasingly attracted broadcasters. The two-inch format has remained the standard for only one reason: It started out as the standard and everybody has it.

Within the last 18 months, several new and economical formats have been introduced. In Europe, the Bosch/Fernseh group's one-inch segmented helical-scan format attracted immediate attention and is a strong candidate to replace the existing standard there. In the U.S., a nonsegmented format is widely preferred, and both Ampex and Sony have fielded their own versions. Broadcasters were enthusiastic about both formats as vastly more economical, easier to use and technically superior videotape systems, but, unfortunately, they were

*continued on page 105*



**The first complete  
low-cost microcomputer  
system for home,  
business or education!**

**Radio Shack TRS-80**

The TRS-80 is for people who want to use a computer now — without the delay, work and problems of building one. The system is fully wired, tested and U.L. listed — ready for you to plug in and use! Program it to handle your personal finances, small business accounting, teaching functions, kitchen computations, innumerable games — and use Radio Shack's expanding line of prepared programs on cassettes. The Z80-based system comes with 4K read/write memory and Radio Shack Level-I BASIC stored in read-only memory. Memory expandable to 62K bytes. Includes CPU, memory, keyboard, display, power supply, cassette data recorder, 300-page manual, 2-game cassette program. Designed and built in USA by Radio Shack. Only 599.95.



Includes everything you need to start using it immediately!

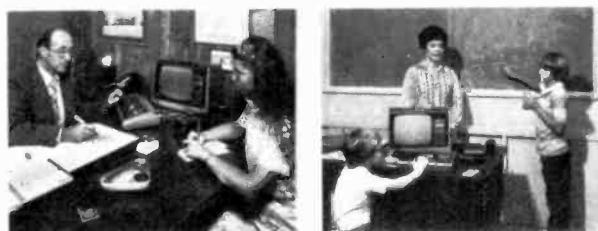

*Clip and Mail Ccupon Today!*

Mail to: Radio Shack, Dept. TRS-80  
205 N.W. 7th St., Ft. Worth, TX 76101

C004

Send me more data on the TRS-80 microcomputer

- Description of applications, software and peripherals available through Radio Shack • Owners' newsletter
- Price list • List of stocking stores and dealers

NAME \_\_\_\_\_ APT. NO. \_\_\_\_\_  
ADDRESS \_\_\_\_\_  
CITY \_\_\_\_\_ STATE \_\_\_\_\_ ZIP \_\_\_\_\_

SOLD ONLY WHERE YOU SEE THIS SIGN:

**Radio Shack**

A TANDY COMPANY • FORT WORTH, TEXAS 76102  
OVER 6000 LOCATIONS IN NINE COUNTRIES

Price may vary at individual stores and dealers

## Single-sideband transmission triples phone system capacity

Bell Labs is now testing out, between Ashburnham and Wendell, Massachusetts, an advanced microwave system that will carry more than three times as many phone calls as the highest capacity radio link now used by the Bell System. It will be the first of its kind to use single sideband (SSB) for high-capacity, long-distance microwave telephone transmission.

The new system—AR6A—will carry



PART OF THE AR6A SINGLE SIDEBAND microwave transmitter, with one of its designers, Bell Laboratories engineer William Robinson.

6,000 calls per channel, as compared with 1,800 for the highest-capacity radio link now used by Bell. It will operate at six gigahertz (6 GHz) and will handle both voice and data signals. The present tests will continue through 1978 and—if the system works as well as expected—AR6A will go into commercial operation by the middle of 1980.

The single-sideband technique, widely used by amateurs and commercial two-way communications on the high- and very-high frequencies, has been hard to adapt to microwave. By eliminating one of the sidebands of a radio transmission, SSB immediately doubles the available spectrum space. By eliminating the carrier, and thereby greatly reducing the power required, it is possible to increase further the number of signals that can be carried on a given band of frequencies. But the technique requires extreme linearity—the output must be an exact replica of the input—and until recently distortion has prevented its use at microwave frequencies.

This problem was overcome in large part

by a greatly improved traveling-wave amplifier. Some nonlinearity still existed, and is being combatted by *predistortion*—a controlled amount of distortion is introduced in such a way as to exactly cancel out the distortion introduced by the equipment.

## Mammoth iceberg spotted by RCA environmental satellite

A giant iceberg, 45 miles long and 25 miles wide (or about the size of Rhode Island), has been observed off Antarctica's Palmer Peninsula by an RCA-built polar-orbiting satellite. The iceberg's ultimate destination is the South Atlantic, where it will dissolve in the warmer waters. It is estimated that the huge ice mass contains enough fresh water to supply all of California for the next 1,000 years!

The weather satellite, launched by NASA, is one of series built by RCA for NOAA (National Oceanic and Atmospheric Administration). The satellites are used by the U.S. Navy and ships of other countries to provide information on safe shipping routes through Antarctica's ice-choked waters. In addition to providing vital weather information, the satellites help predict snow runoff and aid fishermen in locating their catches.

## New technology simplifies custom LSI circuit design

A simple and inexpensive way of custom designing LSI circuits has been developed by Hughes Aircraft Company. The new technology, termed SCAT (Schottky Cell Array Technology) uses a custom interconnection process to outline LSI circuits. This method results in reduced mounting space and greater reliability. A library of standard MSI and SSI Schottky TTL cells provides arrays of up to eight cells that can be interconnected in one-fourth the time and cost of full custom design configurations.

A multilayer metallization process with two extra layers of thin metal film is used. Logic functions are implemented in a manner similar to that done on a two-layer PC

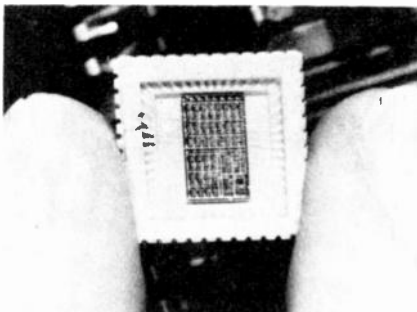

CUSTOM LSI DESIGN is simplified with SCAT (Schottky Cell Array Technology), using two thin metal layers to implement logic functions.

board. The logic interconnections and cell types are left up to the customer.

The SCAT technique eliminates the circuit layout and computer analysis steps of a full custom design. Layout details for the library cells are stored as a set of photoplates for mask generation, thus reducing development to designing two layers of interconnections and mask fabrication. Included in the cell library are a wide range of MSI/SSI gates, counters, flip-flops, multiplexers, arithmetic elements and shift registers.

## Motorola introduces two new solar modules

Motorola Semiconductor Products, Inc., has taken a step in the direction of harnessing solar power to meet some of our

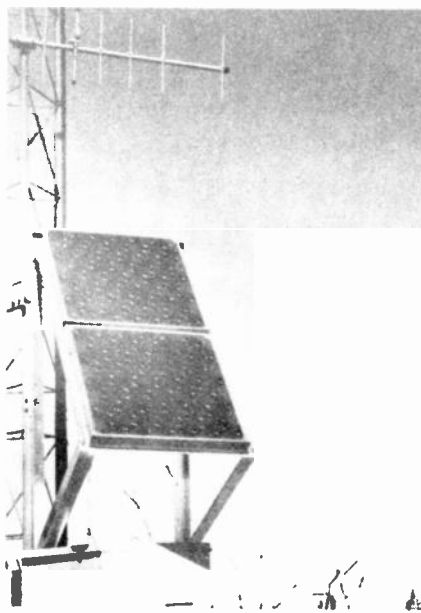

TYPICAL REMOTE SOLAR INSTALLATION, using Motorola's 48-cell module.

energy problems. They have developed two new solar modules that can be used to supply moderate amounts of energy to remote locations.

The modules, a 48-cell array and a 36-cell array, are composed of interconnected 3-inch row-mounted silicon wafers. The surface of each wafer (cell) consists of tiny pyramids that impinge light rays, resulting in a less than 1% loss of sunlight from reflection.

Module outputs are proportional to the number of cells used. For instance, in the 48-cell array, because each cell produces less than 1/2-watt peak power at 25°C, 26 watts of power is produced. However, there are a number of series-parallel interconnection schemes that allow voltage/current

*continued on page 12*



# Where superior technology makes the musical difference: Sansui's new DC integrated amplifier and matching tuner.

Sansui is proud to introduce the new AU-717 DC integrated amplifier and matching TU-717 tuner, designed for your greatest listening pleasure. We are proud of the superlative specifications that our sophisticated research has achieved. The finest available at any price.

But the best specs alone don't always mean the finest music reproduction. And so we are proud that our precision engineering and superior circuitry design create pure and brilliantly clean tonal quality that's distinctly superior.

Listen to what we offer: Frequency response of the AU-717 from main in, 0Hz to 200kHz (+0dB, -3dB), (the widest of any DC integrated amplifier available), gives you sharp, clean transients and greatly reduced phase shift problems. Total harmonic distortion is astoundingly low, less than 0.025%, from 20-20,000Hz. 85 watts/channel min. RMS, both channels driven into 8 ohms.

Dual independent power supplies provide true stereo separation and a large power reservoir. For uncolored phono reproduction equalization is within  $\pm 0.2$ dB (20-20,000Hz, extended RIAA curve). And the calibrated-

attenuator level control guarantees volume precision.

The matching TU-717 tuner features dual IF bandwidth to let you select for lowest distortion (0.07% mono, 0.09% stereo) or maximum selectivity (80dB). S/N is excellent: 30dB mono, 77dB stereo.

In addition, the AU-717's are elegantly styled, offer rack mounting adaptors and are most attractively priced. Less than \$450\* for the AU-717 and less than \$320\* for the TU-717.

Listen to these brilliant new components at your franchised Sansui dealer today. When you hear the new Sansui AU/TU-717's, you will never again want to settle for less than the best.

Sansui. A whole new world of musical pleasure.

\*Approximate nationally advertised value. The actual retail price will be set by the individual dealer or his option.



**SANSUI ELECTRONICS CORP.**

Woodside, New York 11377 • Gardena, California 90247

SANSUI ELECTRIC CO., LTD., Tokyo, Japan

SANSUI AUDIO EUROPE S.A., Antwerp, Belgium • In Canada Electronic Distributors

*Sansui*

CIRCLE 43 ON FREE INFORMATION CARD

# Learn to service Communications /CB equipment at home...with NRI'S COMPLETE COMMUNICATIONS COURSE

**Learn design, installation and maintenance of commercial, amateur, or CB communications equipment.**

The field of communications is bursting out all over. In Citizens Band alone, class D licenses grew from 1 to over 2.6 million in 1975, and the FCC projects about 15 million CB'ers in the U.S. by 1979. That means a lot of service and maintenance jobs . . . and NRI can train you at home to fill one of those openings. NRI's Complete Communications Course covers all types of two-way radio equipment (including CB), AM and FM



special instruction so you can go on the air.

The complete course includes 48 lessons, 9 special reference texts, and 10 training kits. Included are: your own electronics Discovery Lab, Antenna Applications Lab, CMOS Frequency Counter, and an Optical Transmission System. You'll learn at home, progressing at your own speed, to your FCC license and into the communications field of your choice.



Transmission and Reception, Television Broadcasting, Microwave Systems, Radar Principles, Marine Electronics, Mobile Communications, and Aircraft Electronics.

The course will also qualify you for a First Class Radio Telephone Commercial FCC License or you get your tuition back.

**Learn on your own 400-channel digitally-synthesized VHF transceiver.**

You will learn to service all types of communication equipment, with the one unit that is designed mechanically and electronically to train you for CB, Commercial and Amateur communications: a digitally-synthesized 400-channel VHF transceiver and AC power supply. This 2-meter unit gives you "Power-On" training. Then we help you get your FCC Amateur License with

## NEW CB SPECIALIST COURSE NOW OFFERED



NRI now offers a special course in CB Servicing. You get 37 lessons, 8 reference texts, your own CB Transceiver, AC power supply and multi-meter . . . for hands-on training. Also included are 14 coaching units to make it easy to get your commercial radio telephone FCC license—enabling you to test, install, and service communications equipment.

# NRI offers you five TV/Audio Servicing Courses

NRI can train you at home to service TV equipment and audio systems. You can choose from 5 courses, starting with a 48-lesson basic course, up to a Master Color TV/Audio Course, complete with designed-for-learning 25" diagonal solid state color TV and a 4-speaker SQ™

Quadrasonic Audio System. NRI gives you both TV and Audio servicing for hundreds of dollars less than the two courses as offered by another home study school.

All courses are available with low down payment and convenient monthly payments. All courses provide professional tools and "Power-On" equipment along with NRI kits engineered for training. With the Master Course, for instance, you build your own 5" wide-band triggered sweep solid state oscilloscope, digital color TV pattern generator, CMOS digital frequency counter, and NRI electronics Discovery Lab.



™ Trademark of CBS Inc.

# NRI's complete computer electronics course gives you real digital training.

Digital electronics is the career area of the future . . . and the best way to learn is with NRI's Complete Computer Electronics Course. NRI's programmable digital computer goes far beyond any "logic trainer" in preparing you to become a computer or digital technician. With the IC's in its new Memory Kit, you get the only home training in machine language programming . . . experience essential to trouble shooting digital computers. And the NRI programmable computer is just one of ten kits you receive, including a TVOM and NRI's exclusive electronics lab. It's the quickest and best way to learn digital logic and computer operation.

**You pay less for NRI training and you get more for your money.**

NRI employs no salesmen, pays no commissions. We pass the savings on to you in reduced tuitions and extras in the way of professional equipment, testing instruments, etc. You can pay more, but you can't get better training.

**More than one million students have enrolled with NRI in 62 years.**

Mail the insert card and discover for yourself why NRI is the recognized leader in home training. No



salesman will call. Do it today and get started on that new career.

**APPROVED UNDER GI BILL**  
if taken for career purposes Check box on card for details



**NRI SCHOOLS**  
McGraw-Hill Continuing Education Center  
3939 Wisconsin Avenue,  
Washington, D.C. 20016

**Hugo Gernsback** (1884-1967) founder  
**M. Harvey Gernsback**, KOD-6694  
 editor-in-chief and publisher  
**Larry Steckler**, KTX-3644, CET, editor  
**Robert F. Scott**, CET, W2PWG,  
 KXK-8533, technical editor  
**Arthur Kleiman**, KTZ-3288,  
 managing editor  
**Jack Darr**, CET service editor  
**Leonard Feldman**  
 contributing high-fidelity editor  
**Karl Savon**, semiconductor editor  
**Earl "Doc" Savage**, hobby editor  
**David Lachenbruch**, contributing editor  
**Vincent P. Ciconia**, production manager  
**Dale Allinson**, production assistant  
**Harriet I. Matysko**, circulation director  
**Sheila Wertling**, circulation assistant  
**Arline R. Bailey**, advertising coordinator

Cover design by Louis G. Rubsamen  
 Cover photo by Walter Herstatt

Radio Electronics is a member of the *Institute of High Fidelity* and is indexed in *Applied Science & Technology Index* and *Readers Guide to Periodical Literature*.



Radio-Electronics magazine is published by Gernsback Publications, Inc. 200 Park Ave. S., New York, NY 10003 (212) 777-6400

President: M. Harvey Gernsback  
 Vice President: Larry Steckler  
 Treasurer: Carol A. Gernsback  
 Secretary: Bertina Baer

#### ADVERTISING SALES

##### EAST

Stanley Levitan, KZA-5580  
 Radio-Electronics  
 200 Park Ave. South  
 New York, NY 10003  
 (212) 777-6400

##### MIDWEST/Texas/Arkansas/Okla.

Ralph Bergen, KXD-8396  
 Jim Reilly  
 The Ralph Bergen Co.  
 6319 N. Central Ave.  
 Chicago, IL 60646  
 (312) 792-3646

##### PACIFIC COAST Mountain States

Jay Eisenberg, KYF-3277  
 J.E. Publishers Representative Co.,  
 8732 Sunset Blvd.,  
 4th Floor,  
 Los Angeles, CA 90069  
 (213) 659-3810  
 Sales Mart Building  
 1485 Bayshore Blvd., Box 140  
 San Francisco, CA 94124  
 (415) 467-0125

##### SOUTHEAST

J.E. Publishers Representative Co.,  
 214-387-2424

tradeoffs to meet different applications.

The modules can be used to energize microwave relays, navigational aids and forestry systems, among others. Continuous energy storage is provided by batteries recharged during sunlight hours.

#### NBS seminar on time and frequency calibration

On October 17-19, the National Bureau of Standards is presenting a time and frequency seminar at NBS headquarters in Boulder, CO. Aimed at scientists, engineers and lab technicians, the three-day course will offer a practical approach to making time and frequency measurements. Featured will be many discussions and "hands on" workshops dealing with such topics (among others) as establishing traceability, lab equipment and techniques, using high- and low-frequency time and frequency broadcasts, satellite methods and using LORAN.

The \$300 registration fee includes handbooks and other publications, workshops, coffee and refreshments, one seminar dinner (with cash bar), and a certificate of completion. A side trip to radio stations WWV and WWVB in nearby Fort Collins is planned. Accommodations can be made at the Broker Inn, about a mile from the NBS site. For further information, write Sandy Howe (General Information) or George Kamas (Technical Information), NBS, 325 Broadway, Boulder, CO 80302, or call (303) 499-1000.

#### Sencore CB/stereo seminars for service technicians

Sencore, Inc., test-equipment manufac-



A HIGHLIGHT OF THE RECENT SENCORE troubleshooting seminar was the company's all-in-one AM/FM/stereo and CB analyzer, developed to help service in-dash combo units.

turers, recently conducted a series of CB and stereo troubleshooting seminars across the country for service technicians. The main thrust of the learning sessions was to show how new techniques can be applied to repair combination in-dash CB/

stereo units. A highlight of the meeting was a video/tape presentation of Sencore's AM/FM/stereo analyzer and CB analyzer.

"... CB's are going in-dash," stated a company spokesman. "Communications with many CB manufacturers indicate that many of these units will be AM/FM/stereo and CB combinations." And, to prepare for this growing market, he continued, CB dealers have been expanding into stereo service, while hi-fi service centers have been taking on CB's.

Sencore feels that its analyzers will provide a lower-cost, more efficient way to service the combination units. The analyzers are essentially self-contained "service centers" that eliminate the expensive, time-consuming set-ups and intra-instrument cable connections required if separate instruments are purchased.

#### Telecommunications forum predicts world market growth

The phenomenal growth in the worldwide demand for telecommunications equipment was the subject of a recent Executive Forum on International Telecommunications sponsored by Arthur D. Little, Inc., that was held this past June in the nation's capital.

More than 20 international telecommunications executives and a team of experts from Arthur D. Little participated in the Forum, which examined world market growth trends. Participants heard experts predict an 8% total world market growth by 1985, as contrasted to only 6.5% for North American countries. The most dramatic growth in demand will be reflected in Middle Eastern, Third World and European nations, with the U.S. accounting for less than half the total market. These trends and the inevitable changes they will produce were examined on a market-by-market basis, with the emphasis being on the differences between the U.S. and other world markets.

#### Teledyne Acoustic Research "has computer, will travel"

A new "Mini" computer, devised by Teledyne Acoustic Research, is the star of a unique AR "Science of Sound" traveling show aimed at demonstrating some of AR's capabilities in the high-fidelity field.

The "Mini" is a sophisticated digital unit that has been preprogrammed by AR's in-house computer. On-the-spot calculations and data drawn from storage banks use room-dimension and speaker-placement information to provide the ideal listening conditions desired. The computer does all its mathematical tricks before your very eyes. Additionally, performance data of various AR models and their use in specific installations can be shown on the readout screen.

# Fluke Sponsors New Series:

"One Great Family"



## Tired of Reruns?

Fluke counters with a new series in the 5 Hz-520 MHz/time slot.

If you're paying over \$345 for a counter and getting frequency only, tune in on our new 1900-series of priced-right multimeters.

Five different models offer both time *and* frequency, with award-worthy performance and features; the ratings are terrific!

## New Time and Frequency.

Last year's hit, the model 1900A, set the stage for this new series of multimeters by offering frequency, period, period average and totalize *standard* in one great counter.

Now all models in the series offer comparable features and value, with autoranging and autoreset as well.

Most models feature a trigger level control and battery option for reliable field use or line-cord-free bench operation. All typically have a 15 mV sensitivity (guaranteed on most!), plus a 0.5 ppm/month time base for long-term stability.

## The Price is Right.

From this shared base of solid performance features,

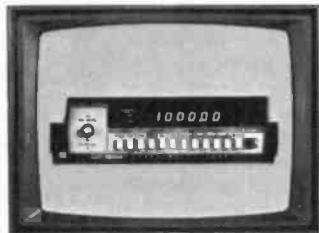

1900A

we've built a series of counters with one model just right for your needs.

The new 1912A, with a 520 MHz range and an extensive package of standard features, offers more capability for \$620\* than you're likely to find anywhere. For 250 MHz measurement perfection, the 1911A multimeter is a best-buy for only \$495.\*



1925A

For lower frequency (125 MHz) applications, specify the 1910A for \$395.\* The 1900A, years ahead in value, has been reduced to \$345\* for even more cost-effective 80 MHz measurement.

For rugged environment applications in the 125 MHz area, you'll want the 1925A with its RFI shielding and dust-resistant steel case. \$750.\* (For only \$225\* more, a special prescaler option extends the 1925A's range to 520 MHz.)

## Tune In and Count.

Call (800) 426-0361, toll free, for the location of the closest office or for complete technical literature. Then stop in for the great family picture, and review the extensive option list for better TCXOs, data outputs, and more. John Fluke Mfg. Co., Inc., P.O. Box 43210, Mountlake Terrace, WA 98043.

\*U.S. price only.

**Command Performance: Demand Fluke Multimeters.**



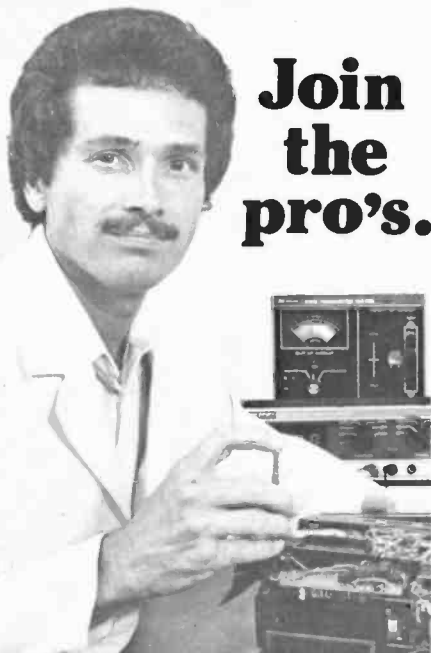

# Join the pro's.

For technical specialists career prospects are good. Forecasts show that job openings in many technical areas are increasing.

In photography a high skill level as a camera repair technician commands a good salary and opens doors to advancement. As with other fields where the jobs are, good training is the key to success. National Camera has successfully trained photo equipment technicians for 25 years. And popular interest in new electronically controlled cameras is helping to create more opportunities than ever for you as a camera technician.

Expand your talents into a new area—work full time or part time, independently or for a wide variety of employers. Learn at home in spare time, or attend intensive training program in Colorado.

- Founded 1952
- Accredited member NHSC, NATTS.
- Approved for Veterans' training.
- Eligible institution.
- Federal financial aid programs.
- Resident training also available.



**National Camera**  
Technical Training Division  
2000 West Union Avenue Dept. 63C  
Englewood, Colorado, 80110 U.S.A.

Return coupon today for free booklet. No salesman will call.

I am interested in  classroom  
 home study  Check here if veteran  
 Please print:

Name \_\_\_\_\_  
 Address \_\_\_\_\_  
 City \_\_\_\_\_  
 State \_\_\_\_\_ Zip \_\_\_\_\_

Send to: National Camera  
 2000 West Union Ave., Dept. GBC  
 Englewood, Colorado 80110

CIRCLE 16 ON FREE INFORMATION CARD

# letters

## TELEPHONE DIALER

I would like to compliment you on the telephone dialer construction article that appeared in the June issue. This is the kind of article that makes me kick myself for not subscribing.

The only thing that I did not like about the article was the size of the PC layout. Printing the foil diagrams half size is inconsiderate of the hobbyist, especially now that there are kits for transferring PC layout from magazine to board. I have no idea how I am going to be able to use the layout published in **Radio-Electronics**. I'll probably end up using it as a guide to construct my own artwork.

Even if I could find a place that would enlarge the layout at a price that I could afford, I would still have a lot of work to do. There are several traces on the layout that seem to have bled together as a result of the reduction.

In summary, thanks for the article but why the heck don't you print foil patterns full size?

K. MATTHEWS  
 Langley, B.C., CANADA

*This very question has been batted around our editorial offices for many moons. Basically, the problem boils down to the fact that we have just so many editorial pages to work with. Within this certain number of pages, we must fit in all our departmental material and our feature articles. Of course, we could gain some space by either cutting down the amount of information that is provided (as is done by one of our competitors) or by printing fewer feature articles. Printing fewer articles means that we might not print the article that would cause you to kick yourself for not subscribing. Obviously, neither of these approaches would work. So we opted for a third approach. That is, to keep the space required for the artwork to a minimum, which creates the problem that you raise.*

*That's the problem and the solution. Believe me, we are not happy with the solution and are constantly searching for a better one. A suggestion was recently made that we might provide full-size artwork to those readers that want it. This, too, has been batted around the office. We're reluctant because we feel it would be unfair to charge our readers for the printing, handling and postage.*

*Perhaps it's time for you to decide what you want rather than for us to decide. So, let's put it to a vote. We can provide full-size printed foil-patterns for about \$2 or full-size photographic film for about \$5. Let us know whether you would want this service or not and whether you would want printed sheets or film. Even if you have a completely different solution, let us know by writing to the Editorial Department, **Radio-Electronics**, 200 Park Ave. So., New York, NY 10003. We'll publish the results in a forthcoming Letters column.—Editor*

## QUAD SCOPE

The article by Stephen Dunifer, "Display Quad Signals on Your Scope," in the June issue, reminded me of a similar circuit I built in 1972.

Your readers might be interested to read of some of my experiences building the scope:

1. Matrix resistors must be closely matched. The exact value is not as important as having resistors of the same value (or as close as you can match them). I selected a group of 5.6K 10% carbon resistors from my "junk box" and used any that fell within a reasonable selected range.

2. When it was put in operation, I found a pattern displaying a very high level signal in one quadrant and a very low level in the diagonal quadrant, compared with the other two quadrants. This was caused by mismatched gain in one section of a bargain-priced dual op-amp. Installing a good IC provided normal operation.

3. Always use IC sockets. It saves wear and tear on both the circuit and one's brain.

4. I used an MC1458 in my final version.

In Mr. Dunifer's article, Fig. 1 has a typographical error at IC2—the "—" voltage should read "—9V." Also, I feel that the reference to Fig. 5 could be clarified by explaining that, when correctly connected, the upper left and right scope quadrants represented the left and right front quad (or stereo), while the lower left and right quadrants represent the corresponding rear quad channels.

Keep up the good work.  
 MAYNARD BERGER  
 Chicago, IL.

## TV TUNER SERVICE

Broken feed-through capacitors that are caused by a technician incorrectly removing the wires from TV tuners has always been a problem for TV tuner services.

It is advisable not to desolder wires from any tuners. Clip them off and resolder, using the least amount of heat and "getting off" the joint as soon as possible.

Not only will your favorite tuner service appreciate the courtesy, but it will save you time and trouble.  
 TED FOSTER  
 Texas Tuner Service  
 Fort Worth, TX

## MAGNET CAN'T "SOLVE ENERGY CRISIS"

In the "Letters Column" in the July 1977 issue, John Ecklin stated "we could solve our energy crisis" by controlling the magnetism of materials.

By reviewing your high school physics book, you'll find that energy is the "ability to do work." Magnetism is a property of  
*continued on page 16*

Let Walter H. Buchsbaum, one of the nation's leading electronics experts, show you

# how 4 easy-to-use troubleshooting techniques can solve 99% of your electronic problems in record time!

Act now. Save \$10.97. Publisher's price: \$12.95.

## Yours for just \$1.98.

Don't spend one minute more than is necessary on any troubleshooting job!

It's not a question of being lazy. It's just a matter of knowing a *sure and quick* way to find the defect. And that's the way you're going to know.

Walter H. Buchsbaum, one of the most respected authorities in electronics, has been collecting surefire troubleshooting methods for many years. From experts. In all areas of electronics. Now he's put the best of them, along with his own proven techniques, into **TESTED ELECTRONICS TROUBLESHOOTING METHODS**.

This book is presently selling for \$12.95. But, now you can have it for just \$1.98. YOU SAVE \$10.97!

It's our way of introducing you to the *Electronics Book Service*, the no-risk book club which is currently keeping over 50,000 technicians, troubleshooters and hobbyists informed of the best, more useful new books in the field of electronics.

**TESTED ELECTRONICS TROUBLESHOOTING METHODS** is typical of the selections we offer members. It gives you solid, expert help on all kinds of troubleshooting problems. It shows you how to *save time—money—and work*.

This is why we have chosen it to introduce you to the *Electronics Book Service*. Join now, as a trial member, and you'll receive your copy of **TESTED ELECTRONICS TROUBLESHOOTING METHODS**—for just \$1.98! This is your *only* financial commitment of membership. For the *Electronics Book Service* is a risk-free book club: As a member, you buy only what you want, when you want, and always at a substantial discount!

When you receive your copy of **TESTED ELECTRONICS TROUBLESHOOTING METHODS**, you'll learn an easy method that reduces the bulk of electronic repair to the simple application of 4 basic troubleshooting techniques. *Four minimum-time, maximum-efficiency procedures that will solve 99% of your electronic repair problems. And with record ease, speed and accuracy.*

- THE SYMPTOM-FUNCTION TECHNIQUE will quickly isolate the defect to a particular part of the equipment. Once you isolate the trouble spot. . .
- THE SIGNAL-TRACING TECHNIQUE will help you find the stage—amplifier—logic gate—or whatever the cause of the trouble.
- THE VOLTAGE-RESISTANCE TECHNIQUE will precisely pinpoint for you the defective component.
- THE VOLTAGE-SUBSTITUTION TECHNIQUE will verify the trouble and, in some types of equipment, find the solution from among the remaining possibilities.

These 4 basic techniques form the foundation for *all* successful troubleshooting. You can use them singly or in combination. They work like magic for all the top-level electronics experts. *And they'll work for you!*

And these 4 techniques aren't the only surefire troubleshooting techniques you'll find in **TESTED ELECTRONICS TROUBLESHOOTING METHODS**. Buchsbaum bring you a *whole battery* of time-saving, work-saving methods

—methods which the nation's most successful electronics experts are using.

For bonuses, Buchsbaum gives you additional guidelines for getting the most out of your equipment. You'll see how to test and calibrate all standard meters. Even how to get the most for your money when you select test equipment.

What's more, you'll discover methods for finding and solving intermittent defects—which are usually hard to find. And for dealing with interference defects—which are often mistaken for component failure.

**TESTED ELECTRONICS TROUBLESHOOTING METHODS** contains over 100 illustrations that simplify these methods and formulas the experts use. You'll have the circuit and block diagrams—tables—charts—schematics—and checklists that make Buchsbaum's troubleshooting techniques easy to apply.

With this battery of simplified troubleshooting techniques, you'll be able to handle all kinds of electronic repair work *quickly—easily—economically*. And without wasting time—doing an unnecessary extra work—or going through endless trial-and-error. For these reasons, **TESTED ELECTRONICS TROUBLESHOOTING METHODS** is a perfect introduction to the . . . **ELECTRONICS BOOK SERVICE**.

The *Electronics Book Service* does a job which you don't have time to do for yourself. We carefully screen the hundreds of books on the subject, select those which are the most useful or which bring you the latest information on technical innovations and improvements of prime importance.

Your membership is an ideal way to keep in touch with the onrushing advances in electronics and its applications—to keep on top of a rapidly changing technology.

As a member, you can build a professional library of superb quality and permanent value—one which will meet your every interest and requirement, always available for you to consult for expert help in any need. And you can acquire this library as quickly or as slowly as you choose.

Remember, the *Electronics Book Service* has no *minimum purchase requirements* as do many book clubs. Once you've paid \$1.98 for **TESTED ELECTRONICS TROUBLESHOOTING METHODS**, you don't need to purchase any further selections!

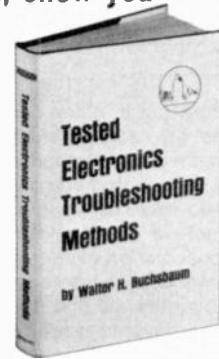

Why delay? Mail the coupon below to get your copy of this \$12.95 handbook for only \$1.98—and to receive all the benefits of membership in the *Electronics Book Service* on a risk-free trial basis. Fill out and mail your coupon right away.

### Here is the practical and efficient way in which the Electronics Book Service operates.

1. When you enroll as a member, you receive—for only \$1.98 (plus postage and handling, with tax where applicable)—your copy of **TESTED ELECTRONICS TROUBLESHOOTING METHODS**. This is the *only* obligation you are committed to make.

2. You are under *no* obligation to accept any minimum number of selections within any time limit. You can take as *many or as few* as you wish. And, you may resign at any time with no obligation once you have paid for your copy of **TESTED ELECTRONICS TROUBLESHOOTING METHODS**.

3. On selections you do accept, your membership entitles you to a discount from the publisher's list price. This discount is available to members only and provides you with substantial savings.

4. Every four weeks we'll send you a free bulletin describing the current selection. If you want the selection, no action is required; it will be shipped to you automatically. If you don't want it, just return the card enclosed with the bulletin.

5. You have at least 10 days to decide whether you want the selection or not. Return the card so we receive it no later than the date specified. If you don't have 10 days to answer and receive an unwanted selection, return it at *our* expense.

6. Each bulletin also describes a number of alternate or additional selections, also available to you at the special discount price for members.

FILL OUT AND MAIL THIS COUPON TODAY.

#### ELECTRONICS BOOK SERVICE

Dept. 6699-M1(7), P.O. Box 42  
West Nyack, N.Y. 10994

Please enroll me in Electronics Book Service on a risk-free trial basis. I am to receive announcements free of charge, and will be entitled to full privileges as a member—without obligation to buy any specific number of club selections. As my first selection under this trial membership, send me **TESTED ELECTRONICS TROUBLESHOOTING METHODS** for only \$1.98 (plus postage and handling, with tax where applicable).

Name \_\_\_\_\_

Address \_\_\_\_\_

City \_\_\_\_\_ State \_\_\_\_\_ Zip \_\_\_\_\_

Offer limited to new members (U.S. and Canada) only

CIRCLE 6 ON FREE INFORMATION CARD

**LETTERS**

*continued from page 14*

some materials (as is color, for example) and has about the same potential for doing useful work as would a change in color.

Mr. Ecklin implies that you can get work from magnetic material, while leaving that material intact—a direct contradiction of the law of conservation of energy. He overlooks the fact that if he wants to lift something with a magnet, he first has to lift the magnet to the elevated position, a procedure that takes at least as much energy as lifting the item itself.

Although it would be indeed delightful to get something for nothing, the laws of nature are not so easily bent to accomplish it.

MARC W. SCHARF  
Kokomo, IN

**RG-8/U COAX DANGEROUS**

There are a number of CB installers headed for possible financial disaster from their use of RG-8/U coax in power leads to CB radios.

RG-8/U is not approved for power wiring due to the low temperature "flow" of its inner insulation and the insulation's "flame" temperature. Using this cable for power leads invites setting the vehicle on fire and a very possible legal judgment against the installer for the vehicle's loss.

If CB installers insist on using RG-8/U

cable for power wiring, even though there is approved shielded power cable available, they should at least install the fuse at the battery and not at the radio.

VERN MOMBERG  
MEG Communications Inc.  
Hood River, OR

**NEW COMPUTER CLUB**

Your readers may be interested to know of our new 50-member computer club.

Monthly meetings are open to anyone with an interest in hobbyist computer systems. Ideas are shared, information exchanged and experiments and problems discussed. The yearly dues of \$5 entitles members to discounts on classes, club purchases and an occasional special program, as well as receiving the monthly newsletter.

For further information, write: Inland Empire Computer Club, Box 1434, Spokane, WA 99210.

STEPHEN L. SALA  
Spokane, WA

**MAGNETIC SEMICONDUCTOR**

John Ecklin's letter in the August 1977 issue prompted me to re-read some of the earlier letters on the same subject. The hypothetical "magnetic semiconductor" in particular is interesting.

Suppose the system shown in Fig. 1 is constructed. The magnetic field blocking screen (a variable permeability device that

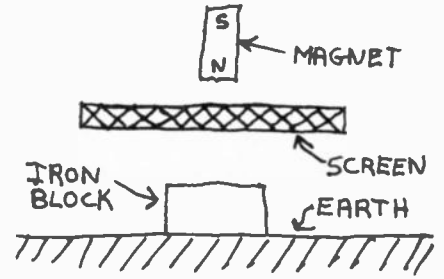

FIG. 1

would "short-circuit" the normal lines of force, thereby removing them from the side opposite the magnet) would be connected to a squarewave oscillator of a suitable frequency. The magnet used would be strong enough to lift the iron block from the ground and then some.

Everything is positioned as shown, and the oscillator turned on. We now have an iron block bouncing up and down. The excess strength in the magnet and the weight of the block would allow a generator or some other device to extract work from the system. Given values for the distances and masses, it should be possible to calculate the minimum power requirements for the screen, based on the law of conservation of energy.

Something like an LED display, with molecules in suspension with an electric charge parallel to their magnetic axis might form such a screen.

ANDREW S. FRASER  
Montreal, Canada

**Treat yourself to a new direct reading DVM today.**



**DVM35**

POCKET PORTABLE  
ANALOG REPLACEMENT  
3-digit, 1% DCV,  
Battery or AC  
Only \$134



**DVM36**

LAB ACCURATE  
POCKET PORTABLE  
3½ digit, .5% DCV,  
Battery or AC  
Only \$158

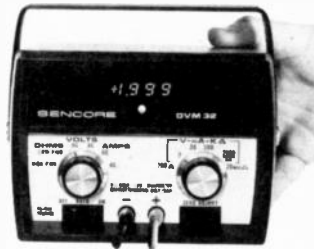

**DVM32**

BENCH & FIELD MASTER  
3½ digit, .5% DCV,  
Battery or AC  
Only \$198



**DVM38**

"PRIME" STANDARD  
AT YOUR FINGERTIPS  
3½ digit, .1% DCV,  
Auto-Ranging  
Only \$348

**A COMPLETE LINE OF DVMs TO FILL YOUR EVERY NEED OR WANT.**

You can be sure more times in more circuits, under more adverse conditions, with greater versatility, accuracy, and meter protection than any other digital multimeters on the market today; and for less money too. 10 Day Free Trial: Try any of these famous DVMs for 10 days. If the DVMs in use don't prove exactly what we say, return them to your Sencore FLPD Distributor.

**SENCORE**

In Canada: Contact Superior Electronics, Quebec

Want more information? We would like to tell you all about the Sencore DVMs by sending you a 24-page Sencore News, a six-page brochure, and the name of your nearest Sencore Distributor today... simply write or circle reader's service number.

3200 Sencore Drive, Sioux Falls, SD 57107

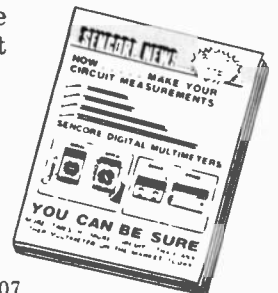



# New Sinclair Cambridge Programmable.

## An astonishing \$29.95!

### How pocket calculators grew up

A couple of years ago, calculators took a step forward. Programmability transformed the slick slide-rule calculator into an advanced scientific machine.

Sadly, it also transformed a cheap little calculating aid into a piece of capital investment.

Now the all-new Sinclair Cambridge Programmable puts programmability where it belongs: in the palm of your hand, for less than \$30.

### The features of the Sinclair Cambridge Programmable

The Cambridge Programmable is genuinely pocketable. A mere 4½" x 2", it weighs about 2oz.

Yet there is absolutely no compromise in the package of functions it offers.

Because the Cambridge Programmable is both a scientific calculator with memory, algebraic logic and brackets (which means you enter a calculation exactly as you write it), and a programmable calculator which offers simple, flexible through-the-keyboard program entry and operation.

The Cambridge Programmable has a 36-step program memory, and features conditional and unconditional branch instructions (go to and go if negative).

There is also a step facility, which allows you to step through the program to check that it has been entered correctly. If there is any programming error, the learn key allows you to correct single steps without destroying any of the remainder of the program.

To achieve this, each program key-stroke has an identifying code, or 'check symbol'. (The symbols for the digit keys are the digits themselves, while the symbols for the operator keys are letters printed beside the keys.)

The check symbol for  $\square$ , for example, is F. So if, as you step through the program, the display shows

check symbol      step number

F 0 0 0 0 2 6

sinclair  
Cambridge Programmable



it means that  $\square$  is programmed as step 26. If step 26 should have been  $\square$ , all you have to do is press



puts machine into 'learn' mode.

the correct step

It's as simple as that!

These facilities make the Cambridge Programmable exceptionally powerful, whether it's running programs you devise for yourself or the programs in the Program Library.

### Use the 294-program library to tailor the machine to your own specialty

Like a full-size computer – and unlike far more expensive specialist calculators – the Sinclair Cambridge Programmable can be programmed to handle calculations concerned with any specialty.

And of course, whatever it's doing the Programmable is error-free – in fact, once it's programmed, it can even be given to an operator who doesn't understand the program!

To save you time, and to help inexperienced programmers, Sinclair have produced a library of 294 programs ready to be entered straight into the calculator.



Using these standard programs, the Cambridge Programmable solves problems from quadratic equations (where the program gives both real and imaginary roots) to twin-T filter design, and from linear regression to bond yields. It even plays a lunar landing game! To realise the full power of the Cambridge Programmable, the Program Library is a must.

(The calculator is supplied with 12 sample programs, and full instructions for entering your own program. The four books in the program library are available at \$4 each, or \$10 for the complete set.)

### Why the Cambridge Programmable costs so little

The Sinclair Cambridge Programmable uses the Sinclair talent for miniaturisation to the full – as you'd expect from the company that pioneered the truly pocketable pocket calculator, and recently introduced the world's first pocket TV.

Chip and circuitry design are unique to Sinclair, and the Cambridge Programmable is assembled by Sinclair's own staff at their headquarters plant. Shipped direct, and sold to you direct, the Cambridge Programmable accumulates no middleman's profits on the way.

The result is a pocket programmable calculator of advanced design, sold by the manufacturer with the manufacturer's own 1-year comprehensive guarantee, at a price unmatched by any comparable calculator.

### 10-day no-obligation offer

There's a lot more to this remarkable calculator than a brief written description can cover.

You need to see it and handle it... to program it yourself in a few seconds to save you hours... to check its performance against tables and graphs... to test the full range of programs available... to evaluate, perhaps, its use as an educational aid in developing a student's computer understanding.

So we're offering a 10-day trial. Send your check or money order with the order form below, and you'll receive a calculator direct. Use it for 10 days, and if you don't feel it's the finest \$29.95 you've ever invested, send it back. We'll refund your money without question.

There's nothing to lose, and so much calculating power to gain.

Post your order today.

# sinclair

Sinclair Radionics Inc., Galleria,  
115 East 57th Street, New York, N.Y. 10022 USA.  
Tel: (212) 355 5005.

To: Sinclair Radionics Inc., Galleria, 115 East 57th Street, New York, N.Y. 10022, USA.

RE-10

Please send me \_\_\_\_\_ (qty) Sinclair Cambridge Programmable(s) at \$29.95 each, including full instructions, and sample programs \$ \_\_\_\_\_

Enclosed is check/MO payable to Sinclair Radionics Inc

\_\_\_\_\_ (qty) AC line adaptor(s) at \$4.95 \$ \_\_\_\_\_

Name \_\_\_\_\_

\_\_\_\_\_ (qty) Program Library Book 1 at \$4 \$ \_\_\_\_\_  
**General/Finance/Statistics**  
(percentage, metric system, memory, games, dates, finance, mortgages, statistics)

Address \_\_\_\_\_

\_\_\_\_\_ (qty) Program Library Book 2 at \$4 \$ \_\_\_\_\_  
**Mathematics** (algebra, calculus, geometry, trigonometry, number theory, transcendental functions)

City \_\_\_\_\_

\_\_\_\_\_ (qty) Program Library Book 3 at \$4 \$ \_\_\_\_\_  
**Physics and Engineering**  
(astronomy, statics and dynamics, relativity, mechanics, properties of matter, fluids, structures, thermodynamics)

State \_\_\_\_\_

\_\_\_\_\_ (qty) Program Library Book 4 at \$4 \$ \_\_\_\_\_  
**Electronics** (networks, circuits, filters, electrodynamics, radiation and propagation)

Zip \_\_\_\_\_

\_\_\_\_\_ (qty) complete set(s) of 4 books at \$10 per set \$ \_\_\_\_\_

(PLEASE PRINT)

Sales tax (NY residents) \$ \_\_\_\_\_

I understand that you will refund purchase price in full if I return calculator(s) and accessories in saleable condition within 10 days of receipt

Post and packing \$ 2.50

Total \$ \_\_\_\_\_

Signature \_\_\_\_\_

---

# At CIE, you get electronics career training from specialists.

**If you're interested in learning how to fix air conditioners, service cars or install heating systems – talk to some other school. But if you're serious about electronics, come to CIE – The Electronics Specialists.**

---

*John E. Cunningham*

**Special Projects Director  
Cleveland Institute of Electronics**

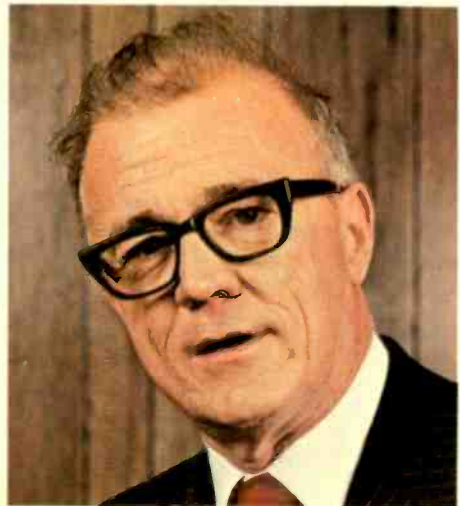

**M**y father always told me that there were certain advantages to putting all your eggs in one basket. "John," he said, "learn to do one important thing better than anyone else, and you'll always be in demand."

I believe he was right. Today is the age of specialization. And I think that's a very good thing.

Consider doctors. You wouldn't expect your family doctor to perform open heart surgery or your dentist to set a broken bone, either. Would you?

For these things, you'd want a specialist. And you'd trust him. Because you'd know if he weren't any good, he'd be out of business.

**Why trust your education and career future to anything less than a specialist?**

You shouldn't. And you certainly don't have to.

**FACT:** CIE is the largest independent home study school in the world that specializes exclusively in electronics.

We have to be good at it because we put all our eggs in one basket: electronics. If we hadn't done a good job, we'd have closed our doors long ago.

**Specialists aren't for everyone.**

I'll tell it to you straight. If you think electronics would make a nice hobby, check with other schools.

But if you think you have the cool—and want the training it takes—to make sure that a sound blackout during a prime time TV show will be corrected in seconds—then answer this ad. You'll probably find CIE has a course that's just right for you!

**At CIE, we combine theory and practice. You learn the best of both.**

Learning electronics is a lot more than memorizing a laundry list of facts about circuits and transistors. Electronics is interesting because it's based on some fairly recent scientific discoveries. It's built on ideas. So, look for a program that starts with ideas—and builds on them.

That's what happens with CIE's Auto-Programmed® Lessons. Each lesson uses world-famous "programmed learning" methods to teach you important principles. You explore them, master them completely... before you start to apply them!

But beyond theory, some of our courses come fully equipped with the electronics gear to actually let you perform hundreds of checking, testing and analyzing projects.

In fact, depending on the course you take, you'll do most of the basic things professionals do every day—things like servicing a beauty of a Zenith color TV set... or studying a variety of screen display patterns with the help of a color bar generator.

Plus there's a professional quality oscilloscope you build and use to "see" and "read" the characteristic waveform patterns of electronic equipment.

**You work with experienced specialists.**

When you send us a completed lesson, you can be sure it will be reviewed and graded by a trained electronics instructor, backed by a team of technical specialists. If you need specialized help, you get it fast... in writing from the faculty specialists best qualified to handle your question.

**People who have known us a long time, think of us as the "FCC License School."**

We don't mind. We have a fine record of preparing people to take... and pass... the government-administered FCC License exams. In fact, in continuing surveys nearly 4 out of 5 of our graduates who take

the exams get their Licenses. You may already know that an FCC License is needed for some careers in electronics—and it can be a valuable credential anytime.

**Find out more! Mail this card for your FREE CATALOG today!**

If the card is gone, cut out and mail the coupon.

I'll send you a copy of CIE's FREE school catalog, along with a complete package of independent home study information.

For your convenience, I'll try to arrange for a CIE representative to contact you to answer any questions you may have.

Remember, if you are serious about learning electronics... or building upon your present skills, your best bet is to go with the electronics specialists—CIE. Mail the card or coupon today or write CIE (and mention the name and date of this magazine), 1776 East 17th Street, Cleveland, Ohio 44114.



Patterns shown on TV and oscilloscope screens are simulated.

**CIE Cleveland Institute of Electronics, Inc.**  
1776 East 17th Street, Cleveland, Ohio 44114  
Accredited Member National Home Study Council

**YES...** John, I want to learn from the specialists in electronics—CIE. Send me my FREE CIE school catalog—including details about troubleshooting courses—plus my FREE package of home study information. **RE-19**

Print Name \_\_\_\_\_

Address \_\_\_\_\_ Apt. \_\_\_\_\_

City \_\_\_\_\_

State \_\_\_\_\_ Zip \_\_\_\_\_

Age \_\_\_\_\_ Phone (area code) \_\_\_\_\_

Check box for G.I. Bill Information:  Veteran  Active Duty

**Mail today!**

# no strings attached

Visit Booths G23 & G25  
NEW/COM '76



**NEW Weller®**  
**CORDLESS**  
**SOLDERING IRON...**  
**GOES ANYWHERE**

Weller's WC-100 . . . the professional quality, feather-light cordless. Lets you make connections anywhere. Without AC cord and outlet.

Fingertip touch on exclusive sliding safety switch activates long-life, nickel-cadmium battery. Heats tip to over 700°F in 6 sec. Locks in "off" position to prevent accidental discharge in use or while restoring energy with fast-power recharger (UL listed).

Simple, instant change to any of 4 tips. . . for any job. Built-in light focuses on tip and work area.

Get this! It's at your dealer or distributor now. . . waiting for you. Need more info first? Request literature.

**Weller-Xcelite**  
**Electronics Division**



**The Cooper Group**

P. O. BOX 728,  
APEX, NORTH CAROLINA 27502

CIRCLE 22 ON FREE INFORMATION CARD

## equipment reports

### Fluke Model 8020A Digital Multimeter



CIRCLE 90 ON FREE INFORMATION CARD

THE JOHN FLUKE MANUFACTURING CO., INC., PO Box 43210, Mountlake Terrace, WA 98043, has been making high-quality test equipment for a long time. They specialize in high-precision lab-type instruments, especially digital voltmeters. Their latest product, model 8020A, is a compact, versatile and accurate digital multimeter.

Despite its small size, the model 8020A is a true multimeter. It reads AC/DC voltages, current and resistance and has a 10-megohm/100-pF input impedance. Its accuracy is 0.25% for AC voltages. The 3.5 digit LCD readout has 0.5-inch-high digits, readable at any practical distance.

It will also perform tricks that some other DMM's can't! It will read conductance directly on two ranges: 2 millisiemens and 200 nano-siemens. (A siemens is the new international unit of conductance, once called an mho. It represents the reciprocal of resistance, or 1/R.) Reading the conductance gives the effect of increasing the resistance range to 10,000 megohms. A simple chart in the instruction manual shows you how to do this. There's no trigger-work involved. Just take the reading and look it up. We tried it out on a couple of high-voltage multiplier resistors of 400 and 800 megohms, and it works.

The same function, with a simple adapter made of a SPDT switch, two banana plugs, a 750K resistor and a transistor socket allows you to check transistors for type, open, shorts, and also gives you a direct reading of the  $I_{CES}$  leakage and the  $\beta$ ! This procedure is really simple. Look at the reading and move the decimal point three places to the right. A reading of .125 means the transistor has a  $\beta$  of 125.

The regular ohms ranges of the model 8020A are set up to make our favorite "high one way, low the other" transistor tests easy.

The unit has six ohms ranges, and every other one is a high-power range that will turn on a transistor junction. These high-power ranges are plainly marked with a diode symbol. The low-power ohms ranges in between permit in-circuit tests without turning on transistors or diodes.

The AC volts ranges can be read with accuracy up to 5 kHz. The readout is RMS for sinewaves. Since waveforms other than sinewaves cause errors, the manual includes a very detailed chart that shows practically every possible waveform from a half-wave rectified AC to a sharp pulse and even a triangle wave. Also shown are peak, peak-to-peak, average and RMS voltages that will be read out; the duty-factor correction for pulses is also indicated.

This type of correction is also included for the current ranges. If the reading must be very precise, you can read the "burden voltage" (the actual drop across the shunt in use), and find the correction factor that must be added to the reading to get the true current. Another very handy chart in the manual shows exactly which buttons to push to set up on any given range or function. This was helpful when we were trying to get the conductance test to work. It *does* pay to read the instruction book!

(Incidentally, an LCD readout shows up brighter in bright light. In a room so dark the panel could barely be seen, the digits were still visible.)

The heart of the model 8020A is a special CMOS-LSI IC that can do everything except walk the dog. Every one of the analog and digital functions are in this IC. It also includes the crystal-controlled clock, which has 3.84-MHz crystal to provide all clock signals. The model 8020A uses dual-slope integration. The crystal clock provides almost complete freedom from any AC line interference.

This is an autopolarity-type DMM. A normal readout means that the hot lead is positive. A negative voltage is indicated by a minus sign to the left of the readout. For overload readings, only the left-hand "1" digit is lit, which is also the normal open-circuit reading for the ohmmeter ranges. Decimal-point placement is also automatic on all ranges. The ohms range reads out kilohms; a full-scale reading of "2" (actually "1.999") means 2000 ohms.

All of the switching is done by eight push-buttons. There are six range pushbuttons that are interlocked. However, the CONDUCTANCE pushbutton and any one of the remaining five range pushbuttons can be locked down at once, which is necessary for the conductance tests. Another pushbutton selects either AC or DC measurement and the final pushbutton selects either milliampere/volts or 1000k ohms/nano-siemens.

The ON-OFF switch is a slide type, located on the upper left-hand side of the case, right under your thumb when you hold it in the normal way (or under your forefinger if you happen to be left-handed).

The model 8020A is powered by one No. *continued on page 24*

# Bearcat<sup>®</sup> 210

# \$289.



## Bearcat<sup>®</sup> 210 Features

- **Crystal-less**—Without ever buying a crystal you can select from all local frequencies by simply pushing a few buttons.
- **Decimal Display**—See frequency and channel number—no guessing who's on the air.
- **5-Band Coverage**—Includes Low, High, UHF and UHF "T" public service bands, the 2-meter amateur (Ham) band, plus other UHF frequencies.
- **Deluxe Keyboard**—Makes frequency selection as easy as using a push-button phone. Lets you enter and change frequencies easily... try everything there is to hear.
- **Patented Track Tuning**—Receive frequencies across the full band without adjustment. Circuitry is automatically aligned to each frequency monitored.
- **Automatic Search**—Seek and find new, exciting frequencies.
- **Selective Scan Delay**—Adds a two second delay to prevent missing transmissions when "calls" and "answers" are on the same frequency.
- **Automatic Lock-Out**—Locks out channels and "skips" frequencies not of current interest.
- **Simple Programming**—Simply punch in on the keyboard the frequency you wish to monitor.
- **Space Age Circuitry**—Custom integrated circuits... a Bearcat tradition.
- **UL Listed/FCC Certified**—Assures quality design and manufacture.
- **Rolling Zeros**—This Bearcat exclusive tells you which channels your scanner is monitoring.
- **Tone By-Pass**—Scanning is not interrupted by mobile telephone tone signal.
- **Manual Scan Control**—Scan all 10 channels at your own pace.
- **3-Inch Speaker**—Front mounted speaker for more sound with less distortion.
- **Squelch**—Allows user to effectively block out unwanted noise.
- **AC/DC**—Operates at home or in the car.

## Bearcat<sup>®</sup> 210 Specifications

### Frequency Reception Range

Low Band	32—50 MHz
"Ham" Band	146—148 MHz
High Band	148—174 MHz
UHF Band	450—470 MHz
"T" Band	470—512 MHz

\*Also receives UHF from 416—450 MHz

### Size

10 1/2" W x 3" H x 7 1/2" D

### Weight

4 lbs. 8 oz.

### Power Requirements

117V ac, 11W; 13.8 Vdc, 6W

### Audio Output

2W rms

### Antenna

Telescoping (supplied)

### Sensitivity

0.6µv for 12 dB SINAD on L & H bands

U bands slightly less

### Selectivity

Better than -60 dB @ ± 25 KHz

### Scan Rate

20 channels per second

### Connectors

External antenna and speaker; AC & DC power

### Accessories

Mounting bracket and hardware

DC cord

The Bearcat<sup>®</sup> 210 is a sophisticated scanning instrument with the ease of operation and frequency versatility you've dreamed of. Imagine, selecting from any of the public service bands and from all local frequencies by simply pushing a few buttons. No longer are you limited by crystals to a given band and set of frequencies. It's all made possible by Bearcat spaceage solid state circuitry. You can forget crystals forever.

Pick the 10 frequencies you want to scan and punch them in on the keyboard. It's incredibly easy. The large decimal display reads out each frequency you've selected. When you want to change frequencies, just enter the new ones.

Automatic search lets you scan any given range of frequencies of your choice within a band. Push-button lockout permits you to selectively skip frequencies not of current interest. The decimal display with its exclusive "rolling zeros" tells you which channels you're monitoring. When the Bearcat 210 locks in on an active frequency the decimal display shows the channel and frequency being monitored.

With the patented track-tuning system, the Bearcat 210 automatically aligns itself so that circuits are always "peaked" for any broadcast. Most competitive models peak only at the center of each band, missing the frequencies at the extreme ends of the band.

The Bearcat 210's electronically switched antenna eliminates the need for the long low band antenna. And a quartz crystal filter rejects adjacent stations as well as noise interference.

Call toll-free 800-521-4414 now to place a BankAmericard or Mastercharge order. This is our 24 hour phone to our order department and only orders may be processed on this line. To order in Michigan or outside of the U.S. dial 313-994-4441.

Add \$5.00 for U.S. shipping or \$9.00 for air UPS to west coast. Charge cards or money orders only please. International orders invited. Michigan residents add tax. Please write for quantity pricing.

**COMMUNICATIONS  
ELECTRONICS**

Box 1002 Dept. 501  
Ann Arbor, Michigan 48106 USA



1604 9-volt battery. The specifications list a service life of 200 hours with an alkaline battery, or up to 150 hours with a carbon-zinc battery. For bench use, the *model A81 AC* adapter can be plugged into a socket on the right-hand side of the case. This adapter is available in 110-, 115-, or 230-volt inputs, or in 230 volts with the European-type line plug.

If the battery is low, the letters **BT** appear on the display at the upper left. However, you've still got time to finish the job, since this readout means that there are about 20 hours of battery life left. A padded carrying case is available, with pockets for the test leads and even the instruction card.

Also available are accessory probes to let you use the unit in many other applications. An AC clamp-on adapter (*model 801-600*) permits AC current readings up to 600 amperes. A high-voltage probe (*model 80K-40*) extends the range to 40 killivolts DC, or 28 killivolts RMS AC. The RF probe (*model 81RF*) reads RF voltages from 100 kHz to 100 MHz with a  $\pm 1.0$ -dB accuracy. It can be used up to 250 MHz for relative readings. The universal temperature probe (*model 80T-150*) converts the *model 8020A* to an accurate thermometer covering a wide range from  $-50^{\circ}$  to  $+150^{\circ}\text{C}$  ( $-58^{\circ}$  to  $+302^{\circ}\text{F}$ ). This probe has a special fast-response sensor, so that no surface preparation is needed, which is very

useful for finding hot spots, checking the case temperature of suspect transistors, etc.

The *model 8020A* uses very sensitive CMOS technology; however, the whole circuit is well protected against accidental overloads, transients and all the catastrophes that can strike unprotected testers. Even the ohms ranges are protected against applications up to 300 volts DC. Voltage ranges are protected against overloads up to 1000 volts, and 2 amperes on the current ranges. In addition, special protection against transients is provided, up to 6 killivolts on all functions. This could be very useful in TV repair or in other situations where transients are commonly experienced.

Here's the best feature of all. Many high-precision DMM's also have high prices. The *model 8020A* is in the affordable area, at \$169.00, complete with battery and test leads. The accuracy of this instrument makes it suitable even for fields such as avionics, where 0.25% readings are required by the FAA and others.

I must also say a kind word about the instruction manual. It is written in plain English! Charts and illustrations are clearly drawn, with a very complete coverage of everything that is needed. The back pages have full instructions for calibration and maintenance tests, a schematic and chassis layout and a parts list. In fact, even a printed label is included so that you can send the instrument to the nearest Fluke service center! A list of these world-wide service centers is included with the meter.

All in all, the *model 8020A* is an impressive piece of test equipment. **R-E**

## Heath SG-1272 Low-Distortion Audio Generator

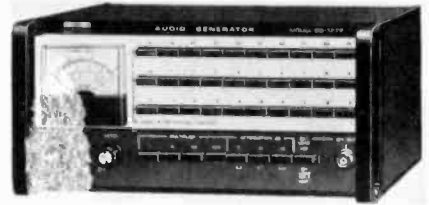

**CIRCLE 50 ON FREE INFORMATION CARD**

THE HEATH COMPANY HAS DEVELOPED AN audio signal generator, *model SG-1272*, that produces low-distortion sinewaves with good stability. The distortion rating is 0.1% from 10 to 40 Hz; 0.04% from 40 Hz to 20 kHz; and rises to 0.1% at 100 kHz!

The output is really flat; within  $\pm 0.2$  dB from 20 Hz to 100 kHz. We fed the output into a wideband oscilloscope and checked for flatness. The result was that the amplitude at 100 kHz was the same as at about 40 Hz. The sinewave displayed at the maximum frequency showed no visible distortion.

The *SG-1272's* output voltage is constantly metered and fully adjustable to a maximum of 10 volts RMS. A **LEVEL** control adjusts the output to any desired level. Three pushbutton attenuators on the panel provide precision-control of the output. These attenuators total 70 dB in 10-, 20- and 40-dB steps, or 0.3%, 0.1% and 0.01% of the voltage. For example, set the meter to 10 volts and depress the 10-dB pushbutton. The output voltage will then drop  
*continued on page 26*



# Special Bonus Offer!

A P Terminal and Distribution Strips for Faster and Easier solderless circuit building and testing. No special patch cords are required, and any solid wire up to No. 20 AWG can be used for connection. Strips accept all components with leads up to .032" diameter, and hardware and mounting templates are provided with every strip. Terminals are non-corrosive nickel/silver.

For the name of the distributor nearest you call Toll-Free 800-321-9668.

Send for our complete A P catalog The Faster and Easier Book.

**Faster and Easier is what we're all about.**

Buy this Model 264L **TERMINAL STRIP**, with 128 five-tie-point terminals, #923261 for only **\$12.50**.

And get this Model 212R **DISTRIBUTION STRIP**, with 24 four-tie-point terminals, #923277 **FREE** of added cost.

Free offer also applies to other sizes.

**Look for the Special Bonus Offer Display at your A P distributor.**

\*Special bonus offer expires 12/31/77



## A P PRODUCTS INCORPORATED

Box 110 • 72 Corwin Drive, Painesville, Ohio 44077 • 216/354-2101 TWX: 810-425-2250

# ELECTRONICS BOOK CLUB

invites you to take this 1040-page tube/transistor/IC substitution library for only

\$ **1.99**



**MASTER TUBE SUBSTITUTION HANDBOOK**

**TOWERS' INTERNATIONAL TRANSISTOR SELECTOR 2ND EDITION**

**You Get All Three Of These Huge Books For Only \$1.99**

## MASTER TRANSISTOR/IC SUBSTITUTION HANDBOOK

A GIANT one-stop, easy-to-use manual that gives you commonly available replacements for over 60,000 U.S. and foreign transistors and ICs, plus basing diagrams. This super-colossal 518-page S/DX-IN-ONE guidebook at your one-stop cross reference list for the simplified replacing of over 80,000 transistors and integrated circuits labeled with manufacturer's parts numbers. It's a single replacement guide for most any repair job you'll ever encounter! Now you can quickly look up virtually ANY part number—be it American, European, Japanese, Taiwanese, or whatever—and immediately find out which of the six major manufacturers of general replacement parts makes it. And, even more than that, you can also check out the basing diagrams for all listed units from the 165 illustrations provided. Not only is this master substitution guide an absolute necessity for most any kind of repair job, it's also a perfect reference for kit builders, experimenters, hams, engineers, and hobbyists. If you're into electronics in any capacity whatsoever, this gargantuan guide is a must to help you keep abreast of the ever-increasing number of new transistors and ICs. Master Transistor/IC Substitution Handbook is an ALL NEW cross-reference guide, painstakingly and meticulously researched and compiled by electronics experts to give you just the kind of easy-to-use manual you've needed and have been waiting for. Every entry is cross-referenced to the closest available substitutes made by leading manufacturers of replacement parts. 518 pgs., 165 illus.

## MASTER TUBE SUBSTITUTION HANDBOOK

A brand-new 3-Section handbook covering 99% of tube replacement needs. Includes receiving, transmitting, commercial, industrial, and foreign tubes... plus base diagrams and B&W and color CRTs. This unique, just-published, quick-reference substitution guide is designed to fit into a slot in your tube caddy, or on your workbench. Compiled by experienced technicians who have your problems in mind, it's a straightforward, no-nonsense volume that arms you with a fast, effective, and reliable means of repairing vacuum-tube equipment. It lists the best substitutes for 99% of the tubes you'll ever need to replace, including those "I-never-heard-of-it" foreign types. Moreover, only readily-available and comparably-priced substitutes are listed—no need for you to search through lists of tubes you'll rarely see in use, or search through pages of irrelevant material to find a substitute. This brand-new fingertip sourcebook contains 3 BKG Sections. Section 1 provides you with a cross-reference of all popular vacuum tubes and their variations, listing substitutes which have similar or superior characteristics. For your convenience, the preferred substitute is listed separately from good substitutes you may use. Section 2 illustrates 576 base diagrams for the applicable tubes in Section 1. Each diagram is listed in alphanumeric order for ease of reference. Section 3 contains a complete listing of both monochrome and color TV picture tubes and substitutions. Detailed notes are included so you can tell at a glance how to fit the tube to the chassis, how to make any necessary wiring changes, chassis alterations, and cabinet modifications, plus matrix tube identification, etc. 322 pgs., 576 illus.

## TOWERS' INTERNATIONAL TRANSISTOR SELECTOR—2ND EDITION

Transistor substitutions, outline diagrams, terminal identifications, manufacturers' codes, and specs for more than 13,000 devices manufactured in the U.S., Japan, Continental Europe, and the United Kingdom. If you want data on a specific transistor, for which you know only the type number, or if you want to know which supplier makes it, or if you need a good substitute, or if you want the complete specifications for any given transistor, there's really only one practical source of data: Towers' International Transistor Selector. This brand-new and completely updated edition is an ultra-complete reference guidebook which is an absolute MUST for anyone who deals with transistors or the equipment in which they're used. This comprehensive volume makes it as easy to locate transistor substitutes for Japanese and European imports as for mass-market U.S. consumer electronic products. And that's not all! This transistor compendium is a comprehensive tabulation of more than 13,000 individual bipolar transistor specifications, with accurate, reliable information on device ratings, characteristics, case details, terminal identifications, applications, manufacturers (domestic and foreign) and their addresses. From start to finish, the emphasis is on practicality. So, you won't see page after page of meaningless engineering data you'll never use. What you WILL see are the kinds of facts you HAVE to know to understand the functional applications of the devices listed. 200 pgs., 7" x 10"

✓ Only \$1.99 for all three!

✓ Regular List Price \$30.85.

✓ Top-Quality Binding

✓ Lists over 125,000 units

✓ Covers 99% of your needs

✓ Includes U.S. & Foreign devices

✓ 1040 data-packed pages

with a Trial Membership in the Book Club that Saves you 25% to 75% on a wide selection of electronics books

Let us send you these three practical, time-and-money-saving books as part of an unusual offer of a Trial Membership in Electronics Book Club.

Here are quality leatherette-bound volumes, each especially designed to help you increase your know-how, earning power, and enjoyment of electronics.

These handsome, hardbound books are indicative of the many other fine offerings made to Members...important books to read and keep...volumes with your specialized interest in mind.

Whatever your interest in electronics—radio and TV servicing, audio and hi-fi, industrial electronics, communications, broadcasting, electronics as a hobby—you will find Electronics Book Club will help you get the job you want, keep it, improve it, or make your leisure hours more enjoyable. With the Club providing you with top quality books, you may broaden your knowledge and skills to build your income and increase your enjoyment of electronics, too.

This Special Offer is just a sample of the help and generous savings the Club offers you. For here is a Club devoted exclusively to seeking out only those titles of direct interest to you. Members are annually offered over 50 authoritative books on all phases of electronics.

This extraordinary offer is intended to prove to you, through your own experience, that these very real advantages can be yours...that it is possible to keep up

with the literature published in your areas of interest, and to save substantially while so doing. As part of your Trial Membership, you need purchase as few as four books during the coming 12 months. You would probably buy at least this many anyway...without the savings offered through Club Membership.

To start your Membership on these attractive terms, simply fill out and mail the coupon today. You will receive the 3-volume Substitution Library for 10-day inspection. YOU NEED SEND NO MONEY! If you are not delighted, return them within 10 days and your Trial Membership will be cancelled without cost or obligation.

ELECTRONICS BOOK CLUB, Blue Ridge Summit, Pa. 17214

**TYPICAL CLUB SELECTIONS (and List/Club prices)**  
 Microprocessor/Microprogramming Handbook \$9 95/\$5.95—  
 VHF/UHF Fire, Police, Ham Scanners Service Manual \$9 95/\$5.95—Modern Guide To Digital Logic \$9 95/\$5.95—CB Radio Schematic/Service Manuals—3 Volumes \$26 85/\$8.95—Color TV Trouble Factsheet \$9 95/\$4.95—CBB's Handbook Of Simple Hobby Projects \$6 95/\$3.95—Modern Electronics Math \$12 95/\$8.95—Electronic Music Circuit Guidebook \$9 95/\$5.95—Build Your Own Working Rebel \$8 95/\$5.95—Intro to Medical Electronics \$9 95/\$8.95—21 Simple Transistor Radios You Can Build \$6 95/\$3.95—Ham Radio Advanced Class License Study Guide \$8 95/\$4.95—Aviation Electronics Handbook \$11 95/\$7.95—Practical CB Radio Repair \$8 95/\$5.95—Radio Astronomy for the Amateur \$8 95/\$5.95

### Facts About Club Membership

- The 3 introductory books carry a publisher's retail price of \$30.85. They are yours for only \$1.99 (plus postage and handling) with your Trial Membership.
- You will receive the Club News, describing the current Selection, Alternates, and other offerings every 4 weeks (13 x a year).
- If you want the Selection, do nothing: it will be sent to you automatically. If you do not wish to receive the Selection, or if you want to order one of the many Alternates offered, you simply give instructions on the reply form (and in the envelope) provided, and return it to us by the date specified. This date allows you at least 10 days in which to return the form. If, because of late mail delivery, you do not have 10 days to make a decision and so receive an unwanted Selection, you may return it at Club expense.
- Personal service for your account—no computers used!
- To complete your Trial Membership, you need buy only four additional monthly selections or alternates during the next 12 months. You may cancel your Membership any time after you purchase these four books.
- All books—including the introductory Offer—are fully returnable after 10 days if you're not completely satisfied.
- All books are offered at low Member prices plus a small postage and handling charge. Prepaid orders shipped postpaid.
- **Continuing Bonus:** If you continue after this Trial Membership, you will earn a Dividend Certificate for every book you purchase Three Certificates, plus payment of the nominal sum of \$1.99, entitles you to a valuable Book Dividend of your choice which you may choose from a list provided Members.

## ELECTRONICS BOOK CLUB

Blue Ridge Summit, Pa., 17214

Please open my Trial Membership in ELECTRONICS BOOK CLUB and send my 3-volume Substitution Library, invoicing me for only \$1.99 plus shipping. If not delighted, I may return the books within 10 days and owe nothing, and have my Trial Membership cancelled. I agree to purchase at least four additional books during the next 12 months, after which I may cancel my Membership at any time.

Name \_\_\_\_\_ Phone \_\_\_\_\_

Company \_\_\_\_\_

Address \_\_\_\_\_

City \_\_\_\_\_

State \_\_\_\_\_ Zip \_\_\_\_\_

(Valid for new Members only. Foreign and Canada add 16%) RE-107

CIRCLE 31 ON FREE INFORMATION CARD

# BENCH PERFORMANCE IN YOUR POCKET



**LIMITED TIME OFFER**  
only **\$9900**  
at participating Hickok distributors

The Hickok Model 239 color bar generator has an exclusive MOS LSI chip which provides 9 Rock Stable patterns and low battery drain.

- Simplified operation with 2 matrix slide switches.
- Crystal controlled chroma and timing oscillators.
- RF adjustable Channels 2-4.
- Powered by 2 standard 9v batteries.

Plus our unique 2-year warranty.

The Hickok Pocket Model 239 or our deluxe bench Model 246 are values you have to see to appreciate. See them at your Hickok distributor or contact us for more information.

~~12900~~

## HICKOK

the value innovator

INSTRUMENTATION & CONTROLS DIVISION  
THE HICKOK ELECTRICAL INSTRUMENT CO.  
10514 Dupont Avenue • Cleveland, Ohio 44108  
(216) 541-8060 • TWX: 810-421-8286

CIRCLE 7 ON FREE INFORMATION CARD

## EQUIPMENT REPORTS

continued from page 24

to 0.3% of the meter reading, or 3.33 volts.

A 0- to 3-volt scale reads the lower voltages. For example, to feed a 50-mV signal to the input of a high-gain amplifier, just set the LEVEL control to 5 volts on the meter and depress the 40-dB pushbutton. The output signal will be  $5 \times .01$ , or .050 volt (50 mV).

The model SG-1272 output signal is fed to an internal 600-ohm load. The meter reads the true voltage across this load; external loads can be used by pushing the LOAD/SELECTOR switch near the output jack.

Three rows of 10-position pushbuttons, (0-90, 0-9 and 0-0.9) select the output frequency. At the bottom of the panel are four interlocked MULTIPLIER pushbuttons (marked  $\times 1$ ,  $\times 10$ ,  $\times 100$  and  $\times 1000$ ). A desired frequency can be obtained by pushing the frequency selection pushbuttons and then the multiplier. For example, for a 1,000-Hz frequency, press pushbuttons 90, 9 and 0.9 and the  $\times 10$  multiplier; the result is 999.9 Hz, a close enough approximation. When the controls were set to the extreme upper limit of 100 kHz, the frequency counter read 99.999 kHz, changing to 100000 periodically. This upper-limit reading was stable.

To use the model SG-1272 as a continuously variable frequency generator, press all three "0" pushbuttons simultaneously. The output frequency can now be controlled by the VARIABLE FREQUENCY control (on the panel near the LEVEL control) together with the multiplier switches.

The oscillator circuit used in the model SG-1272 is a Wien-bridge type. The precision-frequency selection is made possible by using extremely high-precision IC resistor packs. One resistor pack is used with each selector-switch deck, along with 1% capacitors.

A special output jack on the rear panel feeds external sync to a scope, and provides a sample of the output frequency for triggering.

The circuit is powered by a transformer-isolated, dual-voltage DC supply. A slide switch on the rear panel sets the transformer primary for either a 120-volt or a 240-volt input. The -24- and +24-volt DC supplies are tightly controlled by separate IC voltage regulators. The oscillator frequency is stabilized by heavy negative feedback.

The model SG-1272 comes in a metal and plastic cabinet, with handles that also protect the controls. All controls are conveniently placed for easy operation. **R-E**

### B&K Model 530 Semiconductor Tester

THE B&K DIVISION OF DYNASCAN HAS BEEN making semiconductor testers for some time, using their "Dynapeak" circuit. The top of the line, model 530, the latest and most elaborate, uses the basic Dynapeak transistor test system. It locates base connections and identifies them, at the same time testing the transistor for type and quality. All this is done by moving the six-position test switch through all positions.

The device under test can be plugged into a socket on the panel, or hooked up to three color-coded test leads with clips. Once it's



CIRCLE 91 ON FREE INFORMATION CARD

hooked up, all tests except  $F_t$  may be made by moving switches. The dual LED indicators tell whether it is PNP or NPN, and good. For in-circuit testing, an audible beep is heard when you hit the right switch position. This can be turned off if not needed.

Beside the clips, a special probe, FP-5 Dynaflex, may be used for on-the-board tests, especially if the transistors are identified in any way. Once again, all you have to do is make contact to each transistor terminal. The FP-5 has three color-coded, very sharp ball-joint pins, that are spring-loaded. Push them onto the transistor connections with one hand, and move the switch with the other. You don't have to look up if you're using the beeper. When you hit the right connections, the little window on the panel by the switch shows which color lead is on each element.

The model 530 indicates whether a device is a bipolar transistor or an FET, in- or out-of-circuit. The typical bipolar transistor will give an indication in either HI or LO drive, in switch two positions. In LO drive, only one position will give an indication. (Most bipolar transistors will show a small gain with emitter and collector reversed.) However, FET's will show good in two test positions having the same base color (FET gate) because practically all junction FET's are symmetrical. The Dynapeak system uses two "Drive" positions: One HI and one LO. In HI, enough drive is available to turn on transistors in-circuit with more than 10-ohm shunt resistance. The drive voltage is applied with a 3% duty cycle, so that you cannot damage a transistor by excessive conduction.

With the transistor hooked up and identified, out-of-circuit, you can make a great many tests by switching. You can read all kinds of breakdown voltages and leakage currents:  $BV_{CES}$ ,  $I_{CES}$ ,  $BV_{CBO}$ ,  $I_{CEO}$ ,  $BV_{ECS}$ ,  $I_{ECS}$ ,  $BV_{ECO}$ ,  $I_{ECO}$ ,  $BV_{EBO}$  and  $I_{EBO}$ . Simply set the switches as described in the instruction manual. Leakage is read on a meter with a special nonlinear scale: It starts out at 10 microamps per division, and ends with a full-scale reading of 5 mA. The beta or  $g_m$  can be read on dual HI-LO scales below.

Beta readings can be made for comparison, for example, a direct-coupled driver transistor in an audio output stage. You can take the one out of the working channel and read its beta, then select a replacement with the same beta. A mismatched driver transistor can honk up the bias on an output transistor and cause trouble.

For working with VHF or UHF stages, the model 530 provides a separate test for  $F_t$ , the gain-bandwidth product. A direct reading is obtained of the actual  $F_t$ , which is the maximum frequency this transistor will amplify. Three ranges are used: 0-100 MHz, 0-500

continued on page 32



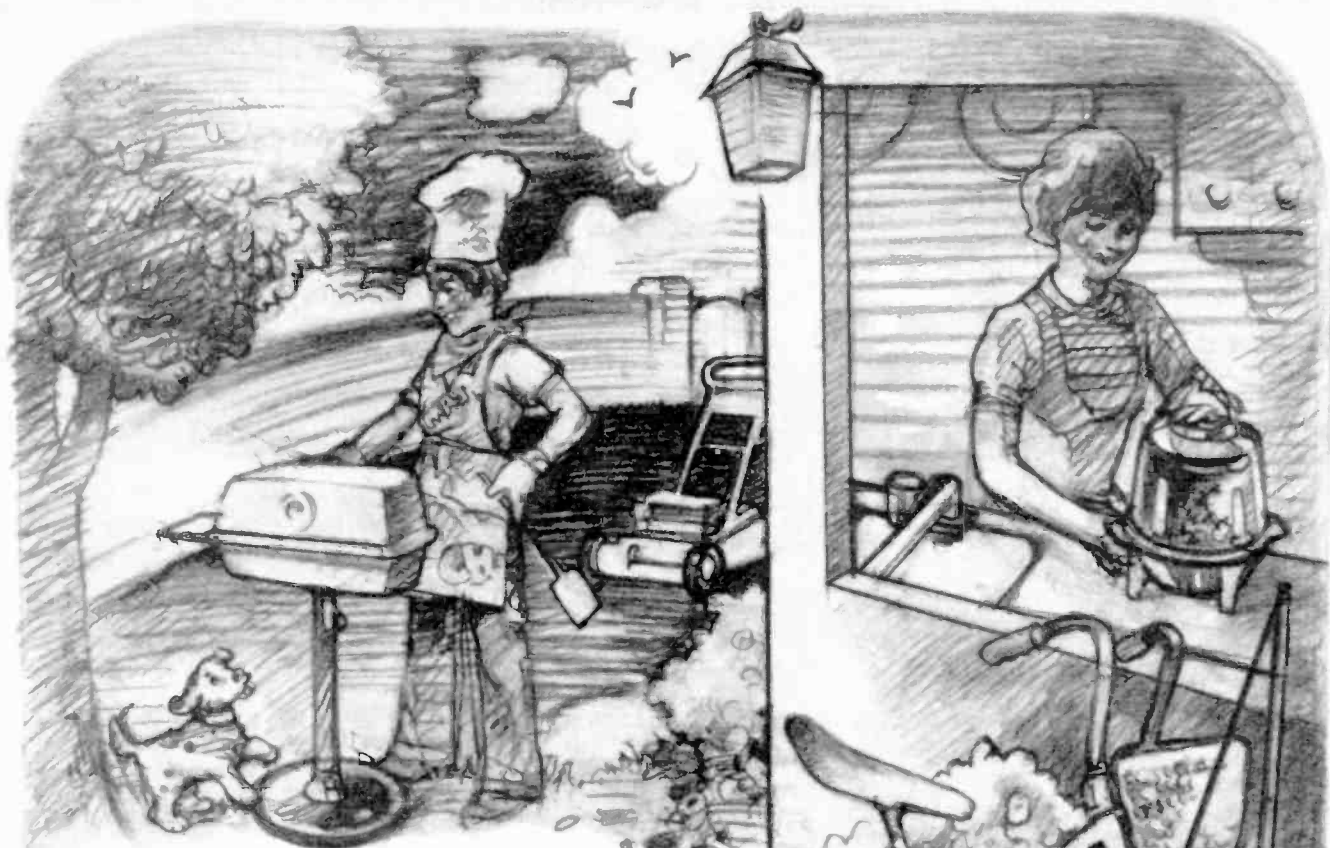

# How many things can you find on this page that start with Sylvania tabs?

You won't have to look very hard. Almost everything you see can come from saving address tabs from Sylvania receiving tube cartons and labels from picture tubes.

The new "Keep Tabs on Sylvania" awards program is now under way, and this year it's even easier to build up a high score. You get a bonus of 50 extra tabs for each Color Bright 85° picture-tube serial number label and 10 extra tabs for every label from other Sylvania color tubes. Pick up your Award Catalog and special tab-saver envelope at your local Sylvania distributor and start collecting your tabs, now.

Put your tabs and award order form in the mail by Nov. 30, 1977 and you'll be able to find a lot of the things in the picture right in your own backyard.

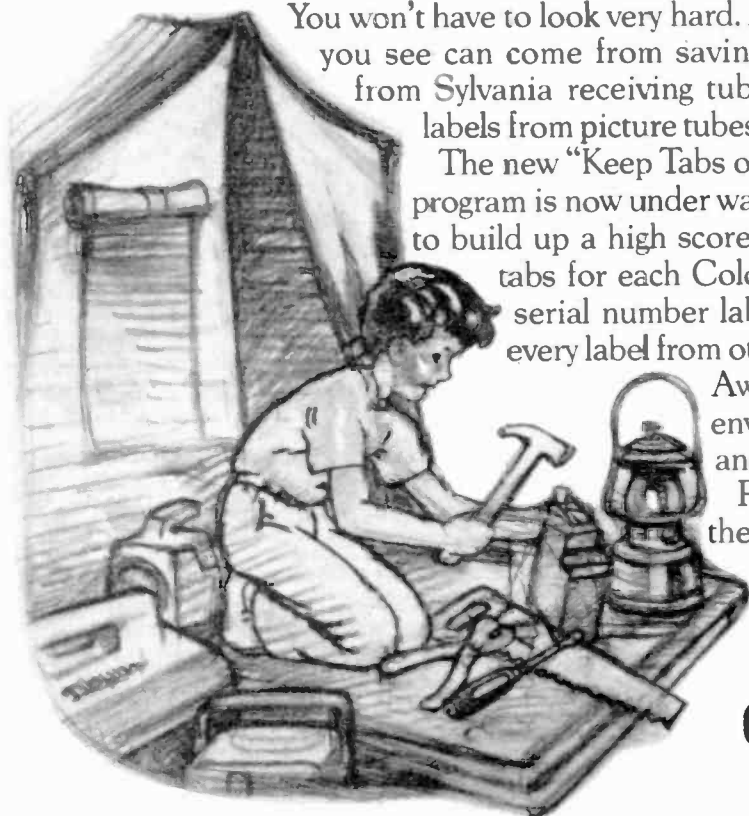

**GTE SYLVANIA**



# they're here!

## the new HEATHKIT<sup>®</sup> Computers... plus exciting new kits for fall!



GD-1186  
Digital  
Scale Kit  
\$99<sup>95</sup>

The new Heathkit Fall catalog has a lineup of new products for just about every interest. Along with our complete line of personal computer systems and accessories, you'll find interesting and useful products for your home, your hi-fi system, your test or hobby bench. Learn more about these exciting new kits YOU can build — send for your FREE Heathkit catalog today!

**NEW H8 8-Bit Computer.** The 8080A based machine with the "intelligent" front panel. 9-digit readout and keypad entry make it one of the easiest-to-use personal computers available today!

**NEW H11 16-bit Computer.** Heath, world leader in kit form products, and Digital Equipment Corporation, world leader in minicomputers, combine to bring you the ONLY 16-bit personal computer priced within reach of the general public. Based on the powerful LSI-11.

**NEW H9 CRT Terminal.** General-purpose peripheral for use with the H8 or H11 or others. Has long and short-form display, 80-character lines, full ASCII keyboard, auto-scrolling, plot mode and more. An excellent terminal value.

**NEW H10 Paper Tape Reader/Punch.** Paper tape mass storage peripheral for use with the H8 or H11. Features totally independent punch and reader; a copy mode for fast, easy tape duplication; precision machined punch block for accurate, consistent punching.

**NEW GD-1186 Digital Electronic Scale.** Tells you your weight (up to 300 lbs.) in big, bright, easy-to-read digits. Reads out to 2/10ths of a pound with far more precision than conventional dial scales. Extra cable lets you mount the readout at eye level.

**NEW AD-1304 Active Audio Processor.** Minimizes background noise from records or broadcast sources. Also adds 7 dB dynamic range to your hi-fi system. Provides greatly enhanced sound reproduction.

**NEW IO-4555 Single-Trace Oscilloscope.** A bright, easy-to-read scope ideal for radio-TV servicing, design experiments, general-purpose troubleshooting. Has super-bright trace, easy to operate controls, TV trigger switch, lots more.

**NEW IM-5225 deluxe FET Multimeter.** Quality general-purpose tester measures AC and DC volts, AC and DC current and resistance. Checks semiconductors in or out-of-circuit too! Has pushbutton function switches, full overload protection, easy-to-read meter with color-coded scales.

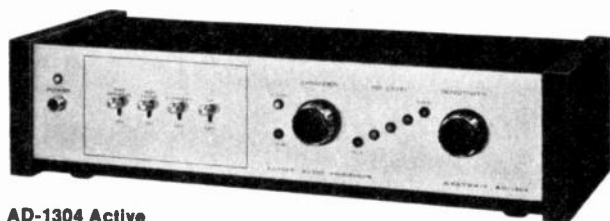

AD-1304 Active  
Audio Processor Kit \$199<sup>95</sup>



IO-4555 Single-Trace  
Experimenter  
Oscilloscope Kit  
\$299<sup>95</sup>

IM-5225 Deluxe  
FET Multimeter Kit  
\$119<sup>95</sup>



**H8**  
8-Bit  
Computer Kit  
\$375<sup>00</sup>



**ALSO AVAILABLE:**  
The famous LA36 DEC  
Writer II Keyboard Printer  
Terminal at a sensa-  
tional low price. **\$1495**

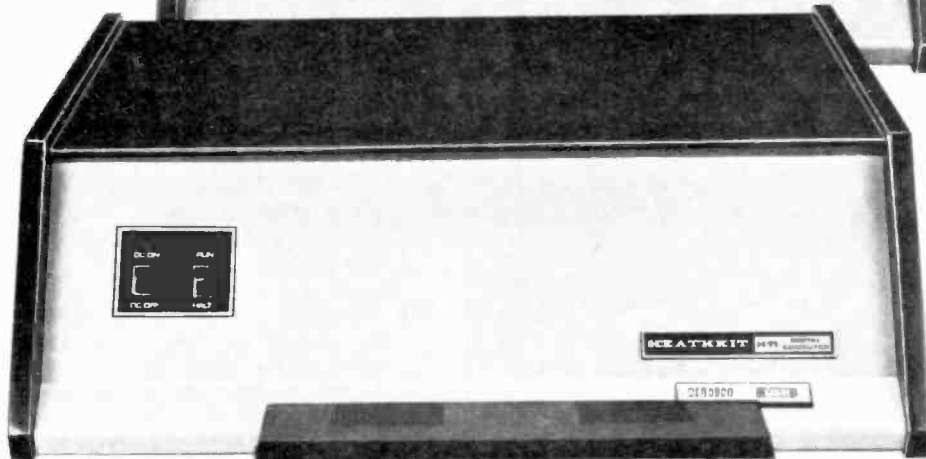

**H10**  
16-Bit  
Computer Kit  
\$1295<sup>00</sup>



**H9**  
CRT  
Terminal Kit  
\$530<sup>00</sup>



**H10**  
Paper Tape  
Reacer/Punch Kit  
\$350<sup>00</sup>

**FREE**

New Heathkit catalog describing nearly 400 fun-to-build, money-saving electronic kits, plus a variety of Heath-recommended top-value assembled products. Send for your FREE copy. Use card or coupon today!

Heath Company, Dept. 020-34C  
Benton Harbor, Michigan 49022



HEATH  
Schlumberger

Heath Company, Dept. 020-340  
Benton Harbor, Michigan 49022

Please send me my FREE Heathkit Catalog.  
I am not on your mailing list.

Name \_\_\_\_\_

Address \_\_\_\_\_

City \_\_\_\_\_ State \_\_\_\_\_ Zip \_\_\_\_\_

CP-130

All prices net FOB, Benton Harbor, Michigan.  
Prices and specifications subject to change without notice.

CIRCLE 100 ON FREE INFORMATION CARD

OCTOBER 1977

31

MHz and 0-1500 MHz. The test actually feeds an RF signal into the transistor and then reads its current gain on the meter; three oscillators are used, at 1.0, 10.0 and 30.0 MHz. The device under test is plugged into one of two sockets on the  $F_i$  test panel. If it has a non-standard base, a little plug-in adaptor with three tiny clips can connect any type. Most transistors will show a reading on two of the scales. Use the highest reading, but don't take a reading below about "10" on any of them, for maximum accuracy. For example, a transistor with an  $F_i$  of 500 MHz will show a

reading on both the 0-500 MHz and 0-1500 MHz scales.

The instruction manual discusses in detail the instrument's operation and circuitry. Full maintenance and calibration test procedures are given. A complete Appendix, with a glossary of transistor terminology, as well as a two-page list of transistor and semiconductor symbols, is in the back of the book.

The *model 530* is housed in a neat "lay down" type case. The panel is well designed; all controls and switches are easy to get at and use. All identification, leakage and beta tests are on the right side, with the  $F_i$  test on the left by itself.

We gave it a good workout on some units we had, including a transistor remote control receiver panel that had been zapped by light-

ning. The *model 530* picked out the bad transistors very quickly, out of a large number. We checked all the numerous transistors very quickly using the FP-5 probe. We consider this tester useful for any kind of work involving semiconductors. **R-E**

### Lunar Electronics DX-555 Signal Generator/ Frequency Counter



#### CIRCLE 92 ON FREE INFORMATION CARD

LUNAR ELECTRONICS, BOX 82183, SAN DIEGO, CA 92138, has developed a compact little combination instrument, the *Model DX-555* frequency counter and RF signal generator.

The *model DX55* signal generator has no dial; it uses the frequency-counter readout. Therefore, the generator can be accurately tuned to any desired frequency. It covers a range from 440 kHz to 30 MHz in three ranges—0.44-1.7, 1.7-7.0 and 7.0-30 MHz. It is tuned by a main tuning knob and a separate fine-tuning control marked SPREAD accurately determines the signal output. The RF output can be modulated by an internal 600-Hz audio tone, which is controlled by a front-panel switch.

The frequency counter has a range from 10 Hz to 30 MHz. A built-in prescaler expands the range to slightly more than 220 MHz. A rocker switch on the back panel marked VLF/VHF controls the prescaler. A 5-digit LED display reads in kHz or MHz and is controlled by the front-panel slide switch. By adjusting the frequency with the selector switch in the kHz position and then switching to MHz, an extra digit can be gained. Simply move the left digit one position off the screen. This provides one more digit for accurate setup or readout.

The counter accuracy was checked against WWV. The signal-generator frequencies were then checked against the same standard. Both results came out very well, even when we set the generator to 1.0 MHz and beat the 10th harmonic against the 10.0-MHz WWV signal. The counter input jack is on the front panel and a shielded cable is provided. The signal-generator output jack is on the back panel. A short test lead and plug are also provided for this.

The *model DX-555* is AC-powered and the line is fused for protection. The DC power supply uses a full-wave bridge rectifier and is regulated by a solid-state voltage-regulator circuit. A 10-MHz crystal-controlled oscillator provides the clock signals for the digital circuitry. Provisions are made for zeroing the frequency counter against WWV if recalibration is necessary.

Standard 7400-series IC's are used in the dividers, buffers, oscillator stages, etc., and two FET's are used in the RF oscillator.

The *model DX-55* is a compact little instrument that should be very useful in CB, Ham radio, two-way radio and many other applications. **R-E**



## sound customizer

Only those who customize know that feeling of special satisfaction you get when the job is done. But when it comes to car stereo systems, the job is usually left half done.

Because no matter how elaborate your electronic system, it must be complemented with the best in

speakers. And they are **Kriket® Series 6000™** car stereo speakers.

Only **Kriket®** speakers have sound baffles that deliver true stereo separation comparable to home speakers valued at hundreds of dollars. If you listen to a **Kriket®** speaker, you'll buy it.

**afs/Kriket®** Acoustic Fiber Sound Systems, Inc.  
Indianapolis, Indiana

All afs®/Kriket® products are manufactured in the U.S.A.

Copyright 1977, Acoustic Fiber Sound Systems, Inc.

# Introductory offer to new members of the ELECTRONICS AND CONTROL ENGINEERS' BOOK CLUB

any one  
of these great  
professional books  
for only **\$1.89**  
values up  
to \$44.50

Special \$1.89 bonus book comes to you  
with your first club selection



287/341  
**STANDARD  
HANDBOOK OF  
ENGINEERING  
CALCULATIONS**  
by T. G. Hicks  
Pub. price, \$24.95  
Club price, \$17.95



286/051  
**OPTOELEC-  
TRONIC APPLI-  
CATIONS  
MANUAL**  
by Hewlett-  
Packard  
Pub. price, \$19.25  
Club price, \$14.50



404/453  
**GUIDEBOOK OF  
ELECTRONIC  
CIRCUITS**  
by J. Markus  
Pub. price, \$29.50  
Club price, \$21.50



423/156  
**INTEGRATED  
ELECTRONICS:**  
Analog Digital  
Circuits and  
Systems  
by J. Millman  
& C. Halkias  
Pub. price, \$22.50  
Club price, \$15.95

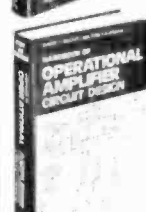

617/97X  
**HANDBOOK OF  
OPERATIONAL  
AMPLIFIER CIR-  
CUIT DESIGN**  
by D. E. Stout  
& M. Kaufman  
Pub. price, \$29.65  
Club price, \$17.50

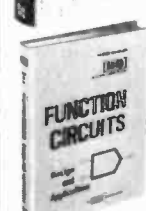

715/70X  
**FUNCTION CIR-  
CUITS:**  
Design and  
Applications  
by Y. J. Wong  
& W. E. Ott  
Pub. price, \$18.50  
Club price, \$14.00



162/468  
**INTEGRATED  
CIRCUITS AND  
SEMICONDUCTOR  
DEVICES:**  
Theory and  
Application, 2/e  
by G. J. Deboo  
& C. N. Burrous  
Pub. price, \$16.95  
Club price, \$12.95

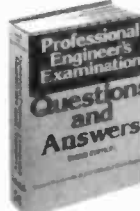

360/936  
**PROFESSIONAL  
ENGINEERS'  
EXAMINATION  
QUESTIONS AND  
ANSWERS**  
by W. S.  
LaLonde &  
W. J. Stack-  
Staikidis  
Pub. price, \$16.50  
Club price, \$13.75



398/615  
**DIGITAL  
COMPUTER  
ELECTRONICS**  
by A. P. Malvino  
Pub. price, \$13.95  
Club price, \$10.95



191/719  
**MICRO-  
PROCESSORS**  
by Electronics  
Magazine  
Pub. price, \$13.50  
Club price, \$10.95



209/731  
**STANDARD  
HANDBOOK FOR  
ELECTRICAL  
ENGINEERS,  
10/e**  
by J. D. Fink &  
J. M. Carroll  
Pub. price, \$44.50  
Club price, \$28.50



209/804  
**ELECTRONICS  
ENGINEERS'  
HANDBOOK**  
by D. G. Fink  
Pub. price, \$42.50  
Club price, \$32.50



238/91X  
**DESIGNING WITH  
OPERATIONAL  
AMPLIFIERS**  
by J. G. Graeme  
Pub. price, \$17.50  
Club price, \$13.50



637/539  
**DIGITAL INTE-  
GRATED CIR-  
CUITS AND  
OPERATIONAL-  
AMPLIFIER, AND  
OPTOELEC-  
TRONIC CIR-  
CUIT DESIGN**  
by Texas  
Instruments  
Pub. price, \$16.50  
Club price, \$12.50

## save time and money by joining the ELECTRONICS AND CONTROL ENGINEERS' BOOK CLUB



Here is a professional book club designed to meet your on-the-job engineering needs by providing practical books in your field on a regular basis at below publisher prices. If you're missing out on important technical literature—if today's high cost of reading curbs the growth of your library—here's the solution to your problem.

The *Electronics and Control Engineers' Book Club* was organized for you, to provide an economical reading program that cannot fail to be of value. Administered by the McGraw-Hill Book Company, all books are chosen by qualified editors and consultants. Their understanding of the standards and values of the literature in your field guarantees the appropriateness of the selections.

How the club operates: Every month you receive free of charge *The Electronics and Control Engineers' Book Club Bulletin*. This announces and describes the Club's featured book of the month as well as alternate selections available at special members' prices. If you want to examine the Club's feature of the month, you do nothing. If you prefer one of the alternate selections—or if you want no book at all—you notify the Club by returning the card enclosed with each Bulletin.

As a Club member, you agree only to the purchase of four books (including your first selection) over a two-year period. Considering the many books published annually, there will surely be at least four you would want to own anyway. By joining the Club, you save both money and the trouble of searching for the best books.

### MAIL THIS COUPON TODAY

ELECTRONICS AND CONTROL ENGINEERS' BOOK CLUB  
P.O. Box 582, Princeton Road, Hightstown, New Jersey 08520

Please enroll me as a member and send me the two books indicated. I am to receive the bonus book at the introductory price of \$1.89 plus my first selection, plus tax, postage and handling. If not completely satisfied, I may return the books within 10 days and request that my membership be cancelled. If I keep the books, I agree to take a minimum of three additional books during the next two years at special Club prices (guaranteed 15% discount, often more). I will receive the Club Bulletin 12 times a year. If I want to examine the featured selection, I need take no action. It will be shipped automatically. If, however, I want an alternate selection—or no book at all—I simply notify the Club by returning the convenient card always enclosed. I will always have a minimum of ten days in which to return the card and you will credit my account fully, including postage. If this is not the case, Membership in the Club is continuous but cancellable by me at any time after the four-book purchase requirement has been filled. This order subject to acceptance by McGraw-Hill. Orders from outside the continental U.S. must be prepaid. All prices subject to change without notice. Offer good for new members only.

Write Code # of \$1.89 bonus  
book selection here

Write Code # of  
first selection here



NAME \_\_\_\_\_

ADDRESS \_\_\_\_\_

CITY \_\_\_\_\_

STATE \_\_\_\_\_ ZIP \_\_\_\_\_

EXTRA SAVINGS: Remit in full with your order, plus any local and state tax, and McGraw-Hill will pay all postage and handling charges. E33330

# IF YOU'RE WAITING FOR SOLDERLESS BREADBOARDS TO BE FASTER, EASIER, MORE VERSATILE AND LOWER-PRICED...

**Incredibly inexpensive.** EXPERIMENTOR solderless sockets begin at \$5.50\* (\$4.00\* for the 40 tie-point quad bus strip) A spool of solder costs more.

**Mix and match.** Use large and small chips in the same circuit without problems. There are two sizes of EXPERIMENTOR sockets with 0.3" and 0.6" centers.

**Full fan-out. A CSC exclusive.** The only solderless breadboard sockets with full fan-out capabilities for **micro-processors** and other larger (0.6") DIP's.

**Microprocessors and other complex circuits are easy to develop.** EXPERIMENTOR quad bus strips give you 4, 8 or 16 buses to simplify your breadboards

**Infinitely flexible.** Circuits can go in any direction, up to any size. All EXPERIMENTOR sockets feature positive interlocking connectors that snap together. Horizontally and/or vertically. And un-snap to change a circuit whenever you wish.

**Easy Mounting.** Use 4-40 screws from the front or 6-32 self-tapping screws from the rear. Insulated backing lets you mount on any surface.

**EXPERIMENTOR 350. \$5.50\*** 46 five-point terminals plus two 20-point bus strips 0.3" centers, 3/8 x 3 1/2 x 2".

**EXPERIMENTOR 650. \$6.25\*** 46 five-point terminals plus two 20-point bus strips. 0.6" centers, 3/8 x 3 1/2 x 2 1/4".

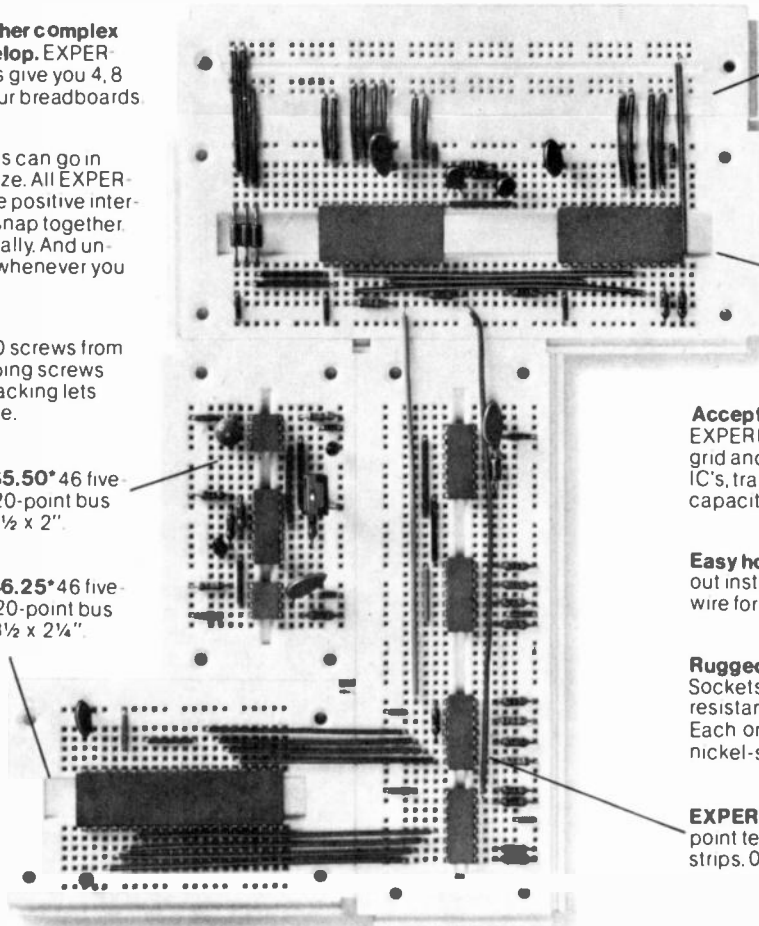

**EXPERIMENTOR QUAD BUS STRIP \$4.00\*** Four 40-point bus strips. 3/8 x 6 x 3/4".

**Designated tie-points.** Simplify translation from breadboard to PC-boards or wiring tables.

**EXPERIMENTOR 600. \$10.95\*** 94 five-point terminals plus two 40-point bus strips. 0.6" centers; 3/8 x 6 x 2 1/4".

**Accepts all standard components.** EXPERIMENTOR sockets conform to an 0.1" grid and are DIP compatible. Also accept IC's, transistors, diodes, LED's, resistors, capacitors, transformers, pots, etc.

**Easy hookup.** Components push in and pull out instantly. Use #22-30 solid AWG wire for jumpers.

**Rugged, dependable construction.** Sockets are constructed from abrasion resistant materials and withstand 100°C. Each one features non-corrosive nickel-silver contacts.

**EXPERIMENTOR 300. \$9.95\*** 94 five-point terminals plus two 40-point bus strips. 0.3" centers; 3/8 x 6 x 2".

## WHAT ARE YOU WAITING FOR?

Discover today how solderless breadboarding can save time and money on every circuit you build. Get acquainted with EXPERIMENTOR™ sockets† and how they simplify circuit design, assembly and testing. Eliminate the hassles and component damage of soldering. No special hardware or jumper cables required, either. And the price is so low, it's hard to believe.

**See your CSC dealer today. Or call 203-624-3103 (East Coast) or 415-421-8872 (West Coast) for the name of your local stocking distributor and a full-line catalog.**

CONTINENTAL SPECIALTIES CORPORATION



44 Kendall Street, Box 1942, New Haven, CT 06509  
203-624-3103 TWX 710-465-1227  
West Coast 351 California St., San Francisco, CA 94104  
415-421-8872 TWX 910-372-7992  
MEXICO ELPRO, S.A., Mexico City 5-23-30-04  
CANADA Len Finkler Ltd., Ontario

†U.S. Patent No. D235,554  
\*Manufacturer's recommended resale  
© 1977, Continental Specialties Corporation

## ROUNDUP

# Digital Clock Kits For Your Car



FRED BLECHMAN, K6UGT

IN THE AUGUST AND SEPTEMBER 1976 ISSUES OF **RADIO-ELECTRONICS**, we reviewed in detail over 30 digital electronic clock kits. Only three were designed for car use, and one of those is no longer available. Since then a number of manufacturers have turned their attention to the huge untapped market of cars, vans, mobile homes, trailers and even airplanes, since standard electromechanical automobile clocks have the reputation of being notoriously poor timekeepers, and often fail long before the useful life of the vehicle.

In the last two years, electromechanical digital clocks have been available as optional equipment on some new cars. It's a little too soon to tell what their long-term accuracy and life span will be. This much is evident: They mostly have small quarter-inch-high digits, and need to be illuminated at night.

But look at the features *electronic* (as opposed to electromechanical) car clocks can offer: (1) large digits (up to 0.5 inch high); (2) self-illumination; (3) display of seconds, month and date; (4) reminder alarm; (5) elapsed-time readout; (6) no moving parts that wear out or need lubrication; (7) accuracy of better than 1 minute per month; (8) simple time-setting with switches, usually to the second; (9) easy installation above or below the dashboard of an existing car—or even *in* the dashboard! (Not all these features are available in all electronic clocks, but most have practically all of them.)

The Comparison Chart shows the various features and characteristics of each clock, as well as the suggested kit or assembled price. Although kit prices are usually stable, check with the manufacturer or distributor for their possible minimum order, latest price, sales tax and shipping/handling charges.

### Clocks for mobile use

Some clocks being offered in kit form are simply warmed-over 117-VAC designs originally intended for in-home use but



APPLIED MARKETING VC-502 in dash-mounting.



APPLIED MARKETING LC-101 with DS-99 desk stand.



APPLIED MARKETING LC-101. LCD readout visible in sunlight.



APPLIED MARKETING DC-201 has red or green LED's.

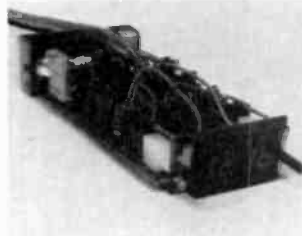

THE AUDIOVOX LED-76 is the smallest of the cased units.

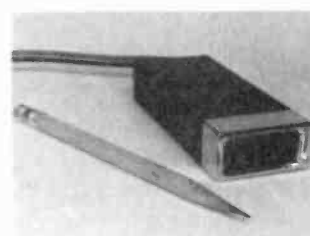

THE AUDIOVOX IN ITS CASE.

ELECTRONIC CAR CLOCKS—COMPARISON CHART

©1977 FRED BLECHMAN

MANUFACTURER OR DISTRIBUTOR	MODEL	PRICE (\$)	DISPLAY FEATURES										CLOCK IC	CASE		SIZE (INCHES)			ASSEMBLY INSTRUCTIONS	APPROXIMATE ASSEMBLY TIME (HRS.)	REMARKS			
			NUMBER OF DIGITS	DIGIT HEIGHT (IN.)	RED LED	FLUORESCENT	ORANGE NEON	COLOR(S)	AUTO. BRIGHTNESS	AM/PM INDICATOR	12 OR 24 HOUR FORMAT	SECONDS		CALENDAR	ELAPSED TIME	REAL TIME RETAINED	ALARM	MULTIPLIED				COLOR	MATERIAL	HIGH
ALPHA ELECTRONICS (TEXAS) BOX 64726 DALLAS, TX 75206	DIGITAL CLOCK FOR VEHICLES	29.95	6	.16	●													ALUMINUM		CLOCK 9 2.5 CASE 2.8	2.8	GOOD	1 1/2	CASE, WITH MAGNETIC: \$4.50.
	LC-101 LIQUID CRYSTAL DIGITAL CLOCK	(49.95)	4	.5	●	LIQUID CRYSTAL	●													CLOCK 2.0 2.5 CASE 2.9	2.9	GOOD		CONSTANT READOUT. PORTABLE. WIRED WITH BACKLIGHT. LC-102 IN DASH; LC-104 PORTABLE; LC-103 WIRED.—ALL SAME PRICE. DS99 DESK STAND FOR LC-101: \$7.00.
APPLIED MARKETING CORP. 800 PINE BLVD. ANN ARBOR, MI 48104	DC-701 DIGITAL CAR CLOCK	(46.95)	4	.3	●													BLACK OR BLACK PLASTIC WITH CHROME RIM		1.4 2.4 CASE 2.7	2.7	GOOD		SMALLEST CLOCK IN THIS REPORT. GREEN DIGITS AVAILABLE.—SAME PRICE IN-DASH DC-202 SAME PRICE.
	VC-501 DIGITAL CLOCK	(39.95)	4	.3	●															2.0 2.5 CASE 1.7	1.7	GOOD		RED, GREEN OR BLUE DISPLAY. NO ZERO SECONDS IN DASH. VC-502 SAME PRICE. DIMS WHEN LIGHTS ON.
AUDIOVOX CORP. 150 MARCUS BLVD. HAUPPAUGE, NY 11787	LED-76 AUTO DIGITAL CLOCK	(53.99)	4	.25	●													BLACK AND GOLD		9 1.6 CASE 3.9	3.9	GOOD		SMALLEST 3-DIGIT CLOCK IN THIS REPORT. DISCOUNT PRICE: \$39.95.
BULLET ELECTRONICS P.O. BOX 19447 R DALLAS, TX 75219	MK-03 AIRCRAFT CLOCK/TIMER	26.95	6	.38	●													NOT AVAILABLE		1.4 2.5 CASE 3.8	3.8	VERY GOOD	5	ELAPSED TIME IN SECONDS FOR 24 HOURS. MANY OPTIONS. SWITCHES NOT INCLUDED. FITS IN RADIO SHOCK CASE.
	MK-05 MINI MOBILE CLOCK	15.95	6	.15	●													ALUMINUM		CLOCK 9 2.6 CASE 3.1	3.1	VERY GOOD	1.5	MAGNIFIED DISPLAY. ALARM SOUND ONLY WHEN ALARM BEING SET. SMALL ALARM SPEAKER NOT INCLUDED.
CC & SS INC. 2309 SANTA MONICA BLVD. SANTA MONICA, CA 90404	CC-5A DIGITAL CALENDAR FLUORESCENT AUTO CLOCK	46.00 (18.95)	4	.3	●													BLACK		2.8 2.8 CASE 3.0	3.0	FAIR	2%	GREEN DISPLAY. GIMBAL MOUNTING. CAN ALTERNATE TIME, SECONDS & DATE ON DISPLAY SECONDS CONTINUOUSLY.
	AC-05 DIGITAL AUTOMOTIVE CLOCK	(34.95)	4	.3	●													BLACK		2.5 DIA. 2.0	2.0	GOOD		AC-05-1: 24 HR. AC-05 FLUORESCENT IN DASH \$37.95; AC-03 (12 HR.) & AC-04 (24 HR.) NO ZERO SECONDS; SHIELDED CABLE; TOUCH SWITCHES.
FAIRCHILD CAMERA & INST. CORP. OPTOELECTRONICS DIVISION 4001 MIRANDA AVE. PALO ALTO, CA 94303	FX-006 AUTO CLOCK	40.00	4	.38	●													NOT AVAILABLE		1.4 1.8 CASE 4.0	4.0	POOR	7	HIGH REL. RUNS HOT. DIFFICULT SHAPE TO ENCLOSE.
HEATH COMPANY BENTON HARBOR, MI 48022	FC-1093 DIGITAL CAR CLOCK	64.95	4	.5	●													BLACK WALNUT		1.9 4.6 CASE 4.8	4.8	EXCELLENT	5	20-HOUR ELAPSED TIME. SECONDS SHOWN ONLY FOR FIRST 20 MINUTES IN ELAPSED TIME MODE. NO TIME RASB ADJUSTMENT.
	AIRCRAFT CLOCK/TIMER	143.35	6	.38	●													BLACK		3.3 3.3 CASE 6.0	6.0	EXCELLENT	8	2 4 DIGIT DISPLAYS. GWT SHOWN CONTINUOUSLY ON ONE DISPLAY. 24-HOUR ELAPSED TIMER. WITH ALARM THAT FLASHES DISPLAY ON AND OFF.
JAMES ELECTRONICS 1071-A HOWARD AVE. SAN CARLOS, CA 94070	QUARTZ DIGITAL AUTO CLOCK OR ELAPSED TIMER	29.95 (29.95)	6	.35	●													GRAY		1.8 5.0 CASE 4.8	4.8	FAIR	1%	BASIC FOSKET CLOCK WITH HOLD AND RESET SWITCHES.
	AUTO WARBLE ALARM CLOCK AND HEADLIGHT ALARM	35.95 (45.95)	4	.5	●													GRAY		1.8 4.0 CASE 4.3	4.3	FAIR	2%	TWO-TONE ALARM SOUNDS AT PRE-SET TIME OR IF HEADLIGHTS ON WITH IGNITION OFF.
JBS ELECTRONICS FOULDER, CO. 80301	400 U-CLOCK (4 PC BOARDS)	5.95	6	.3	●													TWO-PART ALUMINUM AND PLEXIGLAS		1.4 2.7 CASE 4.3	4.3	FAIR	3	CAN USE GREEN OR YELLOW DIGITS. NO COMPONENTS INCLUDED—JUST PC BOARDS AND INSTRUCTIONS. CASE: \$6.95.
JEFF 3015 EATON ROAD CLEVELAND, OH 44122	CAR CLOCK	19.95 (21.99)	4	.5	●													NOT AVAILABLE		1.8 3.1 CASE 1.0	1.0	GOOD	9%	CASE IS HEAVY FIBERGLASS COVERED IN WOODGRAIN VINYL. IN-DASH MODEL WITH BEZEL INSTEAD OF CASE: \$16.99 KIT, \$21.99 ASSEMBLED.
NATIONAL SEMICONDUCTOR CORP. 2800 SEMICONDUCTOR DR. SANTA CLARA, CA 95051	WA 1003 CAR CLOCK	24.95	4	.3	●													BLACK		1.8 3.5 CASE 3.7	3.7	GOOD	2	FILTERABLE TO BLUE, GREEN OR YELLOW. BRIGHT/DIM CONTROLLABLE. COMPLETELY ASSEMBLED MODULE.
NEXUS TRADING CO. BOX 3357 SAN LEANDRO, CA 94578	CAR CLOCK	29.95 (45.95)	6	.3	●													BLACK		1.8 4.0 CASE 4.8	4.8	VERY GOOD	1%	MOLDED CASE AND SWIVEL MOUNT: \$5.00.
	MOBILE LED CLOCK	29.95 (39.95)	6	.38	●													GRAY		1.8 4.0 CASE 4.8	4.8	VERY GOOD	1%	POSTPAID USA. BASIC FOSKET CLOCK WITH MODIFIED DISPLAY ENABLE.
OPTOELECTRONICS, INC. P.O. BOX 219 HOLLYWOOD, FL 33022	#2101 R MOBILE LED CLOCK	29.95 (39.95)	6	.38	●													GRAY		1.8 4.0 CASE 4.8	4.8	VERY GOOD	2	POSTPAID USA. SUPRESEES #2001. MODIFIED FOSKET CLOCK WITH EXCELLENT NEW PC BOARD DESIGNS AND 3 MORE SWITCHES.
	#7005 MOBILE CALENDAR CLOCK	39.95 (49.95)	6	.38	●													GRAY		1.8 4.0 CASE 4.8	4.8	GOOD	2%	POSTPAID USA. 4-YEAR CALENDAR. 9 HOUR AND 59 MINUTE TIMER.





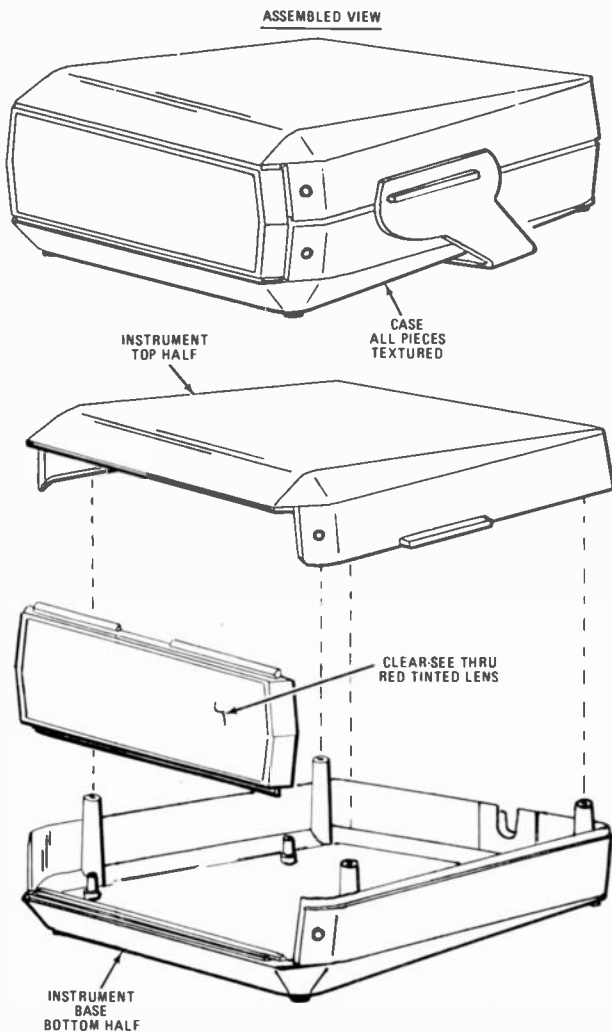

FIG. 1—THE GRAY PLASTIC CASE used with many of the clocks described here is built up of four pieces.

that can be read in direct sunlight, or backlighted for night viewing. The display that appears to be the choice of the Detroit car-makers for future models is the blue-green fluorescent display, used in the National *model MA-1003* car clock module. This display is also used in the CC & SS, Inc. *model CC-6A*, the Applied Marketing *models VC-501* and *VC-502* and the Xantech. Although the actual digits are only 0.3 inch high, Xantech uses a curved lens to increase the apparent height. These fluorescent displays are clear and sharp even in a high ambient lighting situation—but direct sunlight still wipes them out. The CC & SS, Inc. display is recessed behind a green lens in an instrument case for high visibility and to avoid direct sunlight.

Many of the clocks have all the digits in a single display—others use individual digits. The JBS *Mod-U-Clock* has no digits—you supply your own—so you can use different colors, such as red for hours, green for minutes and yellow or orange for seconds!

To achieve proper contrast with the ambient lighting (since it is *contrast* that makes the digits visible, not just brightness), photocells or phototransistors are used in some clocks to dim the display brightness automatically as the surrounding light is reduced. Liquid crystal displays, which reflect existing light, by their nature maintain good contrast in all lighting, but require backlighting in darkness. Colons are used to separate digit groups visually on many displays. They are either on constantly, or blink at a 1- or 2-second rate.

Some of the kits can be built to display either a 12- or a 24-hour format. Most read seconds continually, or seconds can be read by operating a switch. The Heath *model OI-1154* Aircraft Clock/Timer has a separate four-digit display for Greenwich

Mean Time (GMT or “Zulu” time), used for navigational purposes. Several clocks advertise an elapsed-time feature, but be careful! Both Heath clocks, the Bullet *model MK-03* and the Optoelectronics *model 7005* display the elapsed time without destroying the actual time—all the others *cancel out* the local time to display elapsed or trip time!

A few clocks (CC & SS, Inc., Fairchild and Optoelectronics) even keep track of the month and date, and display them on command. These contain four-year calendars and need to be corrected only on February 29 of a leap year.

### An alarming feature

While at first thought it might seem like gilding the lily, some of these car clocks have reminder alarms. Not a bad idea, since you might spend a great deal of time in your car and could use the alarm to help you keep appointments. For van or camper use, these alarms could get you up in time to hit the road before the traffic jams, or time your cooking. The James *Warble Alarm* not only has a two-tone sound, but will also sound off if you leave your lights on after turning off the ignition. This could save you the cost of towing and a new battery!

The alarms are all 24-hour repeatable—just turn them off when they sound, turn them right back on and they’re reset for 24 hours later. To do that, these clocks have an AM/PM indicator if they display in the 12-hour format. A “snooze” feature with all the alarms, except for the Heath *model OI-1154*, lets you discontinue the alarm tone for a short period—usually about 10 minutes—after which it sounds again. Don’t plan on using these alarms as burglar alarms—they aren’t that loud, and you’d need some special circuitry to trigger them at “rip-off” time! The alarms are simply audio oscillators with speakers—some have a steady tone, some beep.

### Possible radio interference

To reduce component count and power consumption in many clocks, a digital scanning technique called multiplexing is used. This turns on digits in sequence so quickly that they seem to be on continuously—a sort of rapid strobing. Unfortunately, this generates radio-frequency interference (RFI) that can create a buzzing sound in your AM car radio, or in CB or ham receivers. A metal case, such as used by Audiovox and Heath, contains the RFI pretty well. Also, the use of two-conductor shielded cable, with the shield as the ground connection, will all but eliminate this potential problem. The Fairchild clock, which offers no case at all, seemed to have the highest RFI of all the units checked.

Many designs use “direct drive” clock IC’s instead of multiplexing. This eliminates all RFI but a small amount that might be generated by the crystal oscillator circuit.

### Battery backup

A backup battery and oscillator are sometimes provided in an in-home clock to keep time during a power failure. While this is not a significant problem in most large cities except during severe weather or a summer “brownout,” some smaller cities and towns have frequent power outages. But why a battery backup in a mobile clock? How often does a car battery go dead? Well, not often—so that’s *not* the reason some of these clocks have a battery. The self-contained battery allows these clocks to keep time *outside* the vehicle, and most will even display time for short periods. This allows you, for example, to set your clock accurately to a time standard in the home.

Radio Shack’s *WWV Converter Kit* (No. 28-133 for \$5.95) will allow you to use any AM radio to receive precise time signals—including your car radio. Of course, you can use an accurate clock or the telephone company time signal as a standard. Once set on battery, you simply carry the clock out to your vehicle and install it. Or you can carry the clock around with you for any other time-critical purpose and display the time only when necessary (such as for synchronizing your next commando raid or space launch!). The CC & SS, Inc. module uses a 1.5-volt AAA alkaline battery to perform all timekeeping

with a *watch* IC, and only uses the vehicle's 12 volts to illuminate the fluorescent display! The Applied Marketing *model LC-101* is completely portable with self-contained watch batteries and a constantly on liquid crystal display.

### The case for a case

The size and appearance of your clock case might well dictate its location in your car, camper or van. The case is also important for environmental protection from dirt and vibration. Unless you're a skilled craftsman, it would be wise to avoid any clock kit that doesn't come with a case, or have a suitable case as an option.

Another consideration in selecting a clock for your vehicle should be *shape*. The Fairchild clock, for example, has a small frontal size, but it's very deep. This makes it ideal for dashboard panel installation (you'll have to make your own faceplate), but it takes a special enclosure, not made by Fairchild, for mounting this clock above or below the dashboard. The S.D. Sales clock is another example of trade-off versatility; the display and the clock boards are entirely separate. The clock board is relatively large and is joined to the display board by 17 wires. While this allows you to "remote" the display above or below the dashboard in a small enclosure and mount the clock board under the dash somewhere else—in another enclosure—it means one *large* case if you mount them together!

Many of the clocks reviewed in this article include a beautifully molded four-piece gray plastic case 1 1/4 high X 4 wide X 4 1/2-inches deep. Figure 1 shows how the top and bottom halves snap together over a fitted chrome-rimmed red front bezel. An angled mounting bracket that can be snapped onto side lugs from either above or below provides four different mounting choices. This case is sold separately by Radio Shack stores for \$3.95 (No. 270-285).

Optoelectronics offers two modern cases of Plexiglas, bent to form a transparent red chassis with your choice of a clear, white or black cover. They come complete with two aluminum angle brackets and self-tapping screws to accommodate any red LED display. *Cabinet I* is the larger of the two and is 3 high X 6 1/4 wide X 5 1/2-inches deep. *Cabinet II* is 2 1/2 high X 5 wide X 4-inches deep. They cost \$6.50 each, and Optoelectronics pays the postage on U.S. orders of \$15 or more. *Cabinet II*, for example, is an excellent choice for the S.D. Sales clock if you want to package it in one case.

Custom plastic cases can be ordered to your specifications in any quantity, from Robert C. Arp, Enclosure Engineering, 3491 Butcher Drive, Santa Clara, CA 95051.

### Can you follow instructions?

Apparently most manufacturers and distributors of these mobile clock kits expect the builder to be somewhat experienced with electronic assembly work. The notable exception is Heath, whose instructions are excellent and for many years have set a standard most others don't even approach. A *beginner* could build the Heath kits, since every part is illustrated and every color code, part identification or polarity is noted. This is not the story with many of the instructions.

Fairchild, for example, had the nicest-looking instructions, complete with photos of the assembled unit. Unfortunately, they had errors and omissions and virtually no step-by-step assembly instructions. The Jeff instructions were on one side of a single sheet with hand-drawn sketches and with just barely enough information. On the other hand, Optoelectronics, Ramsey and Bullet use lots of text and illustrations, and provide detailed schematics in case troubleshooting is necessary.

The assembly time for a particular clock will vary with the builder's experience. It's wise not to rush and to be very careful in soldering and getting the right parts in the right place, "checking twice and soldering once," and observing polarities where noted. Miniature parts are used in all these clocks, so a small-tip soldering iron, small-diameter solder, a jeweler's loupe or magnifying glass and *patience* are essential. Examine all connections for solder bridges or poor soldering—it's a lot

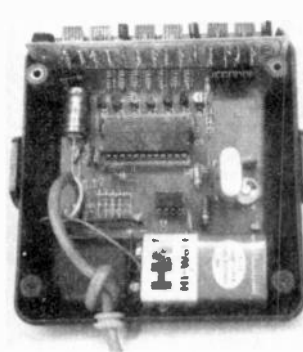

JAMES QUARTZ DIGITAL CLOCK.

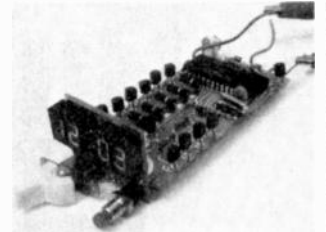

FAIRCHILD FTK0106 shape is suited for dashboard mounting.

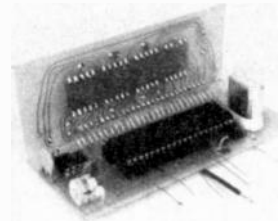

JAMES CLOCK, PARTS LAYOUT.



JEFF CAR CLOCK, showing the 30 jumpers between PC boards.



JAMES DIGITAL AUTO CLOCK with under-dash bracket mount.

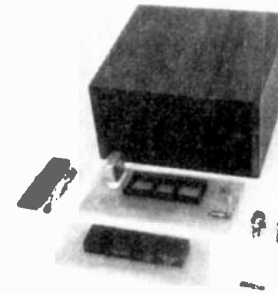

JEFF CLOCK, CASE AND PARTS.



JAMES ALARM CLOCK, with setting and seconds switches.

easier to do this during construction than to spend lots of time scratching your head in troubleshooting or replacing "zapped" parts!

### Installation

Installing almost any mobile accessory can be a real job for the inexperienced builder. However, installing most of these clocks in your vehicle is almost as easy as putting on a side-view mirror, if you have a meter or light to find the positive voltage and ground points at your fuse block. Most clocks use only three wires—positive voltage, ground and "accessory" (switched positive voltage). The positive and ground connections power the clock counting circuitry (except for the CC & SS, Inc. and Applied Marketing *LC-101* and *LC-104* clocks). The accessory connection turns on the display when the ignition is turned on.

At your fuse box, locate a point where positive voltage appears all the time and connect the "positive" clock lead there. A fuse location that shows positive voltage only when the ignition is on, or in the accessory position, is where you connect the "accessory" clock lead. The vehicle chassis is "ground." The Applied Marketing *model LC-101* is simply attached to the dashboard with Velcro hook-and-loop, or double-sided tape, since no wiring connections at all are required! In some clocks, the manufacturer recommends connecting the positive lead direct to the battery, to reduce voltage transients into the clock. Also, it is advisable to fuse the positive and accessory wires to the clock to protect both the clock and vehicle wiring in the event of a dead short in the clock. Also, don't forget that two-conductor shielded wire might be necessary in multiplexed clocks to eliminate RFI problems.

*To be continued.*

# Build 3 Low Cost CB Test Meters

## 1. Signal Strength 2. SWR 3. Power

Get maximum performance by peaking your CB rig with these easy to build low-cost meters

W. E. OSBORNE\*

WITH AN ESTIMATED 12-15 MILLION CB TRANSCEIVERS—LICENSED and unlicensed—now in use, reliable communication on the 27-MHz band in large cities leaves a lot to be desired. Unnecessary chatter on cluttered channels drowns out legitimate messages, while dense traffic and large buildings attenuate transmission and contribute to a serious reduction in range. In addition, many CB rigs operate with a poor impedance match between transmitter and antenna, and suffer a higher-than-necessary SWR figure.

Every connection between transmitter and antenna will set up standing waves, and this problem is often compounded by lumpy solder joints, sharp bends in the line and unclean connections. The net result is a high ratio of power loss in the form of stationary waves on the transmission line—the well-known VSWR, or voltage standing-wave ratio. Adding to the trouble, and often the worst offender, is a mismatch of antenna impedance that reflects power back down the line.

In simple terms, SWR is the loss factor between the total energy leaving the transmitter and the amount accepted and then radiated by the antenna. At least, it translates that way. Obviously the ideal ratio would be 1:1, but there will always be some loss and a very efficient level would be 1.15:1.

Some base rigs have done better than this, but the problems of the average CB'er, with his car installation and lack of test instruments, make a figure of 1.5:1 reasonably acceptable. In this case, the total losses (line, connectors, joints and slight mismatch) would be, in the average case, about 5% of the 4-watt limit. Many CB rigs today, however, are operating at 3:1, or worse, and thus losing more than a quarter of their power.

As a first step, using the smallest of the test instruments described here—a field-strength indicator—will enable any CB owner to quickly determine the relative efficiency of his installation, even without measuring the SWR. Figures 1, 2 and 3 are schematics of a field-strength indicator, an RF power meter, and an SWR bridge, respectively. The field-strength indicator (FSI) can be built from surplus components for one dollar or less, is smaller than a pack of cigarettes, and will enable the CB'er to adjust his antenna and rig for maximum radiated output. The FSI must remain in the same position, relative to the antenna, during adjustments. Construction time is only about half an hour.

### Field-strength indicator

Figure 1 shows the extreme simplicity of the FSI. The FSI

antenna consists of about 8 inches of insulated stranded wire glued or taped around the inside of a small plastic box (the box shown originally contained a power transistor). The antenna RF current is rectified by two diodes, and a 10K potentiometer

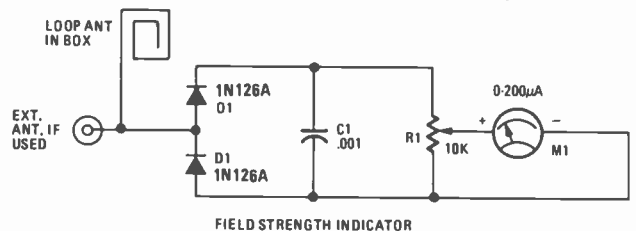

FIG. 1—FIELD-STRENGTH INDICATOR uses a loop antenna and an envelope detector to measure RF signal strength.

### PARTS LIST

All resistors are 1/4-watt, 10%, unless noted.

#### Field-Strength Indicator:

C1—.001  $\mu$ F ceramic disc, lowest voltage

D1, D2—1N126A or equal (1N457, etc.)

R1—10,000-ohm potentiometer (optional)

M1—Subminiature surplus meter, Gemmeter, 200  $\mu$ A or equal

Misc.—Wire, screw, nut, plastic box, etc.

#### RF Power Meter:

R1—20,000 ohms

R2—300,000 ohms

R3—3 megohms

R4—50,000-ohm potentiometer

R5—500,000-ohm potentiometer

C1—5 pF, 50-volt disc, or 3-18-pF ceramic trimmer

C2—10 pF, 50-volt disc, or 3-18-pF trimmer

C3—.001, 50-volt disc

D1—1N126A or equal

S1—SPDT toggle switch

M1—Meter, 0-100  $\mu$ A, 1 1/2 inches

Misc.—Coax receptacles (2), 4  $\times$  2  $\times$  1-inch aluminum box, 12-inch coax lead with plugs.

#### VSWR Bridge:

R1, R2—180 ohms

R3—10,000-ohm potentiometer

C1-C3—.001  $\mu$ F, 50-volt ceramic disc

D1, D2—1N126A or equal

S1—SPDT toggle switch

M1—Meter, 0-50 or 0-100  $\mu$ A, 1 1/2 inches

Misc.—Coax receptacles (2), aluminum box, 12-inch coax lead with 2 male plugs, waveguide shield tube and sensing wires.

\*Dinki-Di, KDZ 7553.

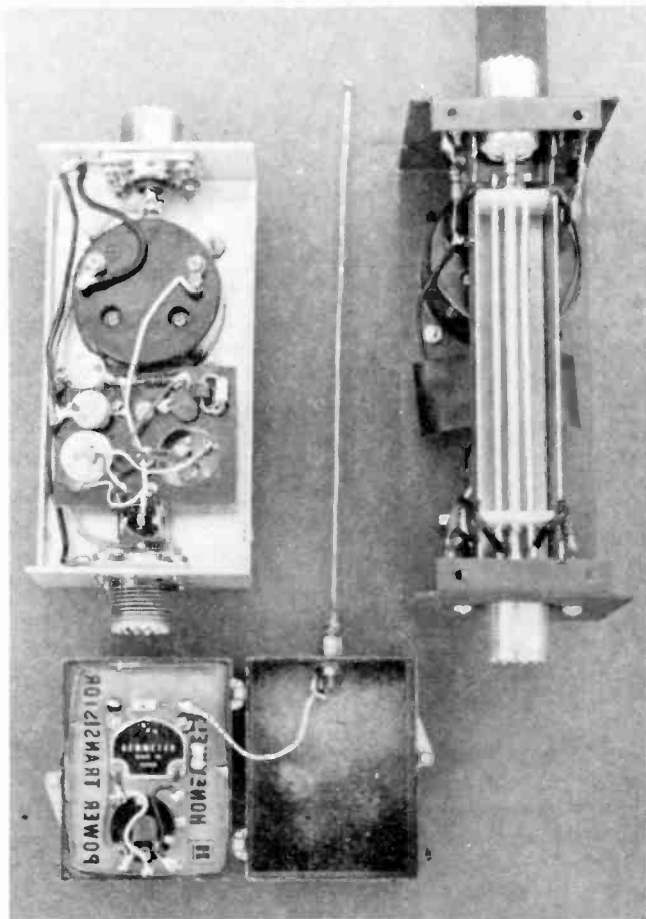

INSIDE VIEWS of the power meter (top left), FS meter (lower left) and SWR bridge (right).

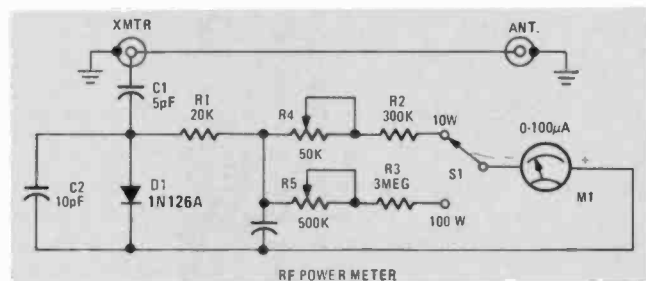

FIG. 2—POWER METER has two ranges and can measure a maximum of 100 watts full-scale.

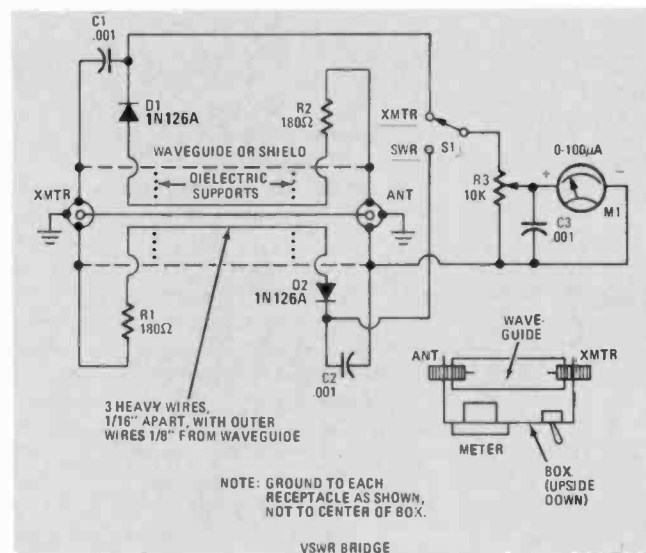

FIG. 3—SWR BRIDGE uses an open waveguide to sense the forward and reflected signals.

provides variable attenuation for the meter. This potentiometer may be omitted (and a 100K fixed resistor substituted) if the unit is always used more than 6 inches away from the CB antenna. The meter is a tiny Japanese surplus item costing 69 cents. With a 200- $\mu$ A movement, it had been used as a battery indicator. If not obtainable in your area, use any 50-, 100-, or 250- $\mu$ A meter.

All components, except the potentiometer, can be mounted on the meter and its two mounting screws. A flexible lead from the antenna connection (diode junction) was also taken to a stud nut on the rim of the box to provide for a short external antenna at a distance of several feet from the CB antenna. Solder a 4-40 screw to one end of a 6-inch length of 14- or 16-gauge bus-bar wire for this antenna. It then screws into the matching stud nut on the box rim, if and when used.

To test your CB transceiver, set (or tape) the FSI box about 6 inches from the base of the CB antenna. Switch on the transceiver, press the TRANSMIT switch and note the reading on the FSI. Now, with the CB power switched off, adjust the antenna length one-eighth of an inch at a time, until maximum FSI reading is obtained.

### RF power meter

The RF power meter shown in Fig. 2 is inserted in the coax line between transmitter and antenna. A 12-inch length of 50-ohm coax, with a male plug at each end, is used for this. The housing is a 4X2X1-inch aluminum box. Although a 100- $\mu$ A meter is shown (hand-calibrated in watts), the surplus meter of Fig. 1 can also be used here, with the series resistors reduced to 100K and 1 meg. A small switch provides two power ranges, 0-10 and 0-100 watts, in case it is used in higher-power rigs. The frequency maximum is about 60 MHz.

Two potentiometers are used, mainly for initial calibration, and could be fixed values after this is done. Incidentally, an easy way to calibrate is on another CB rig, whose output is known. The meter shows actual RF power at the transmitter output (not antenna-radiated power). Check the output on all channels. It should be a fraction under 4 watts, with a slight maximum at the center (Channel 11). Be sure to switch off the power before loosening antenna connections.

(For a more precise power meter calibration, connect the CB set to the XMTR terminal and plug a 50-ohm dummy load into the antenna output connector. Use a VTVM and RF probe to measure the voltage across the dummy load. Calculate the power from the formula  $P = E^2/R$ . With S1 in the 10-watt position, adjust potentiometer R4 so the meter reading corresponds to the calculated power output. Throw the switch to the 100-watt position and adjust R5 so the meter reads correctly.—Editor)

### SWR bridge

To measure the actual standing-wave ratio, some mechanical work is needed to cut and shape a slotted line or open "waveguide". For the 11-meter band, it can be a three-sided piece of square metal tube, 4 $\frac{3}{8}$  inches long and 1 $\frac{1}{16}$  inches square (I.D.). The top side is open (the "slotted line"), and sitting in it, on an insulating block at each end, are three heavy No. 14-gauge wires. The center wire is the transmission line. The outer wires are spaced 1/8-inch from the inner edges of the grounded waveguide tube that runs the length of the chassis. The input and output coax receptacles are mounted in holes at each end of the waveguide. This assembly then fits inside a 5X2 $\frac{1}{4}$ X2 $\frac{1}{4}$ -inch box.

Figure 3 shows the schematic of the SWR bridge, for which a 50- or 100- $\mu$ A meter is recommended. The potentiometer is for meter calibration and protection. Hand-calibrate the meter on a friend's CB rig and antenna with a known SWR. The same 12-inch length of coax used for the RF power meter will also connect the SWR bridge between transceiver and antenna. The SWR is determined by first switching to XMTR and then (with the transmitter on) adjusting the potentiometer for maximum

(continued on page 105)

# HI-FI ACCESSORY



## Build The PHLANGER for Dramatic Music Effects

*Built around an analog delay line, this device connects easily to your hi-fi system to produce dramatic special effects*

PHLANGING CAN MAKE YOUR HEAD spin: the effect can gently roll and sway, or it can seem to turn your whole mind inside out. Phlanging was discovered accidentally in 1958 by recording producer Phil Spector while recording "The Big Hurt." Thinking the vocal part was weak, Spector instructed his engineer to make two tapes and play them back simultaneously to achieve a voice-doubling effect. The dramatic "swooshing" effect that resulted was immediately recognized as a hit sound, and the record indeed received considerable attention.

After its initial success, many musicians and producers wanted to use the phlanging effect in recordings, but the technique of producing small controlled variations of tape recorder playback speed was time-consuming and cumbersome. Then in the 1970's, operational amplifiers and active filters were developed to produce this type of sound in a low-cost unit called a phase shifter. Phase shifters became a craze with musicians, but the octavely related cancellation frequencies of the all-pass networks used in phase shifters provide a much more bland sound than the harmonically related

### MARVIN JONES

notches of true time-delay phlanging. Now that charge-coupled technology has come of age, we have bucket-brigade analog delay lines that allow true phlanging.

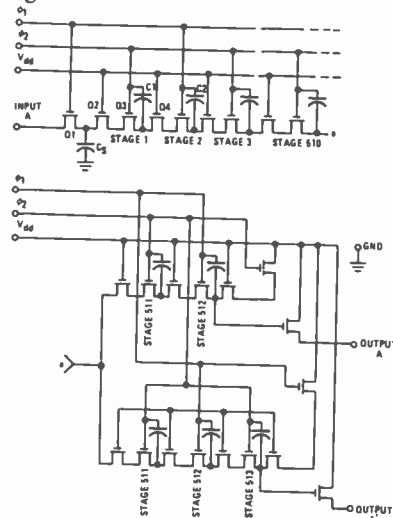

FIG. 1—ANALOG DELAY LINE uses capacitors to store analog voltages.

### How it works

The most important component in the phlanger is the *Reticon SAD-1024* analog delay line made by Reticon Corp., 910 Benicia Rd., Sunnyvale, CA 94086. This new and special IC (See *IC Application of the Month*, in the April 1977 issue) uses N-channel technology to substantially improve both quality and ease of operation. The *SAD-1024* contains MOS transistors and capacitors in two identical arrays, one of which is shown in Fig. 1. The input accepts a maximum signal swing of 0.5 volts peak-to-peak, riding a bias that is 40% of the supply potential. The supply  $V_{dd}$  can range from 4 volts to 15 volts, with 9 volts to 15 volts providing the best specifications. The  $\phi_1$  and  $\phi_2$  are inputs for the biphasic high-frequency clock. These signals must switch between  $V_{dd}$  and ground, and be complementary with minimum overlap. When  $\phi_1$  is high, the input signal is gated through Q1 to input capacitor  $C_1$  (see Fig. 1). At the next clock transition,  $C_1$  is isolated and the last voltage applied to  $C_1$  is held. As  $\phi_1$  goes low,  $\phi_2$  goes high allowing the charge on  $C_1$  to be gated to storage capacitor  $C1$ .

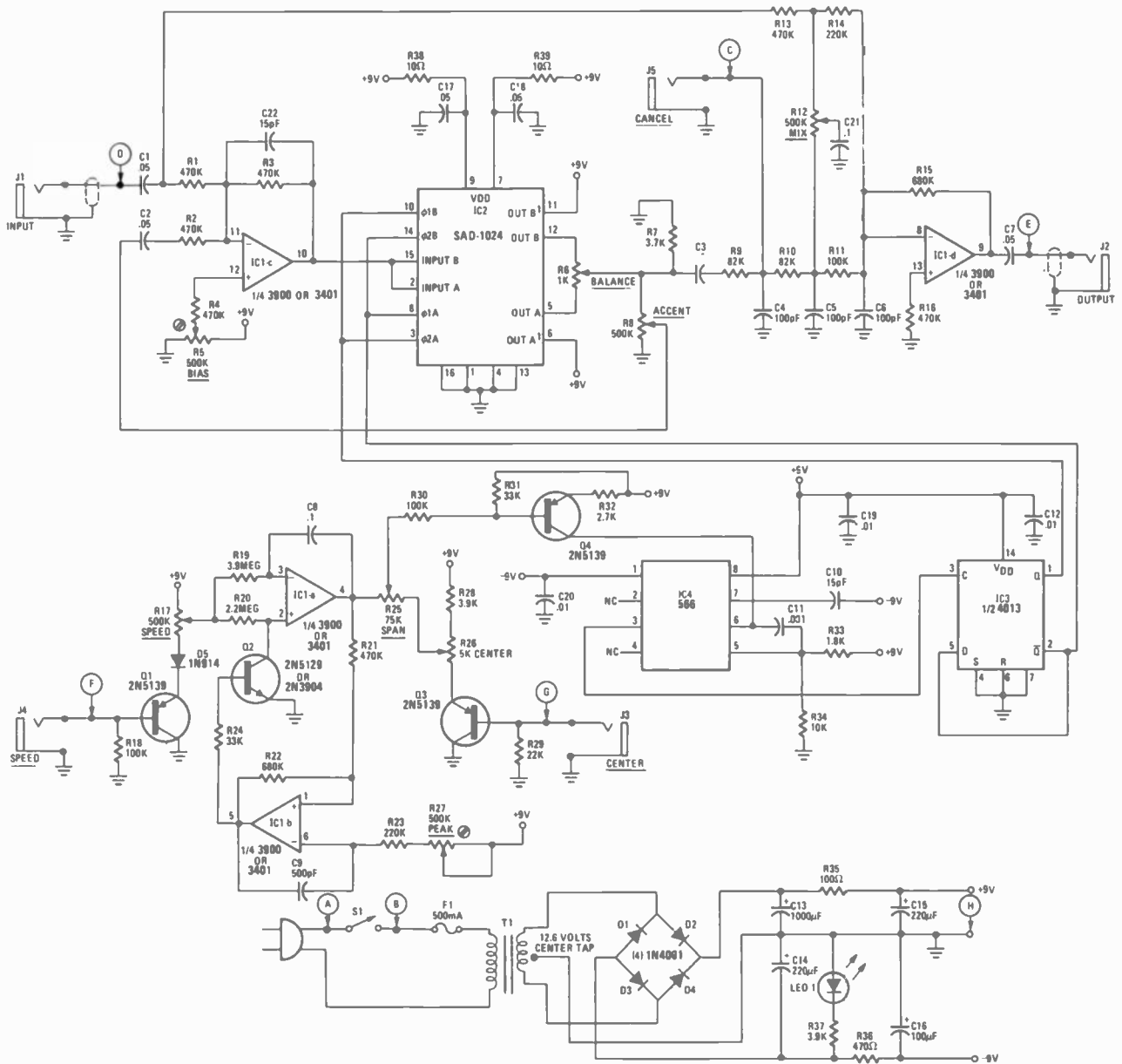

FIG. 2—PHLANGER uses an analog delay line to add "swooshing" effect to music.

### PARTS LIST

All resistors 1/2 watt, 5% unless otherwise noted.

R1-R4, R13, R14, R21—470,000 ohms  
 R5, R27—500,000-ohm, linear PC-mount trimmer  
 R6—1000-ohm, linear PC-mount trimmer  
 R7, R32—2700 ohms  
 R8, R12, R17—500,000-ohm linear potentiometer  
 R9, R10—82,000 ohms  
 R11, R18, R30—100,000 ohms  
 R14, R23—220,000 ohms  
 R15, R22—680,000 ohms  
 R19—3.9 megohms  
 R20—2.2 megohms  
 R24, R31—33,000 ohms  
 R25—75,000-ohm linear potentiometer  
 R26—5000-ohm linear potentiometer  
 R28, R37—3900 ohms  
 R29—22,000 ohms  
 R33—1800 ohms  
 R35—100 ohms

R36—470 ohms  
 R38, R39—10 ohms  
 C1-C3, C7, C17, C18—.05 µF, ceramic disc  
 C4-C6—100 pF, ceramic disc  
 C8, C21—.01 µF, Mylar  
 C9—500 pF, ceramic disc  
 C10, C22—15 pF, ceramic disc  
 C11—.001 µF, ceramic disc  
 C12, C19, C20—.01 µF, ceramic disc  
 C13—1000 µF, 10 volt, electrolytic  
 C14, C15—250 µF, 10 volt, electrolytic  
 C16—100 µF, 10 volt, electrolytic  
 D1-D4—1N4001 diode  
 D5—1N914 or 1N4148 diode  
 LED1—MLS 750  
 Q1, Q3, Q4—2N5139 transistor  
 Q2—2N5129 or 2N3904 transistor  
 IC1—LM3900 or CA3401, quad Norton amp  
 IC2—SAD-1024 analog delay line (Reticon)

IC3—4013-type dual-D flip-flop  
 IC4—566-type VCO  
 F1—500-mA fuse, with surface mount holder  
 J1-J5—1/4-inch phone jacks  
 S1—SPST slide switch  
 T1—12.6 volt, center-tapped, 300-mA power transformer  
 MISC.—Hookup wire, line cord, 16-pin IC socket for IC2, knobs, case and hardware.

The following parts are available from Paia Electronics, Inc., Box 14359, Oklahoma City, OK 73114. Etched, drilled and punched PC board, No. 1500PC, \$9 postpaid.

Complete kit of parts including PC board, case and step-by-step instructions, No. 1500, \$59.95 plus 4-lb. shipping charge.

Oklahoma residents add state and local taxes as applicable.

On the next clock transition, gating transistor Q3 is disabled, and Q4 is enabled to allow the charge in C1 to pass to the next stage. While  $\phi_1$  is again high, another input sample is taken. The discrete voltage levels continue to be clocked through the circuitry until, 512 clock half-cycles later, the original input voltage appears at output A. This same voltage appears also at output A' during the next, or 513th, clock period. Mixing these two outputs allows a more continuous output waveform to be generated, and also provides a means of improved suppression of clocking glitches.

The overall time delay generated by this circuit can be calculated from:  $T_d = N/(2F_c)$ , where N is the number of shift register stages (512 in this case), and  $F_c$  represents the clock frequency at  $\phi_1$  and  $\phi_2$ . Output filtering should be used to remove any residual clock signals that are superimposed on the output and to smooth the sampled stair-step signal into

a duplicate of the original input.

Consideration must also be given to the number of samples required per input waveform period to accurately reproduce the waveform. When the sampling frequency is greater than 10 times the input frequency, oversampling occurs. However, higher sample rates yield higher reproduction accuracy. Critical sampling occurs when the input frequency is one-half the clock frequency, and this is the maximum limit to which the system should be pushed for accurate audio reproduction.

The schematic for the full phlanger is shown in Fig. 2. The input signal is buffered by IC1-c. Bias trimmer R5 adjusts the DC output to 40% of the supply voltage to provide minimum clipping of the signal as it enters the delay circuit. The signal is fed simultaneously to both delay line inputs of IC2. Note that the clock signals to each delay line are reversed so that  $\phi_1$  for one section is

$\phi_2$  for the other. This operation, known as parallel multiplexing, causes each delay line to alternately sample the input signal. Thus, twice as many samples are provided for a given clock frequency, and reproduction accuracy is increased at the output. One output from each delay line are mixed together at BALANCE control R6, while unused outputs are tied to the supply voltage. The ACCENT control R8 feeds a portion of the delayed signal back to the input for regeneration. Low-pass filters R9-C4, R10-C5 and R11-C6 eliminate the remaining clock signal and smooth the sampled waveform into a more linear duplicate of the original. The MIXING control R12 allows selection of the normal input signal, the delayed signal or any blend of the two. The mixed signal is amplified by IC1-d to provide unity gain from the input to the output of the phlanger.

The remaining two sections of IC1 form the low-frequency triangle oscillator used to sweep the phlanger effect. The slope of integrator IC1-a is voltage-controlled. The control voltage is supplied by SPEED control R17 or remote SPEED input J4. Schmitt trigger IC1-a switches the integrator between a positive or negative slope. A fine adjustment of the triangle output amplitude of IC1-a is provided by PEAK control R27. This allows for optimum compatibility with following circuitry. The amount of triangle amplitude used to modulate the high-frequency clock is selected by SPAN control R25. As the voltage from the SPAN control is decreased, more of the fixed DC voltage from CENTER control R26 is used to set the clock to a fixed frequency.

With minimum SPAN and maximum

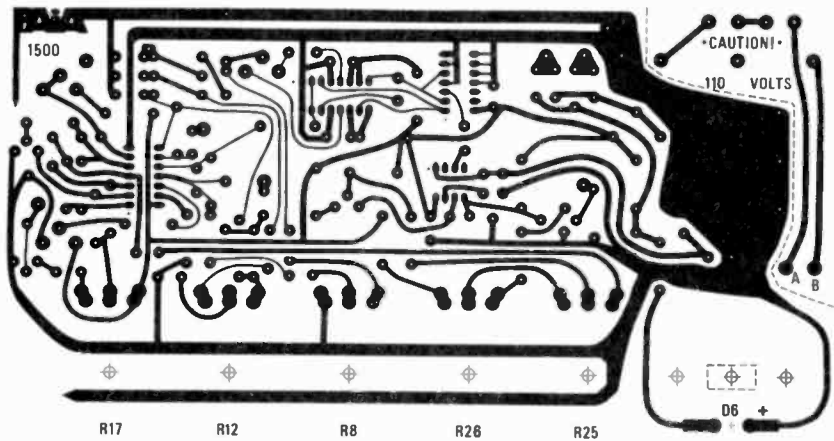

FIG. 3—FOIL PATTERN of single-sided PC board shown half-size.

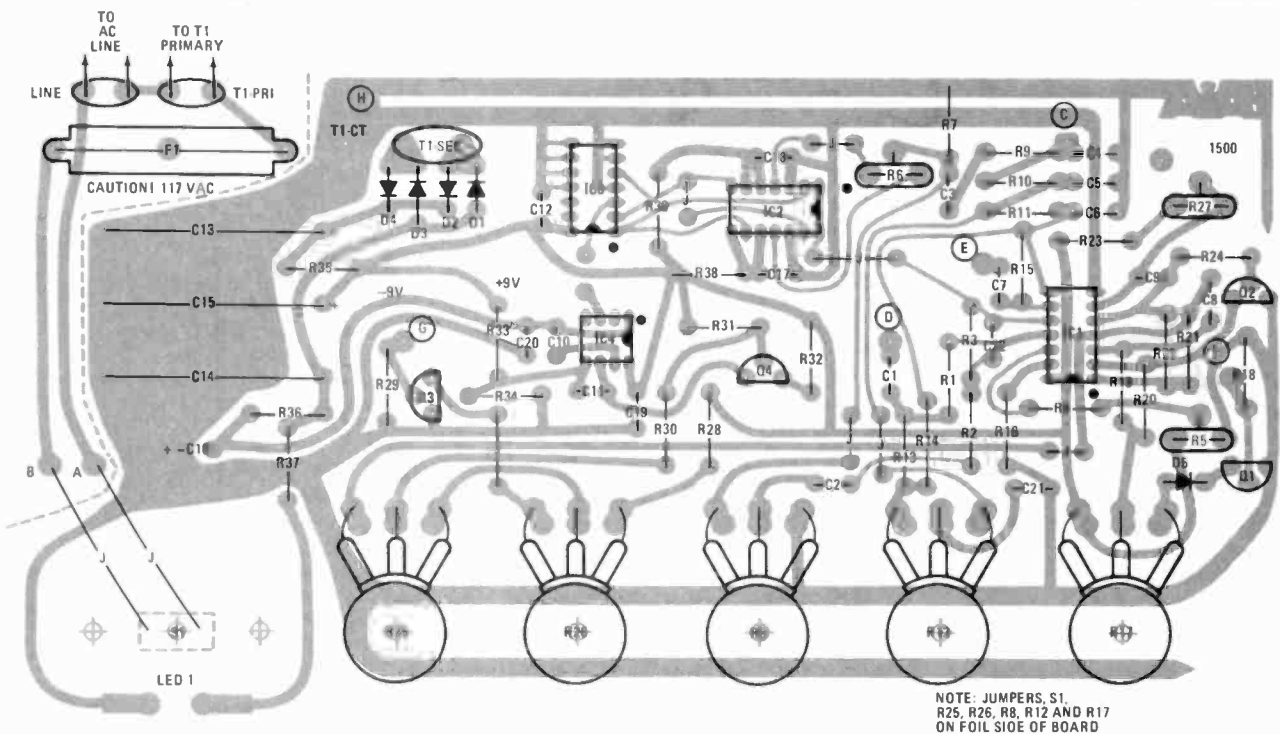

FIG. 4—COMPONENT PLACEMENT diagram.



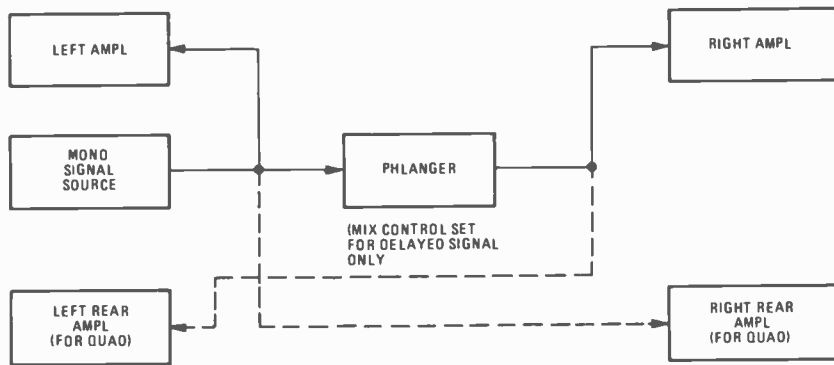

FIG. 5—STEREO EFFECT is produced from mono signal using this hook-up.

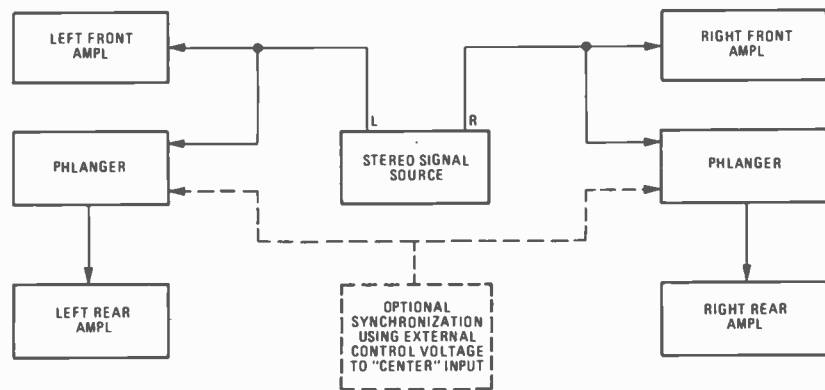

FIG. 6—QUADRIPHONIC EFFECT is produced from stereophonic source using two phlangers.

CENTER control settings, an external control voltage can be applied to J3 to modulate the clock frequency and, in turn, sweep the phlanging effect. The mixed voltage from this control network is applied to current source Q4, which acts as a voltage-controlled timing resistor for high-frequency oscillator IC4. Timing capacitance is provided by C10. The squarewave output of IC4 switches between positive supply and half-supply, so a bipolar supply is used for this IC to make the squarewave switch between positive supply and ground. This signal is now directly compatible with the input of

D-type flip-flop IC3. This circuit divides the frequency in half, but, most important, it provides a set of complementary squarewaves that are very clean and with very little overlap. These signals are used to directly drive the clock inputs of the delay IC. The resulting clock frequency range is 30 kHz to 500 kHz. The power supply is a standard full-wave center-tapped bridge that provides a  $\pm 9$ -volt supply to the circuitry.

**Construction**

Assembly is straightforward, since all components are mounted on the circuit

board except for five jacks and the power transformer. The foil pattern for the circuit board is shown in Fig. 3 and the parts placement is shown in Fig. 4. Use only rosin core solder and a soldering iron (not a gun) with no more than a 35-watt power rating. When installing electrolytic capacitors, transistors, diodes and IC's, be sure to observe proper polarity. Note there are nine wire jumpers indicated by solid lines on the parts placement diagram (Fig. 4). Since the *Reticon SAD-1024* IC is expensive, use a socket for installation safety. The *SAD-1024* and the 4013 flip-flop are both CMOS units, and must be handled carefully. Do not wear synthetic clothing while handling these devices, and ground yourself and your soldering iron before handling or installing the units.

Power switch S1 is installed in the rectangular hole in the circuit board using No. 4-40 hardware. Use two 1 1/2-inch long insulated wire jumpers to connect the switch lugs to points A and B on the foil side of the circuit board. Press power indicator LED1 into the hole below the power switch from the foil side of the board. Then solder the leads to the adjacent foil pads. Before mounting the five potentiometers, bend their solder lugs nearly 180° so that the lugs point toward the shaft rather than the rear of the potentiometer. Install one 1/8-inch nut on the control bushing to act as a spacer, then mount the control as usual, making sure the altered solder lugs lie directly on top of the three oval pads on the foil side of the board. Flow solder into these connections. Mount the power transformer on the case with all five leads connecting to the rear of the circuit board. The letter-designated holes connect to the five jacks mounted on the case. Use coax cable for the input and output connections, with the shield connected to ground only at the jack. Connect point H to the common chassis ground of the five jacks. The remaining three connections can be made with single-conductor insulated wire.

**Testing and calibration**

Before applying power to the phlanger, double-check for cold solder joints, solder bridges and correct parts values and placement. Set the three trimmers to the midpoint of their rotation. Set all potentiometers fully counterclockwise, except CENTER control R26 which should be at maximum. Plug the line cord into a wall outlet and slide the power switch to the right. Power indicator LED1 should glow.

Apply a signal to input J1 with a maximum 0.5-volt amplitude peak-to-peak. Feed output J2 to an appropriate guitar amplifier or hi-fi system input. The normal signal should now be passing unaltered through the unit. Turn MIX control R12 fully clockwise. Adjust BIAS

*continued on page 92*

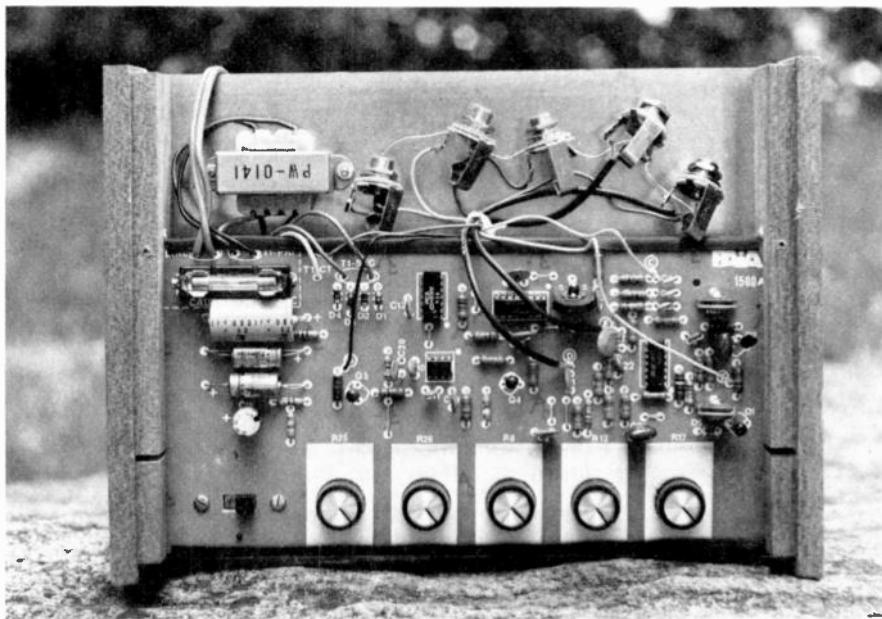

PHLANGER with top cover removed.

# The better the training the better you'll

Send for  
**FREE**  
illustrated  
career  
guide



COMPU-TRAINER  
IN-CIRCUIT TRANSISTOR TESTER  
TROUBLESHOOTER  
VOM

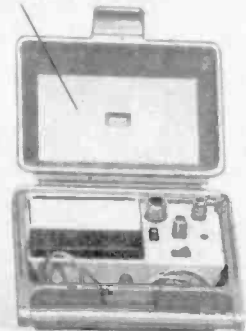
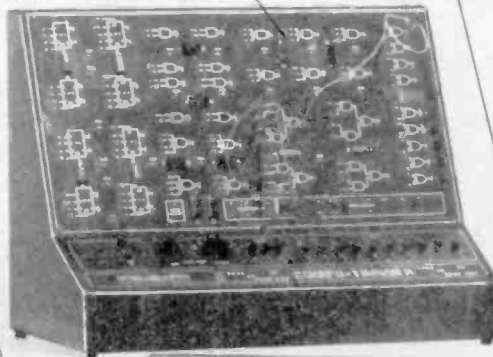

SOLID-STATE  
OSCILLOSCOPE

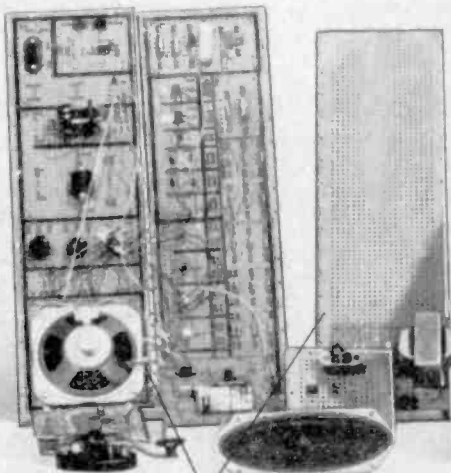

ELECTRO-LAB



(Simulated TV Reception)

As an NTS student you'll acquire the know-how that comes with first-hand training on NTS professional equipment. **Equipment you'll build and keep.** Our courses include equipment like the **NTS/Heath GR-2001 computerized color TV** (25" diagonal) with varactor diode tuning and digital read-out channel selection; (optional programming capability and digital clock avail.)

Also pictured above are other units — 5" solid state oscilloscope, vector monitor scope, solid-state stereo AM-FM receiver with twin speakers, digital multimeter, and more. It's the kind of better equipment that gets you better equipped for the electronics industry.

This electronic gear is not only designed for training; it's field-type — like you'll meet on the job, or when you're making service calls. And with NTS easy-to-read, profusely illustrated lessons you learn the theory behind these tools of the trade.

**Choose from 12 NTS courses** covering a wide range of fields in electronics, each complete with equipment, lessons, and manuals to make your training more practical and interesting.

**Compare our training; compare our lower tuition.** We employ no salesmen, pay no commissions. You receive all home-study information by mail only. All Kits, lessons, and experiments are described in full color. Most liberal refund policy and cancella-

# and the equipment be equipped.

COMPARE OUR  
KITS AND LESSONS.  
COMPARE OUR  
TUITION.

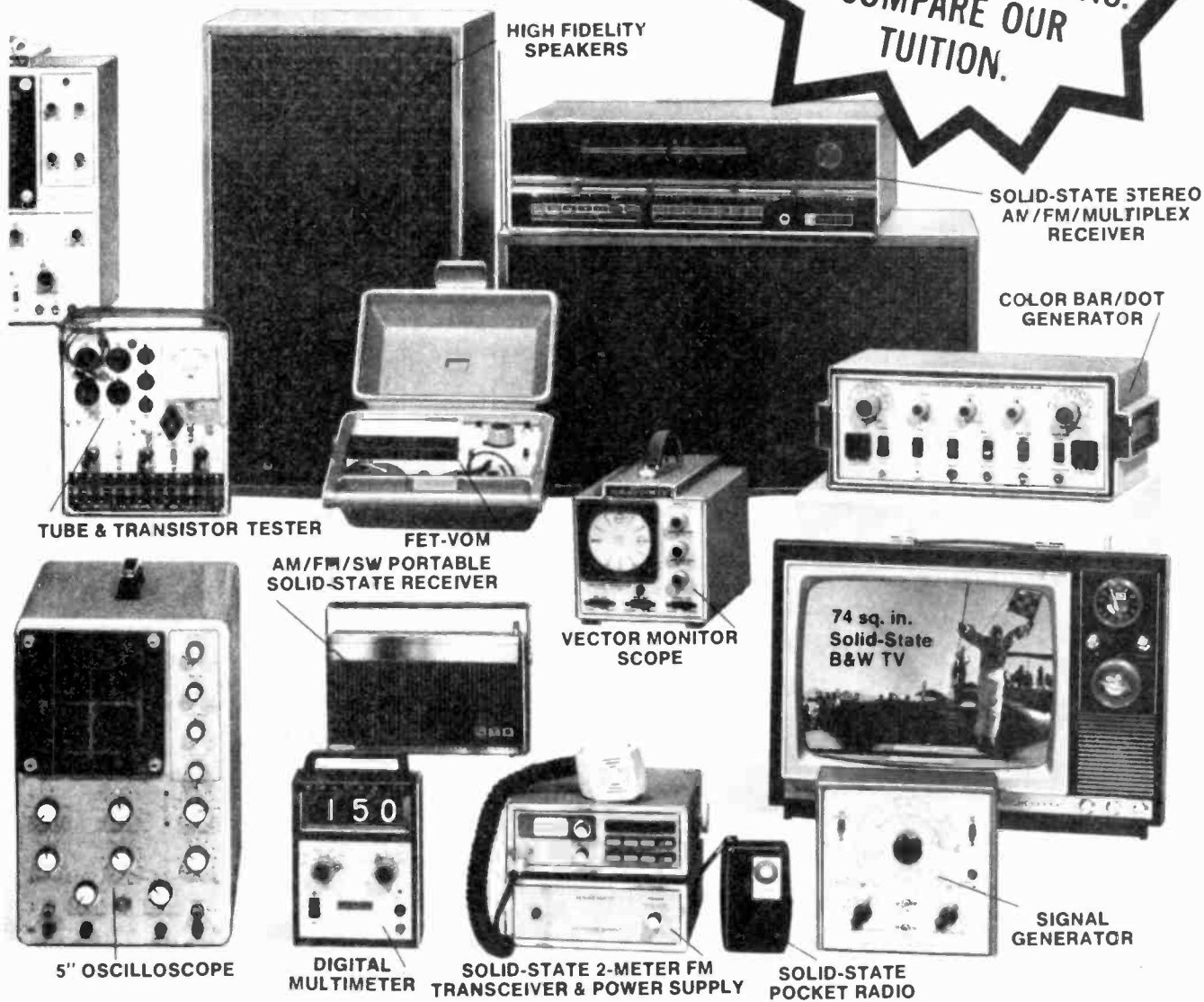

tion privileges spelled out. Make your own comparisons, your own decision. Mail card today, or clip coupon if card is missing.

**NO OBLIGATION. NO SALESMAN WILL CALL**

**APPROVED FOR VETERAN TRAINING**

Get facts on new 2-year extension

**NATIONAL TECHNICAL SCHOOLS**

TECHNICAL-TRADE TRAINING SINCE 1905  
Resident and Home-Study Schools  
4000 So. Figueroa St., Los Angeles, Calif. 90037

**NATIONAL TECHNICAL SCHOOLS** Dept. 206-107  
4000 South Figueroa St., Los Angeles, Calif. 90037  
Please send FREE Color Catalog and Sample Lesson.  
NO OBLIGATION. NO SALESMAN WILL CALL.

Color TV Servicing  
 B & W TV and Radio Servicing  
 Electronic Communications  
 FCC License Course

Electronics Technology  
 Computer Electronics  
 Basic Electronics  
 Audio Electronics Servicing

NAME \_\_\_\_\_ AGE \_\_\_\_\_

ADDRESS \_\_\_\_\_ APT # \_\_\_\_\_

CITY \_\_\_\_\_ STATE \_\_\_\_\_

Please fill in Zip Code for fast service \_\_\_\_\_

Check if interested in G.I. Bill information.  
 Check if interested ONLY in classroom training in Los Angeles.

# Realign Your FM Receiver

*Crosstalk, modulation-time errors and phase-shift problems all result from misaligned FM receivers. Here's how to realign your FM receiver yourself*

T.J.C. MOLLE\*

THE ALMOST UNIVERSAL USE OF STEREO FM receivers makes stereo receiver test equipment an essential in any modern consumer electronics service shop. With today's high-performance receivers, sophisticated test equipment is needed. There are times when the customer must be convinced that the reason for not receiving a good stereo signal is not a fault in his stereo FM tuner but that the trouble is a defective antenna, for example.

Most faults are caused by a failure in the FM decoder circuitry or by component drift. These troubles can be located and corrected fairly simply; the latter simply by realigning the receiver.

But the problem with the normal transmitted stereo signal is that it is difficult to quantify. The signals are not adequate for use as test signals. Even the relatively few stereo test transmissions are useful for little more than balancing the speakers.

The need is for some form of signal source that can provide a complete easy-to-measure stereo signal. One solution is the *Philips PM 6456* FM stereo generator. It simulates a transmitter signal with signals that can be selected, reproduced and measured.

## The FCC standards

Stereo broadcasting brings with it problems not imaginable with a simple domestic record or tape player that has separate right and left channels. The result is that standards are very exacting. The system most widely used is based on the FCC requirements, which insure good reproduction both in stereo and monophonic receivers.

The transmitted stereo FM signal is split into three components:

- The sum of the left and right channels ( $L + R$ ), containing all information for monophonic transmission, called the M signal.

- The sideband formed by amplitude modulation with a suppressed subcarrier of the difference signal ( $L - R$ ), called the  $S_m$  signal; and
- A pilot signal, with a frequency one-half that of the suppressed subcarrier, which is used to regenerate the subcarrier in the receiver, called the P signal.

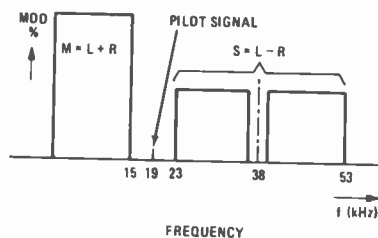

FIG. 1—THE FREQUENCY SPECTRUM of the FCC stereo multiplex signal shows the relative positions of the pilot, M, and  $S_m$  signals.

Fig. 1 shows the spectrum of the resulting stereo multiplex signal.

Some idea of the technical demands of stereo transmission can be gathered from the FCC requirements for a stereo transmission system:

- The 19-kHz pilot signal must be accurate within  $\pm 2$  Hz.
- The phase relationship between the pilot and the subcarrier must be rigidly maintained; zero-axis crossings of the subcarrier in the positive direction must coincide with those of the pilot.
- If only the L or R signal is used for modulation, the amplitude of the M signal must not be more than 3% different from the  $S_m$  signal.
- If only the L or R signal is used for modulation, then the phase difference between the M signal and the envelope of the  $S_m$  signal must not be less than  $3^\circ$ .

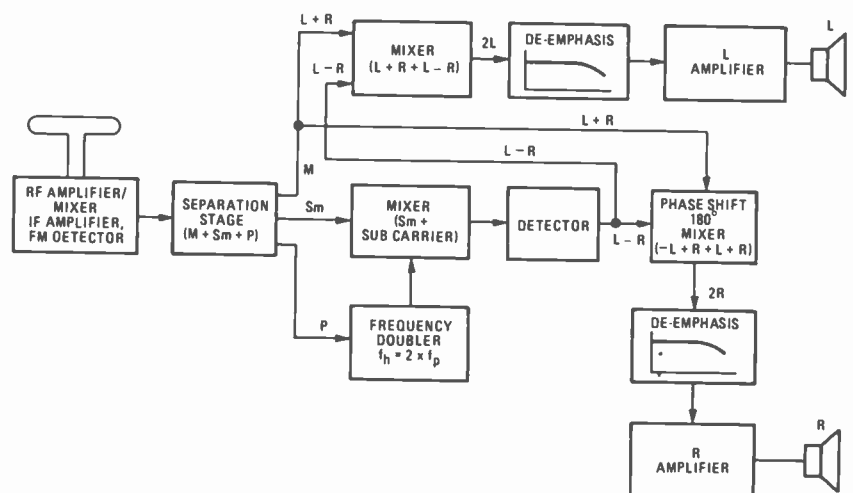
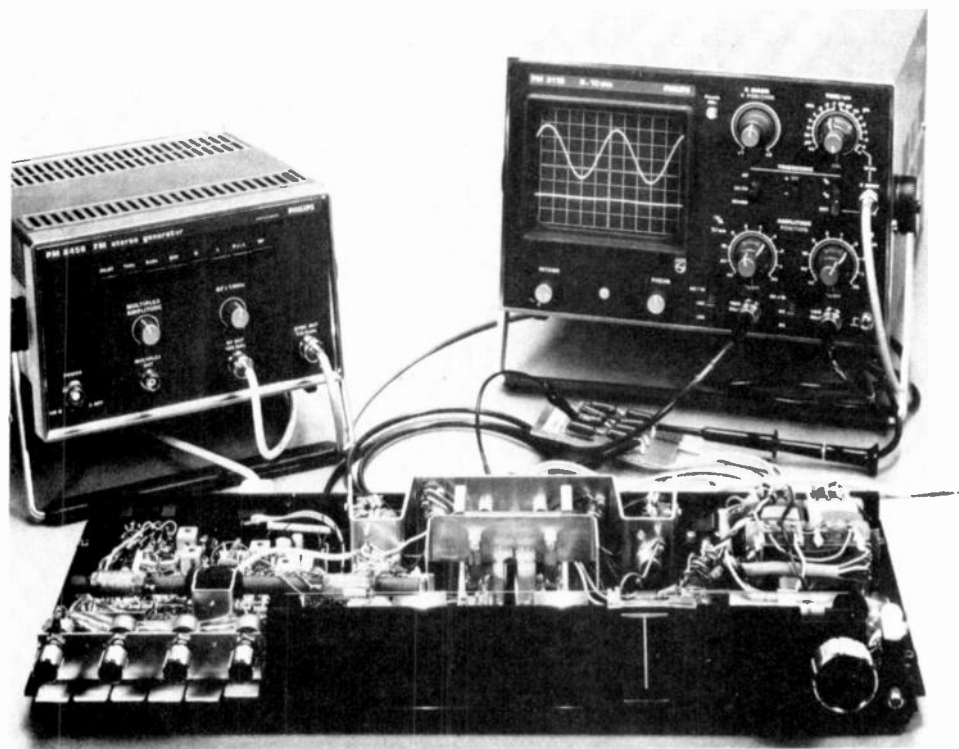

FIG. 2—SIMPLIFIED BLOCK DIAGRAM of a stereo FM receiver.

\*Philips Test & Measuring Instruments Dept., Eindhoven, The Netherlands.



• Crosstalk of the L signal on the right audio channel and vice-versa must be lower than 30 dB.

Obviously if the transmitted signal has to meet such stringent standards, a great deal of attention must be paid to receiver adjustment.

To align or troubleshoot a stereo FM receiver, the only suitable method is to use an FM stereo generator that provides a suitable signal source. It must simulate the transmitter signal, yet provide a choice of stable signals,

which—in contrast to music and speech—can be accurately reproduced and measured.

Another indispensable instrument is an oscilloscope, so that the amplitude, frequency and distortion (if any) can be measured directly and in full detail.

### Receiver operation

Figure 2 is a simplified block diagram of a typical stereo FM receiver/decoder. The receiver detects the multiplex stereo signal and splits it into its three components—M, Sm and

P. The pilot signal is fed through a frequency doubler to regenerate the subcarrier for the Sm signal, to which it is added. The L-R signal is detected from the resulting Sm signal. This L-R signal is then added to the L + R signal (M). In this way, a 2L signal is obtained.  $[(L+R)+(L-R)=2L]$ . To get the R signal, the L - R signal is phase-shifted by  $180^\circ$  and added again to the L + R signal, resulting in a 2R signal  $[(L+R) - (L-R)=2R]$ .

One final stage is de-emphasis. Before the original left- and right-channel signals are fed to the transmitter, the higher frequencies are given pre-emphasis to help increase the high-frequency signal-to-noise ratio. This emphasis has to be removed. After de-emphasis and amplification the left and right signals are applied to their loudspeakers.

### Alignment faults

Typical troubles that arise are phase shift between the 19-kHz pilot signal and the 38-kHz signal regenerated in the decoder; demodulation time errors; and, perhaps most common of all, crosstalk between the left and right channels

All these faults can be cured by realignment, using a stereo generator. Adding an oscilloscope to the test set-up makes possible direct measurement not only of amplitude and frequency, but also of crosstalk, phase-relation and distortion.

The equipment should provide a logical sequence of test signals to enable accurate and fast alignment of a stereo decoder or a complete receiver. The test sequences should include a 19-kHz pilot, internal AF modulation with provision for external modulation, right-channel- and left-channel-only signals, and a right equals minus left signal. A 100-MHz  $\pm 1$  MHz RF signal is also very useful, and is essential for checking a receiver.

### Generator description

Figure 3 is a block diagram of the type of FM generator mentioned earlier in this article.

Signals of 1 and 5 kHz are produced by an audio-frequency oscillator and are pushbutton-selected for channel R, channel L, or both channels in antiphase ( $R=-L$ ). The selected AF signal is also available as an external trigger signal—for an oscilloscope, for example.

The 38-kHz subcarrier is derived from the 19-kHz crystal-stabilized pilot-tone oscillator. The pilot tone is also pushbutton-selected.

In the 19-kHz to 38-kHz frequency converter, the pilot signal is doubled to create the subcarrier signal and is applied to the stereo modulator.

The audio input signal (R or L, or both) is modulated together with the 38-kHz subcarrier frequency.

At point 4 of the stereo modulator the input signal is phase-shifted  $180^\circ$  to insure that the channels are in antiphase when  $R=-L$  is selected.

If the EXT pushbutton is depressed, the complete stereo signal of a recorder or record player can be introduced. The adder circuit adds the 19-kHz pilot tone, when selected, to the stereo multiplex signal. The attenuator adjusts the multiplex signal continuously for the required input level of a stereo FM decoder.

From the moment the RF button is depressed the multiplex stereo signal is RF-modulated at a 100-MHz carrier frequency.

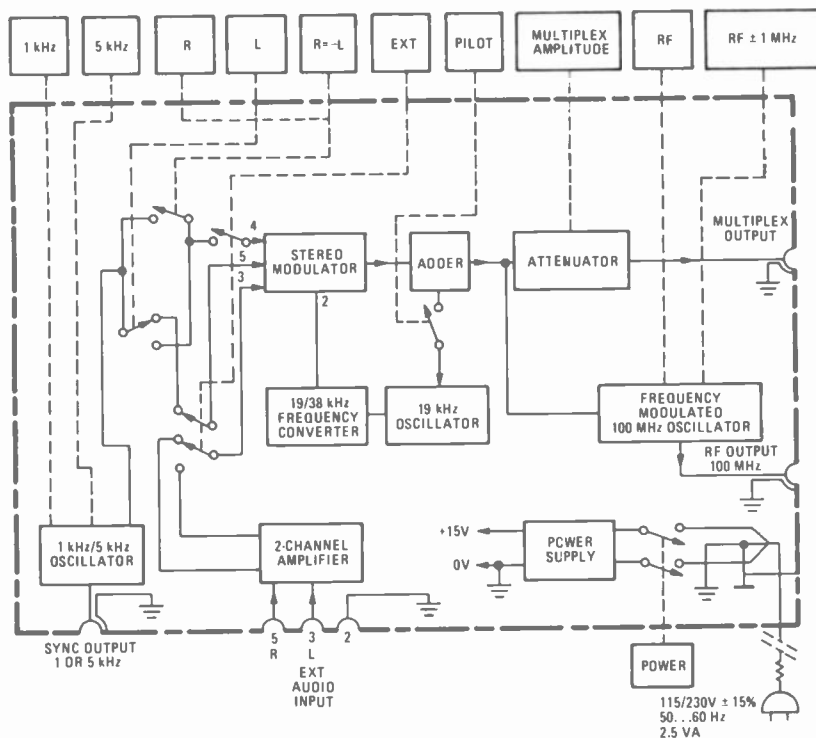

FIG. 3—THIS BLOCK DIAGRAM of a stereo FM generator gives some idea of the facilities available.

The center frequency is adjustable  $\pm 1$  MHz to avoid interference with transmitters on adjacent frequencies.

The complete stereo multiplex signal comprises three components: The sum of the L and R channels, the difference of the L and R channels modulated at the subcarrier frequency, and the pilot frequency.

It will be clear that, although a stereo FM generator is simple compared to a real transmitter, its specifications must be close to the requirements that have to be met by the transmitter signal.

The Philips PM 6456 FM stereo generator offers:

- Crosstalk suppression between the L and R signals for 1 and 5 kHz  $> 40$  dB.
- Phase shift between the pilot and subcarrier  $3^\circ$
- Subcarrier suppression  $> 40$  dB.
- Accuracy of the pilot frequency, 19 kHz  $\pm 2$  Hz.

### Stereo FM alignment

The measuring set-up is simple. The multiplex output of the generator is connected to the decoder input.

The alignment is performed step-by-step (see Fig. 4).

1. The 19-kHz pilot signal is applied without an M and Sm signal (Fig. 5). The input voltage is adjusted to 200 mV peak-to-peak on the scope, using the attenuator in

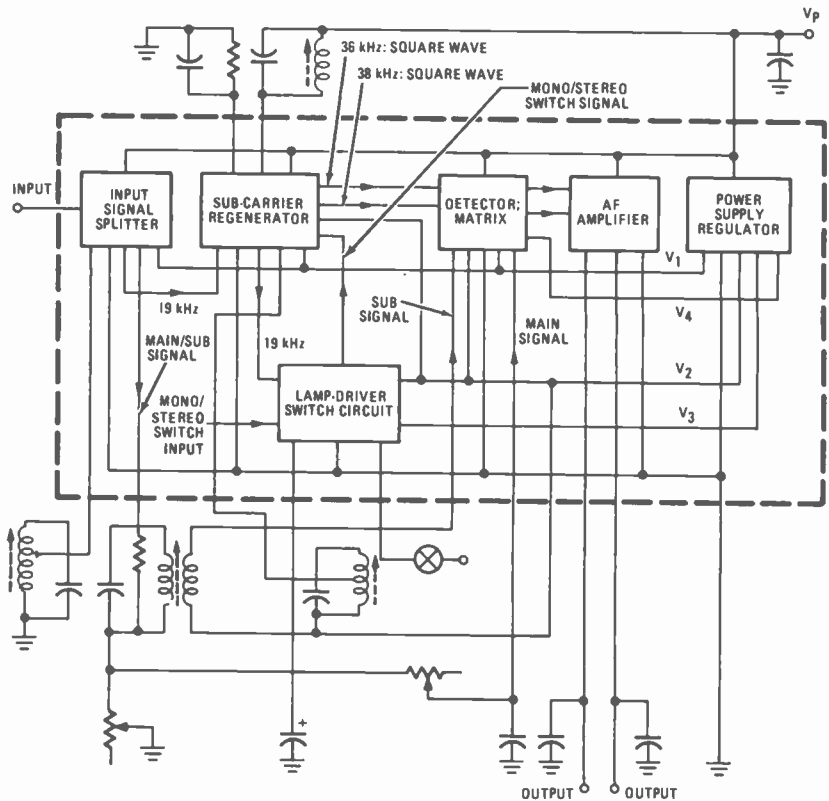

FIG. 4—A STEREO FM DECODER ready for checking and realigning.

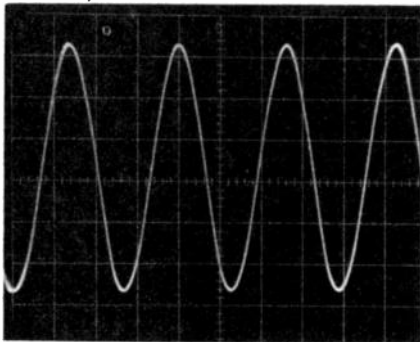

FIG. 5—THE FIRST STEP is to apply the 19-kHz pilot signal, without the M or Sm signals.

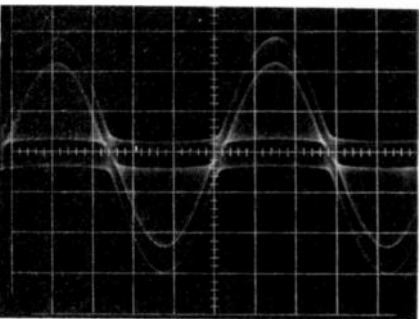

FIG. 6—THE AMPLITUDE OF the multiplex signal at the input is adjusted for 1 volt peak-to-peak.

the multiplexer output. The pilot and subcarrier filters are adjusted at this stage. After the pilot and subcarrier frequencies are measured, the oscilloscope—preferably dual-trace—is connected to the right- and left-channel outputs, respectively.

2. A multiplex signal modulated with only one channel—say L—is now applied, and the decoder adjusted for minimum channel crosstalk. The amplitude of the multiplex

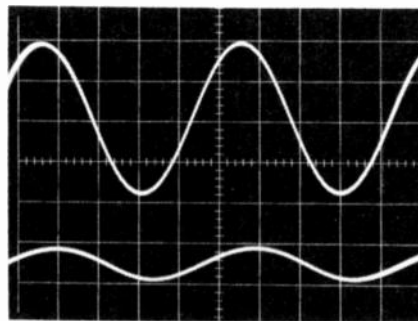

FIG. 7—A DUAL-BEAM OSCILLOSCOPE facilitates the examination of crosstalk between L and R channels. The upper trace shows the signal on the L channel, which results in the crosstalk on the R channel in the lower trace.

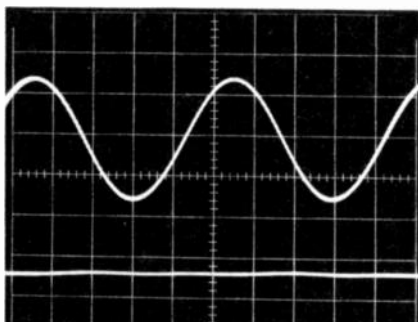

FIG. 8—THE STEREO GENERATOR provides a 1-kHz signal with a pilot to the L channel. Adjustment is made to minimize crosstalk.

signal at the input is 1 volt peak-to-peak (Fig. 6). Figure 7 shows a typical display of part of the L signal causing crosstalk in the R channel. Amplitude and phase then have to be adjusted to minimize this crosstalk (Fig. 8). The process is repeated to check the second channel, in this case, the R channel (Fig. 9). Now the crosstalk in the left channel is minimized.

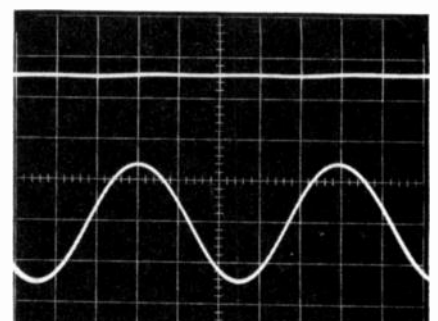

FIG. 9—THE SAME SIGNAL is then applied to the R channel, and crosstalk on the L channel is minimized.

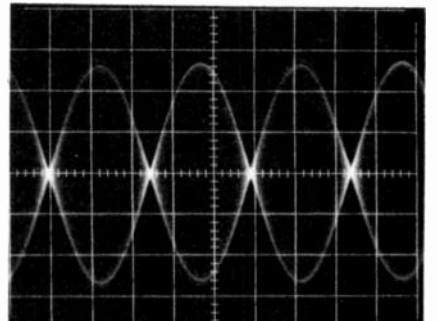

FIG. 10—THE AMPLITUDE OF the Sm signal is adjusted to give zero-axis crossing.

3. Applying only a sideband signal—the addition of the modulating L or R signal in phase opposition in the mixer stage, without the pilot—should result in Sm signals with equal amplitude and phase, providing a display with a sharp zero-axis crossing (Fig. 10).
4. The sideband signal is then applied with the pilot signal, and the resulting L and R output signals are adjusted to the same

(continued on page 106)

# New for Hi-Fi

## CLASS-H Variproportional Amplifier

*New approach to audio amplification provides high efficiency and rates a new class designation. Here's how it works*

**LEN FELDMAN**  
CONTRIBUTING HI-FI EDITOR

FOR MANY YEARS HIGH-FIDELITY AMPLIFIER designers and manufacturers concentrated on Class-A, Class-AB and Class-B circuitry. At the relatively low power-output levels demanded by audiophiles during the beginning of the hi-fi era, power-amplifier efficiency was of little concern. But, as audio enthusiasts began to seek ever more powerful amplification (the newest leader in the receiver "power race" this year is a 250-watt-per-channel heavyweight from Marantz), the efficient conversion of wall-outlet AC power into low-distortion audio power began to be more important. The nation's energy crisis has caused audio enthusiasts to think about the electrical energy consumed by their hi-fi components.

Audio designers have recently turned their attention to new circuits and can more efficiently convert input AC line power to useful audio power. Some time ago, we discussed the so-called Class-G amplifier circuitry developed by Hitachi. Essentially, the Class-G circuit uses two levels of output-transistor devices, each powered by its own supply voltage. Low-power pairs handle signals up to a predetermined amplitude, while the higher-powered pairs, operating at higher supply voltages, take over the job when signal levels exceed the lower supply voltage. In this way, each pair of transistors operates over its most efficient range for a longer period.

Now, Soundcraftsmen of Santa Ana,

CA, have produced another class of audio amplifier that they have tentatively called "Class H." Paul E. Rolfes, Soundcraftsmen chief engineer and the inventor of the new amplification scheme, provided us with information regarding his invention (for which patents are pending) at the recent Consumer Electronic Show in Chicago, IL.

### How it works

A simplified schematic of the Class-H vari-proportional circuitry is shown in Fig. 1. The first thing to note in examining the power-supply arrangement on the left side of Fig. 1 is that the circuit uses two positive- and negative-supply voltage levels (derived from the two take-off points, per polarity, at the power-

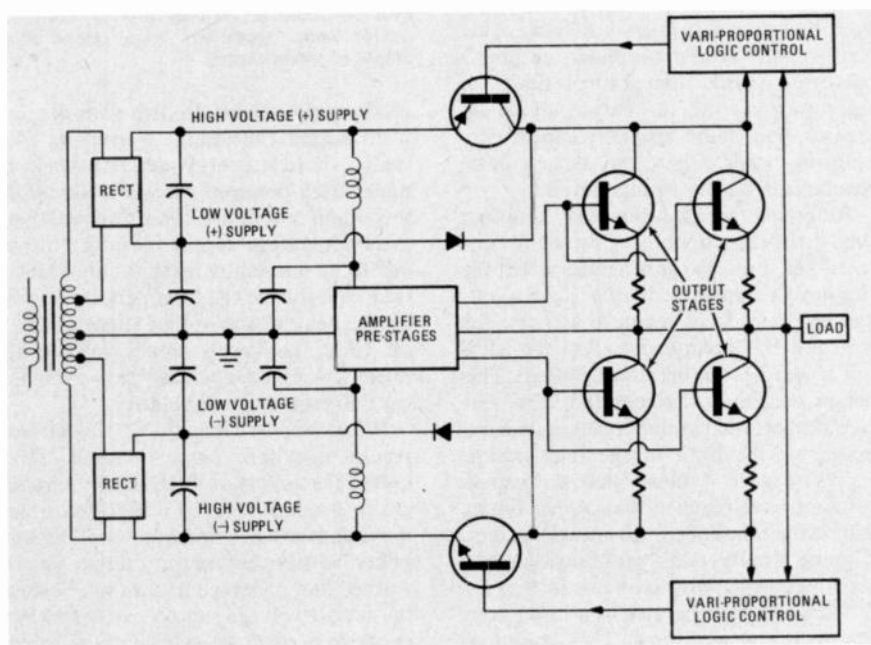

**FIG. 1—CLASS-H AMPLIFIER** uses a dual polarity low- and high-voltage power supply. The logic circuit varies the supply voltage to the output transistors.

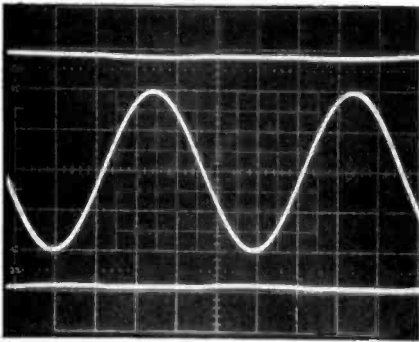

FIG. 2—1 kHz TEST SIGNAL appearing at output of Class-H amplifier. Upper and lower traces show the positive and negative voltage levels supplied to the output transistors.

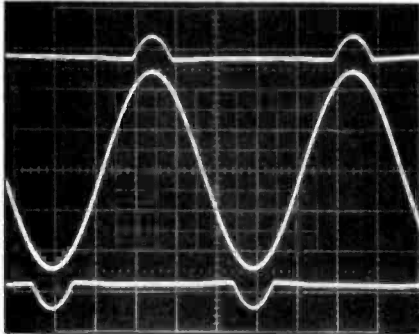

FIG. 3—INCREASING THE AMPLIFIER GAIN shows that as the output signal approaches the supply voltage, the logic circuits increase the supply voltage.

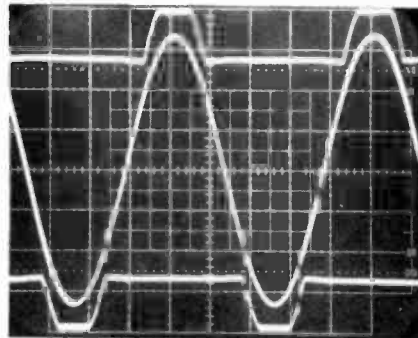

FIG. 4—LARGE OUTPUT SIGNAL swings force the power supply to saturate.

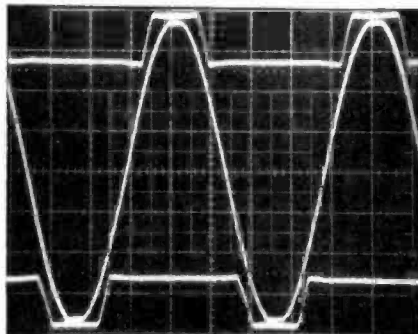

FIG. 5—OUTPUT SIGNAL CLIPS when the output voltage reaches the maximum supply voltage.

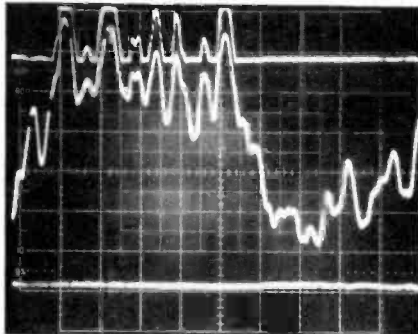

FIG. 6—COMPLEX WAVEFORM is shown in center trace. Upper and lower traces show output of power supply.

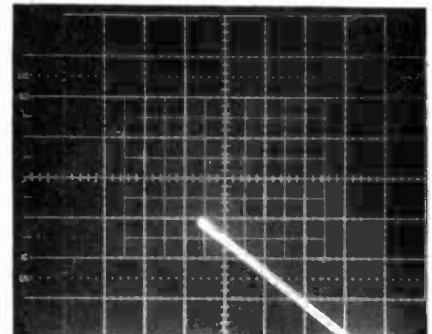

FIG. 7—CURRENT VS. VOLTAGE characteristic of an output transistor. The amplifier is operated at one-third in the Class-AB mode. Area to left of trace is heat dissipation.

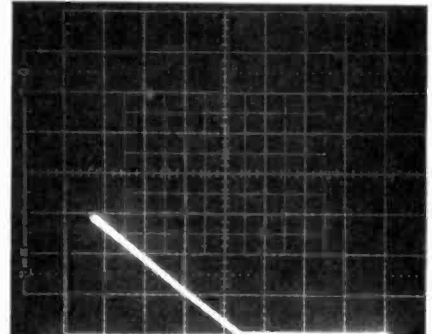

FIG. 8—CURRENT VS. VOLTAGE characteristic of an output transistor operating in the new Class-H mode.

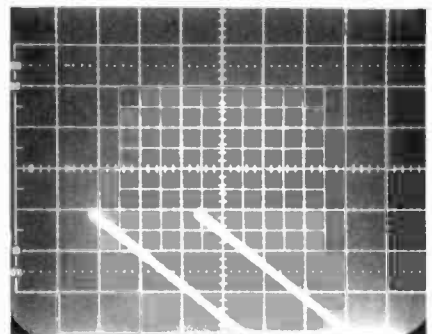

FIG. 9—HEAT DISSIPATION DIFFERENCE between Class-AB and Class-H modes is shown by superimposing Figs. 7 and 8.

transformer secondary). The ratio of these power-supply voltages is arranged so that the low-voltage supply is two-thirds that of the high-voltage supply. In operation, the amplifier appears to work exactly like a conventional Class-AB amplifier at low-power outputs. However, as the signal level approaches the low-voltage supply limit, a difference in operation becomes apparent.

Figure 2 shows two horizontal lines that represent the B+ and B- supplies to the output stages. A 1,000-Hz sine-wave signal at the amplifier output is operating within the voltage limits of these supplies. As the output signal increases, you would normally expect clipping to occur when the output level reaches the supply-voltage levels.

Referring to Fig. 3, however, note that the vari-proportional logic-control circuits (of Fig. 1) have anticipated the sine-wave's approach to the supply-voltage level and have begun to increase the B+ and B- voltages to allow for additional head room or power output. This action continues, as required, until the vari-proportional system reaches its maximum, or the limit of the high-voltage supply. Figure 4 shows that the supply voltages have reached their upper limits, and, if the amplifier is driven still harder, clipping finally takes place against the high-voltage supply, as shown in Fig. 5.

The amplifier operates at a lower voltage most of the time. This conserves energy because it reduces output-stage dissipation, since this dissipation is di-

rectly proportional to the voltages applied across the output transistors. Actually, there is energy conservation even under high-powered sinewave conditions too. Figures 4 and 5 show that although the high-voltage supply is being "turned on" to its maximum level, it only reaches that level during the brief period required by the peak of the output sinewave. It is off (and the lower supply voltage applied) during most of the "duty cycle" of each sinewave-signal polarity.

When we first learned of this circuit, several questions came to mind. First, unless the supply-voltage control circuits are fast-acting, what if a high-frequency musical transient signal caused the amplifier to clip before the higher supply voltage had a chance to turn on. Second, the supply voltage should rise *before* it is actually needed, to avoid any switching blips or discontinuities in signal waveforms.

Obviously, the inventors foresaw the same possible problems. Referring once more to Fig. 3, note that the sinewave peaks are still below the level that would require an increase in supply voltage. Still, the vari-proportional logic circuitry has already detected a rising waveshape and is anticipating that the supply voltage *may* have to be increased. Therefore, it begins to turn on the higher supply voltage before the sinewave actually reaches the lower supply voltage level. In Fig. 4, the slope or rate of increase of the upper waveshape (positive supply voltage) is greater than the slope of the audio-signal sinewave that is "entering" the upper supply. Since the turn-on gain of the upper supply voltage is greater than the amplifier gain, the sinewave signal can never catch up with the higher supply (until it reaches final, upper clipping, as shown in Fig. 5).

Soundcraftsmen also notes that the



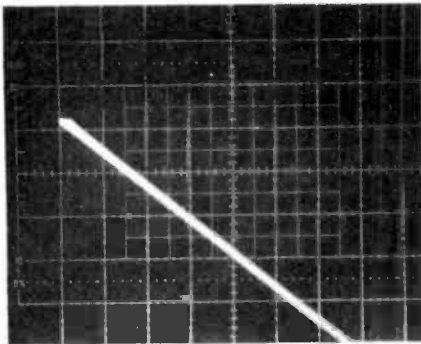

FIG. 10—CURRENT VS. VOLTAGE characteristic of an output transistor when the amplifier is operated at full-rated output in the Class-AB mode.

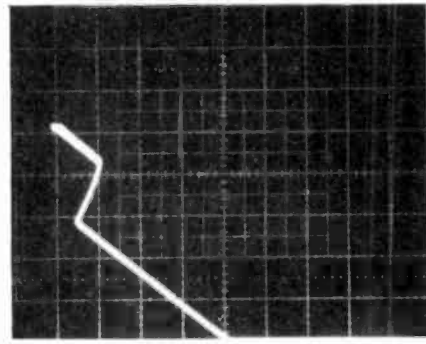

FIG. 11—CURRENT VS. VOLTAGE characteristic of an output transistor in a Class-H amplifier operated at full-rated output.

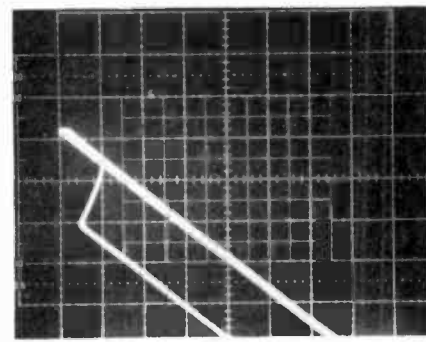

FIG. 12—HEAT DISSIPATION DIFFERENCE between Class-AB and Class-H amplifiers operated at full-rated power is obtained by superimposing Figs. 10 and 11.

inherent slew rate of the higher-voltage supply is greater than that of the audio-amplifier circuits themselves, which is approximately 50 volts-per- $\mu$ s. Therefore, regardless of the signal waveshape, the vari-proportional supply logic anticipates the rising waveshape and turns the higher supply on with gain and slew rate exceeding those of the amplifier itself. It is as if the increased voltage supply gets out of the way of the rising audio signals appearing at the amplifier output.

Figure 6 shows the complex waveforms produced when this amplifier was used to reproduce rock music. As the output signal reaches the lower positive supply voltage, the higher supply voltage is switched in by the vari-proportional control system.

Figures 7 through 12 show the current-versus-voltage characteristic taken on one of the audio-amplifier output trans-



FIG. 13—SOUNDCRAFTSMEN MODEL MA5002 Class-H amplifier.

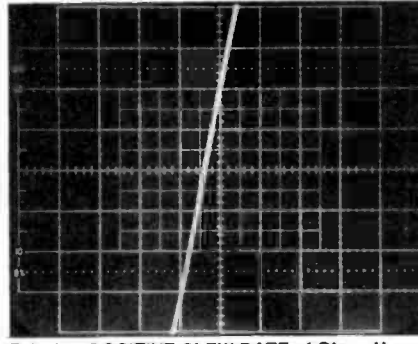

FIG. 14—POSITIVE SLEW RATE of Class-H amplifier operating at 250 watts-per-channel.

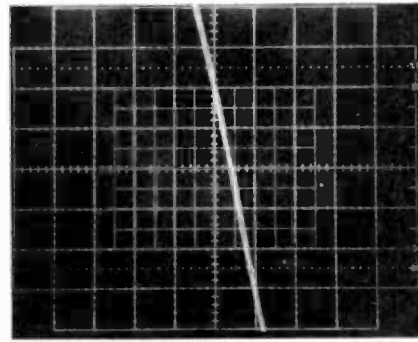

FIG. 15—NEGATIVE-GOING SLEW RATE of Class-H amplifier operating at 250 watts-per-channel.

sistors. Each figure shows transistor heat loss in the area bounded by the scope trace and the X- and Y-axes to the left. In Figs. 7 and 8, a 250-watt amplifier is operated at one-third its rated output power (the required preconditioning test point of the FTC's rule on amplifier-power disclosure).

Figure 7 shows the amplifier operating in conventional Class AB, without the vari-proportional control system. In Fig. 8, the same amplifier is operated at the same power-output level but using the Class-H concept. Figure 7 shows that the area representing transistor dissipation is obviously greater for the conventional amplifier. A double exposure of the two curves on the same film is shown in Fig. 9; the area between the two curves is a direct measurement of the savings in heat dissipation on each output transistor with the vari-proportional concept.

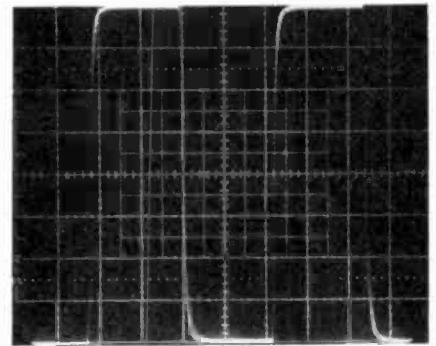

FIG. 16—10 kHz SQUAREWAVE OUTPUT from Class-H amplifier.

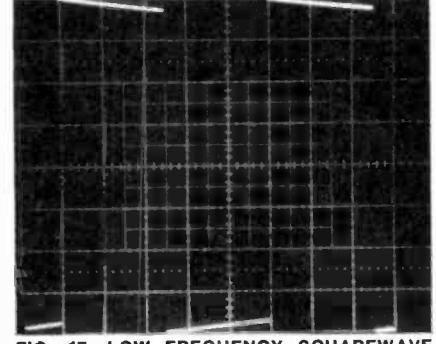

FIG. 17—LOW FREQUENCY SQUAREWAVE output from Class-H amplifier.

Figure 10 shows the same amplifier now delivering its full rated 250-watt output, but without vari-proportional control. In Fig. 11 the same amplifier is delivering full rated output, this time using the vari-proportional dual-supply circuit. The change in slope of the curve in Fig. 11 is caused by the vari-proportional system increasing the voltage available to the output transistors. Again, the area to the left of the trace and bounded by the left and lower X- and Y-axes is substantially greater than that of Fig. 10. Figure 12 again shows a double exposure of two curves; the area between the curves represents the savings in heat dissipation or heat loss for each output device.

The major advantage claimed for this method over other efficiency-improving schemes is that there is no switching or changing of signal paths within the basic amplifier itself. All the controls for increasing the power-output capability on an as-required basis act only within the power supply and are therefore outside the feedback loop of the audio amplifier circuits and have no effect on the distortion, stability or slew rate of the basic amplifier circuit.

#### New power amplifier

Soundcraftsmen's first commercially available product using this circuit approach is their new model MA5002 power amplifier, which is rated at 250 watts-per-channel, into 8-ohm loads, both channels driven from 20 Hz to

*continued on page 106*

# Engineers design electronic circuits —so can you!

**Only CREI offers you a choice  
of 18 home study programs  
in electronics with circuit design,  
plus special arrangements  
for engineering degrees**

Circuit design is perhaps the one qualification that distinguishes advanced technical personnel and engineers from the average electronics technician.

If you can design electronic circuits, you can more readily understand the circuitry of all types of electronic equipment. Thus you can more easily handle the repair and maintenance of such equipment, as well as assist in the development of new electronic systems.

The ability to design electronic circuits to solve practical engineering problems is one of the most valuable skills you can possess. Those with this ability are sought after and command positions of far greater responsibility, prestige and pay than the average technician.

If you are going to have a worthwhile career in the field of electronics, the ability to design circuits is a skill you will want to acquire.

## **Circuit design in all CREI programs**

CREI covers circuit design in its home study programs in electronics. This is one of the factors that makes CREI training different from most other home study schools. CREI programs, of course, are college level—the same level of training you will find in any college or university offering programs in electronic engineering technology.

CREI training, however, is designed for home study. The programs give you effective, step-by-step training to help you move up in your career in electronics by using your spare time for technical self improvement.

## **Unique Design Lab**

CREI gives you both theory and practical experience in circuit design with its Electronic Design Laboratory Program. The professional equipment included in this program allows you to construct, test out and correct the circuits you design until you have an effective circuit.

This Lab Program helps you understand advanced electronics. It also gives you practical experience in many other important areas of electronics, as in prototype construction, breadboarding, test and measurement procedures, circuit operation and behavior, characteristics of electronic components and how to apply integrated circuits.

# Career Training at Home

Only CREI offers this unique Lab Program. It is a complete college lab and, we believe, better than you will find in most colleges. The "Lab" is one of the factors that makes CREI training interesting and effective. And the professional equipment in this program becomes yours to keep and use throughout your professional career after you complete the training.

## Engineering Degree

CREI offers you special arrangements for earning engineering degrees at certain colleges and universities as part of your home study training program. An important advantage in these arrangements is that you can continue your full time job while "going to college" with CREI. This also means you can apply your CREI training in your work and get practical experience to qualify for career advancement.

## Wide Program Choice

CREI gives you a choice of specialization in 14 areas of electronics. You can select exactly the area of electronics best for your career field. You can specialize in such areas as computer electronics, communications engineering, microwave, CATV, television (broadcast) engineering and many other areas of modern electronics.

## FREE Book

In the brief space here, there isn't room to give you all of the facts about CREI college-level, home study programs in electronics. So we invite you to send for our free catalog (if you are qualified to take a CREI program). The catalog has over 80, fully illustrated pages describing your opportunities in advanced electronics and the details of CREI home study programs.

## Qualifications

You may be eligible to take a CREI college-level program in electronics if you are a high school graduate (or the true equivalent) and have previous training or experience in electronics. Program arrangements are available depending upon whether you have extensive or minimum experience in electronics.

Send for this **FREE** Book describing your opportunities and CREI college-level programs in electronics



Mail card or write describing qualifications to

**CREI** **CAPITOL  
RADIO  
ENGINEERING  
INSTITUTE**

McGraw-Hill Continuing Education Center  
3939 Wisconsin Avenue Northwest  
Washington, D.C. 20016

Accredited Member National Home Study Council

## GI Bill

*CREI programs are approved for training of veterans and servicemen under the G.I. Bill.*



# Radio-Electronics

## Tests Dynaco SCA-50



CIRCLE 99 ON FREE INFORMATION CARD

1

**LEN FELDMAN**  
CONTRIBUTING HI-FI EDITOR

DYNACO, INC. IS ONE OF THE FEW MANUFACTURERS who still offer their products in both wired and kit form. The unit we evaluated was factory-wired, but we explored its internal construction in enough detail to state that, with a few hand tools, a soldering iron, and the will to follow the step-by-step assembly instructions to the letter, the *model SCA-50* would make an ideal beginner's project, even if you have never built any hi-fi equipment before.

The *model SCA-50*, shown in Fig. 1 (the cabinet is an option), has a silver extruded front panel whose dimensions far exceed the height and width of the perforated black metal cover normally supplied with the unit. Thus, it is easy to "custom-mount" the unit into any cabinet by making a single cutout.

The two large rotary controls at the upper left section take care of program source selection (there are two TAPE play positions, PHONO, TUNER and a spare or AUX position) and master VOLUME adjustment. Smaller rotary control knobs at the upper right section handle channel BALANCE, BASS and TREBLE. Pushbutton switches below are used for the tape monitor circuit, mono/stereo switching, tone control defeat, and to select one or both pairs of speakers, which can be connected to the rear panel of the unit. A headphone jack adjoins these pushbuttons, while at the extreme lower right section are a POWER on/off button and an indicator light.

Two switched and one unswitched AC convenience receptacles are located at the left end of the rear panel (Fig. 2), next to which are

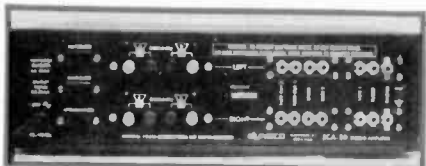

2

thumb-screw, color-coded speaker terminals, inscribed with printed speaker-symbol diagrams and polarities to insure proper connection of up to two pairs of speaker systems. Tape-out and tape-in phono tip jacks come next, followed by the other pairs of input jacks; the phono jacks and their associated ground terminal are located as far away from the AC and power-supply parts as possible. The diagram of Fig. 3 shows the assortment of components that can be connected to and used with *model SCA-50*.

An internal view of the completed amplifier is shown in Fig. 4. Note that the three major

PC boards (the preamp-control board and two power-amplifier modules) come preassembled, so that what appears like a great deal of wiring really is the only major work in assembling the kit aside from the usual mechanical procedures.

### Circuit highlights

The preamp section consists of two active low-noise circuit elements, both using integrated circuits with Class-A output and powered by regulated  $\pm 15$  volts DC. The phono-equalizer section uses DC-connected feedback

**TABLE I**  
**AMPLIFIER PERFORMANCE MEASUREMENTS**

POWER OUTPUT CAPABILITY	R-E MEASUREMENT	R-E EVALUATION
Rms power/channel, 8 ohms, 1 kHz (watts)	32.0	Very good
Rms power/channel, 8 ohms, 20 Hz (watts)	29.0	Excellent
Rms power/channel, 8 ohms, 20 kHz (watts)	30.0	Excellent
Rms power/channel, 4 ohms, 1 kHz (watts)	30.7	Good
Rms power/channel, 4 ohms, 20 Hz (watts)	29.0	Very good
Rms power/channel, 4 ohms, 20 kHz (watts)	25.0	Good
Frequency limits for rated output (Hz-kHz)	10-40	Excellent
<b>DISTORTION MEASUREMENTS</b>		
Harmonic distortion at rated output, 1 kHz (%)	0.022	Excellent
Intermodulation distortion, rated output (%)	0.05	Very good
Harmonic distortion at 1-watt output, 1 kHz (%)	0.018	Excellent
Intermodulation distortion at 1-watt output (%)	0.015	Excellent
<b>DAMPING FACTOR, AT 8 OHMS</b>		
	50	Very good
<b>PHONO PREAMPLIFIER MEASUREMENTS</b>		
Frequency response (RIAA $\pm$ dB)	0.1	Superb
Maximum input before overload (mV)	110	Very good
Hum/noise referred to full output (dB) (at rated input sensitivity)	63	Good
<b>HIGH-LEVEL INPUT MEASUREMENTS</b>		
Frequency response (Hz-kHz, $\pm$ dB)	10-40	Excellent
Hum/noise referred to full output (dB)	82	Very good
Residual hum/noise (minimum volume) (dB)	82	Good
<b>TONAL COMPENSATION MEASUREMENTS</b>		
Action of bass and treble controls	See Fig. 5	Very good
Action of secondary tone controls		
Action of low-frequency filter(s)		
Action of high-frequency filter(s)		
<b>COMPONENT MATCHING MEASUREMENTS</b>		
Input sensitivity, phono 1/phono 2 (mV)	1.65	
Input sensitivity, auxiliary input(s) (mV)	130	
Input sensitivity, tape input(s) (mV)	130	
Output level, tape output(s) (mV)	130	
Output level, headphone jack(s) (V or mW)	250 mW (8 ohms)	
<b>EVALUATION OF CONTROLS, CONSTRUCTION AND DESIGN</b>		
Adequacy of program source and monitor switching		Good
Adequacy of input facilities		Very good
Arrangement of controls (panel layout)		Excellent
Action of controls and switches		Excellent
Design and construction		Very good
Ease of servicing		Excellent
<b>OVERALL AMPLIFIER PERFORMANCE RATING</b>		Very good

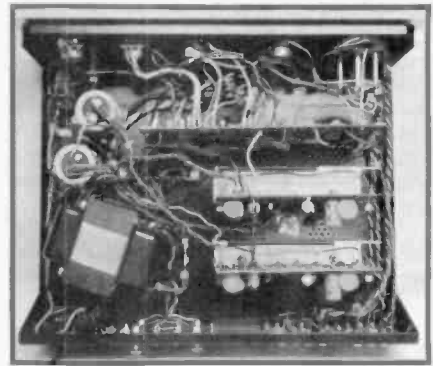
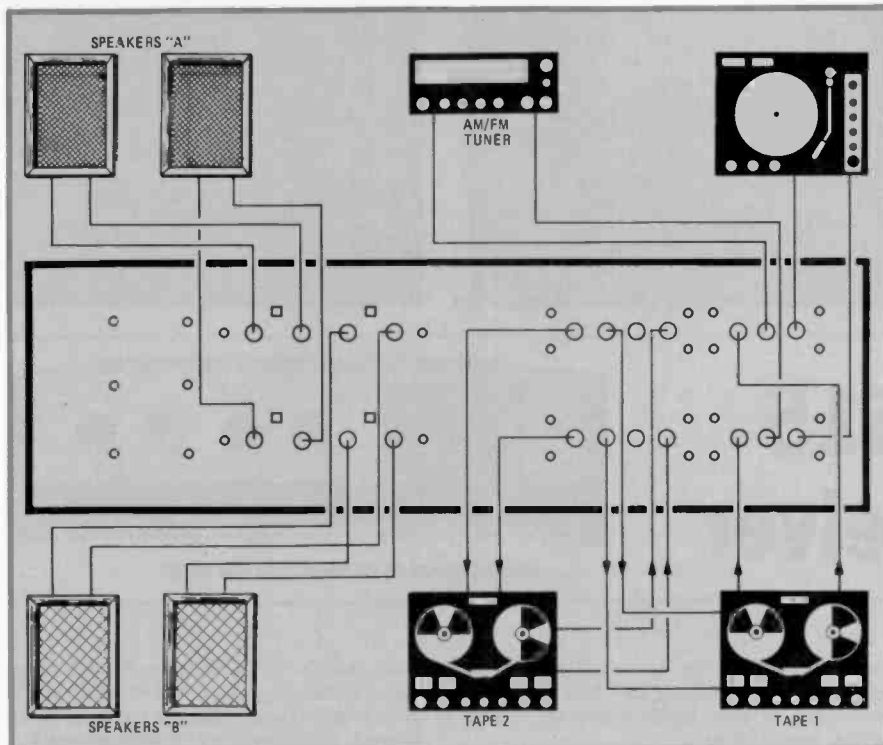

**TABLE II**  
**OVERALL PRODUCT ANALYSIS**

Retail price	\$249 (wired); \$149.00 (kit)
Price category	Low
Price/performance ratio	Excellent (kit); Very good (wired)
Styling and appearance	Very good
Sound quality	Excellent
Mechanical performance	Very good

**Comments:** Dynaco has obviously carried over many of their design ideas incorporated in their more expensive integrated amplifiers into this lowest-powered and lowest-priced unit in the line. The kit price is outstandingly low, but the large difference between the wired and unwired prices makes it something less than a bargain if you lack the inclination (or skill) to assemble and wire the unit yourself. That large price difference is also a clue to the undeniable fact that this unit requires quite a bit of labor if you are going to purchase it in kit form. There seems to be a high density of interconnecting, point-to-point wiring and cabling—more so than on some competitive kits we have examined recently. Kit instructions are easy to follow and well written, and the wiring is made much easier to follow thanks to a large, multi-colored overall wiring diagram, which is separable from the rest of the construction manual and can be kept in full view on your workbench.

If you are looking for the latest frills found in some other preamps or integrated amplifiers, this unit may not be for you. Such niceties as low- and high-cut filters are absent, as is a second tape-monitor circuit (now common on many amplifiers) or a second phono input pair. However, parts used are of top quality, and it is obvious that Dynaco set out to deliver as much performance for a product in this price range as they possibly could, even if that meant leaving out some of the less often used frills or switches that add flexibility and overall versatility in a component system made up of separates. In terms of pure sound, when driving speakers of reasonably high efficiency, we could not fault the *model SCA-50*. The somewhat higher than usual phono input sensitivity was also welcome, and would enable the user to choose a cartridge that delivers somewhat lower output than the norm. Generally (but not always) that means a somewhat higher quality cartridge. All in all—good value, good sound within its power limitations and excellent for the budget-minded.

#### MANUFACTURER'S PUBLISHED SPECIFICATIONS:

**Power Output:** 25 watts continuous per channel, 20 Hz to 20 kHz, 8-ohm loads. **Rated THD:** 0.25%. (**Power at "Clipping":** 35 watts, 1 kHz, 8 ohms; 35 watts, 4 ohms; 20 watts, 16 ohms). **IM Distortion:** 0.1%. **Frequency Response:** Phono: RIAA  $\pm 1.0$  dB. High Level: 15 Hz to 45 kHz,  $\pm 0.5$  dB. **Hum and Noise:** Phono: 72 dB below 10-mV reference; High Level: 89 dB below 0.5-volt input. **Phono Overload:** 100 mV at 1 kHz. **Input Sensitivity:** Phono: 1.65 mV; High Level: 125 mV. **Tone Control Range:**  $\pm 10$  dB at 50 Hz and 15 kHz. **Dimensions:** 13½ x 12 x 4¼ inches high. **Net Weight:** 15 lbs. **Power Consumption:** 20 watts at "no signal"; 240 watts maximum, 50 to 60 Hz, 120 or 240 volts. **Suggested Retail Prices:** \$249 (wired); \$149 (kit).

for RIAA equalization, and the tone-control circuit also uses DC feedback around another IC, with AC feedback used for varying bass and treble response. Turn-on or turn-off "thumps" are attenuated by means of a low-resistance FET at the tone-control output. Power amplifier stages are of the full complementary configuration and are DC-coupled to the speaker terminals, while a differential input pair of transistors is used in the first stage of the power amplifier section.

For circuit and speaker protection, a pair of diodes limit available current for each signal-waveform polarity. In addition, each polarity has a fuse to protect against excessive output current. If the heat-sink surface temperature rises to 80°C., a built-in thermal circuit breaker will shut down the amplifier until safe operating temperatures are achieved. Major power supply parts (transformer, filters, rectifiers, etc.) are all separately mounted and wired; and, since the unit is intended for home construction, the overall layout is open.

#### Amplifier performance measurements

Table I summarizes results of our lab measurements made on the Dynaco *model SCA-50*. Comparing these results with the published specifications in this report, a few comments are in order.

Our measured 32.0 watts (at 1 kHz into 8 ohms) does not contradict Dynaco's claim of "35 watts at clipping." Clipping represents around 1.0% of harmonic distortion, whereas we measured 1-kHz output for rated distortion, which is a lower 0.25%. The amplifier more than met its 25-watt-per-channel "FTC" rating over the entire 20-Hz-to-20-kHz power band. Intermodulation distortion and total harmonic distortion at rated output were, in fact, all well below the rated figures given—often by a whole order of magnitude. The disparity between our hum-and-noise findings and Dynaco's represents a bit of "specsmanship." Dynaco's phono hum-and-noise spec is based upon a 10-mV input signal. On the other hand, our measurement was based upon an actual input sensitivity of 1.65 mV. Our figure of 63 dB, if referenced to 10 mV, would exceed 78 dB—much better than the 72 dB claimed. In the case of high-level input signal-to-hum and noise, Dynaco references a 0.5-volt input signal, whereas in fact the input sensitivity of the high-level circuitry is 130 mV, and it is to that level that our 82-dB result is referenced. Again, if we were to translate that figure to a 0.5-volt reference, hum and noise would result in -93.7 dB—or better than Dynaco's claim. The fact is that the hum and noise figures for both input levels were good—and better than specified. Tone control and loudness control at various levels are shown in Figs. 5 and 6.

## Summary

The Dynaco *Model SCA-50* is a straightforward preamp/amplifier that does not have some of the secondary control features found in more expensive and more powerful units. However, it is well designed for what it is and offers the ambitious kit-building audiophile a chance to win a reasonably priced integrated amplifier in this power class.

Table II contains our overall product evaluation as well as additional summary comments. **R-E**

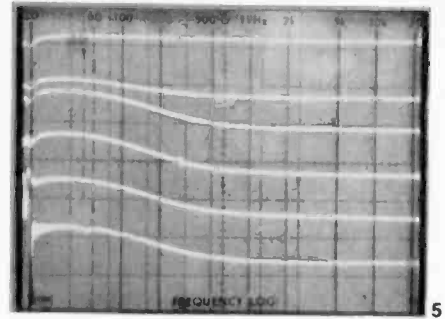
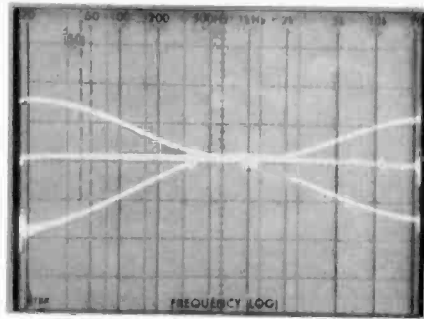

# Heath AR-1515 AM/FM Receiver



CIRCLE 50 ON FREE INFORMATION CARD

HEATH'S MODEL AR-1515 IS A TOTALLY NEW design that is different in appearance from any of Heath's earlier all-in-one receivers. Digital frequency readout has been borrowed from the company's earlier *Modulus* tuner-preamplifier (and works for both the AM and FM frequencies). While the latter separate component, when coupled to a single stereo basic amplifier sells for a total of \$780.00 and delivers 60-watts-per-channel, by combining amplifier and tuner-preamplifier on a single, elegantly designed chassis, Heath offers a 70-watt-per-channel receiver for \$550.00. The

receiver, shown in Fig. 1, is available only in kit form, and if building hi-fi kits is evening recreation in your home, figure on several weeks' work at least.

Figure 1 shows the front panel's hinged flap or "trap door" in its open position, disclosing both the major and less-used controls; but when the flap is closed, only the major rotary controls along the top are exposed: The TUNING knob, MODE switch (mono or stereo), SELECTOR switch for program selection and the VOLUME control. Behind the hinged flap are two speaker-selector pushbutton switches,

BASS, TREBLE and BALANCE controls, a tone defeat switch, high and low filter switches, FM mute switch (Heath calls it a SQUELCH defeat button), BLEND switch (for reduced noise in weak-signal stereo FM reception), LOUDNESS switch, tape monitor and dubbing switches, and a Dolby FM switch (active only if you buy the Dolby board available as an option). The lower section of the panel also contains a head-phone jack and a pair of dubbing jacks (input & output).

The upper left area of the front panel is highlighted by giant frequency-readout illuminated digits. This section of the front panel also contains the center-of-channel and signal-strength meters as well as illuminated words indicating mode, program source selected and the presence of a received stereo signal. (Interestingly, Heath uses the words FM PILOT for this last indication, probably in recognition of the fact that a station could have its 19-kHz pilot "on the air," but at the same time be transmitting monophonic material—either in error or deliberately.)

The rear panel of the *model AR-1515*, shown in Fig. 2, is equipped with the usual array of input jacks, tape-in and out jacks, a chassis ground terminal, 300- and 75-ohm external FM antenna terminals, a pair of preamplifier output and main amplifier input terminals (interconnected by means of plug-to-plug wire jumpers), one switched and one unswitched convenience AC receptacles, an AM antenna jack, and two pairs of speaker-connection sockets designed to accept mating, polarized screw-terminal plugs that are supplied separately. The advantage of this arrangement is that if the speakers have to be disconnected, the polarized plugs remain with the speaker wires so that when they are reconnected, proper phase relationships are maintained between left and right speakers.

The AM antenna jack referred to earlier is for connection of Heath's "built-in" antenna loop. Heath maintains (and we agree) that a traditional large AM loop antenna (the one you build from kit parts ends up as a loop having approximately a two-foot diameter) is a better AM signal interceptor than the more common ferrite "sticks" used on hi-fi receivers.

An internal view of the completed receiver is shown in the photo of Fig. 3. Thirteen separ-

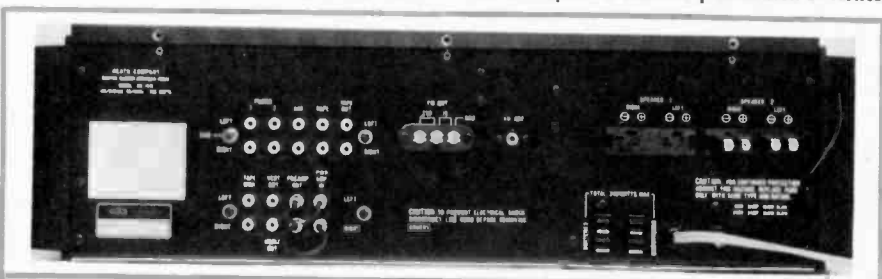

## MANUFACTURER'S PUBLISHED SPECIFICATIONS:

### FM TUNER SECTION:

**Usable Sensitivity:** mono, 1.8  $\mu\text{V}$  (10.3 dBf); stereo, 3.5  $\mu\text{V}$  (16.1 dBf). **S/N Ratio:** mono, 70 dB; stereo, 60 dB. **Selectivity:** 100 dB. **Capture Ratio:** 1.5 dB. **Image, IF and Spurious Rejection:** 90 dB. **AM Suppression:** 65 dB. **50-dB Quieting:** mono, 2.3  $\mu\text{V}$  (12.5 dBf); stereo, 35  $\mu\text{V}$  (36.1 dBf). **Harmonic Distortion:** 1 kHz: mono, 0.3%; stereo, 0.35%. **Stereo Separation:** 40 dB at 1 kHz; 25 dB at 10 kHz. **Frequency Response:**  $\pm 1$  dB, 20 Hz to 15 kHz. **Carrier and SCA Suppression:** 60 dB. **Mute Threshold:** 0  $\mu\text{V}$  to 5  $\mu\text{V}$  (variable).

### AM TUNER SECTION:

**Sensitivity:** 5  $\mu\text{V}$  (50-ohm direct input). **Selectivity:** 20 dB at 10 kHz. **Image Rejection:** at 600 kHz, 70 dB. **IF Rejection:** at 1400 kHz, 60 dB. **Hum and Noise:** -45 dB. **THD:** 3%. **Frequency Response:**  $\pm 3$  dB, 20 Hz to 4 kHz.

### AMPLIFIER AND PREAMPLIFIER SECTIONS:

**Power Output:** 70 watts continuous per channel, 8-ohm loads, 20 Hz to 20 kHz. **THD:** 0.08%. **IM Distortion:** 0.1%. **Damping Factor:** 60. **Frequency Response:** -1 dB, 8 Hz to 45 kHz. **Input Sensitivity:** phono 1 & 2, 2 mV; high level, 200 mV. **Phono Overload:** 100 mV. **Phono Frequency Response:** RIAA  $\pm 0.5$  dB. **Hum-and-noise:** phono, 65 dB; high level, 80 dB, minimum volume, 100 dB. **Tone Control Range:** Bass,  $\pm 12$  dB at 20 Hz; Treble,  $\pm 12$  dB at 20 kHz. **Filter Cutoff:** low, -3 dB at 30 Hz; high, -3 dB at 7 kHz.

### GENERAL SPECIFICATIONS:

**Power Requirements:** 108 to 132 volts or 216 to 264 volts, 50/60 Hz, 60 watts at no signal to 260-watts maximum. **Dimensions:** 21½ W.  $\times$  6⅞ H.  $\times$  15 inches D. **Weight:** 36 lbs. **Price (kit):** \$549.95; (\$589.90 with Dolby option).

**TABLE I**  
**FM PERFORMANCE MEASUREMENTS**

	R-E Measurement	R-E Evaluation
<b>SENSITIVITY NOISE AND FREEDOM FROM INTERFERENCE</b>		
IHF sensitivity, mono ( $\mu\text{V}$ ) (dBf)	1.8 (10.3)	Very good
Sensitivity, stereo ( $\mu\text{V}$ ) (dBf)	3.5 (16.1)	Excellent
50-dB quieting signal, mono ( $\mu\text{V}$ ) (dBf)	2.3 (12.4)	Excellent
50-dB quieting signal, stereo ( $\mu\text{V}$ ) (dBf)	29.0 (34.4)	Excellent
Maximum S/N ratio, mono (dB)	73	Excellent
Maximum S/N ratio, stereo (dB)	64	Good
Capture ratio (dB)	1.3	Very good
AM suppression (dB)	65	Superb
Image rejection (dB)	93	Excellent
IF rejection (dB)	90	Excellent
Spurious rejection (dB)	92	Excellent
Alternate channel selectivity (dB)	100+	Superb
<b>FIDELITY AND DISTORTION MEASUREMENTS</b>		
Frequency response, 50 Hz to 15 kHz ( $\pm$ dB)	1.0	Very good
Harmonic distortion, 1 kHz, mono (%)	0.12	Excellent
Harmonic distortion, 1 kHz stereo (%)	0.40	Good
Harmonic distortion, 100 Hz, mono (%)	0.12	Excellent
Harmonic distortion, 100 Hz, stereo (%)	0.60	Fair
Harmonic distortion, 6 kHz, mono (%)	0.14	Excellent
Harmonic distortion, 6 kHz, stereo (%)	0.64	Good
Distortion at 50-dB quieting, mono (%)	1.4	Fair
Distortion at 50-dB quieting, stereo (%)	0.55	Very good
<b>STEREO PERFORMANCE MEASUREMENTS</b>		
Stereo threshold ( $\mu\text{V}$ ) (dBf)	1.0 (5.2)	Fair
Separation, 1 kHz (dB)	44	Excellent
Separation, 100 Hz (dB)	40	Excellent
Separation, 10 kHz (dB)	30	Very good
<b>MISCELLANEOUS MEASUREMENTS</b>		
Muting threshold ( $\mu\text{V}$ ) (dBf)		See text
Dial calibration accuracy ( $\pm$ kHz at MHz)	"Perfect"	See text
<b>OVERALL FM PERFORMANCE RATING</b>		
		Very good

**TABLE II**  
**AMPLIFIER PERFORMANCE MEASUREMENTS**

	R-E Measurement	R-E Evaluation
<b>POWER OUTPUT CAPABILITY</b>		
RMS power/channel, 8-ohms, 1 kHz (watts)	80.0	Excellent
RMS power/channel, 8-ohms, 20 Hz (watts)	75.0	Excellent
RMS power/channel, 8-ohms, 20 kHz (watts)	75.0	Excellent
RMS power/channel, 4-ohms, 1 kHz (watts)	117.0	Excellent
RMS power/channel, 4-ohms, 20 Hz (watts)	108.0	Excellent
RMS power/channel, 4-ohms, 20 kHz (watts)	108.0	Excellent
Frequency limits for rated output (Hz-kHz)	18-23	Very good
<b>DISTORTION MEASUREMENTS</b>		
Harmonic distortion at rated output, 1 kHz (%)	0.013	Superb
Intermodulation distortion at rated output (%)	0.05	Very good
Harmonic distortion at 1-watt output, 1 kHz (%)	0.013	Excellent
Intermodulation distortion at 1-watt output (%)	0.022	Excellent
<b>DAMPING FACTOR, AT 8 OHMS</b>	60	Excellent
<b>PHONO PREAMPLIFIER MEASUREMENTS</b>		
Frequency response (RIAA $\pm$ dB)	-1.5 dB	Fair
Maximum input before overload (mV)	120	Very good
Hum/noise referred to full output (dB) (at rated input sensitivity)	65	Very good
<b>HIGH LEVEL INPUT MEASUREMENTS</b>		
Frequency response (Hz-kHz, $\pm$ dB)	10-37, 1.0	Very good
Hum/noise referred to full output (dB)	91	Excellent
Residual hum/noise (minimum volume) (dB)	95	Very good
<b>TONAL COMPENSATION MEASUREMENTS</b>		
Action of bass and treble controls	See Fig. 9	Very good
Action of secondary tone controls		
Action of low-frequency filter(s)	See Fig. 10	Excellent
Action of high-frequency filter(s)	See Fig. 10	Excellent
<b>COMPONENT MATCHING MEASUREMENTS</b>		
Input sensitivity, phono 1/phono 2 (mV)	1.7	
Input sensitivity, auxiliary input(s) (mV)	150	
Input sensitivity, tape input(s) (mV)	150	
Output level, tape output(s) (mV)	150	
Output level, headphone jack(s) (V or mW)	105 mW	
<b>EVALUATION OF CONTROLS, CONSTRUCTION AND DESIGN</b>		
Adequacy of program source and monitor switching		Good
Adequacy of input facilities		Very good
Arrangement of controls (panel layout)		Excellent
Action of controls and switches		Good
Design and construction		Excellent
Ease of servicing		Excellent
<b>OVERALL AMPLIFIER PERFORMANCE RATING</b>		
		Excellent

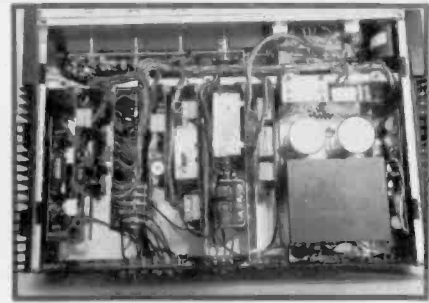

rate PC boards are used (including the optional Dolby FM board that our test sample included). The elaborate wiring harness is supplied completely ready for wiring when purchasing the kit and is fully color-coded for easy identification of wire terminating points.

### FM measurements

Table I summarizes the major performance measurements made for the FM tuner section. The results can be readily compared with the manufacturer's specifications listed elsewhere in this report. In general, sensitivity and quieting for both mono and stereo signals were excellent. THD in stereo, for mid-frequencies, was a shade higher than specified but was deemed acceptable. The stereo threshold level was set a bit lower than we would have liked, so that even very noisy, weak stereo signals are able to switch the circuitry into stereo decoding. Of course, it is always possible to switch the MODE switch to mono; or, in less objectionable situations, to depress the BLEND switch for reduced stereo FM noise at the expense of some high-frequency stereo separation. In our sample, the SQUELCH control (and internal adjustment) had been adjusted so that no muting took place. Of course, a kit builder (we did not assemble ours) could easily set this control for best noise rejection when tuning between stations. We did so, setting the threshold at a comfortable  $3.0 \mu\text{V}$  or so. Natu-

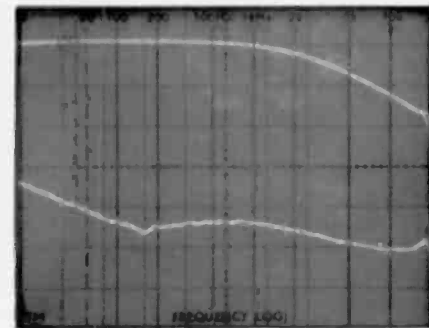
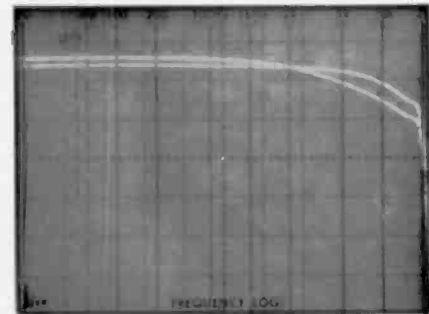

rally, dial calibration was perfect, since the digital counter when properly assembled can only read the "true" received frequency (within 100-kHz increments). Since the readout is governed only by the frequency of the local

*continued on page 80*

# What You Should Know About CB Antennas



*The facts and fallacies  
surrounding CB antennas, mounts and  
installation techniques*

MILTON R. FRIEDBERG\*

NEXT TO GREEK LITERATURE, THE MOST prolific source of myth and misinformation can be found in discussions about Citizens band radio antennas. Many CB'ers are so concerned with "standing-wave ratio," "antenna performance" and "gain" that they totally ignore how an antenna's design affects its performance.

Starting with the question of which antenna is best for mobile applications, the most common answer is a quarter-wave 108-inch whip. This is not necessarily so. When a car stands still, there is no doubt that the long whip is the best antenna you can use. Unfortunately, the car does not always stand still and as the long whip bends back during car movement, it will detune. The extent of the detuning depends on the car speed. In addition, this antenna layback changes the angle of radiation. The same is true of top- and center-load antennas.

So, while on paper a long whip, a top- or a center-loaded antenna may appear the best, a base-loaded antenna is actually the best. The base load has the least amount of change when the car begins to move because the coil does not move. The antenna's capacitance, therefore, changes much less and the chances of dangerous detuning during motion is less.

Antenna performance therefore is affected by mechanical design. The electrical theory that mechanical designers must follow can be summarized as follows: A quarter-wavelength vertical antenna at resonance develops a radiation pattern that is essentially the shape of its

associated mounting plane. Since the quarter-wavelength design operates as a ground-plane antenna, it uses its mirror image in the ground plane to provide essentially the same performance as a halfwave antenna.

On the other hand, a ground plane whose radius is greater than two wavelengths has little practical effect upon the radiation pattern of a vertical CB antenna. A ground plane shorter than two wavelengths will result in a pattern deterioration equal to the relative ground-plane length in any direction.

In mobile applications, the car body acts as the ground plane. This means that, theoretically, the antenna's position on the car has a definite bearing on the relative length of the ground plane from the antenna. An antenna that is mounted near the rear right-hand corner of the vehicle results in a radiation pattern in which the maximum direction is over the left front fender, on a diagonal line from the right rear corner through the left front fender. If the antenna is centered on the trunk deck close to the rear window, the directionality of the pattern is reduced. Mounting the antenna in the center of the car roof provides as omnidirectional a pattern as possible.

## Antenna height

A popular fallacy concerning mobile antennas is that raising the antenna height on the vehicle will effectively increase the range. Actually changing an antenna's location from the bumper to the trunk deck or roof will increase range very little.

The supposed increased gain fails to

materialize because the angular change in pattern caused by a three-foot height increase in the position of a mobile antenna is insignificant when compared with a range of one mile or longer. Height can contribute to gains in range, but it requires a sizable height difference. A 50-foot change, for example, is effective because it can result in an appreciable gain in both the radiation angle and the line-of-sight.

While height changes may not add much to performance, changing an antenna's position can be devastating for other reasons. An antenna designed for a rooftop mount will not work as well when it is trunk-mounted. The better manufacturers specifically design and factory-pretune antennas for specific applications. Therefore, you cannot assume that any antenna will work anywhere.

Range is affected more by RF interference than by the antenna's location; your Good Buddies, not your antenna, are doing you in. The best place to mount an antenna, therefore, is wherever it is the simplest and most convenient. The rooftop mount is still considered the best in terms of radiation pattern; but with the growth of CB's popularity, many other equally effective mounts are now available, and the performance and range depend on the quality of the mechanical construction of the antenna and its mount.

The mount has two basic functions: It electrically insulates the radiating portion of the antenna from the vehicle, and it physically supports the radiator in its proper position. Obviously, the mount should act as a feed-through from the 50-

\*President, Antenna Incorporated, Cleveland, OH.



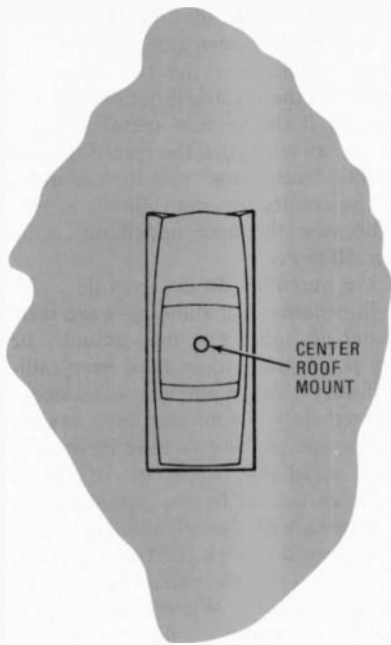

**CENTER-ROOF MOUNT** provides the best omnidirectional response. This location requires a magnetic mount or a hole cut into the roof.

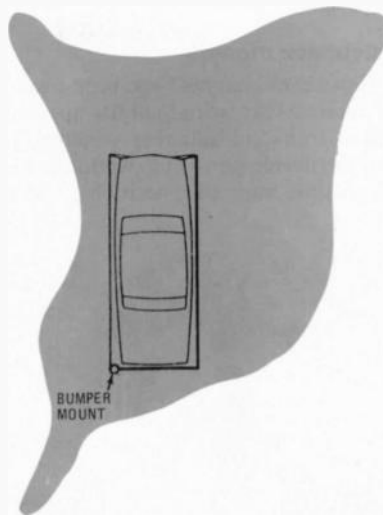

**BUMPER MOUNT** does not provide optimum directional response but antenna attaches directly to bumper.

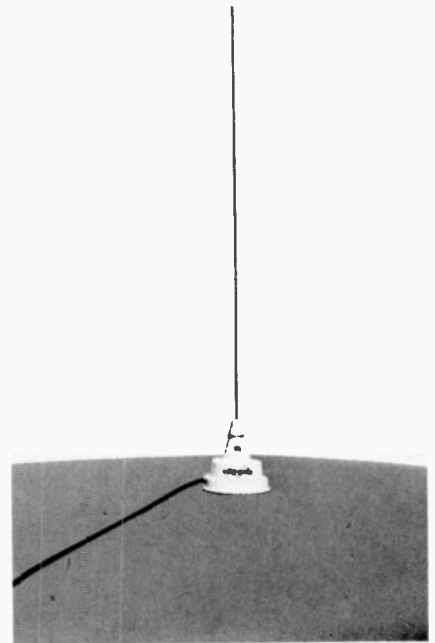

**MAGNETIC ROOF MOUNT** is a cinch to install and remove. It has a 48-inch whip and the magnet is covered with a layer of clear plastic to protect the car roof against scratches.

ohm cable to the whip, and, as in all feed-through insulators, the internal capacitance should be minimized and insulation qualities maximized.

Electrical connections should not be made through compression springs, which can act as loading coils or inductances. Maximum effort should be directed towards making a perfect connection to the vehicular grounding metal, making sure that the ground connection maintains this pristine condition. Those small swivel balls that allow a three-foot whip to stand vertically are totally unnecessary. They only serve to add one more joint in the electrical path and, consequently, more resistance.

This is not to say that the antenna should not be vertical. Antennas mounted at angles will not perform as well as those mounted vertically, but a simple bend of the whip at the top of the adaptor will do a better job without affecting performance. Long whips on large swivel ball mounts are helpful because they can be mounted almost anywhere on any vehicle while still permitting the whip to be vertical.

Faulty designs, however, do not allow the swivel ball to be properly tightened, and poorly designed units only bear on the inner surface of the half-ball. If the half-balls tighten so that they touch at

the center of the ball, the whip motion is resisted by a very short lever arm and the ball turns. Ball size is extremely important. Small swivel balls, even where properly designed and constructed, just do not have a long enough lever to support 102-inch whips!

Obviously, there must be no stress concentrations to break the swivel ball or crack the insulator. Most plastic materials flow under heavy compressive loads. Other inexpensive materials also distort, allowing the ball to loosen on its support, so that it again rotates. No matter how often you tighten that big nut, the whip just comes loose again! With proper design and good materials, you can install the ball once and for all, and while good materials are expensive, corner cutting is a false economy.

### Long whip mounts

Other styles of long whip mountings have problems different from those of the swivel mount. For example, there are two styles of chain bumper mounts. One uses a dog-chain type of link which somehow can't ever be made to stay in place. The stamped-link style is too small to be flexible enough to conform to bumper shapes, and the links stretch when tightened under normal whip movement. In addition, both the dog-chain type and the stamped-link style are subject to either stretching or breaking when the bumper is subjected to any form of impact. If you back into a parking barrier, you usually part company with your chain-mounted antenna.

There is a simple solution to the problem. Since the advent of the impact

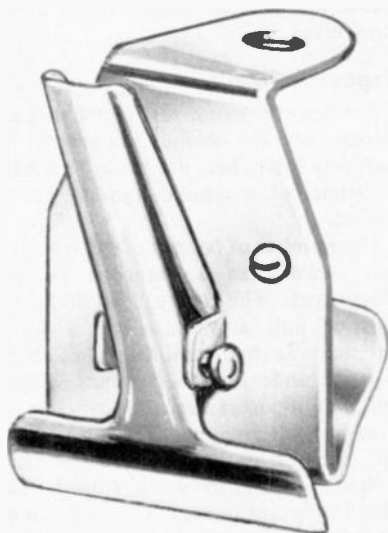

**THE SPRING CLAMP** gutter mount adjusts to the car's rain gutter and needs no screws.

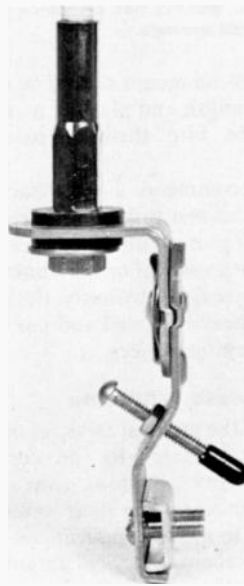

**GUTTER-MOUNT ANTENNA** has a fold-over mount.

safety bumper in 1972, most bumpers have a lip to which a sturdy clamp can be affixed without using chains. The Antenna Incorporated design, for example, combines two adjustments at right angles to each other so that the whip can be put into a vertical position by rotation in either the horizontal or vertical planes (sometimes called "equatorial mounting" by astronomers). This type of mount, when made of a heavy enough material, is an ideal support for long or heavy antennas.

#### Trunk-lid mount

The trunk-lid mount is the easiest antenna to install and is inoffensive to the eye. A metal bracket supports the antenna, which is held to the edge of the trunk by two setscrews. Since the bracket is hidden by a decorative covering cup, the bracket can and should be of stiff steel, heavily cadmium-plated to prevent rust. The setscrews should be cup-pointed (as opposed to cone points) to cut through the paint for grounding while still preventing the setscrews from digging in too deeply.

The bracket should also make room for cable clearance at the trunk edge. If that clearance is missing, what results is a crushed cable, and eventual cable shorting or tearing.

Since even a slight movement of the cup tends to scuff and cut the body paint, a polypropylene plastic cup plus a soft gasket should be used to prevent damage to the trunk-lip paint. Even if the soft gasket is lost, the plastic minimizes the paint damage.

If metal cups are used, they should be nonferrous, and have a decorative finish. Chrome-plated steel cups are the cheap way to cover the mounting bracket, and you can also be sure that the manufacturer has also economized on the support bracket thickness and plating. You get what you pay for!

Obviously, the coax cable termination at the antenna should be secure and include lockwashers for a tight connection. It is best to buy preassembled connections whether you are an installer or a do-it-yourselfer. Make sure the manufacturer has soldered the preassembled connections for maximum reliability. This can save you up to 15 minutes of tedious assembly.

Ideally, the cable should also have an in-line connector so that you can easily feed the cable through from the set to the antenna location. This connector should be the same size as the cable, so that you do not have to drill holes. In installing rear-mount antennas, the easiest cable-feeding method is to remove the bottom rear-seat cushion and feed the in-line connector up behind the vertical cushion to the trunk-hinge area. The secret is that the small in-line connector goes where the cable goes without requiring a large hole. It is virtually impossible to feed the

large PL-259-type connector through from the trunk without completely removing the rear seat back and tearing a large hole in the rear wall.

#### Hatchback mounts

Hatchback mounts have been fostered by the small cars with their lift-up combination trunk lid and rear window. The prime criterion here is innovation to meet all possible mounting positions, and the



**SWIVEL-BALL MOUNT** permits vertical orientation of antenna.

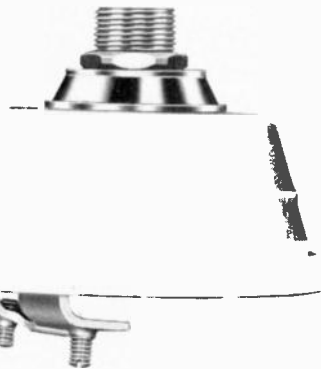

**TRUNK-LID MOUNT** has clearance to prevent coaxial cable damage.

quality of the mount should be measured by its strength and plating, as well as its ability to bite through paint for a ground.

We recommend a hatchback mount that combines a full 360-degree horizontal swivel plus a full 180-degree vertical swivel for a vertical or horizontal mounting on any edge. Obviously, the hardware must be heavily plated and use stainless-steel fastening devices.

#### The cophase syndrome

One of the greatest fallacies of antenna mounting pertains to the cophase, or dual-antenna. A long-time favorite among truckers, the dual antenna does not work in mobile applications.

If you mount a vertical antenna parallel to another vertical antenna exactly 108 inches away, and there is no vertical metal within two wavelengths, or 73 feet,

the resulting radio radiation is increased in a "figure-8" pattern along the bisector of the line between the two antennas. However, if the spacing is not exactly 108 inches, or if the vertical metal is closer than two wavelengths, the results are not the same. Even worse, in a mobile situation, the results become difficult to predict because the base impedance is no longer 50 ohms.

If the antennas do not provide a 50-ohm impedance, the standing-wave ratio goes out of sight. You may actually be losing power that would have been radiated if only a single antenna was used.

Nevertheless, if cophased antennas are used, the easiest way to tune them is to use an auxiliary length of RG-58/U cable from the set to one antenna, trim that antenna with the cable instead of the harness provided with the two antennas, and then trim the other antenna using the same piece of cable. When both antennas are tuned, reconnect the harness and you should be in resonance, provided that the individual legs of the harness are exactly equal in length.

Again, if the antennas are base-station units mounted exactly 108 inches apart, you will end up with true cophasing. However, on a mobile unit, a field strength meter, at least one-fourth of a mile distant directly ahead or behind the car, will not show any real improvement over a single antenna unless you have been lucky and have found a true cophase situation.

#### Theft protection

There are service problems associated with devices that mount antennas on the trunk-lid rim and then fold up to hide the antenna. The ground connection is the culprit. All the devices have a hinge that acts as a high resistance. Moreover, the ground path is from the hinge to the scratched paint at the trunk-lip edge, which can result in no ground. All these things tend to blow those expensive transistors in the final output stage of the transceiver.

#### Magnetic mounts

A magnetic mount or a true disguise antenna are the obvious answers to the theft problem. There are many forms and variations of magnetic mounts on the market.

The number of pounds of lift is not the best measure of a magnetic mount's effectiveness. The ability to lift 900 paper clips or pull a Volkswagen with the antenna is as significant as a pen's ability to write under water. Straight vertical pull is unimportant because cars are not lifted by their antennas. The most important criterion is the magnet's resistance to being dislodged when tipped. Two other important factors: The mount must not "walk" along the roof from the vibration caused by either whip sway or car

*continued on page 78*

## all about RF signal generators

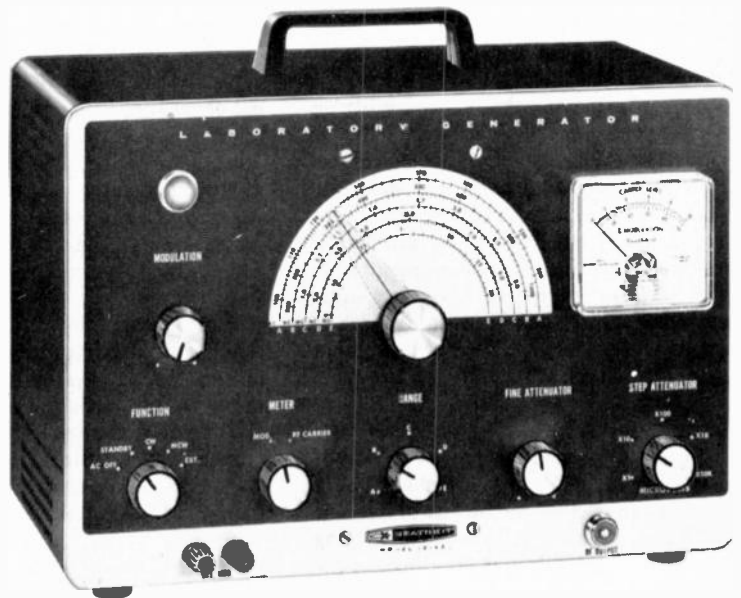

*PART III—A continuation of a series on one of the most versatile and useful test instruments*

**CHARLES GILMORE\***

LAST MONTH WE TOOK A LOOK AT SOME OF the fundamentals of signal generators. Now let's examine some important features that affect its overall performance.

### **Output level stability**

Output level stability, as with output frequency stability, is given through a range of environmental factors including time and temperature, which are of major interest. Other factors that may be included are changes in load and in operating voltage. Again, these are given as plus-minus a number of decibels for the indicated change. Output level stability specifications are usually confined to newer, more expensive generators.

### **Spectral purity of output signal**

The spectral purity specifications indicate the amplitude and frequency of signals other than the desired frequency which appear at the output of the RF signal generator. Although in simple servicing or home experimentation these may be of little or no consequence, they are of the utmost importance for exacting design work. Even the more sophisticated servicing of communications equipment

may be disrupted by signals appearing at undesired frequencies.

### **Harmonic content**

Harmonic content is a specification indicating the maximum amplitude of any harmonics of the output signal. The specification indicates the greatest amplitude of a harmonic in decibels below the fundamental amplitude. This is not necessarily the second harmonic, as push-pull amplifiers are frequently used at the generator output. These amplifiers have a high order of second-order product rejection but permit the passage of third and other odd-order harmonics.

When dealing with the bandswitched LC oscillator where the RF oscillator is oscillating directly on the output frequency, there should be no unwanted signals other than those harmonically related to the fundamental frequency, or those caused by modulation of the fundamental frequency. Harmonics at 20 dB to 30 dB below the fundamental are common on low cost and older generators. The newer high-priced generators operate with 30-dB to 50-dB harmonic suppression.

### **Residual FM**

Residual FM is a specification indi-

cating undesired signals that are caused by unwanted frequency modulation of the basic oscillator. This specification is not confined to FM generators, but is given on both AM and FM generators. Frequently, on low-cost generators, this is a 60-Hz modulation. Residual FM is specified in one of two ways. First, it may be listed as a maximum peak deviation in Hz. Second, it may be specified as a maximum deviation expressed as a percentage of the oscillator frequency.

The residual FM has two effects. When measuring an amplitude modulated system, moderate amounts of residual FM cause no problems at all except the purity of the beat note in the receiver decreases as the amount of residual FM is increased. In other words, a 1-kHz beat note produced in a single-sideband communications receiver would contain a 60-Hz buzz if 60-Hz residual FM existed in the generator. The amplitude of this buzz is directly dependent upon the amount of residual FM.

When making FM measurements, the residual FM becomes significant when it is a reasonable percentage of the desired deviation, or if extremely low-distortion measurements are made, such as those on broadcast FM receivers. For example,

\*Manager Design Engineering, Heath Co., Benton Harbor, MI.

residual FM with 60-Hz deviation would only produce 0.08% noise (that would show up as total harmonic distortion in such an analysis) on a 75-kHz deviation measurement. However, the same 60-Hz residual FM would show up as 1.2% total harmonic distortion when that measurement was made on a system with 5-kHz deviation.

In either case, the acceptability is dependent upon the measurements to be made. In the particular previous example, the 0.08% total harmonic distortion at 75 kHz may be much more significant because total harmonic distortion figures in the area of 0.1% are sought after in high fidelity equipment, whereas total harmonic distortion figures in the area of 5% to 10% are acceptable in the communications industry.

### Residual AM

In a like manner, a signal generator may have residual AM. Residual AM is specified in decibels below the carrier for the RMS value of all AM sidebands lying within a specified frequency range of the carrier. Residual AM has little or no effect on FM measurements, and unless it is a significant factor, it produces no real effect on AM measurements. Residual AM levels of 40 dB or greater need only be of concern in very exacting measurements.

### Phase noise

Phase noise consists of random noise extending above and below the carrier for some considerable range, such as a MHz or more. This noise is generated by the random noise in the generator circuits, creating minor carrier phase shifts. Each of these phase shifts causes frequency or phase modulation and therefore creates a number of sidebands above and below the carrier. As the noise is random, so are the sidebands. Therefore, this group of sidebands appears as random noise.

Phase-noise measurements are usually made as single-sideband measurements. That is, they are made on the upper or lower side of the carrier. Being a random noise, the specification indicates the RMS value of the noise over a small bandwidth, usually 1 Hz, at varying distances from the carrier. It is therefore graphically represented in most cases. On top of the line generators, specifications might include a plot of the single sideband phase noise amplitude relative to the carrier amplitude (expressed in decibels) for frequencies 1 kHz to 1 MHz above the carrier frequency. Phase noise, when specified, is normally found 120 dB to 140 dB below the carrier amplitude. When not specified, it may be considerably higher, but is not normally of concern to the operator.

### Subharmonic signals

Subharmonic signals are those that are fractionally related to the desired RF

output frequency. Non-harmonically related spurious signals are those that can neither be identified as products of modulation nor as harmonics or subharmonics of the basic oscillator frequency. All such products are specified in decibels below the desired output amplitude. Both of these types of spurious signals are generally the result of sophisticated signal generating systems. Subharmonically related signals may be a function of the dividers used for signal generation, and non-harmonically related spurious signals may be the result of third or higher order mixing products when two signals are combined to produce a desired output signal.

Radio-frequency signal generators that use digital frequency meters as part of the readout system are particularly guilty of generating such non-harmonically related spurious signals. The time-base oscillator (often 1 MHz) may have harmonics because it is generated as a squarewave, or subharmonics because it

### The modulation sources

Modulation signals can be derived from one of two sources; either an internal generator or an external signal source. The internal modulating frequencies are usually 400 Hz or 1 kHz, or both. The accuracy of these frequencies is usually in the order of 10%. External modulation input specifications include operating frequency range, which is frequently the classical audio range of 20 Hz to 20 kHz, and may extend to DC on generators with automatic leveling circuitry. Often, the external modulating input specifications include the input impedance of the external modulation amplifiers and the amplitude range over which modulation can be achieved from an external source.

### Percent of modulation

Depth of modulation, or maximum percentage of modulation, indicates the ability of the generator to provide different percentages of modulation. Most cir-



is divided down to a much lower frequency before it is used as a gating signal. These spurious or unwanted signals may well appear in the output of the signal generator. Typical specifications for such signals show them in the -30 dB to -40 dB area, or even lower, depending again on the price of the generator and the nature of signals.

### Amplitude modulation

The most common form of modulation found on RF signal generators is amplitude modulation. The low-cost generators are all AM. With the exception of a few specialized generators, older vacuum tube generators of the moderately expensive variety were all AM. Even though a generator has only AM capability, it can be used on FM equipment, although there are test procedures that are not possible.

cuits are geared to provide lowest distortion at 30% modulation. Many generators, however, do extend to well above 30% modulation capability, with an upper limit between 60% and 90% characteristic for older vacuum tube generators. The newer solid-state generators tend to have a modulation depth range of 0% to 100%. An extremely inexpensive generator may have a fixed percentage of modulation.

Many generators specify a maximum modulation that cannot be achieved at full output. The limitation at full output is a limitation placed on modulation capability by the power amplifier. If the maximum capabilities of the power amplifier are at or near the maximum with an unmodulated output, the power amplifier is not able to handle the added 50% power required for 100% amplitude modulation. A reduction in power amplifier

output amplitude by one-third permits 100% modulation.

### Accuracy of modulation percentage

Modulation percentage accuracy depends on two factors: the type circuit used to make the measurements, and the accuracy of the metering circuit itself. The simpler modulation monitoring technique offers poorer specifications. Modulation accuracy is specified as a percentage of full scale. Typical accuracy figures extend from the worst case  $\pm 10\%$  to the more conventional  $\pm 5\%$ . Remember, these figures are given as a percentage of full scale, so a meter with 100% full scale and  $\pm 5\%$  accuracy set at 30% modulation can only guarantee the modulation depth to be between 25% and 35%.

### Modulation distortion

The best distortion specification for an AM generator is given at 30% modulation, the depth chosen for many standard AM receiver tests. Typical figures range from 1% distortion on some of the better generators to 5% distortion on very low-cost generators. Additional specifications show percentage of distortion at greater modulation depths. Usually the distortion increases significantly at higher modulation levels.

### AM induced FM

In the process of amplitude modulating a generator, especially one of the MOPA (*Master Oscillator/Power Amplifier*) type, some frequency modulation of the carrier is likely. The amount of FM produced this way is different than generator incidental FM. Additional FM is either specified as a percentage of operating frequency, or less than a certain peak deviation.

The incidental FM created by amplitude modulating the generator does not interfere with most routine uses of the signal generator. However, when attempting to measure the susceptibility of an FM receiver to AM modulation, the amount of incidental FM must certainly be taken into consideration. Peak deviation values for most generators run from less than 100 Hz on the best to the area of a few kHz on generators with greater susceptibility.

### Frequency modulation and deviation

Frequency-modulation capability is becoming more and more common as newer generators are being developed with both communications and laboratory use in mind. Maximum peak deviation is the specification equivalent to depth of modulation on an AM generator. Generators may have a maximum peak deviation that varies from band to band, or that is range-switched to maintain uniformity over a number of bands.

The peak-deviation capability of the generator is highly dependent on its use.

One designed primarily as a common communications servicing tool normally has peak-deviation capability in the area of 25 kHz. Generators built for applications involving commercial FM receivers in the 88- to 108-MHz range have peak deviations in excess of 75 kHz and frequently upwards of 300 kHz.

### FM modulation sources

Frequency-modulation sources are typically the same as amplitude modulation sources, offering internal generator and external capability; 400 Hz and 1 kHz are also commonly used with FM generators. External modulation capability also covers the audio range, with an extension to DC for generators providing an electronic frequency offset capability. External inputs specify the required amplitude for the external modulating signal and the input impedance that must be driven.

### Deviation accuracy

Deviation accuracy depends on both compensating networks to insure uniform deviation across the band, and meter accuracy. Once again, this is given as a plus-minus percentage of full scale, which one must take into consideration when setting low levels of deviation.

### FM modulation distortion

Distortion of the modulating waveform is extremely important for certain measurements on FM receivers. This is especially true in receivers designed to receive commercial FM broadcasts. Generators designed to work in this area specify distortion for  $\pm 75$  kHz deviation. Distortion is usually 1% or less. Distortion specs for generators designed for other use may be somewhat higher than this.

### FM induced AM

When frequency modulating the generator, some AM may be introduced. The amount of AM created by the FM process is specified as a percentage depth of AM, and is normally 2% or less. Such AM caused by the frequency modulating process should not be confused with incidental AM.

### Pulse and video modulation

Pulse and video modulation are rather specialized characteristics found only on a few generators. Both are special cases of amplitude modulation. Some earlier vacuum tube generators had built-in pulse generators, as they were designed for radar systems and other such pulse oriented equipment. Video modulation simply indicates an extremely wide bandwidth on the external input so video signals can be handled in the modulation system. Bandwidths in the area of 4 MHz to 6 MHz are required so the video signal can be properly processed. Both pulse and video capability are confined to gen-

erators that operate in the high VHF and the UHF regions, as extremely wide bandwidth is required for these services.

### Many different features

The RF generator is much like the oscilloscope. Both are extremely complex instruments and both command a relatively high price. Both instruments have extensive specifications and both are available with a wide number of optional features. Not all manufacturers include all features or make all features available on all RF generators. Thus, to insure a particular desired feature, another may have to be deleted, or additional features purchased, depending upon what you need. The following is a list of the major ones available today.

### Special outputs

When thinking of RF signal generators, we usually think in terms of a single output that contains the RF signal whose amplitude is controlled by the attenuator and whose frequency is determined by the internal oscillator frequency. Frequently an unattenuated signal is provided that is identical to the signal fed to the attenuator. This unattenuated output may be used to drive an external digital frequency meter so precise signal generator frequency setting can be made. It may also serve as a reference signal in systems where the output signal has been buried in noise, and detection or extracting the signal from the noise depends on having such a reference signal available.

Any time this special output is used, we must make certain that it does not reduce the integrity of the RF shielding. Some generators have a special capacitor that must be connected to this output connector before the generator meets full shielding specifications. In addition to the RF output, some generators have audio frequency outputs consisting of the internal modulation frequencies. Once again, these may be used on special demodulators to test for coherency of the modulated signal with reference to the signal derived from the generator itself.

### Synchronizer input

A number of RF signal generators have an input that permits a slight adjustment of the generator frequency, typically  $\pm 1\%$  or  $\pm 2\%$ , by means of an applied DC voltage. If the generator is used with an external synchronizer, the generator can be locked to an exact frequency. The unattenuated radio-frequency output is applied to the synchronizer input.

The synchronizer compares the generator frequency with a digitally derived version of the same frequency generated from a crystal timebase within the synchronizer. Frequency difference generates a DC output that is used to return the generator to the desired frequency.

*continued on page 82*

# hobby corner

**Timers, timers, timers—555, 7490, 7448—they all work together.**

**EARL R. (DOC) SAVAGE K4SDS**  
HOBBY EDITOR

TIMERS SERVE A VARIETY OF PURPOSES. Perhaps the most useful timer is the 10-minute kind that times eggs, long-distance telephone calls, darkrooms, Ham identification and repeater time-outs.

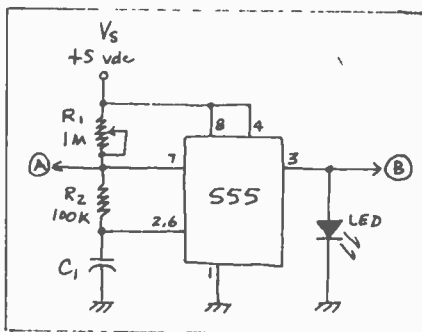

FIG. 1

Figure 1 shows the basic 555 unit. The LED flashes once for each timing interval or period (T), and that interval can be varied from milliseconds to several minutes by the value of  $C_1$  and the setting of  $R_1$ . Table I shows the values of  $C_1$  that produce ranges including certain useful T values.

TABLE I

$C_1$	T
5 $\mu$ F	1 sec.
20 $\mu$ F	15 sec.
25 $\mu$ F	30 sec.
50 $\mu$ F	1 min.

Many other R and C values will produce similar ranges. For example, for 30 seconds:  $C_1 = 10\mu$ F,  $R_1 = 1$  megohm,  $R_2 = 1$  megohm; for 1 minute:  $C_1 = 25\mu$ F,  $R_1 = 2$  megohm,  $R_2 = 100$ K. Note that normal 10%-tolerance components can give slightly different results. Increasing any one or more of these three parts will increase T.

There are two precautions to observe with the 555 circuit. First, when using larger values of  $C_1$ , avoid units with high leakage. Second, the initial interval after each turn-on is always longer than those

that follow. The addition of the parts in Fig. 2-a will make the first T interval more equal to the others. This can be done more accurately by using the Fig. 2-b circuit, but be sure not to adjust the 4K potentiometer so far that it affects the intervals following  $T_1$ .

To actually count the pulses, add the 7490 circuit shown in Fig. 3. The four LED's light up to count from 0 to 9 in the binary (base 2) system. If you have trouble keeping up with the binary counting, you could add the circuit of Fig. 4 for

the usual Arabic numbers. Although you can remove the individual LED's, you could leave them in place and become more familiar with binary numbers while watching both counts.

## Circuit refinements

The counter can be started and

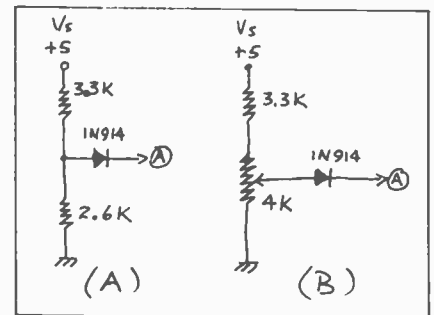

FIG. 2

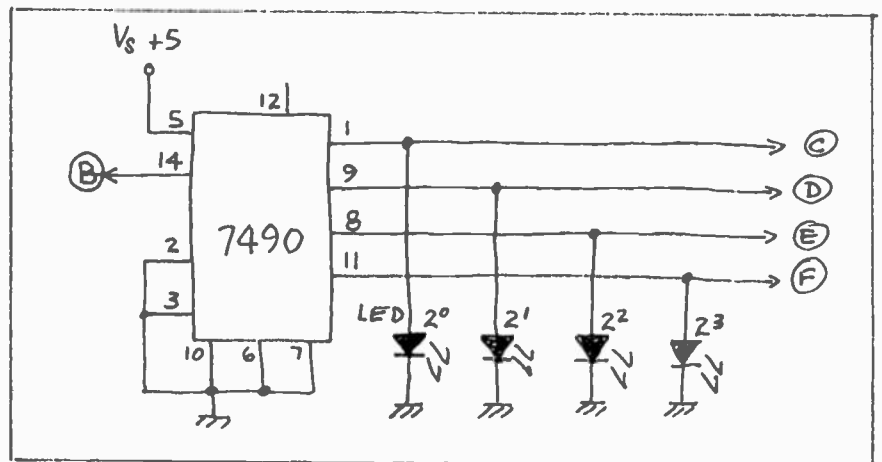

FIG. 3

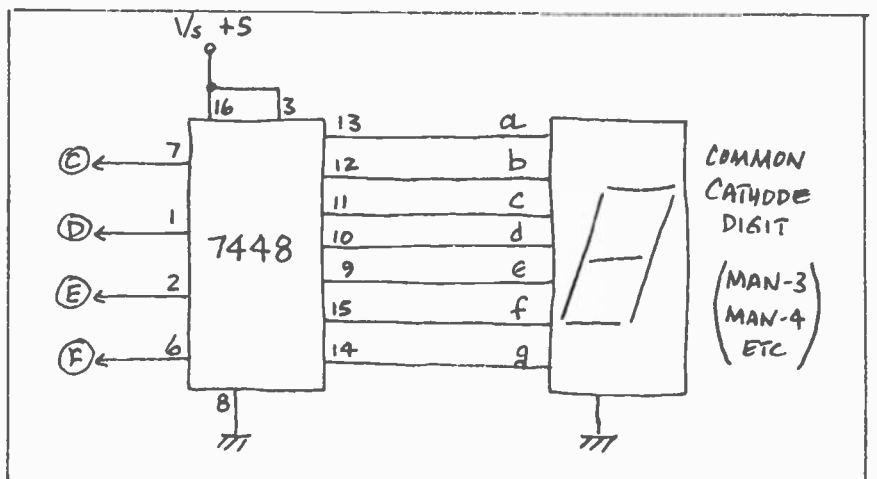

FIG. 4

stopped most conveniently by putting an SPDT switch on pin 4 of the 555 circuit. When pin 4 is grounded, the counter stops; when it is connected to  $V_c$  (+5), the counter runs.

The 7490 circuit can be reset to 0 by connecting pins 2 or 3 to  $V_c$ ; it can be reset to 9 by also connecting pins 6 or 7 to  $V_c$ . The reset and start/stop functions can be combined in a single DPDT switch.

#### Things to try

1. You can have an audible time sig-

nal by connecting a Sonalert between pin 3 of the 555 circuit and ground. If the Sonalert is connected between pin 11 of the 7490 and ground, it will sound a tone warning at count 8.

2. A second digit can be added so that the counter indicates up to 99 intervals. This will require a second 7490 circuit and four LED's for binary; or a second 7490, a 7448 circuit and a 7-segment digital unit for Arabic. In either case, connect the input (pin 14) of the second 7490 to pin 11 of the first 7490. Of

course, a third, fourth and more digits can be added similarly.

3. A common anode digit and a 7447 circuit can be substituted for the 7448 and common-cathode digit.

4. Follow the 7490 with a 74145 (BCD-to-decimal decoder-driver) and 10 LED's to make a 0-to-9 sequential light counter. If interval T is made short, the light will appear to sweep up the line of LED's.

#### Troublesome circuits

If you have trouble with any of these circuits, there could be three causes:

1. You may have made a wiring error, which is easy to correct unless something went up in smoke when you applied power. That's why wiring should *always* be checked before throwing the ON switch—we all make wiring errors from time to time.

2. One of the components may be bad or it may have a value outside of acceptable tolerance. Since sometimes this information is difficult to find, we'll try to call your attention to any parts that seem critical.

3. Typographical errors do occur on rare occasions. This is a toughie to correct in your project. About all we can say is that a correction will be printed as soon as possible.

*continued on page 120*

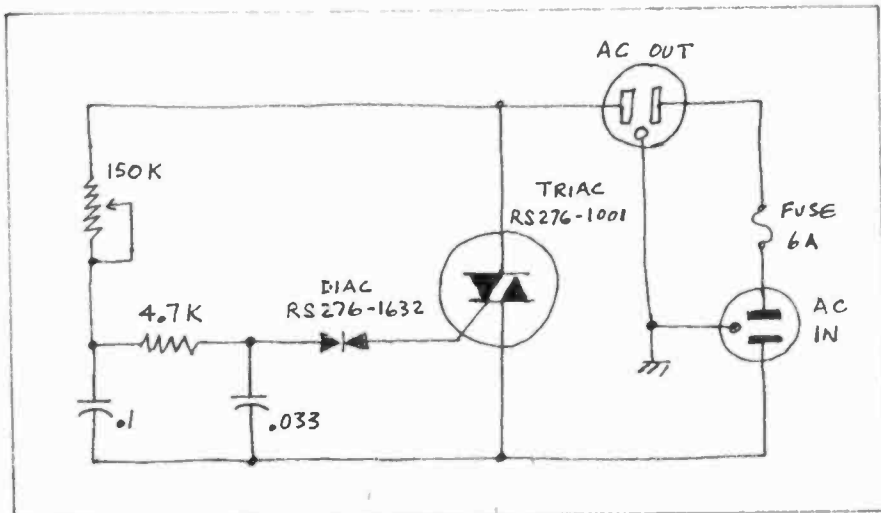
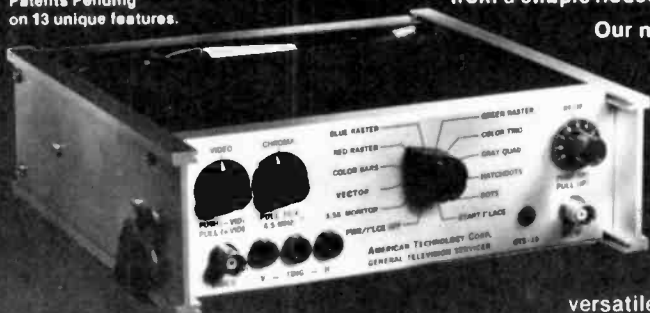

FIG. 5

## Introducing... GTS-10 our new model of General Television Servicer

Patents Pending  
on 13 unique features.



American Technology's model ATC-10, the original General Television Servicer, has earned its reputation for a wide range of useful functions, dependable performance and profit making potential in every imaginable job situation from a simple house call to the toughest dog.

Our new model, the GTS-10, carries on this tradition with added features like 4.5 Mhz Sound Carrier... Blue Raster... Green Raster... Color Trio. Advanced yet sensibly priced the GTS-10 is the ultimate instrument on the TV service equipment market.

Some of GTS-10 features and facts: 3.58 Monitor pattern for oscillator frequency checks with no need to short the AFPC test point / Vector / Color Bars (6th bar marker) / Gray Quad pattern for simplified gray scale tracking checks and adjustments / Red Raster pattern for checking and adjusting purity at the flip of a switch / Hatchdots -

versatile composite pattern for static & dynamic convergence / Crystal controlled RF / Wide range RF-IF attenuator / Video and IF outputs for signal injection / Interlace / and more.

Write for comprehensive 6-page full color brochure that describes these and many more features.

Telephone orders on VISA and MASTERCHARGE accepted for same day shipment.

2 year factory warranty against all failures in normal use.

30 day money back guarantee.

**ATC**  
AMERICAN TECHNOLOGY CORPORATION

225 Main Street, Dept. 10C, Canon City, Colorado 81212, (303) 275-8991

CIRCLE 3 ON FREE INFORMATION CARD

# state of solid state

*Applications of National's tachometer/speed switch IC, plus microcomputer notes and HP's alphanumeric display in a dual in-line package.* **KARL SAVON, SEMICONDUCTOR EDITOR**

BY NATURE, MACHINERY AND ELECTRICAL signals have a related intrinsic characteristic—both exhibit rate of change or frequency. In all kinds of measurement and control applications, frequency is an essential parameter that must be monitored directly or used to regulate an open or closed loop system.

Frequently an electrical signal originates from an electromechanical sensor responding to motion of a machine part. Electronic processing systems can be put together from off-the-shelf reservoirs of analog IC's, digital IC's and the exotic microprocessors. It's not hard to see how such a scheme often outperforms the mechanical alternatives.

The frequency-to-voltage converter is a subsystem that appears over and over again in electronic systems. You will find them in speedometers, tachometers, speed-limit sensing; and automotive lock, clutch and brake controls.

## Tachometer IC

National Semiconductor has added the LM2907 and LM2917 Tachometer/Speed Switch IC's to their analog line. It combines a precision frequency-to-voltage converter with an operational-amplifier/comparator.

The circuits are available in the four possible combinations with and without active Zener regulation and in 8- or 14-pin packages. The 8-pin configuration saves two pins by internally grounding the inverting reference tachometer input and forming an internal connection between the tachometer charge-pump output and the non-inverting input of the operational-amplifier/comparator. Four terminals of the 14-pin package are not used.

The basic concept of the system is to take the input signal and convert it to constant-width output pulses so that the average value of the current is proportional to frequency. In switching the internal currents, the input frequency is doubled. This simplifies the external filtering problem for the user.

First the circuit must interface with the outside world and receive a signal that as a rule is contaminated with noise. Hysteresis sensing is the usual way of

dealing with noise caused by imperfections in pickup devices and harsh environments, and the LM2907 and LM2917 IC's are no exception.

The input signal can be applied differentially to the 14-pin package or single-ended with respect to ground in the 8-pin version. In either case the input feeds a PNP differential amplifier that has emitter-follower input stages with  $10\text{-}\mu\text{A}$  current-source loads. Current-source loads provide the necessary transistor DC current while presenting a high AC impedance. The input amplifier has offsets in the 3.5- to 10-mV range that are about 50 percent higher in the 8-pin version. Input bias current is typically  $0.1\ \mu\text{A}$  and has a maximally specified value of  $1\ \mu\text{A}$ .

Grounding the inverting input of the 8-pin circuit gives the luxury of full input protection. Once one input is connected to ground, the useful range of the remaining signal input terminal is within about 100 mV of ground. The amplifier is protected by a diode from positive voltage swings that exceed  $V_{cc}$  on pin 6. The diode does not restrict the negative voltage swing since the diode is back-biased. Positive swings are limited to  $V_{be}$  (base-to-emitter voltage drop) above ground which is much greater than the voltage needed to completely switch the differential amplifier.

Perhaps the most natural of applications for the LM2907/LM2917 is a

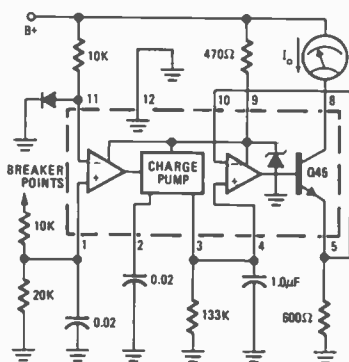

**FIG. 1—ENGINE TACHOMETER** connects to the breaker points on the distributor and has internal Zener regulation to maintain system calibration.

tachometer. Figure 1 shows the hookup for an engine tachometer that connects to the breaker points on the distributor. The 14-pin package is used with internal Zener regulation to hold the system calibration. The output operational-amplifier is wired as a unity-gain buffer amplifier with the output connected directly to the inverting input. Indication of engine speed is displayed on a current meter located in the collector of output-transistor Q45. The collector current is approximately equal to the output voltage divided by the emitter calibration resistor.

The output voltage is proportional to the capacitance connected to pin-2 of the charge pump. Based on this idea, the circuit in Fig. 2 makes a neat capacitance meter that works over a range of 0.01 to

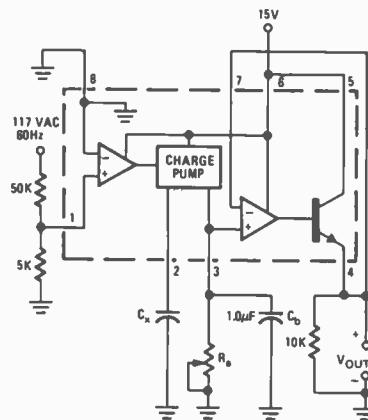

**FIG. 2—CAPACITANCE METER,** the output voltage is proportional to the capacitance connected to pin 2 of the charge pump.

$0.1\ \mu\text{F}$  with  $R_e$  set at 111K. Over this range of capacitance, the output voltage varies from 1 to 10 volts with a 15-volt power supply. A constant frequency reference is taken from the 60-Hz line.

Figure 3 is one possible overspeed alarm where the operational-amplifier comparator is used to compare the converter output with a DC threshold voltage. The circuit flashes the LED when the input frequency exceeds 100 Hz. Increases in frequency raise the average current out of terminal 3 so that frequencies above 100 Hz reduce the charge time of  $C_2$ , increasing the LED flashing rate.

Anti-skid controllers may require an input proportional to the lower of two wheel-speed input sensors or an input proportional to the greater of the two.



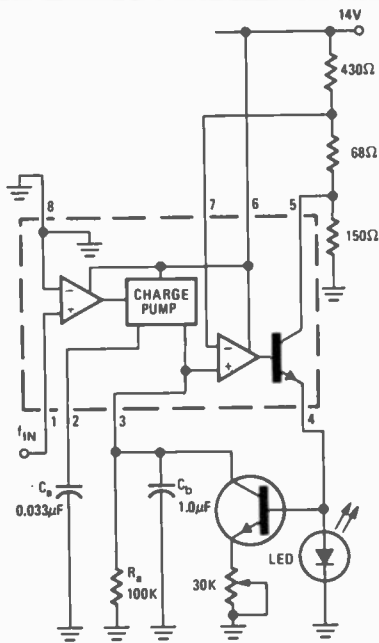

FLASHING BEGINS WHEN  $I_{IN} > 100$  Hz.  
FLASH RATE INCREASES WITH INPUT FREQUENCY  
INCREASE BEYOND TRIP POINT.

**FIG. 3—OVERSPEED ALARM** uses operational amplifier to compare the converter output with the DC threshold voltage.

Figure 4 is a circuit that generates the second function. The two output-follower transistors Q45 and Q45-a act as rectifiers giving the more positive of the two outputs preference. The transistor with the lower base voltage will be cutoff by the other device.

The average of the wheel sensors could be produced by simply summing the charge-pump outputs of two IC's.

In quantities of 100, the LM2907 and LM2917 cost \$1.65 each. They are available from National Semiconductor Corporation, 2900 Semiconductor Drive, Santa Clara, CA 95051.

### Microcomputers

IMSAI's Intelligent Breadboard console is both a learning and developmental tool useful in the conversion of hardware to software. The board connects to an

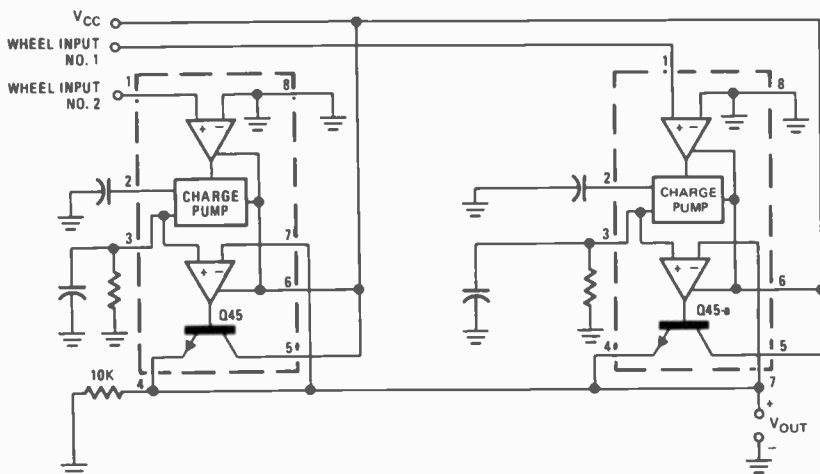

**FIG. 4—AUTOMOTIVE WHEEL—SPEED** detector provides output voltage proportional to the greater of the two wheel speeds.

IMSAI-8080 computer.

Circuits including I/O-interface and memory systems can be breadboarded outside of the computer chassis. IC's, resistors, capacitors, and other components are inserted into solderless terminal strips. LED's are used for indicators.

As a kit the breadboard console with space for 40 16-pin IC's, 10 LED's, two 5-volt regulators, two 50-pin and one 26-pin connectors is priced at \$435. The assembled-unit price is \$625.

Another accessory for the IMSAI-8080 and other computers is a \$399 printer kit. The printer uses the standard 64 character ASCII subset. Lines with more than the 44-character limit are automatically continued on the next line.

Information on both products is available from IMS Associates, Inc., 14860 Wicks Blvd., San Leandro, CA 94577.

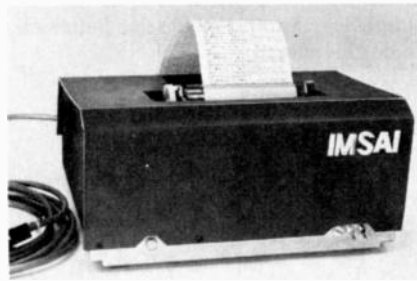

**IMSAI PRINTER** uses the standard 64-character ASCII subset.

North Star Computers, Inc., has introduced an 8080 compatible hardware floating-point board. The floating-point board performs decimal floating-point addition, subtraction, multiplication and division with up to 14 digits. Ten digit multiplications typically take only 111 microseconds compared to 5.5 milliseconds for the best 8080 firmware.

The *model-A* floating-point board has the Altair-IMSAI bus structure and the *model-B* is compatible with the Intel SBC and MDS bus structure. An extended BASIC interpreter is planned to

take advantage of the speed and memory savings of the floating-point board. Price is \$359 for the kit and \$499 assembled. For further information write to North Star Computers, Inc., P.O. Box 4672, Berkeley, CA 94704.

RCA now has a high-level language for their CDP1800 microprocessor family. MicroFORTH executes 10 to 1000 times faster than BASIC. The language is compatible with other languages developed by FORTH, Inc. of Manhattan Beach, CA, for other microcomputers. 8K of memory is used by micro-FORTH with more than 2K of room left for application software. An assembler, compiler, cross compiler, inner interpreter, and outer interpreter support the high-level language. RCA/Solid State Division, Route 202, Somerville, NJ 08876.

EPA's 66-page User's Manual includes programming examples and a flow chart listing of the MON-1 monitor program. The \$5 price is refundable with the purchase of a Micro-68 computer. Inquiries should be sent to Electronic Product Associates, Inc., 1157 Vega Street, San Diego, CA 92110.

Fairchild will manufacture and market the Motorola 6800 microprocessor family. Under an agreement between the two companies Motorola will provide photomasks and technical assistance. Fairchild also manufactures the low cost 8-bit F8 microprocessor. Fairchild Camera and Instrument Corp., 464 Ellis St., Mountain View, CA 94042

### HP components

Hewlett-Packard is producing a low cost Schottky-barrier diode for clipping, clamping, sampling, Baker Clamp transistor speed-up, RF signal detection and power monitoring applications. At 1 mA, the forward voltage is 410 millivolts. Low quantity prices of the HSCH-1001 is 80¢.

The HP HDSP-2000 is a four character 5×7 dot-matrix alphanumeric display including built-in shift registers and externally-programmable constant-current drivers. Upper and lower case letters, punctuation marks, and mathemat-

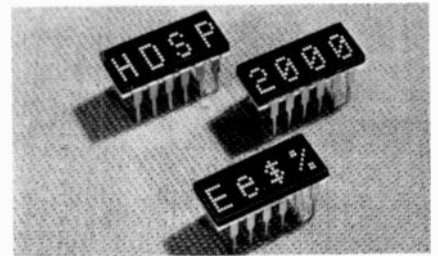

**HEWLETT-PACKARD HDSP-2000** 5×7-dot matrix alphanumeric display.

ical symbols and numbers can be displayed. In clusters of 125 the displays are priced at \$47 each. Unit quantity price is \$80. Inquiries: Manager, Hewlett-Packard Company, 1501 Page Mill Road, Palo Alto, CA 94304.

R-E

# service clinic

## A logical look at digital circuits. *Don't panic, troubleshoot.* JACK DARR, SERVICE EDITOR

I'VE JUST READ AN EDITORIAL BY WARREN Baker in the latest edition of *TSA Newsletter* published by Television Service Association of Northeast New York. He reminds his readers that new things are coming out all the time and that a lot of these items are going to use digital logic, such as video games, remote controls, TV tuners with digital readouts, etc. His main point, which I shall appropriate with deep gratitude, is that someone out there is going to have to service the things.

Guess who? Yep, us. Warren makes another major point: Technicians who don't know digital theory and refuse to learn it are going to be left all alone—way out in left field! Actually, while digital circuitry *looks* quite complex as a whole, most of it is made up entirely of a lot of very simple circuits connected together.

Digital circuits really do only one thing—mostly turn on or off. So, here is a very basic primer on what you will find in such circuits. (These tips are based on several years of scrabbling around trying to find out information myself.)

To start with, the symbols used are confusing because many of them don't show a DC power-supply connection. The fact is, each unit *does* have a DC power supply. Sometimes, the symbols are drawn as shown in Fig. 1, which helps

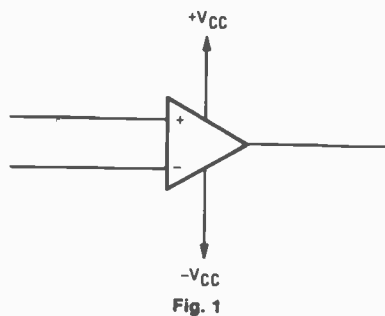

somewhat. Some use a dual-polarity DC power supply, usually +5 and -5 volts. Some use a single-polarity power supply of +5 volts, and others use -5 volts, of course.

Another confusing thing is the lack of any *ground* connections. This applies to both power and signal circuits. In the

dual-polarity power supplies, ground is the center tap of the power transformer (see Fig. 2). In the single-polarity circuit, the "other end" of the DC power supply is the ground or common. This is the negative lead with a +5-volt supply, but could be the positive lead if the DC supply is -5 volts. We'll see a better way to do this shortly.

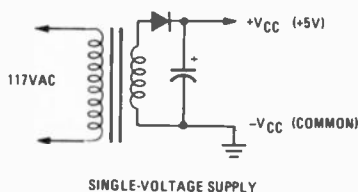
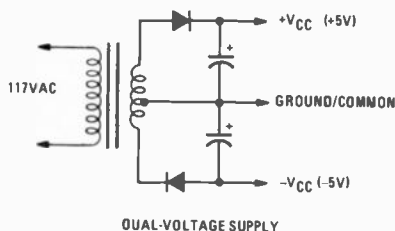

Fig. 2

### Gates and states

Digital circuits have only two "states." The signals used in these circuits are mainly pulses. These may be very short or very long pulses. For example, if an output went from +5 volts to zero and stayed there for quite a while, it can be considered as a very long zero-pulse.

The term "state" is often used. This refers to the voltage on the output of a device. If the output voltage changes from "high to low," it means that the output changes from +5 volts (high) to zero (low). The opposite is true, for a change from low to high. This is one of the good clues that we can use in servicing. Incidentally, I used the term "zero" for low.

In many actual circuits, low may not go to zero but only drop from about +5 to maybe +2 volts. The *change* of level is the actual signal pulse, and if it's enough to activate or cause a change in the state of the following device, fine.

The term "edge" is another mystifier. Digital circuits use pulses. Each pulse has

a negative-going edge and a positive-going edge. These circuits detect the *transition* and it is the edge that is used as the actuating signal. Only the positive-going or negative-going edge is needed to make the next device operate.

Practically all digital circuits use a clock oscillator. The output of this is a squarewave and it is used to control and *time* other devices; such as counters, frequency dividers, switches, etc. Some clock oscillators are simple IC circuits using a single op-amp with feedback; others are crystal-controlled types. One interesting application in a video game uses a 3.58-MHz crystal oscillator and frequency dividers to come out with the horizontal and vertical sync frequencies to control the TV set.

### How to fix them

Now comes the most interesting part: How do you service these units? The answer is not "with great difficulty," but "with logic." We have been using logical troubleshooting methods to fix all kinds of things for many years. Just because it's called "digital logic" is no reason to back off from it. Fortunately, a lot of the circuitry is divided into separate logic blocks or functions. You should be able to pin down the function or stage that is not working properly and replace it by changing an integrated circuit or replacing a module.

For example, in a TV tuner with a digital readout and varactor tuning, if the set tunes to the proper station but the readout doesn't work or shows the wrong channel, we've narrowed down the section that isn't working. Video games are the same. If one player can be controlled normally but the other one can't, here again the fault can be isolated in a hurry.

Plain DC voltmeters will check state levels, etc., as well as DC power supplies. Our present scopes will do very well for tracing pulse signals, checking clock oscillators for operation, and so forth. Most of the original test methods can be used. For example, if the "tune higher" function of a TV tuner isn't working, you can go back to the old cross-check method used in stereo service. Check the channel that isn't working against the one that is. You could use the "tune lower" circuits, for a cross check to see what you should be reading, what DC levels should be found at certain points, and so on.

A product inspired by space technology

**RCA Permacolor**

**Outdoor TV Antennas...  
designed to provide  
the best possible  
picture in the home.**

Permacolor is a product of the RCA Distributor and Special Products Antenna Engineering Laboratory, a specialized facility dedicated to the engineering and development of antenna technology. Permacolor . . . designed by the same corporation which developed the microwave antenna used on the Apollo lunar landing missions.

The Permacolor line is a complete line with advanced engineering features that offer the best possible reception in almost any area, from deep fringe to metropolitan locations. The line consists of: 10 UHF-VHF/FM all band combo models, 7 VHF/FM models, 5 UHF models, an FM only model, and a selection of 75 ohm and 300 ohm antenna kits; plus the amazing Mini-State — the first true miniaturized rotating antenna system.

Permacolor is the first antenna with solid, permanent connections from elements to feed line. The first antenna with pivoting, polypropylene insulators. And, the first antenna with a weather-resistant blue and gold vinyl finish.

Remember. . . Permacolor Antennas are the only outdoor TV antennas that are designed, engineered, and manufactured by RCA — a world leader in electronics.



**Perma-tuned circuits** . . . an original RCA development. Arrangement of elements forming tuned circuits results in full-range, all-channel reception which is maintained throughout the life of the antenna by means of solidly riveted connections of flexible aluminum between elements and feed lines.

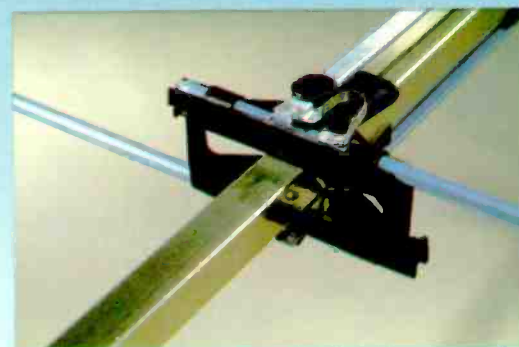

**Polypropylene insulators** . . . an extremely low loss material that resists weathering for peak performance and long life. Entire insulator pivots and snaps into place. Holds its element over a span of almost 6 inches, for great strength.

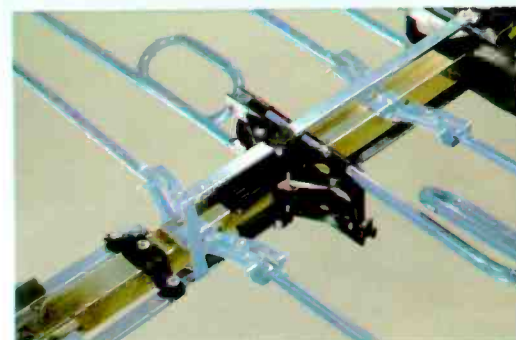

**Permanent electrical connections** . . . flexible aluminum straps and RCA designed splined rivets provide a positive electrical path for the signal to flow from the elements to the receiver with virtually no chance of any interruption; overcoming a major problem found in other antennas.

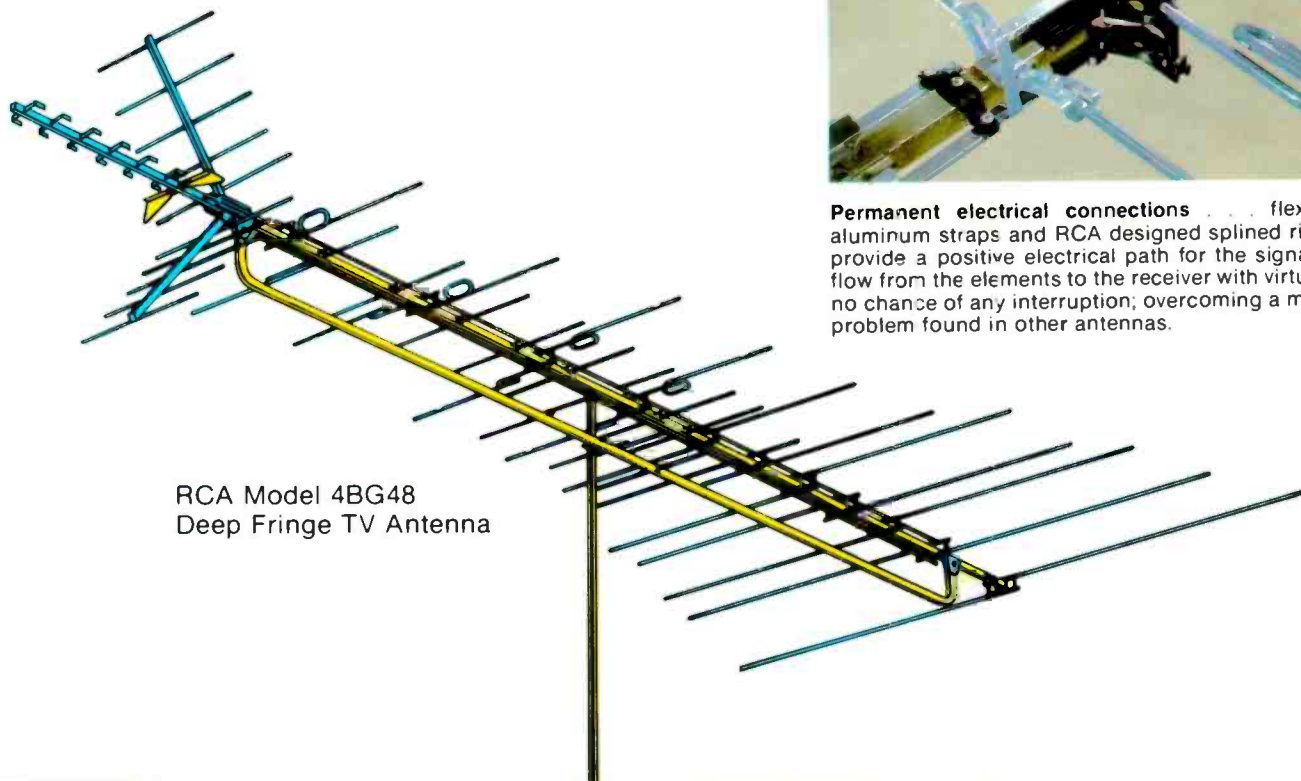

RCA Model 4BG48  
Deep Fringe TV Antenna

# RCA Permacolor Outdoor TV Antennas... so advanced you'll never be satisfied with anything less.

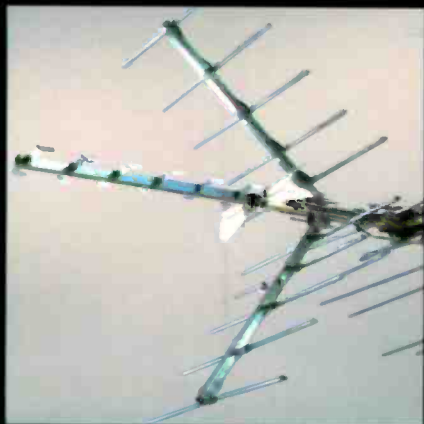

Combination bowtie and corner reflector on UHF-VHF/FM models result in full-range, no compromise, all-channel reception.

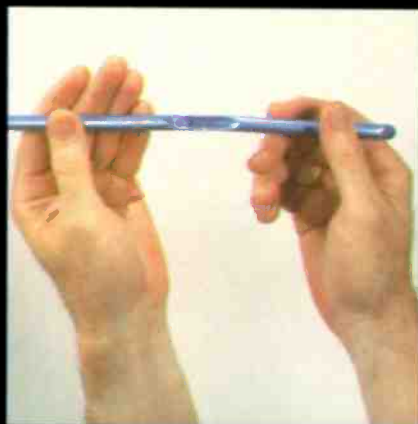

Break-off elements . . . allow you to control FM broadcast reception to suit local conditions. UHF response can be extended to bring in channels 70 to 83 if desired.



V-shaped mast clamps . . . double set of teeth bites into mast, prevents antenna from slipping, and keeps it aimed in the proper direction. Antenna is preassembled, elements unfold with ease and lock into place.

## A few of the Permacolor Antenna models available:

### UHF-VHF/FM OUTDOOR ANTENNAS

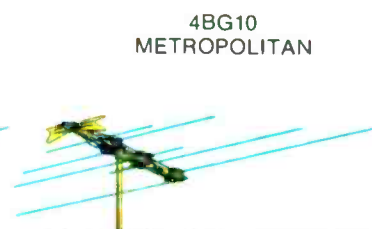
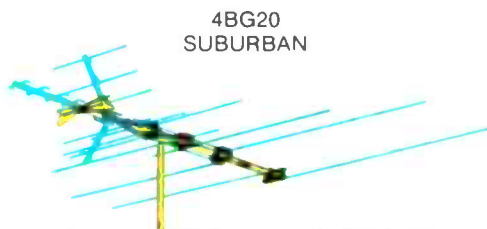
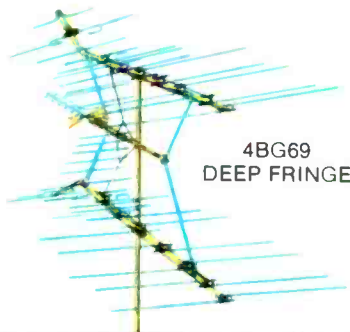

### VHF/FM OUTDOOR ANTENNAS

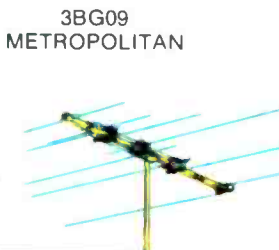
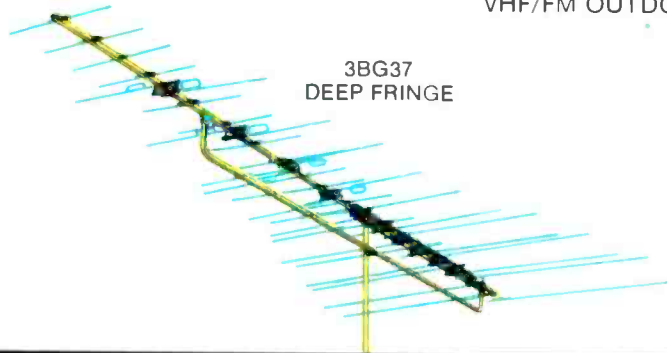

### UHF ONLY



### RCA Antenna Mounting Kit

Some models are also available with a kit that includes everything needed for a normal installation — perfect for do-it-yourselfers.

A complete line of quality RCA accessories — including rotators, reception aids, and installation hardware is available.

RCA Permacolor Outdoor Antennas — your TV picture will show you the difference.

**Permacolor**

**Service data**

For maximum efficiency, you should have clear, well-written, simple service data. Warren Baker's editorial suggests that the obvious source for this data is the manufacturers. He also feels that the manufacturers should conduct schools for training in digital theory and logic. The courses should be conducted on the basis of general theory, not restricted to only one make or model set.

Several manufacturers are beginning to bring out such material. Magnavox, RCA, Sylvania and others have published some useful data, most of which does pertain only to their own products, but it is very handy. Try to track down the manufacturer's service data, it should be a big help when servicing these circuits. **R-E**

**reader questions**

**SOUND PROBLEM**

*There is a sound problem in this CTC-68 RCA. I changed the MAN002A module, which didn't help. Sound is pretty low and distorted. The speaker is good.—R.G., Mena, AR.*

Most likely cause for this would be an open speaker-coupling capacitor which is

C314, a 50- $\mu$ F electrolytic on the mother board. Don't bridge it with another one. Lift one end and tack in a new one.

**QUICK SHUTOFF**

*When I turn this EO-8 Sylvania on, I hear a little sound and see a thin horizontal line, momentarily, then it all shuts down. The +170-volt source reads about +140 volts, the +107-volt source is about +140 volts, and there is nothing on the +27-, +29- and +165-volt sources at all. Can you tell me where to start looking?—J.K., Welleville, OH.*

I believe I'd check out the +107-volt regulator circuit in the DC power supply. The input to the regulator is supposed to be +145 volts, and the output not more than +107 volts. Since the +107-volt line feeds the horizontal output stage, and the output of this stage is directly proportional to its supply voltage, the shut-down circuit on the horizontal driver is evidently acting—as it should! The loss of vertical sweep can be explained by the fact that the vertical is fed from the flyback. So, all you get is a short "burst" of high voltage and then it turns off everything.

From the voltages, it looks as if you have a problem in the +107-volt regulator. With the same voltages on both collector and emitter, the transistor could be shorted. There can also be some fault in the regulator-driver transistor, or one

of the parts in the rest of the circuit could be making the pass transistor turn on and conduct very heavily. Even if the pass transistor is shorted, check all of the other transistors, Zener diodes, resistors, etc., before you try it again. Some of these parts may have been damaged.

You don't see anything on the +27-, +29- and +165-volt lines because these come from the flyback and horizontal-output stage.

**HORIZONTAL OSCILLATOR PROBLEM**

*This G-E HC Porta-Color chassis has a bizarre horizontal problem. When turned on, the horizontal oscillator won't start. The output tube gets red hot and no raster. After about 5-10 minutes it will start, but the raster has 7-8 "ripples" down each side and the picture is naturally torn up. After about 30 minutes it will snap in, make a perfect picture and stay that way till turned off! Would appreciate help.—T.H. Rockville, MD.*

Going on "probabilities", I'd try replacing the .0033  $\mu$ F and .0068  $\mu$ F capacitors across the oscillator coil. This seems to help most of the cases with similar symptoms. The odd appearance of the raster after it does start trying to oscillate is due to the circuit going in and out of oscillation rapidly; "squegging". (Feedback: That did it!)

*continued on page 84*

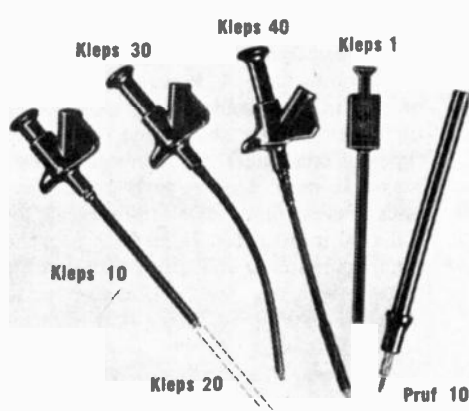

**Clever Kleps**

Test probes designed by your needs—Push to seize, push to release (all Kleps spring loaded).

- Kleps 10.** Boathook clamp grips wires, lugs, terminals. Accepts banana plug or bare wire lead. 4 3/4" long. \$1.39
  - Kleps 20.** Same, but 7" long. \$1.49
  - Kleps 30.** Completely flexible. Forked-tongue gripper. Accepts banana plug or bare lead. 6" long. \$1.79
  - Kleps 40.** Completely flexible. 3-segment automatic collet firmly grips wire ends, PC-board terminals, connector pins. Accepts banana plug or plain wire. 6 1/4" long. \$2.59
  - Kleps 1.** Economy Kleps for light line work (not lab quality). Meshing claws. 4 1/2" long. \$ .99
  - Prof 10.** Versatile test prod. Solder connection. Molded phenolic. Doubles as scribing tool. "Bunch" pin fits banana jack. Phone tip. 5 1/2" long. \$ .89
- All in red or black - specify. (Add 50¢ postage and handling). Write for complete catalog of - test probes, plugs, sockets, connectors, earphones, headsets, miniature components.

Available through your local distributor, or write to:



**RYE INDUSTRIES INC.**  
128 Spencer Place, Mamaroneck, N.Y. 10543  
In Canada: Rye Industries (Canada) Ltd.  
CIRCLE 52 ON FREE INFORMATION CARD



**PROFESSIONAL AIDS SHELF FILES**  
KEEP MAGAZINES, CATALOGS, MANUALS, JOURNALS, DIRECTORIES AND REPORTS NEAT, ORGANIZED



Eliminate the clutter of loose magazines, catalogs, etc. Find what you want, when you want it by utilizing these handy shelf or desk top files.



STORE ON SHELVES

Available in 6 sizes from Reader's Digest to newspaper size. Constructed of heavy duty fibreboard. Attractive blue front panel. Adhesive identification labels included. Popular letter size: 11 1/2 x 9 x 3 3/4



ORGANIZE YOUR DESK

10 for \$15.89  
25 for \$28.97  
Shipped pre-paid Request Catalog Canada, add \$1.00  
**PROFESSIONAL AIDS CO.**  
1 S. WACKER DR., SUITE RE9  
CHICAGO, ILL. 60608

**DESK TOP INSTANT DATA SYSTEM**  
FIND THOUSANDS OF FACTS AT COMPUTER SPEED



NO FILING OR REFILING EVER! COMPACT. EASY-TO-DO

The modern rapid way to locate countless facts at your desk without thumbing thru files. Specially coded cards are used to record any information you want close at hand—technical data, formulas, abstracts, case hist., bibliographies. Obtain just what you need in seconds—any group separates automatically simply by inserting a rod. No slow inefficient cross filing... no mechanical parts... no special training... minimum set up time.

**30 DAY MONEY BACK GUARANTEE**

ONLY \$38.00 POSTPAID  
Basic package (200 cards, hand notcher, sorting rods, instructions).  
**FREE LITERATURE ON REQUEST**

Additional cards: 1000 for \$37.00 postpaid. Sample Card Available  
Information Retrieval System, Div. of PROFESSIONAL AIDS CO.  
1 S. WACKER DR., SUITE RE10  
CHICAGO, ILL. 60608

CIRCLE 1 ON FREE INFORMATION CARD

CIRCLE 2 ON FREE INFORMATION CARD

# computer corner

Interfacing a D/A converter. CHRISTOPHER A. TITUS, DAVID G. LARSEN, PETER R. RONY\* and JONATHAN A. TITUS

AN ANALOG-TO-DIGITAL CONVERTER (A/D converter) is an electronic device that converts analog signals to digital signals. Typical commercial converters are based upon successive approximation, dual-slope integration, staircase-ramp conversion or voltage-to-frequency conversion.<sup>1</sup> An A/D converter is generally used to convert the output from an analog transducer or instrument into digital form suitable for direct observation on a digital display or as input into a computer. All digital panel meters and multi-meters contain built-in A/D converters. Modern A/D converters provide standard TTL outputs that can be coded in binary, binary coded decimal (BCD) or perhaps other less frequently used codes.

To demonstrate how an A/D converter can be interfaced to an 8080-based microcomputer, consider the generalized 10-bit A/D module shown in Fig. 1. In addition to the 10-bit output and analog input pins, the module also contains a START input and a DONE/BUSY output. It

is obviously not possible to simultaneously transfer all 10 bits from the A/D converter into an 8-bit microcomputer. For the 10-bit converter, data is transferred by placing bits D0 through D7 (the 8 least significant bits) in the first input byte and the remaining two bits, D8 and D9 (the 2 most significant bits), in the second byte.

To gate data onto the data bus and into the 8080, 8212 8-bit 3-state buffer chips are used between the A/D outputs and the 8080 data bus. Gating is required so that the 3-state buffers are enabled only when the 8080 requests data. In the case of the 8212 buffer, the gate is incorporated within the IC, so all that is required is a negative IN control signal, and positive O65 and O66 decoded pulses derived from the address bus decoding logic.

The remaining control signals include a START pulse to reset the A/D converter and start internal conversion, and a DONE/BUSY output flag that indicates a conversion has taken place and the 10-bit digital output is ready. These important control signals synchronize the operation of the conversion. Analog-to-digital converters do not continuously convert voltages into digital outputs—the conversions take a finite period of time. The A/D converter must be pulsed or strobed to start each conversion, and a 10-bit binary value cannot be output by the converter immediately after the strobe pulse is applied. In Fig. 1, a 21- $\mu$ s conver-

sion time was required. We used a successive approximation technique that converges on the unknown voltage by making successively smaller tests and comparing the results of such tests to the unknown voltage.

The DONE/BUSY flag, which indicates the converter is either done (logic 1) or busy (logic 0), is input into the microcomputer as a single bit; since there are 6 unused bits at input port O66, bit D7 is assigned to the flag. The START pulse to initiate a conversion must be short and positive. It can be obtained by gating the control signal  $\overline{\text{O}67}$  with a negative device address pulse,  $\overline{\text{O}37}$ , using a 7402 2-input NOR gate.

A typical software subroutine used to perform a single conversion is shown in Table 1.<sup>3</sup> The 10-bit binary result is left in the B and C registers of the 8080, with the least significant 8 bits in register C and the most significant 2 bits in register B in positions D0 and D1. The microcomputer spends time in the test loop as it checks and rechecks the flat bit during conversion. Our A/D conversion took only 21 microseconds, so the computer is in the loop for a short time. For other types of converters, the conversion time may take much longer, perhaps milliseconds or even hundreds of milliseconds for a digital multimeter. In such a case, the microcomputer would spend considerable time waiting for the A/D converter to "flag" the 8080, indicating that the conversion was complete.

An alternative approach is to use the DONE/BUSY flag as an interrupt input to the 8080. After initiating a conversion by

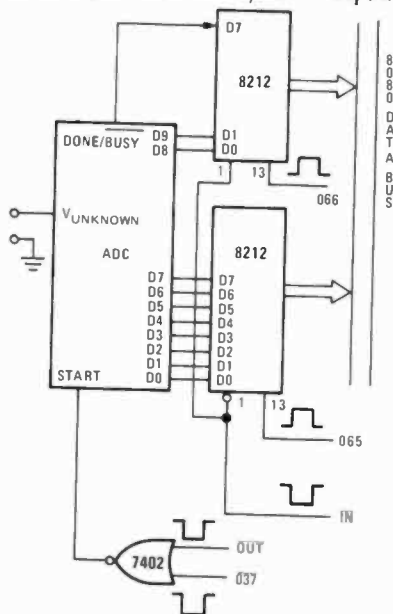

Fig. 1—ANALOG-TO-DIGITAL CONVERTER (ADC) interfaced to an 8080 microcomputer with a pair of 8212 buffer chips.

\*This article is reprinted courtesy American Laboratories. Dr. Rony, Department of Chemical Engineering, and Mr. Larsen, Department of Chemistry, are with the Virginia Polytechnic Institute & State University. Mr. Titus is president of Tychon, Inc.

TYCHON EDITOR-ASSEMBLER V-2

PAGE 01-001

TABLE 1 TYPICAL ADC INPUT ROUTINE FOR A 10 BIT ANALOG-TO-DIGITAL CONVERTER

```

100 000 365 ADC, *100 000
100 001 323 PUSHPSW /SAVE REGISTER A & FLAGS
100 002 037 OUT /STROBE THE ADC TO START A CONVERSION
100 003 333 TEST, IN /INPUT STATUS BIT AND 2 MSB'S
100 004 066 O66
100 005 306 ADI /ADD 1 TO THE FLAG BIT TO CAUSE AN
100 006 200 200 /TO CAUSE A CARRY IF IT IS SET
100 007 322 JNC /NO OVERFLOW, CHECK IT AGAIN
100 010 003 TEST
100 011 100 0
100 012 107 MOVBA /OVERFLOW, FLAG=1, SO SAVE MSB'S
100 013 333 IN /INPUT THE 8 LSB'S
100 014 065 O65
100 015 117 MOVCA /STORE THEM IN REGISTER C
100 016 361 POPPSW /RESTORE REGISTER A & FLAGS
100 017 311 RET RETURN TO MAIN PROGRAM
    
```

outputting a START pulse, the microcomputer proceeds to some other software task during conversion. When the conversion is complete, the A/D converter

starting at 000 070 inputs the 10 data bits and stores them in a data file. As we have stated previously,<sup>4</sup> interrupts should be used with caution. R-E

```

/      TABLE 2  TYPICAL ADC SUBROUTINE FOR AN
/      INTERRUPT TYPE CONVERTER INTERFACE.  THIS
/      ASSUMES THE CONVERTER WILL INTERRUPT WITH
/      A RST7 INSTRUCTION VECTORING TO 000 070.

```

```

*100 000
100 000 373  ADC,  EI      /ENABLE THE 8080'S INTERRUPT
100 001 323      OUT      /START A CONVERSION
100 002 037      037
100 003 311      RET      /RETURN TO MAIN PROGRAM

```

```

/      THIS IS THE ADC'S INTERRUPT SERVICE SOFTWARE

```

```

*000 070
000 070 365  ADCSVC, PUSHPSW /SAVE REGISTER A & FLAGS
000 071 345      PUSHH   /SAVE REGISTERS H & L
000 072 052      LHLD    /GET MEMORY POINTERS INTO H & L
000 073 000      POINT   /SO THE DATA MAY BE STORED
000 074 120      0
000 075 333      IN      /INPUT 8 LSB'S
000 076 065      065
000 077 167      MOVMA   /STORE THEM IN MEMORY
000 100 043      INXH   /INCREMENT MEMORY POINTER
000 101 333      IN      /INPUT 2 MSB'S
000 102 066      066
000 103 167      MOVMA   /STORE THEM, TOO
000 104 043      INXH   /INCREMENT MEMORY POINTER AGAIN
000 105 042      SHLD   /SAVE THE STORAGE AREA ADDRESS
000 106 000      POINT   0
000 107 120      0
000 110 341      POPH   /RESTORE REGISTERS H & L
000 111 361      POPPSW /RESTORE REGISTER A & FLAGS
000 112 311      RET     /RETURN TO MAIN PROGRAM

```

```

*120 000
120 000 000  POINT, 000 /THIS IS WHERE THE ADDRESS OF THE ADC
120 001 020      020 /STORAGE AREA IS KEPT.  IN THIS PROGRAM
                  /THE STORAGE AREA STARTS AT
                  /ADDRESS 020 000.  YOU COULD PLACE YOUR
                  /OWN POINTER ADDRESS HERE, BUT THESE
                  /TWO LOCATIONS MUST BE IN R/W MEMORY

```

interrupts the computer and points it to the A/D converter's service software, which, in this case, is located at 000 070. (A software example is provided in Table 2.)<sup>3</sup> In this example, the A/D converter subroutine is used only to start conversion. The subroutine at 000 070 is called by the interrupt with the aid of a jammed RST 7 instruction byte. The A/D converter interrupts the 8080 only when it has finished a conversion. The software

**Reference**

1. *Analog-Digital Conversion Handbook*, Analog Devices, Inc., Norwood, MA 02062. Copies may be still available for \$3.95.
2. Rony, P.R., Larsen, D.G., Titus, C., and Titus, J.A., "Microcomputer Interfacing: Interfacing a 10-bit DAC," *Amer. Lab.* 9 (1977).
3. The assembly language format shown is that of the resident editor/assembler developed by Tychon, Inc., for 8080 systems.
4. Titus, J. A., Larsen, D. G., and Rony, P. R., "Microcomputer Interfacing: Microcomputer interrupts," *Amer. Lab* 8 (1976).

**Second European CB Congress establishes a federation**

CB'ers from several European countries, meeting in Geneva for a two-day conference, have set up the European CB Federation, with a president, Dirk Dewaele, from Belgium, vice president, Thierry De Pasquier, from Switzerland, and general secretary, Enrico Campagnoli, from Italy.

The new organization was constituted for the liberalization and regulation of CB in Europe. While "private radio" is permitted in some European countries, it is not in others, and some CB'ers have been operating illegally since 1970 on the 27-MHz band set aside by international convention

for private radio.

At its final session the Congress voted a common proposal on CB regulation in Europe, and on the establishment of an Emergency Radio Service, in which members will monitor channel 1 for marine and channel 9 for terrestrial emergencies.

The proposals are to be forwarded to government administrations and particularly to the International Telecommunications Union (ITU) with the object of a renewal of the Geneva Convention in 1979 that will allow an adequate existence for CB in Europe.

There is only  
one

# 2-WAY

## RADIO HOME STUDY COURSE

exclusively devoted  
to professional FM radio equipment

We don't know how many TV repairmen or other people there are in electronics who would like to move up to professional FM two-way radio.

Nor do we know how many servicemen and installers there are already in the field who want to expand and upgrade their knowledge.

But we do know how many home study schools cater exclusively to both these groups.

**ONE!**

Please send me more information.  
 Name \_\_\_\_\_  
 Address \_\_\_\_\_  
 \_\_\_\_\_ Code \_\_\_\_\_  
 I am a former MTI student.  
 I am presently in the military.  
 I am a veteran. KK3

**MTI**  
Formerly  
**MOTOROLA**  
**TRAINING INSTITUTE**  
Summerdale, PA 17093  
(717) 732-3636

## CB ANTENNAS

continued from page 66

motion; and the mount must provide a consistent electrical capacitance to the vehicle ground.

The properly designed magnetic mount bears on the outer edge of its mounting support to present the longest lever arms to counteract tipping forces.

The magnet-mount antenna will work as well, or better, than the standard snap-in rooftop mount—if the loading coil is tuned properly. There is no direct ground with the magnet-mount antenna, but

rather a capacitive coupling. The better manufacturers specially tune the loading coil for the magnet mount, thus eliminating the variables that arise from this capacitive coupling. A standard base-loaded antenna with a magnet added will perform poorly.

### Cable cutting

The last and most important myth regarding antennas is that you can improve the standing-wave ratio (SWR) by cutting the coax cable. Cable cutting, matchboxes and the like serve only to fool your radio into thinking that there is a 50-ohm match where a true match does

not exist. In fact, cutting the cable will result in no change in SWR, and could in some cases result in a higher SWR.

An exception is the cophase antenna. If the 75-ohm cables that connect the two antennas to the phasing harness are not exactly the same length, performance will be very poor indeed. Another exception is the magnet-mount antenna. Since the magnet mount has a capacitance coupling rather than a true ground at its base, the cable can be hot if the length is not just right. That is, the coaxial cable will radiate RF power rather than transmitting that power directly to the antenna with minimum loss. We have found that unless the cable is either 12-foot or 24-foot long, it will be hot.

### Summary

In selecting and mounting mobile antennas, two points should be kept in mind:

1. Choose your antenna based on practicality, not what your friends are using. A 102-inch whip may look great, but it won't do much good if you have to park in a garage.
2. Always look for and buy quality. Cost-cutting will always show up in antenna performance, and a poorly constructed antenna will not stand up to the test of time.

Remember—you get what you pay for! **R-E**

## NEW from JFD!



## STEREO-PLUS ELECTRONIC FM ANTENNA

Helps your FM system deliver more stations . . . clearer sound . . . crisper stereo . . . less noise and interference. Works indoors or outdoors. Check the unique Stereo-Plus features!

- Utilizes **omni-directional** condensed dipole with integrated solid state preamplifier that improves stereo and mono FM **electronically**.
- Ultra-compact**—only 11" long and 1½" thick. Installs easily anywhere—indoors or outdoors.
- No switches, rods or moving parts. **Install it and forget it.**
- Smartly** styled to enhance any home decor.

Write today for brochure 9155 and name of nearest Stereo-Plus dealer.

PATENTS PENDING



Installs on top of any flat surface.



Installs outdoors.



Installs on wall.

JFD ELECTRONICS CORPORATION

A UNIMAX GROUP SUBSIDIARY

PINE TREE RD., OXFORD, N.C. 27565, PHONE: 919-693-3141

CIRCLE 90 ON FREE INFORMATION CARD

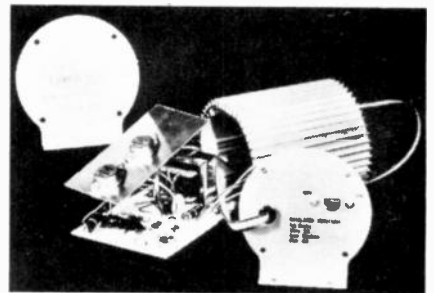

### FROM KIT TO CAR IN 80 MINUTES!

Electronic ignition is "in." Update your car with the TOPS in power, efficiency and reliability — the TIGER SST capacitive discharge ignition (CD).

The TIGER delivers everything other CD's promise — and more: quicker starting, more power, more gas mileage, tune-ups eliminated, lifetime plugs and points, reduced repairs and pollution.

The TIGER can be built and installed in your car in 80 minutes. The TIGER is unique!

The TIGER comes with a switch for TIGER or standard ignition for 12V negative ground only.

**Simpli-Kit \$21.95**

POST PAID U.S.A.

WE ACCEPT:

Mastercharge or BankAmericard.

Send check or money order with order to:

**Tri-Star Corporation**

DEPT. FF, P.O. Box 1727  
Grand Junction, Colorado 81501

CIRCLE 18 ON FREE INFORMATION CARD



# SWTPC announces first dual minifloppy kit under \$1,000



Now SWTPC offers complete best-buy computer system with \$995 dual minifloppy, \$500 video terminal/monitor, \$395 4K computer.



## \$995 MF-68 Dual Minifloppy

You need dual drives to get full benefits from a minifloppy. So we waited to offer a floppy until we could give you a dependable dual system at the right price.

The MF-68 is a complete top-quality minifloppy for your SWTPC Computer. The kit has controller, chassis, cover, power supply, cables, assembly instructions, two highly reliable Shugart drives, and a diskette with the Floppy Disk Operating System (FDOS) and disk BASIC. (A floppy is no better than its operating system, and the MF-68 has one of the best available.) An optional \$850 MF-6X kit expands the system to four drives.



## \$500 Terminal/Monitor

The CT-64 terminal kit offers these premium features: 64-character lines, upper/lower case letters, switchable control character printing, word highlighting, full cursor control, 110-1200 Baud serial interface, and many others. Separately the CT-64 is \$325, the 12 MHz CT-VM monitor \$175.



## \$395 4K 6800 Computer

The SWTPC 6800 comes complete with 4K memory, serial interface, power supply, chassis, famous Motorola MIKBUG® mini-operating system in read-only memory (ROM), and the most complete documentation with any computer kit. Our growing software library includes 4K and 8K BASIC (cassettes \$4.95 and \$9.95; paper tape \$10.00 and \$20.00). Extra memory: \$100/4K or \$250/8K.

**Other SWTPC peripherals** include \$250 PR-40 Alphanumeric Line Printer (40 characters/line, 5 x 7 dot matrix, 75 line/minute speed, compatible with our 6800 computer and MITS/IMSAI); \$79.50 AC-30 Cassette Interface System (writes/reads Kansas City standard tapes, controls two recorders, usable with other computers); and other peripherals now and to come.

### Enclosed Is:

- \_\_\_\_\_ \$1,990 for the full system shown above (MF-68 Minifloppy, CT-64 Terminal with CT-VM Monitor).
- \_\_\_\_\_ \$995 for the Dual Minifloppy
- \_\_\_\_\_ \$325 for the CT-64 Terminal
- \_\_\_\_\_ \$175 for the CT-VM Monitor
- \_\_\_\_\_ \$395 for the 4K 6800 Computer

\_\_\_\_\_ \$250 for the PR-40 Line Printer  
 \_\_\_\_\_ \$79.50 for AC-30 Cassette Interface  
 \_\_\_\_\_ Additional 4K memory boards at \$100  
 \_\_\_\_\_ Additional 8K memory boards at \$250  
 \_\_\_\_\_ Or BAC # \_\_\_\_\_ Exp. Date \_\_\_\_\_  
 \_\_\_\_\_ Or MC # \_\_\_\_\_ Exp. Date \_\_\_\_\_  
 Name \_\_\_\_\_ Address \_\_\_\_\_  
 City \_\_\_\_\_ State \_\_\_\_\_ Zip \_\_\_\_\_



Southwest Technical Products Corp.

219 W. Rhapsody, San Antonio, Texas 78216  
 London: Southwest Technical Products Co., Ltd.  
 Tokyo: Southwest Technical Products Corp./Japan

CIRCLE 62 ON FREE INFORMATION CARD

**RE TESTS HEATH AR1515**  
continued from page 63

oscillator, it is more significant that zero-center readings on the center-of-channel meter corresponded exactly to lowest observed distortion when tuning in FM signals.

Figure 4 is a spectrum analysis showing the frequency response of the tuner section, including high-frequency de-emphasis. Since our unit was equipped with the Dolby option, the two sweeps show the de-emphasis modes provided (25- $\mu$ s de-emphasis, required for Dolby FM reception, is depicted by the upper-trace roll-off). Stereo separation, although listed for three test frequencies in Table I, was excellent across the entire audio spectrum, as can be seen in Fig. 5 (the upper trace is desired channel signal; the lower trace is the undesired channel output).

**Amplifier and preamplifier measurements**

The amplifier of the *model AR-1515* exceeded its rated output at mid-frequencies before reaching the low, 0.08%-rated harmonic-distortion level. Even at the frequency extremes of 20 Hz and 20 kHz, 75-watts-per-channel output was obtained for a 0.8% THD reading (see Table II). Operation into 4-ohm loads produced significantly higher output levels, as expected, although Heath does not offer 4-ohm power specifications. RIAA response was a bit off (-1.5 dB at the high end), but phono overload capability exceeded specifications, at 120 mV for a 1-kHz input signal.

**TABLE III**

**RADIO-ELECTRONICS PRODUCT TEST REPORT**

Manufacturer: Heath Company

Model: AR-1515

**OVERALL PRODUCT ANALYSIS**

Retail price	\$549.95 (kit only) (Add \$39.95 for Dolby)
Price category	Medium/High
Price/performance ratio	Very good
Styling and appearance	Excellent
Sound quality	Excellent
Mechanical performance	Very good

Comments: There are two ways to evaluate the *model AR-1515*. Since it is only available in kit form, it is important to consider the receiver in terms of ease of assembly. The instruction manual supplied with the unit (265 pages long, believe it or not) is written very clearly and, if followed carefully, not only insures successful construction of a complex product, but can serve as a veritable "course" in high fidelity.

In terms of performance, we would give higher marks to the amplifier than to the tuner, although both parts certainly represent high fidelity at its best. Readers are cautioned not to confuse "digital frequency readout" with frequency synthesis. In other words, the tuning mechanism of the *model AR-1515* is conventional; a 4-gang tuning capacitor is used and tuning is only as accurate as that of a pointer/dial-string-calibrated receiver or tuner. The center-of-channel tuning meter must be relied upon and properly aligned if its indications are to correspond with "lowest distortion point" tuning. The hinged trap door (behind which are located the "secondary" controls) makes for a good-looking and uncluttered front panel. A receiver in this price and power class could have included two sets of tape monitors, although this omission is in part offset by the front-panel dubbing-in-and-out jacks. In terms of listeneability, we could not fault the *AR-1515* in any of its modes, and its 70-watt-per-channel capability makes the receiver compatible with just about any high-quality speaker system you connect to it, including low-efficiency acoustic suspension types.

As we have commented before in reviewing some of Heath's other excellent "kit-only" products, it's too bad this fine receiver is not available in wired form—even if it means adding a couple of hundred dollars to its price tag.

continued on page 104

**IN WIRE-WRAPPING  HAS THE LINE.....**

**MODEL WD-30**



PATENT PENDING

**WIRE DISPENSER**

- 50 FT. ROLL OF 30 AWG. KYNAR® WIRE-WRAPPING WIRE
- CUTS THE WIRE TO LENGTH
- STRIPS 1 INCH OF INSULATION

**AVAILABLE IN FOUR COLORS**

- WD-30-B BLUE WIRE
- WD-30-Y YELLOW WIRE
- WD-30-W WHITE WIRE
- WD-30-R RED WIRE

**\$345 EACH**

MINIMUM BILLING \$25.00  
ADD SHIPPING CHARGE \$1.00  
NEW YORK STATE RESIDENTS  
ADD APPLICABLE TAX

®KYNAR PENNWALT

**OK MACHINE & TOOL CORPORATION**

3455 Conner St., Bronx, N.Y. 10475 (212) 994-6600 / Telex 125091

CIRCLE 79 ON FREE INFORMATION CARD

From Dynascan Corporation

Good things  
DO come in small packages...

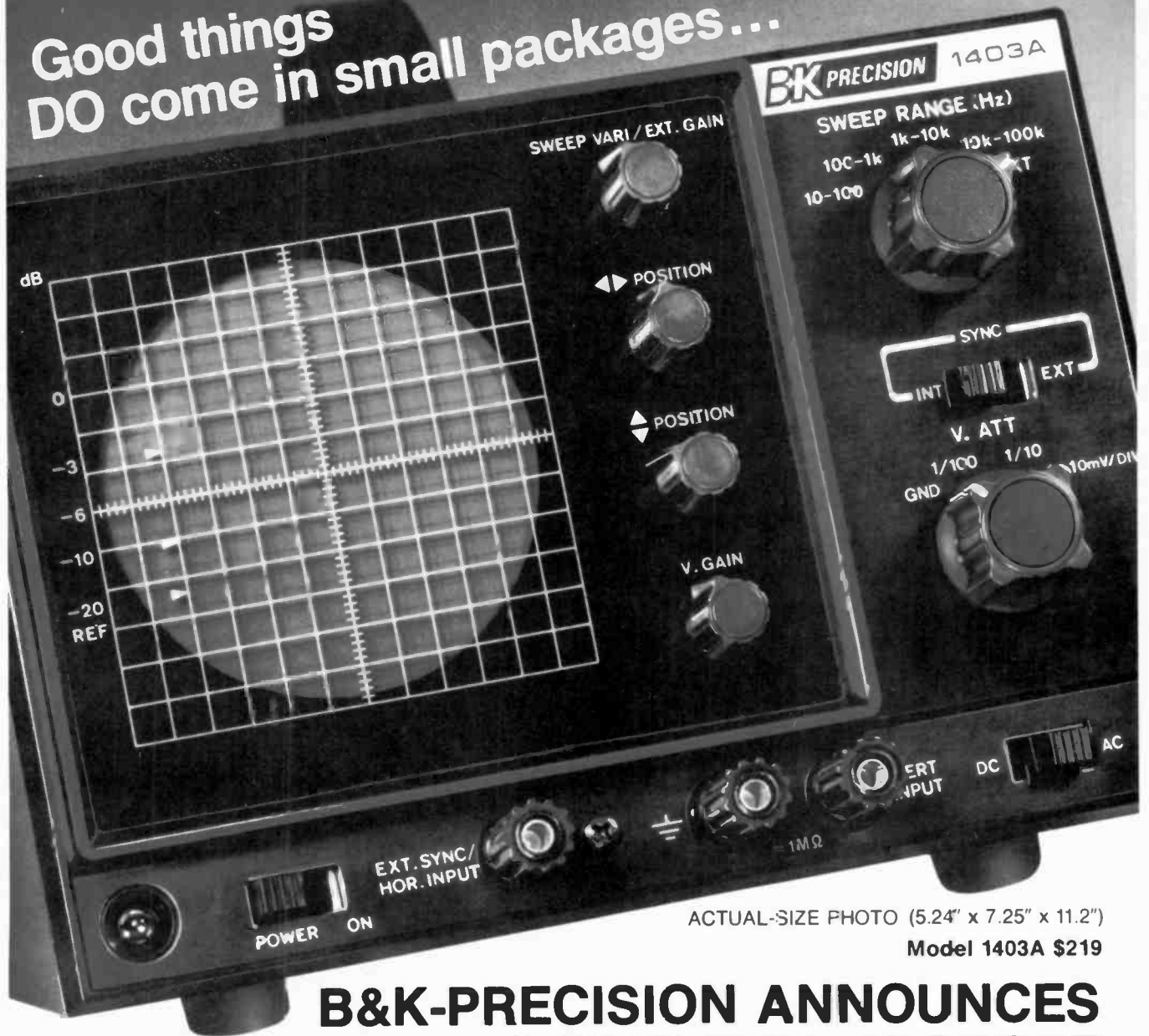

ACTUAL-SIZE PHOTO (5.24" x 7.25" x 11.2")

Model 1403A \$219

## B&K-PRECISION ANNOUNCES A NEW 5MHz 3" SCOPE

The B&K-PRECISION Model 1403A is a real example of taking a good idea and making it even better. We've redesigned our most popular 3" scope to bring you new features and higher performance but retained the same ultra-compact cabinet.

The new high-brightness 3" CRT produces sharp waveforms on a P31 blue phosphor. A smoked glass graticule helps increase image contrast for clear viewing in the brightest rooms. The 1403A is conservatively rated at a 5MHz bandwidth for 10mV/div, vertical sensitivity and will typically sync on signals at 8MHz. This rugged small scope has DC amplifiers on both vertical and horizontal axes and direct deflection terminals for waveform display up to 450MHz! Maximum input is 600Vp-p. Input impedance is 1 megohm for both vertical and horizontal inputs. A Z-axis is also provided.

Perhaps the most striking feature of the 1403A is its ultra-compact size, (HWD) 5.24 x 7.44 x 11.2".

This feature, combined with a sturdy integral handle, makes the 1403A ideal for field service applications. When bench or storage space is at a premium, you'll come to appreciate the convenient size even more.

We think the 1403A is the most cost-effective small scope available. Compare the specs, features, size and price, and we're sure that you'll agree. Available options include the LC-14 carrying case and PR-21 isolation/direct probe.

For immediate delivery, contact your B&K-PRECISION distributor.

**BK PRECISION** DYNASCAN CORPORATION

6460 W. Cortland Avenue, Chicago, IL 60635 312/889-9087

In Canada: Atlas Electronics, Ontario

International Sales: Empire Exporters, Inc., 270 Newtown Road, Plainville, LI, NY 11803

CIRCLE 77 ON FREE INFORMATION CARD

**FREE!**



**MORE THAN  
900 PRODUCTS**

**detectors,  
controls,  
sounders,  
locks,  
tools**

**EVERYTHING NEEDED  
TO PROTECT HOME,  
BUSINESS, INSTITUTION**

Huge selection of high quality professional alarm products. 64 fact-filled pages with detailed specs, diagrams, technical notes.

Products range from basic switches, controls, bells, sirens to most sophisticated detectors — radar, modulated or passive infrared, microwave, ultrasonics, ion, data links using pulse code multiplex, FSK radio, automatic phone dialers, leased line connections and display panels. Full selection of tools, relays, wire, foil, terminals, books.

**WRITE FOR FREE CATALOG TODAY!**

(Outside U.S., send \$1.00.)



**mountain west alarm**  
box 10780 • phoenix, az 85064  
(602) 263-8831

**CIRCLE 10 ON FREE INFORMATION CARD**

**RF GENERATORS**

*continued from page 64*

Thus the synchronizer actually establishes the basic generator frequency, while the generator maintains the leveling characteristics, spectral purity, modulation, and wide range attenuator. In order to utilize the synchronizer, both the uncalibrated RF output and the synchronizer input must be available. The cost of synchronizers is typically the same as the generator itself.

**Output connectors**

Many RF signal generators use the BNC connector for all RF connections and binding posts for audio connections. On the low-cost generators and some older generators, the SO-239 or UHF connector is popular. Occasionally the button-type microphone connector is used. On better generators, a type-N connector is often used. Certain generators, primarily those manufactured by General Radio, incorporate the GR coaxial connector, an extremely uniform impedance connector.

**Solid-state construction**

The radio-frequency signal generator is rare, in that it is one of the few instruments left where solid-state design is an

optional feature. There are a number of major RF signal generators on the market today that are very serviceable, extremely desirable products, but are constructed with vacuum tubes. Even in this day and age, they offer the most cost effective compromise. Solid-state generators do offer faster warmup and therefore instantaneous use, as well as lighter weight. However, both types of generators must be warmed up for some considerable period of time if maximum stability is desired. Vacuum tube generators often do not offer the wide range of features found on the newer solid-state generators. Vacuum tubes are not being used in new generator designs.

**Fine frequency adjustment**

The ultimate resolution of the frequency controls is usually limited by the mechanics of the system. Some RF signal generators have an additional electronic or "delta frequency" control. It permits the user to make slight adjustments in the operating frequency of the generator. The range of such controls is slight, but they permit a high resolution or setability. As they are electronic in nature, they overcome the problem of mechanical backlash in the main tuning system.

**Crystal calibrator**

The higher priced dial readout RF



**Redi-Chec '77 Awards**

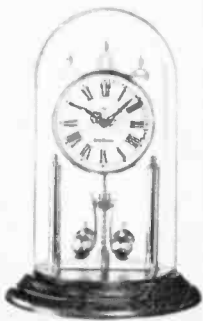

signal generators usually offer an internal crystal calibrator. It can be turned on and its signal, plus a sample of the output signal from the generator, are mixed in a detector. The user may listen to a beat note indicating the signal generator is at an exact multiple of the crystal frequency. Earphones connect to the detector output connector. Depending on the frequency range of the generator, crystals may be supplied in increments of 0.1, 1 or 10 MHz. Generator accuracy is improved by permitting recalibration at fairly small intervals. Crystal oscillator accuracy is usually 0.01% or better.

#### Digital frequency display

As noted earlier, some RF signal generators use a digital frequency meter to accurately display the generator frequency. An internal digital frequency meter gives a high degree of resolution and accuracy for a bandswitched L-C oscillator. A few generators offer an alternative form of digital readout by replacing the circular dial with a mechanical counter similar to the odometer on an automobile. However, the accuracy and resolution of such a system does not significantly exceed the circular or slide rule dial. Some of the RF signal generators that have a digital frequency meter offer an external input so the digital frequency

meter may be used in other ways.

#### Variable frequency audio oscillator

Some generators offer an optional variable frequency audio oscillator in place of the usual two-tone audio oscillator. This generator is configured as a fairly simple audio oscillator with relatively low distortion, for the purpose of generating modulation signals over a fairly wide range of audio frequencies.

#### High-power outputs

Certain RF signal generators generate high-power or high-level signals. These generators, or broadband amplifiers designed to be attached to generators, may produce signals with output levels of 10 to 100 watts, depending on the make or model. External power amplifiers may be of the tuned variety or the broadband variety. Tuned amplifiers tend to have higher output power, while broadband generators are much easier to use.

This concludes our coverage of RF signal generators. If you would like to see similar articles on other kinds of test equipment send us a postcard or a short note. Address it to Test Equipment Editor, Radio-Electronics, 200 Park Ave. South, New York, NY 10003. If you have any specific comments, send them too. R-E

**FREE!**

**EDMUND SCIENTIFIC**

ELECTRONICS  
OPTICS  
SOLAR ENERGY  
MAGNETS  
LASERS



Q.E.M. COMPONENTS  
LABWARE  
MIRRORS  
SURPLUS

**164 PAGE CATALOG**

- Over 4,000 unusual bargains for science and industry.
- In-stock supplies for engineers, experimenters, research labs, hobbyists, etc.
- Order direct and save—buy with complete confidence... every item carries the famous Edmund 30-day money-back guarantee.
- Simply mail this coupon for the newest Edmund catalog.

**RUSH LATEST FREE EDMUND CATALOG**

**EDMUND SCIENTIFIC CO.**  
Dept. EH24, Edscorp Building  
Barrington, N.J. 08007

Name \_\_\_\_\_

Address \_\_\_\_\_

City \_\_\_\_\_

State \_\_\_\_\_ Zip \_\_\_\_\_

**CIRCLE 58 ON FREE INFORMATION CARD**



## Valuable free gifts with your purchases of RCA Entertainment Receiving Tubes!

RCA Redi-Chek Award '77 certificates are available to you with your purchases of RCA receiving tubes from your local participating RCA Tube Distributor. Save these certificates. In required quantities, they are redeemable for an assortment of 221 exciting gifts from the RCA Redi-Chek Award '77 Prize Book.

See your participating RCA Tube Distributor for a copy of the Prize Book. Select the award you wish to earn. Buy

RCA receiving tubes and save the Redi-Chek Award '77 certificates you receive until you have the number required for the award of your choice. Fill out the award order form and mail with your Redi-Chek Award '77 certificates to:

RCA Redi-Chek Award '77 Hq.  
P. O. Box 154, Dayton, Ohio 45401

Always specify RCA receiving tubes! Quality tubes and great awards go hand in hand at RCA!

**RCA** *Redi-Chek Awards '77*

**DEALER CERTIFICATE**

ISSUED BY \_\_\_\_\_

Distributor Name \_\_\_\_\_

City \_\_\_\_\_ State \_\_\_\_\_

Specimen

**One Valuable Certificate**

SERIAL NO \_\_\_\_\_

This certificate is redeemable by mail from RCA Redi-Chek Awards '77 Headquarters, P.O. Box 154, Dayton, Ohio 45401 on required quantities for exchange as stated in the RCA Redi-Chek Awards '77 Prize Book available from participating RCA Tube Distributors.  
 Valid for redemption until midnight of April 30, 1978. Good only in the U.S.A. This certificate void where prohibited, listed or restricted.  
 (Cash redemption value: 1/20 of 1¢)  
 RCA Distributor and Special Products Division, Deptford, NJ 08040

8280 4 4-7501-00

RCA | Distributor and Special Products | Deptford, N.J. 08096

**RCA** Receiving Tubes

## READER QUESTIONS

continued from page 75

### AUDIO TRANSISTOR TOO HOT

The audio output transistor, Q202, in this RCA CTC-30AE runs too hot. However, the voltages and current seem to be in tolerance. All the resistors checked, and those that seemed slightly out of tolerance were replaced. No luck. Any ideas would be appreciated.—K.K., Passaic, NJ

I'll go along with you on the DC voltages, current, etc. It doesn't seem to be dissipating too much power. You might try increasing the heat-sink area just for

luck.

(Feedback: "I couldn't locate the heat sink you recommended, so I made one out of a 3- X 6-inch copper sheet, sprayed it flat black, cut it into fins and bolted it to the existing heat sink. Works fine now! Thanks.")

### HIGH-VOLTAGE PROBLEMS

This Zenith 20X1C38 seems to have a high-voltage regulation problem. However, this problem only shows up when the picture has a brightly colored background, or if the color control is turned all the way up. When these happen, the picture smears and goes out of focus. Regulator circuit voltages seem to be

pretty close, as is the boost voltage. I changed tubes in the color demodulators and the bandpass amplifier just to see if that would help. It didn't; can you?—R.M., Greenville, MS

I hope so! This looks very much like what's called "color blooming," which is what happens if the color control is cranked all the way up.

Try running a grey-scale setup. Turn each picture tube screen control up until you can barely see a line, then back off until it goes out. You could be over-driving if the screens are too high.

(Feedback: "Frankly, I didn't think this would work, but it did. Colors are good, and customer is very satisfied. Thanks!")

### NO HIGH VOLTAGE, NO BOOST

There's no high voltage on this Zenith black-and-white portable. The boost voltage source reads only 17 volts. The fly-back transformer checks good, and my analyst shows a shorted winding in the yoke. Do you think this is right?—J.P., Old Town, FL

Yes.

### SERVICE DATA

I can't seem to find the service data for my Zenith MPS-90W stereo record player. I need the phono cartridge part number.—R.L., Los Alamos, NM

Sams Photofact Folder 839-11 shows the cartridge is a Zenith Part No. 142-151, and the stylus is S68567, which can be replaced by a Sonotone 19T2S for the whole thing.

### NO RASTER

I've checked everything I can think of in this Zenith 12A13C52—there's no raster. The cathode current of the 6LB6 is 180 mA instead of 220 mA. Boost voltage is down to +500 volts instead of +875 volts. Flyback and yoke seem to be good. Grid drive waveform of the 6LB6 is only half the normal amplitude. Where do I go from here?—J.G., Astoria, NY

You didn't give me the DC grid voltage on that 6LB6. With only half the normal drive, the cathode current should be up to about 350 to 400 mA. Try a new 6LB6; this one may be weak. Read the grid voltage and see if it shows too much negative. This would also make the cathode current drop. Check that VDR in the 6LB6 grid circuit. If this is bad it could cause your problem.

### NO SYNC AT ALL

I'm going around in circles. I have neither horizontal nor vertical sync on a Philco 3CY90. I tried most of the modules; no change. Picture, color, etc., OK, still no sync.—D.F., Reading, PA

Stop running in circles. Scope the input to the AGC/sync module. See if you have normal input (which you seem to have) and, if so, you should have normal output. Also check the +20-volt

## NEW FROM LEADER One-Button Range Digital Multimeter.

3 1/2 Digit LED Readout,  
0.5% Accuracy.

1mV to 1000V,  
16 Ranges, Coverage.

Semi-Automatic Ranging  
One Pushbutton.

Fully Automatic  
(20MegΩ) Range.

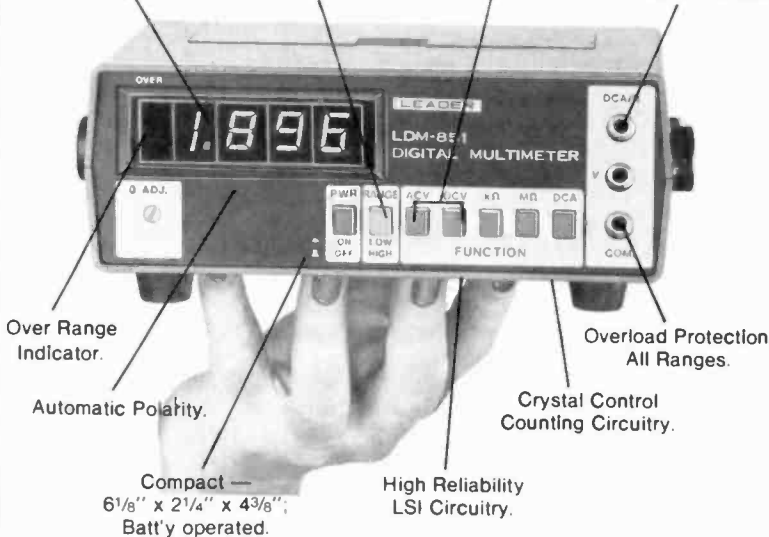

Over Range  
Indicator.

Automatic Polarity.

Compact —  
6 1/8" x 2 1/4" x 4 3/8";  
Batt'y operated.

High Reliability  
LSI Circuitry.

Overload Protection,  
All Ranges.

Crystal Control  
Counting Circuitry.

## Now, Easy Pushbutton Operation Is Yours!

Model LDM-851 . . . \$199.95

See your distributor or write direct for details.

151 Dupont Street, Plainville, N.Y. 11803  
(516) 822-9300  
In Canada: Omnitronix Ltd., Montreal, Quebec

When Quality Counts . . .

**LEADER**  
Instruments Corp.

CIRCLE 38 ON FREE INFORMATION CARD

supply. As a last resort, you should make *sure* that all the contacts on the module are making good contact.

#### NO FM STEREO

*After rewiring the output stages according to directions, this Fisher 600T stereo is working nicely. Now, however, I can't seem to get FM stereo. The stereo lamp lights, though. What goes on?—C.H., Homewood, IL*

If the stereo lamp is lighting up, the 19-kHz pilot carrier must be getting at least that far. Scope the rest of the circuit. You should find 8 volts P-P of 38-kHz pilot on the demodulator-transformer primary, and 1.7 volts P-P on the secondary that feeds the demodulators. If the 38-kHz doubler stage isn't working, this would kill the stereo effect.

#### PICTURE TUBE SUBSTITUTE

*I have a high-voltage problem with this Singer HE8-101. It uses an A23-10W 8-inch diagonal picture tube. The picture blurs and loses brightness after about 10 seconds. Is there a substitute for this tube?—R.K., Los Angeles, CA*

This really seems to be a defective picture tube. See if the HV will stay up with the ultor lead disconnected. A type 9XP4 can be used to replace the A23-10W.

#### BAD CAPACITOR

*Thank you for the reply to my question about all the troubles I was seeing in a CTC-38 RCA chassis. You suggested checking capacitor C104 and the DC bus with the scope. I did, replaced the capacitor and cured the problems.*

*This one capacitor was causing a magenta band in the top of the picture; non-linearity of the vertical sweep; very critical horizontal hold; and even a problem in the audio stage, which caused me to detune the quad coil. All this from only one capacitor!—J.L., Seattle, WA*

Yep. I don't think anyone could ever trace out *all* the possible feedback paths that could result from one capacitor being bad! Not even a computer.

#### TAPE DECK DISTORTION

*I can play a prerecorded tape through this Lafayette RK-725 tape deck, and it sounds fine. However, if I record on it, the sound is badly distorted. I notice that it doesn't erase, either. Any suggestions?—F.A., W. Hartford, CT*

Both these symptoms could be caused by the bias oscillator. The oscillator transformer and the transistors on this unit seem to be encapsulated. If so, you'll have to get an exact duplicate from Lafayette; you can find service data on it in Sams *Tape Recorder Manual TR-156*.

#### GE HELPFUL HINTS

The latest issue of GE's *TV Service News* has a very helpful hint: If you have

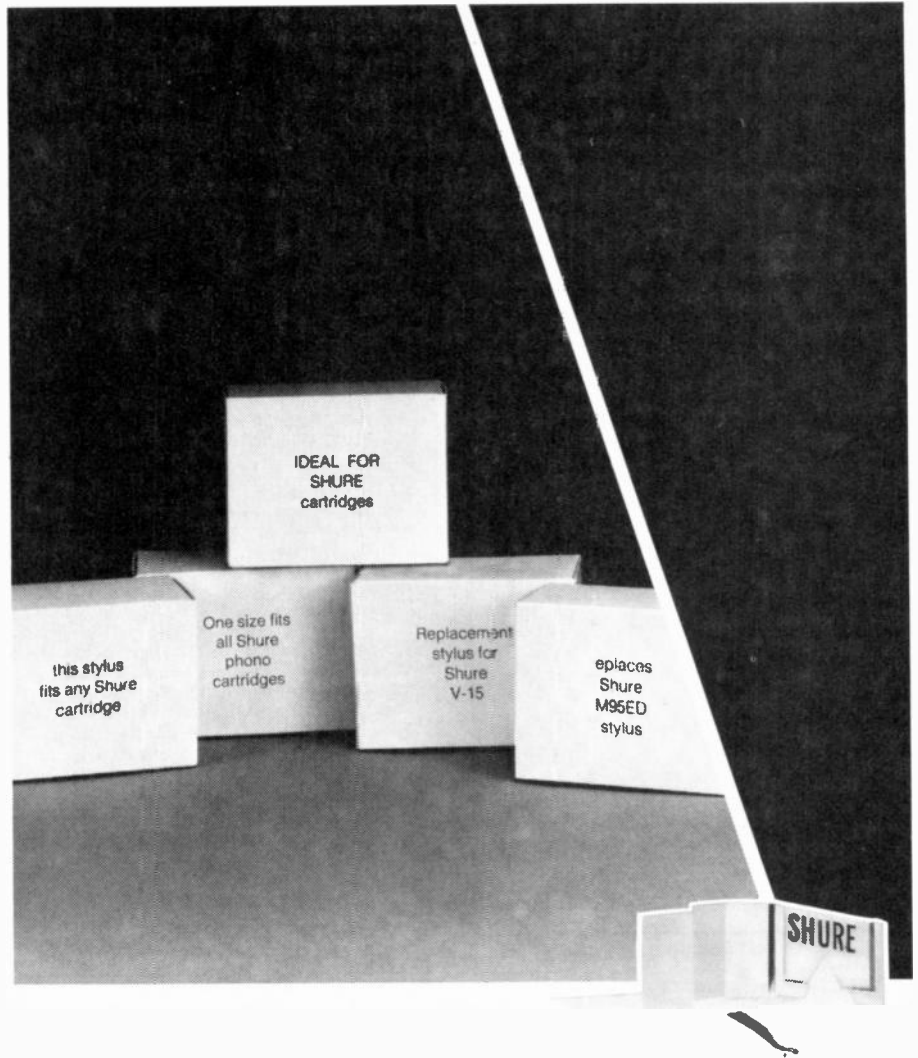

## Needle in the hi-fi haystack.

*Even we were astounded at how difficult it is to find an adequate other-brand replacement stylus for a Shure cartridge. We recently purchased 241 random styli that were not manufactured by Shure, but were being sold as replacements for our cartridges. Only ONE of these 241 styli could pass the same basic production line performance tests that ALL genuine Shure styli must pass. But don't simply accept what we say here. Send for the*

*documented test results we've compiled for you in data booklet #AL548. Insist on a genuine Shure stylus so that your cartridge will retain its original performance capability—and at the same time protect your records.*

Shure Brothers Inc.  
222 Hartrey Ave., Evanston, IL 60204  
In Canada: A. C. Simmonds & Sons Limited



MANUFACTURERS OF HIGH FIDELITY COMPONENTS, MICROPHONES, SOUND SYSTEMS AND RELATED CIRCUITRY

CIRCLE 61 ON FREE INFORMATION CARD

## MATHEMATICS ELECTRONICS ENGINEERING MATHEMATICS ADVANCED MATHEMATICS

These unusual courses are the result of many years of study and thought by the President of Indiana Home Study, who has personally lectured in the classroom to thousands of men, from all walks of life, on mathematics, and electrical and electronic engineering.

You will have to see the lessons to appreciate them!

NOW you can master mathematics and electronics and actually enjoy doing it!

WE ARE THIS SURE:—you order your lessons on a money-back guarantee.

In plain language, if you aren't satisfied you don't pay, and there are no strings attached.

Write today for more information and your outline of courses.

You have nothing to lose, and everything to gain!

**The INDIANA  
HOME STUDY INSTITUTE**  
P.O. BOX 1189  
PANAMA CITY, FLA 32401

CIRCLE 14 ON FREE INFORMATION CARD

### \* SAVE GAS! SAVE on TUNE-UPS!

MODERNIZE and Bring Your Car "UP-TO-DATE" with the MOST EFFICIENT Ignition ever Invented!



## ALLISON XR-700

\* The "XR-700" is a COMPLETELY NEW Ignition System that replaces the inefficient Breaker-Points and Condenser with a highly RELIABLE, Invisible "Infra-red" Light-Beam which CONTROLS the Latest design Solid-State POWER MODULE. This new "Patented" Invention produces the HIGHEST ENERGY, Longest Duration Spark of ANY Ignition System manufactured TODAY!

\* CUSTOMERS REPORT: "THE XR-700 MORE THAN PAYS FOR ITSELF ...and KEEPS ON SAVING MONEY with..."

- ★ INCREASED "GAS-MILEAGE" up to 30%!
- ★ ELIMINATING COSTLY "TUNE-UPS!"
- ★ IMPROVED ENGINE PERFORMANCE!
- ★ QUICKER STARTING IN ANY WEATHER!
- ★ FASTER ACCELERATION...SMOOTHER RUNNING!
- ★ PLUGS LAST UP TO 4-TIMES and LONGER!"

\* THE XR-700 has NO moving parts to wear out...never needs adjustment! Engineered to OUTLAST Your Car...So RELIABLE...So PERFECT...that we give you a LIFETIME WARRANTY... "FREE Repair or Replacement" for as long as you OWN the Unit...even if you change Cars, we will supply the necessary Parts FREE.

\* FITS ALL ENGINES...Domestic or Foreign...4, 6 or 8-Cylinder  
\* EASY INSTALLATION...Completely Factory ASSEMBLED!

Thousands sold at \$59.95

\* NOW... ONLY... **\$39.95** (Cal. Res. add Tax)

THAT'S EVERYTHING...INCLUDING POSTAGE & INSURANCE

\* SAVE! ORDER FACTORY DIRECT!  
Send Check or M/O, State Car Make, Year and No. of Cylinders.

\* MASTERCHARGE or BANKAMERICARD Cardholders  
Order by TOLL FREE PHONE (800) 423-6525 Ext. 3

CALL or WRITE for FREE BROCHURE

\* America's Oldest and Largest Manufacturer  
of Opto-Electronic Ignition Systems. ©



**ALLISON** AUTOMOTIVE CO.

1267 - RL, East EDNA PL., COVINA, CAL. 91722

CIRCLE 35 ON FREE INFORMATION CARD

the GE TV model number, you can instantly tell what the chassis number is. This is the quickest way to find the service data.

If the set is a model WY45523WD, the chassis is a YA. A WHE5264WH is an HE chassis, etc. Here's another hint: If the model number is WYA6330WD A 01, the "A" means a chassis change. The last two digits show only cabinet and appearance changes. The whole number is the service number, which you must be sure to give when ordering parts. This number will be found located with the serial number.

### VERTICAL PROBLEM

*I've got foldover at the bottom and vertical compression in the middle of the raster on this Truetone GEC-3420B-57,19XA chassis. If I crank the controls down enough to see about two-thirds height, the symptoms go away. I've checked all the transistors, resistors and capacitors. The first place the symptom shows up on a scope is on the base of vertical amplifier transistor Q208. Any suggestions, I hope?—D.D., Apalachicola, FL*

The vertical stage in this set is a Class-B audio output amplifier. From the symptoms, you have crossover distortion. The only difference is that you're seeing instead of hearing it. This is normally a bias problem, which could also be causing the foldover.

There's one stage marked "Vert. Crossover," Q212, which would be good to check. You should also check the clamp diodes since these can also affect the output bias.

(Feedback: "Bingo! It turned out to be Q212, the crossover transistor. I had checked it once, but I replaced it and that did it.")

### BRIGHTNESS LEVEL PROBLEM

*I replaced a very bad 23EGP22 picture tube in this Admiral G13, model LK5315. Now there's too much brightness. At minimum brightness control, the picture looks fairly good, but raising the brightness level causes severe blooming, and the raster goes out. I replaced the high-voltage rectifier; no luck. I can't locate the master screen control, although it's shown on the schematic.—D.F., Reading, PA*

You have a later-production 3G13 series chassis that doesn't have a master screen control. The picture-tube screen voltages are fixed and fed from the +660-volt boost. Your problem could be in the screen voltage. Try checking right at the picture-tube socket, and the picture-tube grid and cathode voltages. If the grids are too far positive, the tube could be drawing so much beam current that it overloads the high-voltage supply.

Alternate: Run the setup adjustment using the three "background" controls.



## You can build a better organ than you can buy!

### A magnificent Schober Electronic Organ

What a marvelous way to put your special talents to work! With our Schober Electronic Organ Kits and your skill, you can build yourself some very special satisfaction, and a lifetime of great music!

Schober Organs are literally far superior to comparably-priced "ready-made" units. You could actually pay twice as much and get no better organ...and miss the fun of assembling it yourself. A PC board at a time, component by component, you'll assemble your own "king of instruments." And when you're done, you'll wish there was more to do. And there is! For then, Schober will help you learn to play, even if you've never played a note before!

Schober Organ Kits range from \$650 to \$2850, and you can purchase in sections to spread costs out...or have two-year time payments. Combine the Incomparable quality of Schober components with your talent...and produce a far better organ than you can buy!

Thousands of others have, ever since 1955.

You can have all the details, without cost or obligation. Just send the coupon for the fascinating Schober color catalog (or enclose \$1 for a record that lets you hear as well as see Schober quality.) Why not clip it right now, before you forget?

The Schober Organ Corp., Dept. RE-167  
43 West 61st Street, New York, N.Y. 10023

- Please send me Schober Organ Catalog.  
 Enclosed please find \$1.00 for 12-inch L.P. record of Schober Organ music.

NAME \_\_\_\_\_  
ADDRESS \_\_\_\_\_  
CITY \_\_\_\_\_ STATE \_\_\_\_\_ ZIP \_\_\_\_\_

CIRCLE 82 ON FREE INFORMATION CARD



Since these controls affect the bias, if they're set too high this could be the answer.

### DIODE FAILURE

*After replacing quite a few transistors in the horizontal-output stage in a Tele-dyne 3C174WL, diode D773 burned up. I replaced the diode but it burned up again! This diode supplies the +21.6-volt supply. I can't find any short in this. Everything else seems OK. I'm baffled!—R.W., Springfield, MA*

I checked the service data and found that this chassis is also sold by Sears, Broadmoor, W.T. Grant, and other companies; they all have the same problem.

My suggestion is to replace D773 with a fast-recovery diode, such as RCA SK-3175 or SK-3516.

(Feedback: "That was it. Now I see your article on the subject in the January 1977 issue!")

### FOCUS-VOLTAGE PROBLEM

*I have a Sears model 41101, Ch. 564.80162. The original picture tube is a 490BZB22; suggested substitutes are 490AHB22 or possibly 19EXP22. I can't find the original tube listed anywhere. I put in the 490AHB22 and can't get it to work. Apparently the set's focus voltage is wrong, although Sams shows 4 to 5 kV on the focus anode. Any ideas?—J.F., Minot AFB, ND*

Well, I can't find any mention of the 490BZB22 either. I did find the specs on the 490AHB22; it uses about 24 kV of high voltage and a 4.2 to 5.0 kV focus voltage.

When I checked both the Sams schematic and the Sears data, I saw they show three taps for the focus voltages—+270, +385 and +650 volts. However, the voltage at the focus pin is shown as 4.2 kV! It's quite probable that the original picture tube was a low-focus-voltage type.

If so, you'll have to develop a focus-voltage source that will give you the correct voltage. A Pennsylvania technician solved the problem by using a couple of high-resistance focus-dropping resistors and a big variable 15- to 20-megohm control. If you are getting about 22 kV on the high voltage, the focus should be around 3.9 to 4 kV to sharpen up the scanning lines.

### TRANSISTOR OVERHEATING

*The output transistors in the left channel of this Akai 8080 heat up very quickly after turn-on. Resistance tests of both channels seem about the same. I hope you can help.—G.S., Westmont, IL*

First, disable the left channel by taking out the output transistors or disconnect the collector voltage supply. Second, open the collector supply circuit to the working right channel and hook a DC

milliammeter in series. Third, plug the line cord into a variable-voltage transformer and begin at zero.

Now, bring the line voltage up slowly, watching the current reading. (Turn the volume all the way off.) Note the "resting" current reading at full-line voltage. Check the DC voltages around the output stage and driver(s), and write them down.

Next, disable the right channel and repeat the test. You will probably find that the resting current is much greater in the bad channel. Read all the DC voltages. By keeping the line voltage low, you can hold the current down to a safe level. The most likely cause of the burn-out would be something that is upsetting the bias on the bad channel, making it draw far too much current. Look for defective bias diodes, driver transistors or even output transistors. For a quick check, replace the outputs in the bad channel with the ones in the working channel.

### NO COLOR

*A GE 19CD chassis has a very good black-and-white picture and sound, but no color at all. Tubes and transistors check good. Thanks for any help.—E.Z., Middletown, OH*

Count your blessings. You have high voltage, sweeps, a good IF/video circuit and a good picture tube! Unless all three

# NEW LBO-508 DUAL TRACE OSCILLOSCOPE

## A 20MHz OSCILLOSCOPE AT A 10MHz PRICE



### SPECIFICATIONS

<b>VERTICAL AMPLIFIER</b>	
IDENTICAL FOR BOTH CHANNELS	
SENSITIVITY:	10mV/cm — 20V/cm CALIBRATED IN 11 STEPS (1-26 SEQUENCE UP TO 50V/cm WITH VARIANCE CONTROL)
ACCURACY:	± 3%
BANDWIDTH:	IDC DC—20MHz (1.3dB, 4 cm) (AC) 20Hz — 20MHz (1.3dB, 4 cm)
RISE TIME:	17.5nSec
INPUT IMPEDANCE:	1M OHM SHUNTED BY 36pF (P=0.1)
INPUT COUPLING:	AC, DC, GND
MAX. INPUT VOLTAGE:	600V IDC & AC (0.01)
CHANNEL 3 POL:	INVERTS CH-2 POLARITY
INPUT CONNECTOR:	BNC
<b>TIME BASE</b>	
SWEEP SPEED:	0.5 MICRO SECOND/cm — 200mS/cm
ACCURACY:	10 STEP, 1-25 SEQUENCE
MAGNIFICATION:	±5%
<b>DUAL TRACE DISPLAY</b>	
MODE:	CH1, CH2, X-Y, DUAL, ADD.
CHOP (AUTOMATIC SEL IN DUAL MODE):	700mS/cm — 0.5mS/cm
ALT (AUTOMATIC SEL IN DUAL MODE):	200 MICRO SECONDS/cm — 8.8 MICRO SECONDS/cm
ADD:	SUM OR DIFFERENCE (WITH CHANNEL 2 INV'T)
<b>X-Y DISPLAY</b>	
IE = CH 1 Y = CH 2	
SENSITIVITY:	Y AXIS: 10mV/cm — 20V/cm X AXIS: 10mV/cm — 20V/cm
BANDWIDTH:	X AXIS: DC OR 20Hz — 800kHz (1.3dB, 10cm) LESS THAN 2NAT 100kHz
<b>SYNCHRONIZATION</b>	
MODE:	TRIGGER, AUTOMATIC
SIGNAL SOURCE:	INTERNAL (CH1 OR CH2) OR EXTERNAL, + OR - SLOPE
TRIGGER SENSITIVITY:	TRIGGERED (INT) 2Hz — 15MHz AT 1 cm BERT 2Hz — 15MHz AT 100mV p-p

ANOTHER QUALITY TEST INSTRUMENT BY

**LEADER** instruments Corp.

100 **SPECIAL INTRODUCTORY OFFER** 100

NORMAL PRICE **\$689.95**

INCLUDES PROBES **SAVE \$100** INCLUDES PROBES

ON LBO-508 OSCILLOSCOPE **SPECIAL PRICE \$589.95**

100 OFFER EXPIRES DEC. 31, 1977 100

FOR MORE INFORMATION OR TO ORDER CALL

**TOLL FREE HOT LINE**  
**800-223-0474**

**ADVANCE ELECTRONICS**

54 West 45 Street, New York, N.Y. 10036 212-687-2224

**THE TEST EQUIPMENT SPECIALISTS**



## Telematic SG-785 Ferret Tuner Substituter And Digital Pattern Generator



CIRCLE 111 ON FREE INFORMATION CARD

A FERRET IS A LITTLE ANIMAL THAT YOU SEND into a rat's nest to clean up trouble. Telematic Corp., 108-02 Otis Ave., Corona, NY 11368, remembered this; they named their latest piece of test equipment after it. Their "Ferret," the SG-785, can go into the rat's nest of TV circuitry and clean up troubles that otherwise would be hard to get at.

The Ferret is a combination instrument: it has VHF and UHF tuners for substitution tests which are the fastest and most reliable way of isolating tuner problems. Beside these, it has a built-in crystal-controlled digital pattern generator. This produces either dot or crosshatch patterns. The signal may be injected into the IF or antenna of any TV set. These are very useful for not only color TV servicing, but for many tests in black-and-white TV as well.

The VHF and UHF tuners in the Ferret may be used together or separately. VHF and UHF inputs are provided. Output jacks and a selector switch on the back panel let you use them in any combination desired. They may be substituted for the set's VHF/UHF tuners, feeding the signal directly into the IF input. Also, the Ferret's UHF tuner may be fed into the set's VHF tuner for a cross-check of calibration, sensitivity, etc., of the set's UHF tuner. The INT-EXT switch on the back is used to make this test.

The IF output of the tuners can be connected directly into the IF input of the TV set. Or, by using the clip-leads provided, this signal can be fed into any IF stage, including the last one, for a stage-by-stage test of the IF strip. By feeding the test signal (either the patterns or a TV signal may be used) directly into the input of the last IF stage, a simple AGC test can be made. The last IF is not normally controlled by the AGC. So, this gives you a normal video signal input to the AGC stage, and as a bonus, to the sync-separator as well. If you can get a picture through from this point, you know that the last IF, the video detector and the video stages are working.

Using the GEN OUT jack on the back panel, a signal of up to 1,000 microvolts is available. This is a complete video signal. The digital generator provides very sharp sync pulses. These can be used for signal-tracing through the video stages to spot distortion, loss of gain and so on. Incidentally, the dot pattern comes in very handy for making grey-scale adjustments, purity checks, and as a bonus, it is very good for digging out the cause of the "floating hum-bar" problems that can be so annoying!

The dot and crosshatch are the most needed patterns for convergence work on color TV sets. The digital generator produces very sharp and clear patterns. Of course, they can also be used for linearity, sync and many other problems in all types of TV circuits. The GAIN control adjusts not only the RF gain of the tuners but the level of the digital-pattern signal as well.

You can cross-connect the GEN OUT jack to the Ferret's VHF antenna terminals and feed the IF output into the set's IF input. Tuning to Channel 3, you can see the patterns—the harmonics of the IF signal fall in this range. Or, you can hook directly to the set's VHF input and tune to Channel 3 and still get a very good clean pattern. Of course, as with all tuner substituters, the Ferret can be used to check

the antenna. If you obtain no signals on either the set tuner or the Ferret, the home antenna (or cable) should definitely be suspected. Flipping on the digital pattern generator will verify this.

The Ferret is AC-powered and all outputs are decoupled so that there is no danger when doing signal tracing tests on either tube, hybrid or solid-state sets. The convergence patterns are generated by digital circuitry. This starts with a crystal-controlled oscillator at 377.622 kHz. This signal is divided down by a flip-flop chain to obtain the 15.734 kHz for the horizontal sync. More dividers count this down to obtain the vertical sync. The numerous sharp pips needed for the dot and crosshatch patterns are also obtained from the original oscillator signal. So, the whole thing is all

## Socket to the Bugs for Life.

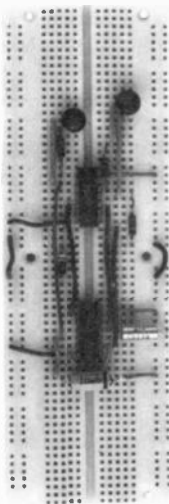

\$16.50\*

\* Suggested resale price.  
Dealer inquiries invited.

**E&I**®

**E&I INSTRUMENTS, INC.**

61 First Street, Derby, Conn. 06418  
(203) 735-8774 Telex No. 96 3536

The highest quality socket in the industry now carries a new low price and a new lifetime guarantee. E&I guarantees the SK-10 socket against all failures. Should it ever break, be damaged or fail to perform as described, return it to E&I postpaid for a free replacement. No questions asked.

We can offer such a guarantee because the SK-10 is a top quality socket built tough for years of use. Integrated circuits and discrete components insert directly without adapters. No patch cords needed. And, of course, no soldering.

For the life of your bugs, pick up an SK-10 today. They're available at your local computer store for only \$16.50\*.

CIRCLE 51 ON FREE INFORMATION CARD

Includes  
Functional  
Tilt Stand!

## NEW EICO 270 3½ DIGIT DMM KIT ONLY \$79.95

Introductory Offer—FREE AC ADAPTOR

The first and only lab accuracy portable DMM Kit featuring MOS/LSI IC economy and reliability. Measures DC/AC Volts, Kilohms, DC/AC milliamps in 21 ranges. Polarity indicators and overload protection are provided, and 0.5 inch LED displays give easiest-to-read digital readout to 1999. The 270 features a basic 0.5% DC accuracy, 10 Megohm input impedance, low voltage drop in all current ranges and automatically-flashing overrange indicator. **Assembled \$109.95**

### FREE '78 EICO CATALOG

Check reader service card or send 75¢ for first class mail. See your local EICO Dealer or call (212) 272-1134, 9:00 a.m.-5:00 p.m. EST. Major credit cards accepted.

EICO—283 Malta St.,  
Brooklyn, N.Y. 11207



CIRCLE 44 ON FREE INFORMATION CARD

tightly locked together and the patterns are very stable. The resulting video signal can be used to check frequency response through the video stages, etc., for the sync pulses are very clean squarewaves and any distortion shows up immediately.

Connecting cables are included for any type of IF input. The standard phono jacks and plugs are used. One has a plug on one end and a jack on the other for the most common type, and another has a pair of miniature insulated clips for off-breed types.

If it should be necessary, the RF frequency of the Ferret can be easily adjusted. Just hook it up to the IF input of a working TV set and adjust the trimmer that is accessible through a hole in the bottom. Tune for maximum sharpness of the crosshatch pattern. You can also cross-connect this to the VHF tuner in the Ferret and tune up on Channel 3 for maximum sharpness.

As I have said, this is a combination instrument capable of making quite a few different tests with ease. These are always very useful; anything that makes servicing easier makes it faster and more profitable, and this is what we need!

R-E

### Tri-Star Corp., Tiger CB Alarm

THE UNNERVING BLAST OF THE HORN INTERRUPTS the thief as he begins to remove your shiny new rig from under the dash. He abandons his objective, slips out of the car and rapidly moves off. That's the envisioned response to the triggered *Tiger CB Alarm*.



### CIRCLE 110 ON FREE INFORMATION CARD

manufactured by Tri-Star Corporation.

The \$9.95 alarm system is contained in a 1½ × 1½ × ¾-inch metal case. A three-foot red wire and an eight-foot black wire extend from the potted bottom of the case. The bubble package includes two self-tapping screws to fasten the alarm, and a solderless connector to make a single direct connection into the car's electrical wiring system.

The installation of the alarm takes three uncomplicated steps. First, fasten the three terminal device to the car with the screws to make the ground connection. The unit can be mounted in either the engine compartment or under the dash after checking that the two wires reach.

Second, route the black wire through the

# Now! RCA offers you three time and money-saving options in Color TV Test Jigs.

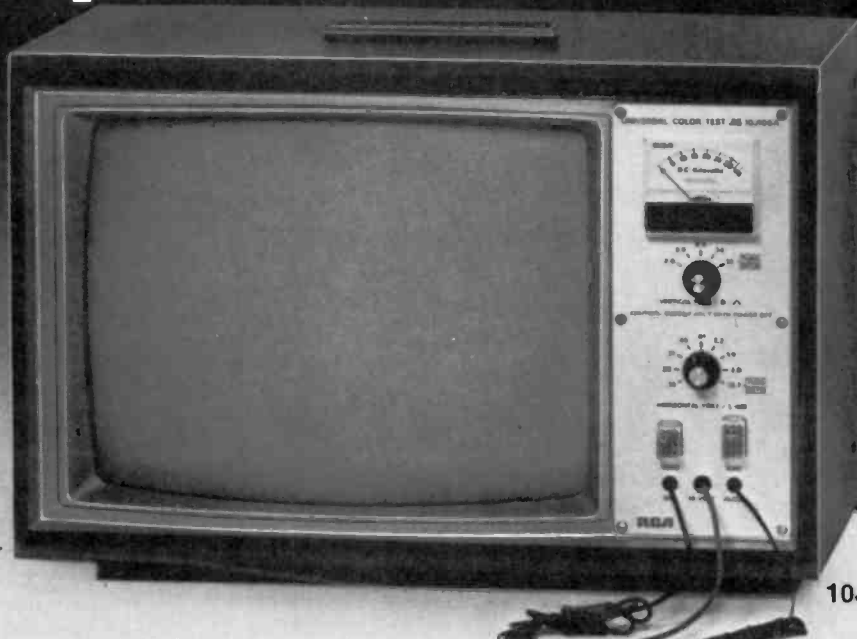

10J106A



10J107

equipment to be protected. More than one accessory can be guarded with a single alarm device by daisy-chaining the black wire through each one. Terminate the black wire by connecting it to ground under a convenient sheet-metal screw on the case of the last instrument in the chain. Make sure, of course, that the final ground connection is made to a device that is electrically connected to chassis ground. Keep the black wire taut so that it is broken as early as possible during a robbery attempt. Interweaving the wire with nearby car wiring is suggested as a camouflage.

Last, splice the red wire to the horn-button side of the horn relay using the supplied connector. The connector is forced onto the wire so that its spring-clip blade slices through the insulation to contact the conductor. The connector has a feedthrough section for the continuous horn wire and a blocked-off section that accepts the alarm's red wire.

Even though the manufacturer lists CB radios, tape players, tachometers, scanners and radar detectors as protectable devices, any accessory can be used, even a nonelectronic one. It is important only that it have a grounded conductive part or that there is a way to snake the black wire through it and then attach it to ground.

When an illegal attempt is made to remove a piece of equipment from the car, one of two things happens. Either the black wire is severed as the accessory is removed, breaking the ground continuity through the black wire; or the ground is directly disconnected when the accessory is physically separated from the car chassis.

Isolation of the black wire from ground

causes the alarm device to internally connect the red wire to ground. Since one end of the horn relay is connected to the car battery, the relay is energized and the horn blows. The horn continues to blow until the black wire is reconnected to ground, the red wire is disconnected from the horn relay or the battery is depleted of charge. (The hope is that the thief is unaware of the function of the black wire.)

The heart of the *Tiger CB Alarm* is an NPN power transistor with a biasing resistor connected between the collector and base terminals. The red wire connects to the collector, the black wire to the base and the case to the emitter. The transistor is held cutoff by the base connection to the black wire, which is wired to ground. Since the case is grounded, the base-to-emitter junction of the transistor is shorted, keeping it cutoff.

If the black wire is disconnected from ground, the base of the transistor is free to rise above ground potential. The resistor between the collector and base supplies current to the base to turn the transistor on. Actually, for the transistor to remain on it must continue to have sufficient collector voltage to supply base current through the biasing resistor. The transistor does not saturate and the collector remains slightly above the forward-biased base-to-emitter potential. The drop is only a small part of the total battery voltage, and the remainder that appears across the horn-relay coil is sufficient to energize it.

If the *Tiger CB Alarm* is damaged during an attempted burglary, return it to Tri-Star with \$1 and they will repair or replace it; the address is Tri-Star Corporation, Box 1727, Grand Junction, CO 81501.

R-E



**NEW EICO 700  
FREQUENCY  
COUNTER KIT**  
**\$69<sup>95</sup>**

At last! A digital counter every CB'er/Hobbyist can afford. Exclusive transmitter-keyed "sniffer" circuit activates counter only on transmit, giving accurate readout of channel frequency. Standard coax connectors and mounting brackets make mobile installation a snap. IC Digital circuitry. Freq. range: 5 Hz-27 MHz (all 40 CB channels) Accuracy:  $\pm 1$  PPM  $\pm 1$  Digit. Readout: Five 0.5" LED Displays; 10 MHz crystal oscillator KHz/MHz Timebase switch; Compact design: 2 $\frac{3}{8}$ "H x 6 $\frac{1}{8}$ "W 5 $\frac{1}{16}$ "D. **Assembled \$99.95**

**FREE '78 EICO CATALOG**  
Check reader service card or send 75¢ for first class mail. See your local EICO Dealer or call (212) 272-1134, 9:00 a.m.-5:00 p.m. EST. Major credit cards accepted.

**EICO—283 Malta St.,  
Brooklyn, N.Y. 11207**



**CIRCLE 44 ON FREE INFORMATION CARD**

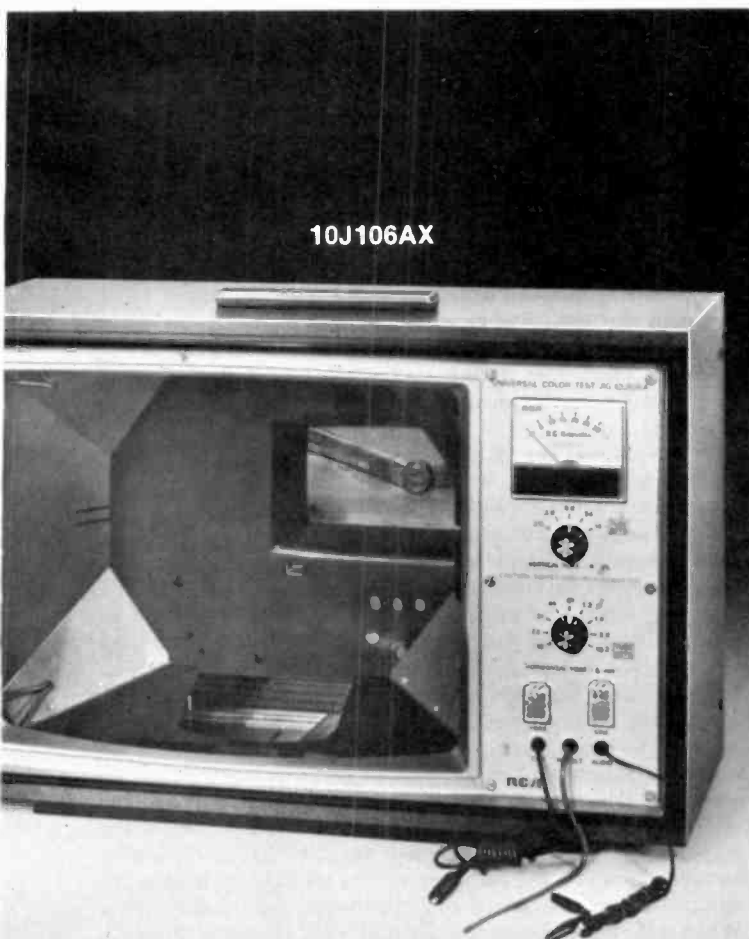

With the new RCA 10J106A Color TV Test Jig you can troubleshoot a TV chassis without bringing the cabinet and picture tube into the shop. The 10J106A helps you isolate picture tube or chassis malfunctions quickly, and without disturbing your customer's picture-tube alignment.

The 10J106A features a 19-inch shielded picture tube; built-in high voltage meter calibrated to 35 kV; two unique front-panel switches for easy changing of yoke impedances; and a built-in speaker. Yoke, picture tube socket, and high-voltage extension cables are supplied, plus a Set-Up Index and instruction book. With the 10J106A you can service thousands of sets whether tube, hybrid or solid-state — including Precision-in-Line types.

The new RCA 10J106AX Color TV Test Jig is exactly the same as the 10J106A except that it comes without a picture tube for those who prefer the economy of installing their own tube.

The RCA 10J107 Color TV Test Jig Adapter modernizes most older test jigs to perform like the 10J106A. And, if you're a do-it-yourselfer, you can build your own jig from a salvaged TV receiver.

See your RCA Distributor for all the details about which option suits you best. Or contact RCA Distributor and Special Products Division, Deptford, NJ 08096.

**RCA** Color TV  
Test Jig



UNIVERSAL  
TEST RIG

DOES IT  
ALL

33KV



\$229.95

PJS-298  
C.R.T. Included

- 33KV Leaded Glass CRT
- 40KV Meter
- Build-In Speaker
- Obsolete-Proof

The PJS-298 Universal Test Rig for tube and Solid State TVs designed for servicing high voltage chassis. Built-in speaker for convenient audio checking, 40KV-50Ua sensitivity meter constant monitoring of the anode voltage. Up-dating is accomplished by means of plug-in modules. (Extension cables included).

FOR FAST TROUBLE SHOOTING . . . .

## "FERRET" TV MINI-ANALYZER



\$99.95  
SG-785

- VHF/UHF Subber
- I.F. - Video Troubleshooter
- Convergence Generator
- Dots and Cross-Hatch Patterns

The "FERRET" is a multi-functional instrument for fast, efficient trouble-shooting and adjustment of all Color and B&W tvs. It is ideal for both shop and field work. (Cables included.)

**Telematic** 108-02 Otis Ave., Corona, N.Y. 11368

CIRCLE 72 ON FREE INFORMATION CARD

## BUILD PHLANGER

continued from page 45

trimmer R5 until the signal is passed with minimum clipping (distortion).

If you have an oscilloscope, view the signal at the wiper of BALANCE trimmer R6. Set the scope controls so you can easily see the clocked audio signal. Two identical signals will seem to appear at different DC levels. Adjust BALANCE trimmer R6 until the two signals converge into one; this is the proper setting. If you do not have a scope, leave R6 at approximate midrotation and proceed with the calibration.

With the delay section properly trimmed, set MIX control R12 to the middle of its range. Decrease the CENTER control R26 setting and listen for the phlanger effect dropping through the audio spectrum. When the CENTER control is at minimum, advance ACCENT control R8 to maximum. You will hear the increased "hollowness" of the filter; and if you sweep CENTER control R26 through its range the phlanger effect becomes more pronounced. With the CENTER control at maximum, advance SPAN control R25 to maximum. The internal low-frequency oscillator will sweep the phlanger effect. At the bottom of each sweep you may hear a short "wheep" or squeal. Adjust PEAK trimmer R27 until this sound is heard, and then return the trimmer to the point at which the squeals stop. As the internal oscillator sweeps the effect, advance SPEED control R17, which will increase the phlanger speed from approximately one sweep every five seconds to about one cycle per second.

With all calibration and checkout completed, all that remains is to mount the circuitry in a suitable enclosure. The phlanger is now ready to be used in its many applications. Here's a few of those applications.

### Using the phlanger

A phlanger can reproduce the sound of tape-reel phlanger with an equal mix of normal and delayed signal. The ACCENT control should be set at minimum, and sweep SPEED and SPAN can be set as you wish. Increasing the ACCENT control will increase the "hollowness" of the sound and will add subjective depth to it. Experiment with the control settings. You'll find many of the effects quite interesting.

Many other effects can be obtained: For example, when the delay-circuit clock speed changes, the delay-line output provides a slight pitch shift. If the clock frequency continually increases, the audio signal will be sampled into the delay line at one frequency, but will be fed out at a higher frequency. Thus, the input frequency will be shifted up by an amount dependent on the rate of increase of clock frequency. In similar fashion, when the clock rate decreases, the input is shifted down in frequency. Using this phenomenon several unique effects can be achieved.

Vibrato effects can be generated with the MIX control set for a 100% delayed signal. The phlanger's triangle wave will then produce a squarewave modulation of pitch; or, by minimizing the SPAN control, an external sinewave can be fed into J3 for the familiar smooth vibrato. Most organs, guitars and synthesizers have provisions for vibrato generation. But imagine, if you will, providing vibrato on a recording of a grand piano, a choir or chimes. If you have recorded several basic instrument tracks and later decide you should have used vibrato on the sax solo, you can easily process that track through a modulated delay line during mixdown rather than going to the trouble of rerecording the entire track.

The phlanger can also be used to generate stereophonic or quadraphonic spatial effects with a monophonic signal. The original signal is fed to the phlanger input and to one of the amplifiers. The phlanger output is then fed to the remaining amplifier (see Fig. 5). The same control settings are used as for vibrato, except the sweep oscillator is set to a lower speed. When a harmonically complex signal is fed through this setup,

certain frequencies will be emitted from the two speakers in-phase. These frequencies will appear to have a source between the speakers. Other frequencies will have varying amounts of phase difference between the two speakers. This will cause a psychoacoustical phenomenon in which the sound seems to emanate from one side of the center. The actual phase relationship will determine whether the source is to the left or the right, and the amount of phase difference will determine how far off-center the sound is located. This dramatic effect sounds even better in a quadriphonic system where opposite corners are driven with the former stereo outputs (see Fig. 6). The sound appears to float and drift above your head. To generate a quadriphonic signal from a stereo source, use a separate phlanger for each side, with the normal signal feeding the front channels and the delay-modulated signals (phlanger outputs) feeding the rear channels. The internal-sweep oscillators can vary the delay times independently causing apparent random motion around the room; or an external modulation signal can be applied to the CENTER remote jack for a synchronized front-to-back motion on each side.

When the phlanger is interfaced with a voltage-controlled music synthesizer, astounding effects can be obtained using

sequencers, envelope generators or envelope followers as control voltage sources for the SPEED and CENTER inputs. To get a full rich sound process the output of one voltage-controlled oscillator through a phlanger. This will give the effect of two voltage-controlled oscillators being used simultaneously.

A phlanger used in conjunction with an organ provides an excellent simulation of large mechanical rotating speakers. With the SPAN, CENTER and ACCENT controls below midrange, the speed can be adjusted for the desired rotating effect, using an equal mix of normal and delayed signal.

Processing miked drums through the phlanger gives an effect of tuning the drum sounds. With the controls set for automatic sweep, the drums sound as if they are constantly being retuned as they are played. The increased tonality of the drums greatly enhances their presence and solo potentials.

A phlanger that has controls for so many sections of the circuitry need not be limited to music processing. For example, you can add delayed triggering to a scope's horizontal-sweep sync circuit or a voice-operated switch to a transmitter that won't chop off the beginning of the message. **R-E**

## The J.M.J. DIGITAL DISPLAY BEZEL FOR APPEARANCE AND PERFORMANCE!

Now you can add a truly professional appearance to your digital projects and improve their performance as well... With the JMJ BEZEL. It will vastly improve the readability of the display and put a finishing touch on any front panel. And that's important, for obviously, the display is the most looked-at feature on any piece of digital equipment.

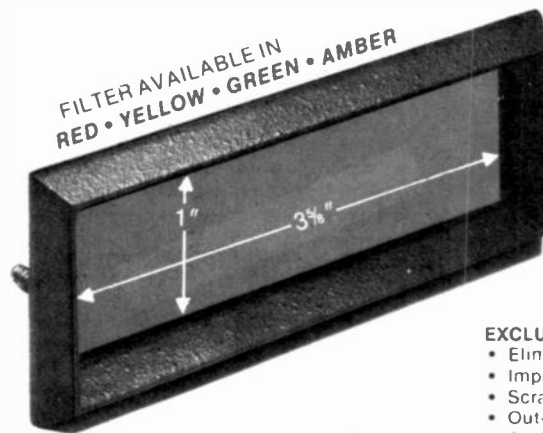

**\$4.95 EACH**

(Please order by color)

**UNIVERSAL SIZE  
HANDLES MOST REQUIREMENTS**

### EXCLUSIVE CHROMAFILTER® SCREEN

- Eliminates glare and reflections
  - Improves contrast and readability
  - Scratch resistant — easily cleaned
  - Out-performs circular polarized types
  - Available in four colors
- ### DIE CAST METAL FRAME
- Nonreflective black finish
  - Durable — heat resistant
  - Integral 6-32 mounting studs
  - No exposed hardware
  - Mounts in panels up to 3/16" thick
  - Includes all hardware and a special template for easy installation

© Panelgraphic Corp., W. Caldwell, N.J.

### DEALERS INQUIRIES INVITED

### ATTENTION CLOCK BUILDERS

Adapters for mounting clock modules and clock displays directly to the JMJ-BEZEL. Assures perfect alignment and simplifies mounting (Please Order by Number). **\$.69 ea.**

#### ADAPTER #1 (Fits the following)

National	Liton	Texas Inst.	Bowmar
MA 1001	LT 601	TIL 364	Opti-Stick
MA 1002	LT 442	thru	
NSB5917	LT 446	TIL 372	
NSB5921	LT 447		
NSB5922			

#### ADAPTER #2 (Fits the following)

National	Liton
MA 1010	LT 701
MA 1012	
MA 1013	

ADAPTER-3 (Universal Mount) For mounting any PC Board to the JMJ-BEZEL (Requires two mounting holes in PC Board).

TERMS: Minimum Order \$4.95  
Add \$1.00 for Postage & Handling  
N.J. Residents Add 5% Sales Tax  
Send Check or M.O. — No COD's

NAME		
ADDRESS		
CITY	STATE	ZIP
___ J.M.J. BEZELS at \$4.95 EA. (COLOR: _____)		
___ ADAPTERS at \$.69 EA. (NUMBER: _____)		
POSTAGE & HANDLING		1.00
5% N.J. SALES TAX		
AMOUNT ENCLOSED		

J.M.J. TECHNICAL PRODUCTS, INC.  
BOX 26, KENDALL PARK, N.J. 08824

## projection television

Convert color to Giant Screen with the

**f1.85**  
Projection TV Lens

FASTEST LENS SPEED FOR BRILLIANCE & BRIGHTNESS  
3 ELEMENTS; 6 OPTIC SURFACES  
FOCAL LENGTH: 12-INCH (305mm)  
MEASURES: 6.5" DIA. x 6.5" LENGTH

**SPECIAL PRICE \$150**

Write For Quantity Prices.

Send \$1 For Building Projection TV.

THE FINEST PROJECTION LENS THAT IS AVAILABLE TODAY



## PROJECTAPIX, LTD.

300 WEST 53 STREET  
NEW YORK, N.Y. 10019  
TELEPHONES: (212) 765-7869

CIRCLE 73 ON FREE INFORMATION CARD

CIRCLE 32 ON FREE INFORMATION CARD

# new products

More information on new products is available from manufacturers of items identified by a Free Information number. Free Information Card follows page 114.

**PULSE/FUNCTION GENERATOR, model 145**, is a convenient dual-purpose instrument, offering pulse-generator outputs with up to 20-MHz cali-



bration rates. Fixed-amplitude outputs are available for TTL and ECL; variable-pulse output, up

to 30 volts peak-to-peak. Unit also allows selection of five operational modes.

The function generator provides sine, square and triangular waveforms with continuous, triggered or gated output. A variable trigger start/stop allows selection of haversine or other outputs.

Unit weighs 11 lbs and measures 11 1/4 x 5 1/2 x 10 1/2-inches. Price: \$895.—Wavetek, 9045 Balboa Ave., San Diego, CA 92123.

**CIRCLE 93 ON FREE INFORMATION CARD**  
**FREQUENCY COUNTER, model MAX-100**, gives readings of 20 Hz to 100 MHz, with 1-second gatetime throughout range and ±1 accuracy (plus timebase error). Features large LED display of readout with 1-second update; overflow signals indicated by left-hand display digit. Crystal-controlled timebase has 3-ppm accuracy and high temperature stability.

Unit operates on 6 AA alkaline or NiCad cells; 110 or 220 VAC (with charger/eliminator), 12 VDC (with mobile charger/eliminator), or any 7.2-10 VDC supply. Supplies include input cable and instruction manual. Optional accessories are mobile charger/eliminator; charger/eliminators for 100-VAC and 220-VAC supply; low-loss tap-



off; antenna and case. Price of the MAX-100: \$139.95.—Continental Specialties Corp., 44 Kendall St., P.O. Box 1942, New Haven, CT 06509.

**CIRCLE 94 ON FREE INFORMATION CARD**  
**DUAL TRACE 15-MHz SCOPE, model 452**, has internal or external triggering with sync positions for TTV, TVH, and VITS. Sensitivity is 5 mV/cm and risetime is rated at 24 ns. Mode automatically shifts from CHOP to ALTERNATE on faster sweeps. Dual matched vertical and horizontal inputs are voltage-calibrated (11 steps in 1-2-5 sequence). Unit includes a built-in 0.5 VP-P 1-kHz squarewave calibrator.

**HOBBY HOUSE**  
Your Home Hobby Center for Quality Kits and Projects  
969 Ball Ave., Union, N. J. 07083 (201) 964-5206

SEND FOR FREE HOBBY HOUSE CATALOG  
LOWEST PRICES ON PRIME COMPONENTS

Some Examples

### HIGH POWER TRANSISTORS

2N 3055 NPN (ITT-TO-3 Case)	2/\$1.00
2N 2869 PNP (RCA-TO-3 Case)	2/\$1.00
DTS 410 NPN (GE TO-3 Case), Equiv to ECG 162	2/\$1.00
2N 1184 PNP (RCA-TO-8 Case)	2/\$1.25

### IN 4148 SWITCHING DIODES

Factory Prime, Taped & Reeled 50/\$1.00

1000 MFD 30 Volt Electrolytic Cap Axial Leads  
5 for \$1.00

### CAPACITOR ASSORTMENT

Popular value disc & low leakage up to & including 1 MFD 40 for \$1.00

### POTENTIOMETER ASSORTMENT

1K to 100K 12/\$1.00

### HELIPOT

10 Turn, Wire Wound Potentiometer  
500 Ohms, 5 Watts, 1/2% Linearity \$1.98

6 FT LINE CORDS  
6 for \$1.00

250K SLIDE VOLUME CONTROLS BY MALLORY  
4/\$1.00

### Terms and Conditions

Orders Shipped Within 24 Hours  
\$5.00 Minimum Order Telephone C.O.D.'s accepted  
\$15.00 Minimum Bank Americard/MasterCharge order  
Add \$1.00 Postage for orders under \$10.00  
Outside Continental U.S. add postage - U.S. Funds  
N.J. Residents add 5% Sales Tax Money Back Guarantee.



**MA1003 MOBILE CLOCK  
MODULE (National)**  
\$21.95 complete

Attaches directly to  
9-12V Battery

Automatic Nighttime  
Dimming

Fluorescent Display gives Color Choice  
(Red, Blue, Green or Yellow)  
when used w/corresponding Color Filter  
Includes — Module, Switches, Filter & Specs

### PAIR OF 6" PIONEER PINCUSHION SPEAKERS

32 ohms, 7 + watts \$3.95 pair

### Pair of 4" Full Range Speakers

4.0 ohms \$2.95 pair

### AC/DC WALL PLUG ADAPTOR-CHARGER

120 volt input/6 VDC 130MA-output \$1.00

6 RPM Gear Motor Syn. Timer Type \$2.95

Shock Mnts. 2 1/2" Square Metal Base 4 for \$2.00

### VOLTAGE REGULATORS

Positive-To 220 Pkg.		Negative-To 220 Pkg.	
7805	\$1.00	7905	\$1.25
7806	1.00	7912	1.25
7812	1.00	7915	1.25
7815	1.00		
7824	1.00	LM309K	1.25

### 7 SEG LED DISPLAYS

33" Type 707/MAN-1 14 Pin Dip  
Common Anode or Cathode

\$59 ea 10 for \$5.00

### CLOCK CHIPS

MM5314	\$3.50	Plug type-12VAC 250MA	2 50
MM5316	3.50	PC Mnt.-12VAC 250MA	1 50
MM5387 (Hi. Cur 5316)	3.95	Bkt Mnt.-5VAC 6 Amp	4.95
MM5375	3.95		

### TRANSFORMERS

### BRIDGES

1 1/2 Amp 200 volt	3/1.00	8,14,16,18 Pin	5 for 1.00
6 Amp 600 volt	3/2.00	24 Pin & 28 Pin	3 for 1.00
25 Amp 200 volts	3/5.00	40 Pin	2 for 1.00
2.5 Amp 1000 volt	5/1.00		

### IC SOCKETS

Jumbo Red LED's	10 for 1.00	100 for 9.00
25 Pk LED's Ass'd Sizes & Colors		2.50
Bi-Polar LED Red/Green		1.00

**CIRCLE 39 ON FREE INFORMATION CARD**

**\$9.95**  
**Complete Clock Kit**  
4 DIGIT 12/24 HOUR  
Includes: PC Board, 5316 Clock Chip, all components & Power Supply  
Features: Displays hrs. & min. - Switch to min. & seconds  
• AM/PM Indicator • Elapsed Timer  
• Fluorescent Display gives color choice (Red, Blue, Green, or Amber) - specify when used with corresponding Color Filter  
OPTIONS: If alarm function desired add (includes speaker & all components) \$2.50  
Plexiglas Case Kit - Red or Blue \$2.00

**2 AMP CIRCUIT BREAKER**  
Front Panel Mount Through 1/2" Diameter Hole  
120 VAC, 32 VDC, Trips at 2.7 amps 2/\$1.00

**60 Hz. Crystal Time Base Kit**  
\$4.95  
Use with Digital Clocks for 12VDC or Portable Operation  
KIT INCLUDES:  
PC Board, 5369 Divider Chip  
35795 MHZ XTAL & All Other Parts  
Complete Instructions

**Blinky/Flasher/Timing Kit**  
\$2.50 each 5 for \$10.00  
Kit includes:  
PC Board, 555 Timer, all components and a connector for a 9V Battery

**BIG-BRIGHT - .5" LED ALARM CLOCK**  
6 DIGIT AC or DC or ELAPSED TIMER KIT  
\$19.95 Complete  
• PC Board Drilled & Silk Screened (Includes Xtal Time Base Circuitry)  
• S375 Nat. Clock Chip & Fairchild Displays  
• Includes EVERY part required for clock and all options except Cabinet and Crystal Time Base components. If desired, see below  
• Brightness Control • 24 Hr Alarm w/snooze  
• Freeze feat. on every mode • 0-60 Min. Elapsed Timer  
• Field Tested over 1 Yr • 12 Hr., 60 Hz oper  
Most Important — Complete Instructions, schematics Pictorials, layouts — everything for trouble free assembly.  
OPTIONS —  
XTAL Time Base Components - \$2.95 when purchased w/clock  
Wood Clock Cabinet - \$4.00 when purchased w/clock



The scope weighs 20 lbs and measures 6½ X 12 X 16 inches. Available with combination stand

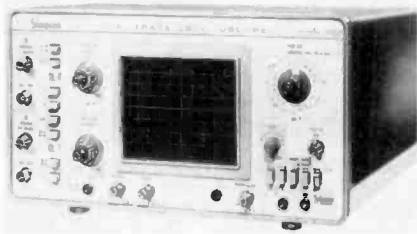

and handle, and optional probes. Priced at \$635.—Simpson Electric Co., 853 Dundee Ave., Elgin, IL 60120.

CIRCLE 95 ON FREE INFORMATION CARD

**ANTENNA CARE PRODUCTS**, *Tennacap* (18-1080), *Tennalube* (18-927), protect against rust and corrosion. *Tennacap* fits over threads of all



standard base-loaded units. *Tennalube* waterproofs threads and facilitates easy removal of antenna when necessary.—GC Electronics, 400 S. Wyman, Rockford, IL 61101.

CIRCLE 96 ON FREE INFORMATION CARD

**WRAPPED-WIRE TOOL**, model P160-4T1, cuts wiring time, eliminates wire stripping and reduces operator fatigue during long wrapping runs. The



lightweight 6.7-inch, 100-volt AC, 60-Hz tool takes either a P180 Silt-N-Wrap bit or a P160-2A

# SpaceSaver: New RCA Flameproof Film Resistor Kit

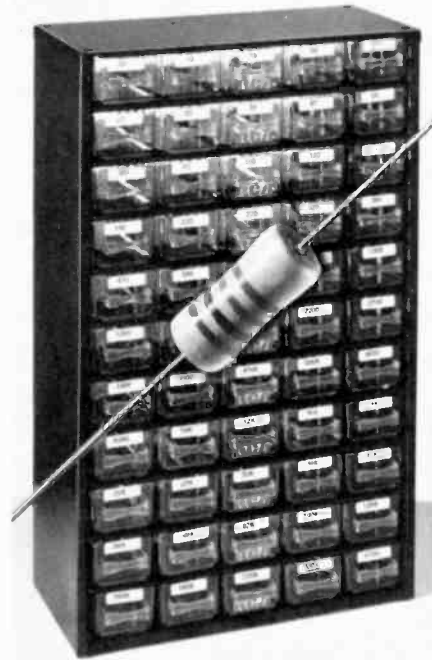

RCA's convenient, preloaded and prelabelled Flameproof Resistor Kit contains a wide range of the most-needed, standard value resistors in ½, 1 and 2 watt ratings. Two of each rating for a total of 330 resistors; all ±2% tolerance. Packed in a sturdy metal-frame cabinet for easy availability.

Service Technicians prefer RCA Flameproof Film Resistors because of their inherent safety characteristics. Design Engineers prefer them because they won't flame or short even under severe conditions. Look to RCA — your best single source for a complete line of flameproof film resistors.

Contact your authorized RCA Parts Distributor for all the details, or write to RCA Distributor and Special Products Division, 2000 Clements Bridge Road, Deptford, NJ 08096.

## RCA Flameproof Film Resistors

**CC:SS**  
QUALITY • RELIABILITY

Here's a mobile digital electronic clock for your car, truck, van, camper, mobile home or airplane that's really DIFFERENT — the CC & SS CC-6A! The four-digit bright green fluorescent display is deeply recessed in a sleek, modern black Stewart-Warner instrument case to keep outside light from "washing out" the display. Automatic dimming prevents night-time glare, and a unique ball-socket pedestal allows you to mount this clock above or below the dashboard at almost any angle — or IN the dashboard without the mount!

But it's not only the outside of this clock that's different. Using only two switches, you can "program" this space-age marvel's integrated circuit "watch chip" to keep track of the month and date with a 4-year calendar that counts the days of each month, as well as the hour, minute and second — and display them alternately if you prefer! Accuracy is controlled by a quartz crystal time base to better than one minute a month. An internal battery, good for over a year, powers all time-keeping functions, keeping track of time, month and date even when not connected to a vehicle. Vehicle power is only used to illuminate the 3½ high digits, which makes for the simplest possible installation — only two wires: power and ground. Of particular interest to those with "ham" or CB equipment in their vehicles, this clock is NOT multiplexed, and does not generate RFI (radio frequency interference).

Kit assembly is relatively simple for such a small clock with so many features and functions. The kit contains ALL parts, including the case, a 1.5V AAA Alkaline battery and detailed, illustrated instructions. The assembled unit comes tested and calibrated.

**CC:SS**  
QUALITY • RELIABILITY

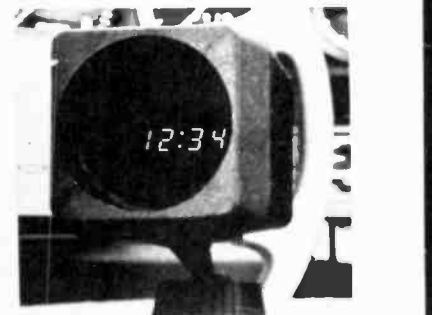

#### FEATURES

- PEDESTAL MOUNT — In, On or Under Dash
- 4.3" HIGH GREEN DIGITS
- 12 HOUR DISPLAY READS SECONDS
- TIME/MONTH-DATE DISPLAY
- RECESSED DISPLAY — NO "WASH-OUT"
- AUTOMATIC BRIGHTNESS CONTROL
- ±5 SEC/DAY ACCURACY
- QUARTZ-CRYSTAL TIME-BASE
- INTERNAL TIME-KEEPING BATTERY
- HAM & CB-ERS NOTE: NO RFI
- EASY TWO-WIRE INSTALLATION

## CC6A 5 FUNCTION ELECTRONIC CALENDAR CLOCK — PORTABLE

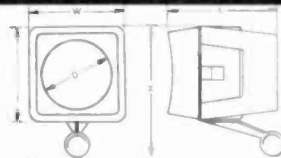

CC-6A	INCH	mm
Window Diameter (D)	2.165 ± .008	55.0 ± .2
Length (L)	3.150 ± .008	80.0 ± .2
Height (H)	3.660 ± .04	93.0 ± 1.0
Width & Height (W & H)	2.750 x 2.750 .08	70 x 70.0 1.2
NET WEIGHT EA.	250 grams (8.83 oz.)	

**ABS'Y**

**\$ 59.95**

**CC & SS INCORPORATED**

2309 SANTA MONICA BLVD.  
SANTA MONICA, CA 90404  
(310) 828-3479

**KIT**

**\$ 39.95**

CIRCLE 47 ON FREE INFORMATION CARD

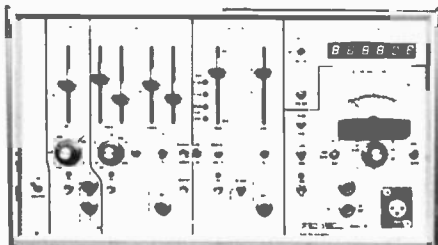

MODEL 101 AUDIO TEST SYSTEM consists of two sine/square/triangle function generators, pulse generator, frequency counter and AC voltmeter. As a system it will generate a frequency response plot on an X-Y recorder or scope.

Time base generator offers symmetrical or independent control of the positive and negative sides of the ramp providing a duty cycle of 1% to 99%. Frequency range is .002 Hz to 100k Hz. Amplitude is 16 Vpp into 500 Ohms with  $\pm 5$  VDC offset. The time base output drives the X axis of an X-Y recorder. Manual mode provided for setup.

Audio sweep generator provides manual frequency adjustment or log/linear sweep of 20 Hz to 20k Hz. Blanking mode provides zero reference line on an X-Y recorder or tone burst. Amplitude is 16 Vpp into 500 Ohms or 10 Vpp into 8 Ohms.

Pulse generator frequency range is .002 Hz to 800k Hz. Pulse width is adjusted independent of frequency from 4 seconds to 40 nanoseconds. Outputs are complementary TTL.

AC Voltmeter has full scale sensitivities from 1 mV to 250 V. Fast/slow, peak/true RMS and log/linear modes are provided. Output drives Y axis of X-Y recorder.

Frequency counter is 6 digit, line triggered, and reads either internal or external. Sensitivity is 100 MV peak at 20k Hz. 1/2 sec. update. 50/60 Hz.

Dimensions: 8x14x3. Shipping weight: 9 lbs. \$650. Stock to 30 days. Warranty: 1 year, 3-year \$60.

FIDELITY SOUND 1894 Commercenter W. #105 San Bernardino, Ca 92408 (714) 889-7823

CIRCLE 17 ON FREE INFORMATION CARD



**WE'RE GROWING!**  
to better represent  
**YOU**

the successful service  
business operator.

\*Over 2500 firms belong  
\*39 State Affiliates  
\*167 Local Associations

**YOU CAN JOIN!**

and learn how to make  
money and work less hours.

Write today for a  
membership application  
and more information.

1715 Expo Lane  
Indianapolis, Indiana 46224  
Phone (317) 241-8172

CIRCLE 85 ON FREE INFORMATION CARD

wrapping bit. A permanent-magnet motor, operating at 4500 to 5100 rpm, powered by a remotely located converter, helps reduce tool weight. High-impact plastic protects against damage and electrical shocks. The P160-4T1, together with the P180 bit, two 100-foot spools of 28-AWG wire and P183 forming and wire cutoff tool, retails for \$80; P160-2A wrapping bit, \$7.95. Battery-powered cordless models available.—Vector Electronic Co., 12460 Gladstone Ave., Sylmar, CA 91342.

CIRCLE 97 ON FREE INFORMATION CARD

**40-CHANNEL GUTTER-MOUNT ANTENNA**, model MS131, is designed for use with grounded metal gutters. A stainless steel whip for strength

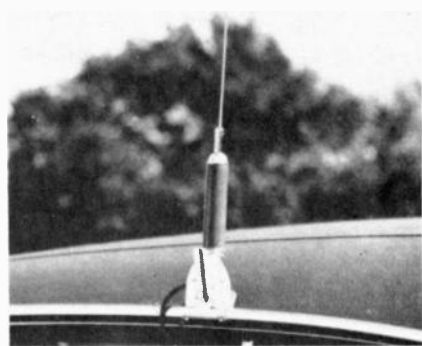

and flexibility, a 17-foot coax cable with attached radio connector, and all mounting hardware are included. Suggested price, \$21.95.—The Antenna Specialists Co., 12435 Euclid Ave., Cleveland, OH 44106

CIRCLE 98 ON FREE INFORMATION CARD

**HIGH-POWER LOAD BANK**, model 230, is a 2-channel precision device to be used as a dummy load for audio equipment. It provides an 8-ohm, 1%, 250-watt output per channel. Five-way binding posts permit parallel (4-ohm) or series (16-

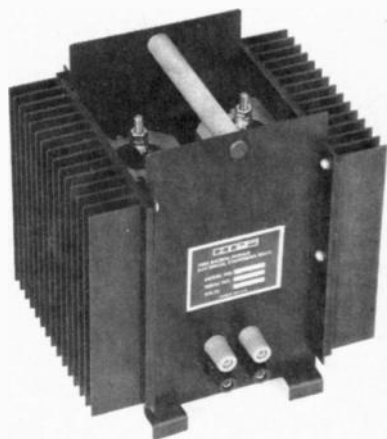

ohm) connections and 500-watt dissipation. Load resistors are heat-sink-mounted. Free-standing unit is mounted on a base for adequate air flow. Price: \$125.—BPI-Audio Test Instruments, 7853 Balboa Ave., San Diego, CA 92111

CIRCLE 99 ON FREE INFORMATION CARD

**IN-DASH CB/CAR STEREO**, model 860CB, combines 8-track stereo tape player and AM-FM-MPX radio as well as all 40 channels. CB controls include mike, radio-tape mode selector, variable squelch, receive/transmit indicator, lights and patented standby monitor.

Stereo section contains indicator lights and manual selector. AM-FM-MPX section provides in-door dial, local/distance switch, mode selector, MPX indicator light and antenna trimmer. Unit delivers 6 watts-per-channel RMS with

For  
faster  
service

USE  
ZIP  
CODE

on  
all  
mail



**A Platt tool case  
won't fall apart at the seams  
because there are no seams.**

Unlike other tool cases, the pockets on a Platt pallet\* are molded. There are no seams, stitches or rivets to tear loose. It's a one-piece unit that's practically indestructible.

The case itself comes in tough, lightweight ABS Thermo-plastic. Inside there are compartments for larger tools.

Platt also has rugged hardware. Like an aluminum rim for extra strength. Steel core handles. And tough brass locks.

Size 6" deep x 13" high x 18" wide  
Complete with two tool pallets.  
Tools shown are not included.

**\$69.<sup>95</sup>**

FOR MORE INFORMATION OR TO ORDER CALL TOLL FREE 800-223-0474

**ADVANCE  
ELECTRONICS**

54 West 45 Street New York, N.Y. 10036 212 687 2224

# SATISFY YOUR APPETITE FOR COMPUTER KNOWLEDGE WITH SAMS COOKBOOKS

Send for the cookbooks and manuals described. Increase your knowledge of minicomputers, microprocessors, computer technology, related computer circuits and peripheral equipment. Be satisfied or your money back.



**How To Buy & Use Minicomputers & Microcomputers**  
By *William Barden, Jr.*  
This manual gives you the basics of minicomputers and microcomputers. Explains their hardware and software, the peripheral devices available and various programming languages and techniques. Allows you to decide which system is best for your needs. 240 pages; softbound. No. 21351 \$9.95



**Microcomputer Primer**  
By *Mitchell Waite and Michael Pardee*  
Written for the beginner in the computer field. All the basic concepts and characteristics of microcomputers are explored. The easy to understand language prepares you for further study. 224 pages; softbound. No. 21404 \$7.95

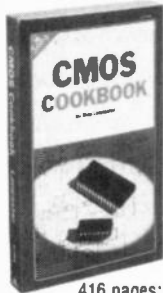

**CMOS Cookbook**  
By *Don Lancaster*  
Your complete guide to the understanding and use of Complementary Metal-Oxide-Silicon integrated circuits. Gives usage rules; power supply design examples; applications; information on breadboards, testing, tools, and interface. Detailed coverage of logic and more. 416 pages; softbound. No. 21398 \$9.95

**The Big CMOS Wall Chart 35" x 23"**  
Big, readable wall chart provides essential information on CMOS devices. No. 21399 \$2.95

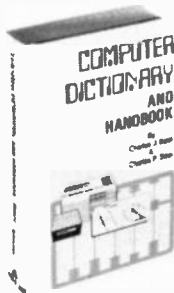

**Computer Dictionary and Handbook**  
By *Charles J. Sippi & Charles P. Sippi*  
At your finger tips you have more than 22,000 definitions, acronyms, and abbreviations dealing with the field of data processing. Also 13 appendices cover a myriad of computer related subjects. 784 pages; hardbound. No. 20850 \$19.50



**TTL Cookbook**  
By *Donald E. Lancaster*  
You'll discover what Transistor-Transistor Logic is, how it works and how to use it. Discusses practical digital applications. You'll learn to build TTL systems that entertain, test and train. 336 pages; softbound. No. 21035 \$8.95

**User's Guide to TTL (Wall Chart) 35" x 23"**  
Shows you needed information on TTL devices at a glance. No. 20180 \$2.50



**TV Typewriter Cookbook**  
By *Don Lancaster*  
Your comprehensive guide to low cost television display of alpha-numeric and graphics data for microprocessor systems, word processing, TV titling and video games. Covers configurations, memories, keyboards, techniques and much more. 256 pages; softbound. No. 21313 \$9.95



**Active-Filter Cookbook**  
By *Don Lancaster*  
Dynamic coverage of active filters. What they are and how to use them. Learn to build and apply them to audio equalizers, speech therapy, psychedelic lighting and more. 240 pages; softbound. No. 21168 \$14.95



**IC Op-Amp Cookbook**  
By *Walter G. Jung*  
Now one book gives you in-depth exposure to IC op amps. Covers theory and over 250 practical circuit applications. 592 pages; softbound. No. 20969 \$12.95

**Send your order Today!**

Send books and/or wall charts checked below, \$ enclosed\*. I understand that, if not completely satisfied, I may return my order within 10 days for a full refund.

- 21351    21399    21080    20969  
 21404    20850    21313    20715  
 21398    21035    21168

\*Include sales tax where applicable. Canadian prices slightly higher.

NAME please print \_\_\_\_\_  
 ADDRESS \_\_\_\_\_  
 CITY \_\_\_\_\_  
 STATE \_\_\_\_\_ ZIP \_\_\_\_\_

EC634

**Howard W. Sams & Co., Inc.**

4300 West 62nd Street  
Indianapolis, Indiana 46206

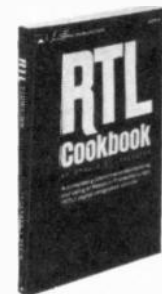

**RTL Cookbook**  
By *Donald E. Lancaster*  
You will learn the how and why of Resistor-Transistor Logic. Obtain useful design information and many digital applications. 240 pages; softbound. No. 20715 \$5.75

CLIP OUT

CLIP OUT

# Got Gas Guzzler Gloom?

Try **AUTOCOMP** for quick relief from high fuel costs.

AUTOCOMP is a continuously updating micro-computer which reads **TRUE MPG** while you drive. Additional pushbutton controls also give automatic readouts of Time, Distance, and Fuel Consumption. You can monitor your engine's performance and your vehicle's efficiency. AUTOCOMP will help you save fuel, improve your driving habits, and provide you with valuable time and trip data. Install AUTOCOMP before your next trip and beat high fuel costs!

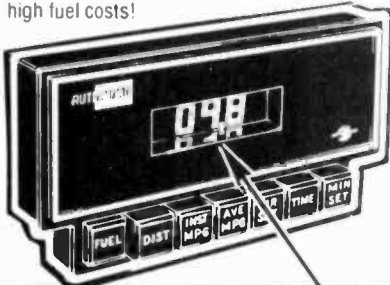

## AUTOMATICALLY DISPLAYS: EXAMPLE

- **FUEL USED** — When the FUEL button is depressed, the display indicates the amount of fuel the vehicle has used since last fill-up, beginning of trip, or last reset (up to 1000 gallons).
- **DISTANCE TRAVELED** — When the DIST button is depressed, the display indicates the distance the vehicle has traveled since the last reset (up to 1000 miles).
- **INSTANT MILES/GALLON** — When the INST MPG button is depressed, the display indicates how many miles per gallon the vehicle is attaining at each moment (up to 200 mpg).
- **AVERAGE MILES/GALLON** — When the AVE MPG button is depressed, the display indicates the average miles per gallon the vehicle has attained since the last reset (up to 200 mpg).
- **CORRECT TIME [clock]** — When the TIME button is depressed, the display indicates the correct time (in hours and minutes). The clock may also be used to display **ELAPSED TIME**.

09.8

187.2

213

19.1

3:45

AUTOCOMP comes with clear, illustrated instructions that make it easy for a do-it-yourselfer to install. Equipment supplied includes the Speedsensor which simply screws onto the speedometer cable, and the digital Flowsensor which easily installs onto the fuel line.



## SAVE \$10 OFF REGULAR PRICE

Order now using the coupon below and save \$10 off the regular list price of \$129.50. A one year limited warranty is provided.



SpaceKom, Inc.  
212 E. Gutierrez St.  
Santa Barbara,  
CA 93101

Please send \_\_\_\_\_  
Vehicle Make/Year \_\_\_\_\_  
Check/Money Order enclosed \_\_\_\_\_  
Card No. \_\_\_\_\_  
Signature \_\_\_\_\_  
Print Name \_\_\_\_\_  
Address \_\_\_\_\_  
City \_\_\_\_\_ State \_\_\_\_\_ Zip \_\_\_\_\_  
DB/A \_\_\_\_\_  
Exp. Date \_\_\_\_\_  
C/Master Charge \_\_\_\_\_

**CIRCLE 48 ON FREE INFORMATION CARD**



50-10,000 Hz. Suggested retail price, \$359.95.—J.I.L., Dept. P, 737 W. Artesia Blvd., Compton, CA 90220.

**CIRCLE 101 ON FREE INFORMATION CARD**

**ELECTRONIC INTERFACE KIT** can be used to turn most Selectric terminals and office typewriters into a microcomputer system. Unit uses stan-



dard ASCII RS-232C input and includes 14 24-volt solenoid drivers. In kit form w/o power: \$325. (Power versions available.) Manual: \$12.—Center for the Study of the Future, 4110 N.E. Alameda, Portland, OR 97212

**CIRCLE 102 ON FREE INFORMATION CARD**

**CB CARRYING CASE, the Universal.** This case has a simple design that permits safe transport of mobile units. Special compartments hold mikes,



power cable and antenna. Top, bottom and rear openings permit in-case operation of all standard-make CB's. Case measures approximately 3 x 9 x 12-inches.—Motorola, Inc., Automotive Products Div., 1299 E. Algonquin Rd., Schaumburg, IL 60196.

**CIRCLE 103 ON FREE INFORMATION CARD**

**MICROCOMPUTER, model Z-2,** is a powerful yet low-cost tool adaptable to many applications. The unit incorporates the Z-80 microprocessor, providing higher throughput in real-time operations such as timesharing. The Z-80 memory boards have a bank-select feature that allows eight independent banks of memory, each with

64 kilobytes of memory.

The microcomputer uses an S-100 bus with compatible peripherals such as a 7-channel A/D and D/A converter, a "BYTESAVER" with PROM programming, color graphics interface, and digital interface. Heavy-duty power supply provides 30 amps from 8 volts and 15 amps from both +18 and -18 volts, sufficient for most power needs, including floppy-disc drive.



The unit comes in a black metal case for rack mounting, or is available in a blue-color, stylized bench cabinet. The microcomputer kit contains the Z-2, a 4-MHz microprocessor card, 21-slot motherboard, power supply, one card socket and card-guide set and front panel. Assembled, the Z-2 includes all the foregoing, plus 21 sockets, card guides and a cooling fan. Kit sells for \$595; assembled, \$995.—Cromemco, Inc., 2432 Charleston Rd., Mountain View, CA 94043.

**CIRCLE 104 ON FREE INFORMATION CARD**

**AM/MOBILE CB RADIO, 'T' Bear,** is top-of-line of a 13-model series designed for the 40-channel market, ranging from in-dash AM/FM/CB's to



base-to-base mobile radios. Suggested price: \$199.99. Other prices from \$144.99 to \$439.99.—Teaberry Electronics Corp., 6330 Castleplace Drive, Indianapolis, IN 46250.

**CIRCLE 105 ON FREE INFORMATION CARD**

**TVI FILTER CABLE** is designed to eliminate or reduce CB-generated front-end overload and harmonic interference to TV Channels 2 and 6. Separate cables are available for either Channel



2 or Channel 6 areas. Cable is fitted with connectors for easy attachment to back-of-set antenna connection and to roof antenna.—Vitek Electronics, Inc., 200 Wood Ave., Middlesex, NJ 08846.

**CIRCLE 106 ON FREE INFORMATION CARD**

**INDOOR ANTENNAS, Color King.** This antenna line lets you choose from among four UHF-VHF-FM console models, an FM stereo console and a specialty UHF model for use with Channels 14

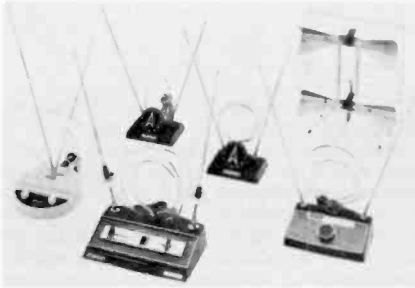

to 83. This broad selection has been designed not only for superior sound, clarity and color reception, but an attractive appearance as well. Details on request.—**Antennacraft**, P.O. Box 1005, Burlington, IA 52601.

**CIRCLE 107 ON FREE INFORMATION CARD**

**IN-DASH CB STEREO RADIOS, models SR-42, SR-44, SR-46, and SR-48,** is a full line of AM/FM/FM stereo units, all with CB circuitry designed to



be used with the model CBM-140-channel transceiver module. Models range from the SR-42,

with manual tuning, to the SR-48 (shown above), with stereo cassette. All have standard switches and controls. Prices: \$89.95 to \$149.95; CBM-1, \$149.95.—**Sparkomatic Corp.**, Milford, PA 18337.

**CIRCLE 108 ON FREE INFORMATION CARD**

**NEGATIVE-ION GENERATOR, Ion-Air,** is a highly sophisticated unit that generates negative ions in sufficient quantities for serious experimentation. Many scientists believe that negative-ion generation contributes to human health and well being, and helps relieve tension, irritability and fatigue. The Ion-Air is a dual-stage unit, using highly charged needles controlled by Faraday cages; the ions are exhausted into the atmosphere by a high-speed fan. Unit is effective in areas up to 14

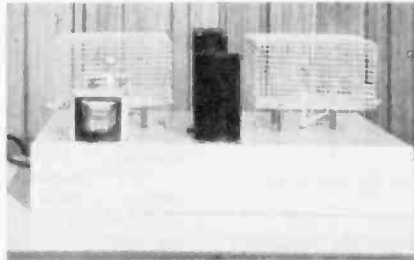

× 14 feet, produces 25,000 volts, with an output of about  $9 \times 10^9$  ions per second. Housed in unfinished mahogany, it weighs 18 pounds and measures 20 × 14 × 7 inches. The Ion-Air comes in kit form, with instructions, schematic, pictorial and construction diagrams and parts list. It also comes assembled or as instructions only. Kit sells for \$165; assembled, \$275; instructions, \$7.50.—**Golden Enterprises**, P.O. Box 1282, Glendale, AZ 85311.

**CIRCLE 109 ON FREE INFORMATION CARD**



**TVT-6 Low cost Direct Video Display**  
only \$35  
Don Lancaster's ingenious design provides software controllable options including:

- Scrolling • Full performance cursor
- Over 2K on-screen characters with only 3MHz bandwidth
- Variety of line/character formats including 16/32, 16/64 ....  
.....even 32/64
- User selectable line lengths

**TELL ME MORE!**

( ) Send instruction manual for the TVT-6 Kit with full operational details. \$1 enclosed.

Name: \_\_\_\_\_

Address: \_\_\_\_\_

City: \_\_\_\_\_ State: \_\_\_\_\_ Zip: \_\_\_\_\_



( ) SEND FREE CATALOG

ELECTRONICS, INC.

DEPT. 10-R 1020 W. WILSHIRE BLVD., OKLAHOMA CITY, OK 73116

**CIRCLE 83 ON FREE INFORMATION CARD**

# Everything you've dreamed of in a scope...including a sensible price.



**WO-527A \$479.00**

See them at your VIZ distributor.

Whether it be for servicing or scientific research, the new WO-527A 15MHz 5" triggered-sweep oscilloscope is designed for a wide range of applications. With its host of useful functions and its advanced solid-state integrated circuits, it's hard to believe it's so reasonably priced.

- Easy-to-use pushbutton controls
- Triggered or automatic sweep; ac or dc triggered
- Unique trigger level control with LED polarity indicators
- 10mV to 20V/cm in 11 ranges
- 19 calibrated sweep ranges
- Preset, automatic TV sync separation circuits
- Built-in calibrated time-base
- Special line selector for TV line-by-line display
- 10 times sweep magnifier

**VIZ Test Instruments Group**  
of VIZ Mfg. Co.

335 E. Price St., Philadelphia, PA 19144



© VIZ 6883

**CIRCLE 42 ON FREE INFORMATION CARD**

# If you like our chemicals, you'll love our solder.

That's because we make it the same way we make our chemicals—with "Total Control."

We control its quality at every step from pure raw tin to hermetically sealing every spool to prevent contamination. That's why Chemtronics solder is so pure it exceeds Federal and Milspecs. And it's why Chemtronics solder takes high temperatures, yet flows evenly at low temperatures. Good flow gives *you* control. No crumbling, no beading, no cold joints. Instead, a bright, strong bond.

Unlike ordinary solders, Chemtronics solder won't sputter or spatter. On old soldered joints, it works in and makes a solid connection.

You know us for our chemicals. Now try us for our solder. Ask your distributor for Chemtronics "Total Control" solder. For valuable tips on soldering, use the Reader Service number below.

 **CHEMTRONICS**  
INCORPORATED  
45 Hoffman Ave.  
Hauppauge, N.Y. 11787



## new books

**QUAD SOUND**, by Marvin Tepper. Hayden Book Co., Inc., 50 Essex St., Rochelle Park, NJ 07662. 128 pp. 5 1/2 × 8 1/4 in. Softcover \$4.95.

A simple, easy-to-understand explanation of how four-channel, or quadri-phonc, sound differs from stereo, what constitutes it, how it is obtained and how to best use it for personal pleasure. The book starts with fundamentals like fidelity, psychoacoustics and the characteristics of both two- and four-channel sounds. Subsequent chapters explain four-channel tape and record, playback and recording, FM broadcasting, four-channel speaker systems, system selection and installation, and equipment troubleshooting, along with easy-to-use charts to help pinpoint system troubles in an easy to understand way.

**HOW TO HEAR AND SPEAK CB IN A SHORT-SHORT**, produced by Roland; written by Martin; designed by Gene. TAB Books, Blue Ridge Summit, PA 17214. 162 pp. 4 1/4 × 8 1/4 in. Hardcover \$6.95.

"This is Whiskerman you're cruising with, modulating on the Space Vibes. Unseen by most but copied by all. Cruise with me, Old Buddy, and in a couple of wild hours you will know enough to modulate with any ACE (a cool CB Dude.)

We'll saddle you up in the CAT DRAGGER so you can dig our fractured chase on Interstate Niner. But if you don't know the lingo, friend, you'll be in Fog City thru Tuesday. 'Cause out here it's Crash Helmets and T-Shirts. We don't fool around!

Lay back . . . it's a 10-4 trip . . . great laughs. Might be wacky, but everybody will surely remember we've been there.

3's and 8's and a lot of great numbers I haven't even told you yet."

**SOLID-STATE ELECTRONICS**, by Frank P. Tedeschi and Margaret R. Taber. Van Nostrand Reinhold Co., 450 West 33 St., New York, NY 10001. 204 pp. 8 × 10 1/4 in. Hardcover \$8.95.

Provides an introduction to fundamental semiconductor and electronic principles. The book does require a familiarity with algebra and basic electricity. All information presented reflects the current state of the art in electronics technology. The book is divided into eleven self-contained sections, each concentrating on specific semiconductor components. Numerous example problems and laboratory experiments bridge the gap between theory and practice.

**BASIC**, by Robert L. Albrecht, LeRoy Finkel and Jerald R. Brown. John Wiley & Sons, Inc., Publishers, 605 Third Ave., New York, NY 10016. 125 pp. 8 1/2 × 10 in. Softcover \$4.95.

This is the latest printing of this programmed instruction-formatted book that teaches BASIC, one of the primary computer programming languages. At the end of each chapter, a self-test is provided to aid the reader in reviewing the material covered in the chapter and to test himself on his progress. Each chapter begins with a list of objectives—what you will be able to do after completing that chapter. If the reader has had some previous experience using BASIC and these objectives look familiar, the book can be used as both a review and guide, showing where you should start following the text. What the reader will learn from the book will be theoretical, until he can actually sit down at a computer terminal and apply his knowledge. Therefore, the publisher recommends that you and the book get together with a computer.

**ADVANCED AND EXTRA CLASS AMATEUR LICENSE Q & A MANUAL**, by Marvin Tepper. Hayden Book Co., Inc., 50 Essex St., Rochelle Park, NJ 07662. 160 pp. 6 × 9 in. Softcover \$5.95.

A guide for the amateur radio operator with a General Class license, who wants to upgrade his license status to the Advanced and then the Extra Class license. Based on the latest FCC syllabus-type study guide, this book asks questions and gives answers, and then explains most answers in a detailed, easy-to-understand way. It also covers Advanced and Extra class license privileges and filing fees. There is also a special section on code copying and an appendix containing the latest FCC rules and regulations.

**BIG EAR**, by John Kraus. Cygnus-Quasar Books, P.O. Box 85, Powell, OH 43065. 228 pp. 5 1/2 × 8 1/4 in. Softcover \$2.95; hardcover \$5.95.

An adventure story of the exploration of the universe and the search for other men. "Big Ear" is a personal, behind-the-scenes account of astronomers, engineers, inventors—their successes and failures. It is the story about the steel and aluminum structures we have raised to probe the cosmos and of our attempts to answer the question "are we alone?".

# Radio-Shack's New Computer System

A user oriented system that includes a video terminal, keyboard, cassette recorder, 4K RAM, 4K ROM and Basic.



**ART KLEIMAN**  
MANAGING EDITOR

EVERY ONCE IN A WHILE, JUST AS THIS magazine is ready to go to press, a manufacturer will introduce a new gadget or gizmo that will make us say "stop the presses." That's exactly what happened when Radio-Shack introduced their new TRS-80 microcomputer system at a press conference held in New York City.

I'm not saying that this new microcomputer is the best system on the market. I don't know if it is or isn't since the answer to that question has to be based on what the user intends to do with the system. But what is amazing is the price—\$599

for a working system, assembled and tested.

## Hardware

The system consists of three modules—keyboard (measuring 16½" X 8 X 3½ inches), video terminal (measuring 16½" X 13½" X 12 inches), and cassette recorder. Housed within the keyboard module is a single PC board that contains the Z-80 microprocessor, 4K of dynamic RAM, 4K of ROM and an interface for the cassette recorder. The memory is internally expandable to 12K of ROM

and 16K of RAM (available as an option for \$280). The keyboard is a standard 53-key ASCII unit. An external power supply comes with keyboard module.

Input and output jacks are located on the back panel of the keyboard for connecting the cassette recorder, the external power supply and the video terminal. Also provided on the back panel of the keyboard is an access port to the TRS-80 bus. This is a non-standard 44-pin bus.

The 12-inch black-and-white video terminal is capable of handling 16 lines of text. Each line has a maximum length of

## SYSTEM 5000

The New Programmable Clock Kit from Digital Concepts. \$29.95

SYSTEM 5000 is the programmable clock kit that makes kit building a new experience. The system has been designed to meet a variety of particular requirements and tastes and programming techniques are used to create a truly individual timepiece. Numerous functions and features are provided for maximum flexibility, adaptability, and any or all can be used to construct many different types of time keeping and timing devices.

SYSTEM 5000 is not a simple LED time of day clock, but a full feature digital timing system. Programming is accomplished by connecting the appropriate jumpers and switches to produce the desired system configuration. Complete assembly and programming manuals are included.

SYSTEM 5000 has a fluorescent readout panel with 1 or 0.5 numeral that brighten and dim automatically according to the ambient light. This unique digital display provides optimum readability at all times from almost any viewing angle.

SYSTEM 5000 can be built as a desk clock, alarm clock, calendar clock, or all three in one full feature timepiece. Time of Day or Time Register can monitor elapsed time or another time zone, such as GMT. A ten minute 10' reminder capability is included to Radio Station use. A digital time base and alarm for high precision stability and uninterrupted operation of the AC line should it fail.

SYSTEM 5000 has an automatic voltage control AC or DC accessories up to 700 Watts by adding the optional relay. Plug your car or stereo to construct a full function clock radio if it puts you to sleep with gentle music and wakes you to music as a siren or both. The system will also control TV's, small appliances, other accessories.



to 700 Watts by adding the optional relay. Plug your car or stereo to construct a full function clock radio if it puts you to sleep with gentle music and wakes you to music as a siren or both. The system will also control TV's, small appliances, other accessories. SYSTEM 5000 can be used to construct timers for a variety of applications. It's ideal for a tomato ripener, timers and controller in laboratories, workshops, and engineering facilities. SYSTEM 5000 includes all components, speaker, two time setting wires, and comprehensives instructions and programming manual. Case & see the "for programming" list top of "kit" items are not included but available as noted. \$29.95

### FEATURES AND SPECIFICATIONS

#### Timekeeping Functions

- Time of Day Register
- Duplicate Time Register
- True 24 Hour Alarm
- D of date 24 Hour Alarm
- 10 Minute Snooze on Alarm
- True For a Year Calendar
- One Hour Down Counter

#### Display

- Bright 4 Digit Fluorescent Panel
- Automatic Brightness Circuit
- 12 or 24 Hour Display Format
- PM and Power Failure Indication
- 1 Hz Activity Indicator
- Power On Clear
- Direct Drive Elimitates all RF!

#### General

- Forward or Reverse Time Setting
- Reset and Count Inhibit Controls
- Seconds Display
- Single 9 Volt Battery Backup
- 700 Watt Relay Optional
- 50 + 60 Hz, 117 Vac, 3 Watts
- 1.5" H x 4.7" W x 4" D

#### RELAY OPTION - \$4.00

Includes 700 Watt relay and all interface components. Will control AC or DC accessories such as appliances, stereos, etc.

#### QUARTZ TIME BASE OPTION - \$6.95

Get extra precision 60 Hz buffered output with the optional stability and accuracy Direct Interface to System 5000 and most other logic level quartz crystal ICs in a single compact G-10 housing. The essential component structure and time stability is excellent.

#### SWITCH OPTION - \$3.75

Contains 4 black SPST push buttons, 2 black DPDT push button and 2 black SPST slide switches. Programs all major features.

#### CASE OPTION - \$11.00

This deluxe hand finished solid walnut (3 1/8" cabinet) forms a ideal housing for the completed system. Includes rear panel and standard "True" fluorescent extra large alarm (blue or green) are \$1.00 ea. Case net time shown: 5" x 4" x 3"

Send your check or money order today for fast delivery. Add 5% to total order to cover shipping and insurance. Outside Continental US add 10%. NJ residents must also add 5% sales tax.



ORDER THIS EXCITING KIT TODAY AND PUT ELECTRONIC TIMEKEEPING TO WORK FOR YOU!

**digital concepts**

Digital Concepts Corporation • 247 Route 46  
Saddle Brook, New Jersey 07662 • (201) 845-7101

## Accuracy like a VTVM... Convenience like a VOM...

NEW BATTERY-OPERATED FET  
SOLID-STATE VOLT-OHMMETER #116

Easy-to-build KIT

\$41.85 = 116K

Factory-Wired & Tested

\$56.12 = 116W



Now you can get all the benefits of a VTVM (laboratory accuracy, stability and wide range) but with its drawbacks gone: no plugging into an AC outlet, no waiting for warm-up, no bulkiness. New Field Effect Transistor (FET) design makes possible low loading, instant-on battery-operation and small size. Excellent for both bench and field work.

Compare these valuable features:

- High impedance low loading: 11 megohms input on DC, 1 megohm on AC
- 500-times more sensitive than a standard 20,000 ohms-per-volt VOM
- Wide-range versatility: 4 P-P AC voltage ranges: 0-3.3, 33, 330, 1200V; 4 RMS AC voltage ranges: 0-1.2, 12, 120, 1200V; 4 DC voltage ranges: 0-1.2, 12, 120, 1200V; 4 Resistance ranges: 0-1K, 0-100K, 0-10 meg., 0-1000 meg.; 40B ranges: -24 to +56DB.

Sensitive easy-to-read 4½" 200 micro-amp meter. Zero center position available. Comprises FET transistor, 4 silicon transistors, 2 diodes. Meter and transistors protected against burnout. Etched panel for durability. High-impact bakelite case with handle useable as instrument stand. Kit has simplified step-by-step assembly instructions. Both kit and factory-wired versions shipped complete with batteries and test leads. 5¼"H x 6¾"W x 2¾"D. 3 lbs.

Send FREE catalog of complete EMC line and name of nearest distributor. RE-10

Name \_\_\_\_\_

Address \_\_\_\_\_

City \_\_\_\_\_

State \_\_\_\_\_ Zip \_\_\_\_\_

**EMC**

ELECTRONIC MEASUREMENTS CORP.  
625 Broadway, New York, N.Y. 10012

OCTOBER 1977

64 characters, upper-case only. In the graphics mode, the screen converts to 48 lines by 128 horizontal line-segments. Text and graphics can be interspersed by software.

The cassette recorder is a standard audio unit. Connecting the remote input of the recorder to the keyboard permits the CPU to turn the recorder on and off.

### Software

The TRS-80 comes complete with a high-level language stored in the ROM—Radio-Shack's own version of Basic, which they have termed Level 1 Basic. This Basic features floating-point arithmetic; numeric, array and string variables; video graphic commands and cassette save and load commands.

Included are such commands as NEW, LIST, RUN, CONTINUE, REMARK, LET, FOR-NEXT-STEP, GOSUB-RETURN, STOP, END, GOTO, IF-THEN, ON..GOTO, ON..GOSUB, PRINT, CSAVE, CLOAD, DATA, READ, and RESTORE.

There are also functions that include MEM, TAB, INT, ABS, RND, and math operations such as add, subtract, multiply, divide, less than, greater than and equals.

Special commands include graphic statements such as CLS(clear screen), SET(x,y), RESET(x,y), POINT(x,y), and formatted PRINT. Array and string capa-

bility, data storage and retrieval are all part of the Basic.

A high-level language, such as Basic, is great for those readers that know something about how to program. But what about those that have had no computer experience at all? What do they do when they take the TRS-80 home, unpack it and plug it in? In answer to this, Radio-Shack will be selling applications software packages. These fall into five categories—games, business, education, home and personal finance. Initially available in the game category is a single cassette containing programs for Blackjack and Backgammon, available free with the TRS-80. A payroll cassette that can handle 15 people will sell for \$19.95. An education in basic math will cost \$19.95. For the home, a kitchen program that includes menus, conversion tables and a message center is \$4.95. In the personal finance category is a seven-cassette portfolio for \$14.95.

### Expansion

As already stated, all of the computer electronics is contained on a single PC board housed within the keyboard module. This may be a disappointment to the avid computer hobbyists who commonly expand their system by dropping PC boards into slots on the motherboard. You can't do it with the TRS-80 since there are no slots and no motherboard.

You can add a slotted motherboard by connecting it to the TRS-80 bus through the access port in the keyboard module. However, the TRS-80 has a non-standard 44-pin bus. So, if you want to be able to use all those 100-pin S100-bus compatible PC boards that are available on the market, you'll need a bus converter. The bus converter is not available, so you'll have to design your own. Not an overly difficult task.

What about memory expansion? The lack of a slotted motherboard means that you can't simply purchase a memory board and drop it into the TRS-80. If you purchase the basic system with 4K of ROM and 4K of RAM and decide at a later time that you need more, you'll have to return the keyboard module to Radio-Shack for a retrofit. Of course, if you're not interested in S100 expansion, the TRS-80 bus will not be a drawback.

Radio-Shack also plans on expanding their system as they go along. Plans call for the introduction of a floppy disc with provisions for an additional 16K of IC memory. Also planned is the introduction of an extended Basic, printer, MODEM, Serial I/O, and an expansion unit for PC boards that is not S100 compatible.

That's the TRS-80. Quite a system for the price. Oh, before I forget, the modules are also available separately. The keyboard sells for \$399, the terminal for \$199 and the cassette deck for \$50. **R-E**



**BK PRECISION**

## SEMICONDUCTOR TESTER

### MODEL 530

- Measure  $f_T$  of bipolar transistors up to 1500 MHz
- Nondestructive testing of transistor and diode breakdown voltages
- Measures transistor beta or FET  $g_m$
- Measures all transistor breakdown and leakage parameters
- Fast testing of transistors, FET's, and SCR's—in or out-of-circuit
- Base diagrams are not required
- No biasing information required
- Identifies all leads of transistors and SCR's
- Automatic identification of PNP/NPN types and N- or P-channel FET's

New from B&K-PRECISION, the Model 530 semiconductor tester can actually perform more tests on more devices than any other comparably priced semiconductor tester. Our top-of-the-line instrument features an exclusive transistor gain-bandwidth product measurement capability, allowing evaluation up to 1500 MHz for bipolar transistors. Other innovative features include nondestructive testing of transistor, SCR, and diode breakdown voltage up to 100 volts, reverse leakage, and gain of all types of transistors, including power FET's.

---

FOR MORE INFORMATION TOLL FREE HOT LINE  
OR TO ORDER CALL **800-223-0474**

## ADVANCE ELECTRONICS

54 West 45 Street, New York, N.Y. 10036 212-687-2224

**THE TEST EQUIPMENT SPECIALISTS**

## Where's the screwdriver?



In a tool box, tools and parts are everywhere. They're hard to find. They get lost. (And they get dirty.)

With a Platt tool case, that wouldn't happen. It's designed so you'll know where everything is. Smaller tools are in individual pockets in our patented one-piece pallet. Larger tools and parts are in compartments. And papers and order book are in lid pockets. (Everything is neat and clean.)

And Platt's tool case helps you look more professional. It comes in handsome, lightweight, durable ABS Thermoplastic. Or rich looking vinyl reinforced by ABS Thermoplastic.

What's more, it also has a 5 year guarantee.

Contact us for complete information on Platt's full line of tool cases and your nearest distributor.

Pat. No. 3,880,285

# platt

Cases for business and industry.

2301 S. Prairie Ave., Chicago, Ill. 60616 (312) 225-6670



CIRCLE 66 ON FREE INFORMATION CARD



# next month

NOVEMBER 1977

## ■ Build A Biorhythm Clock

Digital display in three colors tells you each day how your (PSI) physical, sensitivity and intellectual states stand. And you can build one for less than \$30.

## ■ Circular Polarization For TV

It spells better reception for more viewers. Be one of the first to learn how it works and what it can do for you.

## ■ SPECIAL SECTION Using CB Radio Test Equipment

Forest Belt is the Authority who will take you into the maze of the CB Equipment world, sorting out the electronic wheat from the chaff emphasizing features, flexibility and the wide range of prices of equipment available.

### PLUS

Jack Darr's Service Clinic  
State Of Solid State  
Hobby Corner  
Computer Corner

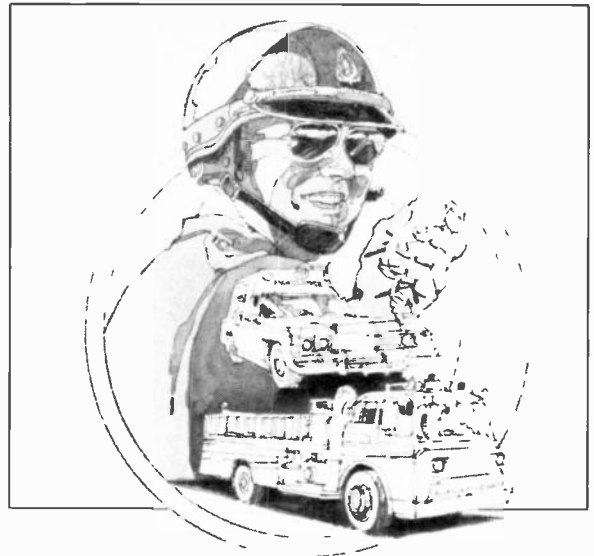

INTERNATIONAL FM 2400CH

## FREQUENCY METER for testing mobile transmitters and receivers



- Tests Predetermined Frequencies 25 to 1000 MHz
- Extended Range Covers 950 MHz Band
- Pin Diode Attenuator for Full Range Coverage as Signal Generator
- Measures FM Deviation

The FM-2400CH provides an accurate frequency standard for testing and adjustment of mobile transmitters and receivers at predetermined frequencies.

The FM-2400CH with its extended range covers 25 to 1000 MHz. The frequencies can be those of the radio frequency channels of operation and/or the intermediate frequencies of the receiver between 5 MHz and 40 MHz.

Frequency Stability:  $\pm .0005\%$  from  $+50^{\circ}$  to  $+104^{\circ}$ F.

Frequency stability with built-in thermometer and temperature corrected charts:  $\pm .00025\%$  from  $+25^{\circ}$  to  $+125^{\circ}$  (.000125% special 450 MHz crystals available).

Self-contained in small portable case. Complete solid state circuitry. Rechargeable batteries.

FM-2400CH (meter only) ..... \$595.00  
RF crystals (with temperature correction) ... 24.00 ea.  
RF crystals (less temperature correction) .... 18.00 ea.  
IF crystals ..... catalog price



International Crystal Manufacturing Company, Inc.  
10 North Lee Oklahoma City Oklahoma 73102  
CIRCLE 59 ON FREE INFORMATION CARD

# Try this exciting new hobby!

Build your own electronic concert organ. It's easy. No technical knowledge required. Just follow the clearly pictured instructions of the famous Wersi do-it-yourself system. Choose from seven different models. Send \$2.00 (refundable) with coupon for colorful 104 page catalog.

**WERSI**



Wersi Electronics, Inc.  
Dept. 24, Box 5318  
1720 Hempstead Road  
Lancaster, PA 17601

Enclosed is \$2.00 for my copy of your 104 page catalog.

Name \_\_\_\_\_  
Address \_\_\_\_\_  
City \_\_\_\_\_ State \_\_\_\_\_ Zip \_\_\_\_\_

CIRCLE 54 ON FREE INFORMATION CARD

# FREE

## BA's 1978 ANNUAL CATALOG!



**260 PAGE RADIO, TV & ELECTRONIC CATALOG**

Your buying guide for Everything in Electronics... Stereo, Hi-Fi, TVs, Radios, Tape Recorders, CB, Kits, Tools, Books and Electronic parts.

**BURSTEIN-APPLEBEE**

Dept. RE-10 3199 MERCIER  
KANSAS CITY, MO. 64111

NAME \_\_\_\_\_  
ADDRESS \_\_\_\_\_  
CITY \_\_\_\_\_  
STATE \_\_\_\_\_ ZIP \_\_\_\_\_

RADIO-ELECTRONICS

### RE TESTS HEATH AR1515 continued from page 80

Hum and noise in phono was as good as claimed and, for high-level inputs, exceeded published claims.

The tone-control range, shown in Fig. 6, was typical of that obtained with simple, hinged BASS and TREBLE controls. Selectable turnover tone controls would have been welcome. The high-cut filter action is shown in Fig. 7.

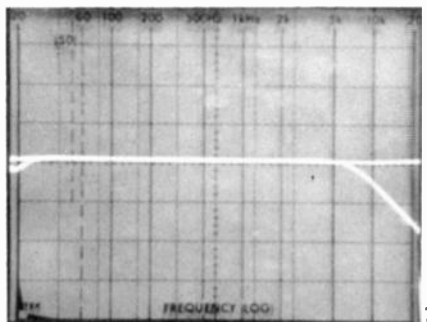
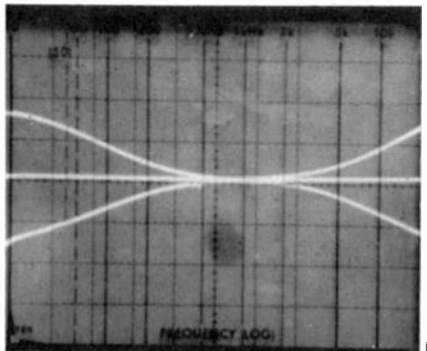

However, the low-cut filter action, with a 30-Hz cutoff point, is barely visible because the analyzer sweep extends only from 20 Hz to 20 kHz.

#### Summary

The overall product analysis is found in Table III, together with our summary comments concerning the features of the model AR-1515. We found the tuning knob was a bit stiff (its shaft is coupled via a rather long and complex path to separate AM and FM tuning gangs). The lack of a flywheel seemed strange and was difficult to get used to. Aside from these minor flaws, the control layout is excellent. It is obvious that a lot of "human engineering" went into this newest Heath design. Even if your area has no Dolby broadcasts at the present, the Dolby option can be purchased in the future and easily added to the finished receiver. **R-E**

Thanks to you  
it works...  
FOR ALL OF US



United Way

advertising contributed for the public good.



## endeco soldering & desoldering equipment

#### SOLDERING IRONS



Pencil style. Safety light. Two heats — 20w and 40w. 6 tips. Unbreakable handle. 2 and 3 wire neoprene cords.

#### DESOLDERING IRONS



Pencil style. Safety light. Some operate at 40w, idle at 20w. 8 tip sizes. 2 and 3 wire neoprene cords.

#### SOLDERING & DESOLDERING KITS



Everything needed to solder or desolder or both. All in a handy lifetime metal box with hasp.

See your distributor or write

**Enterprise Development Corp.**

5127 E. 65th St. • Indianapolis IN 46220  
PHONE (317) 251-1231

CIRCLE 21 ON FREE INFORMATION CARD

## FIND EXACT TV REPLACEMENTS FAST ... FLYBACKS & YOKES FOR ALL BRANDS

New Thordarson TV Parts Guide TVPG10 gives you fast, accurate replacement selection. 168 pages. Over 28,000 original numbers. Includes hundreds of hard to find and discontinued parts. Cross-referenced Thordarson replacements fit EXACTLY. Buy Thordarson flame retardant flybacks and yokes. They are made better than the original. Get your TVPG10 from your Thordarson distributor or send \$1.00 to Thordarson Meissner, Inc., Mt. Carmel, IL 62863.

Send me TVPG10. Enclosed is my check for \$1.00 to cover mailing and handling costs.

Name \_\_\_\_\_  
Address \_\_\_\_\_  
City \_\_\_\_\_  
State \_\_\_\_\_ Zip \_\_\_\_\_

**THORDARSON**

THORDARSON MEISSNER, INC.  
Electronic Center  
Mt. Carmel, Illinois 62863

## LOOKING AHEAD

continued from page 4

mutually incompatible. So broadcasters merely held off and waited.

Clearly this was a case for the SMPTE, the technical association that sets TV and motion picture standards. The SMPTE set up a working group, which deliberated, then brought both manufacturers together. The result: a compromise system consisting of the best features of each format. Unheralded behind-the-scenes hard work by broadcast and VTR engineers was responsible for what will become the first major change in video recording broadcast standards in 21 years.

**Energy:** The advent of solid-state circuits has been lucky for the TV industry, which is now making a large contribution to the reduction in nationwide energy consumption, at least on paper. Television has never been as much of an energy-gulper as an air conditioner or refrigerator, but it has had a great energy-reducing record in recent years. The Federal Energy Administration has assigned TV the following energy-saving goals by 1980, in terms of power consumption as compared with the base year of 1972: For color sets, a 35% reduction in energy use (28% as a result of switching to solid-state, 7% by eliminating instant-on); for monochrome sets, a 65% cut in energy (52% by going to solid-state, 13% by removing instant-on).

**DAVID LACHENBRUCH**  
CONTRIBUTING EDITOR

## CB METERS

continued from page 41

meter reading. Then, switch to SWR and read the ratio directly.

*(Another way to calibrate the SWR bridge is to measure the forward and reflected voltages and use the formula*

$$SWR = \frac{V_f + V_r}{V_f - V_r}$$

*Connect the SWR bridge in the transmission line close to the transmitter; preferably before any baluns, antenna tuners, TVI filters or other devices. With the antenna connected to the bridge output and S1 in the XMTR position, key the CB rig and adjust potentiometer R3 for a full-scale reading (100  $\mu$ A). This is a reference figure for forward voltage  $V_f$ . Without changing the setting of R3, throw switch S1 to SWR and read reflected voltage  $V_r$ . For example, if  $V_f$  is 20, the SWR is  $100 + 20/100 - 20$  or 1.5, a pretty good match between the radio and its antenna.—Editor)*

A final word: while all three instruments make a very useful addition to any CB or ham rig, the tiny field-strength indicator alone provides the means to obtain maximum radiated output—and for only a dollar! The other two instruments add the details of power in watts and the actual standing-wave ratio. All three can be combined into one by adding a 3-pole, 4-position switch.

R-E

WHY WAIT?

# SUBSCRIBE NOW

USE THE POSTCARD ON PAGE 116

# Put Professional Knowledge and a COLLEGE DEGREE in your Electronics Career through HOME STUDY

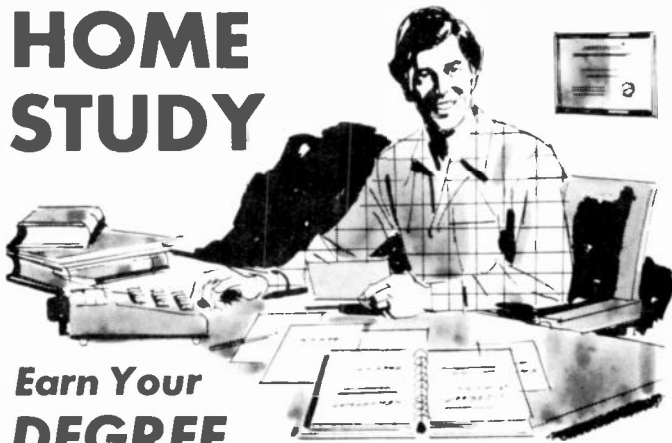

## Earn Your DEGREE

by correspondence, while continuing your present job. No commuting to class. Study at your own pace. Learn from complete and explicit lesson materials, with additional assistance from our home study instructors. Advance as fast as you wish, but take all the time you need to master each topic. Profit from, and enjoy, the advantages of independent study.

The Grantham correspondence degree program in electronics is comprehensive. It begins with basics, written in very simple language, and continues through the B.S.E.E. degree level. Throughout the entire program, heavy emphasis is placed on clear explanations written in great detail, progressing from the simple to the complex, in easy steps.

Our free bulletin gives complete details on the curriculum, the degrees awarded, the requirements for each degree, and how to enroll.

## GRANTHAM COLLEGE OF ENGINEERING

2000 Stoner Ave., P.O. Box 25992, Los Angeles CA 90025

● Telephone (213) 477-1901 ●

Worldwide Career Training thru Home Study

Mail the coupon below for free bulletin.

**Grantham College of Engineering** RE 10-77

2000 Stoner Ave., P.O. Box 25992  
Los Angeles, CA 90025

I have been in electronics for \_\_\_\_\_ years. Please mail me your free bulletin which gives details concerning your electronics degree programs.

Name \_\_\_\_\_ Age \_\_\_\_\_

Address \_\_\_\_\_

City \_\_\_\_\_ State \_\_\_\_\_ Zip \_\_\_\_\_

CIRCLE 81 ON FREE INFORMATION CARD

OCTOBER 1977

JACK DARR, Service Editor of

# Radio-Electronics®

reports on the

**Oneida**

**NU-COLOR  
PICTURE  
TUBE  
RESTORER**



## Oneida Model 90A Picture Tube Restorer

ALL THINGS COME TO HIM WHO WAITS. I HAD TO wait for quite a while, but I finally found just the thing I needed: A new device, made by Oneida Electronic Manufacturing Company. This is their *model 90A Nu-Color* picture tube restorer. This device is designed to restore color to old picture tubes with one or more weak guns.

I had a trade-in Wards TV, with a picture tube so bad it had to be seen to be believed. The blue gun read almost normal emission; the green gun would come up to the bottom end of the BAD sector on the meter; and the red gun just barely wiggled the needle.

The *Nu-Color model 90A* is a plug-in device that is inserted between the picture tube and socket, like a brightener. However, it is *not* a brightener, at least in the usual sense of the word. Between its plug and socket is a little box with three color-coded slide controls, one for each color.

Starting with all controls at the OFF position, I plugged the *Nu-Color* in and turned the set on. As expected, the raster was a bright blue. I adjusted the controls of the *Nu-Color* and came up with a good-looking color-bar pattern. Twiddling the grey scale and the *Nu-Color* controls gave an excellent color picture. Reds saturated normally, with the color control all the way up and all other things looked very good! This device lives up to its claims and its name; it certainly did "restore the color" to this old dog.

As Oneida is careful to explain, the *Nu-Color* is not intended as a "cure-all" for color troubles, but it will help correct problems due to unbalanced picture-tube emission. The device can be installed and adjusted in the home with very little trouble.

**this  
device  
lives up  
to its  
claims  
and its  
name...**

JACK DARR

**Order a  
supply today!**

**FALL SPECIAL...Buy 6, get the 7th FREE!**

Write us direct or call your Oneida distributor for details  
Offer expires Dec. 15th 1977

**Oneida**

**ELECTRONIC MFG. INC.**

P.O. Box 678, Baldwin Street Ext., Meadville, Pa. 16335 · Phone (814) 336-2125

CIRCLE 87 ON FREE INFORMATION CARD

**CLASS H AMPLIFIER**  
*continued from page 55*

20,000 Hz at no more than 0.1% total harmonic distortion. The amplifier, which carries a suggested retail price of just under \$700.00, is shown in Fig. 13. Among its other features are two LED indicators located near each of the input-level control knobs. These indicators are labelled VARI-PROPORTIONAL SYSTEM and light up when the higher-voltage supply is activated by higher-level input and output signals. This provides a visual indication of the vari-proportional system.

In order to confirm Soundcraftsmen claims that the vari-proportional control system does not in any way degrade transient performance of their new *model MA5002* amplifier, Figs. 14 and 15 represent the positive- and negative-going amplifier slew rates. The vertical scale in both figures is 5 volts-per-division, while the horizontal sweep rate is 0.5  $\mu$ s-per-division. The rising (or falling) sloped lines in Figs. 14 and 15 represent the leading or trailing edges of a 10-kHz squarewave applied to the amplifier at a power-output level of 250 watts-per-channel into 8-ohm loads. A full representation of the 10-kHz squarewave output signal at this rated power level is shown in Fig. 16, while a low-frequency squarewave output at the same 250-watt-per-channel level is shown in Fig. 17.

To summarize the differences between Class-G amplifiers and the "Class-H" design: A Class-G amplifier uses two sets of output transistors, each powered by a different supply voltage. When a signal exceeds the power-supply level applied to the low-power output transistors, the higher-powered transistors (using a higher voltage supply) are switched on while the lower-powered pair are switched off. The Class-G approach, therefore, also reduces power dissipation at all operating levels, but requires two types of output devices, with one type operating while the other is cut off. In the Soundcraftsmen vari-proportional system, only one type of output device is used, and it must have a sufficiently high rating to handle the full output of the amplifier in which it is used. However, for most of its operating time, it is *powered* by a lower supply voltage than might be safely applied to it, and its internal dissipation is thereby reduced and the efficiency is therefore increased significantly.

Clearly, with solid-state amplifier design having reached a point of lowest possible distortion, reduced transient distortion and more-than-adequate bandwidth capability, designers seem to be turning their attention to increased efficiency and, thereby, lower cost and greater value for the consumer. Chances are we'll be running out of the alphabet soon if amplifier design innovations continue at their present pace.

R-E

# VECTOR PACKAGING MATERIALS SAVE TIME & MONEY

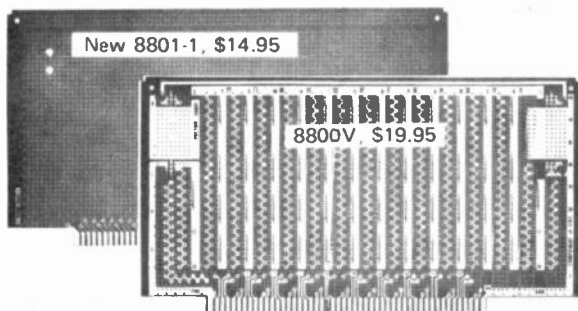

**S100 CARDS—100 PLUG CONTACTS**—Convenient universal tinned pads and bus lines. For interface, memory expansion, breadboarding. Mount almost anything anywhere on card.



**S100 CONNECTORS** for WIRE WRAPPING or SOLDERING

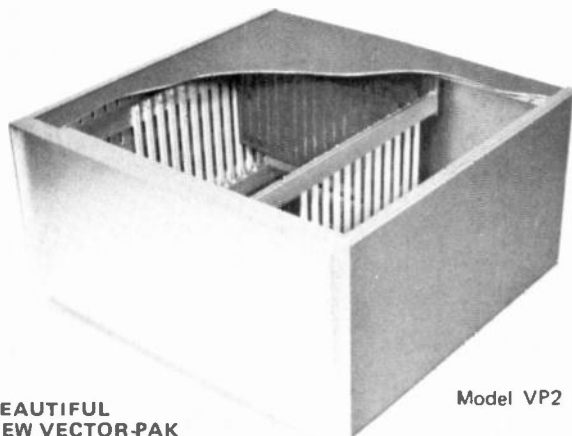

**BEAUTIFUL NEW VECTOR-PAK CASES** for micro-computer circuitry, assembled. Constructed of aluminum, finished in vinyl. Slide out covers for easy access. Includes card guides, heavy chassis plate, perforated bottom cover for cooler operation. Card guides perpendicular to front panel, Model VP1, \$128.30. Card guides parallel to front panel, Model VP2, \$134.30.

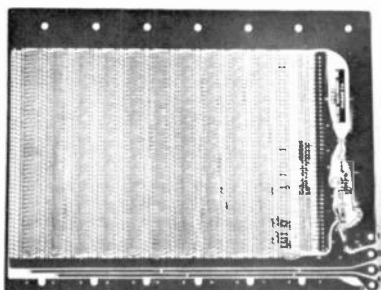

**S100 MOTHER BOARD, \$29.50.** 11 positions ready for connectors. Glass epoxy, plated thru holes, circuitry for active termination, 12 tantalum capacitors and instructions.

**PLUS** revolutionary Slit-N-Wrap wiring tools, Micro-Vector-board,® printed circuit kits, I.C. sockets, extenders.

Send for new catalog.



**VECTOR ELECTRONIC COMPANY, Inc.**  
12460 Gladstone Avenue, Sylmar, CA 91342  
phone (213) 365-9661, twx 910-496-1539

540777

CIRCLE 80 ON FREE INFORMATION CARD

## DON'T MISS ANY

Get every single issue of Radio-Electronics delivered right to your door, and before it appears on the newsstand. Use this coupon and subscribe now.

Mail to: Radio-Electronics  
SUBSCRIPTION DEPT., P.O. BOX 2520,  
BOULDER, COLO. 80322

name (please print)

address

city state zip code

### check offer preferred

- 1 Year—12 issues **ONLY \$8.75**
- 2 Years—24 issues **SAVE MORE \$16.50**  
(You save \$7.50 over newsstand)
- 3 Years—36 issues **GREATER SAVINGS \$24.50**  
(You save \$11.50 over newsstand prices)
- Payment enclosed     Bill Me
- Check here if this is a new subscription
- Check here if you are extending or renewing your subscription

Canada same as U.S.A. Extra Postage: Pan American \$1.50 per year, all other foreign \$2.00 per year.

40J7



ACTUAL SIZE



- Large, bright 7-segment digits
- DC accuracy, 0.5%
- Automatic polarity
- Full overload protection
- 100% overrange
- 1mV resolution
- Test leads supplied with unit
- Rechargeable Battery
- Auto zeroing
- Completely portable

**3 1/2 DIGIT  
MULTIMETER  
MODEL LM-3.5A**

by

**Non-Linear Systems, Inc.**  
*Originator of the digital voltmeter.*

FOR MORE INFORMATION TOLL FREE HOT LINE  
OR TO ORDER CALL **800-223-0474**

**ADVANCE  
ELECTRONICS**

54 West 45 Street New York, N.Y. 10036 212-687-2224

**THE TEST EQUIPMENT SPECIALISTS**

OCTOBER 1977

107



**GENERAL TIME DIGITAL CLOCK MOVEMENT**



- Illuminated Film Strip Numerals
  - 110V Motor
- Special Limited Quantities*

Shipping Wt. 1 lb. G-83 **2.99**

**GIROMALOX HEAT ELEMENT**

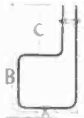

- 1500 Watt - 120V
- Size: A - 10", B - 13.5", C - 3"
- Ideal for Heating, Braising, Etc.

Shipping Wt. 1 lb. N-889 **.69**

**GENERAL TIME DC HOUR METER**



- Operates On 4 to 50 Volts DC
- Permanently Sealed Against Moisture and Dust
- Accurate Within 1% At Temperatures From -20 to +165 Degrees F

Shipping Wt. 1 lb. F-149 **9.39**

**COLOR SUBCARRIER OSCILLATOR QUARTZ 3579.545 KC CRYSTAL**



- Ideal Hobbyist Crystal

E-86 **.88**

**ELECTRONIC 4-RANGE DIGITAL READOUT INTERVAL TIMER KIT**



- 4 Time Functions: 1.9.9 Sec. 1.99 Sec. 1.9.9 Min. 1.99 Min.
- High Noise Tune Readouts
- For Darkroom Use in Both Processing & Enlarging Processes
- As A Timer For Sports & Contest Events (Stop Switch)
- Provides Timed 120V AC Outlet And SP No Contact To Trigger Buzzer Alarm Or Visual Signals

- Uses Standard EIA Components G-10 Fiberglass 4" x 10" P.C. Board, DTL Logic with Two Standard TTL IC's For Noise Readout
- Full Wiring Instructions Included - No Cabinet Or Case Available For Timer

Shipping Wt. 9 lbs. E-207 Now Only **19.99**

**JERROLD 82-CHANNEL TV UNIVERSAL ELECTRONIC TV REMOTE CONTROL**



- Remote Control Of Any TV Set
- UNIVERSAL
- You can use it on any TV. When you buy a new TV you don't have to buy another remote control if someone gets sick, move the remote control to the sick room. Saves Mom a lot of steps.
- 12 VHF Channels • 70 UHF Channels • On-Off
  - Fine Tune • Clean Up CB Interference

Shipping Wt. 8 lbs. New!! TRC-82 **109.95**

- Features of the Jerrold 82-Channel Universal TV Remote Control:
- Turns TV set on and off • Instant push button channel change • Fine tunes TV set for best noise reception • Eliminates direct pickup ghosts • Works with all TV sets - black & white or color • Replaces Defective Tuner
- Simplifies channel selection for the elderly. **Relax!** Now you can control your TV from the comfort of your favorite easy chair.

**FIRE/HEAT SENSOR**



- Heat Sensor Closes At 135 Deg. F. Opens At 105 Deg. F
  - Build Your Own Or Add To Your Security Alarm System
- Great Value!

Shipping Wt. 1 lb. S-2 **.59** 3/1.50

**SIGNAL HORN**



- 1 1/2 - 3 Volts DC (Adjustable)
- Use in Warning Devices, Alarms, Horns, Etc.

Shipping Wt. 1 lb. N-34 **.59** 3/1.50

**SPERRY SP-353 3-DIGIT NUMERIC DISPLAY**



- A flat panel display designed for interlacing with MOS LSI Characters

Shipping Wt. 1 lb. E-28 **1.88** 3/5.00

**PKG/5 1N82A SILICON UHF MIXER DIODE**



Shipping Wt. 1 lb. E-59 **.99**

**MALLORY PTC-401 FULL WAVE BRIDGE 2 AMP - 200 VOLTS**



Shipping Wt. 1 lb. E-90 **.88** 4/3.50

**PKG/4 SPRING LOADED HEAT SINKS**



- Two 1 1/2" long small heat sinks. One with 90 degree angle one straight two 2" long heat sinks one with 90 degree angle one straight

Shipping Wt. 1 lb. E-84 **.99** pkg.

**MAGNETIC BASE 2 1/2" LONG HEAT SINK**



- Strong Magnet

Shipping Wt. 1 lb. E-85 **.69**

**MALLORY COMPUTER GRADE CAPACITORS**



Part No.	Value	Price
L-52	100,000 mfd 5V	1.29
L-54	10,000 mfd 5V	1.49
L-282	21,000 mfd 10V	1.49
L-60	43,500 mfd 25V	1.49
L-283	31,500 mfd 25V	1.49
L-284	1,100 mfd 75V	1.49
L-60	5,000 mfd 75V	2.29
L-67	1,900 mfd 100V	2.29
Average Shipping Wt. 1 lb.		1.49

**SEND FOR FREE CATALOG with hundreds of electronic items**

Minimum order \$3.00 - allow 25¢ per pound shipping and 50¢ handling charge. IL residents add 5% sales tax. Prices good thru May 1, 1977 or while stocks last. Notice: Some items may be of limited quantities and subject to price rise.



Dept. PLI, 4900 Elston, Chicago, IL 60630 • Tel.: 312-283-4800

# Market Center

**CLASSIFIED COMMERCIAL RATE** (for firms or individuals offering commercial products or services) **\$1.40 per word (no charge for zip code)** . . . minimum 15 words.

**NONCOMMERCIAL RATE** (for individuals who want to buy or sell personal items) **85¢ per word** . . . no minimum.

**ONLY FIRST WORD AND NAME** set in bold caps. Additional bold face (not available as all caps) at 10¢ per word. Payment must accompany all ads except those placed by accredited advertising agencies. 5% discount for 6 issues, 10% for 12 issues within one year, if paid in advance. All copy subject to publisher's approval. Advertisements using P.O. Box address will not be accepted until advertiser supplies publisher with permanent address and phone number. Copy to be in our hands on the 26th of the third month preceding the date of the issue (i.e., August issue closes May 26). When normal closing date falls on Saturday, Sunday or a holiday, issue closes on preceding working day.

**BUSINESS OPPORTUNITIES**

**CAFM station.** No investment! Excellent income! Others operate for you. Details free. **CAFM**, Box 5516-FJ, Walnut Creek, CA 94596

**HIGHLY PROFITABLE ONE-MAN ELECTRONIC FACTORY**

Investment unnecessary, knowledge not required, sales handled by professionals. Ideal home business. Write today for facts! **Postcard will do. Barta-BV, Box 248, Walnut Creek, CA 94597.**

**OVERSEAS jobs!** All occupations! Complete details. Where and how to apply. Latest company lists. Resume tips. \$2.00. **INFORMATION SERVICES**, P.O. Box 3345-E, Cocoa, FL 32922

**PLANS & KITS**

**67 KHz SCA kits** for extended FM reception. Includes drilled bakelite case, 110 volt power supply parts, **wired and tested** PC board. Quality product. \$47.50. Fully wired \$60.00. **MUSIC ASSOCIATED**, 65 Glenwood Rd., Upper Montclair, NJ 07043 (201) 744-3387

**BI-LINEAR amplifier**, 2-30 MHz, 60-150 watt. Construction plans, \$3.00. **WILSON**, Box 5516-FJ, Walnut Creek, CA 94596

**FREQUENCY counter:** 300 MHz, crystal timing, lab quality .00003% accuracy, 9-18 vdc supply, internal batteries, 4" x 2" x 4 1/2". Plans only: \$5.00. Kits: 30 MHz, \$100.00 - 300 MHz, \$120.00. **E & J PRODUCTS**, Box 5516-FJ, Walnut Creek, CA 94596

**YES, YOU CAN BUILD AN ELECTRONIC ORGAN**

That has a **PIPE ORGAN SOUND**

With **DEVTRONIX** easy to build assemblies. Own the ultimate in organ design & sound at 1/3 the cost of commercial organs.

**BROCHURE AND DEMO RECORD \$1.00**

**Dept. B**  
5872 Amapola Dr.  
San Jose, CA 95129

**ARTISAN organ kits** feature all new modular construction with logic-controlled stops and **RAM Present Memory System**. Write for brochure to **A O K MANUFACTURING INC.**, P.O. Box 445B, Kenmore, WA 98028

**FREE KIT Catalog**

**STOP!** Take a minute & let us send our latest kit catalog. If you like, send us the name & address of a friend who may also be interested and we'll include to you our booklet "How to build electronic thermometer!"

**DAGE SCIENTIFIC INSTRUMENTS**  
BOX 1054R LIVERMORE CA 94550

**MORSE code typewriter.** \$69.95 kit. \$99.95 wired. Free information. **S. J. ENGINEERING**, P.O. Box 442RE, Canton, MA 02021

**MICROCOMPUTER**—systems—troubleshooting techniques—digital gate decode chart—Both \$5.00. **MICRO INFO ASSOC.**, Box 849, Castroville, CA 95012. Cal. residents add 6% tax.

**HARDCOPY.** Attachments convert Smith-Corona, IBM Executive, and IBM Selectric typewriters to microcomputer printers. **Highest quality printing available.** Free brochure. **TIM STOUT MICROCOMPUTER PRODUCTS**, Box 1573, Fremont, CA 94538

**NEGATIVE Ion Generator.** Detailed construction plans—\$10.00. Complete kit—\$165.00. **GOLD-EN ENTERPRISES**, Box 1282RE, Glendale, AZ 85311

**TUBES,** receiving and industrial, semiconductor, factory boxed, low prices, free price list. **TRANSELETRONIC INC.**, 1365 - 39th Street, Brooklyn, NY 11218. 212-633-2800

## NEW TTL DATA BOOK

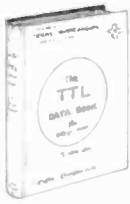

The newest edition of the TTL Data Book for Design Engineers. Detailed specifications on over 900 TTL device types. Both standard TTL and high technology Schottky clamped TTL. Pin assignment drawings of all TTL types. The most complete book on TTL logic written by the same company that invented the integrated circuit. —A must for every scientist, engineer and technician!

ONLY \$4.95

## MODU-CLOCK by RBL

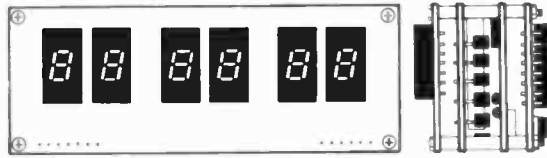

High Quality Printed Circuit Board Project. —NO PARTS INCLUDED.

THOUSANDS SOLD NATIONALLY !!! Unique design utilizes 6 digit LED readout (Man 7, DL 707, etc.) and popular MM5314 Clock Chip. The REL Modu-Clock is the ultimate six digit clock project. Its unique architecture allows the kit builder unlimited versatility. All PC boards measure 1.5" x 4" and mount behind each other, and all connections are brought to the board's edge. The Modu-Clock consists of highest quality drilled, etched and plated PC boards, and can be constructed for either AC or DC operation. (Complete Instructions and parts list are included)

AC Version (3 board set)—Reac-out board, Clock board & Power board . . . \$4.95  
DC Version (4 board set)—Reac-out, Power, Clock & Timebase boards . . . \$5.95

\*NOTE: This kit was designed to be used with the "LOGI CASE" listed below

## DECADE COUNTER MODULE



DCM-1

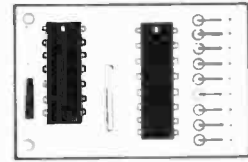

No Parts Included

VERSATILE DECADE COUNTER BOARD. Utilizes a 7447 decoder-driver and a 7490 decade counter. Directly drives any common anode 7 segment LED readout. All connections are brought to the board's edge.

ONLY \$70¢  
10 for \$6.00

## P-C Mount Transformer

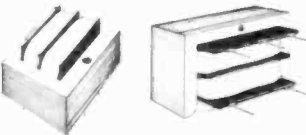

SUPER high quality transformer for almost any project. Input 117 VAC. Outputs 5.5V at 200 Ma, 10.5V at 250 Ma, or 12V at 300 Ma. Complete with necessary specifications.

ONLY \$1.50

## MINI - SWITCHES



Very high quality miniature switches manufactured by C & K. Two different models: Both switches mount in 1/4" hole.

Miniature SPDT momentary (pushbutton). Rated 5 amps @ 125 volts AC.

ONLY 98¢

Miniature SPDT toggle, rated 2 amps @ 250 volts AC or 5 amps @ 125 volts AC.

ONLY \$1.10



## SOLID STATE VOX

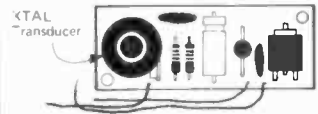

Solid state Voice Operated Switch (VOX). An interesting device with literally hundreds of uses. All parts included and pre-assembled. Size 3.0" x 1.0". Schematic included.

ONLY \$1.50

## 1-3pf Trimmer Capacitor

Miniature 1-3 pF trimmer capacitor. Great for crystal circuits, hand held probes, or any circuit where a very small capacitance is required.



Measures only 3/16" in diameter!!!

ONLY 95¢

## HEP RO170 Diode

The famous HEP 170 general purpose diode. A universal replacement power diode. For TV's, audio, manufacturing and experimenting. Brand new prime units. Now at lowest prices ever!!! 1000 PIV @ 2.5 Amps.

ONLY 20¢  
100 for 14.50



## Jumbo LED



One of our most popular items! Jumbo red Light Emitting Diode. Measures .200" in diameter. These are prime factory units. —Great for experimenting, demonstrations, etc.

ONLY 5/1.00

## Mod - Pot



High quality dual concentric pot. Rear pot 20K linear, front pot 100K log. Internal elements may be interchanged 1/8" and 1/4" inch shafts. Brand new by Allen Bradley. Measures 5/8" square.

ONLY \$1.75  
12 for 3.00 10 for 12.00

## Rubber Feet



High Quality, manufactured by 3M.

Round: 8¢ 12 for 75¢  
Square: 6¢ 12 for 55¢

## 5-Conductor Shielded Wire



26 gauge shielded, jacketed cable. Very high quality. DOZENS of possible uses.

ONLY 15¢/ft  
( \$12.50 / 100 feet )

## Photoflash Capacitor



Brand new Rubycon 360 uf at 600 VDC. Great for experimenting, strobes, etc. This is one of the highest quality electrolytic caps ever made. 3.2" high x 1.0" dia.

Only \$1.95

## Ribbon Cable



SPECTROL Ribbon cable. (per foot)

12 Conductor . . . 25¢  
10 feet for . . . 3.80  
24 conductor . . . 85¢  
10 feet for . . . 7.00

## 13 Pair Twisted Cable

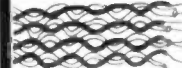

13 pair twisted cable, 22 gauge. Color coded. Many applications.

ONLY 95¢/FT  
10 feet for \$7.50

## 100K Pot

High quality pot. New from Centralab 3/4" diameter, 1/4" shaft. Linear taper 1/2" long shaft. Srelective slotted shaft. Brand new.

only 50¢  
10 for \$4.00



POTENTIOMETER HEX NUTS  
Standard for all 3/8" bushings.  
25 for \$1.00

## LOGI-CASE

Universal instrument enclosure with a wide variety of applications. Interior interior plexiglass rack assembly will hold up to 6 1.5" x 4" circuit boards. Great for packing a lot of components into a very small space. Adds a professional touch to any project or design. Made from 1/8" thick anodize 3, extruded aluminum. So tough that you can run over it with a car without hurting it!!! Now in 2 popular sizes: SMALL, 2 1/2" x 3 3/4" x 1 3/4". LARGE, 6L x 4 1/2" x 2H.

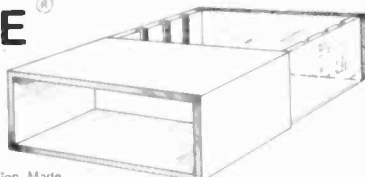

SMALL, Only \$7.95  
LARGE, Only 10.95

\*Both sizes come with a reversible front filter. (Red or Smoke Gray).



MOTOROLA

## 4N27 Opto-Isolator

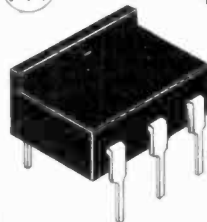

NPN phototransistor and PN infrared light emitting diode. 1500 volt Isolation. 3Ma collector output current. Excellent frequency response to 300 Khz. 2.1 microsecond switching time. Brand new, Motorola 6 pin DIP. With full specifications and data.



SPECIAL \$1.00

10 for \$9.00

# J.B. Saunders Co.

3050 VALMONT ROAD  
BOULDER, COLORADO 80301  
Ph: (303) 442-1212

### Terms:

- All prices subject to change without notice.
- All merchandise subject to prior sale.
- Minimum order \$5.00.
- Please add \$1.00 postage and handling.
- Colorado residents add 3% state sales tax.
- No COD's, please.
- Foreign Orders send U.S. Funds ONLY.

## Schooling of Excellence in Electronic Engineering



**ATTENTION ELECTRONIC TECHNICIANS!** If you have adequate schooling and experience at the technician level you may be able to qualify to enter our home study degree program in Electronics Engineering. No residence classes required for those who qualify. Limited enrollment accepted. Raise your status and pay to the engineering level. Advance Rapidly! Worldwide enrollment and alumni. If you are an electronics technician with above-average ability and ambition, and not willing to settle for anything less than the best, then you should call or write today for FREE revealing descriptive literature. No salesman will call. Our 31st year!

**COOK'S INSTITUTE OF ELECTRONICS ENGINEERING**  
P.O. Box 20345, Jackson, MS 39209  
TEL (601) 922-1833

## EDUCATION & INSTRUCTION

### F.C.C. EXAM MANUAL

**PASS FCC EXAMS!** Memorize, study—Tests—Answers for FCC 1st and 2nd class Radiotelephone licenses. Newly revised multiple choice questions and diagrams cover all areas tested in FCC exams, plus Self-Study Ability Test. \$9.95 postpaid. Money-back guarantee.



**COMMAND PRODUCTIONS** P.O. Box 26348 E  
RADIO ENGINEERING DIV. SAN FRANCISCO, CALIF. 94126

**GRANTHAM'S FCC License Study Guide—377 pages, 1465 questions with answers/discussions—covering third, second, first radiotelephone examinations. \$10.70 postpaid. GSE PUBLICATIONS, 2000 Stoner, Los Angeles, CA 90025**

## FOR SALE

**PRINTED circuit supplies.** A process that always works. Send stamp. **CIRCOLEX**, Box 198, Marcy, NY 13403

## Burglar-Smoke Fire Alarm Catalog

• Billions of dollars lost annually due to lack of protective warning alarms.

**FREE CATALOG** Shows you how to protect your home, business and person. Wholesale prices. Do-it-yourself. Free engineering service.



**Burdex Security Co.**

Box 82802 RE-107 Lincoln, Ne. 68501

**CARBON film resistors—1/4W, 5% (1-4M7 ohms) 3.5¢ each. 50/value—\$0.85. Postage, handling \$1.00. Send 25¢ for catalog, sample, specifications. COMPONENTS CENTER, Box 134R, New York, NY 10038**



## MICRO MINI MIKE™ WIRELESS MICROPHONE

World's smallest, solid state, self-contained. Picks up and transmits most sounds without wires up to 300 ft. through FM Radio. Use as mike, amp., alarm & alert sys. Hot line, baby sitter, etc. Money back guarantee. B/A, M/C cds, COD ok. \$18.95 plus \$1.00 post & h/d. Calif. res. add tax. Mail orders only. Qty. Disc. Avail. **AMC SALES, INC.** Dept. 19, Box 928 • Downey, Calif. 90241

**RECONDITIONED test equipment. \$0.50 for catalog. WALTER'S TEST EQUIPMENT, 2697 Nickel, San Pablo, CA 94806**

**MANUALS for Govt. surplus radios, test sets, scopes. List 50¢ (coin). BOOKS, 7218 Roanne Drive, Washington, D.C. 20021**

## Govt. SURPLUS ELECTRONIC EQUIPMENT CATALOG

**FREE UPON REQUEST!** If you haven't received our new Catalog, write for free copy today. Address: Dept. RE

**FAIR RADIO SALES**  
1016 E. EUREKA • Box 1105 • LIMA, OHIO • 45802

**SAVE on television tuner repairs, tuner parts, modules and test equipment. \$1.50 refundable catalog. OZ'S TUNER SERVICE, Box 2464, La Puente, CA 91746**

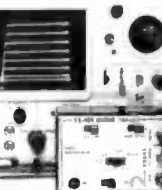

**EC-101 CURVE TRACER**  
STILL BY FAR THE LOWEST COST FULL FUNCTION CURVE TRACER ON THE MARKET. ATTACHES TO YOUR SCOPES IN SECONDS. USED BY EDUCATORS, PROFESSIONALS AND HOBBYISTS ALL OVER THE WORLD. 30 DAY MONEYBACK GUARANTEE.



STILL ONLY \$39.50 ADD 3% IN SALES TAX

PO BOX 1972, BOULDER, COLO. 80506

**Same day shipment.** First line parts only. Factory tested. Guaranteed money back. Quality IC's and other components at factory prices.

### INTEGRATED CIRCUITS

7400TL	17	74LS00A	35	LM137	4.50	CD4011	22	74C14	2.10
7400N	17	74LS00B	35	LM138	4.50	CD4012	22	74C20	2.10
7401N	10	74LS01A	35	LM139	4.50	CD4013	22	74C20B	2.10
7401N	10	74LS01B	35	LM140	4.50	CD4014	22	74C20C	2.10
7402N	23	74LS02A	35	LM141	4.50	CD4015	22	74C20D	2.10
7402N	23	74LS02B	35	LM142	4.50	CD4016	22	74C20E	2.10
7404N	17	74LS04A	35	LM143	4.50	CD4017	22	74C20F	2.10
7404N	17	74LS04B	35	LM144	4.50	CD4018	22	74C20G	2.10
7406N	60	74LS06A	35	LM145	4.50	CD4019	22	74C20H	2.10
7406N	60	74LS06B	35	LM146	4.50	CD4020	22	74C20I	2.10
7408N	20	74LS08A	35	LM147	4.50	CD4021	22	74C20J	2.10
7408N	20	74LS08B	35	LM148	4.50	CD4022	22	74C20K	2.10
7410N	20	74LS10A	35	LM149	4.50	CD4023	22	74C20L	2.10
7410N	20	74LS10B	35	LM150	4.50	CD4024	22	74C20M	2.10
7412N	50	74LS12A	35	LM151	4.50	CD4025	22	74C20N	2.10
7412N	50	74LS12B	35	LM152	4.50	CD4026	22	74C20O	2.10
7414N	60	74LS14A	35	LM153	4.50	CD4027	22	74C20P	2.10
7414N	60	74LS14B	35	LM154	4.50	CD4028	22	74C20Q	2.10
7416N	60	74LS16A	35	LM155	4.50	CD4029	22	74C20R	2.10
7416N	60	74LS16B	35	LM156	4.50	CD4030	22	74C20S	2.10
7418N	60	74LS18A	35	LM157	4.50	CD4031	22	74C20T	2.10
7418N	60	74LS18B	35	LM158	4.50	CD4032	22	74C20U	2.10
7420N	60	74LS20A	35	LM159	4.50	CD4033	22	74C20V	2.10
7420N	60	74LS20B	35	LM160	4.50	CD4034	22	74C20W	2.10
7422N	43	74LS22A	35	LM161	4.50	CD4035	22	74C20X	2.10
7422N	43	74LS22B	35	LM162	4.50	CD4036	22	74C20Y	2.10
7424N	43	74LS24A	35	LM163	4.50	CD4037	22	74C20Z	2.10
7424N	43	74LS24B	35	LM164	4.50	CD4038	22		
7426N	43	74LS26A	35	LM165	4.50	CD4039	22		
7426N	43	74LS26B	35	LM166	4.50	CD4040	22		
7428N	43	74LS28A	35	LM167	4.50	CD4041	22		
7428N	43	74LS28B	35	LM168	4.50	CD4042	22		
7430N	43	74LS30A	35	LM169	4.50	CD4043	22		
7430N	43	74LS30B	35	LM170	4.50	CD4044	22		
7432N	43	74LS32A	35	LM171	4.50	CD4045	22		
7432N	43	74LS32B	35	LM172	4.50	CD4046	22		
7434N	43	74LS34A	35	LM173	4.50	CD4047	22		
7434N	43	74LS34B	35	LM174	4.50	CD4048	22		
7436N	43	74LS36A	35	LM175	4.50	CD4049	22		
7436N	43	74LS36B	35	LM176	4.50	CD4050	22		
7438N	43	74LS38A	35	LM177	4.50	CD4051	22		
7438N	43	74LS38B	35	LM178	4.50	CD4052	22		
7440N	43	74LS40A	35	LM179	4.50	CD4053	22		
7440N	43	74LS40B	35	LM180	4.50	CD4054	22		
7442N	43	74LS42A	35	LM181	4.50	CD4055	22		
7442N	43	74LS42B	35	LM182	4.50	CD4056	22		
7444N	43	74LS44A	35	LM183	4.50	CD4057	22		
7444N	43	74LS44B	35	LM184	4.50	CD4058	22		
7446N	43	74LS46A	35	LM185	4.50	CD4059	22		
7446N	43	74LS46B	35	LM186	4.50	CD4060	22		
7448N	43	74LS48A	35	LM187	4.50	CD4061	22		
7448N	43	74LS48B	35	LM188	4.50	CD4062	22		
7450N	43	74LS50A	35	LM189	4.50	CD4063	22		
7450N	43	74LS50B	35	LM190	4.50	CD4064	22		
7452N	43	74LS52A	35	LM191	4.50	CD4065	22		
7452N	43	74LS52B	35	LM192	4.50	CD4066	22		
7454N	43	74LS54A	35	LM193	4.50	CD4067	22		
7454N	43	74LS54B	35	LM194	4.50	CD4068	22		
7456N	43	74LS56A	35	LM195	4.50	CD4069	22		
7456N	43	74LS56B	35	LM196	4.50	CD4070	22		
7458N	43	74LS58A	35	LM197	4.50	CD4071	22		
7458N	43	74LS58B	35	LM198	4.50	CD4072	22		
7460N	43	74LS60A	35	LM199	4.50	CD4073	22		
7460N	43	74LS60B	35	LM200	4.50	CD4074	22		
7462N	43	74LS62A	35	LM201	4.50	CD4075	22		
7462N	43	74LS62B	35	LM202	4.50	CD4076	22		
7464N	43	74LS64A	35	LM203	4.50	CD4077	22		
7464N	43	74LS64B	35	LM204	4.50	CD4078	22		
7466N	43	74LS66A	35	LM205	4.50	CD4079	22		
7466N	43	74LS66B	35	LM206	4.50	CD4080	22		
7468N	43	74LS68A	35	LM207	4.50	CD4081	22		
7468N	43	74LS68B	35	LM208	4.50	CD4082	22		
7470N	43	74LS70A	35	LM209	4.50	CD4083	22		
7470N	43	74LS70B	35	LM210	4.50	CD4084	22		
7472N	43	74LS72A	35	LM211	4.50	CD4085	22		
7472N	43	74LS72B	35	LM212	4.50	CD4086	22		
7474N	43	74LS74A	35	LM213	4.50	CD4087	22		
7474N	43	74LS74B	35	LM214	4.50	CD4088	22		
7476N	43	74LS76A	35	LM215	4.50	CD4089	22		
7476N	43	74LS76B	35	LM216	4.50	CD4090	22		
7478N	43	74LS78A	35	LM217	4.50	CD4091	22		
7478N	43	74LS78B	35	LM218	4.50	CD4092	22		
7480N	43	74LS80A	35	LM219	4.50	CD4093	22		
7480N	43	74LS80B	35	LM220	4.50	CD4094	22		
7482N	43	74LS82A	35	LM221	4.50	CD4095	22		
7482N	43	74LS82B	35	LM222	4.50	CD4096	22		
7484N	43	74LS84A	35	LM223	4.50	CD4097	22		
7484N	43	74LS84B	35	LM224	4.50	CD4098	22		
7486N	43	74LS86A	35	LM225	4.50	CD4099	22		
7486N	43	74LS86B	35	LM226	4.50	CD4100	22		
7488N	43	74LS88A	35	LM227	4.50	CD4101	22		
7488N	43	74LS88B	35	LM228	4.50	CD4102	22		
7490N	43	74LS90A	35	LM229	4.50	CD4103	22		
7490N	43	74LS90B	35	LM230	4.50	CD4104	22		
7492N	43	74LS92A	35	LM231	4.50	CD4105	22		
7492N	43	74LS92B	35	LM232	4.50	CD4106	22		
7494N	43	74LS94A	35	LM233	4.50	CD4107	22		
7494N	43	74LS94B	35	LM234	4.50	CD4108	22		
7496N	43	74LS96A	35	LM235	4.50	CD4109	22		
7496N	43	74LS96B	35	LM236	4.50	CD4110	22		



# ANNOUNCING NEW LOW PRICES AT RADIO SHACK, THE "PARTS PLACE"

Top quality devices, fully functional, carefully inspected. Guaranteed to meet all specifications, both electrically and mechanically. All are made by well known American manufacturers, and all have to pass

manufacturer's quality control procedures. These are not rejects, not fallouts, not seconds. In fact, there are none better on the market! Count on Radio Shack for the finest quality parts.



## TTL Digital ICs

First Quality Devices Made by National Semiconductor and Motorola

Type	Cat No.	Last Year	NOW ONLY
7400	276-1801	\$ 49	35c
7402	276-1811	\$ 49	35c
7404	276-1802	\$ 59	35c
7406	276-1821	\$ 69	49c
7410	276-1807	\$ 49	39c
7413	276-1815	\$ 19	79c
7420	276-1809	\$ 49	39c
7427	276-1823	\$ 69	49c
7432	276-1824	\$ 69	49c
7441	276-1804	\$ 19	99c
7447	276-1805	\$ 19	99c
7448	276-1816	\$ 19	99c
7451	276-1825	\$ 49	39c
7473	276-1803	\$ 79	49c
7474	276-1818	\$ 79	49c
7475	276-1806	\$ 19	79c
7476	276-1813	\$ 79	59c
7485	276-1826	\$ 19	19
7486	276-1827	\$ 69	49c
7490	276-1808	\$ 19	79c
7492	276-1819	\$ 19	69c
74123	276-1817	\$ 19	99c
74145	276-1828	\$ 19	19
74150	276-1829	\$ 19	19
74154	276-1834	\$ 19	129
74192	276-1831	\$ 19	19
74193	276-1820	\$ 19	19
74194	276-1832	\$ 19	19
74196	276-1833	\$ 19	129

### 74C and 4000 Series CMOS ICs

74C00	276-2301	\$ 69	49c
74C01	276-2302	\$ 69	49c
74C04	276-2303	\$ 69	49c
74C08	276-2305	\$ 69	49c
74C14	276-2310	\$ 19	89c
74C76	276-2312	\$ 19	89c
74C90	276-2315	\$ 29	149
74C192	276-2321	\$ 29	169
74C193	276-2322	\$ 29	169
4001	276-2401	\$ 69	49c
4011	276-2411	\$ 69	49c
4013	276-2413	\$ 19	89c
4017	276-2417	\$ 29	149
4020	276-2420	\$ 29	149
4027	276-2427	\$ 19	89c
4049	276-2449	\$ 99	69c
4050	276-2450	\$ 99	69c
4511	276-2437	\$ 29	169
4518	276-2490	\$ 29	149

## Linear ICs

First Quality Devices by National Semiconductor and Motorola



Type	Cat No.	Last Year	NOW ONLY
301AH	276-017	\$ 69	49c
324N	276-1711	\$ 19	149
339N	276-1712	\$ 19	149
386CN	276-1731	\$ 19	99c
555CN	276-1723	\$ 19	79c
556CN	276-1728	\$ 29	139
566CN	276-1724	\$ 29	169
567CN	276-1721	\$ 29	199
723CN	276-1740	\$ 99	69c
741CN	276-007	\$ 69	49c
741H	276-010	\$ 69	49c
3900N	276-1713	\$ 19	99c
3909N	276-1705	\$ 19	99c
3911N	276-1706	\$ 29	199
4558CN	276-038	\$ 99	79c
75491	276-1701	\$ 19	99c
75492	276-1702	\$ 19	99c
7805	276-1770	\$ 19	129
7812	276-1771	\$ 19	129
7815	276-1772	\$ 19	129

## Experimenter's PC Board

Simplifies IC Projects

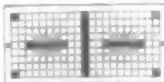

Ideal for two-circuit projects. Fire-retardant copper-clad board is only 2 1/2 x 5 x 1/16". Really simplifies integrated circuit projects by extending leads for easy soldering.  
276-151 ..... 2.99

## Microcomputer Chip

8080A Microprocessor. With a 16-bit address bus capable of addressing up to 65k bytes of memory and up to 256 I/O ports. "TRI-State" data bus gives it DMA and multiprocessing capability. All buses TTL compatible. Up to 244 variable length instructions, with 6 general purpose registers plus an accumulator. 40-pin DIP. 100% Prime. 276-2510 ..... 17.95

RS2102 Static RAM. 1024-word by one bit random access read/write memory. Under 750 nS access. Single -5V power supply. 276-2501 ..... 2.49 each or 8/14.95

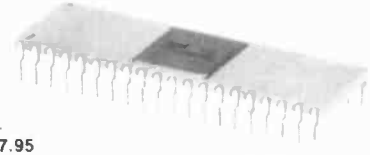

# 1795

## LEDs/Optoelectronics

Item	Cat No.	Reg.	Now Only
☐ Solar Cell	276-115		1.59
☐ Silicon Cell	276-128		1.99
☐ Photocell	276-116		99c
☐ FFT 100	276-130		79c
☐ Lg Red LED	276-041	2/69c	2/49c
☐ Lg Gr LED	276-047	2/69c	2/49c
☐ Med Red LED	276-026	2/69c	2/49c
☐ Med Gr LED	276-040	2/69c	2/49c
☐ Sm Red LED	276-042	2/69c	2/49c

## Digital Displays

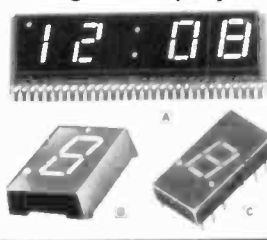

Digits	Size	Drive	Cat No.	Last Year	NOW ONLY
☐ 4	0.5"	Anod.	276-1201	\$9.95	6.95
☐ 4	0.5"	Cath.	276-1202	\$9.95	6.95

Digits	Size	Drive	Cat No.	Last Year	NOW ONLY
☐ 1	0.6"	Anod.	276-056	\$3.99	2.99
☐ 1	0.6"	Cath.	276-056	\$3.99	2.99
☐ 1	0.3"	Anod.	276-053	\$2.99	1.99
☐ 1	0.3"	Cath.	276-062	\$2.99	1.99
☐ 1	0.3"	Anod.	276-1210	4/\$8.97	4/\$6.99
☐ 1	0.3"	Cath.	276-1211	4/\$8.97	4/\$6.99

## Project Accessories

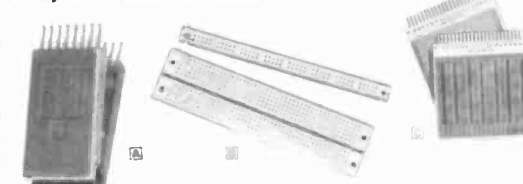

☐ IC Troubleshooting Test Clip. Test up to 14 pins with probes or clips. Reg. 4.99  
276-1950 ..... Sale 2.99

☐ IC Troubleshooting Test Clip. Test up to 16 pins with probes or clips. Reg. 4.99  
276-1951 ..... Sale 3.49

☐ Experimenter Socket. 2x47 rows of 5 connected tie points. 276-172 ..... 9.95

☐ Bus Strip. 2x40 connected tie points. Clips to socket above. 276-173 ..... 1.99

☐ Standard Edge-Card Board. 22-pin. 1295 mounting holes. 276-152 ..... 2.99

☐ 2-Voltage Source Edge-Card Board. 1368 mounting holes. 276-154 ..... 2.99

☐ 3-Voltage Source Edge-Card Board. 1368 mounting holes. 276-153 ..... 2.99

☐ 22-Pin Edge-Card Board Connector. 44 terminals. 276-1551 ..... 2.99

☐ 100-Pin Edge-Card Board Connector. For standard 5-100 hobby computer bus. 276-1554 ..... 4.95 each or 5/19.95

☐ DIP Header. 16-pin spacing. 276-1980 ..... 1.29

☐ Right Angle IC Socket. Mount LEO's vertically. 16-pin spacing. 276-1985 ..... 1.45

☐ Metal Cabinet. 3 1/2 x 2 1/4 x 4". 270-251 ..... 2.59

☐ Metal Cabinet. 4 x 2 1/4 x 6". 270-252 ..... 3.49

☐ Metal Cabinet. 6 1/2 x 2 1/4 x 7 1/4". 270-253 ..... 4.49

## Transformers

6-3 Volts 1.2 Amps. 1 1/2 x 1 1/4 x 1 1/4"	273-050 ..... 2.29
6-3 Volts, 3 Amps. 2 1/4 x 2 1/4 x 1 1/4"	273-1510 ..... 3.99
12 Volts 5 Amps. 4x2x2 1/2"	Reg. 8.95 Sale 6.95
18 Volts (Center Terminal). 4 Amps. Ideal for 5V (using CT), or 12V solid-state regulators. 4x2x2 1/2"	Reg. 8.95 Sale 6.95
273-1514 ..... 2.99	

## Selected Diodes

Type	Cat No.	Last Year	Now Only
1N4401	276-1101		2/39c
1N4303	276-1102	2/59c	2/49c
1N4304	276-1103	2/69c	2/59c
1N4205	276-1104	2/79c	2/69c
1N4735	276-561		2/89c
1N4739	276-562		2/89c
1N-742	276-563		2/89c
1N1744	276-564		2/89c
Trigger Diode	276-1050	\$ 49	39c
1N5401	276-1141		2/69c
1N5402	276-1142	2/69c	2/49c
1N5403	276-1143	2/99c	2/89c
1N5404	276-1144	2/51 19	2/99c
PTC205	276-1114	3/1 39c	

## SCR's and Triacs

Device	Rating	Cat No.	Last Year	Now Only
1-ASCR	200V 1 6A	276-1095	\$1.59	99c
SCR	200V 6A	276-1067	\$1.39	89c
SCR	400V 6A	276-1020	\$1.49	99c
Triac	200V 6A	276-1001	\$1.39	89c
Triac	400V 6A	276-1000	\$1.49	99c
BR	50PIV 1 4A	276-1151		79c
BR	100PIV 1 4A	276-1152		99c
BR	100V 4A	276-1171		1.49
BR	200V 4A	276-1172		1.69
BR	400V 4A	276-1173		1.89
BR	50PIV 6A	276-1180		1.99

## Digital Car Clock Module



Just add switches and install! Type MA1003, with MOS/LSI clock circuit chip, green fluorescent display with four 0.3" digits. Has 2.09 MHz crystal, blinking colon activity indicator. Six-pin edge-connector. For any 12VDC source. 277-1003 ..... 24.95

## Low-Profile DIP Sockets

8-Pin.	276-1995.	Reg. 2 for \$ 69	2/59c
14-Pin.	276-1999.	Reg. 2 for \$1.19	2/89c
16-Pin.	276-1998.	Reg. 2 for \$1.19	2/89c
28-Pin.	276-1997.	Reg. \$1.19 Each	89c
40-Pin.	276-1996.	Reg. \$1.39 Each	99c

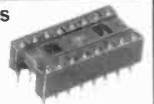

## 8-Rocker DIP Switch

Incorporates 8 on-off switches. For easy change of preset logic states. Fits any 16-DIP socket. 275-1301 ..... 1.99



WHY WAIT FOR MAIL DELIVERY?  
IN STOCK NOW AT OUR STORE NEAR YOU!

# Radio Shack®

Prices May Vary at Individual Stores and Dealers

A TANDY COMPANY • FORT WORTH, TEXAS 76102  
OVER 6000 LOCATIONS IN NINE COUNTRIES

## ADD 24K OF MEMORY TO YOUR COMPUTER — \$450

Now you can buy 3 of our popular 8K COGNORAM II™ boards for \$450. Features? All static design (eliminates dynamic timing hassles); 4 tri-state outputs, configured as two separate, independent 4k blocks with individual protect for each block; zero wait states (4 Mhz 2-80ns); use 1 wait state, implemented on board); provides vector interrupt if write attempted in protected block fully buffered. Fully socketed. True low power.

#SPC-24	Three 8K COGNORAM II™ kits.....	\$450.00
#CK-008	8K COGNORAM II™ (kit form).....	\$163.84
#CK-010	Same but assembled, tested, 1 yr. warr.....	\$188.50
#CK-007	1K COGNORAM II™ (kit form).....	\$100.00
#CK-009	Same but assembled, tested, 1 yr. warr.....	\$120.00

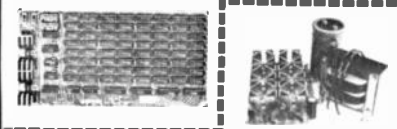

## 12V 8A supply - \$44.50

Kit less case, hardware. Please add sufficient postage.

## YES - we have COMPONENTS

75454 interface driver.....	\$ 0.31
75461 interface driver.....	\$ 0.31
78L12 +12V regulator, TO-92 package.....	\$ 0.30
78L15 +15V regulator, TO-92 package.....	\$ 0.30
2102L-1 fast, low power 1K static RAM.....	\$ 1.95
VECTOR 8800V prototype board (fits S100 buss).....	\$19.95
2708 full speed EROM.....	\$25.00
8PST dip switch, toggle action.....	\$ 2.25

We also stock a full line of CMOS, low power Schottky, and linear ICs at competitive prices...see our flyer.

# GODBOUT

BILL GODBOUT ELECTRONICS  
BOX 2355, OAKLAND AIRPORT, CA 94614

TERMS: Prices good through end of magazine cover date. Call res add tax. BankAmericard®/VISA®/MasterCharge® orders (\$15 min) call (415) 562-0636, 24 hrs. Allow up to \$5 shipping (more for power supplies); excess refund. COI orders OK with street address.

FOR MORE DETAILS, COMPONENTS + MUCH MORE...  
**SEND FOR OUR FLYER**

CIRCLE 26 ON FREE INFORMATION CARD

## TUNER SUB \$19.95

Since all tuner subs that we know of are modified TV Tuners, we decided to market an excellent performing yet very low cost sub for the technician who has to get all he can for his money... a "Poor Boy's Sub" for only \$19.95.

This was not an easy task since cabinets, knobs and controls would push the price far above \$19.95... We searched for a tuner that needed no cabinet and no controls... one that the tech could scrounge the knobs from most any old TV...

It took over two years but we finally found it. The gain is excellent... Battery drain is very low (only 18 mls). It's self biasing so there is no R.F. gain control to fiddle with... It works equally well on tube or transistor sets... b/w or color... and is as easy to use as starting a fight with your wife (well, almost). All you need do is hook the set's IF cable to the "Poor Boy" and view the picture... That's it... no set up controls to confuse you.

We compared the "Poor Boy" with other subs costing over twice the price and found it to work just as well on all the comparison tests we made... and often a lot easier to use... Even though instructions aren't needed... you get those too.

The "Poor Boy" is small enough to easily hold in one hand... no wires or controls dangling around. It comes completely wired and tested including batteries and ready to use. Send a check for only \$19.95, and we even pay the shipping (how about that?) or we will ship COD.

Try it for 10 days... If not completely satisfied... return for full refund.

ALL ORDERS SHIPPED THE SAME DAY RECEIVED!!

### TEXAS TUNER SERVICE

4210 N. 28TH STREET,  
FORT WORTH, TEXAS 76117  
PHONE (817) 834-8201

CIRCLE 67 ON FREE INFORMATION CARD



THE DC 12 CLOCK MODULE ADDS A DIGITAL TIME DISPLAY TO YOUR TV SCREEN \*\*\* AS FEATURED IN JULY RADIO ELECTRONICS PROGRAMMING OPTIONS INCLUDE \* HORIZONTAL & VERTICAL LOCATIONS OF THE DISPLAY \* DISPLAY FREQUENCY (1 TO 10 MIN) DISPLAY FORMAT (12 OR 24 HOURS) \* SECONDS DISPLAY OR SUPPRESSION \* DURATION OF DISPLAY \* AUXILIARY INPUT FOR TEMPERATURE STOPWATCH ETC. COMPLETE KIT WITH INSTRUCTIONS \$36.95 PLUS \$2.00 SHIPPING INCLUDING CIRCUIT BOARD TRANSFORMER AND 50 COMPONENTS FOR INFORMATION ON OTHER CLOCKS AND GAMES WRITE TO

INTERFAB, 27963 CABOT RD,  
LAGUNA NIGUEL, CA, 92677

FREE catalog. IC's, Semi's. CORONET ELECTRONICS, 649A Notre Dame W., Montreal, Que., Canada, H3C-1H8. US Inquiries.

VIDEO tape recorders: Norelco LDL 1000/52 records and plays on 1/2-inch tape. Guaranteed perfect: \$260.00, UPS postage paid. GORDON K. KAPES, 1127 Ridgewood Drive, Highland Park, IL 60035

### AMAZING ELECTRONIC PROJECTS and PRODUCTS:

Lasers Super Powered, Burning, Cutting, Rifle, Pistol, Pocket. See in Dark—Shotgun Directional Mike—Unscramblers—Giant Tesla—Stunwand—TV Disrupter—Energy Producing, Surveillance, Detection, Electrifying, Ultrasonic, CB, Auto and Mech. Devices, Hundreds More—All New Plus INFO UNLTD PARTS SERVICE. Catalog \$1. Information Unlimited, Box 626, Lord Jeffery Court, Amherst, N.H. 03031.

FREE catalog. Solar cells, NiCad's, kits, calculators, digital watch modules, ultrasonics, strobes, LED's, transistors, IC's, unique components. CHANEY'S, Box 27038, Denver, CO 80227

## more than 20,000 different components

### RECTIFIERS

	10	100
	For	For
1N4001	.60	5.00
1N4002	.70	6.00
1N4003	.80	7.00
1N4004	.90	8.00
1N4005	1.00	9.00
1N4006	1.10	10.00
1N4007	1.20	11.00

### JAPANESE TRANSISTORS

2SA484	3.00	2SC482	1.75	2SC1228A	1.25	2SD170	2.00
2SA485	1.65	2SC496	1.10	2SC1237	4.50	2SD180	2.75
2SA497	1.00	2SC517	4.25	2SC1239	4.00	2SD188	.96
2SA634	1.25	2SC604A	.65	2SC1308	4.75		
2SA638	1.25	2SC710	.70	2SC1307	5.50	2SD234	1.00
2SA673	.85	2SC711	.70	2SC1377	5.50	2SD236	1.00
2SA678	.75	2SC735	.70	2SC1383	.75	2SD291	.85
2SA682	.85	2SC756	3.00	2SC1448	1.25	MRF8004	3.00
2SA683	.90	2SC778	4.00	2SC1449	1.30	MPS8000	1.25
2SA699	1.30	2SC781	3.00	2SC1678	5.50	MPS8001	1.25
2SA699A	1.45	2SC789	1.00	2SC1728	2.15	MPSU02	.50
2SA733	.65	2SC798	3.10	2SC1780	2.15	MPSU31	4.00
2SA777	.90	2SC799	4.25	2SC1816	4.50	SK3048	3.25
2SB54	.70	2SC1000	.65	2SC1908	.70	SK3049	4.75
2SB56	.70	2SC1013	1.50	2SC1909	4.75	SK3054	1.25
2SB188	.60	2SC1014	1.50	2SC1957	1.50	2SK19	1.75
2SB187	.60	2SC1018	1.50	2SC1973	1.50	2SK30A	1.00
2SB370	1.00	2SC1018	1.50	2SC1975	4.20	2SK33	1.20
2SB406	.85	2SC1061	1.85	2SC2028	1.10	2SK41	1.75
2SB415	.85	2SC1079	3.75	2SC2029	4.75	3SK22Y	2.75
2SB461	1.25	2SC1098	1.20	2SC2081	1.10	3SK40	2.75
2SB463	1.65	2SC1115	2.75	2SC2092	4.75	3SK45	2.75
2SB507	.90	2SC1170	4.00	2SD72	1.00	3SK49	2.75
2SC371	.70	2SC1172	4.00	2SD77	1.00	4004	3.00
2SC372	.70	2SC1173	.95	2SD88	1.50	4005	3.00
2SC481	1.85	2SC1209	.75	2SD92	1.50	40081	1.50
				2SD118	3.25	40082	3.00

### JAPANESE CIRCUITS

AN203	3.75	LA40E1P	4.65	TA7045M	3.50	UH1C004	9.00
AN208	4.75	LA4400FS	3.80	TA7056P	5.50	UPCA1C	3.95
AN210	3.10	LA4400FR	3.80	TA7080P	1.85	UPC563H2	8.00
AN214	4.90	LD3120	3.10	TA7081P	2.25	UPC568H	2.25
AN241	3.20	MS115PR	4.80	TA7083P	2.25	UPC576C	4.00
AN315	3.50	PL101A	13.50	TA7075P	4.90	UPC596C	3.60
BA511	3.50	PL102A	12.00	TA7088P	2.90	UPC1008C	3.10
BA521	3.95	PL102A-G	12.00	TA7120P	2.90	UPC1008C	3.10
HA1202	3.10	SG613	5.40	TA7150P	4.55	UPC1020H	5.50
HA1306W	5.20	STK011	10.50	TA7153P	6.90	UPC1025H	5.50
HA1308	4.50	STK015	6.50	TA7203P	7.00	UPC1156H	6.50
HA1322	5.20	STK032	14.20	TA7204P	6.50	UPD277C	4.50
LA1201	4.25	STK050	24.50	TA7205P	6.50	UPD857C	19.00
LA4031P	3.50	STK056	11.35	UPC16C	2.50	UPD858C	13.00
LA4032P	4.50	STK151	8.50	UPC20C	5.00	UPD881C	22.00

N.J. residents add 5% sales tax.  
All orders add \$1.00 Postage \$1.50 Canada  
minimum order \$5.00

n-te

## NEW-TONE ELECTRONICS

PO Box 1738A Bloomfield, N.J. 07003  
Phone (201) 748-6171, 6172, 6173

PARTIAL LISTING — WRITE FOR FREE CATALOG

CIRCLE 45 ON FREE INFORMATION CARD



**ACOUSTIC COUPLER BY NOVATION**  
\$47.50

The original only coupler was manufactured for use in T1 725 data terminal. It is compatible with Bell 103 and 113 data sets or the equivalent. The coupler operates asynchronously to a maximum speed of 300 baud in the full or half duplex mode. All signal outputs are compatible with TTL. Transmit freq. is 1270hz, for mark and 1070hz, for space. Receive freq. is 2225hz, for mark and 2025hz, for space. Unit requires 3.12 volts and 33 volts for operation. Complete with schematic and all pertinent information fully reconditioned, calibrated and guaranteed.

RS232 to TTL to RS232 Converter Kit  
P.C. Board and Schematic only \$1.50  
Complete kit with components \$6.50

**PITTMAN 12 VDC MOTOR** \$1.95 ea.

The Pittman runs on as low as 2 volts, rated 12 volts 250 ma. 2.8 in. or torque at 5000 RPM 1 1/8" dia. by 2" long with 0.118" shaft.

10 for \$15.  
New and guaranteed.

**10K LINEAR POT**  
1/4" shaft x 1" dia. base  
10 for \$1.95

**6" POWER CORDS**  
BLACK OR WHITE  
10 FOR ONLY \$2.95

**ARNOLD CORE**  
135 MH per 1000 turns.  
1" ID x 1 7/8" OD x 3/4" THK. p/n A 759136-2  
\$1.50 ea. 100 for \$98.00

**SPECIAL**  
1N914B 100/\$4.95  
1000/\$39.95

**STANDARDS KIT**  
An assortment of precision components for calibration of test equipment.  
Kit includes (10) assorted 1% capacitors, (10) assorted 0.01% resistors, and (1) temperature compensated zener reference diode.  
ONLY \$6.95

**MOLEX I.C. PINS**  
100 for \$9.8  
1000 for \$6.95

**NE 2H/A3C NEON**  
100 for \$4.95  
1000 for \$39.95

**MINI KIT** \$3.95

**60MHZ CRYSTAL TIME BASE**  
Special offer on mini kit includes 3679.545MHZ crystal and MM5369 with schematic

**BISMUTH ALLOY**  
Melts in Boiling Water  
4 oz ingot \$3.95  
1 lb ingot \$9.95

**P.C. BOARD MATERIAL**  
1/16" glass epoxy copper clad. 1 oz. 2-sided or 2 oz. 1-sided.  
size 10 100  
3"x6" 2.50 19.95  
5"x7" 4.00 29.95  
6"x8" 4.00 29.95  
4"x12" 5.00 39.95

**DO-IT-YOURSELF ETCH MATERIAL**  
Ace makes it easy with etch powder. Etch 'em to your own specifications.  
EP-1...makes 1 qt...\$1.50  
EP-2...makes 1 gal...\$3.50  
(with instructions)

**HEAT-SHRINK TUBING ASST.** 25/6" lengths various sizes and colors. \$2.95

**TEFLON TUBING ASST.** 25/6" lengths various sizes and colors. \$1.95

**1/2% PRECISION RESISTOR ASST.** 200 FOR \$4.95  
Asst. contains a balanced inventory.

**ZENER DIODE** 1N752 5.6V 400mW 100 for \$5.95  
1000 for \$49.95

**1/2 LB. MIXED ELECTRONIC HARDWARE**.....\$1.00

**COMPUTER GRADE CAPS**  
32D COMPULYTIC  
5900MFD-60VDC 10/\$12.50  
36D COMPULYTIC  
5000MFD-30VDC 10/\$9.00

**HEWLETT PACKARD**  
7730 3" char. RED common anode.  
\$1.50 ea. 4/\$5.95

**MINI TOUCH-TONE PAD**  
ER 21621 BY CHOMERICS  
Only 1 9/16x2-1/16x5/32" above panel.  
1 2 3 Format features  
4 5 8 Elastomer contacts and simple concealed mounts  
7 8 9 Bubble snap-action key tops.  
\$4.95 with data

**KYNAR Wire Wrap Wire**  
Solid silver plated 30AWG. Blue, Red, Yellow, Black, Green, or White.  
100' Spool \$2.50  
500' Spool \$5.95  
1000' Spool \$9.95

**P&B 24V RELAY**  
KHS17D11 4PDT 3 amp herm. sealed  
Pulled from new equipment. \$98/ea.

**HEAT SINK**  
Thermalloy p/n6030B  
Ideal for that power device. 1" x 1 1/8" h  
\$2.25 ea. 10/\$1.98

**HIGH POWER RECTIFIER**  
Varo H407  
6000V 750ma  
\$2.50 ea.

**WHILE THEY LAST!**  
**MOTOROLA MC1406L 6-BIT D/A CONVERTER**  
\$2.95 EACH 10 FOR \$20.00

**INFRARED SENSOR PAIR**  
1 ea. Infrared LED  
1 ea. Infrared Detector  
\$1.00/set

**LITTLE VINYL FEET**  
self-sticking square or round feet. 1/2"x3/16" H  
Sheet of 50.....\$1.00

**ACE ELECTRONIC** (713) 688-8114  
PARTS 5400 Mitchelldale B-B Houston, Texas 77092

TERMS: Include check or money order. NO C.O.D.  
Texas residents add 5% Canada and Mexico add \$2.50  
Overseas countries add \$5.00 for postage rates.  
**MINIMUM ORDER \$10.** We pay post age up to 10 pounds.

# ADVERTISING INDEX

**RADIO-ELECTRONICS does not assume any responsibility for errors that may appear in the index below.**

Free Information Number	Page
13	AP Products..... 24
	Acoustic Fiber Sound Systems..... 32
	Advanced Electronics..... 87,96,102,107
88	Advanced Computer Products..... 88
35	Allison..... 86
3	American Technology..... 71
86	Avanti Research..... Cover IV
77	B & K-Div. of Dynascan..... 81
	Burstein-Applebee..... 104
74	Chemtronics..... 100
	CIE-Cleveland Institute of Electronics OR-21
68	Communication Electronics..... 23
28	Continental Specialties..... 34
	CREI-Div. of McGraw-Hill Continuing Education..... 56-59
47	CC & SS..... 95
	Digital Concepts..... 101
19	ECD..... Cover II
51	E & I. Instruments..... 89
58	Edmund Scientific..... 83
44	EICO..... 90,91
31	Electronics Book Club..... 25
6	Electronics Book Service..... 15
	EMC-Electronic Measurements..... 101
21	Enterprise Development..... 104
17	Fidelity Sound..... 96
5,8	Fluke..... 13
81	Grantham College of Engineering..... 105
	GTE-Sylvania-Consumer Renewal..... 27
100	Heath..... 28-31
7	Hickok Electrical Instruments..... 26
39	Hobbi House..... 94
14	Indiana Home Study..... 86
59	International Crystal..... 103
4	James Electronics..... Cover III
90	JFD Electronics..... 78
32	JMJ Technical Products..... 93
75	JS & A..... 1
38	Leader..... 84
56	McGraw-Hill..... 33
40	MTI..... 77
10	Mountain West Alarm Supply..... 82
16	National Camera Supply..... 14
	National Radio Institute (NRI)-Div. of McGraw-Hill Continuing Education Center 8-11
	National Technical Schools..... 46-49
85	NESDA..... 96
79	OK Machine & Tool..... 80
87	Oneida Electronics..... 106
83	PAIA..... 99
66	Platt Luggage..... 102
1,2	Professional Aids..... 75
73	Projectapix..... 93
	Radio Shack..... 5
	RCA-Distributor and Special Products 74A-74B,82-83,90-91,95
52	Rye Industries..... 75
	H.W. Sams..... 97
43	Sansui..... 7
82	Schober Organ..... 86
20	Sencore..... 16
61	Shure Brothers..... 85
62	Southwest Technical Products..... 79
	Sinclair Radionics..... 17
48	Spacecom..... 98
72	Telematic-Div. of UXL..... 92
	Thordarson Meissner..... 104
18	Tri-Star..... 78
42	VIZ Mfg..... 99
11	Vaco..... 2
80	Vector Electronics..... 107
22	Weller-Xcelite Div. of Cooper Industries..... 22
54	Wersi Electronics..... 104

# Free Information Number Page

Free Information Number	Page
	Market Center
70	Ace Electronics..... 114
78	ADVA Electronics..... 128
53	Active Electronics..... 118
	AMC Sales..... 110
	ATV Research..... 118
69	Babylon Electronics..... 124
	Karel Barta..... 108
41	Brooks Radio & TV..... 120
	Burdex Security..... 110
	CFR Associates..... 108
	Command Productions..... 110
	Cooks Institute..... 110
	Delta Scientific Instruments..... 108
29	Dage Electronics..... 130
	Devtronix Organ Products..... 108
63	Digi-Key..... 127
30	EDI..... 108
23	Eco Electronics..... 117
76	E.T.I..... 130
	Fair Radio..... 110
46	Fordham Radio Supply..... 128
34	Formula International..... 121
26	Godbout Electronics..... 112
	Information Unlimited..... 112
	Interfab..... 112
33	International Electronics..... 125
24,25	James Electronics..... 122,123
	Lab Science..... 110
	Lakeside Industries..... 128
60	Lin Corporation..... 118
49	Meshna..... 128
45	New Tone..... 112
71	Olson..... 124
37	Optoelectronics..... 119
9	Page Digital Electronics..... 120
12	Printronic..... 120
27	Poly Paks..... 113
36	Quest..... 110
65	Radio Hut..... 131
	Radio Shack..... 111
57	Ramsey Electronics..... 126
64	SD Sales..... 129
15	JB Saunders..... 109
55	Solid State Sales..... 126
67	Texas Tuner..... 112

**MOVING?**

Don't miss a single copy of **Radio-Electronics**. Give us:

**Six weeks' notice**

Your old address and zip code

Your new address and zip code

name (please print)

address

city state zip code

ATTACH LABEL HERE

Mail to: Radio-Electronics  
SUBSCRIPTION DEPT., P.O. BOX 2520,  
BOULDER, COLO. 80322

RADIO-ELECTRONICS

# ETCO<sup>®</sup> ELECTRONICS

# Unusual SURPLUS SPECIALS

## DEK EDUCATIONAL ELECTRIC MOTOR KIT

THOUSANDS SOLD  
TO SCHOOLS

Follow the instructions and from bits and pieces of wire and metal, it springs to life. The instructions teach basic electrical theory. Includes everything necessary except flashlight battery. KT1978.



**\$2.49**  
10/\$19.95

## 110 VAC SOLENOID WATER VALVE

**Surplus!**

Brand new factory surplus - as used in dishwashers, etc. Great for building automated garden watering system, lab work, service and industrial applications. While they last. SU242B.



**3.95**

## MINIATURE THRU-PANEL DIAL REDUCTION DRIVE

10:1 RATIO! 10,000 AVAILABLE

**SAVE!**

Imported from England, this mini reduction drive is ideal for tiny, compact gear. 10:1 ratio. 4mm input bore and output shaft. Mounts in 10mm (3/8") dia. hole. Mounting nut provided. HM024B.

**\$2.95**  
10/\$24.95  
100/\$199.00



## General Motors Surplus CADILLAC HEADLIGHT TURNOFF TIMERS

10,000 AVAILABLE

GM 4L2 0015-01-3996297 UCC2181 Original Cadillac solid state headlight turnoff timers. Brand new with schematic and sheet showing timer, burglar alarm and automotive application ideas. Times from 1 second to 3 minutes. HM162B



**3.95**  
10/\$29.95  
100/\$195.00

## BASF 7" METAL REELS

BASF 1500 AVAILABLE

Brand new 7" precision metal reels that make any recorder look and perform better. In original cartons. Stock up now while they last. Only 1500 available. TR273B

**\$3.95**  
10/\$36.95



## GIANT 22" PARABOLIC MICROPHONE REFLECTOR

**19.95**  
10/\$179.00

**VALUE**

Transparent, sound reflective plastic "dishes" for construction of long distance parabolic microphones and sound projectors. Reflector was especially designed to provide high gain audio capture capability. Microphone construction ideas included. MP233B.



## MINIATURE 6 VDC REED RELAY

FACTORY SURPLUS!

2000 AVAILABLE

Only 1 1/2" x 7/16" x 3/8" H. For those mini circuit applications. 1 amp. contacts. Coil resistance 600 ohms. Pulls in at 5-13 ma. Drops out at 2.5 ma. PC board mounting. Brand new factory surplus. RL012B



**1.49**  
10/\$12.95

## SOUND TRANSDUCERS

**CLOSE-OUT!**

Convert walls, doors, ceilings, etc. into speakers. Transforms audio into high amplitude vibrations that are transmitted to flat surfaces by screw-in transducer. A great experimenter item. SP118B.



**\$9.95**

## SURPLUS SALE!

- SU094B 365/140 uufd variables ..... 19c
- SP063B Unusual Philips 6" 800 ohm spkr. .... \$1.95
- SU031B 8 ohm radio earphone ..... 15c
- TR626B Experimental 2 track recording head ..... 19c
- MS117B Silicon treated record cleaning cloth ..... 19c
- BB033B No. 41 miniature 2kV .5A bulb ..... 6c
- 100/\$4.95 - 1000/\$39.95
- BA324B NiCad charger for 4 pencils ..... \$4.95
- PT166B 10 assorted thermistors ..... \$1.99
- PT167B 100 asst. metal film capacitors ..... \$6.95
- PT123B 100 asst. radio/TV controls ..... \$3.95

## TUBE

## CLOSE-OUT SALE!

BRAND NEW - FACTORY SURPLUS - FULL 90 DAY ETCO WARRANTY!

The following types available in quantity for immediate delivery. Order now while available as these types will become impossible to obtain as inventories are depleted in the world markets.

OB3/VR90	2.89	6F6G	5.81	12DL8	1.99
OD3/VR150	1.49	6FY5	.99	12DS7	2.81
1A5GT	3.61	6G6G	.29	12DT8	2.69
1AD4	1.95	6MK8A	4.12	12EK6	2.19
1L4	2.69	6N7	.89	12K5	1.49
1LA6	2.69	6S8GT	1.99	12SF5	.99
1S5	1.95	6SA7	.99	12SJ7	.99
1T4	1.89	6SG7	2.91	12SL7GT	3.01
2E24	1.95	6SH7	.29	12X4	.69
2X2	.26	6SJ7	2.79	14S7	.69
3Q4	2.29	6SK7	.99	VR21	.10
3S4	2.39	6T4	1.95	25A4	2.39
5AV8	.49	6X5GT	.99	25C5	2.89
5AZ4	.99	7A4	.89	45Z3	1.89
5BQ7	1.99	7A5	1.39	50DC4	.99
5CQ8	1.99	7A6	8.50	76	.99
5J6	.59	7A8	3.99	80	4.69
5Y4G	1.29	7AG7	6.21	83V	3.89
5Z3	1.49	7AK7	3.92	84/6Z4	1.98
6AC7	.59	7C7	6.21	84M	.69
6AF3	3.99	7E7	2.38	117Z4	.99
6AF4	4.61	7F8	6.90	WE101L	5.95
6AH6	2.19	7GS7	3.61	274A	1.99
6AJ5	2.69	7Q7	7.42	401A	2.69
6AK5	2.95	7V7	6.39	403B	3.95
6AK6	2.59	7X6	.99	715B	2.69
6AL7GT	.99	12AC6	1.99	717	.99
6AQ6	.99	12AJ7	.95	807	2.69
6AS6	2.81	12AL5	1.99	878	4.95
6BA4	10.15	12AT7	1.89	1616	.99
6BA7	2.13	12AU7	1.89	5516	1.89
6BD5	.99	12AV6	1.99	5678	.79
6BH6	1.69	12AW6	.89	5823	.49
6BJ6	.99	12AX7	1.89	5829	.99
6BL8	.99	12BA7	1.89	6080	12.95
6BR5	3.21	12BF6	.99	6360A	8.95
6BY5	2.19	12BV7	2.19	8008	7.95
6CU8	3.95	12BZ7	2.89	8345	1.98
6DN6	.89	12C8	1.98	8458	.29
6EV5	2.89	12CS6	.99	9001	1.89



## INCREDIBLE! ON THE FRITZ CALCULATOR BLITZ!

**2.95**  
10/\$24.95  
SU279B

The factory says "It doesn't pay to repair 'em" so ETCO buys 'em cheap! Be smart - take 'em apart. Fix them if you can, or give 'em to the kids! Order now, while we have stock.

"SEE" MUSIC IN FLASHING COLOR!

## The DEK/ite 3-CHANNEL, 1200 WATT COLOR ORGAN KIT

400 watts per channel. A unique DEK/ite of quality parts for easy construction of your own high powered color organ. Use with home music system, PA or music amplifiers. Complete with French, English instructions. KT185B



**21.95**

QUANTITY  
PRICES

## CANADIANS

Advertised merchandise is available at our Canadian stores at the same price as in U.S.A.

- \* MONTREAL, QUEBEC
- \* POINTE CLAIRE, QUEBEC
- \* TORONTO, ONTARIO (coming soon)

## SURPLUS WANTED

We are large quantity buyers of just about anything interesting. Write us today with your listing to A11 Marvin Birnbaum.

## \$1 NEW SURPLUS CATALOG \$1 JUST OFF THE PRESS!

New 64-page bargain packed electronic parts and surplus catalog. Thousands of exciting surplus items and hard to find parts for OEM, schools, hobbyist and industry. FREE copy with each order from this ad.

NAME .....

ADDRESS .....



CANADIAN  
MAILORDER  
CENTER  
183G Hymus Blvd.  
Pointe Claire,  
Quebec H9R 1E9

USA  
MAILORDER  
CENTER  
521 Fifth Ave.,  
New York,  
N.Y. 10017.

MERCHANDISE SUBJECT TO PRIOR SALE. PRICES SUBJECT TO CHANGE WITHOUT NOTICE.

Full remittance with each order, or BANKAMERICARD, MASTERCARD, VISA or CHARGE. Add 10% for postage and handling (excess refunded).

QUALITY PARTS  
GUARANTEED

# 2 IN 1

EASY  
ASSEMBLY

## COMBINED 8 DIGITS 0.5" LED 250MHz FREQ. COUNTER - 3 1/2 DIGITS MULTIMETER

- ICS SOCKETED
- PUSHBUTTON SWITCHES

- DELUXE CABINET
- COMPLETE INSTRUCTIONS

### METER Section

Input protected  
11 Meg Impedance  
Auto Polarity  
Overrange and  
Negative sign indicator  
4 Overlapping ranges  
on AC & DC VOLT  
to 1KV & Current  
to 1 Amp.  
5 Ranges on Ohm  
Accuracy:  
± 1% ± 1 Count

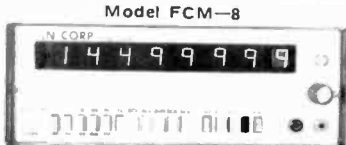

10W X 3 1/2 H X 9 D

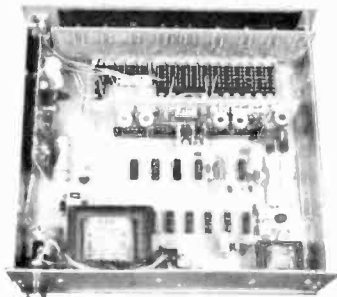

### COUNTER Section

Input - 1 Meg. Ohm  
Shunted by 3 pFd.  
50 mv Sensitivity  
Stability - Crystal  
time base - ± 5 ppm  
1Hz Resolution  
to 30 MHz - 10 Hz  
above.



Please Add  
\$2.50 Shipping  
Per Unit  
California Residents  
Add 6% Sales Tax

## SUPER VALUE!

Model FCM-8 **\$219.95** per kit

**LIN CORP.** 15311 S. Broadway, Gardena, California 90248 (213) 532-8809

CIRCLE 60 ON FREE INFORMATION CARD

### BUILD YOUR OWN TV CAMERA — Ideal for home & business —



THE ECONOMIC ANSWER TO HOME MONITORING OF BUSINESSES, ENTRANCES, DRIVEWAYS, BUSINESS AND INDUSTRIAL SURVEILLANCE... TV... AMATEUR TV PLUS HUNDREDS OF OTHER APPLICATIONS. MODEL TV-1A. SERIES D - KIT FORM \$185. ASSEMBLED \$275. SOLID-STATE. WORKS ON ANY TV SET. OPTIONAL SOUND KIT \$28.95. PHONE OR WRITE for catalog. Dial 402-987-3771

BOX 453-RE ATV Research DAKOTA CITY, NE. 68731

**NEW!** Electronics catalog. Rush \$1.00. Refundable with first order. **HOBBIE-TRONICS**, 4950 Clearwood Way, Sacramento, CA 95841

**TELEPHONE** recording equipment and other 'unusual' electronic devices. Free information. **GARRISON**, Box 128, Kew Gardens, New York, 11354

**BUILDING?** Try our top quality electronic parts in your circuits. No CB's, TV's, or Ham sets—just parts. **BRAND X**, Rt. 3, Box 223, Ontario, OR 97914

**CANADA'S** best prices for IC's & semiconductors. 1st quality only. Catalog 25¢. **C.M. ELECTRONICS**, P.O. Box 95, Longueuil, Quebec, Canada J4K-4X8. U.S. Inquiries invited.

**RADIO** & TV tubes 36¢ each. One year guaranteed. Plus many unusual electronic bargains. Free catalog. **CORNELL**, 4217-E University, San Diego, Calif. 92105

**C2708**: \$25.00; **C1702A**: \$5.00; **C2107A**: \$4.50; **2813**, 32wd X 9-bit FIFO \$6.50; **CA3130T** MOS OPAMP: \$1.75; **NE526** analog voltage comparator \$0.65; **NE553**: \$2.10; **FIGARO** gas sensor: \$5.95; electroluminescent panel, 115VAC: \$0.95; 20-MHz crystal: \$4.50; modular edge connector \$0.15; 24-pin socket \$0.40; 8-position DIP switch: \$2.25; 10-position BCD thumbwheel \$1.50; photoflash, 570 µF: \$0.99. **ELECTRONIC DISCOUNT SALES**, 138 N81st Street, Mesa, AZ 85207

**MAKE** professional-quality PC boards with silk-screen techniques. Complete step by step information, \$4.95 Postpaid. **TERRATRONIC RESEARCH**, Box 513B, Quincy, IL 62301

### TTL PLASTIC DUAL-IN-LINE I.C.

SN7400N	12	SN7453N	14	SN74132N	69	SN74186N	7.50
SN7401N	14	SN7454N	14	SN74136N	59	SN745188AN	1.85
SN7402N	14	SN7460N	14	SN74141N	88	SN74190N	1.04
SN7403N	14	SN7470N	26	SN74142N	3.70	SN74191N	1.04
SN7404N	17	SN7472N	25	SN74143N	3.98	SN74192N	0.84
SN7405N	17	SN7473N	29	SN74144N	3.98	SN74193N	0.84
SN7406N	25	SN7474N	28	SN74145N	69	SN74194N	0.89
SN7407N	25	SN7475N	46	SN74147N	1.58	SN74195N	0.54
SN7408N	17	SN7476N	30	SN74148N	1.19	SN74196N	0.87
SN7409N	17	SN7480N	35	SN74150N	94	SN74197N	0.73
SN7410N	14	SN7481AN	95	SN74151N	61	SN74198N	1.64
SN7411N	20	SN7482N	55	SN74152N	3.45	SN74199N	1.64
SN7412N	21	SN7483AN	65	SN74153N	61	SN74221N	1.14
SN7413N	39	SN7484AN	1.50	SN74154N	95	SN74246N	1.95
SN7414N	62	SN7485N	84	SN74155N	70	SN74247N	1.70
SN7416N	24	SN7486N	30	SN74156N	64	SN74248N	1.75
SN7417N	29	SN7489N	1.85	SN74157N	59	SN74249N	1.75
SN7420N	14	SN7490AN	43	SN74159N	2.50	SN74251N	1.05
SN7421N	20	SN7491AN	59	SN74160N	85	SN74259N	1.35
SN7422N	20	SN7492AN	44	SN74161N	85	SN74265N	0.85
SN7423N	25	SN7493AN	44	SN74162N	85	SN74273N	1.35
SN7425N	25	SN7494N	69	SN74163N	85	SN74276N	0.75
SN7426N	22	SN7495AN	67	SN74164N	98	SN74278N	1.99
SN7427N	25	SN7496N	65	SN74165N	97	SN74279N	0.57
SN7428N	28	SN7497N	2.50	SN74166N	1.09	SN74283N	1.39
SN7430N	14	SN74100N	97	SN74167N	2.75	SN74284N	4.50
SN7432N	23	SN74104N	42	SN74170N	1.69	SN74285N	4.50
SN7433N	30	SN74105N	42	SN74172N	8.75	SN74290N	0.85
SN7437N	21	SN74107N	28	SN74173N	1.24	SN74293N	0.83
SN7438N	21	SN74109N	47	SN74174N	94	SN74298N	1.64
SN7440N	14	SN74110N	52	SN74175N	84	SN74351N	1.92
SN7442N	37	SN74111N	69	SN74176N	77	SN74365N	0.65
SN7443N	68	SN74116N	1.50	SN74177N	76	SN74366N	0.65
SN7444AN	85	SN74120N	1.40	SN74178N	1.19	SN74367N	0.65
SN7445N	65	SN74121N	34	SN74179N	1.49	SN74368N	0.65
SN7446AN	70	SN74122N	38	SN74180N	67	SN74376N	0.75
SN7447AN	59	SN74123N	48	SN74181N	1.94	SN74390N	1.40
SN7448N	69	SN74125N	40	SN74182N	59	SN74393N	1.40
SN7450N	14	SN74126N	40	SN74184N	1.75	SN74426N	0.45
SN7451N	14	SN74128N	59	SN74185AN	1.74	SN74490N	1.90

### CMOS

CD4000BE	13	CD4052BE	1.15
CD4001BE	16	CD4053BE	0.89
CD4002BE	16	CD4055BE	1.29
CD4006BE	99	CD4060BE	0.99
CD4007BE	16	CD4066BE	0.59
CD4008BE	80	CD4068BE	24
CD4009BE	37	CD4069BE	24
CD4010BE	37	CD4070BE	24
CD4011BE	16	CD4071BE	24
CD4012BE	16	CD4072BE	29
CD4013BE	29	CD4073BE	29
CD4014BE	74	CD4075BE	29
CD4015BE	74	CD4076BE	98
CD4016BE	29	CD4078BE	24
CD4017BE	79	CD4081BE	24
CD4018BE	79	CD4082BE	29
CD4019BE	38	CD4085BE	75
CD4020BE	84	CD4086BE	75
CD4021BE	89	CD4502BE	1.15
CD4022BE	89	CD4507BE	39
CD4023BE	16	CD4510BE	1.05
CD4024BE	67	CD4511BE	1.25
CD4025BE	16	CD4512BE	69
CD4026BE	1.39	CD4514BE	2.50
CD4027BE	38	CD4515BE	2.50
CD4028BE	74	CD4516BE	84
CD4029BE	77	CD4518BE	84
CD4030BE	37	CD4519BE	79
CD4033BE	1.60	CD4520BE	79
CD4034BE	2.95	CD4522BE	1.98
CD4035BE	98	CD4526BE	1.50
CD4040BE	99	CD4527BE	1.50
CD4041BE	67	CD4528BE	1.20
CD4042BE	58	CD4531BE	1.25
CD4043BE	45	CD4539BE	1.20
CD4044BE	45	CD4555BE	75
CD4046BE	2.45	CD4556BE	75
CD4047BE	2.45	CD4581BE	2.25
CD4049BE	34	CD4582BE	9.95
CD4050BE	34	CD4585BE	1.80
CD4051BE	89		

### CMOS

74C14/40014PC	75
74C85/40085PC	1.20
80C97/40097PC	0.65
80C98/40098PC	0.65
74C160/40160PC	1.50
74C161/40161PC	1.50
74C162/40162PC	1.50
74C163/40163PC	1.50
74C174/40174PC	1.40
74C175/40175PC	1.40
74C192/40192PC	1.50
74C193/40193PC	1.50
74C194/40194PC	1.40
74C195/40195PC	1.40

### TEXAS INSTRUMENTS

I.C. SOCKETS  
(Low Profile Solder Tail)

Description	Unit Price
8 Pin DIL (C848002)	15
14 Pin DIL (C841402)	18
16 Pin DIL (C841602)	19
18 Pin DIL (C841802)	29
20 Pin DIL (C842002)	35
22 Pin DIL (C842202)	34
24 Pin DIL (C842402)	34
28 Pin DIL (C842802)	45
40 Pin DIL (C844002)	65

### VOLTAGE REGULATORS

SG3501AT	3.60	±5V Dual Tracking Regulator
SG3524J	7.25	Switching Regulator
SG4501T	1.80	-15V Dual Tracking Regulator
RC4194TK	1.95	Variable Dual Tracking Regulator ±35V ±9.5V
RC4195T	2.35	Fixed ±15V Dual Tracking Regulator 105
RC4195TK	3.15	Fixed ±15V Dual Tracking Regulator 1066
78H05KC	6.35	5 Amp 5 Volt Positive Regulator 103
78M00 Series	99	Positive Voltage Regulators (Plastic) 1 amp
10/220 / LM340T	1.39	Positive Voltage Regulator 1/2 Amp
78M00 Series	5.6, 8, 12, 15, 18, 24 Volts	
10/5 / LM340H	1.49	Positive Voltage Regulator 1 Amp
7800 Series	5.6, 8, 12, 15, 18, 24 Volts	
10/3 / LM340K	2.9	Positive Voltage Regulator 100 MA
78L00 AWC Series	2.6, 5, 6.2, 8.2, 12, 15 Volts	
10/92	1.25	Negative Voltage Regulator 1 Amp
7900 Series	5.6, 8, 12, 15, 18, 24 Volts	
10/220 / LM320T	1.35	Negative Voltage Regulator 1/2 Amp
79M00 Series	5.6, 8, 12, 15, 20, 24 Volts	
10/5 / LM320H	1.75	Negative Voltage Regulator 1 Amp
7900 Series	5.6, 8, 12, 15, 18, 24 Volts	
10/3 / LM320K	1.20	Dual In Line Adjustable 4 Terminal Positive Voltage Regulator
78MG12C	1.20	Dual In Line Adjustable 4 Terminal Negative Voltage Regulator
79MG12C	1.45	1 Amp Adjustable Positive Voltage Regulator
78GU10/220	1.25	1 Amp Adjustable Negative Voltage Regulator
78GC10/3	1.80	1 Amp Adjustable Positive Voltage Regulator
79GK10/3	2.10	1 Amp Adjustable Negative Voltage Regulator



Our new comprehensive 1977/1978 Catalogue, listing complete descriptions, illustrations and special monolithic pricing on over 10,000 items, is now available on request.

## Active Electronic Sales Corp.

P.O. BOX 1035 FRAMINGHAM, MASSACHUSETTS 01701  
Telephone Orders & Enquiries (617) 879-0077 New Catalogue available on request  
NOW IN CANADA 5647 Ferrier st. 44 Fasken Dr. Unit 25 MINIMUM ORDER \$10.00 + ADD \$1.00 TO COVER  
2 Locations Montreal, Quebec Rexdale, Ontario POSTAGE & HANDLING + Canadian customers add 30%  
Tel. (514) 735-6429 Tel. (416) 677-4287 for duty and handling. All federal and provincial taxes extra

CIRCLE 53 ON FREE INFORMATION CARD

NEW LSI TECHNOLOGY  
**FREQUENCY COUNTER**

TAKE ADVANTAGE OF THIS NEW STATE-OF-THE-ART COUNTER FEATURING THE MANY BENEFITS OF CUSTOM LSI CIRCUITRY. THIS NEW TECHNOLOGY APPROACH TO INSTRUMENTATION YIELDS ENHANCED PERFORMANCE, SMALLER PHYSICAL SIZE, DRASTICALLY REDUCED POWER CONSUMPTION [PORTABLE BATTERY OPERATION IS NOW PRACTICAL], DEPENDABILITY, EASY ASSEMBLY AND REVOLUTIONARY LOWER PRICING!

- KIT #FC-50C ..... 60 MHZ COUNTER WITH CABINET & P.S. .... **\$119<sup>95</sup>** COMPLETE!
- KIT #PSL-650 ..... 650 MHZ PRESCALER [NOT SHOWN] ..... 29.95
- MODEL #FC-50WT ..... 60 MHZ COUNTER WIRED, TESTED & CAL ..... 165.95
- MODEL #FC-50/600 WT. .... 600 MHZ COUNTER WIRED, TESTED & CAL ..... 199.95

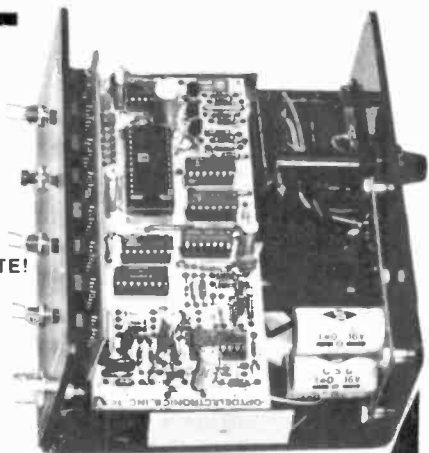

SIZE:  
3" High  
6" Wide  
5 1/2" Deep

**FEATURES AND SPECIFICATIONS:**  
 DISPLAY: 8 RED LED DIGITS .4" CHARACTER HEIGHT  
 GATE TIMES: 1 SECOND AND 1/10 SECOND  
 PRESCALER WILL FIT INSIDE COUNTER CABINET  
 RESOLUTION: 1 HZ AT 1 SECOND, 10 HZ AT 1/10 SECOND.  
 FREQUENCY RANGE: 10 HZ TO 60 MHZ [65 MHZ TYPICAL].  
 SENSITIVITY: 10 MV RMS TO 50 MHZ, 20 MV RMS TO 60 MHZ TYP.  
 INPUT IMPEDANCE: 1 MEGOHM AND 20 PF.  
 [DIODE PROTECTED INPUT FOR OVER VOLTAGE PROTECTION.]  
 ACCURACY: ± 1 PPM (± 0.001%) AFTER CALIBRATION TYPICAL.  
 STABILITY: WITHIN 1 PPM PER HOUR AFTER WARM UP [.001% XTAL]  
 IC PACKAGE COUNT: 8 [ALL SOCKETED]  
 INTERNAL POWER SUPPLY: 5 V DC REGULATED.  
 INPUT POWER REQUIRED: 8-12 VDC OR 115 VAC AT 50/60 HZ.  
 POWER CONSUMPTION: 4 WATTS

KIT #FC-50C IS COMPLETE WITH PREDRILLED CHASSIS ALL HARDWARE AND STEP-BY-STEP INSTRUCTIONS. WIRED & TESTED UNITS ARE CALIBRATED AND GUARANTEED.

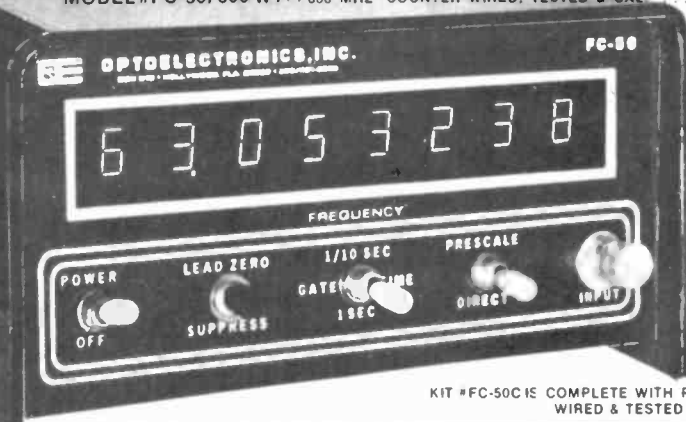

**PLEXIGLAS CABINETS**

Great for Clocks or any LED Digital project. Clear-Red Chassis serves as Bezel to increase contrast of digital displays.

- CABINET I  
3"H, 6 1/4"W, 5 1/2"D Black, White or Clear Cover
- CABINET II  
2 1/2"H, 5"W, 4"D \$6.50 ea.

RED OR GREY PLEXIGLAS FOR DIGITAL BEZELS  
3"x6"x1/8" 95¢ ea. 4/#3

**SEE THE WORKS Clock Kit**  
Clear Plexiglas Stand

- 6 Big .4" digits
- 12 or 24 hr time
- 3 set switches
- Plug transformer
- all parts included

Plexiglas is Pre-cut & drilled  
Kit #850-4CP

Size: 6"H, 4 1/4"W, 3 1/2"D  
Assembled  
\$23<sup>50</sup> ea. 2/#45. \$29<sup>95</sup>

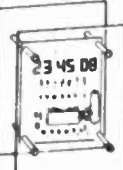

**60 HZ. XTAL TIME BASE**  
Will enable Digital Clock Kits or Clock-Calendar Kits to operate from 12V DC  
1"x2" PC Board  
Power Req. 5-15V (2.5 MA. TYP.)  
Easy 3 wire hookup  
Accuracy ± 2PPM  
#TB-1 (Adjustable)  
Complete Kit **\$4<sup>95</sup>**  
Wir & Cal \$9.95

**SPECIAL PRICING!**  
PRIME - HIGH SPEED RAM

**21L02-3** 400 NS  
LOW POWER - FACTORY FRESH  
1-24 \$1.75 ea. 100-199 \$1.45 ea.  
25-99 1.60 ea. 200-999 1.39 ea.  
1000 AND OVER **\$1.29** ea.

**5-DIGIT LED CLOCK CALENDAR KIT**  
DATE-TIME-SNOOZE ALARM & MORE... KIT 7001

FOR THE BUILDER THAT WANTS THE BEST FEATURING 12 OR 24 HOUR TIME - 29-30-31 DAY CALENDAR. ALARM, SNOOZE AND AUX. TIMER CIRCUITS

Will alternate time (8 seconds) and date (2 seconds) or may be wired for time or date display only, with other functions on demand. Has built-in oscillator for battery back-up. A loud 24 hour alarm with a repeatable 10 minute snooze alarm, alarm set & timer set indicators. Includes 110 VAC/60Hz power pack with cord and top quality components through-out.

- KIT 7001B WITH 6 .5" DIGITS ..... \$39.95
- KIT 7001C WITH 4 .6" DIGITS & 2 .3" DIGITS FOR SECONDS ..... \$42.95
- KIT 7001X WITH 6 .6" DIGITS ..... \$45.95

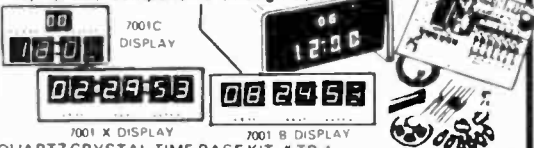

KITS ARE COMPLETE (LESS CABINET)

ALL 7001 KITS FIT CABINET I AND ACCEPT QUARTZ CRYSTAL TIME BASE KIT #TB-1

PRINTED CIRCUIT BOARDS FOR CT-7001 Kits sold separately with assembly info. PC Boards are drilled Fiberglass, solder plated and screened with component layout.

Specify for 7001  
B, Cor X - \$7.95

**AUTO BURGLAR ALARM KIT**

AS EASY TO ASSEMBLE AND EASY TO INSTALL ALARM PROVIDING MANY FEATURES NOT NORMALLY FOUND. RELESS ALARM HAS PROVISION FOR 90S & GROUNDING SWITCHES OR SENSORS WILL PULSE HORN RELAY AT 1HZ RATE OR DRIVE SIREN. KIT PROVIDES PROGRAMMABLE TIME DELAYS FOR EXIT, ENTRY & ALARM PERIOD. UNIT MOUNTS UNDER DASH. REMOTE SWITCH CAN BE MOUNTED WHERE DESIRED. CMOS RELIABILITY. RESISTS FALSE ALARMS & PROVIDES FOR ULTRA DEPENDABLE ALARM. DOES NOT BE FOOLED BY LOW PRICES! THIS IS A TOP QUALITY COMPLETE KIT WITH ALL PARTS INCLUDING DETAILED DRAWINGS AND INSTRUCTIONS OR AVAILABLE WIRED AND TESTED.



KIT #ALR-1 \$9.95  
#ALR-1WT WIRED & TESTED \$19.95

**VARIABLE REGULATED 1 AMP POWER SUPPLY KIT**

- VARIABLE FROM 4 TO 14V
- SHORT CIRCUIT PROOF
- 723 IC REGULATOR
- 2N3055 PASS TRANSISTOR
- CURRENT LIMITING AT 1 amp
- KIT IS COMPLETE INCLUDING DRILLED & SOLDER PLATED FIBERGLASS PC BOARD AND ALL PARTS (LESS TRANSFORMER)
- FORMER: KIT #PS-01 \$8.95
- TRANSFORMER 24V CT will provide 300MA at 12V and 1 Amp at 5V. \$3.50

**MOBILE LED CLOCK**

12/24 HR .4" DIGITS!

MODEL 12 VOLT AC or DC POWERED #2001

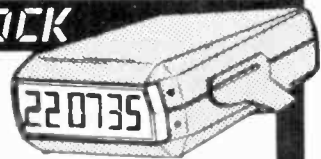

- 6 JUMBO .4" RED LED'S BEHIND RED FILTER LENS WITH CHROME RIM
- SET TIME FROM FRONT VIA HIDDEN SWITCHES • 12/24-Hr. TIME FORMAT
- STYLISH CHARCOAL GRAY CASE OF MOLDED HIGH TEMP. PLASTIC
- BRIDGE POWER INPUT CIRCUITRY - TWO WIRE NO POLARITY HOOK-UP
- OPTIONAL CONNECTION TO BLANK DISPLAY [Use When Key Off In Car, Etc.]
- TOP QUALITY PC BOARDS & COMPONENTS - INSTRUCTIONS.
- MOUNTING BRACKET INCLUDED

KIT #2UG1 \$27<sup>95</sup> 3 OR \$25<sup>95</sup> 115 VAC \$2<sup>50</sup>  
COMPLETE KIT EA. MORE EA. Power Pack EA. #AC-1

ASSEMBLED UNITS WIRED & TESTED ORDER #2001 WT [LESS 9V. BATTERY] \$37<sup>95</sup> 3 OR \$35<sup>95</sup>  
Wired for 12-Hr. Op. if not otherwise specified. EA. MORE EA.

ORDER BY PHONE OR MAIL  
COD ORDERS WELCOME

**OPTOELECTRONICS, INC.**

BOX 219 HOLLYWOOD, FLA. 33022  
PHONE [305] 921-2056 / 921-4425

ORDERS TO USA & CANADA ADD 5% FOR SHIPPING, HANDLING & INSURANCE. ALL OTHERS ADD 10%. ADDITIONAL \$1.00 CHARGE FOR ORDERS UNDER \$15.00 - COD FEE \$1.00. FLA. RES. ADD 4% STATE TAX.



CIRCLE 37 ON FREE INFORMATION CARD

Test Equip. Special Discount Prices



BLUE LATERAL MAGNET/PURITY RING.....	1.79
COLOR DELAY LINE.....	1.69
ZENITH STICK RECTIFIER #103-215.....	5.95
ZENITH TRIPLER # 212-109.....	3.95
RCA COLOR POWER TRANSFORMER #26R150.....	9.95
2—COLOR BURST CRYSTALS (3579.545KC).....	1.89
3—COLOR TV RECTIFIERS 6500KV.....	1.95
5—DUAL DIODES (Common or Series).....	2.49
3—ZENITH VIDEO AMP. #121-743.....	2.00
3—ZENITH VIDEO DRIVER #121-952.....	1.29
TACHOMETER 2 1/2" SQ. PANEL METER.....	2.00
7 TUBE AM FM STEREO AMP. with tubes.....	9.95
6—SILICON RECT. 1 Amp. 1000 Piv.....	1.00
6—SILICON RECT. 2 Amp 1000 Piv.....	1.49
DELUXE PILLOW SPEAKER.....	2.29
3—POLARIZED CHEATER CORDS.....	1.00
4—TV ALIGNMENT KIT.....	1.00
6—TV ALIGNMENT KIT (Color).....	2.79
VU "T" METER (0-20db Scale).....	1.00
100' GREY SPEAKER WIRE.....	2.00
CO-AX CABLE—50' 2.69.....	250' 10.00
3" X 5" SPEAKER.....	1.49
6" X 9" SPEAKER 10 oz.....	5.50
8" SPEAKER 10 oz.....	5.50
6" X 9" SPEAKER 20 oz.....	10.95
2" X 6" SPEAKER.....	1.95
3" TWEETER.....	1.49
STEREO HEADPHONE.....	5.95
100' 300 OHM-100 MIL.—ant wire.....	2.95
RCA 110° FLYBACK TRANS. (Bk & Wht).....	3.95
110° YOKE (Bk & wht).....	4.95
90° COLOR YOKE.....	7.95
70° COLOR YOKE RCA type.....	5.95
70° COLOR CRT BOOSTER.....	3.95
90° COLOR CRT BOOSTER.....	4.50
BEHIND THE SET ANTENNA.....	2.95
UHF TUNERS.....	2.95
UHF TUNERS GE TYPE.....	3.95
PHILCO UHF/VHF TUNERS (Trans).....	9.95
GE TV TUNER (Series EP6X11).....	7.95
WAHL CORDLESS SOLDER IRON.....	17.95
MONO PHONO TONE ARM.....	1.69
3—UHF ANT. LOOP.....	1.79
B&K-280 3 DIG. MULTIMETER.....	84.95
BSR RECORD CHANGER.....	24.95
10-ASSTD. CIRCUIT BREAKERS.....	4.95
HEP-707 TRANSISTOR-55020.....	2.29
2-HEP 50015 TRANSISTOR.....	1.00
HEP 55004 TRANSISTOR.....	1.00
HEP 55011 OR 55012.....	1.00
TRANSISTORS SK3006, SK3018, SK3020.....	1.00 ea
"    SK3122, SK3124.....	1.00 ea
"    SK3009, SK3024, SK3040.....	1.00 ea
GE IC3 or IC 4.....	1.00 ea
5—12BH7 Westinghouse Tubes.....	2.95
SOLID STATE DC POWER SUPPLY 12V-4 Amp.....	14.95
5—ANTENNA MATCHING TRANS (72 to 300 Ohm).....	5.95
TRANSISTOR RADIO as is.....	1.50
TAPE RECORDERS as is.....	4.00
TRANSISTORS ECG-108, ECG116, ECG123A.....	1.00 ea
"    ECG160, ECG-121, ECG 128.....	1.00 ea
TRANSISTOR SPECIAL ECG 154.....	1.00
TUNER SPRAY 16 oz. can.....	1.59
75 —ASSTD. 1/2W RESISTORS.....	1.29
100—    "    1/4W.....	1.00
200—    "    1/4W    "    short leads.....	1.00
70 —    "    1W.....	1.29
35 —    "    2W.....	1.29
50 —    "    CERAMIC COND.....	1.00
SHARP FLYBACK BFT592.....	2.00
5—10K—2 WATT BIAS POTS.....	1.00
3 SPEAKER 7 WAY SEL. SW.....	1.00
10—MINI ELEC. COND. for transistor radios.....	1.00
CONV. RECTIFIER 4 cell.....	1.00
10-456KC IF TRANSFORMERS.....	1.00
RONETTE STEREO CARTRIDGE.....	2.00
10—ASSTD VOLUME CONTROLS.....	1.00
20—ASSTD. WIRE WOUND RESISTORS.....	1.00
TV DAMPER DIODE RCA Type.....	1.95
VARCO STEREO CARTRIDGE TN48.....	2.95
BSR CHANGER.....	24.95

Minimum Order \$5.00 Immediate Delivery  
**BROOKS RADIO & TV CORP.**  
 529 Columbus Ave., New York, N.Y. 10024  
 TELEPHONE 212-874 5600

CIRCLE 41 ON FREE INFORMATION CARD

# NOW!

The PTX  
 Logic Probe  
 Only \$12.95  
 and a new  
 Low Cost  
 Board

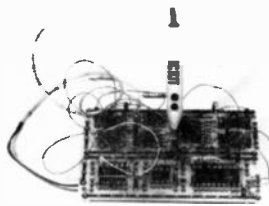

All of our boards feature—  
 • Numbered tie points and colored plugs.  
 • Solid printed circuit boards.  
 • Reusable parts.  
 Our original board handles 10 IC's in sizes from 14-40 pin DIP shown above. Kit includes: Board, plugs, sockets & eyelets. Only \$36.25—Order # 141

**NEW from Printronix- a very low cost board!**  
 Our new board can handle 10 IC's and included with the board are sockets, plugs, even wire. Only \$12.95—Order # 171

A complete package for the Experimenter including one of the above PTX kits and 3 specially selected books: Basic Digital Electronics, OP AMP Circuit Design and Applications, Optoelectronics Guidebook—with tested projects. With kit # 141—\$49.95-Order # 151. With kit # 171—\$26.95-Order # 181.

**Also New- a low cost logic probe!**  
 Good for TTL & C MOS integrated circuits, includes two VLED's and case. Kit-\$12.95—Order # 271  
 Assembled-\$17.95—Order # 261

**Books of interest!**  
 Programming Microprocessors-Order #985—\$6.95. Master Handbook of 1001 Practical Electronic Circuits-Order #800—\$9.95. Microprocessor/Microprogramming Handbook-Order #785—\$6.95. Computer Programming Handbook-Order #752—\$8.95.

**PRINTRONIX**  
 1361 Flatbush Ave.  
 Bklyn, N.Y. 11210

ALL Items are postpaid  
 N.Y. City & State  
 residents add tax

CIRCLE 12 ON FREE INFORMATION CARD

# WIREWRAP

**Wire Wrap Kits**

3	100	500	1000
Cut & Stripped - 30 Kynar Wire	3	86	281
In Red, Yellow, Blue, White, Black	4	90	300
Green or Orange All lengths	4	94	311
Overall 1" Strip on each end	5	98	347
	5	102	363
	6	106	383
	6	110	404

Kit No. 1	\$6.95	Kit No. 2	\$19.95
250 3	100 4	750 2	750 5
250 1	100 5	500 1	100 5 1/2
150 4	100 6	500 3	100 6 1/2
		500 4	100 6 1/2
		500 4	100 7

1 Rail 250 w. e.      Add ncher      10      41      87

On 250 + R      \$4.00      10 \$10 (min.)  
 1000 fr. Rail + \$12.00      5 \$40 (min.)

## Wire Wrap Sockets

Gold 3 Level Closed Entry Design

1.8	10.24	25.29	100.259	250	1K
8 p.p.	41	38	35	31	27
14 p.p.	42	39	36	32	27
18 p.p.	45	43	39	35	32
28 p.p.	63	48	54	47	44
38 p.p.	84	78	71	63	59
48 p.p.	110	110	110	95	90
24 p.p.	91	84	78	68	64
28 p.p.	127	117	108	95	89
40	147	135	147	125	115

1 and side (in) file sockets

## HOBBY WRAP TOOL

\$34.95 Includes Wire Kit 1 FREE



## Wire Wrap Boards

BR00	\$100 Bu	100	100	50	\$11.95	5	\$25	
4.50	R01	R	100	100	10	\$17.95	5	\$25
366.	44	B	100	100	4.6	6.50	5	\$30
3 19 1	72	p	B	100	4.6	9.00	5	\$44

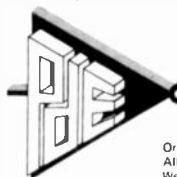

(213) 797 4002 or 797 4007

## Page Digital Electronics

1701 East Orange Grove Blvd  
 Pasadena, California 91104  
 Orders under \$25 and COD Orders add \$2  
 All others shipped UPS Post  
 We accept Visa and MasterCard

CIRCLE 9 ON FREE INFORMATION CARD

## HOBBY CORNER

continued from page 71

You will notice that nothing has been said about a circuit being bad in the first place. That's because everything you see in this column has been checked out and built at least on a breadboard. Any exceptions will be clearly marked "UN-TESTED."

### Iron temperature control

Do you have a light dimmer or motor speed control on your workbench? Of course, it's handy for slowing down the drill or grinder when working in soft materials such as plastic. But at our workbench the soldering iron is usually connected to it.

Just having one all-purpose soldering iron instead of two or three for various uses can cause trouble with many solid-state circuits because excess heat can quickly ruin a part or even a circuit board. However, you can keep your iron at just the right temperature with a dimmer/speed control.

The control shown in Fig. 5 can be assembled quickly and easily. Be sure to provide a good heat sink for the triac. Although the 6-amp unit specified can readily handle any normal electronics iron, you might want to use the control with something heavier.

Once you use the dimmer/speed control with your iron you'll find you destroy fewer parts and boards and your iron and tip will last longer.

### New CB guide

For beginning CB'ers, Radio Shack has published a second edition of *All About CB Two-Way Radio* (RS #68-1046). This updated nontechnical guide covers such topics as how CB got started, types of radios and antennas, how to set up fixed and mobile stations, FCC rules and regulations and plenty of ideas on using CB.

Please remember that we want to hear from you—your needs, suggestions, ideas and circuits. Drop us a note.

73, Doc



You shouldn't be mad at your husband for giving you a TV that doesn't work—this happens to be a microwave oven!



**NEW!**

**ELECTRONIC TOUCH ORGAN KIT**

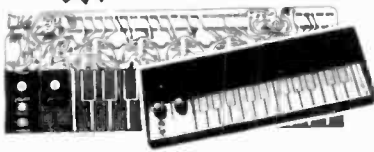

Fantastic new design uses CMOS I.C. and a total of 39 semi-conductors to give a touch control keyboard, all the electronic parts in one PC Board. This organ is easy to build, yet has features like a full two-octave range touch keyboard, variable tremolo; two voices; built-in I.C. amplifier with volume control, complete with speaker and a specially designed plexi-glass case.

BATTERIES NOT INCLUDED \*Ideal kit for beginner or gift for children **\$24.50 ea.**

**SLIM LINE CALCULATOR**

6 Functions with % and memory  
8 Digits LED display  
\*One full year guarantee  
Special Price Only **\$8.50 Ea.**



BATTERIES NOT INCLUDED

**CALCULATOR with STOPWATCH**

6 Functions with % and memory  
8 Digits big green display  
\*Built-in X'tal controlled stop watch count to 1/10 of a second.  
Special Price Only **\$16.50 Ea.**



BATTERIES NOT INCLUDED

**I.C. TEST CLIPS**

Same as the E-Z clips  
With 20" Long Leads  
In Black and Red Colors  
**\$1.75 Per Pair**



**5W AUDIO AMP KIT**

2 LM 380 w/tn volume Control  
Power Supply 6~18V DC  
**only \$5.00 ea.**



**Multi-Color LED Indicator**

Red-Green Colors in one LED  
with Plastic Housing  
**99¢ Ea.**  
Voltage 2V 20 MA per LED

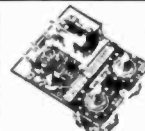

**TIMER KIT**

Time Controlled from 1-100sec.  
Ideal to be used as time delay unit for burglar alarm, photo service, and other purposes. Max. loading 110V, 2 AMP. Supply voltage 12-18V D.C.  
**\$11.50 each**

FT-80 ELECTRONIC IC TIMER

**ELECTRONIC ALARM SIREN**

COMPLETE UNIT  
Ideal for use as an Alarm Unit, or hookup to your car back up to make a reverse Indicator Light Output up to 130 dB.  
Voltage Supply 6~12V **\$7.50**



AU-999

**19 KEY HEXADECIMAL KEY PAD**

• 1-0 • Homekey  
• ABCDEF • ←→ Key  
**SPECIAL \$10.50 ea.**



Low Cost Hexadecimal 16 Key Pad

Designed for Calculator. Can be used for Computer Data Entry Pad or Digital Lock. All key tops blank with super good touch feeling. **\$0.95 ea.**

**DIGITAL ELECTRONIC LOCK KIT**

**\$6.50 ea.** for auto ignition, entry door, burglar, alarm, etc.  
CMOS I.C. 4 Digits Programmable to Any Combination  
16 CIRCUIT  
400R RELAY and KEY PAD NOT INCLUDED



**POWER SUPPLY KIT**

0-35V D.C. REGULATED  
Uses UA723 and ZN3055 Power TR output can be adjusted from 0-35V, 2 AMP. Complete with PC board and all electronic parts.  
0.35 POWER SUPPLY **\$9.50 each**  
Transformer for Power Supply, 2 AMP 24V \$3.90 ea.

**MA1003, 12V DC CLOCK MODULE**

Built in X'TAL controlled time base. Protected against automotive volt transients. Automatic brightness control with 0.3" green color display. Display turnoff with ignition "OFF".  
**\$23.50 EACH**



**EDGE CONNECTORS (IMSA1 Type)**

Dual 50 (100 pin)  
0.125 spacing wire-wrap  
**\$4.50 EACH**



DB25 Type CONNECTOR  
Male **\$3.40 each**  
Female **\$3.75 each**

Plastic Housing for Connector \$1.00 each

**MULTI-COLOR RIBBON CABLES**

Type	Conductors	AWG	Price Per Ft.
A	15	20	0.40
B	12	24	0.40
C	18	24	0.45
D	26	26	0.50
E	13	30	0.25
F	22 prs.	26	0.40

red/white twisted prs.  
(over 50 ft. per type—less 15%)

**QUARTZ CRYSTALS**

1 MHZ	\$4.95
2 MHZ	\$5.25
4 MHZ	\$5.25
10 MHZ	\$5.25
3.579 MHZ	\$1.25

Color TV Type

**CB MICROPHONE**

500 MIC for CB Unit  
Talk Switch with Connector and Cord  
**\$2.50 each**  
CLOSE OUT SALE



**TV GAME MODULATOR UNIT**

FCC Approved For channel 3 and 4  
With FCC Coil  
**ONLY \$4.50**  
TI 1955  
Alternative AY3 8500-1  
6 Game (2B Pin Dip)  
TV Game Chip with Data  
Tennis Squash hockey,  
practice & 2 shooting.  
Special Only \$11.00

PC Board for TV Game with Data \$2.50 ea.  
Switch Box between Game & TV \$1.25 ea.



TI 1955  
Alternative AY3 8500-1  
6 Game (2B Pin Dip)  
TV Game Chip with Data  
Tennis Squash hockey,  
practice & 2 shooting.  
Special Only \$11.00

**NI-CD RECHARGEABLE BATTERIES**

AA size 1.5V **\$1.25 ea.**  
C size 1.5V **\$1.50 ea.**  
Sub C size **\$1.50 ea.**  
F size 1.5V **\$2.50 ea.**



**AUTO ALARM KIT**

The Currenlighter Auto Alarm is an electronic, self controlled auto protection system, normally mounted within the glove box of an automobile. Two minutes after turning off the ignition, the alarm automatically turns itself "on." When the auto is re-entered, the horn will sound after a 10-45 second entry delay. The automobile owner, by inserting the ignition key, will activate the alarm. Once activated, the alarm will sound for two minutes before automatically turning off. The alarm then resets and is ready to again protect the vehicle from unwanted entry.

FEATURES: Simple installation. 5 wires. Automatically turns on when auto is parked. Adjustable entry time. Extended exit time to allow for unshut exit from vehicle. Numerous applications include protection of boats, campers, trailers, motorcycles, trucks. Cannot be deactivated by "hot wiring" an auto. Cannot be turned off without ignition key. Neg. alive ground only.  
**ONLY \$10.00 PER KIT**

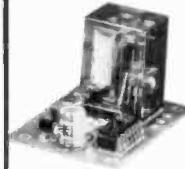

**ELECTRONIC SWITCH KIT**

CONDENSER TYPE  
Touch on Touch Off  
use 7473 I.C.  
and 12V relay  
**\$5.50 each**



**FM WIRELESS MIC KIT**

Transmit range up to 100 ft.  
Easy to assemble  
(Mic included)  
**\$4.50 each**

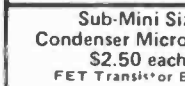

Sub-Mini Size  
Condenser Microphone  
**\$2.50 each**  
FET Transistor Built-in

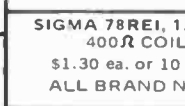

SIGMA 78REI, 12DC RELAY  
400R COIL SPDT  
**\$1.30 ea. or 10 for \$10.00**  
ALL BRAND NEW UNITS

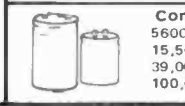

Computer Grade Capacitors  
5600 MFD 6V **\$2.20 ea.**  
15,500 MFD 75V **\$4.95 ea.**  
39,000 MFD 12V **\$2.00 ea.**  
100,000 MFD 6V **\$3.50 ea.**

**TV Games**

Direct Sales Only **\$29.50**

FEATURES:  
• 4 Games—Tennis, Hockey, Racquet Handball and Single Handball.  
• Auto counter display on the screen.



**WIRE WRAPPING TOOL**

**\$33.50**  
Wire Wrapping In Bulk  
100' **\$2.00**  
500' **\$8.50**

**Sub Mini Size PANEL METER**

500 UA  
**ONLY \$1.20 ea**  
MATCHED PAIR  
POWER TRANSISTORS  
MOTOROLA MJE2955 PNP  
MJE3055 NPN  
10 AMP 60 VOLTS 90 WATTS  
**\$2.25 PER PAIR**

**TRANSFORMERS**

24V CT (12-0-12V)  
800 MA **\$2.25 ea.**  
12 or 24V 2 amp Output  
**\$3.90 each**

**AC POWER SUPPLY**

Adapter Type Transformer  
12V AC Output 200 MA  
**\$2.75 each**  
6V DC Output 130MA **\$1.90 ea.**  
8.7V DC Output 130MA **\$1.90 ea.**  
12V DC Output 100MA **\$1.90 ea.**

**50 UA PANEL METER**

Best designed for metal finger. Scales from 0-10 but can be erased and your own scale cut on top. Brand new in box.  
**Only \$3.80 ea.**

**CLOCK KIT MOST POPULAR MMS314 KIT**

WITH A NEW CASE!  
Features: 12 24 Hour Display  
50 50 HZ Input 6 Digit Readout  
Kit Includes: Grey, Color Plastic Case  
MMS314 Clock Chip PC Boards and Trans  
formers, 6 1/2 inch Color 0.3" Full-Readout.  
All other Transistor Drivers and other Components.  
**Special Only \$14.95 ea.**

**SAE DIP SWITCHES**

Part No. 1004 692 4KSPST SW  
1008 692 8XSPST SW  
4 Toggle SPST Switches on a Mini-DIP  
18 units Only **\$1.50 ea.**  
3 Toggle SPST Switches on a DIP  
116 pins Only **\$2.60 ea.**

**MINI-MINI TOGGLE SWITCH**

Half-size of submini toggle switch  
rated 3 amp 125V AC contact  
1-9 10-99  
MS-2427 SPST 0.90 0.80  
MS-244 SPDT 1.00 0.90  
MS-245 DPDT 1.20 1.10  
**LARGE QUANTITY AVAIL FOR OEM**

**SUBMINIATURES TOGGLE SWITCHES**

SPDT On/Off **\$1.30 ea.**  
DPDT On/Off **\$1.50 ea.**  
3PDT On/Off **\$1.75 ea.**  
Mini-Size Rocker Type  
Also Available at the Same Price

**JOY STICK**

4 100K Volume pot in one unit, very resistance, adjustable to the angle of the stick. Perfect for electronic games of model or motor control.  
**only \$7.50**

**PUSH-BUTTON SWITCH**

N/Open Contact  
Color: Red, White, Blue, Green, Black. 4/5/1.00  
N/Close also  
Available **50¢ ea.**  
**LARGE QTY AVAILABLE**

**SOLID STATE ELECTRONIC BUZZER**

Mini-Size 1"x3/4"x3/4"  
Supply voltage 1.5V-12V  
Ideal for Alarm or Tone Indicator  
**\$1.50 each**

MINIMUM ORDER \$10.00. California residents add 6% sales tax. All orders add 10% postage for out of state. Overseas countries add 15% of total order for postage. SEND CHECK OR MONEY ORDER TO **10/77**



**FORMULA INTERNATIONAL INC.**

12603 CRENSHAW BOULEVARD • HAWTHORNE, CALIFORNIA 90250  
For more information please call (213) 679-5162  
STORE HOURS 10-7 Monday - Saturday



## CRYSTALS

THESE FREQUENCIES ONLY

Part #	Frequency	Case Style	Price
CY1A	1.000 MHz	HC33 U	\$5.95
CY2A	2.000 MHz	HC33 U	\$5.95
CY2 01	2.010 MHz	HC33 U	\$1.95
CY3A	4.000 MHz	HC18 U	\$4.95
CY7A	5.000 MHz	HC18 U	\$4.95
CY12A	10.000 MHz	HC18 U	\$4.95
CY14A	14.31818 MHz	HC18 U	\$4.95
CY19A	18.000 MHz	HC18 U	\$4.95
CY22A	20.000 MHz	HC18 U	\$4.95
CY30B	32.000 MHz	HC18 U	\$4.95

XR-2206KB Kit \$29.95 Special XR-2206KA Kit \$19.95

WAVEFORM GENERATORS	EXAR	TIMERS
XR-205	XR-555CP	\$ 1.95
XR-2206CP	XR-320P	1.55
XR-2207CP	XR-556CP	1.85
	XR-2556CP	3.20
	XR-2940CP	3.25
MISCELLANEOUS	PHASE LOCKED LOOPS	
XR-1310CP	XR-4136	\$ 7.00
XR-1310EP	XR-1468	3.85
XR-1800P	XR-1468	5.80
XR-2567	XR-1489	4.80
	XR-567CP	1.95
	XR-567CT	1.70

## CONNECTORS

PRINTED CIRCUIT EDGE-CARD

156 Spacing-Tin-Double Read-Out

Bifurcated Contacts — Fits 054 to 070 P.C. Cards

15/30	PINS (Solder Eyelet)	\$1.95
18/36	PINS (Solder Eyelet)	\$2.49
22/44	PINS (Solder Eyelet)	\$2.95
50/100	PINS (Wire Wrap)	\$6.95
50/100A (1.00 Spacing)	PINS (Wire Wrap)	\$6.95

25 PIN-D SUBMOUNTURE

DB25P	PLUG	\$3.25
DB25S	SOCKET	\$4.95

## HEAT SINKS

205-CB	680-75A	
205-CB	Beryllium Copper w-black finish for TO-5	\$ .25
291-.36H	Aluminum for TO-220 Transistors & Regulators	\$ .25
680-75A	Black Anodized Aluminum for TO-3	\$1.60
401-A	Black Anodized Aluminum — predrilled mounting holes for TO-3 — 4x 1/4 x 2"	\$1.75

## DIP SWITCHES

SPST Slide Action

#206-4 (8 pin dip) 4 switch unit \$1.75 ea.

#206-7 (14 pin dip) 7 switch unit \$1.95 ea.

#206-8 (16 pin dip) 8 switch unit \$2.25 ea.

## Etching Kits

32 X A-1	P.C. Etch Materials Kit enough for 3 circuit boards	\$29.95 ea.
27 X A-1	Etched Circuit Kit Complete kit — only add water	\$ 9.95 ea.
3662	6.5 X 4.5 X 1/16 Epoxy glass P-pattern 44 P.C. Tabs-spaced 156	\$ 6.95 ea.
22/44	Mating connector for plugboard — 22 pin double reader	\$ 2.95 ea.
8800V	Universal Microcomputer/Processor plugboard — Epoxy Glass — complete with heatshrink and mounting hardware 5 3/32 X 10 X 1 1/16 copper clad	\$19.95 ea.

## Vector

### 1/16 VECTOR BOARD

Part No.	Hole Spacing	P-Pattern	W	L	Price	2 Up
PH-NO. C	6-IP4 062x3xP	4.50	6.50	1.72	1.32	
	169P4 02x3xP	4.50	1.00	3.69	3.37	
EPDY	8-IP4 062	4.50	6.50	2.01	1.86	
GL-55	8-IP4 062	4.50	8.50	2.56	2.31	
	169P4 062	4.50	1.00	5.04	4.53	
	169P4 062	8.50	17.00	9.23	8.26	
EPDY-GL-55	169P4 062C1	4.50	1.00	6.80	6.12	

## Vector

### SLIT-N-WRAP WIRE WRAP TOOL

Slits and opens insulation exposing bare wire

- No pre-cutting or pre-stripping.
- Comes complete with two - 100 ft spools #28 AWG wire

Model P180 \$24.50

### HEXADECIMAL ENCODER 19-KEY PAD

1 - 0  
 ABCDEF  
 Return key  
 Optional Key (Period)  
 — Key

\$10.95 each

### 63 KEY KEYBOARD

\$24.95

This keyboard features 63 unenclosed SPST keys, unattached to any kind of P.C.B. A very solid molded plastic 13 x 4 base suits most applications

HDD165 16 LINE TO FOUR BIT PARALLEL KEYBOARD ENCODER CHIP \$7.95

## TOOLS

A97MS	Diagonal Cutter - 4" semi-flush cut	\$8.50 ea.
A11DMS	Chain Nose Pliers - 4 1/4" long	7.50 ea.
T-6	Wire Stripper - #16 to #26 gauge	3.75 ea.
55B	Wire Stripper - #10 to #20 gauge	2.50 ea.
CS-8	Cutter-Crimper Tool - 8 1/2" long	8.50 ea.
Nibbling Tool	Cuts, Trims or Notches Metal up to #18 gauge	6.95 ea.
Nibbling Tool Replacement Punch		3.75 ea.
PERMACEL P-29 PLUS	Electrical Tape - All Weather - 1/2" x 3/4" x 66' roll	\$7.95 ea.
1-9 Rolls	10-up Rolls	\$6.95/10 roll package

## MICROPROCESSOR COMPONENTS

8080A CPU	\$19.95	8228 System Controller - Bus Driver	\$10.95
8214 8 Bit Input/Output	4.95	MC6800 8 Bit MPU	\$2.50
8214 Priority Interrupt Control	15.95	MC6802 Periph Interface Adapter	15.00
8216 Bi-Directional Bus Driver	6.95	MC6801A1 128 x 8 Static RAM	6.00
8224 Clock Generator/Driver	10.95	MC68030L8 1024 x 8 Bit ROM	18.00
CDP1802 - with user manual	39.95	Z80 CPU	49.95

RAM'S	CPUS	SR'S	UART'S	ROM'S	SPECIAL REQUESTED ITEMS
1101 256 x 1 Static	2101 256 x 4 Static	1024 Dynamic	30k 30ud	Char Gen - upper case	AY-3-8500-1 \$13.95
2102 1024 x 1 Static	2107-5280 4096 x 1 Dynamic	1024 Dynamic	30k 30ud	Char Gen - lower case	MC3081P \$ 5.00
7111 256 x 3 Static	2102 1024 x 1 Static	1024 Dynamic	30k 30ud	Char Gen - upper case	MC3081P (74416) \$ 7.50
8101 256 x 1 Static	2102 1024 x 1 Static	1024 Dynamic	30k 30ud	Char Gen - lower case	MC14585 \$ 3.50
8111 256 x 4 Static	2102 1024 x 1 Static	1024 Dynamic	30k 30ud	Char Gen - upper case	MC14585 \$ 7.50
8999 16 x 1 Static	2102 1024 x 1 Static	1024 Dynamic	30k 30ud	Char Gen - lower case	MC14562 \$ 14.50
9102 1024 x 1 Static	2102 1024 x 1 Static	1024 Dynamic	30k 30ud	Char Gen - upper case	CD4059 \$ 9.95
93421 386 x 1 Static	2102 1024 x 1 Static	1024 Dynamic	30k 30ud	Char Gen - lower case	CD4070 \$ 14.95
93421 386 x 1 Static	2102 1024 x 1 Static	1024 Dynamic	30k 30ud	Char Gen - upper case	MC14409 \$ 14.95
93421 386 x 1 Static	2102 1024 x 1 Static	1024 Dynamic	30k 30ud	Char Gen - lower case	MC14410 \$ 14.95
93421 386 x 1 Static	2102 1024 x 1 Static	1024 Dynamic	30k 30ud	Char Gen - upper case	
93421 386 x 1 Static	2102 1024 x 1 Static	1024 Dynamic	30k 30ud	Char Gen - lower case	

## PARATRONICS

Featured on February's Front Cover of Popular Electronics

**Logic Analyzer Kit MODEL 100A \$229.00/Kit**

Some applications are:

- Troubleshooting microprocessor address, instruction, and data flow
- Examine contents of ROMS
- Tracing operation of control logic
- Checking counter and shift register operation
- Monitoring I/O sequences
- Verifying proper system operations during testing

Easy to assemble — comes with step-by-step construction manual which includes 80 pages on logic analyzer operation.

**PARATRONICS TRIGGER EXPANDER - Model 10**

Adds 16 additional bits. Provides digital delay and qualification of input clock and 24-bit trigger word. — Connects direct to Model 100A for integrated unit.

Model 10 — \$229.00 Baseplate — \$6.95

**BUGBOOK**

Continuing Education Series

BUGBOOK I & II - Basic concepts of TTL Logic — over 90 experiments \$17.00/set

BUGBOOK IIa - Introduces UART — recommended for RTTY enthusiast \$5.00/book

BUGBOOK III - Explores 8080 chip — introduces Mark 80 Microcomputer \$15.00/book

555 TIMER APPLICATIONS SOURCEBOOK WITH EXPERIMENTS — over 100 design techniques \$6.95/book

CMOS-M-DESIGNERS PRIMER AND HANDBOOK a complete CMOS instruction manual \$6.00

INSTRUCTORS MANUAL Necessary for instruction on Bugbook I and II. \$3.00

Introductory Offer — all 6 books (worth \$49.95) SPECIAL - \$42.95

## CONTINENTAL SPECIALS

PROTO BOARD 6 (6" long X 4" wide)	\$15.95	Other CS Proto Boards	
PB100 - 4 1/2" x 6"	\$ 17.95	PROTO CLIPS	
PB101 - 5 1/2" x 4 1/2"	29.95	14 PIN	\$4.50
PB102 - 7" x 4 1/2"	39.95	16 PIN	4.75
PB103 - 9" x 6"	59.95	24 PIN	8.50
PB104 - 9 1/2" x 8"	79.95	DESIGN MATES	
PB203 - 9.75 x 6 1/2 x 2 1/2	75.00	DM1 - Circuit Designer	\$4.95
PB203A - 9.75 x 6 1/2 x 2 1/2	120.00	DM2 - Function Generator	69.95
		DM3 - RC Bridge	59.95
MAX-100 Frequency Counter 20 MHz-100MHz — 8 digit — 6 LED Available September 15, 1977	\$134.95	Logic Monitor for 8080, 8085, 8088, 8086 CMOS Devices	\$84.95
QT PROTO STRIPS		QT type #holes price	
QT-595		QT-595 590 12.50	
QT-598		QT-598 bus strip 2.50	
QT-475		QT-475 170 10.00	
QT-478		QT-478 bus strip 2.25	
QT-478		QT-355 350 8.50	
QT-478		QT-358 bus strip 2.00	
QT-355		QT-185 180 4.75	
QT-358		QT-125 120 3.75	
QT-358		QT-85 80 3.25	
QT-358		QT-75 70 3.00	
		Experimenter 300 \$ 9.95	
		Experimenter 600 \$10.95	

\$5.00 Minimum Order — U.S. Funds Only California Residents — Add 6% Sales Tax Spec Sheets - 25c — Send 35c Stamp for 1977A Catalog Dealer Information Available

**James ELECTRONICS**

1021-A HOWARD AVE., SAN CARLOS, CA. 94070  
 PHONE ORDERS WELCOME — (415) 592-8097  
 All Advertisements Good Through October

## Timeband

### Digital Alarm Clocks

• 24 hour alarm  
 • Doze Button  
 • 100% Solid State  
 • Large Red LED Display (8 mgt)  
 • Alarm PM indicator  
 • Seconds display at touch of button  
 • Power failure indicator  
 • One year factory warranty

C-500 Ivory Case \$16.95  
 C-500B Ebony Case \$16.95

C-8211 Woodgrain Case \$19.95

### Timeband LAMP CLOCK

• 24 hour alarm  
 • Doze button  
 • Alarm-on indicator  
 • 8" high Red LED Display  
 • AM/PM Indicator  
 • High Intensity lamp  
 • Lamp shuts off when collapsed

Model C-590 (Ivory) \$29.95

### ERC AM/FM 8-Track Stereo Receiver

With BSR Changer

- PLL System
- BSR Record Changer
- Slide Controls
- Automatic AFC Control
- 4 Speaker Output
- Walnut finish vinyl covered wood veneer with smoke dust cover

Size: 20" W x 9 1/4" H x 15 1/4" D  
 Model 8365 \$149.95

### DIGITAL STOPWATCH

• Bright 6 Digit LED Display  
 • Times to 59 minutes 59.99 seconds  
 • Crystal Controlled Time Base  
 • Three Stopwatches in One  
 • Times Simple Event — Split & Taper  
 • Size 4.5 x 2.15 x .90 (4ths ounces)  
 • Uses 3 Penrite Cells

Kit — \$39.95  
 Assembled — \$49.95  
 Heavy Duty Carry Case \$5.95

Stop Watch Chip Only (7205) \$19.95

### IMC 3 1/2 DIGIT DVM KIT

This 0-2 VDC .05 per cent digital voltmeter features the Motorola 3 1/2 digit DVM chip set. It has a 4 LED display and operates from a single +5V power supply. The unit is provided complete with an injection molded black plastic case complete with Bezel. An optional power supply is available which fits into the same case as the 0-2V DVM allowing 117VAC operation.

A. 0-2V DVM with Case \$49.95  
 B. 5V Power Supply \$14.95

### JE700 CLOCK

The JE700 is a low cost digital clock, but it is a very high quality unit. The unit features a simulated walnut case with dimensions of 6 x 2 1/2 x 1. It utilizes a MA72 high brightness readout and the MM5314 clock chip.

12 or 24 Hour  
 115 VAC  
 KIT ONLY \$17.95

### Rejected ATARI GAME BOARDS

Over 60 Reusable IC's, misc. transistors, resistors, diodes, caps, crystals, switch, etc. (8 1/2" x 16"). Limited Quantity.

\$4.95 ea.

### INSTRUMENT/CLOCK CASE

Injection molded unit. Complete with red bezel. 4 1/2" x 4" x 1-9/16"

\$3.95 ea.

### JE803 PROBE

The Logic Probe is a unit which is for the most part indispensable in trouble shooting logic families. TTL, DTL, RTL, CMOS. It derives the power it needs to operate directly off of the circuit under test, drawing a scant 10 mA max. It uses a MA103 readout to indicate any of the following states by these symbols: (H) 1 (LOW) 0 (PULSE) P. The Probe can detect high frequency pulses to 45 MHz. It can't be used at MOS levels or circuit damage will result.

\$9.95 Per Kit

### T-1L 5V 1A Supply

This is a standard TTL power supply using the well known LM309K regulator IC to provide a steady 1 AMP of current at 5 volts. We try to make things easy for you by providing everything you need in one package, including the hardware for only

\$9.95 Per Kit

### 7400N TTL

SN7400N	.16	SN7459A	.25
SN7401N	.16	SN7460N	.22
SN7402N	.21	SN7470N	.45
SN7403N	.16	SN7471N	.39
SN7404N	.18	SN7473N	.37
SN7405N	.24	SN7474N	.32
SN7406N	.20	SN7475N	.30
SN7407N	.29	SN7476N	.39
SN7408N	.25	SN7479N	.50
SN7409N	.25	SN7480N	.50
SN7410N	.18	SN7482N	.38
SN7411N	.30	SN7483N	.30
SN7412N	.33	SN7485N	.89
SN7413N	.45	SN7486N	.39
SN7414N	.30	SN7488N	3.50
SN7416N	.35	SN7489N	2.49
SN7417N	.35	SN7490N	.45
SN7420N	.21	SN7491N	.75
SN7421N	.33	SN7492N	.49
SN7422N	.49	SN7493N	.49
SN7423N	.29	SN7494N	.79
SN7425N	.29	SN7495N	.89
SN7426N	.29	SN7496N	.89
SN7427N	.37	SN7497N	4.00
SN7429N	.42	SN74100N	1.00
SN7430N	.26	SN74101N	1.00
SN7431N	.33	SN74102N	1.00
SN7432N	.33	SN74103N	1.00
SN7433N	.33	SN74104N	1.00
SN7434N	.33	SN74105N	1.00
SN7435N	.33	SN74106N	1.00
SN7436N	.33	SN74107N	1.00
SN7437N	.33	SN74108N	1.00
SN7438N	.27	SN74109N	1.00
SN7439N	.25	SN74110N	1.00
SN7440N	.15	SN74111N	1.00
SN7441N	.89	SN74112N	1.09
SN7442N	.59	SN74113N	1.09
SN7443N	.75	SN74114N	1.15
SN7444N	.75	SN74115N	1.40
SN7445N	.75	SN74116N	1.40
SN7446N	.81	SN74117N	1.40
SN7447N	.69	SN74118N	1.15
SN7448N	.79	SN74119N	2.35
SN7449N	.26	SN74120N	2.00
SN7451N	.27	SN74121N	1.00
SN7453N	.27	SN74122N	1.09
SN7454N	.20	SN74123N	1.09
SN7455N	.20	SN74124N	1.09
SN7456N	.20	SN74125N	1.09
SN7457N	.20	SN74126N	1.09
SN7458N	.20	SN74127N	1.09
SN7459N	.20	SN74128N	1.09
SN7460N	.20	SN74129N	1.09
SN7461N	.20	SN74130N	1.09
SN7462N	.20	SN74131N	1.09
SN7463N	.20	SN74132N	1.09
SN7464N	.20	SN74133N	1.09
SN7465N	.20	SN74134N	1.09
SN7466N	.20	SN74135N	1.09
SN7467N	.20	SN74136N	1.09
SN7468N	.20	SN74137N	1.09
SN7469N	.20	SN74138N	1.09
SN7470N	.20	SN74139N	1.09
SN7471N	.20	SN74140N	1.09
SN7472N	.20	SN74141N	1.09
SN7473N	.20	SN74142N	1.09
SN7474N	.20	SN74143N	1.09
SN7475N	.20	SN74144N	1.09
SN7476N	.20	SN74145N	1.09
SN7477N	.20	SN74146N	1.09
SN7478N	.20	SN74147N	1.09
SN7479N	.20	SN74148N	1.09
SN7480N	.20	SN74149N	1.09
SN7481N	.20	SN74150N	1.09
SN7482N	.20	SN74151N	1.09
SN7483N	.20	SN74152N	1.09
SN7484N	.20	SN74153N	1.09
SN7485N	.20	SN74154N	1.09
SN7486N	.20	SN74155N	1.09
SN7487N	.20	SN74156N	1.09
SN7488N	.20	SN74157N	1.09
SN7489N	.20	SN74158N	1.09
SN7490N	.20	SN74159N	1.09
SN7491N	.20	SN74160N	1.09
SN7492N	.20	SN74161N	1.09
SN7493N	.20	SN74162N	1.09
SN7494N	.20	SN74163N	1.09
SN7495N	.20	SN74164N	1.09
SN7496N	.20	SN74165N	1.09
SN7497N	.20	SN74166N	1.09
SN7498N	.20	SN74167N	1.09
SN7499N	.20	SN74168N	1.09
SN7500N	.20	SN74169N	1.09
SN7501N	.20	SN74170N	2.10
SN7502N	.20	SN74171N	2.10
SN7503N	.20	SN74172N	2.10
SN7504N	.20	SN74173N	1.50
SN7505N	.20	SN74174N	1.25
SN7506N	.20	SN74175N	99
SN7507N	.20	SN74176N	90
SN7508N	.20	SN74177N	90
SN7509N	.20	SN74178N	99
SN7510N	.20	SN74179N	99
SN7511N	.20	SN74180N	99
SN7512N	.20	SN74181N	2.49
SN7513N	.20	SN74182N	3.50
SN7514N	.20	SN74183N	3.50
SN7515N	.20	SN74184N	1.50
SN7516N	.20	SN74185N	2.20
SN7517N	.20	SN74186N	15.00
SN7518N	.20	SN74187N	6.00
SN7519N	.20	SN74188N	3.95
SN7520N	.20	SN74189N	3.95
SN7521N	.20	SN74190N	1.19
SN7522N	.20	SN74191N	1.25
SN7523N	.20	SN74192N	8.9
SN7524N	.20	SN74193N	8.9
SN7525N	.20	SN74194N	1.25
SN7526N	.20	SN74195N	7.5
SN7527N	.20	SN74196N	1.25
SN7528N	.20	SN74197N	7.5
SN7529N	.20	SN74198N	1.75
SN7530N	.20	SN74199N	1.75
SN7531N	.20	SN74200N	5.59
SN7532N	.20	SN74201N	9.0
SN7533N	.20	SN74202N	11.79
SN7534N	.20	SN74203N	6.00
SN7535N	.20	SN74204N	6.00
SN7536N	.20	SN74205N	6.00
SN7537N	.20	SN74206N	7.5
SN7538N	.20	SN74207N	7.5
SN7539N	.20	SN74208N	7.5
SN7540N	.20	SN74209N	7.5
SN7541N	.20	SN74210N	7.5
SN7542N	.20	SN74211N	7.5
SN7543N	.20	SN74212N	7.5
SN7544N	.20	SN74213N	7.5
SN7545N	.20	SN74214N	7.5
SN7546N	.20	SN74215N	7.5
SN7547N	.20	SN74216N	7.5
SN7548N	.20	SN74217N	7.5
SN7549N	.20	SN74218N	7.5
SN7550N	.20	SN74219N	7.5
SN7551N	.20	SN74220N	7.5
SN7552N	.20	SN74221N	7.5
SN7553N	.20	SN74222N	7.5
SN7554N	.20	SN74223N	7.5
SN7555N	.20	SN74224N	7.5
SN7556N	.20	SN74225N	7.5
SN7557N	.20	SN74226N	7.5
SN7558N	.20	SN74227N	7.5
SN7559N	.20	SN74228N	7.5
SN7560N	.20	SN74229N	7.5
SN7561N	.20	SN74230N	7.5
SN7562N	.20	SN74231N	7.5
SN7563N	.20	SN74232N	7.5
SN7564N	.20	SN74233N	7.5
SN7565N	.20	SN74234N	7.5
SN7566N	.20	SN74235N	7.5
SN7567N	.20	SN74236N	7.5
SN7568N	.20	SN74237N	7.5
SN7569N	.20	SN74238N	7.5
SN7570N	.20	SN74239N	7.5
SN7571N	.20	SN74240N	7.5
SN7572N	.20	SN74241N	7.5
SN7573N	.20	SN74242N	7.5
SN7574N	.20	SN74243N	7.5
SN7575N	.20	SN74244N	7.5
SN7576N	.20	SN74245N	7.5
SN7577N	.20	SN74246N	7.5
SN7578N	.20	SN74247N	7.5
SN7579N	.20	SN74248N	7.5
SN7580N	.20	SN74249N	7.5
SN7581N	.20	SN74250N	7.5
SN7582N	.20	SN74251N	7.5
SN7583N	.20	SN74252N	7.5
SN7584N	.20	SN74253N	7.5
SN7585N	.20	SN74254N	7.5
SN7586N	.20	SN74255N	7.5
SN7587N	.20	SN74256N	7.5
SN7588N	.20	SN74257N	7.5
SN7589N	.20	SN74258N	7.5
SN7590N	.20	SN74259N	7.5
SN7591N	.20	SN74260N	7.5
SN7592N	.20	SN74261N	7.5
SN7593N	.20	SN74262N	7.5
SN7594N	.20	SN74263N	7.5
SN7595N	.20	SN74264N	7.5
SN7596N	.20	SN74265N	7.5
SN7597N	.20	SN74266N	7.5
SN7598N	.20	SN74267N	7.5
SN7599N	.20	SN74268N	7.5
SN7600N	.20	SN74269N	7.5

### Timeband<sup>®</sup> by AIRCHILD

#### Watches

Men's & Ladies

- Solid State
- Displays hour, minute, second, month & day
- Free set of replacement batteries
- Choose LED or LCD styles
- One year factory warranty



T249 White w/bracelet \$19.95  
T248 Yellow w/bracelet \$22.95  
LED



T237 White w/bracelet \$22.95  
T236 Yellow w/bracelet \$25.95  
LED



T2437 White w/bracelet \$28.95  
T2436 Yellow w/bracelet \$34.95  
LED



T245 White w/strap \$29.95  
T244 Yellow w/strap \$34.95  
LCD



T235 White w/strap \$24.95  
T234 Yellow w/strap \$27.95  
LCD

### WIRE WRAP CENTER

#### HOBBY-WRAP TOOL-BW-630



- Battery Operated (Size C)
- Weights ONLY 11 Ounces
- Wraps 30 AWG Wire onto Standard DIP Sockets (.025 inch)
- Complete with built-in bit and sleeve

**\$34.95** (batteries not included)

---

#### WIRE-WRAP KIT - WK-2-W

WRAP • STRIP • UNWRAP

- Tool for 30 AWG Wire
- Roll of 50 Ft. White or Blue 30 AWG Wire
- 50 pcs. each 1", 2", 3" & 4" lengths - pre-stripped wire.

**\$11.95**

---

#### WIRE WRAP TOOL WSU-30

WRAP • STRIP • UNWRAP - \$5.95

---

#### WIRE WRAP WIRE - 30 AWG

25 ft. min \$1.25 50 ft. \$1.95 100 ft. \$2.95 1000 ft. \$15.00  
SPECIFY COLOR - White - Yellow - Red - Green - Blue - Black

---

#### WIRE DISPENSER - WD-30

- 50 ft. roll 30 AWG KYNAR wire wrap wire **\$3.45 ea.**
- Cuts wire to desired length
- Strips 1" of insulation Specify - Blue-Yellow-White-Red

### CMOS

CD4000	.25	74C00N	.39
CD4001	.25	74C02N	.55
CD4002	.25	74C04N	.65
CD4003	2.50	74C10N	.75
CD4007	.25	74C20N	.65
CD4009	.25	74C21N	.65
CD4010	.59	74C29N	2.15
CD4011	.85	74C37N	1.50
CD4012	.25	74C47N	1.15
CD4013	.47	74C51N	2.95
CD4016	.56	74C59N	3.00
CD4017	1.35	74C69N	1.25
CD4019	.55	74C62N	2.90
CD4020	1.49	74C66N	1.75
CD4022	1.25	74C67N	2.15
CD4023	.25	74C67N	3.25
CD4024	1.50	74C67N	3.25
CD4025	.25	74C68N	3.25
CD4026	\$3.95	74C69N	3.25
CD4027	.59	74C71N	2.60
CD4028	1.65	74C73N	2.75
CD4029	2.90	74C75N	2.75
CD4030	.65	74C75N	4.50
CD4035	1.85	MC14566	2.70
		MC14016	.56

### CHANNEL F

Freeze Action • Speed Option  
Automatic time and scorekeeping  
Battery-free AC operation  
Dual controls with 8-way action  
Built-in Pro Hockey and Tennis games  
Easy hook-up on any B/W or Color TV  
Factory warranty

**\$159.95**

Channel F - additional cartridges - \$17.95 ea.

0811	Tie-Tac-Toe/Shooting Gallery	0815	Spacewar (2 players)	0813	Blackjack (1 or 2 players)
0812	Desert Fox/Shooting Gallery	0816	Spacewar (1 player)	0814	Spill (1 or 2 players)
		0817	Spacewar (1 player)	0815	Drag strip (1 or 2 players)
		0818	Spacewar (1 player)	0820	Maze (2 players)
		0819	Spacewar (1 player)	0822	Baseball (2 players)

### BK PRECISION New

#### 3 1/2-Digit Portable DMM

- Overload Protected • 3<sup>rd</sup> High LED Display
- Battery of AC operation • Auto Zeroing
- 1mv, 1V<sub>a</sub>, 0.1 ohm resolution • Overrange reading
- 10 meg input impedance
- DC Accuracy 1% typical
- Range: DC Voltage - 0-1000V AC Voltage 0-1000V
- Freq. Response 50-400 Hz/DC AC Current 0-1000mA
- Resistance 0-10 meg ohm
- Size 6 1/4 x 4 1/4 x 2 1/4

**Model 2800 \$99.95**  
AC Adapter BC-28 **8.00**  
Rechargeable Batteries BP-28 **20.00**  
Carrying Case BL-28 **6.00**

---

#### DATA HANDBOOKS

7400 Pin-out & Description of 3400/7400 ICs **\$2.95**  
CMOS Pin-out & Description of 4000 Series ICs **\$2.95**  
Linear Pin-out & Functional Description **\$2.95**  
All THREE HANDBOOKS **\$6.95**

---

#### ZENERS - DIODES - RECTIFIERS

TYPE	VOLTS	W	PRICE	TYPE	VOLTS	W	PRICE	
1N4745	3.3	400m	4/10	1N4005	500 PV	1/2	AMP	10/10
1N4751	5.1	400m	4/10	1N4006	600 PV	1/2	AMP	10/10
1N4752	5.6	400m	4/10	1N4007	1000 PV	1/2	AMP	10/10
1N4753	6.2	400m	4/10	1N4008	50	200m	6/10	6/10
1N4754	6.8	400m	4/10	1N4009	15	10m	15/10	15/10
1N4755	8.2	400m	4/10	1N4010	15	10m	12/10	12/10
1N4756	15	400m	4/10	1N4015	75	25m	20/10	20/10
1N5232	5.6	500m	28	1N4734	5.6	1	28	28
1N5235	6.8	500m	28					

Sonar

POLICE  
FIRE



RA-422

### 3-Channel VHF RECEIVER 150-174 MHz

REG. 29.99 **2299**

•Less Crystals

## BSR SMOKE & FIRE DETECTOR

XM-646

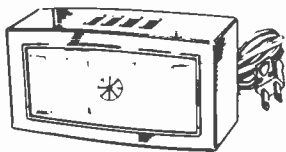

**1499** REG. 19.99

•Protect Your Family

## Toshiba TRANSISTOR AMPLIFIER MODULE

XM-670

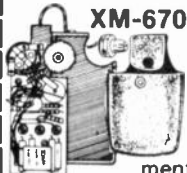

**399** Reg. 6.99

•Experimenter's Delight



## NI-CAD BATTERY "AA SIZE"

**\$1** BA-341  
EA. REG. 1.50

•1.2 Volts  
•Rechargeable

	REG.	NOW
2" PM Speaker, 8 Ohms, SS-295		.29
8-Track Tape Deck with Play-back Pre-Amp.		
4-Pole AC Motor, Less Cabinet, RA-604		9.99
Ni-Cad Batt. Packs, 2-AA cells-2.4 Volts, BA-359		.99
Ni-Cad Batt. Packs, 3-AA cells-3.6 Volts, BA-327	3.50	1.49
Ni-Cad Batt. Packs, 4-AA cells-4.8 Volts, BA-361		2.29
Volume Control Kit, 12 Pcs. Assorted, VC-274	1.00	.59
Stereophone with Card & Plug, PH-331	7.00	2.99
100 Pc. Resistor Kit, 1/4-1/2 Watt, RR-877	1.79	.79
50 Pc. Elect. Cap. Kit, Low Voltage, Axial-Radial, CD-487		5.00 2.99
40 Pc. Solder Terminal Strips, XM-501	1.30	1.00
AM Pushbutton Auto Radio-New, AU-500	10.99	9.99
Sonar 30-50 MHz. (3-Ch.) plus AM std. Broadcast Pocket Receiver, RA-577	39.00	29.99
Electronic Camera Shutter Assembly, XM-637		.99
Singer 12 Digit MOS Calculator Chip with Data Sheet, XM-635	2.90	1.79
UHF Varactor Timer, Data Incl., XM-676	1.99	1.49
Electronic "Choo-Choo" Module for Model Railroad, AM-549	1.99	.99
Siphon Pump-6 Ft. Squeeze Type, XM-675		.59 .39
6 VDC to 12 VDC Converter, AU-297	16.00	7.00
4 Channel Converter for Car Stereo, HF-213	7.90	2.00
Timing Motor 1 Rev. Every 4 Hours 120 VAC, MO-407	1.69	.59
Teletron Digital Clock Movement, 1 1/4" Numerals, 117 VAC, 60 Hz. Removed from Equipment, SW-853	5.99	4.99
2 1/4" 60 Ohm Speaker, SP-435	1.19	.69
AM-FM-MPX Receiver Chassis, Solid State 11-12 VAC Input, Tape Out Jacks, RA-574	9.99	7.99
Universal AC Adapter, 117 VAC Input, 6, 7.5 and 9 VDC Output @ 300 Ma, BA-159	7.00	4.99

# BONUS SALE

With a \$25 prepaid order get an intel data catalog  
With a \$50 prepaid order get the 8080 user manual

## 8K RAM BOARD

FULLY ASSEMBLED & TESTED, JUST PLUG IT IN - 64 2102's (in sockets)  
ALTAIR & IMSAI 8080 COMPATIBLE, ON BOARD REGULATORS, FULLY BUFFERED

**\$189.95**

WHO NEEDS A KIT? BUY IT, PLUG, & GO

## IC SOCKETS

SOLDER TAIL TIN		WIRE WRAP TIN (3)	
pins ea.	10 100	pins ea.	10 100
8 25¢	22 18	14 45¢	40 32
14 25¢	22 18	16 48¢	43 35
16 27¢	23 20	24 75¢	70 60
24 50¢	45 36		
28 80¢	75 68		
40 99¢	94 89		

molex  
500\*4.75 5K \$38  
1K 8.50 10K 70  
2K 16 50K 325

## CARBON FILM RESISTORS

High quality .25W 5% ALL STANDARD VALUES FROM 2.7Ω to 2.2M STOCKED IN DEPTH  
each ten hundred thousand 100 minimum  
10¢ 40¢ \$1.60 \$14- per value  
no mix of values

## RESISTOR ASSORTMENTS

LEADS TRIMMED FOR PRINTED CIRCUIT BOARD  
200 1/4W 5% 200 1/2. 5%  
\$2- \$2-

## COUNTER DISPLAY KIT

Ideal module for home built counter projects. Includes 7490 decade counter 7475 latch, 7447 decoder, and RCA .6" NUMITRON display. PCB with plated thru hole and instructions supplied.....  
KITS SUPPLIED FROM ONE TO TEN DIGITS PER BOARD (all interconnects plated)...

**\$5.89** per digit

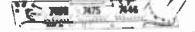

## -SUPER SPECIALS-

74S206 DIP 256:1 45NS RAM	\$ .90
93410f " " " "	.90
LM308AH OP-AMP w/pwr.	.90
JA776 " " PROGRAMMABLE	.90
78L05 1092.1A + REGULATOR	.30
78L12 " " " "	.30
78L24 " " " "	.30
MM5369 CRYSTAL OSC TIME BASE	1.75
MM5058 1024 BIT STATIC S.R. MINI	2.00
LM300 ADJUSTABLE REGULATOR	.60
LM723 " " " "	.50
747 DUAL OP-AMP	.50
ZENER 16V 1W on tape	.10
DIAC 27 VOLT TRIGGER DIODE	.20
CERAMIC FILTER 10.7 MHz.	1.25
7812 10-3 1amp REGULATOR	.69
78M05 10220.5A " "	.69

## -SWITCHES-

RED PUSH BUTTON  
N.O. MOMENTARY  
CONTACT, 1/4" HOLE

30¢ each	
8 \$ 2	
100 \$ 22	
1000 195	actual size



MINI MINI TOGGLE  
EXTRA SMALL D.P.D.T.  
3A 125VAC CONTACTS

each \$1.50	
8 - 10.	actual size
100 - 95.	



JBT HRI-223 5 AMP DPDT  
ROCKER SWITCH WITH PANEL  
MOUNTING HARDWARE.....

79¢ ea.	
ten \$6	
\$49/c	



## Numeric Display

1/4" Single Digit  
GaAsP LED

**FND 70**

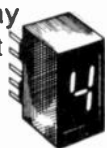

COMMON CATHODE WITH RH DECIMAL  
COMPACT - 10 DIGITS IN 3" PANEL WIDTH  
HIGHLY LEGIBLE - BRIGHT RED 1/4" CHARACTER  
EASILY READ WITHIN 10 FEET OVER A WIDE  
VIEWING ANGLE (140°)  
LOW POWER - 125 mW PER DIGIT AT TYPICAL  
BRIGHTNESS

79¢ each-ten \$6.95  
100- \$49

## DIP TRIMMER

12 TURN 1/4"x1/4"x1/4"  
5K or 200K only  
mg. DALE  
TEN FOR \$4



POTTER  
BRUMFIELD

Type KHP Relay  
4 PDT 3A Contacts  
24VDC COIL  
650 ohms  
120VAC  
10.5MA

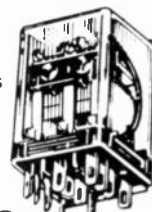

**\$1.60 ea.**

## 150 Mhz Prescaler

Use your low frequency counter to measure  
VHF or UHF frequencies. This kit will divide the  
input signal by ten (10 or 100 with 550MHz option)  
Kit contains drilled circuit board, 2 MC10131  
IC's, all parts needed and instructions.  
150/170MHz KIT .....\$12.95  
650MHz option W/1IC90 IC.....\$29.95  
-requires 3v at app. .2A, power supply  
and case are not part of kit-

## TO-92 TRANSISTORS

50 FIRST QUALITY PLASTIC  
TRANSISTORS ASSORTED TYPES  
PNP, NPN, AND EVEN A FEW  
DARLINGTONS... THESE ARE  
NOT U-TEST SPECIALS FROM FACTORY  
REJECT BARRELS, BUT FIRST QUALITY  
PARTS WITH HOUSE NUMBERS.  
JUST 250K AVAILABLE-SO STOCK UP  
NOW ... FIFTY FOR \$2-



## SUPER LED'S

This family of LED's are mounted in a 7-pin  
header with a 6/32 threaded stud to secure  
to a heat sink... THE AMPERES  
continuous current rating (with heat sink)  
can be pulled at up to 25A with low duty  
cycle. Data supplied w/order.  
M2 Infra red w/low lens \$2.99 ea.  
M3 Infra red w/high lens  
M4 Visible Red with low lens  
M4H Visible Red with high lens



PO BOX 41778  
Sacramento, Ca.  
95841 916 334 2161

Money back guarantee - \$5 minimum order.  
We pay post on orders for \$10 or more. All  
payment must be in U.S. funds Foreign  
orders must include post BAC & MC are  
not prepaid orders and shipping is added

# BABYLON ELECTRONICS



# Olson electronics

260 S. FORGE ST.  
DEPT. L-4 AKRON, OHIO 44327

NAME \_\_\_\_\_  
ADDRESS \_\_\_\_\_  
CITY \_\_\_\_\_ STATE \_\_\_\_\_ ZIP \_\_\_\_\_  
ENCLOSE POSTAGE AND SALES TAX

QTY.	STK #	DESCRIPTION	PRICE EA.	TOTAL

CIRCLE 71 ON FREE INFORMATION CARD

CIRCLE 69 ON FREE INFORMATION CARD

# INTERNATIONAL ELECTRONICS UNLIMITED

**10% OFF WITH \$25 ORDER**  
**15% OFF WITH \$100 ORDER**

THESE DISCOUNTS APPLY TO TOTAL OF ORDER — SPECIALS INCLUDED

TTL	7400	.13	7451	.17	74153	.89
	7401	.16	7453	.17	74154	1.20
	7402	.15	7454	.17	74155	.97
	7403	.15	7460	.17	74156	.97
	7404	.16	7464	.35	74157	.99
	7405	.19	7465	.35	74158	1.79
	7406	.20	7470	.30	74160	1.23
	7407	.28	7472	.30	74161	.97
	7408	.18	7473	.35	74162	1.39
	7409	.19	7474	.28	74163	1.09
	7410	.16	7475	.49	74164	.99
	7411	.25	7476	.30	74165	.99
	7413	.43	7483	.68	74166	1.25
	7414	.65	7485	.88	74170	2.10
	7416	.35	7486	.40	74173	1.49
	7417	.35	7489	2.25	74174	1.23
	7420	.16	7490	.43	74175	.97
	7422	.30	7491	.75	74176	.89
	7423	.29	7492	.48	74177	.84
	7425	.27	7493	.48	74180	.90
	7426	.26	7494	.78	74181	2.45
	7427	.29	7495	.79	74182	.79
	7430	.20	7496	.79	74184	1.90
	7432	.23	74100	.98	74185	2.20
	7437	.25	74105	.98	74187	5.75
	7438	.25	74107	.37	74190	1.15
	7440	.15	74121	.30	74191	1.25
	7441	.89	74122	.30	74192	.95
	7442	.59	74123	.65	74193	.85
	7443	.73	74125	.54	74194	1.25
	7444	.73	74126	.58	74195	.74
	7445	.73	74132	.89	74196	1.25
	7446	.81	74141	1.04	74197	.73
	7447	.79	74145	1.04	74198	1.73
	7448	.79	74150	.97	74199	1.69
	7450	.17	74151	.79	74200	5.45

LOW POWER	74100	.29	74151	.29	74190	1.40
	74102	.29	74155	.29	74191	1.20
	74103	.23	74171	.29	74193	1.50
	74104	.29	74172	.45	74195	1.50
	74106	.29	74173	.56	74198	2.25
	74110	.29	74174	.56	74194	2.25
	74120	.29	74178	.75	74195	2.30
	74130	.29	74185	1.09		
	74142	1.39	74186	.65		

LOW POWER SCHOTTKY	741500	.36	741532	.38	741595	2.09
	741502	.36	741540	.45	7415107	.59
	741504	.36	741542	1.40	7415164	2.20
	741508	.36	741574	.59	7415193	2.20
	741510	.36	741590	1.30	7415197	2.20
	741520	.36	741593	1.30		

HIGH SPEED	74400	.25	74422	.25	74461	.25
	74401	.25	74430	.25	74462	.25
	74404	.25	74440	.25	744674	.39
	74408	.25	74458	.25	7446101	.58
	74410	.25	74452	.25	7446102	.58
	74411	.25	74453	.25	7446103	.60
	74412	.25	74455	.25	7446106	.72
	74421	.25	74460	.25	7446108	.72

CMOS	4000A	.26	4018A	1.19	4066A	.89
	4001A	.25	4020A	1.72	4068A	.44
	4002A	.25	4021A	1.18	4069A	.44
	4006A	1.35	4022A	.94	4071A	.26
	4007A	.26	4023A	.25	4072A	.35
	4008A	1.52	4024A	.89	4073A	.39
	4009A	.57	4025A	.25	4075A	.39
	4010A	.54	4027A	.59	4078A	.39
	4011A	.29	4028A	.98	4082A	.35
	4012A	.25	4030A	.44	4518A	1.56
	4013A	.45	4035A	1.27	4528A	1.56
	4014A	1.27	4040A	1.39	4585A	2.10
	4015A	1.27	4042A	1.47		
	4016A	.68	4049A	.59		
	4017A	1.01	4050A	.59		

	74C00	.19	74C74	1.04	74C162	2.49
	74C02	.26	74C76	1.34	74C163	2.66
	74C04	.44	74C107	1.13	74C164	2.66
	74C08	.68	74C151	2.62	74C173	2.22
	74C10	.35	74C154	3.15	74C195	2.26
	74C20	.35	74C157	1.76	80C95	1.15
	74C42	1.61	74C160	2.48	80C97	.96
	74C73	1.04	74C161	2.49		

CALCULATOR CHIPS	CT5002	12 digit, 4 function fixed decimal battery operation — 40 pin	1.95
	CT5005	12 digit, 4 function plus memory, fixed decimal — 20 pin	2.49
	MM5525	8 digit, 4 function, floating decimal 18 pin	1.98
	MM5536	8 digit, 4 function, 9V battery operation — 18 pin	2.95
	MM5538	8 digit, 5 function plus memory and constant floating decimal, 9V battery operation — 24 pin	3.95
	MM5539	9 digit, 4 function, 9V battery operation — 22 pin	3.95



**6 Digit Clock Kit**  
MM5314 with 6 NS71 .27" displays 2 P.C. boards — Display board may be remote. Internal or wall transformer can be used. 50-60 Hz, 12-24 hour. Includes all necessary transistors, resistors, capacitors, diodes, 3 switches and complete assembly instructions.

**CK6-3** ..... \$14.95

**MM 5330** ..... \$6.95  
4 1/2 DIGIT DVM LOGIC

**LH 0070** ..... \$6.95  
BCD BUFFERED REF

**MM 5616** ..... \$1.25  
QUAD BI-LATERAL SWITCH

IC SOCKETS	Solder Tail - low profile		
	8 pin	\$ 17	24 pin .42
	14 pin	.20	28 pin .39
	16 pin	.22	40 pin .69
	18 pin	.29	

SPECIAL DEVICES	372 AF-IF Strip Detector DIP	2.93
	546 AM Radio Receiver Subsystem DIP	.75
	1310 FM Stereo Demodulator DIP	2.90
	1496 Balanced Modulator-Demodulator	.99
	1800 Stereo multiplexer DIP	2.44
	LNL2208 FM Gain Block 34db (typ) mDIP	1.18
	LNL2209 FM Gain Block 48db (typ) mDIP	1.35
	2513 Character Generator 64x85 DIP-24	10.20
	3086 Transistor Array DIP-14	.73

LINEAR CIRCUITS	100	\$ 71	171	2.42	223	.62
	301	.24	176	.68	733	.89
	302	.53	180	1.30	739	1.07
	104	.80	180-8	1.25	741	.32
	105	.17	181	1.75	747	.71
	107	.26	182	1.75	748	.35
	108	.89	183	2.95	1458	.62
	109A	1.35	184	2.95	1800	2.48
	110	1.07	190	2.95	1900	.39
	111	.95	550	.79	7525	.90
	119	1.11	555	.45	7524	.71
	1201	1.39	556A	1.19	7525	.90
	120K	1.39	560	3.39	8038	4.25
	122	1.70	562	3.39	8864	2.25
	124	1.52	565	1.18	75150	1.75
	119	1.58	566	1.95	75451	.35
	140A	1.58	567	1.95	75452	.35
	1401	1.49	710	.35	75491	.71
	172	2.93	711	.26	75492	.80

DISCRETE LED'S	ME4	INFRARED CLEAR DOME 170"	EACH .29
	MV10B	CLEAR DOME 170"	.25
	MV50	CLEAR — AXIAL .09"	.12
	MV50	RED — AXIAL .09"	.12
	NBL100	RED .19"	.12
	RL209	RED DIFF. SUBMINIATURE .12"	.12
	RLT-T1-03	WHITE DIFF. SUBMINIATURE NO FLANGE .12"	.15
	RLC-200	RED DIFF. CURRENT REG. 190" CONST. BRIGHTNESS 4.5-12.5V	.23
	RLC-201	RED DIFF. CURRENT REG. CONST. BRIGHTNESS 4.5-12.5V	.23
	RL-4403	RED DIFF. FULL FLOOD .190"	.15
	GREEN	SPOT .190"	.18
	CLEAR	POINT .190"	.15

LED S	DL 10A	RFD CA .27" LHD	\$1.89
	DL 707	RFD CA .30" RHD	1.49
	DL 507	RFD CA .50" RHD	1.49
	FND 359	RFD CC 375" RHD	.89
	DL 702	RFD CC .30" LHD	1.39
	NSN 74R	RFD CC .30" RHD	1.49
	DL 500	RFD CC .50" RHD	1.49
	MAN5	GREEN CA .27" LHD	1.39
	MAN8	YELLOW CA .27" LHD	1.39
	MAN82	YELLOW CA .3" LHD	1.89
	MAN66	RFD CA .6" LHD	2.19
	DL747	RFD CA .6" LHD	2.19

## DIGITAL

7416	.29
7427	.24
7437	.19
7454	.12
7493	.39
7495	.69
74145	.89
9602	.59
74C154	2.49

## SPECIALS

MEMORIES	
1101	5.69
1103	.69
1702A	5.95
5262	.99
74S200	3.25
82S23	2.75
93410	1.39

## LED DISPLAYS

DL10A	\$1.49
NSN 74R	.99
FND 359	.59
MAN 72	.99
DL702	.99

MV10B	6/S1.00
MV50	16/S1.00
556	.99
567	1.19

**2102** ..... \$1.29  
1024X1 STATIC RAM 16 PIN

**2708** ..... \$16.95  
1 x 8K EROM

CENTRAL PROCESSING UNIT  
**8008** ..... \$16.95  
**8080A** ..... \$19.95

**UART**  
AY51013A ..... \$6.95  
SP-425-09 9 digit .25" neon direct interface with MOS/LSI, 180 VDC, 7 wgs. 1.29

CALCULATOR DISPLAY  
9 MAN 3 M ON PC BOARD  
..... 99¢

MEMORIES  
1101 2 1/2 bit RAM MOS 16 pin 5.99  
1103 1024 bit RAM MOS Dynamic 18 pin .99  
1702A 2048 bit PROM-STATIC 16 pin 5.95  
2102 1024 bit Rom Static 16 pin 1.49  
5201 2048 bit PROM-STATIC 16 pin 9.95  
5261 1024 bit RAM MOS Dynamic 16 pin .99  
5262 1024 bit RAM MOS Dynamic 22 pin 1.29

KEYBOARD  
20 KEYS 2 SLIDE SW 3 x 3  
..... 99¢

**MM5389** Divider mDIP  
Crystal 3.58 MHz color TV Crystal 2.010 MHz ..... 2.49

## MINIATURE SOLID STATE ELECTRONIC BUZZER

LONG LIFE — HIGH RELIABILITY  
LOW CURRENT DRAIN  
NO MOVING CONTACTS

78 dB min AT 1 FT. — 450 Hz 4A  
EB-106 6V 15mA 4-9 VDC \$1.99  
EB-112 12V 15mA 8-20 VDC 1.99



**4 Digit Clock Kit**  
MM5312 and 4 NS71 .27" displays 12-24 hours, 50-60 Hz. One P.C. board accommodates clock, displays, and all necessary transistors, resistors, capacitors, diodes, 2 switches, complete instructions and schematics for assembly.  
**CR4-2** ..... \$10.95

CARBON FILM RESISTORS ±5% ALL STANDARD VALUES 1/4 OR 1/2 WATT			
QTY.	PRICE (each)	PRICE (Minimum 10 per value)	
0-10	\$ .10 ea		
10-100	\$ .10 ea	\$ .05 ea	
100-1000		\$ .04 ea	

METAL FILM RESISTORS ALL STANDARD VALUES + 1% 1/4 WATT			
QTY.	PRICE (each)	PRICE (Minimum 10 per value)	
0-10	\$ .20 ea		
10-100		\$ .15 ea	
100-1000		\$ .10 ea	

TANTALUM CAPACITORS Solid dipped +20%			
	1 mld 35V	5 .25	10 mld 16V \$ .40
	.33 mld 35V	.25	10 mld 25V .45
	1 mld 35V	.25	15 mld 10V .80
	2.2 mld 20V	.25	15 mld 20V .45
	2.2 mld 35V	.30	22 mld 16V .45
	3.3 mld 35V	.30	33 mld 10V .40
	4.7 mld 16V	.30	47 mld 6V .40
	6.8 mld 6V	.30	56 mld 6V .45
	6.8 mld 50V	.40	150 mld 15V .50

## SHIFT REGISTERS

2502	1024 bit MULT DYN 16 pin	\$2.95
2504	1024 bit MULT DYN 8 pin	2.95
2511	Tri-State Dual 50-100-200 bit	
	STATIC 14 pin	2.95
2518	Hex 32-bit STATIC 16 pin	2.95
2519	Hex 40-bit STATIC 16 pin	2.95
2527	Dual 256 bit STATIC 8 pin	2.95
2532	Quad 80 bit STATIC 16 pin	3.95
5013	1024 bit accum. Dynamic 8 pin	1.75
5016	500/512 bit Dynamic 8 pin	1.59

OPTO ISOLATORS  
MC D2 Opto isolator diode \$1.19  
MC E2 Opto isolator transistor .79

Date sheets on request. Add 30¢ each if item is priced below \$1.00 each.

**MINI-KITS**

**FM WIRELESS MIKE KIT**

FM-1 \$2.95  
Transmit up to 300 to any FM radio. Sensitive mic input requires dynamic crystal or ceramic mic. Runs on 3 x AA batteries.

**TONE DECODER KIT**

A complete tone decoder on a single PC Board. Features 400 to 5000 Hz adjustable frequency range, voltage regulation, 50% CUE for touch tone decoding, tone burst detection, FSK demodulation, and many other uses. Use for 12 button touchtone decoding. Runs on 3 x AA batteries.  
Complete Kit, TD-1 ..... \$4.95

**LED BLINKY KIT**

A great attention getter which alternately flashes 2 jumbo LEDs. Use for name badges, buttons, or warning type panel lights.  
Complete Kit, BL-1 ..... \$2.95

**SUPER SNOOP AMPLIFIER**

A super-sensitive amplifier which will pick up a pin drop at 10 feet! Great for monitoring baby's room or as a general purpose test amplifier. Full 2 watts of output, runs on 8 x 12 volts, uses any type of mic. Requires 8 x 12 volt speaker.  
Complete Kit, BN-9 ..... \$4.95

**MUSIC LIGHTS KIT**

See music come alive! 3 different lights flicker with music, or strobe. One light for lows, one for the mid-range and one for the highs. Each channel individually adjustable and drives up to 300 watts. Great for parties, band music, nice clubs and more.  
Complete Kit, ML-1 ..... \$7.95

**SIREN KIT**

Produces upward and downward wail characteristic of police siren. 2000 Hz audio output, runs on 3 1/2 volts, uses 8 x 12 volt speaker.  
Complete Kit, SM-3 ..... \$2.95

**CODE OSCILLATOR KIT**

Powered 1 watt audio oscillator of approx. 1 MHz, good for many uses. Great for testing alarm, battery checker, voltage indicator and code oscillator.  
Complete Kit, CP-1 ..... \$2.60

**POWER SUPPLY KIT**

Complete triple regulated power supply provides variable 15 volts @ 200mA and +5 volts @ 1 amp. 50mA load regulation, good filtering and small size. All less transformers requires 6.3V @ 1 amp and 18 to 30V AC.  
Complete Kit, PS-3LT ..... \$6.95

**DECADE COUNTER PARTS KIT**

Includes 7480A 32 MHz counter, 7475 latch, 7447 LED driver, LED resistor, current limiting resistors, hook up details and instructions on how to build an easy-to-use "cost" counter. Kit of Parts, DCU-1 ..... \$3.80



**Frequency Counter \$79.95 KIT**

You've requested it, and now it's here! The CT-50 Frequency Counter Kit has more features than counters selling for twice the price. Measuring frequency is now as easy as pushing a button, the CT-50 will automatically place the decimal point in all modes, giving you quick, reliable readings. Want to use the CT-50 mobile? No problem, it runs equally as well on 12 VDC as it does on 110 VAC. Want super accuracy? The CT-50 uses the popular TV color burst freq. of 3.579545 MHz for time base. Tap off a color TV with our adapter and get ultra accuracy — .001 ppm! The CT-50 offers professional quality at the unheard of price of \$79.95. Order yours today!

CT-50, 60MHz Counter Kit ..... \$79.95  
CT-50WT, 60 MHz counter, wired and tested ..... \$159.95  
CT-600, 600 MHz prescaler option for CT-50, add ..... \$29.95



**UTILIZES NEW MOS-LSI CIRCUITRY SPECIFICATIONS**

Sensitivity: less than 25mV  
Frequency range: 5Hz to 60MHz, typically 65MHz  
Gate time: 1 second, 1/10 second, with automatic decimal point positioning on both direct and prescale  
Display: 8 digit red LED .4" height  
Accuracy: 10 ppm, .001 ppm with TV time base!  
Input: BNC, 1 meg ohm direct, 50 ohm with prescale option  
Power: 110 VAC 5 watts or 12 VDC @ 1 Amp  
Size: Approx. 6" x 4" x 2", high quality aluminum case  
Color burst adapter for .001 ppm accuracy available in 6 weeks. CB-1, Kit ..... \$14.95

**VIDEO TERMINAL KIT \$149.95**

A compact 5 x 10-inch PC card that requires only an ASCII keyboard and a TV set to become a complete interactive terminal for connection to your microprocessor asynchronous interface. Its many features are single 5-volt supply, crystal controlled sync and baud rates (up to 9600 baud), 2 pages of 32 characters by 16 lines, read to and from memory, computer and keyboard-operated cursor and page control, parity error display and control, power-on initialization, full 64-character ASCII display, block-type see-thru cursor. Keyboard/computer control backspaces, forward spaces, line feeds, rev. line feeds, home, returns cursor. Also clears page, clears to end of line. Selects page 1 or 2, reads from or to memory. The card requires 5 volts at approx. 900 mA and outputs standard 75 ohm composite video.

TH3216 Kit ..... \$149.95  
TH3216, Assembled and Tested ..... \$239.95  
VD-1, Video to RF Modulator Kit ..... \$ 6.95

**600 mHz Prescaler**



Fully assembled and tested. Extends the range of your counter to 10 times higher in frequency. Works with any counter. High sensitivity input with built-in on-chip pre-amp.  
PS-1B—10 ..... \$59.95



**SIX DIGIT 12/24 HR CLOCK KIT**

Want a clock that looks good enough for your living room? Forget the competitor's kludges and try one of ours! Features: Jumbo 4" digits, Polaroid lens filter, extruded aluminum case available in 5 colors, quality PCB boards and super instructions. All parts are included, no extras to buy. Fully guaranteed. One to two hour assembly time. Colors: silver, gold, black, blue and bronze (specify).  
Clock Kit, DC-5 ..... \$22.95  
Alarm Clock, DC-8, 12 hr. only ..... \$24.95  
DC-5 with 10 min. 1D timer ..... \$25.95  
Mobile Version, DC-7 ..... \$25.95  
Assembled and tested clocks available, add \$10.00 to kit price.

741 MINI DIP, house marked ..... 10/\$2.00

Phone orders welcome

**LINEAR**

555	.50
556	.75
566	1.49
567	1.49
324	1.49
1458	.49
380	1.49

**REGS**

309K	.99
340K-12	.99
7805	.99
7812	.99
7815	.99
78MGM	1.50
723	.49

**TRANSISTORS**

PNP 2N3904 type	10/\$1.00
PNP 2N3906 type	10/\$1.00
PNP Power Tab 40W	3/\$1.00
PNP Power Tab 40W	3/\$1.00
FET MPF-102 type	3/\$2.00
UJT 2N2646 type	3/\$2.00
2N3055 NPN Power	.75

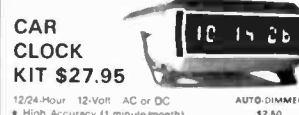

**CAR CLOCK KIT \$27.95**  
12/24-Hour 12-Volt AC or DC  
• High Accuracy (1 minute/month)  
• 6 jumbo 4" LED readouts  
• Easy, no-polarity hookup  
• Display brightens with ignition  
• Case-mounting bracket included  
• Super instructions  
Complete Kit, DC-11 ..... \$27.95

**ramsey electronics**

BOX 4072A ROCHESTER, NY 14610 (716) 271-6487

**CIRCLE 57 ON FREE INFORMATION CARD**

**UNIVERSAL 4K x 8 MEMORY BOARD KIT \$74.50**  
32 2102 1 fully buffered, 16 address lines, on board decoupling for any 4 of 64 pages, standard 44 pin buss.

**EXPANDABLE F8 CPU BOARD KIT \$99.00**  
featuring Fairbug PSU 1K of static ram, RS 232 interface, documentation, 64 BYTE register on paper tape.

**4K BASIC FOR FAIRBUG \$25.00**  
on paper tape.

**C/MOS (DIODE CLAMPED)**

74C10	.22	4012	.22	4023	.22	4042	.78
74C193	1.50	4013	.40	4024	.75	4046	2.25
4001	.22	4015	.95	4025	.22	4049	.40
4002	.22	4016	.40	4027	.40	4050	.40
4006	1.20	4017	1.05	4028	.88	4055	1.50
4007	.22	4018	1.00	4029	1.10	4066	.80
4009	.43	4019	.25	4030	.22	4071	.27
4010	.42	4020	1.05	4033	1.50	4076	1.05
4011	.22	4022	.95	4035	1.10		

**WSU 30 Hand wire wrap tool used to wrap unwrap & Strip #30 wire \$5.50**

**#24, EIGHT CONDUCTOR SPECTRA FLAT CABLE 10/8 \$1.50 100/78 \$12.50**

**DIP SOCKETS**  
8 PIN — 22 24 PIN — 40  
14 PIN — 25 28 PIN — 50  
16 PIN — 28 40 PIN — 60  
18 PIN — 30

**#30 WIRE WRAP WIRE SINGLE STRAND 100/61 \$4.40**

7/08 BK EPROM ..... \$20.95  
2513 4 AT 4 SHIFT REG ..... \$ 1.95  
2513 CHARACTER GEN ..... \$ 9.95  
2518 HEX 32 BIT SR ..... \$ 2.50  
2102 1 1024 BIT RAM ..... \$ 1.29  
2107B ..... \$ 4.25  
MK4008P ..... \$ 1.95  
5280 4K DYNAMIC RAM ..... \$ 4.75  
1101A 256 BIT RAM ..... \$ .85  
MM5203 UV PROM ..... \$ 6.95  
1702A UV PROM ..... \$ 4.95  
5704-K PROM ..... \$10.95  
AY 5 1013 UART ..... \$ 6.95

**LIGHT ACTIVATED SWITCH TO 18 200V 1A \$ 1.10**  
IN 4148 10/1M ..... 16 \$1.99

**LED READOUTS**

FND 359 C.C. 4" .50 HP 7740 .3" C.C. \$1.25  
FND 70 C.C. 4" .50 MANK 7.3" C.A. \$ .95  
FND 503 C.C. 5" .85 NS 30-3 deg array \$ .75  
FND 510 C.C. 5" .85 DI 747C A 6" \$1.95

**PRINTED CIRCUIT BOARD**  
4 1/2" x 6 1/2" SINGLE SIDED EPOXY BOARD 1 16 (10 mil) thickness ..... 5/\$2.60  
**7 WATT LD-65 LASER DIODE IR \$89.50**

2N 3820 P FET ..... \$ 4.45  
2N 5457 N FET ..... \$ 4.45  
2N2646 ..... \$ 4.45  
ER 600 TRIGGER DIODES 4 ..... \$1.00  
2N 6028 PNP TO 18 ..... \$ 6.65

**INSTANTaneous MULTI-TURN TRIM POT'S**  
100, 500, 1K, 2K, 5K, 10K, 25K, 50K, 100K, 200K, 500K, 1Meg \$ 7.5 each 3/\$2.00

**MULTI-TURN TRIM POT'S similar to Booms**  
3010 style 3 16 .5 R 1 1 4 .90 100  
1K, 10K, 50K ohms \$1.50 ea. 3/\$4.00

**VERIPAC PC BOARD**  
This board is a 1.16" wide single paper epoxy board. 4" x 6 1/2" DRILLED and ETCHED which will hold up to 21 single 14 pin IC's or B, 16, or LSI DIP IC's with buses for power supply connector.  
AV 5081 YELLOW/GREEN ..... \$4.00  
BIPOlar LED ..... \$ .90  
FP 100 PHOTO TRANS ..... \$ .50  
RED, YELLOW, GREEN or AMBER  
LARGE LED'S ..... 6/\$1.00  
1L5 (MCT-2) ..... \$ .75  
MOLEX PINS ..... 100/\$1.00  
1000/\$8.00

10 WATT ZENERS 3.9, 4.7, 5.6, 8.2, 12, 15, 18, 22, 100, 150 or 200V ea. \$ .60  
1 WATT ZENERS 4.7, 5.6, 10, 12, 15, 18 or 22V ..... ea. \$ .25  
MC6880 MODEM CHIP ..... \$9.95

**Silicon Power Rectifiers**

PRV 1A 3A 12A 50A 175A	
100 06 14 30 80 3 70	
200 07 20 35 1 15 4 25	
400 09 25 50 1 40 6 50	
600 11 30 70 1 80 8 50	
800 15 35 90 2 30 10 50	
1000 20 45 110 3 75 12 50	

**SILICON SOLAR CELLS**  
2 1/2" diameter  
4V at 500 ma. \$4.00 / 2V at 200 ma. \$2.00

**REGULATORS**

309K	.95	340K 5, 12, 15	
723	.50	or 24V	\$.85
LM 376	.60	340T 5, 6, 8, 12	
320K-5 or 15V	\$.40	15, 18 or 24V\$1.10	
320T 5, 12, 15		78 MG	\$.135
or 24V	\$.85	79 MG	\$.135

**RS232 CONNECTORS**  
DB 25P male ..... \$2.95  
DB 25S female ..... \$3.50

**TRANSISTOR SPECIALS**

2N3588 NPN Si TO 18	\$.95
2N3772 NPN Si TO 3	\$1.60
2N1546 PNP GE TO 3	\$.75
2N4988 PNP Si TO 3	\$1.00
2N6056 NPN Si TO 3 Darlington	\$1.70
2N5086 PNP Si TO 92	4/\$1.00
2N4895 PNP TO 66	\$.60
2N404 PNP GE TO 5	5/\$1.50
2N3919 NPN Si TO 3 RF	\$1.50
MPSA 13 NPN Si TO 92	3/\$1.00
2N3767 NPN Si TO 66	\$.70
2N2222 NPN Si TO 18	5/\$1.00
2N3055 NPN Si TO 3	\$.70
2N3004 NPN Si TO 92	5/\$1.00
2N3906 PNP Si TO 92	5/\$1.00
2N5296 NPN Si TO 20	\$.50
2N6109 PNP Si TO 20	\$.55
2N3638 PNP Si TO 5	5/\$1.00
2N6517 NPN TO 92 S	3/\$1.00

**TTL IC SERIES**

7400	14	7445	.55	74151	.60
7401	14	7446	.65	74153	.60
7402	14	7447	.65	74154	.95
7403	14	7448	.65	74155	.70
7404	18	7450	.15	74157	.58
7405	18	7472	.29	74161	.85
7406	.25	7473	.29	74163	.80
7407	.25	7474	.29	74164	.95
7408	18	7475	.45	74165	.95
7409	17	7476	.30	74173	1.20
7410	14	7480	.35	74174	.95
7411	20	7483	.62	74175	.82
7412	20	7485	.87	74176	.75
7413	39	7486	.30	74177	.75
7414	63	7489	1.85	74180	.65
7416	.25	7490	.42	74181	.90
7417	.25	7491	.58	74190	1.00
7420	14	7492	.43	74191	1.00
7425	.25	7493	.45	74192	.83
7426	.22	7494	.70	74193	.83
7427	.25	7495	.65	74194	.85
7430	14	7496	.65	74195	.52
7432	.25	74107	.28	74257	1.25
7437	.21	74121	.38	74259	.87
7438	.21	74123	.65	74279	.87
7440	14	74125	.40	75324	1.75
7441	70	74126	.40	75491	.65
7442	40	74150	.90	75492	.65

**MINIATURE DIP SWITCHES**  
CTS-206 4 Four SPST switches in one minidip package ..... \$1.75  
CTS-206-8 Eight SPST switches in a 16 pin dip package ..... \$1.95

5BV SPST Miniature DIP Switch (resistance: 575, 3320)

**Full Wave Bridges**

PRV	2A	6A	25A
200	.75	1.25	2.00
400	.95	1.50	3.00
600	1.00	1.75	4.00

**SANKEN AUDIO POWER AMPS**  
S-1019 G 10 WATTS ..... \$ 7.95  
S-1020 G 20 WATTS ..... \$15.95  
S-1050 G 50 WATTS ..... \$27.95

**TANTALUM CAPACITORS**

22UF 35V 5/16 10UF 20V	\$.25
47UF 35V 5 1/16 22UF 25V	\$.40
68UF 35V 5 1/16 15UF 35V	3/\$1.00
1UF 35V 5 1/16 30UF 6V	5/\$1.00
2 2UF 20V5 5 1/16 10UF 15V	\$.40
3 3UF 35V 4 1/16 47UF 20V	\$.35
4 7UF 15V 5/16 10UF 15V	\$.50
6 8UF 35V 4 1/16 10UF	\$.50

**M/001 ALARM CLOCK CHIP \$5.75**

**74LS SERIES**

74LS00	23	74LS126	65	LINEAR CIRCUITS	
74LS02	23	74LS132	80	LM 101	.75
74LS03	23	74LS136	.39	LM 301	748 31
74LS04	28	74LS138	.72	LM309	.30
74LS05	28	74LS139	.72	LM 308	.95
74LS08	23	74LS151	.98	LM 311	.95
74LS09	23	74LS153	.93	LM 318	1.35
74LS10	23	74LS155	1.40	LM 319	.85
74LS11	23	74LS156	.95	LM 324	1.05
74LS13	50	74LS157	.98	LM 339	1.10
74LS15	28	74LS160	1.02	LM 358	1.40
74LS20	23	74LS161	1.02	LM 377	2.50
74LS21	23	74LS162	1.02	LM 380	.95
74LS22	23	74LS163	1.02	LM 381	1.25
74LS26	33	74LS168	1.10	LM 382	1.25
74LS27	27	74LS169	1.10	LM 537	2.50
74LS30	23	74LS170	1.12	LM 553	2.50
74LS32	33	74LS173	1.39	LM 555	.44
74LS37	37	74LS174	1.05	LM 556	.85
74LS38	37	74LS175	1.22	560	2.00
74LS40	27	74LS279	75	565	1.10
74LS51	23	74LS190	1.50	566	1.50
74LS54	23	74LS191	1.50	567	1.50
74LS74	49	74LS192	1.75	703	.90
74LS90	95	74LS193	1.75	709	.75
74LS92	88	74LS195	1.25	710	.75
74LS93	85	74LS196	.99	711	.35
74LS94	40	74LS197	.99	741C or V	31
74LS96	40	74LS221	1.25	747	.65
74LS99	89	74LS259	1.35	LM 130	2.50
74LS99</					

## DIGI-KEY CORPORATION

Quality Electronic Components

### DON'T FORGET OUR DISCOUNTS WHEN COMPARING PRICES MICROPROCESSORS

**Best Values Yet!**

8080A	8-BIT CPU, 2 USEC CYCLE	\$12.95
8212	8-BIT I/O PORT	\$ 3.95
8216	BI-DIRECTIONAL BUS DRIVER	\$ 4.25
8224	CLOCK GENERATOR	\$ 3.95
8228	SYSTEM CONTROLLER	\$ 6.95
8251	COMMUNICATIONS INTERFACE	\$12.95
8255	PERIPHERAL INTERFACE	\$11.95
1702A	2K EPROM (256x8)	\$ 6.95
2708	8K EPROM (1Kx8)	\$29.50
2102-1	1K RAM 500 NS.	\$ 1.79
SC/MP	5 VOLT SC/MP CPU	\$ 9.95
2650	MICROPROCESSOR 1.25 MH-2 CLOCK 40 DIL.	\$24.95

## 8080A CHIP SET

ONE EACH 8080A, 8212, 8224 and 8228 PLUS SIXTEEN 2102-1's — ALL FOR

### \$49.95

**PRICE BREAKTHROUGH ON 74LS'**

74LS00	28	74LS30	28	74LS90	57	74LS157	75	74LS248	79
74LS01	28	74LS32	33	74LS92	57	74LS158	75	74LS249	79
74LS02	28	74LS33	33	74LS93	57	74LS160	102	74LS253	84
74LS03	28	74LS38	33	74LS107	39	74LS161	102	74LS257	75
74LS04	29	74LS40	28	74LS109	39	74LS162	102	74LS258	75
74LS05	29	74LS42	67	74LS110	29	74LS163	102	74LS266	84
74LS08	29	74LS47	79	74LS113	39	74LS164	102	74LS283	79
74LS09	29	74LS48	77	74LS114	39	74LS168	114	74LS290	65
74LS10	28	74LS51	28	74LS125	49	74LS169	114	74LS293	65
74LS11	28	74LS52	28	74LS126	49	74LS170	123	74LS296	67
74LS12	28	74LS53	28	74LS127	49	74LS171	134	74LS366	67
74LS13	47	74LS54	28	74LS132	81	74LS172	134	74LS367	67
74LS14	47	74LS57	39	74LS136	39	74LS174	106	74LS368	67
74LS15	28	74LS58	39	74LS138	73	74LS175	84	74LS369	67
74LS16	28	74LS59	39	74LS139	73	74LS176	84	74LS370	67
74LS17	28	74LS60	39	74LS140	73	74LS177	84	74LS371	67
74LS18	28	74LS61	39	74LS141	73	74LS178	84	74LS372	67
74LS19	28	74LS62	39	74LS142	73	74LS179	84	74LS373	67
74LS20	28	74LS63	39	74LS143	73	74LS180	84	74LS374	67
74LS21	28	74LS64	39	74LS144	73	74LS181	84	74LS375	67
74LS22	28	74LS65	39	74LS145	73	74LS182	84	74LS376	67
74LS23	28	74LS66	39	74LS146	73	74LS183	84	74LS377	67
74LS24	28	74LS67	39	74LS147	73	74LS184	84	74LS378	67
74LS25	28	74LS68	39	74LS148	73	74LS185	84	74LS379	67
74LS26	28	74LS69	39	74LS149	73	74LS186	84	74LS380	67
74LS27	28	74LS70	39	74LS150	73	74LS187	84	74LS381	67
74LS28	28	74LS71	39	74LS151	73	74LS188	84	74LS382	67
74LS29	28	74LS72	39	74LS152	73	74LS189	84	74LS383	67
74LS30	28	74LS73	39	74LS153	73	74LS190	84	74LS384	67
74LS31	28	74LS74	39	74LS154	73	74LS191	84	74LS385	67
74LS32	28	74LS75	39	74LS155	73	74LS192	84	74LS386	67
74LS33	28	74LS76	39	74LS156	73	74LS193	84	74LS387	67
74LS34	28	74LS77	39	74LS157	73	74LS194	84	74LS388	67
74LS35	28	74LS78	39	74LS158	73	74LS195	84	74LS389	67
74LS36	28	74LS79	39	74LS159	73	74LS196	84	74LS390	67
74LS37	28	74LS80	39	74LS160	73	74LS197	84	74LS391	67
74LS38	28	74LS81	39	74LS161	73	74LS198	84	74LS392	67
74LS39	28	74LS82	39	74LS162	73	74LS199	84	74LS393	67
74LS40	28	74LS83	39	74LS163	73	74LS200	84	74LS394	67
74LS41	28	74LS84	39	74LS164	73	74LS201	84	74LS395	67
74LS42	28	74LS85	39	74LS165	73	74LS202	84	74LS396	67
74LS43	28	74LS86	39	74LS166	73	74LS203	84	74LS397	67
74LS44	28	74LS87	39	74LS167	73	74LS204	84	74LS398	67
74LS45	28	74LS88	39	74LS168	73	74LS205	84	74LS399	67
74LS46	28	74LS89	39	74LS169	73	74LS206	84	74LS400	67
74LS47	28	74LS90	39	74LS170	73	74LS207	84	74LS401	67
74LS48	28	74LS91	39	74LS171	73	74LS208	84	74LS402	67
74LS49	28	74LS92	39	74LS172	73	74LS209	84	74LS403	67
74LS50	28	74LS93	39	74LS173	73	74LS210	84	74LS404	67
74LS51	28	74LS94	39	74LS174	73	74LS211	84	74LS405	67
74LS52	28	74LS95	39	74LS175	73	74LS212	84	74LS406	67
74LS53	28	74LS96	39	74LS176	73	74LS213	84	74LS407	67
74LS54	28	74LS97	39	74LS177	73	74LS214	84	74LS408	67
74LS55	28	74LS98	39	74LS178	73	74LS215	84	74LS409	67
74LS56	28	74LS99	39	74LS179	73	74LS216	84	74LS410	67
74LS57	28	74LS00	39	74LS180	73	74LS217	84	74LS411	67
74LS58	28	74LS01	39	74LS181	73	74LS218	84	74LS412	67
74LS59	28	74LS02	39	74LS182	73	74LS219	84	74LS413	67
74LS60	28	74LS03	39	74LS183	73	74LS220	84	74LS414	67
74LS61	28	74LS04	39	74LS184	73	74LS221	84	74LS415	67
74LS62	28	74LS05	39	74LS185	73	74LS222	84	74LS416	67
74LS63	28	74LS06	39	74LS186	73	74LS223	84	74LS417	67
74LS64	28	74LS07	39	74LS187	73	74LS224	84	74LS418	67
74LS65	28	74LS08	39	74LS188	73	74LS225	84	74LS419	67
74LS66	28	74LS09	39	74LS189	73	74LS226	84	74LS420	67
74LS67	28	74LS10	39	74LS190	73	74LS227	84	74LS421	67
74LS68	28	74LS11	39	74LS191	73	74LS228	84	74LS422	67
74LS69	28	74LS12	39	74LS192	73	74LS229	84	74LS423	67
74LS70	28	74LS13	39	74LS193	73	74LS230	84	74LS424	67
74LS71	28	74LS14	39	74LS194	73	74LS231	84	74LS425	67
74LS72	28	74LS15	39	74LS195	73	74LS232	84	74LS426	67
74LS73	28	74LS16	39	74LS196	73	74LS233	84	74LS427	67
74LS74	28	74LS17	39	74LS197	73	74LS234	84	74LS428	67
74LS75	28	74LS18	39	74LS198	73	74LS235	84	74LS429	67
74LS76	28	74LS19	39	74LS199	73	74LS236	84	74LS430	67
74LS77	28	74LS20	39	74LS200	73	74LS237	84	74LS431	67
74LS78	28	74LS21	39	74LS201	73	74LS238	84	74LS432	67
74LS79	28	74LS22	39	74LS202	73	74LS239	84	74LS433	67
74LS80	28	74LS23	39	74LS203	73	74LS240	84	74LS434	67
74LS81	28	74LS24	39	74LS204	73	74LS241	84	74LS435	67
74LS82	28	74LS25	39	74LS205	73	74LS242	84	74LS436	67
74LS83	28	74LS26	39	74LS206	73	74LS243	84	74LS437	67
74LS84	28	74LS27	39	74LS207	73	74LS244	84	74LS438	67
74LS85	28	74LS28	39	74LS208	73	74LS245	84	74LS439	67
74LS86	28	74LS29	39	74LS209	73	74LS246	84	74LS440	67
74LS87	28	74LS30	39	74LS210	73	74LS247	84	74LS441	67
74LS88	28	74LS31	39	74LS211	73	74LS248	84	74LS442	67
74LS89	28	74LS32	39	74LS212	73	74LS249	84	74LS443	67
74LS90	28	74LS33	39	74LS213	73	74LS250	84	74LS444	67
74LS91	28	74LS34	39	74LS214	73	74LS251	84	74LS445	67
74LS92	28	74LS35	39	74LS215	73	74LS252	84	74LS446	67
74LS93	28	74LS36	39	74LS216	73	74LS253	84	74LS447	67
74LS94	28	74LS37	39	74LS217	73	74LS254	84	74LS448	67
74LS95	28	74LS38	39	74LS218	73	74LS255	84	74LS449	67
74LS96	28	74LS39	39	74LS219	73	74LS256	84	74LS450	67
74LS97	28	74LS40	39	74LS220	73	74LS257	84	74LS451	67
74LS98	28	74LS41	39	74LS221	73	74LS258	84	74LS452	67
74LS99	28	74LS42	39	74LS222	73	74LS259	84	74LS453	67
74LS00	28	74LS43	39	74LS223	73	74LS260	84	74LS454	67

## INTEGRATED CIRCUITS TTL, CMOS, LINEAR

7400	27	7476	32	74181	215	4012	23	4520	114
7401	21	7480	70	74182	215	4013	23	4527	188
7402	21	7482	70	74184	219	4014	96	4528	88
7403	21	7483	70	74185	219	4015	96	4585	123
7404	21	7485	89	74188	350	4016	40	2107-1	179
7405	21	7486	89	74189	350	4017	105	8008A	125
7406	25	7489	219	74190	123	4018	105	CA3046	75
7407	25	7490	44	74191	123	4019	23	LM211N	125
7408	21	7491	70	74192	88	4020	114	LM309K	180
7409	21	7492	44	74193	88	4021	114	LM324A	126
7410	21	7493	44	74194	88	4022	96	LM340T-5	125
7411	21	7494	70	74195	88	4023	23	LM340T-8	125
7412	21	7495	70	74196	88	4024	84	LM340T-18	125
7413	25	7496	70	74197	88	4025	23	LM340T-25	125
7414	89	74100	126	74198	149	4026	168	LM340T-15	125
7416	25	74107	30	74199	149	4027	40	LM340T-18	125
7417	25	74109	33	74201	109	4028	23	LM340T-24	125
7420	21	74121	33	74202	55	4029	114	LM3909N	69
7421	25	74122	44	74203	55	4030	23	MC1456V	100
7423	35	74123	67	74204	55	4031	51	MC1456V	100
7425	35	74125	40	74205	55	4032	51	MC1456V	100
7426	25	74126	40	74206	55	4033	114	MC1302P	115
7427	35	74132	70	74207	55	4034	114	NE530T	324
7428	26	74137	80	74208	55	4035	114	NE540L	204
7429	21	74145	70	74209	55	4036	79	NE540V	48
7432	25	74147	163	74210	55	4037	79	NE566A	88
7433	30	74148	130	74					

# FORDHAM BEST BUYS

## SENCORE TF 40 Pocket Cricket Portable Transistor & FET Tester

- ✓ Solid state
- ✓ Completely portable
- ✓ 100% safe test in seconds



FOR PRICING AND TO PLACE YOUR ORDER:

Call collect for Mr. Louis (516) 752-0050

Master Charge, BankAmericard & C.O.D.'s accepted

**FREE** 148 page catalog of over 3000 items test equipment CB tools tubes components and a full line of electronic supplies

**YOUR ONE STOP DISCOUNT CENTER**

# FORDHAM

RADIO SUPPLY CO., INC.  
855 Conklin St., Farmingdale, N.Y. 11735

CIRCLE 46 ON FREE INFORMATION CARD



### AM/FM RADIO \$10

Plugs into wall, add your 2 speakers and you're ready to go. Calibrated s/o motion am/fm tuning dial. Has stereo amps for use with phono or tape inputs to give stereo output. Solid state new.



### UNIVERSAL POWER SUPPLY

Operates on 115 or 230V. Output by switches 4.5VDC, 6 VDC, 7.5VDC or 9 VDC. Also has universal 4 way output plug to fit most any device. Good for 300 MA. \$6.00 each 3 for \$15.00.

**CHARACTER GENERATOR CHIP**  
Memory is 512X5 produces 64 five by seven ASCII characters. New by National, w/specs \$6.00

**TOUCHTONE ENCODER CHIP**  
Compatible w/Bell system. Ideal for repeater work. W/specs \$6.00

**SMOKE - FIRE - INTRUDER ALARM**  
12 VDC w/ 5 inch loud bell, w/instructions. Fine biz. for car, camper, boat, home W/ instructions \$22.00

customer pays all postage  
MESHNA, PO BOX 62, E. Lynn Ma 01904

CIRCLE 49 ON FREE INFORMATION CARD

**PICTURE TUBE MACHINE**

We buy and sell NEW and USED CRT rebuilding machinery. COMPLETE TRAINING. Buy with CONFIDENCE from the ORIGINAL MFGR.

For complete details send name, address, zip to  
LAKESIDE INDUSTRIES  
3520 W. Fullerton Ave.  
Chicago, Ill. 60647  
Phone: 312-342-3399

**POWERFUL, adjustable, regulated, three output power supply** and 900 easily removable parts in complete Cartrivision television recorder electronic assembly with documentation. Perfect for **Microprocessor, IC, transistor, television, CB radio applications.** \$24.95 total. BankAmericard, Master Charge. Free brochure. **MADISON ELECTRONICS, INCORPORATED, 369, D101, Madison, AL 35758. Satisfaction guaranteed.**

**NAME brand digital/analog test equipment.** Discount prices. Free catalog. **SALEN ELECTRONICS, P.O. Box 82, Skokie, IL 60076**

**PC boards from your art.** Send \$2 for info. **ASSEMBLY SYSTEMS, Dept PC, Box 221, Wadsworth, OH 44281**

## WANTED

**SEEKING Japanese transistors for CB repair?** Request complete list. Compare 1 to 9 prices: 2SC710 .59, 2SC517 3.95, 2SC799 3.60, 2SC1306 4.40, 2SC1678 2.25, TA7205P 3.90, BA 521 3.70, BA511 3.40. **FUJI-SVEA ENTERPRISE, Dept. RE, P.O. Box 40325, Cincinnati, OH 45240**



## HIGH BLOOD PRESSURE Treat it...and live.

The National High Blood Pressure Education Program, U.S. Department of Health, Education, and Welfare.

# ADVA

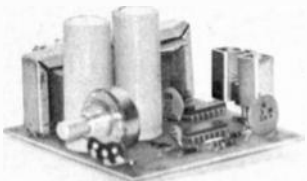

## KIT \$11<sup>95</sup>

ASSEMBLED \$17.95

ADD \$1.25 FOR POSTAGE/HANDLING

# VARIABLE POWER SUPPLY

- Continuously Variable from 2V to over 15V
- Short-Circuit Proof
- Typical Regulation of 0.1%
- Electronic Current Limiting at 300mA
- Very Low Output Ripple
- Fiberglass PC Board Mounts All Components
- Assemble in about One Hour
- Makes a Great Bench or Lab Power Supply
- Includes All Components except Case and Meters

### OTHER ADVA KITS:

**LOGIC PROBE KIT** Use with CMOS TTL DTL RTL HTL MNIL and most MOS IC's. Built-in protection against polarity reversal and overvoltage. Draws only a few mA from circuit under test. Dual LED readout. Complete kit includes case and clip leads. **ONLY \$7.95**

**FIXED REGULATED POWER SUPPLY KITS** Short-circuit proof with thermal current limiting. Compact size and typical regulation of 0.5% make these ideal for most electronic projects. Available for 5V @ 500mA, 6V @ 500mA, 9V @ 500mA, 12V @ 400mA, 15V @ 300mA. Specify voltage when ordering. **\$9.95 ea**

These easy-to-assemble kits include all components, complete detailed instructions and plated fiberglass PC boards. Power supply kits do not include case or meters. Add \$1.25 per kit for postage and handling.

**1 MAIL NOW! FREE DATA SHEETS** supplied with many items from this ad. **FREE ON REQUEST** 741 Op Amp with every order of \$5 or more. 749 Dual Op Amp or two E100 FET's with every order of \$10 or more. Postmarked prior to 12/31/77. One free term per order. **ORDER TODAY!** All items subject to prior sale and prices subject to change without notice. All items are new surplus parts. 100% functionally tested.

**WRITE FOR FREE CATALOG** \$7.77 (free over 100 term orders) card in stock. Send 13c stamp.

**TERMS** Send check or money order (U.S. funds) with order. Add 5% postage for U.S. Canada and Mex. \$1.00 handling charge on order under \$10. C.O.D. orders add 8% sales tax. Foreign orders add 10% postage. C.O.D. orders add \$1.00 service charge.

### MORE SPECIALS:

**RC4195DN +15V @ 50mA VOLTAGE REGULATOR IC.** Very easy to use. Makes a neat Highly Regulated +15V Supply for OP AMP's, etc. Requires only unregulated DC (118-30V) and 2 bypass capacitors. With Data Sheet and Schematics. 8-pin PDIP \$1.25  
**RC4136 Quad 741 Low-Noise Op Amp** PDIP \$0.95  
**LM1214 FM Multiplex Stereo Demodulator** DIP 0.99  
**LM2111 FM IF Subsystem (IF Amp, Det., Limiter)** DIP 0.99  
**1N6263 Hot Carrier Diode** 0.4V @ 1mA 0.1ns D0-35 1.00  
**ZENERS-Specify Voltage** 3.3, 3.9, 4.3, 5.1, 6.8, 8.2 400mW 4/\$1.00  
9.1, 10, 12, 15, 16, 18, 20, 22, 24, 27, or 33V (-10%) 1 Watt 3/\$1.00

- **MONEY-BACK GUARANTEE**
- **ALL TESTED AND GUARANTEED**

**ADVA ELECTRONICS**  
BOX 4181 EN, WOODSIDE, CA 94062  
Tel. (415) 851-0455

# FREE IC or FET's WITH \$5 & \$10 ORDERS.† DATA SHEETS WITH MANY ITEMS.

DIODES & RECTIFIERS	TRANSISTORS	TRANSISTORS	TRANSISTORS	LINEAR IC's
1N45610 6/51	2N706 80 24	2N4001 3/51	2N5638 2/51	LM340K 5 1/20
1N483 10 6/51	2N710 24	2N4002 58/35	2N5640 2/51	LM340 5 1/20
1N488 6/51	2N729 48	2N4121 3/51	CP643 54 00	LM340T 6 1/20
1N748 10 6/51	2N911 3/51	2N4122 3/51	CP650 55 00	LM340T 12 1/20
1N750 6/51	2N1613 50 29	2N4124 5/51	CP651 54 00	LM340T 15 1/20
1N814 15/51	2N1711 29	2N4126 5/51	E150 4/51	LM340T 24 1/20
1N962 10 6/51	2N1800 18	2N4130 5/51	E161 3/51	LM378 55
1N974 4/51	2N1803 38	2N4135 4/51	E102 3/51	LM377 2.50
1N982 10 6/51	2N2219 24	2N4274 5/51	E175 3/51	LM380 1/20
1N992 10 6/51	2N2222 6/51	2N4302 5/51	MPF102 16*	NE555V* 2/51
1N994 6/51	2N2224 5/51	2N4303 29	MPF104 3/51	NE568A 50 80
1N3064 6/51	2N2369 4/51	2N4338 4/51	MPF112 4/51	LM709C 29
1N3800 6/51	2N2606 10 32	2N4360A 2/51	MP25S15 3/51	LM709C 29
1N4001 12/51	2N2609 5/51	2N4361 5/51	SE1001 4/51	LM723H 2/51
1N4002 12/51	2N2905 50 24	2N4362 50 90	SE1002 4/51	LM723M* 3/51
1N4003 12/51	2N2906A 50 24	2N4418 2/51	SE2001 4/51	LM739H 51 00
1N4004 12/51	2N2907 5/51	2N4418A 50 90	SE2002 4/51	LM741C 3/51
1N4005 16/51	2N2512 51 50	2N4456 10 51	SE501 3/51	LM741CM* 4/51
1N4006 16/51	2N3563 6/51	2N4601 51	SE503 3/51	LM741CN14 34
1N4007 10/51	2N3564 4/51	2N4637E 2/51	SE520 53 30	LM747C 65
1N4140 18/51	2N3665 10 6/51	2N4800E 2/51	TI73 10 3/51	748C DIP 35
1N4154 25/51	2N3760 6/51	2N4801 52 50	TS75 1/51	748C DIP 1 00
1N4370 10 2/51	2N3838 6/51	2N4955 5/51	DIGITAL IC's	844C DIP 35
1N4372 10 2/51	2N3838A 5/51	2N4965 5/51	55173M 52 95	LM1304 1 15
1N4654 16/51	2N3841 5/51	2N5087 4/51	55173M 52 95	LM1304H 3/51
1N4728 14 3/51	2N3842 6/51	2N5088 4/51	SN7400 16	LM1311H 41 40
1N4753 4/51	2N3843 8/51	2N5126 10 6/51	SN7410 16	KR2556C 1 55
1N6231 10 6/51	2N3844 4/51	2N5135 5/51	SN7410N 16	2740D 1 95
1N5236 6/51	2N3846 4/51	2N5138 5/51	SN7410N 16	CA3028A 1 75
	2N3888 10 2/51	2N5139 5/51	SN7451 18	CA3040 84
	2N3890 3/51	2N5163 3/51	SN7473 30	LM3075N1 1 45
	2N3891 10 4/51	2N5197 55 00	SN7473N 35	CA3000 62
	2N3821 50 80	2N5210 3/51	SN7476 44	CA194D 1 80
	2N3822 70 2N5300 2/51	2N5307 5/51	LM7476N 35	RC4194D 1 50
	2N3823 40 2N5307 5/51	2N5308 5/51	LM7476N 35	RC4194H 1 50
	2N3824 50 2N5308 5/51	2N5312 1 90	LM7476N 35	RC4194H 1 50
	2N3825 50 2N5309 5/51	2N5313 1 90	LM7476N 35	RC4194H 1 50
	2N3826 50 2N5310 5/51	2N5314 1 90	LM7476N 35	RC4194H 1 50
	2N3827 50 2N5311 5/51	2N5315 1 90	LM7476N 35	RC4194H 1 50
	2N3828 50 2N5312 1 90	2N5316 1 90	LM7476N 35	RC4194H 1 50
	2N3829 50 2N5313 1 90	2N5317 1 90	LM7476N 35	RC4194H 1 50
	2N3830 50 2N5314 1 90	2N5318 1 90	LM7476N 35	RC4194H 1 50
	2N3831 50 2N5315 1 90	2N5319 1 90	LM7476N 35	RC4194H 1 50
	2N3832 50 2N5316 1 90	2N5320 1 90	LM7476N 35	RC4194H 1 50
	2N3833 50 2N5317 1 90	2N5321 1 90	LM7476N 35	RC4194H 1 50
	2N3834 50 2N5318 1 90	2N5322 1 90	LM7476N 35	RC4194H 1 50
	2N3835 50 2N5319 1 90	2N5323 1 90	LM7476N 35	RC4194H 1 50
	2N3836 50 2N5320 1 90	2N5324 1 90	LM7476N 35	RC4194H 1 50
	2N3837 50 2N5321 1 90	2N5325 1 90	LM7476N 35	RC4194H 1 50
	2N3838 50 2N5322 1 90	2N5326 1 90	LM7476N 35	RC4194H 1 50
	2N3839 50 2N5323 1 90	2N5327 1 90	LM7476N 35	RC4194H 1 50
	2N3840 50 2N5324 1 90	2N5328 1 90	LM7476N 35	RC4194H 1 50
	2N3841 50 2N5325 1 90	2N5329 1 90	LM7476N 35	RC4194H 1 50
	2N3842 50 2N5326 1 90	2N5330 1 90	LM7476N 35	RC4194H 1 50
	2N3843 50 2N5327 1 90	2N5331 1 90	LM7476N 35	RC4194H 1 50
	2N3844 50 2N5328 1 90	2N5332 1 90	LM7476N 35	RC4194H 1 50
	2N3845 50 2N5329 1 90	2N5333 1 90	LM7476N 35	RC4194H 1 50
	2N3846 50 2N5330 1 90	2N5334 1 90	LM7476N 35	RC4194H 1 50
	2N3847 50 2N5331 1 90	2N5335 1 90	LM7476N 35	RC4194H 1 50
	2N3848 50 2N5332 1 90	2N5336 1 90	LM7476N 35	RC4194H 1 50
	2N3849 50 2N5333 1 90	2N5337 1 90	LM7476N 35	RC4194H 1 50
	2N3850 50 2N5334 1 90	2N5338 1 90	LM7476N 35	RC4194H 1 50
	2N3851 50 2N5335 1 90	2N5339 1 90	LM7476N 35	RC4194H 1 50
	2N3852 50 2N5336 1 90	2N5340 1 90	LM7476N 35	RC4194H 1 50
	2N3853 50 2N5337 1 90	2N5341 1 90	LM7476N 35	RC4194H 1 50
	2N3854 50 2N5338 1 90	2N5342 1 90	LM7476N 35	RC4194H 1 50
	2N3855 50 2N5339 1 90	2N5343 1 90	LM7476N 35	RC4194H 1 50
	2N3856 50 2N5340 1 90	2N5344 1 90	LM7476N 35	RC4194H 1 50
	2N3857 50 2N5341 1 90	2N5345 1 90	LM7476N 35	RC4194H 1 50
	2N3858 50 2N5342 1 90	2N5346 1 90	LM7476N 35	RC4194H 1 50
	2N3859 50 2N5343 1 90	2N5347 1 90	LM7476N 35	RC4194H 1 50
	2N3860 50 2N5344 1 90	2N5348 1 90	LM7476N 35	RC4194H 1 50
	2N3861 50 2N5345 1 90	2N5349 1 90	LM7476N 35	RC4194H 1 50
	2N3862 50 2N5346 1 90	2N5350 1 90	LM7476N 35	RC4194H 1 50
	2N3863 50 2N5347 1 90	2N5351 1 90	LM7476N 35	RC4194H 1 50
	2N3864 50 2N5348 1 90	2N5352 1 90	LM7476N 35	RC4194H 1 50
	2N3865 50 2N5349 1 90	2N5353 1 90	LM7476N 35	RC4194H 1 50
	2N3866 50 2N5350 1 90	2N5354 1 90	LM7476N 35	RC4194H 1 50
	2N3867 50 2N5351 1 90	2N5355 1 90	LM7476N 35	RC4194H 1 50
	2N3868 50 2N5352 1 90	2N5356 1 90	LM7476N 35	RC4194H 1 50
	2N3869 50 2N5353 1 90	2N5357 1 90	LM7476N 35	RC4194H 1 50
	2N3870 50 2N5354 1 90	2N5358 1 90	LM7476N 35	RC4194H 1 50
	2N3871 50 2N5355 1 90	2N5359 1 90	LM7476N 35	RC4194H 1 50
	2N3872 50 2N5356 1 90	2N5360 1 90	LM7476N 35	RC4194H 1 50
	2N3873 50 2N5357 1 90	2N5361 1 90	LM7476N 35	RC4194H 1 50
	2N3874 50 2N5358 1 90	2N5362 1 90	LM7476N 35	RC4194H 1 50
	2N3875 50 2N5359 1 90	2N5363 1 90	LM7476N 35	RC4194H 1 50
	2N3876 50 2N5360 1 90	2N5364 1 90	LM7476N 35	RC4194H 1 50
	2N3877 50 2N5361 1 90	2N5365 1 90	LM7476N 35	RC4194H 1 50
	2N3878 50 2N5362 1 90	2N5366 1 90	LM7476N 35	RC4194H 1 50
	2N3879 50 2N5363 1 90	2N5367 1 90	LM7476N 35	RC4194H 1 50
	2N3880 50 2N5364 1 90	2N5368 1 90	LM7476N 35	RC4194H 1 50
	2N3881 50 2N5365 1 90	2N5369 1 90	LM7476N 3	



**★ Imsai - Altair "A" Compatible Kits ★**

Dealer inquiries welcome on these items:

**Z-80 CPU BOARD**

From the same people who brought you the \$89.95 4K RAM KIT. We were not the first to introduce an Imsai/Altair compatible Z-80 Card, but we do feel that ours has the best design and quality for the lowest price! The advance features of the Z-80 such as an expanded set of 158 instructions, 8080A software compatibility, and operation from a single 5VDC supply, are all well known. What makes our card different is the extra care we took in the hardware design. The CPU card will always stop on an M1 state. We also generate TRUE SYNC on card, to insure that the rest of our system functions properly. Dynamic memory refresh and NMI are bought out for your use. Believe it or not, not all of our competitors have gone to the extra trouble of doing this. As always this kit includes all parts, all sockets, and complete instructions for ease of assembly. Because of our past experience with our 4K kit we suggest that you order early. All orders will be shipped on a strict first come first served basis. Kit includes Zilog Manual and all parts. Kit shipped with 2 MHz crystals.

Z-80 Chip & Manual - \$49.95; Add \$5.00 for Z-80A  
Z-80 Manual - \$7.50 Separately.

**Complete kit - \$149.**

**4K LOW POWER RAM**

IMSAI AND ALTAIR 8080 PLUG IN COMPATIBLE. USES LOW POWER STATIC 21L02 - 1 500ns. RAM's. FULLY BUFFERED, DRASTICALLY REDUCED POWER CONSUMPTION, ON BOARD REGULATED, ALL SOCKETS AND PARTS INCLUDED. QUALITY PLATED THROUGH PC BOARD. For 250 ns RAM's add \$10.

THE WHOLE WORKS **\$89.95**  
**kit**

**NEW! DESIGN CONSOLETTTE KIT - \$89.95**

S.D. Sales announces the inexpensive way to beat the wire wrap jungle. Our latest kit gives you 124 solderless quick connect terminals, enough for eight 16 pin IC's and provides 50 x 8 common buss matrix. Has regulated +5VDC and +/- 15VDC. all at 1 AMP. Voltage regulation at 100%. Also includes a pulse generator variable from 10hz to 50mhz and .01 sec. to 100 nano seconds. Generator output is +5V. In kit form only and includes all parts, sockets: front panel measures 7 1/4" x 8 3/4", and hardware. case not available.

**CAR/BOAT KIT**

**\$34.95**

*Music to your Ears!*

*New Item!*

**MUSICAL HORN**

Musical Horn kit for car, boat or home. Plays any tune from Mozart to Led Zeppelin. Change tunes in seconds; complete solid state electronics. Standard or custom tunes available at \$6.95 each. (You supply the sheet music - we supply electronics for your favorite tune.) One song supplied with original order. Standard tunes available: DIXIE - EYES OF TEXAS - ON WISCONSIN - YANKEE DOODLE DANDY - NOTRE DAME FIGHT SONG - PINK PANTHER - AGGIE WAR SONG - ANCHORS AWAY - NEVER ON SUNDAY - BRIDGE OVER RIVER QUI - CANDY MAN - Standard 2 inch 8 ohm speaker supplied. Power horn available for car/boat kit.

**HOME KIT**

**\$26.90**

Kit includes speaker which operates from your door bell. When door bell is pushed your favorite tune is played. Car/boat kit includes speaker which operates from car/boat horn ring. Allow 4 weeks delivery on both kits.

*Limited Quantity!*

**\$9.95 kit**

**6 DIGIT ALARM CLOCK KIT**

We made a fantastic kit even better. Redesigned to take advantage of the latest advances in IC technology. Features: Litronix Dual 1/2" displays, Mostek 50250 super clock chip, single I.C. segment driver, SCR digit drivers. Greatly simplified construction. More reliable and easier to build. Kit includes all necessary parts (except case). For P.C. board add \$3.00; AC XFMR add \$1.50. Do not confuse with Non-Alarm kits sold by our competition! Eliminate the hassle - avoid the 5314!

NEW! WITH JUMBO LED READOUTS!

1000 MFD Filter Caps Rated 35 WVDC Up-right style with PC leads. Most popular value for hobbyists. 4/\$1.00	SLIDE SWITCH Assortment Our best seller. Includes miniature and standard sizes, single and multi-position units. All new. 12/\$1.00	POWER RESISTOR 15 OHM 25W BY CLAROSTAT 75¢ ea.	RESISTOR ASSORTMENT 1/4W 5% & 10% PC leads. A good mix of values! Special! 200/\$2.	P.C. LEAD DIODES 1N4148/1N914 100/\$2. 1N4002 1A 100 PIV 40/\$1.	THERMISTORS MEPCO - NEW! 1.5K OHM 5/\$1.00	DISC CAP ASSORTMENT P.C. Leads. At least 10 different values. Includes .001, .01, .05 plus other standard values. 60/\$1.00
---	---	---	--	--	---	--

**AMD-1702A**

*Huge Factory Purchase*

FACTORY PRIME UNITS! BRAND NEW!

1.5 Micro-Seconds Access Time.

**10/\$40. \$4.95 ea.**

★ *Special!* ★

3.579545 MHz Time Base Crystal \$1.25

28 PIN SOCKETS 3 for \$1.00

11,000 MFD 50WVDC Computer Grade Cap \$3.00 each

39 MFD 16 V Mallory Electrolytic 15 for \$1.00

**FACTORY PRIME! 21L02-1**

Not only are our RAM's faster than a speeding bullet but they are now very low power. We are pleased to offer prime new 21L02-1 Low Power and Super Fast RAM's. Allows you to STRETCH your power supply farther and at the same time keep the wait light off!

**500ns 8/\$12.95**

**250ns 8/\$15.95**

IC'S REMOVED FROM PC BOARDS ALL TESTED; FULL SPEC.

**IC's from XEROX**

1402 A Shift Regulator - 50c  
MH0025CN - 55c

7400 - 9c	7430 - 9c	7493 - 26c
7402 - 9c	7440 - 9c	74121 - 22c
7404 - 9c	7437 - 10c	74123 - 32c
7406 - 11c	7438 - 10c	74151 - 9c
7407 - 11c	7451 - 9c	74155 - 22c
7410 - 9c	7474 - 16c	74193 - 35c
7416 - 13c	7475 - 24c	8233 - 35c
7420 - 9c	7486 - 16c	Intel - 1302 - 45c

*Great Buy!*

**MK50397-\$8.95**

S.D. Sales Exclusive! Elapsed time IC. Specially modified six digit counter circuit to measure 59 min., 59 sec., 99/100 sec. Perfect for dark room timers, chess timers or any timing applications. Supplied with data sheet and applications.

**MOS 6 Digit Up/Down Counter**

40 PIN DIP. Everything you ever wanted in a counter chip. Features: Direct LED segment drive, single power supply (12 VDC TYPE), six decades up/down, pre-loadable counter, separate pre-loadable compare register with compare out-put. BCD and seven segment outputs, internal scan oscillator, CMOS compatible, leading zero blanking, 1MHZ. count input frequency.

**\$12.95**

CALL IN YOUR BANK-AMERICARD OR MASTER CHARGE ORDER IN ON OUR CONTINENTAL UNITED STATES TOLL FREE WATTS LINE:

Texas Residents Call Collect:

**214/271-0022**

**1-800-527-3460**

**TERMS:**

*Money Back Guarantee!*

NO COD'S. TEXAS RESIDENTS ADD 5% SALES TAX. ADD 5% OF ORDER FOR POSTAGE & HANDLING. ORDERS UNDER \$10.00 ADD 75c. FOREIGN ORDERS - U.S. FUNDS ONLY!

**Orders over \$15. - Choose \$1. FREE MERCHANDISE!**

## WIRE WRAP PROTOTYPE BOARDS

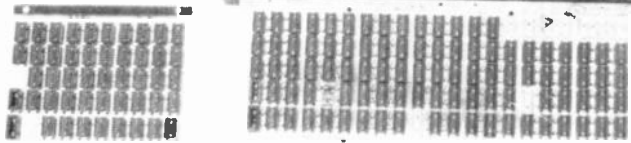

We have 2 unique WIRE WRAP BOARDS, with original costs up to \$175.00 each. These boards are out of systems, so you must remove the previous wire wrapping. Both boards contain 14 and 16 pin sockets, with provision for replacing some of the 14 pin sockets for 16 pin sockets if needed. Ideal for prototyping, or building permanent devices without the need of PC boards.

STOCK NO.6558R 75 to 100 sockets, \$18.75 ea. 2/36.00  
STOCK NO.6559R 40 to 50 sockets \$11.75 ea. 2/22.00

## VIDEOCUBE TV/MICRO-COMPUTER INTERFACE

This is the TV interface device described in the AUGUST issue of RADIO-ELECTRONICS. The VIDEOCUBE will interface video cameras, TV games, and video output of computers to any TV set. Consists of a modulator and oscillator, which puts the information on channel 2 of your TV set. We supply a reprint of the article, and all data to put the kit together. Complete kit contains ALL parts. Partial kit contains all hard to get parts including PC board & special coils.

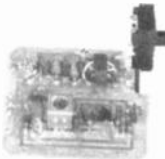

STOCK NO.5500R complete kit & reprint \$13.95 2/26.00  
STOCK NO.5500RK, Partial kit with reprint \$11.95 2/22.00

## DELTA ELECTRONICS

7 OAKLAND ST. P.O. BOX 2  
AMESBURY, MASS. 01913  
Phone (617) 388-4705



Visit our retail outlets, DELTA ELECTRONICS, 590 Commonwealth Ave., Boston, Mass. & DELTA ELECTRONIC HOBBIES, 5151 Buford Hwy. Doraville, (Atlanta) Ga.

CIRCLE 29 ON FREE INFORMATION CARD

# How to:

Did you ever want to know how to manage your money to make every penny count?

You can learn how to do it.

Did you ever want to grow your own vegetables but you don't have a backyard?

You can learn how to do that, too.

We're the Consumer Information Center of the government. And we have over 200 publications, brochures, and pamphlets that tell you how to do a lot of different things.

How to sleep like a lamb.

How to keep your home in good shape.

And how to keep your shape in good shape, too.

Our free catalog lists brochures about buying a used car. About health and recreation.

Children. Food

and nutrition.

Saving energy.

Even

how

to find

a job.

that's

right

for you.

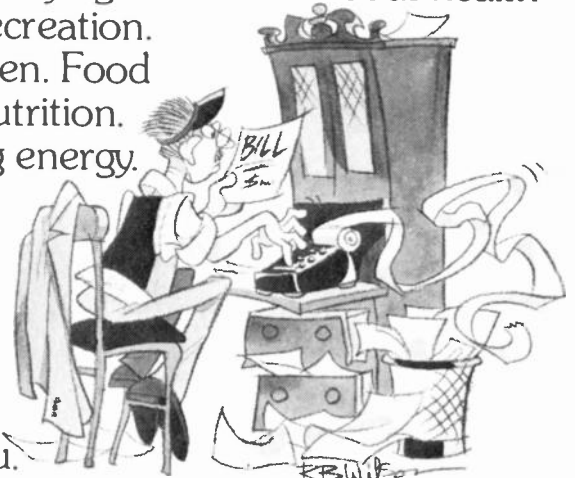

Most of these publications are free. Most of the rest are 50¢ or less.

## Free catalog.

How to get the catalog that lists them all?

Just write Consumer Information Center, Pueblo, Colorado 81009.



General Services Administration  
Consumer Information Center



## BUILD YOUR OWN TROUBLE FREE OSCILLOSCOPE

Engineered by Heath Co. and Manufactured for use by RCA Institutes

Ideal and Inexpensive for Professional Service Technicians, Students, and Experimenters

A five-inch scope, designed for the needs of service technicians — a stable instrument operated at a high degree of dependability — a trouble-free performer. Formerly RCA Inst. Model 825.

Easy to assemble. Two modern printed circuit boards to reduce point-to-point wiring. Combined simple instructions and operating manual included.

Frequency response from 3 Hz to 5 MHz, +1.5 dB. The response at 3.58 MHz color TV carrier is -2.2 dB. Special features include two preset adjustments to facilitate instantaneous oscillator lock-in for TV vertical and horizontal sweep circuits. Test communication equipment (including CB's). Hi-Fi's, Radios and TV's. Order your scope.

Was \$118.95 — Now only \$69.95

New Jersey Residents add 5% sales tax  
Inquire about other products.

ETI Products Dept. 2639-107 Technical Home  
Study Schools Little Falls, N.J. 07424

Enclosed is my check for \$69.95 Send me  
Oscilloscope Kit, postpaid.

Name \_\_\_\_\_ (Please print)

Address \_\_\_\_\_

City \_\_\_\_\_ State \_\_\_\_\_ Zip \_\_\_\_\_

Visa/BankAmericard  Mastercharge  
 American Express  Carte Blanche

Card Number \_\_\_\_\_

Inter-bank # \_\_\_\_\_ Expiration \_\_\_\_\_

For  
faster  
service

USE  
ZIP  
CODE

on  
all  
mail

CIRCLE 76 ON FREE INFORMATION CARD

# Radio Hut

Money back guarantee. NO COD'S. Texas residents add 5% sales tax. Add 5% of order for postage and handling. Orders under \$15.00 add 75 cents. Foreign orders add 10% for postage.

For your convenience, call your BankAmericard or Master Charge orders in on our Toll Free Watts Line: 1-800-527-2304. Texas residents call collect 1-214-271-8423.



P. O. Box 38323R  
Dallas, Texas 75238



Memorex computer boards with IC's, diodes, transistor, etc. 5 Boards containing 100 - 200 IC's  
**ONLY \$ 4.25**

BRIDGE RECTIFIERS		
6 Amp	50V	1.10
10 Amp	50V	1.25
25 Amp	50V	1.39

**MK 5005**  
4 digit counter/latch decoder; 7 segment output only. 24 pin dip with specs.  
**\$ 8.00 EACH**

**UNSCRAMBLER KIT**  
for all Scanners

- Tunes easily
- Full instructions included
- Easy to install
- 3 1/2" x 3 1/2" x 1 1/2"

**Only \$19.95**

**RESISTORS**  
Over 50,000,000 in stock

.330 ohm	22K ohm
470 ohm	27K ohm
.1680 ohm	33K ohm
1K ohm	39K ohm
1.2K ohm	43K ohm
2.2K ohm	47K ohm
3.3K ohm	82K ohm
4.7K ohm	100K ohm
6.8K ohm	150K ohm
10K ohm	220K ohm
20K ohm	

\*1.8 W only  
\*1.2 W only

All resistors are P.C. Lead but are not pull offs  
100 min. order for each value

NO MIX 100/99

## PLASMA DISPLAY KIT

Kit Includes: 12 digit display .4" Character Power supply for display above Complete specs for hookup.

Line cord Not Included. **ONLY \$ 3.95**



## SPECIAL DEVICES

82S23	2.19
2513	10.00
2102-1	.99
1101A	.75
1103A	1.10
8T13	1.50
8T97	1.25
MM5233	1.50
300KC xtal	1.50

## REGULATORS

7805	7818
7806	7824
7808	7905
7812	7912
7815	7915

Your Choice \$ .95

## READOUTS



FND70 .4"C.C. .59  
FND800 .8"C.C. 1.69  
T1 6 digit array C.C. 3/1.00  
MAN 8 .3"CA Yellow .89  
LT767 .7" C.C. 4 digit stick \$ 3.95

## WATERGATE SPECIAL

Telephone Relay automatically starts and stops tape recorder. No batteries required. Kit complete with drilled P.C. Board.

Parts and Case **ONLY \$ 10.95**



## CLOCK KIT

Kit includes

- LT701 clock module
- Power Supply
- Punched Case
- 12 hour operation only



Complete except for line cord

LT701E 12 hour clock  
LT701G 24 hour clock

**ONLY \$ 14.95**

## VARIABLE POWER SUPPLY KIT NO. 1

\*Continuously variable from 5V to 20V  
\*Excellent regulation up to 500 mil.  
\*4400 Mfd of filtering  
\*Drilled fiberglass PC Board  
\*One hour assembly  
\*Kit includes all components  
\*Case Included **ONLY \$10.95**

## VARIABLE POWER SUPPLY KIT NO. 2

Same as above but with 1 amp output, also with case. **ONLY \$13.95**

## BATTERY CLIPS

Standard 9V battery clip with 4-1/2" tinned leads. 25/\$1.00

## TRANSISTORS DIODES

*MJE1103	3 1.00
MJ301	1 30
2N2222	6 1.00
2N2369	6 1.00
2N2905	4 1.00
*2N2907	15 1.00
2N3906	6 1.00
2N4400	6 1.00
2N4443 SCR	3 1.00
1N4004	15 1.00
1N4007	10 1.00
1N4148 (1N4914)	20 1 00
3N201 VHF Pre-amp	.80
D40C1 Power Darl.	4 1.00
EN930	.20
1N746	.25

\*House numbered and P.C. Lead

## PC BOARDS

4 digit PCB for FND800 or 807	2 50
6 digit PCB for FND800 or 807	3 50
4 digit PCB for DL 707	1 50
6 digit PCB for DL 707	2 00
4 digit PCB for FND503 or 510	2 00
6 digit PCB for FND503 or 510	3 00
4 digit PCB for DL 747	2 50
6 digit PCB for DL 747	3 00
4 digit PCB for DL 727 or 728	2 00
6 digit PCB for DL 727 or 728	3 00
4 digit PCB for FND359 or 70	1 75

NOTE: All PC Boards are multiplexed for adding additional digits.

## SOCKETS

14 pin	.22
16 pin	.25
18 pin	.25
24 pin (ww only)	.95
28 pin	.35
40 pin	.50

## CMOS SALE

CD4000	.16
CD4001	.16
CD4002	.16
CD4007	.16
CD4009	.45
CD4010	.45
CD4011	.16
CD4012	.16
CD4013	.29
CD4014	.75
CD4015	.75
CD4016	.29
CD4017	.80
CD4018	.80
CD4019	.39
CD4020	.85
CD4021	.90
CD4022	.90
CD4024	.70
CD4025	.19
CD4027	.39
CD4028	.75
CD4029	.99
LD4030	.16
CD4034	2.30
CD4035	.99
CD4040	1.00
CD4041	.69
CD4042	.59
CD4043	.60
CD4044	.59
CD4046	.90
CD4047	.59
CD4049	.35
CD4050	.35
CD4051	.90
CD4053	.90
CD4056	1.00
CD4058	.90
CD4060	1.00
CD4066	.69
CD4069	.30
CD4071	.16
CD4076	.99
74C04	.29
74C107	.29
CD4116	.39
CD4507	.40
CD4512	.50
CD4516	.85
CD4518	.85
CD4520	.85

## LS

74LS00	.26	74LS145	1.00
74LS02	.26	74LS151	.70
74LS03	.26	74LS153	.70
74LS04	.30	74LS155	.69
74LS05	.32	74LS156	.76
74LS08	.26	74LS157	.95
74LS09	.26	74LS158	.85
74LS10	.26	74LS160	.85
74LS11	.35	74LS161	.85
74LS13	.58	74LS162	.85
74LS14	1.05	74LS163	.85
74LS15	.26	74LS168	.85
74LS20	.24	74LS169	.85
74LS21	.35	74LS170	2.00
74LS22	.35	74LS173	1.10
74LS26	.35	74LS174	1.00
74LS27	.35	74LS175	1.00
74LS30	.34	74LS190	.95
74LS32	.35	74LS191	.95
74LS37	.33	74LS192	.95
74LS38	.38	74LS193	.95
74LS40	.34	74LS194	.95
74LS42	.80	74LS195	.95
74LS51	.26	74LS196	.85
74LS54	.26	74LS197	.85
74LS55	.26	74LS251	.85
74LS73	.75	74LS253	.85
74LS74	.49	74LS257	.85
74LS76	.49	74LS258	.85
74LS86	.45	74LS260	.26
74LS90	.85	74LS266	.26
74LS92	1.00	74LS279	.55
74LS93	1.00	74LS290	.75
74LS100	.49	74LS293	.75
74LS112	.49	74LS295	.95
74LS113	.40	74LS298	.95
74LS114	.40	74LS365	.55
74LS125	.55	74LS366	.55
74LS126	.65	74LS367	.55
74LS132	1.00	74LS368	.85
74LS133	.35	74LS390	1.75
74LS136	.39	74LS393	1.45
74LS138	.85	74LS670	3.25
74LS139	.85		

***	T T L	***	
*		*	
7400	.17	7473	.21
7401	.17	74H74	.45
7402	.17	7474	.35
7403	.17	7475	.55
74H04	.25	7476	.35
74S04	.30	7480	.45
7404	.17	7483	.76
7406	.25	7485	.39
7408	.17	7485	.35
7409	.17	7490	.71
7410	.17	7491	.71
7411	.25	7492	.71
7413	.45	7493	.67
7420	.17	7494	.90
7421	.17	7495	.71
7423	.35	7496	.85
7425	.27	74100	.96
7426	.25	74121	.31
7427	.17	74123	.61
7430	.25	74125	.44
7432	.30	74141	.71
7437	.35	74145	.97
7438	.35	74151	.71
7440	.17	74153	.81
7442	.60	74154	.97
7443	.60	74161	.91
7444	.65	74163	1.05
7446	.85	74164	1.05
74L47	1.75	74174	.91
7447	.81	74175	1.40
7448	.81	74180	.76
7450	.20	74181	2.25
7451	.17	74191	1.20
7453	.17	74192	1.20
7454	.17	74193	.95
7470	.35	745195	1.05
7472	.21	74195	.65

**ORDER BY PHONE.** Charge your order to BankAmericard or Master Charge.

**USE OUR TOLL FREE WATTS**

**1-800-527-2304**

**60 Hz L(\*)K**

**Crystal Time Base Kit - Kit**  
enables a MOS clock circuit to operate from a DC power source. Ideal for car, camper, van, boat, etc.

60Hz output with an accuracy of .005% (typ.) Low power consumption 2.5 ma (typ.). Small size will fit most any enclosure. Single MOS IC oscillator/divider chip 5-15 volts DC operation.

**ONLY \$ 5.95**  
**2 for \$10.00**

**NOW! For the Dallas Area Residents.**  
Come Visit Our Retail Store.  
3717 Lincoln Court, Garland, Texas

**Tues. - Fri. 10 AM to 6 PM**  
**Sat. 10 AM to 3 PM**  
**CLOSED MONDAY**



# Nikko's Mix and Match Components

The separate components series from Nikko Audio features two well-designed tuners and three integrated amps. New this year is the NA 550 integrated amplifier with 45 watts\* per channel, with less than 0.05% THD.

Also new in the Nikko line is the NA 850 with 60 watts\* per channel, and less than 0.05% THD. Both the NA 550 and NA 850 integrated amps have myriad features like responsive VU meters with variable control, 5-position tape control switch (for dubbing), speaker protection circuitry, and Nikko's exclusive circuit breakers. The NA 850 also features a subsonic filter and tone defeat.

The TRM 750 integrated amp, like all

Nikko products, is a superb performer, from its quality features to its built-in reliability. The TRM 750 delivers 55 watts\* per channel, and no more than 0.15% THD.

Nikko's NT 850 AM/FM tuner is uncannily quiet and station grabbing. Normal and narrow IF circuitry provides high selectivity and low distortion while a front mounted multipath switch aids in reducing noise.

Last, but not least, is the FAM 450 AM/FM tuner. It's an established performer with excellent specifications and a typically modest Nikko price.

Now that you've read about our exciting separate components, we invite you to write to us for complete product infor-

mation and the name of a Nikko Audio dealer near you.

Once you have seen and heard Nikko Audio products, we think you'll make this your year of Nikko.

\*Minimum RMS per channel both channels driven into 8 ohms from 20Hz to 20kHz.

## Nikko Audio

For those who take their stereo seriously  
Nikko Electric Corp. of America  
16270 Raymer St., Van Nuys, Calif. 91406  
(213) 988-0105 ©Nikko Audio, 1977

In Canada: Superior Electronics, Montreal, Quebec

CIRCLE 89 ON FREE INFORMATION CARD

# ATTENTION DEALERS:

## Announcing

# Jim-pak<sup>®</sup>

## electronic components

### One-Stop Component Center

- ★ Over 200 quality items including integrated circuits, resistors, diodes, transistors, capacitors, connectors, switches, sockets, LEDs and Data Books covering all JIM-PAK<sup>®</sup> items.
- ★ Immediate delivery on all orders
- ★ Store display racks available
- ★ Stock rotation and return policy
- ★ Direct mail program available from list of active electronic buyers in dealers' area.
- ★ National advertising campaign in leading electronics magazines to include list of qualifying dealers
- ★ Nationally known manufacturers' products at prices every dealer can afford
- ★ Guaranteed products
- ★ Standard industry part numbers



A component line of proven sellers developed for the independent dealer. Ideal for computer shops, school stores, electronic dealers, hobby shops, or any location where there is a potential market for electronic sales.

A product line which supplies most of your needs from one distributor with a reputation for fast and efficient service. Attractive and compact display racks make initial installation of the JIM-PAK<sup>®</sup> line easy.

Your customers deserve the best. Now you can profitably retail name brand components at competitive prices. Be the first in your area to announce and sell the JIM-PAK<sup>®</sup> line. Write or call today.

FOR MORE INFORMATION AND PRICING SCHEDULE CONTACT:



a division of James Electronics, 1021 Howard Avenue, San Carlos, California 94070, (415) 592-8097

CIRCLE 4 ON FREE INFORMATION CARD

# Revolutionary breakthrough in CB antenna design



Photo courtesy of Edmund Scientific Co.

## AVANTI Invents the Saturn™ Base

The reason the "Saturn" is so revolutionary is that it is absolutely the only **combination vertical and horizontal omni-directional antenna**. That's right, it needs no rotor! You can pick up mobiles (which are vertical) or horizontal and vertical beams.

The "Saturn", invented after years of research by Avanti engineers, is the latest development using AVANTI's unique CO-INDUCTIVE principle to give you the performance of two antennas combined into one.

The "Saturn" not only works on both polarities, but pounds out signals like an air hammer and picks them up like a magnet. Both polarities offer high gain figures.

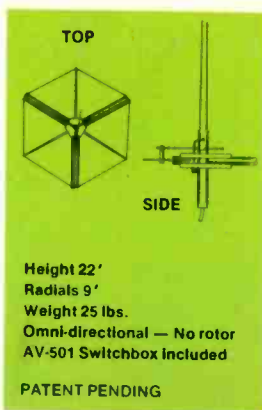

Those of you who are worried about sun spots and "skip" can relax too. This antenna really helps. When the sun spots cause a signal shift, you can often change polarity (just like our P.D.L. or Moonraker) and still pick up the desired channel with no loss of transmission.

The P.D.L. and Moonraker made dual polarity famous as the only antennas to have during the last sun spot cycle, and this time around any serious C.B.'er will want to have the "Saturn."

In fact, having a "Saturn" and a "P.D.L." or "Moonraker" will put you in the elite group of C.B.'ers who "always seem to get out better."

Avanti makes a complete line of high performance base and mobile CB antennas from \$11.95 to \$404.00. Write for free Avanti catalog.

**avanti**®

AVANTI RESEARCH AND DEVELOPMENT, INC.,  
340 Stewart Avenue, Addison, IL 60101

© Copyright 1977, All rights reserved

Creators of the famous

CIRCLE 86 ON FREE INFORMATION CARD

