

**Radio-Electronics**

**HI-FI TEST REPORT**

75c ■ JULY 1975

# Radio-Electronics

THE MAGAZINE FOR NEW IDEAS IN ELECTRONICS

**SPECIAL TEST EQUIPMENT**  
**For Industrial Servicing**

**ALL ABOUT SCOPES**  
**Special 4-Part Story**

**NEW COLOR TV CAMERA**  
**Now You Can Make Your Own**

**COSMOS**  
**ALARM CIRCUITS**  
**Stop Burglars Fast**

**OPERATIONAL**  
**AMPLIFIER IC's**  
**See How They Work**

**PA SYSTEM PROBLEMS**  
**Solve Them Effectively**

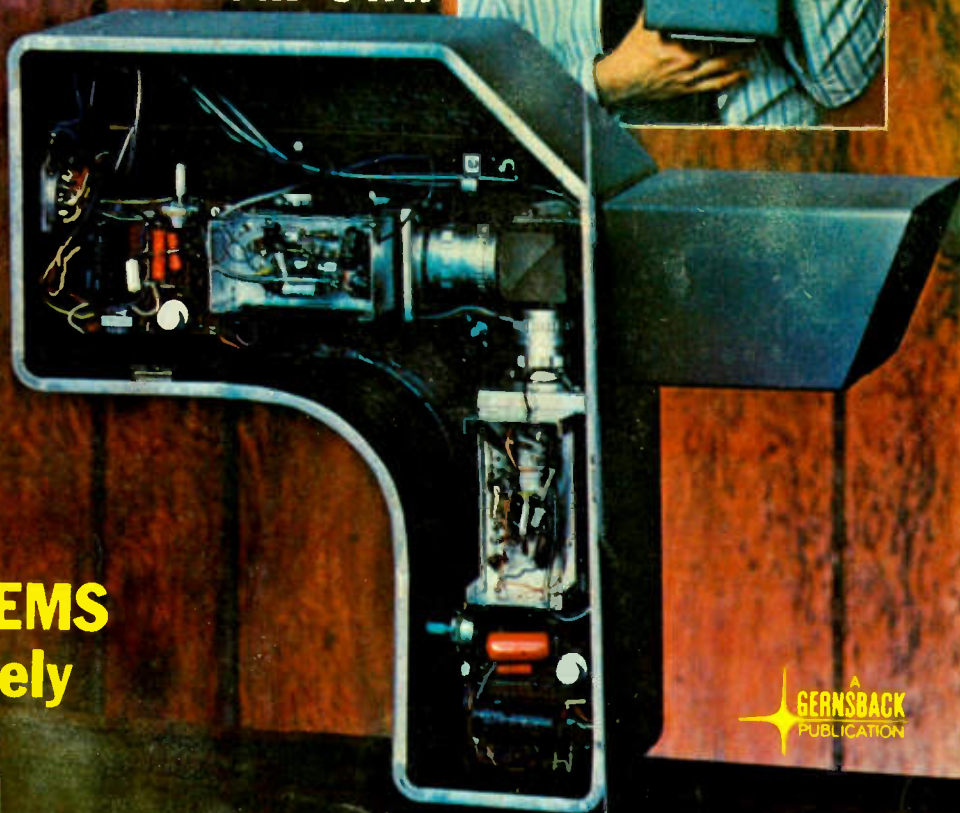

**GERNSBACK**  
PUBLICATION

07  
H B ESHELMAN  
339 E FRONT ST  
BERNICK  
647012 EHL 0339F059 04 A MAR79

**Service Clinic**  
**New High-Fidelity Gear**  
**Step-by-Step TV Troubleshooting Charts**





**HOME OFFICE—INDIANA:**  
5233 S. HWY. 37  
BLOOMINGTON, IN 47401  
TEL. 812, 824-9331

**ALABAMA:**  
524 32ND STREET SOUTH  
BIRMINGHAM, AL 35222  
TEL. 205, 323-2657

**ARIZONA:**  
2412 W. INDIAN SCHOOL RD.  
PHOENIX, ARZ 85061  
TEL. 602, 279-8718

**CALIFORNIA—NORTH:**  
4611 AUBURN BLVD.  
SACRAMENTO, CA 95841  
TEL. 916, 482-6220

**CALIFORNIA—SOUTH:**  
5111 UNIVERSITY AVE  
SAN DIEGO, CA 92105  
TEL. 714, 280-7070

**COLORADO:**  
4958 ALLISON ST  
ARVADA, CO 80001  
TEL. 303, 423-7080

**FLORIDA—NORTH:**  
1918 BLANDING BLVD.  
JACKSONVILLE, FL 32210  
TEL. 904, 389-9952

**FLORIDA—SOUTH:**  
12934 N.W. 7TH AVE  
MIAMI, FL 33168  
TEL. 305, 685-9811

**KANSAS:**  
3116 MERRIAM LN  
KANSAS CITY, KS 66106  
TEL. 913, 831-1222

**LOUISIANA:**  
2914 WYTCWOOD DR  
METAIRIE, LA 70033  
TEL. 504, 885-2349

**MARYLAND:**  
1105G SPRING ST  
SILVER SPRING, MD 20910  
TEL. 301, 565-0025

**MASSACHUSETTS:**  
191 CHESTNUT ST  
SPRINGFIELD, MA 01103  
TEL. 413, 734-2737

**MICHIGAN:**  
13709 W. 8 MILE RD  
DETROIT, MI 48235  
TEL. 313, 862-1783

**MINNESOTA:**  
815 W. LAKE ST  
MINNEAPOLIS, MN 55408  
TEL. 612, 824-2333

**MISSOURI:**  
8456 PAGE BLVD  
ST. LOUIS, MO 63130  
TEL. 314, 428-1299

**NEW YORK:**  
993 SYCAMORE ST  
BUFFALO, NY 14240  
TEL. 716, 891-4935

**NEW JERSEY—N.Y. CITY:**  
158 MARKET ST  
E. PATERSON, NJ 07407  
TEL. 201, 791-6380

**NORTH CAROLINA:**  
724 SEIGLE AVE  
CHARLOTTE, NC 28205  
TEL. 704, 332-8007

**OHIO—NORTH:**  
5682 STATE RD  
CLEVELAND, OH 44134  
TEL. 216, 845-4480

**OHIO—SOUTH:**  
US TUNER SERVICE  
8180 VINE ST  
CINCINNATI, OH 45215  
TEL. 513, 821-2298

**OKLAHOMA:**  
3007 N. MAY  
OKLAHOMA CITY, OK 73106  
TEL. 405, 947-2013

**OREGON:**  
5220 N. E. SANDY BLVD  
PORTLAND, OR 97213  
TEL. 503, 282-9636

**PENNSYLVANIA—EAST:**  
1742-44 STATE ROAD  
UPPER DARBY, PA 19082  
TEL. 215, 352-6609

**PENNSYLVANIA—WEST:**  
257 RIVERVIEW AVE. W  
PITTSBURGH, PA 15202  
TEL. 412, 761-7648

**TENNESSEE:**  
3614 LAMAR AVE.  
MEMPHIS, TN 38118  
TEL. 901, 365-1918

**TEXAS—NORTH:**  
MOPAC LANE  
LONGVIEW, TX 75601  
TEL. 214, 753-4334

**TEXAS—EAST:**  
4324-26 TELEPHONE RD.  
HOUSTON, TX 77032  
TEL. 713, 644-6793

**WISCONSIN:**  
3509 W. NATIONAL  
MILWAUKEE, WI 53215  
TEL. 414, 643-8800

# PTS ELECTRONICS

Precision Tuner Service



is proud to announce the **GRAND OPENING**  
of our new Service Centers in

**MILWAUKEE**  
**PHOENIX**  
**SEATTLE**

432 YALE AVE. N.  
SEATTLE, WASHINGTON 98101  
TEL. 206-623-2320



**\$10<sup>95</sup>**

*now you too...*  
*...get Fast 8 hr. Service!*

**1 YEAR GUARANTEE**

Come and see us. PTS Branches are all company owned—No Franchises—we care for our customers. For a TUNER PART or COMPLETE TUNER REBUILT, come to us, we will take care of your tuner problems like no one else can. WE'RE PROFESSIONALS — 18 years experience made us what we are!

**LET US TAKE CARE OF YOUR TUNER PROBLEMS...**

PTS will repair any Tuner — no matter how old or new, give you the Fastest Service available—8 hours—in and out the same day. Overnight transit to one of our strategically located plants, and the BEST QUALITY — you and your customers are satisfied!

PTS uses only ORIGINAL PARTS! No home-made or make-do, inferior merchandise. (this is why we charge extra for major parts!) You get your tuner back in Original Equipment condition.

Color • Black & White • Transistor  
• Tubes • Varactor • Detent UHF  
All Makes

**VHF or UHF ..... \$10.95**  
**UV-Comb. .... \$17.95**

Major parts and shipping  
charged at cost.  
(Dealer net!)

PTS ELECTRONICS, INC. is recommended by more TV manufacturers and overhauls more tuners than all other tuner services combined!

**PTS-NUMBER ONE**

**AND STILL TRYING HARDER!**

(NOT A FRANCHISE COMPANY)



# The test set by which to judge all tv sets.



New RCA ICTJ,  
Model 10J106

## INTRODUCING THE ALL-NEW RCA Industry Compatible Test Jig

Here's a test jig engineered for use with virtually all television receivers: the RCA 10J106. To assist your servicing efforts, not only will it judge the performance of practically every RCA color chassis built in the last decade — tube type, hybrid or solid state — but readily available pin connection adapters permit testing of almost every other leading TV chassis. RCA's 10J106 is destined to become the standard of the service industry.

### Check these features:

- A 19" picture tube with 33 KV capability.
- A simple 2-switch system for matching yoke impedances. No additional transformers to buy or plug in.
- A built-in high voltage meter calibrated to 35 KV, red-lined at 33 KV for safety. Built-in static convergence, and built-in matching transformer for 9 different horizontal deflection outputs.
- 5-step vertical matching transformer matches virtually all TV chassis.
- Lightweight, portable cabinet with convenient handle.
- Accessories included for RCA sets: two 4-ft. cables for kines and yokes; moxle to octal adapter; special yoke adapter; two convergence loads for RCA chassis; high voltage lead; ground lead; audio cable and speaker; high voltage extension cable; continually-updated Cross Reference Handbook; set-up and instruction manuals.

Call your RCA Distributor. He's waiting to hear from you. Or contact RCA Distributor and Special Products Division, Cherry Hill Offices, Camden, N.J. 08101.

**RCA** Distributor and  
Special Products Division

Circle 11 on reader service card



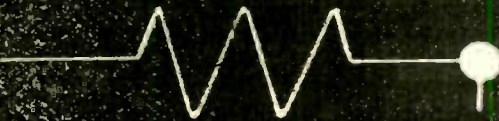
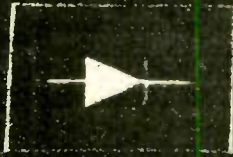

# SYLVANIA ECG

semiconductors  
replacement guide  
and catalog

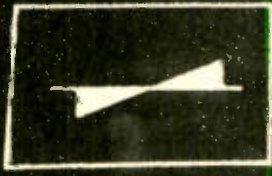
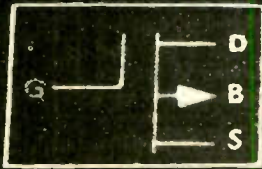
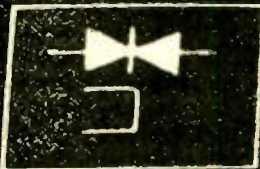
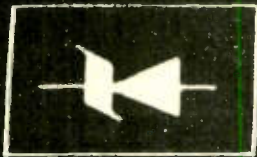

• entertainment • industrial • commercial

Our big new 1975 edition is now off the press. It cross-references 106,000 part numbers – more than any other guide in the business. Pick up a copy today at the Sylvania distributor where you get Sylvania ECG™ Semiconductors.

We're helping you make it.

**GTE SYLVANIA**



# Radio-Electronics®

THE MAGAZINE FOR NEW IDEAS IN ELECTRONICS

More than 65 years of electronics publishing

JULY 1975 Vol. 46 No. 7

## BUILD ONE OF THESE

- 29 **Color TV Camera Costs About \$400**  
Try this 2-color system that produces lifelike results. It's an experimenter's dream. *by Gary Davis*
- 48 **Digital Memory For Your Scope**  
*Part II:* Final construction details include printed-circuit board patterns and parts placement diagrams. *by Chris Titus*
- 50 **COSMOS IC Burglar Alarm Circuits**  
*Part III:* More alarm circuits that really work plus useful data on how to use them effectively. *by R. M. Marston*

## HI-FI AUDIO STEREO

- 32 **R-E Tests The Sansui QRX-6001**  
First of a series of lab test reports that tell the true facts about new hi-fi gear. Exclusive to Radio-Electronics. *by Len Feldman*
- 45 **Make PA Work!**  
How to solve the problems of setting up a PA system so it can really do its job. *by David Yoshinari*

## GENERAL ELECTRONICS

- 4 **Looking Ahead**  
Tomorrow's news today. *by David Lachenbruch*

## TEST EQUIPMENT

- 16 **Equipment Report**  
Heath model 10-4510 dual-trace oscilloscope kit.
- 22 **Equipment Report**  
ACS Mark I function generator
- 25 **Equipment Report**  
Hickok model 270 function generator
- 35 **Test Equipment For Industrial Servicing**  
A detailed look at what's available today. The story includes both new and old equipment. *by Jack Darr*
- 53 **All About Oscilloscopes**  
*Part II:* Wrapup on what scope specifications really mean. Find out how much you know. *by Charles Gilmore*

## SOLID-STATE ELECTRONICS

- 42 **All About IC Operational Amplifiers**  
*Part II:* See how op-amps work and how you can put them to use. *by Don Lancaster*
- 87 **R-E's Replacement Guide for Japanese Transistors**  
*Part XXVIII:* More listings in our growing directory. *compiled by Elizabeth and Robert F. Scott*

## TELEVISION

- 60 **Step-By-Step Troubleshooting Charts**  
What to do when a set has been damaged by lightning. *by Stan Prentiss*
- 65 **Service Clinic**  
More on HEW hold-down circuits in solid-state receivers. *by Jack Darr*

## DEPARTMENTS

- 98 Advertising Index      84 New Literature
- 14 Letters                    70 New Products
- 6 New & Timely            85 Next Month
- 101 Readers Service Card

## ON THE COVER

If you've always wanted to build your own color TV camera, here's your chance. This issue we feature the first part of a special construction article that tells you how you can do it now. For full details turn to page 29.

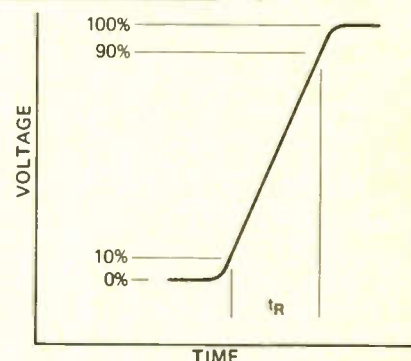

RISETIME IS JUST ONE important scope specification. Find out just what it and the other scope specs mean and what you should know about them before you buy your next scope. See page 53

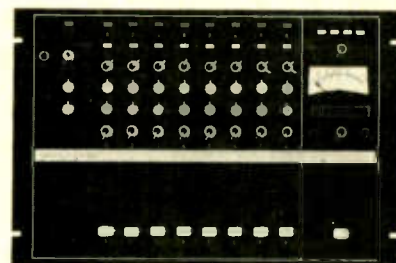

PA SYSTEMS AREN'T MAGIC. It just takes know-how to make them work right. Get some this month. See page 45

Radio-Electronics, Published monthly by Gernsback Publications, Inc., 200 Park Avenue South, New York, NY 10003, Phone: 212-777-6400. Second-class postage paid at New York, NY and additional mailing offices. One-year subscription rate: U.S.A., U.S. possessions and Canada, \$8.75. Pan-American countries, \$10.25. Other countries, \$10.75. Single copies 75c. © 1975 by Gernsback Publications, Inc. All rights reserved. Printed in U.S.A.

Subscription Service: Mail all subscription orders, changes, correspondence and Postmaster Notices of undelivered copies (Form 3579) to Radio-Electronics Subscription Service, Boulder, CO 80302.

A stamped self-addressed envelope must accompany all submitted manuscripts and/or artwork or photographs if their return is desired should they be rejected. We disclaim any responsibility for the loss or damage of manuscripts and/or artwork or photographs while in our possession or otherwise.

As a service to readers, Radio-Electronics publishes available plans or information relating to newsworthy products, techniques and scientific and technological developments. Because of possible variances in the quality and condition of materials and workmanship used by readers, Radio-Electronics disclaims any responsibility for the safe and proper functioning or reader-built projects based upon or from plans or information published in this magazine.



# looking ahead

## Calculators' future

Worldwide calculator production totaled about 34 million units in 1974 and it will rise to more than 92 million in 1978, according to forecasts by Coleman & Co., a New York broker. Coleman predicts that the average factory price of all calculators will decline by 1978 from today's \$36.56 to \$22.39. Hand-held consumer calculators now average \$26.12 at the factory and will drop to \$11.40 in the same period.

L. J. Sevin, president of Mostek, a calculator manufacturing firm, warned American manufacturers that the calculator could go the way of the transistor radio—to the Far East. Before the end of this year, he said, Oriental assemblers may be able to put together six-digit calculators for considerably under five dollars. He gave this breakdown of costs: Vacuum-fluorescent display, 90¢; 4-function chip, \$1.30; keyboard, 60¢; battery 8¢; case, 20¢; labor 13¢; packaging and instructions, 16¢.

## Electronic journalism

In a few short months, television news coverage has been revolutionized by ENG. ENG means "electronic news gathering" and it was the hottest topic at the recent convention of the National Association of Broadcasters. In seminars and at the equipment exhibitions, it became obvious that the entire TV broadcasting industry is changing over from film to ENG for on-the-spot news coverage. ENG owes its existence to a little black box—called the time base corrector—that converts the output of a portable video tape recorder to a broadcast-quality signal.

In its simplest terms, ENG replaces news film with tape. Portable color cameras, some

of them weighing no more than a 16-mm film camera, are used to feed portable battery-operated VTRs, such as the Sony U-Matic or the Akai ¼-inch recorder. The tape is rushed back to the studio where it is electronically edited—generally using two special videocassette editing recorders. The output of the edited tape is fed through the time base corrector into a standard two-inch broadcast VTR for airing. Broadcasters using ENG cite these advantages: Speed—electronic editing plus elimination of the need for processing makes it possible to cover later stories on newscasts. More coverage—because ENG requires smaller crews than film, extra news teams can be used with the same staff. Economy—tape can be used over and over.

## Sony home VTR

Sony has introduced a videocassette recorder in Japan designed specifically for home use, and plans to market a similar unit in the United States this fall. Unlike Sony's industrial U-Matic VTR which uses ¾" wide tape, the new "Betamax" home device employs ½-inch tape. The most striking feature of the new home system is its extreme economy of tape. The helical-scan recorder moves the tape along at a lazy 1.57 IPS, making it possible to record a full hour of video on about 494 feet of tape in a pocket-sized cassette that costs only \$15. A 30-minute cassette will sell for \$10.

Sony says the tape economy is the result of a new recording head with an extremely narrow gap and a new high-density tape formulation. In Japan, a console containing the record-player, a clock-timer and a 17-inch Trinitron color set sells for about \$1,500. Future Sony color sets will have built-in VTR jacks to accommodate a videocassette deck that sells

for about \$760 in Japan. Since the deck doesn't put out an RF signal, it must be attached internally to older sets, at a charge of about \$100. The U.S. version of the color TV-VTR console is expected to include a 19-inch set, in keeping with American tastes for larger screens. Sony says it is producing 5,000 decks and 2,000 TV-VTR consoles monthly.

The new recorder provides the highest density of video information storage yet achieved on magnetic tape. A total of 20.6 square feet of tape is required for an hour's recording. This compares with 70.3 square feet an hour for the ¾-inch Sony U-Matic, 56.2 square feet for RCA's proposed home videocassette recorder and 93.8 square feet for the standard Japanese cartridge or open-reel video tape recorder.

## AM stereo

Why not put stereo on AM, too? This idea has cropped up from time to time, but never got very far. Now RCA has asked the EIA to set up a special study committee and has submitted its own proposed system. The RCA system uses a multiplexed L-R signal, frequency modulated. RCA says broadcasters who also have FM stereo outlets can use the same multiplex equipment to provide stereo AM and FM simultaneously. Regular AM receivers would still pick up a monophonic signal. To reproduce AM stereo signals, a special IC discriminator chip would be required in the receiver. Channel separation of 25 dB is claimed.

Two stations actually are broadcasting in AM stereo—but using a different system. Station XETRA in Tijuana, Mexico, has been putting out AM stereo since 1970, and WFBR in Baltimore is currently experimenting with it. Both are using a sideband system, in which the left and

right signals are transmitted slightly above and below the assigned station frequency. A radio tuned to the station's exact frequency receives a composite left-plus-right signal. To receive stereo programming, two radios can be used—each tuned to the proper sideband.

## Ghostless TV?

ABC has completed tests of circular polarization of TV signals in Chicago and is asking the FCC to approve this transmission system as an option for broadcasters. According to RCA, which is backing ABC's petition to the FCC, circular polarization can "virtually eliminate ghosting." This is because a signal which is polarized in a clockwise direction becomes a counterclockwise signal after it is reflected from an obstruction. This counterclockwise signal would be invisible to a special antenna designed for clockwise polarization.

The immediate beneficiaries of circular polarization would be viewers dependent on rabbit-ear antennas for reception. The new polarization method would give them more opportunity to eliminate ghosts by positioning the dipoles. For others, there's a catch. Although circular polarization won't harm reception by outdoor antennas, it won't improve it either. For ghost-free reception, a new antenna would be required. For broadcasters, too, the new system has a price. In addition to erecting a new transmitting antenna, an additional transmitter and a new tower will often be required. No wonder RCA is interested—it sees circular polarization creating a \$35 to \$50-million market in new transmitting and receiving equipment.

by DAVID LACHENBRUCH  
CONTRIBUTING EDITOR



# TUNER SERVICE CORPORATION

**SUBSTITUNER**



INTRODUCING  
AT JUST

**\$39.95**  
U.S.A. ONLY

WITH CABLES

ONE YEAR  
GUARANTEE

STILL ONLY

**\$9.95**  
U.S.A. ONLY



ALL PARTS  
INCLUDED

EXCEPT TUBES  
AND TRANSISTORS

PROVIDES YOU WITH A COMPLETE SERVICE  
FOR ALL YOUR TELEVISION TUNER REQUIREMENTS.

## FEATURES

- A UHF Tuner with 70 channels which are detented and indicated just like VHF channels.
- A VHF Hi Gain Solid State Tuner.
- AC Powered.
- 90 Day Warranty.

Demonstrate the **SUBSTITUNER** to your customers and show improved reception with their TV sets.

You may place your order through any of the Centers listed below.

## REPAIR

- VHF OR UHF ANY TYPE ..... (U.S.A. ONLY) \$ 9.95
- UHF/VHF COMBINATION ..... (U.S.A. ONLY) \$15.00
- IN THIS PRICE ALL PARTS ARE INCLUDED. Tubes, transistors, diodes, and nuvistors are charged extra. This price does not include mutilated tuners.
- Fast, efficient service at our conveniently located Service Centers.
- All tuners are ultrasonically cleaned, repaired, realigned, and air tested.

## REPLACE

- UNIVERSAL REPLACEMENT TUNER \$12.95 (U.S.A. ONLY)
- This price buys you a complete new tuner built specifically by Sarkes Tarzian Inc. for this purpose.
- All shafts have a maximum length of 10½" which can be cut to 1½".
- Specify heater type parallel and series 450 mA. or 600 mA.

## CUSTOMIZE

- Customized tuners are available at a cost of only \$15.95. With trade-in \$13.95. (U.S.A. ONLY)
- Send in your original tuner for comparison purposes to any of the centers listed below.



WATCH US  
GROW

HEADQUARTERS	BLOOMINGTON, INDIANA 47401	537 South Walnut Street	Tel. 812-334-0411
ARIZONA	TUCSON, ARIZONA 85713	P.O. Box 4534, 1528 S. 6th Ave.	Tel. 602-791-9243
CALIFORNIA	NORTH HOLLYWOOD, CALIF. 91601	10654 Magnolia Boulevard	Tel. 213-769-2720
	BURLINGAME, CALIF. 94010	1324 Marsten Road	Tel. 415-347-5728
	MODESTO, CALIF. 95351	123 Phoenix Avenue	Tel. 209-521-8051
FLORIDA	TAMPA, FLORIDA 33606	1505 Cypress Street	Tel. 813-253-0324
	FT. LAUDERDALE, FLORIDA 33315	1045 W. 23rd Street, Bay 16	Tel. 305-524-0914
GEORGIA	ATLANTA, GEORGIA 30310	938 Gordon Street S.W.	Tel. 404-758-2232
ILLINOIS	CHAMPAIGN, ILLINOIS 61820	405 East University Street	Tel. 217-356-6400
	CHICAGO, ILLINOIS 60621	737 West 55th Street	Tel. 312-873-5556
	SKOKIE, ILLINOIS 60076	5110 West Brown Street	Tel. 312-675-0230
INDIANA	HAMMOND, INDIANA 46323	6833 Grand Avenue	Tel. 219-845-2676
	INDIANAPOLIS, INDIANA 46204	112 West St. Clair Street	Tel. 317-632-3493
IOWA	WEST DES MOINES, IOWA 50265	822 10th Street	Tel. 515-277-0155
KENTUCKY	LOUISVILLE, KENTUCKY 40208	2920 Taylor Boulevard	Tel. 502-634-3334
LOUISIANA	SHREVEPORT, LOUISIANA 71104	3025 Highland Avenue	Tel. 318-221-3027
MARYLAND	BALTIMORE, MARYLAND 21215	5505 Reisterstown Rd., Box 2824	Tel. 301-358-1186
MISSOURI	ST. LOUIS, MISSOURI 63132	10530 Page Avenue	Tel. 314-429-0633
NEVADA	LAS VEGAS, NEVADA 89102	1412 Western Avenue No. 1	Tel. 702-384-4235
NEW JERSEY	TRENTON, NEW JERSEY 08638	901 North Olden Avenue	Tel. 609-393-0999
	JERSEY CITY, NEW JERSEY 07307	547-49 Tonnelle Ave., Hwy. 1 & 9	Tel. 201-792-3730
OHIO	CINCINNATI, OHIO 45216	7450 Vine Street	Tel. 513-821-5080
	CLEVELAND, OHIO 44109	4525 Pearl Road	Tel. 126-741-2314
OREGON	PORTLAND, OREGON 97210	1732 N.W. 25th Avenue	Tel. 503-222-9059
TENNESSEE	GREENEVILLE, TENNESSEE 37743	1215 Snapps Ferry Road	Tel. 615-639-8451
	MEMPHIS, TENNESSEE 38111	3158 Barron Avenue	Tel. 901-458-2355
TEXAS	DALLAS, TEXAS 75218	11640 Garland Road	Tel. 214-327-8413
VIRGINIA	NORFOLK, VIRGINIA 23513	3295 Santos Street	Tel. 804-855-2518
WISCONSIN	MILWAUKEE, WISCONSIN 53216	4722 West Fond Du Lac Avenue	Tel. 414-871-7655
CANADA	ST. LAURENT, QUEBEC		
	CALGARY, ALBERTA		

IF YOU WANT TO BRANCH OUT INTO THE TV TUNER REPAIR BUSINESS,  
WRITE TO THE BLOOMINGTON HEADQUARTERS ABOUT A FRANCHISE.

Circle 3 on reader service card



## Citizens banders comment on proposed FCC regulation changes

REACT (Radio Emergency Associated Citizens Teams), the national organization of Citizens banders that organized to help motorists and others, commented in general favorably on the proposed revisions of the FCC Citizens band regulations. Among the REACT's were:

**Expansion of the Class-D band:** Increasing the number of channels, as proposed, is favored. But REACT opposes the elimination of straight AM in the Class-D service. Further, it suggests that expansion of the Class-D band should not be substituted for action to establish a new Class-E service in the 225-MHz region. REACT also advocates that all channels be open to both inter-station and intra-station calls.

**Single sideband:** Retain the current 23 Class-D channels with both AM and SSB options. Divide the new channels equitably between AM and SSB-only operation, creating a basis for evaluating SSB-only operation.

**Emergency channel:** Limit emergency channel-9 to AM, to assure maximum participation in monitoring. Permit, on the emergency channels, communications necessary to maintain voluntary monitoring on those channels.

(An SSB emergency channel may become necessary, though REACT approaches the idea "with great reservations.")

**Calling channel:** The use of channel-11 for calling only is endorsed.

**Permissible communications:** Reducing the silent period to 1 minute "is appropriate." There is no objection to lowering the age limit to 16 years.

**Station identification:** Simplifying procedure by requiring the station to state only its own call sign is constructive, and may lead more licensees to give proper call sign identification.

**Antennas:** Changes in height limits, etc., are generally approved. But the establishment of antenna acceptance procedures is questioned. It would, REACT believes, increase complications and costs to the licensee, without benefiting him or contributing to the enforcement effort.

## Service organizations propose effective warranty procedure

To help solve the problem of providing warranty service, a committee composed of representatives of the three national electronic service dealer organizations have worked out a pro-

posal covering the warranty of consumer electronic equipment and the implementation of that warranty. The proposal will be submitted to all the national associations for study, approval and action.

The committee was composed of Nolan Boone, chairman, Little Rock, AR (member of NARDA, NATESA and NESDA); Joe Senatra, Milan, IL (representing NARDA); Leon Skalish, Glenolden, PA (representing NATESA) and Larry Steckler, Hicksville, NY (representing NESDA). The committee met at the Bismarck Hotel, Chicago, January 10 and 11, 1975.

Text of the proposal follows:

### WARRANTY STATEMENT

The warranty should be a full warranty for ninety (90) days covering all parts and all service. In any equipment using a picture tube, that tube along with any devices permanently attached to it by the manufacturer shall be covered (parts and service) for one (1) year.

**Exclusions (items not covered by the warranty).**

Faults outside the equipment (for example but not limited to—no AC power, antenna or reception problems).

Adjustment of any controls described in the owner's manual.

Abuse or misuse of the equipment (for example but not limited to—foreign objects inside the equipment, including liquids; dropping the equipment).

### IF AN ITEM IS NOT SPECIFICALLY EXCLUDED IT IS COVERED BY THE WARRANTY

#### IMPLEMENTATION OF THE WARRANTY

##### 1. Warranty Claims Filed by the Service Dealer

All claims shall be filed on an acceptable form. (It is the recommendation of the committee that a single form be developed for all warranty claims. Since EIA has developed such a form, they are encouraged to continue its development and full acceptance.)

##### 2. Manufacturers Payment to the Service Dealer

The amount of payment shall be determined by an agreement between the manufacturer and the service dealer. (The committee recommends that the service dealer should not accept any payment rate that is lower than that dealer's non-warranty service charges. This includes parts as well as service.)

(This follows the procedures stated presently in the law of the State of

(continued on page 12)

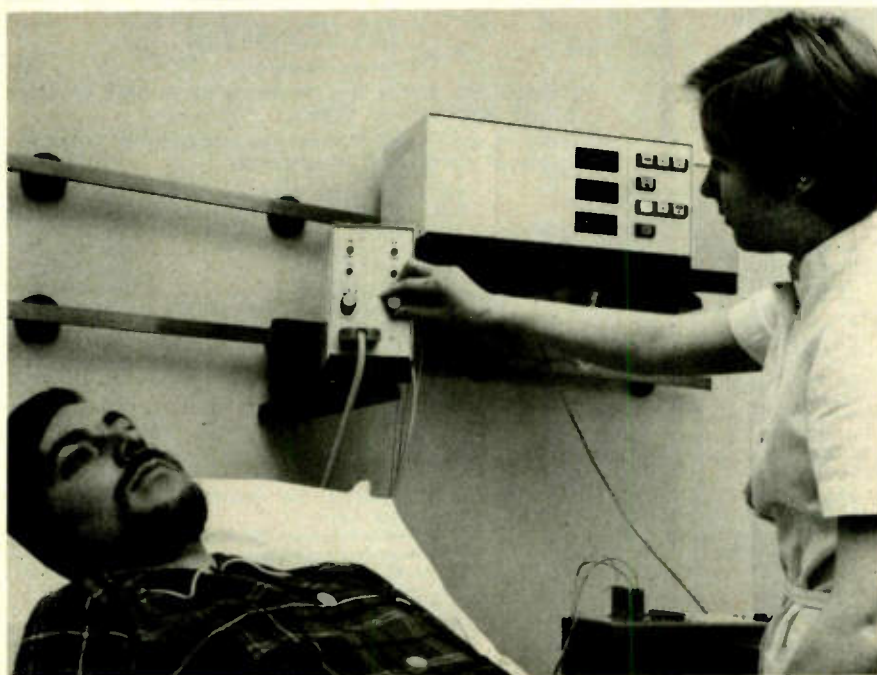

**INSTANT CHECKER FOR PACEMAKERS** operates over ordinary phone lines. This one at the German Heart Center of Munich makes it possible for a patient to get a check in 50 seconds. Doctors and nurses at the Heart Center can then use the information to take indicated action immediately, often saving a life. (Electronic technicians may be equally interested in the track system that permits equipment to be made mobile and brought to each patient's bed.)



# Avoid serious problems when replacing film capacitors

## Use genuine Sprague Type PP and PM Capacitors in critical deflection circuits.

The next time you replace a dipped tubular in one of the newer color TV sets, don't automatically assume you're replacing an ordinary every-day film or paper capacitor. If it happens to be a deflection capacitor used for commutation or S-shaping, you need a polypropylene or polycarbonate film replacement with (1) high a-c current-carrying capability; (2) close capacitance tolerance; (3) good capacitance stability. The standard replacement capacitors used in the industry, even our superior Type PS dipped tubulars, just won't do the job . . . they could cause the set to become inoperative again.

Play it safe . . . dipped tubulars may look alike on the surface, but there can be a big difference in the film dielectric. Keep a supply of Sprague Type PP and PM capacitors

on hand for those critical situations where ordinary replacements could cause serious problems.

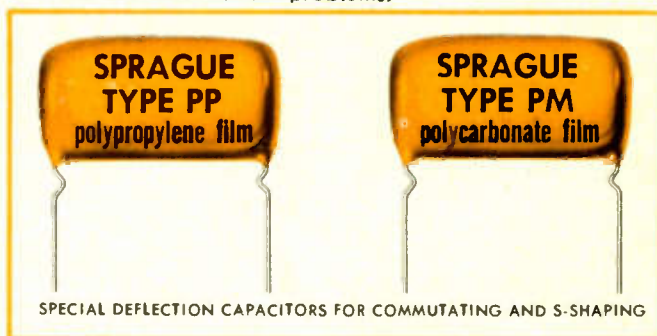

## A Service Technician Introductory Super Special . . .

### the KF-28 ASSORTMENT

...a total list price value of \$65.00... with a regular dealer net of \$35.95...

for a low, low **\$25<sup>20</sup>** net



Be ready for those critical application replacements in today's color TV sets with the KF-28 Assortment. It contains 41 Type PP and PM polypropylene and polycarbonate capacitors in 20 popular ratings, stocked in a handy cabinet that puts the film capacitors you need at your fingertips, neatly organized and easy to find. Measuring 9<sup>3</sup>/<sub>4</sub>" wide x 5" high x 6<sup>1</sup>/<sub>2</sub>" deep, this attractive blue 9-drawer cabinet has clear plastic drawers with adjustable dividers. Pre-labeled drawer fronts identify the capacitors inside. A raised area on top of the cabinet and a depression in the bottom facilitate stacking of two or more cabinets.

Get a KF-28 Assortment from your Sprague distributor today!

#### ASSORTMENT KF-28 CONTENTS

Quan.	μF	@ WVDC	Cat. No.	Quan.	μF	@ WVDC	Cat. No.
2	1.5	@ 150	PM15-M1.5	2	.01	@ 600	PP6-S10S
2	.01	@ 400	PP4-S10	2	.066	@ 600	PP6-S66S
2	.015	@ 400	PP4-S15	2	.075	@ 600	PP6-S75S
2	.033	@ 400	PP4-S33S	2	.022	@ 800	PP8-S22S
2	.06	@ 400	PP4-S60S	2	.047	@ 800	PP8-S47S
2	.081	@ 400	PP4-S81S	2	.051	@ 800	PP8-S51S
2	.2	@ 400	PP4-P20	2	.0018	@ 1600	PP16-D18
2	.0018	@ 600	PP6-D18S	2	.002	@ 1600	PP16-D20
2	.0022	@ 600	PP6-D22S	2	.0033	@ 1600	PP16-D33
3	.0039	@ 600	PP6-D39S	2	.0039	@ 1600	PP16-D39

For cross-reference information on close-tolerance polypropylene and polycarbonate film capacitors, showing original part numbers with correct Sprague replacements, ask your Sprague distributor for Cross-Reference Guide C-873, or write to: Sprague Products Company, 81 Marshall Street, North Adams, Mass. 01247.

MEMBER



**THE BROAD-LINE PRODUCER OF ELECTRONIC PARTS**



Circle 4 on reader service card



# Compare what you get training and you'll

## Compare costs

Only NRI offers five complete TV/Audio Servicing Courses from \$370 to \$1,095 . . . with convenient, inexpensive time payment plans. In the Master Course in color TV servicing, with a 25" diagonal solid-state color TV, you save as much as \$600 under the next leading home study school.

NRI saves you tuition because our costs are lower. We pay no salesmen, and we engineer our own kits and training equipment. We don't buy "hobby kits" from others. Nor do we penalize you with big interest charges for time payments. We pass the savings on to you.

## Compare training

NRI is one of the few home study schools that maintains its own full-time staff of technical writers, editors, illustrators, development engineers and publications experts. The people who design the kits also design the lessons . . . so that theory and practice go hand in hand. The lessons aren't "retro-fitted" to an outside-source "hobby kit." At each stage of building, you experiment with the *power on*; you don't wait till the set's completed to learn troubleshooting. The NRI set is designed exclusively for training. It is also a superb 100% solid-state receiver for your personal use.

## Compare choices

Most schools offer one course in color TV servicing, period. Only NRI offers you five different courses to match your needs and budget. The comprehensive 65-lesson course, complete with 7 kits, costs as little as \$370. Or you can choose the \$465 course that includes a 12" diagonal black & white portable TV for hands-on experience. Then there's the 19" diagonal solid-state color TV course for \$795; the advanced color TV course for trained technicians with an 18" diagonal color TV for \$645; and finally, the magnificent 25" diagonal solid-state color TV course, complete with console cabinet, oscilloscope, TV pattern generator, and a 3½ digit digital multimeter, for \$1,095. Other schools charge you hundreds of dollars more for an equivalent course.





# in TV/Audio home choose NRI.

## Compare equipment    Compare schools

NRI has engineered the widest variety of professional electronic lab equipment ever designed entirely for training at home. When you enroll in the Master Course in TV/Audio Servicing, for instance, you receive kits to build a wide band, solid-state, triggered sweep, service type 5" Oscilloscope; color pattern generator; solid-state radio; and a digital multimeter.

Before you settle on any home training course, compare the over-all program. See if you are getting kits engineered for experimentation and training . . . or merely "hobby kits". Count the experiments . . . compare the components. Don't just count kits. (Some schools even call a slide rule a kit.)

Home study isn't a sideline with NRI. We've been its innovating leader for 60 years. Ask any of the hundreds of thousands of NRI graduates. They'll tell you . . . you can pay more but you can't buy better training.

Along with each course, NRI provides bite-size, fully-illustrated lessons; personally graded tests; and the kind of person-to-person teaching that makes learning easier and faster.

Send for the free NRI full-color electronics catalog and discover why so many choose NRI. You'll find courses offered in TV/Audio Servicing, FCC License, Complete Communications Electronics, Digital Computer Electronics, Marine and Aircraft Electronics, Mobile Communications, etc.

**MAIL CARD  
FOR YOUR  
FREE NRI  
CATALOG**



NO SALESMAN WILL CALL.

**AVAILABLE FOR CAREER  
STUDY UNDER GI BILL**

Check box on card for information.



**NRI SCHOOLS**  
McGraw-Hill Continuing Education Center  
3939 Wisconsin Avenue,  
Washington, D.C. 20016





Hugo Gernsback (1884-1967) founder

**M. Harvey Gernsback**  
editor-in-chief and publisher

Larry Steckler, CET, editor

Robert F. Scott, W2PWG, CET,  
technical editor

Arthur Kleiman, associate editor

Jack Darr, CET service editor

I. Queen, editorial associate

Leonard Feldman  
contributing high-fidelity editor

David Lachenbruch, contributing editor

Karl Savon, semiconductor editor

Barbara Schwartz, editorial assistant

Vincent P. Ciconia, production manager

Sarah Martin, production assistant

Harriet I. Matysko, circulation director

Arline R. Bailey, advertising coordinator

Cover photo courtesy Walter Herstatt

Cover design by Louis G. Rubsamen

Radio Electronics is a member of the *Institute of High Fidelity* and is indexed in *Applied Science & Technology Index* and *Readers Guide to Periodical Literature*.



Radio-Electronics is published by Gernsback Publications, Inc. 200 Park Ave. S. New York, NY 10003 (212) 777-6400

President: M. Harvey Gernsback

Secretary: Bertina Baer

## ADVERTISING SALES

### EAST

Stanley Levitan, Sales Manager  
Radio-Electronics  
200 Park Ave. South  
New York, NY 10003  
(212) 777-6400

### MIDWEST/Texas/Arkansas/Okla.

Ralph Bergen  
The Ralph Bergen Co.  
6319 N. Central Ave.  
Chicago, IL 60646  
(312) 792-3646

### PACIFIC COAST/Mountain States

Jay Eisenberg  
J.E. Publishers Representative Co.,  
8732 Sunset Blvd.,  
4th Floor,  
Los Angeles, CA 90069  
(213) 659-3810

Sales Mart Building  
1485 Bayshore Blvd., Box 140  
San Francisco, CA 94124  
(415) 467-0125

Minnesota that says: "Reasonable compensation... shall be the amount of money that the service dealer charges his other customers for like services or repairs not covered by warranty protection... In addition, the manufacturer shall reimburse the service dealer at that dealer's normal retail price... for all parts and materials needed to effect the manufacturer's guarantee.")

All claims submitted to the manufacturer shall be paid *in full* or returned with question, within 30 days of receipt of the claim by the manufacturer.

### 3. Parts

Defective warranty parts removed by the service dealer shall be retained by that dealer for one (1) month and ten (10) days. The manufacturer may request that removed parts be picked up by his agent or be shipped to him at the expense of the manufacturer. If this request is not made by the end of the period of 1 month and 10 days from the date of the claim, the parts may be disposed of by the service dealer.

Payment for parts shall be a part of the warranty agreement between the manufacturer and the service dealer. (See Part 3: Manufacturer's Payment to the Service Dealer for details.)

Many of the procedures and recommendations and procedures in the proposal above are the result of long-term efforts by national, regional, State and local associations, who have put a great deal of time and effort into developing a practical warranty plan that would protect the equipment owner by making it possible for the service dealer to implement the manufacturer's warranty.

### Electronic lead poisoning test is quick and inexpensive

A new blood test for lead poisoning can be performed in one minute, with equipment far less complex and expensive than has previously been needed.

The new technique, devised by scientists at Bell Laboratories, uses the fluorescence, or light emission, of the blood when the sample is irradiated with a beam of blue light. To conduct a test, the nurse would take a drop of blood from the subject's finger, place it on a glass slide and insert it in a special fluorimeter. If the person has absorbed excessive amounts of lead, the blood gives off red light of a specific frequency. The intensity of the red fluorescence is recorded on a digital meter to indicate the lead level in the blood.

Lead poisoning is a serious problem, especially in cities, though the situation was improved somewhat by the 1970 restriction of lead in paint. Over 30,000

cases of lead poisoning were reported in the United States in 1973, and it is estimated that 25% of children, 5% of men and 2% of women have in their bodies quantities of lead that are near the toxic level. Young children often swallow paint chips and breathe dust

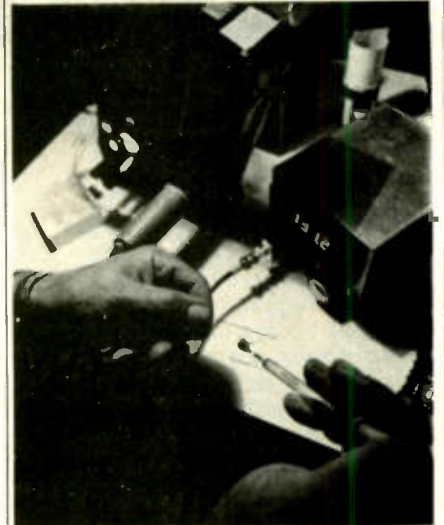

**THE PORTABLE ELECTRONIC TESTER** uses a single drop of blood (note the slide, foreground) and gives a quick digital readout.

that may have fallen from the walls of old houses. Another source of lead is city dust that has a high lead content from automobile exhausts.

Bell Labs scientists have also devised an inexpensive portable instrument that can be used by a school nurse. Former techniques required a small test tube full of blood, and expensive and complicated equipment and techniques, including atomic spectroscopy.

### Electronic labels will identify vehicles or shipping containers

A system that will identify large shipping containers, trucks or other vehicles by serial or license number has been delivered to the US Army by Fairchild Space and Electronics Co. for testing and evaluation.

The system uses electronic labels to identify and record the location of containers used to transport goods. It can identify railroad cars, piggyback trailers and automobiles equally well.

The automatic interrogator reads the serial number on each container that passes through its field, reading labels while the containers are in motion at speeds as great as 85 miles-per-hour and at distances up to 20 feet. The accuracy is expected to be several orders greater than that obtained with existing systems.

R-E



410 to 1  
you'll find  
the  
devices  
you need  
here.

Over 103,200 devices can be replaced by 250 RCA SK Series types. That's 410 to 1! Best ratio in the industry. Which means the odds are, SK is your best, fastest way to get what you need. With minimum inventory. And RCA provides the top quality you'd expect from a top manufacturer of OEM devices. Same strict AQL standards, same strict Director of Quality Assurance. Get SK devices and your free 1975 SK Series Replacement Guide from your local RCA distributor.

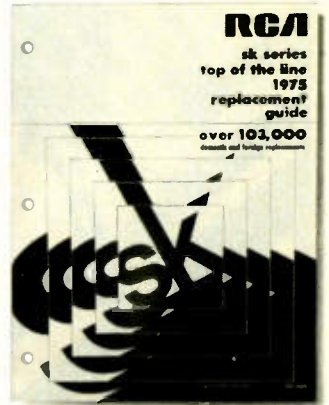

**RCA** SK Series

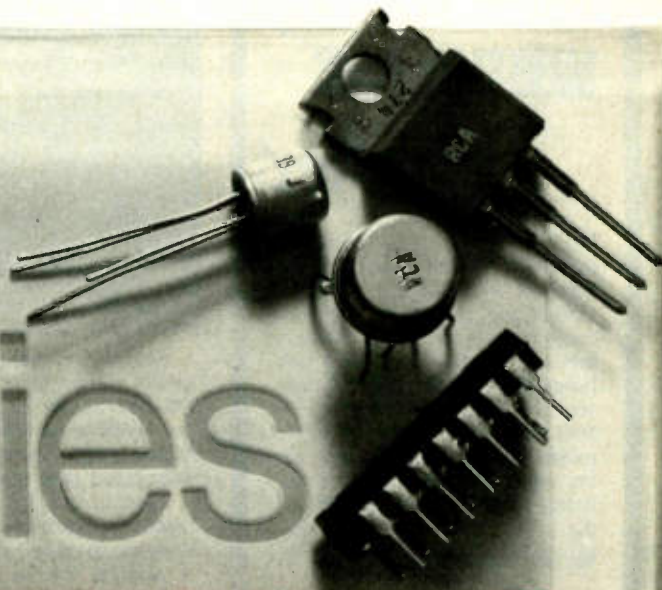

It's OK if it's **sk**

Circle 5 on reader service card



# plug in and go soldering

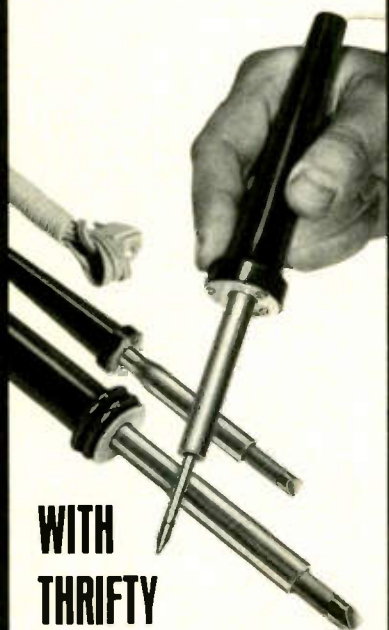

WITH  
THRIFTY  
MARKSMAN IRONS  
BY **Weller**<sup>®</sup>

Pre-tinned tips for instant action. Five different ratings for technicians and hobbyists. Heat- and impact-resistant handles grip comfortably. Premium, stainless steel barrel for strength, corrosion resistance, and more even temperatures. Cone shape, screw-driver, chisel tips; Soldering Kit, Hot Knife Kit for wire stripping and plastic cutting. Full-view card pack lets you see and read about these UL-listed, factory-pre-tested irons before you buy.

See your local distributor or write...

**Weller-Xcelite  
Electronics Division**



**The Cooper Group**  
P. O. BOX 728,  
APEX, NORTH CAROLINA 27502

Circle 6 on reader service card

# letters

## MOD FOR ALARM SYSTEM

In regard to your article "Protect Your Home, Build An Electronic Alarm System" in the April 1974 issue of **Radio-Electronics**, I would like to make a slight modification.

A problem is encountered when the door is first opened to arm the security system. When the alarm is first turned on, pins 8 and 9 of IC1 are at zero potential. When the door is opened, pin 9 goes to a logic 1. As soon as the door is closed, pin 8 changes to a logic 1 at a time constant of  $R4 \times C3$ . At the same time, pin 9 is discharging at a time constant equal to  $R5 \times C4$ . There is a slight coincidence on pins 8 and 9 during which the output pin 10 goes to a logic zero and latches in starting the fifteen-second delay.

The problem can be solved by replacing R4 with a 1-megohm resistor. This change in value will slow down the charging rate and eliminates the coincidence problem.

TEDDY VANSTEEN  
Lindenhurst, NY

## TVT—MARK-8

I just wanted to add my thanks for the Mark-8 Minicomputer project.

I have enclosed two photographs, one of the Mark-8 next to my TV Typewriter, and the other, an internal view of my Mark-8 with the front panel lying down.

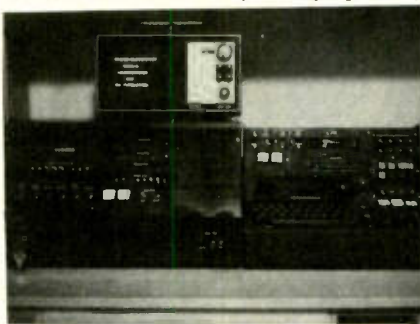

As can be seen, I panel mounted the LED's rather than putting them on the PC board and used modular construction with a simple mother board and Molex edge connectors instead of the suggested wire connectors.

I am in the process of writing an interactive supervisor program to execute commands typed on the TV Typewriter. It permits me to create and edit programs, execute them, list them, or store them on cassette via an interface I designed.

My TV Typewriter, constructed last year thanks to you, also has a programmable desk calculator in the same cabinet.

I would like to see some sort of calculator interface, since the Mark-8 is a little limited in dealing with large decimal numbers. In addition, while my present Mark-8 will use 1K of 1101 memory, I would like to expand with a

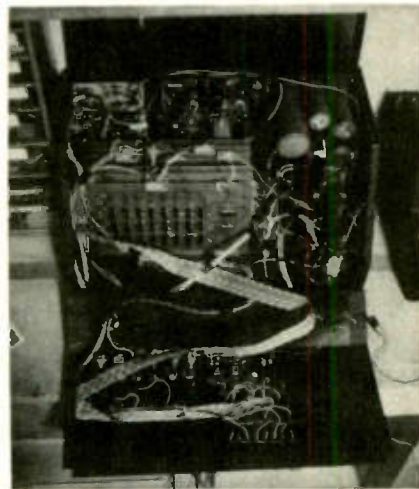

denser chip and a PROM. How about another board providing up to 3K of 2102 RAM or some PROM.

Lastly, let me add my voice to those requesting a regular column based on the Mark-8 for new programming ideas and hardware.

Thanks again for a great project.  
STEVEN J. WINICK  
Silver Spring, MD

## LOOK ME OVER!

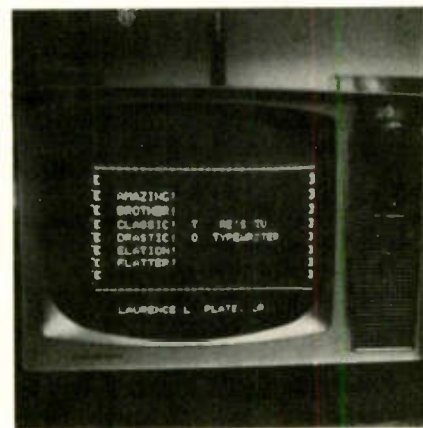

I installed my TVT in cabinets and moved all the switches from the main-frame to the keyboard cabinet.

I added four keys to my TVT to get the [, ], — and / symbols, completing the TVT alphabet set.

LAURENCE PLATE JR.  
Santa Barbara, CA



# Radio Shack announces new heights in Archer® antennas!

FCC rules now allow your omnidirectional CB antenna to be 60 feet above ground—triple the old limit! Take advantage of the amended rules to upgrade your antenna (Part 95, Sections 95.3 & 95.37C).

**Deluxe Colinear.** Outstanding 4 dB gain and low radiation angle—this is the one for maximum omnidirectional CB range. 19-ft., 10-in. 5/8-wave radiator. Static dissipator. Fits masts to 1-5/8" dia. #21-1133.

**Half Wave.** More gain (3.75 dB) than many high-priced omni's. 5-section seamless aluminum half-wave radiator, 52" radials, static dissipating hex loops, 1.25-to-1 VSWR. Fits masts to 1-5/8" dia. #21-902.

**Ground Plane.** The low-priced "omni with the mostest." All tubular aluminum elements, quarter wave radiator, three 108" quarter wave radials, static discharge protector. Fits masts to 1-5/8" dia. #21-901.

## FREE New 1976 Radio Shack Catalog

OVER 2000 PRODUCTS  
EXCLUSIVES ON EVERY PAGE  
BEAUTIFUL FULL COLOR

Stereo • Quadraphonic • Phonographs  
TV Antennas • Radios • Citizens Band  
Kits • Recorders • Tape • Tools  
Auto Tune-Up • Electronic Parts  
Test Instruments • More!



164 pages of the finest in home and hobby electronics. Respected brand names like Realistic, Micronta, Archer, Science Fair — and they're available only at Radio Shack stores and dealers nationwide! See what's really new in electronics by getting this catalog now

SEND FOR YOURS TODAY!  
FILL OUT COUPON BELOW

1976 Mail to Radio Shack, P. O. Box 1052, 535  
Catalog Ft. Worth, Texas 76101. (Please print.)

Name \_\_\_\_\_ Apt. No. \_\_\_\_\_

Street \_\_\_\_\_

City \_\_\_\_\_

State \_\_\_\_\_ ZIP

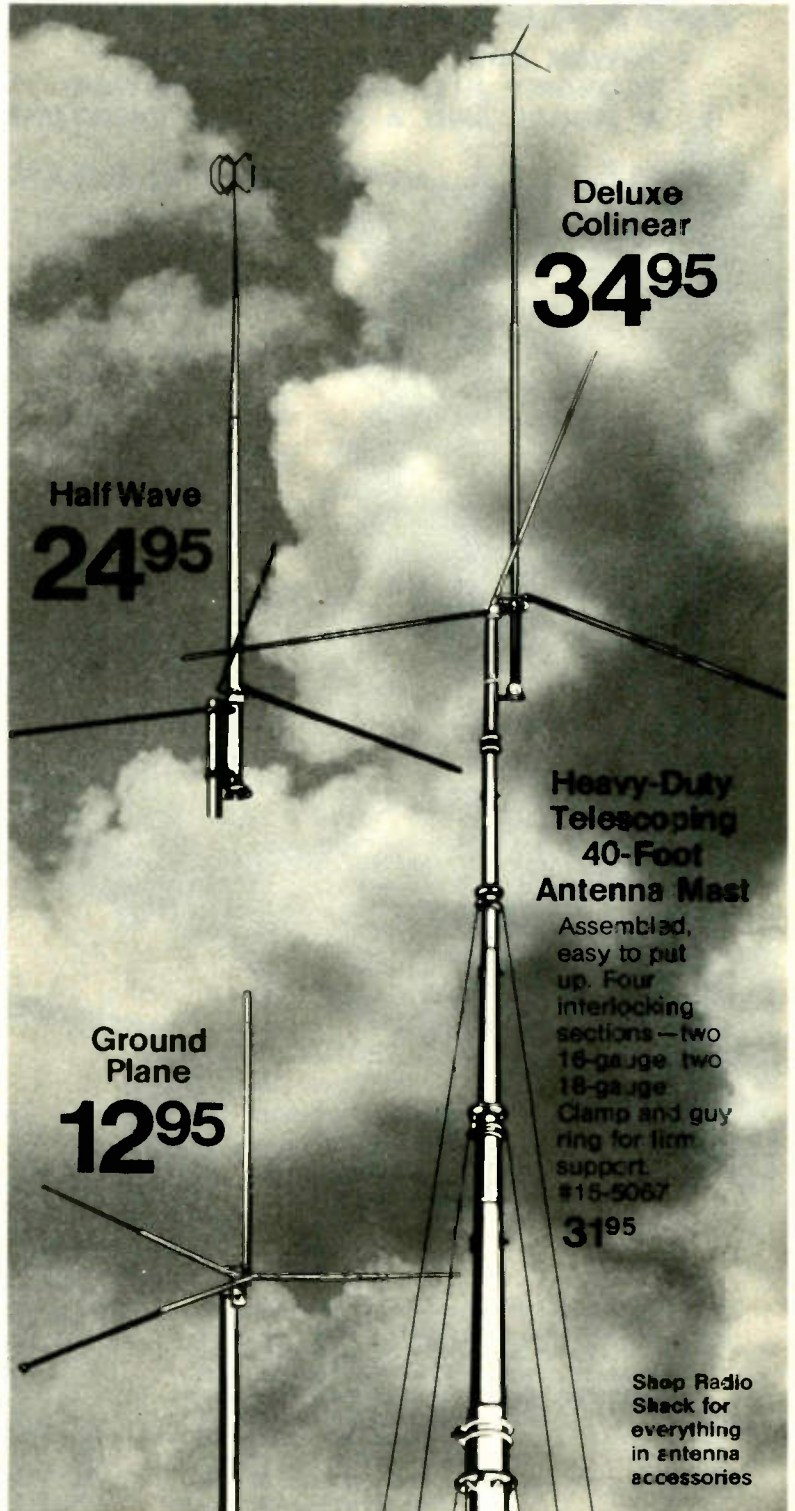

Half Wave  
**24<sup>95</sup>**

Ground Plane  
**12<sup>95</sup>**

Deluxe Colinear  
**34<sup>95</sup>**

Heavy-Duty Telescoping  
40-Foot Antenna Mast

Assembled, easy to put up. Four interlocking sections—two 16-gauge two 18-gauge. Clamp and guy ring for firm support. #15-5067  
**31<sup>95</sup>**

Shop Radio Shack for everything in antenna accessories



Mastercharge or Bank Americard at participating stores

There's only one place you can find them . . .

# Radio Shack®

A TANDY CORPORATION COMPANY

3000 STORES • 50 STATES • 7 COUNTRIES

Retail prices may vary at individual stores.

Circle 7 on reader service card



# BUILD & TEST CIRCUITS AS FAST AS YOU THINK!

- POWER FOR THE PROFESSIONAL
- ECONOMY KITS FOR THE HOBBYIST
- A MODEL AND A PRICE FOR EVERYONE

## equip reports

### Heath IO-4510 DC-15 MHz Dual-Trace Oscilloscope

THE OSCILLOSCOPE HAS ALWAYS BEEN A necessity on the experimenters and technicians workbench. Up until recently however, the calibrated dual-trace triggered-sweep scope has been considered a luxury item. But this has all changed. The advent of integrated circuits and the application of state-of-the-art electronics in consumer products has made the scope a necessity.

For those readers considering purchasing a new scope, the IO-4510 should definitely be among the ones being considered. This recent addition to the Heath Co. line is a lab-quality instrument with impressive specifications.

The vertical amplifiers have a sensitivity of 1mV/cm to 5 V/cm in a 1-3-5 sequence, accurate to 3%. Frequency response is DC to 15 MHz (-3dB). Rise time is 24 nanoseconds with less than 3% overshoot. The input impedance is 1 megohm shunted by 38 pF. Maximum input voltage is 400 volts peak combined AC and DC.

The horizontal time base has a range of 200 ms/cm to 100 ns/cm in 22 calibrated steps with a 1-3-5 sequence, accurate to within 3%. A concentric control provides continuously variable speeds between steps, with a maximum range of 500 ms/cm. The variable control can be pulled out to expand any sweep speed times five, accurate to within 5%.

An external horizontal input signal can be applied directly to the deflection circuits by turning the time base switch to the appropriate position. This input has an impedance of approximately 200K ohms. A horizontal input attenuator is not provided and the input sensitivity is 0.2 V/cm. All input connections are of the BNC type.

In the X-Y mode, one of the scopes two vertical amplifiers is used as the horizontal amplifier. Therefore, the horizontal sensitivity is equal to the vertical sensitivity and a calibrated attenuator is available for the horizontal signal. The scope is switched to the X-Y mode by turning the time base switch to the appropriate position. The X-Y phase shift is less than 3° at 100 kHz (an important factor to consider when using the scope as a vectorscope).

Triggering can be selected from either the line frequency, either vertical input signal or an external trigger signal. The trigger select switch and concentric level

(continued on page 22)



### PROTO BOARD 203

Breadboard Prototyping with 5 Volt, 1 AMP Regulated Power Supply included! A total ready-to-use power breadboard prototest device with a built-in regulated, short-proof power supply. Just plug-in and start building! 2 extra floating 5-way binding posts for external signals. Self-contained with power switch indicator lamp and power fuse. 24-14 pin DIP capacity. Attractive two-tone quality case. All metal construction. 9 $\frac{3}{4}$ "L x 6 $\frac{1}{2}$ "W x 2 $\frac{3}{4}$ "H. 5 lbs. Order today!

**\$75**

Add \$2.50 shipping/handling

A modestly priced kit for the economy-minded experimenter . . .

### PROTO BOARD 100

A low cost, big 10 IC capacity breadboard kit with all the quality of QT sockets and the best of the Proto Board series . . . complete down to the last nut, bolt and screw. Includes 2 QT-35S Sockets; 1 QT-35B Bus Strip; 2 5-way binding posts; 4 rubber feet; screws, nuts, bolts; and easy assembly instructions.

**19<sup>95</sup>**

Add \$1.50 shipping/handling.

**PROTO-CLIP**  
for Power-On,  
Hands-Off Signal  
Tracing. No more  
shorting leads.  
Costs less than . . .

**\$5**

Bring IC leads from pc board for fast signal tracing and troubleshooting. Inject signals. Wire unused circuits into boards. Scope probes and test leads lock onto Dynagrip inset (see circle) for hands-off testing. Plastic construction eliminates springs, pivots. Non-corrosive nickel/silver contacts for simultaneous low resistance connections.

PC-14, 14-pin Proto Clip, \$4.50 ea.

PC-16, 16-pin Proto Clip, \$4.75 ea.

Add 75¢ shipping/handling.

Order today off-the-shelf from CSC or local distributor. Charge: BAC, MC, AX. Write for free catalog. Free English/Metric Slide Rule with each order. Dealer inquiries invited.

Foreign Orders add 15%.

Patents Pending Made in USA  
Prices subject to change

**CSC** Continental Specialties Corp.

Box 1942, New Haven, CT 06509 • 203/624-3103

W. Coast Off.: Box 7809, S. Francisco, CA 94119 • 415/383-4207  
Canada: Available thru Len Flinkler Ltd., Ontario

Circle 8 on reader service card



# MITS Altair Computer Report

## A Computer Language You Can Understand

ALTAIR BASIC is an inexpensive, general-purpose computer language with the power for advanced data processing. It is easy to learn and to use.

ALTAIR BASIC is part of the overall MITS computer concept. That is, **computers must be made understandable and affordable.**

ALTAIR BASIC comes in three versions. The first of these is a 4K BASIC designed to run in an Altair with as little as 4,000 words of memory. This powerful BASIC language has **6 functions** (RND, SQR, SIN, ABS, INT, and SGN) in addition to **15 statements** (IF... THEN, GOSUB, RETURN, FOR, NEXT, READ, INPUT, END, DATA, LET, DIM, REM, RESTORE, PRINT, STOP and **4 commands** (LIST, RUN, CLEAR, SCRATCH).

The second ALTAIR BASIC option is the 8K BASIC designed to run in an Altair with as little as 8,000 words of memory. This BASIC language is the same as the 4K BASIC only with **8 addi-**

**tional functions** (COS, LOG, EXP, TAN, ATN, INP, FRE, POS) and **4 additional statements** (ON... GOTO, ON... GOSUB, OUT, DEF) and **1 additional command** (CONT). This BASIC has a multitude of advanced STRING functions and it can be used to control low speed devices—**features not normally found in many BASIC languages.**

The third ALTAIR BASIC is the EXTENDED BASIC version designed to run on an Altair with as little as 12,000 words of memory. It is the same as the 8K BASIC with the addition of PRINT USING, DISK I/O, and double precision (13 digit accuracy) add, subtract, multiply and divide.

ALTAIR BASIC is only the beginning. MITS is currently engaged in an extensive software development program. Our Disk Operating System is scheduled for delivery in August. Other software now available includes an Assembler, System Monitor, and Text Editor.

## ALTAIR USERS GROUP

The Altair Users Group is both a means of communication among Altair Users and a method of building a comprehensive library of Altair Programs. All Altair purchasers are entitled to a free, one year membership in this group.

Members of the Altair Users Group are encouraged to submit programs by entering Altair "Software Contests." Winners of these contests are awarded prizes of **up to \$1,000** credit toward the purchase of an Altair Computer or Altair options.

Contest winners are announced in the Altair newspaper, **Computer Notes**, which is published monthly and mailed free to all members of the Altair Users Group. **Computer Notes** contains complete update information on Altair hardware and software developments, programming tips, general computer articles and other useful information.

**Associate Memberships** are available to non-Altair customers for only \$30.00 a year. Membership fees are refunded to Associate Members who buy an Altair Computer within 8 months after they become a member.

## COMPUTER TRADE-IN

If you have a Mark 8 or a Scelbi-8H computer and you'd rather have an Altair 8800, we will offer you \$150.00 on a trade-in for an Altair plus 4K of memory.

For an Altair Computer kit, send in your used computer plus a check for \$561.00 (\$439.00 for an Altair plus \$264.00 for memory plus \$8.00 for postage and handling minus \$150.00). For an assembled Altair with 4K of memory, send in your used computer plus a check for \$817.00.

## PRICES

Altair Computer kit with complete assembly instructions	\$439.00
Assembled and tested Altair Computer	\$621.00
1,024 word memory board	\$176.00 kit and \$209.00 assembled
4,096 word memory board	\$264.00 kit and \$338.00 assembled
Full Parallel Interface board	\$92.00 kit and \$114.00 assembled
Serial Interface board (RS232)	\$119.00 kit and \$138.00 assembled
Serial Interface board (TTL or teletype)	\$124.00 kit and \$146.00 assembled
4K BASIC Language (when purchased with Altair, 4,096 word memory and Interface board)	\$60.00
8K BASIC Language (when purchased with Altair, 2,4,096 word memory boards and Interface board)	\$75.00
EXTENDED BASIC (when purchased with Altair, 3,4,096 word memory boards and Interface board)	\$150.00

NOTE: Altair Computers and software come with complete documentation and operating instructions. BASIC language is available on either paper tape or cassette tape (specify). Warranty: 90 days on parts for kits and 90 days on parts and labor for assembled units. Prices, specifications and delivery subject to change.

# MITS

"Creative Electronics"

MITS/6328 Linn, N.E., Albuquerque, NM 87108 505/265-7553

**MAIL THIS COUPON TODAY!**

Enclosed is check for \$ \_\_\_\_\_

BankAmericard # \_\_\_\_\_  or Master Charge # \_\_\_\_\_

Altair 8800  Kit  Assembled  Options

Include \$8 for postage and handling (list on separate sheet)

Time Payment Plan  Altair Users Group Associate

Please send free Altair System Catalog

NAME \_\_\_\_\_

ADDRESS \_\_\_\_\_

CITY \_\_\_\_\_ STATE & ZIP \_\_\_\_\_

MITS/6328 Linn, N.E., Albuquerque, NM 87108 505/265-7553

## ALTAIR TIME PAYMENT PLAN (kits only)

The Altair time payment plan allows you to be the owner of an Altair Computer with 256 words of memory for **just \$68.75 a month**. Each month (for 8 months) you send in your payment and we send you part of an Altair kit until you have the complete system. The advantages to this plan are: **NO interest** or financing charge, **GUARANTEED** price based on today's price, and free, immediate membership to the Altair Users Group.

Here's how our payment plan works:

	You Pay	You receive
Month One	\$68.75	Assembly, Operators, and Theory of Operation manuals
Month Two	\$68.75	Power Supply (includes board and all components)
Month Three	\$68.75	Expander Card
Month Four	\$68.75	Case with hardware
Month Five	\$68.75	1K Static Memory Board with 256 words of memory
Month Six	\$68.75	CPU Board with all components except processor chip
Month Seven	\$68.75	Control Board with all components
Month Eight	\$68.75	Processor chip
<b>Total</b>	<b>\$550.00</b>	<b>(Retail price: Altair \$439.00, Memory \$103.00, Postage and handling \$8.00—total \$550.00)</b>

Our terms are cash with order, BankAmericard or Master Charge. If you send in an early payment we will make an early shipment. By the same token, a late payment will result in a late shipment. (After 60 days past due, the balance of the deal is cancelled. All payments must be made within 10 months)

Offer expires July 30, 1975.





Wm. I.  
Electric

NORRISTO

Electric HEATING CONTRACTOR  
FLAMELESS  
ELECTRIC HEAT  
FOR HOMEY COMFORT AND CONVENIENCE

CALL US FOR  
AND AN





# “Learn an honest trade,” my old man used to say, “and you’ll never have to knuckle under to any man.”

(A TRUE STORY)

Bill De Medio of Conshohocken, Pa., has it made.

At 23, he’s a licensed master electrician. The top of a trade where there aren’t enough good men to go around.

But more important, Bill’s his own boss and calls his own shots.

“I just went into my own business. And even before the sign on my truck was dry, I got my first big job.

“The contractor for a new group of houses asked me to do all the wiring. And there’s bound to be a lot more work from him and other builders.

“If it wasn’t for my ICS training as an electrician, I’d still be in some dead-end job—hating what I was doing, taking orders from everyone, and never getting any thanks for it.

“As a master electrician, you’re the boss on the job—even when you’re working for someone. You get respect, good money, and like my old man said, you don’t have to take baloney from anyone.”

## The right combination for success

Bill De Medio has the right combination for success. He’s in a growing field. And he has good training for it. You could, too.

Especially if you’re interested in one of the fast-growing careers where ICS concentrates its training. Like Electrician. Engineering. Automotive Mechanic. TV Repair & Servicing. Drafting. Air Conditioning. (Check your choice on attached card.)

## Ideal way to learn

As an ICS student, you study at home, on your own schedule. You waste no time traveling to and from class. And you never have to miss a paycheck.

*At 23, Bill De Medio has more freedom, more security, and gets more respect than guys twice his age. (Photograph by Frank Cowan.)*

But you’re never alone. Skilled instructors are always ready to help you.

If you ever have doubts or problems or just want to talk to your instructor, you can call ICS from anywhere, Toll-free.

## ICS training works

More than 8,500,000 men and women have turned to ICS for career training in the past 80 years.

Government agencies, unions and some of America’s top corporations (including Ford, U.S. Steel, Mobil, Alcoa, Pan Am, GE, Motorola and RCA) use ICS courses in their own training programs.

## Free demonstration lesson

If you want your job to give you more, (more money, more day-to-day satisfaction, and more future) send for our career guide booklet and free demonstration lesson.

Remember, it’s your life. You might as well make the most of it. ©1973 ICS

**ICS** International Correspondence Schools  
Scranton, Pennsylvania 18515

Please send me the Free Career Guidance Booklet and Free Demonstration Lesson for the field I have checked below. I understand I am under no obligation.

- |   |  |
|---|--|
| <input type="checkbox"/> Electrician                      | <input type="checkbox"/> Accountant            |
| <input type="checkbox"/> Automotive Mechanics             | <input type="checkbox"/> Business Management   |
| <input type="checkbox"/> TV Service & Repair              | <input type="checkbox"/> Drafting              |
| <input type="checkbox"/> Airline/Travel Specialist        | <input type="checkbox"/> Civil Engineering     |
| <input type="checkbox"/> Airline Passenger Agent          | <input type="checkbox"/> Interior Decorating   |
| <input type="checkbox"/> Airline Cargo Agent              | <input type="checkbox"/> Motel/Hotel Mgt.      |
| <input type="checkbox"/> Architectural Drafting           | <input type="checkbox"/> Restaurant/Club Mgt.  |
| <input type="checkbox"/> Mechanical Engineering           | <input type="checkbox"/> Income Tax Specialist |
| <input type="checkbox"/> Diesel/Truck Specialist          | <input type="checkbox"/> FCC Licensing         |
| <input type="checkbox"/> Transmission Specialist          | <input type="checkbox"/> Engineering           |
| <input type="checkbox"/> Electronics Technician           | <input type="checkbox"/> ICS High School       |
| <input type="checkbox"/> Data Processing Mgt.             | <input type="checkbox"/> Diploma Program       |
| <input type="checkbox"/> Air Conditioning & Refrigeration | <input type="checkbox"/> or Equivalency        |

Check for special information, if age 16 or under  
N A 805F

Name \_\_\_\_\_ Age \_\_\_\_\_

Address \_\_\_\_\_

City \_\_\_\_\_

State \_\_\_\_\_ Zip \_\_\_\_\_

Canadian residents use this address for service from ICS Canadian, Ltd.  
In Hawaii: 931 University Ave., Honolulu, Hawaii 96814.

(If card is missing, please fill in the coupon and mail it to: ICS, Scranton, Pennsylvania 18515.)



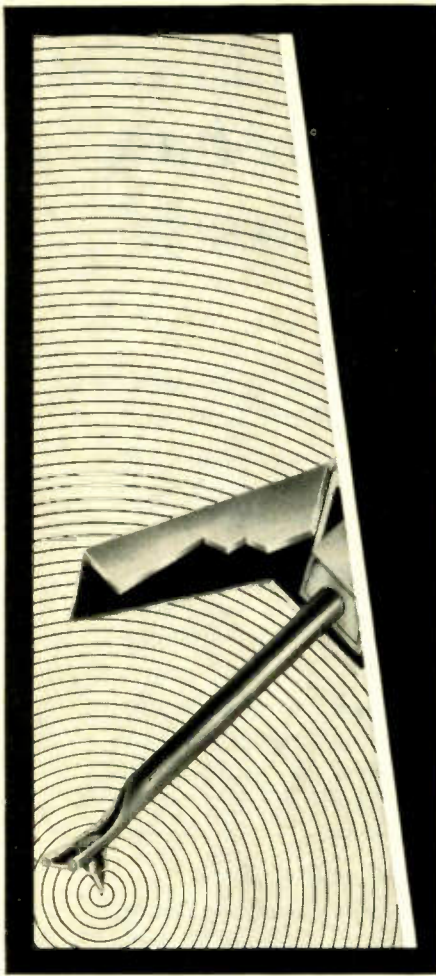

## Straight talk about a stylus

You can still hear some audiophiles refer to the record stylus as . . . "the needle." The fact is that the stylus of today bears no more resemblance to a needle than it does to a ten-penny nail. In fact, a Shure stylus is probably the most skillfully assembled, critically important and carefully tested component in any high fidelity system. It must maintain flawless contact with the undulating walls of the record groove—at the whisper-weight tracking forces required to preserve the fidelity of your records. We put everything we know into Shure Stereo Dynetic Stylus Assemblies—and we tell all about it in an informative booklet. For your copy, write:

Shure Brothers Inc.  
222 Hartrey Ave., Evanston, Ill. 60204  
In Canada: A. C. Simmonds & Sons Limited



Circle 10 on reader service card

## EQUIPMENT REPORTS

(continued from page 16)

control permits the time base to be triggered at any point along the positive or negative slope of the trigger signal. In addition, an AUTO position on the concentric level control generates a baseline when no trigger signal is present. This aids the operator in locating a trace when there is no input signal applied to the scope. The AUTO position also triggers the time base at the zero crossing point of the trigger signal.

The TRIGGER MODE select switch permits triggering on either AC or DC trigger signals. In the DC mode, the bandwidth of the trigger signal is DC to 30 MHz, typically DC to 45 MHz. In the AC position, the bandwidth of the trigger signal is 20 Hz to 30 MHz, typically 20 Hz to 40 MHz. A third position of the TRIGGER MODE select switch permits triggering on the high-frequency components of the trigger signal only. This ACF position has a trigger bandwidth of 15 kHz to 30 MHz, typically 15 kHz to 45 MHz. The scope will trigger on any input signal that will produce a vertical deflection of 0.5 cm or less. The sensitivity of the external trigger input is 0.5 V or less, typically 0.1 V. The impedance of the external trigger input is 1 megohm shunted by approximately 30 pF. An internal non-adjustable delay line allows the scope to display at least 20 ns of pretriggered waveform.

A front panel connector provides a calibrated 1 V peak-to-peak square wave. This signal can be used for calibration checks and for probe compensation adjustments.

The CRT graticule measures 6 cm × 10 cm and the illumination is adjustable. A P31 phosphor is used that produces a blue trace. This phosphor is a compromise between a fast writing speed and high burn resistance. The CRT is a special type that uses post-deflection acceleration to increase the writing speed. The acceleration potential is 4000 volts.

### Assembly

Typical of Heath Co. products, the assembly instructions are concise and easy to follow.

The circuits are mounted on five plug-in printed circuit boards. The delay lines are etched and comprise two more printed circuit boards. Assembly was straight forward and high-quality components were provided.

A hefty number of IC's are used and all IC's are mounted in sockets for easy removal. Circuit board interconnection is done via a pre-assembled wiring harness. Chassis layout is neat and the circuit boards are easily accessible. Both the top and bottom covers are removable.

One sure blessing are the printed circuit board switches. These eliminate the need to connect wires to each individual point on the rotary switches. An assembly chore that I despise with a passion. Jumper wires are also minimized by the use of double-sided boards where necessary.

The scope is housed in a 6 $\frac{1}{16}$  in. high × 12 $\frac{7}{8}$  in. wide × 21 $\frac{1}{2}$  in. deep metal

cabinet with a swing handle that matches other top-of-the-line test instruments from Heath. An AC line switch allows operation from a 100 to 140 VAC or 200 to 280 VAC power source.

### Comments

Assembly was smooth and the scope worked perfectly when power was first applied, except for one hitch. The input to one of the vertical amplifiers was grounded. A few minutes of investigation revealed that the printed circuit board near the input switch wasn't completely etched through. One good scrape with a sharp instrument cleared this problem up instantly.

The calibration procedures are complex and require some patience. The initial calibration procedures should be gone through about three times from beginning to end to set the scope up properly. I'm not criticizing the scope for this point. In fact, I'm complimenting it. All lab-quality calibrated scopes are typical of complex calibration procedures. After the initial calibration procedures are completed, simple touch-up calibration should be performed periodically.

I have used the scope for about two months and it has performed flawlessly. I've yet to find a signal that this scope cannot give a rock-steady display of. The sensitivity is adequate for just about any application you can think of. I would have preferred the bandwidth to be in the 30 MHz to 50 MHz range, but for the price, the scope is hard to beat. Then again, how often do you run across signals that have components higher than 15 MHz.

The scope sells for \$549.95 in kit form. The factory wired and calibrated version, SO-4510, sells for \$750. R-E

## ACS Mk 1 Function Generator

FOR SOME REASON, PROBABLY DUE TO MY sedentary habits, I had read about Function Generators, but had never seen one before. So when I opened the box and found one, a little of what we used to refer to as "woodshedding" was in order. In the long ago and far away, this meant going to the woodshed with an alleged



Circle 91 on reader service card

musical instrument for badly needed practice. So, I had to do a little excavation in my reference library. This turned up an excellent description of the thing. ("Electronic Measurements and Instrumentation," Oliver and Cage, McGraw-Hill; Ch. 10, Audio Signal Sources, pp. 345-349).

It turns out to be a very special type of audio signal generator. Sine, square  
(continued on page 25)





Southwest Technical Products Corporation

219 W. Rhapsody  
San Antonio, Texas 78216

July, 1975

DYNACO IS RIGHT —

Most of you are aware of the new FTC Power Amplifier Rating Rule. I would like to commend Dynaco Inc. for having the courage to challenge portions of this rule and I would like to join them in asking for a review by the FTC. The purpose of this rule was to protect consumers from being misled by inflated power output claims and confusing distortion and bandwidth figures; by "home entertainment" sound equipment manufacturers. Such manufacturers are, generally speaking, divided into two groups; the packaged or console systems manufacturer and the component systems manufacturer. The "Rule" applies to both, although I do not feel that component manufacturers have been guilty of the type advertising that the FTC seeks to eliminate. The vast majority of the consumers who purchase component sound equipment are sound "enthusiasts". They have available to them at least half a dozen magazines that regularly test and report on this type equipment. No component manufacturer in his right mind would attempt to sell his product by resorting to the type advertising and claims that have been used by console manufacturers. The type consumer that purchases component sound equipment is far too knowledgeable to be fooled by fantastic power output claims.

The "Rule" is supposed to provide "a single industry standard which is meaningful to the consumer". (Federal Trade Commission bulletin—Nov. 1974) Now any of you who are in any way familiar with amplifiers well know that such a thing is simply impossible unless a considerable amount of information (some of it quite technical) is provided. The "Rule" does not do this however. It attempts to inform the consumer by means of a single statement concerning power output at a specific bandwidth and distortion level. Worse, yet, it does not allow any type statement on other characteristics, such as bandwidth, unless the prescribed power and distortion information is also given. The effect of the "Rule" as it now stands is to make it impossible for a manufacturer to provide some types of data no matter how badly he may want to.

The worst part however is yet to come. In addition to the problems with the required disclosure all amplifiers must be preconditioned by being operated at one third (1/3) rated power output for a period of one hour. Now this just happens to be almost exactly the point at which maximum heat is generated by a class B amplifier. This may be a realistic operating level for console equipment, but it is totally unrealistic as far as the average component amplifier is concerned. As Dynaco points out, this is only 5.0 dB below maximum output (clipping). Operation under such conditions would result in almost continuous gross distortion which the owner of component equipment would never tolerate. This is like requiring the automobile manufacturers to run all cars on a dynamometer at maximum rated horsepower output for the equivalent of 500 miles before any tests are made to "warm up the engine". You can imagine the result. Neither cars, or amplifiers sold for personal use are designed to withstand operation at maximum stress point on a continuous basis. Requiring this can only result in one of two things; the manufacturer will derate the power and seriously mislead the consumer as to actual capabilities, or he will be forced to add considerable cost to the product to make it capable of continuous operation under worst case conditions. Unfortunately some manufacturers of industrial duty "wall shakers" have cheered on this concept for selfish reasons.

I do not think that the "Rule" as now stated helps the consumer. It is now quite clear what the results are going to be for the purchaser of console equipment. Read the ads and see for yourself; manufacturers of this type sound equipment simply no longer make any statements about power output, distortion, or bandwidth. Do the consumers now know more than previously? Have they been helped in any way? I feel that this attempt at regulation has resulted in problems for component manufacturers, whose customers were in no need of government bureaucratic protection and no benefit whatsoever to the purchasers of console equipment who still don't know any more than before.

I would be happy to send anyone who is interested a copy of Dynaco's excellent technical analysis of the situation. If you would like to offer any comments pro or con directly to the FTC, you can write: Mr. C. E. Aldhizer—FTC, Room 508 Indiana Bldg. 615 Indiana Ave., Washington, D.C. 20580.

Daniel Meyer

A handwritten signature in cursive script that reads "Dan". The signature is written in dark ink and is positioned to the right of the printed name "Daniel Meyer".



# If you're thinking about putting together a hi-fi system first take it apart in your mind.

The quality sound of high fidelity components will give you years of enjoyment—if you choose your system wisely in the beginning.

To help you choose wisely, the Institute of High Fidelity has published the "Official Guide to High Fidelity." Written in easy-to-understand language, the Guide's abundantly illustrated 176 pages will help you appreciate true high fidelity sound — and give you all the information you need to make an intelligent buying decision. EXTRA! Earn a handsome Certificate of Audio Achievement and ID Card entitling you to many valuable benefits, when you pass a test included in the book.

Just send \$2.00 check or money order to cover cost, postage and handling — and it's yours.



## INSTITUTE OF HIGH FIDELITY

Acoustic Research Inc. • Altec • Audio Dynamics Corp. • Audio Times • Bose Corp. • Bozak • B.I.C. Turntables/Speaker Systems • BSR (USA) Ltd. • Cerwin-Vega Inc. • C/M Laboratories • Crown International • Dokorder Inc. • Dual (United Audio Products) • Dynaco Inc. • Electro-Voice • Elpa Marketing Industries Inc. • Empire Scientific Corp. • Ess Inc. • Fisher Radio • FM Guide • Harman-Kardon Inc. • High Fidelity Trade News • Hitachi Sales Corp. • Infinity Systems Inc. • JBL Loudspeakers • Jensen Sound Laboratories • JVC • Kenwood Electronics Inc. • Koss Corp. • Maxell Corp. of America • Maximus Sound • Miracord (Benjamin Sound) • Nikko • North American Philips Corp. • Pickering Cartridges/Headsets • Pioneer Electronics • Rectilinear Speaker Systems • Sansui • Scintrex Inc. • H. H. Scott Inc. • Sherwood Electronic Labs • Shure Brothers Inc. • Sony Corp. of America • Soundcraftsmen • Stanton Cartridges/Headsets • Stereo Review • Superex Stereophones • Sylvania • Tandberg of America Inc. • Tannoy (America) Ltd. • TDK Electronics Corp. • TEAC • Technics by Panasonic • Utah Electronics.

### INSTITUTE OF HIGH FIDELITY, INC. 489 Fifth Avenue, New York, N.Y. 10017

Please send me a copy of Official Guide to High Fidelity. Attached is \$2.00 to cover cost, postage, handling.

Name \_\_\_\_\_

Address \_\_\_\_\_

City/State \_\_\_\_\_

Zip \_\_\_\_\_

(Send no cash or stamps)





**EQUIPMENT REPORTS**  
(continued from page 22)

and triangular waveforms can be generated with extreme precision. How, in just a moment. The name function generator comes from the fact that there is a mathematical function which can describe any sine wave or other signal with a continuously-repeating waveform. So the signal can also describe the mathematical function; ergo, function-generator.

The major difference between this instrument and the older types is that it does not generate signals by means of a conventional oscillator. They're synthesized—"made up" from a different type of signal. Integration of a square wave can develop a triangular waveform. A triangular waveform, fed through a long series of biased-diodes and resistors, will product a sine waveform. The use of large numbers of diode-resistor combinations, easily possible in IC circuitry, can give us sinewaves with very low distortion.

Before the advent of the IC, such instruments were large and very expensive. Now, they come in very compact packages indeed. The one I got is the Mk. 1, built by American Circuits and Systems, Inc., Box 149, Planetarium Station, N.Y. 10024. This is a little dandy; it's only 4 inches high, 11 inches long and 8 inches deep. This will generate all three function signals (sine, square and triangle) over a frequency range from 10 Hz to 1.0 MHz. A 5-step decade control on the front panel, together with a continuously variable control, lets you set any desired frequency, at an accuracy of  $\pm 5\%$  of full-scale.

Maximum output level is 20 volts P-P. This can be adjusted to whatever level is needed, by means of a three-step attenuator; Normal (0 dB), -20 dB and -40 dB. A continuous attenuator is also provided for fine adjustment. The DC level of the output signal can be adjusted, positive or negative, by the Offset control. Range of DC offset is  $\pm 10$  volts open-circuit,  $\pm 5$  volts into 600 ohms. The waveform desired is selected by a switch on the panel.

More interesting features are found on the rear panel. By the use of the FM jack, the signal can be frequency-modulated. Feeding a signal into the VCO jack changes the frequency; this stands for voltage controlled oscillator. A square wave fed into this will make the Mk. 1 generate a series of "bursts" of high-frequency, separated by short periods of much lower frequencies. A ramp waveform, going from 2 volts to 12 volts, with the Frequency dial set at "1", will linearly increase the frequency by 10:1. These can also be used as outputs, for working with TTL circuitry.

The ACS Mk 1 is a new development in function generators. Previous types have been quite bulky, and more than quite expensive. Due to the use of IC's, this unit can be sold at a price that makes it available to the rest of us! It can be bought in kit form, for still more savings. While these have always been

considered lab instruments in the past, signal generators of this type could well be very useful in service shops and smaller schools. Especially so in shops doing hi-fi work. A source of low-distortion signals over such a wide range is always a useful tool. **R-E**

**Hickok Model 270  
Function Generator**

IF YOU SAID TO MANY TV TECHNICIANS, "Hand me that function generator," you wouldn't get it. In fact, you wouldn't have gotten it from the average technical writer of this column either up until a while ago. However, if you said "Hand me that versatile audio-frequency signal generator with sine, square and triangle



Circle 92 on reader service card

waveform outputs, plus a lot more," you'd get a function generator. It would be a Hickok model 270, in fact. This started out as a lab instrument, but we won't go into that. What we do want to cover is the numerous things that an instrument like the model 270 can do in the typical electronics service shop.

This little instrument is useful in audio

INTERNATIONAL  
FM 2400CH

**FREQUENCY  
METER for testing  
mobile transmitters  
and receivers**

- Tests Predetermined Frequencies 25 to 1000 MHz
- Extended Range Covers 950 MHz Band
- Pin Diode Attenuator for Full Range Coverage as Signal Generator
- Measures FM Deviation

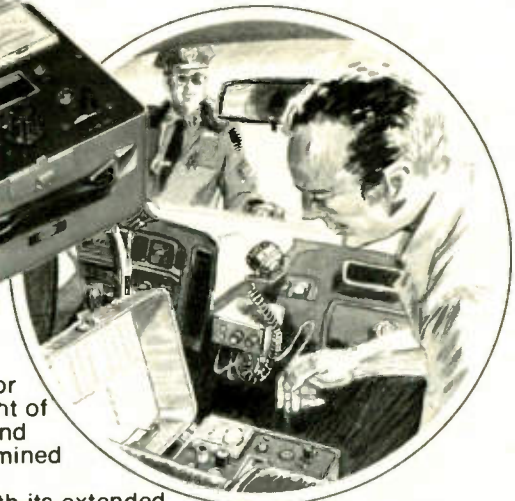

The FM-2400CH provides an accurate frequency standard for testing and adjustment of mobile transmitters and receivers at predetermined frequencies.

The FM-2400CH with its extended MHz. The range covers 25 to 1000 frequencies can be those of the radio frequency channels of operation and/or the intermediate frequencies of the receiver between 5 MHz and 40 MHz.

Frequency Stability:  $\pm .0005\%$  from  $+50^\circ$  to  $+104^\circ\text{F}$ .  
Frequency stability with built-in thermometer and temperature corrected charts:  $\pm .00025\%$  from  $+25^\circ$  to  $+125^\circ$  (.000125% special 450 MHz crystals available).

Self-contained in small portable case. Complete solid state circuitry. Rechargeable batteries.

- FM-2400CH (meter only) ..... \$595.00
- RF crystals (with temperature correction) ... 24.00 ea.
- RF crystals (less temperature correction) .... 18.00 ea.
- IF crystals ..... catalog price

Write for catalog!



Circle 12 on reader service card



and radio, and also in many tests for TV circuits. I found a whole lot of things that I had always wanted to do, but never could. Handy, fast and accurate tests that can help speed up service work in a great many areas.

The sine and square waves are already familiar to us. The sinewave output of the model 270 has less than 1% distortion up to at least 20 kHz. The rise-time of the square wave is 0.5 microseconds or less. In addition, the model 270 will go up to at least 500 kHz with little distortion. So, you can feed a square wave into a video amplifier stage and check it for frequency response, ringing, delay, and so on.

The new one is the triangle waveform. This is very handy for checking gain-linearity of amplifiers, and even oscilloscopes. Clipping is very easy to spot; easier than with a sinewave, even! Also; if the amplifier has any distortion, this shows up as a bend or warp in the straight sides of the triangle!

The nuts and bolts features of the model 270 are really simple. The frequency is controlled by a main dial calibrated from 1 to 10. The operating frequency range is determined by 6 push-buttons. Ranges start at 1.0 Hz to 10 Hz, and go up in order to an upper frequency of 1.0 MHz. All you do is multiply the dial reading by the figure on the button. For example, on the  $\times 10$  range, a dial setting of 5 gives you 50 Hz.

A variable attenuator gives you fine

control of the output level. There are also three fixed pushbutton attenuators, 0 dB, -20 dB and -40 dB. You can get up to -80 dB of attenuation by using both the knob and the pushbuttons. (Note: at least *one* of the attenuator buttons and one of the waveform buttons must be down. If they aren't, no output. Ask me how I found out.)

The controls are arranged very conveniently, so that operation of the instrument is simple. The dial is marked in white figures on a black background—easy to read. It is AC-powered and comes on instantly. There are many other special tests that can be made with the model 270. These are hooked up to a printed-circuit card connector on the back panel. You can get PSK (Phase Shift Keying), FSK (Frequency Shift Keying), AM modulation where an external signal is modulated by the 270's output frequency or vice versa, and FM keying. You can even feed another signal into the rear connector and use the 270 as a mixer, you'll get the sum of the two signals at the output terminals. This lets you make intermodulation distortion tests very quickly. Many other tests can be made, the instruction manual has full details.

The model 270 does all of these things with one huge (!) IC; not physically big, but electronically big. The DC power supplies are electronically regulated. This enables it to have a very good stability rating for both frequency and amplitude

calibration. Something less than 0.1% under line voltage or temperature variations.

One of the "Things I always wanted to do but never could" is an *audio sweep*. All you need is a source of a low AC voltage; a 6-volt filament transformer or the 6-volt filament from your tube-tester. Hook a small pot (100-500 ohms,) right across this. Now, connect the voltage output and the common to the FM terminals on the back of the model 270. The hot side must be connected through a blocking capacitor, somewhere around 0.5 to 1.0  $\mu$ F.

Varying the AC voltage will now make the 270 sweep the dial frequency both ways from the indicated frequency. The amount of voltage controls the range of sweep. Feed the regular output terminals to the input of any audio amplifier. If you scope the input with one channel of that new dual-channel scope, you'll see that this is absolutely flat. Now hook the other channel to the output of the amplifier, and there you are. You will usually see the zero-beat point in the center of the screen, with the frequency going up in both directions. This too *should* be flat. The chances are that it won't be, at first. You can see the actual effect of both the bass and treble control settings. Somewhere in there you should be able to find a point where the output *is* flat. If so, you've got a good amplifier. You can use any of the three output waveforms for this, but I like the sinewave best. You

## TeleMatic Universal Test Rig System

- TRS 330 -  
**SOLID STATE and TUBE SERVICES TODAY'S TV'S:**  
 COMPLETE WITH ADAPTORS FOR 90% OF TODAY'S TV'S

- KV Meter
- Built In Speaker
- Up Front Plug Ins
- All Extensions

TRS-330 SYSTEM	
Master Test Rig MJ-195	\$149.95
Adaptor Assortment DA-299	180.90
Regular (Less Picture Tube)	<del>\$330.85</del>
<b>SAVE \$30.90</b>	<b>SPECIAL \$299.95</b>

Send literature and name of my distributor.  
 Telematic 2245 Pitkin Ave., Brooklyn, N.Y. 11207

NAME \_\_\_\_\_

ADDRESS \_\_\_\_\_

CITY \_\_\_\_\_ STATE \_\_\_\_\_ ZIP \_\_\_\_\_



can check the effect of the bass-boost controls and anything else in the amplifier.

By raising the center frequency of the sweep, you can make sweep-frequency tests of radio IF stages, and even on RF stages up to 1.0 MHz. Just hook the scope to the output of the detector, sweep it at 60 Hz and away you go. This was a feature of the old Hickok 288 RF signal generators of long ago (and still is. I have one on my bench that is used for this job today.) You can spot regeneration or any other problem in an IF stage in short order. This is a place where you can use that old recurrent-sweep scope. Its frequency response will be ample for this kind of work.

The wide frequency coverage of the model 270 makes it possible to do tests in video stages. Hook the output to the video detector output or video amplifier input and adjust the frequency to make the pattern you want. Use a square wave for this and you can make any number of vertical bars on the TV screen. You can get down to only a single bar that gives you a half-black, half-white screen. Very handy for checking overshoot, ringing and horizontal smear in the video amplifier. The triangle waveform will show a gradually shaded pattern from the edge to center.

By feeding a square wave external signal into the AM modulation terminal on the back panel, you can generate "tone-burst" signals at any frequency you want.

This is often used to check hi-fi systems for response to sudden peaks of signal, and so on. Incidentally, you can use your old audio generator for this if it has a square wave output. If it doesn't, you can make up a clipper with a couple of diodes that will give you an acceptable square wave for the modulation, or I should say keying. Takes only a very small signal to do this.

You will find many other tests that you can make with this versatile little instrument. Read the instruction book for details.

Fitting right in with present conditions, the model 270 doesn't cost an arm and a leg, for an instrument of its quality and precision. **R-E**

**BASIC ELECTRICITY AND AN INTRODUCTION TO ELECTRONICS**, Third Edition, by the Howard W. Sams Editorial Staff. Howard W. Sams & Co., Inc., 4300 W. 62 Street, Indianapolis, IN 46268. 208 pp. 10 3/4 x 8 1/4 in. Softcover \$5.95 (in Canada \$7.25).

From beginning to end, this book appears to have been written for the student and beginner who sees a bright future in electronics and wants to learn more about it. It begins with a description of the composition of matter and the role of the electron. Progressing in an orderly fashion, the text lays the foundation for each new subject from the structure of atoms to basic circuits in the important science of electronics. **R-E**

**MANUAL OF LINEAR INTEGRATED CIRCUITS**, by Sol D. Prenskey. Reston Publishing

Co., Inc., Box 547, Reston, VA 22090. 289 pp. 9 x 6 in. Hardcover

This volume explains and illustrates the field of linear integrated circuits including op-amps and all other forms of linear IC's. It offers a thorough discussion of the underlying principles strengthened by a host of application schematics. In addition, there is a comprehensive selection guide and cross-references for IC type numbers. There is also a complete section on breadboarding and testing techniques. As a practical presentation of basic principles, there are more than 100 application schematics and the cross-reference index describes well over 300 manufacturers type numbers with identifying codes for second source types.

**PRACTICAL TRIAC/SCR PROJECTS FOR THE EXPERIMENTER**, by Richard Fox. TAB Books, Blue Ridge Summit, PA 17214. 192 pp. 8 1/2 x 5 1/4 in. Hardcover \$7.95; Softcover \$4.95.

Here is a balanced blend of thyristor theory and practical circuits using readily available low-cost SCR's, triacs and diacs. The volume contains complete easy-to-understand operational theory applicable to all the basic thyristor devices: the SCR, the programmable unijunction transistor, the diac and the triac itself. As the theory begins to fall into place, the reader will find himself using thyristors for myriads of little jobs around the shop, for variable control of line voltage or on-off switching of high-current loads or control of AC loads. Perhaps he'll even want to build the light organ. Written for both the technician and advanced hobbyist, the book assumes a basic knowledge with respect to the basic fundamentals of semiconductor circuitry. **R-E**

## TeleMatic COMBO-DEAL STD 440



### VHF/SUB UHF/SUB ALL CHANNEL TUNERS



TeleMatic Sub-Tuners save hours of guesswork by rapidly pinpointing trouble in the antenna, UHF or VHF Tuners, or I.F. Stages. Powered by popular transistor batteries.

### COMBO-DEAL STD 440

KT-730	VHF/SUB	\$45.00
KTU-745	UHF/SUB	16.95
	REGULAR PRICE	\$61.95
	SAVE (On deal)	12.00
	<b>SPECIAL ONLY</b>	<b>\$49.95</b>

Send literature and name of my distributor.  
Telematic 2245 Pitkin Ave., Brooklyn, N.Y. 11207

NAME \_\_\_\_\_  
ADDRESS \_\_\_\_\_  
CITY \_\_\_\_\_ STATE \_\_\_\_\_ ZIP \_\_\_\_\_

Circle 15 on reader service card

# Polariss 40 KV DUAL RANGE Probe

Current & Voltage Reading  
For Today...  
And Tomorrow!

MODEL 651 **\$29.95**

RANGE NO. 1: 40,000 VOLTS DC  
RANGE NO. 2: 0-400 MA DC

Send literature and name of my distributor.

**Polariss New York**  
2862 FULTON STREET  
BROOKLYN, N.Y. 11207

Name \_\_\_\_\_  
Address \_\_\_\_\_  
City \_\_\_\_\_ State \_\_\_\_\_  
Zip \_\_\_\_\_



# Portable Digital Multimeter at an Analog Price

ONLY  
**\$99<sup>95</sup>**

less batteries and optional  
AC adapter/charger



**9 reasons why our  
new meter should  
be your next:**

**1. ANALOG PRICE**

**2. RELIABLE**

Fully overload protected  
Built-in battery check  
Impact-resistant Cyclocac<sup>®</sup>  
case

**3. EASY TO READ**

Large 3-digit LED readout  
Automatic polarity, decimal  
point and out-of-range  
indication

**4. COMPLETELY PORTABLE;  
USE IT ANYWHERE**

Only 4.38 x 6.38 x 2" deep  
Operates from 4 ordinary  
"C" cells or AC with optional  
adapter/charger

**5. HIGH-LOW POWER OHMS**

Measures accurately in solid  
state circuitry

**6. HIGH RESOLUTION**

1mV, 1 $\mu$ A, 0.1 ohm

**7. DIGITAL ACCURACY**

DC volts typically  $\pm 1\%$   
F.S.; AC volts and ohms  
typically  $\pm 2\%$  F.S. except  
 $\pm 2.5\%$  on highest range

**8. RANGES**

DC and AC volts, 0-1, 10,  
100, 1000V;  
DC and AC current, 0-1, 10,  
100, 1000mA;  
Ohms, 0-100, 1K, 10K, 1 meg,  
10 megs.  
10 meg industry standard  
input impedance

**9. IN STOCK AT YOUR  
DISTRIBUTOR**

**MODEL 280**  
*Shown  
actual size*

**BK PRECISION**

PRODUCTS OF DYNASCAN  
1801 W. Belle Plaine Ave. Chicago IL 60613



# **BUILD**

## **this COLOR TV CAMERA for about \$400**



*Having only two channels of video, this camera produces remarkable color pictures. Any amateur or experimenter can build it for about \$400*

by GARY DAVIS

INCREASING INTEREST IN CLOSED-CIRCUIT TV and the public acceptance of color have created a need for a low-cost color camera. A complex, high-quality broadcast color camera can cost \$90,000 or more. Although recent developments have brought the cost down for educational and industrial use, prices are still out of range for most amateurs and experimenters.

The camera described in this article was developed on the premise that an advanced experimenter or amateur could build a color camera without getting into extremely complex mechanical, optical, or electrical problems. All parts are easy to obtain. The two vidicon tubes are standard low-cost black and white types. Color filters are low-cost and available at any glass company. To keep the cost, weight, and size to a minimum, a small black and white TV set is used to supply all voltages and scanning signals to the camera head. The camera uses only 12 transistors in addition

to the black and white TV set. The optical system is extremely simple. The cost of the camera, excluding the case, is approximately \$400.

### **Color processing**

There is a little known process of using only two colors instead of three to generate color images. This theory dates back to 1914 when William F. Fox and William H. Hickley patented a color motion picture process involving a red filtered scene shown alternately with a green filtered scene projected in black and white only while the red filtered scene was projected through a red filter. The effect was later independently re-discovered by Dr. Edwin H. Land in 1955. This phenomenon has since become known as the Land Color Theory after articles by Land appeared in the proceedings of the *National Academy of Science* in 1959 and the May, 1959 issue of *Scientific American*. Dr. Land found that the human eye can perceive scenes

in full color when the image is filtered through long- and short-wavelength filters, then recorded separately on black and white photographic film.

To recover the scene in full color, it is then only necessary to project the scene recorded on the two separate photographs, with a long wavelength light source illuminating the long wavelength photograph, and a short wavelength light source illuminating the short wavelength photograph. In Land's process, the colors in the scene arise not from the choice of wavelengths, filters, or overall brightness levels, but rather from the interplay of longer and shorter wavelengths over the entire scene.

My camera system is similar to Land's process. The two color filter wave lengths correspond to the wave length or combination of wave lengths, generated by the three illuminating phosphor colors in a conventional color picture tube. The filter for the long wavelength image, centered at



approximately 650 millimicrons, is red. The short wavelength filter, centered at approximately 475 millimicrons is cyan, a bluish-green. In effect the two color channels are a combination of the three primary colors. Inputs to the green and blue color difference amplifiers of the color monitor are combined, allowing the blue-green phosphor dots to produce cyan, corresponding to the cyan or short wavelength filter in the camera head. The red color difference amplifier and the red phosphor dots of the color monitor handle only the signal from the red or long-wavelength tube.

Colors hold true over a wide range of different red, green and blue images due to the interplay of the red and cyan signals. In fact, the only camera operating color controls are the red and cyan lens iris adjustments. The receiver contrast control may also have to be re-adjusted depending upon lighting conditions. The color receiver tint and color-level controls have no effect in this arrangement since the signal is not encoded to a NTSC signal.

Tests indicate that NTSC color encoding can be done by feeding the cyan signal to the combined blue and green color inputs, and sending the red to the normal red input of a commercial NTSC color encoder. With this arrangement, the camera output could be video taped or transmitted by a ham TV transmitter.

Extensive testing of both the conventional three-tube color system and the simpler two-tube system indicates of course, that the two-tube system cannot duplicate three-tube performance in all respects. The main difference being some averaging of colors along the junction point of the blue-green spectrum, some difficulty with

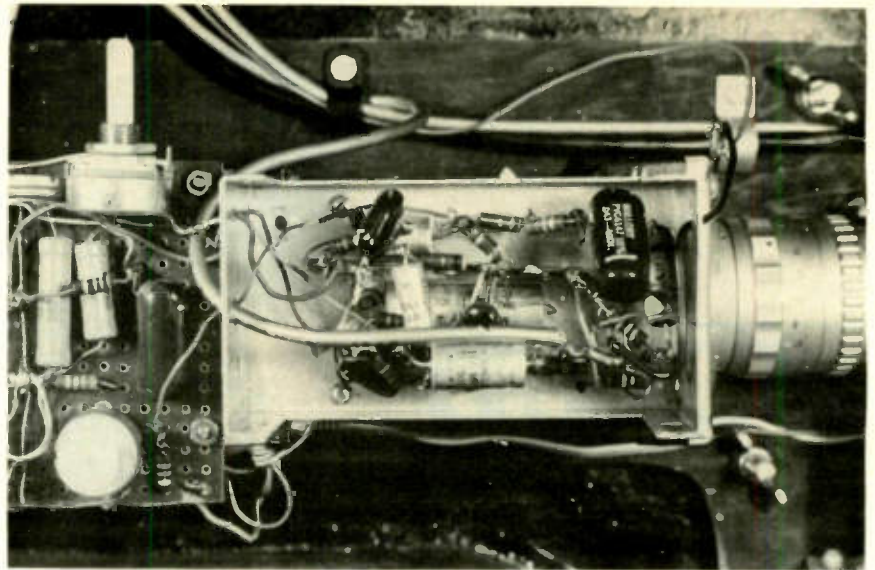

Close-up view of one of the preamplifier circuits that are mounted over the vidicon tubes.

shades of yellow and some hues of magenta. However, the system produces surprisingly good color. The colors are rich and vivid. Blues are blue, greens are green, and reds are red. Complex colors such as skin tones, browns, hair colors, etc. are reproduced well.

The advantage of using only two tubes instead of three, at least for the home experimenter or low-cost application, far outweighs the relatively minor additional color discrepancies encountered with the two-color process. These advantages include:

Camera registration, the art of overlapping images to perfectly coincide, is much simpler.

The camera can be built with one-third less parts.

Camera sensitivity is greater since light must be divided only two ways instead of three.

Optics are much simpler allow-

ing the use of a simple cube prism to split the incoming light in two directions.

#### How it works

Figure 1 is a block diagram of the entire camera system. Light from the scene first passes through a cube prism. The prism itself absorbs approximately 40% of the light. Approximately 50% of the remaining light is bent 90 degrees to the red lens. The prism is available from Edmunds Scientific Co. The cyan camera lens gets a straight through view of the scene. Both camera lenses are Cosmimar 25 mm, available from Denson Electronics Corp. The prism must be placed before the objective lens so the glass in the prism won't affect the focal length of the lens. The color filters are placed between the lens and vidicon face plate. The cyan filter consists of two layers of Plexiglas green No. 2414. The red

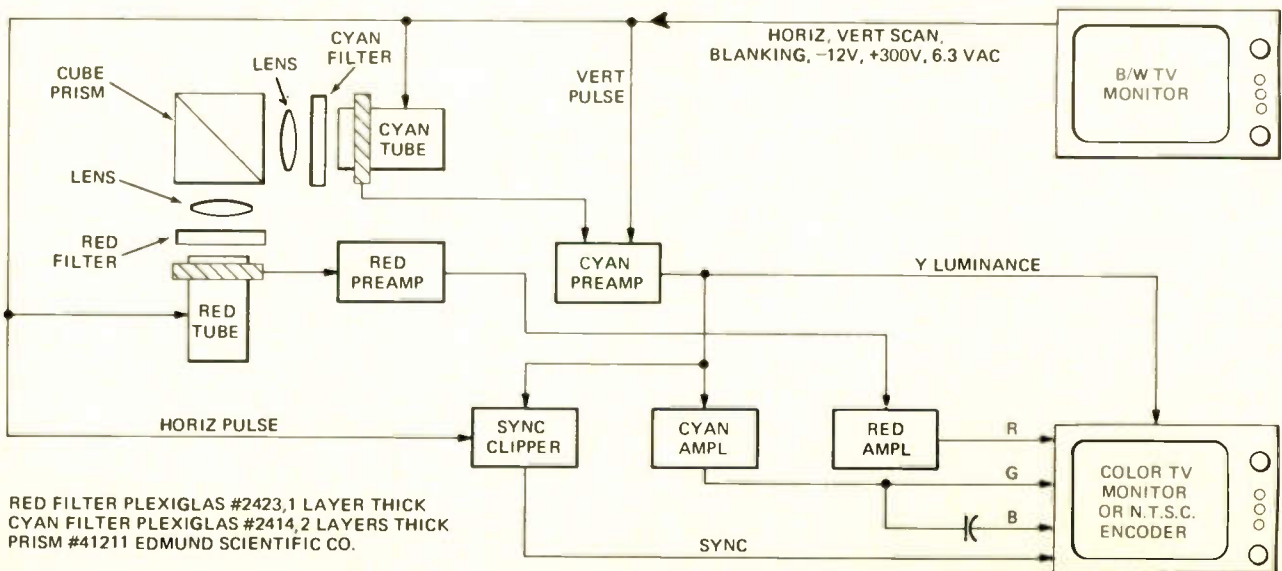

FIG. 1—BLOCK DIAGRAM of the camera head. Operating voltages and sync signals are supplied by a black-and-white TV receiver.



filter is Plexiglas red No. 2423, one layer thick. Both yoke and focus coil assemblies are available from Denson Electronics. This assembly also contains the alignment magnets which are used to register the two images. These yokes are built to very close tolerances and register well. Don't be tempted to substitute another type of yoke.

Again, referring to the block diagram, the black and white TV feeds horizontal, vertical, scan, blanking, -12 volts, +300 volts, and 6.3 VAC to the camera heads. The output of the cyan vidicon is fed to the cyan preamp. A vertical sync pulse is added and the video amplified to approximately 1 volt VP-P. This output also forms the luminance signal and is fed to the color monitor's luminance amplifier to provide the black and white information. The cyan preamp also feeds the cyan amplifier where the signal is inverted and raised in amplitude to drive the grids of the G - Y and B - Y amplifiers. The grids are coupled together with a .5  $\mu$ F capacitor.

The cyan preamp output is also fed to the sync clipper where the vertical sync pulse is inverted and sent to the color monitor's sync separator. The horizontal sync pulse is fed separately to the sync clipper in order to prevent contamination of the blue and green amplifier in the monitor. The red preamp output drives the red amplifier which in turn drives the R - Y amplifier. The sync clippers, cyan amplifier, red amplifier and a -18 volt power supply are located in the color monitor so that all signals may be sent to the color monitor on a single 4-conductor

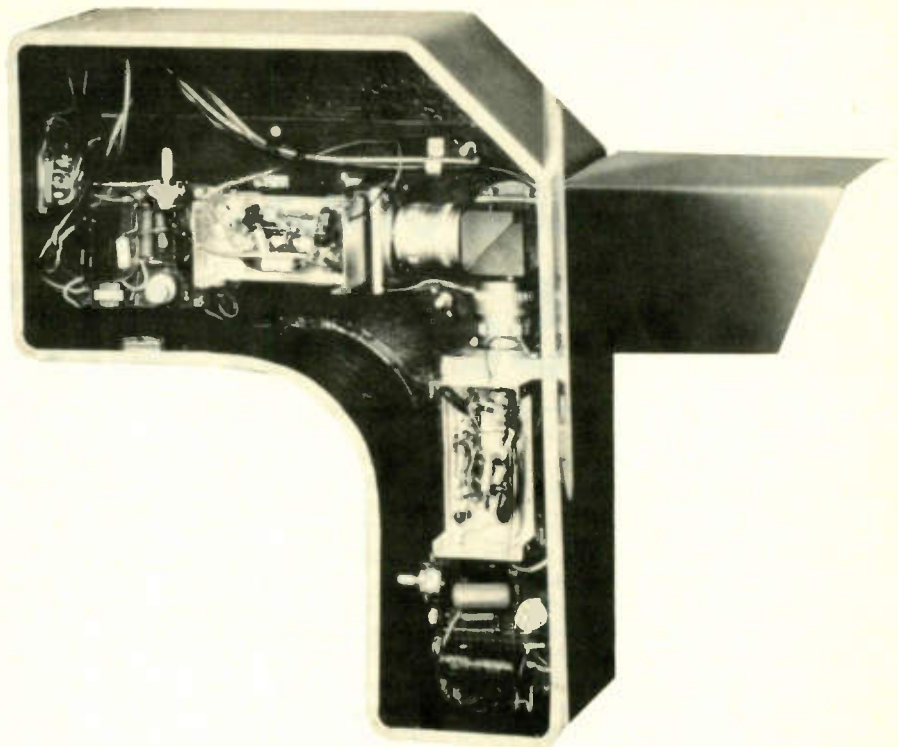

LAYOUT OF THE CAMERA HEAD is shown. Camera case was constructed from sheet metal.

cable. A multi-conductor cable is used between the black and white TV set and the camera head. This 2-piece configuration also allows the camera to be used hand-held. The camera head weighs 18 lbs.

Many camera builders will want to include the small black and white TV in the camera case to act as a view finder. The horizontal sync will have to be re-applied to the TV sync separator for operation as a view finder.

Do not use an AC-DC type TV with this project because of the shock hazard involved. A square sun shade on the front of the camera prevents stray light from striking the prism in bright sunlight. Paint the inside of the camera case black. The camera case is not commercially available and may be constructed out of sheet aluminum.

I found the easiest method of mounting the parts for mechanical alignment is to build each camera head as a separate unit. After both heads are tested and operate correctly, lay both heads and the prism on a wood mounting board. The camera is initially registered and adjusted mechanically, optically, and electrically while laying on its side. Remember, for good registration, every optical and electrical parameter—focal length distance, scan amplitude, yoke alignment, optical and electrical focus adjustments—must exactly match the other channel. Finally, when all electrical adjustments and tests are complete, screw down the heads and mount the prism. The whole camera assembly is then placed inside the camera case. All camera tests and registration adjustments are made using a standard TV test pattern with a series of vertical color stripes glued to the top of the test pattern. The colors I use are red, orange, yellow, dark green, light blue, dark blue, and magenta.

Next month we will cover the camera heads, circuit details, modification of the two TV sets, adjustments registration, and final check out. R-E

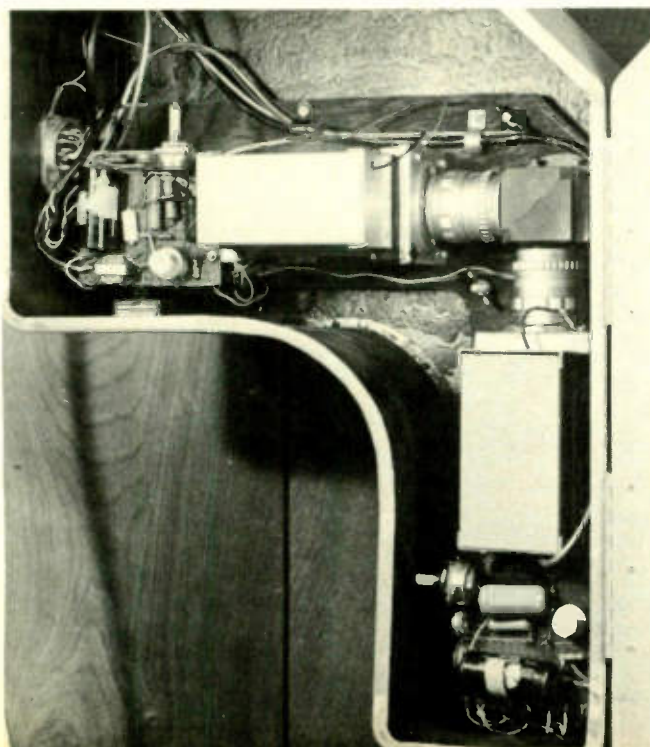

CLOSE-UP VIEW of camera head shows details of layout and optical system.



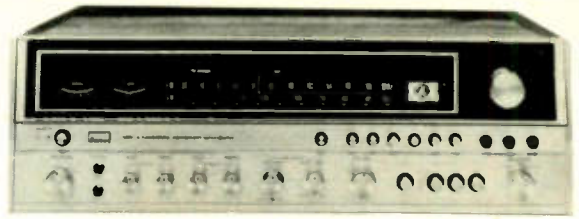

# Tests Sansui QRX-6001

by **LEN FELDMAN**

CONTRIBUTING HIGH-FIDELITY EDITOR

THE SANSUI QRX-6001 4-CHANNEL RECEIVER is one of two versatile quadriphonic all-in-one units introduced by that firm during the past year. The two units differ primarily in their output power-ratings, with the more powerful QRX-7001 selling for \$120.00 more than the unit reviewed here and delivering 10 additional watts-per-channel, according to published ratings. Both units have every needed facility for handling all 4-channel material, including QS (developed by Sansui), SQ (the matrix system promoted by CBS) and so-called "discrete", and CD-4 records (jointly developed by JVC and RCA.)

An overall view of the front panel is shown in Fig. 1. The softly illuminated dial scale area contains both a center-of-channel tuning meter and a signal-strength meter. Above the linearly calibrated FM frequency scale, illuminated words appear to denote stereo FM reception as well as the many modes of quadriphonic listening. An indicator light at the right of the frequency scale displays a large numeral "2" or "4" depending upon user's selection of 2-channel or 4-channel listening. Detailed views of the left and right sections of the front panel are shown in Figs. 2 and 3.

Pushbutton switches handle power on/off, 2-channel stereo selection (with an optional choice of having the back speakers reproduce the same material as the front pair), synthesized quadriphonic listening (from stereo program sources), QS, SQ and discrete 4-channel modes. Three screwdriver adjustable recessed controls are used to set up the CD-4 demodulator circuit to match phono cartridges used with the receiver and a test record is packed with each receiver for this purpose. The lower section of the front panel contains nine rotary controls (including speaker switching of main, remote or both, dual concentric pairs of bass and treble controls for front and rear channels, balance controls for left-right and front-back adjustment, a master volume control and a program source selector switch) and four more push-buttons for loudness compensation, two tape monitoring circuits and selection of auxiliary inputs which are independent of the setting of the main rotary selector

switch. A pair of phone jacks (for connection of stereo or 4-channel headphones) are located adjacent to the speaker selector switch.

Details of the rear panel are shown in Figs. 4 and 5. A diagram that shows the variety of equipment with which the QRX-6001 is designed to operate is in Fig. 6. A pivotable AM ferrite bar antenna is also located on the rear panel and is usually sufficient for most receiving sites.

## Circuit configuration and features

The FM front-end of the receiver contains a dual-gate transistor (FET) used as an RF amplifier. A four-gang capacitor tunes in the FM stations. Two sections serve as interstage tuning between RF amplifier and mixer stages. The FM I.F. section contains five integrated circuits, six bipolar transistors and multiple dual-element ceramic filters. The CD-4 demodulator circuit uses 24 transistors, 2 IC's and 6 FET's. Tone controls are

**TABLE I**  
**RADIO-ELECTRONICS PRODUCT TEST REPORT**

Manufacturer Sansui Model #QRX-6001

### FM PERFORMANCE MEASUREMENTS

SENSITIVITY, NOISE AND FREEDOM FROM INTERFERENCE	R-E Measurement	R-E Evaluation
IHF sensitivity, Mono ( $\mu$ V)	2.2	good
Sensitivity, Stereo ( $\mu$ V)	30.0	acceptable (see text)
50 dB quieting signal, Mono ( $\mu$ V)	3.8	good
50 dB quieting signal, Stereo ( $\mu$ V)	50	acceptable
Maximum S/N ratio, Mono (dB)	70	very good
Maximum S/N ratio, Stereo (dB)	62	good
Capture ratio (dB)	1.5	good
AM suppression (dB)	55	acceptable
Image rejection (dB)	75	very good
I-F rejection (dB)	90	excellent
Spurious rejection (dB)	80	good
Alternate channel selectivity (dB)	73	very good

### FIDELITY AND DISTORTION MEASUREMENTS

Frequency response, 50 Hz to 15 kHz ( $\pm$ dB)	+0.5, -2.0	good
Harmonic distortion, 1kHz, Mono (%)	0.3	good
Harmonic distortion, 1kHz, Stereo (%)	0.45	very good
Harmonic distortion, 100 Hz, Mono (%)	0.2	very good
Harmonic distortion, 100 Hz, Stereo (%)	0.6	good
Harmonic distortion, 6 kHz, Mono (%)	0.4	very good
Harmonic distortion, 6 kHz, Stereo (%)	1.3	acceptable
Distortion at 50 dB quieting, Mono (%)	0.6	very good
Distortion at 50 dB quieting, Stereo (%)	1.2	acceptable

### STEREO PERFORMANCE MEASUREMENTS

Stereo threshold ( $\mu$ V)	30.0	poor
Separation, 1 kHz (dB)	33	good
Separation, 100 Hz (dB)	31	good
Separation, 10 kHz (dB)	31	excellent

### MISCELLANEOUS MEASUREMENTS

Muting threshold ( $\mu$ V)	30	poor (see text)
Dial calibration accuracy ( $\pm$ kHz @ MHz)	100 @ 108	very good

### EVALUATION OF CONTROLS, DESIGN, CONSTRUCTION

Control layout	good
Ease of tuning	very good
Accuracy of meters or other tuning aids	excellent
Usefulness of other controls	good
Construction and internal layout	very good
East of servicing	good
Evaluation of extra features, if any	very good

### OVERALL FM PERFORMANCE RATING

good





FIG. 2 — LEFT SECTION OF FRONT PANEL includes meters, speaker selector, two phone jacks, and two sets of tone controls.



FIG. 3—RIGHT SECTION OF FRONT PANEL includes 2-channel/4-channel mode indicator, and main or auxiliary input selector. Pushbuttons just below the dial scale selects the various 4-channel decoding modes.

**TABLE II  
RADIO-ELECTRONICS PRODUCT TEST REPORT**

Manufacturer Sansui Model #QRX-6001

**AMPLIFIER PERFORMANCE MEASUREMENTS**

	R-E Measurement	R-E Evaluation
<b>POWER OUTPUT CAPABILITY</b>		
RMS power/channel, 8-ohms, 1 kHz (watts)	32.5	good
RMS power/channel, 8-ohms, 20 kHz (watts)	26	very good
RMS power/channel, 8-ohms, 20 kHz (watts)	25.5	very good
RMS power/channel, 4-ohms, 1 kHz (watts)	N/A	see text
RMS power/channel, 4-ohms, 20 Hz (watts)	N/A	see text
RMS power/channel, 4-ohms, 20 kHz (watts)	N/A	see text
Frequency limits for rated output (Hz-kHz)	18-24	excellent
<b>DISTORTION MEASUREMENTS</b>		
Harmonic distortion at rated output, 1 kHz (%)	0.065	excellent
Intermodulation distortion, rated output (%)	0.11	very good
Harmonic distortion at 1 watt output, 1 kHz (%)	0.07	very good
Intermodulation distortion at 1 watt output (%)	0.09	good
<b>DAMPING FACTOR, AT 8 OHMS</b>	12	acceptable
<b>PHONO PREAMPLIFIER MEASUREMENTS</b>		
Frequency response (RIAA $\pm$ — dB)	1.0	very good
Maximum Input before overload (mV)	250	superb
Hum/noise referred to full output (dB) (at rated input sensitivity)	63	very good
<b>HIGH LEVEL INPUT MEASUREMENTS</b>		
Frequency response (Hz-kHz, $\pm$ — dB)	15-30, 1	excellent
Hum/noise referred to full output (dB)	82	excellent
Residual hum/noise (min. volume) (dB)	86	very good
<b>TONAL COMPENSATION MEASUREMENTS</b>		
Action of bass and treble controls	See Fig. 9	good
Action of secondary tone controls	N/A	N/A
Action of low frequency filter(s)	N/A	N/A
Action of high frequency filter(s)	N/A	N/A
<b>COMPONENT MATCHING MEASUREMENTS</b>		
Input sensitivity, phono 1 (mV)	2.34	
Input sensitivity, auxiliary input(s) (mV)	95	
Input sensitivity, tape input(s) (mV)	100	
Output level, tape output(s) (mV)	100	
Output level, headphone jack(s) (V or mV)	N/A	
<b>EVALUATION OF CONTROLS, CONSTRUCTION AND DESIGN</b>		
Adequacy of program source and monitor switching		very good
Adequacy of input facilities		good
Arrangement of controls (panel layout)		very good
Action of controls and switches		excellent
Design and construction		very good
Ease of servicing		good
<b>OVERALL AMPLIFIER PERFORMANCE RATING</b>		
(NA = Not available, or non-applicable)		very good

the familiar Baxandall feedback type. Relay and terminal protection is provided for the power output sections, each of which is direct-coupled to the speakers in a complementary-symmetry circuit. In addition to the relay protection circuitry, each output line is fused, but fuses can be reached only by removing the wood cabinet.

The most sophisticated circuitry in this receiver is probably the QS-Variomatrix decoder. Three IC's form the heart of this decoder circuit and it provides up to 20 dB of separation in all directions when reproducing QS encoded matrix 4-channel discs. By changing the coefficients of the matrix it is also adapted to the QS format.

Equally interesting is the newly developed "synthesizer" circuit developed by Sansui. This circuit, in effect, "encodes" ordinary stereo programming, making it more suitable for QS 4-channel decoding by the QS-Variomatrix circuit just discussed. While most stereo programs produce an interesting "4-channel effect" when played through any matrix decoder, the "synthesizer" circuit enhances this effect significantly.

**FM tuner measurements**

Results of our FM performance measurements are in Table I. Stereo sensitivity, which seems quite poor upon first glance, is really a function of the mono-to-stereo switching threshold of the tuner section. Since this switching occurs at a rather high 30 microvolts, to all intents and purposes that is the "stereo sensitivity" of the receiver. Muting threshold in our view, is also set too high (at 30  $\mu$ V) and what's more, because of the arrangement of the function switch, muting can only be defeated (for tuning to those "weak signals") when the switch is set to the mono position. This insures that weak stereo signals will not break through the muting barrier, but prevents users from DX'ing for distant stereo signals—however noisy they might be. Overall performance rating of the FM section might have merited a "very good" or even an excellent (instead of the "good" assigned) were it not for this limitation.



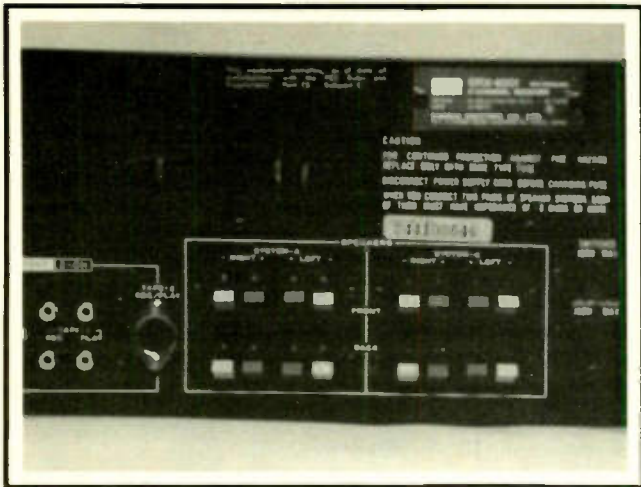

FIG 4 (above)—RIGHT SECTION of rear panel.

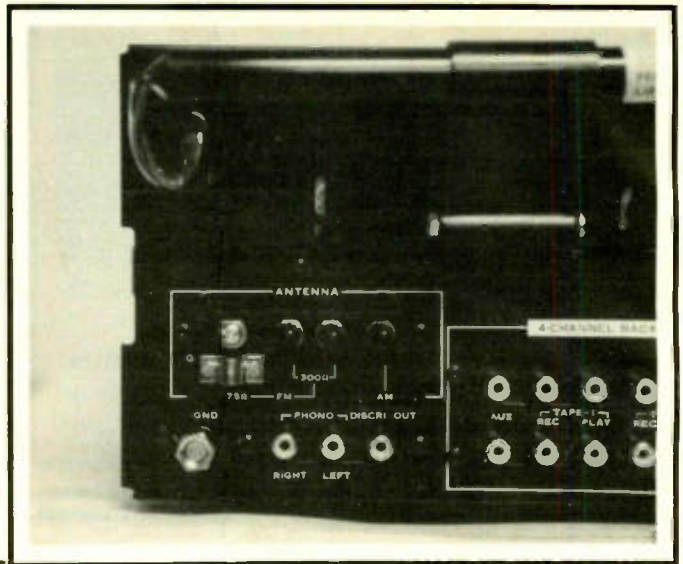

FIG 5 (right)—LEFT SECTION of rear panel.

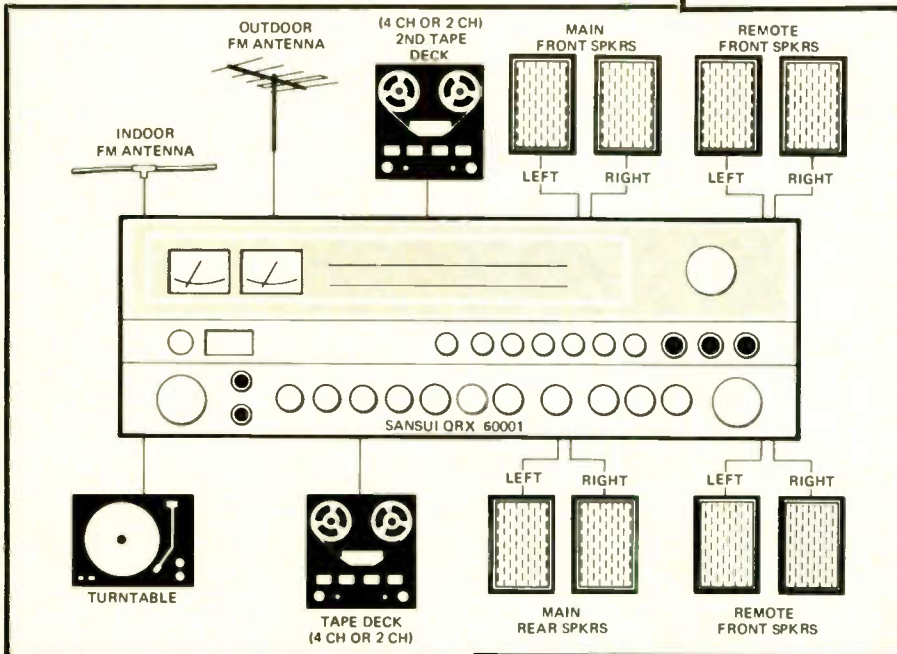

FIG. 6—THE VARIOUS components that can be connected to the Sansui QRX-6001 are shown.

### Amplifier performance measurements

Amplifier performance measurements are listed in Table II. Since Sansui chose not to provide an FTC approved power rating for 4-ohm operation, no power output measurements were made with 4 ohm loads, nor can we vouch for unconditional stability at 4-ohm load operation with full power delivered continuously. At 8 ohms, however, the amplifier generally exceeds its ratings by a fairly wide margin. For example, at 25 watts per-channel output, THD and 1M distortion measured only 0.065% and 0.11% respectively for mid-frequencies and distortion readings were still well below the rated 0.5% even at the frequency extremes of 20 Hz and 20 kHz. Tone control range and loudness control action (measured at -30 dB below full rated output) is shown in Fig. 7 and conforms to expectations. Sansui elected to boost both treble (moderately) and bass in their loudness circuitry. Listeners who

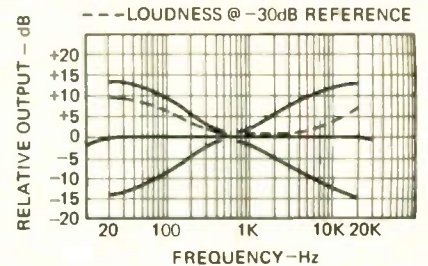

FIG. 7 — BASS, TREBLE AND LOUDNESS control range, Sansui QRX-6001.

prefer only bass enhancement at low listening levels would be better off using the tone controls rather than the "fixed" loudness compensation circuitry for that purpose.

While our hum measurement in "phono" falls short of the 70 dB claimed by Sansui, we suspect that their measurement is made using some form of weighting curve, whereas ours is measured  
(continued on page 64)

## TABLE III RADIO-ELECTRONICS PRODUCT TEST REPORT OVERAL PRODUCT ANALYSIS

Manufacturer	Sansui	Model	#QRX-6001
Retail Price			\$759.00
Price Category			Medium-high
Price/Performance Ratio			good
Styling and Appearance			excellent
Sound Quality			very good
Mechanical Performance			very good

### Comments:

The Sansui QRX-6001 4-channel receiver is designed to favor its use as a quadraphonic component. QS-Variomatrix performance has been refined to the point where, with proper program material, separation is virtually as good as that obtained from discrete sources. Recognizing that other 4-channel program sources exist, Sansui has finally incorporated a good CD-4 demodulator circuit, as well as semi-logic in its SQ matrix decoding (not as effective for SQ listening as the Variomatrix QS circuits are for QS records and broadcasts, but certainly better than earlier non-logic equipped SQ decoders). With a good antenna (or in strong signal areas) the high stereo threshold will pose no problems. Power output is ample for even moderately low-efficiency speaker systems, but stay away from speaker systems that require more than 20 watts minimum.



# Test Equipment for Industrial Servicing

Here's a roundup of industrial test equipment, offering many special features and accessories. This equipment is used in automotive, marine, aircraft and many other applications

by JACK DARR  
SERVICE EDITOR

FIRST THERE WAS ELECTRICITY AND THEN came electronics. They were considered as separate disciplines for quite a while. There was some basis for this. Electrical work involved high voltages and currents, and heavy machinery. Electronics was confined to little radios. Now, we find electronic controls on all kinds of electrical machinery, and the twain have met again.

They were never truly separate. I refuse to belabor the obvious point that electronics training *begins* with a solid foundation in basic electricity. Also, all electronic tests are made by reading electrical quantities; volts, current, etc. So, technicians working in this field could call it "electronicity" or something equally silly. The equipment covered here will be intended for industrial use: everything *but* "entertainment electronics" radio, TV, audio. This includes industrial, appliance, automotive, aircraft, marine, and many others.

## The instruments

The speed and accuracy with which we do the job depends on our instrumentation. We work with quantities which cannot be seen or heard (though they can be *felt*, in certain cases. Also smelled). The first test instrument was a D'Arsonval DC milliammeter. We shunted this and got an ammeter. Adding multiplier resistors gave us a DC voltmeter. Adding rectifiers we got an AC voltmeter. With a little switching, we could put all this in the same case, and the volt-ohm ammeter was born. There was only one thing we couldn't read with ease; *alternating current*. None of the early VOM's had any way of reading this.

Things have changed. The test equipment manufacturers are making it easier and easier for us. They are giving us simpler, specialized test instruments to get the readings we need a lot faster. They're compact, rugged, and have an accuracy that would have been unbelievable about 20 years ago. This article will be an admittedly incomplete rundown on some typical units in this field. We'll show you the latest units from three of the older companies. This is equipment that is available *now*, off the shelf. Things that can help us get the job done fast.

## The VOM's

The basic unit in most of these testers is a VOM—a VOM that the old timers wouldn't recognize! Most of them use 20,000 ohms-per-volt movements. Some use FET amplifiers for even greater sensitivity. Quite a few of these are very compact; "shirt-pocket" types. The rest are the old "standard" size. They are available in special carrying cases, made of tough plastic. These are heavily padded with foam plastic, and have pockets for the various accessories, test leads, and so on. They look like expensive attache cases; very neat.

They're all well-protected against accidental damage, physical or electrical. The VOM's are built into high-impact plastic cases. Electrically, all of the meters have protective diodes to save the movement from surges or inadvertent overloads. Many are also protected by special fast-blow fuses (bless their hearts), they provide spare fuses inside the meter case, to save you a long trip back to the shop. One make has a special circuit-breaker: a bright red button pops up on overloads. These are about as foolproof as possible, though probably not totally foolproof. Somebody will invariably try to read line voltage on the ohms scale, or something.

Beside the standard VOM ranges, special "adapters" are available. With these, you can read practically any quantity you need; speed, temperature, pressure, sound level, and on and on. You'll see more on these as we go along.

## Special features

I've always been fond of test equipment that makes things easier. I believe that the one thing that made the greatest impression on me was the "clamp-on ammeter." As I just said, in the early days, you simply couldn't read alternating current without going through a lot of trouble. There were AC ammeters, of course. They were about 12 inches in diameter, weighed around 30 pounds and cost an arm and a leg. The only place you saw them was in power-houses. Like all current meters up till now, you had to open the circuit and put them in series.

Now it's a breeze; actually, a one-hand operation. You can have a meter that fits in the palm of your hand, with

a pair of funny-looking jaws and a push-button. Push the button, the jaws open; close them around any one conductor in the circuit and presto; an instant amp reading. As all working technicians know, the actual load current drawn by any kind of electrical unit is the best indicator of its condition. Let's see how this handy little device does it.

Figure 1 shows how it works. The

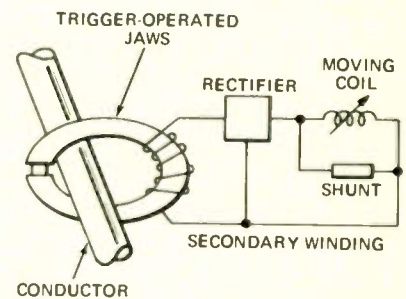

FIG. 1 — AC AMMETER MEASURES CURRENT without direct electrical connection. (courtesy Amprobe)

"jaws" are actually the *iron core* of a transformer. The conductor acts as a one-turn primary. Another winding on the core steps the voltage up so the meter can read it. The changing magnetic flux in the wire, when current is flowing, gives us an AC voltage directly proportional to the amount of current flowing in the conductor. To read currents of different values, shunts are connected across the meter by a selector switch, usually in the clamp-on adapter unit. *No disturbance of the circuit is necessary.*

The only thing you must do is to be sure that you have only one of the circuit conductors inside the jaws. More than one will upset the magnetic fields, and the reading will be incorrect. Either conductor of a two-wire circuit can be used. For house wiring and similar testing, go to the circuit breaker box, where the wires are easy to get at. The instrument's jaws are well-insulated, so you can go in without danger of shorting anything.

For any plug-in unit, such as an appliance, special plug-in "line-splitters" are available. These separate the conductors; they're built in plastic cases, with a "ring" to clamp the jaws through. Several of these are made with built-in



**IF YOU ARE READY FOR SERIOUS CAREER**

# **Learn College-Level**





ADVANCEMENT NOW—

# Electronics at Home

## With CREI's unique Electronic Design Laboratory Program

There is only one way to a career in advanced electronics—through advanced training. You can get such training through a resident engineering college or you can take a CREI specialized college level electronics program at home.

**Wide Choice of Programs.** CREI offers you program arrangements with *fourteen* areas of specialization in advanced electronics. You can select exactly the area of specialization for the career you want.

CREI also offers program arrangements *both* for those with extensive experience in electronics *and* for those with only limited experience. All programs are college-level, except for a brief introductory level course, which is optional.

**Unique Laboratory Program.** CREI now offers a unique *Electronic Design Laboratory Program* to train you in the actual design of electronic circuits. You also get extensive experience in tests and measurements, breadboarding, prototype building and in other areas important to your career. The Lab Program makes it easier for you to understand the principles of advanced electronics. Only CREI offers this complete college type laboratory program.

The Lab Program includes professional equipment which becomes yours to keep. You will especially appreciate the Electronic Circuit Designer, which is available only through this program and which you will find extremely valuable throughout your professional career.

**College Credit.** You can actually earn college credit through CREI programs, which you can use at recognized colleges for an engineering degree. CREI maintains specific credit transfer arrangements with selected colleges in the U. S.

**Industry Recognized Training.** For nearly 50 years CREI programs have been recognized throughout the field of electronics. CREI students and graduates hold responsible positions in every area of electronics and are employed by more than 1,700 leading organizations in industry and government.

**Qualifications to Enroll.** To qualify for enrollment, you should be employed in electronics or have previous experience or practical training in the use of electronic equipment. You must also be a high school graduate or true equivalent.

**All CREI Programs are available under the G.I. Bill**

**Send for FREE Book.** If you are qualified, send for CREI's full color catalog describing these college-level programs and your career opportunities in advanced electronics. Mail card or write for your copy of this book.



**CREI** CAPITOL  
RADIO  
ENGINEERING  
INSTITUTE

McGraw-Hill Continuing Education Center  
3939 Wisconsin Avenue Northwest  
Washington, D. C. 20016



Accredited Member, National Home Study Council



multipliers; you can read the current directly, or divide by 10 or by 20, for low values of current. (I'll admit that this was news to me, and I don't have any details, but some people claim to be making clamp-ons that can read DC! The principle of operation is slightly different, but they are just as simple to use.)

### Special test adapters

In addition to the easy alternating current tests mentioned before, special adapters can give you readings of many different quantities. Read temperature on a VOM? But certainly! All you need is a plug-in thermocouple, and a scale or scales on the VOM calibrated in degrees Fahrenheit, or degrees Celsius. Read speed in RPM? Same thing. A small generator is held on the end of a rotating shaft; it develops a voltage proportional to the speed, and the meter has scales to read it. Another version uses light, chopped and read out on a meter. No physical contact with the revolving machinery is needed.

The government-specified safety tests for AC leakage on any appliance can be made. Special scales are provided on many units. Under OSHA, this is mandatory for most appliance service work. With these instruments, it's fast and easy.

For testing small thermocouple controls, used with gas-fired appliances, special millivolt ranges are provided. They start at about 50 mV and go up to about 1.5 volts.

Light levels and sound levels, also required tests under some OSHA regulations, are equally simple. Many of the special VOM's can do this with plug-in sensors. For production-line or quality-control testing, these can be obtained in single-function units, for making that one test.

For electricians working with poly-phase AC lines and equipment, an adapter is available that will identify the correct phase-sequence of any three-phase line. It will work up to 550 volts, and can be used with the AC voltmeter of the VOM.

For the final touch, many of these testers can be bought in special models calibrated at 50 Hz for overseas work, or at 400 Hz for aircraft and marine work. These are special-order types, of

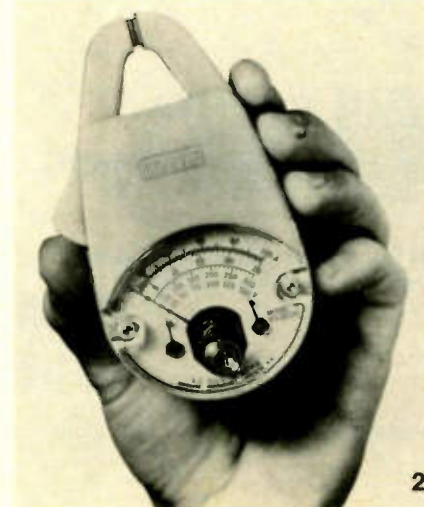

2

course. All U.S. units are calibrated for 60 Hz.

Let's look at a few typical models starting with the ultra-compact "shirt-pocket" types. Figure 2 is the Amprobe Model YT-25100, in their "Junior" line. This is also an AC voltmeter; test leads can be plugged into the case.

Figure 3 shows a higher range unit,



3

the Amprobe RS-1000. This, too is a voltmeter. It's a multi-range instrument; the scales are on a cylinder operated by the thumbwheel control of the switch. Only the scale in use can be seen. It will read AC current from 0-15 amps up to the scale seen here, 1000 amps. An ohmmeter range is also provided.

For the Really Big Stuff, a special kind of Clamp-on is used, as in Fig. 4.

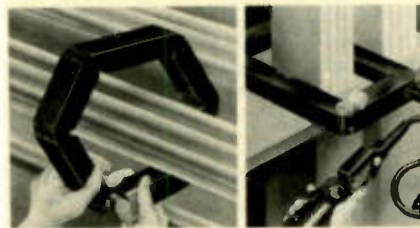

4

This is the Amprobe "Amp-Tran"; it is used with any of the RS series Amprobes. It can read currents up to 6000 amperes. It's used with the huge bus-bars found in power plants and heavy industry.



5

Going on in alphabetical order, the Simpson Electric Co's "Amp-Clamp" can be used with any AC voltmeter, having a full-scale range of 2.5, 3.0 or 5.0 volts, at 5000 ohms-per-volt minimum (Fig. 5). The current range varies with the meter used. It'll go up to 250 amps with

a 2.5-volt AC scale, or to 500 amps with a 5-volt meter.

Figure 6 shows the latest version of



6

the Amp-Clamp, just introduced. This is a self-contained unit with its own meter. There are three models, the 294, 295 and 296. The difference is only in the ranges and functions. Test leads can be plugged into the unit for voltage and resistance readings. Note the little button on the side of the case. You can hook up the Amp-Clamp, turn the machine on, and then press the button. This locks the meter needle in place; you can take the reading and then look at it later! Ranges from 0-6 amps up to 300 amps.

Figure 7 shows a familiar face. This



7

is the Triplet Model 310 Miniature VOM, with a Model 10 Clamp-On AC Ammeter adapter. The adapter plugs into the top of the case and locks. This automatically makes contact with the Common jack; the test lead is then plugged into the VOM jack, and the selector switch set for 3 volts AC. The current-range switching is then done by the selector switch on the Model 10 Adapter. As you can see, this is really a "one-hand" operation. (You can use your *right* hand if you like!)

The unit shown is the original version of the Model 310. There is a later model just out, the 310-Type 3. This is a drop-resistant, ruggedized version, with a textured surface on the case to make it easier to hold.

By unscrewing the tip from the common test-lead and putting it in the end of the case, any of the 310's can be used "one-hand" for any kind of testing (Fig. 8). For applications needing very high sensitivity, there is another one, the 310-F, a FETVM. The later versions have a very handy polarity-reversing switch on the upper left corner of the



case; under the man's right thumb in Fig. 8. This reverses the polarity of not



only the DC voltmeter but the ohmmeter; very convenient for transistor tests.

For the last, (but not least) of the shirt-pocket instruments in this area, Fig. 9 shows the Amprobe Model VT-100



9

“Volt-Probe”. It reads AC or DC voltages. There is no meter needle! The scale lights up to show you the voltage reading. Very useful for working in some of the dark places we get into!

Now we come to the “standard” size VOM’s; the larger units like the Simpson 260, Triplet 630, and others. However, in these something new has definitely been added. These are far more versatile than the old ones. All of the stock ranges are provided, and many special ranges as well, as you’ll see.

In alphabetical order again, Fig. 10 shows the Amprobe Models AM-1 and AM-2. The AM-2 is a standard VOM. The AM-1 has the same ranges, and provision for temperature readings with a

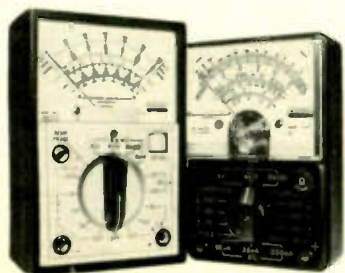

10

plug-in thermocouple probe. Note the DC “millivolt” ranges, for checking control thermocouples.

The Simpson Model 265 seen in Fig. 11 can read AC and DC volts, and has a



11

low-voltage scale of 300 mV, as well as plug-in AC and DC amperage. Current up to 12 amps can be read.

The Triplet Model 615 in Fig. 12 is a specialized industrial-test VOM with many special ranges. Up to three separate



12

thermocouple probes can be plugged in at the same time. Any one of these can be read by moving the selector switch. Handy for reading input and output temperatures, on air-conditioners, etc. The DC millivolts ranges start at 60 mV full-scale, and go to 1500 mV. A built-in AC leakage test is included; this is the one we’re supposed to make on all appliances before delivery. With this, it can be done with a flip of the switch.

For reading AC current, a slightly different version of the clamp-on ammeter is used. This works exactly like the rest, but has extension leads so that the meter can be left on the bench. Line-splitters and dividers are available with it.

All of these instruments are available in special carrying cases, to hold the basic instruments and the adapters, probes, etc. Fig. 13 shows the Amprobe Model TM-43A. The line-splitters and extensions are strapped in the lid, and in pockets in the case. Other instruments in this line have their own cases, some smaller than the one shown.

Figure 14 shows the Triplet Model 615 in its carrying case. The thermocouple probe is at the left, with the test leads, and the AC ammeter clamp-on and line-splitter, divider are at the right.

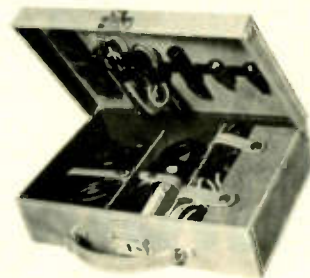

13



14

Figure 15 shows the Simpson 260 VOM, and one of its “family” of adapters. These plug into the Model 260, to convert it to quite a variety of uses. In addition to the Audio Wattmeter unit



15

shown, there are adapters to make the 260 into a transistor tester, DC VTVM, battery-tester, temperature tester, AC ammeter microvolt attenuator, and even a “milliohmmer.” The last one has a low range of 0.1 ohm full-scale. Note the heavy test-leads needed to get accurate readings in this area. Incidentally, the Simpson units shown also have the carrying cases.

Now we come to the single-function testers, for specialized work. Figure 16 shows the Amprobe “Fastemp” thermometer. Three separate probes can be used at once, with a selector switch. This is their Model T-150. Intermitent or continuous readings can be made.

(continued on page 68)



# Understanding the OP AMP

The operational amplifier is an important building block to the design engineer and experimenter. This article presents some practical circuit applications.

by DON LANCASTER

THE FIRST ARTICLE IN THIS SERIES (MAY 1975 issue) described the operational amplifier and presented 14 basic rules needed to design around them.

This concluding article describes a few practical devices and presents and presents some circuit applications.

### Some devices

So, we now have most of the use rules for negative-feedback op-amps, particularly the 741. Let's take a close look at some actual devices, and then we'll go on to some actual circuits you might like to try or use for design.

The four easiest to use op-amps are the 741 itself, available from just about anybody (see the table). The 5558, a dual 741 in an 8-pin can and a plastic mini DIP is from *Signetics* and in a can and 8- and

14-pin DIP's from *Motorola* as a MC1458; a quad 741 in a 14-pin package called the 4136 is made by *Raytheon*; finally a greatly improved 741 called the LM318 is available from *Advanced Micro Devices* and *National*. Condensed data for these four devices appear in Figs. 1 through 4. Only the 741 and the LM318 have pins brought out for balancing offsets—you have to use external offsets for the rest of the circuits. Costs vary widely, but around 80¢ per 741-style amplifier new and half that for surplus are typical, with the LM318 priced under \$5. The LM318 is thus very much a premium device, but anytime you need the slew rate or the higher frequency response, it is a very good choice. There are other moderately improved 741-style devices, including the *Motorola* MC1741S, and several devices

by *Silicon General*. These are intermediate in price and performance and generally offer around 5 V/ $\mu$ s slew-rate and better noise performance. And, of course, there are many premium devices offering considerably better performance.

Finally, there are some other quad amplifiers often called *Norton amplifiers* or *automotive op-amps*. These are not true operational amplifiers and cannot be used in the circuits that follow. Further, there are very serious use restrictions for these devices. For the vast majority of your applications, you'll find the devices of Figs. 6 through 9 the best overall choice to use.

### Some applications

Let's turn to some applications. We'll assume you have a good split power sup-

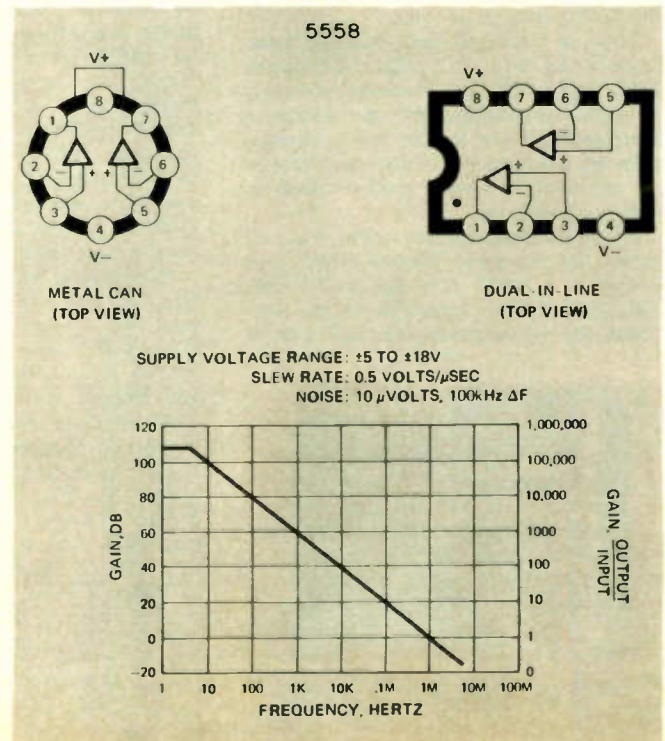
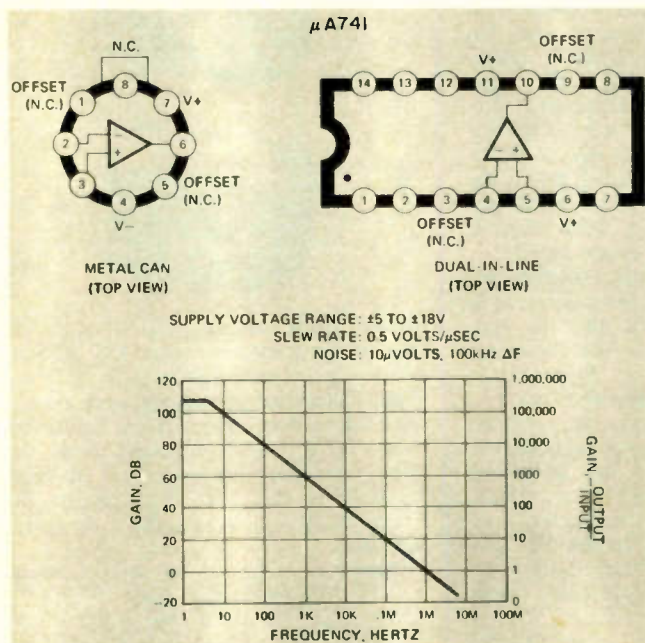
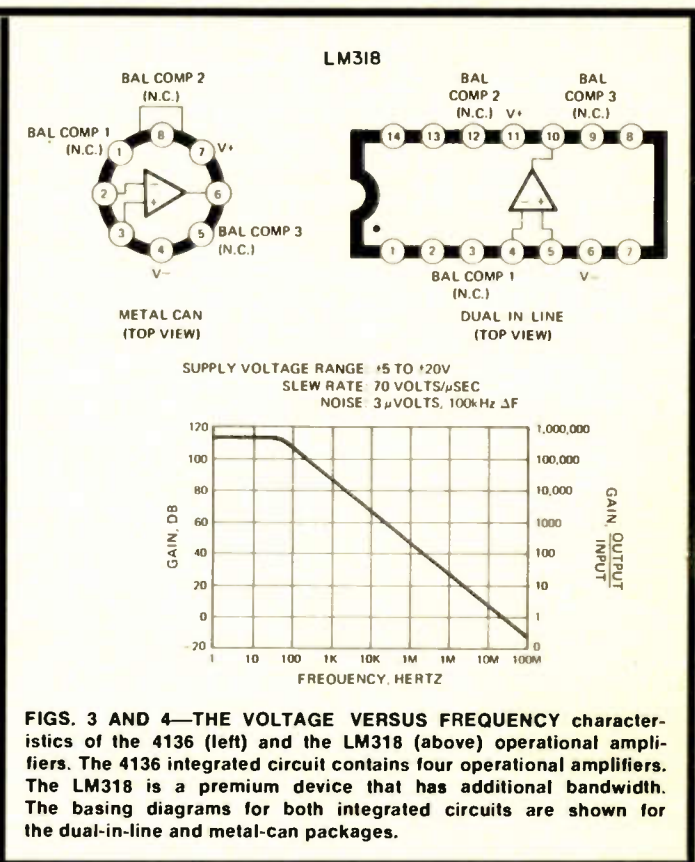
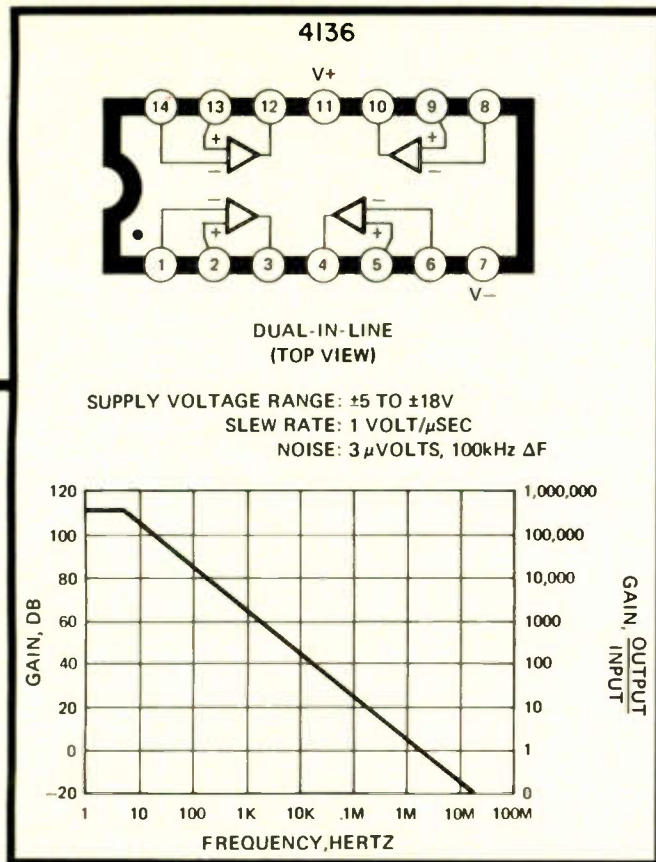

FIG. 1 (above)—THE VOLTAGE VERSUS FREQUENCY characteristics of the  $\mu$ A741 op-amp.

FIG. 2 (right)—THE VOLTAGE VERSUS FREQUENCY characteristics of the 5558 op-amp.





**FIGS. 3 AND 4—THE VOLTAGE VERSUS FREQUENCY** characteristics of the 4136 (left) and the LM318 (above) operational amplifiers. The 4136 integrated circuit contains four operational amplifiers. The LM318 is a premium device that has additional bandwidth. The basing diagrams for both integrated circuits are shown for the dual-in-line and metal-can packages.

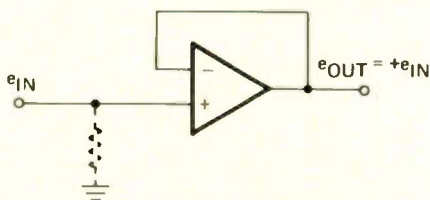

**FIG. 5—THE UNITY-GAIN CONFIGURATION** of an operational amplifier. The circuit has a voltage gain of exactly one.

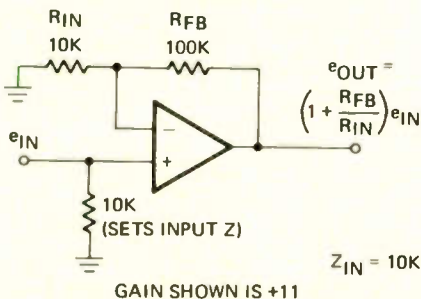

**FIG. 6—THIS CONFIGURATION** allows the gain to be adjusted by the ratio of feedback to input resistance.

ply, ranging from  $\pm 5$  to  $\pm 20$  volts, with  $\pm 15$  being the best, or its battery equivalent.

Suppose we use 100% voltage feedback from the output to the negative input. The output voltage always must equal the input voltage and the gain of the amplifier will always force the difference between output and the + input to zero. The output will follow the + input with unity gain, giving us a *voltage follower*. The input impedance is very high since we are going into the + input and the frequency response (although not necessarily the slew rate) is very good since we don't

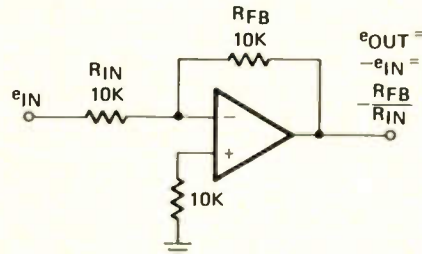

**FIG. 7—INVERTING VOLTAGE FOLLOWER** circuit. The gain is determined by the ratio of feedback and input resistance.

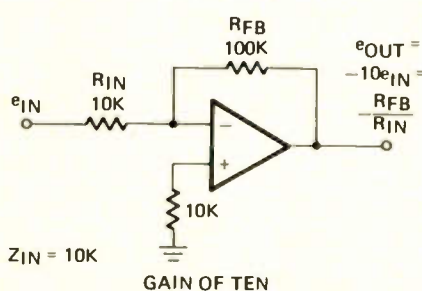
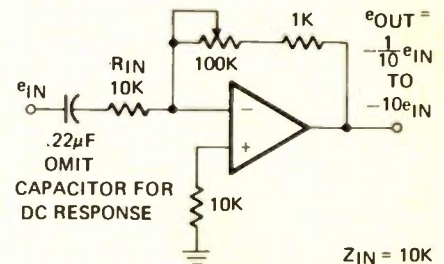

**FIG. 9—INVERTING SUMMING AMPLIFIER** circuit. The gain of each input is independently determined by the resistance ratio.

need much loop gain. The output impedance is very low and you can think of the circuit as a super emitter follower.

The circuit is shown in Fig. 5. Its advantages over a single transistor include a gain of *exactly* one, no temperature dependent 0.6-volt offset between input and output, a higher input impedance, and a lower output impedance. Note that you must provide base current bias through your source for the + input.

Figure 6 gives us a voltage follower with gain. Here instead of 100% feedback, we feed back only a fraction, voltage-divider style, and we end up with



**FIG. 8—INVERTING VOLTAGE FOLLOWER** circuit. This configuration allows adjustment of the gain via a potentiometer.

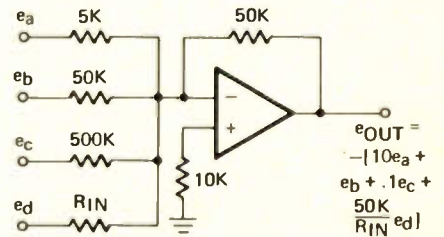

**FIG. 9—INVERTING SUMMING AMPLIFIER** circuit. The gain of each input is independently determined by the resistance ratio.

a non-inverting voltage amplifier with gain. The gain is anything you want from one upward to anything less than ten times the open-loop gain. Reasonable limits for a gain of ten are 10 kHz and 100 kHz for unity gain. With the LM318, you can run respectively at 200 kHz and 2 megahertz for the same gains.

Note that the gain is *NOT* the ratio of the two resistors but is *one plus the ratio*. Thus, the *minimum* gain is unity. Note also that you must provide base bias current for the + input through the source of your signal.

The standard inverting gain-of-one am-



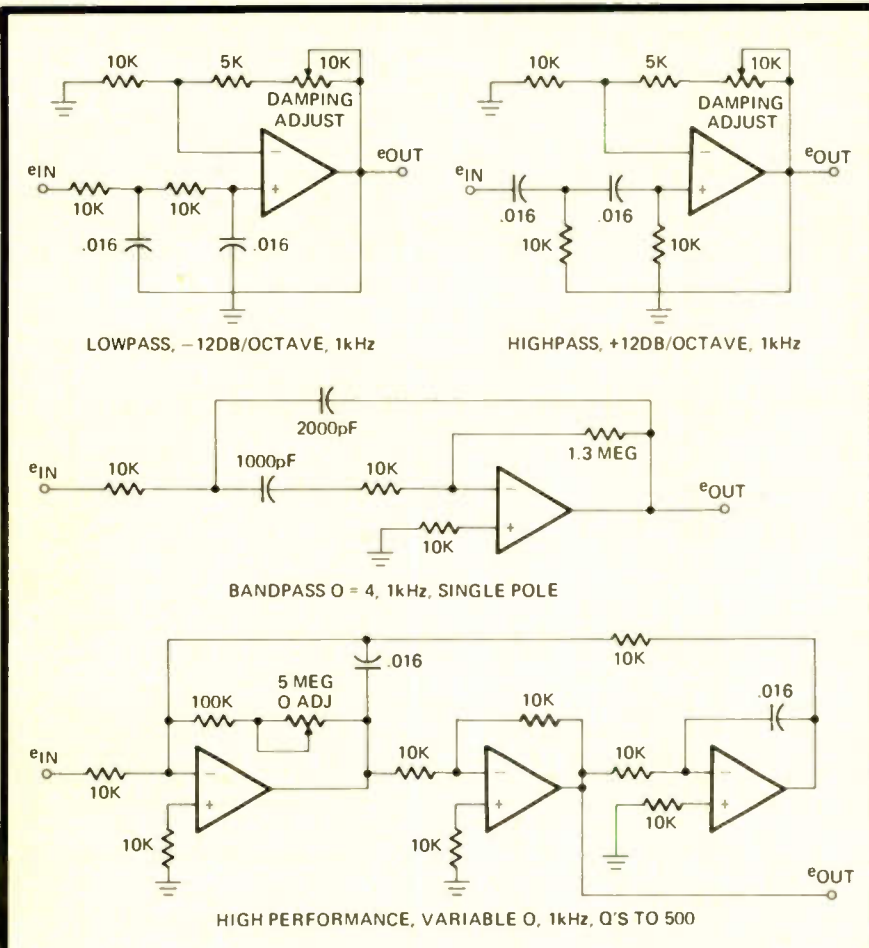

FIG. 10—ACTIVE FILTER circuits. Highpass, lowpass, and two bandpass filter circuits are shown. The values of the capacitors are changed to change the frequencies.

plifier is shown in Fig. 7. Here the gain is set by the ratio of the output resistor to the input resistor. With a 10K resistor on the input and a 100K resistor on the output, the gain will be 10, and so on. DC bias need not be provided by the source, and you can capacitor-couple the input for AC only applications. With identical resistors, the gain will be  $-1$ . Since we are going into the  $-$  input and since the  $-$  input is a virtual ground, the input impedance equals the input resistor, or 10K if a 10K resistor is being used. We can vary the gain as shown in Fig. 8. In Fig. 9, we have a mixer or summer circuit. As many inputs as needed can be used, and the gain of each will be independently set by the ratio of its input resistor and the feedback resistor. Since there is a virtual ground on the  $-$  input, there is no interaction between inputs and you get a linear summation of the inputs. Input impedance and gain is set for each input by its resistor. Note that the circuit inverts, so the low-frequency output will be  $180^\circ$  out-of-phase with the input.

Figure 10 shows us some active filter circuits, including second-order low-pass and high-pass filters, and two different types of bandpass poles. The frequencies shown are 1 kHz. Change capacitors to change frequency. The damping control sets the peakedness or droop of the response at the cutoff frequency. The three-amplifier band-pass filter needs only a gain of 3Q or so per amplifier at the center frequency and independently adjusts Q, gain, and frequency. Q's of several hundred to a thousand are possible.

A ramp generator is built using the circuit of Fig. 16. It is also called an integrator and the slope rate of charge buildup is given by the formula:

$$i_{in} = C \frac{\Delta v}{\Delta t}$$

$i$  = current in milliamperes

$C$  = capacitance in  $\mu F$

$\Delta v$  = voltage change in volts

$\Delta t$  = time interval in milliseconds

Note that you MUST enter via the  $-$  input for an integrator of this type and you must provide base current bias through the source.

A voltage-controlled oscillator or VCO can be built using the combined integrator-comparator circuit of Fig. 11. The negative input continuously charges the capacitor in the positive direction. When it reaches zero, the snap-action comparator (note positive feedback) trips a monostable and current source (both these have to be precision) and charges the capacitor rapidly negative. The capacitor jumps back negative and the time to charge is set by the input current. Output frequency is precisely related to the input voltage. It is called a charge subtractor VCO and can be made very stable. Maximum frequency using 741's is around 10 kHz, with best performance below 5 kHz.

We'll end our applications survey with a quick look at some non-linear techniques. If we use an op-amp and two ordinary silicon diodes, we can build the half-wave rectifier with a choice of polarity shown in Fig. 17. The normal 0.6-volt drop across the silicon diode is taken out completely by the op-amp, and you

(continued on page 82)

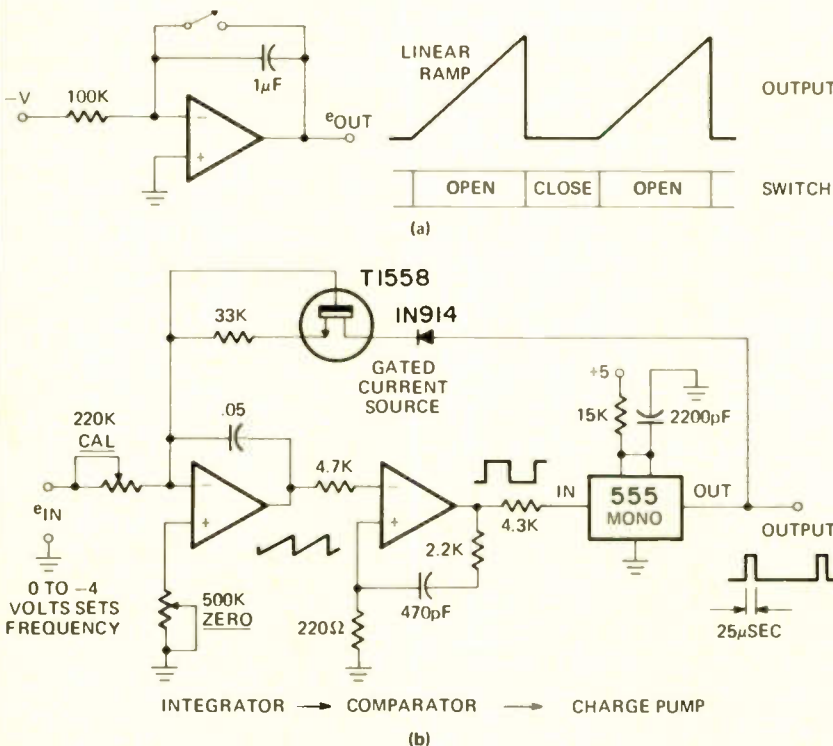

FIG. 11—ACTIVE INTEGRATOR is shown in a. The slope of the linear ramp output is determined by the R-C time constant. The switch returns the output to zero. A voltage-controlled oscillator using an integrator is shown in b.



# Make PA Work

Setting up and operating a sound reinforcement system is not difficult if you are aware of the intricacies that are involved in the procedure

by DAVID YOSHINARI\*



THE SOLUTION TO MOST SOUND REINFORCEMENT problems is usually found in the proper match between performers, equipment, and the environment. With the proper choice of equipment and careful planning, a sound equipment installer can overcome problems that often prevent a sound reinforcement system from performing as it should.

Sound reinforcement systems come in a large variety of types. A simple system used for lectures might consist of a single microphone, amplifier, and loudspeaker, while an outdoor rock concert could require an array of equipment that can only be transported by a caravan of trucks. To illustrate two basic types of systems often encountered, let's look at two examples.

Figure 1 shows a system intended to provide sound reinforcement for a lecture or speech. Typically, a single microphone is placed on a podium or a floor stand, perhaps two feet in front of the lecturer. The microphone is connected to a small microphone mixer, a power amplifier and a pair of loudspeakers located on each side of the stage. In some installations, a single speaker or cluster is located directly above the stage. This simple system, called a public address system, would certainly be adequate for

\*Senior Development Engineer  
Shure Brothers, Inc., Evanston, IL.

a local political speech or a graduation day ceremony. But when a rock group arrives for an appearance, a much larger system is a must.

A typical sound system designed for live entertainment is shown in Fig. 2. In this system, many microphones are used to cover all vocalists and several musical instruments. Multiple power amplifiers and large, efficient speaker systems are needed for the vocalists in order to compete with the high sound levels produced by the electrified musical instruments. The microphone mixer, or audio console, is preferably located in the audience seating area where the sound technician can both see and hear the performance. Most groups demand an on-stage monitor or "foldback" system consisting of speakers aimed back toward the group, rather than toward the audience. These speakers reproduce the vocalists and percussion instruments so the group can hear themselves sing over the sound of their electrified instruments. Finally, accessory devices such as echo units, equalizers, limiters, electronic crossovers and digital time delay lines may be included to produce various sound effects.

Even though the systems of Figs. 1 and 2 are drastically different, they share problems that are common to most sound reinforcement systems. Specifically, problems related to sound quality, intelligi-

bility, feedback, coverage, reliability and equipment compatibility will be frequently encountered in most sound reinforcement situations.

## Sound quality

In sound reinforcement systems, poor sound quality usually refers to poor fidelity, lending an unnatural character to the sound. Poor fidelity is normally caused by frequency response problems or by the presence of distortion. Consequently, the solution to the problem of poor sound quality requires a system with good frequency response and low distortion.

A reasonable design goal for frequency response of a sound reinforcement system is uniform response from 150-Hz to 7-kHz for speech-only systems and from 50-Hz to 12-kHz for speech and music systems. Some factors that affect frequency response are 1) Cables. To achieve good high-frequency response, high-impedance microphone cables must be kept under 20 feet in length. If longer cable runs are required, low-impedance microphones should be used. 2) Loud speaker response. The loudspeakers chosen for the job must have a wide-range frequency response both on-axis and off-axis. 3) Microphone response. A microphone should be chosen with a frequency response that complements the



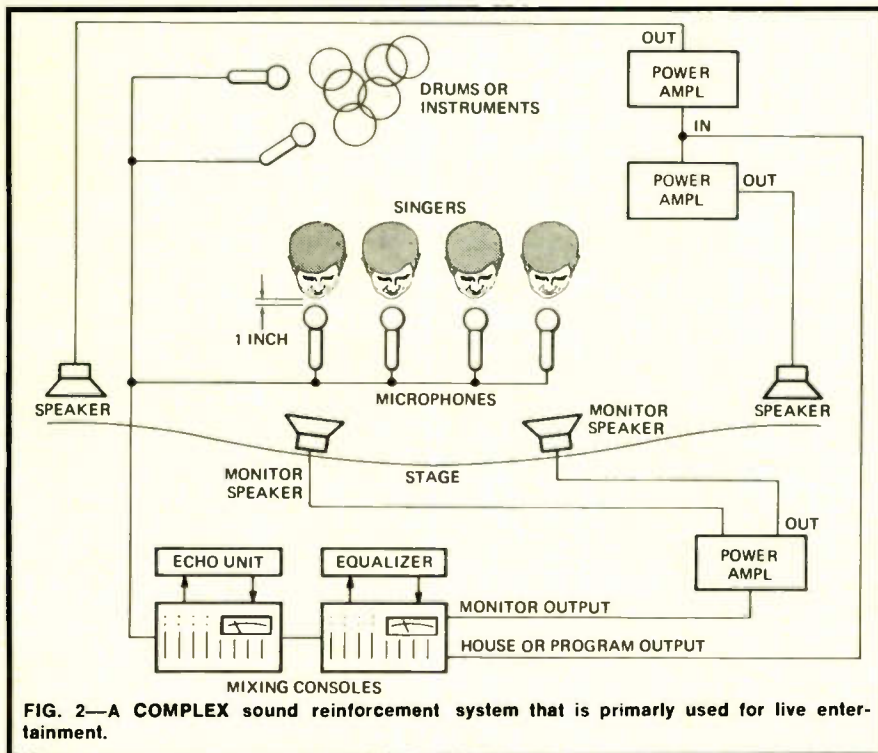
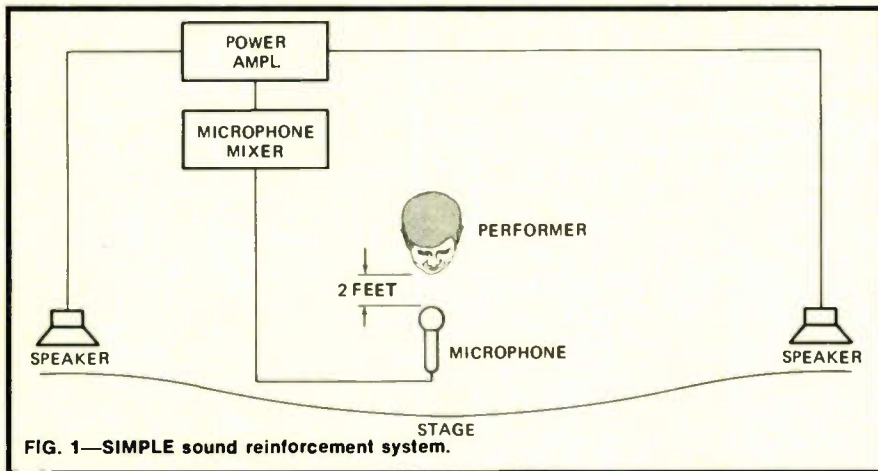

THE AUDIO CONSOLE should be placed in the audience for easily blending the sound.

original sound source. Manufacturer's catalogs can supply many hints concerning the proper choice of microphones.

Even when all of these three factors are considered, the frequency response of the system may still be inadequate, due to the characteristics of the room itself. In a difficult acoustical environment, electronic equalizers and filters can be used to compensate for deficiencies in the system or room response.

Distortion is the second key factor that

contributes to poor sound quality. Distortion can originate in several places in a sound system. For example, Some condenser microphones contain electronic circuitry which can be overdriven when subjected to high sound pressure levels. When high sound levels are expected, the choice of a good quality dynamic microphone will prevent this source of distortion.

Microphone input circuits in mixers or audio consoles may also generate distortion if they are overdriven as a result of high sound pressure levels. A circuit that performs perfectly for the system shown in Fig. 1 with its relatively low sound pressure input to the microphone, might overload badly when used with the loud singing often associated with the system shown in Fig. 2. To prevent this type of distortion (which is very common), the microphone signal level must be reduced to an acceptable level. Some audio consoles have input attenuators for this purpose. If you are installing a console that does not have this feature, insert external attenuator pads of 15 dB or more

in the microphone lines. Then check every other electronic device in the sound system and make sure that it is operating within its intended range of signal levels. A VU meter or overload indicator is very helpful here.

Another common source of distortion is power amplifier clipping. This is often caused by overdriving the power amplifier input. If the power amplifier does not have enough output power for the job, it may be operating at nearly full power on an average basis with no reserve power for peaks. Peak clipping and distortion will result. A speaker load impedance that is too low for the power amplifier will make this situation even worse.

Loudspeakers can also contribute to distortion in the sound system. Inherently, every loudspeaker produces some distortion due to nonlinearities in the conversion of electrical energy to sound energy. At higher sound levels, this distortion may become objectionable. This is particularly true of speakers that are not specifically designed for sound reinforcement applications. Sound-reinforcement speakers can generally operate at high sound pressure levels without objectionable distortion. Nevertheless, even sound reinforcement loudspeakers must be used within their ratings. Check them periodically to make certain that there has been no deterioration.

### Intelligibility

Intelligibility is the most important problem in vocal sound reinforcement. Good intelligibility is necessary to achieve communication between the person speaking and his audience. The causes of poor intelligibility are primarily related to frequency response, distortion, ambient noise and room reverberation.

For maximum intelligibility, the frequency response of the system should emphasize those portions of the human voice that convey the most speech information. This frequency response is not necessarily optimum for high fidelity music reinforcement. Many studies have shown that a peak of 3- to 6-dB in the frequency range of 4- to 7-kHz can be helpful in emphasizing critical sibilant and consonant sounds. Excessive low frequency response can be detrimental to intelligibility and it is usually advantageous to provide a low-frequency roll-off below 150 Hz. Microphones are available with these frequency response characteristics and additional equalization is not normally required.

Ambient noise in a room reduces intelligibility by masking the speech information. Ventilation fans, motors, audience noise (especially in dinner clubs) and sound leakage from outdoor sources (traffic, machinery, etc.) are prime contributors to the ambient noise level in a room. For good intelligibility in a noisy environment, the sound system should be capable of producing a level approximately 20 to 25-dB higher than the ambient noise level. The amplifier power and speaker efficiency must be adequate to achieve this level.

An excessively reverberant room will



reduce the intelligibility of any sound reinforcement system. In such a room, the audience may hear a great deal more reverberation than direct sound, and intelligibility will be impaired. In this case, the excessive reverberation is really a "noise" competing with the desired sound. Reverberation problems can be minimized by using directional speakers located close to the audience and aiming them away from large reflective walls or ceilings. The best solution to the reverberation problem, although usually impractical and expensive, would be to acoustically treat the room with sound-absorbing materials.

### Feedback

Acoustical feedback is such a common problem in sound reinforcement that we almost expect it to make its presence known as if it were part of the live performance. Regardless of the size or complexity of the system, feedback is one problem that any sound technician would like to eliminate. Three kinds of equipment are normally used to reduce or eliminate feedback: directional microphones, directional speakers and electronic equalizers.

A good unidirectional microphone can greatly reduce the likelihood of feedback. A unidirectional microphone has maximum sound pickup in only one direction, so aim it in the direction of the originating sound. In this position, it will tend to pick up the desired sound while rejecting both the direct and reverberant sound field that the loudspeaker system produces at the sides and rear of the microphone. A sound system test for feedback should always be made under actual performance conditions. Items such as tables and podiums can direct sound reflections into the microphone, and these items should be considered part of the total sound system environment.

The directional characteristics of the loudspeaker system can also be used to minimize feedback problems. Speakers should be placed as far forward on the stage as possible and aimed toward the audience and away from the microphones. In reverberant environments, the reflected sound of the speakers can eventually reach the microphone and cause feedback. In this situation, the speakers should be placed high and aimed downward at the audience to minimize reflections from the rear wall and ceiling.

Once the microphones and loudspeakers have been positioned for minimum feedback, electronic equalization can add further improvement by reducing the gain of the system at frequencies where feedback occurs. Figure 3 shows an electronic filter designed to reduce feedback any of eight one-octave filter bands. Narrow-band filters containing as many as 27 one-third octave filter bands are also available to provide finer control. An ordinary digital frequency meter is very useful for identifying feedback frequencies. The technique used for feedback equalization is to slowly increase the system gain until a feedback frequency is sustained. The appropriate filter is then adjusted while the system gain

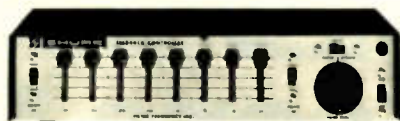

FIG. 3—SHURE M610 equalizer is designed for controlling feedback.

control is increased until the feedback mode shifts to a different frequency. The procedure is then repeated with other filters.

If feedback suddenly occurs during a performance, it would be unwise to attempt an adjustment of a narrow-band equalizer. To cope with this situation, some consoles provide anti-feedback filters which can be instantly switched into the console circuit to eliminate the feedback condition. The console in Fig. 4

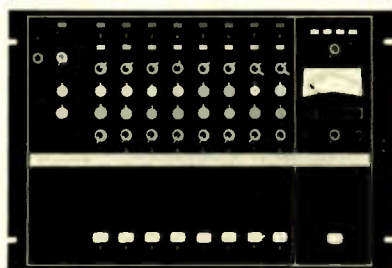

FIG. 4—SHURE SR101 audio console.

provides one additional aid to control feedback. It has a phase reversal switch controlling the console output. As surprising as it may seem, low-frequency feedback problems can often be eliminated by using this switch.

### Coverage

Coverage refers to the ability of a sound reinforcement system to deliver an adequate sound level to the entire listening area. Inadequate coverage is usually due to low speaker sensitivity, too few speakers, improperly aimed speakers, insufficient amplifier power or inadequate gain.

Loudspeaker sensitivity is expressed in terms of the sound pressure level (SPL) produced on-axis at a reference distance for a given power input in watts. The Electronic Industries Association (EIA) method of measurement uses a distance of 30 feet with a power input of 1 milliwatt. Another commonly used set of conditions is a 1-meter measurement for a power input of 1-watt. Speaker manufacturers generally use one of these two rating methods. From either rating method, the SPL can be determined for any other distance or power input (within the speaker's maximum power rating). Textbooks covering loudspeaker design contain equations that can be used for these calculations. As a rule of thumb, the SPL decreases by 6-dB each time the distance from the speaker is doubled, and it increases by 10-dB each time the power is increased by a factor of 10. For example, a speaker which produces 102-dB SPL at 4-feet with a power input of 1-watt will produce 96-dB at 8-feet, 90-dB at 16-feet, 84-dB at 32-feet and so forth.

If the required SPL at 32 feet is 94 dB, then the amplifier power would have to be increased from 1 watt to 10 watts (10 dB).

In general, horn-loaded loudspeakers have high efficiency but a very large enclosure is required to achieve good low-frequency response with this type of speaker system. In applications where size and portability are important, some column loudspeakers feature excellent efficiency in a relatively small package. It is possible to combine the features of both types of loudspeakers as shown in Fig. 5. The loudspeaker illustrated in



FIG. 5—SHURE SR108 column speaker system.

this figure combines high-efficiency with a wide frequency response.

The correct number of loudspeakers is determined by the size and shape of the room. In a rectangular room seating about 1000 persons, a pair of speakers similar to the one shown in Fig. 5 will usually be adequate. The speakers should

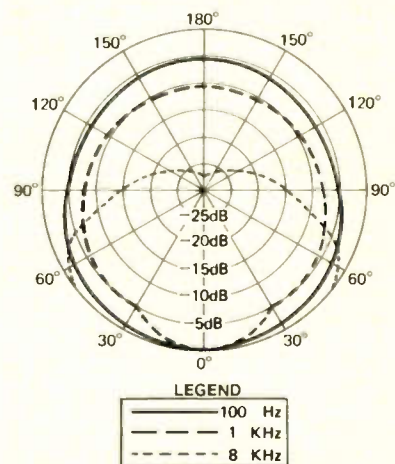

FIG. 6—HORIZONTAL POLAR RESPONSE graph for speaker system shown in Fig. 5.

be placed on each side of the sound source and positioned so that they aim toward the back of the listening area. If the room is particularly wide, it may be necessary to cluster two or three speakers on each side of the stage. In this case, each speaker should be positioned so that

*(continued on page 63)*



# BUILD THIS Digital Scope Memory

Add this accessory to any scope to convert it to a  
4-channel digital storage scope

by CHRIS TITUS

LAST MONTH WE PRESENTED THE CIRCUIT description, operation and construction details of the DSSC.

This month, the article will conclude with a few applications on the foil patterns.

## Ramp selection

To determine whether we need a positive or negative sawtooth for the X-axis deflection, we must first examine the operation of an SN7476 J-K flip-flop. We know that if both J and K are at a logic 1 (+5V), we can clock the clock input of the flip-flop and the output frequency of either Q or Q will be exactly 1/2 of the clock frequency. If we were to observe the clock input and the Q output of the flip-flop on a dual-trace scope, we would expect to see the waveform in Fig. 5. Notice that the Q output changes on the negative edge (NET) of the clock signal. Also remember that the scope's beam is being swept from left to right.

If instead of sweeping the beam from left to right, we could imagine the beam being swept from right to left, we would expect to see the waveform in Fig. 6. The visual differences are fairly obvious. In Fig. 6, the J-K flip-flop looks as if it were a positive edge triggered (PET) device.

Using these two examples, the selection of the appropriate ramp is fairly simple. We must calibrate our instrument so that when we test a SN7476 with the DSSC, the scope display looks like Fig. 5. Of course, different devices could be used for the calibration, but the SN7476 is very common and easy to use. It is important not to confuse the SN7476 with the many other types of flip-flops. If different scopes are to be used quite often with the DSSC, it would be very easy to bring out both ramps to a SPDT switch mounted on the rear of the DSSC.

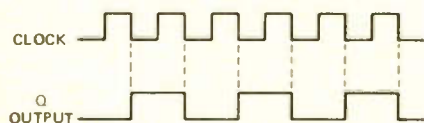

FIG. 5—OUTPUT WAVEFORM from a J-K flip-flop that would be observed on an oscilloscope.

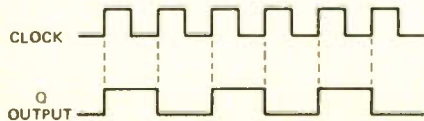

FIG. 6—OUTPUT WAVEFORM from a J-K flip-flop if the scope beam traced from right to left.

This would certainly speed the calibration procedure.

## Using the DSSC

To use the DSSC to diagnose digital logic, we must first properly adjust some of the external controls. No matter which channel we use to trigger the DSSC or what our data acquisition speed is, we must always arm the DSSC before each use by depressing the ARM pushbutton. After the DSSC is armed and triggered, the data will continue to be displayed until the DSSC is again armed or power is lost. We must also set the CHANNEL SELECT switch to determine which of the possible 6 signals; the 4 data inputs, manual pushbutton or external trigger source, will be used for triggering. We must also determine whether we will trigger the DSSC on a positive or negative edge (PET or NET).

The frequency selected will greatly influence the quality and usefulness of the displayed data. If we want to observe a 2-KHz (500- $\mu$ s) pulse train, we would not set the frequency at 2MHz (1 pnt/500 ns). At this frequency, we would completely fill the memory before one complete cycle of the 2-KHz signal had occurred. Too low a frequency will often result in a display of seemingly random

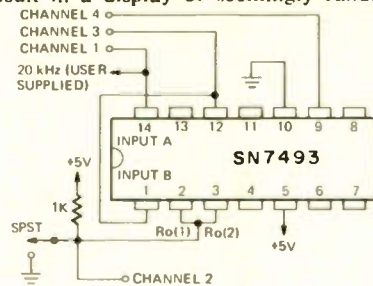

DSSC CONTROL SETTINGS  
FREQUENCY - 200 KHz  
CHANNEL SELECT - CHANNEL 2  
PET/NET - NET  
PRE-TRIGGER/NORMAL - PRE-TRIGGER  
DELAY/NORMAL - NORMAL  
THUMBWHEEL SWITCHES - NOT APPLICABLE

BY GROUNDING THE SWITCH TO THE Ro(1) AND Ro(2) INPUTS WE TRIGGER THE DSSC.

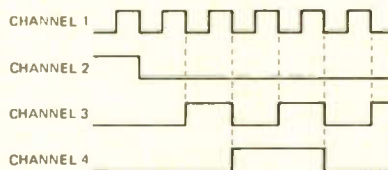
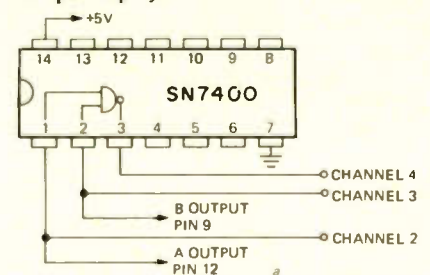

FIG. 7—4-BIT BINARY COUNTER can be tested using the DSSC. The connections are shown in a, and the resulting waveforms are shown in b.

data. A reasonable rule-of-thumb would be to select a frequency 4 or 5 times faster than the data frequency. It may be desirable in some cases to use the crystal clock in the DSSC to synchronize the logic under examination to the DSSC. These frequencies can be derived from the 2-deck rotary switch and be brought out to a binding post.

The PRE-TRIGGER/NORMAL and DELAY/NORMAL switches can be set to all 4 possible combinations. Normally however, either both the switches will be in the NORMAL position or one will be in the PRE-TRIGGER position and the other in either the PRE-TRIGGER or DELAY position. The setting of the thumbwheel switches is self-explanatory. Note that in the DELAY mode, the trigger source, as selected by the CHANNEL SELECT switch, is also used to pulse the down counters. Finally, a good ground *must* be established between the DSSC, via a GND binding post and the logic being tested.

Figures 7 and 8 are just two examples of some TTL circuits that can be tested with the DSSC, the appropriate DSSC switch settings, and the observed oscilloscope display. R-E



DSSC CONTROL SETTINGS  
FREQUENCY - 200 KHz  
CHANNEL SELECT - CHANNEL 3  
PET/NET - NET  
PRE-TRIGGER/NORMAL - NORMAL  
DELAY/NORMAL - NORMAL  
THUMBWHEEL SWITCHES - NOT APPLICABLE  
KEEP THE PREVIOUS COUNTER CIRCUIT, KEEPING THE SWITCH CLOSED TO GROUND, ADD THE SN7400 AND MOVE THE DATA INPUT WIRES FOR CHANNELS 2, 3 & 4.

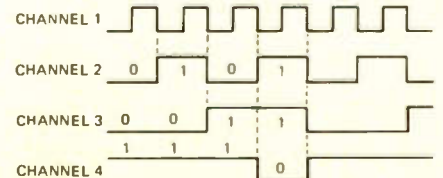

IF WE JUST LOOK AT CHANNELS 2, 3 & 4, WE WILL HAVE THE TRUTH TABLE FOR A 2 INPUT NAND GATE!

FIG. 8—THE DSSC can be used to dynamically test NAND gates. The connections are shown in a, and the resulting waveforms are shown in b.



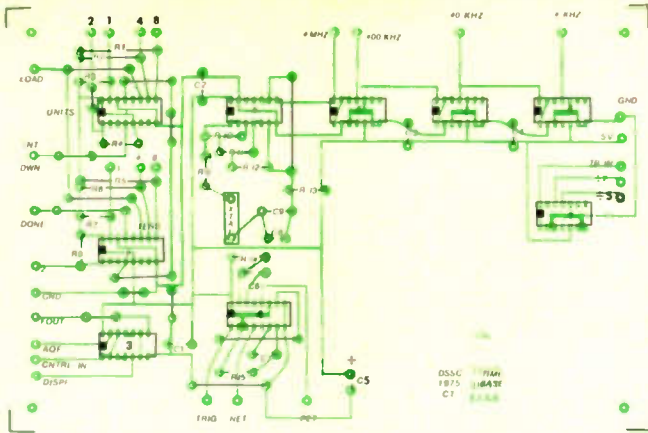

COMPONENT LAYOUT of the time base circuit board shown from the component side up.

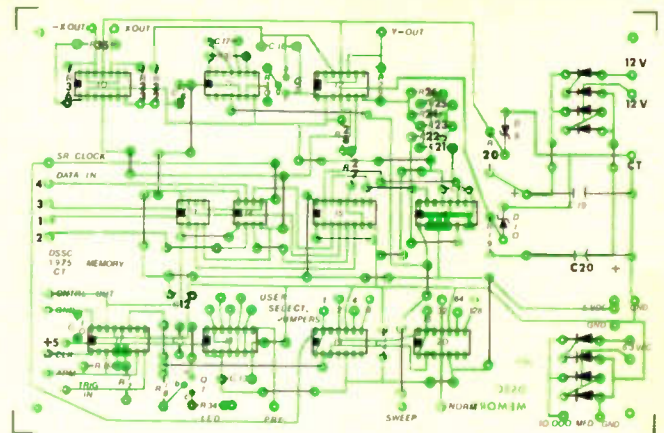

COMPONENT LAYOUT of the memory circuit board shown from the component side up.

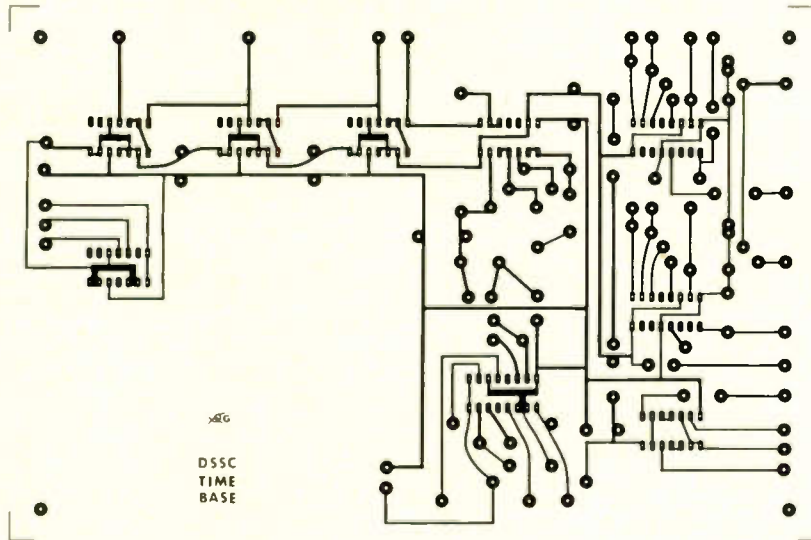

FOIL PATTERN for the time base circuit board is shown 1/2-size.

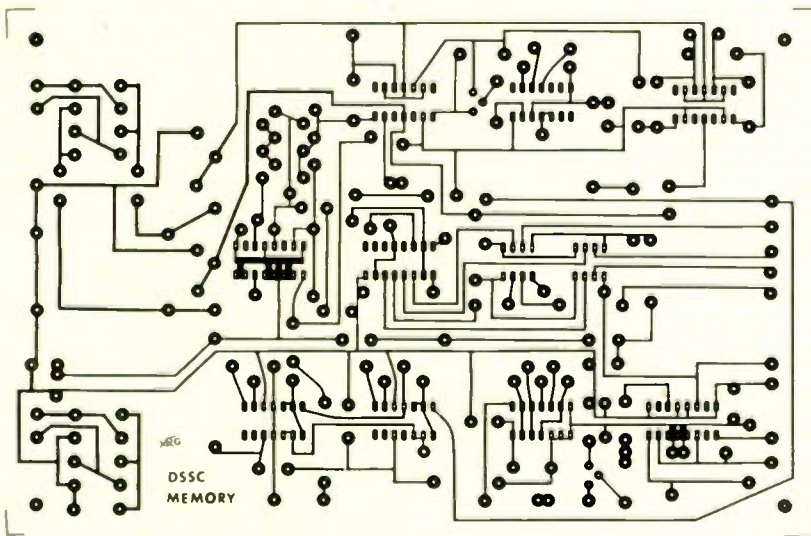

FOIL PATTERN for the memory circuit board is shown 1/2-size.

- R1-R8, R13, R16, R17, R30, R32—1000 ohms
- R9, R11, R18, R34—220 ohms
- R10—560 ohms
- R12—1800 ohms
- R14, R15, R28—470 ohms
- R19—47 ohms, 1W
- R20—220 ohms, 1/2 W
- R21-R26, R27, R29—10,000 ohms

- R31, R35, R36—4700 ohms
- R33—5600 ohms
- C1-C4, C10-C16—.1-μF ceramic disc
- C5—100-μF 6V electrolytic
- C6, C7—62-pF ceramic disc
- C8—33-pF ceramic disc
- C9—1.7—14-pF trimmer; Johnson 189-505-5 or equal

- C18—.001-μF polystyrene
  - C17—.002-μF ceramic disc
  - C19, C20—500-μF 25V electrolytic
  - C21—10,000-μF 10V electrolytic
  - Q1—2N2222 general purpose NPN
  - Q2—2N5060 SCR
  - D1-D8—1N4001 or equal
  - D9, D10—12V, 1W Zener, 1N4742 or equal
  - IC1, IC2—74192 synchronous decade up/down counter—TTL
  - IC3, IC5—7400 quad nand gate—TTL
  - IC4—74123 monostable multivibrator—TTL
  - IC6, IC7, IC8, IC9—7490 decade counter—TTL
  - IC11—74121 monostable multivibrator—TTL
  - IC10, IC12—747 dual operational amplifier
  - IC13, IC14—N2527V dual 256 bit static shift register (Signetics)—MOS
  - IC15—74153 dual four-to-one multiplexer—TTL
  - IC16, IC17—7476 dual J-K flip-flop—TTL
  - IC18—7430 8-Input positive nand gate—TTL
  - IC19, IC20—7493 4-bit binary counter—TTL
  - Q3—LM309K or equal
  - T1—24VCT 1/2 A power transformer
  - T2—6.3V 1A power transformer
  - LED—MV 5020 or equal
  - XTAL—4.0000 MHz crystal available from International Crystal, 10 North Lee, Oklahoma City, OK 73102
- Order as: 4,000 KHz EX series crystal \$3.95
- S1—2 pole, 11 position, 2 deck rotary switch, NON-SHORTING (1 pole/deck)
  - S2—1 pole, 6 position rotary switch, NON-SHORTING
  - S3, S4, S5, S9—SPDT miniature toggle switch
  - S6, S7—SPST normally open, momentary pushbuttons
  - S8—Digltran 23102-2; 2 module thumb-wheel switch, BCD complement with one common

**Misc.**

Mounting hardware, fuseholder, line cord, fuse, power (110 VAC) switch, 6-5 way binding posts, 2 BNC connectors for the X and Y signals, pilot light, rubber feet, Bud chassis AC 412 and bottom plate BPA 1520.

The Johnson 189-505-5 is available from:  
Circuit Specialists Co., Box 3047  
Scottsdale, AZ 85257

— or —  
Burstein-Applebee, 3199 Mercier St.  
Kansas City, MO 64111

Both the memory and time base Glass, Epoxy printed circuit boards, drilled, cut to size and ready for component insertion are available for \$12.95 postpaid from Techniques Inc., 235 Jackson Street, Englewood, NJ 07631. New Jersey residents should add 5% sales tax.





# Easy-to-build **COSMOS** burglar alarms

*Three more burglar alarms are described. In addition, different sensor systems and methods of installing a burglar alarm system are explored.*

by R. M. MARSTON

IN PARTS 1 AND 2 OF THIS 3-PART ARTICLE, we showed how you can use modern COS/MOS digital integrated circuits to produce your own tailor-made burglar alarm systems. In this concluding part of the series, we show how you can use COS/MOS to make a variety of 10-watt alarm-call generators to use in place of alarm bells or sirens in these alarm systems. We also give advice on how to select alarm sensor systems to solve your own particular home-protection problems.

## Alarm-call generators

The COS/MOS digital IC known as the CD4001AE quad 2-input NOR gate can readily be made to function as a modulated or unmodulated low-frequency waveform generator. The output of such a generator can easily be fed to a speaker via a simple 10-watt 2-transistor power amplifier stage. Such a system functions as a very efficient alarm-call generator, for use in place of conventional alarm bells or sirens. These alarm generators can be activated via the normally-open contacts of the main alarm system.

The circuit of a simple 10-watt monotone alarm-call generator is shown in Project 11. Here, two gates of the CD4001AE integrated circuit act as an 800-Hz square-wave generator. The output of this generator is fed to a 5-ohm speaker via a direct-coupled power amplifier stage formed by Q1 and Q2. The action of the circuit is such that the transistors are alternately switched from the fully off to the saturated states at a rate of 800 Hz, so the power losses of the circuit are quite low. More than 10 watts of power are fed to the speaker from the 12-volt supply.

The Project 11 circuit makes use of only two of the four available gates of the CD4001AE COS/MOS IC. The remaining two gates are disabled by shorting pins 8, 9, 12 and 13 to pin 7.

Project 12 shows how all four of the gates of the CD4001AE can be interconnected to make a pulsed-tone alarm-call

generator, which produces an 800 Hz tone that is pulsed on and off at a rate of 6 Hz. Here, gates A and B are wired as a 6 Hz square-wave generator, which is used to alternately enable and disable the 800 Hz oscillator formed by gates C and D. The output of the 800 Hz oscillator is fed to the speaker via transistors Q1

and Q2. More than 10-watts of power are fed to the speaker from the 12 volt supply.

Finally, Project 13 shows the connections for making a warble-tone alarm-call generator. The output of this generator switches alternately between 600 Hz and 450 Hz at a rate of about 6 Hz. Here, the 6-Hz oscillator formed by gates A

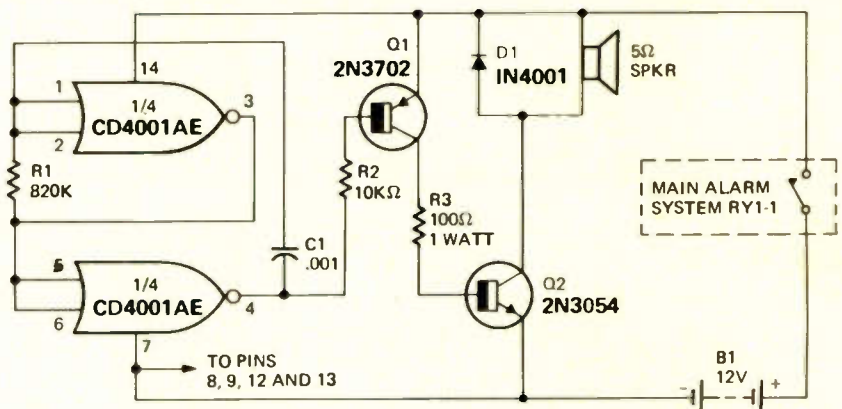

**PROJECT 11—MONOTONE 10-watt alarm-call generator.** Two gates of the CD4001 IC form an 800-Hz square-wave generator.

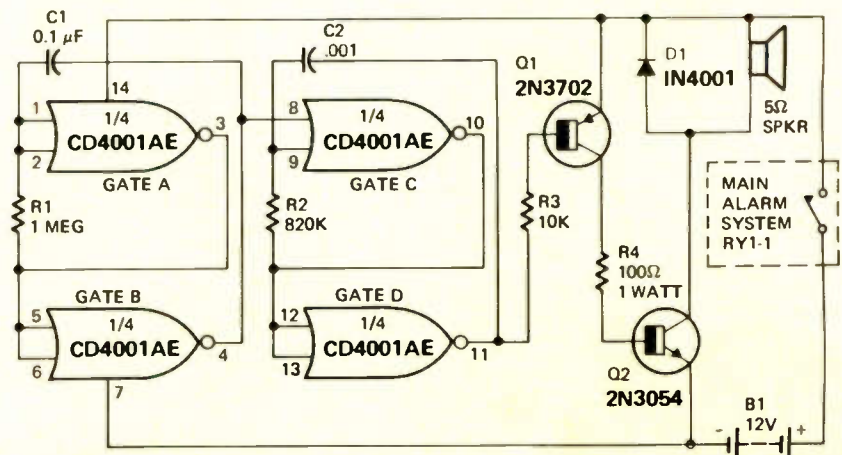

**PROJECT 12—PULSED-OUTPUT 10-WATT alarm-call generator.** This circuit uses all four gates of the CD4001 IC.



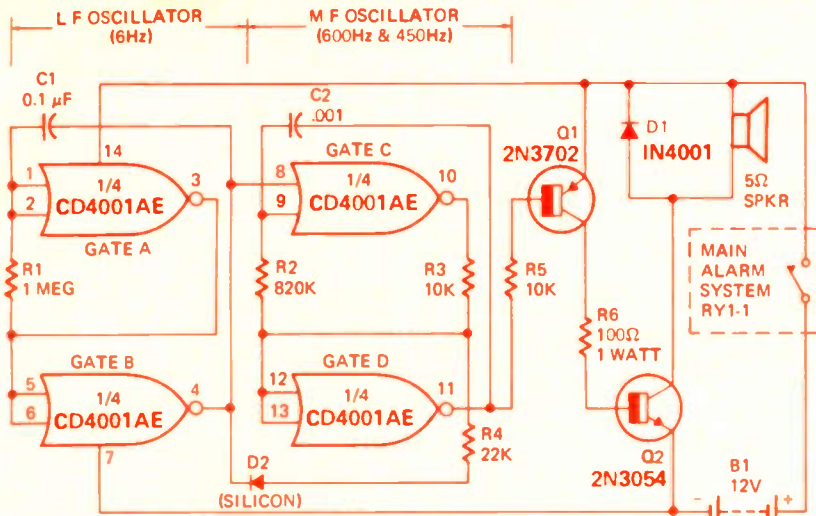

NOTE: D2 = GENERAL-PURPOSE SILICON DIODE

**PROJECT 13—WARBLE-TONE 10-WATT alarm-call generator.** The output switches between 600-Hz and 450-Hz.

and B is used to vary the period and thus the frequency of the oscillator formed by gates C and D. The output of the CD-4001AE is fed to the speaker via Q1 and Q2. The output power of the circuit is greater than 10-watts.

Note that the three alarm-call generator circuits of Projects 11 through 13 each use a 12-volt battery supply. Also note that each circuit uses a 5-ohm speaker, and that a damping diode is wired across this speaker to suppress unwanted back EMF's.

Your choice of the three alarm-call generator systems will be entirely a matter of personal taste. As can be seen from the circuit diagrams, each type of generator can easily be converted to either of the other two types by simply changing a few IC connections and adding or deleting a few components, so I suggest that the reader tries out all three circuits and then decides which sound he likes best.

Once a generator system has been selected, it can be activated from the main alarm system by wiring the alarm's normally open RY1-1 contacts in series with the generators positive supply lines, as shown in the diagrams. Note that the generator must use supply batteries that are independent of those of the main alarm system.

### Alarm sensor systems

All the alarm circuits that we've described in this story are 'contact-operated' types. They are activated by the making or breaking of electrical contacts that are built into simple sensor devices. These sensors can take the form of micro-switches or reed relays that are activated by the opening of a door or window, of pressure pads that close when a person steps on a rug or carpet, or of lengths of wire or foil that break when a person forces an entry through a window, wall, floor, or ceiling.

The selection of a complete alarm sensor installation depends on a number of factors. Included amongst these are the physical properties of the particular building that is to be protected, the value

of the goods that are to be protected, and the ideas on crime prevention of the individual property owner. The choice of an installation is a very personal matter. The following notes are given to help you make that choice.

Any building can, for crime prevention purposes, be regarded simply as a box that forms an enclosing perimeter around a number of interconnected compartments. This perimeter 'box' is the shell of the building, and contains walls, floors, ceilings, doors and windows. To commit any crime within the building, an intruder must first break through this perimeter, which thus forms the owners first line of defense.

Once an intruder has entered the building, he can move from one room or 'compartment' to the next only along paths that are pre-determined by the layout of internal doors and passages. In moving from one room to the next, he must inevitably pass over certain 'spots' in the building, as is made clear in Fig. 3, which shows the ground-floor plan of a small house. Thus, to move between the lounge and the hall he must pass over spot X1. To move between the kitchen and the hall he would tend to

pass over spot X2, and to move from the ground floor to the upper floor he must pass over spot X3. These spot points form the owners second line of defense.

Thus, the owner can obtain protection by using full or partial 'perimeter' defense, or by using 'spot' defense, or by using a combination of the two methods.

The most expensive type of alarm sensor installation that can be fitted is the full perimeter defense system that includes series-connected sensor wires built into all walls, floors and ceilings, as well as microswitches or reed relays on all doors and windows. This type of installation is normally fitted only to commercial buildings such as jewelry stores and storage warehouses where the risks of burglary by skillful intruders is very high.

The least expensive type of alarm sensor installation is the spot defense system, which can consist of just two or three pressure pads wired in parallel and hidden under rugs or carpets. This type of installation is adequate where the risks of burglary are small and the value of the protected goods is fairly low.

Intermediately priced 'partial' perimeter defense installations can range from something as simple as a microswitch on a single side or rear door, to something that includes microswitches or reed-relays on all doors and window frames, plus protective foil on all windows and sky lights. These systems can give adequate protection against both the amateur and professional burglar, particularly when the installation is coupled to a spot defense system.

Burglars can, in general terms, be described as fitting into three distinct types. The most common of these is the novice or amateur burglar who will enter a house at random in the hope that it contains items worth stealing. This type of intruder usually has insufficient skill or motivation to beat even the simplest detector devices, and will run off at the first sound of an alarm bell.

The second type of intruder is the small-time professional. This type of burglar breaks into a house only if he is sure that it contains valuable items. Before attempting to enter a house he makes a thorough reconnaissance of its defense systems, and commits the actual

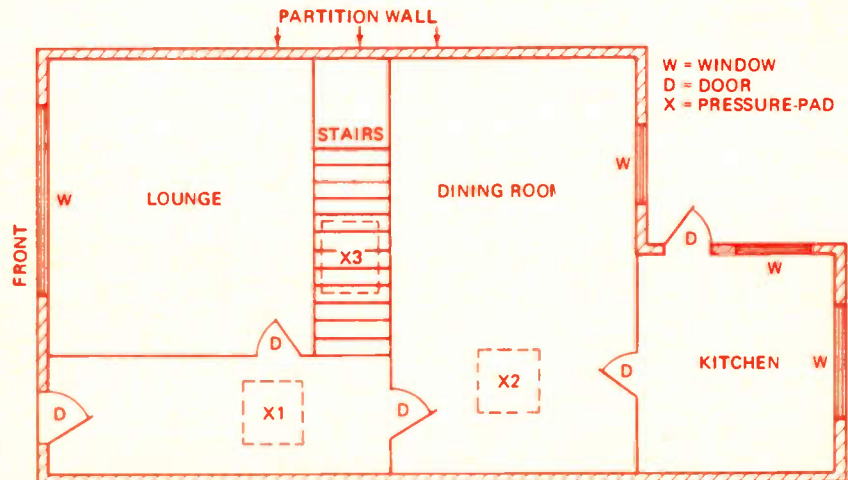

**FIG. 3—GROUND-FLOOR PLAN** of a small house showing suitable positions (marked "X") for pressure-pad "spot" defenses.



burglary only if he thinks he has found an unprotected entry point, such as a skylight or an accessible ceiling or floor. He may be so nonchalant that he will ignore an alarm bell for several minutes before fleeing. The best defense against this type of intruder is a carefully thought out partial perimeter system combined with a few 'spot' defense points.

Finally, the most difficult burglar to beat is the organized professional, who plays for high stakes and will go to great lengths to win. He may be willing to simply crash his way through a defense wall and hurt anyone that gets in his way. He may be undeterred by the sound of an alarm bell. The most effective defense against this type of criminal is a multiple perimeter system where the main building is surrounded by a partially-protected outer perimeter, such as a wall, and all valuables are held within a fully-protected inner perimeter, such as a strong room.

It should be noted that all alarm systems should, ideally, be fitted with a 'panic' facility, to enable the owner to summon aid if an intrusion occurs while he is on the premises.

Different crime-prevention authorities have different ideas on the best way to protect a home against burglary. Some claim that every effort should be made to keep burglars out of the house at the outset and that all possible points of entry should be protected. Others claim that a determined and skillful burglar can get past all but the most comprehensive perimeter defense systems, so the most sensible approach is to have a very simple partial perimeter defense system combined with an efficient spot defense network, so that the intruder can enter the premises with relative ease but is scared off as soon as he gets inside.

Thus, there are many points to consider when selecting a sensor system and the reader must make up his own mind as to the best system to use in his particular case. Once the sensor system has been selected, the layout of the complete alarm system installation must be considered. The following notes should be of value in this respect.

### Alarm system installations

Figure 4 shows how a complete alarm system installation can be broken down

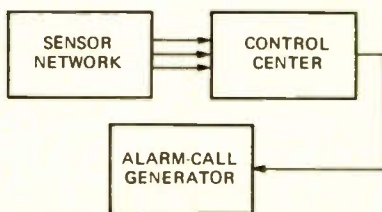

FIG. 4—BLOCK DIAGRAM of a practical alarm system installation.

into three basic 'blocks', namely, the sensor network, a control center, and the alarm-call generator. The layout of the sensor network has already been discussed, and is a matter of individual decision.

The alarm-call generator can either be mounted in a prominent position on

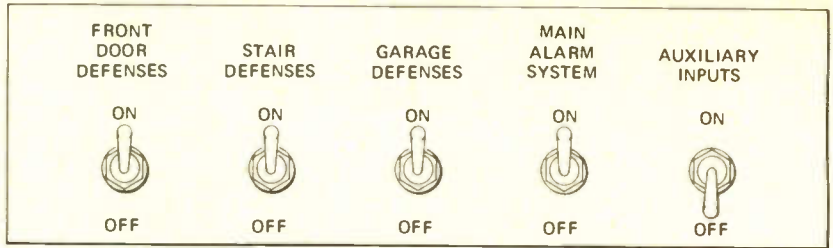

FIG. 5—TYPICAL CONTROL CENTER instrument panel is shown.

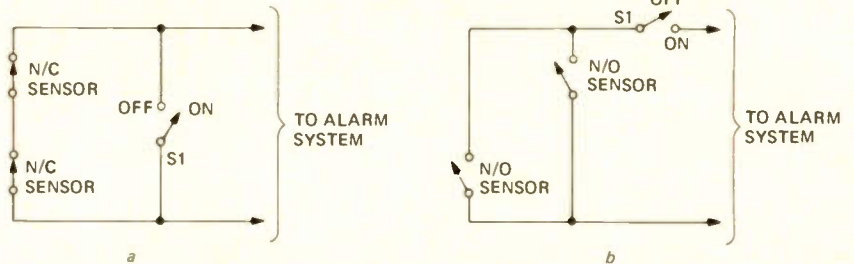

FIG. 6—METHOD OF ENABLING and disabling sensors. Circuit-a shows connections for series-connected normally-closed sensors. Circuit-b shows connections for parallel-connected normally-open sensors.

the front of the building to act as a deterrent to would-be burglars, or it can be concealed inside of the house in such a position that it can be heard equally well inside and outside the building. In either instance, the generator and its battery supply should be housed in a strong burglar-proof box, and connected to the control center either via an armor-clad cable, or via cable that is concealed within the plasterwork, etc.

The control center contains the electronics of the alarm system, together with the systems battery supply, plus a number of switches that enable different parts of the system to be turned on or off or to be tested. The center should ideally be housed in a burglar-proof box, and the connections to the sensors should be made via armor-clad cable or concealed wiring.

Figure 5 shows a typical control center instrument panel, with five control switches. It should be remembered that, as shown in Parts 1 and 2 of this article, certain sections of the alarm system (such as fire sensors and panic facilities) must

be permanently enabled, so the MAIN ALARM SYSTEM switch controls the burglar alarm sections of the circuit only. The auxiliary sensor devices, such as flood, over-heat, power-failure, or gas-leak detectors, are controlled by the AUXILIARY INPUTS switch. The last three switches enable individual sections of the burglar alarm sensor system, such as the front door, stair, or garage defenses, to be connected or disconnected from the circuit.

Finally, Fig. 6 shows the connections for turning individual sections of the alarm sensor network on and off. Series-connected normally-closed sensor networks can be enabled and disabled by wiring them in parallel with the MAIN ALARM SYSTEM switch (S1), as shown in Fig. 6-a. The sensors are enabled when S1 is open, and are disabled when S1 is closed. Parallel-connected normally-open sensor networks can be enabled and disabled by wiring them in series with S1, as shown in Fig. 6-b. The sensors are enabled when S1 is closed, and are disabled when S1 is open. **R-E**

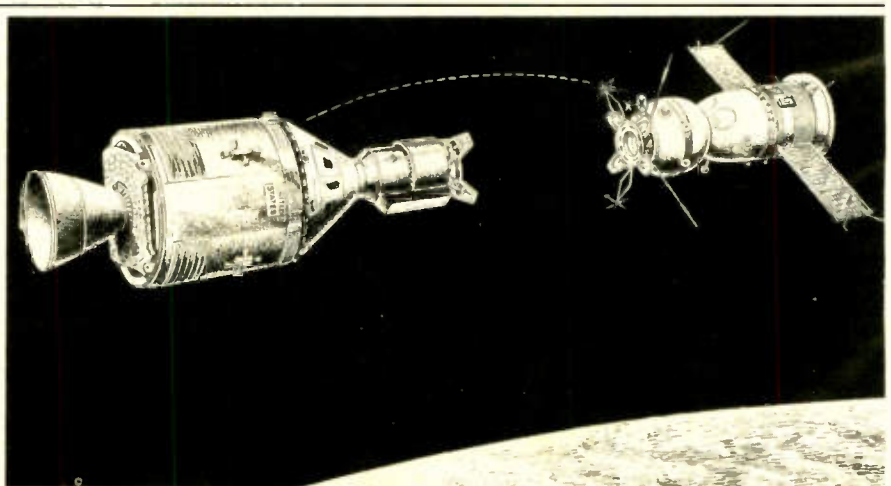

APOLLO AND SOYUZ ABOUT TO DOCK in the forthcoming Apollo Soyuz Test Project, as seen by an imaginative artist. The vehicles will be interlocked with the help of a VHF Ranging System designed and built by RCA, and mounted aboard both vessels. Range is determined by transmitting radio signals from Apollo to Soyuz and retransmitting them to Apollo. By measuring the time required to make the round trip, the distance between the vehicles is monitored continuously.



# All About OSCILLOSCOPES

Oscilloscopes often look easy but there's more to them than meets the eye. This article explores oscilloscope specifications and features

by CHARLES GILMORE\*

TO MORE COMPLETELY UNDERSTAND THE oscilloscope, the exact meaning of the numerous specifications applied to oscilloscope capabilities must be thoroughly understood. The modern high-performance oscilloscope has many involved and interrelated specifications indicating its performance characteristics. It is extremely important when selecting an oscilloscope that the measurement requirements be understood and that all specifications of the instruments under consideration be compared on an equal basis.

## Vertical bandwidth

Vertical bandwidth is one of the most fundamental specifications of an oscilloscope. This specification, more than any other, will determine the suitability of a particular oscilloscope for the measurement job at hand. It is the goal of the oscilloscope manufacturer to create a vertical amplifier whose frequency response is constant until an upper frequency limit is reached, where a controlled roll-off (decrease in gain) starts. The bandwidth of the oscilloscope is defined as the point at which the displayed vertical signal has been reduced by 3-dB with respect to some low-frequency reference point. As vertical signals increase in frequency, the oscilloscope should continue to roll-off at a rate slightly greater than 6-dB per octave. This controlled roll-off is necessary to provide proper vertical amplifier response to complex signals.

Oscilloscopes having a vertical frequency response which rolls off at a rate considerably greater than 6dB per octave will not faithfully reproduce the high frequency components of complex waveforms. On the other hand, oscilloscopes with insufficient high-frequency attenuation will tend to overshoot.

Note that a signal reduced by -3dB is at its half power point, not half voltage point. At -3dB, the voltage is 0.707 of the reference value. In addition, a signal reduced in amplitude by 3-dB due to an increase in frequency has a large phase shift with respect to the reference point, normally in the area of 45°.

Occasionally, the vertical bandwidth of an oscilloscope is specified with a deflec-

tion limitation. Such a specification might read 10-MHz at 4-centimeter deflection, 8-MHz at full deflection. This specification indicates the oscilloscope may not be used at its full bandwidth if full deflection must be used. This specification is popular with solid-state oscilloscopes that have a limited vertical-plate driving capability. Generally speaking, most higher cost modern oscilloscopes are not specified in this manner. However, one should be cautious when purchasing a unit if this will result in application limitations.

Oscilloscopes come with vertical amplifiers that are only AC coupled as well as with vertical amplifiers having both AC and DC coupling—usually switch selectable. AC/DC coupling is the most versatile, but AC-only coupling is generally lower in cost. When an oscilloscope is operated in the AC coupled mode, it will exhibit an upper -3dB bandwidth caused by the vertical amplifier high-frequency roll-off and a lower -3dB bandwidth caused by the low-frequency limitation of the AC input coupling capacitor. The -3dB lower-frequency limit is usually 2 to 10Hz. When AC coupled, the highest potential that may be applied across the input coupling capacitor must be specified. This is usually 400 to 600 volts. It should be noted that this specification is peak AC plus DC, not just DC.

The input mode selection may also have a third position in addition to the AC and DC positions described above (See Fig. 1). This third position, usually called ground, disconnects the input connector from the input amplifier. The input to the vertical amplifier is grounded. This feature is frequently used to note the zero volt input position of the trace on the CRT.



FIG. 1—A CLOSEUP PHOTOGRAPH of the vertical input of a Heath IO-4510 dual-trace 15-MHz oscilloscope. Notice the three position input coupling switch, with the center position marked ground.

## Risetime

Closely related to vertical bandwidth is vertical risetime. Risetime is defined (See Fig. 2) as the time required for the

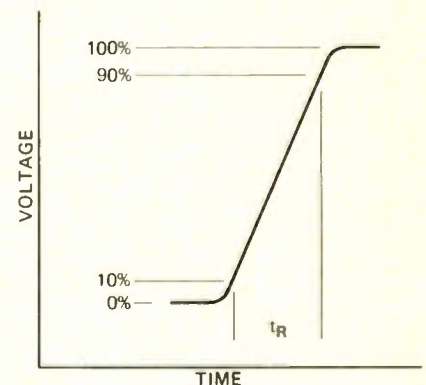

FIG. 2—THE DEFINITION OF RISE TIME. Fall time is also defined in a similar manner.

signal to increase in amplitude from 10% of its total value to 90% of its total value. The risetime specification of an oscilloscope is important in determining the limits of risetime measurements that may be made by the oscilloscope. Risetime is directly related to bandwidth. The formula is:

$$t_r = 0.35/F_{3dB}$$

This equation gives the risetime in microseconds when the -3dB bandwidth is given in megahertz. An oscilloscope which meets this requirement will have proper high-frequency roll off.

Risetime is especially important if the oscilloscope is to be used for pulse analysis. If pulse analysis is of prime concern, the oscilloscope should ideally have a risetime that is equal to or less than 20% of the risetime of the pulse to be measured.

## Deflection sensitivity

Vertical deflection sensitivity ranks equally with vertical bandwidth as an important oscilloscope specification. Both of these limitations can prevent a measurement from being made.

The deflection or input-sensitivity specification indicates the smallest voltage that will produce a standard deflection (usually 1 vertical division on the

\*Design Engineer Heath Company, Benton Harbor, Mich.



# Learning with CHEERS





# Electronics no picnic.

**It takes work.  
And a few  
sacrifices.  
But  
it's worth it!**

The minute you start your CIE course you'll see why CIE is different than other home-study schools.

Because as a CIE student you'll get the kind of electronics training that prepares you for a career, not just a job. We'll give you a meaningful, well-rounded foundation in electronics theory and practice. And with our special Auto-Programmed® Lessons, we'll make sure you grasp the key theories and methods of modern Electronics. No "fun and games" frills. No time-wasting, superficial lesson material. No "snap" exams.

We'll challenge your thinking.

We have to. Because after you graduate, employers will expect you to really know how to analyze and troubleshoot virtually all kinds of electronics equipment. Some employers of electronics personnel have told us that our graduates have what it takes.

That's why we're so thorough. We've got a 40-year reputation to uphold and we're going to keep it by giving our students the best *independent home-study* training we can.

Sure, some of our weaker students drop out. (Learning Electronics with CIE is no free ride.) But you can bet on this... the ones who do make it are ready! Ready to go out and make it in the rewarding world of Electronics. And that's the reason you want to learn, isn't it?

## **You can have attractive job opportunities**

There have already been many exciting developments and breakthroughs in

Electronics and some people might assume there will be no new frontiers... no new worlds to conquer. Not so.

Electronics is still growing. In nearly every one of the new and exciting fields of the Seventies you'll find electronics skills and knowledge in demand. Computers and data processing. Air traffic control. Medical technology. Pollution control. Broadcasting and communications.

### **Importance of an FCC License**

If you want to work in commercial broadcasting... television or AM or FM broadcasting... as a broadcast engineer, federal law requires you to have a First Class Radiotelephone License. Or if you plan to operate or to maintain mobile two-way communications systems, microwave relay stations or radar and signaling devices, a Second Class FCC License is required.

But even if you aren't planning a career which involves radio transmission of any kind, an FCC "ticket" is valuable to have as Government certification of certain technical skills. It's a job credential recognized by some employers as evidence that you know your stuff.

A good way to prepare for your FCC License exam is to take one of the CIE career courses which include FCC License preparation. We are confident you can successfully earn your license, if you're willing to put forth an effort,

because the vast majority of CIE students have. In fact, based on continuing surveys, close to 9 out of 10 CIE graduates have passed their FCC exams!

So if you are serious about getting ahead in Electronics... if you are willing to put in the extra work... get in touch with us.

We have many *career* courses for you to select from. If you already have some electronics training, you may want to skip our beginner-level courses and enroll in an intermediate program. Or, if you're really hot, there's a tough, college-level course called "Electronics Engineering" that can make you even better.

### **Send today for FREE school catalog**

Send today for our FREE school catalog and complete package of *independent home-study* career information. For your convenience, we will try to have a representative call to assist in course selection. Mail reply card or coupon to CIE... or write: Cleveland Institute of Electronics, Inc., 1776 East 17th Street, Cleveland, Ohio 44114.

Do it TODAY.

### **G.I. Bill Benefits**

All CIE career courses are approved for educational benefits under the G.I. Bill. If you are a Veteran or in service now, check box for G.I. Bill information.

## **CIE Cleveland Institute of Electronics, Inc.**

1776 East 17th Street, Cleveland, Ohio 44114  
Accredited Member National Home Study Council

Yes, I want your FREE school catalog and career information package today.

I am especially interested in:

- |  |  |       |
|--|--|-------|
| <input type="checkbox"/> Electronics Technology  | <input type="checkbox"/> Industrial Electronics  | RE-56 |
| <input type="checkbox"/> FCC License Preparation | <input type="checkbox"/> Electronics Engineering |       |
| <input type="checkbox"/> Color TV Maintenance    | <input type="checkbox"/> Other _____             |       |
| <input type="checkbox"/> Mobile Communications   | _____  |       |

Print Name \_\_\_\_\_

Address \_\_\_\_\_

Apt. \_\_\_\_\_

City \_\_\_\_\_

State \_\_\_\_\_

Zip \_\_\_\_\_

Age \_\_\_\_\_

Check box for G.I. Bill Information.  Veteran  On Active Duty

Circle 17 on reader service card



CRT).<sup>\*</sup> Stated in another way, deflection sensitivity indicates the maximum vertical amplification available. As a typical example, an oscilloscope might have a sensitivity of 10-mV. This oscilloscope would display a 10-mV peak-to-peak signal as 1-cm high on the CRT. Note that this is a peak-to-peak specification, not RMS. A 10-mV RMS sinewave would cover approximately 2.82 divisions as a 10-mV RMS sinewave signal is a 28.2-mV peak-to-peak signal. Sensitivity obviously costs money; therefore, the amount of sensitivity required must be weighed against the cost of the oscilloscope. Often the oscilloscope is utilized with an accessory probe and this probe acts as a voltage divider, reducing the input signal by a factor of 10 or more. If this is the case, one must remember the oscilloscope sensitivity is effectively reduced by the same factor. To obtain maximum sensitivity, some models offer increased sensitivity at a reduced bandwidth. Oscilloscopes offering this feature typically give an additional gain of 10 at a reduction in bandwidth by a factor of four. For example, a 10-MHz oscilloscope might maintain 10-MHz bandwidth at 10-mV per-centimeter. However, the input attenuator may be adjustable to 1-mV per-centimeter, but with a bandwidth of only 2½-MHz. Often this bandwidth is adequate, as high-frequency signals may not be of interest at high sensitivity levels.

### The input attenuator

The maximum sensitivity of an oscilloscope cannot be used on all measurements. For example, a 10-mV per centimeter oscilloscope with 6-cm of total vertical display will show an off screen display for signals in excess of 60mV. In order to overcome this problem, an input attenuator is provided. This input attenuator is usually one of two types. On the simplest oscilloscopes, this may be nothing more than a variable control, or at best, a three position switch labeled  $\times 1$ ,  $\times 10$ ,  $\times 100$ . In such oscilloscopes, the amount of attenuation and the vertical sensitivity are generally uncalibrated. The more sophisticated oscilloscopes have an attenuator with steps calibrated in resultant vertical deflection sensitivity. This is usually a 1-2-5 sequence, although occasionally a 1-3-10 sequence is used.

For example, let's take an oscilloscope that has a basic deflection sensitivity of 1 millivolt-per-centimeter. Due to high impedances and stray capacitances, a simple resistance divider will not maintain the same attenuation at high frequencies as it does at DC. To correct this, the input attenuator must be capacitively compensated. With compensated attenuators, attenuation is constant at all frequencies.

<sup>\*</sup>Many of the older oscilloscopes used full-screen or one-inch as a standard. Generally, the change to more modern oscilloscopes has seen a change from a full-screen specification to a per-division specification. Time-base specifications reflect this as well. The recurrent sweep was specified in terms of frequency of a sawtooth wave which covered the full display area; newer designs specify time-per-division.

The step attenuator has a disadvantage in that it will not allow signals of any arbitrary amplitude to be made exactly full-scale or some other desired size. To permit such operation, most oscilloscopes include a variable control that adjusts the effective attenuation between the indicated value and its next highest position. For example, an oscilloscope used at 500 millivolts-per-division can be adjusted continuously between 500 millivolts-per-division and 1 volt (1000 millivolts)-per-division by use of this control. The variable control will have a CALIBRATED position (normally, extreme clockwise). In the CALIBRATED position, the deflection factors indicated on the step attenuator fall within the accuracy limits set for the oscilloscope. Accuracy of attenuation is normally  $\pm 3$  to  $\pm 5$  percent. Vertical accuracy specifications also include any inaccuracies found in the vertical amplifier. Accuracies are frequently not specified at the high frequency limits, at temperature extremes, nor on extremely low cost instruments.

### Input impedance

For most service work, a high input impedance is desirable. One megohm has been chosen as a standard. As was noted in the discussion on attenuation, there is capacitance involved with attenuators. Therefore, the input impedance specification of an oscilloscope includes the value of capacitance found in parallel with the 1-megohm resistance. This capacitance usually lies in the area of 20 to 40 pF, if the oscilloscope is designed to be used with a divider probe. Obviously, the lower the capacitance the better. Other impedances have been used. Some of the older very low cost oscilloscopes have inputs ranging from 100K to 10 megohms. Some of the very sophisticated high-frequency oscilloscopes built today have a nonreactive input for their 150 MHz-plus capability.

### Input connectors

Most oscilloscopes are provided with a BNC input connector. This is the most desirable, considering the availability of cables and probes with mating BNC connectors. Other input connectors used are the 3- or 5-way binding posts (generally used on very low cost oscilloscopes) and the UHF connector (SO-239) found on some older models (see Fig. 3).

### Positioning range

Vertical amplifiers are provided with a continuously variable control permitting the operator to adjust the vertical position of the trace. The range of the position control and the effect of extreme positioning will be different for different oscilloscopes. The range of the position control is measured in windows. A window is the full distance across the CRT in the direction of interest. For example: an oscilloscope specified as having two vertical windows is capable of deflecting a waveform occupying the full vertical display area upward to the extent that the bottom of the waveform is at or above the display center line. The con-

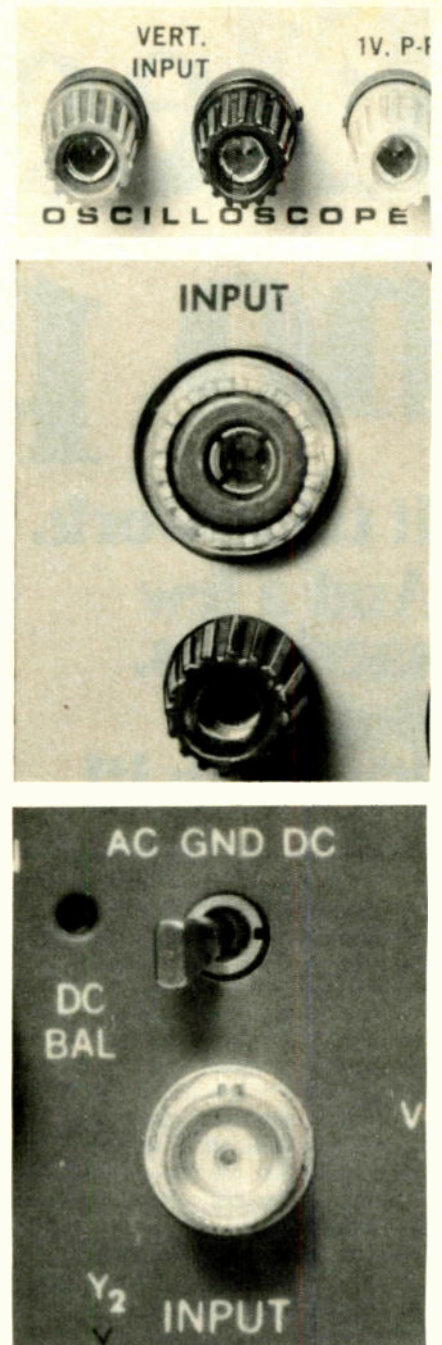

FIG. 3 — COMMON INPUT CONNECTORS used for oscilloscopes. The BNC (bottom), the 5-Way (top), and the UHF (middle). Most frequently the vertical input will be one of the coaxial types; however, the horizontal and trigger inputs may be 5-Way.

rol should also be able to deflect the trace downward until the top of the waveform will be at or below the center line. When the position control is adjusted to either of these extremities, there should be no on screen distortion of the waveform. The position control may have more range, but beyond the two windows (one window on screen, one half up, and one half down) there may be distortion of the trace. Vacuum tube oscilloscopes tend to have a larger number of vertical windows. The more modern solid state oscilloscopes are frequently limited to two windows, and many have as little as one and one half windows.



## Vertical delay lines

To correct for trigger and sweep start-up, a delay line is used in the vertical amplifier circuit. The object of the delay line is to uniformly delay signals of all frequencies by an amount slightly greater than the time required to permit triggering, start-up of the sweep circuits, and unblanking of the CRT before the triggering signal is presented to the CRT. Specifications will indicate the amount (number of nanoseconds) of pre-triggered waveform which will be displayed.

Delay lines are generally some form of transmission line and they are expensive, but they are essential for good pulse analysis work. Today this is especially necessary with the use of digital circuitry, where the measurement of pulse risetime may be critical to the proper operation of a circuit.

## Recurrent sweep

As noted earlier, recurrent-sweep is the simplest form of time base available. The recurrent-sweep time base offers no way of making calibrated time measurements except by comparison. The recurrent-sweep specifications indicate the upper and lower frequencies of the sweep oscillator. The frequency can be changed with a variable control within a decade range and over multiple decades in switched steps. A sweep oscillator frequency range from 5 Hz to 500 kHz is typical. Converted to time-per-division, assuming there are 10 horizontal divisions, this gives an equivalent range of 20 ms-per-division to 200 ns-per-division. A few oscilloscopes make provisions to lower the sweep oscillator frequency by use of an external capacitor.

The recurrent-sweep time base may also have a control to adjust the amplitude of the synchronizing signal injected into the sweep oscillator from the vertical amplifier. Switch selection of positive (+) or negative (-) going synchronizing signal is frequently made available. Often this same switch will permit positive or negative synchronization on an external signal or a sample of the powerline frequency.

## Calibrated sweep

Oscilloscopes with a calibrated-sweep permit the user to make time measurement, and as a result, specifications with accuracy limits as opposed to the operational characteristics of the recurrent-sweep. The period of the time base is selected by time-per-division.\*

The switch sequence is either decade (on lower cost oscilloscopes) or 1-2-5. Slowest sweep speeds vary with the manufacturer and the price of the oscilloscope, but usually are in the vicinity of 200 ms-per-division to 2 seconds-per-division. The fastest sweep speeds are dependent upon the bandwidth limit of the oscilloscopes. A rule of thumb is the

\*The majority of oscilloscopes use the centimeter as the basic horizontal and vertical division. There are some oscilloscopes, however, with vertical divisions slightly longer or slightly smaller than a centimeter. For this reason, the general term "division" will be used.

fastest sweep speed should present no less than three complete cycles of a waveform whose frequency is identical to the vertical bandwidth of the oscilloscope. For example, a 10-MHz oscilloscope would require an upper sweep speed of  $3 \times \frac{1}{10 \times 10^6} = 300$  ns for the full horizontal span, or 30 ns-per-division. This requirement would be met by an oscilloscope time base having a maximum speed of 200 ns-per-division and a  $\times 10$  magnifier yielding a 20-ns per-division display.

For low bandwidth oscilloscopes (3-5 MHz), the fastest sweep speeds are in the area of 1 to 0.5  $\mu$ s-per-division and sweep speeds of 0.2  $\mu$ s-per-division to 0.5  $\mu$ s-per-division are common on 50 MHz oscilloscopes. Although the time-per-division may be stepped in either a 1-2-5 or 1-10-100 sequence by the time base switch, there is usually provision to vary the time-per-division continuously between steps with an uncalibrated control. Accuracy of the time base is usually  $\pm 5$  to  $\pm 3$  percent. Time base speeds are often affected by temperature, line voltage variations, and age, so they should not be used as ultimate standards of time comparison.

## Triggering controls

The triggered oscilloscope gains much of its flexibility from the various modes of operation which may be selected for the time base trigger circuits. The trigger

signal, taken from the vertical amplifier, is used to start the sweep generator. Variations on the trigger signal include selection of positive or negative triggering, level of triggering, AC or DC coupling, high or low frequency filtering, and selection of trigger source including an external source, the power line as well as the vertical amplifier channels. Each of these features adds to the ability to observe complex waveforms, (see Fig. 4).

Older oscilloscope designs also incorporate a stability control which assists in proper operation of the trigger circuits. The stability control is adjusted prior to using the trigger level control. Generally speaking, stability controls are not found on modern oscilloscope designs.

The method of defining trigger sensitivity and triggering bandwidth are not consistent. The following are Heath Company standards for such measurements. Trigger sensitivity indicates the smallest deflection (or external input level) that will permit a stable trace on the face of the CRT. Sensitivity of 1 division or less is desirable. An oscilloscope requiring more than 1 division of vertical deflection in order to maintain a stable display does not have sufficient trigger sensitivity for many applications.

Trigger bandwidth can be defined as the highest frequency at which a stable trace can be maintained with some nominal deflection (often one division). Trigger bandwidth determines the ease with which the oscilloscope will trigger on complex waveforms and what the stability of high-frequency signals will be. An oscilloscope with a trigger bandwidth twice the vertical bandwidth provides exceptional triggering performance, while one with a triggering bandwidth of less than its own vertical bandwidth creates difficulties when complex waveforms are being observed.

## Time-base modes

The time-base generator itself usually has two modes of operation, normal, and automatic (auto). In the normal mode, the sweep generator is cycled by each trigger pulse, which follows the completion of a sweep and hold-off period. In the automatic mode, the oscilloscope automatically generates trigger pulses in the absence of a signal in the vertical amplifier. This provides an automatic baseline (trace) during the absence of a vertical signal rather than the blank CRT evidenced by no signal in normal mode.

Some oscilloscopes provide a time base mode called single-sweep. Single-sweep permits the operator to select a set of conditions that will trigger the sweep, and then "arm" the sweep. When the particular set of conditions occurs, the time base will be activated for one sweep and then remain locked out until re-armed. This mode is especially useful when attempting to observe fast events occurring randomly and at widespread intervals. Frequently, such events will be recorded by an oscilloscope camera.

## Horizontal bandwidth

As the main requirement of the horizontal amplifier is to pass the sweep sig-

(continued on page 82)

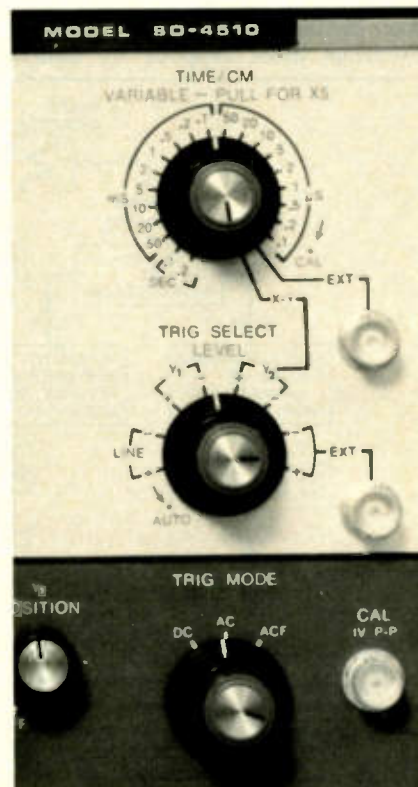

FIG. 4 — THE TRIGGERING AND SWEEP CONTROLS of the Heath IO-4510 dual trace 15 MHz oscilloscope. Note that in addition to source and slope selection, the operator may also select DC, AC, or ACF (AC coupled through a 15 kHz high pass filter) coupling. The automatic mode is selected by full counter-clockwise operation of the trigger level control.



# Step-by-step TV Troubleshooters Guide

*Troubleshooting a television receiver that has been struck by lightning isn't difficult if careful analysis and step-by-step procedures are used.*

by STAN PRENTISS

WHEN LIGHTNING STRIKES A VACUUM tube or a transistor television set, the problems often differ, but lots of work and careful analysis can cure the problems just the same. High input impedances in tube receivers plus larger turn-on potentials and more ac coupling usually prevent the lightning arc from penetrating much beyond the i.f. amplifiers or power supply. But with small signal devices and a great deal of dc coupling, there are relatively more damage-susceptible base-to-emitter and base-to-collector junctions combined with well-known bipolar tendencies to short. As a result, solid-state receivers can have additional subsystems affected other than tuners, i.f. strips, and power supplies—at least this one did.

When delivered to the distributors, the complaint tag read: "Fuse blows after warmup, brightness can't be controlled, contrast won't work, too much video noise, no picture, hit by lightning." The set was a 19DC22 Zenith with 4 receiving tubes, 5 IC's, 15 transistors, and a high voltage tripler. Now, since the receiver came from a local TV shop (or, in a similar instance, from an "electronics enthusiast"), the initial procedure is a careful visual inspection for severed wires, dangling components, poor or wrong connections, burned areas, and missing or damaged circuit boards. Indeed, one side of the pincushion transformer coil was disconnected, a number of capacitor and resistor leads clipped, left open, or rejoined with a smear of solder, and a few bare wires crunched together. All these have to be reconnected, separated, and secured *before* troubleshooting procedures are begun.

With the various circuits restored to their probable operating conditions, the immediate reaction is to turn the set on. **But don't you dare!** Remember, this receiver has raster but *no* picture, will blow power supply fuse and has all its lightning-developed troubles plus others that may have been around before the lightning bolt.

So approach the problem carefully, deliberately, and in low gear.

## Step-by-step

First, try a substitute tuner for at least vhf (uhf too, if possible) and also a preliminary i.f. check. If a substitute tuner isn't available, just disconnect the old tuner from B+ as well as the i.f. cable, *then* turn the set on. As expected, the fuse does not blow, the 24-volt regulator output is acceptable, and there is no special drain on any of the power supply voltages—they're fine. So you either repair the tuner yourself (maybe only a transistor), send it out to a specialty house such as Castle, PTS, etc., or install an exchange tuner supplied by Zenith.

With another tuner in place, however, the picture is still far from satisfactory, and there are either potential i.f. or agc problems yet to be detected and conquered.

In many of the newer receivers—just as in this Zenith—most operational sections are located on plug-in boards. So several screws later, the i.f. strip is disconnected and replaced as well as the IC on the video processor module that supplies sync, video, and agc outputs to the rest of the receiver. Now, indeed, a picture does appear that is somewhat recognizable, but the brightness control remains limited, contrast advance produces rippling distortion when turned toward maximum drive, and there is no

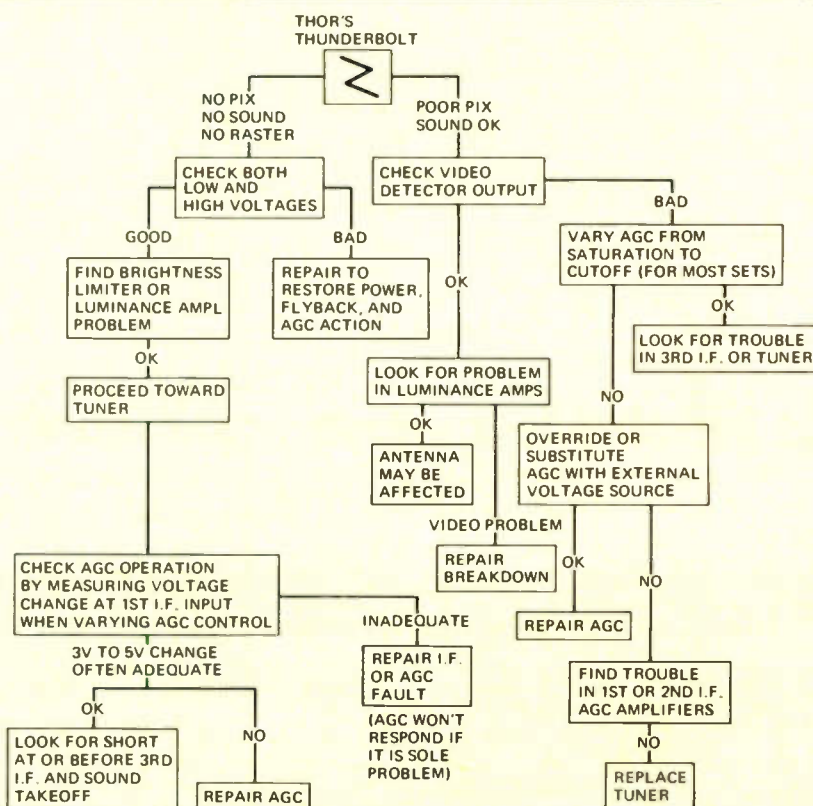

**THIS IS A DIFFICULT CHART** because tube and transistor sets react differently, especially when luminance is ac coupled, or agc is composite-waveform detected instead of just the sync tips. So we proceed in several different directions to cover most situations.



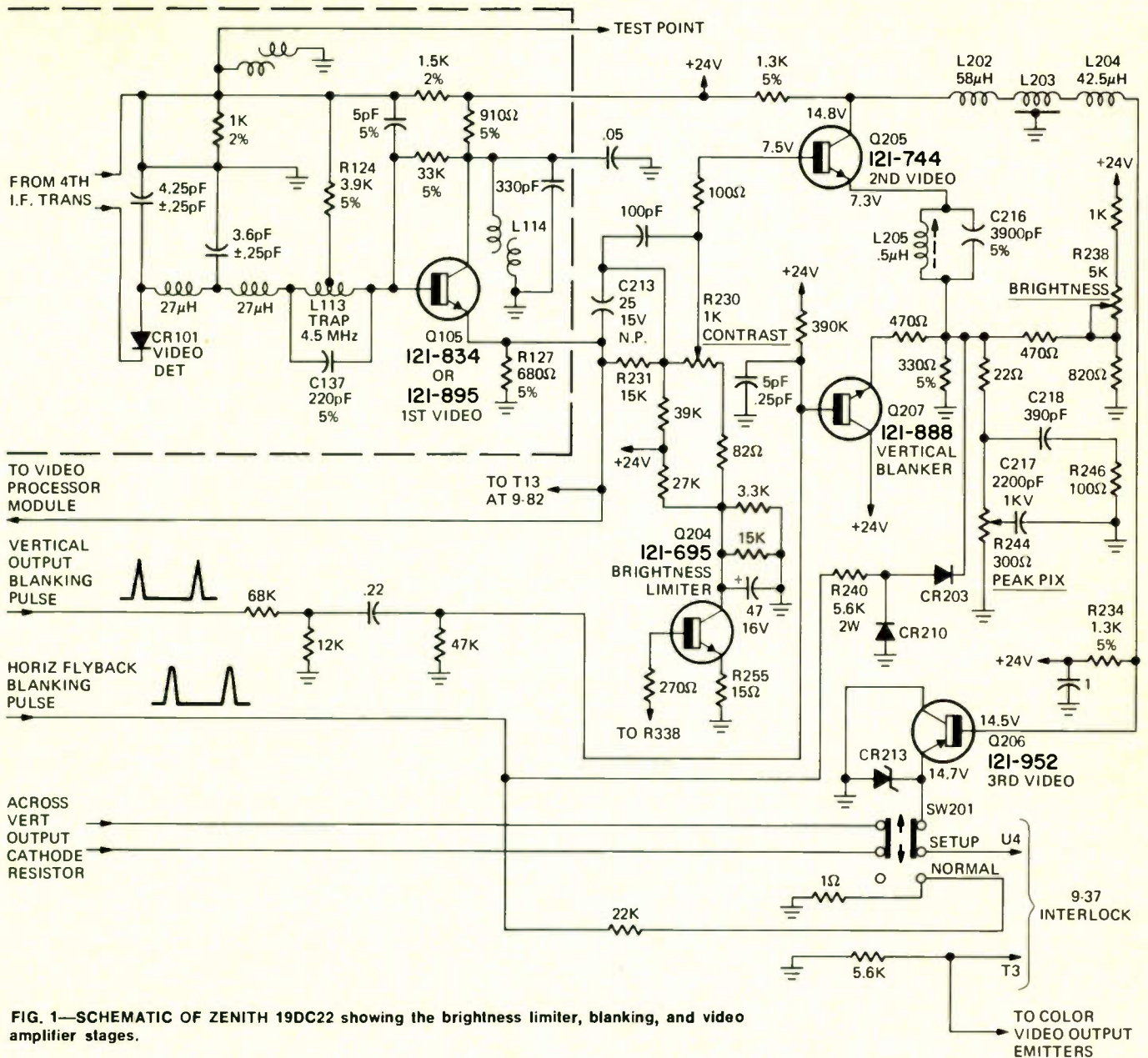

FIG. 1—SCHEMATIC OF ZENITH 19DC22 showing the brightness limiter, blanking, and video amplifier stages.

color.

Obviously there are difficulties in the video amplifier section also, and the lack of color may either result from this problem or can be a separate fault of its own. Again, the procedure is simply step-by-step. However, instead of replacing parts and semiconductors wholesale, a little circuit inspection is often helpful in these or any other circumstances to prevent wasting both time and parts. A few minutes spent in rational contemplation may save hours of frantic futility. So with tuner, i.f., and agc sections repaired and in operation, let's look at the rest.

#### Video amplifier analysis

The schematic in Fig. 1 shows video being envelope detected through half-wave rectifier CR101, and sound trapped by L113, a special non-distorting inductor and resistor-capacitor

combination (R124-C137) used to reject the 4.5-MHz signal and prevent possible 920-kHz beats between the 3.58-MHz chroma sidebands and intercarrier sound. L114 in the collector circuit of Q105 is a channel-8 self-resonant coil. The video signal, still in negative polarity, is developed across R127 and routed to both the video processor module and to the 2nd video amplifier Q205. The emitter circuit of Q205 has a C216-L205 broadly-tuned parallel trap normally set to remove stray 3.58-MHz chroma information that does not belong in the luminance channels. The video signal from the collector of Q205 now proceeds through peaking coils L202-L204 and the L203 delay line—necessitated by slower moving, narrower passband chroma—to the base of the 3rd video amplifier Q206. This is a PNP follower stage, whose emitter is clamped by the Zener diode CR213.

Two of these three video amplifying stages have additional controls. The brightness limiter, connected to one end of the contrast control will conduct harder when there is additional high voltage demand. Lowering the dc potential on this control and, consequently, the base drive of the video amplifier, will reduce cathode ray tube beam current. There are also horizontal and vertical blanking pulses—both positive in polarity—connected to the emitter of the second video amplifier Q205. During the 1.4-ms field retrace, Q205 is back biased and cut off by a positive vertical pulse on its emitter, and during horizontal retrace, by an 11.1  $\mu$ s positive pulse to the same emitter. Consequently, the 2nd video amplifier and the remainder of the luminance circuits are blanked at both field and line rates to securely cut the pix tube off during these synchronizing intervals. There is also a dc



brightness control in the emitter of the 2nd video amplifier that biases this stage from the +24-volt line, and also an RC peak picture potentiometer-capacitor arrangement which, when tuned, rolls off high frequency response by producing degeneration in the same amplifier. All right, now that the theory is developed, let's get to troubleshooting.

### Oscilloscope to the rescue

Since the +24-volt bus supplies most transistors and all IC's, and you've already established that enough current isn't being drawn to blow 24-volt regulator fuse, the best means to tackle this problem is with a dc oscilloscope. Why dc? Because you'll need to read both dc levels and ac amplitudes simultaneously to correlate your information. Time base and its reciprocal, frequency, are incidental, since the problem is loss of luminance and chroma. First, let's tackle the luminance breakdown; and to do this we'll work slightly backwards, exactly as you would do if there was an i.f. fault.

Our basic problem appears to be the waveform at the base of Q206 shown in Fig. 2 (upper trace). Instead of some seven volts in amplitude, this trace barely measures six volts and is hardly more than a smear where separate video and sync levels must appear. The blanking pulse at the emitter of the vertical blanking amplifier is precisely 18 volts (Fig. 2, lower trace), as it should be, and requires no further consideration. However, the waveform at the emitter of the 2nd video amplifier contains the same distortion, while the base of this transistor has a *fixed* dc value, regardless of contrast control setting, and exhibits additional distortion whenever the contrast control tries to increase bias. A quick check of the brightness limiter confirms that it will control picture tube blooming by simple, manual adjustment—so it, too, can be eliminated.

But how do you decide whether Q205 or Q206 is at fault? In this instance, since they're dc coupled, by deductive reasoning. Luminance and contrast are both affected, remember, and the 3rd video amplifier emitter follower is a larger metal case transistor that undoubtedly has greater emitter-to-base breakdown and power handling ability than the 2nd amplifier, which is a small signal device. So pull Q205 out of its holder and replace it.

Video once more comes booming in, as the emitter of the 1st video amplifier produces a good composite waveform—Fig. 3, upper trace—and the base of 3rd video amplifier (Fig. 3, lower trace) responds with good video and sync separation and also a change

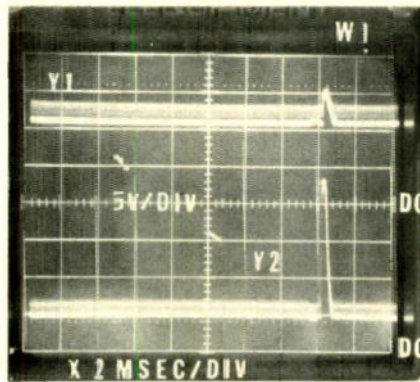

FIG. 2—A BREAKDOWN at the base of the 3rd, video amplifier is evident in top trace. Bottom trace shows a good vertical blanking pulse at the emitter of the vertical blanker.

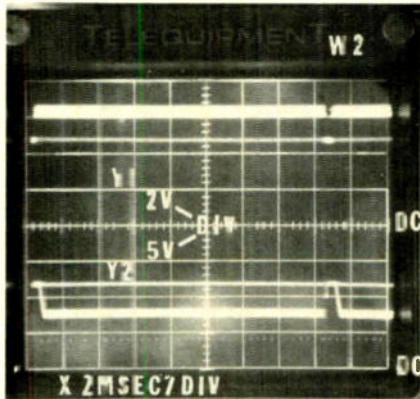

FIG. 3—THE EMITTER of the first video amplifier is good as shown in top trace. Bottom trace shows the base waveform of the 3rd video amplifier when repaired.

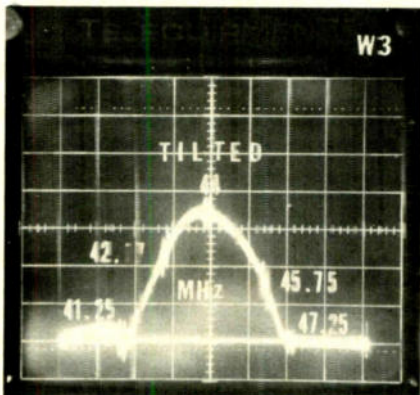

FIG. 4—SWEEPED RESPONSE at initial mating of new tuner and i.f. strip—slightly off.

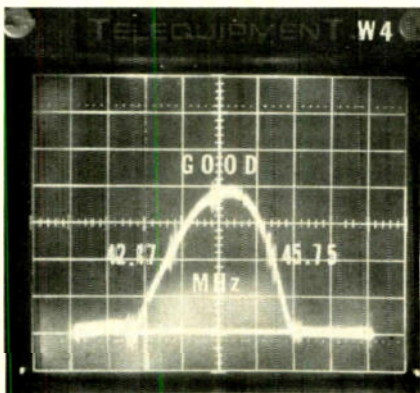

FIG. 5—MIXER COLLECTOR COIL tweaking balances video carrier and chroma subcarrier markers.

in dc level. The 3rd video amplifier, of course, tells us the rest of the luminance channels are all right and, lo-and-behold, excellent contrast with very black vertical, broad bars appear on the receiver's pix tube. This means the luminance problems are over, but there's still no color. A sensitive finger tip, however, soon fixes that. The chroma amplifier IC on the chroma module assembly (not shown) is rather warm to the touch, and a simple substitution restores all color bright as ever.

### Final touch up

Yes, i.f. response curves *do* change as illustrated in Fig. 4. Although the 41.25-MHz sound carrier and 47.25-MHz lower adjacent channel sound carrier traps are exactly in place, the 42.17-MHz chroma and 45.75-MHz video carrier markers are off somewhat more than their nominal 50 percent points should tolerate. Therefore, a little tweaking of the mixer coil is in order, and they're virtually balanced (See Fig. 5). The "haystack" is now ready to go to work with full bandpass chroma and luminance, and no i.f. waveform tilt to disturb color. R-E

**RESISTIVE AND REACTIVE CIRCUITS**, by Albert Paul Malvino, McGraw-Hill Book Co., 1221 Avenue of the Americas, New York, NY 10020. 592 pp. 9 1/4 x 7 1/4 in. Hardcover \$12.95.

A comprehensive textbook that provides all the information needed to prepare a technician for more advanced electronic courses. The first part of this book discusses resistive circuits with dc or ac sources as these are very prominent today because of direct-coupled circuits. The second part of the book covers reactive circuits such as transients, ac theory without using trigonometry or complex numbers. The final section of the book which does require a knowledge of trigonometry goes into extensive coverage of things such as phasor analysis, resonance and instantaneous ac analysis. Definitely a textbook quite valuable to anyone who wants to more fully understand both resistive and reactive circuitry.

**SIMPLIFIED COMPUTER PROGRAMMING—THE EASY RPG WAY**, by Kelton Carson, TAB Books, Blue Ridge Summit, PA 17214. 240 pp. 8 1/2 x 5 1/4 in. Hardcover \$8.95; Softcover \$5.95.

A computer, being a very complex system, requires literally thousands of steps and instructions to perform even a simple operation. The instructions are provided by a program which may be compared to a list of instructions for computing the square root, for example. Rather than actually write out the thousands of instructions for a computer, the programmer uses a language to have the computer prepare a program for him. By doing this, all that is left for the programmer is to write a few instructions in a few simple forms. The computer then translates the simple people language of the forms to the complex machine language of the computer. This book shows how it's done.



## MAKE PA WORK

(continued from page 47)

its angle of coverage slightly overlaps that of the speaker next to it. Coverage angles will usually be specified by the speaker manufacturer in the form of a polar response graph as shown in Fig. 6. This particular speaker (Fig. 5) provides coverage over a 140 degree angle in the horizontal plane.

In rooms with high ceilings, speaker clusters may again be used. In this case, it may be necessary to tilt some of the speakers vertically in addition to overlapping their horizontal directional patterns. To make sure coverage is adequate, it is wise to walk around the entire listening area while the speaker is in operation, adjusting the position of the speakers for an even sound-level throughout the room.

### Reliability

It should be obvious that reliability is a most important characteristic of good sound reinforcement equipment. Yet we still hear about microphones that "died," power amplifiers with shorted output transistors and speaker voice coils that opened up. To avoid these problems, choose rugged, conservatively designed equipment, read the instructions and use the equipment properly.

Microphones for sound reinforcement use must be particularly rugged. They must be impervious to corrosion and strong enough to withstand accidental drops onto a hard stage. They must include built-in dust filters to prevent foreign particles from reaching the microphone diaphragm that could cause noise, distortion, or eventual failure. Microphones which can withstand recording studio use may not be rugged enough for sound reinforcement applications.

Power amplifiers, mixers, and other electronic equipment should be capable of operating properly over a wide range of AC line voltages. It is not uncommon to find AC line voltages as high as 130 volts. And for large outdoor concerts, perhaps operating from portable generators with long AC extension cords, AC line voltages as low as 90 volts are sometimes encountered. It is a good practice to check out all electronic equipment with a variable voltage AC supply to make sure performance is not degraded within the range of expected AC line voltages.

The power amplifier in a sound reinforcement system must be reliable under all possible conditions of use. In addition to amplifying the output of the mixer or console, it must provide a good match to the speaker system in terms of power capability and impedance rating. Even though many ambiguous power output specifications are still being used, the sound technician is primarily concerned with the continuous power output that the amplifier can deliver to its rated load impedance. Fortunately, most commercial power amplifiers intended for sound reinforcement rather than home entertainment use are specified in this manner. A good commercial-grade power amplifier

should be capable of delivering this power indefinitely without blowing fuses or overheating, even while operating in a rack cabinet containing many heat-producing devices. A power amplifier designed for sound reinforcement should be capable of withstanding a shorted output for long periods of time. Figure 7 shows a typical power amplifier suitable for sound reinforcement use. Many high-power amplifiers designed for home



FIG. 7—SHURE SR105 POWER AMPLIFIER.

stereo systems are not adequate for commercial use due to inadequate protection circuitry and low thermal dissipation capability.

There are two primary aspects of loudspeaker reliability. These are the power handling ability and environmental protection. Loudspeakers are generally supplied with a rated maximum power handling capability in watts. Unfortunately, not all speaker manufacturers use the same methods for determining this rating. In general, speakers are rated in terms of maximum watts of program material rather than continuous sine wave power. It is essential to determine the maximum power capability of each speaker in use and make certain that the maximum rating will not be exceeded. It would be easier to match speakers to power amplifiers if the speakers were rated in terms of the maximum voltage which should be applied to them, since it is relatively easy to determine the output voltage capability of power amplifiers.

similar situation exists at each interconnection point in a sound system. If a sound system is constructed of components that are supplied by a single manufacturer, then interconnection should present no problems. But, if equipment is supplied by various manufacturers, it is necessary to pay particular attention to clipping levels, normal operating levels, impedances, gain, and noise specifications.

Table 1 serves as a guideline for interfacing system components according to their voltage levels. All of the voltages shown can be expressed in dBv, which means dB relative to 1.0 volt. This should not be confused with levels expressed in dBm, which means dB relative to 0 dBm. The reference "0 dBm" is the voltage necessary to produce 1 milliwatt of power in 600 ohms (0.775 volt rms). If an impedance other than 600 ohms is used, it is necessary to add or subtract a correction factor to take into account the different impedance. It is convenient to express voltage levels in dBv, because no particular value of impedance is implied.

When interconnecting two pieces of equipment, it is advisable to have about 10 to 15 dB of "head room." This means that the average signal level at the interconnection should be at least 10 to 15 dB below the output clipping level of the unit supplying the signal and 10 to 15 dB below the input clipping level of the following unit.

In any sound reinforcement system, the user will encounter several pieces of equipment, each with at least one level control. Overall, there may be three to six level controls, each capable of affecting the overall level in the room. Obviously, there will be many different ways of setting these several controls that will yield the proper overall gain. Unfortunately, many of these possible ways will yield either clipping at some point or too much output noise. It is best to read the manufacturer's instruc-

TABLE 1—TYPICAL VOLTAGES AND IMPEDANCES

	Impedance Ohms	Typical Voltage Range (V)	Voltage Range (dBv)
Lo-Z Microphones	50-250	0.1 mV to 100 mV	-80 to -20 dBv
Hi-Z Microphones	20K to 100K	1.0 mV to 1.0V	-60 to 0 dBv
Lo-Z Mixer Input	300 to 2.2K	30 mV to 1.0V (clipping level)	-30 to 0 dBv
Hi-Z Mixer Input	50K to 1 meg	320 mV to 10V (clipping level)	-10 to +20 dBv
Line Level Mixer Output	50 to 600	1V normal 10V peak	0 dBv normal +20 dBv peak
Power Amplifier Input	5K to 100K	0.5 to 2.0V	-6.0 to +6.0 dBv
Auxiliary Unbalanced Accessories	10K to 100K	0.1V to 1.0V	-20 to 0 dBv

Loudspeakers that will be used outdoors should be weatherproof. These speakers are constructed with waterproof drivers, special glues and corrosion-proof hardware. Speakers intended for portable applications should be particularly rugged.

### Equipment compatibility

We have already mentioned that speakers and power amplifiers must be matched in terms of power compatibility. A

tion books in order to determine optimum level settings. In general, it is desirable to set level controls near the front of the system as high as possible, consistent with adequate input clipping levels and adequate mixing range. Level controls near the power amplifier end of the system generally should be operated at reduced levels that still allow the power amplifier to develop full output power. In this way, a good signal to noise ratio will be preserved. (turn page)



## Other considerations

We have discussed six significant problem areas common to most sound reinforcement systems. There are many other problems that can arise in specialized systems, and naturally, the problem you experience at the moment is worse than any other. To complete our discussion of sound reinforcement systems, four other areas deserve attention. These are stage monitors, portability, specialized accessories and safety.

## Stage monitoring

The popularity of musical instruments located close to the vocal microphones has created a problem by making it difficult for a vocalist to hear his own voice. To solve this problem, a second totally independent sound system is used to provide stage monitoring.

To establish a monitor system, the audio console shown in Fig. 4 is equipped with individual monitor selection on every input channel and a separate monitor output for power amplifiers driving speakers on the stage. This hookup is shown in Fig. 2. The monitor system is capable of providing an independent selection of any voice or instrument on stage. The main criteria for choosing monitor speakers are peak-free frequency response, medium to high efficiency and small size.

## Portability

Portable sound systems are becoming more common as a result of their flexibility. The system shown in Fig. 2 could be a portable system that might be moved from auditorium to gymnasium to meeting room all in the same day. Professional entertainers prefer to travel with their own complex systems to assure consistent results, rather than perform using an inferior "house" installation. Some factors that must be considered when choosing equipment for portable applications are: size, weight, ease of operation and hookup, and the availability of rugged portable shipping cases.

An example of a portable system is shown in Fig. 8. In the photo is the console shown in Fig. 4. The power of amplifier shown in Fig. 7 and a pair of



FIG. 8 — PORTABLE sound reinforcement system.

portable speaker columns complete the system. The console and power amplifier are in portable cases, that also provide room for the console-to-amplifier cable. The speakers also have cable storage space. This entire system can easily be

carried in a station wagon and it can be set up in minutes.

## Accessories

Many accessories and techniques are available for advanced sound reinforcement systems. A brief description of some of these is included, but a detailed study is beyond the scope of this article. A real-time spectrum analyzer is a tool that greatly simplifies the equalization of a room. When used with a calibrated test microphone and a pink noise generator, the real-time analyzer displays the average energy in each fractional octave band of the sound field produced by the speaker system at the location of the test microphone. A perfectly flat system equalization would appear as a straight line across the display of the real-time analyzer.

In large halls, speakers are placed in different locations throughout the hall to form a distributed speaker system. A 70.7-volt power amplifier is used to keep power losses in the speaker lines to a minimum. At the speaker, this higher voltage is coupled through a matching transformer to drive the low impedance speakers. In these systems, electronic (digital) delay devices can be used to reduce echoes.

Microphone placement for stage musicals and theatrical productions has always been a perplexing problem. The stage-mounted microphone stand shown in Fig. 9 aids distant sound pickup on a hard-surfaced stage. By keeping the microphone close to the stage floor, phase

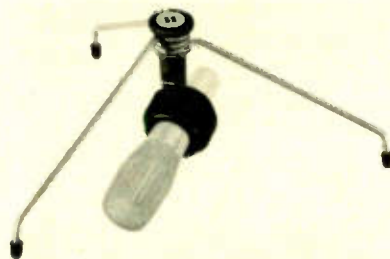

FIG. 9 — STAGE-MOUNTED MICROPHONE provides superior sound pick-up on hard-surfaced stages.

cancellation due to reflected sound is minimized; this results in a greater output level and frequency response. In addition, the stage-mounted microphone stand can be hidden along the stage apron or behind footlighting.

For special effects, tape echo units, tape and digital delay devices, limiters or compressors, balanced modulators, electronic phasing (flanging) effect devices and keyboard synthesizers are sometimes interfaced with the sound system. The majority of these devices are electrically unbalanced and designed to interface with the audio console at an output level approximately 0.5 volts. To accommodate the input and output of these accessories, the console should have a pair of "link jacks" that break into the console signal path at the correct level. Tape recorders and synthesizers can be plugged into the console's auxiliary inputs directly, and balanced line-level equipment can be used on the line-level output of the console to drive power amplifiers. R-E

## R-E TESTS SANSUI QRX-6001

(continued from page 34)

"open circuit," referenced to maximum input sensitivity. The 63 dB measurement under these circumstances, is a highly acceptable hum and noise figure. Overall, the amplifier section is somewhat more conservative in design and ratings than the tuner section, and both the matrix and CD-4 circuitry performs well. Our amplifier section rating, therefore, moves up to the "very good" classification.

## Utilization and listening tests

Controls are easy to use, and only a few minutes of familiarization with the front panel is required by anyone confronted with the receiver. The instruction manual is well written and includes many illustrations. We appreciated the "click stop" positions of the tone and balance controls that enabled us to return to preferred settings easily. Most of our listening test was confined to playing QS and SQ encoded discs, with a sprinkling of CD-4 discs thrown in. The QS Variomatrix system is an outstanding technological achievement—and works well for quadriphonic FM broadcasts as well as for QS encoded records. Two FM stations in our listening area use the QS encoding system, and listening to them over a set designed specifically for this format was a revelation.

As for the audio amplifier section, the low damping factor seemed to have no degrading effect on the bass we heard, and power output was more than adequate for our high-efficiency floor standing speaker systems, both in stereo and in 4-channel listening. Bear in mind that the Sansui QRX-600 does not include the so-called "strapping" or paralleling feature common to other 2/4-channel receivers. For this reason, it should be considered only by those who plan to equip their listening rooms with four speakers at the outset.

Our capsule summary, along with overall comments, is tabulated in Table III. We encountered no unusual heat problems when operating the QRX-6001 receiver over extended periods of time for high-level musical listening. The receiver also withstood its pre-conditioning tests at one-third continuous power output for one hour. Limited test time precludes our making a statement regarding long-term reliability and service-free performance. However, the physical layout, construction and short-term performance would indicate that the receiver is conservatively and well designed from this point of view as well. R-E





# R-E's Service Clinic

## High-voltage hold-down circuits

Part III:  
These circuits can produce  
some strange reactions

by JACK DARR  
SERVICE EDITOR

HERE IS THE CONCLUDING PART IN THIS series of articles describing the new high-voltage hold-down circuits. The RCA and Zenith circuits are covered.

Zenith's 25CC55 power supply chassis uses a limit-switch transistor and circuit for the hold-down function. Figure 6 shows this circuit. A special polarized neon lamp is connected into the base return of the limit-switch transistor Q209. A pulse from the flyback is fed to the anode of diode CR210, charging the 0.47- $\mu$ F capacitor, C242. If the pulses are within a safe operating limit, the capacitor will not take enough charge to allow the neon lamp to fire.

If the pulse voltage rises, indicating more output from the flyback and more high voltage, the charge on the capacitor goes high enough to let the neon lamp fire. The charge on the capacitor will hold the neon on (firing continuously) between flyback pulses. Once this lamp

The collector of the limit-switch transistor is directly connected to the anode of CR214, in the 24-volt regulator transistor base. So, the voltage drop from

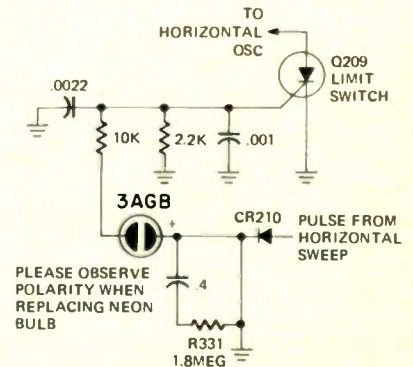

FIG. 7—LIMIT SWITCH IN 25DC57, with an SCR instead of the 25CC55's transistor.

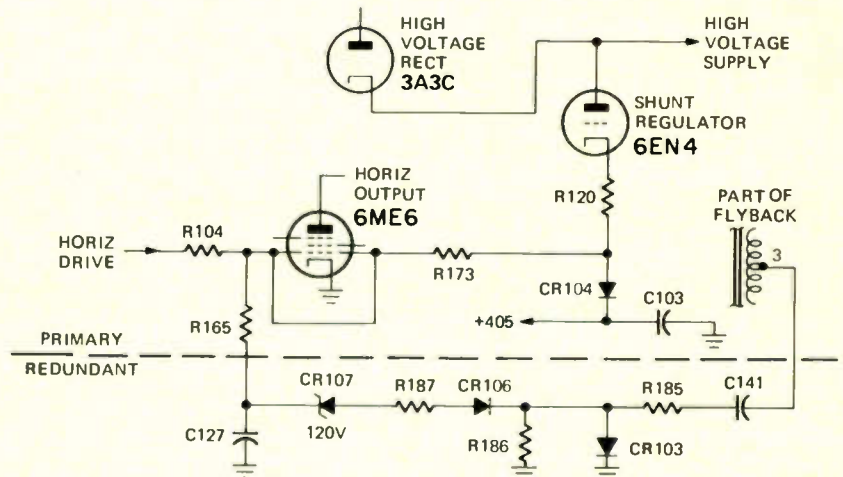

FIG. 8—THE REDUNDANT REGULATOR principle, found in RCA CTC 39 and CTC 50.

fires, it alters the base voltage of the limit-switch transistor, which goes into heavy conduction. With its emitter grounded, the collector voltage drops sharply when the transistor is in saturation.

the limit-switch transistor action turns off the 24-volt regulator transistor. It stops conducting (becomes an open circuit). The collector of the limit-switch transistor is the voltage source for the video module, as well as the I.F. and tuner AGC. In heavy conduction, this voltage drop practically kills the picture, due to the AGC action. The raster will stay on, but no picture or sound.

In the later model 25DC57's, the reaction is the same; the transistor limit-switch has been replaced by an SCR (Fig. 7). Although the operation is the same, now the limit-switch SCR's anode feeds the horizontal oscillator. When it fires, the voltage drop turns off the horizontal oscillator and the HV. You lose the raster, of course. The reaction and symptoms of the SCR circuit is slightly different. If it is fired by a rise in HV, or accidentally fired by a line surge or

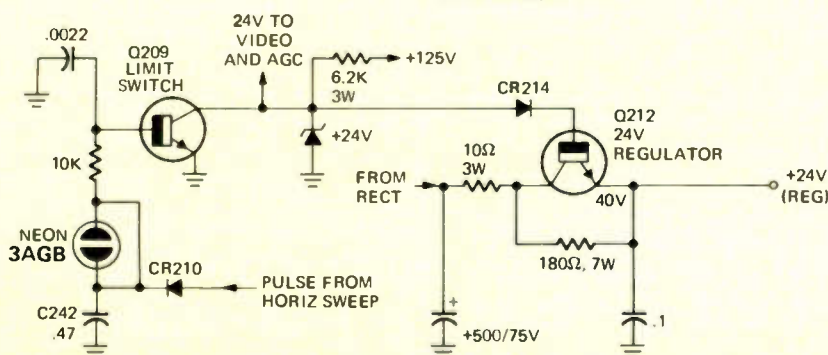

FIG. 6—ZENITH 25CC55 HAS LIMIT switch transistor for high-voltage hold-down.



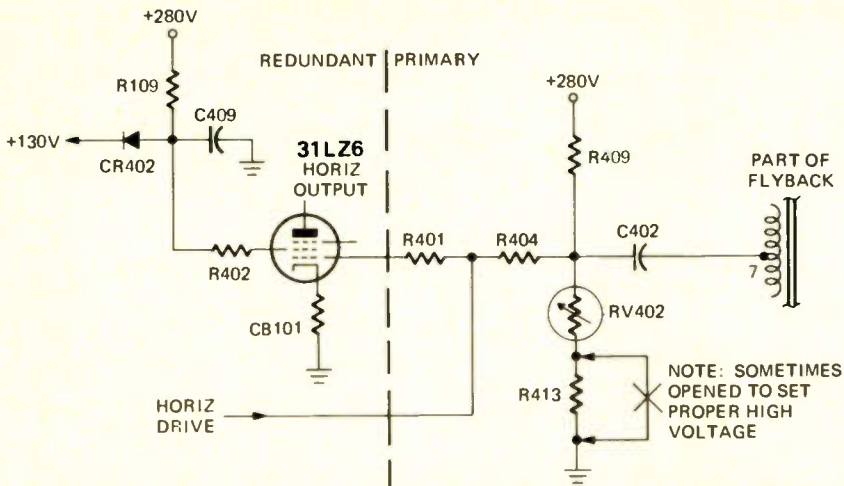

FIG. 9—REDUNDANT HV REGULATOR in screen-grid circuit, RCA CTC 51 and similar.

arc, the TV will be turned off. To check for this, turn the switch off and wait for about 10 seconds. This allows the charge on the capacitor to leak off. If the "trip" was accidental, the receiver will come on again as it should.

The neon lamp gives a good indication of what has happened. If it's lit, this shows that the limit switch has been tripped (in either circuit). Try turning the power off and waiting the 10-second period. If the set won't come on when the switch is turned on, then you check out the HV and horizontal sweep circuits, plus the regulator and limit switch. The neon lamp is a very special polarized type. Use only exact duplicates for replacements, and when you install it be sure it's properly polarized!

### Redundant regulators

In such sets as RCA's CTC39, CTC50, and later ones, you'll find the redundant-regulator system in use. This is the "triple-threat" type I mentioned in the beginning. Figure 8 shows the basic circuit. As you can see, it has a "stock" shunt regulator (that's one) the diode in its cathode (that's two) and a spare that goes into action if the first two fail! The primary regulator circuit is the same as that explained before.

The redundant regulator is below the dashed line. A pulse from the flyback is fed through C141 and R185 to shunt diode CR103. This diode acts as a clamp to hold the voltage to a certain negative level. If the flyback pulse rises in amplitude, raising the HV output, the 120-volt Zener diode CR107 conducts. This charges the filter circuit capacitor, C127. The higher negative voltage is fed through R165 to the 6ME6 control grid, reducing the output.

The part numbers shown in Fig. 8 are those used in the RCA schematic of the CTC39. The CTC50 circuit is exactly the same, but part numbers are different.

To check either circuit, read the DC voltage on the junction of R165 and CR107. In the CTC-39, this should be  $-78 \text{ volts} \pm 10 \text{ volts}$ . In the CTC50, (the parts will be R106 and CR105), the DC voltage will be  $-63 \text{ volts} \pm 7 \text{ volts}$ . If this voltage is out of limits, high, look for trouble in the HV circuitry. If it is too low, check the redundant-regulator circuitry.

### Redundant screen regulator

The CTC51, 52, 53 and 55 RCA's use a slightly different type of redundant regulator, with a novel effect. Figure 9 shows the circuit. The operation of the primary regulators is just the same, though part numbers will differ. For this, the pulse is fed to the VDR, RV402, which develops a negative grid voltage as before.

The redundant regulator is applied in the screen grid circuit of the 31LZ6. The clamp diode CR402 sets the screen grid voltage at +130V. It also connects the big filter capacitor of the +130-volt source to the screen for bypassing. C409 looks like a screen bypass, but it is a very small unit.

Circle 18 on reader service card



If the primary regulator circuit goes out, letting the output rise, this causes the horizontal output tube to draw more screen-grid current. This drops the screen-grid voltage. Diode CR402 turns off, being reverse-biased. The main effect of this is to disconnect the filter capacitors from the 31LZ6's screen grid circuit! An unbypassed screen grid causes heavy degeneration, and reduces the gain of a tube. (Like the old radios with an open screen bypass!) So, the flyback drive is reduced, and the HV held within safe limits.

To check the operation of this type of regulator, turn the set off. Temporarily connect a 6,800-ohm, 5-watt resistor from the 31LZ6 control grid to ground. This is Point F on the PW-400 board. Connect a DC voltmeter from the screen grid to ground, and turn the set on. Screen grid voltage must not read more than +95 DC. If it's higher than that, check the dropping resistor R109, 12,000 ohms 4-watts, to see if it has been burned or dropped in value. (When you finish, be sure to take the shunt resistor off the control grid!)

#### Summation

As you can see, there are several different types of these circuits. You will see quite a few different reactions and symptoms. You will probably run into slightly different versions in other sets, but if you remember the purpose of the things, they won't be hard to diagnose and repair.

The most important thing, to me, is to remember that they're there! In a lot of cases, troubles in the redundant regulator and similar circuits could cause an unwary technician to replace flybacks, yokes, and so on, only to find that he still had the same trouble he had when he started. This is embarrassing (and I'm not going to tell you how I get information like that!) Seriously, your best source of data on the use of these circuits is the factory service meetings and factory service literature. Check as much of this as you can, and it'll go a long way toward keeping you out of unnecessary trouble. This we can live without—we've got enough as it is! **R-E**



"Yes, Fred still tries to fix our TV. How'd you guess?"

now available for the telephone experimenter

## COMPLETE CONSTRUCTION PLANS

TELEPHONE PLANS \$3.00 each.  
Answering Device, Automatic Dialer, "Black Box", Call Inverter, Call Limiter, Conference Bridge, Central Dial Exchange, Melodic Ringing Generator, Recorder-Actuator, Remote Control, Schematics, Speakerphone, Teletalk Burglar Alarm, Voice Scrambler, Dial/Tone Converter, Tone/Dial Converter.  
MISCELLANEOUS PLANS \$2.00 each.  
Bifedback Limiter, Multifrequency Encoder Network, Horticulture Stimulator, Indecadron Speaker Enclosure, Photographic Pinhole Camera

ALL OF THE CONSTRUCTION PLANS ABOVE: \$24.95 AIRMAILED

LEARN THE SECRETS OF YOUR TELEPHONE



Have you ever wondered what lies behind that telephone dial? Now you can learn the tricks of the telephone trade. Get the inside story of telephone systems—their quirks and flaws, and remain up to date on vital occurrences within the telephone industry. TELEPHONE ELECTRONICS LINE is a publication designed for the telephone enthusiast. Phone "Tweak" and experiments, containing interesting articles which offer a wealth of hard-to-find information. Technical theory is also discussed, among the following items: **Current News Items • Code Numbers Illustrations • Games • Facts • Plans Projects • History • Comics • Stories Facts previously Tel. Co. confidential is now published in TEL!**

One year subscription rate: United States \$8.00, Canadian & foreign \$10.00.

ALL OF THE CONSTRUCTION PLANS ABOVE PLUS A ONE YEAR SUBSCRIPTION TO TELEPHONE ELECTRONICS LINE: \$24.95 AIRMAILED

## THE LEGAL ASPECTS OF INTERCONNECTION

The complete reference book to your LEGAL RIGHTS as a telephone subscriber. Study toll evasion, tariffs, wiretapping, customer provided equipment, and many more!

ALL OF THE CONSTRUCTION PLANS ABOVE AND A ONE YEAR SUBSCRIPTION TO TEL PLUS "THE LEGAL ASPECTS OF INTERCONNECTION" \$49.00 AIRMAILED

TELETRONICS COMPANY OF AMERICA  
22035 BURBANK BLVD., WOODLAND HILLS CA 91364 USA

Circle 19 on reader service card

## You don't have to buy a new car to get an electronic ignition.



Most of you know the evaluation of automotive electrical systems . . . an evaluation characterized only occasionally by efficiency and performance. I know that, and that's why I use the Delta Mark Ten B CDI on all my cars, new and old. And believe me, you don't have to have a new car to appreciate the best electronic ignition available today. Study these features and you'll know what I mean.

1. Mark Ten and Mark Ten B Capacitive Discharge Ignition Systems are manufactured by Delta Products, Inc., a company with a conscience, and with a proven record of reliability both in product and in customer relations.
2. The Mark Ten CDI's really do save money by eliminating the need for 2 out of 3 tune-ups. Figure it out for yourself. The first tune-up or two saved pays for the unit, the rest is money in your pocket. No bunk!
3. Because the Mark Ten CDI's keep your car in better tune, you actually can save on expensive gasoline.
4. With a Mark Ten, spark plugs stay clean and last longer . . . fouling is virtually eliminated.



No matter what kind of car you drive, it too can use a Delta quality lift.

I want to know more about Mark Ten B CDI's. Send me complete no-nonsense information on how they can improve the performance of my car.

Name \_\_\_\_\_  
Address \_\_\_\_\_  
City \_\_\_\_\_ State \_\_\_\_\_ Zip \_\_\_\_\_



**DELTA PRODUCTS, INC.**

P.O. Box 1147, Dept. RE, Grand Junction, Colo. 81501  
303-242-9000

Mark Ten B, assembled . . . . .	\$64.95 ppd	Standard Mark Ten, assembled . . . . .	\$49.95 ppd
Mark Ten B, kit . . . . .	\$49.95 ppd	Deltakit® . . . . .	\$34.95 ppd

Circle 20 on reader service card



## INDUSTRIAL TEST EQUIPMENT

(continued from page 41)

with the press-to-read button, which has a lock-on position.

Figure 17 shows the Simpson Model 229 Series 2 AC Leakage Current Tester. It can read potential leakages that might be dangerous to the user. This could be a production-line tester or used in large shops.

The Simpson Electric Co. has two Insulation Testers; these are their Models 400 and 401. Both are powered by self-contained batteries. The only difference is in the test voltage range. The Model 400 tests up to 500 volts, and the Model 401 up to 1,000 volts. Each has ohm-



16

meter ranges from 0-0.4 ohm up to 200 megohms, in three ranges. To save the batteries, they are turned on only when



17

the button on the probe is pushed. The probe also has a light built into the tip, so that you can see the point you're checking!

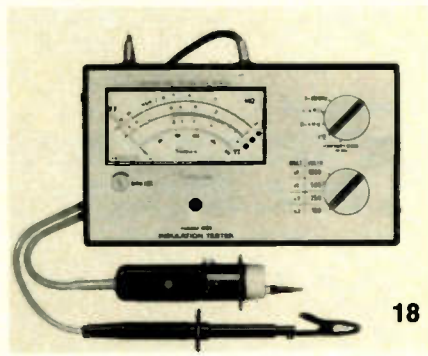

18

## BARGAIN BONANZA

OF

## EDLIE

HIGHEST QUALITY

## KITS

ONLY NEW PRODUCTS

- (D175) 70 1/2w CARBON RESISTORS \$1.00  
Asst. values. Some 5%.
- (D154) 150 CUT LEAD RESISTORS \$1.00  
Carbon, all leads long enough for soldering.
- (D149) 20 POLYSTYRENE TOP GRADE CAPACITORS \$1.00  
Popular sizes.
- (D253) 7 AMP POWER TRANSISTOR \$1.49  
Si NPN. Similar to SK3054. 90v, 90w.
- (D132) 20 DUAL POTENTIOMETERS \$1.00  
Asst. ohmages.
- (D131) 13 ELECTROLYTIC CONDENSERS \$1.00  
FP types, tubulars, some multiple sections.
- (D138) 10 SLIDE SWITCHES \$1.00  
All types: DPDT, SPST, etc.
- (D134) 8 ROTARY SWITCHES \$1.00  
Some multiple gang.
- (D125) 4 TRANSFORMERS \$1.00  
Some power, filament, output, worth up to \$10 each.
- (D144) TRANSISTOR REPAIR KIT \$1.19  
Various parts used to repair transistorized devices.
- (D137) 10 INSTRUMENT KNOBS \$1.00  
Made by Rathenon, etc. With set screws.
- (D164) 4 ROLLS OF WIRE \$1.00  
Approx. 25 ft. per roll, 20-28ga.
- (D148) 4 ROCKER SWITCHES \$1.00  
Assorted.

### LED's — IC's

- (DCT7001) CLOCK \$5.95  
Alarm & date. With data.
- (DMM5314) CLOCK \$4.95  
6 digit, hold count, w/data.
- (D8038) VOLT. CONT. OSC. \$4.95  
With data.
- (DLM309K) 5 volt lamp REGULATOR \$1.35
- (D293) SEVEN SEGMENT LED's \$1.00  
14 pin DIP guar.
- (D102) CALCULATOR KEYBOARD \$3.95  
Wild Rover C-1380. Can be used with CT5001. 4 function, clear, clear entry and constant.
- (D223) 10 ASST. LED's guaranteed \$1.00
- (D242) 3 LED's Yellow or green (specify) guar.
- (D001) 5 RED LED's guaranteed \$1.00
- (DLSS32) 10 ZENER DIODES \$1.19  
1w, 3-30v, under 1v forward characteristic.

- (D141) 6 RCA JACK STRIPS \$1.00  
From 2-6 per strip.
- (D142) 50 PRECISION RESISTORS \$1.00  
All 1%, 1/2w and 1w, low and high ohmages.
- (D128) 13 MINIATURE ELECTROLYTIC CAPACITORS \$1.00  
Axial & upright, popular values.
- (D150) 15 HI-FI KNOBS \$1.00  
Every one superb! Purchased from Harmon Kardon, Fisher, etc.
- (D156) 60 DISC CAPACITORS \$1.00  
Asst. from .0001 to .1, most 600v, Z5U, NPO, N750, etc.
- (D147) 4 lb. GRAB BAG SPECIAL \$1.00  
Full of exotic and exciting electronics parts.
- (D155) TUBE BONANZA! \$1.00  
20 asst. popular tubes, untested.

**MONEY BACK GUARANTEE**  
Terms: Minimum order \$4.00. Include postage. Either full payment with order or 20% deposit, balance C.O.D.

**WRITE FOR FREE VALUE PACKED CATALOG**  
Listing thousands of components, tubes, transistors, IC's, kits, test equipment.

**BONUS FREE CAPACITOR KIT**  
With Every \$5 Purchase

### SURPLUS TUBES

All guaranteed for 1 full year.

ANY 3 FOR \$1.25

Acquired from U.S. Defense depots or removed from equipment (new and used). These are laboratory tested and guaranteed for one full year. Most are of such standard makers as RCA, GE, etc.

- |      |       |      |        |
|------|-------|------|--------|
| 3A3  | 6AQ5  | 6DE4 | 6X4    |
| 3AF4 | 6AQ7  | 6DR7 | 10EW7  |
| 3BN6 | 6AT6  | 6DW4 | 12AE7  |
| 3DG4 | 6AU6  | 6EA8 | 12AL5  |
| 3EJ7 | 6AV6  | 6EB8 | 12AL11 |
| 3KT6 | 6AV11 | 6EJ7 | 12AT7  |
| 3Q4  | 6AX4  | 6EM7 | 12AU7  |
| 4BC5 | 6AX5  | 6ER5 | 12AV6  |
| 4BN6 | 6AY3  | 6EY6 | 12BE6  |
| 4BU8 | 6AY11 | 6GF7 | 12BH7  |
| 4BZ7 | 6BA6  | 6GH8 | 12C8   |
| 4CY5 | 6BG6  | 6GN8 | 17JZ8  |
| 4HA5 | 6BJ8  | 6GU7 | 18FW6  |
| 5V6  | 6BQ6  | 6K6  | 21KQ6  |
| 5Y3  | 6BZ6  | 6K11 | 25L6   |
| 6AC7 | 6CB6  | 6LB6 | 35EH5  |
| 6AF4 | 6CG7  | 6SN7 | 35Z5   |
| 6AG5 | 6CL6  | 6T8  | 36AM3  |
| 6AG7 | 6CM7  | 6V6  | 50A5   |
| 6AL5 | 6DA4  | 6W4  | 50L6   |

- (D140) TAPE RECORDER SPARE PARTS KIT \$2.95  
Parts for repairing most tape recorders: capacitors, meter, pilot lamp, jacks, and MUCH MORE.
- (D167) 10 MINIATURE POTENTIOMETERS \$1.00  
For transistor applications.
- (D145) 50 TIE LUGS \$1.00  
From 2 lugs up.
- (D182) 2 TUNING METERS \$1.00  
Misc., miniature.
- (D222) 20 DIODES \$1.00  
1A 50PIV. Epoxy, guar.
- (D126) 10 HUM BALANCERS \$1.00  
Asst. values.
- (D575) BATTERY CLIPS \$1.15  
For stand. 9v battery.
- (D1094) DISPENSER PACK SOLDER \$1.00  
60/40 Rosin Core, .04" x 110".
- (D174) 20 SCREW TERMINAL BOARDS \$1.00  
Speaker type, from 2-8 term.
- (D136) 50 RADIO KNOBS \$1.00  
Asst. shapes, sizes, colors.
- (D181) 8 NE2 NEON LAMPS \$1.00  
With pigtail leads.
- (D377) SMALL PHONO ARM \$9.99  
Complete with cartridge. Used in many children's phonos.
- (D005) 50 FEET SHIELDED CABLE \$1.00
- (D006) SHIELDED WIRE KIT \$1.00  
10 pcs. of heavy gauge 28" cable.

## FREE catalog over 2000

unique tools, handy kits, precision instruments, technical supplies.



Our 23rd year of service to the World's finest craftsmen and technicians.

A carefully selected and tested assortment of unique, hard-to-find tools, clever gadgets, precision instruments, bargain kits. One-stop shopping for the technician, craftsman, hobbyist, lab specialist, production supervisor. Many tools and measuring instruments available nowhere else. One of the most unusual and complete tool catalogs anywhere. Get your copy of the NC FLASHER today.

**National Camera** 2000 West Union Ave. Dept. GBA  
Englewood, Colorado, 80110  
Phone (303) 749-1893



Figure 19 shows an interesting instrument. It is the Simpson Model 410 Photo-Tachometer. No physical contact with rotating machinery is needed. A white (or black) mark is placed on the flywheel, gear, or whatever is to be

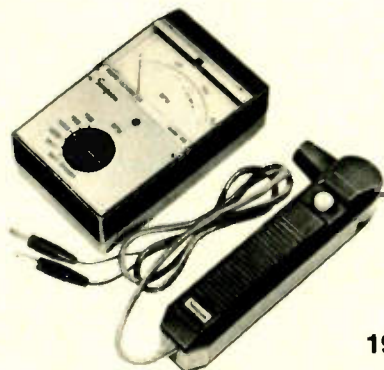

19

checked. The probe is held near the moving object; it can operate up to 12 inches away under the right conditions. It has a built in light and a photo-detector. Speed is read out directly on the multi-range meter.

Figure 20 shows the Simpson Model 886 Sound Level Meter, in its carrying case with all of the accessories needed. The round thing at the left is a calibra-



20

tor. This is held over the end of the Sound-Level meter, and provides a calibrated sound-source for accurate measurements. This kind of thing is often



21

needed to make checks required by OSHA for ambient noise-levels in plants, etc. (Rock bands not included. After all, it only goes to 140 dB!) Note the special "OSHA" calibration on the dial.

(to page 86)

# Now...the most enjoyable do-it-yourself project of your life—a Schober Electronic Organ!

You'll never reap greater reward, more fun and proud accomplishment, more benefit for the whole family, than by assembling your own Schober Electronic Organ.

You need no knowledge of electronics, wood-work or music. Schober's complete kits and crystal-clear instructions show you—whoever you are, whatever your skill (or lack of it)—how to turn the hundreds of quality parts into one of the world's most beautiful, most musical organs, worth up to twice the cost of the kit.

Five superb models with kit prices from \$575 to around \$2,300, each an authentic musical instrument actually superior to most you see in stores, easy for any musically minded adult to learn to play, yet completely satisfying for the accomplished professional. And there are accessories you can add any time after your organ is finished—lifelike big auditorium reverberation, automatic rhythm, presets, chimes, and more.

Join the thousands of Schober Organ builders who live in every state of the Union. Often starting without technical or music skills, they have the time of their lives—first assembling, then learning to play the modern King of Instruments through our superlative instructions and playing courses.

Get the full story FREE by mailing the coupon TODAY for the big Schober color catalog, with all the fascinating details!



Circle 22 on reader service card

The Schober Organ Corp., Dept. RE-140  
43 West 61st Street, New York, N. Y. 10023

- Please send me Schober Organ Catalog.  
 Enclosed please find \$1.00 for 12-inch L.P. record of Schober Organ music.

NAME \_\_\_\_\_  
ADDRESS \_\_\_\_\_  
CITY \_\_\_\_\_ STATE \_\_\_\_\_ ZIP \_\_\_\_\_

## GET YOUR ALL NEW, BIG 1975 TV TECH AID COLOR TV BOOK



- Brand new, all-in-one book. Over 500 trouble shooting tech-tips.
- Covers all leading manufacturers, Admiral, Emerson, GE, Magnavox, Motorola, Panasonic, Philco, RCA, Silvertone, Sony, Sylvania and many others.
- Full schematic diagrams help you find symptoms, cause and cure of recurring troubles in all types of situations.
- Saves you time and money.

### BACK ISSUES: GET 'EM WHILE THEY LAST!! SPECIAL REDUCED RATES

- PLEASE SEND:
- |  |  |  |
|--|--|--|
| <input type="checkbox"/> 1970 Book Form \$3.00             | <input type="checkbox"/> 1971 12 Issues \$3.00 | <input type="checkbox"/> 1973 12 Issues \$3.00 |
| <input type="checkbox"/> 1971 B&W Book \$3.00              | <input type="checkbox"/> 1972 12 Issues \$3.00 | <input type="checkbox"/> 1974 12 Issues \$5.95 |
| <input type="checkbox"/> 1975 All New Color TV Book \$7.95 |  |  |

MAIL CHECK OR MONEY ORDER TO:

### TV TECH AID

P.O. Box 603  
Kings Park, N.Y. 11754

ES12

Name \_\_\_\_\_  
Address \_\_\_\_\_  
City \_\_\_\_\_  
State \_\_\_\_\_ Zip \_\_\_\_\_

Circle 23 on reader service card



# FREE EICO CATALOG

## 346 Ways To Save On Instruments, Burglar Alarms, Automotive & Hobby Electronics!

The more you know about electronics, the more you'll appreciate EICO. We have a wide range of products for you to choose from, each designed to provide you with the most pleasure and quality performance for your money. The fact that more than 3 million EICO products are in use attests to their quality and performance.

**"Build-it-Yourself" and save up to 50% with our famous electronic kits.**

For latest EICO Catalog on Test Instruments, Automotive and Hobby Electronics, Eicocraft Project kits, Burglar-Fire Alarm Systems and name of nearest EICO Distributor, check reader service card or send 50¢ for fast first class mail service.

EICO—283 Malta Street,  
Brooklyn, N.Y. 11207

Leadership in creative electronics  
since 1945.



Circle 24 on reader service card

# new products

More information on new products is available from the manufacturers of items identified by a Reader Service number. Use the Reader Service Card inside the back cover.

**DIGITAL MULTIMETER, model 21** measures capacitance, AC volts, DC volts and resistance. Palm-sized unit has 4 DC ranges with 1-mV resolution; 4 AC ranges with 1-mV res-



olution; 4 resistance ranges with 1-ohm resolution and 4 capacitance ranges with 1-pF resolution. 3½-digit 0.027-inch LED readout (up to 2000 counts); simplified five-step calibration. Powered by 4 rechargeable NiCad batteries. \$269.00 with battery charger and belt carrying case.—Data Technology Corp., 2700 South Fairview, Santa Ana, CA.

Circle 31 on reader service card

**TRIODE, model DX-475.** Water-cooled triode is used in industrial RF generators. Metal ceramic envelope construction permits high processing temperatures that yield better outgassing and higher maximum seal temperatures. Helical water cool-

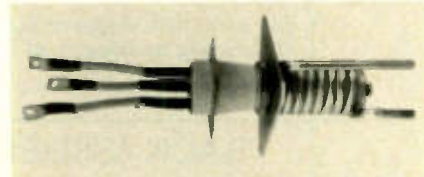

ing coil is an integral part of the tube anode. The "K" grid provides a safety factor in grid dissipation.

Other features include an integral grid connector, anode mounting and flexible filament leads for elimination of accessory hardware and ease of installation. Unit is rated at 20 kW input and 10 kW plate dissipation. — Ampere Electronic Corp., 230 Duffy Avenue, Hicksville, NY 11802.

Circle 32 on reader service card

**ELECTRONIC CROSSOVER NETWORK, model SF-850.** For use in bi-amp or tri-amp high-fidelity component systems. Solid-state

unit provides ten different crossover points for low- and mid- and high-frequency driver elements with each range level adjustable to meet the needs of speaker elements and listening room.

Crossover frequencies: 125 Hz, 250 Hz, 500 Hz, 700 Hz, 1 kHz, 2 kHz, 4 kHz, 6 kHz, 8 kHz. Variable slope for each crossover



point. Cut-off slopes are 6 dB/octave, 12 dB/octave or 18 dB/octave. Less than 0.3% harmonic distortion; signal-to-noise ratio greater than 85 dB. Power requirements are 120 V, 50-60 Hz, 5 watts. 13¼ × 5½ × 13 in.; 12 lbs. 6 oz.; \$199.95. — U.S. Pioneer Electronics Corp., 75 Oxford Drive, Moonachie, NJ 07074.

Circle 33 on reader service card

**PA AMPLIFIERS, CHS-A Series.** Four amplifiers incorporate an electronic compressor and have facilities for connecting reverberation unit or acoustic equalizer unit.

Model CHS-20A is rated at 20 watts and comes equipped with one high- or low-impedance unbalanced microphone input and two high-impedance high-level auxiliary



inputs. Each input has a separate volume control plus master volume and tone controls, compression switch, power switch and pilot light. Models CHS-35A, CHS-60A and CHS-100A are all similar except for their power ratings which are 35, 60 and 100 watts, respectively. They have two high or low impedance unbalanced microphone inputs and two high-impedance high-level auxiliary inputs, each with volume control, plus master volume and tone controls, compression switch, power switch and pilot light. — Lear Siegler Inc., Bogen Div., P.O. Box 500, Paramus, NJ 07652.

Circle 34 on reader service card

**QUICK-OP, model 200-741.** Just plug in components. Solderless connectors on breadboard accept wire sizes from .010-in. to .032-in. Panel is keyed to operational amplifier action that enables circuits to be set up with component leads alone. Patch leads are rarely required when typical



leaded devices such as 1/4-watt resistors, diodes, capacitors, etc. are used. Circuit may be quickly verified; there is no clutter of rarely used or unidentified tie points.

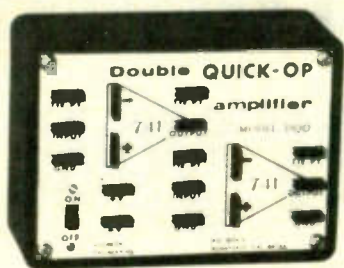

Internal operational amplifiers are mounted for easy replacement and wired for low capacitance and leakage paths. Houses two standard 9-volt transistor batteries. 2 7/8 x 4 x 1 1/8 in.; 4 1/2 oz. less batteries; \$24.95 (Initial offer).—Hildreth Engineering Co., P.O. Box 3, Sunnyvale, CA 94088.

Circle 35 on reader service card

**COMPONENT KITS**, *Interkits* offer quality electrolytic, tantalum, metalized polyester film and subminiature polyester film capacitors, carbon composition resistors, plus rectifier, Zener and switching diodes. Only one type of product is in each kit. Array of

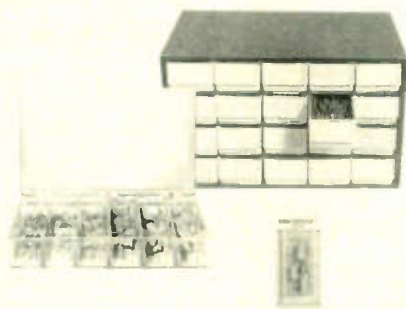

values provided permits design engineers, servicemen or hobbyists to fulfill virtually every circuit need for that type component.

Choose from 12 design engineer kits \$29.95 each; 12 service technician kits \$9.95 each; 12 hobbyists kits (blister-packed) \$2.99 each. — International Components Corp., 105 Maxess Road, Melville, NY 11746.

Circle 36 on reader service card

**SUPER CASE**, *Tools*, contains 48 professional problem-solving tools. Included are seven pliers, two wrenches, two reversible screw drivers, 13 specialty drivers, seven



hollow shaft nut drivers, four screw holding drivers, four testers, two crimping and stripping tools, plus seven unusual type

tools for specific problem-solving areas. Heavy duty attache case measures 19 x 14 x 6 in. Pallets have pockets of heavy duty, see thru-vinyl. Top section has pocket for technical manuals and bottom section has compartments for test meters and other gear.—Vaco Products Co., 510 North Dearborn Street, Chicago, IL 60610.

Circle 37 on reader service card

**ALARM CLOCK RADIO KIT**, model GR-1075. AM/FM digital electronic alarm clock radio kit reads out the time in bright orange digits that dim automatically in darkened rooms. A 24-hour alarm cycle feature allows you to go to bed at 9:00 and set the alarm for 10:00 without being awakened in an hour. Alarm can be set to go off with



a controlled volume electronic "beep" or with music from an AM or FM radio station. A 7-minute snooze cycle is repeatable for up to one hour. Another feature is an internal standby battery supply that takes over in the event of a power failure (batteries not supplied).

Solid-state circuitry—entire unit (including clock) contains four IC's, 41 transistors and 35 diodes. \$129.95.—Heath Co., Benton Harbor, MI 49022.

Circle 100 on reader service card

(continued on page 76)

## Don't cut yourself out of a career as a two-way radio technician...

MTI offers the only training for professional FM two-way radio available. Qualified technicians are employed in government, industry, and public service. But training is your key.

You could cut out a career as a two-way radio technician by cutting out this coupon. We'll send you information on how you can learn more about this specialized field, at home, for only \$345.

Name \_\_\_\_\_

Address \_\_\_\_\_

City/State/Zip \_\_\_\_\_

I am a veteran or serviceman on active duty.



formerly

**MOTOROLA TRAINING INSTITUTE**

College Hill, Summerdale, Pennsylvania 17093

Circle 26 on reader service card

# THE CURVE TRACER THAT WON'T COLLECT DUST.



The Hickok Model 440 semiconductor curve tracer is all purpose and convenient to use. It's the ideal instrument for testing, evaluating, classifying and matching all types of transistors, FET's and diodes. You'll get stable, full range dynamic displays that you can accurately scale right from the screen.

- Pull-out card for easy, fast set-up and operation.
- Set-up marks for rapid set-up of 80% of tests.
- Unique INSTA-BETA display takes the guesswork out of transistor and FET parameter measurement.
- In-or-out of circuit testing.
- A full range professional tracer at a price you can afford.

The Model 440 is the most modern, versatile tracer available. See it at your Hickok distributor or send for our technical bulletin.

**\$165<sup>00</sup>**

**HICKOK**  
the value innovator

INSTRUMENTATION & CONTROLS DIVISION  
THE HICKOK ELECTRICAL INSTRUMENT CO.  
10514 Dupont Avenue • Cleveland, Ohio 44108  
(216) 541-8060 • TWX: 810-421-8286

Circle 27 on reader service card



# The better the training the better you'll

Send for  
**FREE**  
illustrated  
career  
guide

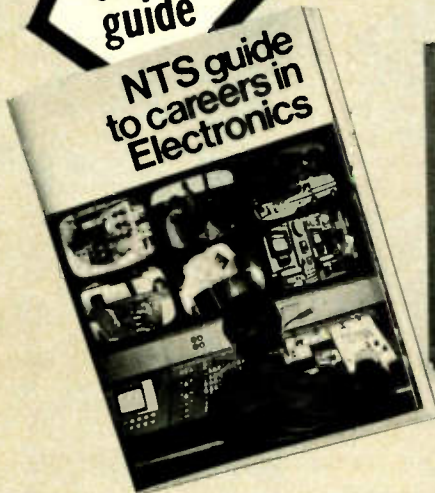

IN-CIRCUIT TRANSISTOR TESTER  
TROUBLESHOOTER  
VOM

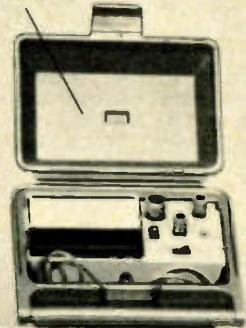
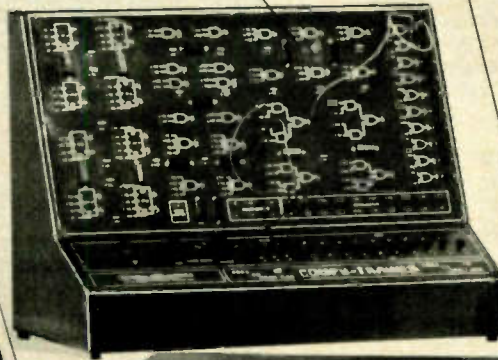

SOLID-STATE  
OSCILLOSCOPE

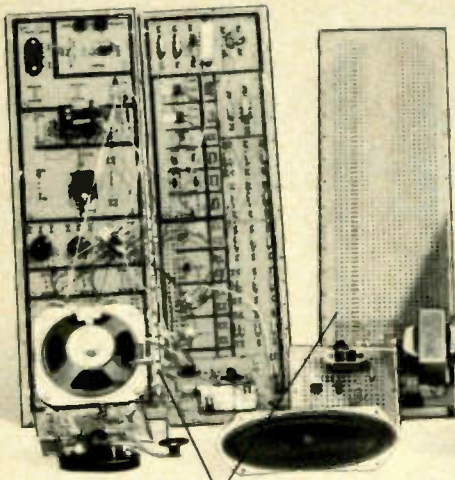

ELECTRO-LAB

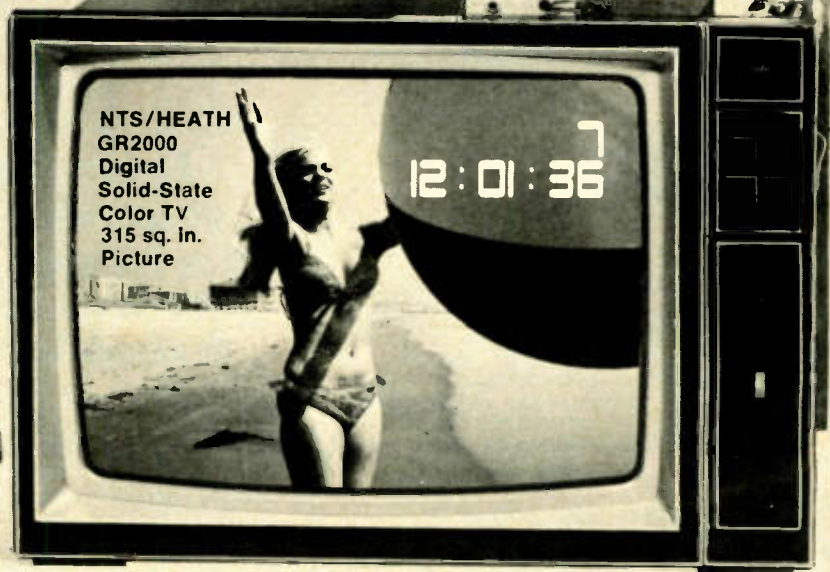

(Simulated TV Reception)

As an NTS student you'll acquire the know-how that comes with first-hand training on NTS professional equipment. **Equipment you'll build and keep.** Our courses include equipment like the **NTS/Heath Digital GR-2000 Solid State color TV** with first-ever features like silent varactor diode tuning; digital channel selection, (with optional digital clock), and big 315 sq. in. ultra-rectangular screen.

Also pictured above are other units — 5" solid state oscilloscope, vector monitor scope, solid-state stereo AM-FM receiver with twin speakers, digital multimeter, and more. It's the kind of better equipment that gets you better equipped for the electronics industry.

This electronic gear is not only designed for training; it's field-type — like you'll meet on the job, or when you're making service calls. And with NTS easy-to-read, profusely illustrated lessons you learn the theory behind these tools of the trade.

**Choose from 12 NTS courses** covering a wide range of fields in electronics, each complete with equipment, lessons, and manuals to make your training more practical and interesting.

**Compare our training; compare our lower tuition.** We employ no salesmen, pay no commissions. You receive all home-study information by mail only. All Kits, lessons, and experiments are described in full color. Most liberal refund policy and cancella-



# and the equipment be equipped.

COMPARE OUR  
KITS AND LESSONS.  
COMPARE OUR  
TUITION.

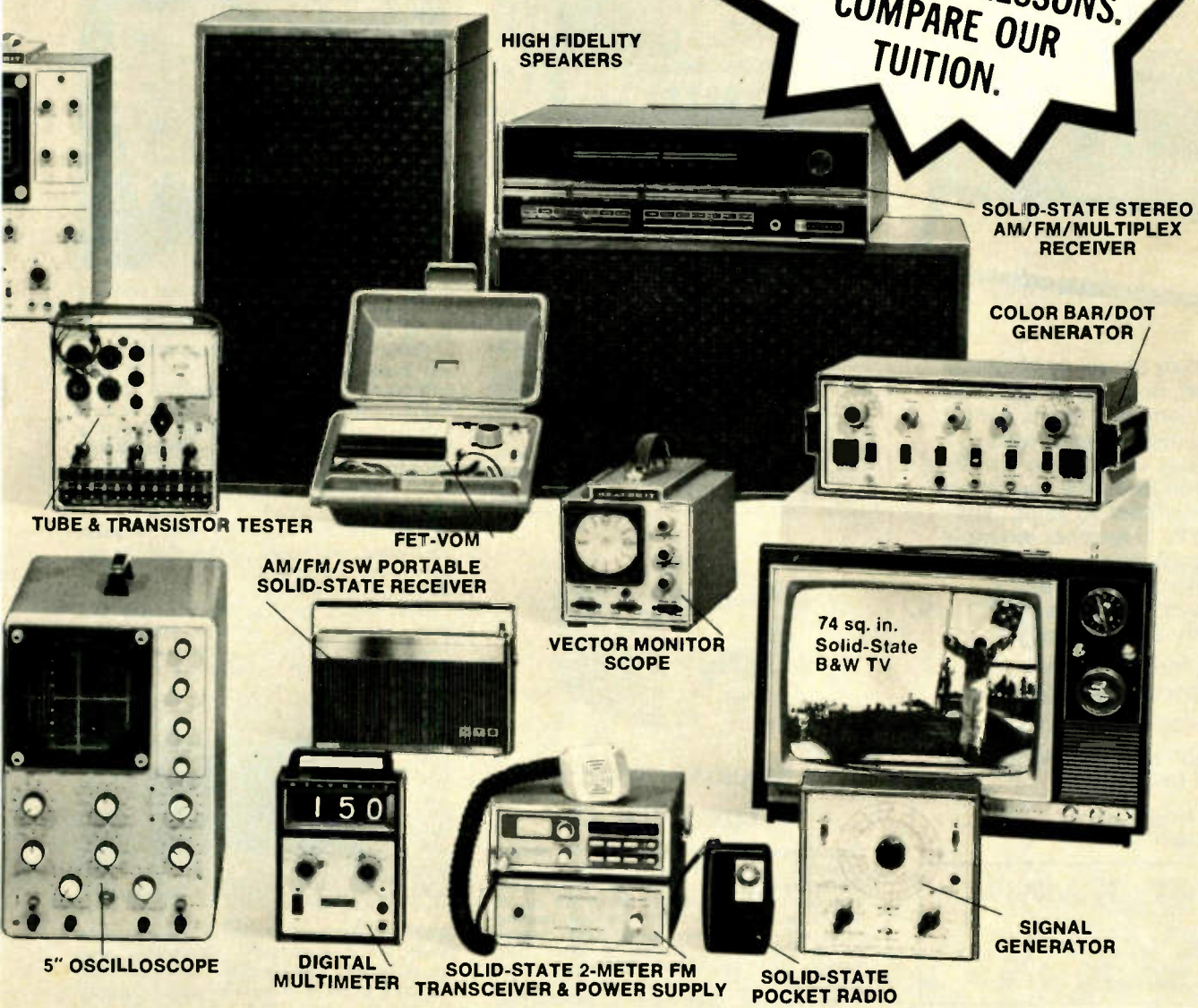

tion privileges spelled out. Make your own comparisons, your own decision. Mail card today, or clip coupon if card is missing.

**NO OBLIGATION. NO SALESMAN WILL CALL**

**APPROVED FOR VETERAN TRAINING**

Get facts on new 2-year extension

**NATIONAL TECHNICAL SCHOOLS**

TECHNICAL-TRADE TRAINING SINCE 1905  
Resident and Home-Study Schools  
4000 So. Figueroa St., Los Angeles, Calif. 90037

**NATIONAL TECHNICAL SCHOOLS** Dept. 206-075  
4000 South Figueroa St., Los Angeles, Calif. 90037  
Please send FREE Color Catalog and Sample Lesson.  
NO OBLIGATION. NO SALESMAN WILL CALL.

- |   |  |
|---|--|
| <input type="checkbox"/> Color TV Servicing           | <input type="checkbox"/> Electronics Technology      |
| <input type="checkbox"/> B & W TV and Radio Servicing | <input type="checkbox"/> Computer Electronics        |
| <input type="checkbox"/> Electronic Communications    | <input type="checkbox"/> Basic Electronics           |
| <input type="checkbox"/> FCC License Course           | <input type="checkbox"/> Audio Electronics Servicing |

NAME \_\_\_\_\_ AGE \_\_\_\_\_

ADDRESS \_\_\_\_\_ APT # \_\_\_\_\_

CITY \_\_\_\_\_ STATE \_\_\_\_\_

Please fill in Zip Code for fast service \_\_\_\_\_

- Check if interested in G.I. Bill information.  
 Check if interested ONLY in classroom training in Los Angeles.



# DIGITAL PERFORMANCE YOU CAN RELY ON.



The Hickok Model 334 DMM is a rugged, non-temperamental, hardworking tool that's easy to use and easy on your eyes. Hickok has established a unique reputation in digital electronics during the past 10 years. The Model 334 is another example of our engineering expertise — an economical lab quality instrument with exceptional durability and accuracy.

- Easy reading, green fluorescent display
- 3½ digit — auto polarity
- 26 ranges including 200 mV AC & DC ranges
- Fast response — 2.5 readings/sec

Basic Accuracies (% of reading)  
 DC Volts;  $\pm 0.2\%$  ( $\pm 0.5\%$  on 200V, 1200V ranges)  
 AC Volts;  $\pm 0.5\%$  ( $\pm 2.0\%$  on 200 mV, 2V ranges)  
 OHMS;  $\pm 0.5\%$   
 DC Current;  $\pm 1.5\%$   
 AC Current;  $\pm 2.0\%$

Ask to see the Model 334 at your Hickok distributor. It's a no compromise DMM at a price you can afford.

**\$22900**

## HICKOK

the value innovator

INSTRUMENTATION & CONTROLS DIVISION  
 THE HICKOK ELECTRICAL INSTRUMENT CO.  
 10514 Dupont Avenue • Cleveland, Ohio 44108  
 (216) 541-8060 • TWX: 810-421-8286

Circle 28 on reader service card

## NEW PRODUCTS

(continued from page 71)

**LOGIC MONITOR.** Compact, self-powered, self-contained, pocket-size unit requires no calibrations or adjustments as it simultaneously displays static and dynamic logic

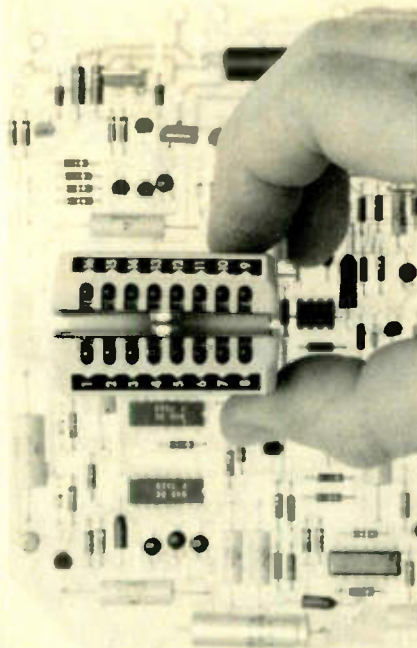

states of DTL, TTL, HTL or CMOS DIP IC's. Used for troubleshooting and signal tracing. High intensity LED's turn on when lead



## 12 REASONS YOUR CAR NEEDS TIGER CDI

Instant starting in any weather - Eliminates tune-ups - Increases gas mileage - Increases horsepower 15% - Improves acceleration and performance - Spark plugs last up to 70,000 miles - Reduces engine maintenance expense - Amplifies spark plug voltage to 45,000 volts - Maintains spark plug voltage to 10,000 RPM - Reduces exhaust emissions - Dual ignition switch - An Unconditional LIFETIME GUARANTEE - Installs in 10 minutes on any car with 12 volt negative ground - No rewiring - Most powerful, efficient and reliable Solid State Ignition made.

SATISFACTION GUARANTEED or money back

TIGER 500 assembled . . . . . \$53.95  
 TIGER SST assembled . . . . . \$42.95  
 Post Paid in U.S.A.

Send check or money order with order to:

**Tri-Star Corporation**  
 P.O. Box 1727 B  
 Grand Junction, Colorado 81501

DEALER INQUIRIES INVITED

Circle 29 on reader service card

voltages exceed the 2-volt threshold. No power supply is needed as power seeking gate network locates DIP supply leads and feeds them into the unit. 4X2X1.5 in.; \$84.95.—Continental Specialties Corp., 44 Kendall Street, Box 1942, New Haven, CT 06509.

Circle 38 on reader service card

**OSCILLOSCOPE, model 1222A.** 15-MHz dual-channel scope has built-in delay line to make visible the leading edge of traces. Gives option of viewing Channel-A with Channel-B either added or subtracted (A±B modes). Identical dual-channels provide calibrated X-Y displays. Has 3% vertical accuracy, cali-

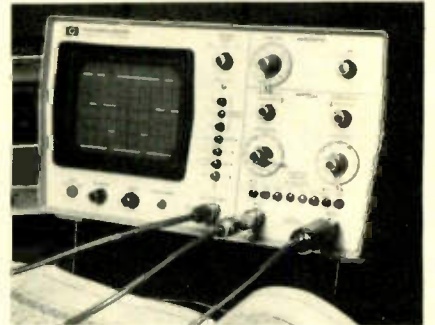

brated 8 X 10 cm display, internal graticule to eliminate parallax error, DC coupling, triggered sweep and pushbutton beam-finder.

Deflection factor is adjustable from sensitive 2 mV/cm to 10 V/cm. Built-in TV sync separation assures stable automatic triggering on frame or line for convenient TV troubleshooting. Calibrated sweep accuracy is within 4%. \$895.00—Hewlett-Packard Co., 1501 Page Mill Road, Palo Alto, CA 94304.

Circle 39 on reader service card

**ALARM SYSTEM, model 511 Alert.** Wireless, solid-state, residential alarm system for do-it-yourself installation in apartments or single family dwellings.

Dual-function unit consists of control unit that houses a radio receiver and a loud klaxon alarm; exits and entrances are protected by transmitter/magnetic sensor com-



binations; personal protection is provided by portable "panic-button" transmitters. Unit incorporates FSK coding technique that makes it virtually immune to radio frequency interference. With FSK, many radio frequency channels are available. — Linear Corp., 347 South Glasgow Avenue, Inglewood, CA 90301.

Circle 40 on reader service card

**HEAT TOOL, Heat Pen** is pneumatic flameless heat tool. Uses less than 300 watts of electricity and less than 1.5 cfm of pressurized air. Built to meet OSHA standards, no dangerous hot areas and has no motor or fan to wear out. Long-life interchangeable plug-in heating elements allow versatility by providing a range of heat from 150° to 800° F. Elements may be changed without use of tools within ten seconds.

Comes complete with 400°-600°F element, control unit with power and safety switches, baffle adapter and grounded cord



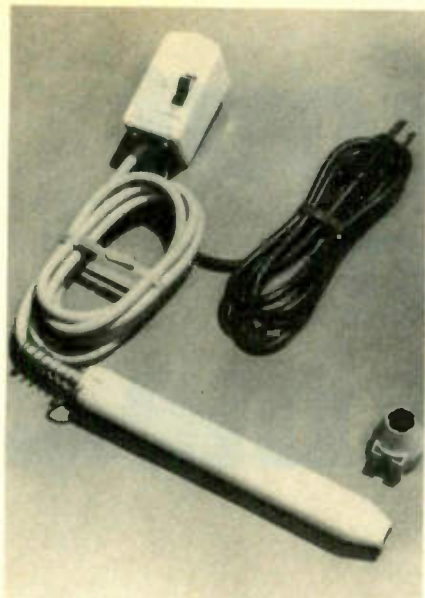

set. 5 oz.; \$79.50. Accessories include a complete line of baffles, remote foot switch, air regulators and fittings. — Instruments America, Inc., 823 N.W. 57th Street, Ft. Lauderdale, FL 33309.

Circle 41 on reader service card

**MODULATORS** add CCTV programs into master TV antenna systems or CATV systems. Designed to provide optimum performance, free of adjacent channel problems, beat and other problems associated with mixing into a system. Accept composite-video and/or audio signals. Video signals may be obtained on TV camera, video tape recorder, film chain or TV demodulator in either color or monochrome. Audio signals are derived from AM or FM tuner, tape recorder or high impedance dynamic microphone. Broadcast quality of signals occupy any one VHF TV channel from 2 to 13. May also be used as carrier-substitution generators.

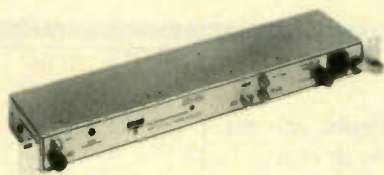

**Model AVTM 4923**, provides both modulated visual and modulated aural RF carrier output on any single VHF TV channel; can be used to put both video and audio on unused channel of MATV system or onto single TV receiver. **Model VMT 4922** provides only modulated visual RF carrier output on any single VHF channel; can be used to put video on un-used channel of MATV system or onto a single TV receiver. **Model VM 4925** is similar to **VMT 4922** with additional capability of modulating video bandwidth of up to 8 MHz wide for high resolution CCTV or modulating combined 4.5 MHz aural and video signal from a microwave down converter output. **Model AMT 4921** provides only aural RF carrier output on single VHF TV channel; can be used to put audio on unused channel of MATV system or into single receiver. — **Blonder-Tongue Laboratories, Inc.**, One Jake Brown Road, Old Bridge, NJ 08857.

Circle 42 on reader service card

**1**  
**out of**  
**2 who**  
**have it**  
**don't**  
**know**  
**it...**

**Do you?**

21 million Americans have high blood pressure. But 50 percent of those who have it, don't know it.

When blood pressure goes higher than it should, and stays high, it sets the stage for heart attack or stroke.

Most cases of high blood pressure can be controlled with drugs and other advances in treatment. That's why you should see your doctor regularly. Only he can tell if you need help.

A public service message from your Heart Association



Continued on Page 40

**You'll never know how much good you can do until you do it.**

You can help people.

In fact, there's a crying need for you. Your talents. Your training. Your concerns. They make you valuable to your business. They can make you priceless to your community.

If you can spare even a few hours a week, call the Voluntary Action Center in your town. Or write: "Volunteer," Washington, D.C. 20013.

It'll do you good to see how much good you can do.

**Volunteer.**  
The National Center for Voluntary Action

A Public Service of The Magazine & The Advertising Council



## ENJOY OLD RADIO-TV

**A FLICK OF THE SWITCH**  
your new 1930-1950 book



**A FLICK OF THE SWITCH** is your time trip through the golden days of radio broadcasting and into the dawn of television. Revisit "cathedral" radios, old Ham days and many more. Discover the rewards of collecting. Over 1,000 pictures make this book the 1930-1950 collector's reference. Order your copy of this 260-page book now! \$9.95 hard-cover, \$6.95 handbook.

Other valuable books are **Vintage Radio (1887-1929)** \$7.95 hard-cover, \$5.95 handbook; **Radio Collector's Guide (1921-1932)** \$4.95; **1927 Radio Encyclopedia** \$12.95 hard-cover, \$9.95 soft-cover; **1926-1938 Radio Diagrams** \$7.00. Also, we'll furnish any pre-1951 diagram for \$3.50.

Send today to Vintage Radio, Dep't R, Box 2045, Palos Verdes Peninsula, CA., 90274. Postage paid. Cal. residents add 6% tax.

\_\_\_\_\_ \$ \_\_\_\_\_  
\_\_\_\_\_ \$ \_\_\_\_\_  
\_\_\_\_\_ \$ \_\_\_\_\_  
**TOTAL** \_\_\_\_\_



Name \_\_\_\_\_  
Address \_\_\_\_\_  
City \_\_\_\_\_ St. \_\_\_\_\_ Zip \_\_\_\_\_

**FREE** Radio Age Guide with each order **FREE**

## VINTAGE RADIO SERIES

# EIGHT INSTRUMENTS IN ONE

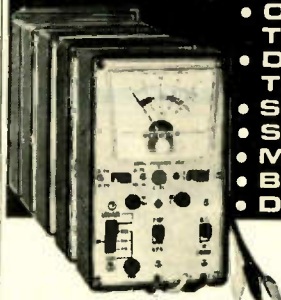

- Out-of-Circuit Transistor Analyzer
- Dynamic In-Circuit Transistor & Radio Tester
- Signal Generator
- Signal Tracer • Voltmeter
- Milliammeter
- Battery Tester
- Diode Checker

### Transistor Analyzer Model 212

Factory Wired & Tested—\$26.95  
Easy-to-Assemble Kit—\$17.95

**YOU DON'T NEED A BENCH FULL OF EQUIPMENT TO TEST TRANSISTOR RADIOS!** All the facilities you need to check the transistors themselves — and the radios or other circuits in which they are used — have been ingeniously engineered into the compact, 6-inch high case of the Model 212. It's the transistor radio troubleshooter with all the features found only in more expensive units. Find defective transistors and circuit troubles speedily with a single, streamlined instrument instead of an elaborate hook-up.

**Features:**  
Checks all transistor types — high or low power. Checks DC current gain (beta) to 200 in 3 ranges. Checks leakage. Universal test socket accepts different base configurations. Identifies unknown transistors as NPN or PNP.

Dynamic test for all transistors as signal amplifiers (oscillator check), in or out of circuit. Develops test signal for AF, IF, or RF circuits. Signal traces all circuits. Checks condition of diodes. Measures battery or other transistor-circuit power-supply voltages on 12-volt scale. No external power source needed. Measures circuit drain or other DC currents to 80 milliamperes. Supplied with three external leads for in-circuit testing and a pair of test leads for measuring voltage and current. Comes complete with instruction manual and transistor listing.

EMC, 625 Broadway, New York 12, N. Y.

Send me **FREE** catalog of the complete value-packed EMC line, and name of local distributor.

NAME \_\_\_\_\_ RE-7

ADDRESS \_\_\_\_\_

CITY \_\_\_\_\_ ZONE \_\_\_\_\_ STATE \_\_\_\_\_

# EMC

ELECTRONIC MEASUREMENTS CORP.  
625 Broadway, New York, N. Y. 10012



# You can tear out all the cards in this magazine...

# But this is the one you should mail!

---

**If you're thinking of investing your money  
in a learn-at-home program in electronics, there are  
a few things you should know first.**

---

Selecting a home electronics program isn't easy. It could be one of the most important decisions you'll ever make for your future. So you want to decide carefully and get the best education you can.

After all, you're investing your time and money, and you want a full return on that investment.

#### **What should you look for before you select a school?**

You probably want a school with a proven track record of quality and performance. You want personal attention plus, the convenience of learning at home. You want the most up-to-date technical texts... teaching aids and learning methods.

But most of all you want to actually learn what electronics is all about. Not just theory, but actual hands-on experience with the latest and best technical equipment available today!

#### **At Bell & Howell Schools, you get all that... and so much more!**

Bell & Howell Schools has been in the home-study electronics business a long time. Almost half a century. In that time, we have developed teaching techniques that provide our students with the most vital and comprehensive learning system available for at-home study.

#### **Techniques like our "step-by-step" concept of learning.**

At Bell & Howell Schools, we start you off with the basics. Then take you step by step through the learning process. You work at a comfortable pace—not too fast... not too slow. If you already have some learning or experience, we'll arrange advanced standing in the program so you can skip the beginning lessons. And don't worry if you don't have any electronics background. 25% of our graduates never



even had any electronics training before enrolling with Bell & Howell Schools. (Based on a recent survey of our graduates conducted by an independent research firm. Survey results available on request.)

### Or our system of personal contact.

No course is without its problems. And when you get hung up on a problem, you want answers and you want them fast. Here at Bell & Howell Schools, we combine the convenience and pleasure of learning at home with a system of personal contact with faculty and other students that rivals—if not beats—any other program available.

For problems that "just can't wait" we have a toll-free "hot-line" that you can call and discuss your questions with an experienced instructor. You get real attention—someone whose only job is to see to it that your individual questions are answered. And answered quickly and clearly!

To help you develop your thoughts and understand electronics principles more thoroughly, Bell & Howell Schools has developed a unique feature that no other learn-at-home program has—In-Person Help Sessions in 50 major cities throughout the United States. These let you get together with instructors and other fellow students. There you can talk shop with other people who share your interests... explore your problems further... and get additional assistance.

But that's not all that Bell & Howell Schools will do for you! In addition to our vast experience and expertise, is a philosophy that the best learning comes from working with the best equipment available. And that's exactly what our students do!

### What better way to learn electronics than to actually work with electronics equipment?

And what better way to find out how things fit together... how they work and why they work than to actually build the equipment? And we don't mean gadgets that will be worthless to you later.

We mean equipment like the Bell & Howell Schools exclusive "Electro-Lab"™ electronic training system including design console, digital multimeter and oscilloscope, that you can use professionally after you've graduated.

The design console will allow you to set up and examine circuits without having to solder them in place.

The digital multimeter measures voltage, current and resistance and displays its findings in big clear numbers for easier reading.

And the solid-state "triggered sweep" oscilloscope is similar in principle to the kind used in hospital operating rooms to monitor heartbeats. But you'll use it to monitor and analyze tiny integrated circuits. And you'll find the "triggered sweep" feature locks in signals for easier observation.

### That's not all you build when you choose a course from Bell & Howell Schools!

To learn the most advanced electronics technology, you have to work with the most advanced training tools.

So in addition to the exclusive "Electro Lab"™ system that you will build as part of Bell & Howell's Home Entertainment Electronics program, you'll also build a 25" diagonal color TV with digital features.

Sounds exciting, doesn't it? Well, digital electronics is exciting! Its growth and application are giving us new and better products and a whole new realm of split-second accuracy that was just a dream a few years ago. And this new technology is being applied more and more to TV's, clocks, radios and other home entertainment equipment.

By studying with Bell & Howell Schools—one of the first schools to introduce digital electronics as part of its training program—you can actually get in on the ground floor of this new technology while learning all the basic electronics principles and skills you'll need to detect and troubleshoot problems professionally on digital and other electronic equipment.

Make no mistake about it! As you build your digital color TV, you'll get a thorough grounding in electronics principles. You'll develop a working knowledge of "state of the art" integrated circuitry and the 100% solid-state chassis. Plus you'll actually know how to program a special automatic channel selector to skip over "dead" channels and how to build a remarkable on-the-screen digital clock that flashes the time in hours, minutes and seconds.

### But most importantly, you'll have the skills that could lead you to a brighter future...

And isn't that what education is supposed to be all about? At Bell & Howell Schools we've always thought so although no school can guarantee you a job or income opportunity. Get full details about us, our courses, our philosophy of education by mailing the postage-paid card today. If you take one of our courses for vocational purposes, this program is approved by the state approval agency for Veterans' Benefits.

Mail card today for full details!



"Electro-Lab"™ is a registered trademark of the Bell & Howell Company. Simulated TV test pattern.

If card has been removed, write:  
An Electronics Home Study School  
DEVRY INSTITUTE OF TECHNOLOGY

763/4R1



ONE OF THE  
**BELL & HOWELL SCHOOLS**

4141 Belmont, Chicago, Illinois 60641



... here Today!

# "IGNITION OF THE FUTURE" ALLISON "OPTO-ELECTRIC"

★ The BEST... the ULTIMATE...  
of ALL the Ignition Systems!

● (We challenge ANYONE  
to dispute this Fact)

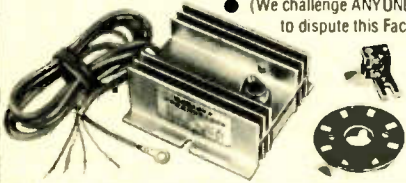

● Never wears out or needs any Maintenance!



● Does more than Pay for itself in  
GAS SAVINGS

... it gives you Maximum Power  
with continuous PEAK PERFORMANCE

... while reducing Maintenance  
and Operating Costs!



● The Allison OPTO-ELECTRIC System eliminates the Points and Condenser, replacing them with an OPTO-ELECTRONIC TRIGGER, using a Light-Emitting Diode and Photo Transistor. As there are NO moving parts in rubbing contact... Timing adjustments are PERMANENT. The only "TRUE" Electronic Ignition... that you can buy for under \$100.

● Gives 40-Times more Timing Accuracy than ANY system using "Mechanical" Breaker-Points! UNLIMITED RPM! "Electronically-Controlled" DWELL automatically supplies HIGHEST Performance at both Low and High speeds. Spark strength does not fall off at high RPM. POSITIVE SPARK helps eliminate "Misfire" for faster acceleration and improved Engine Performance! Smoother running (No timing fluctuation as with Magnetic Units). Easier Starting under any condition! Sparkplugs LAST 3 to 10-Times LONGER.

All SOLID-STATE Components. UNAFFECTED By Temperature, Moisture, or Vibration! Highest grade materials Guarantee you solid, Dependable Performance.

★ Perfect Timing and Dwell never change.

Pays for itself! Eliminates ignition Tune-Ups forever!  
"INFINITE LIFE" Once installed... Never needs replacing.

● PERFECT TIMING INCREASES Engine Efficiency and Gas Mileage. SAVES Precious Fuel! Allison gives you MAXIMUM Engine Efficiency 100% of the time... and that's the name of the game for BETTER Gas Mileage and Economy.

★ PROVEN RELIABILITY!

Dyno Tested up to 15,000 RPM.  
Road and Race Proven.  
(Opto-Electric Systems won at  
INDY Two years in a row!)

● QUICK AND EASY INSTALLATION

★ If you want the BEST, and SAVE! This is IT!

● ORDER with CONFIDENCE...  
SATISFACTION GUARANTEED! Only \$49.95  
1-YEAR FACTORY WARRANTY. COMPLETE.

● As you can see, you're not taking any  
chances at all... Send your Order Today.

State Make, Year, Engine Size. (Calif. Res. add Tax).  
● (So New...it's Sold ONLY FROM FACTORY DIRECT).

You may use your MASTER CHARGE or BANKAMERICARD.  
Send us (1) Your Number, (2) Interbank No., (3) Exp. Date.

● Before buying any other Type ignition system...

Send Postcard for our FREE BROCHURE.

★ If you have already installed a C-D ignition system,  
Modernize and Increase its Efficiency...

CONVERT YOUR "C-D" UNIT TO BREAKERLESS!  
Opto-Electric "TRIGGER UNIT"... Only \$34.95

● Our BEST Salesmen are the owners  
and users of our ALLISON System!



**ALLISON**  
AUTOMOTIVE COMPANY

1269-L, East EDNA PL., COVINA, CAL. 91722

RADIO-ELECTRONICS

82

Circle 30 on reader service card

## SCOPES

(continued from page 59)

nals with reasonable fidelity, the bandwidth of this amplifier is generally not great. Bandwidths in the order of 1 to 3-MHz are quite common. Normally this is no serious limitation, as most external horizontal signals are of the sweep nature themselves.

One should also remember that when specifying a limit of horizontal bandwidth such as -3-dB at 3-MHz, the manufacturer is also specifying a phase shift. In certain measurements (especially phase measurement), phase shift in the horizontal amplifier can cause measurement errors.

The input impedance of a horizontal amplifier may vary from oscilloscope to oscilloscope. However, most oscilloscopes are specified with either 100K or 1 megohm with some shunt capacitance. On more elaborate oscilloscopes, the horizontal sensitivity specification may also include specifications for a horizontal attenuator and a variable gain control. The most limited of oscilloscopes has only a fixed amplitude specified for horizontal sensitivity. External horizontal input connectors will normally be the same as those of the vertical input. However, the 5-way binding post is occasionally used when the vertical input connector is of the BNC type. R-E

## OP-AMPS

(continued from page 44)

get a linear rectifier that crosses over essentially at zero. You can add a second stage to invert one side to make this into a full-wave rectifier.

There are, of course, many more things we can do with low-cost operational amplifiers, particularly the 741, its improved offspring, and the LM318. The only trick

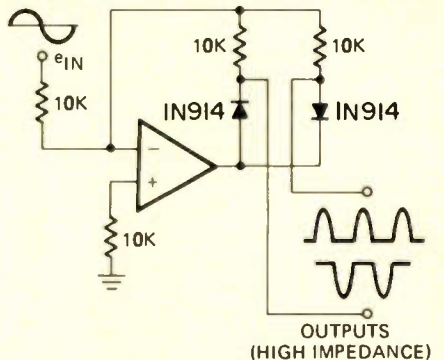

FIG. 17—PRECISION RECTIFIER eliminates diode offset and non-linearity.

is to be sure you obey the simple use rules associated with them. Remember, always use feedback (usually to -). Always provide a source for input base current bias on both the + and - inputs. And never try to run at an operating frequency unless you have at least ten times the open loop gain your circuit calls for. R-E

For  
faster  
service

USE  
ZIP  
CODE

on  
all  
mail

# MINI-BAR<sup>®</sup> color generator

\$89.50

BG-10 battery-operated, fits in shirt pocket!

No AC plug in... automatic on & off with LED indicator... fast, easy hook-up with coaxial cable... all essential patterns... Low power consumption for extended battery life (Uses inexpensive 9 volt batteries) • Shuts off when not in use • Enclosed RF cable compartment • Size: 5 1/2" x 3" x 1 1/8". Only 12 ounces • TV station type sync signals • CMOS LSI IC for all counting functions... no internal adjustments • RF output on Ch. 3, 4 or 5.

BG-10 (less battery) ..... \$89.50  
CC-1 Carrying Pouch ..... \$ 2.95



See your distributor or write

**LECTROTECH, INC.**

5810 N. Western Ave.,  
Chicago, Illinois 60659  
(312) 769-6262

Circle 61 on reader service card



# MONEY SAVING BUYS

FREE \$1 BUY WITH EVERY 10 YOU ORDER

Only applies to "\$1" Buys

FREE GIFT WITH EVERY ORDER

CANADIANS: Ordering is easy—we do the paperwork—try a small order

**RCA 110° FLYBACK TRANSFORMER**  
 We scooped the Market. Latest type standard for all 110° TV's (Blk. & Wht.). RCA's design of large Coil produces 18KV—assuring adequate width Incl. Schematic Diagram application for any TV.  
 List price \$13.90 **3.95**  
 Your price .....  
 10% off in lots of 3.



**WESTINGHOUSE ALL TRANSISTOR HOME/OFFICE MESSAGE CENTER**  
 Leaves messages for other for replay... Built in speaker/microphone for talk-in convenience... Records up to 3 minutes of messages... Illuminated signal shows when a message is waiting. Control adjusts playback volume without affecting recording volume... Capstan Drive: **7.95**  
 BRAND NEW SOLD AS IS

**SHANNON MYLAR RECORDING TAPE**

3"	— 225'	.....	.18	CASSETTE C-60	.....	.59
3 1/4"	— 600'	.....	.79	CASSETTE C-90	.....	1.19
5"	— 600'	.....	.82	CASSETTE C-120	.....	1.97
5"	— 900'	.....	.90	8-Track — 64 Min.	.....	1.29
5"	— 1200'	.....	1.49	8-Track — 80 Min.	.....	1.59
5"	— 1800'	.....	1.89	8-Track — Cleaner	.....	1.49
7"	— 1200'	.....	.97			
7"	— 1800'	.....	1.32	3" TAPE REEL	.....	.09
7"	— 2400'	.....	1.99	3 1/4" TAPE REEL	.....	.12
7"	— 3600'	.....	3.49	5" TAPE REEL	.....	.29
				7" TAPE REEL	.....	.35

- MARKET SCOOP COLUMN**
- 7 TUBE AM-FM STEREO AMPLIFIER CHASSIS Completely assembled—AS IS needs slight adjustments **22.50**
  - KANDU—Printed Circuit Kit Trace & Etch your own circuits easy to use instructions **9.95**
  - 15—ASSORTED IC'S For Experimenters **1.00**
  - TRANSISTOR RADIO • NEW Excellent value **3.95**
  - Silicon NPN HV TRANSISTOR RCA—SK-3021—Hep-240 **1.00**
  - RCA—SK-3026—Hep-241 **1.00**
  - Transistor Specials—Your Choice SK3006, SK3018, SK3020 **1.00**
  - SK3122, SK3124 **1.00**
  - Transistor Specials—Your Choice SK3009, SK3024, SK3040 **1.98**
  - TACHOMETER 2 1/2" Sq. Panel Meter 1-VDC, full scale 33 Ohm coil resistance 0-6000 R.P.M. **2.00**
  - I—CASSETTE type dynamic Mike with universal plugs—200 Ohms **2.99**
  - VU 1" PANEL METER 0-20 db Scale **1.29**
  - 100' GRI SPEAKER WIRE 2 Cond. mini zip, 101 uses **2.00**
  - WAHL-CORLESS SOLDER IRON Complete with Auto Charger, Fast Heating, Compact **15.95**
  - 5—Audio Output TRANSFORM Sub-min for Trans Radios **1.00**
  - 5—I.F. Coil TRANSFORMERS 456-Kc for Transistor Radios **1.00**
  - 6" UNIVERSAL SPEAKER Top quality Special buy **1.59**
  - 12" UNIVERSAL SPEAKER Top Quality... Large Magnet **5.89**
  - 10" PHILCO SPEAKER Top Quality... Large Magnet **3.95**
  - 8" UNIVERSAL SPEAKER—Large Magnet—Special Buy **2.99**
  - 3" UNIVERSAL TWEETER 1 oz. Magnet **1.29**
  - 2 1/2"x4" SPEAKER Special Buy 10 for \$5 **69¢**
  - 4"x6" "QUAM" 16 OHM SPK. Large magnet... Special BUY (10 for \$15.00) **1.79**
  - 8" — HEAVY DUTY 10 Z. SPEAKER Ceramic Type—8 Ohm 1—6"x9" Heavy Duty 10 oz. Speaker Ceramic Type... 8 Ohm **4.50**
  - 1—5"x7" UNIVERSAL SPK. (10-20-40 OHM Imped.) **2.95**
  - 3 SPEAKER 7 WAY SELECTOR SWITCH Wall Mount STANCOR POWER TRANSFORMER 117V—50—60 Cycle—Pri. Sec. 12.6 Cent. Tap 2 Amp. **3.29**
  - POWER TRANSFORMER (1T-4R)—110V Pri.—12V Sec. Used in many transistor Power supplies **2.29**
  - COMPLETE CONVERGENCE ASSY.—Inc. Yoke, Board & Plug Conn. Adaptable to most 90° sets **3.95**
  - COLOR DELAY LINE—Used in most color sets **1.69**
  - 7—ASSORTED VOLUME CONTROLS with switch **1.00**
  - 10—ASSORTED VOLUME CONTROLS less switch **1.00**
  - 15—ASST. ROTARY SWITCHES All popular types—\$20 value **1.00**
  - DELUXE PILLOW SPEAKERS With plug & volume control **2.49**
  - 2—12BH7 RCA TUBES **1.00**
  - 10—ASST OIODE CRYSTALS 1N34, 1N48, 1N60, 1N64, etc. **1.00**
  - TUBE & CONTINUITY CKR. Model PT425 (Tests fuses, heaters, lamps, Etc.) **1.98**
  - VARGO Stereo Cartridge-CN-72 With mounting bracket, flipover needle **2.95**
  - Stereo Headphones Hi-Fi Quality Complete with Stereo plug **5.95**
  - 10—STANDARD TRANSISTORS NPN & PNP 2N404, 2N414, etc. **1.00**
  - 25' Shielded MIKE CABLE Gray 25/1 **1.89**

Test Equip. Special Discount Prices

**BK EICO Leader SENCORE**

- MERCURY COMPACT TUBE TESTER Model #990 Miniature-sized Specia Saver Full sized in performance **49.95**
- TELMATIC Tuner-Mate KT-730 Portable "Substi-Tuner" Instant Tuner Check **42.50**
- TELEMATIC Test Jig Model—EJ-190—Master Rigs—Combo Rigs—Econo Rigs **49.95**

**KLEPS "CLEVER" TEST PROOS**  
 "Third-hand" test prods, reach into out of way places - Insulated - cannot slip - accommodates bare wire or banana plug—no soldering.

- PRUF 10—Versatile Test Probe **89¢**
- KLEPS 10—Bleethook Clamp 3/4" long **1.39**
- KLEPS 20—Bleethook Clamp 7" long **1.49**
- KLEPS 30—Flexible Forked Tongue 6" long **1.79**
- KLEPS 40 FLEXIBLE-PC Board Terminals 8 1/4" long **2.59**
- KLEPS ECONOMY Kleps for Light Work **99¢**

- 4 — TV ALIGNMENT TOOLS 1.00 most useful assortment #1
- 4 — TV ALIGNMENT TOOLS 1.49 For Color TV #2
- 6 — TV COLOR ALIGNMENT TOOLS Most popular type **2.79**
- TV TWIN LEAD-IN 300 ohm 500'—\$7.100'—\$1.50, 50' CO-AX CABLE RG59U (Black) 250'—\$10, 100'—\$4.50, 50' **2.69**
- 5—DUAL OIODE—MOST POPULAR TYPES Common cathode or Series connected **2.50**
- CONVERGENCE RECTIFIER—For Color TV 4 Cell—Used in RCA—Philco, etc. **1.00**
- TV DAMPER OIODE Single—Replace RCA part #120818 Dual—RCA part #135932 **\$2.29** **\$3.95**
- COLOR POWER TRANS. —Good for most sets 26K150 List Price—\$36.75 **6.95**
- 6—Top Brand Silicon RECT. 1 amp., 1000 PIV **1.00**
- 5—PNP TRANSISTOR general purpose, TO-5 case **1.00**
- 5—NPN TRANSISTORS general purpose, TO-5 case **1.00**
- 25—ASSORTED TRANSISTORS big factory scoop—sold as-is **1.00**
- 5—9 VOLT MOTORS Excellent for hobbyist **1.00**
- 2—ELECTROLYTIC CONDENSERS Axial leads—500—25V **1.00**
- ELECTROLYTIC CONDENSER 300 mfd.—200V **1.00**
- 2—ELECTROLYTIC CONDENSERS 80/100/60 MFD—180V **1.00**
- 2—ELECTROLYTIC CONO 200/30/4—mfd—350V **1.00**
- 3—ELECTROLYTIC CONO 100 mfd.—100V, 50 mfd.—75V **1.00**
- 2—ELECTROLYTIC CONO 40 mfd—500V, 40 mfd—400V **1.00**
- 50—ASST. CERAMIC CONDENSERS—Most desirable values **1.00**
- 4-50' HANKS Hook-Up Wire assorted colors **1.00**
- 10—SETS PHONO PLUGS & PIN JACKS RCA type **1.00**
- 8—MINI PILOT BULBS With 8 1/2" Leads—6.3V 30MA (5000 Hrs) **1.00**
- 8—MINI PILOT BULBS With 12" Leads—6.3V, 150MA (5000 Hrs.) **1.00**
- 32—TEST PROO WIRE **1.00**
- DELUXE QUALITY red & black 10—MINI ELECTROLYTIC Cond For Transistor & miniature work **1.00**

- 110° TV DEFLECTION YOKE for all types TV's Incl schematic **4.95**
- "COMBINATION SPECIAL" RCA 110° FLYBACK plus 110° DEFLECTION YOKE **6.95**
- 90° FLYBACK TRANSFORMER for all type TV's (Blk. & Wht.) **2.95**
- 90° TV DEFLECTION YOKE for all type TV's (Blk. & Wht.) **3.95**
- 70° FLYBACK TRANSFORMER for all type TV's (Blk. & Wht.) **2.00**
- 70° TV DEFLECTION YOKE for all type TV's (Blk. & Wht.) **2.00**
- OLYMPIC & SHARP FLYBACK Part #MFT592 Equip. Stancor #110-408 **2.00**
- Thordarson #Fly339 **2.00**
- 90° COLOR YOKE For all Rectangular 19 to 25" Color CRT's **7.95**
- 70 COLORE YOKE For all round color CRT's **8.95**
- DELMONICO NIVICO COLOR FLYBACK Part #A20411-B **7.95**

**SARKES TARZIAN TUNER 41mc**  
 Latest Compact Model good for all 41 mc TV's. BRAND NEW



Best TUNER "SARKES TARZIAN" ever made — last word for stability, definition & smoothness of operation. An opportunity—to improve and bring your TV Receiver up-to-date. Complete with Tubes **7.95**

- WESTINGHOUSE FM TUNER #476-V-015D0 1 Transistor **3.99**
- WESTINGHOUSE FM TUNER (121278 Tube) **1.00**
- UHF TUNER—Transistor Type Used in all TV sets **3.95**
- G.E. UHF TUNER—TRANSISTOR TYPE Model #285X4 **3.95**
- ADMIRAL TV TUNER Model #94C393-1 (2HA5-4LJ8) Model #T94C41-3 (Transistor) **7.95**
- WELLS GARONER TUNER Part #7A 120-1 (4G87-2HA7 Tubes) **7.95**
- G.E.—TV TUNER (2GK5-4LJ8) Model #EP 86x11 Transistorized **7.95**
- GE TV TUNER ET 86x198, (8GK5-6BL8) **5.95**
- UNIVERSAL TV Antenna Back of set mounting... 5 section rods **2.99**
- BLUE LATERAL Magnet Assy. (Replacement for most color TV's) **1.79**
- 5—10K—2 WATT BIAS POTS Used in solid state application **1.00**
- COLOR CONVERGENCE ASSY. Universal type—good for most sets **2.49**
- COLOR-TV RECTIFIER—Used in most color sets—6500 kv 3 for **1.95**
- 2 COLOR-TV CRT SOCKETS Wired leads, for all color TV's **1.00**
- 3—RCA 110° CRT SOCKETS Wired leads, for all TV's **1.00**
- 4—36" Hi-Fi CABLES RCA Molded 1/8" phone plug at one end stripped and tinned leads on other end **1.00**
- 4—POLARIZED CHEATER COO Grey **1.00**
- 70° COLOR TUBE BRIGHTNER **3.95**
- 90° COLOR TUBE BRIGHTNER **4.95**
- 2—Colorburst Quartz-Crystal For most color TV sets 3579, 345 KC **1.89**
- 5—ASST GLOBAL VARISTOR Popular replacements for most COLOR TV **1.00**
- UHF or VHF Matching Trans. Simple Fool-proof Installation **1.00**

- 6—TRANSISTOR RADIO EARPIECES wires complete with plug **1.00**
- 7—TV ELECTROLYTIC CONDENSERS desirable types 25—,0033 DISC CERAMIC CAPACITORS C. R. L. **1.00**
- 50—ASST. TERMINAL STRIPS all types, 1-lug to 8-lug **1.00**
- UNIVERSAL 4" PM SPEAKER Top Quality **1.00**
- ZENER DIODE • MOTOROLA **1.00**
- HEP 103 1 Watt—6.2 Volts CAR POWER ADAPTOR 12 Volt In—6V, 7.5V 9 Volt Out—300MA **4.95**
- 50—ASST. TUBULAR CONO-CONDENSERS Popular values **1.00**
- TRANSISTOR RADIO asst type good, bad, broken, as-is, potluck **1.50**
- TAPE RECORDER assorted types good, bad broken, as-is, potluck **4.00**
- 200 ASST. 1/2 W RESISTORS Top Brands, Short Leads, Excellent Selection **1.00**
- 75—ASST 1/2 WATT RESISTORS stand, choice ohmages, some in 5% **1.00**
- 100—ASST 1/2 WATT RESISTORS stand, choice ohmages, some in 5% **1.00**
- 70—ASST 1 WATT RESISTORS stand, choice ohmages, some in 5% **1.00**
- 35—ASST 2 WATT RESISTORS stand, choice ohmages, some in 5% **1.00**
- 50—PRECISION RESISTORS asst. list-price \$50 less 98% **1.00**
- 20—ASSORTED WIREWOUND RESISTORS, 5, 10, 20 watt **1.00**
- 10—ASST SLIDE SWITCHES SPST, SPDT, DPDT, etc. **1.00**
- 25—SYLVANIA HEAT SINKS For Transistors **1.00**
- 20—ASSORTED TV COILS I.F. VIDEO, sound radio, etc. **1.00**
- 1—ELECTROLYTIC CONO. 200/300/100/100 MFD—25V **1.00**
- 1—ELECTROLYTIC CONO 100 MFD—300V **1.00**
- 3—ELECTROLYTIC CONO 20/20 MFD—450V **1.00**
- 40—ASST. TUBE CARTONS Most popular types **1.00**
- 2—ELECTROLYTIC Condensers 300 mfd—200V, 300/60 mfd—150V **1.00**
- 4—ELECTROLYTIC CONO 75/30mfd—150V **1.00**
- ELECTROLYTIC CONDENSERS 200/200 mfd.—200V **1.00**
- 2—ELECTROLYTIC CONO 1000 mfd.—25V **1.00**
- 250—ASST SOLOERING LUGS best types and sizes **1.00**
- 250—ASST WOOD SCREWS finest popular selection **1.00**
- 250—Asst Self Tapping SCREWS #6, #8, etc. **1.00**
- 100—ASST 6/32 SCREWS and 100—6/32 HEX NUTS **1.00**
- 100—ASST 8/32 SCREWS and 100—8/32 HEX NUTS **1.00**
- 100—ASST 2/56 SCREWS and 100—2/56 HEX NUTS **1.00**
- 100—ASST 4/40 SCREWS and 100—4/40 HEX NUTS **1.00**
- 100—ASST 5/40 SCREWS and 100—5/40 HEX NUTS **1.00**
- 500—ASSORTED RIVETS most useful selected sizes **1.00**
- 300 ASSORTED WASHERS most useful selected sizes **1.00**
- 100—ASST RUBBER BUMPERS for cabinet bottoms—other uses **1.00**
- 100—ASST RUBBER GROMMETS best sizes **1.00**
- 15—DIPPEO MYLAR CAP. .01—600V **1.00**
- 15—DIPPEO MYLAR CAP. .033—600V **1.00**
- 15—DIPPEO MYLAR CAP. .0033—1000V **1.00**
- 15—DIPPEO MYLAR CAP. .047—400V **1.00**
- 15—Molded Tubular Capacitors .056—400V **1.00**
- 15—DIPPEO MYLAR Condensers .0039 400V **1.00**

IMMEDIATE DELIVERY... Scientific light packing for safe delivery at minimum cost. HANDY WAY TO ORDER... Send check or money order, add extra for shipping. Lists of new offers will be returned in your order. Please specify refund on shipping overpayment desired:  CHECK  POSTAGE STAMPS  MERCHANDISE (our choice) with advantage to customer

**BROOKS RADIO & TV CORP., 487 Columbus Ave., New York, N.Y. 10024** TELEPHONE 212-874 5600

Circle 62 on reader service card



APPLIANCE & INDUSTRIAL MAINTENANCE  
 TESTERS • OSCILLOSCOPES • PICTURE TUBE  
 TESTERS • VOMMERS • CASES  
 AF, RF & SWEEPERS • TRANSFORMERS  
 AC LEAKAGE TESTERS • METERS  
 SOLID STATE TESTERS • ELECTRONIC  
 VOLTOHM METER • METERS  
 ISOTAPS • SOUND  
 GENERATORS • MONITORS  
 BATTERY TESTERS • SUPPLIES  
 PORTABLE TESTERS • CURRENT  
 AC VOLTMETERS • COLOR BAR  
 TESTERS • ACCESSORIES

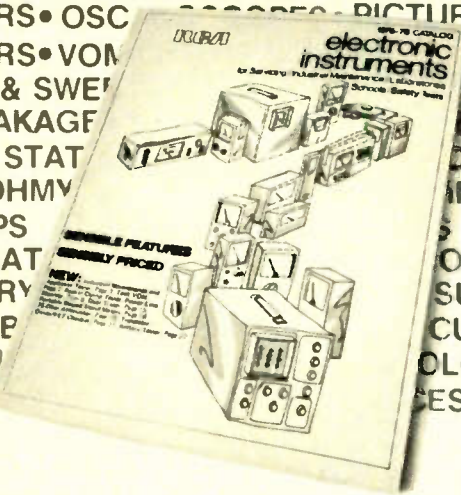

**RCA Test Instruments...**  
**The broad line for a wide range**  
**of applications.**

Whether it's for use in consumer or industrial electronics, laboratories, schools, safety tests or for everyday electrical or electronic maintenance, there's an RCA Electronic Instrument for your application.

log. It's yours free for the asking. Just contact any one of the more than 1,000 RCA Distributors worldwide. Or write RCA Distributor and Special Products Division, Cherry Hill Offices, Camden, N.J. 08101.

And you can find out about them all in the new 1975 RCA Electronics Instruments Cata-

**RCA** Electronic Instruments

Circle 63 on reader service card

**For  
 faster  
 service**

**USE  
 ZIP  
 CODE**

**on  
 all  
 mail**

**new lit**

All booklets, catalogs, charts, data sheets and other literature listed here with a Reader Service number are free. Use the Reader Service Card inside the back cover.

**1975-76 REPLACEMENT CATALOG AND TELEVISION GUIDE FOR TRANSFORMERS.** 66-page catalog features several hundred replacement transformers. Includes color TV components, deflection yokes, flybacks, vertical outputs and filter chokes as well as power, filament and audio transformers. —Triad-Utrad Litton Distributor Services, 305 North Briant Street, Huntington, IN 46750.

Circle 43 on reader service card

**QUARTZ CRYSTAL CATALOG.** 10-page catalog provides product information on the company's line along with application engineering information. Contains: general engineering and design information, method of testing, definitions, low frequency crystals, medium frequency crystals, temperature coefficient curves generalized for medium and high frequencies, high-frequency crystals and mil spec crystals. —Crystek Crystals Corp., 1000 Crystal Drive, Fort Myers, FL 33901.

**TECHNICAL BOOKS CATALOG.** 42-page catalog describes over 339 current and forthcoming books plus 14 of the firm's electronic book/kits. Includes books on advertising, appliance repair, audio, hi-fi, stereo, do-it-yourself, electronic music, transistors, semi-conductors, hobby and experiment, medical electronics, test equipment and much more. —Tab Books, Blue Ridge Summit, PA 17214.

Circle 44 on reader service card

**PROFESSIONAL PRODUCTS CATALOG.** 24-page catalog features unidirectional dynamic microphones, ribbon microphones, omni-directional dynamic microphones, utility microphones, microphone mixers, audio control components, stereo preamplifiers, "plug-in" problem solvers, microphone accessories, component accessories and stereo cartridges. Contains many illustrations. —Shure Brothers Inc., 222 Hartrey Avenue, Evanston, IL 60204.

Circle 45 on reader service card

**DIAGRAM AND SERVICE MATERIAL** for practically any TV, radio or stereo set can be secured for a reasonable price. This firm supplies such material from its own manuals, Sams' Photofacts, old Rider's and its files of original factory data accumulated over many years. This data goes all the way back to antique radios and early TV's as well as material of all manufacturers of recent past and right up to sets of the 70's. The company promises to quote by return mail. Most prices are about \$2.00, some lower and a few higher. —Supreme Publications, 1760 Balsam Road, Highland Park, IL 60035. R-E

Circle 46 on reader service card

**The PAIA pygmy Amp ...**  
**Take it anywhere!**

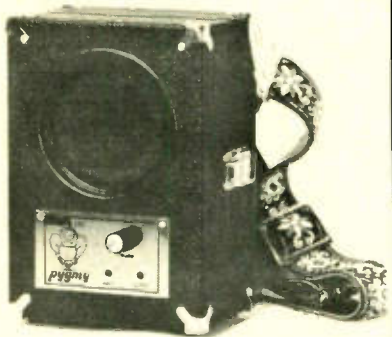

PUT IT TOGETHER ...  
 SLING IT OVER YOUR SHOULDER ...  
 AND YOU'RE READY TO GO

for only \$39.95 plus shipping 6lbs. for the complete kit.

- penlight battery powered
- 5" acoustic suspension speaker (10oz magnet)
- over 10 watts peak power (1.2w.R.M.S.)
- phone, high & low level outputs
  - sturdy vinyl covered case
  - extra easy assembly

Our FREE catalog holds even greater surprises! Send for it!

PAIA Electronics, Dept. "R",  
 1020 W. Wilshire Blvd., Oklahoma City, OK 73116

RADIO-ELECTRONICS

Circle 64 on reader service card

**FREE burglar —**  
**fire**  
**alarm catalog**



**over 500**  
**systems,**  
**detectors,**  
**controls,**  
**sounders,**  
**tools, locks,**  
**supplies**

**TO PROTECT HOMES,**  
**BUSINESSES, INDUSTRY**

Huge selection of hard-to-find security equipment from stock. 96 fact-filled pages loaded with 100's of highest quality professional alarm products, technical notes, diagrams.

**ONE-STOP SUPERMARKET**  
**SELECTION INCLUDES:**

ultrasonics, radar, infrared, undercarpet mats, magnetic contacts, smoke & heat detectors; Controls; Alarms: bells, sirens, phone dialers, lights, guard panels. Large selection of tools, relays, wire, holdup alarms, books. Fills need for industry, alarm cos., businesses, homes, Institutions. Order your copy today.



**mountain west alarm**  
 4215 n. 16th st.  
 phoenix, az. 85016  
 (602) 263-8831

Circle 65 on reader service card



# next month

AUGUST 1975

## ■ Liquid Crystal Clock You Can Build

It has 2-inch tall numbers and takes only a single IC plus a dozen other parts to complete. It will cost about \$70 to build.

## ■ Hi-Fi Tape Transports

In the new tape decks even the transports include a considerable amount of electronic circuitry. See what's there so it won't be new the first time you examine one of these decks.

## ■ Special Test Equipment

None of it is new, but all are rarely seen. For example, have you ever heard of a phase lock synchronizer.

## ■ How To Use Your Oscilloscope

There are heaps of controls on that front panel and if you don't use them correctly, you're not going to get a trace that means anything. So here's a run-down on how to handle a modern scope. We know you'll enjoy it.

## ■ Lab-Tested Hi-Fi Equipment Reports

Len Feldman continues to present detailed reports that tell you more about hi-fi gear than you've ever seen before.

PLUS

State-Of-Solid-State

R-E's Japanese Transistor Replacement Guide

Step-By-Step Troubleshooting Guide

**If You Work In Electronics:**

## GRANTHAM OFFERS YOU College-Level Training and a college degree.

Electronic Circuit Design, Engineering Analysis (including mathematics thru calculus), Classical and Solid-State Physics, Engineering Design, etc., etc., are all part of the Grantham home-study degree program in Electronics Engineering.

### PUT PROFESSIONAL RECOGNITION IN YOUR CAREER.

By adding college-level home training and a college degree to your experience, you can *move up* to greater opportunities in electronics.

Grantham offers the A.S.E.T. degree by correspondence. After earning this degree, you may continue with additional correspondence plus a 3-day residential seminar and certain transfer credits, to earn the B.S.E.T. degree. Then, the B.S.E.E. is available through further study.



### GRANTHAM SCHOOL OF ENGINEERING

2000 Stoner Ave., Los Angeles CA 90025

● Telephone (213) 477-1901 ●

Worldwide Career Training thru Home Study

Mail the coupon below for free bulletin.

Grantham School of Engineering RE 7-75  
2000 Stoner Ave., Los Angeles, CA 90025

I have been in electronics for \_\_\_\_\_ years. Please mail me your free bulletin which gives details concerning your electronics degree programs.

Name \_\_\_\_\_ Age \_\_\_\_\_

Address \_\_\_\_\_

City \_\_\_\_\_ State \_\_\_\_\_ Zip \_\_\_\_\_

Circle 66 on reader service card



## MATHEMATICS ELECTRONICS

We are proud to announce two great new courses for the electronic industry.

These unusual courses are the result of many years of study and thought by the President of Indiana Home Study, who has *personally* lectured in the classroom to *thousands* of men, from all walks of life, on mathematics, and electrical and electronic engineering.

You will have to see the lessons to appreciate them!

NOW you can master mathematics and electronics and actually *enjoy* doing it!

**WE ARE THIS SURE:** you sign no contracts—you order your lessons on a money-back guarantee.

**In plain language, if you aren't satisfied you don't pay,** and there are no strings attached.

Write today for more information and your outline of courses.

You have nothing to lose, and everything to gain!

**The INDIANA  
HOME STUDY INSTITUTE**  
DEPT. RE-775, P.O. BOX 1189  
PANAMA CITY, FLA 32401

Circle 67 on reader service card

**Some stores  
sell test  
equipment  
at discount  
prices.**

**At Fordham  
we discount  
their discount  
prices.**

B&K, EICO, RCA, SENCORE  
FLUKE, HICKOK and LEADER

Complete line of tubes,  
tools and electronic supplies

**FREE CATALOG  
FORDHAM**

RADIO SUPPLY CO., INC.

558 Morris Ave., Bronx, N.Y. 10451  
Tel: (212) 585-0330

Circle 68 on reader service card

## INDUSTRIAL TEST EQUIPMENT

(continued from page 69)

An instrument for reading light levels is shown in Fig. 21. This is Simpson's Model 408 Illumination Level Meter. This is used to get a check on light levels in work areas, etc.; once again necessary for compliance with certain OSHA regulations.

For certain tests, a continuous monitoring and recording of quantities can be very helpful. This can check line voltage, load current, temperature, and other things. Figure 22 shows a typical unit, the Amprobe Model LAVA81, which is a recording Volt-Ammeter. Other models



in the same line record temperatures, AC voltage, or voltage and current simultaneously. Any quantity that can be converted to an electrical signal by a transducer can be recorded. Simpson also makes a strip-chart recorder. It's their Model 603.

Lastly but not leastly, here is an ingenious little instrument that can really be very handy. It's the Amprobe Model ALP-501. It's a conventional volt-ammeter-ohmmeter, with something added.

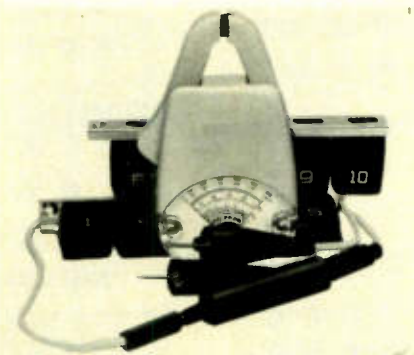

It has an automatic "wire-identifier" feature. You simply plug the ends of the wires into the Station-Marker Holder, and then go to the other end. There, just touch the probe to any of the wires, and the meter will read out its *number!* Note the "1 through 10" boxes on the meter-scale. It's called the "Line-Probe."

The service technician should be as familiar with the arsenal of specialized test equipment as he is with the common everyday test equipment. **R-E**

**WE'LL YOU SAVE MONEY**

**SONY**  
**PIONEER**  
**Sansui**  
**PHILIPS**

**ON FAMOUS BRAND  
NATIONALLY  
ADVERTISED**

**STEREO COMPONENTS,  
VIDEO & PROFESSIONAL  
PRODUCTS EQUIPMENT**  
WRITE TODAY FOR OUR QUOTE AND  
OUR COMPLETE AUDIO CATALOG.  
FAST DELIVERY IN FACTORY SEALED CARTONS  
**FOR IMMEDIATE QUOTE**  
CALL (202) 723-6060  
THE COST OF YOUR CALL WILL BE DEDUCTED  
FROM ANY ORDER OVER \$200.00

**A.D.R. AUDIO VIDEO**  
6200 CHILLUM PLACE N.W.  
WASHINGTON, D.C. 20011  
Master Charge/BankAmericard Honored on Mail Orders

Circle 69 on reader service card

## RGS ELECTRONICS

### 008A MICROCOMPUTER KIT

8008 CPU, 1024 × 8 memory; memory is expandable. Kit includes manual with schematic, programming instructions and suggestions; all ICs and parts supplied except cabinet, fuses and hardware.

Includes p.c. boards **\*\$375.00**  
MANUAL ONLY, \$25.00  
(No Discount on Manual)

### 008A-C AUDIO CASSETTE ADAPTER KIT

Kit includes all ICs, p.c. board, schematic and instructions. Will interface most audio cassette recorders to the 008A Micro-computer. NOT intended to interface with any other computer. **\*\$100.00**

### 008A-K ASCII KEYBOARD INPUT KIT

Kit includes keys, p.c. board, ICs, schematic and instructions. This kit is intended to interface **ONLY** with the RGS Electronics 008A Microcomputer **\*\$135.00**

### TRANSISTORS

NPN General purpose TO-92 \$ .08; \$5.95/100  
PNP General purpose TO-92 \$ .08; \$5.05/100  
Other transistors and JFETs available at our usual low prices; all are tested, good units. Specs available in our flyer.

**RGS ELECTRONICS, 3650 Charles St. Ste K,  
Santa Clara, CA 95050 (408) 247-0158**

We sell many ICs and components not listed in this ad, included most of the 7400 series; send a stamp for our free flyer.

**TERMS OF SALE:** All orders prepaid; we pay postage on all U.S. orders. Handling charge of \$1.00 on U.S. orders under \$10.00, foreign orders under \$25.00. California residents please include sales tax. Please include name, address, and zip code on all orders and flyer requests.

**\*DISCOUNTS: 10% OFF ORDERS OVER \$25.00 - 20% OFF ORDERS OVER \$250.**

PRICES SUBJECT TO CHANGE WITHOUT NOTICE.

Circle 70 on reader service card



# R-E's SUBSTITUTION GUIDE FOR JAPANESE TRANSISTORS

## PART XXVIII

by ROBERT & ELIZABETH SCOTT

	ARCH	DM	G-E	ICC	IR	MAL	MOT	RCA	SPR	SYL	WOR	ZEN
2S42	RS276-2006	T-230/232	GE-3	ICC-230/232	TR-01	PTC 105	HEP-230/232	SK 3009	RT-124	ECG 104	WEP-230	ZEN 325/
2S43	RS276-2005	T-254	GE-52	ICC-254	TR-05	PTC 102	HEP-254	SK 3004	RT-120	ECG 102	WEP-631	ZEN 305
2S44	RS276-2005	T-254	GE-52	ICC-254	TR-05	PTC 102	HEP-254	SK 3004	RT-120	ECG 102	WEP-631	ZEN 305
2S45	RS276-2004	T-253	GE-2	ICC-253	TR-05	PTC 102	HEP-253	SK 3005	RT-118	ECG 100	WEP-254	ZEN 304
2S46	NA	NA	GE-52	NA	TR-05	PTC 102	NA	SK 3003	RT-120	ECG 102	WEP-631	NA
2S47	NA	NA	GE-52	NA	TR-05	PTC 102	NA	SK 3003	RT-120	ECG 102	WEP-631	NA
2S49	RS276-2004	T-253	GE-2	ICC-253	TR-05	PTC 102	HEP-253	SK 3005	RT-118	ECG 100	WEP-254	ZEN 304
2S51	NA	NA	GE-2	NA	TR-05	PTC 102	NA	SK 3005	RT-118	ECG 100	WEP-254	NA
2S52	RS276-2004	T-253	GE-2	ICC-253	TR-05	PTC 102	HEP-253	SK 3005	RT-118	ECG 100	WEP-254	ZEN 304
2S53	RS276-2004	T-253	GE-2	ICC-253	TR-05	PTC 102	HEP-253	SK 3005	RT-118	ECG 100	WEP-254	ZEN 304
2S54	RS276-2005	T-254	GE-52	ICC-254	TR-05	PTC 102	HEP-254	SK 3004	RT-120	ECG 102	WEP-631	ZEN 305
2S56	RS276-2005	T-254	GE-52	ICC-254	TR-05	PTC 102	HEP-254	SK 3004	RT-120	ECG 102	WEP-631	ZEN 305
2S57	NA	NA	GE-51	NA	TR-17	PTC 107	NA	NA	NA	NA	NA	NA
2S58	NA	NA	GE-50	NA	TR-17	PTC 107	NA	SK 3008		ECG 126	WEP 635	NA
2S60	RS276-2003	T-639	GE-2	ICC-639	TR-05	PTC 102	HEP-639	SK 3005	RT-118	ECG 100	WEP 254	ZEN 314
2S75B	NA	NA	NA	NA	TR-85	NA	NA	NA	NA	ECG 102A	NA	NA
2S91	RS276-2004	T-253	GE-2	ICC-253	TR-05	PTC 102	HEP-253	SK 3005	RT-118	ECG 100	WEP 253	ZEN 304
2S92	RS276-2004	T-253	GE-50	ICC-253	TR-17	PTC 107	HEP-253	SK 3008	RT-118	ECG 100	WEP 253	ZEN 304
2S93	RS276-2004	T-253	GE-50	ICC-253	TR-17	PTC 107	HEP-253	SK 3008	RT-118	ECG 100	WEP 253	ZEN 304
2S95	NA	NA	NA	NA	TR-21	PTC 136	NA	SK 3122	RT-102	ECG 123A	WEP 735	NA
2S96	NA	NA	GE-1	NA	TR-85	PTC 109	NA	SK 3006	RT-188	ECG 126	WEP 635	NA
2S97	NA	NA	NA	NA	TR-85	NA	NA	SK 3006	RT-188	ECG 126	WEP 635	NA
2S98	NA	NA	GE-1	NA	TR-85	PTC 109	NA	SK 3006	RT-188	ECG 126	WEP 635	NA
2S101	RS276-2009	T-50	GE-61	ICC-50	TR-24	PTC 139	HEP-50	SK 3122	RT-102	ECG 123A	WEP 736	ZEN 100
2S102	RS276-2009	T-50	GE-63	ICC-50	TR-25	PTC 121	HEP-50	SK 3122	RT-102	ECG 123A	WEP 736	ZEN 100
2S103	RS276-2009	T-50	GE-63	ICC-50	TR-87	PTC 121	HEP-50	SK 3024	RT-114	ECG 128	WEP 243	ZEN 100
2S104	RS276-2009	T-50	GE-63	ICC-50	TR-87	PTC 136	HEP-50	SK 3024	RT-114	ECG 128	WEP 243	ZEN 100
2S109	RS276-2005	T-636	GE-50	ICC-636	TR-17	PTC 107	HEP-636	SK 3008	RT-119	ECG 126	WEP 635	ZEN 312
2S110	RS276-2005	T-636	GE-50	ICC-636	TR-17	PTC 107	HEP-636	SK 3007	RT-188	ECG 126	WEP 635	ZEN 312
2S111	RS276-2005	T-636	GE-54	ICC-636	TR-08	PTC 107	HEP-636	SK 3005	RT-118	ECG 100	WEP 254	ZEN 312
2S112	RS276-2005	T-636	GE-50	ICC-636	TR-17	PTC 107	HEP-636	SK 3008	RT-119	ECG 126	WEP 635	ZEN 312
2S131	RS276-2023	T-52	GE-20	ICC-52	TR-53	PTC 133	HEP-52	SK 3122	RT-102	ECG 123A	WEP 736	NA
2S134	NA	NA	NA	NA	NA	NA	NA	SK 3123	RT-136	ECG 176	NA	NA
2S141	RS276-2005	T-636	GE-50	ICC-636	TR-17	PTC 107	HEP-636	SK 3006	RT-188	ECG 126	WEP 635	ZEN 312
2S142	RS276-2005	T-636	GE-51	ICC-636	TR-85	NA	HEP-636	SK 3006	RT-188	ECG 126	WEP 635	ZEN 312
2S143	RS276-2003	T-635	GE-50	ICC-635	TR-17	PTC 107	HEP-635	SK 3006	RT-188	ECG 126	WEP 635	ZEN 311
2S144	NA	NA	GE-51	NA	TR-17	NA	NA	NA	RT-188	ECG 160	NA	NA
2S145	RS276-2003	T-635	GE-50	ICC-635	TR-85	PTC 107	HEP-635	SK 3006	RT-188	ECG 126	WEP 635	ZEN 311
2S146	RS276-2003	T-635	GE-51	ICC-635	NA	NA	HEP-635	SK 3006	RT-188	ECG 126	WEP 635	ZEN 311
2S148	NA	NA	GE-51	NA	NA	NA	NA	NA	RT-188	ECG 160	NA	NA
2S155	RS276-2004	T-253	GE-2	ICC-253	TR-05	PTC 102	HEP-253	SK 3005	RT-118	ECG 100	WEP 254	ZEN 304
2S159	RS276-2004	T-253	GE-2	ICC-253	TR-05	PTC 102	HEP-253	SK 3005	RT-118	ECG 100	WEP 254	ZEN 304
2S160	RS276-2004	T-253	GE-2	ICC-253	TR-05	PTC 102	HEP-253	SK 3005	RT-118	ECG 100	WEP 254	ZEN 304
2S163	RS276-2005	T-254	GE-52	ICC-254	TR-05	PTC 102	HEP-254	SK 3004	RT-120	ECG 102	WEP 631	ZEN 305
2S167	RS276-2004	T-253	GE-53	ICC-253	TR-08	NA	HEP-253	SK 3005	RT-118	ECG 100	WEP 253	ZEN 304
2S174	RS276-2004	T-253	GE-53	ICC-253	TR-08	NA	HEP-253	SK 3005	RT-118	ECG 100	WEP 253	ZEN 304
2S175	NA	NA	GE-50	NA	TR-17	PTC 107	NA	SK 3006	RT-188	ECG 160	NA	NA
2S176	NA	NA	GE-2	NA	TR-85	NA	NA	SK 3006	RT-188	ECG 126	WEP 635	NA
2S178	RS276-2004	T-253	GE-2	ICC-253	TR-05	PTC 102	HEP-253	SK 3005	RT-118	ECG 100	WEP 253	ZEN 304
2S179	RS276-2005	T-254	GE-52	ICC-254	TR-05	PTC 102	HEP-254	SK 3004	RT-120	ECG 102	WEP 631	ZEN 305
2S189	NA	T-254	GE-53	ICC-254	TR-85	PTC 135	HEP-254	SK 3004	RT-121	ECG 102A	WEP 250	ZEN 305
2S201	NA	NA	GE-51	NA	NA	NA	NA	NA	RT-188	ECG 160	NA	NA
2S273	NA	NA	NA	NA	TR-85	PTC 102	NA	NA	RT-121	ECG 102A	WEP 250	NA
2S277	NA	NA	GE-54	NA	NA	NA	NA	NA	NA	ECG 103A	NA	NA
2S301	NA	NA	GE-21	NA	TR-88	NA	NA	SK 3025	RT-115	ECG 129	WEP 242	NA
2S302	RS276-2021	T-51	GE-21	ICC-51	TR-88	NA	HEP-51	SK 3025	RT-115	ECG 129	WEP 242	ZEN 101
2S302A	NA	T-52	NA	ICC-52	TR-88	NA	HEP-52	NA	RT-187	ECG 159	NA	NA
2S303	RS276-2021	T-51	GE-22	ICC-51	TR-88	NA	HEP-51	SK 3025	RT-115	ECG 129	WEP 242	ZEN 101
2S304	RS276-2021	T-51	GE-22	ICC-51	TR-88	NA	HEP-51	SK 3025	RT-115	ECG 129	WEP 242	ZEN 101
2S305	NA	NA	NA	NA	NA	NA	NA	SK 3025	RT-115	ECG 129	NA	NA
2S306	RS276-2021	T-51	GE-22	ICC-51	TR-30	NA	HEP-51	SK 3114	RT-115	ECG 159	WEP 242	ZEN 101
2S307	RS276-2021	T-51	GE-22	ICC-51	TR-30	NA	HEP 51	SK 3118	RT-115	ECG 159	WEP 242	ZEN 101
2S321	NA	NA	GE-21	NA	TR-52	NA	NA	SK 3114	RT-115	ECG 159	WEP 242	NA
2S322	RS276-2023	T-52	GE-21	ICC-52	TR-52	NA	HEP-52	SK 3114	RT-115	ECG 159	WEP 242	NA
2S323	RS276-2023	T-52	GE-22	ICC-52	TR-52	NA	HEP-52	SK 3114	RT-115	ECG 159	WEP 242	NA
2S324	RS276-2023	T-52	GE-22	ICC-52	TR-52	NA	HEP-52	SK 3114	RT-115	ECG 159	WEP 242	NA
2S326	RS276-2023	T-52	GE-22	ICC-52	TR-52	NA	HEP-52	SK 3114	RT-115	ECG 159	WEP 242	NA
2S327	RS276-2023	T-52	GE-22	ICC-52	TR-52	NA	HEP-52	SK 3114	RT-115	ECG 159	WEP 242	NA

(to be continued)



# market center

**CLASSIFIED COMMERCIAL RATE** (for firms or individuals offering commercial products or services). \$1.40 per word . . . minimum 15 words.

**NONCOMMERCIAL RATE** (for individuals who want to buy or sell personal items) 85c per word . . . no minimum.

**FIRST WORD AND NAME** set in bold caps at no extra charge. Additional bold face at 10c per word. Payment must accompany all ads except those placed by accredited advertising agencies. 10% discount on 12 consecutive insertions, if paid in advance. All copy subject to publisher's approval. Advertisements using P.O. Box address will not be accepted until advertiser supplies publisher with permanent address and phone number. Copy to be in our hands on the 26th of the third month preceding the date of the issue (i.e. August issue closes May 26). When normal closing date falls on Saturday, Sunday or a holiday, issue closes on preceding working day.

## WANTED

**COMPUTER** printed circuit boards and equipment. Send list now! **FLATIRON ENTERPRISES**, 4654 Harwich St., Boulder, CO 80301

**QUICK cash . . .** for electronic equipment, components, unused tubes. Send list now! **BARRY**, 512 Broadway, New York, NY 10012, 212 Walker 5-7000

## EDUCATION & INSTRUCTION

**FREE** educational electronics catalog. Home study courses. Write to **EDUKITS WORKSHOP**, Department 269 G, Hewlett, NY 11554

**LEARN design techniques.** Electronics design Newsletter. Digital, linear construction projects, design theory and procedures. Annual subscription \$6.00, sample copy \$1.00. **VALLEY WEST**, Box 2119-A, Sunnyvale, CA 94087

## PLANS & KITS

**NEW organ kit builders guide** \$3.00. Circuits, block diagrams, details on diode keyed IC divider and independent oscillator designs. Many new kits and models. Keyboards also for synthesizers. Manual cost refundable with purchase. **DEVTRONIX ORGAN PRODUCTS**, Dept. B, 5872 Amapola Dr., San Jose, CA 95129

**CONVERT** any television to sensitive, big-screen oscilloscope. Only minor changes required. No electronic experience necessary. Illustrated plans \$2.00. **SANDERS**, Dept. A-25, Box 92102, Houston, TX 77010

**CIRCUIT** collections: 20 useful circuits you can build. Includes schematics, parts list, description, \$3.98. **RJE COMPANY**, 28 Park Street, Jamestown, NY 14701

**FREE** catalog. Most unusual electronic kits available. Music accessories, surf, wind synthesizers, wind chimes, many others. **PAIA ELECTRONICS**, Box B14359, Oklahoma City, OK 73114

## F.C.C. EXAM MANUAL

PASS FCC EXAMS! Memorize, study—Test—Answers for FCC 1st and 2nd class Radio-telephone licenses. Newly revised multiple choice questions and diagrams cover all areas tested in FCC exams, plus Self-Study Ability Test. \$9.95 postpaid. Money-back guarantee.



**COMMAND PRODUCTIONS** P O Box 26348 E  
RADIO ENGINEERING DIV SAN FRANCISCO, CAL 94126

**DIGITAL clock calendar kit.** (7001 IC, transistors, resistors, diodes, capacitors, Xformer, PC boards, .33" displays, switches, etc.) \$25.95. **Giant Clock display kit.** 2" digits. (75 selected red LED's, PC board). \$22.95. **Super value—clock calendar with giant display.** \$45.95. All components new — first quality. Enclose 10% postage & handling. **SIL-TECH**, 3630 South Kenwood Lane, Tempe, AZ 85282

**ELECTRONIC musical chime.** Program any 10 note melody: Plans \$3.50. **TV ping pong game.** Plays through your set's antenna terminals: Plans \$3.25. **ARS SYSTEMS**, Box 1922G, Sunnyvale, CA 94088

## FOR SALE

**MANUALS** for Gov't. surplus radios, test sets, scopes, List 50c (coin). **BOOKS**, 7218 Roanoke Drive, Washington, DC 20021

**FREE** flexible magnetic strip with, 20 dics, or 10 bar, or 2 stick, or 8 assorted magnets, \$1.00. Any 5 sets, \$4.50. **MAGNETS**, Box 192-FF, Randallstown, MD 21133

**RECONDITIONED** test equipment, \$0.50 for catalog. **WALTER**, 2697 Nickel, San Pablo, CA 94806

# COMPUTER SYSTEM\*

INCLUDES  
512 CHAR  
TERMINAL

INCLUDES  
4K

# \$650.00



Shown is \$870.00 model (assembled).

**KIT INCLUDES**  
8-BIT PARALLEL COMPUTER based on MOTOROLA 6800 MICROPROCESSOR With 4K WORDS of read/write memory. (expandable to 64K words). READ ONLY MEMORY containing mini-assembler, expanded instruction set, symbolic debugging aid. CRT driver and remote or cassette program loader/dumper. Kit also includes TV TERMINAL module which generates 16 lines of 32 characters (512 characters total) on a television (does not include TV). 53 KEY KEYBOARD capable of generating whole 7-bit ASCII character set. Also includes 8-BITS OF DIGITAL I/O. ATTRACTIVE KEYBOARD CHASSIS capable of housing keyboard and other modules, and POWER SUPPLY. We supply all parts. PC boards, manuals and membership in SWAP (Sphere user group) \$100.00 EXTRA adds standard ASYNCRONOUS I/O (EIA, current loop, TTL), standard FSK MODEM and AUDIO CASSETTE INTERFACE. Other systems and modules such as memory (expandable to 64K) are available as kits or assembled.

Warranty and maintenance plans, hardware, software, and peripherals (floppys, paper tape, etc.) specs and prices will be sent upon request. For fastest reply send double postage stamped, self-addressed legal envelope to SPHERE - 96 EAST 500 SOUTH. BOUNTIFUL, UTAH 84010

Bank Americard and MasterCard accepted.

\* A computer isn't a system without peripherals and software.

## MOVING?

Don't miss a single copy of **Radio-Electronics**. Give us:

Six weeks' notice

Your old address and zip code

Your new address and zip code

ATTACH  
LABEL  
HERE

name (please print)

address

city state zip code

Mail to: Radio-Electronics  
SUBSCRIPTION DEPT., BOULDER, COLO.  
80302







**T1980 D/A.** X-Y analog output with Z-axis control. Price: \$385.00. Other interfaces. **RAY SPORLEDER**, R.R. #5, Box 48, Bloomington, IN 47401

**HOLD-IT!** A new precision electronic product. Details free. **INNOVATIVE CONCEPTS**, 4018 Clarke, Ft. Worth, TX 76107

**PRINTED CIRCUIT**

EPOXY GLASS CIRCUIT BOARD STOCK; CARBIDE DRILL BITS; TAPE RESIST; ARTWORK; BUBBLE ETCHERS

SEND S.A.S.E. FOR FLYER

**TRUMBULL**

833 BALRA DR., EL CERRITO, CA. 94530

**QUICK** cash for your used Altair 8800, TV Typewriter, interfaces, software, etc. Contact us for service, parts, and free applications information. **ALCOVE**, 230 Main, North Reading, MA 01864 (617) 664-4271

**SURPRISE!** Build inexpensively, the most unusual test instruments, futuristic gadgets using numerical readouts! Catalogue free! **GBS**, Box 100B, Greenbank, WV 24944

**SOLDERING IRON USERS  
NEW! SAME SOLDER TIP**

• SOLDERS • DESOLDERS • RESOLDERS  
**EXCELLENT FOR P.C. WORK**

Type A 1/4" dia., 6-32 threads ..... \$1.98  
Type F 3/8" dia., Plug Type Tip ..... 2.13  
Type H 1/2" dia., Plug Type Tip ..... 2.28  
**GUNMASTER**, Box 743, Kings Park, N.Y. 11754

**FREE** catalog. IC's, Semi's. **CORONET ELECTRONICS**, 649A Notre Dame W., Montreal, Que., Canada, H3C-1H8. US Inquiries. **RADIO & TV** tubes 36c each. One-year guarantee. Plus many unusual electronic bargains. Free catalog. **CORNELL**, 4217-E University, San Diego, CA 92105

**\*HOBBYIST SPECIAL\***  
These reject watch guts lack the IC and readout; but they do have the timing crystal, voltage converter for driving LCD displays, powercell, misc. parts, trimmer cap, + more. Many useful parts for..... **\$1.95**

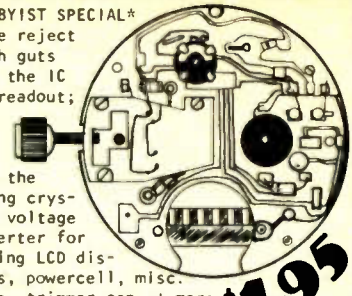

**GODBOUT**  
BILL GODBOUT ELECTRONICS  
BOX 2355, OAKLAND AIRPORT, CA 94614

CHECK OUT OUR FLYER, YOU WON'T REGRET IT. CIRCLE THE BINGO CARD AND WE'LL DO THE REST.

**MINICOMPUTER BASIC CHIP SET \$65**  
8-2102s, 1-8008

ANOTHER FIRST: PROM PROGRAMMING SERVICE FOR 1702-5202-5203 ETC. CALL OR WRITE—

**CHEAP CLOCK \$12.95**

**6 DIGITS, BOARD, PARTS, & LENS. LESS CASE & XFRMER**

Items shipped PPD; orders under \$10 add 50¢. Cal res add tax. Call (415) 357-7007 for Mastercharge or BAC. No CODs.

Circle 79 on reader service card

**INTEL 8008 8 BIT MICRO PROCESSING CHIP** (with data book) \$49.50  
2102-2 1024 BIT RAM ..... \$ 6.95  
5202A UV PROM ..... \$24.00  
MM5203 UV PROM ..... \$24.00

**MINIATURE TRIM POTS**  
5K, 10K, 25K, 50K, 100K \$ .75 ea. 3/\$2.00

**MULTI-TURN TRIM POTS**  
Similar to Bourns 3010 style, 3/8" x 5/8" x 1 1/4"; 50, 100, 2000, 5000 ohms \$1.50

**LIGHT ACTIVATED SCR'S**  
TO-18, 200V 1A \$1.75

**PRINTED CIRCUIT BOARD**  
4 1/2" x 6 1/2" single sided epoxy board, 1/8" thick, unetched \$ .50 ea. 5/\$2.20

**MC14435 & MC1405L**  
A two piece 3 1/2 digit A/D converter system for panel meters and DVM's. Schematic for low cost DVM included. \$39.95

2N3820 P FET ..... \$ .60  
TIS 73 N FET ..... \$ .50  
2N4891 UJT ..... \$ .50  
ER900 TRIGGER DIODES ..... 4/\$1.00  
2N6028 PROG. UJT ..... \$ .75

**VERIPAX PC BOARD**

This board is a 1/4" single sided paper epoxy board, 4 1/2" x 6 1/2", DRILLED and ETCHED which will hold up to 21 single 14 pin IC's or 8, 16 or LSI DIP IC's with bussers for power supply connector. \$5.25

RED/GREEN BIPOLAR LED ..... \$1.30  
M7-2 PHOTO TRANS ..... \$ .60  
GREEN OR YELLOW LED ..... \$ .30  
RED GAP OSL-3 LED ..... \$ .20  
14 PIN DIP SOCKETS ..... \$ .40  
16 PIN DIP SOCKETS ..... \$ .50  
MOLEX PINS ..... 100/\$1.00  
1000/\$8.00

**10 WATT ZENERS**  
3.9, 4.7 OR 18V ..... \$ .75 EA.  
1. WATT ZENERS 5.6, 10, 12, 15, 18, OR 22V ..... \$ .40 EA.

**Silicon Power Rectifiers**

PRV	1A	3A	12A	50A
100	.06	.14	.30	.80
200	.07	.20	.35	1.15
400	.09	.25	.50	1.40
600	.11	.30	.70	1.80
800	.15	.35	.90	
1000	.20	.45	1.10	

**REGULATED MODULAR POWER SUPPLIES**

+ -15VDC AT 100ma ..... \$24.95  
115VAC INPUT ..... \$24.95  
5VDC AT 1A, 115VAC INPUT ..... \$19.95  
12V .6A ..... \$24.95  
IN 4148 (IN914) ..... 14/\$1.00

1103 1024 bit RAM ..... \$4.75  
NEC 6003 2048 bit RAM ..... \$9.50  
1101 256 bit RAM ..... \$1.75  
8223 PROM ..... \$4.75  
7489 RAM ..... \$2.75

Terms: FOB Cambridge, Mass. Send Check or Money Order. Include Postage. Minimum Order \$5.00. COD's \$20.00.

**TRANSISTOR SPECIALS**

2N1546 PNP GE TO-3 ..... \$ .95  
2N5086 PNP Si TO-92 ..... 4/\$1.00  
2N4898 PNP TO-66 ..... \$ .60  
2N404 PNP GE TO-5 ..... 4/\$1.00  
2N3919 NPN Si TO-3 RF ..... \$1.50  
MPSA13 NPN Si TO-92 ..... 3/\$1.00  
2N3767 NPN Si TO-66 ..... \$ .70  
2N2222 NPN Si TO-18 ..... 5/\$1.00  
2N3055 NPN Si TO-3 ..... \$1.00  
2N3904 NPN Si TO-92 ..... 4/\$1.00  
2N3906 PNP Si TO-92 ..... 4/\$1.00  
2N5296 NPN Si TO-220 ..... \$ .50  
2N6109 PNP Si TO-220 ..... \$ .55  
2N3866 NPN Si TO-5 Si RF POWER \$ .75  
MJ2252 NPN Si TO-66 ..... \$ .90  
2N3638 NPN Si TO-5 ..... 5/\$1.00  
2N6517 NPN TO-92 Si ..... 3/\$1.00

**CAPACITORS**

35V at .47 of TANT 5/\$1.00  
35V at 6.8 of TANT 3/\$1.00  
20V at 150 of TANT ..... \$ .40  
6V 30 of TANT ..... 5/\$1.00  
12V 200 of ELEC ..... \$ .30  
200V 4.7 of ELECT ..... \$ .30

CD201 100x100 IMAGE SENSOR CHARGED COUPLE DEVICES USED IN SOLID STATE CAMERAS, WITH APPLICATIONS. \$1.98

FPA 711-7 LEVEL Diode Array Optical Tape Readers ..... \$5.95

Conductive Elastometer low profile calculator keyboard. A 2 3/4" x 3 1/4" x 1/2" flex key. 195K-6 keyboard having 0-9, +, -, \*, /, =, K+C buttons with off, on switch. \$6.00

**TTL IC SERIES**

74L00	.30	7476	-.45
7400	.14	7480	-.60
7401	.17	7483	-.80
7402	.14	7485	-1.10
7403	.17	7486	-.40
7404	.21	7490	-.60
7405	.20	7491	-1.00
7406	.35	7492	-.75
7407	.37	7493	-.60
7408	.18	7495	-.80
7410	.17	7496	-.85
7411	.27	8267	-1.95
7412	.45	74107	-.40
7413	.72	74121	-.50
7416	.37	74123	-.90
7417	.37	74125	-.65
7420	.17	74126	-.70
7425	.36	74150	-.99
7426	.27	74151	-.84
7427	.31	74153	-1.05
7430	.17	74154	-1.49
7432	.27	74155	-1.05
7437	.36	74157	-1.17
7438	.35	74163	-1.45
7440	.17	75164	-1.75
7441	.95	74165	-1.75
7442	.90	74173	-1.55
7445	1.05	74175	-1.60
7446	1.10	74177	-1.50
7447	1.00	74181	-3.00
7448	1.00	74192	-1.40
7472	.33	74193	-1.28
7473	.38	74195	-.80
7474	.35	74196	-1.85
7475	.60	75491	-1.10

8038C IC VOLT CONT. OSC ..... \$4.50

5311, 5314 or 5316 CLOCK CHIPS ..... ea. \$6.75

C17001 CALENDAR ALARM CLOCK CHIP ..... \$9.95

10 PIN TO-5 TEFLON PC SOCKETS ..... \$ .60

**C/MDS (DIODE CLAMPED)**

74C02 \$ .55 CD4019 \$ .58  
74C10 \$ .60 CD4022 \$1.25  
74C157 \$2.15 CD4023 \$1.30  
74C165 \$3.50 CD4024 \$1.00  
CD4001 \$ .30 CD4025 \$ .30  
CD4002 \$ .30 CD4026 \$1.67  
CD4006 \$1.50 CD4027 \$1.20  
CD4007 \$ .30 CD4028 \$1.09  
CD4009 \$ .67 CD4029 \$1.42  
CD4010 \$ .65 CD4030 \$ .30  
CD4011 \$ .30 CD4035 \$1.42  
CD4012 \$ .30 CD4042 \$ .84  
CD4013 \$ .53 CD4046 \$2.50  
CD4015 \$1.17 CD4047 \$3.10  
CD4016 \$ .65 CD4050 \$ .58  
CD4017 \$1.35 CD4055 \$2.70

**DO-33-A 3 DIG. LED Full Wave Bridges**

ARRAY READOUT \$1.95  
MAN-1, Red or Yellow PRV 2A 6A 25A  
LED READOUT ..... \$2.50 200 .95 1.25 4.00  
MAN-3 READOUT \$1.75 400 1.15 1.50 5.00  
MAN-4 READOUT \$2.00 600 1.35 1.75 6.00  
SLA 3 ..... \$4.50

2516-64x68 CHARACTER GEN. .... \$9.95

CD 110 LINEAR 256 XI BIT SELF SCANNING CHARGED COUPLED DEVICE, WITH DATA ..... \$150.00

**SANKEN AUDIO POWER AMPS**

Si 1010 G 10 WATTS ..... \$ 6.40  
Si 1020 G 20 WATTS ..... \$13.95  
Si 1050 G 50 WATTS ..... \$24.95

**LINEAR CIRCUITS**

LM 309K 5V 1A REGULATOR ..... \$1.50  
723 -40 +40V REGULATOR ..... \$ .58  
301/748-Hi Per. Op. Amp. .... \$ .30  
LM 320 -5 or -15 V REG. .... \$1.75  
LM 376 -V to 37V POS REG. \$ .58  
741A or 741C OP. AMP. .... \$ .31  
709C OPER. AMP. .... \$ .25  
340T-5, 12, 15, 18, 24V POS. REG. TO-220 ..... \$1.75  
101 OPER. AMP. HI PERFORM. \$ .75  
LM 308 Oper. Amp., Low Power \$1.05  
747-DUAL 741 ..... \$ .75  
556-DUAL TIMER ..... \$1.30  
537-PRECISION OP. AMP. .... \$2.60  
LM 3900-QUAD OP. AMP. .... \$ .49  
LM 324 QUAD 741 ..... \$2.20  
560-PHASE LOCK LOOP ..... \$2.50  
561-PHASE LOCK LOOP ..... \$2.50  
565-PHASE LOCK LOOP ..... \$2.50  
556 FUNCTION GEN. .... \$2.50  
567-TONE DECODER ..... \$2.85  
703-RF-IF AMP. .... \$ .41  
LM370-AGC SQUELCH AMP. .... \$1.15  
555-2 μs -2 HR. TIMER ..... \$ .88  
553 QUAD TIMER ..... \$3.50  
FCD 810 OPTO-ISOLATOR ..... \$1.35  
1456 OP. AMP. .... \$ .95  
1458 DUAL OP. AMP. .... \$ .65  
LM 380-2W AUDIO AMP. .... \$1.39  
LM 377-2W Stereo Audio Amp. \$2.50  
LM 381-STEREO PREAMP ..... \$1.69  
LM 382-DUAL AUDIO PREAMP \$1.69  
LM 311-HI PER. COMPARATOR \$ .95  
LM 319-Dual Hi Speed Comp. \$1.15  
LM 339-QUAD COMPARATOR \$1.45

**TRIACS SCR'S**

PRV	1A	10A	25A	1.5A	6A	35A
100	.40	.70	1.30	.40	.50	1.20
200	.70	1.10	1.75	.60	.70	1.60
400	1.10	1.60	2.60	1.00	1.20	2.20
600	1.70	2.30	3.00			3.00

Send 20c for our catalog featuring Transistors and Rectifiers 145 Hampshire St., Cambridge, Mass.

**LISTEN TO Spectacular 4-Channel Sound!**

Vista SQ Decoder  
Exclusive CBS Licensed  
IC'S FOR SUPERB FIDELITY AND CHANNEL SEPARATION WITH FULL LOGIC AND WAVE MATCHING

**FIXED BLEND KIT SQ-1 \$40.00**  
**VARIABLE BLEND KIT SQ-3 \$55.00**

All Parts Except Case and Power Supply.  
+20V 75mA IC Regulated Power Supply Kit Available. Only \$5.00 when ordered with a decoder kit.

Shipped prepaid in USA NY State add Tax \$2.00 additional for CANADA

**PHOTOLUME CORPORATION**  
118 East 28th STREET, New York, N.Y. 10016

Circle 88 on reader service card



**SOLID STATE SALES**  
P.O. BOX 740  
SOMERVILLE, MASS. 02143 TEL. 617 547-4005

WE SHIP OVER 95% OF OUR ORDERS THE DAY WE RECEIVE THEM







## 2102-2 MOS 1024 BIT MEMORY

FULLY DECODED STATIC RANDOM ACCESS MEMORY  
DIRECTLY TTL COMPATIBLE INPUTS AND OUTPUT  
SINGLE 5V SUPPLY -- NO CLOCKS OR REFRESH

**NEW**

**\$6.95 EA. (DIP) 8 FOR \$49.95**

Numeric Display  
1/4" Single Digit  
GaAsP LED



COMMON CATHODE WITH RH DECIMAL

Compact--10 digits in 3" panel width

ACTUAL SIZE

Highly legible-- bright red 1/4" character easily read within 10 feet over a wide viewing angle

125 mW per digit at typical brightness

**SUPER SPECIAL \$ .75**

**TEN for \$5.95**

**SPECIAL**  
**8223**  
**PROM**



8 BIT  
32 WORD  
MEMORY

\$3.00 EA.

10 - \$29

WE PROGRAM

FOR \$5 EACH

## CD-2 COUNTER KIT

Unit includes board, 7490, 7475, quad latch, 7447 seven-segment driver, and RCA DR2010.

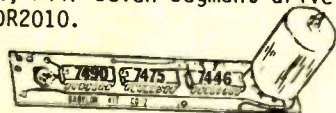

COMPLETE KIT only \$11.95; FULLY-ASSEMBLED \$15.00; boards can be supplied separately at \$2.50 per digit.

## RCA 2010

Numitron Digital Display Tube, incandescent 5-volt 7-segment:

.6" High numeral visible from 30 ft

Standard 9-pin base (solderable)

Left-hand decimal point

EACH \$5.00 5 FOR \$20.00

## TTL DIP

7400	.20
74H00	.25
7401	.20
74H01	.25
7402	.25
7403	.25
7404	.25
74H04	.30
7405	.30
7406	.40
7408	.30
7400	.20
7410	.20
7413	.75
7417	.40
7420	.20
74L20	.30
74H20	.30
74H22	.30
7430	.20
74H30	.30
74L30	.30
7440	.20
74H40	.30
7442	1.00
7447	1.50
7450	.20
74H50	.30
7451	.20
74H51	.25
7453	.20
7454	.20
74L54	.25
74L55	.25
7460	.16
74L71	.25
7472	.40
74L72	.60
7473	.35
74L73	.75
7474	.45
74H74	.75
7475	.80
7476	.55
74L78	.70
7480	.50
7483	.70
7489	3.00
7490	1.00
7492	.65
7493	1.00
7495	.65
74L95	1.00
74107	.50
74145	1.25
74180	1.00
74193	1.50
74195	.80

## CMOS

CD4000	\$.55	CD4016	1.00
CD4001	.45	CD4019	1.00
CD4002	.45	CD4023	.45
CD4007	1.00	CD4024	1.60
CD4008	3.25	CD4025	.45
CD4009	.75	CD4027	1.00
CD4010	.75	CD4030	1.00
CD4011	.45	74C20	.65
CD4012	.45	74C42	2.00
CD4013	1.00	74C157	2.50
CD4015	3.00	74C161	3.00
		74C195	2.00

## TRANSISTOR

**SPECIAL**

2N3568-HEP736	
TO92 PLASTIC	
NPN 300mW	
60V 40-120B	
EACH	\$ .15
TEN	1.00
100	9.00
1000	80.00

NEW-TELEDYNE  
MARKED T3568



## POTTER BRUMFIELD

Type KHP Relay  
4 PDT 3A Contacts

24 VDC (650 coil) \$1.50 EA.

120 VAC (10.5 MA coil) \$1.75 EA.

## SEND FOR FREE FLYER!

C.O.D. PHONE ORDERS  
ACCEPTED--\$10 MINIMUM

All IC's new and fully tested, leads plated with gold or solder. Orders for \$5.00 or more are shipped prepaid, smaller orders--add 55c. California residents add Sales Tax.....IC's shipped within 24 hours.

P.O. BOX 41727

**BABYLON ELECTRONICS**

SACRAMENTO, CA

95841

916 334 2161

## LIQUID CRYSTAL CALCULATOR \$10.00

Rejects and require repairs but most easily repaired. Desk top models. We furnish 32 page instruction and trouble shooting. 8 digit 4 function. Two models available.

AC model # SP102A  
\$10 each; 3 for \$26.50  
Btry. model # SP102B  
\$11 each; 3 for \$30.00

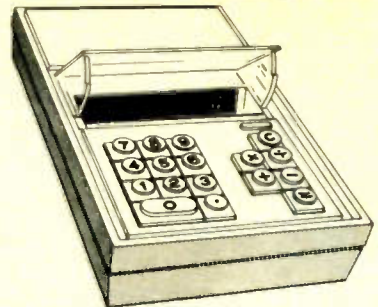

## PANAPLEX 12 DIGIT DISPLAY

12 digit neon (180 volts) display. Genuine Burroughs Panaplex II cold cathode gas discharge 7 segments. Unused and we include the special socket. Measures 3 3/8 x 7/8 (pic shown is full size). Data sheet included. Good for clocks, timers, counters, any type of digital readout use. Readability at 15 feet.

# PANAPLEX \$6.00

## HI-VOLTAGE (NEON) DRIVER PACKAGE

Package of 3 IC units for interfacing of high voltage neon type displays with low voltage calculator chips. This set of three IC's consists of Cathode Driver IC, Anode Driver IC, and Level Shifter IC. We include data for use. Good with Panaplex displays, Sperry displays, Anaplex displays, etc. From what we can see, no one seems to have them and this is the first time offered at surplus prices. They are first line devices, surplus due to a manufacturer of keyboard displays going out of business.



# DION \$6.00

## MOS ASCII ENCODER CHIP

With all the interest in keyboard encoders, TV readouts, etc. this single chip ASCII encoder should be welcome news. And the price...unbelievable at \$9.95. 40 pin DIP, made by MOS Technology. Data sheets enclosed with each order.

# SP-105 \$9.95; 3 for \$25

Please add shipping cost on above.

*Meshna*

**SURPLUS ELECTRONIC MATERIAL**  
19 ALLERTON ST., E. LYNN, MASS. 01904

## TRIPLE REGULATOR BOARD



This board has 3 regulators, +12 volts @ 200 ma., and a tracking regulator, 0 to 5 volts @ 500 ma. Regulation is 0.5% for all regulators. We supply circuit diagram and data sheet.

5 1/2" x 3 1/4"

STOCK NO.R9013 Triple voltage regulator, \$5.95 ea. 2/10.00

## SOPHISTICATED PARTS BOARD

This board is loaded with exotic parts. 6 741 op amps, 4 dipped tantalum caps., multi turn trimpot, 20 transistors, including complimentary 2N3904 & 2N3906, plus about 100 1/2 watt resistors, diodes and zeners.

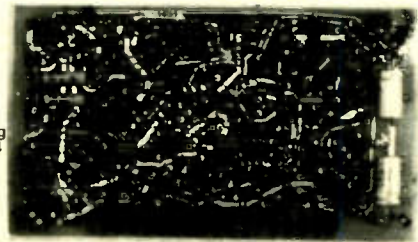

STOCK NO.R9327 Sophisticated parts board \$2.00 ea. 3/5.00

## POWER TRANSFORMERS

90V @ 2A.ct., 6.3V @ 1.5A 8 1/2lb.	Stk. R9315	9.95	2/19.00
70V @ 1.5A ct., 6V @ .5A 5 1/2lb.	Stk. R9314	6.50	2/12.00
36V @ 1A.ct., 6.3V @ .2A 3Lb.	Stk. R9313	3.50	2/6.00

Enclose sufficient postage. Excess will be refunded. Send for our new catalog 14. 64 pages of electronic bargains.



**DELTA ELECTRONICS CO.**

BOX 1, LYNN, MASSACHUSETTS 01903  
Phone (617) 388-4705

Circle 76 on reader service card

Circle 75 on reader service card



# INTERNATIONAL ELECTRONICS UNLIMITED

**10% Off on orders over \$25.00**  
**15% Off on orders over \$100.00**  
**20% Off on orders over \$250.00**

## TTL

7400	\$ .19	7450	\$.24	74151	\$ .89
7401	.19	7451	.27	74153	1.29
7402	.19	7453	.27	74154	1.25
7403	.19	7454	.29	74155	1.19
7404	.22	7460	.19	74156	1.29
7405	.22	7464	.39	74157	1.29
7406	.39	7465	.39	74160	1.58
7407	.39	7470	.49	74161	1.39
7408	.25	7472	.36	74163	1.59
7409	.25	7473	.39	74164	1.89
7410	.19	7474	.39	74165	1.89
7411	.29	7475	.40	74166	1.65
7413	.49	7476	1.11	74170	2.95
7415	.39	7483	1.11	74173	1.65
7416	.39	7485	1.10	74174	1.80
7417	.39	7486	.44	74175	1.85
7420	.19	7489	2.75	74176	1.85
7422	.29	7490	.69	74177	.85
7423	.32	7491	1.00	74180	1.00
7425	.27	7492	.79	74181	3.65
7426	.29	7493	.79	74182	.89
7427	.32	7494	.89	74184	2.30
7430	.22	7495	.89	74185	2.19
7432	.26	7496	.89	74187	5.95
7437	.39	74100	1.50	74190	1.50
7438	.39	74105	.49	74191	1.50
7440	.19	74107	.49	74192	1.25
7441	1.09	74121	.47	74193	1.25
7442	.89	74122	.47	74194	1.39
7443	.89	74123	.99	74195	.99
7444	.89	74125	.60	74196	1.25
7445	.99	74126	.79	74197	.99
7446	.99	74141	1.15	74198	2.19
7447	.89	74145	1.15	74199	2.19
7448	1.15	74150	.95	74200	7.95

## LOW POWER TTL

74100	\$.25	74L51	\$.29	74L90	\$1.49
74102	.25	74L55	.33	74L91	1.45
74103	.25	74L71	.25	74L93	1.69
74104	.25	74L72	.39	74L95	1.69
74106	.25	74L73	.49	74L98	2.79
74110	.25	74L74	.49	74L164	2.79
74120	.33	74L78	.79	74L165	2.79
74130	.33	74L85	1.25		
74142	1.49	74L86	.69		

## HIGH SPEED TTL

74100	\$.25	74H21	\$.25	74H55	\$.25
74101	.25	74H22	.25	74H60	.25
74104	.25	74H30	.25	74H61	.25
74108	.25	74H40	.25	74H62	.25
74110	.25	74H50	.25	74H72	.39
74111	.25	74H52	.25	74H74	.39
74H20	.25	74H53	.25	74H76	.49

## 8000 SERIES TTL

8091	.59	8214	1.69	8811	.69
8092	.59	8220	1.69	8812	1.10
8095	1.39	8230	2.59	8822	2.59
8121	.89	8520	1.29	8830	2.59
8123	1.59	8551	1.65	8831	2.59
8130	2.19	8552	2.49	8836	2.59
8200	2.59	8554	2.49	8880	1.33
8210	3.49	8810	.79		

## 9000 SERIES TTL

9002	.39	9309	.89	9601	.99
9301	1.14	9312	.89	9602	.89

Data sheets supplied on request  
 Add \$.50 ea. for items less than \$1.00

## CMOS

4000 AE	\$.40	4019 AE	\$2.10	4066 AE	\$1.05	4014 AE	2.10	4049 AE	.90	4528 AE	1.60
4001 AE	.40	4020 AE	2.20	4068 AE	.40	4015 AE	2.10	4050 AE	.90	4585 AE	2.40
4002 AE	.40	4021 AE	2.05	4069 AE	.40	74C00	\$.24	74C74	\$1.15	74C162	3.25
4006 AE	1.75	4023 AE	.40	4071 AE	.40	74C02	.29	74C76	1.49	74C163	2.95
4007 AE	.40	4024 AE	1.45	4072 AE	.40	74C04	.49	74C107	1.25	74C164	2.95
4008 AE	2.45	4025 AE	.40	4073 AE	.40	74C08	.39	74C151	2.90	74C173	2.90
4009 AE	.80	4027 AE	1.20	4075 AE	.40	74C10	.75	74C154	3.50	74C195	2.95
4010 AE	.80	4028 AE	1.75	4078 AE	.40	74C20	.39	74C157	1.95	80C95	1.50
4011 AE	.40	4030 AE	.85	4081 AE	.40	74C42	1.79	74C160	2.75	80C97	1.25
4013 AE	.80	4042 AE	1.90	4082 AE	.40	74C73	1.15	74C161	3.25		

# JULY SPECIALS

## DIGITAL

7404	Hex inverter	\$1.19
7406	10V hex inverter	.29
7410	Triple 3 input NAND	.17
7437	Quad 2 input NAND buffer	.29
7442	BCD to decimal DCDR	.59
7490	Decade counter	.59
74107	Dual J-K flip flop	.39
74123	Retrig monostbl mult	.89
74125	Quad D flip flop	1.69
8263	3 input 4 bit mult	5.99
8267	2 input 4 bit mult	2.79
74C00	Quad 2 input NAND gate	.19

## MEMORY

1103	Fully decoded — 1024 bit static RAM	
MOS	— 18 pin	\$1.99
5260	Fully decoded — 1024 bit dynamic RAM	
MOS	— 16 pin	.99

**SPECIAL PURCHASE LED DISPLAY MAN 3M**  
 \$.25 ea. 5/\$1.00 8/\$1.50

## 16 BIT MICROPROCESSOR CHIPS

MM5750	Arithmetic and logic unit	\$30.00 ea.
MM5751	Control and read only memory	\$40.00 ea.
(Imp-16 standard set or extended set)		
Set of 4 MM5750 and 1 MM5751		\$129.00

## CT5005 CALCULATOR CHIP

12 digit — 4 function with memory — chain operation ..... \$4.95 ea.

## 8008 CENTRAL PROCESSING UNIT

8 bit microcomputer capability — 16 pin DIP \$44.95 ea.

## POCKET CALCULATOR KIT



5 function plus constant — addressable memory with individual recall — 8 digit display plus overflow — battery saver — uses standard or rechargeable batteries — all necessary parts in ready to assemble form — instructions included. 3" x 5 1/2" ASSEMBLED

\$10.95  
\$24.95

## LINEAR

301	Hi perf amp	mDIP	\$1.99
311	Volt comp.	mDIP	.79
555	Timer	mDIP	.89
567	Tone decoder	mDIP	2.75
3900	Quad amp	DIP	.33
75453	Dual per. drv	mDIP	.10

## MEMORIES

1101	256 bit RAM MOS	\$1.75
1103	1024 bit RAM MOS	3.95
2101	1024 bit static RAM	6.95
5203	2048 bit UV eras PROM	19.95
5260	1024 bit RAM	2.95
5261	1024 bit RAM	2.95
5262	2048 bit RAM	7.95
7489	64 bit ROM TTL	2.75
8223	Programmable ROM	3.95
74200	256 bit RAM tri-state	7.95

## CALCULATOR & CLOCK CHIPS

5001	12 DIG 4 funct fix dec	3.95
5002	Same as 5001 exc btry pwr	4.95
5005	12 DIG 4 funct w/mem	5.95
MM5725	8 DIG 4 funct chain & dec	2.25
MM5736	18 pin 6 DIG 4 funct	5.95
MM5738	8 DIG 5 funct K & Mem	5.95
MM5739	9 DIG 4 funct (btry sur)	5.95
MM5311	28 pin BCD 6 dig mux	4.45
MM5312	24 pin 1 pps BCD 4 dig mux	4.95
MM5313	28 pin 1 pps BCD 6 dig mux	4.95
MM5314	24 pin 6 dig mux	4.95
MM5316	40 pin alarm 4 dig	5.95

## LED's

MV10B	Red TO 18	\$ .25
MV50	Asial leads	.20
MV50Z0	Jumbo Vis. Red (Red Dome)	.25
	Jumbo Vis. Red (Clear Dome)	.25
ME4	Infra red diff. dome	.60
MAN1	Red 7 seq. .270"	2.50
MAN2	Red alpha num. 32"	4.95
MAN4	Red 7 seq. .190"	2.15
MAN5	Green 7 seq. .270"	2.95
MAN6	.6" high solid seq.	4.95
MAN7	Red 7 seq. .270"	1.35
MAN8	Yellow 7 seq. .270"	3.95
MAN6A	.4" high solid seq.	3.50
MAN66	.6" high spaced seq.	4.65
DL707	Red 7 seq. .3"	2.15
MCT2	Opto-iso transistor	.69

## SHIFT REGISTERS

MM 5013	1024 bit accum. dynamic	mDIP	\$1.95
MM 5016	500/512 bit dynamic	mDIP	1.75
MM 5058	1024 bit static	DIP	3.95
SL 5-4025	Dual 64 bit static	DIP	1.50

## LINEAR CIRCUITS

300	Pos V Reg (super 723)	TO-5	\$ .79
301	Hi Perf Op Amp	mDIP TO-5	.32
302	Volt follower	TO-5	.59
304	Neg V Reg	TO-5	.89
305	Pos V Reg	TO-5	.79
307	Op AMP (super 741)	mDIP TO-5	.29
308	Micro Pwr Op Amp	mDIP TO-5	.99
309K	5V 1A regulator	TO-3	1.50
310	V follower Op Amp	TO-5 mDIP	1.19
311	Hi perf V Comp	mDIP TO-5	1.05
319	Hi Speed Dual Comp	DIP	1.29
320	Neg Reg 5.2, 12, 15	TO-3	1.25
322	Precision Timer	DIP	1.15
324	Quad Op Amp	DIP	1.89
339	Quad Comparator	DIP	1.69
340T	Pos Volt Reg (5V-6V)		
	8V-12V-15V-18V-24V)	TO-220	1.75
370	AGC/Squelch AMPL	TO-5 or DIP	1.15
372	AF-IF Strip detector	DIP	.79
373	AM/FM/SSB Strip	DIP	3.25
376	Pos. V. Reg	mDIP	.59
377	2w Stereo amp	DIP	2.69
380	2w Audio Amp	DIP	1.29
380-B	Low Audio Amp	mDIP	1.25
381	Lo Noise Dual preamp	DIP	1.69
382	Lo Noise Dual preamp	DIP	1.69
550	Prec V Reg	DIP	.79
555	Timer	mDIP	.99
560	Phase Locked Loop	DIP	2.75
562	Phase Locked Loop	DIP	2.75
565	Phase Locked Loop	DIP TO-5	2.65
566	Function Gen	mDIP TO-5	2.50
567	Tone Decoder	mDIP	2.95
709	Operational AMPL	TO-5 or DIP	.29
710	Hi Speed Volt Comp	DIP	.39
711	Dual Difference Compar	DIP	.29
723	V Reg	DIP	.69
739	Dual Hi Perf Op Amp	DIP	1.19
741	Comp Op AMP	mDIP TO-5	.35
747	Dual 741 Op Amp	DIP or TO-5	.79
748	Freq Adj 741	mDIP	.39
1304	FM MulpX Stereo Demod	DIP	1.19
1307	FM MulpX Stereo Demod	DIP	.82
1458	Dual Comp Op Amp	mDIP	.69
1800	Stereo multiplexer	DIP	2.75
LH2111	Dual LM 211 V Comp	DIP	1.89
3065	TV-FM Sound System	DIP	.69
3075	FM Det-LMTR & Audio preamp	DIP	.79
3900	Quad Amplifier	DIP	.39
7524	Core Mem Sense AMPL	DIP	.79
7534	Core Mem Sense Amp	DIP	.79
8864	9 DIG LED Cath Drvr	DIP	2.50
75451	Dual Peripheral Driver	mDIP	.39
75452	Dual Peripheral Driver	mDIP	.39
75453	(351) Dual Periph. Driver	mDIP	.39
75491	Quad Seq Driver for LED	DIP	.79
75492	Hex Digit Driver	DIP	.89
MCT2	OPTO-ISO TRANS	mDIP	.69

## DTL

930	\$.17	937	\$.17	949	\$.17
932	.17	944	.17	962	.17
936	.17	946	.17	963	.17



Shipment will be made via first class mail — postage paid in U.S., Canada and Mexico — within three days from receipt of order. Minimum order — \$5.00. California residents add sales tax.

**INTERNATIONAL ELECTRONICS UNLIMITED**  
 P.O. BOX 1708 / MONTEREY, CA. 93940 USA  
 PHONE (408) 659-3171

Circle 78 on reader service card



## Saxitone's Bicentennial Tape Shoppe CASSETTE LABELS

Plain white cassette labels. Norelco cassette cleaners, famous brand cassettes. Send for open reel and cassette discount catalog.

	1-9	10-99	100	1000	10M
Cassette Labels (Multiples of 10)		.02	.015	.01	.006
Norelco Cassette Cleaner	.65	.60	.55	.50	.45
Scotch Cassette SC90HE	3.25	3.10	2.95	2.80	2.75

\*Buy 10. SC90HE, get 5 free.  
Plus Postage by Weight and Zone. Minimum Order \$5.00

### OPEN REEL STEREO TAPE BUYERS!

At last! An open reel catalog, including titles, songs, etc. of 95 long play, 2-3 hour albums by American Airlines or Ampex 4 track stereo tapes. Send \$1.00—and we will also mail you a 140-page Harrison stereo tape guide—so you'll get both for \$1.00—and this \$1.00 is refundable on your first \$10.00 purchase of open reel stereo tapes at our 30% discount.

We've Got the "Spirit" The Prices And The Address To Prove It  
SAXITONE TAPES 1776 Columbia Rd., N.W., Wash. D.C. 20009

NEW Canadian Magazine, "Electronics Workshop", \$5.00 yearly, sample \$1.00.  
ETHCO, Box 741 "A", Montreal

LOW-noise resistors— $\frac{1}{4}$ W, 5% carbon film from 10 — 3.3 megohms for  $3\frac{1}{2}$ c each. Fifty of one value for \$1.25. 1N4148 diodes for 6c. 75c postage. Free samples/specifications. COMPONENTS CENTER—RE, Box 134, New York, NY 10038

**PARTS! CORNELL TUBES!**

Send For FREE CORNELL'S New Color Catalog 48 pgs New Items

**33¢** per tube

**36¢** per tube

ORDER FREE IF NOT SHIPPED IN 74 HOURS!

4215 E. UNIVERSITY AVE SAN DIEGO CALIF 92105

SAMS Photofacts, 1-891, JOY CEARLEY, 6517 Dakar, Wort Worth, TX 76116. Phone (817) 732-5403

PHOTOGRAPHIC timer digital readout, crystal time base, alarm, footswitch, guaranteed. CASCADE LABS, 5637 Bayview Ave. Richmond, CA 94804

# S. D. SALES CO.

P. O. BOX 28810 DALLAS, TEXAS 75228

## 6 Digit Digital Clock Kit

Our Engineer said it would be "impossible" to sell a Six Digit kit for this price. But because of several special super buys we made on chips and displays we can offer this unbelievable bargain on our Clock Kit. Sure, this price is too good to be true, but rest assured, all parts in this kit are prime, first run units. Also, all kits are sold with an unconditional money back guarantee.

### Here's What The Kit Includes:

- 1 — MM5314 National Clock Chip with socket
- 6 — Common Cathode Led Readouts (.25 in. char.)
- 13 — NPN and PNP Driver Transistors
- 2 — Push Button Switches for time set
- 1 — Rocker Switch for time hold
- 1 — 1000 MFD 25V Filter Cap
- 4 — IN4001 Rectifiers
- 1 — IN914 Diode
- 2 — .01 Disc. Caps
- 9 — Carbon Resistors

**\$9<sup>95</sup>**  
(KIT)

WITH SPECS.  
POSTPAID

(PC Board for Kit \$3.00)

All you need to add is a 12VAC Transformer, perfboard, and your choice of case. The above parts, if ordered separately from our competitors, could cost you as much as \$20. Buy from S.D. and you'll be happy with our quality parts and ultra fast shipment.

## ARNOLD TORROID CORES

#A-759135-2. Perfect for chokes, transformers, etc. OD-1.875 IN. ID-.918 IN. H-.745 IN. Permeability — 60. L-135 MH/1000 turns. Cross Sectional Area — 1.95 CM<sup>2</sup>. Regular Factory Cost \$5.00  
Our Price — 99¢

### 48 HOUR SERVICE

You deserve, and will get prompt shipment. On orders not shipped in 48 HRS., a 20% cash refund will be sent. We do not sell junk. Money back guarantee on every item. WE PAY POSTAGE. Orders under \$10 add 75¢ Handling. No C.O.D. Texas Res. add 5% tax.

### INTEL 1K 2102 RAM

Factory prime, tested units. Factory selected for much faster speed than units sold by others. 650 NS. These are static memories that are TTL compatible and operate off +5 VDC. The real workhorse of solid state memories because they are so easy to use. Perfect for TV typewriters, mini-computers, etc. With specs. \$6.99 ea. or 8 for \$40

## ALTAIR 8800 USERS!

Get your system going inexpensively with our memory and Input/Output cards. All are fully 8800 compatible and include every standard 8800 feature plus more. Check these features:

- Designed for maximum versatility to meet your system requirements
- Easy to assemble and use
- Maximum noise rejection built in
- Two sided epoxy, plated thru holes
- Gold plated edge contacts
- 100% GUARANTEED

### INPUT/OUTPUT

This one card will meet all common I/O requirements. Interface your Altair with the TV Typewriter and at the same time a teletype or modem, plus other devices.

- Two input and two output ports (parallel)
- One serial I/O for any teletype and/or EIA RS-232C device, uses a UART
- Two special ports for any imaginable control needs
- Program serial data from 35 to 9600 baud
- Full I/O handshaking provided

ORDER KIT No. 3P+S ..... \$125.

### MEMORIES

Our high speed, low power static read write memory (RAM) allows the 8800 to run at top speed. All our memory IC's are 100% tested to Military STD-883! Each card accepts up to 4096 8 bit words.

ORDER KIT No. 4KRA

w/4Kx8	.....	\$225.
w/2Kx8	.....	125.
w/1Kx8	.....	85.

Our PROM card accepts up to eight 1702A or 5203 erasable programmable read only memories. All necessary 8800 interface logic is provided but NO PROM's.

ORDER KIT No. 2KRO .... \$ 50.

Write for assembled unit pricing. Send for our FREE flyer or order now from:

### PROCESSOR TECHNOLOGY CO.

2465 Fourth St., Berkeley, Calif. 94710

(415) 549-0857

Terms: All items postpaid. California residents add sales tax. 20% deposit required on COD orders. Discounts: 5%, orders over \$375; 10%, over \$600.

Circle 87 on reader service card

ELECTRONIC Ignition: Capacitor, transistor, pointless, Auburn sparkplugs. Information 10c. ANDERSON ENGINEERING, Epsom, NH 03234

## WAREHOUSE DISCOUNTS ON

NATIONALLY ADVERTISED

- C.B. RADIOS
- MONITOR SCANNERS FIRE POLICE
- MARINE ELECTRONICS

IN FACTORY SEALED CARTONS

BUSINESS - RECREATION - PERSONAL  
SATISFACTION GUARANTEED

WRITE FOR QUOTE

ELECTRONICS WAREHOUSE, INC.

6234 LITTLE RIVER TURNPIKE (DEPT. 7)

ALEXANDRIA, VA. 22312

OR PHONE: (703) 258-1300

ELECTRONIC parts! New! Solid State devices! Free flyer: DARTEK ELECTRONICS, Box 2460, Dartmouth, Nova Scotia, Canada U.S. inquiries.

FREE Bargain Catalog. Ultrasonic devices, LED's, transistors, IC's, keyboards, Xtals, unique components. CHANEY's, Box 15431, Lakewood, CO 80215

BURGLAR alarm dialing unit automatically calls police. \$29.95. Free literature. S&S SUPPLY, Box 12375G, North Kansas City, MO 64116

INTEL 8080, 8-bit CPU: \$175.00; MM5203Q-1, 2048 RE-PROM: \$15.50; AY5-1008, TTY RX: \$6.00; AY5-1010, TTY TX: \$6.00; AY5-1013A UART: \$13.95; AY5-2376 KYBD encoder: \$12.95; XR205, function gen: \$10.50; XR210 FSK MOD/DEM/OD: \$6.00; XR2240, 5MHZ XTAL: \$2.95; TV-typewriter II PCB's (main & memory): \$39.50; prog. timer: \$4.95. ELECTRONIC DISCOUNT SALES, 138 N. 81st ST., MESA, AZ 85207



# IC'S EXAR KITS

## FUNCTION GENERATOR KIT

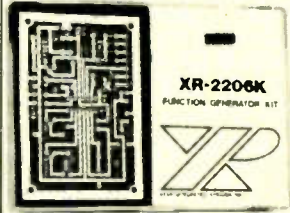

features sine, triangle and square wave. THD 0.5% typ. AM/FM capability.

- XR-2206KA \$19.95**  
Includes monolithic function generator IC, PC board, and assembly instruction manual.
- XR-2206KB \$29.95**  
Same as XR-2206KA above and includes external components for PC board.
- TIMERS**
- XR-555CP Monolithic Timer \$ 1.10
  - XR-320P Precision Timer 1.55
  - XR-555CP Dual-555 Timer 1.85
  - XR-2555CP Quad Timing Circuit 3.20
  - XR-2240CP Programmable Counter/Timer 4.80
- PHASE LOCKED LOOPS**
- XR-210 FSK Demodulator 5.20
  - XR-215 High Frequency PLL 6.50
  - XR-567CP Tone Decoder (mini DIP) 1.95
  - XR-567CT Tone Decoder (TO-5) 1.70
- STEREO DECODERS**
- XR-1310P PLL Stereo Decoder 3.20
  - XR-1310EP PLL Stereo Decoder 3.20
  - XR-1800P PLL Stereo Decoder 3.20
- WAVEFORM GENERATORS**
- XR-205 Waveform Generator 8.40
  - XR-2206CP Monolithic Function Generator 5.50
  - XR-2207CP Voltage-Controlled Oscillator 3.85
- OTHER EXAR IC'S**
- XR-1468CN Dual +15V Tracking Regulator 3.85
  - XR-1488N Quad Line Driver 5.80
  - XR-1489AN Quad Line Receiver 4.80
  - XR-2208CP Operational Multiplier 5.20
  - XR-2211 CP FSK Demodulator/Tone Decoder 6.70
  - XR-2261P Monolithic Proportional Servo IC System w/4 ea. Driver Transistor 3.75

### \*Special Requested Items\*

8008 Processor	\$29.95	8267	\$ 4.00	4024P*	\$2.25
1101 256 x 1 RAM	2.25	2513*	11.00	NB797	3.00
2102 1024 RAM	5.50	2518	7.00	MC1741	4.00
AYS-1013 UART	9.95	2519	4.00	MC4044	5.50
RC4191 TK	5.95	2524*	3.50	40409	1.65
8101	18.00	2525	7.00	40410	1.75
8263	7.00	2529*	4.00	40673	1.75

### DIODES (Zener)

TYPE	VOLTS	W	PRICE	TYPE	VOLTS	W	PRICE
IN746	3.3	400m	4/1.00	IN4003	200 PIV	1 AMP	1.10
IN751A	5.1	400m	4/1.00	IN4004	400 PIV	1 AMP	1.10
IN752	5.6	400m	4/1.00	IN3600	50	200m	6.00
IN753	6.2	400m	4/1.00	IN4148	75	10m	15.00
IN754	6.8	400m	4/1.00	IN4154	35	10m	12.00
IN6558	15	400m	4/1.00	IN4734	5.6	1w	28
IN5232	5.6	500m	28	IN4735	6.2	1w	28
IN5234	6.2	500m	28	IN4736	6.8	1w	28
IN5235	6.8	500m	28	IN4738	8.2	1w	28
IN5236	7.5	500m	28	IN4742	12	1w	28
IN4556	25	40m	6/1.00	IN4744	15	1w	28
IN4558	150	7m	6/1.00	IN1183	50 PIV	35 AMP	1.60
IN485A	180	10m	5/1.00	IN1184	100 PIV	35 AMP	1.70
IN4001	50 PIV	1 AMP	09	IN1185	200 PIV	35 AMP	1.80
IN4002	100 PIV	1 AMP	10	IN1188	400 PIV	35 AMP	3.00

### TRANSISTORS

MPS418	5/81	2N2906A	4/81	2N3095	4/81
2N2191A	3/81	2N2907A	5/81	PN4249	4/81
2N2221	4/81	2N3053	2/81	PN4250	4/81
2N2222A	5/81	2N3055	4/81	2N4429	5/81
2N2369	5/81	2N3775A	2/81	2N5129	2/81
2N2369A	4/81	2N3803	5/81	2N5139	5/81
2N2484	4/81	2N3904	4/81	C10681 SCR	2/51

### CAPACITOR CORNER

50 VOLT CERAMIC DISC CAPACITORS

10pF	0.05	1049	50-100	0.01	05	04	0300
22pF	0.05	04	03	0047	05	04	035
47pF	0.05	04	03	01	05	04	035
100pF	0.05	04	03	022	06	05	04
220pF	0.05	04	03	047	06	05	04
470pF	0.05	04	035	1	42	39	075

100 VOLT WET FILM CAPACITORS

001mF	12	10	07	022mF	13	11	08
0022	12	10	07	047mF	21	17	13
0047mF	12	10	07	1mF	27	23	17
0.01mF	12	10	07	22mF	33	27	22

20% DIPPED TANTALUM ISOLATED CAPACITORS

1.35V 28	23	17	1.5 35V 30	26	21
1.5 35V 28	23	17	2.2 25V 31	27	22
2.2 25V 28	23	17	3.3 25V 31	27	22
3.3 35V 28	23	17	4.7 25V 32	28	23
4.7 35V 28	23	17	6.8 25V 36	31	26
6.8 35V 28	23	17	10 25V 40	35	29
10 35V 28	23	17	15 25V 53	50	40

### MINIATURE ALUMINUM ELECTROLYTIC CAPACITORS

47 50	15	13	10	47 25	15	13	10
1 50	16	14	11	47 50	16	14	11
3.3 50	15	13	10	1166	20	15	13
47 25	16	14	11	1 25	16	14	11
10 25	15	13	10	1 50	16	14	11
10 50	16	14	11	47 16	15	13	10
22 25	17	15	12	47 25	15	13	10
22 50	24	20	18	47 50	16	14	11
47 25	19	17	15	10 16	14	12	09
47 50	25	21	19	10 25	15	13	10
100 50	24	20	18	10 50	15	14	11
100 50	35	30	28	47 50	24	21	19
220 25	42	38	35	100 16	19	15	13
220 50	45	41	38	100 25	24	20	18
220 50	75	70	67	100 50	35	32	29
1000 16	55	50	45	220 16	23	17	16
2000 16	70	62	55	470 25	31	28	26

## \* JAMES Summer Specials \*

TTL IC'S	DIODES - TRANSISTORS
7400 Quad NAND Gate 6/\$1.00	IN751A 5.1 400M 7/51.00
7447 8CD Seven Seg. Dec. 89	IN9558 15 400M 6/81.00
7490 Decade Counter 1.50	IN4002 100Piv 1 AMP 15/51.00
74100 4 Bit Bistable Leth 1.25	IN4003 200Piv 1 AMP 15/51.00
74150 16 Line 1 Mult 1.50	IN4004 400Piv 1 AMP 15/51.00
74154 4-16 Line Decoder 1.00	IN148 (IN914) 6.2 20/51.00
	2N3055 NPN 1W 5/51.00

**NEW KITS \$9.95 per kit**  
TTL Logic Probe Kit Detects TTL levels, pulses, with man 3 readout

**DIGITAL VOLTMETER KIT**  
0-10 Volt, 3 1/2 digits (Man 7) 0VM MOS - LSI Design Size 3" x 3" x 1 1/2" **\$39.95**

**4' POWER SUPPLY CORDS . . .**  
Black **.59¢ ea.**

**8' POWER SUPPLY CORDS**  
Black or Gray **1.45 ea.**

**MULTIPURPOSE KEYBOARDS**  
20 Keys - Touch Tone No schematic needed. (loop off) key tops. This unit may be cut apart for smaller units.

**SWITCHES**  
SLIDE SWITCHES DP-0T Locking 0.5A-0C PART NO. 1-8 10 29 30 up 223 462 051 B 39 30 27

**SUB-MINATURE TOGGLE**  
SPOT ON/NONE ON PART No. 1 2 9 223 462 051 B 39 30 27

**PB PUSH-BUTTON SERIES - (SPOT)**  
5 AMP RATINGS Momentary Action Switch Normally Open or Normally Closed. (For N.C. circuit use terminals 2 & 1; for N.O. 2 & 3; for N.C. and N.O. 1, 2&3 PB-126 52.35 51.95

**NEW PROTO BOARD-100**  
Here's a low cost, big 10 IC capacity breadboard kit with all the quality of OT Sockets and the best of the Proto-Board series . . . complete down to the last nut, bolt and screw. Includes 2 OT-35S Sockets, 1 OT-35B Bus Strip, 2 5 way binding posts, 4 rubber feet, screws, nuts, bolts, and easy assembly instructions. **COMPLETE KIT . . . \$19.95**

### DISPLAY LEDS

CA Common Anode	CC Common Cathode	MAN 3 Com Cath.	MAN 4 Com Cath.	MAN 7 Com Cath.	DL 33 Com Cath.	DL 747 Com Anode.
74C10N 65	74C20N 65	74C30N 65	74C42N 2.15	74C73N 1.50	74C74N 1.15	74C74N 1.15
74C00N 3.95	74C040 3.95	74C042 2.75	74C044 2.75	74C046 2.75	74C047 2.75	74C048 2.75
74C009 89	74C049 1.00	74C050 1.00	74C051 2.90	74C052 2.95	74C053 3.45	74C054 3.45
74C010 68	74C055 1.00	74C056 1.00	74C057 2.15	74C058 3.25	74C059 3.25	74C060 3.25
74C011 39	74C061 1.00	74C062 1.00	74C063 3.00	74C064 3.00	74C065 3.00	74C066 3.00
74C012 39	74C067 1.95	74C068 1.95	74C069 2.75	74C070 2.75	74C071 2.75	74C072 2.75
74C013 1.00	74C073 2.60	74C074 2.60	74C075 2.75	74C076 2.75	74C077 2.75	74C078 2.75
74C014 1.00	74C079 2.60	74C080 2.60	74C081 2.75	74C082 2.75	74C083 2.75	74C084 2.75
74C015 1.00	74C085 2.60	74C086 2.60	74C087 2.75	74C088 2.75	74C089 2.75	74C090 2.75
74C016 1.00	74C091 2.60	74C092 2.60	74C093 2.75	74C094 2.75	74C095 2.75	74C096 2.75
74C017 2.55	74C097 2.60	74C098 2.60	74C099 2.75	74C100 2.75	74C101 2.75	74C102 2.75
74C018 1.50	74C103 2.60	74C104 2.60	74C105 2.75	74C106 2.75	74C107 2.75	74C108 2.75
74C019 1.50	74C109 2.60	74C110 2.60	74C111 2.75	74C112 2.75	74C113 2.75	74C114 2.75
74C020 1.50	74C115 2.60	74C116 2.60	74C117 2.75	74C118 2.75	74C119 2.75	74C120 2.75
74C021 1.50	74C121 2.60	74C122 2.60	74C123 2.75	74C124 2.75	74C125 2.75	74C126 2.75
74C022 1.50	74C127 2.60	74C128 2.60	74C129 2.75	74C130 2.75	74C131 2.75	74C132 2.75
74C023 39	74C129 2.60	74C130 2.60	74C131 2.75	74C132 2.75	74C133 2.75	74C134 2.75
74C024 1.95	74C135 2.60	74C136 2.60	74C137 2.75	74C138 2.75	74C139 2.75	74C140 2.75
74C025 39	74C137 2.60	74C138 2.60	74C139 2.75	74C140 2.75	74C141 2.75	74C142 2.75
74C027 1.95	74C139 2.60	74C140 2.60	74C141 2.75	74C142 2.75	74C143 2.75	74C144 2.75
74C028 2.65	74C141 2.60	74C142 2.60	74C143 2.75	74C144 2.75	74C145 2.75	74C146 2.75
74C029 3.95	74C143 2.60	74C144 2.60	74C145 2.75	74C146 2.75	74C147 2.75	74C148 2.75

### IC SOLDEARTAIL - LOW PROFILE (TIN) SOCKETS

8 pin	\$ .22	20	18	24 pin	\$ .68	62	56
14 pin	.26	23	21	28 pin	.89	.81	73
16 pin	.29	.26	.24	36 pin	1.10	.99	90
18 pin	.46	.41	.37	40 pin	1.25	1.13	93
22 pin	.65	.59	.53				

### SOLDEARTAIL STANDARD (TIN)

14 pin	\$ .30	.28	.26	28 pin	\$ .99	1.26	81
16 pin	.33	.31	.29	36 pin	1.39	1.26	115
18 pin	.42	.39	.37	40 pin	1.59	1.45	130
24 pin	.59	.54	.49				

### SOLDEARTAIL STANDARD (GOLD)

8 pin	\$ .30	.27	.24	24 pin	\$ .70	.63	57
14 pin	.35	.32	.29	28 pin	1.10	1.00	90
16 pin	.38	.35	.32	36 pin	1.55	1.40	126
18 pin	.52	.47	.43	40 pin	1.75	1.59	145

### WIRE WRAP SOCKETS (GOLD) LEVEL #3

10 pin	\$ .45	.41	.37	24 pin	\$1.05	.95	.85
14 pin	.46	.42	.38	28 pin	1.40	1.25	110
16 pin	.55	.50	.45	36 pin	1.59	1.45	130
18 pin	.75	.68	.62	40 pin	1.75	1.55	140

### 50 PCS. RESISTOR ASSORTMENTS \$1.75 PER ASS'T.

||
||
||





# STOP THIS MAN AT YOUR DOOR!

## \$ 12.95

Now available in kit form — you can build your own home/apartment security alarm and save dollars.

The alarm automatically provides a fixed exit delay, variable entry time, and anti-noise pollution bell shut-off. Kit comes with drilled P.C. board, resistors, capacitors, diodes, silicon transistors, and some hardware.

To complete the alarm you need only a cabinet, 12 volt battery, and wire in N.C. perimeter switches, which are available at local electronic parts stores.

**FREE** for limited time a 6" alarm bell will be included with each kit ordered. Total shipping wt. 2 1/2 pounds.

**R. A. G. S.**  
1751 SARATOGA AVE.  
SAN JOSE, CALIF. 95129

TERMS: California residents add 6% sales tax. No cash or C.O.D. orders, please. Include sufficient postage, excess refunded.

Circle 81 on reader service card

## LOOK FOR

### THE

### AUGUST

### ISSUE OF

### RADIO-

### ELECTRONICS

### AT YOUR

### NEWSDEALER

### JULY 17

## MEMORY SYSTEM \$125.00

1024 core memory system, 1024 words memory, 8, 9, or 10 bits/word. Random access, with all logic, register, timing, control, core select and sense functions in one package. New, with 60 page booklet includes schematics, Measures only 9x4x1 inches. Good start for mini-computer.

## TONE GEN. BOARD

3 Octave tone gen. board from Magnus Organ. Unused with instructions & amp. \$9.95 2 for \$18.

## PIANO KEYBOARD \$9.95

For use with above organ or synthesizer, etc.

## MULTI-USE XFMR \$8.95

Output 18 V @ 6 amp; 17 V @ 6 amps; 10 V @ 10 amp. Brand new. \$8.95 ea., 2 for \$15; 10 for \$50.

## BELLTONE PAGER

Made for Bell System. Clip-on belt or pocket pager-receiver. Used condition, complete radio receiver on freq. of 35 Mhz with reed-decoder tone alert. An interesting & useful experimenters gadget. Limited quantity.

#SP-125 \$5.00 each 6/\$25

Please add shipping cost on above.

FREE catalog



*Meshna* **SURPLUS ELECTRONIC MATERIAL**  
P.O. Box 62  
19 ALLERTON STREET  
E. LYNN MASS. 01904

Circle 84 on reader service card

## CB SPECIALS

2SC517	4.75	2SC781	3.25	2SC1237	2.00	2SC1678	5.75
2SC710	70	2SC799	4.25	2SC1239	2.80	2SC1679	5.75
2SC711	70	2SC1013	1.50	2SC1243	1.50	2SC1957	3.50
2SC735	70	2SC1014	1.50	2SC1306	5.25	2SD235	1.00
2SC756	1.50	2SC1017	1.50	2SC1307	6.25	MFFB004	3.00
2SC773	.85	2SC1018	1.50	2SC1377	6.75	4004	3.00
2SC774	1.75	2SC1173	1.25	2SC1449	3.50	4005	3.00

## JAPANESE TRANSISTORS

2SA52	60	2SB370	1.10	2SC478	.80	2SC829	.75	2SC1509	1.25
2SA101	70	2SB379	.65	2SC482	1.75	2SC833	.70	2SC1569	1.25
2SA103	70	2SB380	.70	2SC491	2.50	2SC838	.70	2SC1756	1.25
2SA221	60	2SB405	1.00	2SC495	.70	2SC839	.85	2SD30	.95
2SA473	85	2SB407	1.20	2SC497	1.60	2SC930	.65	2SD45	2.00
2SA495	.65	2SB415	1.05	2SC515	.80	2SC945	.65	2SD64	.75
2SA497	.55	2SB461	1.25	2SC535	.95	2SC1010	.80	2SD65	.75
2SA505	.65	2SB463	1.65	2SC536	.65	2SC1012	.80	2SD68	.70
2SA562	70	2SB471	1.75	2SC537	.70	2SC1013	1.50	2SD72	1.00
2SA607	2.25	2SB474	1.75	2SC563	2.50	2SC1014	1.50	2SD88	1.50
2SA613	1.00	2SB481	1.20	2SC564	.70	2SC1018	1.50	2SD120	.85
2SA643	.85	2SB492	2.15	2SC568	.70	2SC1030	3.25	2SD130	1.50
2SA647	2.75	2SB495	.95	2SC582	.85	2SC1051	2.50	2SD141	2.25
2SA673	.85	2SB605	2.00	2SC591	2.50	2SC1061	1.65	2SD151	2.50
2SA679	2.25	2SB606	.60	2SC605	1.00	2SC1079	3.95	2SD170	2.00
2SA682	.95	2SC15	.85	2SC619	.70	2SC1096	1.20	2SD180	2.00
2SA699	1.30	2SC24	.65	2SC620	.80	2SC1098	1.15	2SD198	2.50
2SA699A	2.00	2SC32	.65	2SC627	1.75	2SC1115	2.75	2SD201	2.50
2SA705	.55	2SC33	.65	2SC644	.70	2SC1166	.70	2SD218	5.00
2SA714	2.50	2SC41	4.00	2SC645	.85	2SC1170	4.00	2SD235	1.00
2SA720	70	2SC49	.80	2SC687	2.50	2SC1172B	4.25	2SD261	.80
2SA733	.65	2SC56	.95	2SC684	2.10	2SC1173	1.25	2SD291	.85
2SB22	.65	2SC143	3.50	2SC687	2.50	2SC1213	.75	2SD292	.85
2SB54	70	2SC154	3.75	2SC696	2.35	2SC1226	1.25	2SD300	2.50
2SB56	70	2SC162	3.75	2SC710	.70	2SC1237	2.00	2SD313	1.20
2SB77	70	2SC163	4.50	2SC711	.70	2SC1239	2.80	2SD315	.75
2SB128	2.50	2SC185	1.40	2SC712	.70	2SC1293	.85	2SD318	.95
2SB135	.95	2SC202	1.00	2SC713	.70	2SC1308	5.00	2SD34-1	.95
2SB152	4.50	2SC206	1.00	2SC732	.70	2SC1317	.60	2SD350	3.50
2SB172	.55	2SC240	1.10	2SC733	.70	2SC1325	5.00	2SD352	.80
2SB173	.55	2SC261	.65	2SC735	.70	2SC1347	.80	2SD380	6.00
2SB175	.55	2SC291	.65	2SC739	.70	2SC1377	6.75	2SD389	.95
2SB178	1.00	2SC320	.75	2SC756	1.50	2SC1383	.75	2SD390	.75
2SB186	.60	2SC352	.75	2SC774	1.75	2SC1393	.60	2SD437	6.00
2SB187	.60	2SC353	.75	2SC775	2.00	2SC1409	2.75	2SD458	.80
2SB235	1.95	2SC371	.70	2SC778	3.00	2SC1410	2.75	2SD1111	3.50
2SB303	.65	2SC372	.70	2SC783	1.00	2SC1446	1.25	2SD1115	3.75
2SB324	1.00	2SC390	.70	2SC784	.70	2SC1447	1.25	2SK15	2.25
2SB337	2.10	2SC397	.70	2SC785	1.00	2SC1448	1.25	2SK30	1.25
2SB364	.65	2SC394	.70	2SC792	3.00	2SC1450	1.00	2SK46	1.60
2SB365	.65	2SC458	.70	2SC793	2.50	2SC1454	2.75	3SF11	3.14
2SB367	1.60	2SC460	.70	2SC828	.75	2SC1507	1.25	SG605	4.95

20% off on Replacement orders of 25.00 or more. Above is partial list of current stock available at drastic reductions. Send for complete list!

ALL PARTS GUARANTEED AND TESTED ON PREMISES. WRITE FOR FREE CATALOG AND LG. QUANTITY DISCOUNTS.

RADIO-ELECTRONICS

96

## OEM SPECIALS

1N270	.06	2N630	3.10	2N1540	.90	2N2325	2.10	2N3247	3.50	2N3856	.20	2N4403	19
1N749.A	16	2N677C	5.00	2N1543	3.00	2N2326	3.00	2N3250	.40	2N3866	.90	2N4409	19
1N750.A	16	2N706	20	2N1544	80	2N2327	4.00	2N3375	4.95	2N3903	.19	2N4410	19
1N751.A	16	2N706B	35	2N1549	1.05	2N2328	4.25	2N3393	.19	2N3904	.19	2N4416	75
1N914	.06	2N711	35	2N1551	3.50	2N2329	6.00	2N3394	.19	2N3905	.19	2N4441	85
1N4148	.06	2N711B	50	2N1552	3.50	2N2368	.25	2N3414	.22	2N3906	.19	2N4442	.90
1N4746	.50	2N718	18	2N1554	1.75	2N2369	.19	2N3415	.25	2N3924	3.25	2N4443	1.25
1N4747	.50	2N718A	25	2N1557	1.50	2N2484	.20	2N3416	.28	2N3925	4.50	2N4852	60
1N4749	.50	2N720A	1.35	2N1560	3.00	2N2712	.25	2N3417	.30	2N3954	4.50	2N5061	25
1N5355	.75	2N759A	.90	2N1605	.35	2N2894	.40	2N3442	1.90	2N3954A	4.90	2N5064	40
1N5357.A,B,75	2N760			40	2N1613	.30	2N2903	3.50	2N3553	1.50	2N3955	2.50	
1N5358.A,B,75	2N877			2.25	2N1671	1.00	2N2904	.19	2N3563	.18	2N3955A	2.90	
1N5359.A,B,75	2N894			1.75	2N1711	.30	2N2904A	.25	2N3565	.18	2N3957	1.30	
2N173	2.00	2N918	.19	2N1907	4.25	2N2905	.19	2N3638	.18	2N3958	1.20	2N5138	6.25
2N178	.90	2N930	.19	2N2060	1.90	2N2905A	.25	2N3642	.19	2N4037	.60	2N5157	8.95
2N327A	1.25	2N956	.20	2N2102	.40	2N2906	.19	2N3643	.15	2N4093	.90	2N5198	3.85
2N334	1.25	2N960	.40	2N2218	.20	2N2906A	.20	2N3645	.15	2N4124	.18	2N5294	.60
2N336	.90	2N962	.40	2N2218A	.25	2N2907	.19	2N3646	.10	2N4126	.23	2N5296	.45
2N338A	1.10	2N967	.40	2N2219	.20	2N2907A	.25	2N3730	1.25	2N4141	.23	2N5306	20
2N404	.90	2N1136	1.25	2N2219A	.25	2N2913	.75	2N3731	1.65	2N4142	.16	2N5354	25
2N443	1.05	2N1137A	1.65	2N2221	.19	2N2914	1.25	2N3740	1.00	2N4143	.15	2N5369	20
2N456	1.15	2N1143	1.75	2N2222	.19	2N2916A	3.75	2N3771	1.90	2N4220A	.90	2N5400	50
2N501A	3.50	2N1302	.25	2N2222A	.19	2N3053	.19	2N3773	2.10	2N4234	1.25	2N5401	50
2N508A	3.50	2N1305	.30	2N2270	.30	2N3054	.70	2N3819	2.10	2N4400	.19	2N5458	35
2N512B	2.50	2N1377	1.25	2N2322	1.50	2N3055	.75	2N3823	.60	2N4401	.19	2N5467	28.00
2N555	4.50	2N1420	18	2N2323	1.60	2N3227	2.10	2N3843	.25	2N4402	.19	C106B1	.45
2N652A	.90	2N1483	1.00	2N2324	2.00								

## SILICON UNIJUNCTIONS

2N2646	To-18	.50
2N2647	To-18	.65
2N6027 PUT	To-92	.55
2N6028 PUT	To-92	.75
2N1671	To-5	1.00
D5E37	To-18	4/1.00

## INTEGRATED CIRC.

UA703C	.40
CA3066	4.00
CA3068	6.50
MC1305	1.50

## RECTIFIERS

	10	100
1N4001	.60	5.00
1N4002	.70	6.00
1N4003	.80	7.00
1N4004	.90	8.00
1N4005	1.00	9.00
1N4006	1.10	10.00
1N4007	1.20	11.00

TRANSISTOR GRAB BAG—Germanium and Silicon small sigs and power transistors. Untested, 50/1.00 FAIRCHILD 9L00 IC's, prime units. .29  
HOBBYISTS 16 Pin Digital IC - Untested. 15/1.00 709C Hi-Perf. Op Amp 5/1.00  
Fairchild 7400 IC - While They Last! 8/1.00 741C Hi-Perf. Op Amp 4/1.00



*New-Tone Electronics*  
P.O. BOX 1738 A  
BLOOMFIELD, N.J. 07003

TERMS: Check or money order. COD's accepted. Include 10% for postage and handling. N.J. residents add 5% sales tax. Minimum order 5.00.



**C-MOS**

4000AE	26	25
4001AE	26	25
4002AE	26	25
4004AE	5.83	5.82
4006AE	1.35	1.34
4007AE	26	25
4008AE	1.79	1.78
4009AE	56	55
4010AE	59	58
4011AE	26	25
4012AE	26	25
4013AE	47	46
4014AE	1.49	1.48
4015AE	1.26	1.25
4016AE	56	55
4017AE	1.20	1.19
4018AE	1.49	1.48
4019AE	52	51
4020AE	1.49	1.48
4021AE	1.34	1.33
4022AE	1.11	1.10
4023AE	26	25
4024AE	90	89
4025AE	26	25
4026AE	3.72	3.70
4027AE	50	49
4028AE	50	49
4029AE	1.27	1.26
4030AE	44	43
4033AE	3.01	3.00
4035AE	1.27	1.26
4040AE	1.49	1.48
4041AE	4.06	4.05
4042AE	75	74
4043AE	60	59
4044AE	60	59
4047AE	3.54	3.53
4048AE	1.43	1.42
4049AE	52	51
4050AE	52	51
4051AE	1.34	1.33
4052AE	1.34	1.33
4053AE	1.34	1.33
4055AE	2.68	2.58
4056AE	4.43	4.39
4060AE	1.50	1.49
4066AE	90	89
4069AE	78	68
4071AE	26	25
4076AE	1.68	1.48
4081AE	26	25
4510AE	1.98	1.78
4516AE	2.88	2.78
4518AE	3.28	2.98
4520AE	1.88	1.68
4901AE	43	36
4911AE	43	36

**7400N TTL**

7400N	\$1.14
7401N	\$1.14
7402N	\$1.14
7403N	\$1.14
7404N	\$1.14
7405N	\$1.14
7406N	\$1.14
7407N	\$1.14
7408N	\$1.14
7409N	\$1.14
7410N	\$1.14
7411N	\$1.14
7412N	\$1.14
7413N	\$1.14
7414N	\$1.14
7415N	\$1.14
7416N	\$1.14
7417N	\$1.14
7418N	\$1.14
7419N	\$1.14
7420N	\$1.14
7421N	\$1.14
7422N	\$1.14
7423N	\$1.14
7424N	\$1.14
7425N	\$1.14
7426N	\$1.14
7427N	\$1.14
7428N	\$1.14
7429N	\$1.14
7430N	\$1.14
7431N	\$1.14
7432N	\$1.14
7433N	\$1.14
7434N	\$1.14
7435N	\$1.14
7436N	\$1.14
7437N	\$1.14
7438N	\$1.14
7439N	\$1.14
7440N	\$1.14
7441N	\$1.14
7442N	\$1.14
7443N	\$1.14

**DECODED READ/WRITE RAM**

P1103 \$6.20

**SCHOTTKY TTL**

74500N	45	74574N	1.30
74502N	80	74585N	6.10
74503N	75	74586N	2.70
74504N	75	745112N	2.20
74508N	80	745113N	1.50
74510N	75	745132N	3.60
74511N	75	745133N	9.0
74520N	80	745138N	2.40
74530N	80	745139N	2.40
74532N	80	745140N	9.0
74540N	80	745151N	2.40
74551N	80	745153N	2.40
74564N	80	745157N	2.40

**LOW POWER TTL**

74L00N	34	74H00N	34	74H53N	36
74L02N	34	74H01N	34	74H54N	36
74L03N	39	74H04N	38	74H55N	36
74L04N	39	74H05N	37	74H60N	36
74L10N	34	74H08N	40	74H61N	36
74L20N	38	74H10N	36	74H62N	36
74L42N	1.62	74H11N	36	74H71N	80
74L51N	34	74H20N	36	74H72N	74
74L73N	74	74H21N	36	74H73N	90
74L74N	89	74H22N	36	74H74N	87
74L90N	1.62	74H30N	36	74H76N	90
74L93N	1.74	74H40N	36	74H101N	80
74L95N	1.62	74H50N	36	74H102N	80
93L00	1.50	74H51N	36	74H103N	1.10
93L01	1.60	74H52N	36	74H106N	95
93L08	3.20				
93L09	1.80				
93L10	2.80				
93L11	4.20				
93L12	1.80				
93L14	1.70				
93L16	3.20				
93L18	3.50				
93L21	1.50				
93L22	1.80				
93L24	2.80				
93L28	3.70				
93L34	4.00				
93L38	4.20				
93L40	6.50				
93L41	6.50				
93L60	3.00				
93L66	2.70				

**HIGH SPEED TTL**

74S158N	2.40
74S160N	4.70
74S174N	3.30
74S175N	3.30
74S181N	10.20
74S189N	5.10
74S194N	3.30
74S195N	3.30
74S253N	2.40
74S253N	2.40
74S258N	2.40
74S260N	9.0
74S280N	5.70

**BIPOLAR MEMORY**

C3101	6.50
P3101	4.30
C3101A	9.00
P3101A	5.80
IM5501CDE	7.30
IM5501CPE	5.80
MM5560N	7.30
MM5560N	5.80
DM5899N	5.80
93403PC	5.80

**TWO-PHASE MOS CLOCK DRIVER**

MMH026CN \$5.50

**COMPUTER INTERFACE**

DM8820N	2.40
DM8820AN	2.40
DM8830N	6.90
DM8831N	5.20
DM8832N	6.00
NB8T26B	6.00
9600PC	1.30
9601PC	1.20
9602PC	2.10
9614PC	2.30
9615PC	1.60
9616DC	5.00
9617PC	3.50
9620PC	4.00
9621PC	4.00

**PULSE GENERATOR**

Interdesign 1101: 0.1Hz-2MHz, 0.5V Output, var. width, line or battery operation. \$159.00

**WAVEFORM GENERATOR**

**XR205K KIT** Only \$25.00  
Here's a highly versatile lab instrument at a fraction of the cost of conventional units. Kit includes two XR205 IC's, data & application notes, PC board (etched & drilled, ready for assembly) and detailed instructions.

**DUAL LOW NOISE OP AMP**

LM333N:  $V_{io} = 6mV$ ,  $I_b = 1000 nA$ ,  $I_e = 2000 nA$ , Noise = 1.5dB, \$2.20



**CALCULATOR (Limited Qty.) \$19.00**

**1024-BIT N-Channel RAM**

2601-1	11.40
2601-21	11.40
2602B	8.00
2602-1B	8.00
2602-2B	8.00
MK4102P	11.40
7552-1CPE	8.00
7552-2CPE	8.00

**DISPLAYS**

OPCOA	
SLA1 Red	2.25
SLA11 Green	3.50
SLA21 Yellow	3.50
SLA7 Red	1.60
LITRONIX	
DL80 Red	6.00
DL81 Red	6.00
DL10 Red	6.00
DL10A Red	4.00
DL101 Red	4.90
DL57 Red	9.90
DL61 Red	12.00
DL33 Red	4.00
DL44 Red	6.00
DL402 Red	4.00
DL701 Red	3.40
DL704 Red	2.25
DL707 Red	2.35
DL747 Red	2.50
XCITON	
XAN72 Red	2.00
XAN52 Green	2.00

**74LS**

74LS00	58
74LS01	58
74LS02	58
74LS03	58
74LS04	63
74LS05	63
74LS08	58
74LS09	58
74LS10	58
74LS11	58
74LS15	58
74LS20	58
74LS21	58
74LS22	58
74LS27	64
74LS30	58
74LS32	64
74LS51	58
74LS52	58
74LS55	58
74LS73	92
74LS74	92

**LEDs**

.125" dia.	
209 Red	\$25
209 Yellow	35
209 Green	35
.160" dia.	
216 Red	25
216 Yellow	30
216 Green	30
.200" dia.	
220 Red	25
220 Yellow	30
220 Green	30
LOW PROFILE	
226 Red	\$25
226 Yellow	30
226 Green	30
226 Orange	30
5053 Red	35
5053 Yellow	40
5053 Green	40
5053 Orange	40
216 = MV5024	
5053 = MV5053	
MV50 Red	\$30

**9300 SERIES**

9300PC	1.00
9301PC	1.20
9304PC	1.50
9306PC	6.90
9308PC	2.50
9309PC	1.60
9310PC	1.50
9311PC	2.30
9312PC	1.20
9314PC	90
9316PC	1.50
9318PC	2.30
9321PC	1.30
9322PC	1.20
9324PC	2.00
9326PC	2.95
9328PC	3.30
9329PC	4.10
9342PC	1.15
9346PC	1.75
9366PC	1.75

**OPTOISOLATORS**

MONSANTO	
MC72 1.35	
LITRONIX	
IL1 1.30	
IL12 1.40	
IL16 1.80	
IL74 1.35	
IL74.15	
ILQ74 3.40	

**1-AMP RECTIFIERS**

1N4001	1.00	700	60.00
1N4002	1.10	800	70.00
1N4003	1.20	900	80.00
1N4004	1.30	1000	90.00
1N4005	1.40	1100	100.00
1N4006	1.50	1200	110.00
1N4007	1.60	1300	120.00

**PHASE-LOCKED LOOPS**

LM567CM Mini-dip 1.80

**INTERFACE MODULES**

CY1010	Instr. Amp., Bipolar Input	29.00
CY1011A	Instr. Amp., Bipolar Input	49.00
CY1020	Instr. Amp., FET Input	34.00
CY1021A	Instr. Amp., FET Input	49.00
CY2137	DAC, 10 Bit, Low Drift	39.00
CY2218	DAC, 12 Bit, 2 Quad Multiplying	149.00
CY2237	DAC, 12 Bit, Low Drift	69.00
CY2735	DAC, 4 Digit BCD, Low Cost	79.00
CY3035	ADC, 8 Bit, Sect. Counting	89.00
CY3635	ADC, 3 Digit BCD, Sect. Count, Low Cost	119.00

**PREMIUM QUALITY COMPONENTS**

We've been buying and selling top quality components for nearly ten years. Our annual volume exceeds \$3 million. We handle only original parts, from the world's leading manufacturers and our customers include some of the largest and most quality-conscious companies. Now you can take advantage of our component buying skills and power and select from a broad range of advanced circuits.



**AUDIO AMPS**

Type	V	W	Ω	Price
LM352	6	15	8	1.60
LM354A	6	27	8	2.50
TAAE1812	6	15	8	1.60
TAAG21A12	6	27	8	2.00
TBA641811	6	18	2	4.00
TBA800	5	30	4	2.20
TBA810AS	4	20	4	3.00
TBA820	3	16	0.75	4.00
TCA830	6	20	2	4.20
TCA940	6	24	6.50	8.00

**KC SOCKETS**

SOLDER-TIN	
8 pin DIL	22
14 pin DIL	26
16 pin DIL	29
24 pin DIL	75
28 pin DIL	1.10
36 pin DIL	1.70
40 pin DIL	1.90
16 pin DIL	45
14 pin DIL	35
16 pin DIL	40
TEFLON	
3 pin TO-5	55
4 pin TO-5	65
6 pin TO-5	90
8 pin TO-5	1.10
10 pin TO-5	



# Quality Electronic Components

**SPECIAL SAVINGS DISCOUNT ON LINEAR AND DIGITAL INTEGRATED CIRCUITS**

Discount 4% from the total of your I.C. order if it exceeds \$25.00 based on single list prices. 7% for \$100.00 or more; 10% for \$100.00 or more. Additional large quantity discounts offered.

## TTL & CMOS INTEGRATED CIRCUITS

7400N	25c	7445N	81c	7495N	90c	74193N	\$1.17	4027AE	.67c
7401N	25c	7446N	81c	7496N	81c	74198N	\$2.75	4028AE	\$1.09
7402N	25c	7447N	81c	7497N	81c	74197N	\$2.75	4029AE	\$1.42
7403N	25c	7448N	90c	74121N	38c	4000AE	30c	4030AE	50c
7404N	25c	7450N	23c	74122N	45c	4001AE	30c	4033AE	\$1.67
7405N	25c	7451N	23c	74123N	\$1.08	4002AE	30c	4034AE	\$3.34
7406N	25c	7452N	23c	74141N	99c	4006AE	\$1.50	4035AE	\$1.42
7407N	25c	7454N	23c	74150N	\$1.44	4007AE	30c	4040AE	\$1.67
7408N	25c	7459N	25c	74151N	90c	4008AE	\$1.17	4041AE	92c
7409N	25c	7460N	23c	74153N	81c	4009AE	67c	4042AE	84c
7410N	25c	7470N	36c	74154N	\$1.44	4010AE	67c	4043AE	67c
7411N	25c	7472N	36c	74155N	81c	4011AE	30c	4044AE	67c
7413N	25c	7473N	32c	74156N	81c	4012AE	30c	4046AE	\$2.51
7414N	25c	7474N	32c	74157N	72c	4013AE	53c	4049AE	58c
7417N	25c	7475N	54c	74158N	\$1.53	4014AE	\$1.67	4050AE	58c
7418N	25c	7476N	36c	74160N	\$1.26	4015AE	\$1.17	4051AE	\$1.50
7420N	25c	7480N	72c	74161N	\$1.17	4016AE	65c	4052AE	\$1.50
7421N	25c	7482N	72c	74162N	\$1.26	4017AE	\$1.34	4053AE	\$1.50
7423N	72c	7483N	72c	74163N	\$1.26	4018AE	\$1.67	4066AE	\$1.67
7424N	25c	7485N	\$1.40	74164N	\$1.35	4019AE	58c	4066AE	\$1.00
7430N	25c	7486N	32c	74165N	\$2.45	4020AE	\$1.67	4071AE	30c
7437N	25c	7489N	\$4.47	74166N	\$2.07	4021AE	\$1.50	4072AE	30c
7438N	25c	7490N	50c	74175N	\$1.00	4022AE	\$1.25	4073AE	30c
7440N	25c	7491N	81c	74180N	81c	4023AE	30c	4075AE	30c
7441N	\$1.17	7492N	50c	74181N	\$2.25	4024AE	\$1.00	4081AE	30c
7442N	65c	7493N	50c	74182N	90c	4025AE	30c	4082AE	30c
		7494N	81c	74192N	\$1.26	4026AE	\$1.67		

## LINEAR INTEGRATED CIRCUITS

555V MINIDIP TIMER	82.5c	558V MINIDIP DUAL AMP	75.0c
565A DIP PLL	\$3.38	567V MINIDIP DECODER	\$3.38
741V MINIDIP OP AMP	50.0c	723A DIP VOLTAGE REG.	82.5c
748V MINIDIP OP AMP	42.0c	747A DIP DUAL AMP	97.5c
L129 5 VOLT REG	\$1.80	LM3900 DIP QUAD AMP	60.0c
L131 15 VOLT REG	\$1.80	L130 12 VOLT REG	\$1.80
		LM309K 5 VOLT REG	\$1.75

## MINIATURE ALUMINUM ELECTROLYTIC CAPACITORS

### AXIAL LEAD TYPE

-60°C plus 85°C Tolerance -10 plus 50% (regulator types 47, 100, 150 plus 75% at 100V or less)

1 100/25V	14	12	11c	33 100/16V	15c	12	11c	33 100/16V	25c	25c	24c
2 100/25V	14	12	11c	47 100/16V	17c	14	13c	33 100/25V	44c	25c	22c
3 100/25V	14	12	11c	47 100/16V	17c	14	13c	47 100/16V	37c	30c	27c
4 100/25V	14	12	11c	47 100/25V	19c	15c	14c	47 100/25V	49c	39c	35c
10 100/16V	14	12	11c	100 100/16V	19c	15c	14c	100 100/16V	49c	39c	35c
10 100/25V	14	12	11c	100 100/25V	24c	17c	16c	100 100/25V	75c	60c	55c
22 100/16V	14	12	11c	220 100/16V	24c	18c	17c	220 100/16V	75c	60c	55c
22 100/25V	15c	13c	12c	220 100/25V	35c	25c	24c				

## 1 AMP SILICON RECTIFIERS

1N4001 50 PIV	12/\$1	100/56 1000/548	1N4005 600 PIV	81/\$1	1000/59	1000/570
		1N4007 1000 PIV	6/\$1	100/51	1000/588	

## SILICON SIGNAL & SWITCHING DIODE

IN4148 (IN914 equiv.)	12/\$1	100/\$7	1M/\$50	5M/\$220
-----------------------	--------	---------	---------	----------

## MOLEX SOLDERCON I.C. TERMINALS

100/\$1	500/\$4.20	1000/\$8.20	5000/\$38.20	50,000/\$175
---------	------------	-------------	--------------	--------------

## LED 7 SEGMENT DISPLAYS

DATALIT-704	\$1.00	DATALIT-707	\$1.50
-------------	--------	-------------	--------

## MACHINE SCREWS, NUTS & LOCKWASHERS

2-56 1/4 Screw	90c/c	2-56 1/2 Screw	98c/c	6 AMP SPST M.O.	
4-40 1/4 Screw	96c/c	4-40 3/8 Screw	96c/c	CONTACTS	
6-32 3/8 Screw	\$1.05/c	6-32 1/2 Screw	88c/c	Call Volume	1 to 10
8-32 3/8 Screw	\$1.05/c	8-32 5/8 Screw	\$1.35/c	5V	\$2.00 \$1.50
2-56 Hex Nut	\$1.45/c	2 Lock Washer	45c/c	6V	\$2.00 \$1.50
4-40 Hex Nut	\$1.45/c	4 Lock Washer	45c/c	12V	\$2.00 \$1.50
6-32 Hex Nut	\$1.45/c	6 Lock Washer	45c/c	24V	\$2.00 \$1.50
8-32 Hex Nut	\$1.50/c	8 Lock Washer	45c/c		

## DISC CAPACITORS I.C. SOCKETS

100 pf/500V	7c	5.5c	4.5c	3.6c	8 pin Solder	27c	21c
220 pf/500V	7c	5.5c	4.5c	3.6c	14 pin Solder	29c	23c
470 pf/500V	7c	5.5c	4.5c	3.6c	16 pin Solder	32c	25c
.001/500V	7c	5.5c	4.5c	3.6c	18 pin Solder	34c	26c
.0022/500V	7c	5.5c	4.5c	3.6c	24 pin Solder	54c	42c
.0047/500V	7c	5.5c	4.5c	3.6c			1 to 10
.01/500V	10c	7.5c	6.3c	5.0c	8 pin W.W.	38c	30c
.01/25V	5c	3.5c	3.0c	2.4c	14 pin W.W.	50c	39c
.022/25V	6c	4.0c	3.5c	2.7c	16 pin W.W.	54c	42c
.047/25V	9c	6.0c	5.3c	4.2c	18 pin W.W.	88c	68c
1/25V	12c	9.0c	7.5c	6.0c	24 pin W.W.	98c	80c

## 1/2 & 3/4 WATT CARBON COMP. RESISTORS

5 each of the 85 standard 10% values (2.2-22M) 1/2 W Resistors (425 pcs.)  
Sorted by value \$12/set 2-4 are \$11/set 5-9 are \$10/set.  
5 each of the 70 standard 10% values (10-5.6M) 3/4 W Resistors (350 pcs.)  
Sorted by value \$12/set 2-4 are \$11/set 5-9 are \$10/set.

## SILICON TRANSISTORS

EN918	10-106	21c	18.5c	16.5c	2N3645	10-105	20c	17.5c	16.0c
EN930	10-106	21c	18.5c	16.5c	2N3646	10-106	22c	19.0c	17.5c
EN272	10-106	21c	18.5c	16.5c	2N3904	10-92	22c	19.0c	17.5c
EN269A	10-106	21c	18.5c	16.5c	2N3906	10-92	22c	19.0c	17.5c
EN2907	10-106	21c	18.5c	16.5c	2N414	10-92	22c	19.0c	17.5c
2N2712	10-98	16c	16.0c	14.5c	2N4126	10-92	22c	19.0c	17.5c
2N4391A	10-98	22c	19.0c	17.5c	2N4401	10-92	22c	19.0c	17.5c
2N3397	10-98	22c	19.0c	17.5c	2N4403	10-92	22c	19.0c	17.5c
2N3393	10-98	22c	19.0c	17.5c	2N5087	10-92	22c	19.0c	17.5c
2N3394	10-98	22c	19.0c	17.5c	2N5089	10-92	22c	19.0c	17.5c
2N3563	10-106	20c	17.5c	17.5c	2N5129	10-106	19c	17.0c	15.0c
2N3565	10-106	20c	17.5c	16.0c	2N5133	10-106	19c	17.0c	15.0c
2N3638	10-105	20c	17.5c	16.0c	2N5134	10-106	19c	17.0c	15.0c
2N3638A	10-105	20c	17.5c	16.0c	2N5137	10-106	19c	17.0c	15.0c
2N3640	10-106	20c	17.5c	16.0c	2N5138	10-106	19c	17.0c	15.0c
2N3641	10-105	20c	17.5c	17.5c	2N5139	10-106	19c	17.0c	15.0c
2N3643	10-105	20c	17.5c	16.0c	2N3055	10-3	\$1.00	95.0c	85.0c

## FIELD EFFECT TRANSISTORS

MP1102	10-92	44	380	350	2N5457	10-92	47	420	375
--------	-------	----	-----	-----	--------	-------	----	-----	-----

## NPN DARLINGTON TRANSISTOR

MP5-A13	10-92	Min. DC Current Gain of 5,000 or 10mA	36	320	290
---------	-------	---------------------------------------	----	-----	-----

Send for Free Catalog or Mail Readers Service Card  
COD ORDERS ACCEPTED FOR SAME DAY SHIPMENT  
CALL 218-681-6474  
Orders Less than \$10.00 add 50c Service Charge - Others Postpaid  
"Only Quality Components Sold!"

## DIGI-KEY CORPORATION

P.O. Box 126 Thief River Falls, MN 56701

# ADVERTISING INDEX

**RADIO-ELECTRONICS does not assume responsibility for any errors which may appear in the index below.**

## READER SERVICE CARD NO. PAGE

30	Allison Automotive	82
69	A.D.R. Audio	86
16	B & K Division of Dynascan Corp.	28
	Bell & Howell Schools	78-81
62	Brooks Radio & TV Corp.	83
72	Castle TV Tuner Service Corp.	Cover IV
18	Channellock	66
17	CIE, Cleveland Institute of Electronics	54-57
8	Continental Specialties Corp.	16
	CREI, Division of McGraw-Hill Continuing Education Center	36-39
20	Delta Products Corp.	67
21	Edlie Electronics	68
71	Edmund Scientific Co.	100
24	EICO, Electronic Instrument, Inc.	70
	EMC, Electronics Measurement Corp.	77
68	Fordham Radio Supply Co.	86
66	Grantham School of Electronics	85
	GTE Sylvania Electronic Components	2
100	Heath Co.	Cover III
27,28	Hickok Electrical Co.	71, 76
	ICS, International Correspondence Schools	18-21
67	Indiana Home Study Institute	86
12	International Crystal Mfg. Co.	25
61	Lectrotech, Inc.	82
9	MITS, Micro-Instrumentation Telemetry Systems, Inc.	17
26	MTI, Motorola Training Institute	71
65	Mountain West Alarm Supply Co.	84
25	National Camera Co.	68
	National Technical Schools	72-75
	NRI Schools, Division of McGraw-Hill Continuing Education Center	8-11
64	PAIA Electronics	84
1	PTS Electronics	Cover II
7	Radio Shack	15
63	RCA Distributor and Special Products Division, Test Equipment	84
11	RCA Parts & Accessories	1
5	RCA Solid State Division	13
70	RGS Electronics	86
22	Schober Organ	69
10	Shure Bros.	22
13	Southwest Technical Products	23
4	Sprague Products Corp.	7
14, 15	Telematic	26, 27
19	Teletronics Company of America	67
29	Tri-Star	76
3	Tuner Service Corp.	5
23	TV Tech Aid	69
	Vintage Radio	77
6	Weller-Xcelite Electronics Division	14

## MARKET CENTER

## READER SERVICE CARD NO. PAGE

73,74	Ancrona Corp.	97, 99
	ATV Research	98
75	Babylon Electronics	92
	Command Productions	88
	Cornell Electronics	94
76	Delta Electronics	92
77	Digi-Key	98
	Electronics Warehouse Inc.	94
79	Bill Godbout Electronics	90
	Gunnmaster	90
78	International Electronics Unlimited	93
80	James Electronics	95
	Lesco Electronics	98
83,84	Meshna Electronics, John Jr.	92, 96
82	New-Tone Electronics	96
88	Photolume Corp.	90
85,86	Poly Paks	89, 91
	Processor Technology Co.	94
81	R.A.G.S.	96
	Saxitone Tape Sales	94
89	S.D. Sales Co.	94
	Solid State Sales	90
90	Sphere	88
	Trumbull	90

**SUMMER Specials**—ICM 8038 function generator \$3.50. Mostek MK50250 "beeper" 6-digit alarm clock IC \$5.95. Jumbo 0.6" 747 LED display \$1.95. 0.33" 707 display 85c. Solar cells, 2x2cm, 0.5V @ 50mA, only .020" thick! \$1.50 each, 10/\$9.95. Bargain catalog 25c redeemable. **DIAMOND-BACK ENGINEERING, P.O. Box 194, Spring Valley, IL 61362**



**LINEAR INTEGRATED CIRCUITS**

GENERAL PURPOSE AMPLIFIERS		1.24	25.99	100
SL201B	GP amplifier	4.01	3.51	3.01
SL201C	GP amp	1.87	1.64	1.40
<b>MATCHED NPN TRANSISTORS</b>				
SL301A	Matched pair	2.72	2.46	1.40
SL301B	Matched pair	2.30	2.01	1.72
SL303A	Matched triplet	4.37	4.78	4.09
SL303B	Matched pair	9.23	3.43	2.93
SL305B	Dual matched pairs	7.37	6.44	5.52
SL312B	Matched pair w/tail	2.85	2.56	2.27
SL354B	Matched quad	4.22	3.70	3.17
SL360C	2.5GHz matched pair	10.3	9.56	8.18
SL362C	2.6GHz low noise pr	16.26	14.20	12.14
SL3045C	Transistor array	2.77	2.43	2.09
SL3145C	2.5GHz trans. array	14.78	12.94	11.09

<b>AUDIO CIRCUITS</b>				
SL414A	3W audio amplifier	4.22	3.70	3.17
SL415A	5W audio amplifier	5.49	4.81	4.12

<b>POWER CONTROL CIRCUITS</b>				
SL440	Power control circuit	5.49	4.81	4.12

<b>TRANSISTOR ARRAYS</b>				
SL3046	Five transistor array	1.85	1.61	1.37

<b>LINEAR RF AMPLIFIERS</b>				
SL501A	RF amplifier	19.25	16.84	14.44
SL501B	RF amplifier	5.91	5.17	4.44
SL502A	RF amplifier	14.55	13.04	11.54
SL502B	RF amplifier	3.88	3.49	3.09
SL503A	RF amplifier	16.50	14.78	13.07
SL503B	RF amplifier	4.12	3.70	3.27
SL551A	RF amplifier	18.82	16.87	14.92
SL551B	RF amplifier	5.89	5.28	4.67
SL552A	RF amplifier	18.82	16.87	14.92
SL552B	RF amplifier	5.89	5.28	4.67
SL553A	RF amplifier	21.09	18.90	16.71
SL553B	RF amplifier	6.28	5.62	4.96
SL510C	RF det. & video amp	25.34	22.18	19.00
SL511C	RF det. & video amp	25.34	22.18	19.00

<b>LIMITING WIDEBAND AMPLIFIERS</b>				
SL521A	Limiting RF amp	27.72	24.26	20.80
SL521B	Limiting RF amp	17.58	15.58	13.57
SL521C	Limiting RF amp	10.59	9.27	7.95
SL571A	Limiting RF amp	37.80	33.08	28.35
SL571B	Limiting RF amp	17.48	15.48	13.48
SL571C	Limiting RF amp	17.48	15.48	13.48
SL525C	Wideband amplifier	5.80	5.20	4.60
SL530C	Logarithmic amp	17.58	15.58	13.57
SL550C	200MHz wideband amp	25.34	22.18	19.00
SL1030C	200MHz wideband amp	25.34	22.18	19.00

<b>RADIO COMMUNICATIONS CIRCUITS</b>				
SL610C	RF amplifier	4.07	3.56	3.06
SL611C	RF amplifier	4.07	3.56	3.06
SL612C	IF amp	4.07	3.56	3.06
SL613C	Limiting amp/det.	8.66	7.58	6.49
SL620C	VOGAD	6.15	5.39	4.62
SL621C	AGC generator	6.15	5.39	4.62
SL622C	AF amp/VOGAD	15.21	13.31	11.41

<b>TELEVISION CIRCUITS</b>				
SAA570A	Limit. IF amp/FM det.	4.22	4.22	3.30
SAA661	Limit. IF amp/FM det.	4.73	4.73	3.70
SAA700	Signal processor	10.14	10.14	7.92
SAA701	Signal processor	10.14	10.14	7.92
SBA780	Limit. IF amp/FM det.	4.73	4.73	3.70
SL432	Limit. IF amp/FM det.	4.73	4.73	3.70
SL437C	IF & AGC for PNP tuners	13.52	13.52	10.56
SL437D	IF & AGC for NPN tuners	13.52	13.52	10.56
SL442	Switch mode power supply control	9.24	7.92	6.60

<b>TELEVISION CIRCUITS</b>				
SL450	TV IF system	7.39	6.34	5.28
SL456A	TV IF system	7.39	6.34	5.28
SL456B	TV IF system	7.39	6.34	5.28
SL457A	TV IF system	7.39	6.34	5.28
SL457B	TV IF system	7.39	6.34	5.28
SL910	Color demodulator	10.14	10.14	7.92
SL917	Color decoder	13.52	13.52	10.56

<b>DIGITAL INTEGRATED CIRCUITS</b>				
Description: 1.24 25.99 100 up				
<b>PROCESS CONTROL CIRCUITS</b>				
SP520	Gray code counter	13.94	12.49	11.04
SP521	Binary rate multip.	13.94	12.49	11.04
SP522	Phase loc. div. & com.	13.94	12.49	11.04

<b>PECL II - SP1000 SERIES</b>				
SP1005B	Dual 4 I/P OR/NOR gate	1.71	1.48	1.25
SP1005B	Dual 4 I/P OR/NOR gate	1.71	1.48	1.25

<b>PECL II - SP1000 SERIES</b>				
SP1005B	Dual 4 I/P OR/NOR gate	1.71	1.48	1.25
SP1005B	Dual 4 I/P OR/NOR gate	1.71	1.48	1.25

<b>PECL II - SP1000 SERIES</b>				
SP1005B	Dual 4 I/P OR/NOR gate	1.71	1.48	1.25
SP1005B	Dual 4 I/P OR/NOR gate	1.71	1.48	1.25

<b>PECL II - SP1000 SERIES</b>				
SP1005B	Dual 4 I/P OR/NOR gate	1.71	1.48	1.25
SP1005B	Dual 4 I/P OR/NOR gate	1.71	1.48	1.25

<b>PECL II - SP1000 SERIES</b>				
SP1005B	Dual 4 I/P OR/NOR gate	1.71	1.48	1.25
SP1005B	Dual 4 I/P OR/NOR gate	1.71	1.48	1.25

<b>PECL II - SP1000 SERIES</b>				
SP1005B	Dual 4 I/P OR/NOR gate	1.71	1.48	1.25
SP1005B	Dual 4 I/P OR/NOR gate	1.71	1.48	1.25

<b>PECL II - SP1000 SERIES</b>				
SP1005B	Dual 4 I/P OR/NOR gate	1.71	1.48	1.25
SP1005B	Dual 4 I/P OR/NOR gate	1.71	1.48	1.25

<b>PECL II - SP1000 SERIES</b>				
SP1005B	Dual 4 I/P OR/NOR gate	1.71	1.48	1.25
SP1005B	Dual 4 I/P OR/NOR gate	1.71	1.48	1.25

<b>PECL II - SP1000 SERIES</b>				
SP1005B	Dual 4 I/P OR/NOR gate	1.71	1.48	1.25
SP1005B	Dual 4 I/P OR/NOR gate	1.71	1.48	1.25

<b>PECL II - SP1000 SERIES</b>				
SP1005B	Dual 4 I/P OR/NOR gate	1.71	1.48	1.25
SP1005B	Dual 4 I/P OR/NOR gate	1.71	1.48	1.25

<b>PECL II - SP1000 SERIES</b>				
SP1005B	Dual 4 I/P OR/NOR gate	1.71	1.48	1.25
SP1005B	Dual 4 I/P OR/NOR gate	1.71	1.48	1.25

<b>PECL II - SP1000 SERIES</b>				
SP1005B	Dual 4 I/P OR/NOR gate	1.71	1.48	1.25
SP1005B	Dual 4 I/P OR/NOR gate	1.71	1.48	1.25

<b>PECL II - SP1000 SERIES</b>				
SP1005B	Dual 4 I/P OR/NOR gate	1.71	1.48	1.25
SP1005B	Dual 4 I/P OR/NOR gate	1.71	1.48	1.25

<b>PECL II - SP1000 SERIES</b>				
SP1005B	Dual 4 I/P OR/NOR gate	1.71	1.48	1.25
SP1005B	Dual 4 I/P OR/NOR gate	1.71	1.48	1.25

<b>PECL II - SP1000 SERIES</b>				
SP1005B	Dual 4 I/P OR/NOR gate	1.71	1.48	1.25
SP1005B	Dual 4 I/P OR/NOR gate	1.71	1.48	1.25

<b>PECL II - SP1000 SERIES</b>				
SP1005B	Dual 4 I/P OR/NOR gate	1.71	1.48	1.25
SP1005B	Dual 4 I/P OR/NOR gate	1.71	1.48	1.25

<b>PECL II - SP1000 SERIES</b>				
SP1005B	Dual 4 I/P OR/NOR gate	1.71	1.48	1.25
SP1005B	Dual 4 I/P OR/NOR gate	1.71	1.48	1.25

<b>PECL II - SP1000 SERIES</b>				
SP1005B	Dual 4 I/P OR/NOR gate	1.71	1.48	1.25
SP1005B	Dual 4 I/P OR/NOR gate	1.71	1.48	1.25

<b>PECL II - SP1000 SERIES</b>				
SP1005B	Dual 4 I/P OR/NOR gate	1.71	1.48	1.25
SP1005B	Dual 4 I/P OR/NOR gate	1.71	1.48	1.25

<b>PECL II - SP1000 SERIES</b>				
SP1005B	Dual 4 I/P OR/NOR gate	1.71	1.48	1.25
SP1005B	Dual 4 I/P OR/NOR gate	1.71	1.48	1.25

<b>PECL II - SP1000 SERIES</b>				
SP1005B	Dual 4 I/P OR/NOR gate	1.71	1.48	1.25
SP1005B	Dual 4 I/P OR/NOR gate	1.71	1.48	1.25

<b>PECL II - SP1000 SERIES</b>				
SP1005B	Dual 4 I/P OR/NOR gate	1.71	1.48	1.25
SP1005B	Dual 4 I/P OR/NOR gate	1.71	1.48	1.25

<b>PECL II - SP1000 SERIES</b>				
SP1005B	Dual 4 I/P OR/NOR gate	1.71	1.48	1.25
SP1005B	Dual 4 I/P OR/NOR gate	1.71	1.48	1.25

<b>PECL II - SP1000 SERIES</b>				
SP1005B	Dual 4 I/P OR/NOR gate	1.71	1.48	1.25
SP1005B	Dual 4 I/P OR/NOR gate	1.71	1.48	1.25

<b>PECL II - SP1000 SERIES</b>				
SP1005B	Dual 4 I/P OR/NOR gate	1.71	1.48	1.25
SP1005B	Dual 4 I/P OR/NOR gate	1.71	1.48	1.25

<b>PECL II - SP1000 SERIES</b>				
SP1005B	Dual 4 I/P OR/NOR gate	1.71	1.48	1.25
SP1005B	Dual 4 I/P OR/NOR gate	1.71	1.48	1.25

<b>PECL II - SP1000 SERIES</b>				
SP1005B	Dual 4 I/P OR/NOR gate	1.71	1.48	1.25
SP1005B	Dual 4 I/P OR/NOR gate	1.71	1.48	1.25

<b>PECL II - SP1000 SERIES</b>				
SP1005B	Dual 4 I/P OR/NOR gate	1.71	1.48	1.25
SP1005B	Dual 4 I/P OR/NOR gate	1.71	1.48	1.25

<b>PECL II - SP1000 SERIES</b>				
SP1005B	Dual 4 I/P OR/NOR gate	1.71	1.48	1.25
SP1005B	Dual 4 I/P OR/NOR gate	1.71	1.48	1.25

<b>PECL II - SP1000 SERIES</b>				
SP1005B	Dual 4 I/P OR/NOR gate	1.71	1.48	1.25
SP1005B	Dual 4 I/P OR/NOR gate	1.71	1.48	1.25

<b>PECL II - SP1000 SERIES</b>				
SP1005B	Dual 4 I/P OR/NOR gate	1.71	1.48	1.25
SP1005B	Dual 4 I/P OR/NOR gate	1.71	1.48	1.25

<b>PECL II - SP1000 SERIES</b>				
SP1005B	Dual 4 I/P OR/NOR gate	1.71	1.48	1.25
SP1005B	Dual 4 I/P OR/NOR gate	1.71	1.48	1.25

<b>PECL II - SP1000 SERIES</b>				
SP1005B	Dual 4 I/P OR/NOR gate	1.71	1.48	1.25
SP1005B	Dual 4 I/P OR/NOR gate	1.71	1.48	1.25

**PLESSEY SEMICONDUCTORS**

SL623C	AM det./AGC amp/11.9	9.79	8.40	7.11
SL624C	Multimode det. AF amp	5.70	5.00	4.28
SL640C	AF amplifier	3.85	3.38	2.90
SL640C	DBL. bot. modulator	7.55	6.60	5.68
SL641C	Receiver mixer	7.55	6.60	5.65
SL645C	Square law device	7.55	6.60	5.65
SL650B	Mod./phase loc. loop	10.86	9.31	7.76
SL651C	Mod./phase loc. loop	6.80	5.83	4.86
SL651B	Mod./phase loc. loop	12.06	10.34	8.62
SL651C	Mod./phase loc. loop	7.56	6.84	5.40
<b>OPERATIONAL AMPLIFIERS</b>				
SL701B	Op. amplifier	7.13	6.23	5.39
SL702B	Op. amplifier	3.56	3.12	2.67
SL702B	Op. amplifier	7.13	6.23	5.39
SL702C	Op. amplifier	3.56	3.12	2.67
SL717A	Dual comparator	10.35	9.06	7.76
SL717C	Dual comparator	6.57	5.76	4.94
SL751B	Op. amplifier			







# For free information on products advertised or mentioned in the editorial pages of this issue...

*Use one of these Reader Service Cards*

## RADIO-ELECTRONICS READER SERVICE 775

The numbers I have circled below indicate the material I would like to receive:

1	2	3	4	5	6	7	8	9	10	11	12	13	14	15
16	17	18	19	20	21	22	23	24	25	26	27	28	29	30
31	32	33	34	35	36	37	38	39	40	41	42	43	44	45
46	47	48	49	50	51	52	53	54	55	56	57	58	59	60
61	62	63	64	65	66	67	68	69	70	71	72	73	74	75
76	77	78	79	80	81	82	83	84	85	86	87	88	89	90
91	92	93	94	95	96	97	98	99	100	101	102	103	104	105
106	107	108	109	110	111	112	113	114	115	116	117	118	119	120

Reader Service available to U.S.A. and Canadian readers only

What test equipment did you buy? Check off each one that applies.  
 A \_\_\_\_\_ Scope. B \_\_\_\_\_ Digital Multimeter. C \_\_\_\_\_ Multimeter.  
 D \_\_\_\_\_ Frequency Counter. E \_\_\_\_\_ Curve Tracer. F \_\_\_\_\_ Tube/Transistor Tester. G \_\_\_\_\_ Color Bar Generator. H \_\_\_\_\_ Sine Square-Wave Generator.

NAME \_\_\_\_\_  
 ADDRESS \_\_\_\_\_  
 CITY \_\_\_\_\_ STATE \_\_\_\_\_ ZIP \_\_\_\_\_

Cards without Zip Codes will not be processed

Void after September 30, 1975

## RADIO-ELECTRONICS READER SERVICE 775

The numbers I have circled below indicate the material I would like to receive:

1	2	3	4	5	6	7	8	9	10	11	12	13	14	15
16	17	18	19	20	21	22	23	24	25	26	27	28	29	30
31	32	33	34	35	36	37	38	39	40	41	42	43	44	45
46	47	48	49	50	51	52	53	54	55	56	57	58	59	60
61	62	63	64	65	66	67	68	69	70	71	72	73	74	75
76	77	78	79	80	81	82	83	84	85	86	87	88	89	90
91	92	93	94	95	96	97	98	99	100	101	102	103	104	105
106	107	108	109	110	111	112	113	114	115	116	117	118	119	120

Reader Service available to U.S.A. and Canadian readers only

What test equipment did you buy? Check off each one that applies.  
 A \_\_\_\_\_ Scope. B \_\_\_\_\_ Digital Multimeter. C \_\_\_\_\_ Multimeter.  
 D \_\_\_\_\_ Frequency Counter. E \_\_\_\_\_ Curve Tracer. F \_\_\_\_\_ Tube/Transistor Tester. G \_\_\_\_\_ Color Bar Generator. H \_\_\_\_\_ Sine Square-Wave Generator.

NAME \_\_\_\_\_  
 ADDRESS \_\_\_\_\_  
 CITY \_\_\_\_\_ STATE \_\_\_\_\_ ZIP \_\_\_\_\_

Cards without Zip Codes will not be processed

Void after September 30, 1975

### HERE'S HOW:

1. Circle the number on the attached postcard that corresponds to the number at the bottom of each advertisement or editorial item of interest.
2. Detach the postcard. Fill in your name and address and mail.
3. Be sure to print or type your name and address. Be sure to include zip code.

### IMPORTANT:

The Clinton, Iowa Reader Service address is a data processing center which handles *only* Reader Service literature request cards. All other mail sent there may be delayed in reaching the proper department. For subscription problems (missing copies, change of address, etc.) write Radio-Electronics Subscription Service, Boulder, Colorado 80302. Address all other correspondence to Radio-Electronics, 200 Park Avenue South, New York, New York 10003.

FIRST CLASS  
 PERMIT 597  
 BOULDER, COLO.

**BUSINESS REPLY MAIL**  
 no postage stamp necessary if mailed in the United States

POSTAGE WILL BE PAID BY

**Radio-Electronics**  
 SUBSCRIPTION SERVICE  
 BOULDER, COLORADO 80302





# For new ideas in electronics read Radio-Electronics

PLACE  
STAMP  
HERE

## Radio-Electronics

### READER SERVICE

P.O. Box 2707  
Clinton, Iowa 52732

PLACE  
STAMP  
HERE

## Radio-Electronics

### READER SERVICE

P.O. Box 2707  
Clinton, Iowa 52732

Subscribe today to the magazine which keeps you up-to-date with the newest ideas and innovations in electronics. (If you already are a subscriber, do a friend a favor and pass this subscription card along to him.)

### check offer preferred

- 1 Year — 12 issues **ONLY \$8.75**     2 Years — 24 Issues **SAVE MORE \$16.50**  
(You save \$1.50 over newsstand)
- 3 Years — 36 Issues **GREATER SAVINGS \$24.50**  
(You save \$2.50 over newsstand prices)

- Payment enclosed     Bill Me     Check here if you are extending or  
renewing your subscription
- Check here if this is a new subscription

Name \_\_\_\_\_

Address \_\_\_\_\_

City \_\_\_\_\_ State \_\_\_\_\_ Zip \_\_\_\_\_

IMPORTANT

Canada same as U.S.A. Extra Postage: Pan American \$1.50 per year, all other foreign \$2.00 per year.

## During the next 12 months

Radio-Electronics will carry up-to-the minute articles on:

- solid-state technology
- color TV • stereo
- test equipment • radio
- computers • careers
- industrial electronics
- servicing TV-radio-stereo
- experimenter circuits
- exceptional construction projects

Don't take a chance on missing even one issue. Subscribe now and save!



### NEW IDEAS AND INNOVATIONS IN ELECTRONICS

The newest ideas and innovations in electronics appear in Radio-Electronics. Keep up-to-date!

Subscribe Today!



# New 21" (diag.) Heathkit digital-design Color TV

Popular Electronics editors called the digital-design GR-2000 "the color TV of the future." Now you can enjoy the same technology and features in the new GR-2050 with the convenient, popular 21-inch picture tube.

**On-screen electronic digital channel numbers**—big, bright, bold, and easy to read, even from across the room. **On-screen electronic digital clock time**—low cost insurance against missed programs. In 12 or 24 hour format, 4 or 6 digits. **Silent, electronic, touch-tuning**, thanks to the combination VHF-UHF varactor tuner. No knobs to turn, nothing to wear out. Just touch to tune...on the front panel or the Remote. **Programmable digital counter/channel selector**—a computer-like programming board for you to pre-program any 16 stations, UHF or VHF, or both, in any order, even repeating if you wish. Touch the tune button and the counter silently sweeps up or down through all 16 channels, stopping when you release the button.

**Exclusive fixed ten-section LC bandpass filter**—does away with adjusted traps yet eliminates interference from adjacent channel, etc. And it never needs instrument alignment.

**100% solid-state**—with more ICs than any other set and a black negative matrix picture tube for brighter, more vivid pictures.

**Easy to build with modular circuits. Easy to service** with built-in digital dot generator, check-out meter, and slide-out service drawer. Build the GR-2050 TV of the future...Remote, \$89.95. Cabinets from \$119.95\*



**599.95** less cabinet



## New 2½-digit Heathkit DMM—only \$79.95

Full function capability. Four overlapping AC & DC voltage & current ranges plus five resistance ranges with accuracy of 1% on DCV, 1.5% on ACV, 1.5% on AC & DC current, and 2% on resistance. Ranges: (full scale) DCV, 2, 20, 200, 1000V; ACV, 2, 20, 200, 700V rms (25 Hz to 10 kHz); DC current, 2, 20, 200, 2000 mA; AC current, 2, 20, 200, 2000 mA (25 Hz to 10 kHz); Ohms, 200, 2k, 20k, 200k, 2000k ohms. Lighted panel indicators show overrange, positive and negative DC voltages and current at a glance. All solid-state design uses IC circuitry for a clear non-blinking display with up-date every 16 msec. One megohm input impedance with overload protection on all ranges; automatic decimal positioning; isolated floating ground; universal banana jack inputs; 120 or 240 VAC operation; one circuit board for easy assembly; blue & white heavy-duty metal case. Kit IM-1212, \$79.95; Assembled SM-1212, \$125\*.

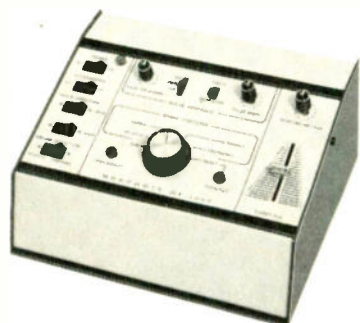

**New Model Railroad Control Center/Power Supply** provides acceleration and braking of unsurpassed realism plus power for two HO or N-gauge engines and accessories. Throttle slide control plus 5-position Brake switch (Run, Release, Normal, Quick-Service, Emergency), and Mode switch (Momentum or Direct). Adjustable pulse width and frequency allow accurate control at low speeds, eliminate "jack rabbit" starts. Voltage control optimizes for each engine. One circuit board; builds in two evenings. Kit RP-1065, \$79.95\*.



**New Digital Tachometer** is faster than any meter-type tach. Numbers whirl by to show peak performance level your engine reaches. Great for monitoring best cruising RPM for your car, camper, boat (inboard or outboard), planes, cycles, mowers, tractors, even stationary engines. 2-digit electronic readout shows RPMs from 100 to 9900 in 100 RPM steps. For 4, 6, or 8 cyl., 4-cycle engines; 2, 3, or 4 cyl. 2-cycle engines; 2, 3, or 4-rotor Wankel engines; conventional, C-D, or factory electronic ignitions (12 v. neg. grd. only). Black die-cast case with bracket. Kit CI-1079, \$49.95\*.

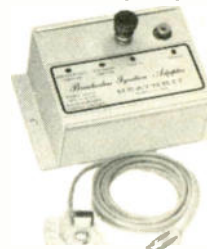

**New Breakerless Ignition Adapter** develops timing signal electronically so your car is timed correctly at all speeds and stays correct for longer periods. For use with C-D ignition systems only, it replaces the points of all pre-1975 GM V-8 and V-6 engines, and all AMC V-8s with external dwell adjustment. Unit mounts under hood; sensor mounts in distributor without removing points (switch returns engine to point timing when you wish). Operates from -37.2°C to +85°C. Easy to build. Kit CP-1051, \$44.95\*.

**HEATHKIT ELECTRONIC CENTERS**—Units of Schlumberger Products Corporation. Retail prices slightly higher.

ARIZ.: Phoenix; CALIF.: Anaheim, El Cerrito, Los Angeles, Pomona, Redwood City, San Diego (La Mesa), Woodland Hills; COLO.: Denver; CONN.: Hartford (Avon); FLA.: Miami (Hialeah), Tampa; GA.: Atlanta; ILL.: Chicago, Downers Grove; IND.: Indianapolis; KANSAS: Kansas City (Mission); KY.: Louisville; LA.: New Orleans (Kenner); MD.: Baltimore, Rockville; MASS.: Boston (Wellesley); MICH.: Detroit; MINN.: Minneapolis (Hopkins); MO.: St. Louis (Bridgeton); NEB.: Omaha; N.J.: Fair Lawn; N.Y.: Buffalo (Amherst), New York City, Jericho (L.I.), Rochester, White Plains; OHIO: Cincinnati (Woodlawn), Cleveland, Columbus, Toledo; PA.: Philadelphia, Pittsburgh; R.I.: Providence (Warwick); TEXAS: Dallas, Houston; VA.: Norfolk (Va. Beach); WASH.: Seattle; WIS.: Milwaukee.

Send for  
**FREE  
Catalog**



<b>HEATH</b>		<b>Heath Company,</b> Dept. 20-07 Benton Harbor, MI 49022	
<b>Schlumberger</b>			
Please send my free 1975 Heathkit Catalog.			
NAME _____			
ADDRESS _____			
CITY _____		STATE _____	ZIP _____
*PRICES ARE FACTORY MAIL ORDER, FOB PRICES & SPECIFICATIONS SUBJECT TO CHANGE WITHOUT NOTICE.			
			CL-568



*Proved in the lab! . . . approved in the field!*

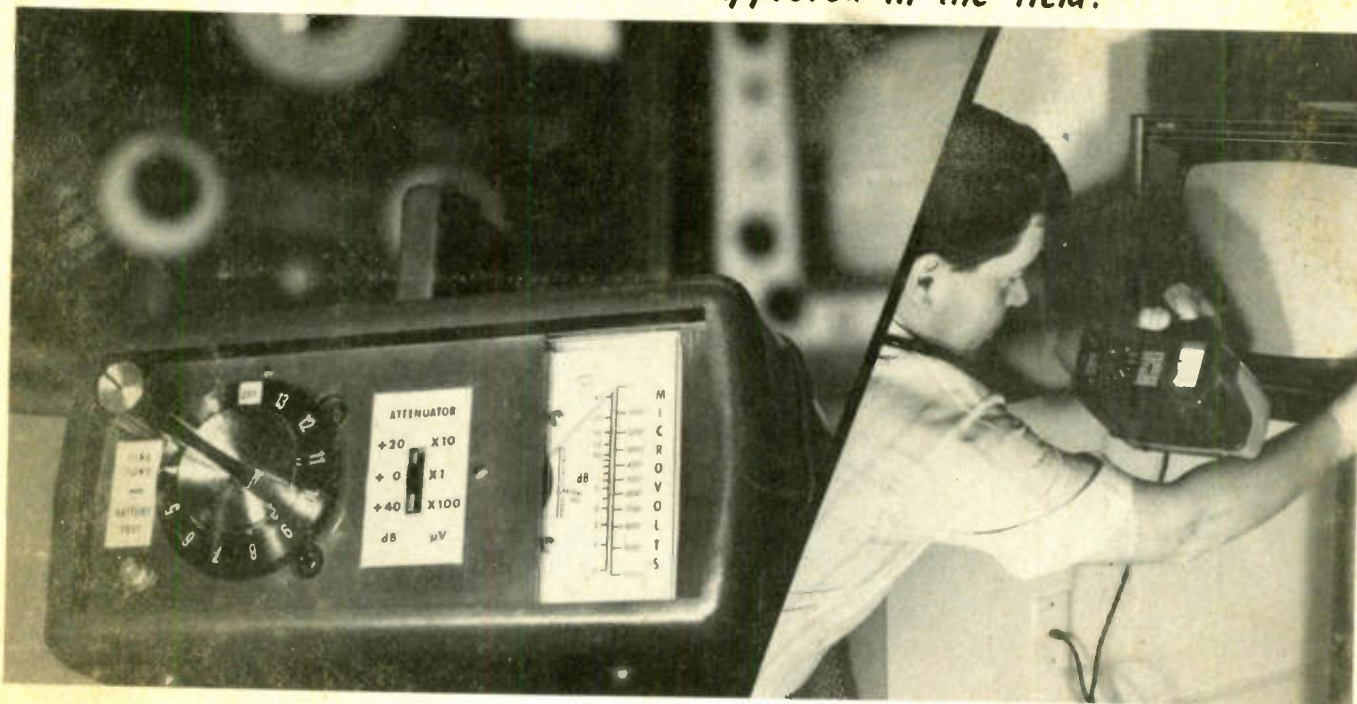

# The NEW MEZZNER™ TELEVISION FIELD STRENGTH METERS

Invaluable for

- Antenna installation
- Antenna evaluation
- MATV
- CATV
- Output calibration of TV signal generators and similar signal sources

The instruments use two 9v alkaline transistor batteries for field use, plus inbuilt power supply with wall plug-in transformer for 120vac operation.

## VHF Model FSM - V net \$119.95

Range: 20 microvolts to 100 millivolts  
Meter: Scale calibrated in microvolts (linear) and dB (log.). Ref: 0dB = 1 millivolt. Full scale basic range 1 millivolt  
Attenuator: X 1 (+ 0dB); X 10 (+ 20dB); X 100 (+ 40dB)  
Tuning: All 12 VHF channels  
Inputs: 75 ohms - "F" connector; 300 ohms - screw terminals  
Accuracy:  $\pm$  3dB typ.



## UHF Model FSM - U net \$99.95

Range: 20 microvolts to 10 millivolts  
Meter: Scale calibrated in microvolts (linear) and dB (log.)  
Attenuator: X 1 (+ 0dB) and X 10 (+ 20dB)  
Tuning: Full UHF band, Ch. 14 - 83  
Inputs: 75 ohms - "F" connector; 300 ohms - screw terminals  
Accuracy:  $\pm$  3dB typ.

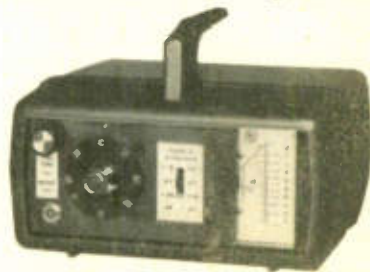

These instruments boast the extra features of all Castle products-advanced technology-modern styling-and they work!

Ask your electronic distributor for them . . . or write for more details.



**CASTLE TV TUNER SERVICE, INC.**

5715 N. Western Ave., Chicago, Ill. 60645 • Ph. 312-561-6354

In Canada: Len Finkler Ltd., Ontario

Circle 72 on reader service card