

# Radio Electronics

JULY 50c

New — Careers in Electronics for You



Service your car with an  
**Electronic Auto Analyzer**

**SCR electric fence is simple and safe**  
**Build Antenna rotator remote control**  
**Measuring Turntable Wow and Flutter**

A E CASERTA 5-66  
R D  
BAFLO PA

# PICK ANY NUMBER FROM 1G3GT TO 19AU4 AND YOU'RE A WINNER!

1G3GT/1B3GT	4HA5	6BZ6	6GW8	8CW5
1X2B	5HG8	6CB6A	6HA5	9A8
3BZ6	5U8	6CG7	6HG8	10CW5
3CB6	6AL5	6DT6	6SA1	12AT7
3GK5	6AU4GTA	6EH7	6SN7GTB	12AU7A
3HA5	6AU6A	6EJ7	6U8A	12AX4GTB
4BL8	6AV6	6GB5	6U9	12AX7A
4EH7	6AX4GTB	6GJ7	6X9	15CW5
4EJ7	63A6	6GK5	6Y9	16A8
4GK5	6BL8	6GK6	8BQ5	19AU4

...AND ON AND ON. FOR THE COMPLETE LIST, WRITE  
AMPEREX ELECTRONIC CORPORATION, HICKSVILLE, L.I., NEW YORK 11802.



## About reliability in electrolytic capacitors

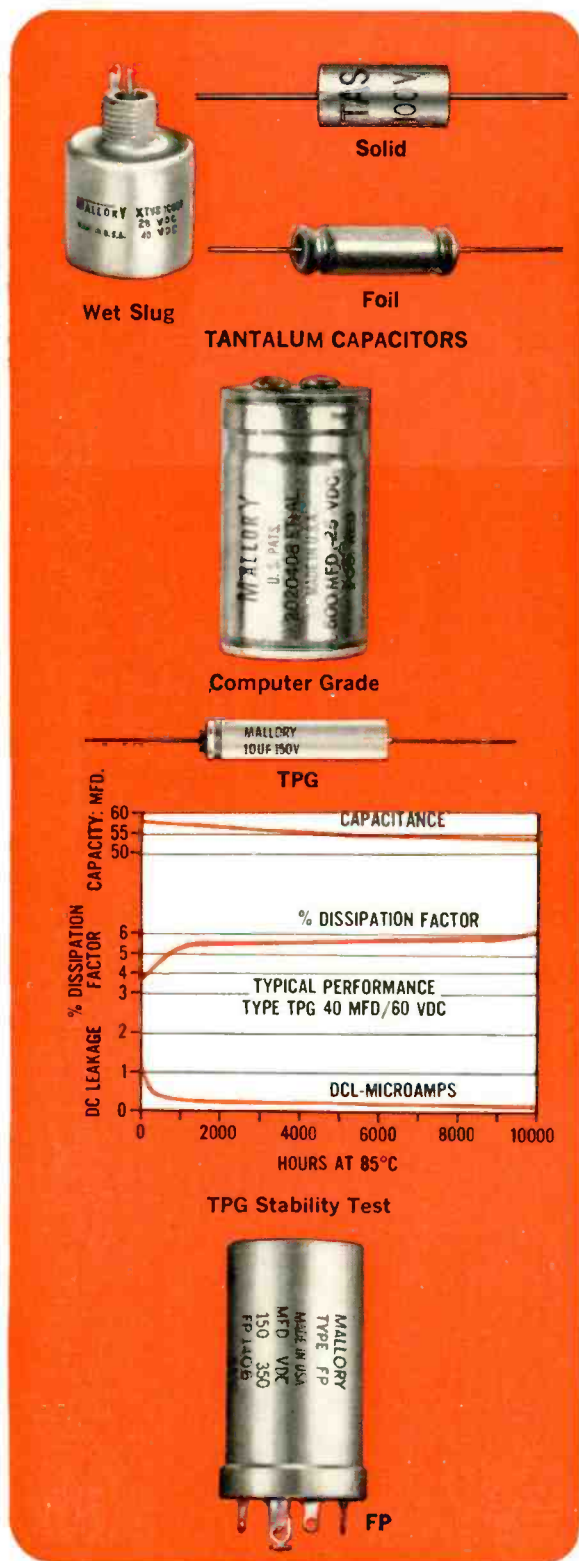

**Wet Slug**

**Solid**

**Foil**

**TANTALUM CAPACITORS**

**Computer Grade**

**TPG**

**TPG Stability Test**

**FP**

The figure includes a line graph titled "TPG Stability Test" showing the performance of a TPG capacitor over 10,000 hours at 85°C. The graph plots three metrics: CAPACITANCE (mfd), % DISSIPATION FACTOR, and DC LEAKAGE (microamps). The y-axis for capacitance ranges from 50 to 60 mfd, for dissipation factor from 0 to 6%, and for DC leakage from 0 to 2 microamps. The x-axis represents hours at 85°C from 0 to 10,000. The capacitance line remains stable around 58 mfd. The dissipation factor line starts at approximately 4.5% and stabilizes around 5.5%. The DC leakage line starts at approximately 1.5 microamps and drops to near 0.5 microamps within the first 1,000 hours.

Reliability has become a big, important word in electronics today. Makers of military equipment demand it—and get it—because today's intricate weapons and warning systems can't risk failure of even the smallest component. But a lot of other electronic manufacturers are setting requirements for reliability that often come close to the military.

When it comes to electrolytic capacitors, you can have just about any level of reliability you want—and are willing to pay for. Highest reliability usually means highest price, because it takes a lot of costly testing to verify reliability. We make 'em all, so we can be unbiased.

The highest reliability comes in tantalum capacitors—wet slug, foil and solid electrolyte. The best of these have a "mean time between failure" in the tens of thousands of hours. Or putting it another way, their failure rate level is around 0.01% per 1000 hours. Although they are used mostly in military gear, tantalum capacitors have become increasingly popular for industrial circuits where you need maximum assurance against failure. And they give you an unbeatably high amount of capacity in small size.

In recent years, aluminum electrolytics have been catching up on tantalum in the reliability race. Take Mallory CG Computer Grade capacitors. Tests we've run for 60,000 hours at elevated temperatures indicate that CG's will last *twenty* years in a computer. But you don't need to own a computer to make good use of them. They're a fine solution to getting a lot of capacitance for power supply filtering, especially in low voltage supplies for line-operated solid-state equipment. Standard ratings go up to 115,000 mfd. Pleasant surprise: CG's are often your best buy when you need a lot of microfarads!

We make a "miniature computer grade" called the TPG that's a real winner for high reliability service. In our certification testing of the TPG, we had only *one* electrical failure in *one million* piece-hours of test. Tests that extend to 10,000 hours (see chart) show that its electrical values are exceptionally stable.

And don't forget the Mallory standards. The Mallory Type FP has been used for years in millions of TV and radio sets and as top choice for replacement by service technicians. And it has racked up a record for dependability that's unbeatable in its field.

Your Mallory Distributor is the man to see whenever you need top quality capacitors—not only electrolytics, but also the DISCAP® ceramics, the all-Mylar® GEM and PVC types, and new Mallory polystyrene capacitors he carries in the Mallory line. Ask for a copy of the new 1965 Mallory General Catalog to guide your selection. Mallory Distributor Products Company, a division of P. R. Mallory & Co. Inc., P. O. Box 1558, Indianapolis, Indiana 46206

\*Du Pont trademark

# Radio-Electronics

JULY 1965 VOL. XXXVI No. 7

Over 55 Years of Electronic Publishing

## GUEST EDITORIAL

- 27 **Electromedicine: End of the Wonder-Drug Era?**.....Joseph R. Hixson

## TELEVISION

- 28 **Plug In To MATV**.....Lon Cantor  
*Master-antenna TV distribution systems are in great demand*
- 37 **What's a Keyed Circuit?**
- 40 **Transistor TV Portables**.....Robert F. Scott  
*Circuit features and troubleshooting reminders*
- 47 **Converting Vhf to Uhf for Tests and Demonstrations**
- 57 **What, No Color?**.....Homer L. Davidson  
*Hints on curing colorless color pictures*

## RADIO

- 43 **Restoring Old Radios**.....Jack Darr  
*A short course in judicious patching—mechanical and electrical*
- 46 **Antenna Rotator Remote Control for TV, CB and Hams**.....R. P. Bintliff  
*"Extension switch" takes only about an hour to fix up*

## TEST INSTRUMENTS

- COVER STORY** 38 **Service Your Car with an Electronic Auto Analyzer**.....Louis M. Dezettel
- 60 **Cycloids for Frequency Measurement**.....Tom Jaski  
*It takes a scope and a simple adapter*
- 65 **Equipment Report: Viking VFS Frequency Standard**

## GENERAL

- 20 **Service Clinic**.....Jack Darr  
*High-Voltage Regulators*

- CAREER SERIES** 50 **Broadcast Engineering: Radio**.....Jack Darr  
*What the radio-station engineer does, what it takes to get the job*
- 53 **Code-Practice Oscillator—On a Key**.....Frederick W. Chesson
- 52 **What's Your EQ?**

## AUDIO-HIGH FIDELITY-STEREO

- 32 **Measuring Turntable Wow and Flutter**.....Edgar Villchur  
*Simple, inexpensive, precise flutter and speed measurements for technician or audiophile*
- 48 **Filters for Recording FM Stereo**.....Fred Blechman  
*Simple filters drop 19- or 38-kc FM stereo pilots by 30 db or more*
- 54 **The Two-State Amplifier**.....Norman Crowhurst  
*First of a series on a radically new amplifier design*
- 65 **Equipment Report: Harman-Kardon SR-900**

## ELECTRONICS

- 35 **SCR Electronic Fence Charger**.....Earl T. Hansen  
*Keep animals in and people out*

## THE DEPARTMENTS

12 Correspondence  
86 New Books  
75 New Literature

72 New Products  
70 New Semiconductors & Tubes  
4 News Briefs

80 Noteworthy Circuits  
76 Technotes  
84 Try This One  
52 50 Years Ago

**ON THE COVER:** Photo by Harry Schlaack. Jaguar XKE supplied by Jaguar Cars, Inc.

HUGO GERNSBACK, editor-in-chief and publisher. M. HARVEY GERNSBACK, editor. Fred Shunaman, managing editor. Robert F. Scott, W2PWG, technical editor. Peter E. Sutheim, associate editor. Jack Darr, service editor. I. Queen, editorial associate. John J. Lamson, eastern sales manager. Wm. Lyon McLaughlin, technical illustration director.

GERNSBACK PUBLICATIONS, INC., 154 W. 14 St., N. Y. 10011. AL 5-7755. Board Chairman Hugo Gernsback, President M. Harvey Gernsback, Secy. G. Aliquo, Treas. Charles A. Raible



Member,  
Institute of High Fidelity  
Radio-Electronics  
Is Indexed In  
Applied Science  
& Technology Index  
(Formerly  
Industrial Arts Index).

# Choose Your Tailor-Made Course in N.T.S. "PROJECT METHOD" ELECTRONICS!

Now! N.T.S. — one of America's oldest leading home-study and resident technical schools — offers you GREATER CAREER OPPORTUNITIES IN ELECTRONICS. N.T.S. "Project Method" home training lessons are shop-tested in the Resident School in Los Angeles. You work on practical job projects, learn to use shop manuals and schematics. Your N.T.S. training is individual. You proceed at your own pace. The Schools' practical methods, plus more than 60 years of experience, have helped thousands of students all over the world to successful careers. Prepare now for a secure future in one of 8 N.T.S. Electronics Courses designed to fit your own particular needs.



Work on the electronic "brains" of industry — computers, data processing and other automation equipment. Become a TV-Radio Technician, an electronics field engineer, or succeed in your own business.

## CHOOSE YOUR FIELD — INSURE YOUR FUTURE!

- 1 ELECTRONICS-TV-RADIO-SERVICING & COMMUNICATIONS** A basic course thoroughly covering fundamentals of electronics, radio, TV servicing and communications.
- 2 MASTER COURSE IN ELECTRONICS-TV-RADIO, PLUS ADVANCED TV & INDUSTRIAL ELECTRONICS** This course covers everything included in Course No. 1 plus Automation and every phase of the Electronics industry.
- 3 FCC LICENSE** Preparation for this government license essential for interesting jobs in radar, radio, television, communications, guided missiles, many others. Upon completion of this course, if you do not pass the FCC exam for a 1st Class Commercial Radiotelephone License your tuition will be refunded.
- 4 RADIO SERVICING (AM-FM-Transistors)** Train for radio sales and service with dealer or distributor.
- 5 TELEVISION SERVICING (Including Color)** Covers installation, adjustment, repair and servicing of black and white and color television . . . prepares you for your own sales and service business.
- 6 STEREO, HI-FI AND SOUND SYSTEMS** A growing field. Prepares you to build, install and service modern sound equipment for home or industry.
- 7 BASIC ELECTRONICS** Gives you the fundamentals you must know to build on for a future Electronics career. Also offers an excellent background for Salesmen, Purchasing Agents, and others in Electronics.
- 8 ELECTRONICS MATH** Simple, easy-to-follow instructions in the specialized math you need in many electronics jobs.

Most courses include Equipment Kits. THERE ARE NO KIT DEPOSITS. Everything included in your low tuition.

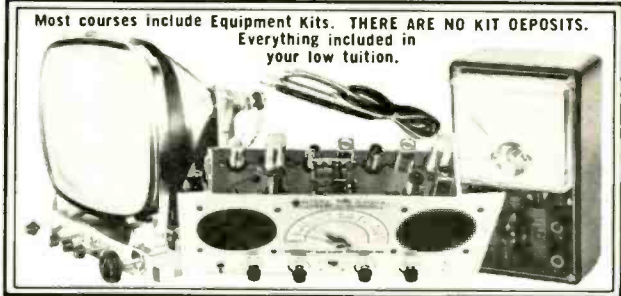

### CLASSROOM TRAINING AT LOS ANGELES

You can take classroom training in our famous Resident School at Los Angeles in Sunny Southern California. N.T.S. is the oldest and largest school of its kind. Associate in Science Degree also offered in our Resident Program. Check Resident School box in coupon for full details.

### HIGH SCHOOL AT HOME

Learn easily. New modern method. National also offers accredited high school programs for men and women. Take only subjects you need. Study at your own pace. Latest approved textbooks — yours to keep — everything included at one low tuition. Check High School box in coupon for information.



### MAIL COUPON TODAY FOR FREE BOOK AND SAMPLE LESSON

In Field of Your Choice. You enroll by Mail — and Save Money. No Salesmen: This means lower tuition for you. Accredited Member N.H.S.C.

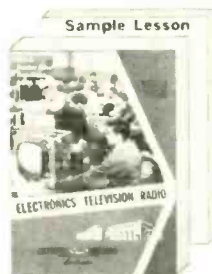

4000 S. Figueroa St., Los Angeles, California 90037

## NATIONAL TECHNICAL SCHOOLS

4000 S. Figueroa St., Los Angeles, California 90037

Please Rush FREE Electronics "Opportunity Book" and actual sample lesson on course checked below:

- Electronics-TV-Radio Servicing & Communications
- Master Course in Electronics-TV-RADIO
- Advanced TV & Industrial Electronics
- FCC License
- Radio Servicing (AM-FM-Transistors)
- Television Servicing (Including Color)
- Stereo, Hi-Fi and Sound Systems
- Basic Electronics
- Electronics Math

Dept. 206-75

Name \_\_\_\_\_ Age \_\_\_\_\_

Address \_\_\_\_\_

City \_\_\_\_\_ State \_\_\_\_\_ Zip \_\_\_\_\_

- Check here if interested ONLY in Classroom Training at L.A.
- Check here for High School Department Catalog only.

RADIO-ELECTRONICS. July 1965, Volume XXXVI, No. 7. Published Monthly at Ferry Street, Concord, N.H. 03302. Second-class postage paid at Concord, N. H. SUBSCRIPTION RATES: U. S. and possessions, Canada: \$5 for 1, \$9 for 2, \$12 for 3 years. Other countries: \$6.50 for 1, \$12 for 2, \$16.50 for 3 years. Single copies: 50¢. © 1965, by Gernsback Publications, Inc. All rights reserved. POSTMASTERS: Send Form 3579 to 154 W. 14th St., New York 10011.

# NEWS BRIEFS

## TV PREVENTS SUBWAY CRIME

The closed-circuit TV scanning system of Milan, Italy's new subway line (R-E, *What's New*, Feb. 1965, p. 43) has had an unexpected byproduct. There has not been a single purse-snatching, mugging or other violent act in the first 5 months of operation in any of the 21 stations of the line. Since every part of each station is directly under the eye of the station-master—who can switch from a long-range view to a closeup—crime indeed becomes difficult. Subway guards can be rushed immediately to any position and a fleeing thief reported on constantly by the speakers in the station.

## CLOSED-CIRCUIT TV HAS A COMPETITOR

Five schools in Fulton County, N. Y. are linked together through a communications system that transmits the instructor's voice and "blackboard" handwriting through conventional telephone circuits.



The electronic writing unit. Paul Reed of Gloversville High School is conducting a Greek literature course.

The system, developed by General Telephone and Electronics Corp., transmits handwriting produced on a master unit over ordinary telephone circuits in the form of voice-frequency electrical tones to a receiving unit at the remote classroom where it is pro-

jected on a screen. At the same time, the instructor carries on two-way discussions with all the students.

A course in Greek literature is being transmitted from Gloversville High School, and briefhand, a form of shorthand, is being taught from Northville Central School. The other schools taking part in the program are Johnstown High School, Mayfield Central School and Broadalbin Central School.

## ELECTRICAL RECORDING IS 40 YEARS OLD

Some 40 years ago this summer, the first audiences heard the "new sound" of phonograph records made electronically, an improvement so great over the old acoustical method of recording that listeners today will hardly believe that people listened to the old acoustic records for entertainment.

The files are incomplete, but it appears that Columbia signed a contract for electrical recording with Western Electric early in 1925, a few days or weeks earlier than did Victor. The first electrical recording Columbia made was on March 31, 1925, by the Associated Glee Clubs on the stage of the Metropolitan Opera House. The record carried on one side "John Peel" on the other. "Adeste Fideles." Exactly when the record reached the market is not known, but it was definitely within the next three months.

The first electronic phonograph for home use was put on the market by Brunswick in September 1925.

## VACUUM TUBE'S DAY NOT YET OVER?

Vacuum tubes still have a bright future, but not in receiving equipment. This was the opinion of Prof. Glen Wade of Cornell University, speaking before the IEEE session on "State-of-the-tube-art." The receiving tube will be eliminated in a few years, he said. But there are fields in which the vacuum tube is unlikely to be replaced, such as satellite applications and ion engines for space travel. Wireless transmission of power, equipment for

food processing and preservation are other areas in which tubes may long predominate. Dr. Wade also called attention to the possibility of new developments in tube design and materials which might make the tube more important in the future than now expected.

## ACHIEVES FOUR FELLOWSHIPS

Dr. Victor Twersky, who directs research at the Western operation of Sylvania Electronic Systems, was recently elected a Fellow of the Acoustical Society of America. This made him the first to hold fellowships in four major scientific groups (the other three being American Physical Society, the Institute of Electrical and Electronics Engineers, and the Optical Society of America).

## MASTER FM ANTENNA GOING UP ON EMPIRE STATE

What is said to be the nations' first master FM transmitting antenna will be erected at the very tip of the Empire State Building (1,250 feet up). It will be able to broadcast the signals of 17 FM stations simultaneously. The transmitters will be located on the 81st floor.

The setup will give greater FM coverage and stronger signals than before in the New York metropolitan area. Three stations, WQXR-FM, WHOM-FM and WLIB-FM, have already signed an agreement to transmit their FM signals beginning next fall.

## NEW TRENDS IN TV AND TYPESETTING SEEN BY RCA HEAD

Thin-screen wall-mounted color television receivers and battery-operated portables whose bright colors can be viewed in any outdoor location were predicted by Elmer W. Engstrom, president of RCA, at the company's annual meeting on May 4.

Dr. Engstrom also dwelt on the formation of the Graphic Systems Division, to develop, manufacture and market new electronic equipment and

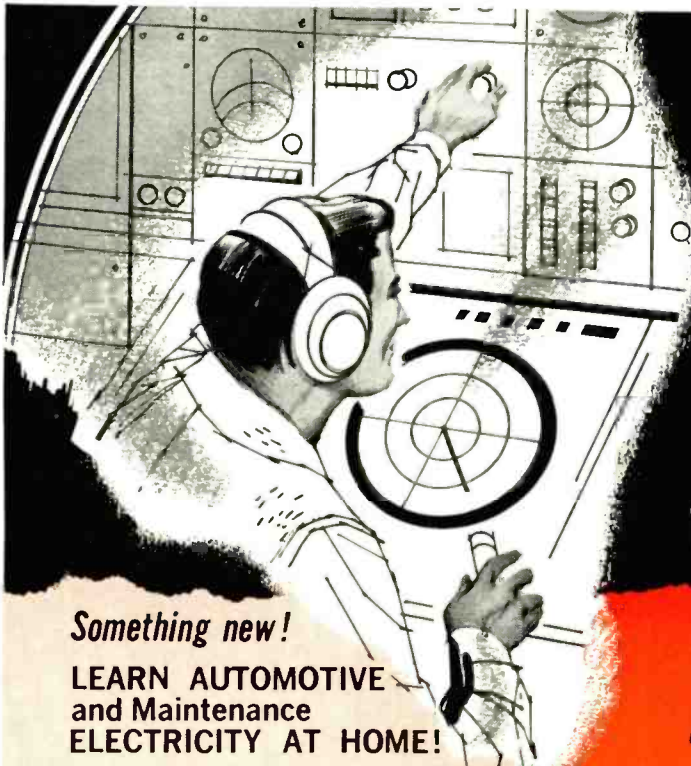

# 5,000 FIRMS HAVE EMPLOYED DeVRY TECH ELECTRONICS GRADUATES...

There Must be a Reason!

*Something new!*

## LEARN AUTOMOTIVE and Maintenance ELECTRICITY AT HOME!

Here's another great opportunity for the man who wants his own business or a bigger pay check with a brighter future. It is a NEW DeVry program that gives you the advantage of earning while you learn.

Prepare in spare time at home for profitable jobs which can take you all the way from trouble-shooting on the electrical systems of automobiles, marine engines, trucks, tractors and other gasoline engines, to the general maintenance of electrical equipment in the home or in light industry.

DeVry's new program "brings the classroom to your home" through the magic of AUDIO-VISUAL AIDS: Lectures recorded by DeVry instructors combined with colorful 8 x 10" transparencies to make learning easier. You get the advantages of "programmed" learning through modern texts which are also handy for future



reference. To develop practical skill, you get and keep valuable shop equipment and manuals. This includes building the brand-new DeVry Transistorized Automotive Analyzer and the DeVry Silicon Battery Charger — ideal "tools" for earning extra money as you go.

This new program covers the entire electrical systems in automobiles and other vehicles, including transistorized ignition systems, alternators and regulators, and other applications. In the maintenance field, it covers lighting, electric motors, controls, wiring — even transistors. The graduate from this program can be either a specialist as a troubleshooter on the electrical system of an automobile, or handle electrical lighting, heating, alarm and control systems. It is ideal for "one man" maintenance departments.

Check coupon at right and mail it today for FREE facts.

*Let Us Prepare You at Home or In  
One of Our Two Big Resident Schools  
for a Profitable Career in*

# ELECTRONICS

Across the continent, leading employers of personnel trained in electronics tell us that DeVry training is "Tops." Get the full story of DeVry Tech and the advantages it offers, by filling in the coupon below. The two free booklets pictured below tell of many fine opportunities for trained men in electronics: the great variety of jobs, from research, production, operation, maintenance and servicing of electronic equipment — to a neighborhood TV-radio sales and service business of your own. They'll tell you too, how DeVry has prepared men for good jobs with outstanding firms: on practical, "brass-tacks" problems with actual electronic equipment.

Here's good news: you don't need advanced education or previous technical experience to get started. If you can follow simple directions, you should be able to prepare with DeVry's help for real money in a field that may offer the opportunity of your lifetime.

**Employment Service:** With many employers so enthusiastic about DeVry Tech graduates, it's no wonder our Employment Service can help our graduates get started in electronics, or can assist them toward promotions later.

**FREE!**

SEND COUPON  
FOR BOOKLETS  
ON ELECTRONICS  
AS A CAREER



### DeVRY TECHNICAL INSTITUTE

4141 Belmont Ave., Chicago, Ill. 60641, Dept. RE-7-V

I AM INTERESTED IN ELECTRONICS. Please give me your two free booklets, "Pocket Guide to Real Earnings" and "Electronics in Space Travel"; also include details on how to prepare for a career in this field. The following opportunity fields (check one or more) interest me:

- |  |   |
|--|---|
| <input type="checkbox"/> Space & Missile Electronics | <input type="checkbox"/> Communications         |
| <input type="checkbox"/> Television & Radio          | <input type="checkbox"/> Computers              |
| <input type="checkbox"/> Microwaves                  | <input type="checkbox"/> Industrial Electronics |
| <input type="checkbox"/> Automation Electronics      | <input type="checkbox"/> Broadcasting           |
| <input type="checkbox"/> Radar                       | <input type="checkbox"/> Electronic Control     |

I AM INTERESTED IN AUTOMOTIVE AND MAINTENANCE ELECTRICITY. Please supply further information.

NAME \_\_\_\_\_ AGE \_\_\_\_\_

ADDRESS \_\_\_\_\_ APT. \_\_\_\_\_

CITY \_\_\_\_\_ STATE \_\_\_\_\_ ZIP \_\_\_\_\_

Check here if you are under 16 years of age.

Canadian residents: Write DeVry Tech of Canada, Ltd.,  
2095A 970 Lawrence Avenue West, Toronto 19, Ontario

ACCREDITED MEMBER OF NATIONAL HOME STUDY COUNCIL

## DeVry Technical Institute

Chicago • Toronto

NEWS BRIEFS continued

systems for handling all types of printed information. He stated that "... it is our conviction that the graphic arts field, and particularly the printing industry, offers a major opportunity for new electronics technology..." and pointed out that the new division could draw extensively on RCA's long experience in such areas as facsimile transmission and reproduction, electronic printing, and computerized typesetting.

The shareholders' meeting was,

like last year's, held in two cities. Chairman Sarnoff and the other officials in the Chicago Opera House were linked by closed-circuit television to shareholders in the NBC studio in New York City. Questions were asked and answered, and motions put with equal ease whether the participants were in one meeting place or the other.

**FRENCH CLASSROOM TV IS DONE WITH MIRRORS**

A new approach to classroom TV has been taken by the Ecole Nationale

de Radiotechnique et d'Electricité at Clichy, France. The receivers for the classroom television system of that school are installed in the ceiling. The image is reversed, and the student has a mirror on his desk. Looking down at the mirror he sees a correct reflected picture. Thus the student can see the television screen without looking up from his desk to a TV set across the room. Both teachers and students approve the system.

**IEEE GERNSBACK AWARD**

Thomas L. Wilson, of Del Rio, Texas, a student at Rice University, was awarded the Hugo Gernsback Award at the Southwestern IEEE Conference in Dallas. The \$500 award, anonymously donated to the IEEE, is for the best and most imaginative paper by an undergraduate predicting the future in science and engineering. Mr. Wilson's paper was titled "A Priori Tomorrow."

**NEW FOG DETECTOR USES LASER BEAM**

A new fog detector, developed by the Hoffman Science Center, beams an intense ray from a radiating diode through the air to determine the presence and amount of fog.

The diode is mounted in a cylindrical beam-projecting light pipe and beamed toward a spherical mirror which focuses and directs the rays into the fog. The density of the fog can be recorded most conveniently either by reflecting the beam from a mirror in the beam path, or simply by measuring

RADIO-ELECTRONICS is published by Gernsback Publications, Inc. Editorial, Advertising, Subscription and Executive offices: 154 West 14th Street, New York 10011.

Subscribers: When requesting change of address please furnish an address label from a recent issue. Allow one month for change of address.

**ADVERTISING REPRESENTATIVES:** East: John J. Lamson, Eastern Sales Manager, RADIO-ELECTRONICS, 154 West 14th Street, New York 10011, 212 AL 5-7755; Midwest: P. H. Dempers Co., 740 North Rush Street, Chicago, Illinois 60611, 312 MI 2-4245; Southeast: Neff Assoc., 15 Castle Harbor Isle, Ft. Lauderdale, Fla. 33308, 305 LO 6-5656; J. Sidney Crane, Assoc., 22 B St., N.E., Atlanta, Ga. 30309, 404 TR 2-6720; Texas/Arkansas: Media Sales Co., 2600 Douglas Avenue, Irving, Texas 57060, 214 BL 5-6573; West Coast/Oklahoma: Husted-Coughlin, Inc., 1830 W. 8th Street, Los Angeles, Calif. 90057, 213 389-3132; Husted-Coughlin, Inc., 444 Market Street, San Francisco, Calif. 94111, 415 GA 1-0151; United Kingdom: Publishing & Distributing Co., Ltd., Mitre House, 177 Regent St., London W.1, England.

**NOT JUST HORNS  
NOT JUST CONES**

**OXFORD**

**HAS THE FULL LINE**

Model OP-6



Model DVC-8J4



**to Supply Commercial Sound Needs...**

Model OH-10



From the OP-6 & OP-8 paging and talkback horns and the OH-10 outdoor high fidelity system, which changed the outdoor speaker market in 1964, to the startling new DVC-8H4 and DVC-8J4 units with two separate voice coil winding, providing immediate access to the speaker, Oxford is the one source best qualified to supply all your speaker needs.

Our line also includes intercom speakers, public address speakers, all-weather cones, shallow ceramic magnet units, and the "Specialist Series." The Specialists (which includes models DVC-8H4 and DVC-8J4) are a series of popular 8-inch speakers that have been prepared for "instant use" by the commercial sound installer, with factory installed transformers and bulk packaging.

It makes good sense to use the line that is orientated toward the commercial sound installer by both design and marketing. For more information on the OXFORD, line, write for complete catalog.

**OXFORD  
TRANSDUCER  
CORPORATION**



A Subsidiary of Oxford Electric Corporation

2331 North Washtenaw Avenue • Chicago 47, Illinois



“Sure,  
you work hard,  
but that’s not  
enough...”

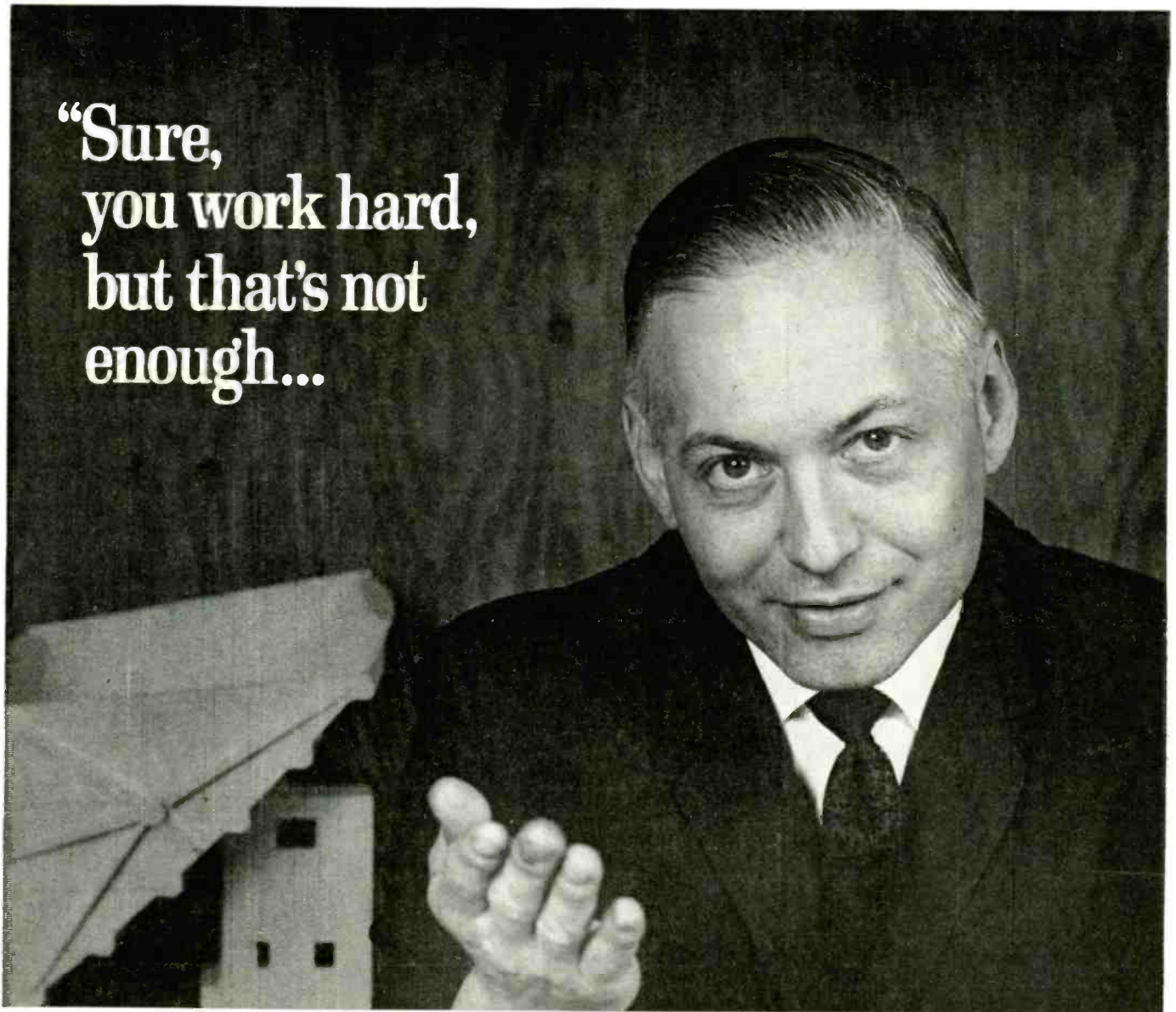

...you need more education to get ahead in electronics”

No matter how hard you work, you can't really succeed in electronics without advanced, specialized technical knowledge.

Going back to school isn't easy for a man with a full-time job and family obligations. But CREI Home Study Programs make it possible for you to get the additional education you need without attending classes. You study at home, at your own pace, on your own schedule.

CREI Programs cover all important areas of electronics including communications, servomechanisms, even spacecraft tracking and control. You're sure to find a program that fits your career objectives.

Accredited Member of the National Home Study Council



You're eligible for a CREI Program if you have a high school education and work in electronics. Our FREE book gives all the facts. Mail coupon or write: CREI, Dept. 1407C 3224 Sixteenth Street, N.W., Washington, D. C. 20010



**SEND FOR FREE BOOK**

**The Capitol Radio Engineering Institute**  
Dept. 1407C 3224 Sixteenth Street, N. W.  
Washington, D. C. 20010

Please send me FREE book describing CREI Programs in Electronics and Nuclear Engineering Technology. I am employed in electronics and have a high school education.

Name \_\_\_\_\_ Age \_\_\_\_\_

Address \_\_\_\_\_

City \_\_\_\_\_ State \_\_\_\_\_ Zip Code \_\_\_\_\_

Employed by \_\_\_\_\_

Type of Present Work \_\_\_\_\_

# TUNER REPAIRS

Includes ALL parts (except tubes)...  
ALL labor on ALL makes for complete overhaul.

# \$9.50



**FAST, 24-HOUR SERVICE**  
with **FULL YEAR WARRANTY**

Sarkes Tarzian, Inc., largest manufacturer of TV and FM tuners, maintains two completely-equipped Service Centers, offering fast, dependable tuner repair service. Tarzian-made tuners received one day will be repaired and shipped out the next. More time may be required on other makes. Every channel checked and realigned per manufacturer's specs. Tarzian offers full, 12-month guarantee against defective workmanship and parts failure due to normal usage. Cost, including all labor and parts (except tubes), is only \$9.50 and \$15 for UV combinations. No additional costs. No hidden charges. You pay shipping. Replacements at low cost are available on tuners beyond practical repair.

Always send TV make, chassis and Model number with faulty tuner. Check with your local distributor for Sarkes Tarzian replacement tuners, parts, or repair service. Or, use the address nearest you for fast factory repair service.

**SARKES TARZIAN, INC.**  
TUNER SERVICE DIVISION

Dept. 200  
537 South Walnut St.,  
Bloomington, Indiana  
Tel: 332-6055

Dept. 200  
10654 Magnolia Blvd.,  
North Hollywood, Calif.  
Tel: 769-2720

MANUFACTURERS OF TUNERS, SEMICONDUCTORS,  
AIR TRIMMERS, FM RADIOS, AM-FM RADIOS,  
AUDIO TAPE and BROADCAST EQUIPMENT

## NEWS BRIEFS continued

the backscatter (the amount of light reflected from the fog itself).

Frank Nickl, head of the Hoffman research team, explained that the present experimental diode equipment has about one-tenth of the output of the final version, which will be ready next January. Four detecting units are slated by the Science Center, a division of Hoffman Electronics Corp., for delivery to the Coast Guard, Air Force, Bureau of Standards and Weather Bureau for testing and evaluation.

### 2-MILE LASER BEAM GENERATED BY MULTIPLE REFLECTIONS

A laser beam more than 2 miles long has been generated in a 10-foot space by scientists of the Bell Laboratories. The experiment, conducted by Donald Herriott and Harry Schulte, was performed by reflecting the beam more than a thousand times between two mirrors. Because the points of reflection on the mirrors do not overlap, information can be modulated onto the light beam, stored and retrieved 10  $\mu$ sec later. This opens the way for optical delay lines that could be used as high-speed, sequential computer memories.

Because light waves are dispersionless (all component frequencies travel at the same velocity), information modulated onto the laser beam is not distorted in the delay line.

To get the maximum number of

reflections without interference, Herriott and Schulte bent two spherical mirrors into slightly cylindrical shapes. This caused the horizontal radius of curvature of the mirrors to differ slightly from the vertical. As a result, the light spot—the point where a beam hits the mirror—moves with each reflection to form a Lissajous pattern.

The maximum number of beam reflections is limited by the area and the scattering loss of the mirrors. During 1,000 reflections (10 microseconds delay) the beam's power is reduced only 20 db by scattering. This would indicate that two or three thousand reflections (delays of 20 to 30 microseconds) are feasible.

### WORLD'S LONGEST ANTENNA BUILT IN ANTARCTIC

A 21-mile-long, plastic-coated  $\frac{3}{4}$ -inch copper-cable antenna has been laid on the Antarctic icecap to study radio conditions in space. The National Science Foundation reports that it is twice as long as any built before.

The antenna radiates very-low-frequency waves of the kind generated by lightning. These are expected to travel far out into space along lines of force in the earth's magnetic field, and follow the lines as they curve back to the globe in the opposite hemisphere. Scientists have heard low frequencies called "whistlers", supposed to be generated by lightning strokes, and they expect somewhat similar effects from the waves radiated from the 21-mile antenna.

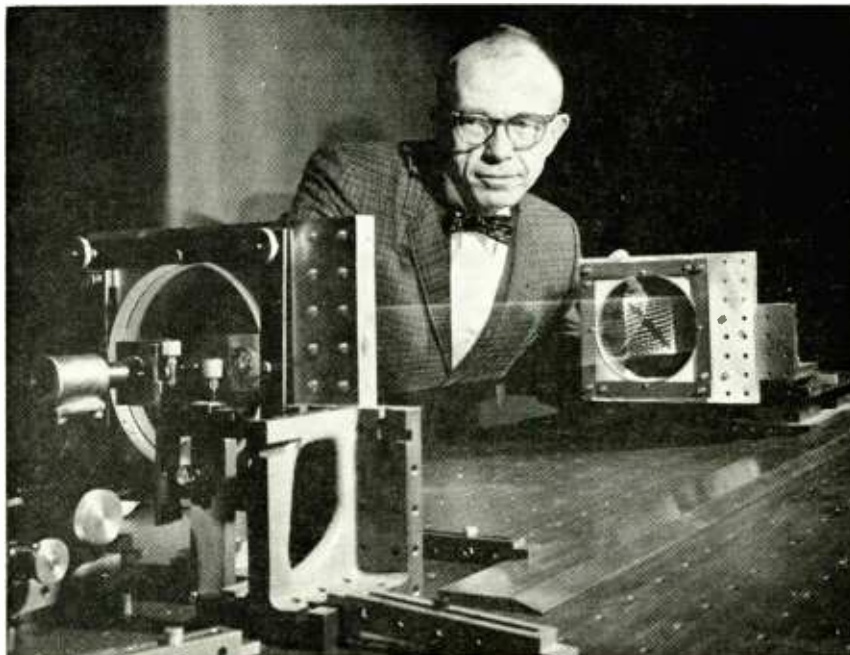

Harry Schulte of Bell Labs demonstrates the equipment by moving the mirrors closer together and reflecting the beam about 400 times, thus making it possible to see the points of light on the screen.

**NOW—TELEVISION PICTURES  
ON PHONOGRAPH RECORDS**

An electronic system that plays television pictures from a phonograph record has been developed by Westinghouse. The same long-play disc carries the sound track.

The recording is not a live television picture, but a series of stills produced every 6 seconds. The equipment contains two storage tubes. A scan converter builds up a complete television picture which is then read out and recorded on tape or disc in 6 seconds. The second storage tube then supplies information for the next recorded picture. In playback the process is reversed, and a slow-to-fast scan conversion displays the picture on the TV screen. One picture is read out repeatedly and displayed during the time that the next one is being formed on the storage tube from the video information in the groove of the recording.

Westinghouse promises equipment that will permit a user of the system, called *Phonovid*, to prepare his own sight-and-sound programs. The pictures would, in this case, be recorded on tape, and could be played back directly through the Phonovid system—or, if a number of copies were required, used to make a master phonograph record. The equipment is expected to be especially useful in educational work, and is more flexible than educational-TV movies or classroom films.

**ST. LOUIS TESA OFFERS  
REWARD FOR TIPS ON VANDALS**

The St. Louis Television & Electronic Service Association is offering \$1,000 total in rewards for information leading to the arrest and conviction of whoever has been breaking TV service-shop windows and damaging service trucks.

Windows have been broken with pellet guns. Other apparently deliberate damage has been inflicted on stores and vehicles for several months. The motive for the attacks is apparently not robbery.

Anyone who has such information is asked to write TESA—St. Louis, 4933 Delmar Blvd., St. Louis, Mo., or to call 314 PR 3-0587.

**TROUBLE WITH PORTABLES IS,  
THEY CAN BE CARRIED... OFF**

Milwaukee TV shops have been victimized by thieves who apparently are masters of a blitz technique. A recent report in the Wisconsin *TESA News* notes: "Six new 19-inch portable TV's were stolen so quickly that the thieves were not seen by residents living in the upstairs apartments."



Up to 400 TV pictures and 40 minutes of sound can be recorded by Phonovid on the two sides of a 12-inch long-play record. All the electronic circuitry is housed in the small compartment under the fold-out turntable. Price will be around \$10,000.

**PURIFY COLOR TV IN YOUR HOME**

**Portable Demagnetizer**  
**SAFE-EASY TO USE!**

**IMPROVE YOUR COLOR TV RECEPTION!**

You can now purify and eliminate stray colors in your Color TV Set. Portable, compact, easy to use, the New Walsco Demagnetizer comes complete with operating instructions. Maintain a clear picture on your set... see your nearest TV Appliance dealer or call your serviceman today.

**Walsco ELECTRONICS** | Eastern Plant: Hicksville, L.I., N.Y.  
A DIVISION OF G-C ELECTRONICS | Western Plant: Los Angeles, Calif.  
MAIN PLANT: ROCKFORD, ILL.

# IF THE RCA MARK VIII C-B TRANSCEIVER IS SO GREAT AT \$114<sup>95</sup>\* ...



- 9 crystal-controlled transmit and receive channels
- Tunable receiver for reception of 23 C-B channels; dial marked in both channel numbers and frequency
- Exceptionally good voice reproduction
- Highly selective superheterodyne receiver with one rf and two if amplifier stages
- Electronic switching—no relay noise or chatter
- Illuminated "working channel" feature
- Light and compact—only 3½ inches high, weighs only 8 pounds with mike; fits easily under the dashboard of even a compact car
- Improved Automatic Noise Limiter to reduce effects of ignition and similar interference

## ...HOW COME THE NEW MARK NINE IS WORTH \$20<sup>00</sup>\* MORE?



*It has all the Mark VIII features—PLUS these additional features...*

- Combination "S" Meter and Relative RF Output Meter. "S" Meter indicates the relative strength of incoming signal in "S" units. RF Output Meter (EO) indicates relative strength of the signal being transmitted.
- Spotting Switch. Permits precise manual tuning of receiver without use of receiver crystals. Receiver can be tuned (or "spotted") quickly to any incoming channel for which you have a transmit crystal. This means, when you buy crystals for extra channels,

you can (if you wish) omit the RECEIVE crystals and buy only TRANSMIT crystals. This feature alone pays the price difference if you use a number of channels.

- External Speaker Jack. Lets you connect an external speaker to the set, so incoming calls can be heard in remote locations.

**GET THE FACTS.** Write for free descriptive folder on either the Mark VIII or Mark Nine to: Commercial Engineering, Department G39R, RCA Electronic Components and Devices, Harrison, N.J.

**AVAILABLE THROUGH YOUR AUTHORIZED RCA C-B RADIO DISTRIBUTOR**

\*Optional distributor resale price.



**The Most Trusted Name in Electronics**

### NEWS BRIEFS continued

In boldface type at the end of the article is this: "Police suggested that TV shops do not display portables in their store windows. It is too easy to steal them quickly."

### CALENDAR OF EVENTS

**73rd Annual Meeting, American Society for Engineering Education, June 21-24; Illinois Institute of Technology, Chicago, Ill.**

**San Diego Symposium for Biomedical Engineering, July 6-8; US Naval Hospital, San Diego, Calif.**

**14th Annual Convention, National Community Television Association, July 18-23; Denver Hilton Hotel, Denver, Colo.**

**Annual IEEE Conference on Nuclear & Space Radiation Effects, July 12-15; University of Michigan, Ann Arbor, Mich.**

**6th International Conference on Medical Electronics & Biological Engineering, Aug. 23-27; Tokyo, Japan**

### SEARCH TUNING FEATURED IN TRANSISTOR PORTABLES

Signal-seeking tuners—long an adjunct of top-of-the-line automobile radios—are now being featured in some of the better Japanese transistor portables. The heart of the tuning mechanism is a tuning capacitor, capable of continuous rotation, driven by a spring motor.

Pressing the "search-tune" button energizes a relay and starts the motor. Electronic circuits sample the i.f. signal and stop the motor when the carrier of the next station is centered in the i.f. passband.

### BRIEF BRIEFS

General Electric will soon begin manufacturing color tubes, which, they say, will be an improved version of the industry's standard "three-gun" type, and will incorporate the brighter rare-earth phosphors similar to those introduced by Sylvania. The announcement was made at the annual shareholders' meeting by Fred J. Borch, president.

General Electric has announced a new 11-inch color TV receiver, using a picture tube of G-E's own manufacture. The set will be on the market sometime in the late fall, "in time for the Christmas trade," it is expected. A feature of the new set is a marking system which optimizes color reception when the marks on the control knobs point straight up.

Dr. Elmer W. Engstrom, president of the Radio Corporation of America, received the Charles Proteus Steinmetz Centennial Medal of the National Academy of Engineering at the first annual meeting of the academy in Washington, D.C. **END**

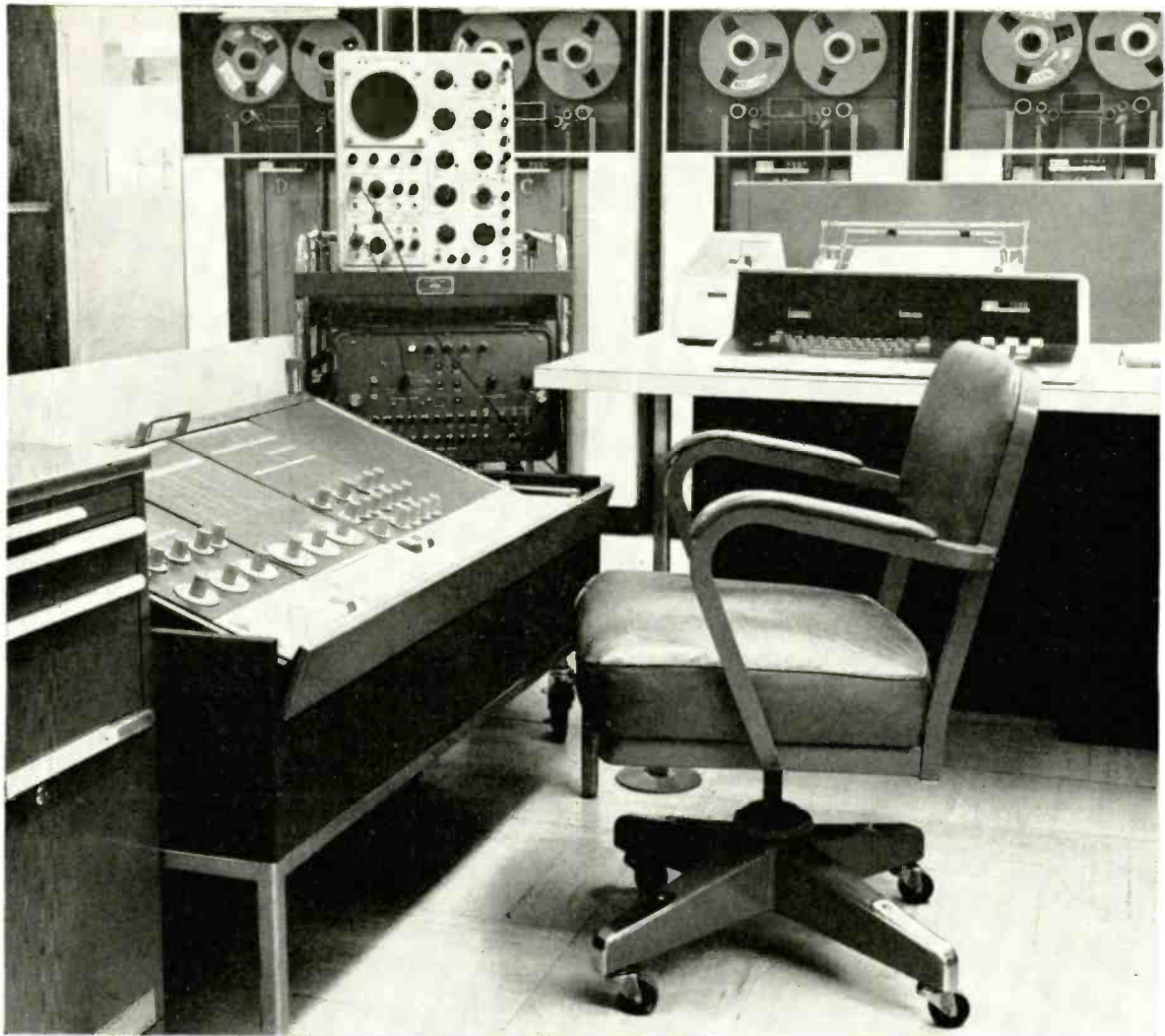

## Sit right down in this high-paying job . . . after you get your FCC License

It's true. There are hundreds of high-paying, challenging jobs for men with official proof of their electronics skill and knowledge . . . the Commercial FCC License. And the quickest, easiest, most economical way to get your license is Cleveland Institute of Electronics Home Study. Will it work for you? Cleveland Institute is so sure of it they make this exclusive promise: "Should you fail to pass your Commercial FCC License examination after completing one of our licensing programs, we will refund all your tuition payments." The offer is as straightforward as it sounds . . . you get your FCC license or your money back!

You'll be amazed how fast, how easily you can learn electronics with Cleveland Institute's "Auto-Programmed" Lessons. Facts and concepts are presented in small, easy-to-understand segments, then reinforced with clear explanations and examples. Through this modern, proven method, you will learn at your own pace . . . and remember what you learn!

So pick the program that fits your career objective, mark your choice on the coupon, and mail it today. We'll send

you, without obligation, complete details on Cleveland Institute home study. Act right now . . . there will never be a better time to start towards a high-paying, interesting job in electronics. Cleveland Institute of Electronics, 1776 E. 17th St., Dept. RE-6, Cleveland, Ohio 44114.

### Mail Coupon TODAY For FREE Catalog

#### Cleveland Institute of Electronics

1776 E. 17th St., Dept. RE-6  
 Cleveland, Ohio 44114

Please send FREE Career Information prepared to help me get ahead in Electronics, without further obligation.

#### CHECK AREA OF MOST INTEREST—

- |   |  |
|---|--|
| <input type="checkbox"/> Electronics Technology | <input type="checkbox"/> First Class FCC License   |
| <input type="checkbox"/> Industrial Electronics | <input type="checkbox"/> Electronic Communications |
| <input type="checkbox"/> Broadcast Engineering  | <input type="checkbox"/> Advanced Engineering      |



Your present occupation \_\_\_\_\_

Name \_\_\_\_\_ Age \_\_\_\_\_  
 (Please Print)

Address \_\_\_\_\_ County \_\_\_\_\_

City \_\_\_\_\_ State \_\_\_\_\_ Zip \_\_\_\_\_

A leader in Electronics Training . . . since 1934

## Cleveland Institute of Electronics



1776 E. 17th St., Dept. RE-6, Cleveland, Ohio 44114

Accredited Member

JULY, 1965

brand new  
...and very important...  
**QUAM COLOR TV  
REPLACEMENT  
SPEAKERS PREVENT  
COLOR PICTURE  
DISTORTION**

OFTEN CAUSED BY STRAY  
MAGNETIC FIELDS FROM  
ORDINARY LOUDSPEAKERS



When you use an ordinary loudspeaker in a color TV set, you're looking for trouble... picture trouble. The external magnetic fields from standard loudspeakers will deflect the primary color beams, causing poor registration and distorted pictures.



**QUAM RESEARCH SOLVES  
THIS PROBLEM**

An entirely new construction technique, developed in the Quam laboratories, encases the magnet in steel, eliminating the possibility of stray magnetic fields and the problems they cause! These new Quam speakers have been eagerly adopted by leading color TV set manufacturers. Quam now takes pride in making them available for your replacement use. Five sizes (3" x 5", 4", 4" x 6", 5 1/4", 8")... in stock at your distributor.

**QUAM**  
QUAM-NICHOLS COMPANY

234 E. Marquette Rd. • Chicago, Ill. 60637

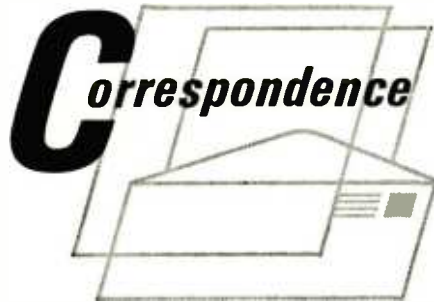

**AUTO RADIO CONVERSION HINTS**

Dear Editor:

Please extend my congratulations to Mr. Alex Burr on his excellent article about converting old auto radios. I have converted several, and all have worked well.

Some readers may have trouble with hum. Save for possible heater-cathode leakage (check all tubes), hum is usually caused by insufficient filtering. The original supply frequency from the vibrator was about 115 cycles (230-cycle ripple), and the original filtering will usually not be enough to remove 120-cycle ripple. Replace all filter capacitors with 40- $\mu$ f 350-volt units, or shunt additional capacitance across the original filters.

If that doesn't help—or isn't enough—shield all heater and pilot-lamp leads.

You can get better bass by removing all cathode bypass capacitors in rf, i.f. and audio stages except the output stage. To improve high-frequency response, remove or reduce the audio plate bypass capacitors. In push-pull stages, reduce the value of the capacitor connected between the plates and insert a resistor in series with it. The value will have to be determined by experiment. Choose the value that gives best highs without whistle or squeal.

**NOW . . .  
PERFECT  
CONVERGENCE**

You'll save time, temper and money by following this cool, logical approach to one of color TV's most persnickety jobs: convergence. Robert G. Middleton, author of dozens of TV texts and articles, has perfect convergence all sewed up.

Coming in  
**August  
RADIO-  
ELECTRONICS**

Connecting 6-volt 60-cycle ac to half of the power transformer primary, as suggested by the editor in the article, works better than any other method suggested. A particularly attractive feature of this method is that you can use the heater winding of an old TV power transformer, which many people have lying around, or which you can buy for a couple of dollars.

Be sure to use a fuse just greater than the current drain of the set, in series with the 6-volt lead to the set. (A fuse of the original rating will do.) To eliminate noise, replace 0Z4 rectifiers with 6X5-GT—the only necessary change is to ground pin 7 and connect a 6-volt lead to pin 2. Many radios are wired for direct substitution of a 6X5 for an 0Z4.

DENNIS C. SMITH

Detroit, Mich.

**CHANCE OF METER DAMAGE**

Dear Editor:

In the November 1964 RADIO-ELECTRONICS, page 106, appears an item by Albert Koehler called "Meter Borrowing Saves Expense." In this circuit, an spdt switch disconnects the meter from the rest of the vtvm circuitry [making it possible to "borrow" the meter alone for use in experimental circuits—Editor]. Unless a dpdt switch is used, to separate the meter completely from the vtvm, there is a possibility of damage to vtvm, meter movement and the equipment under test. The diagram shows a simplified circuit of a typical vtvm.

Note the extraneous circuit paths if the ground connection from the vtvm to the circuit under test is completed, which would be a likely condition if the vtvm had just been used for voltage or resistance checks. Also, the vtvm circuit's resistance and capacitance could

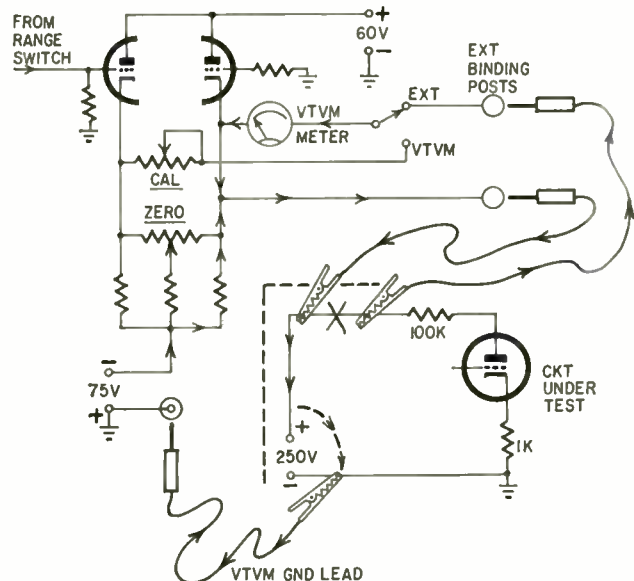

load the circuit under test if it is a high-impedance circuit.

F. W. CHESSON

Waterbury, Conn.

## TV CONVERSION HEADACHE

Dear Editor:

The reader who requested advice on getting the sound carrier on West German TV (Service Clinic of January, 1965) may run into difficulty if he merely replaces his sound i.f. transformers with 5.5-mc ones as suggested by Mr. Darr.

The trouble is that the video i.f. bandwidth on US sets may not be wide enough to have enough 5.5-mc sound carrier available at the sound i.f. input. One alternative is to broad-band the video i.f. stages, a rather tedious task. Another is to split the sound carrier off at the mixer output as in the older US sets. The latter would require new sound i.f. transformers in the vicinity of 40 mc, or another converter to drop the sound carrier to 4.5 mc.

When I was stationed in Paris, I had a similar (only worse) problem with the French TV. The French channel is 11.25 mc wide and the sound is AM. I finally ended up with the sound carrier split off at the mixer and going through a crystal-controlled converter to 4.5 mc. I changed the ratio detector

to an AM detector. Also, with 819 lines, a 4-mc video bandwidth will not give as good horizontal resolution as with the US, 525 lines, so I also broad-banded the video i.f. and the video, too. The whole job required about 200 hours of work, and I'd never do it again. It's much simpler to go out and buy a French TV set!

JAMES E. DUPREE  
Colonel, USA, Ret.

San Antonio, Tex.

## ON CLEANING RELAYS

Dear Editor:

Read your interesting and humorous article "Launching the Boat's Electronics" in the February 1965 issue of RADIO-ELECTRONICS, page 34.

I cannot agree with the use of bond paper for cleaning relay contacts. From my experience, bond paper will leave a film and has a tendency to create trouble, especially on contacts that carry low current.

May I suggest that when it is necessary to clean contacts that a burnisher (cleaned with a lint-free cloth) dampened with trichloroethylene be used. The desired result is usually obtained by rubbing the burnisher between the contacts two or three times while applying light pressure.

W. A. McDERMID

Cooksville, Ont.

## Mr. Robberson Replies

Although Mr. McDermid prefers another method of contact cleaning, I have been using bond paper to burnish transmitter and receiver relay contacts for 35 years and have not yet suffered the trouble he reports. He must have used linty paper, or else tried to use paper on contacts so rough they needed more than simple film removal.

Because lint-free cloth and trichloroethylene are scarce along my waterfront, I'm going to stick to my method. Oh, yes—if you should rub a fiber off the paper, take a breath, purse your lips, and blow some  $\text{CO}_2 + \text{N}_2 + \text{O}_2 + \text{Ar} + \text{Ne}$ , etc. on the contacts. A few forceful applications of this mixture should do the trick.

ELBERT ROBBERSON

Setauket, N.Y.

## OTHER MODIFICATIONS TO OLD AUTO RADIO

Dear Editor:

Thank you for the article "New Life for Old Auto Radios" in the April issue of RADIO-ELECTRONICS.

I rewired my conversion so the switch on the volume control turns the primary of the transformer on and off. I also found space to add a 12AU7 as a cathode-follower output to drive a

# great profits



that's about the size of it

Microminiaturization has come to cartridge design in the new Sonotone Micro-Ceramic<sup>®</sup> Cartridge—a king-sized profit-maker in a tiny case. This remarkable new cartridge updates to 1965 performance almost any phonograph using a ceramic cartridge produced within the past 20 years.

The Sonotone Micro-Ceramic Cartridge embodies all the advantages of miniaturization and light weight. Designed for low mass, lightweight tonearms—it weighs less than 1 gram (without bracket). Superb stereo performance is assured by—high compliance; ability to track at the low forces required by today's modern record changers; excel-

lent separation and a smooth, clean response over the full audio range. To top it off, all Micro-Ceramic cartridges are equipped with the virtually indestructible Sono-Flex<sup>®</sup> stylus. For ease of installation, three different standard mounts are available.

Four Micro-Ceramic cartridges cover all of your replacement needs; the "27T," a high capacitance model for transistorized phonographs; the high compliance "25T" for deluxe stereo units; the "26T" and "28T" for replacement in a wide range of popularly priced phonographs.

For comprehensive Cartridge Replacement Guide, write:

**SONOTONE**  
audio products

Sonotone Corp., Electronic Applications Div., Elmsford, N. Y.

**CORRESPONDENCE continued**

30-watt amplifier and two 15-inch speakers.

This works very well in a large metal garage with an auto antenna on the roof and a long shielded lead to the radio. This, plus the radio's metal case, eliminates static from fluorescent lights and other nearby equipment.

Sensitivity and selectivity are excellent—some of the old car radios are just built that way!

A word of caution: some of the older sets use a 6-volt field coil on the speaker. The speaker should be re-

placed with a permanent-magnet type.

ALEX SEED

Casa Grande, Ariz.

**NOMO IS EVEN MORE USEFUL**

Dear Editor:

In my "Do-It-Yourself Parallel-R, Series-C Nomogram" (Feb. 1965 R-E, page 97), I think it should have been pointed out that it can be used for more than two components at a time. It can be used to find the combined parallel value of any number of resistors, or the combined series value of any number of capacitors.

It also makes easy the job of se-

lecting two lower-wattage resistors to be used in parallel for a high-watt dissipation. Start with  $R_T$  and work backward.

MELVIN T. HYATT

Prairie Village, Kan.

**RECORDER CONVERSION DATA**

Dear Editor:

Jack Darr's Service Clinic for March 1965 carried some bad news for the owner of a Grundig TK-30 purchased in Germany who wished information about its conversion from 50- to 60-cycle current.

We think there is hope for the owner of that tape recorder. Our shop has converted a number of TK-30's by merely replacing the flywheel/capstan.

Our shop has been servicing German audio equipment for many years and would be happy to supply information regarding proper use and repair.

JOHN REILICH

Eurotech Service Co.

66-44 Forest Ave.

Ridgewood, N.Y. 11327

END



**Perk it up with Perma-Power  
COLOR-BRITE**

Perma-Power does for color TV sets what we've done for millions of black and white CRT's: adds an extra year of useful picture tube life.

When a color tube begins to fade, COLOR-BRITE instantly brings back the lost sharpness and detail. It provides increased filament voltage to boost the electron emission and return full contrast and color quality to the 3 gun color picture tube.

COLOR-BRITE is automatic . . . no switching or wiring. Just plug it in. Your delighted customers will brighten up as fast as their color sets!

Model C-501, for round color tubes.

List Price \$9.75

Model C-511, for rectangular color tubes.

List Price \$9.75



COLOR-BRITE is a Hue-Brite product from Perma-Power, famous in TV service for b & w Vu-Brites and Tu-Brites.

**Perma-Power** COMPANY

5740 N. TRIPP AVE., CHICAGO, ILLINOIS 60646

PHONE (312) 539-7171

**40-WATT "SWITCHING-MODE" AMPLIFIER YOU CAN BUILD!**

Rumors of a radically new kind of transistor audio amplifier have been circulating on both sides of the Atlantic for some time. In August RADIO ELECTRONICS: the first such amplifier designed especially for home construction! A 40-watt public-address amplifier of fantastic efficiency—smaller than a cigar box, it weighs only 40 ounces, works from a 12-volt battery. (Principle underlying this breakthrough is discussed on page 54 of this issue.)

COMING IN AUGUST  
**RADIO-ELECTRONICS**



"Hey, Fred, don't you think it'd be a good idea to buy a stool?"

RADIO-ELECTRONICS



# LIVE BETTER ELECTRONICALLY with LAFAYETTE RADIO ELECTRONICS

## HI-FI AND CB EQUIPMENT Headquarters

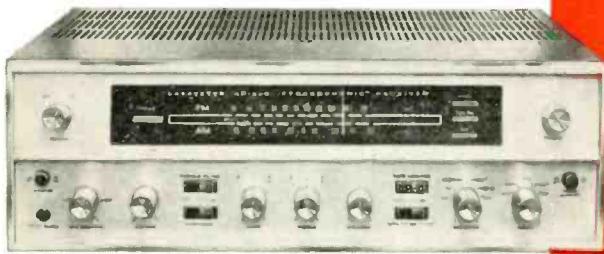

Model HB-500  
**139<sup>50</sup>**  
99-3027WX

### NEW! LAFAYETTE 70-WATT COMPLETE AM-FM STEREO RECEIVER

Just Add Speakers and Enjoy FM, FM Stereo and High-Quality AM Reception

■ A powerful 70-Watt Amplifier plus Complete Preamplifier Control Facilities plus a Standard AM Tuner plus a sensitive FM Tuner plus an FM Stereo Tuner—all on One Compact chassis ■ Amazing FM "Stereo Search" Circuit Signals Presence of Stereo Broadcasts ■ Tuned Nuvistor "Front End" provides Greater Sensitivity, Lower Noise ■ Bar-Type Tuning Indicator for AM and FM ■ Variable AFC Control ■ Imported

TAKES REELS UP TO 7"



‡ adaptable to stereo playback

DYNAMIC MICROPHONE

Model RK-137A  
**89<sup>50</sup>**  
99-1511WX

### THE WIDELY ACCLAIMED LAFAYETTE RK-137A TAPE RECORDER

FEATURING **4**-TRACK STEREO PLAYBACK‡  
**4**-TRACK MONAURAL RECORD PLAYBACK

With Electronic Track Selector Switch, VU Recording Level Meter and Pause Switch For Instant Editing

Includes Lightweight carrying case, dynamic microphone, output cable, 7 inch empty tape reel.

• Two Speeds—3¼ & 7½ ips • Pause Lever Provides Instant Stop for Editing • Record—Erase Safety Switch • Fast, Rugged Shift Lever Control • Extension Speaker Jack • High Impedance Monitoring Jack • VU Meter Recording Level Indicator • Electronic Track Selector Switch • Specially Designed Heavy-Duty 6x4" PM Speaker • Separate Erase and Recrd Heads • Imported



Small . . . Quiet . . . Powerful!

### NEW! LAFAYETTE SOLID-STATE DUAL CONVERSION 5-WATT CB TRANSCEIVER

With Authentic Mechanical Filter

- ✓ Only 3" high—fits easily in any car
- ✓ Special multi-stage noise limiting circuit ends problem of mobile noise
- ✓ The same output as the most powerful tube unit yet uses only 1/50th of the battery power

The Perfect Unit For Mobile!

- 12 Crystal Transmit and Receive Positions • 23 Channel Tunable Receiver With Spotting Switch • 3-Stage Transmitter Rated For Full Legal Power • Dual Conversion Receiver with 5/10 μV Sensitivity • Multi-Stage Automatic Noise Limiting Circuit • Rugged Silicon Mesa Transistors • Compact—3"Hx11¼"Wx6½"D • 12V DC Mobile Operation (Negative or Positive ground) • 117V AC operation when used with Matching Solid-State AC Power Supply (Optional at \$16.95)



Model HB-400  
**169<sup>50</sup>**  
99-3001WX

### NEW! LAFAYETTE 23-CHANNEL 5-WATT CB TRANSCEIVER

Double Side Band Full Carrier

- ✓ 17-Tube Performance with 13 Tubes
- ✓ Low Noise Nuvistor "Front End"
- ✓ 5 Double-Tuned If Transformers
- ✓ Meets All FCC Requirements

With Advanced "Range-Boost" Circuit

- Frequency Synthesized Circuit Provides 23 Crystal-Controlled Transmit & Receive Channels—No Extra Crystals to Buy • Continuous One-Control Channel Tuning • Full 5-Watt Input • Push-To-Talk Microphone & Electronic Switching • Dual Conversion Receiver With 3/10 μV Sensitivity • Delta Tuning Offers "Fine Tuning" of ±2.5Kc on Receive • Illuminated "S" and RF Output Meter • Variable Squelch, Variable Noise Limiter, AGC • Built-in 117V AC & 12V DC Power Supply • "Vari-Tilt" Mounting Bracket for Easy Mobile Installation • Plug-in Facilities For Lafayette Selective Call Unit

**FREE!**

**LAFAYETTE RADIO ELECTRONICS**

1965 CATALOG NO. 650 516 PAGES!

See The Largest Selection in Our 44-Year History

- Stereo Hi-Fi — Famous Brands plus Lafayettes own Top-Rated Components
- Citizens Band Equipment
- Tape Recorders • Ham Gear
- Radio's, TV's and Accessories
- P.A. Equipment; Intercoms
- Test Equipment • Optical Goods
- Auto Accessories • Musical Instruments

JULY, 1965

LAFAYETTE RADIO ELECTRONICS  
Dept. JG-5, P.O. Box 10  
Syosset, L.I., N.Y. 11791

Send me the FREE 1965 Lafayette Catalog 650 \$..... enclosed; send me ..... (Prices do not include shipping charges).

Name.....  
Address.....  
City..... State..... Zip.....



***Learning electronics at home is faster, easier, more interesting with new achievement kit***

**GET A FASTER START IN THE COURSE YOU CHOOSE WITH NRI'S REMARKABLE ACHIEVEMENT KIT**

When you enroll with NRI we deliver to your door everything you need to make a significant start in the Electronics field of your choice. This remarkable, new starter kit is worth many times the small down payment required to start your training. And it is only the start . . . only the first example of NRI's unique ability to apply 50 years of home-study experience to the challenges of this Electronics Age. Start your training this exciting, rewarding way. No other school has anything like it. What do you get? The NRI Achievement Kit includes: your first set of easy-to-understand "bite-size" texts; a rich, vinyl desk folder to hold your training material in orderly fashion; the valuable NRI Radio-TV Electronics Dictionary; important reference texts; classroom tools like pencils, a ball-point pen, an engineer's ruler; special printed sheets for your lesson answers—even a supply of pre-addressed envelopes and your first postage stamp.

Only NRI offers you this pioneering method of "3 Dimensional" home-study training in Electronics, TV-Radio . . . a remarkable teaching idea unlike anything you have ever encountered. Founded more than half a century ago—in the days of wireless—NRI pioneered the "learn-by-doing" method of home-study. Today, NRI is the oldest, largest home-study Electronics school. The NRI staff of more than 150 dedicated people has made course material entertaining and easy to grasp. NRI has simplified, organized and dramatized subject matter so that any ambitious man—regardless of his education—can effectively learn the Electronics course of his choice.

**DISCOVER THE EXCITEMENT OF NRI TRAINING**

Whatever your reason for wanting knowledge of Electronics, you'll find the NRI "3 Dimensional" method makes learning exciting, fast. You build, test, experiment, explore. Investigate NRI training plans, find out about the NRI Achievement Kit. Fill in and mail the postage-free card. No salesman will call. NATIONAL RADIO INSTITUTE, Electronics Division, Washington, D. C. 20016



## ELECTRONICS COMES ALIVE AS YOU LEARN BY DOING WITH CUSTOM TRAINING EQUIPMENT

Nothing is as effective as learning by doing. That's why NRI puts so much emphasis on equipment, and why NRI invites comparison with equipment offered by any other school, at any price. NRI pioneered and perfected the use of special training kits to aid learning at home. You get your hands on actual parts like resistors, capacitors, tubes, condensers, wire, transistors and diodes. You build, experiment, explore, discover. You start right out building your own professional vacuum tube voltmeter with which you learn to measure voltage and current. You learn how to mount and solder parts, how to read schematic diagrams. Then, you progress to other experimental equipment until you ultimately build a TV set, an actual transmitter or a functioning computer unit (depending on the course you select). It's the practical, easy way to learn at home—the priceless “third dimension” in NRI's exclusive Electronic TV-Radio training method.

## SIMPLIFIED, WELL-ILLUSTRATED “BITE-SIZE” LESSON TEXTS PROGRAM YOUR TRAINING

Certainly, lesson texts are a necessary part of training . . . but only a part. NRI has reduced reading matter to “bite-size,” programmed texts as simplified, direct and well-illustrated as half a century of teaching experience can make them. The best scientific techniques and extensive study have gone into each book. The amount of material in each text, the length and design, is precisely right for home-study. NRI texts are programmed with NRI training kits to make things you read about come alive. As you learn, you'll experience all the excitement of original discovery. Texts and equipment vary with the course you select. Choose from three major training programs in TV-Radio Servicing, Industrial Electronics and Complete Communications. Or select one of seven specialized courses for men with specific wants or needs. Check the courses of most interest to you on the postage-free card and mail it today for your free catalog.

## *custom training kits “bite-size” texts*

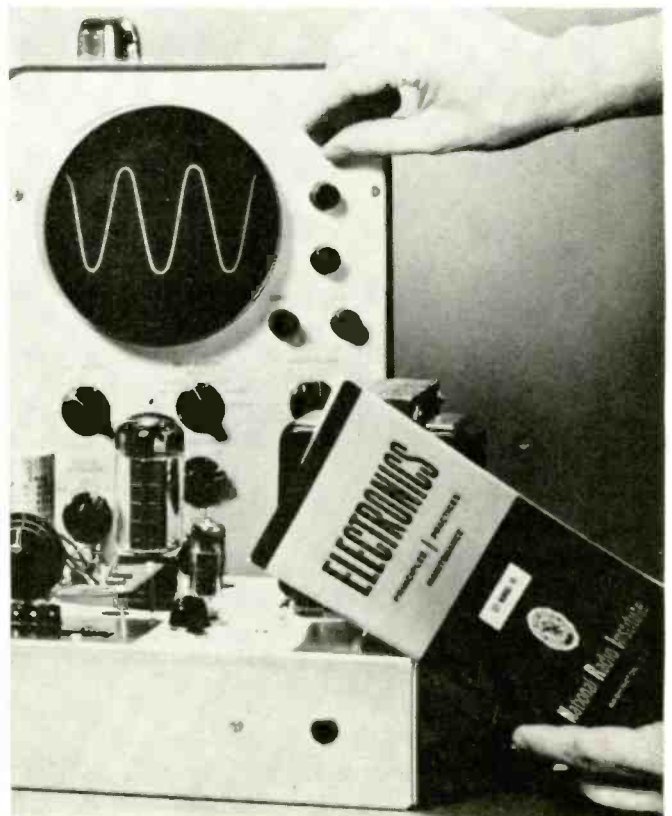
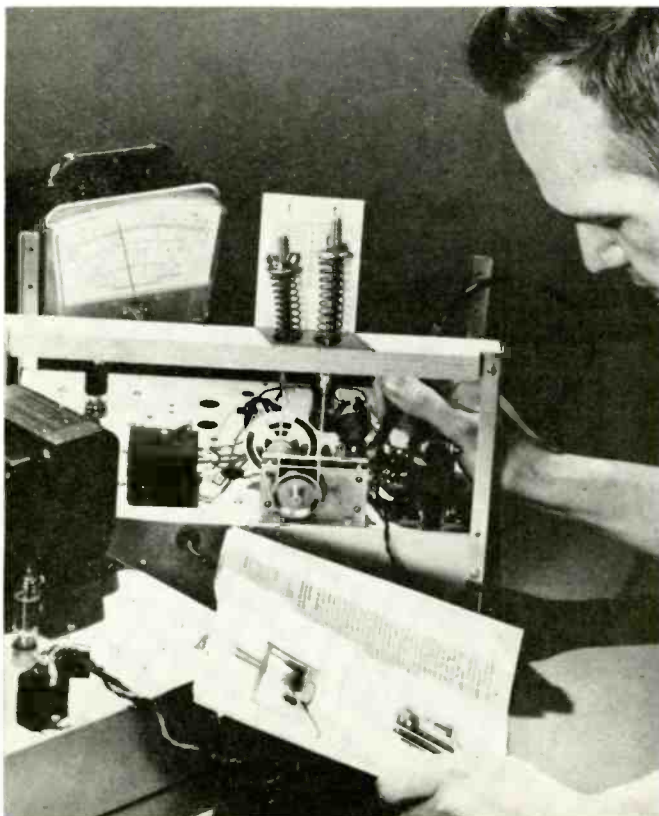

# SERVICE CLINIC

By JACK DARR Service Editor

## High-Voltage Regulators

One circuit is common to all color TV sets: the high-voltage regulator. Only minor variations are found between the earliest models and this year's. The addition of an adjustable control is about all! They all use the same tube, a 6BK4. Let's see what it is and what it does.

It's a beam triode, with a top-cap plate connection. Its maximum plate voltage rating is 27,000! But maximum plate current is only 1.6 ma. With 25,000 volts on the plate, it takes only -15 volts to cut the plate current off completely. The 6BK4-A, the latest type, is exactly like the original but will handle 30 watts plate dissipation instead of 25 as does the 6BK4; they're interchangeable, of course, but I'd use an "-A" for a plain 6BK4, instead of vice versa.

How does it work? We connect the 25,000-volt high-voltage circuit of a color TV direct to its plate, and return its cathode to ground (eventually). So, any plate current this tube takes must come from the HV supply. It acts as a

shunt or load across the high voltage. Now, if we can control the tube's plate current, we can change the loading on the HV supply and regulate it.

What we need is a control signal that indicates the output of the flyback; this includes the horizontal output tube, damper, yoke, etc. If this changes, so does the high voltage, boost voltage and everything else. So, if we feed the boost voltage to the regulator tube as grid bias, we can make the tube's plate current follow any change. Fig. 1 shows a typical circuit. This is from an RCA CTC 15, but they're all alike, since they

do the same thing with the same tube.

Applied voltages will differ, but the actual grid-to-cathode voltage will be almost the same in every case. The amount of bias depends on whether the designer wanted a high or low regulator current. We might see an operating bias of -10 volts (according to Sams Photofact data), so the tube would be drawing about 0.5 ma, at 25,000 volts. In the CTC 5 chassis, which had no adjustable control, the bias was -15 volts, which is very close to cutoff, and on some recent RCA schematics it is -5 volts.

Our main control signal for the grid comes from the boost voltage. If the flyback output goes up, the boost (and the HV, too) go up with it, quite naturally. So, the control grid is returned to the boost, through a matched pair of 1.5-meg resistors. (This is the "unboosted boost" here, not the 1,150-volt "boosted boost.") Something like 750-800 volts, although it isn't given.

Now, if the boost voltage rises—goes more positive—the grid bias of the regulator tube goes more positive, too. Then the tube draws more plate cur-

This column is for your service problems—TV, radio, audio or general and industrial electronics. We answer all questions individually by mail, free of charge, and the more interesting ones will be printed here.

If you're really stuck, write us. We'll do our best to help you. Don't forget to enclose a stamped, self-addressed envelope. Write: Service Editor, Radio-Electronics, 154 West 14th Street, New York 10011.

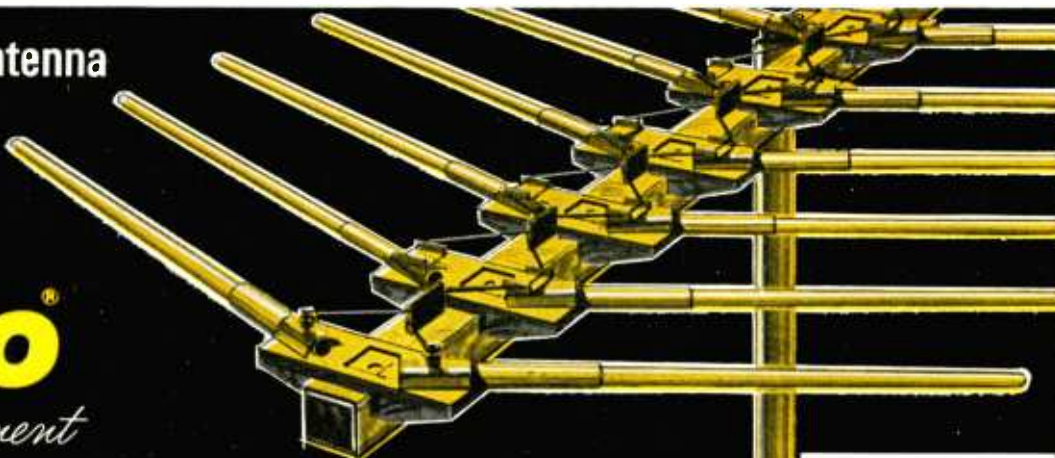

The VHF-FM antenna that challenges all competition

**NEW**

**FINCO**<sup>®</sup>

*Swept Element*

**"COLOR-VE-LOG"**

**VHF-FM ANTENNA**

Finco's Color Ve-Log challenges all competition on color or black and white reception and stands behind this challenge with a "Guarantee of Supremacy". The swept element design assures the finest in brilliant color and sharply defined black and white television reception — as well as superb FM monaural and stereo quality. FINCO precision-engineered features make these advanced-design antennas indispensable to good home sight-and-sound systems. And, of course, they carry the famous unconditional guarantee from the leading manufacturer in the field — FINCO. Promote the Color Ve-Log Antennas with pride, sell them with confidence, and profit handsomely.

Featuring Finco's Exclusive Gold Corodizing

<b>VL-5</b> 5 element VHF-FM 5 driven elements List price \$16.95	<b>VL-10</b> 9 driven elements 1 parasitic element List price \$34.95
<b>VL-7</b> 7 element VHF-FM 7 driven elements List price \$23.95	<b>VL-15</b> 15 element VHF-FM 9 driven elements 6 parasitic elements List price \$46.95
	<b>VL-18</b> 18 element VHF-FM 9 driven elements 9 parasitic elements List price \$54.50

The FINNEY Company • 34 W. Interstate Street • Bedford, Ohio

Write for color brochure #20-307, Dept. RE

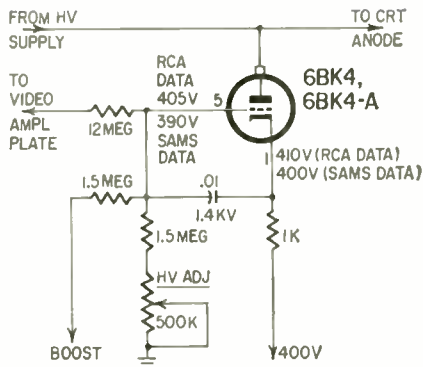

Fig. 1—High-voltage regulator circuit in an RCA CTC 15 color set. It's a variable shunt load on the high-voltage supply.

rent: this puts an additional load on the HV supply, which has increased with the boost, and loads it down enough to hold the voltage to the normal 25,000.

If the boost voltage falls, or heads in a negative direction, the opposite happens. The grid bias of the regulator becomes more negative: this reduces its plate current and takes some of the load off the HV supply. This lets the HV go up slightly, enough to compensate for the drop in supply, and once again we hold the rated 25 kv.

How do we check such a circuit? We measure the voltage and current. Most color sets have provision for opening the regulator cathode to read the current directly. In sets without, just unsolder one wire and hook up your milliammeter. I like the current measurement, for it is a direct one. If the thing isn't drawing the right current, it isn't working. Also, no matter what the applied voltages are (or seem to be), if the tube is drawing the right current, it is working!

Use a 1-ma meter. The normal operating current will be about 700 to

#### Follow that "beep!"

The inside story about the new PLUTO—an electronic marker that runs "eternally" on only negligible power. Called a Perpetual Low-power Unattended Transistor Oscillator—it's highly effective as an electronic marker for personal property—or a terrific object for a treasure-hunt. Fiendishly clever pulsed operation extends battery life to shelf life, yet each pulse contains a whale of a lot of energy. Track the signal on your transistor portable.

Coming in August  
**RADIO-ELECTRONICS.**

**YOU'VE NEVER HEARD IT SO GOOD!**  
Announcing another Scott engineering breakthrough . . .  
The sensational-sounding new Scott 344 solid-state tuner/amplifier

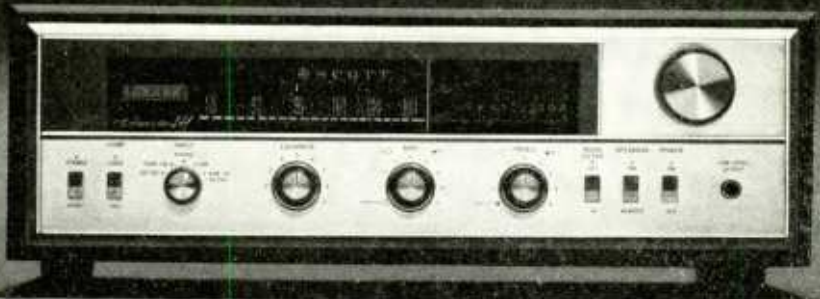

"It's great!", "The sound was fabulous", "I never heard anything like it!" . . . These were the comments of Scott's demanding product evaluation panel upon first hearing the new Scott 344 solid-state tuner/amplifier.

The tuner section of the 344 is the same as that of Scott's pioneering solid-state 312 FM stereo tuner, of which Audio Magazine (July 1964) said: "It is one of the finest tuners Scott makes. And that means it is one of the finest tuners anywhere."

The revolutionary amplifier section of this new 344 uses entirely new Scott-developed circuits. Peak power capabilities approach one hundred watts . . . enough to handle the extreme dynamics of any music.

Scott confidently invites your own personal evaluation of the 344. See it . . . hear it . . . compare it and decide for yourself if you have ever before experienced sound so clear, so sparkling, so lifelike . . . or if you have ever seen a more handsome, compact unit. \$429.95 Slightly higher West of Rockies.

Please send FREE 1965 Scott 20-page full-color Guide to Custom Stereo.

Name .....  
Address .....  
City ..... Zone .... State .....

H. H. Scott, Inc., 111 Powdermill Rd., Maynard, Mass. 01707



# Precise Scope Spectacular!

(now going on at leading electronic distributors)

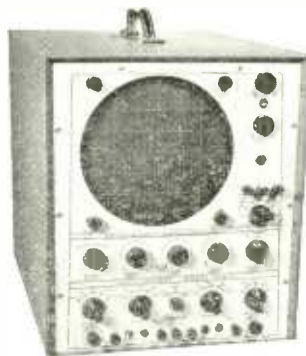

Four top quality scopes (kits or wired) including a low cost color scope, Model 3151, K. \$89.95, W. \$137.95 • a top value in a 5" general radio and TV scope, Model 315, K. \$79.95, W. \$113.95 • two professional performance scopes the 7" Model 300C, K. \$169.95, W. \$222.95, and the 8½" Model 308, K. \$179.95, W. \$249.50. Prices slightly higher in West. Save now at your Precise distributor. For free 1965 catalog write:



**PRECISE ELECTRONICS & DEVELOPMENT DIV. OF DESIGNATRONICS, INC.**  
76 EAST SECOND STREET, MINEOLA, NEW YORK 11501

---

# Beethoven

Electronics Conquers Concert Hall Acoustics—Big news in Britain is the “new sound” of the Royal Festival Hall in London. Engineers found they could alter the acoustics of the hall (or any hall) completely with an all-electronic trick called “assisted resonance.” Engineer James Moir, who worked on the project, explains how it works.

# Barker

New 40-Watt Public-Address Amplifier You Can Build—Rumors of a radically new kind of transistor audio amplifier have been circulating on both sides of the Atlantic for some time. Next month: *the first such amplifier designed especially for home construction!* A 40-watt public-address amplifier of fantastic efficiency—smaller than a cigar box, it weighs only 40 ounces, works from a 12-volt battery. (Principle underlying this breakthrough is discussed on page 54 of this issue.)

# Beep

Follow that “Beep!”—The inside story about the new PLUTO—an electronic marker that runs “eternally” on only negligible power. Called a Perpetual Low-power Unattended Transistor Oscillator—it’s highly effective as an electronic marker for personal property—or a terrific object for a treasure-hunt. Fiendishly clever pulsed operation extends battery life to shelf life, yet each pulse contains a whale of a lot of energy. Track the signal on your transistor portable.

**All in August**

**RADIO-ELECTRONICS**

---

## SERVICE CLINIC continued

900 microamperes (0.7–0.9 ma). Move the HV ADJUST control and check its effect: the current should change above and below the normal value. If, as I found in one set, you have *voltage* on the tube, but read no *current*, check some voltages. In this case, I read + 325 on the grid and + 385 on the cathode. A –60-volt bias! This is enough to cut off a tube with a much less steep slope than the 6BK4! It takes only –15 volts to stop *all* plate current, remember.

Some late sets use a connection to the video output plate circuit. When a very-high-brightness (almost white) scene is shown, it calls for a heavy beam current in the CRT, with a resulting heavy load on the HV. So, the HV would normally fall. However, the HV regulator’s grid is connected to the video output through a very large resistor (12–15 meg) so that a bright scene causes the grid voltage to go negative. This reduces the plate current in the regulator and its loading on the HV, so that regulator action is improved. The opposite happens with a dark scene. This means very little beam current and less loading on the HV supply. So, the regulator grid goes more positive and the loading is increased, holding the HV steadier.

Troubles in this circuit? Resistors changing value and capacitors leaking. There are only a few resistors, but they’re critical! Since a change of only 1 volt makes a great difference in the 6BK4 plate current, you can see that these big resistors must be right on the button all the time. Some circuits use bypass capacitors. Needless to say, *any* dc leakage in these will really foul things up. To make a reliable test, take the capacitors out completely. Hook one end to the dc-volts probe of a vtvm, then touch the other end to the highest voltage you can get; the boost is fine for this. If you get any “permanent” voltage reading, after the first charging kick, throw the capacitor out, quick! Even 1 volt of leakage is too much! Use good high-voltage types for replacements, and test *them* the same way before you put them in.

Quick-check for regulator trouble: pull the 6BK4 tube and turn the set on. If you now get high voltage, then there *is* trouble in the regulator circuit. Don’t leave the set on too long: you might get flashovers. I’ve seen the HV go up to 30,000 without the regulator tube in place! Measure the voltage on grid and cathode, preferably between grid and cathode, and make sure that it is within limits.

This is basically a simple circuit, but it can give you some fine headaches if you don’t use the proper test methods on it. Good luck, and watch that boost voltage: it bites!



Introducing  
the remarkable new  
**UNIDYNE A**  
... in the  
Quality tradition of the  
Unidyne Family

**UNIDIRECTIONAL DYNAMIC  
MICROPHONES**

Now... Eliminate feed-back problems in  
low budget sound systems with the new

**SHURE UNIDYNE/A**

UNIDIRECTIONAL PROBLEM-SOLVING ABILITY AT AN OMNIDIRECTIONAL PRICE

only **\$52.00** list

Low impedance model 580SB

High impedance model 580SA only \$59.00

Write for complete specifications and technical data :

Shure Brothers, Inc., 222 Hartrey Avenue, Evanston, Illinois

## SERVICE CLINIC continued

### Admiral 16L1C: hash in B-plus; agc trouble

I've got an Admiral 16L1C in the shop. Good pix and sound for about 1 minute. Then both go at once. I get a normal waveform at W-1 (in Sams 394-1) while it's working. When it quits this jumps all over the place, and the B-plus waveform W14 goes crazy, too. I've substituted tubes, but nothing helps. What's wrong?—O.C., Bushton, Ill.

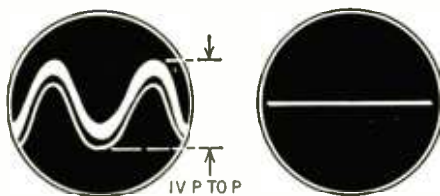

Fig. 2—Normal waveform at output of filter in this Admiral chassis shouldn't exceed 1 volt peak-to-peak. Anywhere else along the B-plus line, after other filters, you should get a straight line. Any ripple indicates a defective filter capacitor.

An intermittent filter capacitor. Your normal B-plus wave, W14 (Fig. 2), should remain steady at the ripple value shown, about 1 volt peak to peak. If it doesn't, or if a scope reading on your B-plus supply lines anywhere else in the circuit shows anything except a nice flat dc line, look out!

The filter capacitors are supposed to take out all fluctuations like that; that's what they're for. If you get fluctuations, try bridging filters.

### Interference in antenna system

We have an amplified signal distribution system in our showroom. We had some troubles with it, so we added an antenna-mounted preamplifier. We have a good all-channel antenna, aimed at a channel-12 station 85 miles in one di-

rection. Channels 3, 10 and 13 are 27 miles in the other, all maximum-power transmitters.

We have very bad windshield-wiper interference on 10 and 13, sound interference on unused channel 9, and so on! Where is the defective part in this system?—A.S., Sacramento, Calif.

You haven't got one. Just the opposite. Everything is working *too well!* You're using a very high-gain, deep fringe antenna, plus a high-gain antenna-booster, plus a high-gain broad-band amplifier. You are simply overloading the input of the broad-band amplifier!

The "interference" is actually what the CATV technicians call *spatter*, and is due to trying to get the signals through the amplifier at too high a level. Also, if any single channel in such a system is more than 6 db higher than the others, you'll get the same trouble. Such stations must be padded down to the same level as the rest.

Get a good field-strength meter and check the rf signal level at the input of the broad-band amplifier. If this is more than about 1,200–1,500  $\mu\text{V}$  per channel, it will have to be reduced. I believe I'd try this without the antenna booster; try reorienting the antenna to see if you can't improve the situation in that way. If you use the booster, I'd put it on a separate channel-12 antenna, to bring that station up.

### "Self-Changing Contrast"

I'm having problems with a Zenith 16D25 chassis. About twice a month, the picture fades to varying degrees of black and stays that way for a day or two, although once or twice the picture will come back to normal.

Contrast and brightness controls have their normal effect, but won't bring the picture up "out of the black". If I pull the CRT socket and then put it back, it works normally! (Confound it!) What to do?—P.H., Lakewood, Ohio

I know the first thing I'd do: clean that CRT socket! I've seen some very funny (funny-unusual, not funny-haha) effects from corroded contacts in tube sockets: including rectification of strong rf signal from a nearby AM broadcasting station.

Also, this could be a defective video amplifier tube. Even if it tests perfectly good, replace it. Also, check all the resistors and capacitors in the video output circuit for leakage, change of value, etc. Heat the plate-load and other resistors, with an ohmmeter across them, to see if you're getting a thermal drift. Check the peaking coils for intermittent connections.

The video output in this set is "semi-dc-coupled", so even a leaky coupling capacitor in the *grid* circuit of

### POWER YOUR CIRCUITS WITH SUNSHINE!

Compact, efficient silicon solar cells supply electrical power from sunlight and help make satellites and space probes possible. Read how they work, learn about a generous handful of circuits you can try with inexpensive experimenters' silicon cells.

Coming in August

RADIO-ELECTRONICS.

RADIO-ELECTRONICS

voice-activate  
any tape recorder

Voice-matic

The only device in the world that will convert any tape recorder into a voice-actuated unit. Tape recorder records when you speak . . . turns off when you stop. Permits complete operation of recorder from a distance or when hands are busy. Ideal for conferences and group activities. Installs in seconds without tools . . . no soldering. Has pause and sensitivity controls to meet all requirements. Can be used as on-off switch to control hi-fi, CB or ham transmitters, electrical appliances, etc. In leatherette case, complete with cord for battery-operated and transistor tape recorders. Under \$35.00

Made in USA

See your tape recorder dealer or write:



kinematix, inc.

2040 W. Washington Blvd.,  
Chicago, Illinois 60612  
Area Code 312 666-0066



the video amplifier tube could cause the change in CRT cathode voltage that you have. I don't think it's the CRT, but I could be mistaken. Should be some part that is affecting the bias voltage. Check 'em all.

### Transistorized Stethoscope Amplifier

*Do you have a circuit for an inexpensive transistorized amplifier that I can use as an electronic stethoscope? Also, what kind of a microphone will I need for this?—P.M., Tucson, Ariz.*

We have had several requests for this circuit. Our editors have tried to find or design such a circuit, without any luck.

There are two problems. One, it is very difficult to get the required low-frequency gain. The energy in heart sounds is very weak to begin with, and is all concentrated in a very small band around 80 to 110 cycles. It's almost impossible to get sufficient gain at these frequencies. It *can* be done, but the price and complexity of the resulting amplifier puts it far out of the ordinary home constructor's reach.

Microphones are equally difficult. No standard pickup will do the job; we've tried everything. The only thing I found that gave good results was a specially designed stethoscope mike, and its price was \$95 net!

I'm afraid that the response on this query is very negative, and we'll have to go back to the simple but highly efficient stethoscope in its original form, cold or not!

### Identifying "Stacked-B" Stages

*I'm new at this business. How can you positively identify a "stacked" B+ circuit?—E.C., St. Romuald, Que.*

Look at the voltages on the control grid and the cathode. If the grid, for example, is shown with 125 volts positive on it, the stage *must* be "stacked." Also, in this case, the cathode will usually have a high voltage, near that of the grid.

Sams Photofact diagrams use a drafting convention which indicates stacked voltages. A small triangle beside the indicated voltage means "measured from —", usually the cathode of the tube itself, or from the cathode of the following tube. To get the effective operating voltage on *any* tube, measure from the *tube's own cathode*.

### Instant-On Rectifier Reversed?

*I've hooked up an "instant-on" circuit (RADIO-ELECTRONICS, Jan. '62) to a Muntz 624T. On "standby" it radiates a hum-modulated signal that seems to peak at around 1010 kc! I can hear it plainly over the whole broadcast band.*

*What's going on here and how do I stop it?—J.T., San Rafael, Calif.*

It looks to me as if you could have only one thing that would cause such a condition: the instant-on rectifier is reversed! The basic idea of the original circuit was to insert the rectifier in series with heater strings, so that it gave them only a half-wave-rectified ac. This works out to about half of the normal current.

The rectifier must be hooked up so that its output is *negative* with respect to the normal B+ voltage of the set. In fact, it ought to be hooked up so that it is only in the heater string but, on some switches, you can't do this. Try reversing your rectifier. You must be getting some positive B+ in this set somewhere, to get rf output. Something is oscillating, with raw ac or pulsating dc on its plate!

### Short Tube Life in Muntz Vertical Output

*The 12L6 tube in a Muntz 721STP lasts about 2 weeks. When it's new, all scope patterns look OK, and it works. After a while, the vertical jitters begin, and it goes haywire. When you test the 12L6, it's dead-shortened. Help!—W. E., Sullivan, Mo.*

The 12L6 is not, as I thought, a "12-volt 6L6". It's a 12-volt 50L6! There's a great difference, like between a 50-ma maximum plate current rating and a 100-ma max.! So, hook a milliammeter in the cathode circuit of this poor little tube and see what the current is. In this "one-pentode vertical-oscillator-and-output" circuit, it's working pretty hard! It won't take much of a drift in voltages or resistance values to put it out of commission in a short time.

Check the grid bias, and check for leaky coupling capacitors. Even a little bit of positive grid voltage here will overload the tube and probably cause it to short out. Check the heater voltage, too. **END**



*"Guess what the actors do after you turn off the TV."*

# don't gamble

*Get the Vidicon quality you pay for...*



*with Amperex Vidicons, pre-tested and pre-selected to match your specific application*

With three Amperex low filament-current (0.6W) Vidicon types to choose from—pre-selected for you by Amperex—the 55850 AM—for low cost applications, the 8483 for all conventional applications, and the 55850 S for the most exacting commercial and broadcast applications...with each Amperex type offering unparalleled tube-to-tube uniformity (each tube comes with its own test data, covering all important parameters) and with each and every Amperex vidicon providing you with sensitivity and resolution second to none, outstanding lag characteristics and amazingly uniform operation throughout its life...with all this and more (our vidicons are packed and shipped in individual gimble-stabilized containers) getting the exact number of tubes you need...of the quality you need...at the right price...is now a safe bet, no longer a gamble!

For complete data, write: Amperex Electronic Corporation, Tube Division, Hicksville, Long Island, N. Y. 11802.

## Amperex®

IN CANADA: PHILIPS ELECTRON DEVICES, LTD., TORONTO 17, ONTARIO.

YOU GET PRODUCT PLUS FROM YOUR SYLVANIA DISTRIBUTOR



# CONSUMERS' CHOICE

## Here's how.

	BRIGHTEST COLOR PICTURE	BEST OVERALL COLOR PERFORMANCE	CLEAREST COLOR PICTURE TO WATCH	BRIGHTEST BLACK AND WHITE PICTURES
Sylvania color bright 85 picture tube	76.1%	66.6%	68.0%	77.7%
Picture Tube A	6.9	9.8	8.9	7.4
Picture Tube B	9.5	13.7	13.4	7.1
Picture Tube C	7.5	9.9	9.7	7.8

Test made under supervision of John J. Henderson and Associates, N. Y. Note: Not all people answered all questions—votes tabulated for 100% of answers to each.

In six major cities from coast to coast, 9,789 consumers compared the new *color bright 85*<sup>TM</sup> picture tube to ordinary non-rare-earth color tubes in three leading brands of TV sets. Sylvania's new tube, the first with rare-earth phosphors, was the overwhelming choice.

## Here's why.

The vivid colors, derived from europium rare-earth compounds, are unexcelled for true color fidelity. In monochrome, the picture is noticeably brighter; there's better contrast too. And today this extraordinary tube is still the performance leader. Sylvania's new air-spun screening process gives *color bright 85* picture tubes the competitive difference in the sharpest images ever displayed.

The *color bright 85* tube is available to you now for today's growing color TV market. It is a product of Sylvania Electronic Tube Division, Electronic Components Group, Seneca Falls, N. Y.

**SYLVANIA**  
SUBSIDIARY OF  
GENERAL TELEPHONE & ELECTRONICS **GTE**  
RADIO-ELECTRONICS



JOSEPH R. HIXSON  
SCIENCE REPORTER  
THE NEW YORK  
HERALD TRIBUNE

## Electromedicine: End of the Wonder-Drug Era?

Guest editorial by JOSEPH R. HIXSON

**I**N Cleveland, a young man paralyzed from the neck down eats his meals with the aid of an arm brace wired to a computer. In Rochester, the blood pressure of a hypertensive woman drops to near normal levels at the behest of an electronic pulse device implanted in her neck. And in Brooklyn, a victim of heart failure turns the dial on a tiny transmitter held next to his chest when he needs to climb a flight of stairs.

The list of such electronic substitutes for failing bodily functions grows longer every day. The transistor hearing aid is a crude piece of hardware by today's medical electronic standards. It has one enormous advantage over the devices now being tested in the nation's medical centers: if the battery goes dead, the deaf person simply unsnaps his device and buys a new one. If a circuit fails, he takes the device in for repairs or buys a new one.

But if the tiny nerve center in a human heart has ceased to send impulses to the cardiac muscle, battery failure or the breakdown of a Pacemaker component can mean death within minutes. The level of reliability required of today's electronic life savers is of the same order as that specified by the National Aeronautics & Space Administration for parts in the Gemini and Apollo spaceships and for the probes sent to the moon, Mars and Venus.

But the components of even a Mariner spacecraft sent to Mars need work for only about 8 months. A cardiac Pacemaker must jab the heart electronically almost 40 million times a year for an indefinite number of years. Replacing such a device involves surgery on a patient whom doctors would classify as a "high risk."

*Mr. Hixson has been a science writer for the Herald Tribune since November 1962, and has written medical books and articles for 16 years.*

Such are the considerations to be kept in mind when one reads the rosy-hued predictions of a billion-dollar market for medical instruments and equipment by 1970.

A doctor misread an X-ray in Brooklyn the other day and sent an elderly auto accident victim home with a fractured pelvis. The man died within hours of internal bleeding. And in Seattle, a plastic shunt connecting an artery and a vein of a victim of kidney failure came apart while the patient slept. He was dead within minutes as his artery pulsed blood into his bed. The same shunt that saved his life by making possible artificial kidney treatments to cleanse his blood of wastes also killed him when it came apart.

Computers that read X-rays or electrocardiographs will be making and are today making life-and-death decisions. They must work every time. Thus quality control in the electronics industry is facing a crucial test. Recognizing this fact, the Federal Government is now seeking to obtain for the Food & Drug Administration the power to approve all devices for human medical use just as it must now OK the marketing of a drug.

But there is another facet of the problem. Meticulous care in routine matters can handle, to a large extent, the reliability crisis. But only brains, supplemented by big transfusions of money, can narrow what might be called the knowledge gap. The case of the paralyzed young man in Cleveland is a good example:

At the Highland Valley Hospital in suburban Warrensville, researchers from Western Reserve University and the Case Institute of Technology mounted a powered metal splint on Edward Rosak's right arm and hand. They attached the prosthesis (artificial limb) to a computer that had been programmed with arm and hand movements required to bring a fork or spoon from plate to mouth.

The doctors also installed a small, infrared light source on the man's eyeglasses. Now, when he wants to eat, the youthful paraplegic simply turns his head to aim the light beam at one of three photoelectric cells on his bed table. By so doing he activates one of the eating programs in the computer, which then moves his arm and hand. The doctors have also managed to pick up with tiny electrodes some of the residual nerve impulses in the young man's shoulder. These are amplified and transmitted to activate his finger muscles.

Yes, the boy does eat without human assistance. And of course the project is teaching the researchers on the elementary "how to" level. But the technology required is far, far removed from that required to replace lost nerve function. It resembles recent operations in which doctors have transplanted lungs, heart and livers from the dead to replace similar diseased organs in the living. The operations, thus far, have simply showed that the surgery is possible. But all the beneficiaries of the transplanted organs have quickly died.

The way that nerve fibers transmit their vital messages—their action thresholds, their frequency and the electrochemistry of their action, has been revealed in brilliant physiological research. But scientists are still unable to duplicate their subtle communication.

A patient whose nerve cells have been damaged by a polio virus or a stroke or an accident is in the same plight medically that he would have been in the Middle Ages. And that is why three out of four operations to restore severed arms and legs turn out failures.

*continued on page 78*

By LON CANTOR\*

IT TAKES A LOT LESS KNOW-HOW TO plan and install an MATV system than to repair a TV receiver. And there's a lot more money in it! Yet technicians have left this lucrative market almost untapped.

Who needs an MATV system? Almost everybody. Most homeowners today own two or more TV sets. While they may not have a set in every room, they do have a portable they would like to move from room to room.

Many bars and bowling alleys are putting in TV sets. In motels, an MATV system is a must, and even apartment-house owners are beginning to realize that good TV reception raises the value of their apartments.

Two recent developments have increased the demand for MATV systems: the growth of color and the coming of age of educational TV. Color TV requires stronger signals for good pictures. This makes an MATV system in every TV showroom a virtual necessity. The growth of educational TV means that soon every school in the country must be equipped for it. More than 90% of the schools now being built will include some form of educational TV.

It's easy to get started in MATV. If you've had successful experience with single-antenna installations, you already know most of the fundamentals.

Moreover, equipment manufacturers are eager to help in planning systems. The major MATV equipment makers, Blonder-Tongue and Jerrold, maintain application engineering departments whose sole job is to help you design and install systems. Send them a description of the building and prevailing local signal conditions, and they will design the system for you. A typical system design prepared by an applications engineer and sent to a TV technician looks a lot like Fig. 1.

#### How to plan your MATV system

What would happen if you tried to connect 20 TV receivers directly to a single antenna? In the first place, you'd

\*Jerrold Electronics Corp., Philadelphia, Pa.

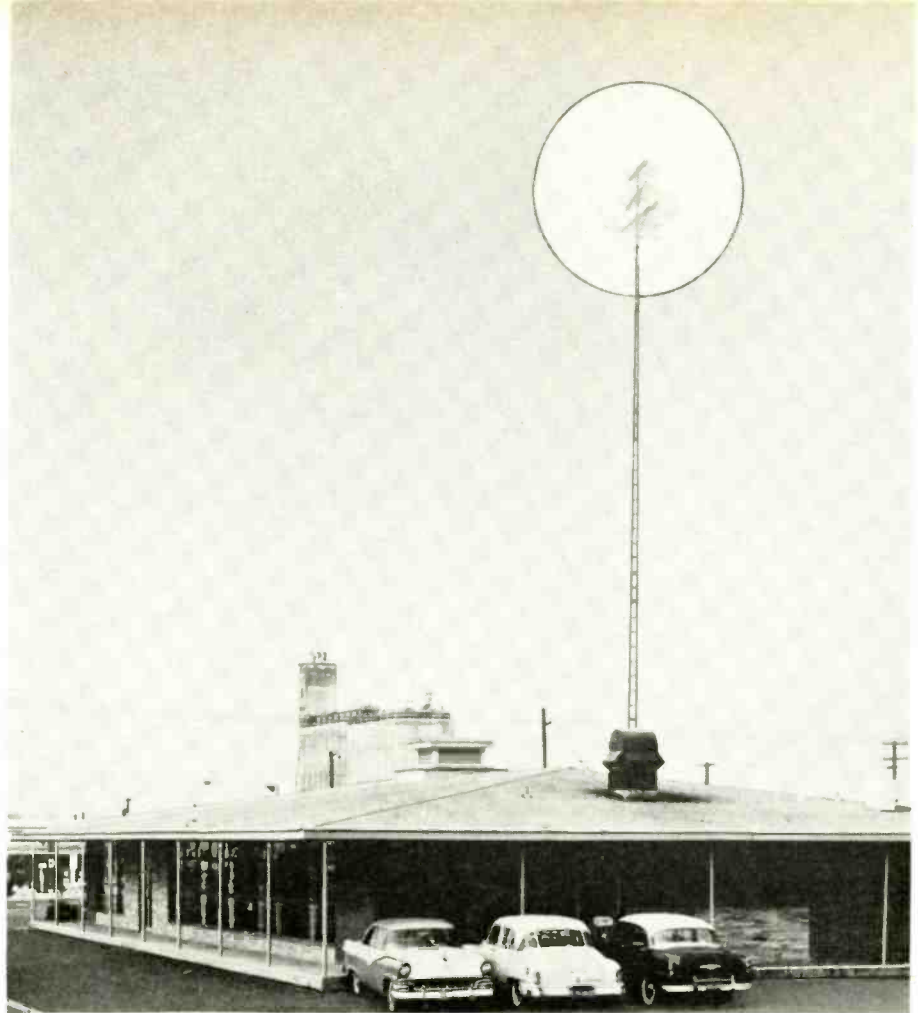

# PLUG IN TO MATV

Master-Antenna TV installations for hotels, motels, showrooms—even homes—are easy and profitable

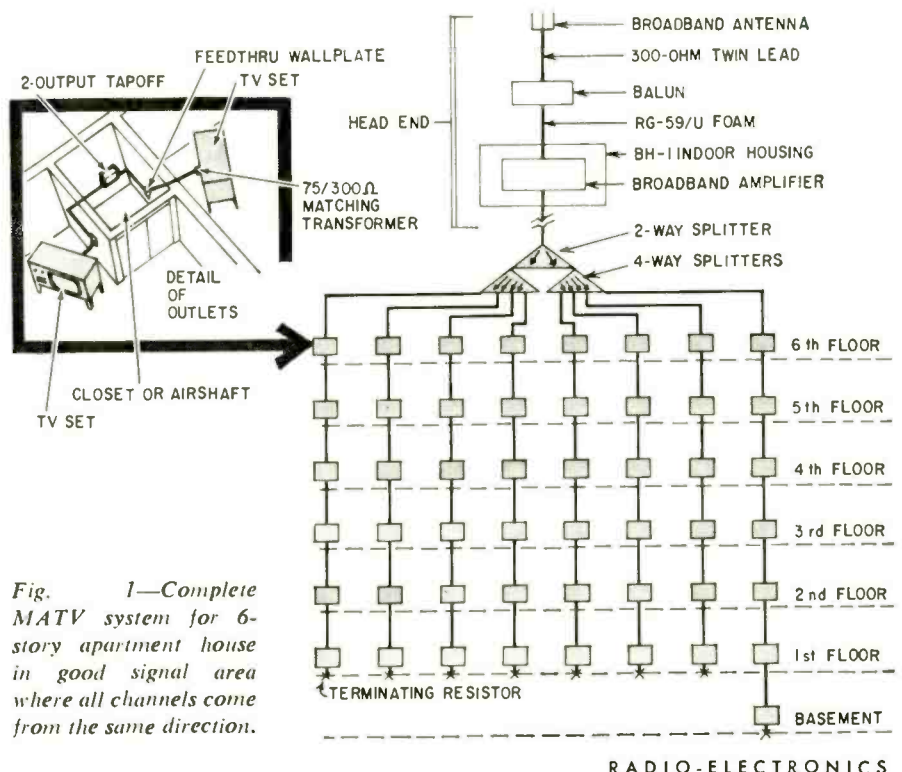

Fig. 1—Complete MATV system for 6-story apartment house in good signal area where all channels come from the same direction.



Ordinary TV ribbon lead is not suitable for MATV systems because it is not shielded. Hundreds of feet of ribbon line strung through a building would pick up signals directly, resulting in ghosts. Ribbon lead also picks up interference, and two close together are inductively coupled. For this reason, 75-ohm coaxial cable is recommended for MATV systems. In general, RG-11/U is used outdoors and RG-59/U indoors. Both are now available with foam dielectric, allowing larger center conductors and, therefore, lower signal losses.

All cable causes some signal attenuation, varying with conductor resistance and dielectric heating. Cable attenuation increases in direct proportion to frequency. The table shows the attenuation of MATV cables.

Now that we have through lines for each apartment in Fig. 1, we must provide *tapoff*. A tapoff takes a portion of the signal from the through lines and feeds it to the TV set. It also isolates the set from the through line.

Fig. 2 is a representative schematic of a tapoff. Resistor R1 represents the signal loss in the trunk line caused by inserting the tapoff. Manufacturers generally specify this as "through-line loss," and it seldom exceeds 1 db.

Resistor R2 represents the isolation between the TV receiver and the through line. This is specified as "isolation loss." The most common isolation is 17 db (12 db and 23 db are sometimes used in very large systems). In our typical apartment house, we need tapoffs with two outputs to serve two apartments per floor from a single through line.

The 75-ohm coaxial distribution cable must be matched to 300-ohm TV sets. This is the job of a matching transformer. Many tapoffs have built-in matching transformers. That is, input to these tapoffs is the 75-ohm through line, and output is 300-ohm ribbon.

These tapoffs eliminate the need for separate matching transformers, but they are not always practical. In our building, for example, we are using one tapoff with two outputs to serve two apartments. Since the tapoff is not located in the same room as the TV set, a separate wall-mounted matching transformer is used in each apartment.

Separate matching transformers are also required in all strong-signal-area installations. In these areas, even the short length of flat ribbon lead from the wall to the set will pick up enough signal to cause ghosts. A separate matching transformer must be mounted right on the

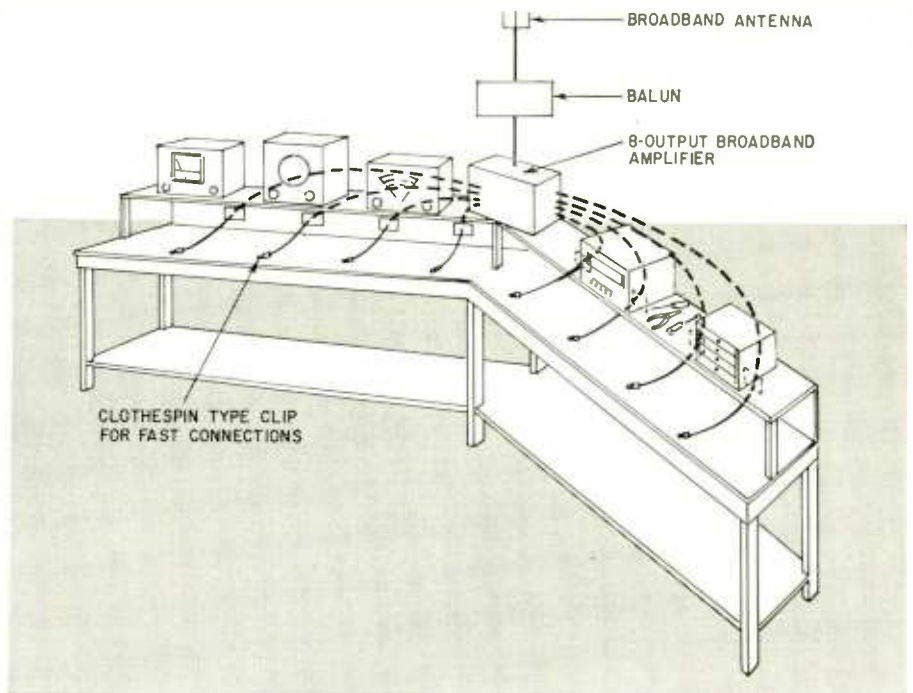

Fig. 4—Simple TV service bench system.

TV set or even inside it.

All 75-ohm through lines in a master TV system must be terminated with a 75-ohm resistor. This is important. Unterminated lines result in standing waves, which cause ghosts.

Now that the distribution system has been laid out, we must calculate the distribution-system losses. Actually, "losses" is a misnomer. Most of the signal is not "lost"—it is merely distributed. Only in the sense that all of the signal that doesn't get to a specific set in the system is "lost" to that set is the term "losses" correct.

How much signal does a receiver need to display a good picture? The answer depends on the particular receiver, together with the subjective standards of the viewer, but we ignore this in MATV work. Instead, we arbitrarily set a minimum standard of 1,000 microvolts, across 75 ohms, of combined picture

and sound carrier voltages. This minimum assumes that the picture carrier is as strong as or stronger than the sound carrier. The 1,000  $\mu\text{V}$  gives us a comfortable margin of safety.

Our concern, therefore, is to make sure that each TV receiver in the system gets at least 1,000 microvolts of signal. If the last set on the longest line gets enough signal, all others in the system will, too.

In our apartment building, we start at the basement TV set (since this is the longest line), and calculate the losses to the head end of the system.

There are three types of losses in a distribution system:

**1. Cable loss.** In the system shown in Fig. 1, there are about 150 feet of RG-59/U (foam dielectric) between the head end and the basement set. The table shows that RG-59/U foam cable causes a loss of 4.2 db per 100 feet at

#### CHARACTERISTICS OF CABLES USED IN MATV SYSTEMS

Cable	Interference rejection	Signal loss in db per 100 Feet				Effect of weather
		Ch 2	Ch 6	Ch 7	Ch 13	
RG-11/U	Excellent	1.4	1.7	2.7	3.2	Loss unaffected by heat or rain
RG-11/U Foam	Excellent	1.1	1.4	2.1	2.3	
RG-59/U	Excellent	2.7	3.5	5.1	5.8	
RG-59/U Foam	Excellent	2.1	2.7	3.9	4.2	
300-ohm ribbon	Fair	.75	1.1	1.5	1.8	Loss increases 6 times when wet

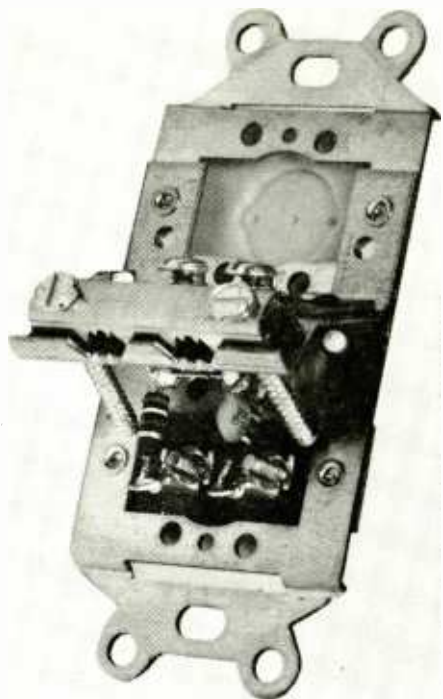

An MATV tapoff junction.

channel 13. (Losses are always figured at the highest channel in the system. In this case, we'll assume that channel 13 is to be included). Cable loss, therefore, is 6.3 db ( $1.5 \times 4.2$ ).

**2. Splitter loss.** A two-way splitter causes about 3 db loss, while a four-way splitter causes 6 db loss. Notice that, to get to the basement TV set, you go through one two-way splitter and then one four-way splitter. Splitter loss, then, is 9 db (3 db + 6 db).

**3. Tapoff loss.** There are two types of tapoff losses—through-line and isolation. To get to the basement set, we must go through the through-line loss of seven TO-2-75 tapoffs. According to the manufacturer's specifications, the through-line loss of these units is 0.7 db per tapoff. Total through-line loss is equal to seven tapoffs times 0.7 db per tapoff, or 4.9 db. Isolation loss of the TO-2-75 tapoff (17 db) is calculated only once—not multiplied by seven—

because the signal goes through only one isolating resistor on its journey from the head end to the basement set.

Adding all these losses together, we find that the total distribution-system losses are:

150 ft of RG-59/UF @	
channel 13	6.3 db
(1) two-way splitter	3
(1) four-way splitter	6
Tapoff through loss	
(7 × 0.7 db)	4.9
Tapoff isolation loss	17
<i>Total distribution system loss</i>	<b>37.2 db</b>

In other words, between the head end and the basement TV set, 37.2 db of signal will be lost. There is no need to compute the losses in any of the other through lines. The 37.2 db is called the total distribution-system loss. It is this loss that must be overcome by the head-end amplifier of the MATV system.

Now we know the total distribution-system loss, we can choose a head end for our system. Suppose the apartment house is located in an area about 20 miles from the transmitting stations and that all channels come from the same direction. The first thing is to put up an antenna. That's easy. It's exactly like a single-home installation, except that you can afford to use a better antenna and install it more securely. (A future article will deal more thoroughly with MATV antennas and head ends, and how to solve specific reception problems.) In an area this close to TV transmitters, you should receive between 2,000 and 5,000  $\mu\text{v}$  per channel, using a good broad-band Yagi.

These signals will then have to be amplified to overcome the distribution-system losses. How much amplification will be needed? Since total distribution-system losses are 37.2 db, we should use an amplifier with about 40 db gain, such as the Blonder-Tongue model MLA-c or the Jerrold model 2300.

Most MATV amplifiers have an input impedance of 75 ohms, to match

coaxial cable. Since the antenna impedance is 300 ohms, a matching transformer, called a *balun*, is required.

The principles explained for this typical system can be used for all MATV systems, large and small. A subsequent article will explain MATV installation and service techniques, as well as how to eliminate various types of interference.

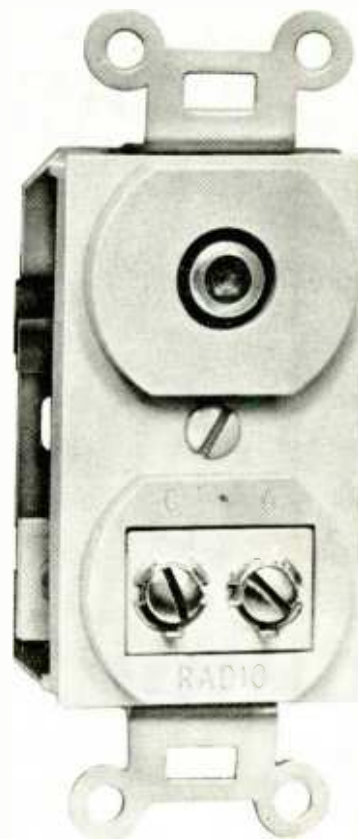

Jerrold combination TV and FM tapoff.

To get started in the MATV business, begin with the simplest of systems. Next time you install an antenna in a home, try to sell the idea of a complete home system, with an outlet in every room. Such a system is shown in Fig. 3. You can install a similar small system in a TV showroom, a bowling alley or a small apartment house.

In fact, a TV service-bench system such as that shown in Fig. 4 might be a good jumping-off point. Once you have had experience with these small systems, it's relatively easy to handle large MATV systems in motels, schools and apartment houses. And remember, almost every MATV system you sell will also include a service policy. When a customer connected to an MATV system has trouble, he almost invariably blames the system and calls you. This can add a substantial number of TV service customers to your business. END

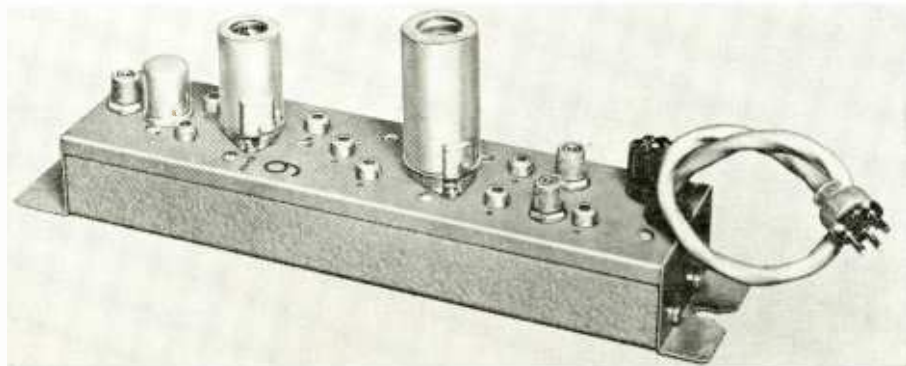

Jerrold model PMA Positive Matched Amplifier, for channel 6.

# Measuring Turntable Wow and Flutter

Equipment and test records available to almost anyone offer a quick, precise way to measure turntable speed and speed variations

By EDGAR VILLCHUR\*

The March issue of RADIO-ELECTRONICS carried the first of this pair of articles—"Measuring Turntable Rumble." This second part discusses wow, flutter and speed regulation, and explains how to measure them simply and accurately.

FLUTTER IS THE GENERAL TERM FOR speed variations in a reproducing mechanism that cause variations of pitch. Wow is a colloquial designation for these pitch variations when they occur at a slow rate. The wavering, sick-sounding background music sometimes heard in old movie films on TV represents an extreme case of wow.

Several brands of flutter meters are available, costing in the neighborhood of a few hundred dollars. These flutter meters measure the frequency variation of a standard 3,000-cycle tone played from a test record or tape, in percent.

Unfortunately the raw flutter percentage, taken without considering the rate of flutter, has limited significance. It has been established that flutter at the

Fig. 1—Scope trace of 3,000-cycle flutter test tone. Horizontal movement to left and right represents frequency variation caused by turntable flutter. Do not confuse this with a constant drift in either direction which may be controlled or minimized by adjusting the scope's frequency control.

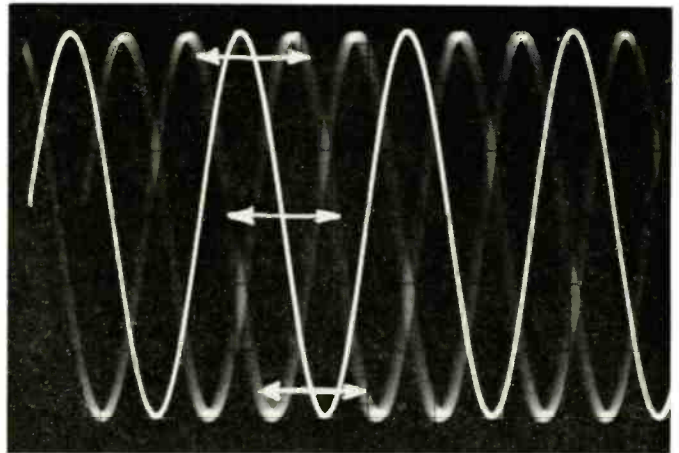

slow rate of 2–3 cycles per second (two or three up-and-down frequency variations a second) can be perceived much more readily than flutter at other rates. Low-frequency flutter in the 0.5-cycle range is about half as perceptible, and flutter at higher rates—10 cycles and above—is only about one-fourth as perceptible for the same percent of frequency deviation.

The flutter meter used in AR's test

chamber gives weighted readings to compensate for these differences in perception. Weighted flutter meters are not available commercially, but it is possible with experience to make a weighted subjective evaluation of turntable flutter by ear, or by ear and oscilloscope, using the following procedure:

1. Play the 3,000-cycle flutter test tone. The only reliable flutter test record that I know, aside from AR's specially made one, is the Varo 37-1002 (\$10.95 postpaid, Varo, Inc., Electrokinetics Div., 402 E. Gutierrez St., Santa Barbara, Calif.). There are other records with flutter test tones, but I have found them to be either erratic or to contain too much built-in flutter.

2. Turn the bass control all the way down to isolate the effects of rumble and of random groove irregularities, and adjust the volume control for a comfortable level.

3. Connect an oscilloscope (one with facilities for completely disabling horizontal lock with the input signal) across the highest-impedance amplifier output tap of one channel. Put the scope on "free run"; that is, turn off the horizontal sync.

Adjust the scope frequency control to display four or five sine waves of the 3,000-cycle tone and make the trace as stationary as possible. You will



Tester on AR production line checks mechanical regulation with "nickel test".



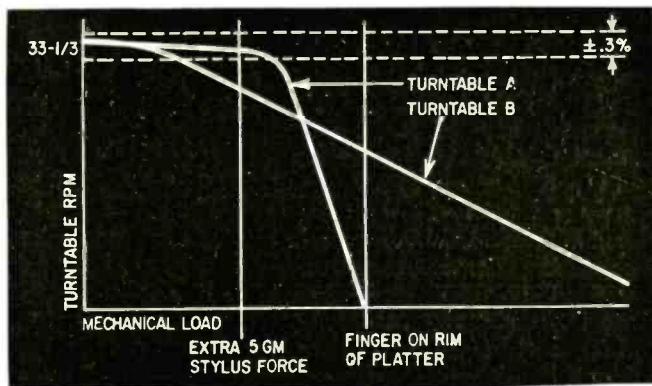

Fig. 2—Turntable A keeps within the NAB limit for speed accuracy over the range of mechanical load encountered in practice, and then stalls under heavier loads. Turntable B drops below the NAB limit in the operating load range, but turns at low speed under heavy load. (See text.)

However, the speed and duration of even a single motion of the trace is significant, since it represents a half-cycle of the instantaneous frequency deviation from 3,000 cycles.

The least desirable trace movements are those that are fast (high flutter percentage) and that oscillate back-and-forth two or three times a second (the most audible flutter rate). Skill in interpreting the trace movements will come from comparing different turntables and correlating the visual display with the sound from the speakers.

You will not hear a perfectly steady tone, even from the best of turntables. The test conditions were purposely designed for maximum sensitivity, and the perception of pitch variation in the test tone far exceeds the perception of flutter in reproduced music. The audible wavering of pitch and the oscillation of the scope trace on a first-class reproducing turntable are at least as low as on a professional tape recorder.

It should be remembered that in listening to the flutter test tone, the weighting for flutter rate is automatic. While flutter cannot be evaluated on a quantitative or absolute basis by the method described here, an experienced operator can make a relative evaluation of turntables that probably has more validity than flutter meter readings.

#### Speed accuracy and regulation

Most technicians are familiar with the stroboscope card used for checking turntable speed accuracy. It is important to use an accurate card that will lie flat and that has a well centered mounting hole (such as Audiotech Strobe Disc 30-230). It is also important to know that a glance at the lines or dots to see whether they are drifting is not an adequate test for accuracy by professional standards.

not be able to stop the oscillation to left and right illustrated in Fig. 1—this is the flutter—but with care you should be able to stop drift in any one direction. Do not apply horizontal sync to stop the trace. If you cannot stop the drift entirely by the scope frequency control, you will have to discount the drift in your evaluation.

4. The rate at which the trace oscillates left and right is the flutter rate.

The maximum speed at which the trace moves in any one direction represents the instantaneous percent of flutter. (The distance that the trace moves is also an index of flutter percentage, but only at a given flutter rate, since for the same percentage the trace will move farther at low flutter rates than at high ones.)

One should not expect a steady oscillation that can be counted easily.

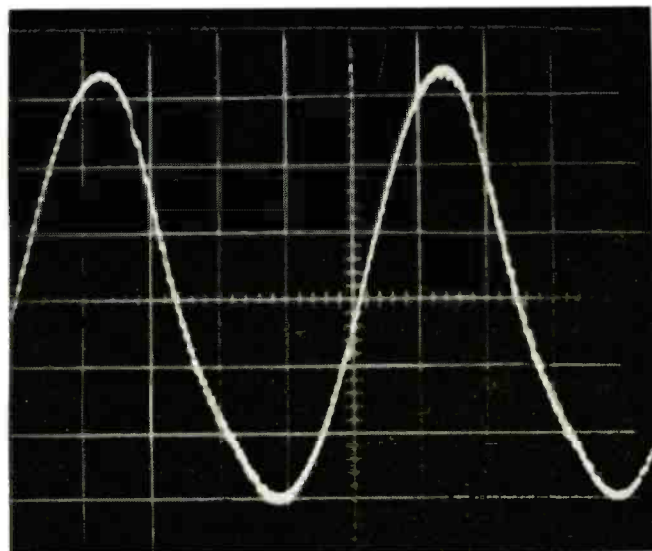
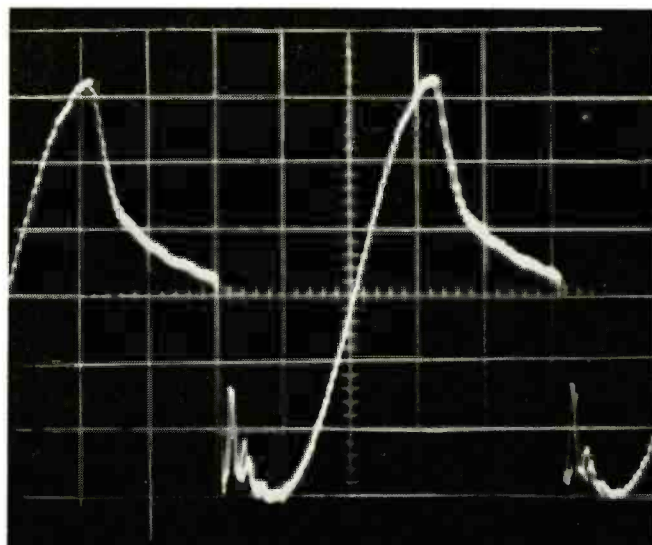
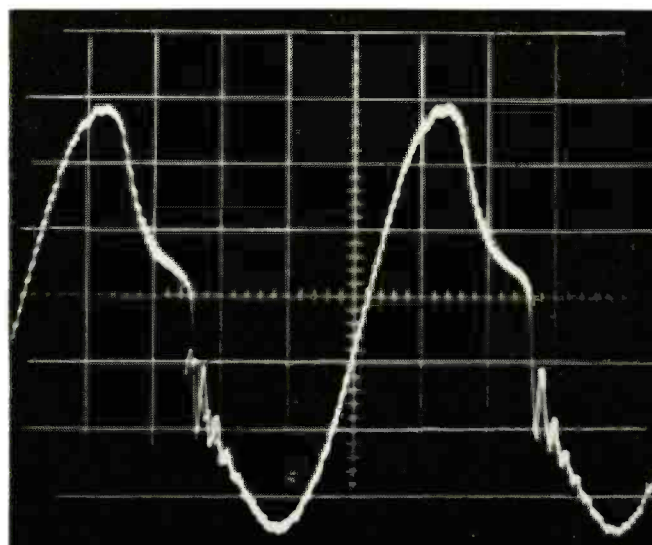
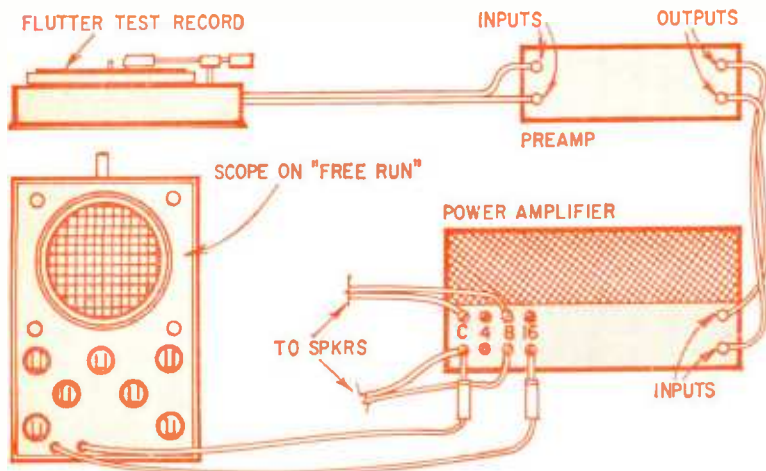

Fig. 3—Cartridge output on 6-cm/sec 300-cycle tracing test. Left—1/4-gram stylus force; below, left—1-gram force; below, right—3/4-gram force.





*Test setup for checking flutter. Fig. 1 is a typical scope trace produced by flutter.*

The NAB standard for speed accuracy is  $\pm 0.3\%$  for reproducing turntables and  $\pm 0.1\%$  for recording turntables. Three-tenths of 1% speed error corresponds to a drift on a standard strobe card of 21 lines per minute, or only 1 line every 3 seconds. To measure such slow drift it is necessary to hold a pencil or similar marker over the strobe card and actually count the number of lines that pass the marker during a timed 60-second interval. Fluorescent illumination makes the count much easier, although ordinary ac incandescent light is adequate.

Speed regulation refers to the constancy of speed under different conditions—changed input voltage or changed mechanical load.

Electrical regulation is tested with a variable-voltage transformer. The input voltage to the turntable is varied over a range of 100 to 130 volts, and the speed is checked with a strobe card to see whether it stays within the NAB  $\pm 0.3\%$ . This test should be made under conditions of maximum mechanical load as described in the section following.

The test for mechanical regulation must be designed in terms of the differences of mechanical load that the platter is likely to encounter during operation. Whether or not the turntable uses a synchronous motor is of little moment here. Much of the turntable speed variation resulting from mechanical load changes is associated with the drive mechanism which couples the motor to the platter rather than with the motor itself. The platter may slow down beyond acceptable limits while the rpm of the motor armature remains rock-steady.

A tone arm imposes more drag when it is playing the outer grooves of a record than when it is playing the inner grooves. This difference in load is equivalent to adding about 2 grams of stylus force (often called, incorrectly, tracking pressure) to a cartridge playing the outside grooves. Another source of load variation is created by a heav-

ily recorded passage, which is equivalent to 1 or 2 grams added to the stylus force. Dust cleaners that bear on the record as it turns create a drag equivalent to an extra 4 to 6 grams of stylus force.

These data were determined experimentally. They form the basis for the mechanical regulation test applied to AR turntables, which we call the "nickel test." Turntable speed is checked while the cartridge is playing the outside grooves of a record at 2.5 grams stylus force. The tester uses a foot-operated automatic timer. Speed must be within the NAB professional limit of 21 lines drift.

The stylus force is then increased to 7.5 grams by placing a US nickel—which makes a very accurate 5-gram weight—on the cartridge. Speed must stay within NAB limits. We impose the further condition that the extra 5 grams do not slow down the turntable more than 0.3%.

This may not seem to be a difficult test, but at least half of current record players will not pass it, and there are no turntables that do not show any speed change at all. In making the test, be sure to use a cartridge that can accept 7.5 grams without the needle bottoming.

There are two widely held misconceptions about testing turntables for mechanical regulation. One is that the speed of starting is an index of high power and therefore of good regulation. In fact, fast startup (necessary in cueing applications) is an index of high starting torque and of nothing else. Some motors, notably those of the induction type, have very high starting torque relative to their running torque. Others, like the synchronous permanent-magnet type, have very poor starting torque relative to their running torque.

The second misconception is that turntable regulation can be checked by placing a finger against the rim of the platter and seeing how much force it takes to stop it. This test may give some indication of the turntable's suit-

ability for being harnessed to a buzz-saw, but not of its suitability for playing records at constant speed in the face of small changes in mechanical load.

Some turntables slow down beyond acceptable limits at very light changes of mechanical load encountered during operation, and yet will continue to rotate, at an unusably slow speed, under conditions of very heavy load. Other turntables keep within the very stringent NAB professional speed limits under all load conditions encountered in practice, and yet will stall out with the relatively light pressure of a finger. The speed vs load curves of these two types of turntable are illustrated in Fig. 2.

### Arm-cartridge tracing

There is a test record on the market (model 211, \$4.98, HiFi/Stereo Review, 1 Park Ave., New York, N.Y.) that puts an end to guesswork about how many grams of stylus force are needed for different cartridges mounted in different arms.

Two bands of heavily recorded 300-cycle tones (6 cm/sec peak velocity) are used, one for the left channel and one for the right. Stylus force is increased until each tone is reproduced without buzzing or breakup. It is very useful to monitor the test tones on an oscilloscope. Fig. 3 shows scope displays of successful and unsuccessful tracing.

The NAB Standard allows record warp as high as  $\frac{1}{16}$  inch, and many records show considerably more than this. The tracing test should, I believe, include playing the test tones with a  $\frac{3}{16}$ -inch wedge under the rim of the test record to simulate a bad warp. This last test procedure takes into account tone-arm inertia and friction. Although the simulated record warp is exaggerated, a real and more shallow warp which covers a smaller arc of the record circumference may induce arm velocities as great.

I find that most cartridges require stylus forces in the range between  $\frac{1}{4}$  and 3 grams on this test when mounted in high-quality arms. The instruction booklet accompanying the model 211 record suggests an even higher range, but the booklet was written over a year ago. We found only two cartridges that will trace reliably as low as  $\frac{1}{4}$  grams. While many cartridges will play lightly recorded passages at a fraction of a gram, this is not a proper basis on which to recommend operating conditions.

AR's production test chamber used the *HiFi/Stereo Review* test record for the tracing test until we had our own record made, whose tracing test is in imitation of the model 211. We also use this test daily at our demonstration rooms. I consider it fundamental for setting stylus force correctly, and for checking the performance of the stylus, the cartridge, and the arm. **END**

# SCR ELECTRIC FENCE CHARGER

Safe, simple, reliable electric fence charger uses common parts.

By EARL T. HANSEN

AN ELECTRIC FENCE ENERGIZER MUST be effective, dependable, economical and, above all, safe. This unit is. The energy supplied to the fence is a high-voltage pulse from a standard automobile ignition coil. Dependability and long life are assured by all-solid-state design. Cost of parts is less than \$15, not including the ignition coil. Working from the ac line is far more economical than battery operation, so it is worth while to extend the fence wire to a sheltered power source.

This system is safe for several reasons. The short-duration-pulse principle has been proved safe. Energy is present for only 1 millisecond during each second. This short duty cycle cannot cause a burn of any significance, or cause muscles to "freeze" to the wire. The short-circuit current and total energy are limited to a safe value by the characteristics of the coil and capacitor. Ac line voltage is prevented from reaching the fence in two ways: transformer isolation, and an earth ground on the ignition coil which would blow a fuse in the event of a shorted transformer or wiring error. Failure of one or more components would blow a fuse or stop the unit from working. In no case could a dangerous voltage be present at the output.

Transformer T1 and the associated circuitry form a 150-volt dc power sup-

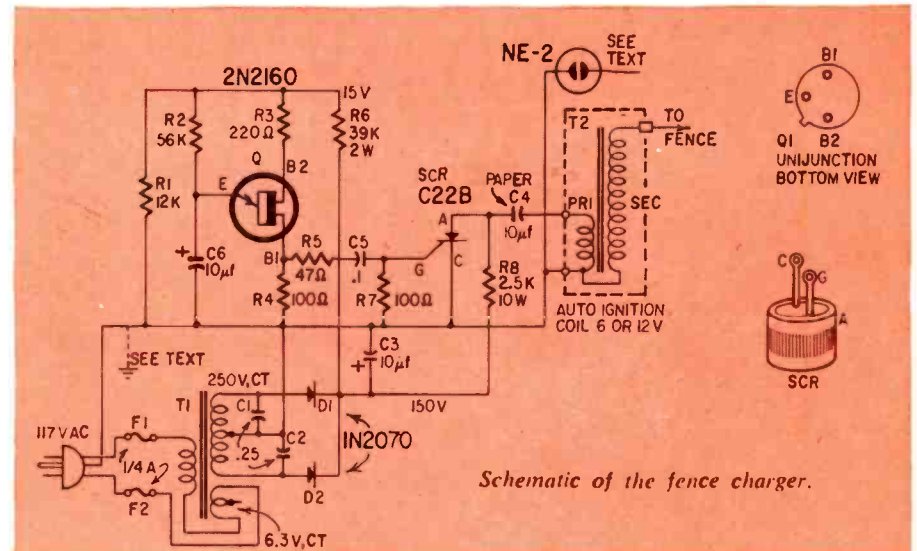

Schematic of the fence charger.

ply. The 6.3-volt ac winding is connected in series-aiding with the primary, to reduce the secondary voltage slightly. C1 and C2 serve a dual purpose. Most important is to protect diodes D1 and D2 from transients which can occur in this type of equipment. The capacitors also reduce the primary current by improving the power factor. This is important if a long ac feed line is used. C4 is charged to 150 volts through R8. The SCR remains cut off and appears as an open circuit to the charge, until triggered on.

- C1, C2—0.25  $\mu$ f, 400 volts
  - C3, C6—10  $\mu$ f, 150 volts
  - C4—10  $\mu$ f, paper or oil-filled, 150 volts or more
  - C5—0.1  $\mu$ f, 100 volts
  - D1, D2—1N2070, or equivalent 400-volt silicon rectifier
  - F1, F2— $\frac{1}{4}$ -amp slow-blow fuses and holders
  - NE-2 or equivalent small neon lamp (optional, see text)
  - Q—2N2160, 2N2646 or equivalent unijunction transistor
  - R1—12,000 ohms
  - R2—56,000 ohms
  - R3—220 ohms
  - R4, R7—100 ohms
  - R5—47 ohms
  - R6—39,000 ohms, 2 watts
  - R8—2,500 ohms, 10 watts
- All resistors  $\frac{1}{2}$  watt 20% unless otherwise noted
- SCR—G-E C22-B, or equivalent 200-volt silicon controlled rectifier, 3 amp or more
  - T1—Pri. 117 volts; sec. 250 vct, 25 ma. 6.3 volts, any current (Knight 62 G 008, Stancor PS-8416 or equivalent)
  - T2—Any good 6- or 12-volt automobile ignition coil
- Ac cord and plug, wire, base and miscellaneous hardware

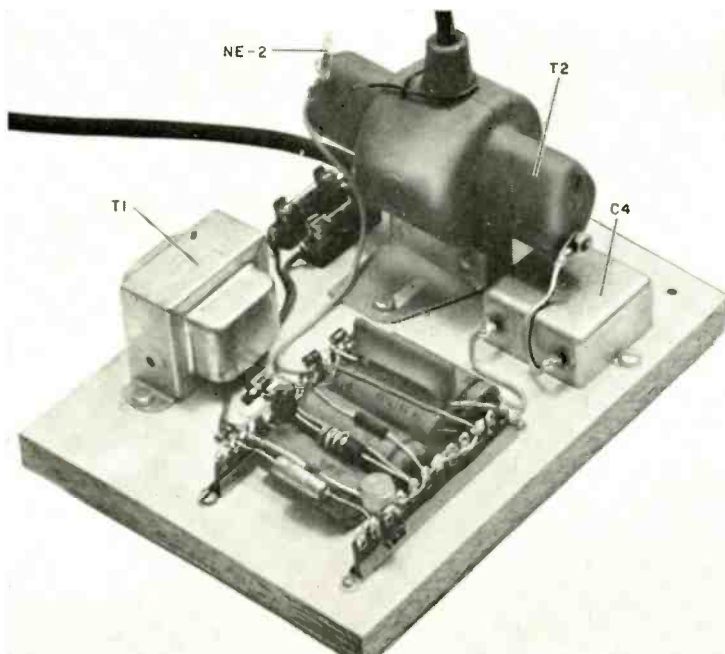

The SCR fence charger. The line cord has 3 wires with 3-prong plug. If your electrical system does not have 3-wire outlets or grounded conduit, be sure to use direct external ground.

Q is a unijunction transistor in a relaxation oscillator circuit. R6 and R1 form a voltage divider to supply 15 volts to the oscillator. C6 charges through R2. When the charge on C6 reaches the breakdown point, Q conducts hard and discharges C6 from emitter to base 1 through R4. The resulting pulse developed across R4 is applied to the SCR gate through R5 and C5. The triggered SCR discharges C4 through the primary of T2.

Since the turns ratio of T2 is approximately 100:1, a 15-kilovolt pulse appears on the secondary (when un-

loaded). The capacitive loading of the fence reduces this to half or less. As a part of the discharge cycle, the resonant characteristics of C4 and T2 cause the anode of the SCR to go negative, turning it off. C5 differentiates the initial pulse from Q. This assures a trigger pulse of shorter duration than the output pulse and allows a clean turnoff of the SCR. The peak short-circuit current is limited to approximately 50 ma. The pulse duration is about 1/2 millisecond. The repetition rate is about 2 per second.

### Construction

A wooden base simplifies construction and reduces cost, and is entirely adequate for sheltered use. None of the component values are critical, except to assure a high enough power and voltage rating. Parts layout is not critical and may be varied as desired. The phasing of the 6.3-volt winding must be tried to see that the secondary voltage is reduced slightly.

Three types of standard ignition coils were tried with equally good re-

*Details of small-parts wiring. Two solder-lug strips support all the pigtail components and provide test-points at every junction. A paper capacitor is a must for C4. A bath-tub unit like that shown may not be readily available. Molded paper tubulars may be paralleled to make a satisfactory substitute of the required capacitance.*

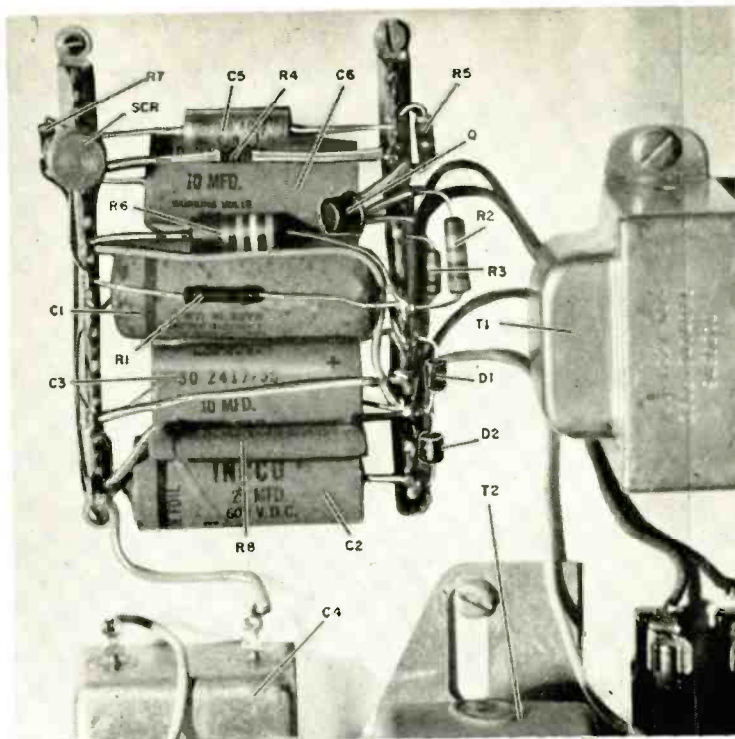

*Simple electric fence keeps horse inside his plot.*

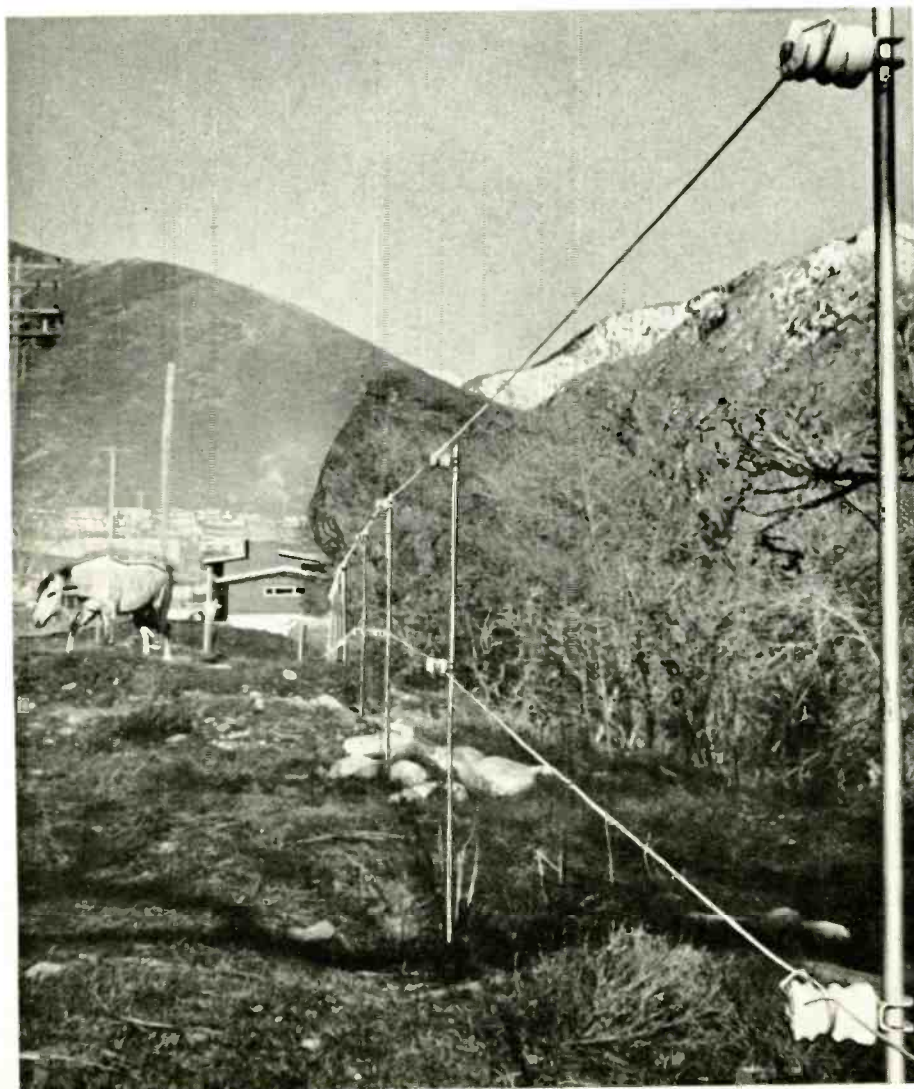

sults. The new high-ratio transistor types were not tried, and are not recommended. The polarity of the primary is not important. However, if the terminal common to both primary and secondary is known, make it the ground connection.

Electrolytic (polarized) capacitors are *not* satisfactory for use as C4; paper or oil-filled types are recommended. (Electrolytics were tried but the SCR would not always turn off after the discharge cycle when the output was shorted to ground.) Values less than 10  $\mu$ f may be used, with a decrease in output energy.

The anode (case) of the SCR may be connected by clamping, or by soldering if you take care not to overheat it. Heat sinks are not required for either of the semiconductors. The short duty cycle causes no heating.

The neon bulb (NE-2) is an optional visual monitor. Its ungrounded lead is a few inches of wire positioned an inch or two away from T2's secondary output lead. The bulb flashes during normal operation but ceases if the fence becomes grounded.

If a three-prong grounded ac outlet is not available at the planned location of the unit, the internal ground circuit *must* be brought out separately and connected to a *good* earth or waterpipe ground.

When the completed unit is first turned on, it may not operate immediately. It may take a few minutes for C6 to "form" after a period of shelf idleness. During operation there is a slight ticking sound and the unloaded output should produce a 1/2-inch or longer

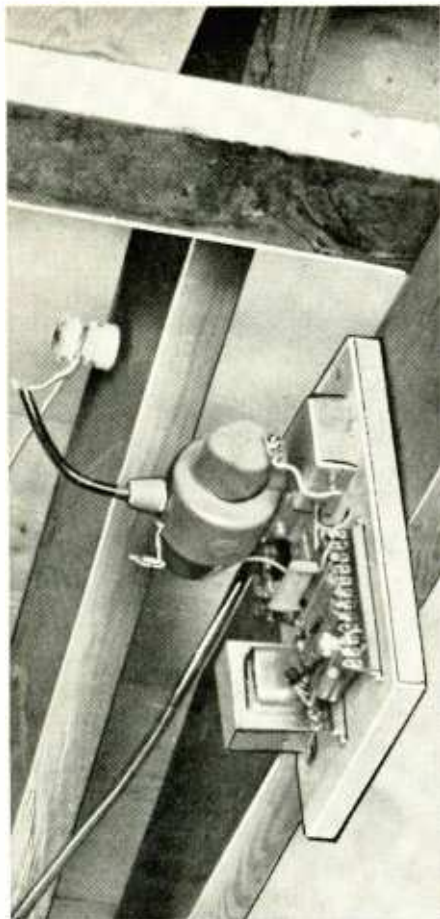

Fence charger installed on joist in barn. Insulated high-voltage lead can be seen coming from coil T2; it's soldered to fence wire suspended from knob insulator.

spark. The pulse rate may be increased up to 5 per second by decreasing R2. Faster rates will not allow C4 to charge fully and the output will be reduced.

### Using the fence charger

Electric fence materials and practices are standard and will not be discussed here. The unit pictured has been in operation for several months, energizing a quarter mile of fence with no trouble. It controls a frisky horse very well. Operation is not affected by temperature extremes. The system is effective in the wettest weather. The maximum length of fence that can be energized effectively is not known. However, the output energy of this charger is equal to that of the best commercial line-powered units.

Radio and TV interference is negligible and cannot normally be detected 100 feet away on the broadcast-band or higher frequencies. However, there can be noticeable interference if poor fence insulation allows visible or audible sparking to occur. This of course should be repaired. Power consumption is less than 20 watts. Prolonged short circuit of the output will not damage the charger. END

# What's a Keyed Circuit?

By JACK DARR  
SERVICE EDITOR

Keyed circuits (or gated circuits—same thing) crop up more and more in today's electronics, and especially in TV. The best-known ones are used for agc, to pick the agc voltage only from the horizontal sync pulses for better noise rejection.

But there are other kinds, for other jobs. In a color set, you'll find one usually labeled "Burst Keyer" (Fig. 1). Here it controls the burst amplifier through the common 1,800-ohm cathode resistor. On the plate, there's burst and video from the video amplifier. How do we make the circuit react only to burst? Key it.

Notice the connection to pin 2 of the 6AN8 marked "flyback pulse". The burst is on the back porch of the horizontal sync pulse. Element voltages are arranged so that the burst keyer (triode

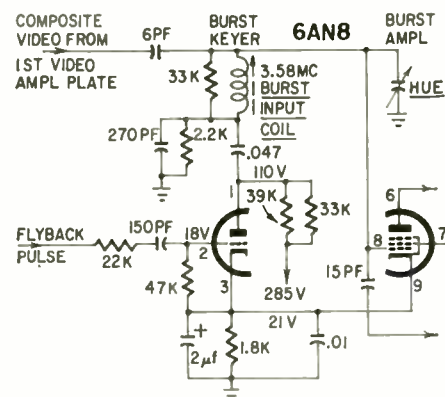

Fig. 1—This circuit separates color burst from rest of signal. Keyer turns amplifier on and off with flyback pulse.

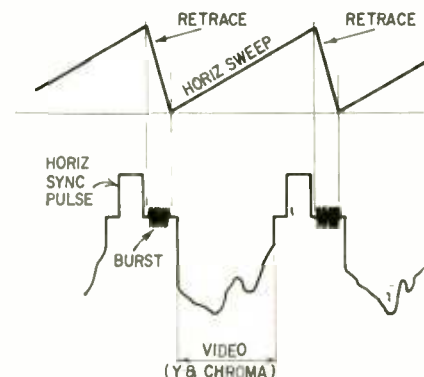

Fig. 2—Time sequence of events in composite video and sweep circuits. Gate opens just long enough to let burst through during horizontal retrace.

section) keeps the burst amplifier (pentode section) cut off during sweep time, so that no video gets into the burst circuits. But during horizontal retrace time, the flyback pulse opens the gate and lets the burst amplifier amplify burst. (See Fig. 2.) Eventually the burst ends up controlling the 3.58-mc crystal reference oscillator through the phase detector circuit.

Now look at Fig. 3. These are color demodulators. At the input, from the bandpass amplifier, we have two signals mixed together at the transmitter, and we have to recover the separate signals.

To do it, we can use another gating circuit, but this time phase is the key, not amplitude, as it was with the burst circuit. The two signals, mixed though they may be, are in quadrature—90° apart in phase. Now see how the cathodes are connected: both to the same source (the 3.58-mc reference oscillator, through a transformer), but one goes direct and the other through a phase-shift network. The shift is exactly 90°.

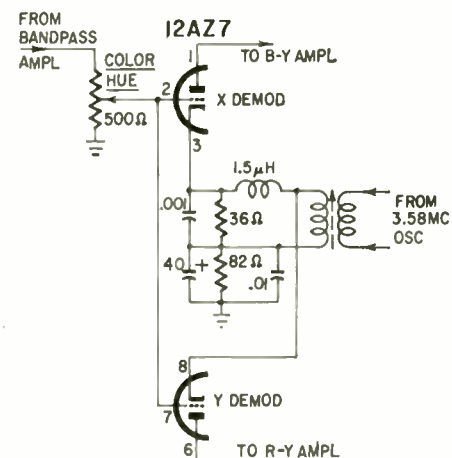

Fig. 3—A different kind of keying uses phase rather than amplitude to route components of composite color signal along proper paths.

Each tube conducts only when its grid and cathode voltages are in phase, not when they're 90° apart. So only that part of the grid signal which is at that moment in phase with the 3.58-mc reference at the cathodes gets through. In other words, the tubes are keyed by the phase of the reference oscillator voltage, and the B-Y and R-Y signals are sent along the right paths.

There! That's not so tough, is it?

# Service Your Car with an Electronic Auto Analyzer

## COVER STORY

AMONG ELECTRONIC TECHNICIANS ARE many do-it-yourself auto enthusiasts who fool around with their own car maintenance, often for fun. Most of us understand the electrical system of a car, and many of us would service our own cars' "electrics" if we had the proper instrumentation.

This Auto Analyzer measures about 90% of the electrical functions of a car. It is primarily a dwell-angle meter, a tachometer and a vom with ranges specifically covering the electrical values found in a car. It also has some extra functions.

The entire unit is self-contained, operating from four size-D flashlight batteries, built in. It is housed in a steel case measuring 6½ inches high by 12½ wide and 5½ deep. A 12-position switch selects functions and ranges. The front panel includes an OHMS adjust control which sets the shorted-probes full-scale setting, an RPM control which, when the RPM CALIBRATE button is pressed, also sets full-scale meter deflection, a forward-reverse diode test switch, a spark-output neon flasher bulb, and two cable sockets. One is for current measurements and the other for all other tests. Solid metal handles on the front panel extend 1½ inches and are used for toting as well as for protecting the meter in case of rollover. A latched trap door in the rear is access to a storage compartment where the cables are kept when not in use. The battery compartment has a screw-on cap on the side of the case for easy replacement of batteries.

### What it does

**Dwell Angle.** One important adjustment in an ignition system is the dwell angle of the breaker points. Dwell angle is the rotation period in degrees during which the points remain closed. The dwell-angle circuit is simply an ohmmeter, with the scale reading in degrees, which averages the time during which the points are closed. In the case of an 8-cylinder engine, for instance, a complete point action segment is 1/8th of 360°, or 45°. Thus 45 is the full-scale figure for checking dwell of an 8-cylinder engine. If points are closed half the time, the meter pointer would be at mid-scale: 22½°. A diode added to the circuit keeps the car battery voltage from



affecting the readings.

**Tachometer.** The tachometer measures a pulse rate, which you read on the meter in terms of engine rpm. Three transistors and associated circuitry are a Schmitt trigger pulse counter. Two of the transistors are a pulsed square-wave generator. Pulses are taken from the primary of the ignition coil by merely clipping the test leads across the one primary terminal and ground. Four shunting variable resistors set calibration points for ranges of tachometer speed and engine cylinders.

**Vom.** The voltmeter has two ranges: a 3.2-volt range to check individual battery cells, and a 16-volt range for the entire 12-volt battery. An excellent way to check battery condition or capacity is to discharge the battery at three times the ampere-hour rating for 15 seconds. If the battery reads 9¼ volts after this test, it is good. A similar check can be made by cranking a warm engine for 30 seconds (with the distributor center wire pulled out), after which the battery should read 9½ volts or more.

Current measurements are made through an external heavy metal shunt strip. The meter reads the voltage drop across a portion of this shunt. With the shunt external, the instrument itself does not need to carry heavy currents. The shunt strip has one end slotted to fit under regulator or generator terminals. Approximate figures are provided with

the instrument as a general guide to proper operation. They will vary from make to make; consult auto maintenance manuals for exact figures.

An ohmmeter position measures the resistance of the secondary winding on the distributor coil and of the ignition cable, and is an excellent continuity checker for many areas of the car's electrical system.

### How you'll work with it

**Dwell angle adjustment.** Dwell angle is the total time in degrees during which the ignition breaker points on an engine remain closed during the explosion cycle of each cylinder. The explosion cycle is, as previously stated, 45° for an 8-cylinder engine (60° for 6 cylinders and 90° for 4 cylinders). If the points are closed during half the time of the explosion cycle, they are said to have a dwell angle of 22½° (half of 45). On the Knight-Kit Auto Analyzer, full-scale deflection for an 8-cylinder engine is the 45° mark (like shorting the prods of an ohmmeter), and is the equivalent reading of breaker points closed all the time—an impossible situation, of course. If the points are open half the time and closed half the time, the reading would be half-scale or 22½°.

To get best engine performance, dwell angle adjustment must be correct. The points need to close and stay closed long enough to saturate the core when



# TRANSISTOR TV PORTABLES

A penetrating look at an all-transistor midget—particularly at the horizontal deflection circuits, where the greatest differences between tube & transistor practice appear.



*Sony Micro-TV 4-203UW*

**ROBERT F. SCOTT**  
TECHNICAL EDITOR

AROUND THE BEGINNING OF 1964, THE one or two transistor television sets on the market were considered novelties. Few technicians expected to be called on to service any one of more than a dozen models within the next year. Well, there are at least 14 models on the market. You will have to service them and it is necessary to be familiar with their basic and specific circuits if you are to do the job rapidly and profitably.

Transistor sets use the same basic circuits as tube sets, but you'll find more stages in some sections. There will be a few more service controls; waveforms and signal polarity will vary from one model to the other. Diodes will be more numerous than in tube sets. You'll have to watch for the troubles they can cause when defective. Some of the diodes have conventional functions—afc phase comparators and ratio detectors. Others are used as transient suppressors, wave shapers, dampers, voltage multipliers and signal limiters.

Too, you may find p-n-p and n-p-n transistors in the same circuit. You'll have to be extra careful when measuring voltages. Taking measurements on an n-p-n stage and interpreting them as p-n-p or vice versa can really gum up your troubleshooting.

This article describes a typical transistor TV set. A detailed block diagram (Fig. 1) and a schematic (Fig. 2) of the horizontal deflection circuit will give you an idea about what you will be up against.

## A typical transistor portable

The block diagram is of the Singer TV-6, a personal portable that uses 26 transistors, 14 germanium diodes and 6 silicon rectifiers. It uses a 6-inch (diagonal measurement) 90° rectangular picture tube with a 12-volt 150-ma heater and electrostatic focus. The i.f. circuitry is a conventional intercarrier type. The sound and video carrier i.f.'s are 22.25 and 26.75 mc, respectively. The video bandwidth is 3 mc. The cabinet is 6 inches wide, 7 inches high and

7 inches deep (8 inches with ac power supply). It weighs 5.7 lb (7.5 lb with ac supply).

The tuner is a turret type using three mesa transistors. The oscillator slugs can be adjusted through a hole in the fine tuning knob. The 75-ohm built-in antenna is normally connected and matched to the tuner. Two input jacks are provided for a 300-ohm external antenna. The DX jack is used in weak-signal areas. The LOCAL jack connects the antenna through a 15-db attenuator pad. This jack is used when overloading causes poor sync, tearing, negative pictures or crossmodulation. The built-in antenna is automatically disconnected when an external antenna is plugged in.

The video i.f. amplifier is a four-stage circuit using mesa transistors. D1 is connected in series with the emitter resistor in the first stage. It stabilizes the bias and minimizes crossmodulation. D2 is the overload diode connected across the primary of the second i.f. transformer. It is biased so it does not conduct on normal signals. Very strong signals override the bias. The diode conducts and reduces the gain by damping the i.f. transformer. Video detector D3 feeds the video and a/c amplifiers.

The video amplifier uses drift transistors. The first is a combined common-emitter amplifier and emitter follower. The 4.5-mc intercarrier sound signal is developed across a sound take-off transformer in the collector circuit. Composite video for the video output and sync circuits is taken off the contrast control in the emitter circuit. The emitter resistor (contrast control!) is bypassed by a series-tuned 4.5-mc trap. The video output stage feeds the cathode of the picture tube.

The 4.5-mc sound i.f. amplifier uses drift transistors in conventional capacitance-neutralized circuits. The first stage is a straight amplifier. The second is an amplifier-limiter. D6 and D7 are ratio detector diodes.

## The sync separator

Composite video from the detector is fed to the sync separator base. D8 removes any noise pulses riding on the



*Philco N-1052BK*

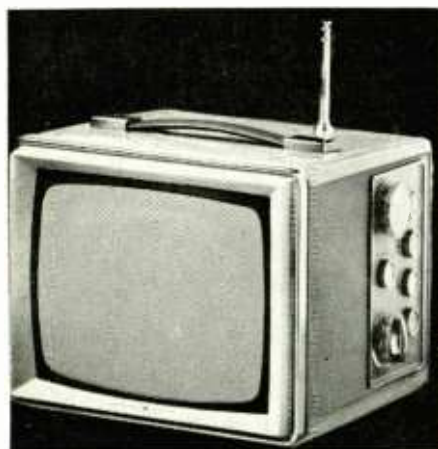

*General Electric TR-803*



*Delmonico's 4T-40UHF*



sync pulses. The sync separator is a p-n-p alloy transistor biased to cutoff so it conducts only on the sync pulses. The amplified and inverted pulses are fed to the sync amplifier—an n-p-n transistor also biased to cutoff. Sync pulses are further clipped, shaped and fed to the vertical and horizontal deflection circuits.

**Keyed agc**

The composite video from the detector is fed to the base of the agc amplifier, a p-n-p transistor. A keying pulse, developed during the horizontal retrace time, is tapped off the flyback transformer and fed to the oscillator through D4. The amount of collector current that flows is determined by the height of the sync pulses. The resulting negative agc voltage is fed through D5 to the base of the second video i.f. amplifier. The first i.f. amplifier is controlled by returning its base to the sec-

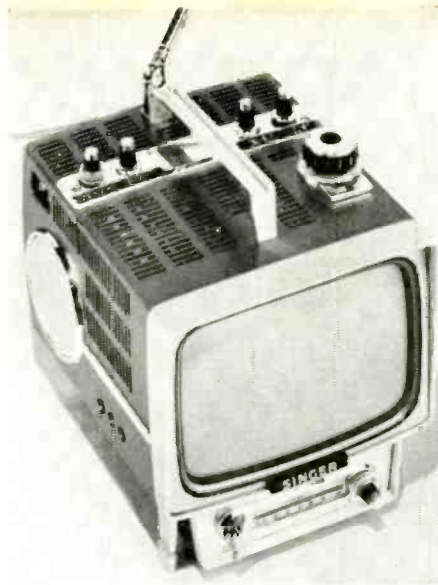

*Singer TV-6 described in this article*

ond i.f. amplifier's emitter. On strong signals, the agc amplifier develops a higher negative agc voltage. This increases the bias on the i.f. amplifiers and reduces their gain. The

AGC control, between collector and ground, sets the agc level.

**Horizontal deflection circuit**

If you want an idea of what you can expect in the way of circuitry, take a look at Fig. 2, the schematic of the horizontal deflection circuit. Impressive, isn't it?

Negative-going sync pulses from the sync amplifier are fed to the base of the sync splitter, a p-n-p alloy transistor. The sync pulses developed in the emitter and collector circuits are applied simultaneously to the afc phase-detectors, D10 and D11. A comparison signal is tapped off the horizontal deflection circuit. A correction voltage is developed and fed to the afc amplifier through an integrator network consisting of the .005- $\mu$ f and .02- $\mu$ f capacitors and the 6,800-ohm resistor. This signal is amplified and fed to the horizontal blocking oscillator. The ring-

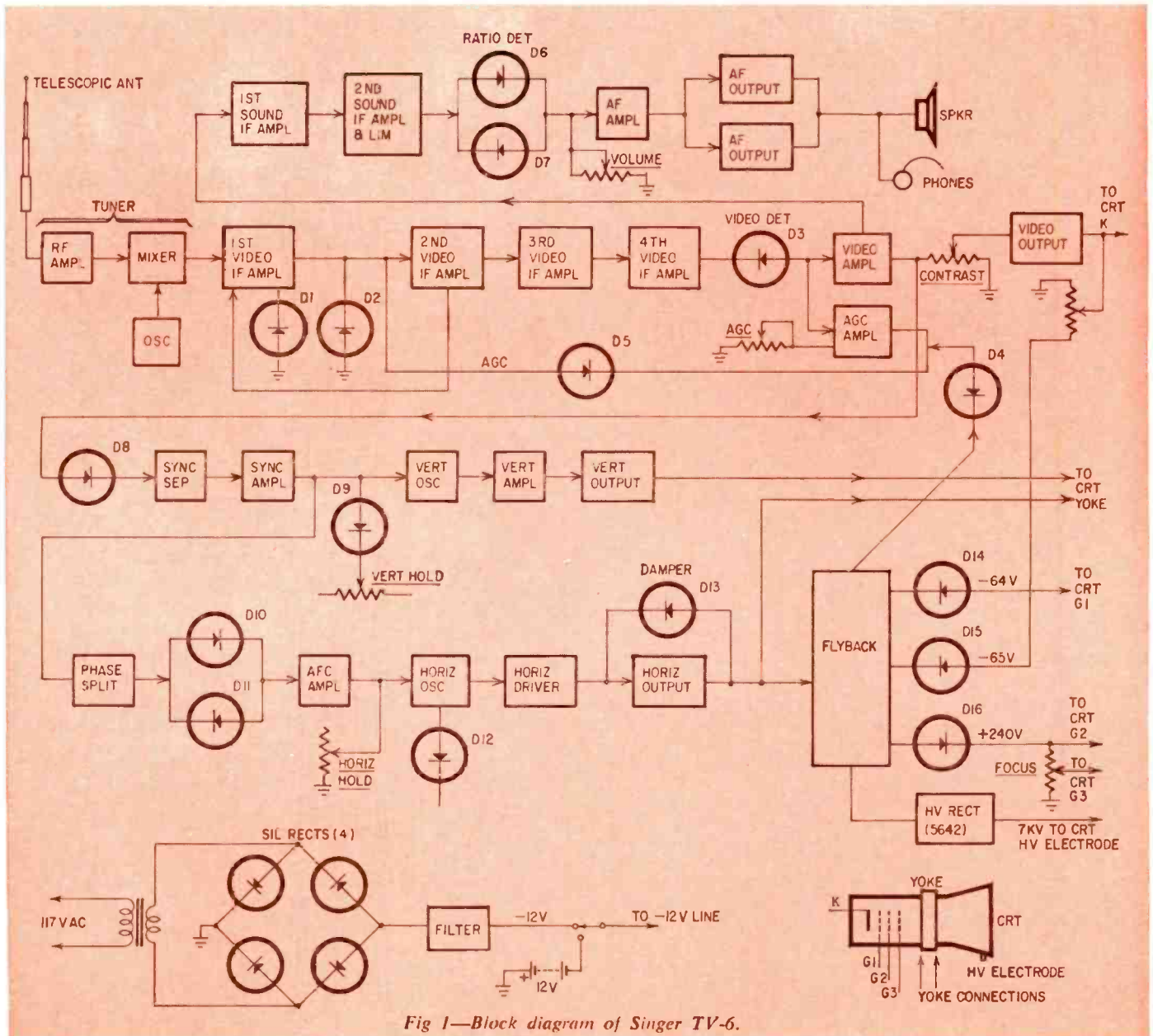

*Fig 1—Block diagram of Singer TV-6.*

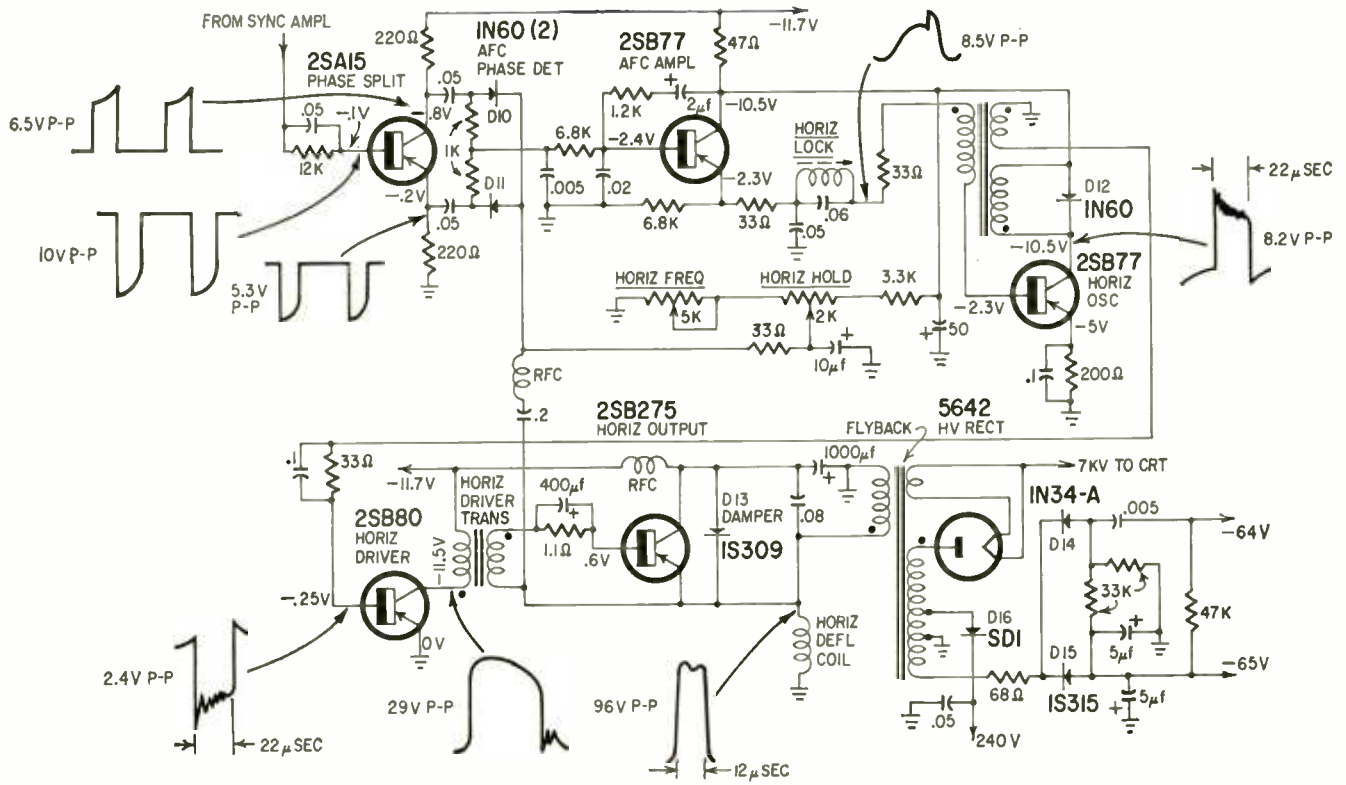

Fig. 2—Horizontal deflection circuit of the Singer TV-6.



Sharp Model TRP-601



Channel Master's portable

ing coil in the emitter circuit is the horizontal lock control that provides precise sync.

The horizontal driver is fed from an output winding on the oscillator transformer. The amplified drive signal is transformer-coupled to the horizontal output transistor. This stage produces high-current pulses at the emitter that feed the horizontal deflection coil in the yoke, producing a sawtooth current in the coil, producing a sawtooth current in the coil, producing a sawtooth current in the coil.

The primary of the flyback transformer is in parallel with the horizontal deflection coil. The output emitter current is stepped up and rectified to produce 7,000 volts for the high-voltage anode of the picture tube. The high-voltage secondary is tapped to supply intermediate voltages. D14 and D15 supply approximately 65 volts to bias G1 in the CRT. D16 provides plus 240 volts for G2 and the focus electrode.

This has been a brief look at a typical transistor TV receiver. Future articles will analyze various sections of a number of similar receivers and will cover troubleshooting and circuit adjustment. Some of the sets to be covered are the Delmonico 4T-20U, Panasonic Mitey-9, Realtone TR-6867, Sony Micro TV 5-303W, Sharp TRP-601, Candle MT-510, General Electric TR805AEB and the Philco Nomad N1052. END



Realtone Transvision TR-6867



Panasonic Mitey 9U

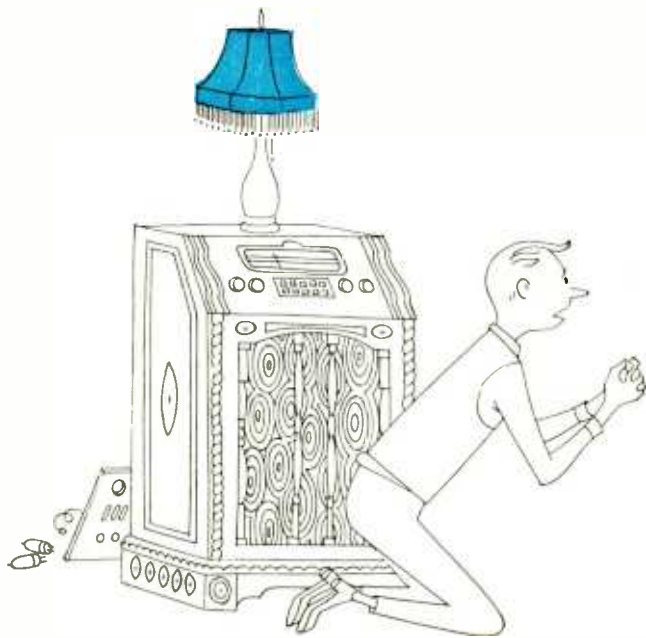

# RESTORING OLD RADIOS

Knowing how to get those old Stromberg-Carlsons and other quality receivers back in shape will endear you to many!

By JACK DARR SERVICE EDITOR

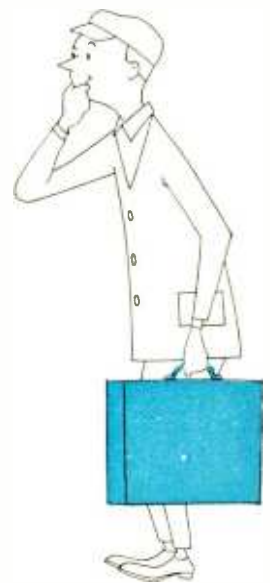

ALL OF US GET THIS QUESTION ONCE IN a while: "I've got an old radio at home. Beautiful cabinet, and my wife won't throw it away. It hasn't worked for a long time. Can you fix it?"

Truthfully, a lot of these jobs aren't too profitable, but they're almost always good "prestige" jobs: other men have probably tried to fix them, without results! If you can straighten them out and make them play again, you have made a friend. Of course, don't make any rash promises until you've *seen* the radio!

It will usually be one of the large console types, possibly FM-AM, with a record changer. Here is one possibility: after the radio is repaired, you have a good opportunity to sell him a modern 4-speed changer to replace the original

78-rpm unit.

Little radios usually aren't worth the effort. However, the old RCA's, Stromberg-Carlsons, Capeharts and so on, are very well designed chassis capable of amazingly good reproduction if they're in good shape.

We'll give you a list of all the things which cause trouble in these sets. By checking them out methodically, you can restore the sets to full performance in a very short time, and gain a reputation as an electronic whiz!

First, check all the tubes. As a rough guess, any that are more than 50% "down" will give trouble. However, you'll find that weak tubes have surprisingly little effect on performance in some circuits, because of the very conservative design of first audio ampli-

fiers, some i.f. stages, etc. Some tubes have prohibitively high prices: the Lok-tal series, for example, and some of the older types. A well stocked junk box can be very helpful indeed! Some tubes may be so old that your distributor will give you a bargain, just to get rid of them! In a few cases, substitution will be possible. Sets using octal-base tubes will be the easiest to restore, since there are so many octals around.

Next, check the filters. Age is the worst enemy of electrolytic capacitors; they dry up. Electrolytics are universal, and you'll have no trouble at all in finding suitable single-unit replacements. You may even be able to find duplicates of the original multiple-unit filter capacitors. There will usually be ample room in the chassis to install separate-unit filters (Fig. 1).

Watch out for unusual (to us, that is) filter networks. A lot of these sets used a "floating B-minus" circuit, with a voltage divider in the negative return for bias voltages. This is always filtered, as in Fig. 2. If this capacitor is included in the original filter block, its polarity will be *reversed*. Standard practice: re-

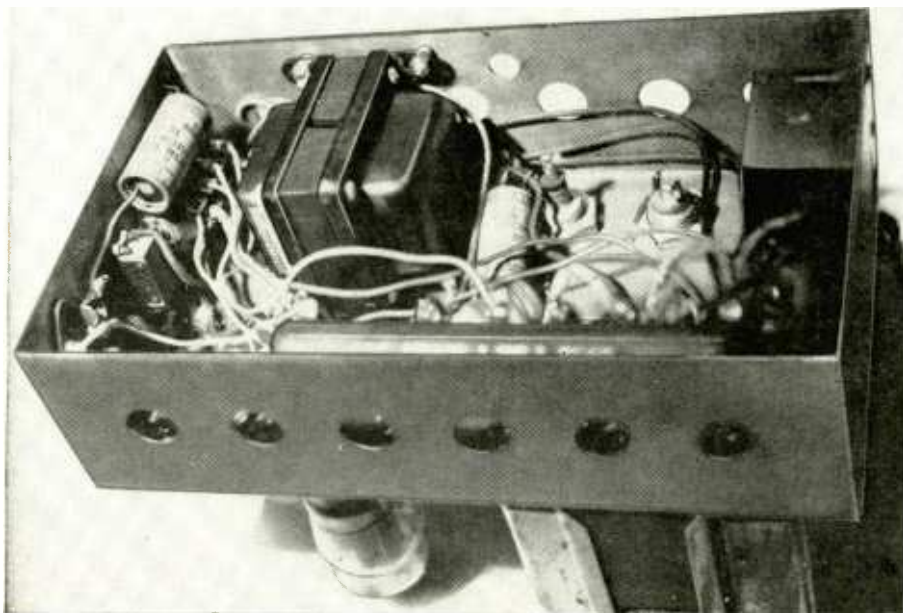

Fig. 1—Original wet electrolytics can be replaced with smaller modern dry units. Leave the old cans on the chassis for appearance's sake.

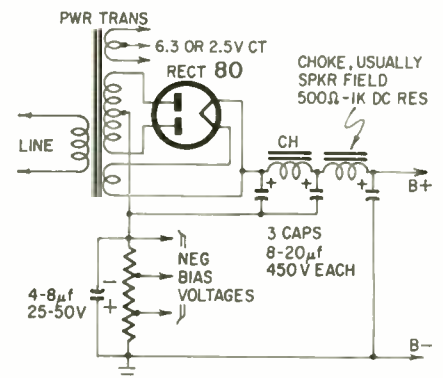

Fig. 2—Typical floating-negative power supply circuit common in older sets. Watch electrolytic polarity!

place main filters with an ordinary multiple unit, and the bias filter with a separate unit. Since these are always low-voltage, you can get a comparatively large capacitor in a small case, and there will be plenty of room for it. Omit this bias filter, and you'll get a "mysterious" hum that bridging the main filters won't affect at all!

Notice in Fig. 2 that the negative connections of the main filter capacitors do *not* go to chassis, but to the center tap of the high-voltage winding on the power transformer! When making your initial checks on the radio, be sure that some technician unfamiliar with the circuit hasn't connected a replacement filter capacitor directly to ground! A quite common occurrence, and I've found that it often causes a severe hum.

After checking out the power supply, check out the resistors in the bias voltage divider. If these open, there will be no B-plus. If they should short to chassis, or be deliberately shorted to chassis by the aforementioned inexperienced technician, the bias voltages will be upset, and you'll probably have a mysterious distortion and hum. You'll need complete service data on all of these sets. Rider's old Radio Manuals, Beitman's Supreme manuals and factory service data are essential. Most of the sets we're talking about were built before Sams started printing Photofacts Folders! You need service data to check the value of the bias voltages.

Check the speaker and output transformer. Older transformers were prone to damage from electrolysis, which ate up the fine wire, causing an open circuit or high-resistance joint. A dc resistance check will catch it. The resistance of each half of push-pull transformers should be within 10% of the other, and speaker field coils should be within 10% of rated resistance.

Bad transformers must be replaced. Defective speaker field coils can sometimes be repaired, since the joint which causes most of the trouble is the connection between the fine-wire winding and the flexible lead on the outside of the coil. Carefully lift off the wrapping and look for the end of the lead: it will be sitting on a square of "empire cloth" (a yellow plastic-coated fabric) and will usually have a bright green spot at the end. This indicates corrosion. Clean away all traces of green, resolder the joint and check for correct dc resistance. If OK, spray clear plastic or coil dope on the winding, and replace the outer covering.

Check audio voltage-amplifier stages (there were often two or three), i.f. stages, mixer and oscillator for correct voltages. You will probably find dropping resistors changed in value, lowering the operating voltages. Check the screen-grid voltages especially, since

(Right) Original i.f. transformer can be replaced with modern small one. Mounting it below deck shortens leads, though top mounting would probably have done as well.

Mirror at right shows original transformer and shield can (removed) on top of chassis.

Underchassis view (below) of old radio. Round dish-like object is coil shield base. This one contains an rf choke. Wires corroded at point where they join terminals can often be repaired. Be sure to replace shields.

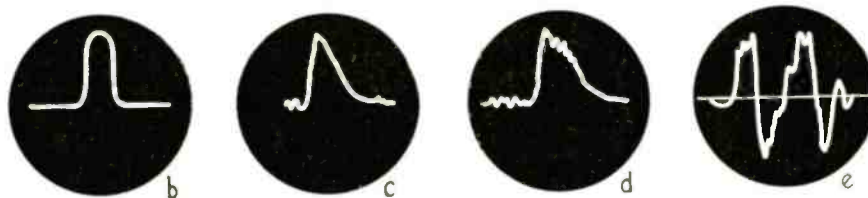
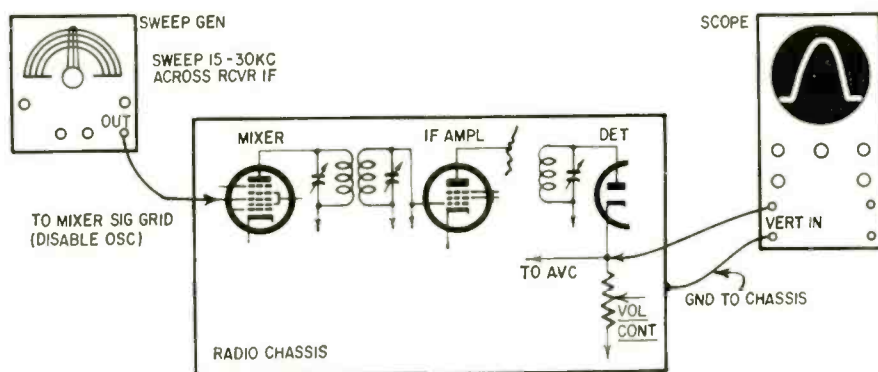
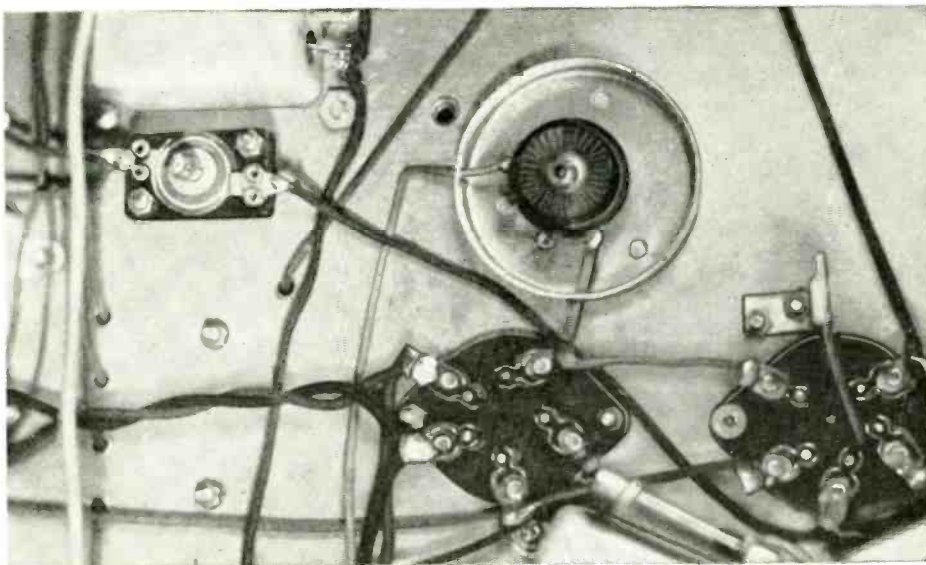
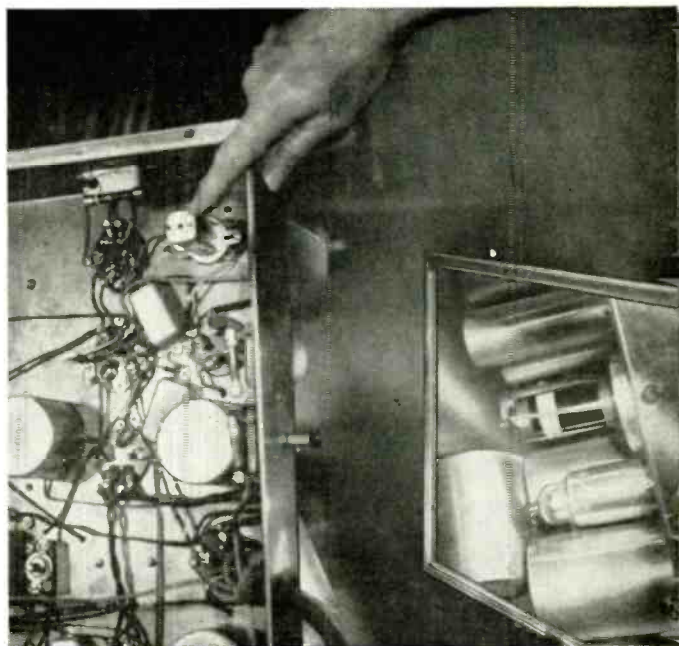

Fig. 3-a—Hookup for checking alignment and stability of i.f. stages. In b, an approximately normal response curve; c—incipient oscillation (note "triangular" shape); d—actual oscillation, squeals in audio; e—severe oscillation, probably enough to block receiver completely.

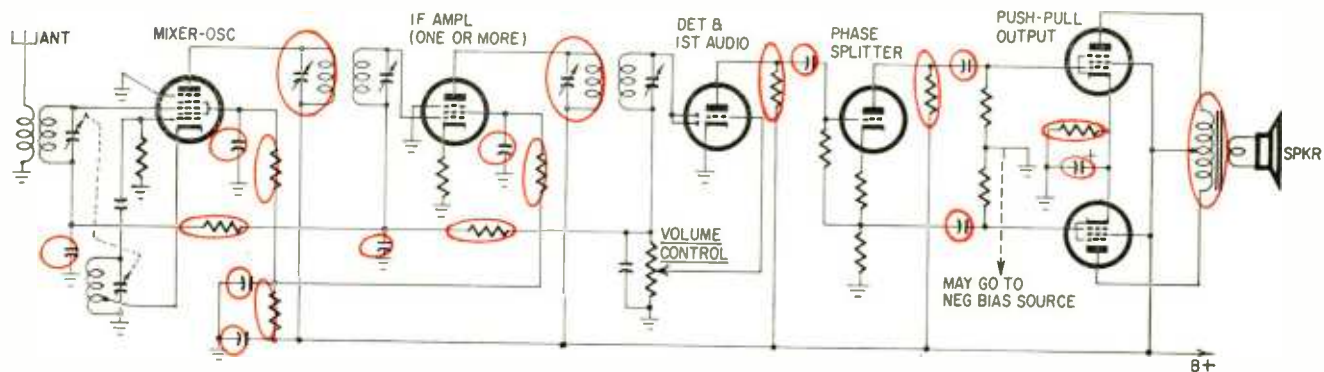

Fig. 4—Things to check, systematically, from speaker to antenna. This schematic is only a skeleton, showing basic parts.

low screen voltage will affect the gain of the stage a lot. You'll often find tetrodes or pentodes in first audio amplifier stages—watch out for low screen voltages here. Common practice was to use a 2.2-megohm or even larger resistor as a screen dropper, and a drift in this resistor can cause loss of screen voltage and a severe loss of gain, plus distortion.

Check mixer and oscillator supply voltages. Trouble with the signal-to-noise ratio can come from low oscillator injection voltage. Loss of sensitivity or selectivity or both can be due to low plate or screen voltages on rf or i.f. stages.

Watch out for leakage in coupling capacitors. Quick test: disconnect the grid end of the capacitor, or pull the tube, since these are all parallel-heater sets. Measure the dc voltage on the open end of the capacitor. If you find a steady positive voltage, replace the capacitor. Bypass capacitors in plate and screen supply circuits can leak and cause voltage loss there.

You may find i.f. transformers and oscillator coils open, too, from electrolytic corrosion. I.f. transformers can be replaced by the newer small ones. Watch out for too much gain in the transformer. If you run into oscillation, you may have to reduce the gain of the stage by reducing plate voltage, increasing bias, etc. Best check: hook up sweep generator and scope to make an i.f. response curve (Fig. 3). Look for traces of oscillation on the curve. If it's there, you'll be able to see it without any trouble at all. Fig. 4 is the basic circuit of a superhet with parts to be checked.

Novelty: I replaced an i.f. transformer in a very old chrome-plated-chassis job. To retain the appearance of the chassis, I put the original i.f. can (empty, of course) back over the new miniature transformer!

Band switches, volume controls, pushbutton tuners and any kind of control will probably be very dirty and noisy. A liberal application of spray cleaner will usually fix them up. Volume controls can be replaced by standard

units, and band switches can be cleaned and the contacts tightened up by a careful working over with the slotted tip of a soldering aid, if they're worn too badly.

Hint: if the band switch is worn very badly, on a multiband set (one having several short-wave bands, as many of these did), the owner will probably allow you to cut out the short-wave parts, leaving only the broadcast band. Simply solder the band switch contacts together! Because of the complexity and time needed, I wouldn't recommend trying to *replace* a band switch, except in very unusual cases, and with the owner's knowledge that it's going to cost him *plenty*!

Wiring can be one of the worst problems. Rubber-covered wire deteriorates badly with age. So, don't *move* any of the wiring unless it is absolutely necessary. Cables that must be moved, speaker wiring, etc., should be replaced with new flexible wire. However, as long as the original wiring is left in place, it is usually safe enough. Sometimes you can lift one end of a wire, slip a piece of soft spaghetti over it and tack it back in place. This is a good way to cope with mouse damage. Mickey loves insulation!

This must be a "method" job: start at the power supply and work your way back toward the antenna, checking out every part as you go. It sounds like a two-week job, but it isn't. After a little practice, you'll be surprised how rapidly you can make a complete overhaul on one of these old crocks. I checked the time on my last one and it took just over 2 hours of actual bench time. I replaced four filter capacitors, seven resistors and 6 capacitors.

The final step should be a thorough cleanup of the chassis. Blow out the dust and wipe off wax, grease and less sanitary accumulations, and, most of all, clean up the dial glass until it shines! Also, be very sure that the dial cable, if any, is in good shape, not slipping. Clean up the cabinet, if it is not already clean (as many are), and you've got yourself a restoration all completed. END

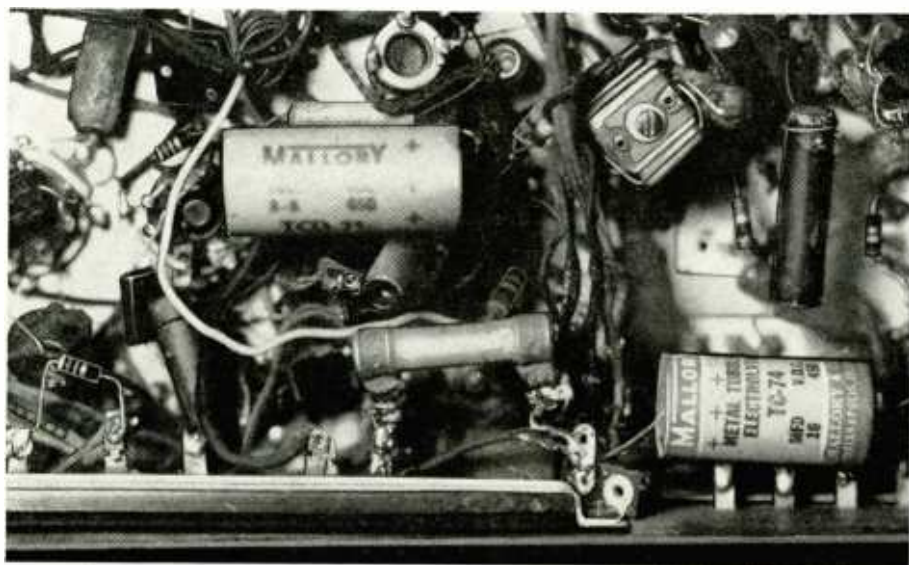

Here's a set that's been worked on many times by many people, and shows its scars. Good idea to tie down large lead-mounting electrolytics. Flat "Candohm" divider resistor (bottom of photo) can be replaced in parts with 5-watt or bigger single resistors, if necessary.

# Antenna Rotator Remote Control For TV, CB and Hams

Simple lever-switch attachment gets direction-indicator and control-box off your operating desk. By R. P. BINTLIFF

FOR CONVENIENCE OF OPERATION IN A ham or CB station, the receiver, vfo, key, microphone and various control or accessory items are usually located within easy reach of the operator. The result is often an overcrowded operating table, with unoccupied space at a premium. My shack is no exception, but this modification of an antenna rotator control box has provided some relief.

The rotator in this case is an Alliance T-12, but the remote switching can be used with other rotators of similar design. The "stock" version is operated by a bar switch on the indicator control box close by.

The remote-control unit shown in the photos permits relocating the indicator box to where you can see it without having it in the way. It consists of a two-pole three-position momentary-contact lever switch mounted in a 2 1/8 x 2 3/4 x 1 5/8-inch Mini-box. Instead of a Mini-box mounting, the switch can be installed on an existing control panel or at some other location, as you like.

A brief look at a simplified rotator schematic (Fig. 1) may be helpful.

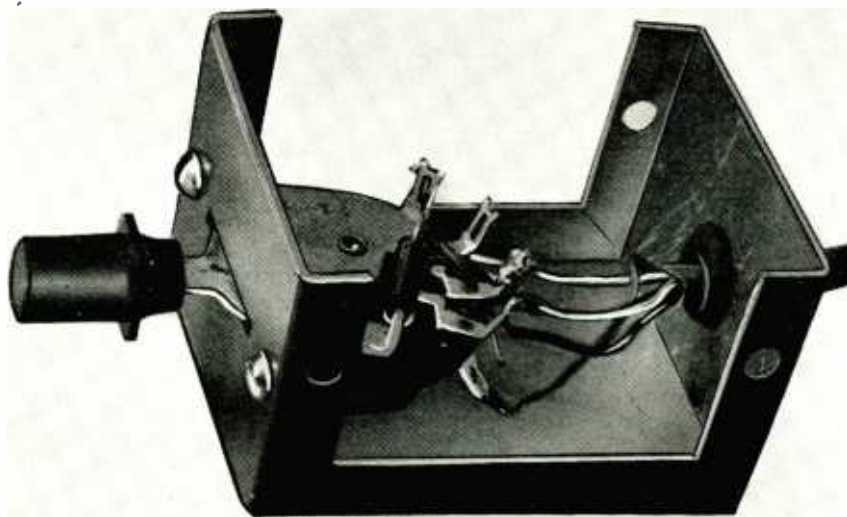

It's only a switch in a box, and a 5-wire cable.

The rotator's reversible motor is operated by a dpdt center-off, spring-return switch (S1). The switch contacts are arranged so that S1-a first closes the

24-volt circuit and then S1-b applies primary power to the stepdown transformer. A remote-control unit must duplicate that switching sequence. The dashed lines show the added wiring connected to a Jones socket.

Lever switches are best suited for S2 in this application, since their switching sequence can be controlled. I tried bending the contacts of leaf-type lever switches, but switching was not completely reliable. So I used a wafer type of lever switch instead. The switch must be a momentary-contact one, because a positive-action switch can accidentally be left in either of the two energized positions. Continuing to apply power after the rotator's mechanical stop is reached may overheat the transformer and damage the rotator.

A Centralab PA7002 switch was selected because it is compact, has a positive spring action and is easy to modify. To alter the rotary contact of S1-b (for the switching sequence), straighten the bent-over tabs that fasten it to the wafer and carefully remove it. This shorting type contact must be filed down as shown in Fig. 2. An ignition or model-maker's file is useful here.

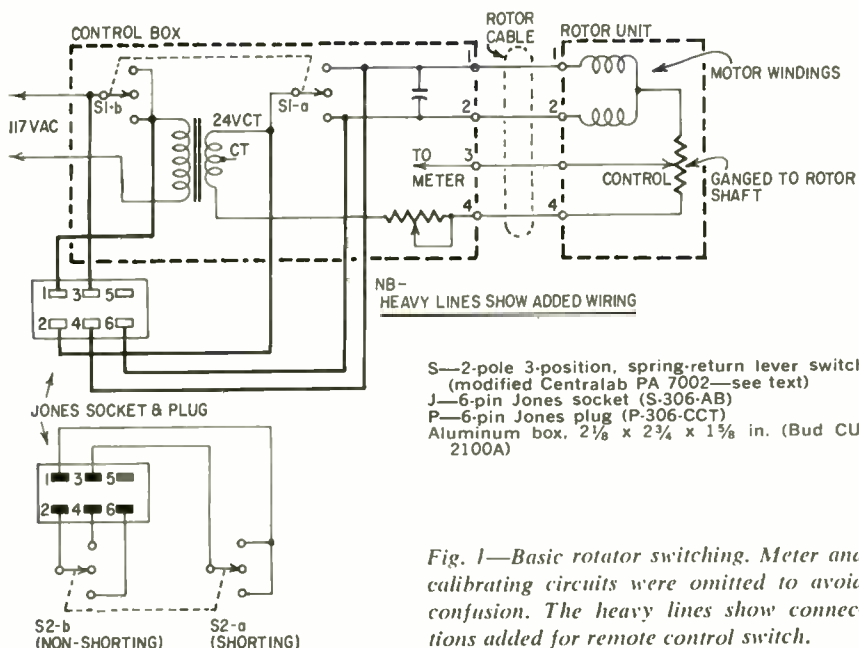

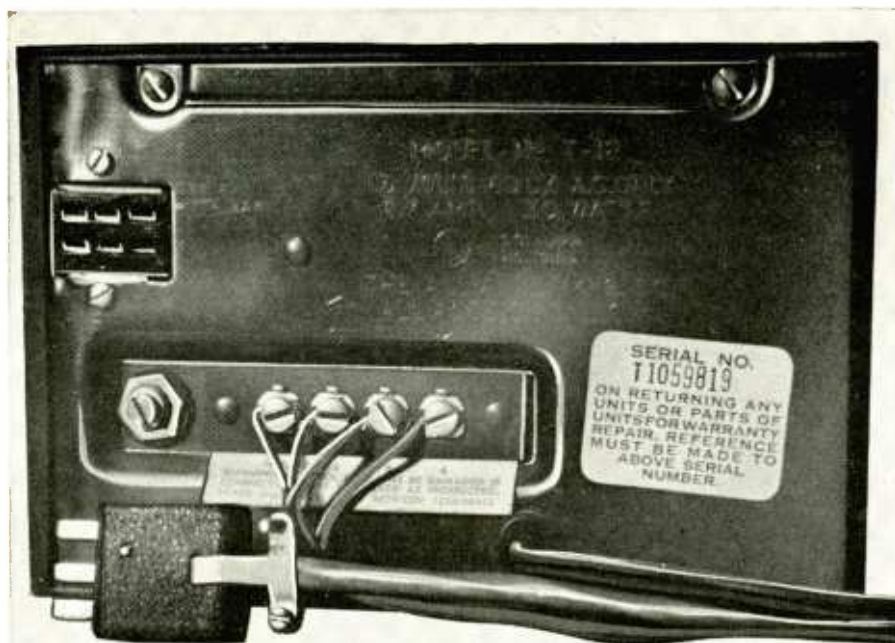

6-prong Jones plug shown at end of cable fits into mating female connector in new hole at upper left of control box back. Double-check connections before putting box into operation. Mistakes can do damage, and are a nuisance to track down later.

Fig. 2—How to file down rotary lever switch contact.

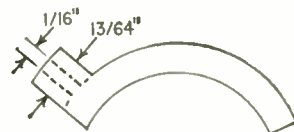

If you can scrounge a suitable non-shorting contact from your junkbox, you can save yourself some work. To install the new contact, stick its tabs into the correct wafer slots and bend them down tight.

A five-conductor cable and a six-pin Jones plug connect the control box to the indicator box. Install a mating socket as shown in the photo. The 1x $\frac{3}{4}$ -inch socket opening can be made with two cuts of a  $\frac{3}{4}$ -inch square chassis punch. Finally, wire the socket as shown in heavy lines in Fig. 1. Though the wiring is simple, check it out with an ohmmeter before you apply power.

Since the remote-control unit switch parallels the indicator/control-box switch contacts, either switch can be used to operate the rotator.

Without junkbox parts, this remote control unit cost me about \$3. It has been very handy in contests.

## Converting VHF To UHF For Tests And Demonstrations

TV TECHNICIANS IN VHF AREAS CAN simulate uhf signals with any single-tube uhf converter, according to a simple method devised by Blonder-Tongue Laboratories, Inc.

A technician merely takes an un-amplified, single-tube converter and hooks it up backward. Instead of converting uhf to vhf, in the traditional manner, the converter changes a local vhf channel into uhf.

The backward hookup method is especially useful for technicians in vhf-only areas that have a new uhf channel due to go on the air.

The diagram illustrates how Blonder-Tongue's model BTX-99A converter is hooked up to simulate uhf. The setup is most effective with an input from either channel 5 or 6, but any of the low channels will work if they are strong enough.

Ordinarily, the uhf antenna is connected to the converter terminals marked UHF ANT. The output connects to the set's antenna terminals. The desired uhf signal is preselected by the tuner and fed to the crystal mixer. The mixer diode combines the uhf input signal with the output of the oscillator. The difference between the oscillator signal and the input uhf signal is set by the tuner to be 82 mc, so the output is received on a TV set on channel 5 or 6.

When the converter is hooked up backward, as shown, the signal from the vhf antenna is mixed with the output of the uhf oscillator. The sum of these frequencies is equal to the uhf channel to which the converter is tuned. It passes through the uhf preselector to the UHF ANT terminals and then to the set.

If the picture is snowy the input signal is not strong enough. Use a vhf booster between the antenna and the converter.

This method enables a technician to simulate any uhf channel by setting the converter's tuning knob to the desired position. END

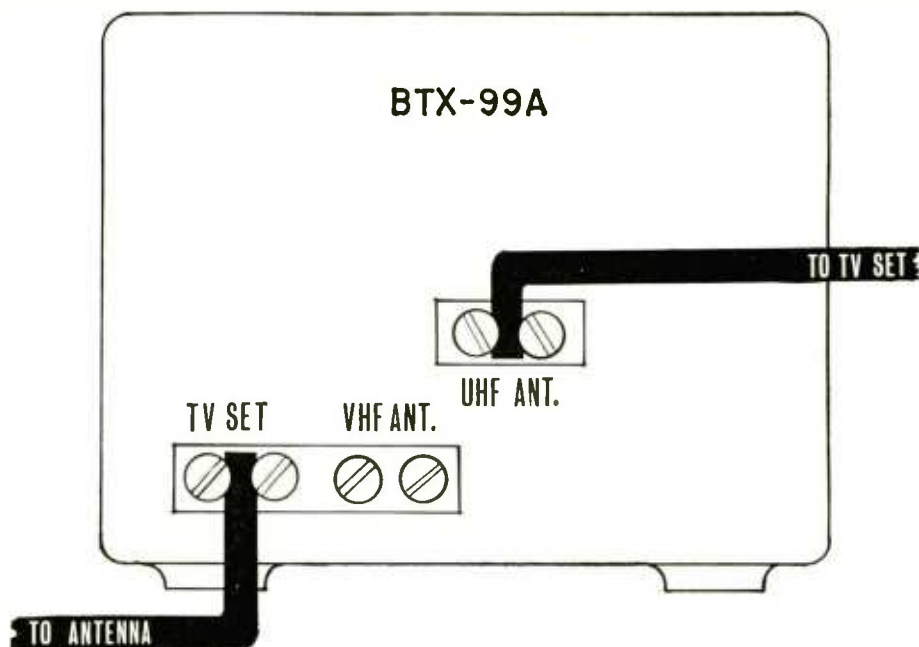

Plagued by rushing noises in all your taped FM programs? Could be "beats" from the 19-Kc stereo-multiplex pilot by FRED BLECHMAN K6UGT

*Simplest of all—19-kc tuned trap.*

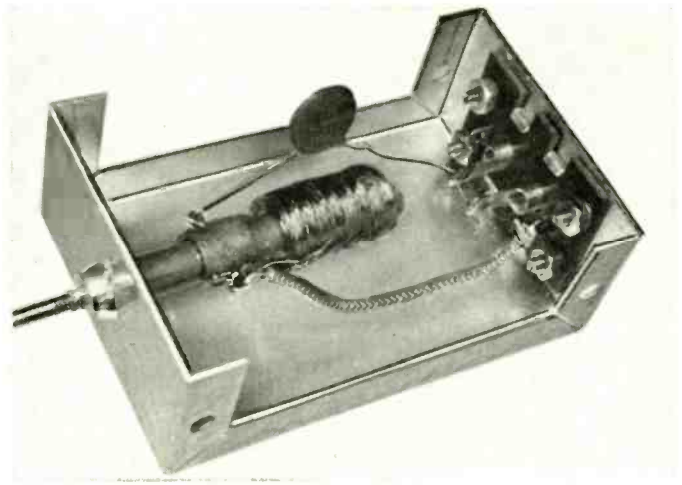

# Filter for Recording FM Stereo

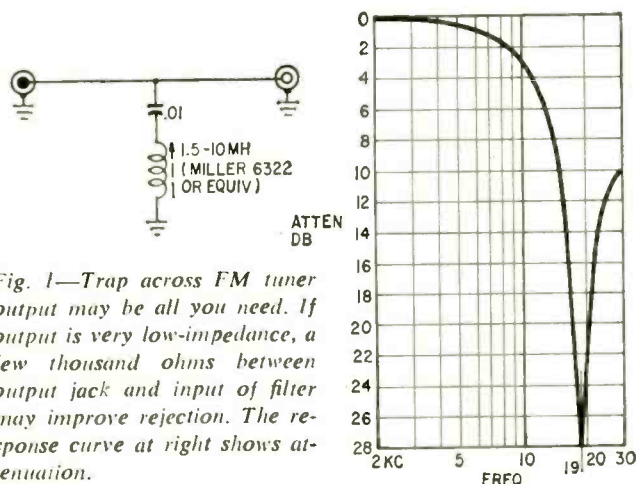

Fig. 1—Trap across FM tuner output may be all you need. If output is very low-impedance, a few thousand ohms between output jack and input of filter may improve rejection. The response curve at right shows attenuation.

SINCE FM MULTIPLEX STEREO HAS COME ON THE SCENE, many tape recording enthusiasts have had difficulty recording FM music. There are whistles, squeals or buzzes on the recording, in monophonic as well as stereo tapes. If you're having this difficulty, the FM recording filters described here should help you.

Why the noises? When an FM station broadcasts multiplex stereo, a 19-kc "pilot carrier" is transmitted for synchronization and carrier regeneration in the multiplex receiving circuits. You can't hear it, since it's above the normal hearing range, but you can be sure it's there during stereo-casts. If you are recording monophonically, this 19 kc can generate harmonics in the recorder circuitry which "beat" with the recorder's bias oscillator at an audio frequency—thence the whistles and squeals.

Even more sneakily, the 19-kc harmonics can get amplified and change your recording bias, with consequent distortion. The clue is simply this: if you get good recordings on a particular station when it broadcasts monophonically, but have distortion, whistles or squeals on your recordings when the same station is stereocasting, you can be sure you need a 19-kc filter. Two simple filters described later in this article suppress the 19 kc by about 30 db.

If you like to record FM multiplex broadcasts in stereo, you are even more likely to encounter problems. Why? Because your multiplex detecting circuitry *doubles* the 19-kc pilot carrier to 38 kc and increases its strength! Unless your multiplexer has a 38-kc attenuator at its output, you are probably going to have trouble getting "clean" stereo recordings. A simple outboard 30-db 38-kc attenuator can be added between your multiplexer and recorder.

One word of warning: You must be prepared to accept some loss of high frequencies when you add any of these filters to your system. They are not expensive, exotic circuits, and their attenuation curves extend into the audible range. The maximum attenuation, of course, is at the design frequency of either 19 or 38 kc. The attenuation-vs-frequency curves (Figs. 1 and 2) show some loss of highs, which appears more serious than listening tests indicate: the average listener can barely tell the difference. However, if you are a

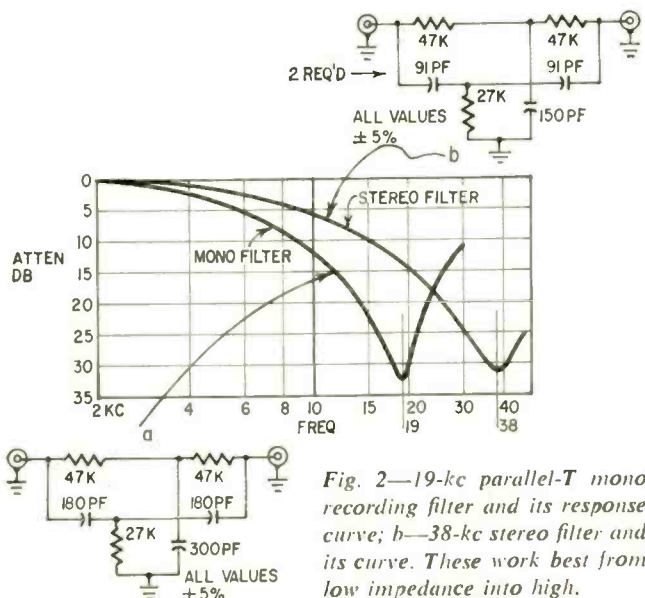
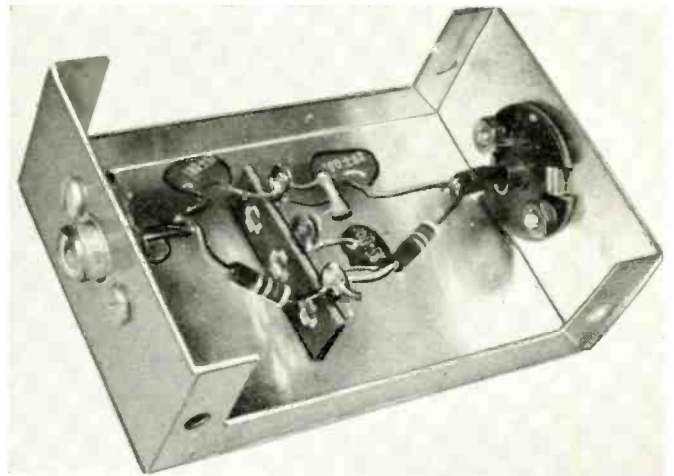

Fig. 2—19-kc parallel-T mono recording filter and its response curve; b—38-kc stereo filter and its curve. These work best from low impedance into high.





*A single parallel-T filter for 19 kc.*

real discriminating audiophile and truly treasure every 15-kc overtone, you will want more elaborate filtering devices than these.

Your next decision depends on whether you intend to record mono or stereo. For mono recordings, the simplest, most effective method of "dumping" the 19 kc is to use an inductor and capacitor in series across the tuner audio output. Fig. 1 shows the circuit and the attenuation-vs-frequency curve. You get a 28-db reduction of the 19-kc pilot carrier at the recorder.

The parts are built into a 3¼ x 2½ x 1½-inch Minibox, using appropriate input and output jacks, as shown in the photos. The inductor is first slug-tuned to resonance at about 19 kc with an audio generator and vtm or oscilloscope, then adjusted for minimum interference in use. Connect it between the tuner output and the recorder input with shielded cables.

An alternate design is shown in Fig. 2-a. This is a 19-kc-notch parallel-T network. No adjustment is required if the components are 5% tolerance. The maximum attenuation

to 19 kc is 32 db. This unit is called "Model T" in the photos, and is also built in a 3¼ x 2½ x 1½-inch Minibox, with a three-lug terminal strip (center lug grounded) used for mounting the parts.

For recording stereo multiplex, just use two parallel-T circuits in the same box. Each T must have maximum attenuation at 38 kc in this case. The circuit and attenuation characteristic for each channel are shown in Fig. 2-b. My "box" had slightly over 30-db attenuation at 38 kc. Build *two* of these circuits in a 3½ x 2½ x 1½-inch Minibox, using a common chassis ground point for all components. This can be done easily with a five-lug terminal strip (center lug grounded), as shown in the photo. Four single jacks (or two dual jacks) will be required in this unit: input and output for each channel. The completed unit is connected in your system between the demultiplexed audio outputs and the recorder inputs, using shielded cables for the interconnections.

If you still have whistles or squeals even when using these filters, you are in big trouble! END

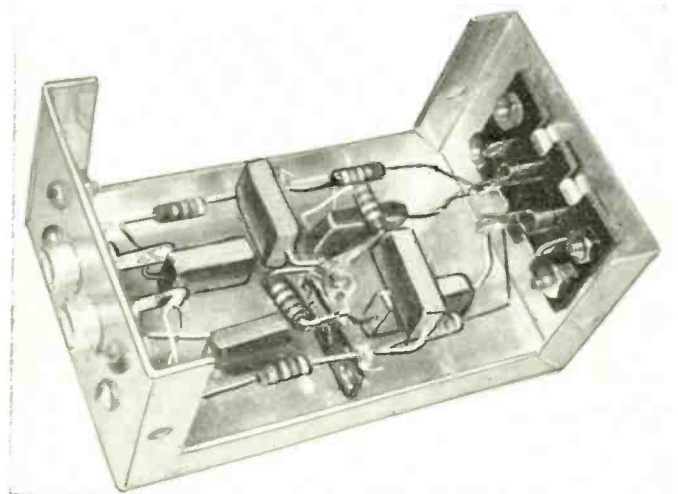

*Dual parallel-T's for stereo (38 kc).*

# Broadcast Engineering: Radio

By JACK DARR

FROM ABBEVILLE, I.A. (WARI), TO ZAREPHATH, N. J. (WAWZ), there are thousands of AM radio stations, and more are being built every day. Most of these are small locals. Besides furnishing local news and entertainment, they provide a most fruitful market for young men wanting to get into radio engineering. There are *never* enough licensed engineers to go around! The graduate of a radio school, with the FCC's ink not yet dry on his First-Class Radiotelephone license, can get a job any time.

Pay scales vary between communities. Since most of these stations are in small towns, wages are usually ample, and above the local average. The budding engineer can have his choice:

lio at the age of 5 left him with both legs in braces, but it didn't slow him down too much! After graduation from high school in Mena, Ark., his home town, he took a year and a half of college, majoring in English. His technical training was taken at the State Rehabilitation Center. After ten and a half months, he passed the tests and got the "ticket". He's been working at the station ever since—about a year and a half now.

He drives his own car, a white Ford Thunderbird, bought after going to work at the station. He rides horseback, chases girls and has a big time in general. A continual kidder, with an intermittent dimple, Jerry is a serious student of electronics, and he's made real

drums at local dances, and is a most popular fellow around town.

Now let's look at a typical working day at the station, and then talk to the men. Wayne opens the station up at 6:00 AM and works alone until 7:00. Jerry comes in just before 7:00, pulls the news from the teletype, and sorts it for the 7 o'clock news, first of many during the day. While this is going on, Wayne is being happy and cheerful over the air, playing records, mostly country and Western, which he loves dearly! Most of the work at a station of this size is playing records, and reading commercials ("spots"), although many live programs of local interest are broadcast from the little studio next to the control room.

Jerry now takes over at the console, and Wayne reads the early news from the studio. Jerry interrupts him at frequent intervals to read spots (and also make faces at him through the window, trying to make him laugh. This is old stuff for Wayne, though, and he reads calmly on.)

As each spot is read, the copy is moved from the top of the thick stack on the clipboard, or a page turned in the "repeater" book on top of the console. (The "repeater" book is a loose-leaf binder of spots that are read without change for several days or weeks.) As each spot is broadcast, it is checked off on the detailed *program log*, the announcer initialing the proper place to show the bookkeeping department and the advertiser that his commercial was read as scheduled.

At 30-minute intervals, the engineer on duty takes the meter readings on the transmitter behind him and enters them in the *transmitter log*, which must be kept up to date at all times. It shows the frequency deviation, plate voltage and current of the final rf stage, and the rf line current to the antenna. As each engineer goes on or off duty, he must sign the log. By FCC rules, a licensed engineer must be on duty at all times when the station is on the air.

Between times, he selects records from the racks lining the walls, cues them up on the turntables on either side, cues up special tape-recorded spots, plays electrical transcriptions, and reads the typed spot copy. At times, this makes him wish he had three arms!

After about 8:00 AM, things get calmer. The early rush is over, most men have gone to work, and the spots

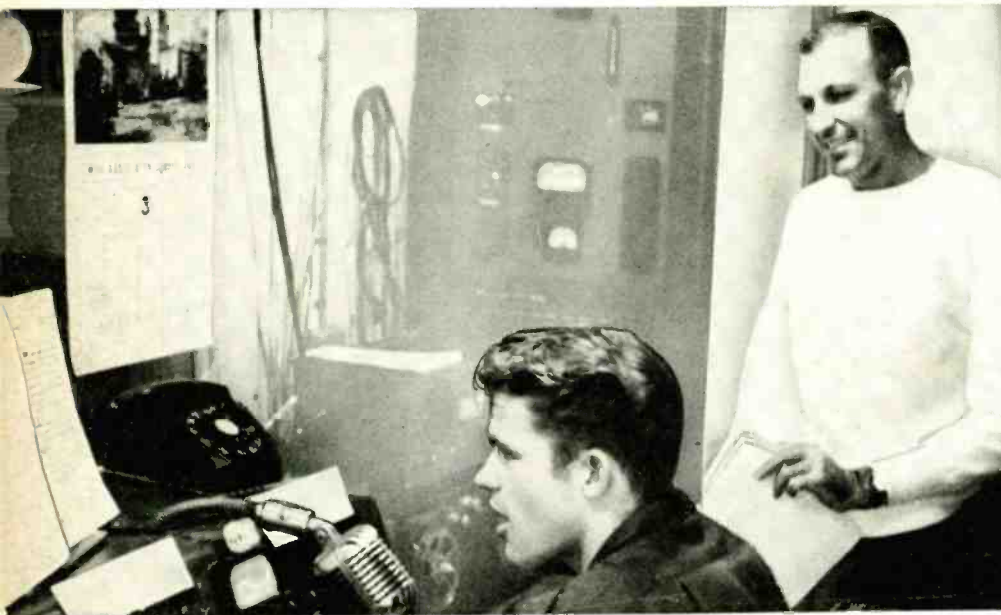

*Jerry reads a spot while Wayne sorts out copy. Engineers in small stations often take shifts at the microphone. But even if you stutter in a falsetto, there are plenty of straight technical jobs in radio broadcasting.*

he can work in these stations for a year or two, getting invaluable experience and getting paid for it, then going on to better-paying jobs. Or, if he likes the leisurely pace of small-town living, he can stay as long as he wants. Many new men have become chief engineers of their stations a year or so after graduating from radio school! Turnover is often rapid, depending on the individual.

Let's see what the real engineers do, how they do it and how they like it.

Here's Jerry Hamby: 21, chunky, cheerful and just a wee bit ornery. Po-

progress in learning the ins and outs of real-life work on radio transmitters.

Here's Wayne Ramsey, the chief engineer. A tall, rangy, 32-year-old Texan with a perpetual grin, he started as a musician. Deciding to get into radio, he took his training at the Elkins Radio School in Dallas. He got his ticket in 1958, and came here shortly afterward as second-shift engineer. He became chief in about a year, when the chief at the time left to work for the FAA. Single, he drives a Chevrolet Impala, plays a mean "swing guitar" or

are now less frequent, aimed at the housewife doing her daily work. Wayne officially goes off duty now, coming back before noon; a third man takes over then. The work shifts are broken up like this at most stations, so that the men work a few hours, then get a rest. This one, like many of the smaller stations, is "daytime only": it signs on at sunrise and signs off at sunset.

Now we can get a chance to talk to the boys and see what's going on. Jerry puts a long-playing record on a turntable, announces its title, and we sit down.

"Jerry, how do you like working here?"

"Fine! Wouldn't trade it for anything else!" he says enthusiastically.

"How about you, Wayne?"

"Me, too, I reckon," he draws. "Gettin' along pretty good right now, I'd say."

"How did you come to get into radio?"

"Well," Wayne answered, "at the time, it looked like the best way to be sure of getting a job! Worked out that way, too. Never been out of work since I started in it."

"Jerry?"

"Yep. Same thing. I was always crazy about radio and electronics. Remember how I used to pester you when I was in high school? When I got the chance to go to radio school at the rehab center, I jumped at it."

"Tell me, what do you think is the hardest thing about getting into this kind of work?"

They both spoke at once. "That FCC test!" They laughed.

"Oh, come on, now. It wasn't that hard, was it?"

"You're dern right it was!" Jerry grinned. "I took it twice before I managed to pass it."

"Wouldn't a' passed it then if the FCC man hadn't been his uncle!" said Wayne, almost straight-faced. Jerry's dimple popped out again, and I said, "Now I know *that* isn't so! He can't be Jerry's uncle; he's mine! How do you think I got my ticket?"

"We've always wondered!" they said together.

"Seriously, though," Jerry said, "it isn't too hard, if you've really been studying like you ought to. If you want it bad enough to make a real effort, you can pass." Wayne nodded in agreement.

"All right. Now, what was the hardest part of it *after* you got the job?"

They both spoke at once: "Learnin' to talk!" "Talkin'!"

Now I grinned: "Good old mike fright, huh?"

They both agreed, emphatically.

"Well, you got over it, I'd say," said I, for these two had very good

'chatter' on their disc-jockey shows. They seemed always at ease.

"It's hard to do, at first," Jerry said thoughtfully. "I was scared to death every time I opened that mike switch! Just don't let it get you down, though, and you'll get along fine. Worst trouble I had was talking too fast at first. I wanted to get through and get it over with."

"You know," said Wayne, "it looks to me as if the radio schools ought to put in a part on how to talk over the mike. A training course in announcing. Sure would help a lot of these boys."

"That's right," I agreed. "In fact, most of the engineers in these stations have to be combination men [combination engineer-announcers], don't they?"

"Darn right," he agreed. "All of 'em I've ever seen. Never worked at one where they *didn't*."

"OK, now, what would you say about this as a "career opportunity in electronics" as the ads say?"

"Good! About the best there is, I'd say," Wayne answered. "Why, do you know, I get three or four letters a month wanting to know if I know of a man with a ticket who'll go to work

What are your duties as chief engineer?"

"Just keep the thing on the air!" He grinned. "I keep the logs, file 'em, keep up the FCC reports and stuff. If we do have trouble, we all pitch in and get it fixed as soon as we can. I pull regular maintenance—that is, check up on the transmitter meter readings, clean switches and relays, change tubes and so on, and run a proof every so often [the *proof of performance* tests FCC requires]. Actually, by keeping up on the maintenance, we don't go off the air too often, outside of an emergency."

"Like the mouse, eh?" I said, remembering the time a mouse had got across the terminals of the high-voltage transformer and knocked the station off the air in a cloud of bad-smelling smoke.

"Well, what's the worst thing about it?" I asked.

"Staying up late for 'election parties!'" answered Wayne with a tremendous yawn. "I'm not caught up on my sleep yet after the last one. I had to get up and open the cotton-pickin' station the next morning, too! I believe I slept all the way through the 7:00 o'clock news, talkin' in my sleep! Oh, well,



Large metropolitan stations usually divide their duties. This engineer at New York's WQXR has his hands full keeping broadcast operations smooth and unobtrusive, while the announcer in the background does the talking.

right away. My gosh, there ought to be a lot of jobs. Just look right around here: why, there's a little radio station every 40 miles in all directions! They're always looking for men."

"Yes, sir!" said Jerry, beaming up at the license in its frame on the wall. "If you've got that blue ticket, you can go to work almost anywhere you want to at any time!"

"Well, one more thing, Wayne. What about your technical duties? We've been talking about playing records, reading spots and so on. Now, how about the actual 'radio' part of it?

once every four years ain't too bad!"

Summing up, I'd say that this is an excellent field for the young man who wants to get into electronics or radio. The technical education needed isn't too hard to get. With a reasonable amount of study, most men seem to be able to pass the tests in from 1 to 2 years. A good background of math is a big help, although all courses include math.

If you've been working with electronics—especially radio or audio—for some years, you may be able to pass the test with only a brief study of FCC

laws and communications and broadcast practice (Elements I and II of the examination). Most of the technical material will be familiar to you, except for specialized broadcast practices.

The Government Printing office has available a study guide to FCC exams, for 75 cents; address Superintendent of Documents, Washington, D. C. 20025. Another helpful recent book is *Radio Operating Questions and Answers* (13th Edition), by Hornung and McKenzie, published in 1964 by McGraw-Hill (\$8.25). Technical bookstores will be able to turn up other study guides and textbooks.

Both resident and correspondence school courses are available in all sections of the country. Rehabilitation and vocational training courses, with state help, are frequently available.

Cost of training varies. Resident schools are higher, of course, since the cost of living must be added to the tuition. Many resident schools have employment agencies, which help the student to get part-time work. Correspondence courses taken at home are the least expensive, with the advantage of staying home while training. Costs of many courses can be financed on a



The engineer may be working on the console while the announcer's on the air!

time-payment basis; get in touch with several schools and get the full details. If you are disabled, state programs often provide technical training or finan-

cial assistance, or both; student-loan plans are helpful, too.

The work is pleasant, and the hours aren't bad. Although the job can get hectic at times, it's seldom monotonous.

Though even as a beginning radio broadcast engineer you'll have plenty of stimulating responsibility and room to grow, there is still more opportunity as you graduate to larger stations, particularly ones in cities. Chief engineers of 10-kw and 50-kw stations are often "upper management" as well as engineers; they may supervise a staff of half a dozen engineers and technicians and have responsibility for planning new studio, control and transmitter facilities, purchasing equipment and advising the station manager or owner on technical matters. Often there are public-relations duties, too—checking out listeners' complaints about reception, interference, blanketing and so on.

All in all, there's no better job assurance than that little blue sheet of paper in its frame, with your name and the words "First Class Radiotelephone Operator" on it! If you can't get a good job with one of these, you'd starve to death in a candy store! END

## WHAT'S YOUR EQ?

### From Here To Infinity

Shown in the diagram is an infinite mesh of resistors interconnected so as to form a "screen".

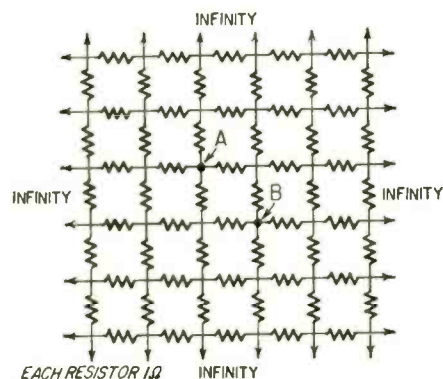

If each resistor is 1 ohm, what is the exact resistance between points A and B?—*R. Shubert*

### Radio-Electronics Is Your Magazine!

Tell us what you want to see in it. Your suggestions may make it a better magazine for the rest of the readers as well as yourself. Write to the Editor, RADIO-ELECTRONICS, 154 West 14th St., New York, N. Y. 10011.

### More Resistance

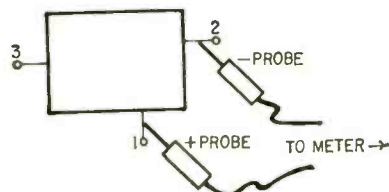

Observing polarities as shown, connect an ohmmeter to box terminals 1-2 and note reading. Short terminals 1-3, and reading *increases*. What's in the box? (Plus and minus markings on probes refer to actual ohmmeter voltage polarity and not necessarily to test jack markings on the instrument.)—*Alvin L. Hooper*

Three puzzles for the students, theoretician and practical man. Simple? Double-check your answers before you say you've solved them. If you have an interesting or unusual puzzle (with an answer) send it to us. We will pay \$10 for each one accepted. We're especially interested in service stinkers or engineering stumpers on actual electronic equipment. We get so many letters we can't answer individual ones, but we'll print the more interesting solutions—ones the original authors never thought of.  
Write EQ Editor, Radio-Electronics, 154 West 14th Street, New York, N. Y. 10011.  
Answers to this month's puzzles are on page 85.

Conducted by  
E. D. CLARK

### Steady Current

In this circuit, a 10,000-ohm potentiometer is connected in series with a milliammeter, a 12-volt battery and a

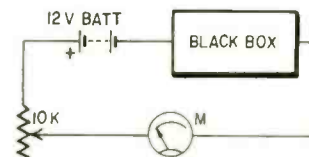

black box. The current in the circuit is about 1 ma regardless of the setting of the 10,000-ohm pot. What's in the black box?—*John C. Fakan*

### 50 Years Ago

In Gernsback Publications  
In July, 1915  
Electrical Experimenter

Phonograph-Telephone Lecturer  
Macrophone — Loud-Speaking Telephone  
Build a Photophone  
Talks 721 Miles by Wireless  
The Goldschmidt Tone Wheel Detector  
Locating Buried Pipes Electrically

# Code-Practice Oscillator—On a Key

By **FREDERICK W. CHESSON**

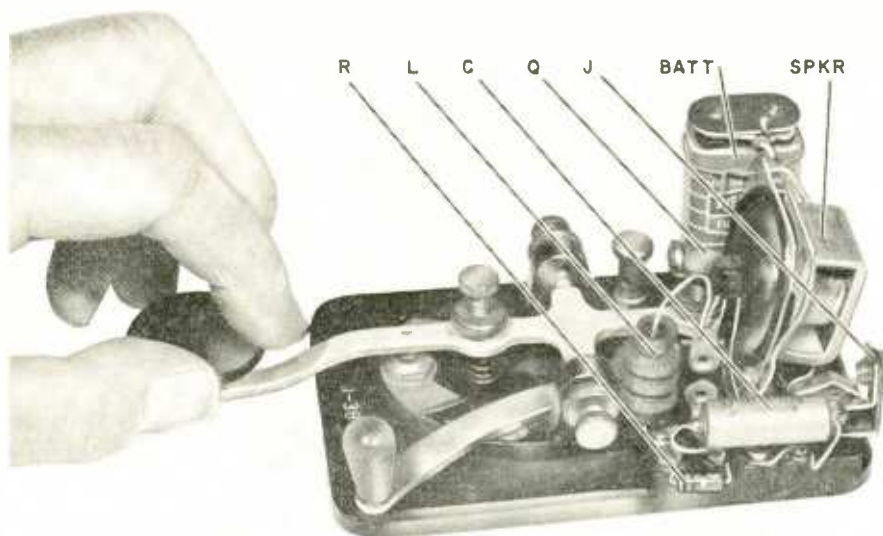

The unijunction code-practice oscillator. All parts, including the battery and miniature speaker, are mounted on a J-38-type telegraph key.

Here's an ultra-simple code-practice oscillator built right onto a key base—including battery and speaker! Using a single unijunction transistor as its only active part, the tiny oscillator can be used by itself or with several earphones for group practice. The pulses from the transistor contain enough harmonics so you can pick up the signal on a radio—to simulate real "short-wave code" reception!

The diagram and photo show all the details you'll need to build this unit. The same circuit also makes a good portable signal injector for radio and hi-fi checking.

## Construction

A J-38 type key (still commonly sold as surplus) is the basis of the oscil-

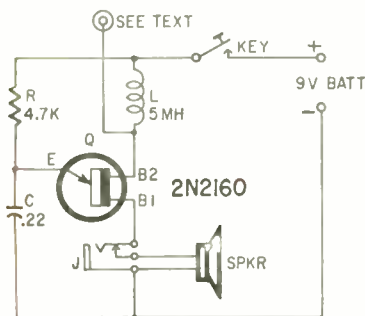

Unijunction oscillator uses only eight parts, including key and battery.

## VALUES OF R FOR VARIOUS FREQUENCIES

R (ohms)	Frequency (cycles)
4,110	1,000
5,600	850
6,800	600
8,200	500
10,000	400

lator, though any similar key with a 3 x 5-inch base can be used. If you choose the J-38, remove the binding posts and contact strips at the rear of the base, but leave the brass screw eye. Most of the components are fastened to a four-terminal type 4-140 Jones strip, one end of which is sawed off to clear the key subbase. The miniature jack is mounted on an L-shaped bracket fastened by a screw at the other end of the Jones strip. The 1 1/2-inch loudspeaker is mounted on a bracket tilted about 80°. The battery is held in place with thin wires through the screw eye and a hole in the speaker frame. A single-terminal solder lug strip connects the 5-mh

- Batt—9-volt battery (Eveready 216 or equivalent)
- C—0.22  $\mu$ f, 100 volts
- J—miniature closed-circuit jack (Lafayette MS-282 or equivalent)
- L—5-mh choke (Miller 6304 or equivalent)
- Q—2N2160 unijunction (G-E)
- R—4,700 ohms, 1/10 to 1/2 watt
- Spkr—1 1/2 inches, 10 ohms (Argonne AR-95 or equivalent)
- Telegraph key

(L) to the base-2 lead of the unijunction transistor and also provides a signal takeoff point.

## Applications

As a code oscillator, the little speaker gives an output loud enough to be heard clearly in a quiet room. The earphone from a transistor radio can be plugged into the jack, which can be connected either to cut out the speaker or to allow parallel operation of speaker and phones.

For group code practice with increased volume, connect a lead from the base-2-and-choke junction to the antenna terminal of a radio, with a .001- $\mu$ f capacitor in series. Tune to the lower end of the broadcast band, avoiding strong stations, and operate the key. A very good solid tone, about the same as from the little built-in speaker, will come from the radio.

The oscillator also makes a highly portable test set. With the parts given in the schematic, a signal of 1,000 cycles with amplitude spikes of 2 volts appears across the speaker coil. This signal can be used to check radios through either rf, i.f. or audio stages. If the miniature jack is to be used for test signals, wire it for parallel operation with the speaker. The closed-circuit switch of the J-38 key lets you run the oscillator continuously without upsetting the key contact adjustments. END



"Watch what you say—Harold's rigged his hearing aid to get fringe reception."

# THE TWO-STATE AMPLIFIER

**Radically new system of audio amplification. Learn how it works—next month we'll tell you how to build a super-efficient 40-watt PA amplifier on this principle.**

WHEN TRANSISTORS CAME ALONG, MOST audio hobbyists waxed enthusiastic. But mainly, transistor audio resolved into a substitution which eventually proved to have *some* advantages over tubes, but nothing really exciting. We have the same old choice of class A or class B with its variations. Oh, yes, single-ended push-pull can have a few more modifications with the addition of complementary symmetry.

But we're still faced with power limitations: the part of the supply power that doesn't get turned into audio has to be burned up as heat in the output transistors. This is where we could use a breakthrough.

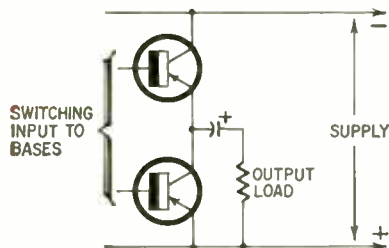

Fig. 1—Basic transformerless output, to illustrate two-state modulation.

## Two-state modulation

Somewhat over a year ago, some of the more technical publications announced a new "two-state modulation" which uses transistors in the way they work best—as switches—with high-speed pulse modulation and filtering, to produce audio. This form was also called class D, because that was the next available unused letter of the alphabet. I prefer the term "two-state" because that really describes what it does.

Let's take a look to see how far two-state modulation helps. Without getting into details of drive circuits (we can make them do what we want, if we decide it's worth while), Fig. 1 shows an output circuit of the single-ended push-pull variety that can be converted to "two-state" or "class-D"—whichever name you prefer. All it entails is, instead

By **NORMAN CROWHURST**

of applying *audio* to the bases, you *switch* them as indicated in Fig. 2.

When no audio is present, the switching sequence will be as at (a). The average output across the load is half the supply voltage. The coupling capacitor stops direct current from flowing into the load, but the average current through the two transistors will be half what the supply voltage would drive through the load without that capacitor to stop it. At the transistors, the current flows first through one, then through the other; at the load, it flows back and forth.

When an audio signal equivalent to part of the maximum output voltage is applied, the time interval during which each alternate transistor conducts or is cut off will be changed from the equal parts of (a) to the unequal parts of (b). Now the average voltage at the junction of the two transistors is momentarily higher than at (a), so the pulse contains an element of the audio.

At (c) is shown the condition for peak audio signal in one direction: the top transistor conducts, momentarily, for the whole pulse duration, while the bottom one stays off.

Without filtering, the output would be very "raw"—a lot of the ultrasonic switching (pulse) frequency present. This can be removed by filtering (Fig. 3). Also feedback can be used to linearize amplification, just as in any audio amplifier.

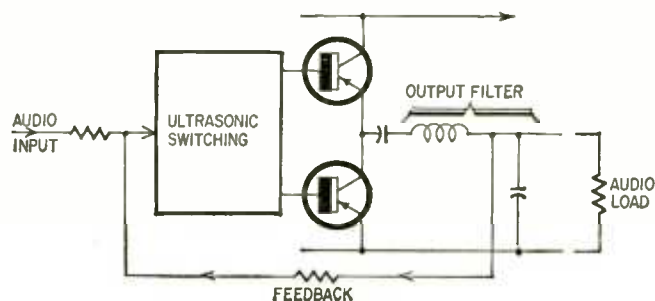

Fig. 3—Use of feedback around amplifier using two-state modulation.

This whole idea started from the fact that, when a transistor is cut off, it doesn't dissipate any power, and when it's all the way "on", so that full current flows with almost no voltage drop, it dissipates very little. By switching it rapidly so the "in-between" state lasts only a very short time, the dissipation normally associated with handling continuous audio waves is virtually eliminated.

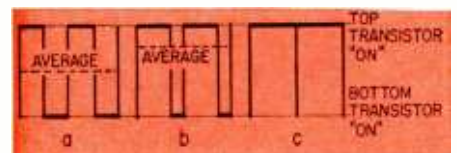

Fig. 2—Switching waveforms in two-state modulation.

That's a nice theory, until you stop to figure out what happens to the power you "save". Looking at Fig. 2, you see that with no audio present, switching at full voltage is occurring, with considerable high-frequency square-wave current being passed to the load, unless filtering is used. Only at an audio peak (Fig. 2-c) does the ultrasonic pulse momentarily disappear, so the current is momentarily "all audio."

Analyzing this step by step, with a sine wave as an example, Fig. 4 shows what happens. When the audio wave crosses the "zero line," the output is all ultrasonic power. At both peaks of the audio wave, all the power is momentarily audio. In between, there is always the same total power, but some of it is ultrasonic and some of it is audio.

So, we've made the transistors more

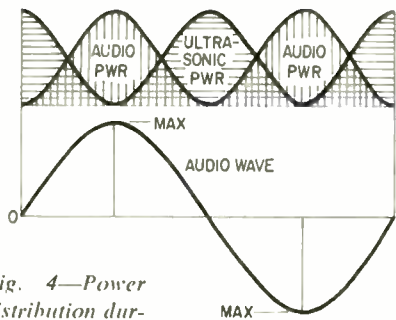

Fig. 4—Power distribution during the handling of a full-level audio sine wave by two-state modulation.

efficient and reduced their dissipation, but we're still taking the same power as a class-A circuit does from the supply. Instead of heating up the transistors with dc, we're heating up the load with ultrasonic power.

Of course, we don't do that. We filter out the ultrasonic. So where does that power go? You can deduce in some vague way that this must make the circuit behave more like class B, as far as its varying power demand goes. But the efficiency of the circuit now depends on a filter. And, to be efficient, the filter has to throw an inductive kick back to the transistors.

It's not turning out quite as easy as the announcement would have us believe. So I did some more thinking, to see what could be done to overcome this basic problem. What I came up with, after a few changes, was something that really is a breakthrough in power amplification with transistors. Finding it was quite exciting, so I'll take you through the steps that led to it, and in a later article give a construction piece that will enable you to make one for yourself.

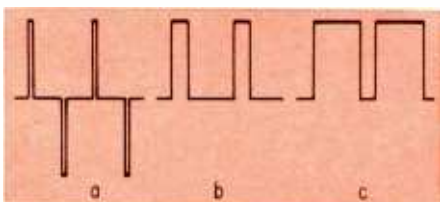

Fig. 5—Combining class-B with two-state modulation: (a) no audio; (b) about 1/4 amplitude in one direction; (c) full amplitude in the same direction.

### A double switching circuit

Fig. 5 illustrates the first step, in terms of waveform. Instead of switching the full voltage and current at quiescent, we switch only a very short pulse, alternately, in opposite directions. To introduce audio modulation, first we get rid of the pulse in the direction that is momentarily not needed, and then we make the pulse in the direction the audio momentarily takes grow in length (duration) until eventually it would fill the whole pulse period, as before.

Obviously there is much less power in the waveform at Fig. 5-a than in that

at Fig. 2-a. And the power in the waveforms of Fig. 5-b and -c is proportional to, in fact is virtually equal to, the power needed in the audio waveform at those instants.

It didn't prove difficult to produce this result—we'll see how in a moment—but I ran up against a snag. When the pulse in the unwanted direction disappears it produces distortion in the audio that the filtering cannot remove. At one point on the audio waveform, the pulse is there, of minimum workable duration; at the next point, it has completely disappeared. This produces a notch in the waveform.

Nothing can get rid of this effect. You can change "bias" (the duration of the minimum pulse) just as you change dc bias in a class-B circuit, to get rid of crossover distortion. But this crossover distortion is obstinate—it won't go as easily.

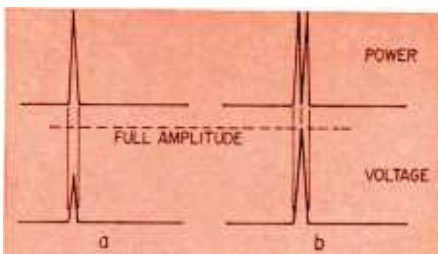

Fig. 6—Power relation with half-level and full-level pulse, each of minimum duration: (a) power makes one excursion to maximum; (b) with full level pulse, power makes two excursions to maximum, once during rise, once during fall.

### Combined pulse modulation

Take another look at the pulses. That perfectly square front is really an idealized pulse. All real pulses take a finite time to rise and fall, even if it's only a fraction of a microsecond. So couldn't we let it come and go gradually, once we've got it down to minimum width (duration)? And, while we're about it, we can save a little power at quiescent, too.

Fig. 6 illustrates: (a) shows a voltage pulse stopped in its switch-on at the halfway point and switched off immediately. Halfway on is the maximum power the transistor can dissipate—half voltage at half current; (b) is a full-amplitude pulse. After it passes the halfway point during the switch-on, power falls back to zero for full current (or close to zero). Then, as it switches off again, it repeats the power pulse, going through maximum at the halfway point on the voltage or current waveform.

So we can see that a full-amplitude, minimum-width pulse dissipates just twice as much in the transistor as a half-amplitude pulse. This is true only of minimum-width pulses—ones that switch off immediately they're on. As soon as we increase the pulse width or duration, due to modulation, it must go to full amplitude to keep minimum dissipation.

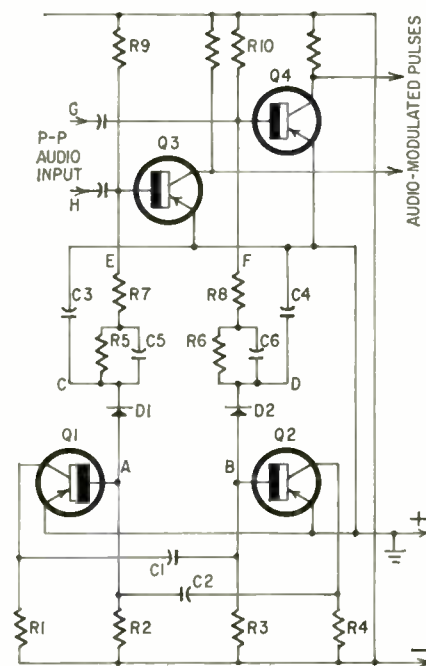

Fig. 7—Schematic to illustrate a way of achieving the modulation method shown in Fig. 5. This works, but with difficulties described in text.

### Basic circuits

That's what we do, now how do we do it? Fig. 7 shows the drive circuit that produces the variable-width pulses. Transistors Q1 and Q2 are a multivibrator that produces the ultrasonic switching frequency. Resistors R1, R4 can be 100-ohm 2-watt (for a 12-volt supply), and Q1, Q2 can be 2N395's. With base resistors R2, R3 each 1,000 ohms, and C1, C2 each .05  $\mu$ f, the switching frequency will be about 18 kc. Smaller capacitors will make the frequency correspondingly higher.

Interlaced sawteeth will be produced at points A and B (Fig. 8-a), but the slope finishes too soon to permit full period control to be used. This is overcome by using low-forward-resistance diodes D1, D2 (1N283's will serve here), which charge capacitors C3, C4 at each positive-going pulse, giving them time to discharge through R7, R8 and the base circuits of Q3, Q4. C3, C4 can be .01  $\mu$ f, and R7 and R8, 2,700 ohms. We'll come back to R5, R6 and C5, C6 in a moment. For now imagine R7, R8 are connected directly to the diode cathodes.

Resistors R9, R10 are chosen (they too can be 2,700 ohms each) so that Q3 and Q4 are maintained normally con-

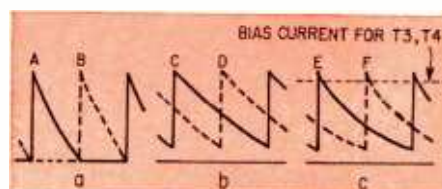

Fig. 8—Waveforms associated with multivibrator action (Fig. 7).

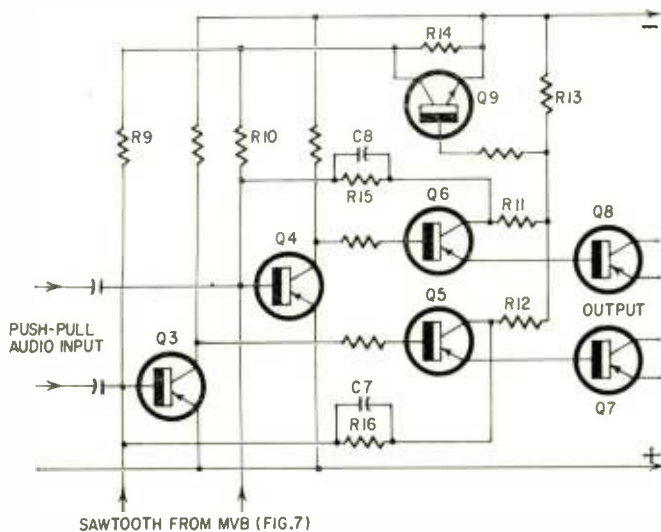

Fig. 9—Modification to circuit of Fig. 7 that overcomes all the problems.

ducting (for now the collector resistors can have any value to limit current to safe value for the transistors—which can be 2N323's), except for the very front edge of the pulse received through R7, R8. Now, if audio is applied at points G and H, push-pull, the duration of the pulses will be modulated, by varying the point at which transistors Q3, Q4 switch on again, after being switched off by the pulse.

The current through points E and F decreases after the initial pulse, and it is this decrease that determines when base current starts again in transistor Q3 or Q4, terminating the pulse. With the waveform shown at C and D (Fig. 8-b) the width of pulse is not very easy to control. Slight changes can make it either disappear altogether, or get too wide to use as a minimum pulse.

Without R5, R6 and C5, C6, the current waveform at E and F is the same as the voltage waveform at C and D. But introducing these components (R5, R6 can be 1,000 ohms; C5, C6 can be .0033  $\mu$ f) initial part of the trailing edges at E and F can be sharpened to the form shown at Fig. 8-c. This permits the minimum-width pulse to be controlled much more effectively.

That is the circuit that enables a pair of output push-pull transistors to be driven with a waveform of the type shown in Fig. 5. Now we have to introduce the amplitude control for minimum-width pulses. This is done with the additional circuitry of Fig. 9.

The negative-going pulses (switch-off of the transistors) at the collectors of Q3, Q4 are fed to the bases of drive transistors Q5, Q6 (these can be 2N524's). To provide the needed current, collector resistors for the mixers (Q3, Q4), can be 150 ohms 1 watt, and the resistors from collector to base of Q5, Q6 can be 120 ohms. These make the "off" condition of Q5 and Q6 more definite.

Now the variable pulses passed by Q5, Q6 will cause them to conduct (collectors to go positive). In Fig. 9,

part of the collector load for Q5, Q6 is separate (R11, R12) and part common (R13). This is so that resistor-capacitor combinations R15, C8 and R16, C7 can be used to sharpen the pulse waveforms by positive feedback. Later I found that R11 and R12 are not needed.

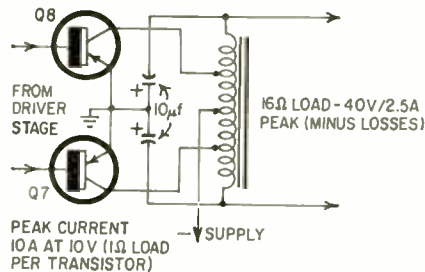

Fig. 10—How an autotransformer can be used in the output stage with this system. It transforms 16-ohm load to 1 ohm per side.

Common resistor R13, which later became the only one (R11 and R12 were eliminated), limits the drive current to output transistors Q7 and Q8. The voltage it develops is also used, through a suitable base resistor, to control n-p-n transistor Q9 (a 2N388), connected across a series resistor, R14, in series with bias resistors R9, R10. The value of this will be less than 1,000 ohms.

Normally, with no signal and no pulse, Q9 is nonconducting and a small voltage is dropped across R14. When a small pulse comes along, the negative voltage across R13 through the base resistor of Q9 causes it to conduct, momentarily increasing the bias current through R9 and R10, to the point where the pulse is terminated by causing Q3 or Q4 to conduct again.

Adding the n-p-n negative-pulse feedback not only allows a controlled pulse amplitude to be used (which the audio first offsets as amplitude modulation, until full height of one or the other is reached, so width modulation can begin), it also serves as an automatic "bias" for the output transistors, by controlling the quiescent pulse precisely.

To complete the picture of how the whole thing works, let's see how the out-

put stage can be arranged (Fig. 10). Output transistors Q7, Q8 are fed by the drive stage working as an emitter follower. (That it has current-limiting resistors in its collector circuits does not alter its being an emitter follower from the output transistor's viewpoint.)

The output transistors are collector-coupled to the load by a push-pull autotransformer, in this case a stepup. The two electrolytic capacitors across the output side, with the leakage inductance between taps, filter out the ultrasonic pulses that remain, so the load receives only audio components.

That's what goes into the making of this new circuit. Next month, I'll deal with a few more problems, and give complete details on a 40-watt public address amplifier you can construct for yourself. **END**

## 700 VOLTS LIGHTS 80 WELL

Recently, a high-school boy brought in a radio he had built in a school project. "It won't work," he moaned.

The set used a type 80 rectifier which lit normally when the set was turned on. Before testing the voltages, I decided to check the wiring first—fortunately!

The boy had wired the 5-volt filament of the 80 directly across the 700-volt secondary of the power transformer.

This should have burned out the filament of the rectifier.

But it didn't. Why? Pencil and pad and a little computing with Ohm's law brought the answer.

The rated filament current of an 80 rectifier is 2 amperes. The dc resistance of the power transformer's secondary winding is about 350 ohms. The resistance of the rectifier's filament is about 3 ohms. Thus, this circuit with a potential of some 706 volts had a resistance of 350 plus 3, or a total of 353 ohms.

Using Ohm's law, we find that the most current that can flow is  $I = E/R = 706/353 = 2$  amperes, the correct rated filament current of the 80. Thus, the tube lit normally.

Oddly, too, the voltage across the filament came to an approximate 6 volts, so, even though the wiring was awry, the rectifier tube received normal current and voltage.

I do not suggest that readers try this, because the filament wired across the power transformer's secondary amounts to a dead short, and if left connected for any time the winding will burn out.

Fortunately, this incorrectly wired receiver was not left on for long, so the power transformer was not damaged. When the filament of the rectifier was wired correctly and the secondary's high-voltage winding was hooked up as it should have been, the set worked perfectly.—Joseph D. Amorose



# WHAT, NO COLOR?

Trouble in the color section! Shouldn't be hard to find and fix

By HOMER L. DAVIDSON

THE TIME WAS 7:45 AM. I HAD JUST PUT my key in the front door of my shop when a dealer from a neighboring town pulled up with a color receiver. The boys helped unload the defective set, and symptoms were filled out on the service repair card. Brand-new color set, just out of the packing box, and no color. This was unusual; most color sets have been coming in with good purity and convergence. A little touch is all that is needed.

The color receiver was fired up with both uhf and channel 5 antennas tied on. A black-and-white picture tuned in on channel 5 was very good. There was no color telecast at that time, but a fellow can check a color set for color without a station, if he has a few tools and equipment. A good color bar

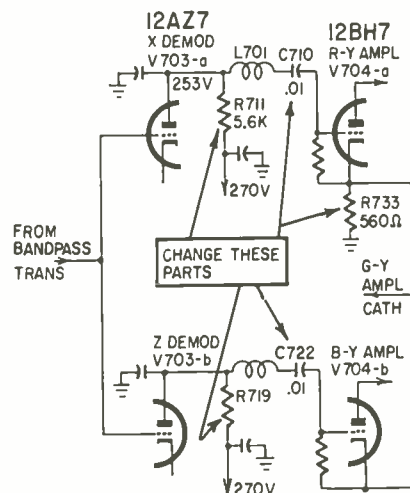
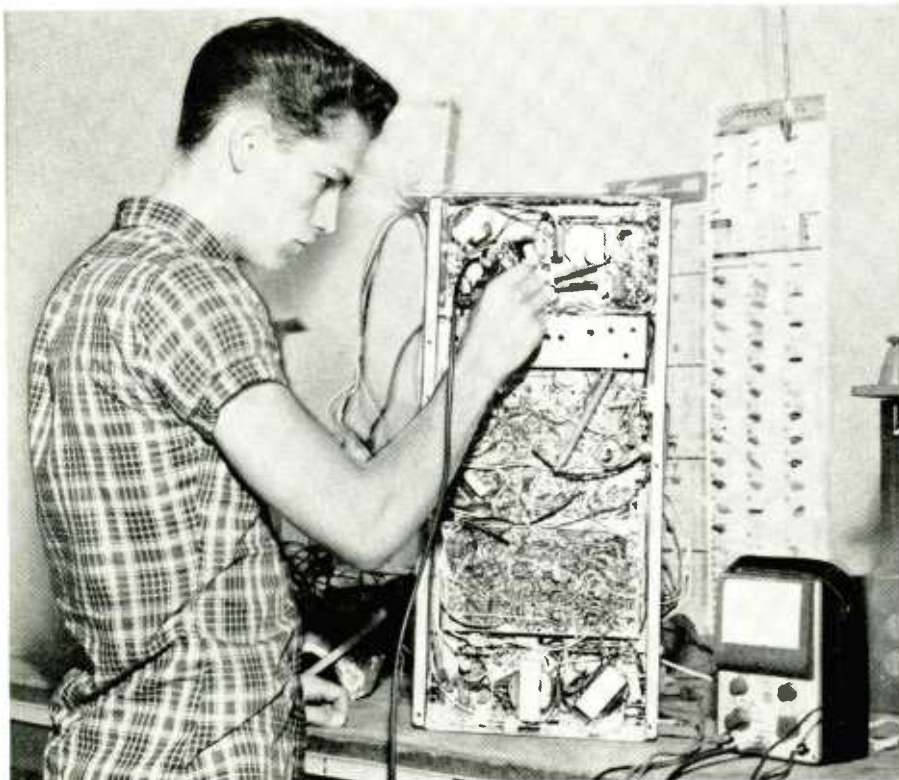

Fig. 1—Two very leaky capacitors burned up three resistors in this CTC 7.

generator works out fine.

From the front of the screen you can tell if the chroma section is performing by fine-tuning a black-and-white picture a little to one side. Notice the color fringing? Be sure the color killer control is up, and the color contrast control also. Color fringing or burst will appear next to the picture features, and show that the color section is working. Now turn the color contrast control down. The fringing disappears. When there is no color fringing, you know the color section is not working. This set had no color fringing.

You can also clip a color bar generator to the antenna terminals. If color bars show up on the screen, 9 times out of 10 the receiver is working. But the tenth time may get you. The signal from the generator is strong, and even if your defective receiver has too little color gain, the generator may make the color look real good. This also applies in a very-weak-signal area. Color receivers in fringe areas need all the gain they can get. In most fringe-area cases, the color killer control must be wide open.



Checking voltages in a color set. An 11-megohm-input-resistance vtvm is best for almost all checks.

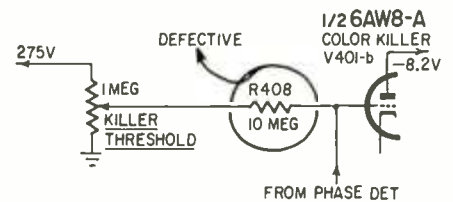

Fig. 2—When R408 increased, it kept the color amplifier partly cut off. Result: weak color.

(The color killer adjustment may be on the rear chassis apron, or inside [concentric with] another front control.)

I pulled the back off that new color set and took a peek inside. Of course there couldn't be too much wrong. Yes, it was just a crack in the side of a chroma oscillator tube (6GH8). The tube was white on top. The set must have had rough treatment in shipping.

Most color receivers follow much the same scheme. One tube may do two or three jobs, for there is often more than

one section in the tube envelope.

Don't be frightened of color TV! Servicing color is no different from servicing black-and-white, except for the chroma section and color picture tube. Of course the high voltage is a little hotter, but the principles are the same.

One of the best ways to check out a chroma section or learn just how it works is to pull a few tubes and see what they do to the color picture. First, pull the color oscillator, a 6U8. In the old color sets this tube was quite critical. Then a new, more reliable type, a 6EA8, came out. When the 3.58-mc oscillator, first bandpass amplifier, second bandpass amplifier or phase detector is pulled, there is no color. Pulling the reactance tube and burst amplifier will throw the color out of sync or phase. These appear as shaded color lines. If you pull the X-demodulator or R - Y amplifier, you eliminate the red from the picture. The Z-demodulator or B - Y amplifier takes away the blue color, and the G - Y removes the green.

To see what might actually go wrong in a chroma section, let's take some case histories.

In the older RCA CTC7 chassis, the 6U8 oscillators are quite critical. You can select them for the best mutual conductance ( $g_m$ ), or substitute a 6EA8 tube. In another chassis, a 12AZ7 X-demodulator had shorted. There wasn't any red in the picture. An open heater in this same tube, of course, will cause the same trouble.

A very common trouble in this chassis was leakage or shorting in coupling capacitors C710 and C722 between the demodulators and the R - Y, G - Y and B - Y amplifiers (Fig. 1). This placed a high B-plus voltage on the grids of these 12BH7 tubes, making them draw heavy current. The common cathode resistor R733 and plate loads R711 and R719 got hot and burned. All these parts had to be replaced. A vom would detect this trouble right away. After a while, when that chassis came to the shop for any repair, those two coupling capacitors were automatically replaced with 1,000-volt types.

Faulty B - Y, R - Y and G - Y amplifiers change the black-and-white

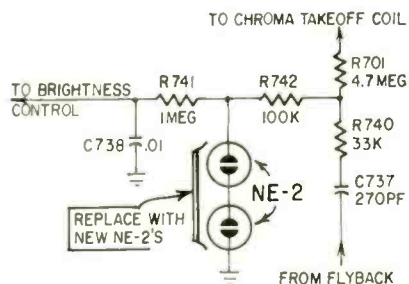
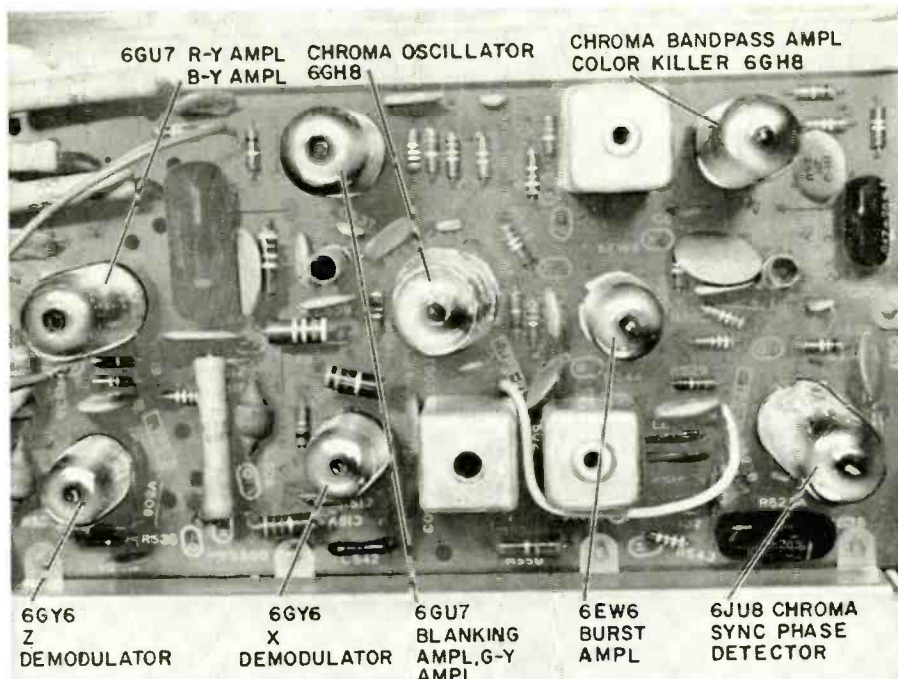

Fig. 3—Poor regulation (bad neons) in the brightness control circuit caused the picture to pull in when the control was advanced.



Color-circuits board from an RCA set, with all tubes and their functions called out.

color temperature on the screen. When one tube is replaced, it is best to put two known good ones in the set. These tubes and circuits are slightly heat-sensitive so let the set warm up before beginning black-and-white temperature adjustments.

In a RCA CTC10 chassis, only a small amount of color was visible. The chroma section was weak. Resistor R408 (Fig. 2) had increased in value and was cutting the color off. With the color bar generator on the antenna terminals, the color signal wasn't bad. But

when a color broadcast came on, you could hardly see it.

This same CTC10 and also chassis CTC11 had a common trouble: loss of color, poor brightness, and picture sides that would pull in when the brightness control was advanced. All this was caused by two little old neon lamps in the brightness control circuit. These two NE-2 bulbs are in series. When one or both are bad, they get cherry red. Replace both.

The circuit also extends into the chroma takeoff coil section. It is always

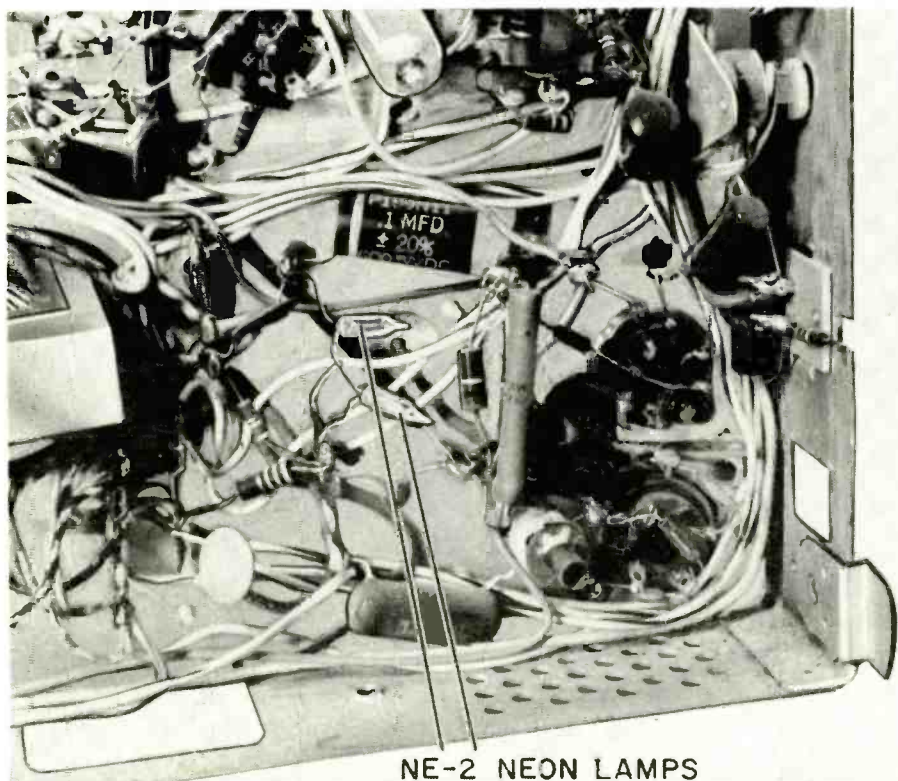

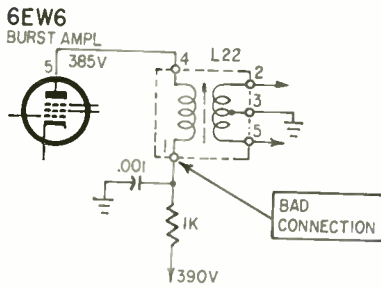

Fig. 4—More solder connections almost always mean more intermittents! This bad 'un in the burst amplifier caused on-and-off color.

wise to replace both these neon bulbs whenever the set is in for repair. Fig. 3 shows the location of these two neon bulbs.

If you are in a fringe color area, R701, a 3.3- or 4.7-megohm resistor, can be clipped out of the circuit. This is in one leg of the chroma takeoff coil and is located at the rear and on top of the chassis. Disconnecting it will give you more color gain.

Let's take the case of an Admiral 24E2 color chassis. The color would come and go intermittently. All color tubes were replaced but, if any color tube was wiggled, color still came and went. The chassis was pulled and turned over. When I pushed up and down on the color-section printed-circuit board, color was intermittent. Taking a closer look at the board, it seemed that around the burst amplifier the trouble really acted up.

I put a voltmeter on the plate of the 6EW6 burst amplifier (Fig. 4). The voltage rose and fell with the color. Coil terminal 1 was also dead. But just around it on the etched wiring, the voltmeter read 400 volts. A poor solder connection at pin 1 was corrected, clearing up the intermittent.

A farmer pulled in with his pickup truck and dropped off an RCA CTC11C color set. The symptoms were horizontal color bars, not in sync or in phase. I replaced the reactance tube and burst amplifier—to no avail. The chassis was pulled.

I knew the trouble was somewhere in the phase and sync sections. Then I checked voltages and found a shorted .01- $\mu$ f postage-stamp capacitor was the trouble. It had shorted and R713 was warm. Both parts were replaced and the color picture was back to normal. To be on the safe side, I went through the color afpe (automatic frequency and phase control) alignment. Do this according to the set designer's instructions. The capacitor and resistor are shown in Fig. 5.

In the CTC11C, color gain can be increased by removing R701, a 4.7-megohm resistor.

On the RCA CTC15 and CTC16 chassis, uhf stations seemed to cause os-

cillations in the set when a color program was tuned in. Right at the point of color reception, as you turned the uhf dial, heavy black lines appeared. They would wander and the trouble proved to be oscillations in the age circuit of the uhf tuner. A .047- $\mu$ f capacitor was soldered to the green wire and to ground to eliminate them. This trouble appeared only on the uhf band. Before I deliver a new set, I always solder in a new capacitor.

The CTC16 chassis also suffered from intermittent contrast, which affected color reception. A 50- $\mu$ f electrolytic capacitor in the contrast circuit (Fig. 6) was the culprit.

Only a few color cases have been mentioned here, but of course there are many others. We might start at the antenna. Never use one that is too sharp (too narrow in bandwidth) for color reception. Use a broad-band antenna. Especially on the uhf band, do not use Yagi type antennas for color. Several small stacked bow-tie translator antennas should be used for good bandwidth and gain.

As an example, a doctor in our town moved from a smaller house to a larger one down by the river. His color set worked fine at the old place but not at the new one. After several hours of checking I came to the conclusion that the set was OK. The uhf black-and-white picture was perfect, but there was no color. Yes, the station was transmitting color, but Doc wasn't getting it.

The uhf antenna was old and looked like an off-breed or a home-

made affair. A new four-stacked bow-tie antenna was installed with a round polyethylene-filled lead. We now had plenty of good color.

Remember also that color reception cannot be any better than the black-and-white picture. If there is snow in the black-and-white picture, you will have colored snow in the color picture. The tuner, i.f. stages and video stages of the color receiver must be in tip-top shape. In a fringe area, a good antenna, lead-in and receiver are "musts."

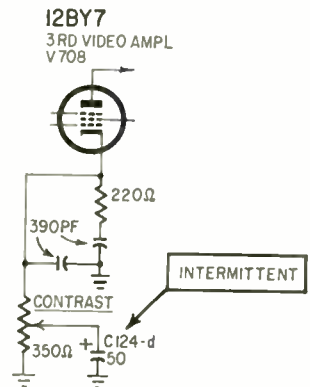

Fig. 6—Intermittent electrolytic here caused sudden contrast changes.

Of course, if the color picture tube is weak or one of the guns is out, color will be poor. The color picture tube acts just like a black-and-white tube when it goes bad. But you do have three guns instead of one. If red is gone or weak, check the picture tube. (Nine times out of ten, the red gun goes down before the other two.) A good color picture-tube checker is a must.

You can check the color picture tube for color in the home if you do not have a tester along. Take the convergence switch box and short out two of the guns at a time. With a little experience you can tell a weak gun from a good one. We might add that any of these colors will be missing also if the B - Y, G - Y, and R - Y amplifier tubes or components are defective.

When the color receiver repair is finished and the chassis is back in its cabinet, several adjustments have to be made. First, degauss the picture tube. Set the focus control and purity. Be sure the screen does not have a touch of red or green in the corners. Purity adjustments take only a few minutes. Hook up the color dot-bar generator and check convergence. Adjusting the convergence magnets may be all that is needed to touch up the black-and-white picture. Be sure to check the black-and-white temperature adjustment. Sometimes a slight blue tint is about right. Set the color killer and age controls. Finally, check out the receiver on a color program.

END

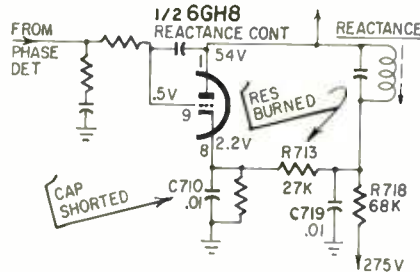
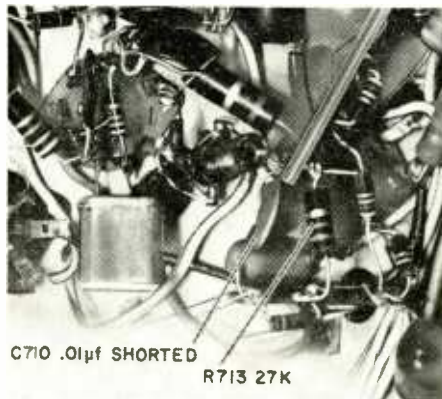

Fig. 5—Shorted C710 caused out-of-sync color bars.



# CYCLOIDS FOR FREQUENCY MEASUREMENT

They're more flexible  
and often  
more accurate than  
Lissajous figures

By TOM JASKI

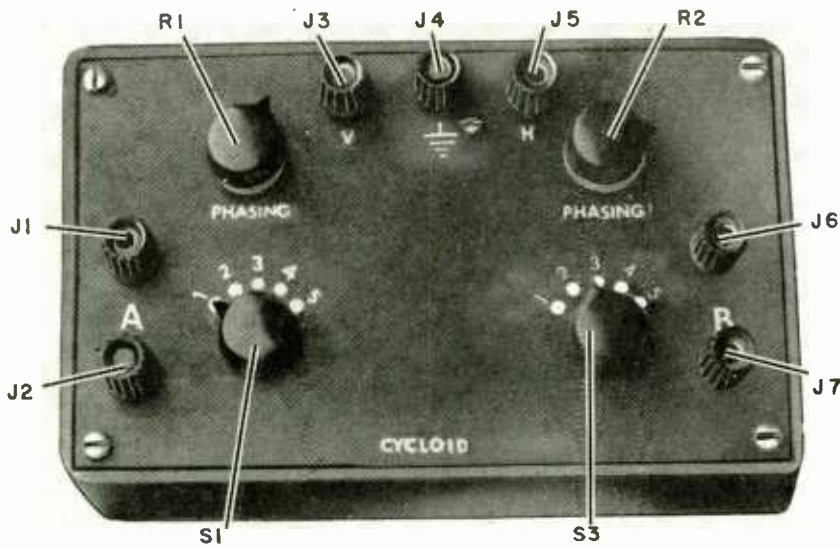

The completed scope adapter.

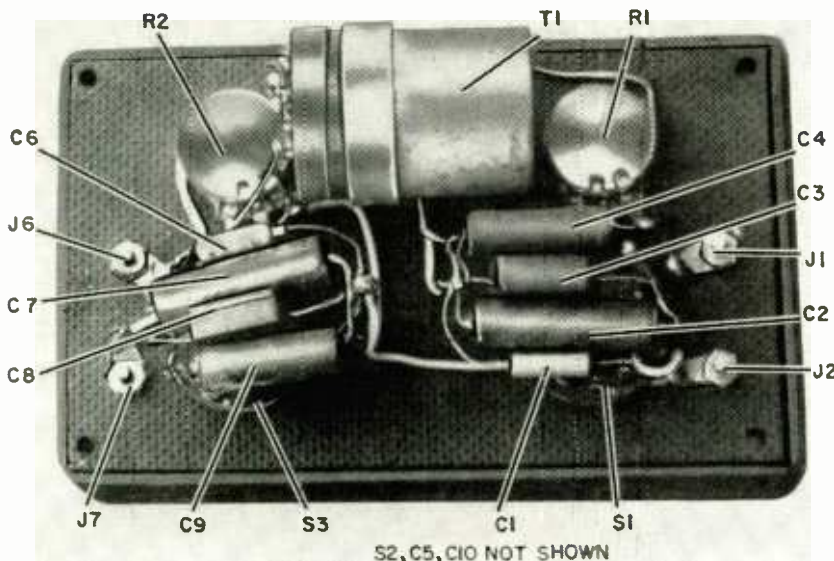

All components are mounted on the back of the front panel.

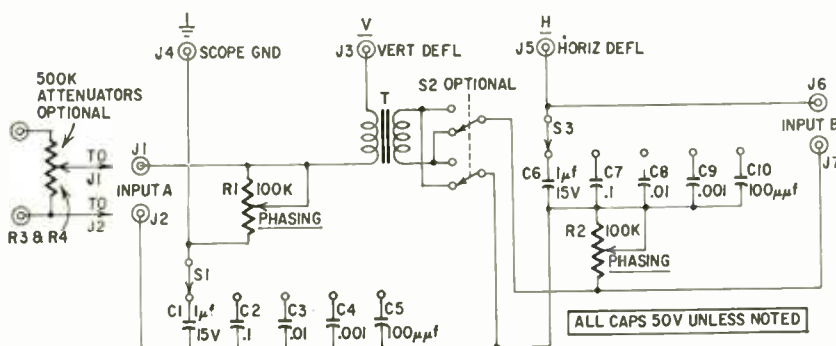

- R1, R2—pot, 100,000 ohms
- R3, R4—pot, 500,000 ohms (optional)
- C1, C6—1  $\mu$ f, 15 volts
- C2, C7—0.1  $\mu$ f
- C3, C8—0.01  $\mu$ f
- C4, C9—0.001  $\mu$ f
- C5, C10—100  $\mu$ uf
- All capacitors 50 volts unless noted
- J1, J2, J3, J4, J5, J6, J7—3-way binding posts
- S1, S3—single-pole 5-position rotary switch
- S2—dpdt toggle (optional)
- T—audio transformer, high impedance, 1:1 up to 3:1 (ratio not critical)
- Plastic box and cover, 3 1/16 x 6 x 2 inches
- Miscellaneous hardware

Fig. 1—Circuit of simple scope adapter that will permit you to display cycloids.

R1, R4—pot, 500,000 ohms  
 R2, R3—dual pots, 100,000 ohms per section, linear  
 R5, R6—100,000 ohms, 1/2 watt  
 C1, C6, C11, C16—1  $\mu$ f  
 C2, C7, C12, C17—0.1  $\mu$ f  
 C3, C8, C13, C18—0.01  $\mu$ f  
 C4, C9, C14, C19—0.001  $\mu$ f  
 C5, C10, C15, C20—100  $\mu$ f  
 All capacitors 50 volts

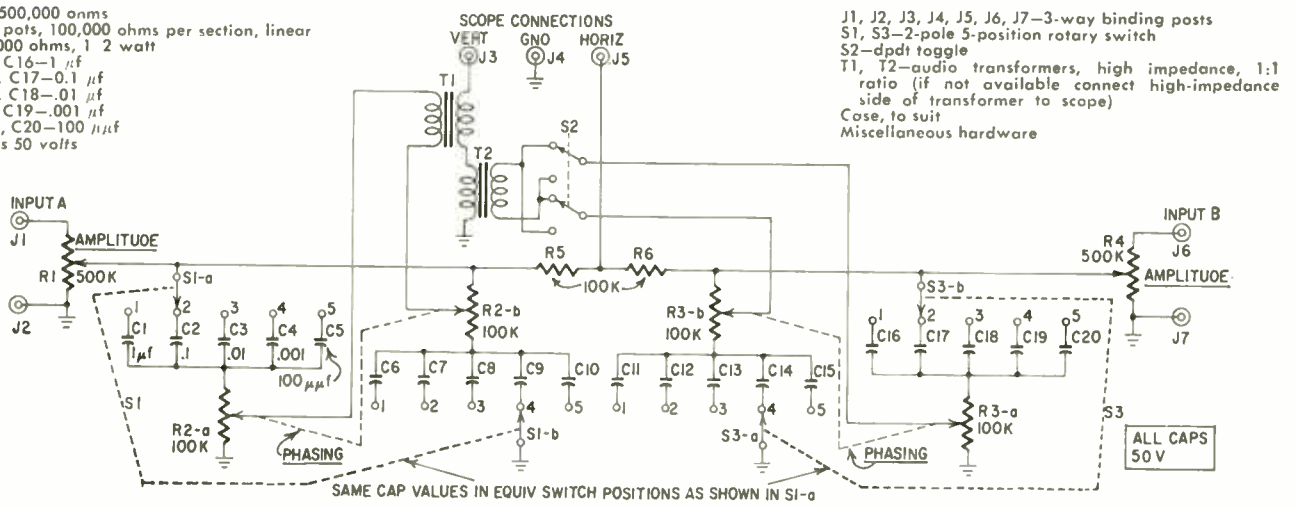

Fig. 2—A more refined version of the adapter shown in Fig. 1.

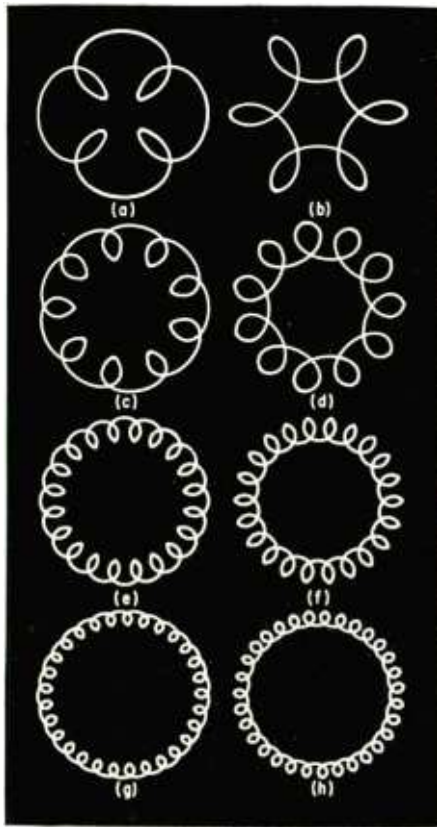

Fig. 3—Cycloid patterns of various frequency ratios. Outside and inside loop patterns are shown for each: a, b—5:1; c, d—10:1; e, f—21:1; g, h—30:1.

well as magnitude. The circuit in Fig. 1 has one unfortunate aspect. When we change the phase (with R1 or R2), we also change the magnitude. A much improved version of the circuit (also much more expensive) is shown in Fig. 2. Here phase shifting does not affect the magnitude of the signal. The two transformers are needed to isolate the A and B shifted portions, because the scope amplifiers have a common ground. A three-winding transformer could replace the two transformers. Winding ratios are not critical, but the closer you can get to 1:1:1, the better.

The equipment in Fig. 1 does not have attenuators, on the assumption that the sources will include these. If not, they must be added, as they were in Fig. 2.

If you expect to measure frequency often, the more elaborate circuit will pay its way in convenience. Compared to the cost of a frequency meter, it is inexpensive.

#### How to read cycloids

Before we can read cycloids we must create them. To make it easy on yourself, follow this simple procedure:

1. Select the lower frequency of the two and apply it to the scope amplifiers, keeping the other voltage at zero. Now adjust phase and amplitude of the low-frequency voltage until you get a satisfactory circle.

2. Turn the low-frequency voltage to zero and apply the high-frequency

voltage. Adjust this for phase and amplitude until you get a very small circle.

3. Return the amplitude of the low-frequency voltage to its previous value. The result should be a cycloid, such as you see in Fig. 3. Whether you will get an epicycloid or a hypocycloid depends on the phase of the two voltages at the transformer. By throwing the reversing switch, you can change from one kind of cycloid to the other.

Reading cycloids is simple. For the kind shown in Fig. 3, you count the loops made by the small voltage. If the loops are inside the circle, add 1, for the number of loops plus 1 is the frequency ratio. If the loops are outside the circle, subtract 1. The number of loops minus 1 is the frequency ratio. Now as you can see, ratios of as much as 51 to 1 are duck soup with such cycloids. Ratios of 100 to 1 can be counted.

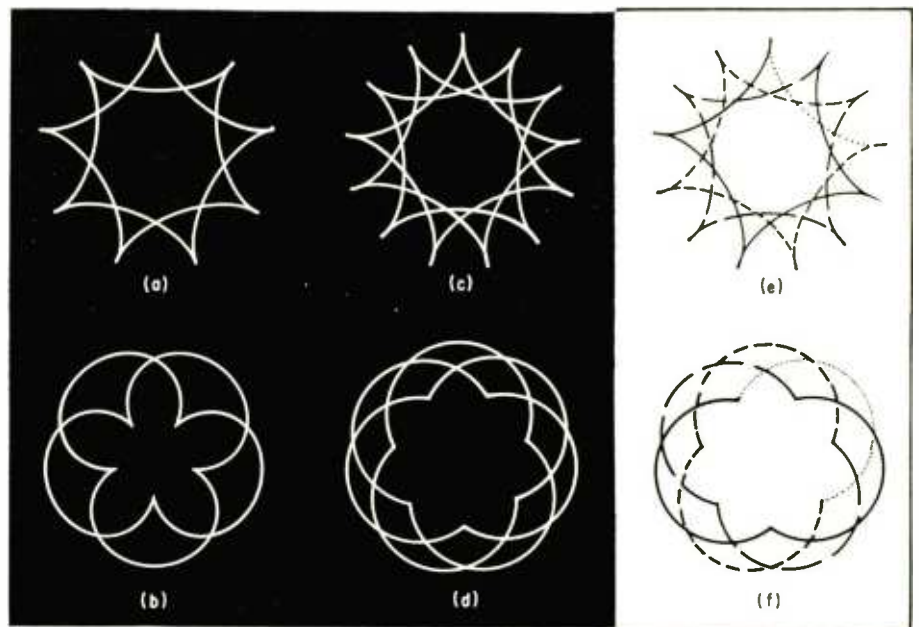

Fig. 4(a, b)—Outside- and inside-loop patterns for 3 1/2:1 ratio; (c, d)—same for 3 1/2:1 ratio; (e, f)—figures c and d redrawn to show number of overlaps. In each, start with short-dash line and go around, counterclockwise in e and clockwise in f. Count short-dash path as one lap; next, long-dash, then solid, totaling three. Dotted line completes figure and is not counted.

# Are These Fallacies Stopping You From Building Heathkit Electronics?

**A "YES" ANSWER CAN COST YOU HUNDREDS OF DOLLARS!**

**Fallacy:** *"Too Technical & Complicated To Build".*

**FACT:** Every Heathkit is designed to be "beginner-built". This is proven by the thousands of people from children to senior citizens, from all walks of life, who have built them. Over 300 years of accumulated kit-engineering, the most experienced staff in the business, insure your success. No special skills or knowledge are needed . . . just some spare time and a few simple tools . . . we supply everything else. Famous Heathkit non-technical, step-by-step instructions and clear "exploded" diagrams identify each part, show you exactly what to do and how to do it . . . even how to solder. Nothing is left to chance. Send for a manual and see for yourself!

**Fallacy:** *"Takes Too Much Time To Build It".*

**FACT:** The average Heathkit can be built in just a few evenings. Kit builders regard this time as well spent, not only in terms of dollar savings, but in fun and relaxation. It's like getting two hobbies for the price of one! You'll be surprised how fast you finish, working only a few hours each evening. And the pride of craftsmanship and self-satisfaction when you're done makes it more than worth the small effort.

**Fallacy:** *"Doesn't Perform As Well As Factory-Built Models".*

**FACT:** The first Heathkit design consideration is performance. Our special staff of kit engineers use the latest, most sophisticated techniques in the "state of the art". And much effort is devoted to developing new design. For example, Heath introduced the first successful all-transistor stereo components. Only after rigid performance tests are passed, does kit assembly enter the picture. But don't take our word for it. Compare the specifications . . . read the Heathkit reviews by respected authors and editors . . . or ask any Heathkit owner!

**Fallacy:** *"Kits Use Inferior Parts".*

**FACT:** Heath's reputation for top quality has always been respected by kit builders and non-kitbuilders alike. In fact, we're noted for our conservative ratings. Actually our engineers "over-specify" parts to insure that extra margin for best performance and long, dependable life. As you build your kit, you'll recognize famous names like GE, Sylvania, RCA, Weston, Tung-Sol, etc., on the parts you use.

**Fallacy:** *"Because Of Its Low Price, It Just Can't Be As Good".*

**FACT:** Because you build it yourself, you save the labor cost of factory-built models. Even more significant, buying direct from the Heath factory eliminates high dealer markups. With Heath, your money goes where it should . . . in parts quality, not product distribution.

**Fallacy:** *"Takes Special Test Gear To Align It".*

**FACT:** A prerequisite to every Heathkit design is that they meet specifications after assembly *without* instrument alignment. All critical circuits are completely wired and prealigned at the Heath factory. All other alignment steps are accomplished with the simple "Alignment Without Instruments" instructions in each Heathkit manual.

**Fallacy:** *"If Something Goes Wrong, I Can't Get It Repaired".*

**FACT:** The Heath Company's most vital concern is your satisfaction, and every effort is made towards this end. If you do encounter problems, first check the "In Case Of Difficulty" section, and "Trouble-Shooting" chart in each manual. Because of the intimate knowledge gained through kit assembly, most kit builders make repairs themselves, thus saving service charges. Heath also maintains a staff of consultants to help & advise you . . . just drop them a note. And you can always take advantage of factory service facilities, as well as local authorized Heathkit service centers.

**Fallacy:** *"Mail Order Doesn't Offer the Extra Services I Want".*

**FACT:** Mail order selling is one of the oldest and most reliable forms of product distribution. Its current growth rate is higher than retailing. The Heath Company's success has been built on it. We offer more services than many retailers . . . liberal credit terms, advice on product selection, and complete servicing facilities. In addition, you enjoy the added savings of direct-to-you delivery, and the convenience of shopping right in your home. And who doesn't get excited when a package arrives in the mail?

**Join The Thousands Who Put Their Confidence In Heath . . . Send For Your FREE Catalog Now!**

# It's Like Getting A Training Course Free...

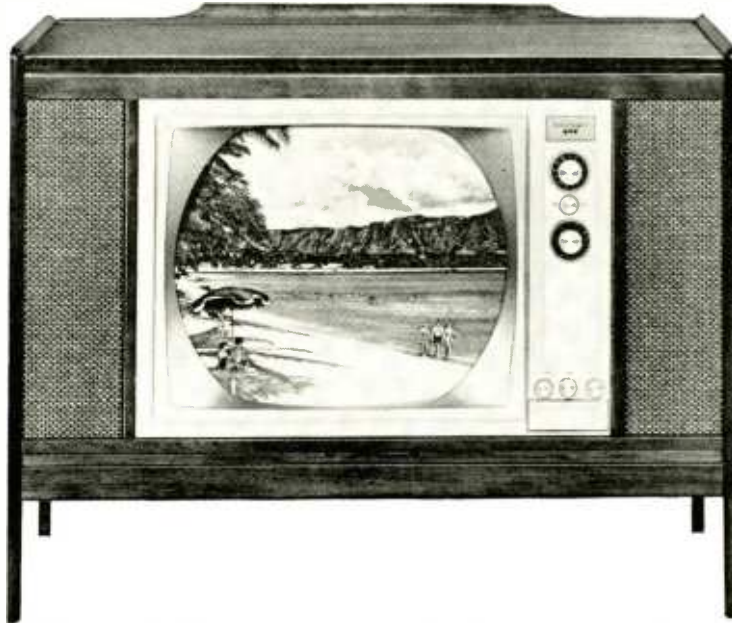

## When You Build A Heathkit® Color TV...\$399

**"Do-It-Yourself" Plus Famous Heathkit Manual Make You An Expert!** What better way to learn about color TV than to build one yourself! And that's exactly what you do with the Heathkit 21" All-Channel, High Fidelity Color set. You do the complete job . . . mount the parts, wire the leads (tuners, I.F. and high voltage sections are prebuilt & aligned), and even converge, align, and adjust the picture with the degaussing coil and built-in dot generator. Takes around 25 hours.

And with this superb set, you go a step further. The big 1¼ lb., 138-page instruction manual is an education itself on color TV operation & theory. Hubert Lockett aptly describes it in an article from *Popular Science*: "The manual provided with the kit is a masterpiece. It is nearly a half-inch thick and lavishly illustrated with drawings, photographs, X-ray views of circuit boards, and even 32 plates in full color. Only 28 pages of the 138-page manual are devoted to the usual step-by-step procedures. The rest covers the theory of operation, detailed descriptions of each circuit, trouble-shooting, service information, adjustments, and operation."

And The Performance? TV serviceman E. C. Van Dyke of Baltimore wrote: "After constructing Kit #GR-53A, I can truthfully say that I have

never seen a color television look so good!" About all we can add are the features for your comparison:

- Built-in Service Center . . . includes degaussing coil & dot generator to demagnetize, adjust & maintain set
- 26 tube, 8 diode circuit; 24,000 volt regulated picture power
- Deluxe Standard-Kollsman VHF tuner with push-to-tune fine tuning for individual channels, plus transistorized UHF tuner
- High definition 70° 21" color tube with bonded safety glass
- Automatic color control & gated automatic gain control
- Line Thermistor for longer tube life
- Circuit breaker protection; transformer operated
- Two hi-fi outputs plus tone control
- Chassis mounts on one-piece metal frame for easy set-up & servicing
- Only color TV you can install 3 ways—wall, custom cabinet or either Heath factory-assembled cabinets
- 1-year warranty on picture tube, 90 days on all other parts. Get full details & specifications by sending for your FREE Heathkit catalog. Or better yet, use the coupon and order your set now!

Kit GR-53A, chassis, tubes, mask, UHF & VHF tuners, mounting kit, special 6" x 9" speaker, 127 lbs. . . . . \$399.00  
 Assembled GRA-53-7, walnut wood cabinet (illust. above), 85 lbs. . . \$115.00  
 Assembled GRA-53-6, walnut-finished hardboard cabinet, 52 lbs. . . \$49.00

### COMPLETE TEST LINE FOR EVERY SERVICING NEED!



TV Sweep Alignment Generator, Kit IG-52, 14 lbs. . . . \$67.95



Color Bar & Dot Generator, Kit IG-62, 13 lbs. . . . \$64.95

### Now Available Kit Or Assembled!

- VTVM . . . Kit IM-11, \$24.95; Assemb. IMW-11, \$39.95
- Service-Bench VTVM . . . Kit IM-13, \$32.95; Assemb. IMW-13, \$49.95
- AC VTVM . . . Kit IM-21, \$33.95; Assemb. IMW-21, \$52.95
- Capacitor Checker . . . Kit IT-11, \$29.95; Assemb. ITW-11, \$49.95
- 5" Oscilloscope . . . Kit IO-12, \$76.95; Assemb. IOW-12, \$126.95
- Audio Generator . . . Kit IG-72, \$41.95; Assemb. IGW-72, \$64.95
- RF Signal Generator . . . Kit IG-102, \$27.95; Assemb. IGW-102, \$54.95
- Variable-Voltage Regulated Power Supply . . . Kit IP-32, \$56.95; Assemb. IPW-32, \$84.95
- Regulated DC Power Supply . . . Kit IP-20, \$72.95; Assemb. IPW-20, \$114.95
- Battery Eliminator . . . Kit IP-12, \$47.50; Assemb. IPW-12, \$59.95



## FREE!

See these and over 250 other Heathkits. Save up to 50% by doing the easy assembly yourself. Send for your FREE Heathkit catalog today.

HEATH COMPANY, Dept. 20-7 Benton Harbor, Michigan 49023  
 In Canada: Daystrom Ltd., Cooksville, Ontario

Please send FREE 1965 Heathkit Catalog.

Enclosed is \$ \_\_\_\_\_, plus shipping.

Please send model(s) \_\_\_\_\_

Name \_\_\_\_\_ (Please Print)

Address \_\_\_\_\_

City \_\_\_\_\_ State \_\_\_\_\_ Zip \_\_\_\_\_

Prices & Specifications subject to change without notice.

CL-208

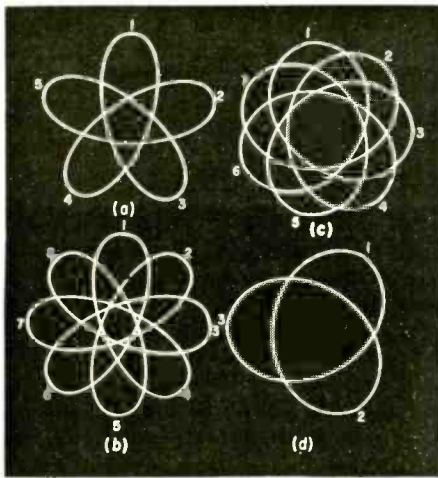

Fig. 5—Outside loop patterns showing ratios of less than 1. a—2:3. b—3:5. c—2:5. d—1:2.

Fractional ratios are not much more difficult. Here, you must count not only the cusps (loops) but also the number of overlapping similar figures made by the pattern. Sometimes these overlapping figures are easy to see, as in Fig. 4-a, where there are obviously two figures. Then the formulas for the frequency ratios are:

$$\text{ratio} = \frac{f \text{ (loops)} + p \text{ (figures)}}{p \text{ (figures)}}$$

$$\text{ratio} = \frac{f \text{ (loops)} - p \text{ (figures)}}{p \text{ (figures)}}$$

Let us examine some of these figures. In Fig. 4-e and f, the possible "figures" for both kinds of cycloids developed from Fig. 4-c and d have been drawn. Still other configurations are possible.

#### Ratios less than 1

When dealing with ratios of less than 1, outside loops are more easily read, but the technique of reading them is different. Take a look at the patterns in Fig. 5. All represent ratios of less than 1.

To get the ratio for Fig. 5-a, number all the loops as shown. Then follow the trace from loop 1 counterclockwise. It goes to loop 3, excluding loops 2, 4 and 5. Count the number of skipped loops between loops 1 and 3 in each direction. We skipped one at the right side (loop 2) and two at the left side (loops 5 and 4). As we are dealing with outside loops, we add 1 to our figures. This gives 1 plus 1, or 2 (going clockwise), and 2 plus 1, or 3 (going counterclockwise). Assembled into a ratio, we get 2 to 3. But it might also be read 3 to 2. How do we know which is correct?

It's easier than you might think. We simply increase the frequency of one of the input signals—for example

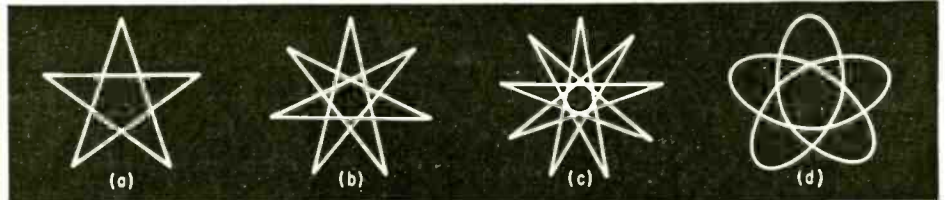

Fig. 6—Star figures formed by varying the phase and amplitude settings are also interesting.

the signal of known frequency. If it is the higher frequency the greater number of loops skipped (loops 4 and 5 in Fig. 5-a) will increase, but not the smaller. If it is the lower frequency the smaller number of loops (loop 2 in the example) will increase, but not the larger.

Now let's try again, this time with Fig. 5-b. Again number all the loops. Now follow the trace counterclockwise from loop 1. It goes to loop 4 excluding two loops going clockwise (right side) and four loops going counterclockwise (left side). Adding 1 to each figure gives us a 3 to 5 ratio. Now you figure the ratios for the other two figures. Remember to check to see which frequency is larger, so you know how to set up the ratio. You should count 2 to 5 for Fig. 5-c and 1 to 2 for Fig. 5-d.

#### Rotating figures

Like Lissajous figures, cycloids may also rotate a little. In that case the same rule applies. Count the number of cusps passing a given point per second. Then the frequency deviation from the exact ratio is given by the count. Whether these are to be subtracted or added you can find easily enough by

changing one frequency a little. If increasing the frequency makes the figure rotate faster, the count must be added to the frequency you have changed (calculated from the other one and the ratio) or subtracted from the frequency you did not change to make the pattern rotate faster.

Thus if you find a figure that indicates a ratio of 5 to 1, and your known frequency is 60 cycles, the other one is near 300. If the pattern rotates so that 3 cusps per second pass the reference point (which is any arbitrary point outside the figure), and the pattern rotates faster if you increase the higher frequency, the actual frequency is 303 cycles.

Many interesting figures can be made with cycloids. They depend on the voltage and phase adjustments you use. Some examples are shown in Fig. 6. The same voltages could have caused daisy-like patterns with different voltage adjustments. Thus cycloids provide not only an accurate way of measuring relative frequency in very fine steps and over a large range, but also can provide hours of amusement if you like to create artistic patterns on the scope.

END

## A TUBE WITH A SENSE OF TIME?

A swindle in stolen color television sets is reported to be operating in some areas. The swindlers manage to sell the same set many times over to different customers. The perpetrators allegedly net \$100 on each "sale" of the set.

These "sharpies" contact an individual with whom they are acquainted and ask him if he is interested in purchasing a color TV set for \$100, at the same time letting the prospective customer know that the set is stolen. The set need not be paid for until it is delivered to the home.

Upon delivery of the set to the home, the buyer is advised that if anything should go wrong with the set to call one of them (dispensers of the stolen sets) immediately, since they have to send one of their own repairmen so the theft will not be discovered.

The swindlers have a tube in the set that functions for approximately 48 hours, after which the set no longer works. The buyer contacts the swindlers

for repair service, and they in turn send one of their own men to the home. After looking over the set, the alleged repairman states that he has to take it back to the shop to work on it. It is never returned, and the buyer is out \$100.

When the customer contacts the swindlers to inquire when the set will be returned, he is told that the police have confiscated it and that he—the customer—is very fortunate in not being involved for having purchased the allegedly stolen set.

The swindlers keep repeating this method of operation as often as they can find someone to pay \$100—always using the same TV set. —From the FBI Law Enforcement Bulletin

What we want to know is how to rig a tube (or any other part) to make it work for just 48 hours or thereabouts, rather than cut out after 8 or wobble along for a week. We welcome suggestions from our more devious readers. In fact, we'll print the best ideas.—Editor



# EQUIPMENT REPORT

## Harman-Kardon SR-900

WHEN MOST AUDIO MANUFACTURERS were still timidly clinging to tube design, Harman-Kardon was up to its neck in transistors. As far back as 1961, the Harman-Kardon engineering team—then headed by Stewart Hegeman—developed the Citation A all-transistor pre-amp, which still sets a high mark in sound reproduction. Now the firm's long experience in solid-state audio has been applied to all-in-one receivers. The result is the Stratophonic series.



The classic moniker is intended to signify "high-sounding," and the SR-900—top model of the series—fully justifies its name. Its performance places it clearly in the forefront of today's solid-state receivers. Surprisingly, its price of \$469 is almost competitive with top-bracket tube units.

The first thing I expect from solid-state equipment—no matter what its other virtues—is a low hum level. In this respect, the SR-900 proved truly outstanding. Even with the volume control in maximum position, and with the selector switch on magnetic phono input, the background remains inaudible. The music emerges against virtual silence. In my test location—a country house in the Berkshire hills of Massachusetts, remote from traffic and other noises—this total absence of hum was really striking and added greatly to the dramatic impact of the music.

The backwoods test location also revealed the excellent sensitivity of the SR-900. With a six-element Yagi roof antenna, the tuner section provided full limiting on FM stations from New York City, more than a hundred air miles away. With just about every station between Boston and Philadelphia crowding the dial, I had no selectivity trouble.

Later I left the outer fringe and took the unit to New York City to try it under signal conditions typical of metropolitan areas. Most local stations came in fine without any antenna at all—further proof of the SR-900's sensitivity. And when an indoor antenna was connected and excessive signal strength tipped the tuning meter all the way to maximum, there were no audible signs of overloading. It would seem that Harman-Kardon has successfully solved the most obstinate problem of transistor tuner design: how to accommodate a

wide range of incoming signal strengths without overloading rf stages.

When the adjustable interstation muting is switched in, the flywheel tuning rolls silently from one station to another without white noise between channels. The Stereologic circuit (selected by a special position on the program selector switch) senses when a station is broadcasting in stereo and automatically switches the receiver to stereo, lighting the stereo indicator. When a mono station is tuned in, the SR-900 automatically reverts to the mono mode. A control at the rear lets you select the response threshold for this kind of automation. If a stereo signal comes in too weak for satisfactory stereo reception, it is automatically reproduced in mono, so that noise and distortion are kept at a minimum.

The sound quality of the SR-900 is, for all practical purposes, limited only by the quality of the signal source. A live stereo broadcast or an exceptionally fine recording reproduced on the SR-900 is a striking demonstration of "transistor sound" at its best. The music comes through with startling clarity. Most important, there is no harshness in the strings or solo woodwinds at low volume. Evidently Harman-Kardon succeeded in eliminating the switching distortion in the class-B output stages responsible for the typical harshness of some earlier transistor amplifiers.

Thanks to superb damping, transients are crisp and sharp, and the bass in particular is well controlled. With the bass controls well advanced, the bass from our K.I.H. speakers remained tight and solid, without a trace of boominess.

The discreetly elegant front panel is very sensibly laid out for convenience of operation. In addition to the customary controls, it displays several uncommon features. One is a switch that lets the signal bypass the tone controls, eliminating the phase lag inevitably introduced by the tone control circuits. Another eminently practical feature of the SR-900 is the provision for feeding the output to two separate pairs of stereo speakers, simultaneously or one pair at a time.

There are other thoughtful touches. Speaker terminals, for instance, are far enough apart to prevent shorting between neighboring leads, and a raised ridge between "hot" and ground terminals prevents accidental shorting.

Considering the exceptional performance of the tuner and the amplifier, these extra features are indeed gilding the lily. In short, the SR-900 sets new standards for an all-in-one unit. Frankly, I looked for flies in the ointment. I found one: the position markers on the knobs are hard to read.—*Hans Fantel*

## MANUFACTURER'S SPECIFICATIONS

IHF music power: 75 watts, both channels  
Frequency response: 5 to 60,000 cycles at full output  
Harmonic distortion: less than 0.2%  
Hum & noise suppression: 95 db  
Damping factor: 40  
Square-wave rise time: 2.5  $\mu$ sec  
FM usable sensitivity (IHF): 1.85  $\mu$ v  
Image rejection: better than 70 db  
Spurious-response rejection: better than 85 db  
Multiplex separation: 40 db  
Price: \$469  
Harman-Kardon, Inc., 15th & Lehigh Ave., Philadelphia 32, Pa.

## Viking VFS Frequency Standard



WITH THE ENORMOUS NUMBERS OF TWO-way radios in use today, more and more technicians find that it pays to get an FCC license and go full or part time into two-way servicing.

A must for this kind of work is a frequency standard and a method of checking modulation deviation.

The Viking VFS does these jobs extremely well and with a minimum of fuss—especially the frequency measurements.

It is reliably accurate to .0002% as a primary standard, and when calibrated against WWV and used as a secondary standard, it is correct to .00003%. Either way its accuracy exceeds considerably the required tolerance limits specified for all transmitters.

The heart of this standard is a 100-kc crystal installed in a thermostatically controlled crystal oven. In addition four locked oscillators of 50 kc, 25 kc, 20 kc and 5 kc may be selected individually. Harmonic amplifiers then provide output all the way to 500 mc.

This kind of standard makes it necessary only to select the proper oscillator so that a harmonic will fall exactly on the transmitter frequency. No math is necessary, however, since a calibration chart for all present two-way frequencies is firmly affixed to the lid. Often the same oscillator setting may be used for a number of transmitter frequencies. As an example, in the 30- to 50-mc range, you use the 20-kc position for any assigned frequency measurements. In the 450-mc band, the 50-kc oscillator is used for all measurements.

For frequencies that are not multiples of any of the oscillators, a deviation control on the 100-kc oscillator shifts

*continued on page 70*

# SOMEONE SHOULD DEVELOP AN EASY WAY TO LEARN ELECTRONICS AT HOME

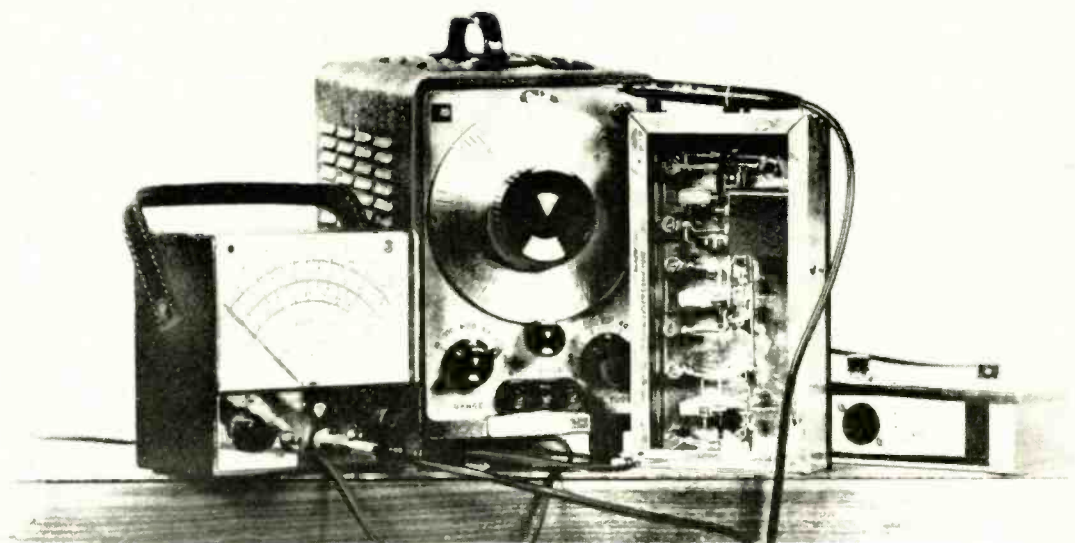

## RCA INSTITUTES DID!

Here is a whole new approach to learning electronics at home! RCA Institutes, one of the nations' largest schools devoted to electronics, has developed a faster, easier way for you to gain the skills and the knowledge you need for the career of your choice. Here for the first time, is a student-proved, scientifically designed way to learn. If you have had any doubts in the past about home training in electronics —if you have hesitated because you thought you might not be able to keep up—or that electronics was too complicated to learn—here is your answer! Read how RCA Institutes has revolutionized its entire home training ideas!

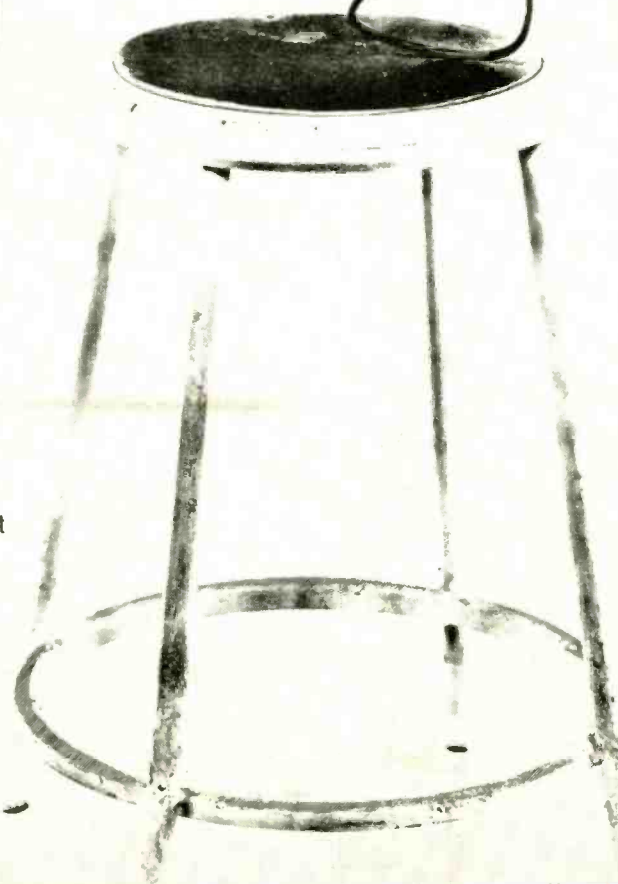

# NEW CAREER PROGRAMS BEGIN WITH "AUTOTEXT" INSTRUCTION METHOD!

**Start to learn the field of your choice immediately!**

**No previous training or experience in electronics needed!**

With this new revolutionized method of home training you pick the career of your choice—and RCA Institutes trains you for it. RCA's Career Programs assure you that everything you learn will help you go directly to the field that you have chosen! No wasted time learning things you'll never use on the job! The Career Program you choose is especially designed to get you into that career in the fastest, easiest possible way!

And each Career Program starts with the amazing "AUTOTEXT" Programmed Instruction Method—the new, faster way to learn that's almost automatic! "AUTOTEXT" helps even those who have had trouble with conventional home training methods in the past. This is the "Space Age" way to learn everything you need to know with the least amount of time and effort.

### CHOOSE A CAREER PROGRAM NOW

Your next stop may be the job of your choice. Each one of these RCA Institutes Career Programs is a complete unit. It contains the know-how you need to step into a profitable career. Here are the names of the programs and the kinds of jobs they train you for. Which one is for you?

**Television Servicing.** Prepares you for a career as a TV Technician/Serviceman; Master Antenna Systems Technician; TV Laboratory Technician; Educational TV Technician.

**FCC License Preparation.** For those who want to become TV Station Engineers, Communications Laboratory Technicians, or Field Engineers.

**Automation Electronics.** Gets you ready to be an Automation Electronics Technician; Manufacturer's Representative; Industrial Electronics Technician.

**Automatic Controls.** Prepares you to be an Automatic Controls Electronics Technician; Industrial Laboratory Technician; Maintenance Technician; Field Engineer.

**Digital Techniques.** For a career as a Digital Techniques Electronics Technician; Industrial Electronics Technician; Industrial Laboratory Technician.

**Telecommunications.** For a job as TV Station Engineer, Mobile Communications Technician, Marine Radio Technician.

**Industrial Electronics.** For jobs as Industrial Electronics Technicians; Field Engineers; Maintenance Technicians; Industrial Laboratory Technicians.

**Nuclear Instrumentation.** For those who want careers as Nuclear Instrumentation Electronics Technicians; Industrial Laboratory Technicians; Industrial Electronics Technicians.

**Solid State Electronics.** Become a specialist in the Semiconductor Field.

**Electronics Drafting.** Junior Draftsman, Junior Technical Illustrator; Parts Inspector; Design Draftsman Trainee Chartist.

### SEPARATE COURSES

In addition, in order to meet specific needs, RCA Institutes offers a wide variety of separate courses which may be taken independently of the Career Programs, on all subjects from Electronics Fundamentals to Computer Programming. Complete information will be sent with your other materials.

### LIBERAL TUITION PLAN

RCA offers you a unique Liberal Tuition Plan—your most economical way to learn. You pay for lessons only as you order them. No long term contracts. If you wish to stop your training for any reason, you may do so and not owe one cent until you resume the course.

### VALUABLE EQUIPMENT

You receive valuable equipment to keep and use on the job—and you never have to take apart one piece to build another. **New—Programmed Electronics Breadboard.** You now will receive a scientifically programmed electronic bread-

board with your study material. This breadboard provides limitless experimentation with basic electrical and electronic circuits involving vacuum tubes and transistors and includes the construction of a working signal generator and superheterodyne AM Receiver.

**Bonus From RCA—Multimeter and Oscilloscope Kits.** At no additional cost, you will receive with every RCA Institutes Career Program the instruments and kit material you need to build a multimeter and oscilloscope. The inclusion of both these kits is an RCA extra.

### CLASSROOM TRAINING ALSO AVAILABLE

RCA Institutes maintains one of the largest schools of its kind in New York City where classroom and laboratory training is available in day or evening sessions. You may be admitted without any previous technical training; preparatory courses are available if you haven't completed high school. Coeducational classes start four times a year.

### FREE PLACEMENT SERVICE

In recent years, 9 out of 10 Resident School students who used the Free Placement Service had their jobs waiting for them when they graduated. And many of these jobs were with top companies in the field—such as IBM, Bell Telephone Labs, General Electric, RCA, and radio and TV stations and other communications systems throughout the world.

**SEND ATTACHED POSTAGE PAID CARD FOR COMPLETE INFORMATION, NO OBLIGATION. NO SALESMAN WILL CALL. FREE BOOK INCLUDED. CHECK HOME STUDY OR CLASSROOM TRAINING.**

**RCA INSTITUTES, Inc., Dept. RE-75**

A Service of Radio Corporation of America  
350 West 4th St., New York, N.Y. 10014



**The Most Trusted Name in Electronics**

its frequency approximately 10 cycles up or down. This control must be used for checking frequencies in the 150-mc range. Here again no mathematics is needed because the correct setting is indicated in the lid.

Each instrument is individually calibrated in deviation so that you may check any crystal-controlled frequency whether specifically assigned by the FCC or not.

The VFS does require that the frequency of the transmitter or receiver under test be known to within a few kc (that is, somewhere in the channel), which of course is always true with crystal-controlled apparatus. It is difficult to check frequencies of vfo's for example unless the dial calibration is known to be good within a few thousand cycles. However, using a closely calibrated receiver with the VFS, the frequency may be spotted to within a few cycles easily, even at high frequencies.

Another important point about the VFS is that it can be used for calibrating other frequency standards, such as crystal-controlled test sets.

I have used the Zero-Beat, as it used to be called, for almost a year now, calibrating transmitters on many frequencies. I have not seen any frequency standard easier to use for two-way radio, or one more tolerant of its power source. Power-line voltages from 90 to 130 do not change the calibration or accuracy.

A built-in modulation-frequency deviation device, using the Bessel null method, lets you check modulation. This is not quite so easy as metered deviation, but, used with care, is just as accurate—perhaps more so. A 2,083-cycle oscillator is fed to the audio input of the transmitter. The deviation control in the transmitter is turned from minimum until the first audio null occurs. This is exactly at 5-kc deviation. The disadvantage of this system is that the input amplitude must be known for each make and model of transmitter; this is usually supplied by the manufacturer. But on the plus side, this information *should* be known when using any deviation monitor.

The VFS sells for \$695. I think it would be a good investment for anyone seriously interested in entering the two-way field, or for the service company that needs an additional frequency standard to make quick, precise checks. —Wayne Lemons

Dimensions: 18 7/8" wide, 11 1/8" high, 6 1/4" deep  
 Weight: 21 lb  
 Power input: 50 watts  
 Frequency range: 5 kc to 500 mc  
 Accuracy: field service .0002%, Laboratory set-up .00003%, Stability, .0002% 30 days  
 Warmup time: 18 minutes  
 Accessories supplied: Coax cable, calibration chart.

Price: \$695  
 Manufactured by Viking Instruments, Inc., Town Road, East Haddam, Conn.

# NEW SEMI-CONDUCTORS AND TUBES

## SILICON POWER TRANSISTORS FOR AUDIO

A whole new line of silicon n-p-n power transistors especially for use in audio amplifiers has been announced by RCA. There are 20 of them—numbered 40309 through 40328—and they can be adapted to a wide variety of PA, utility

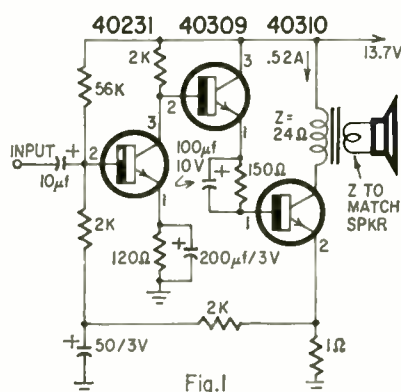

Fig.1

and hi-fi audio amplifier designs from 2 to 50 watts. Some of the amplifiers described in RCA design notes can be operated directly off the power line, like the 117-volt ac-dc table radio described in the June issue of RADIO-ELECTRONICS (page 39).

Twenty transistors is too many to describe fully in this column, so we'll

have to limit the presentation to saying that the 20 form a family, members of which can be used singly or combined in various ways to produce a remarkable variety of useful amplifiers. Two are diagrammed here. The line even includes a p-n-p silicon transistor—a somewhat rare breed—as shown in the 10-watt amplifier on this page.

Now: the circuits. Fig. 1 is a modest but conservatively designed 2-watt amplifier billed as ideal for low-power mobile work or for other applications where temperature variations are large. Total harmonic distortion at 2 watts, 1 kc, is 2%; the circuit will produce up to 3 watts at mid-range before the distortion becomes serious. Since the amplifier is all class-A, it draws a more or less constant current (525 ma) from 13.7-volt supply (normal average voltage in a moving car with a 12-volt-nominal electrical system).

Another neat circuit (Fig. 2) is a 10-watt class-AB high-quality amplifier with a series-connected transformerless output stage. The design is conventional; it follows what has become known as "the G-E circuit," used in several commercial amplifiers as well as (in slightly modified form) in RADIO-ELECTRONICS' own T-40/40 amplifier in the March 1965 issue. Frequency response is claimed as flat from 15 cycles to 100 kc (3-db points, 0 db taken as 8 watts at 1 kc).

Harmonic distortion is claimed to remain well under 1% at 8 watts from 20 cycles to 20 kc. Quiescent power dissipation is less than 1 watt. The amplifier is said to be stable at all temperatures up to 71°C. The credit for that is shared by the silicon transistors, the two 1N3754 silicon diodes and the dc feedback around the amplifier through various loops. Input sensitivity is not stated specifically, but it is probably around 1 volt

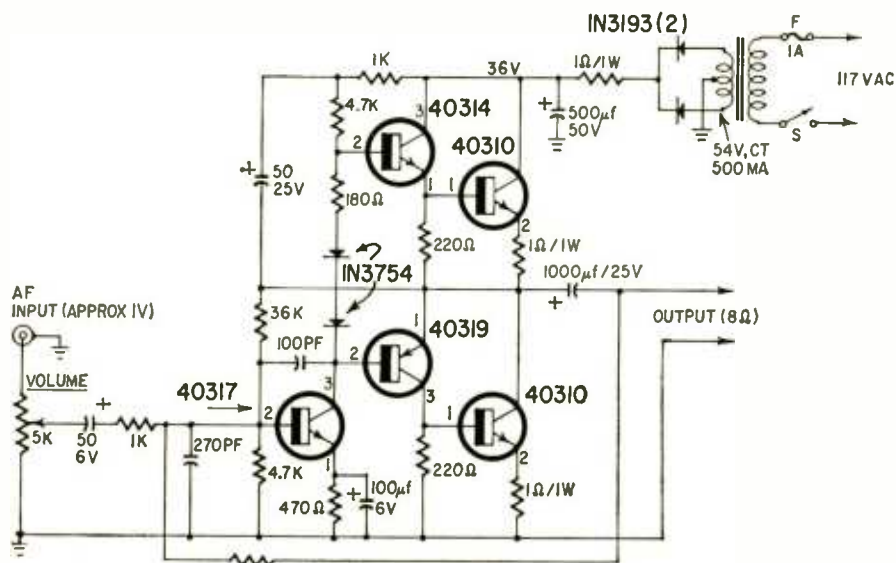

Fig.2

across the 5,000-ohm volume control for full output.

The line of transistors is somewhat more expensive than a comparable line of germanium transistors, but that's usual for silicon and usually justified by the greater design flexibility and wider operating-temperature range. One-apiece retail prices range from about \$1.05 to \$3.75 at RCA distributors. Data sheets and application notes are available from RCA Electronic Components & Devices, Harrison, N. J.

### ELECTROSTATIC IMAGE ORTHICON

A highly sensitive "see-in-the-dark" image orthicon that uses electrostatic focusing and deflection was recently announced by General Electric. Called the Z-7804, the new tube is expected to weigh only about one-twentieth as much as a comparable electromagnetic tube with all its associated coils, draw some 30 times less power, and be about one-fifth the size.

Electrostatic focusing and deflection has been used before on vidicons (a much less sensitive kind of tube), but never on image orthicons. The orthicon functions in starlight with high resolution, while the vidicon usually needs daylight. Satellite applications are obvious, but they were impractical until now because of the high power requirements of the heavy electromagnetically controlled orthicon.

The Z-7804 has a high-gain, thin-film magnesium oxide target with a sensitivity 10 to 20 times that of glass targets. The target can store a signal for a substantial time before readout, making low frame rates, or beam pulsing, possible. Variable scan-rate and frame-rate circuits are far simpler with this tube than with electromagnetic versions.

"Blooming" or halo caused by bright, shiny objects is less of a problem with G-E's new tube than with older types. Blooming caused by excessive subject brightness can mean losing the picture altogether for several seconds.

G-E admits readily that some electromagnetically focused and deflected orthicons will outperform the Z-7804 in very-high-resolution jobs, but the lower drain, lighter weight, smaller size and simpler circuitry are expected to outweigh many disadvantages. END

### Non-Commercial Classified Ads

- RADIO-ELECTRONICS now has a new Non-Commercial rate of 30¢ per word for individuals. (Our commercial rate remains at 55¢ per word.)
- Readers interested in buying or selling personal items or equipment can now do so at little cost.
- See the Market Center section for details and order form.

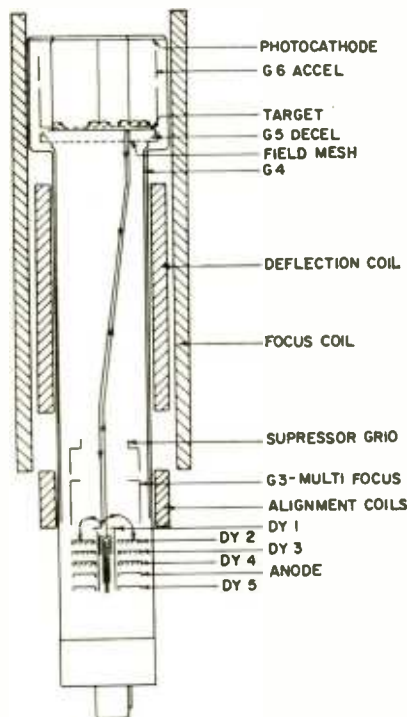
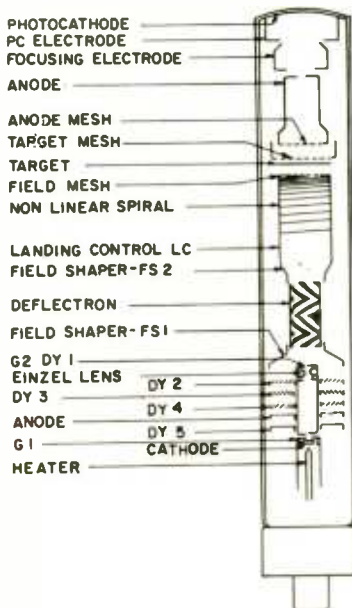

At left, cross-section of General Electric's new electrostatically focused and deflected image orthicon. At right, conventional, magnetically focused and deflected I.O. and its yokes and coils. New tube eliminates deflection, focus and alignment coils, eliminating more than 15 pounds of weight. Self-contained deflectron, Einzel lens and nonlinear spiral lens in new tube focus and deflect beam. Decreased length of new tube is also shown.

# for successful COLOR TV servicing

## own these SAMS BOOKS



### Color TV Training Manual, New Second Edition.

by C. P. Oliphant & Verne M. Ray. This newly revised comprehensive manual is the most up-to-date guide available for technicians preparing to service color TV receivers. Full information on: Colorimetry; Requirements of the Composite Color Signal; Make-up of the Color Picture Signal; RF and IF Circuits; Video, Sync & Voltage-Supply Circuits; Bandpass Amplifier, Color-Sync and Color-Killer Circuits; Color Demodulation; Matrix Section; Color Picture Tube & Associated Circuits; Setup Procedure; Aligning the Color Receiver; Troubleshooting. Includes full-color illustrations invaluable for setup, alignment, and troubleshooting. 224 pages; 8 1/2 x 11". Order TVC-2, only..... \$595

### Color TV Servicing Made Easy

by Wayne Lemons. Written in "made easy" style. Takes the mystery out of color TV servicing. Familiarizes you with color principles and setup adjustments; thoroughly covers color circuitry, adjustments, and servicing of all color TV sets produced to date. This book will help to put you into this fast-growing, profitable service work. 128 pages; 5 1/2 x 8 1/2". Order CSL-1, only..... \$250

### Know Your Color-TV Test Equipment

by Robert G. Middleton. Explains clearly and easily the function and circuit action of each color TV test instrument. Covers: White-Dot and Cross-Hatch Generators, Color-Pattern and Color-Bar Generators, Rainbow and NTSC Generators, Principles of Video-Frequency Sweep Generators and Testing, Lab-type equipment, and valuable setup information. Profusely illustrated. 160 pages; 5 1/2 x 8 1/2". Order KOC-1, only..... \$250

### Color TV Trouble Clues

Invaluable field-tested guide to trouble clues and procedures for color TV receiver repair. Describes types of troubles encountered, troubleshooting techniques, alignment and sync problems, convergence, etc. Includes data on use of test equipment to speed color TV servicing. Fully illustrated with photographs and schematics. A "must" for color TV service technicians. 96 pages; 5 1/2 x 8 1/2". Order COL-1, only..... \$195

### 101 Ways to Use Your Color TV Test Equipment

by Robert G. Middleton. Written in the time-tested formula acclaimed by thousands of TV technicians. Shows you practical uses for your test equipment to diagnose color TV circuit troubles quickly and easily. Describes proper equipment hookups, how to evaluate test results, how to check instruments; includes time-saving techniques. 144 pages; 5 1/2 x 8 1/2". Order TEM-9, only..... \$250

### Color TV Guidebook

A special Howard W. Sams publication about color TV servicing techniques, equipment required, and related subjects. General information includes outlook for color TV manufacturers, broadcasting networks, and technicians. Specific sections deal with starting a color TV service business, troubleshooting and repair techniques, antennas, color tube stocking, transistorized color TV, small-town color TV problems, new circuits and developments. 8 1/2 x 11". Order PFR-1, only..... \$100

## HOWARD W. SAMS & CO., INC.

Order from your Sams Distributor today, or mail to Howard W. Sams & Co., Inc., Dept. RE-7, 4300 W. 62nd Street, Indianapolis, Ind. 46206

- Send me the following books:
- |                                |                                |                                |
|--------------------------------|--------------------------------|--------------------------------|
| <input type="checkbox"/> TVC-2 | <input type="checkbox"/> KOC-1 | <input type="checkbox"/> TEM-9 |
| <input type="checkbox"/> CSL-1 | <input type="checkbox"/> COL-1 | <input type="checkbox"/> PFR-1 |
- Send FREE Sams Booklist. \$\_\_\_\_\_ enclosed

Name \_\_\_\_\_

Address \_\_\_\_\_

City \_\_\_\_\_ State \_\_\_\_\_ Zip \_\_\_\_\_

My Distributor is \_\_\_\_\_

IN CANADA: A. C. Simmonds & Sons, Ltd., Toronto 7

# NEW PRODUCTS

**30-WATT STEREO AMPLIFIER, LA-224A**, has 3-position input selector; 4-position mode selector; independent bass and treble controls for each channel; concentric volume/balance control; pilot light; rumble filter switch; phase-reverse switch; speaker/headphone selector switch; power on-off switch; headphone jack. Power output: 15 watts per



channel—30 watts mono. Frequency response from 25 to 25,000 cycles  $\pm$  1.5 db. Harmonic distortion 1.25% at 15 watts. Hum and noise: magnetic phono, —56 db; tuner, —75 db. 8- or 16-ohm speaker impedance switch on rear, hum adjust and ac outlet. Ten tubes. For 105-125 volts, 50/60 cycles ac. 12 $\frac{1}{2}$  x 5 $\frac{1}{2}$  x 8 $\frac{1}{2}$  in., 20 lb.—Lafayette Radio Corp., 111 Jericho Turnpike, Syosset, N. Y.



**LAVALIER MICROPHONE, model S-58**, has slide-type on-off switch. Response: 60-13,000 cycles. Output level —60 db. Impedance high and 150 ohms. 25-ft cable and assembly furnished. —Turner Microphone Co., 909 17th St., N.E., Cedar Rapids, Iowa

**TV/FM FIELD-STRENGTH METER, model FS-2**: 3 $\frac{1}{2}$  lb.; 2 bands for channels 2-6; FM channels 7-13; uhf adapter position; separate picture and



sound carriers. 4 db scales from —33 to +60. Performs with accuracy of  $\pm$  1.75 db. 8 $\frac{1}{2}$  x 4 $\frac{1}{2}$  x 3 in. with carrying case and two 9-volt batteries.—Sadelco, Inc., 601 W. 26 St., New York, N. Y. 10001

**VOICE-ACTUATED RECORDER CONVERTER, KX-5000. Voice-matic**, works with all tape recorders. It starts when you speak, turns off when you stop. Has: ON-OFF switch; sensitivity control to determine degree of sound to operate unit from 2 to 20 feet away; pause control adjusts pause time between sentences; input/output jacks, standard  $\frac{1}{4}$ -in. phone type; output switching jack to use with tape recorders with floor control switch or to switch on or off any battery-operated device; switching contacts, 2 amperes. 3 $\frac{1}{2}$  x 2 $\frac{1}{4}$  x 1 in., 12 oz less batteries (uses 2 standard 9-volt batteries).—Kinematix, Inc., 2040 W. Washington Blvd., Chicago, Ill. 60612



**WIDE-BAND SWEEP GENERATOR, model 890**, vhf and uhf, has sweep signal with center at any frequency from 500 kc to 1,000 mc, sweep widths from 100 kc to 200 mc. Rf output, monitored by matched crystal diodes feeding a 2-stage push-pull alc amplifier, is flat within  $\pm$  .5 db up to 800 mc and  $\pm$  1.5 db from 800 to 1,200 mc (at maximum sweep width). Applications include circuit alignment, measurement of gain, loss and vswr.—Jerrold Electronics Corp., 15th & Lehigh Ave., Philadelphia 32, Pa.

**VHF-UHF FIELD-STRENGTH METER, the Signal Commander**, has two linear scales, 0-100  $\mu$ v and 20-40 db reference to 1 microvolt. Switched attenuators extend this range to 100,000  $\mu$ v and 100 db. Plug-in tuning heads for vhf and uhf and uhf TV and for 25-900-mc coverage. Accepts both 50- and 72-ohm unbalanced systems without adapters. Small balun connects to uhf-type coaxial fitting to convert for 300-ohm balanced lines. Has silicon transistors; frequency measure-



ments accurate to 5%; signal-strength measurement accurate to within 1.5 db. Operates on two 8.4-volt mercury batteries. 9 $\frac{1}{2}$  x 4 $\frac{1}{2}$  x 3 $\frac{1}{2}$  in., 3 $\frac{1}{2}$  lb.—Amphenol-Borg Distributor Div., 2875 S. 25 Ave., Broadview, Ill. 60155

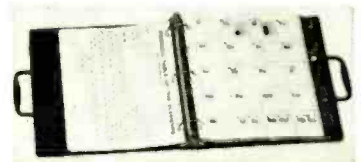

**ELEMENT COLLECTING KIT** has 36-page instruction manual, two books—*The Elements* and *Atoms, Crystals, Molecules*, periodic table of all known elements, 5 clear vinyl sheets with 20 pockets each for housing samples, all contained in 11 $\frac{1}{2}$  x 10 $\frac{1}{2}$ -in. binder.—Edmund Scientific Co., 106 E. Gloucester Pike, Barrington, N. J. 08007

**AM/FM/FM STEREO TUNER KIT, AJ-43C**, has 25-transistor, 9-diode circuitry; features automatic switching to stereo, stereo indicator light, afc on the FM band, individual AM and FM tuning me-

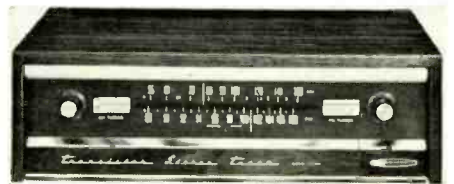

ters, slide-rule dial. Zener-regulated transformer-operated power supply. Walnut cabinet; factory-assembled and aligned FM front end and 5-stage FM i.f. circuit board.—Heath Co., Benton Harbor, Mich. 49023

**80-WATT STEREO AMPLIFIER KIT, LK-60**, has light-bulb fail-safe circuit which glows warning to recheck wir-



ing. Output circuit monitor facilitates bias and balance adjustment. Steady-state power: 30 watts per channel. Music power: 40 watts per channel. Harmonic distortion less than 0.8%; frequency response, 10-40,000 cycles. Tape input and output; bass and treble controls for each channel; front-panel stereo headset output.—H. H. Scott, Inc., Dept. P., 111 Powdermill Rd., Maynard, Mass.



**TRANSISTOR IGNITION SYSTEM, model AM-275.** Power transistor is mounted on special heat-radiating aluminum case with cooling fins, operates on any 6- or 12-volt negative-ground system. Includes 400:1 ratio coil, transistor switching unit, ballast resistor, wire and instructions.—Olson Electronics, Inc., 260 S. Forge St., Akron, Ohio 44308



**PROFESSIONAL TAPE ACCESSORY KIT, model ACI-100,** consists of bulk tape eraser, (which erases reeled tape in seconds), splicing and editing block with self-adhesive bottom for mounting on tape deck, splicing tape, spray head cleaner, marking pencil, and cutting tool.—Artronics Co., Inc., 630 Cleveland Ave., River Vale, N.J.

**SOLID-STATE AM/FM STEREO TUNER, the ST-2000,** can handle strong input signals without overload or cross-



JULY, 1965

talk. Sensitivity: 2.9 microvolts IHF for FM and 50  $\mu$ v per meter for AM. I.f. rejection is 55 db, image rejection better than 45 db and spurious response rejection exceeds 60 db. Flywheel tuning with d'Arsonval tuning indicator and meter. Three front-panel switches for AM/FM, stereo/monaural and on/off functions. Stereo indicator light and convenience outlet. 13 $\frac{1}{4}$  x 4 $\frac{1}{4}$  x 10 $\frac{1}{2}$  in., 9 lb.—Harman-Kardon, Inc., 15th & Lehigh Ave., Philadelphia 32, Pa.



**WIRE STRIPPER, No-Nik.** Head of tool grips and centers wire—precision blade scores insulation without touching conductor, and conductor is drawn through its own insulation. Wire gauge stamped on centering device, handles are color-coded. Available for Nos. 18, 20, 22, 24, 26, 28, 30 and 32 size wire.—Claus Cutlery Co., Fremont, Ohio



**UHF CONVERTER / ANTENNA, Convertenna model 4003** combines VU-82 indoor antenna with transistor uhf converter. 300-ohm output and input match set and antenna. Operates from 120 volts, 50-60 cycles ac outlet. Built-in diplexer reverses directivity 180° by switching. Butterfly dipole with 96-in. nontarnish elements. — Channel Master Corp., Ellenville, N. Y.

**DIPPED MYLAR CAPACITORS KIT, Deal #150X,** includes free Xcelite PS 120 nutdriver set (10 pieces). 150 capacitors of 10 most popular types



packed in plastic bags with capacitance value, working voltage and part number.—Arco Electronics, Div. of Loral Corp., Community Dr., Great Neck, N. Y. 11022



**TACHOMETER/DWELL-ANGLE METER, model 100,** connected to ignition system of all 4-, 6-, 8-cylinder cars through single pair of external leads for all measurements of dwell angle or engine rpm. Has 2 rpm scales (0-1,200 and 0-6,000). Instruction book and cross-reference chart with settings for all popular cars since 1953. Operates on pair of internal flashlight cells.—Electronic Measurement Corp., 625 Broadway, New York, N.Y. 10012

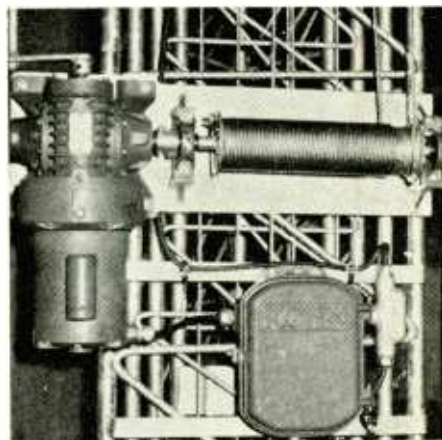

**MOTORIZED WINCH UNIT, model 100 Tower Controller** for 11D series crank-up towers, consists of the winch, a heavy-duty weatherproof motor and gearbox and the controller. Factory-wired, supplied with 25 feet of 2-conductor power cable. Requires 2 connections to a 115-volt 60-cycle source. Model 200 remote control unit optional.—Rohm Mfg. Co., Peoria, Ill.

**ILLUMINATED BUTTONS, Glo-Button, X Series,** requires no bulb or electrical power. Button has translucent front screen with legend marked in opaque color; fluorescent illuminator is on pusher



# NEW PRICES from QUIETROLE



the oldest, most widely proved and sold radio and TV lubricant

2 oz. bottle with dropper	LIST \$1.49
4 oz. bottle	LIST 2.54
4 oz. bottle (brush-n-cap)	LIST 2.64
8 oz. bottle	LIST 5.07
6 oz. spray can — with extender	LIST 2.79
3 oz. spray can — with extender	LIST 1.79

Quietrole is your guarantee of the most effective, quick silencer of noisy radio and TV controls — the quality product that is a top value. Get Quietrole at quality jobbers.

Some territories still available for experienced representation.



manufactured by **QUIETROLE Company**  
Spartanburg, South Carolina

with 2 legs extending from rear. When button is pressed, these legs bring illuminator flush with screen and legend lights up due to reflected ambient light, projecting symbol that signals switch control status. *Glo-Buttons* mount on standard .050 x .187 plungers in two mounting planes to match horizontal or vertical panel layouts. Available legends: numerals 1-18 letters A-R, ON, OFF.—Switchcraft, Inc., 5555 N. Elston Ave., Chicago, Ill. 60630

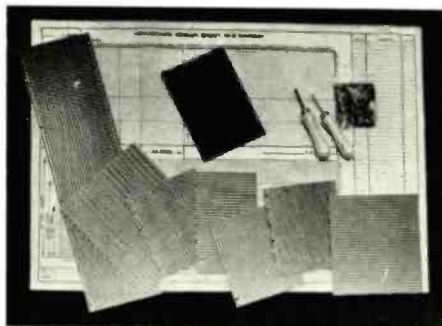

**LABORATORY DEVELOPMENT KIT, model VBK-7**, consists of 8 assorted Veroboards up to 18 in. long; plain Veroboard with staggered 0.1-in. grid, spot face cutter, terminal-pin insertion tool, 500 terminal pins, reproducible design sheet and instructions on Vero circuit concept.—Vero Electronics, Inc., 48 Allen Blvd., Farmingdale, N. Y.



**4-TRACK TAPE RECORDER, model 3200**, includes sound-with-sound. Capable of adding a second track while playing a previously recorded track. Has VU meter, pause-edit control, 3-digit index counter, 2 extended-range 6-in. oval speakers, automatic shut-off, 3 tape speeds. 10 watts per channel output, 18,000 cycles response.—Rheem Califone, 5922 Bowcroft St., Los Angeles, Calif. 90016

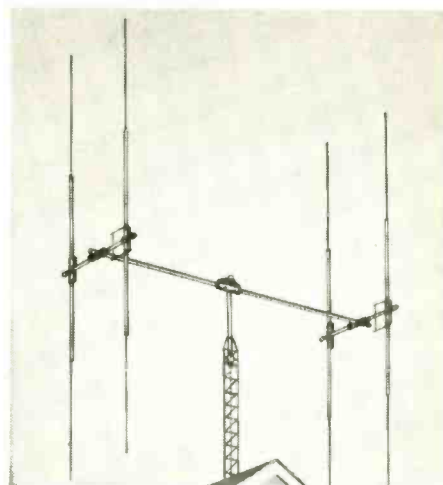

**CITIZENS-BAND BEAM ANTENNAS.** The 114DB (shown) uses 2-element beams and multiplies effective radiated power of an efficient 5-watt CB transceiver to 42 watts. Model 116DB uses 3-element beams, raises power of 5-watt transceiver to 93 watts, designed for use with heavy-duty TV rotator. Standard rotator for the 114DB. Heavy-gauge aluminum, reliability in winds up to 100 mph.—Hy-Gain Electronics Corp., 8700 N.E. Highway 6, Lincoln, Neb. 68501

## Non-Commercial Classified Ads

**RADIO-ELECTRONICS** now has a new Non-Commercial rate of 30¢ per word for individuals. (Our commercial rate remains at 55¢ per word.)

Readers interested in buying or selling personal items or equipment can now do so at little cost.

See the classified section for details and order form.



**SOLDERING IRONS**, pencil type, available in 7 temperatures ranging from 450°F to 1,000°F. Air-cooled handle; stainless-steel jacket on element. Various colors.—Hunter Tools, 9851 Alburts Ave., Santa Fe Springs, Calif. **END**

All specifications from manufacturers data

## IF YOU SELL, SERVICE, GIVE ORDERS, YOU NEED SONAR BUSINESS RADIO FM-40

25-50 mc  
37 WATTS  
FCC TYPE ACCEPTED



CONSTRUCTION

TRUCKING



### Power-Packed! Engineered for Rugged Business Use!

Excellent performance, dependability and operational convenience provided by FM-40 reflect the experience and design ability that has made Sonar the undisputed leader in this demanding form of business radio art. Greater range because of Voice-Power designed circuitry • Compact and lightweight • Easily installed in smallest vehicles • Smartly styled for office use • Noise free squelch for crisp clear communication • Accessory plug for Sonar Call, selective Calling System • Accessory plug for high power Linear Amplifier • 12 VDC & 117 VAC • 1 year warranty • Size: 4 3/4" H x 9 1/2" x 11 1/4" L • Weight: 10 lbs.

Complete 1 pr. of Crystals, Power Mike, Brackets, & 2 power cables **\$28950**

**SONAR RADIO CORPORATION** Dept. 410  
73 Wortman Ave., Brooklyn 7, N. Y.

Please send me information on Business Radio FM-40 and BR-21 matching Amplifier.

Name.....  
Address.....  
City..... Zone..... State.....



**BR-21 FOR ADDED POWER LINEAR RF AMPLIFIER** is a matching companion to cover greater distances with increased transmit power. Available for either base or mobile.



# NEW LITERATURE

**PRETAX SALE CATALOG.** *Olson Flag Days.* 32 pages of component bargains. Federal Excise Tax Ruling 56-8, due July 1, 1965, will raise most amplifier and speaker prices.—Olson Electronics, Inc., 260 S. Forge St., Akron, Ohio 44308

**1965 FULL-LINE CATALOG.** 36 pages, many new products and new format, featuring new line of solid state products, such as FM multiplex stereo tuner/amplifier, FM stereo multiplex generator, color signal generator. Photographs of each item, plus specs and dealer list.—Eico Electronic Instrument Co., Inc., 131-01 39th Ave., Flushing, N. Y. 11352

**AUDIO EQUIPMENT CATALOG.** *No. 100.* 36 pages with photos of cartridges, mikes, earphones, speakers, baffles, intercoms, jacks, capacitors, transistor AM-FM front ends, etc.—Speco, Components Specialties Inc., 101 Buffalo Ave., Freeport, N.Y.

**CATALOG.** *Cameradio 65.* 384 pages, 5½ x 8½ in. All kinds of components (hardware, resistors, capacitors, transformers). Illustrated, with component index and manufacturer's index.—Cameradio Co., 1121 Penn Ave., Pittsburgh, Pa. 15222

**CAPTIVE SCREW CATALOG.** 6 pages, engineering data, drawings and installation details on new line of captive screws with quad lead threads and mating quad lead nut-plates. Also retractable spring-loaded captive fastener which mates with any standard nut-plate or tapped hole.—Calfax Inc., 2500 Compton Blvd., Redondo Beach, Calif.

**APPLICATION GUIDE FOR RCA MEMORY PRODUCTS.** *MP-315.* 24 pages, looseleaf punched. General information on RCA ferrite magnetic devices for memory applications, discussing magnetic fundamentals, hysteresis characteristics, operating principles of ferrite cores, design considerations for core selection and memory devices, transfluxors, typical memory system, and definitions.—RCA, Electronic Components & Devices, Harrison, N.J. 50¢.

**VACUUM AND GAS MEASURING INSTRUMENTS.** 7 data sheets, 1 short-form catalog and price list. Photos, charts, diagrams, characteristics and specs on omegatron, ionization gauge tubes, standard sight port windows, Pyrex-Kovar seals, standard stems, helium diffusion cell.—Electron Technology, Inc., 626 Schuyler Ave., Kearny, N.J. 07032

**ETV BOOKLET & MATV PRODUCT CATALOG.** 4 and 8 pages, respectively: the first telling why a master TV system is needed for educational TV; second, the catalog, has photos and specs of broadband amplifiers (uhf and vhf), single-channel amplifiers, converters, attenuators, outlets, filters and traps, housings, transformers, splitters, mixers, tapoffs.—Blonder-Tongue, 9 Alling St., Newark, N.J. 07102

**ELECTRONIC MEASURING INSTRUMENTS.** 1965 *CATALOG.* 12 pages, photos and specs of vtvm's, decade amplifier, uhf millivoltmeter, ac/dc voltmeter-ohmmeter, precision calibrators, capacitance meter, ac/dc linear converter, micropotentiometer, and accessories.—Ballantine Labs, Inc., PO Box 97, Boonton, N.J. 07005

**PRECISION POT CORE BOOKLET.** *Ferroxcube Bulletin 220.* 24 pages, looseleaf. Up-to-date data replacing *Bulletins 202* through *210, 212, 213* in company's catalog. Charts, curves, photos and text taking ferrites from scratchpad to wound inductor with inductance, Q, temperature coefficient and smallest package.—Ferroxcube Corp. of America, Saugerties, N.Y.

**SYNCHRONOUS MOTORS AND TIMERS.** *Condensed Catalog No. MT-200.* for special engineering applications with emphasis on high-torque output and reliability. 20 pages, looseleaf-punched; dimension drawings, photos. Series ranges from water softener actuator to advertising display color wheels.—Controls Co. of America, 2001 N. Janice Ave., Melrose Park, Ill. 60160

**AUDIO PRODUCTS CATALOG.** *SAH-76.* 16 pages photos, specs of line of ceramic and crystal phono cartridges, replacement needles, tone arms, ceramic mikes, learning-lab mike units, loudspeakers, high-compliance speaker systems.—Electronic

Applications Div., Sonotone Corp., Elmsford, N.Y. 10523

**CAPACITOR CATALOG.** 12 pages, illustrated, lists 88 types of standard variable air capacitors. 3-hole-punched.—Hammarlund Mfg. Co., 73-88 Hammarlund Dr., Mars Hill, N.C. 28754

**SOLDERING-IRON CATALOG.** 12 pages, 5-hole-punched; describes features, applications and prices of 9 basic models rated 6 to 230 volts and 12 to 1,250 watts—tip sizes from 1/16 to 2 in.—General Electric Co., Schenectady 5, N.Y.

**COMPONENTS CATALOG.** *No. 6F5.* 40 pages, looseleaf-punched. Large assortment of terminals, taper pins, hardware, cable clamps and ties, instrument dials, knobs and instrument cases, tube and transistor sockets, etc.—Waldom Electronics, Inc., Chicago, Ill. 60632

**FOLDER.** 4 pages, looseleaf-punched, drawings, specs and curves on Octavium system: low-frequency sound reproducer (15-70 cycles) with 15-in. woofer and radiating wood-and-styrofoam enclosure.—Aladdin Electronics, Inc., 1450 6th St., Berkeley, Calif. 94710

**CATALOG.** *Q-65.* 17 page, 3-hole-punched, on 1965 Q series digital circuit modules with drawings, specs, price list (21% reduction) for all 25-kc, 100-kc and 1-mc modules.—Engineered Electronics Co., 1441 E. Chestnut Ave., Santa Ana, Calif. 92702

Any or all of these catalogs, bulletins, or periodicals are available to you on request direct to the manufacturers, whose addresses are listed at the end of each item. Use your letterhead—do not use postcards. To facilitate identification, mention the issue and page of RADIO-ELECTRONICS on which the item appears. UNLESS OTHERWISE STATED, ALL ITEMS ARE GRATIS. ALL LITERATURE OFFERS ARE VOID AFTER SIX MONTHS.

## COMPLETE TUNER OVERHAUL

ALL MAKES — ONE PRICE



9.95

**ALL MAKES  
ALL LABOR  
AND PARTS  
(EXCEPT TUBES)\***

**ONE LOW PRICE INCLUDES ALL UHF, VHF,  
COLOR AND UV COMBINATION TUNERS**

Simply send us the defective tuner complete; include tubes, shield cover and any damaged parts with model number and complaint. Your tuner will be expertly overhauled and returned promptly, performance restored, aligned to original standards and warranted for 90 days.

UV combination tuner must be single chassis type; dismantle tandem UHF and VHF tuners and send in the defective unit only.

Exact Replacements are available for tuners unfit for overhaul. As low as \$12.95 exchange. (Replacements are new or rebuilt.)

**CASTLE TV TUNER SERVICE, INC.**

MAIN PLANT: 5715 N. Western Ave., Chicago 45, Ill.  
EAST: 41-96 Vernon Blvd., Long Island City 1, N. Y.  
CANADA: 136 Main Street, Toronto 13, Ont.  
\*Major Parts are additional in Canada

## LOOK! A NEW ELECTRONICS SLIDE RULE with complete instruction program



Here's a great new way to solve electronic problems accurately, easily . . . a useful tool for technicians, engineers, students, radio-TV servicemen and hobbyists. The Cleveland Institute Electronics Slide Rule is the only rule designed specifically for the exacting requirements of electronics computation. It comes complete with an illustrated Instruction Course. You get four AUTO-PROGRAMMED lessons . . . each with a short quiz you can send in for grading and consultation by CIE's expert instructors.

See for yourself. Learn how to whip through

all kinds of reactance, resonance, inductance, AC and DC circuitry problems in seconds . . . become a whiz at conventional computations too!

This all-metal 10" rule is made to our rigid specs by Pickett, Inc. . . . comes complete with top grain leather carrying case and Instruction Course. A \$50 value for less than \$20. Send coupon for FREE illustrated booklet and FREE heavy vinyl Pocket Electronics Data Guide. Cleveland Institute of Electronics, 1776 E. 17th St., Dept. RE-112, Cleveland, Ohio 44114.

**GET BOTH FREE!**



**ELECTRONICS  
SLIDE RULE**

**Send coupon today →**

### Cleveland Institute of Electronics

1776 E. 17th St., Dept. RE-112, Cleveland, Ohio 44114

Send FREE Electronics Slide Rule Booklet. Special Bonus: Mail promptly and get FREE Pocket Electronics Data Guide too!

NAME \_\_\_\_\_ (Please Print)

ADDRESS \_\_\_\_\_ COUNTY \_\_\_\_\_

CITY \_\_\_\_\_ STATE \_\_\_\_\_ ZIP \_\_\_\_\_

**A leader in Electronics Training . . . since 1934**

before you buy any  
color generator...  
get all the facts

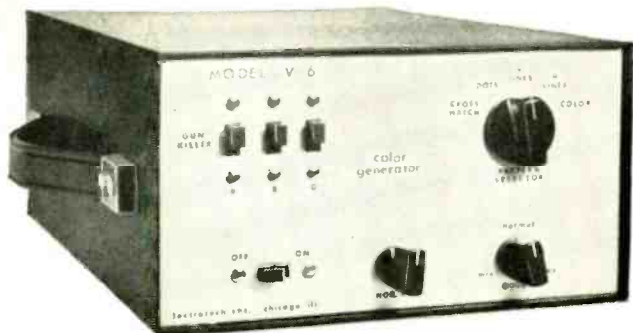

only one\* has all  
these features and  
it's only 99<sup>50</sup>

## LECTROTECH V6

Any comparison will prove that the Lectrotech V6 truly stands alone. Provides all of the time-tested standard features plus many Lectrotech exclusives for the fastest, most reliable color installation and servicing. The V6 gives you: Crystal-controlled keyed rainbow color display • All cross hatch, dots, vertical lines only, horizontal lines only • Red-blue-green gun killer (usually extra or not available on other color bar generators) • Exclusive Dial-A-Line feature (Horizontal adjustable 1 to 4 lines wide) • Exclusive solid state reliability • Exclusive voltage-regulated transistor and timer circuits • Exclusive simplified rapid calibration • Off-On Standby Switch • Adjustable dot size • Color level control • Connects to antenna terminals (no connections needed inside of set) • Power transformer-line isolated, to prevent shock hazard • Lightweight and portable, only 4½" H. x 7½" W. x 10¾" D. Weight, 7½ lbs.

\*Except our own V7



**V7** Sensational new Lectrotech V7 — the only complete Color TV Test Instrument.

Has all the features and performance of the V6 PLUS Lectrotech's exclusive built-in Color Vectorscope for simplified visual color servicing.

Complete.....only **189<sup>50</sup>**



See your distributor or write for details  
before you buy any color generator.

**LECTROTECH, INC.**  
1737 Devon Avenue • Chicago, Illinois 60626

# TECHNOTES

## ODD HEATER-STRING TROUBLE

Recently a small five-tube G-E radio came into my shop with the complaint of intermittent reception. Sometimes the set would come on and quit later, while at other times it wouldn't come on at all.

The set was playing but in a few minutes went dead. Voltage checks on the avc line showed it to be normal. (This particular model has a history of leaky capacitors in the i.f. transformers that puts a B+ voltage on the avc terminal of the transformer.) Plate voltage readings were normal except on the plate of the 12AV6 first audio, where the reading was 90 volts instead of the usual 55. This indicated that the tube was not drawing plate current.

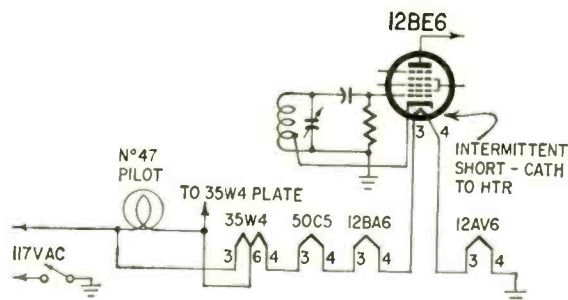

All resistors and capacitors in this circuit measured good, so I substituted a new tube. The set now worked perfectly. The next evening I turned it on again and it was dead. I turned the set over to remove the new tube, and it wasn't even lit. Back in went the old tube, still no light. An ohmmeter test (with the set turned off) of the heater circuit showed the 12BE6 to have a cathode-to-heater short. The cathode of the 12BE6 is connected to a tap on the oscillator coil, which goes to ground. Thus when the heater shorted to the cathode, the heater string was grounded, bypassing the 12AV6 tube. This kept the tube from lighting, thus the plate drew no current.

Just because a tube isn't heated up is no sign that it is burned out!—James A. Fred

## SPLIT PICTURE

The flyback in a Fleetwood 17-5 had shorted and been replaced with an exact duplicate by another technician. Now the set showed a horizontal blanking bar (picture split vertically). This trouble is usually caused by a defect in the phase detector or sampling circuit.

In this case, the leads of the sampling pulse winding on the flyback were transposed. After I reversed them, the picture was normal again.

Watch for this—the leads are usually not marked for proper polarity.—E. L. Deschambault

## PRATT & WHITNEY TAPEOMATIC DRILL

*Trouble:* Position error in X or Y axis.

*Cure:* If trouble persists after photoelectric transducer phasing has been set to manufacturer's service instructions, check photocell currents. If unequal, balance by increasing the low value by adjusting the associated lamp resistor. Should this prove unsuccessful, increase the current through

both photocells 5%. Repeat, if necessary, to a maximum increase of 20%. This will usually restore normal operation.—R. C. Roetger

### WATCH THAT SOLVENT

When transistor radios develop noisy controls, don't squirt commercial solvents into the pots. Often the solvent leaks or drips onto surfaces visible from the outside of the case, marking them permanently. These compounds can be applied safely with an eyedropper by holding the set so that any excess fluid will drip harmlessly onto the bench.—Steve P. Dow

### EICO 377: NO OSCILLATIONS

An Eico 377 audio generator would not oscillate. V2, a 6K6-GT, had a red-hot plate and screen. We checked voltages with a vtvm. The voltage on V2's control grid was 80—much too high. Replacing C7, the coupling capacitor, fixed the trouble.—Pierre Cappaert

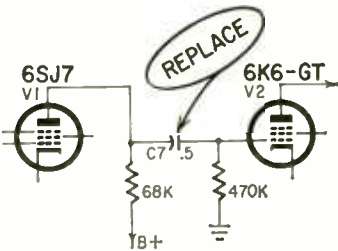

### TEMPORARY REPLACEMENT

The 8CM7 vertical oscillator/amplifier in my customer's series-string receiver was defective. I had only a 6CM7 to replace it with, but its heater drew 0.6 ampere instead of the 0.45 of the 8CM7.

I heated the heater of the 6CM7 in my tube tester, bringing it to operating temperature. Then I quickly inserted the tube into the 8CM7 socket. It worked.

I explained to customer that I would be back the next day with the correct tube, and warned him meantime not to turn his set off, else he'd lose his picture when he tried to turn it on again.—E. L. Deschambault

### WINEGARD COLORTRON AMPLIFIER

A few months after installation, the output of this amplifier fell. The signals at the receiver dropped from near 200 $\mu$ v to less than 100 (relative readings with the same field-strength meter).

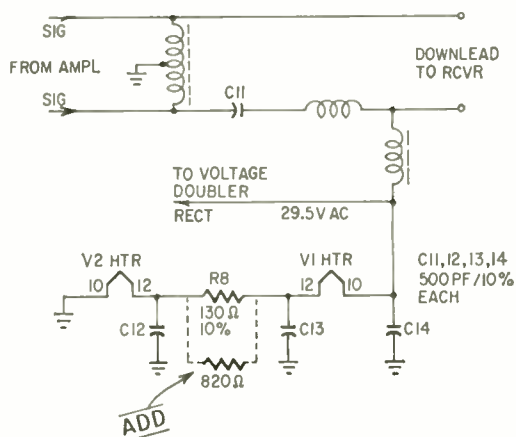

Checks on the amplifier showed the input voltage to the amplifier to be 28 vac instead of 29.5 (117 vac to the power supply). This is only 5% off. R8 was 140 ohms. This is less than 8% off for a 10% resistor. This resistor was dropping

## add an fm-stereo service center with this one new sencore unit!



### THE SENCORE MX129 FM STEREO MULTIPLEX GENERATOR & ANALYZER

FM-Stereo growth continues to mount and is fast becoming as big a field as Color TV. This means more FM-Stereo service business for you, now and in the future. Is your shop equipped? It can be—completely and economically—with the MX129, the FM-Stereo "Service Center in a Case." The instantly stable, 19-Transistor, crystal controlled MX129 is the most versatile, most portable (only 7½ pounds), most trouble free and efficient multiplex unit on the market—just like having your own FM-Stereo transmitter on your bench or in your truck. Powered by 115 volts AC, it produces all signals for trouble shooting and aligning the stereo section of the FM receiver . . . can be used to demonstrate stereo FM when no programs are being broadcast. Self-contained meter, calibrated in peak to peak volts and DB, is used to accurately set all MX129 controls and as an external meter to measure channel separator at the FM-Stereo speakers. NO OTHER EQUIPMENT IS REQUIRED. only **\$169<sup>50</sup>**

#### SIGNALS AVAILABLE FOR ALIGNMENT, TROUBLE SHOOTING AND ANALYZING:

- FM-RF carrier with composite multiplex audio signal with 38kc suppressed carrier, 19kc pilot and 67kc SCA signals
- Multiplex signal formed by 60 or 1000 cycle internal tones or any external signal
- Full control over left and right channel amplitude (modulation)
- External 67kc SCA signal available for trap adjustment
- Composite signals available for signal injection FM detector

professional quality — that's the difference!

**SENCORE**  
426 SOUTH WESTGATE DRIVE • ADDISON, ILLINOIS

**FREE ELECTRONICS CATALOG**  
Tremendous Bargains (see coupon)

# BUILD YOUR RADIO

**CIRCUITS AT HOME**  
with the New Progressive  
**RADIO "EDU-KIT"®**  
All Guaranteed to Work!

Reg. U.S.  
Pat. Off.



**PRACTICAL** only  
**HOME RADIO COURSE** \$26.95

**NOW INCLUDES**

- ★ 12 RECEIVERS
- ★ 3 TRANSMITTERS
- ★ 50. WAVE GENERATOR
- ★ AMPLIFIER
- ★ SIGNAL TRACER
- ★ SIGNAL INJECTOR
- ★ CODE OSCILLATOR

TRAINING ELECTRONICS  
TECHNICIANS SINCE 1946

- ★ No Knowledge of Radio Necessary
- ★ No Additional Parts or Tools needed
- ★ Excellent Background for TV
- ★ School Inquiries Invited
- ★ Attractively Gift Packed

## FREE EXTRAS

- SET OF TOOLS • RADIO & ELECTRONICS TESTER • ELECTRIC SOLDERING IRON • TESTER INSTRUCTION MANUAL • MEMBERSHIP IN RADIO-TV CLUB: CONSULTATION SERVICE • HI-FI GUIDE
- QUIZZES • TV BOOK • FCC AMATEUR LICENSE TRAINING
- RADIO BOOK • PRINTED CIRCUITRY • PLIERS-CUTTERS
- ALIGNMENT TOOL • WRENCH SET • CERTIFICATE OF MERIT
- VALUABLE DISCOUNT CARD

### WHAT THE "EDU-KIT" OFFERS YOU

The "Edu-Kit" offers you an outstanding PRACTICAL HOME RADIO COURSE at a rock-bottom price. Our kit is designed to train Radio & Electronics Technicians, making use of the most modern methods of home training. You will learn radio theory, construction, servicing, basic Hi-Fi and TV repairs, code, FCC amateur license requirements.

You will learn how to identify radio symbols, how to read and interpret schematics, how to mount and lay out radio parts, how to wire and solder, how to operate electronic equipment, how to build radios. Today it is no longer necessary to spend hundreds of dollars for a radio course. You will receive a basic education in radio, worth many times the small price you pay, only \$26.95 complete.

### THE KIT FOR EVERYONE

The Progressive Radio "Edu-Kit" was specifically prepared for any person who has a desire to learn Radio. The "Edu-Kit" has been used successfully by young and old in all parts of the world, by many Radio Schools and Clubs in this country and abroad. It is used for training and rehabilitation of Armed Forces Personnel and Veterans throughout the world.

The Progressive Radio "Edu-Kit" requires no instructor. All instructions are included. Every step is carefully explained. You cannot make a mistake.

### PROGRESSIVE TEACHING METHOD

The Progressive Radio "Edu-Kit" is the foremost educational radio kit in the world, and is universally accepted as the standard in the field of electronics training. The "Edu-Kit" uses the modern educational principle of "Learn by Doing." Therefore, you will construct radio circuits, perform jobs and conduct experiments to illustrate the principles the various radio parts included in the "Edu-Kit." You then learn the function, theory and wiring of these parts. Then you build a simple radio. With this first set, you will enjoy listening to regular broadcast stations, learn theory, practice testing and troubleshooting. Then you build a more advanced radio, learn more advanced theory and techniques. Gradually, in a progressive manner, and at your own rate, you will find yourself constructing more advanced multi-tube radio circuits, and doing work like a professional Radio Technician.

Included in the "Edu-Kit" course are 20 Receiver, Transmitter, Code Oscillator, Signal Tracer, Signal Injector, Square Wave Generator and Amplifier circuits. These are not unprofessional "bread board" experiments, but genuine radio circuits, constructed by means of professional wiring and soldering on metal chassis, plus the new method of radio construction known as "Printed Circuitry." These circuits operate on your regular AC or DC house current.

In order to provide a thorough, well-integrated and easily-learned radio course, the "Edu-Kit" contains practical work as well as theory; troubleshooting in addition to construction; training for all whether your purpose in learning radio be for hobby, business or job; progressively-arranged material, ranging from simple circuits to well-advanced topics in Hi-Fi and TV. Your studies will be further aided by Quiz materials and our well-known FREE Consultation Service.

### THE "EDU-KIT" IS COMPLETE

You will receive all parts and instructions necessary to build 20 different radio and electronics circuits, each guaranteed to operate. Our Kits contain tubes, tube sockets, variable electrolytic, mica ceramic and paper dielectric condensers, resistors, tin strips, coils, hardware, tubing, punched metal chassis, instruction manuals, hookup wire, solder, selenium rectifiers, volume controls, switches, knobs, etc.

In addition, you receive Printed Circuit materials, including Printed Circuit chassis, special tube sockets, hardware and instructions. You also receive a useful set of tools, a professional electric soldering iron, and a self-powered Dynamic Radio & Electronics Tester. The "Edu-Kit" also includes Code Instructions and the Progressive Radio Amateur License training. You will also receive lessons for servicing with Fidelity Guide and Quiz Book. Everything is yours to keep.

J. Statist, of 25 Poplar Pl., Waterbury, Conn., writes: "I have repaired several sets for my friends, and made money. The "Edu-Kit" paid for itself. I was ready to spend \$240 for a course, but I found your ad and sent for your Kit."

### UNCONDITIONAL MONEY-BACK GUARANTEE

The Progressive Radio "Edu-Kit" has been sold to many thousands of individuals, schools and organizations, public and private, throughout the world. It is recognized internationally as the ideal radio course.

By popular demand the Progressive Radio "Edu-Kit" is now available in Spanish as well as English. It is understood and agreed that should the Progressive Radio "Edu-Kit" be returned to Progressive "Edu-Kit" Inc., for any reason whatever, the purchase price will be refunded in full, without quibble or question, and without delay.

The high recognition which Progressive "Edu-Kit" Inc. has earned through its many years of service to the public is due to its unconditional insistence upon the maintenance of perfect engineering, the highest instructional standards, and 100% adherence to its Unconditional Money-Back Guarantee. As a result, we do not have a single dissatisfied customer throughout the entire world.

**ORDER FROM AD - RECEIVE FREE BONUS**  
**RADIO & TV PARTS JACKPOT WORTH \$15**

- Send "Edu-Kit" Postpaid. I enclose full payment of \$26.95.
- Send "Edu-Kit" C.O.D. I will pay \$26.95 plus postage.
- Rush me FREE ELECTRONICS BARGAIN CATALOG. Include descriptive literature on "Edu-Kit."

Name.....  
Address.....

**Progressive "EDU-KITS" Inc.** 1186 Broadway, Dept. 244G  
Hewlett, N. Y.  
(ATT: S. GOODMAN, M.S. in ED., PRES.)

## TECHNOTES Continued

17.6 volts with less than the normal tube current of 0.13 amp through it. This is 0.7 volt more than normal.

The 1.5-volt input difference, the 0.7-volt difference because of R8, and an unbalance in the tubes caused the heater voltage to be 5 volts on one tube and 5.4 on the other. Correcting this by shunting 820 ohms across R8 brought the field-strength readings back to their original values.—James R. Giles

END

## Electromedicine: End of the Wonder-Drug Era?

continued from page 27

But there are problems whose solution doesn't require more knowledge than we now have. Unquestionably the most important of these is the development of an artificial heart or—more specifically—devising a way to power it. The kind of energy required by a heart Pacemaker or by the blood-pressure device developed in Rochester is well within the capabilities of modern, long-life battery technology.

And technicians have had some success in recharging implanted batteries by induction from a charger held outside the skin. (Doctors don't like the battery to be outside the body because the wires that bring electricity to the device can also bring infection through the necessary holes in the skin.)

But to run a pump such as the human heart requires vastly more energy. One artificial heart, developed at the Cleveland Clinic Foundation, runs on compressed air, but the conduit is impractically large. There is talk now of compact atomic generators that could be implanted in the body, but the hazards of radiation pose a formidable obstacle.

Recently, engineers demonstrated power transmission by microwave beam. They flew a helicopter about as big as a man with the energy of a beam transmitted from the ground (RADIO ELECTRONICS, January 1965, p. 72). But the human biologist must worry about the heat generated in wave-power transmission. Perhaps a wavelength can be found that will not dissipate its energy by heating living tissue that lies in the path of its target.

But solving the power problem for an artificial heart is not going to end the problem. For the medical men do not yet know enough about the restrictions that human red blood cells place on dynamic fluid flow. You cannot handle blood as you would plasma substitutes or dextrose. You cannot send red blood cells into strong eddies or around sharp curves without damaging them irreparably. The unknowns of this problem are the real stumbling block in the path of replacing the human heart.

But those who are interested in the basic energy-producing mechanism of the body may yet find ways to substitute for failing heart action without supplying a new heart. At the University of Wisconsin, scientists are closing in on the chemical electronics of mitochondria, the units within muscle cells that supply the energy for contraction. These researchers have now isolated units called electron transfer particles. These particles take energy from the sugar in the blood and transfer it to the adenosine triphosphate molecules that serve as storage batteries for the cells.

This sort of biochemical investigation suggests by its very nomenclature its close relationship to concepts familiar to workers in electronics. There is no mystical difference. The processes are the same, only carried on by different molecular entities.

There are similar resemblances in problems of the transfer of oxygen and carbon dioxide across the remarkable membranes in the human lung and for the exchange of wastes and electrolytes that goes on in the tiny tubules of the human kidney. General Electric recently demonstrated

a membrane that allowed a hamster to live completely surrounded by water. And several college engineering departments are working to replace the large, expensive and cumbersome artificial kidney machines.

Unfortunately, for every medical researcher who welcomes the help that physics and electronics can give him, there are dozens of doctors who argue that medicine is being "dehumanized", that the patient is actually suffering from the splintering of the kindly, lovable general practitioner into the coldly intellectual specialist.

The dean of the Harvard University Medical School was recently queried on this medical controversy which, in one form or another, emerges in practically every state and national medical meeting. He asked me whether I thought a patient would rather die with his hand comfortingly held by a gentle general practitioner or survive under the care of a more impersonal specialist.

In fact, automation is worrying organized medicine as much as it alarms industrial workers. But those who confidently expect to overcome our three major killers—heart disease, cancer and stroke—are banking heavily on computers and electronics to swing the balance in their favor.

Just in the past 2 years, doctors have seen the following examples of what electronics technology can do for medicine:

- At the Kaiser-Permanente Foundation in San Francisco, people coming in for annual health checkups now undergo more tests in 2 hours than were previously possible in a day spent at the clinic. Thanks to automatic blood testing machines and computer records of X-rays, electrocardiographs and other tests, examining doctors can examine the physical condition of a patient and question him with all needed current information at hand. There is no waiting period for test results to come in. And there need be no bulky filing cabinets from which earlier medical data must be laboriously retrieved.

- In two brain research centers, one in the United States and one in England, scientists are now able to see patterns in brain waves that they could never see without the aid of computers. In the US, the link of computer and electroencephalograph has enabled the researchers to tell by his brain waves what color a person is looking at. In England, doctors say they can distinguish a neurotic from a psychotic patient and both from a normal person by computer analysis of brain waves in a situation in which the subject must learn to respond to a stimulus.

- Recordings of patients' heart activity are now being sent over telephone lines to computers that know as much about what is normal and what is not as any competent heart specialist. Thus communications and computer electronics can make any doctor a reasonably good heart specialist if he has an electrocardiograph machine, a "black box" translator device and a telephone.

- Increased knowledge of the importance of the electric charge of body tissues has already produced an improved wound dressing made simply of gold leaf with an induced positive charge. Some research indicates that electrically charged air may benefit the victims of certain diseases.

Recently there occurred in Paris a typical scientific brou-ha-ha over a claim that some cancers in rats had been controlled by electromagnetic induction. The claim may well have been false, but few medical experts today would deride the idea that magnetic fields exert profound effects on the electrochemical processes of life.

In short, it seems that the era of "wonder drugs" is coming to an end and the age of medical electronics is here. A much closer working relationship between engineers and technicians on the one hand and physicians on the other will be required to obtain the full fruits of *electromedicine*.

The human race may well have a working mechanical heart before it sets foot on the moon!

END

JULY, 1965

# new Webster band-spanner "565"



## CITIZENS BAND 2-WAY RADIO

Low in price...ultra-compact...high in performance...ideal for business and personal use. Both a 2-way radio and a p.a. system.

Fully transistorized... uses effective planar silicon transistors • Extremely low standby drain on battery—no tube filaments • 5-channels • 5-watts power input • "Tiny-lamp" gives positive indication of amplifier operation and modulation • Two-stage noise limiter • Adjustable squelch • 1½"H, 6¼"W, 7½"D.



Suggested price **\$129<sup>95</sup>**

Please send information on "565" C-B radio

Name \_\_\_\_\_

Number \_\_\_\_\_ Street \_\_\_\_\_

City \_\_\_\_\_ State \_\_\_\_\_ Zip Code \_\_\_\_\_

WEBSTER 317 Roebling Rd. So. San Francisco, Calif.

# EIGHT INSTRUMENTS IN ONE

- Out-of-Circuit Transistor Analyzer
- Dynamic In-Circuit Transistor & Radio Tester
- Signal Generator
- Signal Tracer • Voltmeter
- Milliammeter
- Battery Tester
- Diode Checker



## Transistor Analyzer Model 212

Factory Wired & Tested — \$18.50  
Easy-to-Assemble Kit — \$13.50

**YOU DON'T NEED A BENCH FULL OF EQUIPMENT TO TEST TRANSISTOR RADIOS!** All the facilities you need to check the transistors themselves — and the radios or other circuits in which they are used — have been ingeniously engineered into the compact, 6-inch high case of the Model 212. It's the transistor radio troubleshooter with all the features found only in more expensive units. Find defective transistors and circuit troubles speedily with a single, streamlined instrument instead of an elaborate hook-up.

### Features:

Checks all transistor types — high or low power. Checks DC current gain (beta) to 200 in 3 ranges. Checks leakage. Universal test socket accepts different base configurations. Identifies unknown transistors as NPN or PNP.

Dynamic test for all transistors as signal amplifiers (oscillator check), in or out of circuit. Develops test signal for AF, IF, or RF circuits. Signal traces all circuits. Checks condition of diodes. Measures battery or other transistor-circuit power-supply voltages on 12-volt scale. No external power source needed. Measures circuit drain or other DC currents to 80 milliamperes. Supplied with three external leads for in-circuit testing and a pair of test leads for measuring voltage and current. Comes complete with instruction manual and transistor listing.

EMC, 625 Broadway, New York 12, N. Y.

Send me FREE catalog of the complete value-packed EMC line, and name of local distributor.

NAME \_\_\_\_\_ RE-7

ADDRESS \_\_\_\_\_

CITY \_\_\_\_\_ ZONE \_\_\_\_\_ STATE \_\_\_\_\_

# EMC

ELECTRONIC MEASUREMENTS CORP.  
625 Broadway, New York 12, New York  
Export: Pan-Mar Corp., 1270 B'way, N.Y. 1

# Why Do You Read So Slowly?

A noted publisher in Chicago reports there is a simple technique of rapid reading which should enable you to double your reading speed and yet retain much more. Most people do not realize how much they could increase their pleasure, success and income by reading faster and more accurately.

According to this publisher, anyone, regardless of his present reading skill, can use this simple technique to improve his reading ability to a remarkable degree. Whether reading stories, books, technical matter, it becomes possible to read sentences at a glance, and entire pages in seconds with this method.

To acquaint the readers of this publication with the easy-to-follow rules for developing rapid reading skill, the company has printed full details of its interesting self-training method in a new book, "Adventures in Reading Improvement" mailed free to anyone who requests it. No obligation. Simply send your request to: Reading, 835 Diversey Parkway, Dept. 448B, Chicago, Ill. 60614. A postcard will do. Include your zip code.

# NOTEWORTHY CIRCUITS

## MATCHING TRANSISTORS IN AUDIO OUTPUT STAGES

Matching the two transistors in the push-pull output stage of a radio or amplifier is usually important to prevent serious distortion, loss of power and early failure. But matched pairs are hard to come by commercially, and expensive, too. Matching them yourself is often time-consuming unless you have a transistor analyzer that can quickly compare leakage and small-signal current gain.

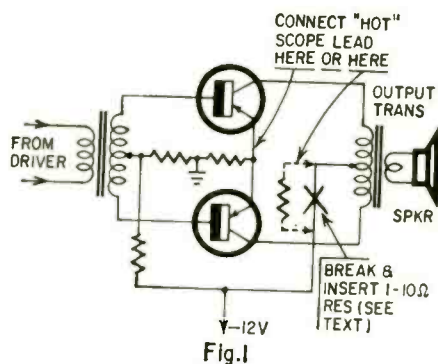

As in testing or matching tubes, it turns out that the best "test instrument" is the apparatus the transistors are to be used in. All you need besides the radio or amplifier you're working on is your oscilloscope and a single-frequency audio tone, 1 kc or lower. The 400-cycle signal from an rf signal generator is fine.

How you connect the scope depends on the circuit of the radio's output stage. In an ordinary transformer-coupled circuit, such as in Fig. 1, you can connect across the common-emitter resistor if there is one, or otherwise break the common-collector supply lead (output transformer center tap) and insert a resistor of 5 ohms or so. Connect the scope across that. (In high-powered amplifiers with husky power transistors in the output stage, the resistance may have to be less than 1 ohm to prevent disturbing the stage.)

Now feed in an audio signal at any convenient point (across the volume control, for example). You should see on the scope a pattern like Fig. 2-a or 2-b. Each upward "arch" represents a

## 3 New GERNSBACK LIBRARY Paperback books...

### TV SWEEP OSCILLATORS

By Harry E. Thomas  
TV SWEEP OSCILLATORS is a practical working tool and handy reference book for everyone who fixes TV sets. Written in clear, easy-to-understand language, it gives you all the practical facts you will ever need on the subject. Includes:

TV Sweep Systems-The Relaxation Oscillator... Capacitor Charge and Discharge-Pulse Techniques... Multivibrators and Blocking Oscillators... Sawtooth Generation in Sweep Systems... Variations in Sweep Oscillators... Failure Analysis in the General Operation and Servicing of Sweep Oscillators... and much more!

No. 119 Paperback—252 pages .....\$3.95

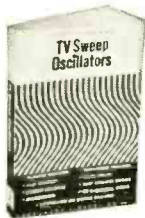

### THE HANDBOOK OF ELECTRONIC TABLES

is fast... easy... accurate... unique... and provides a wide variety of solutions to electronics problems!

The HANDBOOK is the first book to be totally devoted to electronic tables. The advantages of these tables are multiple: they're easy to use, they give you a high degree of accuracy and offer a wide variety of solutions. The tables are carried out to several decimals. You don't have to memorize any formulas, carry a slide rule or work out your problems: the answers have already been worked out for you.

No. 125 Paperback—160 p. ....\$2.95



### ADVANCED RADIO CONTROL

by Edward L. Safford, Jr.

A revolutionary challenge for the hobbyist interested in expanding his knowledge of radio control.

NEW IDEAS and concepts stimulating the imagination of the radio control hobbyist.

EXPLAINS how to use advanced radio control techniques for model planes, boats, trains, trucks, tractors, autos, and robots. This latest book brings you ideas which have never appeared in print before. And... it's a practical introduction to rockets and robots at the hobby level. Contains clear and concise diagrams.

No. 122 Paperback—192 pages .....\$3.50



### Get your copies of these new GERNSBACK LIBRARY

Handy Paperback books at Your local Radio-Electronics Parts Distributor

...or use the handy coupon to order

GIVE THIS COUPON to your local Parts Distributor or mail to:  
GERNSBACK LIBRARY  
154 West 14th Street,  
New York, N.Y. 10011

Please send me:

No. 119  TV SWEEP OSCILLATORS \$3.95

No. 125  THE HANDBOOK OF ELECTRONIC TABLES \$2.95

No. 122  ADVANCED RADIO CONTROL \$3.50

I enclose \$ \_\_\_\_\_

NAME \_\_\_\_\_

STREET ADDRESS \_\_\_\_\_

CITY \_\_\_\_\_

STATE \_\_\_\_\_

ZIP \_\_\_\_\_

RE-7-65-P



# CLIP AND MAIL THIS COUPON NOW

to get your choice of  
ANY 2 OF THESE  
ELECTRONICS BOOKS

for only \$1.99 SAVING YOU UP TO \$13.50!

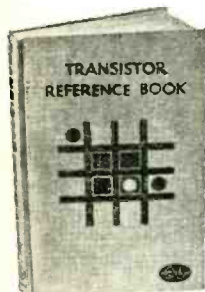

26.  
**TRANSISTOR  
REFERENCE  
BOOK**  
by David  
Kilpatrick,  
William  
Dittrich,  
David Emmel

Lists all transistors, cross references them and supplies information on their operating characteristics. Clothbound—Retail Price \$6.00



87.  
**PRACTICAL  
AUTO RADIO  
SERVICE &  
INSTALLATION**  
by Jack  
Greenfield

How to handle bugs in these specialized sets. How to service power supplies, various tube types, hybrids. Time-saving hints on installations and removal. Clothbound—Retail Price \$4.60



92.  
**FUNDA-  
MENTALS OF  
SEMICON-  
DUCTORS**  
by M. G.  
Scroggie

Thoroughly explores the entire field of semiconductor devices—transistors, rectifiers, photoelectric devices, thermistors, varistors, etc. Clothbound—Retail Price \$4.60



96.  
**HOW TO FIX  
TRANSISTOR  
RADIOS AND  
PRINTED  
CIRCUITS**  
(2 volumes—  
count as one  
book) by  
Leonard C.  
Lane

Theory and practical knowledge in a remarkable, easy-to-understand way. Tells how transistors work, why they amplify. Explains current and voltage gain; analyzes circuits. Reference section for "instant servicing." Hundreds of diagrams. Clothbound—Retail Price \$9.90

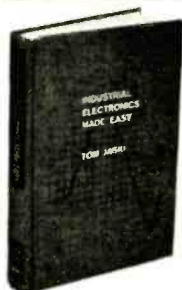

99.  
**INDUSTRIAL  
ELEC-  
TRONICS  
MADE EASY**  
by Tom Jaski

Operation and maintenance of industrial equipment, dielectric, induction and microwave heating processes and applications. Control systems actuated by photoelectric, infrared, pressure, and other transducers. Clothbound—Retail Price \$5.95



104.  
**BASIC RADIO  
COURSE**  
(Revised and  
Enlarged  
Edition) by  
John T. Fryc

So popular that 8 printings have been sold out! Everything you want to know—Ohm's Law, capacitance, tubes, transistors, and how they work in a receiver—practical servicing techniques. Clothbound—Retail Price \$5.75



105.  
**BASIC TV  
COURSE**  
by George  
Kravitz

A completely up-to-date guide to TV that covers such new developments as transistorized portables. A thorough practical discussion of circuit operation, sync methods, sweep systems, tuners, amplifiers, variations in power styles. Presents technical detail in easy-to-follow style. Clothbound—Retail Price \$5.75

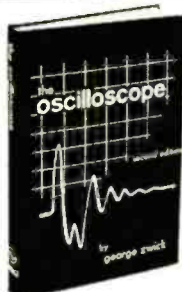

108.  
**THE OSCILLO-  
SCOPE** (Latest  
Revised  
Edition) by  
George Zwick

A thorough book that enables technicians to become masters of the scope. Incorporates the newest uses and techniques. Fully illustrated. Clothbound—Retail Price \$5.20

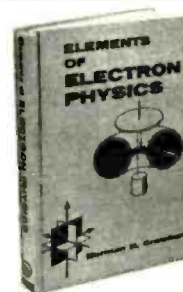

113.  
**ELEMENTS  
OF  
ELECTRON  
PHYSICS**  
by Norman H.  
Crowhurst

Explains the how and why of electronics in simple understandable language. Covers the beginnings of electronics, electron theory, solid-state semiconductors, tubes for electronics and electronic circuits. Clothbound—Retail Price \$5.65

YOU TAKE NO RISK | You may cancel your membership at any time



with an Introductory Membership  
in the GERNSBACK LIBRARY  
ELECTRONICS BOOK CLUB

**GERNSBACK LIBRARY ELECTRONICS BOOK CLUB**

1-3-RE-365

A Division of Gernsback Publications, Publishers of RADIO-ELECTRONICS  
154 West 14th Street, New York, N. Y. 10011

Please enroll me as a member of the GERNSBACK LIBRARY ELECTRONICS BOOK CLUB and send me the 2 books whose numbers I have indicated in the boxes at the right for ONLY \$1.99 (plus a few cents postage) which I will pay after examining the books for 10 days. I agree to purchase 4 additional Selections—or Alternates—during the first year I am a member. These books will be announced in the bi-monthly CLUB BULLETIN which I will receive FREE. I may cancel my membership at any time after buying these books. I am to receive a DIVIDEND BOOK CERTIFICATE with each book I buy after the first 4 Selections. These certificates may be used to obtain EXTRA books, which I may select from the members' dividend book catalog you will send me.



INDICATE  
BY NUMBER  
THE 2 BOOKS  
YOU WANT

I may read the two Introductory Books I have selected for 10 days and may cancel my subscription by returning them in good condition. (Money returned, of course.)

NAME \_\_\_\_\_  
(PLEASE PRINT—IT PREVENTS ERRORS)

STREET ADDRESS \_\_\_\_\_

CITY \_\_\_\_\_

STATE \_\_\_\_\_ ZIP CODE NO. \_\_\_\_\_

**SAVE POSTAGE COSTS** — enclose your payment of \$1.99 now and we will pay the postage. Same return privilege.

Your membership in this unique book club for those interested in electronics will help you to protect your future . . . increase your knowledge and earning power . . . keep you up-to-date on all latest electronic developments . . . OR it can bring you greater enjoyment from leisure hours if electronics is your hobby.

**YOU ENJOY SAVINGS OF UP TO 30% AS A CLUB MEMBER**

The purpose of this big money saving Introductory Membership offer is to demonstrate to you through the two books you select the advantages you will enjoy as a club member. Increase your knowledge and earning power and at the same time benefit from very substantial savings on every book you select.

A check of the list of recent selections will demonstrate to you the really big savings you will enjoy every time you accept one of the club selections. As a club member you enjoy savings as high as 30% on electronics books that will form an invaluable part of your library. Take this step to insure your role in the fast-moving electronics field.

**BOOKS ARE SELECTED BY OUTSTANDING AUTHORITIES**

Members of the Club are assured that they will have a selection of important new books coming off the presses. Club books are selected by a committee of television, radio and electronics authorities. Selections are made from the latest books in the famed Gernsback Library and those of other outstanding publishers in

the field. All of the books are deluxe hard cover clothbound books—they make a handsome addition to your library and are manufactured by skilled craftsmen to stand years of constant reference use and wear.

**YOUR CLUB BULLETIN WILL KEEP YOU POSTED ON THE LATEST BOOKS IN EVERY AREA OF ELECTRONICS**

As a Club Member you will receive a FREE subscription to the Club Bulletin. This publication brings you concise reviews of the most important books published in the field of electronics and provides you with other useful information you will want to save for reference. Each Bulletin describes the new Selection or Alternate. Then you can decide whether you want to accept the new selection or not. You have no obligation to take each selection.

As a new member you only agree to buy 4 books from the scores of new books listed in the Club Bulletin during the year . . . and you always enjoy special Members' savings on each.

Enjoy all of these benefits. Clip and mail the coupon at the top of this page now. Remember, you may read the 2 books you select FREE for 10 days and if you are not 100% satisfied just return them to us and cancel your subscription and you owe nothing. You have everything to gain and nothing to lose by accepting this New Members' Introductory Offer.

◆ **TYPICAL RECENT SELECTIONS** ◆

Give you an idea of the wide range of subjects covered by books selected for club members—and the wonderful savings you enjoy on every book!

	Retail Price	Club Price
• ELECTRONICS DATA HANDBOOK .....	\$4.95	\$3.25
• NEW SHORTCUTS TO TV SERVICING .....	9.90	6.50
• TUBES AND CIRCUITS .....	4.95	3.75
• HI-FI MADE EASY .....	5.00	3.75
• ELEMENTS OF TAPE RECORDER CIRCUITS .....	5.00	3.75
• BASIC ELECTRONIC TEST PROCEDURES .....	8.50	5.95
• ELECTRONIC DESIGN CHARTS .....	5.95	4.95
• BASIC TRANSISTOR COURSE .....	5.75	4.50
• THE V. T. V. M. ....	4.60	3.35
• HOW TO BUILD TINY ELECTRONIC CIRCUITS .....	5.85	4.95

**new...** A Club Members' Book Dividend Plan that brings you

**EXTRA** books of your own selection

NOW we have added an important PLUS VALUE to our book club plan. With each book you buy after the first 4, you will receive a GERNSBACK ELECTRONICS BOOK CLUB DIVIDEND CERTIFICATE. You can exchange these certificates for books of your selection listed in your Members' Book Dividend Catalog which indicates the number of certificates needed for each book. This means you will be getting EXTRA books in addition to your savings on every Selection or Alternate.

## SILICON RECTIFIER SALE

IMMEDIATE DELIVERY  
FULLY GTD NEWEST TYPE  
AMERICAN MADE FULLY TESTED

750 MA-SILICON "TOPHAT" DIODES  
LOW LEAKAGE FULL LEAD LENGTH

PIV/RMS 50/35 .05 ea.	PIV/RMS 100/70 .07 ea.	PIV/RMS 200/140 .10 ea.	PIV/RMS 300/210 .12 ea.
PIV/RMS 400/280 .14 ea.	PIV/RMS 500/350 .19 ea.	PIV/RMS 600/420 .23 ea.	PIV/RMS 700/490 .27 ea.
PIV/RMS 800/560 .35 ea.	PIV/RMS 900/630 .45 ea.	PIV/RMS 1000/700 .60 ea.	PIV/RMS 1100/770 .75 ea.

ALL TESTS AC & DC & FWD & LOAD  
SILICON POWER DIODE STUDS

D.C. AMPS	50 PIV 35 RMS	100 PIV 70 RMS	150 PIV 105 RMS	200 PIV 140 RMS
3	.08 ea.	.12 ea.	.16 ea.	.22 ea.
12	.25	.35	.50	.75
15	.65	.90	1.25	1.40
50	1.50	1.75	2.20	2.60
100	1.60	2.00	2.40	3.00

D.C. AMPS	300 PIV 210 RMS	400 PIV 280 RMS	500 PIV 350 RMS	600 PIV 450 RMS
3	.27 ea.	.29 ea.	.37 ea.	.45 ea.
12	.90	1.30	1.40	1.65
15	2.00	2.35	2.60	3.00
50	3.25	4.00	4.75	6.00
100	3.60	4.50	5.25	7.00

"SCR" SILICON CONTROLLED RECTIFIERS "SCR"

PRV	AMP	AMP	AMP	PRV	AMP	AMP	AMP
7	.30	.50	.85	7	1.75	2.15	2.50
16	.45	.75	1.00	300	2.00	2.40	2.75
25	.80	1.25	1.50	400	2.40	2.75	3.25
100	1.50	2.00	2.50	500	3.20	3.40	3.80
200	1.25	1.80	2.25	400	3.40	4.00	4.50

### SPECIALS!

100 Different Precision Resistors  
1/2-1-2 watt 1/2%-1% TOL \$1.50  
2 amp 1000 Piv Silicon Power Rect. .70 ea. 10 for \$6.50

T.V. Replacement Antenna List \$11.50 ea.  
J. F. D. Supersensitive, 4 Sections Monopole  
Antenna, replacement for most sets \$1.25 ea.

Computer Grade Condenser 15,500 MFD  
15 VDC American Mfg. .75 ea.  
Type IN34 DIODE GLASS .07 ea. 100 for \$5

Money Back guarantee. \$2.00 min. order. Orders  
F.O.B. NYC. Include check or money order. Shpg.  
charges plus. C.O.D. orders 25% down.

Warren Electronic Components

230 Mercer St., N. Y., N. Y. 10012 • OR 3-2620

# TRY THIS ONE

## MAKING FLAT COILS

To make flat spiral coils for telephone pickups, and flat broadcast coils for miniaturized equipment, I start with an old-fashioned spiderweb coil. This is made by putting an *odd* number of pins or nails in a dowel rod and winding the wire as shown. When the coil is wound, one side is covered with vinyl cement.

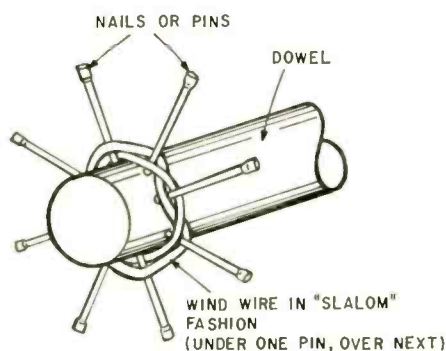

(The nails can be covered with a thin layer of paraffin to keep glue from sticking to them.) When the cement sets, remove the pins and coil. Squeeze the coil between two flat plastic or wood pieces in a vise or press. Now you have a flat spiral coil. The thinner the pins, the more successful the process. For very small coils of fine wire, use sewing needles.

Two such coils placed on either side of a plastic base make an excellent rf or i.f. transformer. By placing one coil on the plastic side of a copper laminate board, and connecting one end to a copper disc the size of the coil (after etching), the flat spiral coil can be provided with capacitance. Inductance of the spiral coil  $L = .00194 dn^2\mu$  where  $d$  = outside diameter of spiral,  $n$  = number of turns and  $\mu$  = permeability, usually 1.—Tom Jaski

## EPOXY RESIN COMPOUND REPAIRS BROKEN KNOBS

Have you ever repaired a TV set or radio, finished the job and found that a knob is broken off or gone altogether? You look into your \$200 assortment of knobs and nothing matches the broken one. The local distributor says he has just sold the last one and it will take only 2 weeks to get a new one. You know that the last knob took 6 weeks, another knob 8 weeks. Here is your answer for those hard-to-get-knobs. Don't get me wrong—I like to sell knobs also, but there are times when a set will sit on the shelf for months with just a little old broken knob.

Some distributors stock a mending



glue called Twin-Weld (also found at most hardware stores). Twin-Weld is a fiberglass-epoxy material. When the contents of the two tubes are mixed together, the resulting goop will bond most anything into one piece—metal to wood, ceramic, concrete, glass, bricks, anything. It is best to mix in a throw-away container; or be sure and clean the container up before the epoxy sets. (Twin-Weld epoxy is a product of Fybrglas Industries, Chicago, Ill.)

Mix just enough epoxy material for the knob to be repaired with. Take the broken piece and put it back into its original position. If a flat spring was in the broken piece, also place it in as originally manufactured. Spread glue on the joining surfaces and also all around the broken piece of the knob. Coat the surface well; the epoxy mixture will not run down the side of the knob. On very-long-shank knobs, it is best to coat the entire length with epoxy. Let the knobs set over night. The next morning the mixture will be very hard and can be filed or ground smooth. The photo shows the mending operation.

If a long-shank knob needs repair and a piece is missing, the shaft must be built up into its original shape. Place the small spring into position and lay a small piece of masking tape over it. Don't use too big a piece—leave enough room so that the epoxy will bond to the cracked side of the knob. Simply apply a lot of mixture where the piece is missing and go clear around the whole knob shank. Wrap a layer of masking tape around the mended knob and let set overnight. Tear the masking tape off the next morning and grind or file the patched part down into a decent looking knob.

This type of epoxy mixture is also very good for repairing radio cabinets. —Homer L. Davidson

## PROTECTING SMALL DRILLS

Avoid premature breakage of small, delicate drills by pushing the drill through a cork, rubber ball, etc. before chucking in the drill press. The cork keeps the drill from bending in the middle while biting into the work.—Ed Mayover

END

# "Which microphone should I use?"

- for tape recording
- for broadcasting
- for CB and ham
- for public address
- for any application...

Free Booklet—  
Everything You  
Want To Know  
About Micro-  
phones! Send  
Coupon Today!



LTV UNIVERSITY  
A Division of LINC-TELECO-VOICET, INC.

Dept. 8, P.O. Box 1056, Oklahoma City, Okla.

Name \_\_\_\_\_

Address \_\_\_\_\_

City \_\_\_\_\_ State \_\_\_\_\_ Zip Code \_\_\_\_\_

# WHAT'S YOUR EQ?

These are the answers. Puzzles are on page 52.

## From Here To Infinity

The solution is not too difficult if the superposition principle is employed.

Let 1 amp from some source enter the mesh at node A, and leave the mesh at infinity. Because of symmetry, the current (shown in solid lines) divides evenly at each successive node. For example, at A, the current divides four ways into 1/4-amp currents. These 1/4-amp currents go on to divide into 1/12-amp currents, and so on.

Now, let 1 amp enter at infinity and leave the mesh at node B. The currents (dotted lines) leading to node B must add evenly, that is 1/4 amp must come from each of the four branches leading to B, and so on.

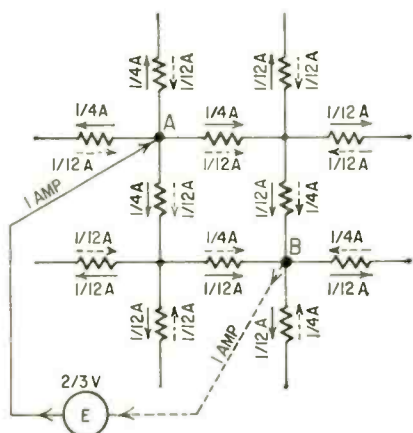

If both of these effects are superposed, the combined effect is the same as if we had 1 amp flowing into A and out B by means of a battery connected to A and B. Adding the voltage drops along either path from A to B:

$$V_{ac} = \left(\frac{1}{4} + \frac{1}{12}\right) \text{ amp} \times 1 \text{ ohm} = \frac{1}{3} \text{ volt}$$

$$V_{cb} = \left(\frac{1}{4} + \frac{1}{12}\right) \text{ amp} \times 1 \text{ ohm} = \frac{1}{3} \text{ volt}$$

Total voltage between A and B is 2/3 volt. Therefore:

$$R = \frac{\frac{2}{3} \text{ volt}}{1 \text{ amp}} = \frac{2}{3} \text{ ohm}$$

## More Resistance

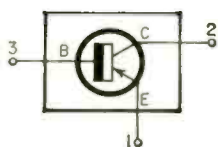

The box contains a p-n-p germanium power transistor connected to terminals as shown.

## Steady Current

The black box contains three components—a transistor, a resistor and a 1.5-volt battery. In operation, the transistor base-emitter circuit is biased by the 1.5-volt battery, causing the transistor to conduct. As current flows through the external circuit via the 1,500-ohm resistor, a voltage drop is developed which bucks the 1.5-volt battery. The result is that the current is regulated to the point where the voltage drop across the 1,500-ohm resistor just equals the bias voltage minus the base-emitter voltage.

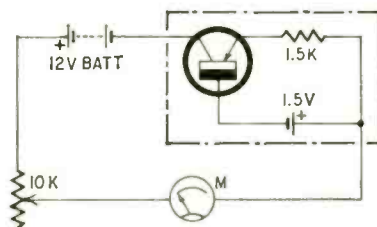

This very simple circuit is quite effective, and is the basis for most solid-state current regulators.

**ZIP** stands for the Post Office Department's new Zoning Improvement Plan. When renewing your RADIO-ELECTRONICS subscription, or sending us a change of address, please let us know what your ZIP Code is. We'll add it to your address mailing plate... and you'll get speedier delivery service from the Post Office. By the way, when writing to us, address: RADIO-ELECTRONICS, 154 West 14th St., New York, N. Y. 10011.

Every No-Noise Aerosol Product

*Guaranteed*

**Non-Flammable  
Non-Toxic and  
Won't Affect Plastics**

**"NO NOISE"**  
VOLUME CONTROL  
&  
CONTACT RESTORER

**"TUNER-TONIC"**  
WITH PERMA-FILM

**EC-44** for all electrical contacts

FREE 5" plastic extender push-button assembly for pin-point application with all No-Noise products.

**ELECTRONIC CHEMICAL CORP.**  
813 Communipaw Avenue, Jersey City 4, N. J.

# ELECTRONICS

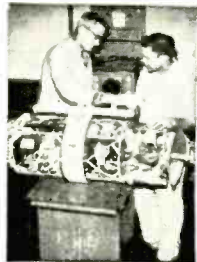

## Engineering-Technicians

Bachelor of Science Degree, 30 Months  
Save Two Years' Time

- Radio-Television Plus Color Technician (12 Months)
- Electronics Engineering Technology (15 Months)
- Electronics Engineering (B.S. Degree)
  - Electrical Engineering (B.S. Degree)
  - Mechanical Engineering (B.S. Degree)
  - Civil Engineering (B.S. Degree)
  - Architecture (B.S. Degree) (36 Months)

The Nation's increased demand for Engineers, Electronic Technicians, Radio TV Technicians is at an all time high. Heald Graduates are in demand for Preferred High Paying Salaries. Train now for a lucrative satisfying lifetime career.

Approved for Veterans  
**DAY AND EVENING CLASSES**

# HEALD'S

**ENGINEERING COLLEGE**  
Est. 1863—101 Years  
Van Ness at Post, RE  
San Francisco, Calif.

Write for Catalog and Registration Application. New Term Starting Soon.

Your Name .....

Address .....

City .....

State .....

## 50 easy-to-build Transistor Circuits

**Electronic Projects**  
FOR  
students, beginners,  
hobbyists



at your  
dealer  
**\$1.95**  
or mail  
coupon

100 pages of exciting transistor projects you can make with easy-to-get inexpensive parts. No technical knowledge needed—just the small tools shown. Tells you HOW TO: solder, recognize electronic parts, read electronic symbols. Clear pictorial and wiring diagrams make instructions easy. You can make: crystal radio, sun-powered radio, electronic megaphone, flashers, intercom, hi-fi tester, appliance tester, tachometer, stereo balance, code transmitter, and 40 other useful devices. A wonderful introduction to electronics. Published by Semitron, the leading professional line of semiconductors.

**SEMITRON**

Semitronics Corp.  
265 Canal St.  
N.Y., N.Y. 10013

I enclose \$1.95. Send me your 50-projects handbook postpaid.

Name.....

Address.....

City.....State.....Zip.....

## ALL NEW WINEGARD TRACKER

Has **TWICE** the range of  
Ordinary UHF antennas!

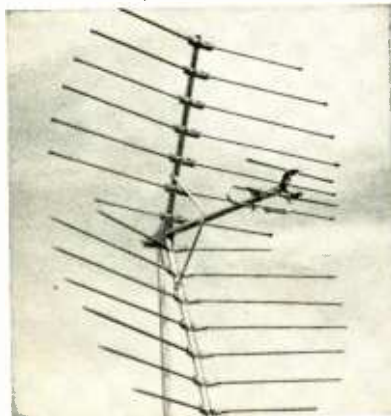

- Uses "Controlled Incident Wave" principle to give it as much signal capture ability as a VHF antenna
- With pre-amp, TRACKER is actually 17 times more sensitive than ordinary UHF antennas, (brings hundreds of thousands of TV viewers into range of good UHF reception for the first time)
- VSWR of 1.5:1 or better on all channels, highest gain across all UHF channels 14-83.
- Factory pre-assembled, Lightweight, All Aluminum construction, Gold Anodized.
- Compact Carton (45" x 7" x 4 1/2") saves valuable storage space.

TRACKER is the best UHF antenna you can buy. Ask your distributor or write for spec. sheets today.

**Winegard Co. ANTENNA SYSTEMS**

3013-H KIRKWOOD • BURLINGTON, IOWA

# NEW BOOKS

**ELECTRONIC MOTOR CONTROL**, by Allan Lytel. Howard W. Sams & Co., Inc., 4300 W. 62 St., Indianapolis 6, Ind. 5 1/2 x 8 1/2 in., 224 pp. Paper, \$3.95

Discusses all types: tubes, semiconductors, magnetic amplifiers, etc. Includes troubleshooting data and schematics of typical industrial controls.

**WORLD MEDIUM WAVE GUIDE 1965**, World Publications. Obtainable from Gilfer Associates, Box 239, Park Ridge, N.J. 6 3/4 x 9 in., 58 pp. Paper, \$1.95.

Lists all medium-wave broadcast stations in the world, and all North American television stations. This is a supplement to the "World Radio-TV Handbook" which does not list the American broadcast stations. The listing is in two parts: North American countries, and countries outside North America. The listing is by frequencies, beginning with 520-kc stations (540 in North America) and continuing to the top of the broadcast band. There is also a North American list by states and provinces (Mexico, interestingly, is listed in the non-North American stations) and a list of American and Canadian television stations.

**THE RADIO AMATEUR'S HANDBOOK**, by Headquarters Staff of American Radio Relay League, Newington 11, Conn. 6 1/2 x 9 1/2 in., 686 pp. Paper, \$4.

This is the latest edition of one of the world's most widely read and most often used technical manuals. It has been brought up to date to include the latest developments in theory, practice, circuitry and components. The section on vacuum-tube characteristics is the most comprehensive and useful that you will find anywhere. A must for progressive hams, experimenters and communications technicians and engineers.

**SEMICONDUCTOR NETWORK ANALYSIS AND DESIGN**, by Vasil Uzunoglu. McGraw-Hill Book Co., 330 W. 42nd St., New York, N.Y. 10036. 6 x 9 in., 372 pp. \$12.50.

An advanced text that links theory with engineering solutions. Suitable for graduate students.

**PHOTOCELL APPLICATIONS**, by Rufus P. Turner. Lafayette Publication No. 10-0102, 111 Jericho Turnpike, Syosset, N.Y. 11791 5 1/2 x 8 1/2 in., 80 pp. Paper, \$1.50

Covers the whole subject concisely and compactly. Numerous schematics of experimental and practical circuits, with complete parts lists for the constructor.

**PRINCIPLES AND APPLICATIONS OF BOOLEAN ALGEBRA**, by Salvatore A. Adelfio and Christine F. Nolan. Hayden Publishing Co., Inc., 850 3rd Ave., New York, N.Y. 10022. 6 x 9 in., 336 pp. Cloth, \$8.

In its purpose of explaining Boolean algebra and applying them to basic elec-

tronic circuits, the authors have been highly practical. Well over half the book is devoted to electronics applications of this branch of math so important to electronics.

**ELECTRONIC PROJECTS FOR STUDENTS, BEGINNERS & HOBBYISTS (Vol 1, Parts 1 and 2)**. Semitronics Corp., 265 Canal St., New York, N.Y. 10013 5 1/2 x 8 1/2 in., 96 pp. Paper, \$1.95

A book aimed at the student, beginner and hobbyist. After a brief introduction, designed to explain without terrorizing, some 50 projects are described, ranging from a simple diode crystal set to a sound-operated receiver for use in a garage-door opener or for similar applications. Complete parts lists are given and a master list of parts that covers all of the experiments appears at the end of the book.

**2-WAY MOBILE RADIO HANDBOOK**, by Jack Helmi. Howard W. Sams & Co., Inc., 4300 W. 62 St., Indianapolis 6, Ind. 5 1/2 x 8 1/2 in., 223 pp. Paper, \$3.95

A guide to equipment and systems used in the Citizens and business bands, with many schematics. Installation tips, operational theory, test and maintenance, and even how to set up a repair and sales business.

**LES TECHNIQUES ULTRA-SONORES**, by P. Hémarinquer. Editions Chiron, 40 rue de Seine, Paris VIe, France. 5 1/2 x 8 1/2 in., 261 pp. Paper, 30 francs.

Although this book has the handicap of being in French, the literature on ultrasonics is so sparse that many will welcome its rather complete coverage, which begins with generators and ends with applications in various fields. Old-time readers will remember Hémarinquer as an author in **RADIO-ELECTRONICS** and *Radio Craft*.

**HI-FI TROUBLES . . . HOW YOU CAN AVOID THEM . . . HOW YOU CAN CURE THEM**, by Herman Burnstein. Gernsback Library No. 120, 154 W. 14 St., New York, N.Y. 10011. 5 x 8 1/2 in., 160 pp. Paper, \$3.95

Shows the high-fidelity owner how to locate his troubles with simple equipment, and, having found them, to cure them. By one of the country's leading writers on high-fidelity subjects.

**FUNDAMENTALS OF DATA PROCESSING**, by Allan Lytel. Howard W. Sams & Co., 4300 W. 62 St., Indianapolis 6, Ind. 5 1/2 x 8 1/2 in., 320 pp. Paper, \$6.95

A clear, detailed description of computers as used by business, engineering and industry. Diagrams and examples explain the applications of the machines and the math they employ. END

**RADIO-ELECTRONICS**

# SCHOOL DIRECTORY

## ADVANCE in Electronics

Advancement in electronics comes to those who really *understand* basic principles. If you are handicapped by a poor understanding of these vital "basics", you need the *strong foundation training* offered by Grantham School of Electronics.

"Grantham," year after year, continues to stand for **QUALITY** electronics training **IN A HURRY** — *quality*, in that the Grantham integrated-subject-matter method promotes learning progress through understanding — *in a hurry*, in that the Grantham method leads to greater accomplishment in less time than conventional methods.

Grantham avoids the all-too-common practice of teaching *by rule*, without any reason being given for the rule. Grantham seeks to have the student understand the reasons so well that rules are *not memorized by rote* but, rather, *are understood and therefore remembered*. This method not only makes learning more interesting but also improves learning speed and retention.

Grantham training is available in resident classes or by correspondence. Our schools are located in Hollywood, Seattle, Kansas City, and Washington, D.C. Write for our free catalog which contains all pertinent details. Ask for *Catalog 57-K*.

**Grantham School of Electronics**  
1505 N. Western Ave, Hollywood, Calif. 90027

## A JOB or a POSITION ?

The difference is **ELECTRONIC MATHEMATICS**

**NOW! A NEW WAY TO LEARN**—I. H. S. I. WAY. A complete home study course in electronic math to help you get the position you want—**MORE MONEY—MORE RESPECT.**

**COURSE PREPARED BY COLLEGE PROFESSORS** who have lectured to thousands of men on math and engineering. You learn at home quickly, easily — **AS FAST** as you want.

**YOU SIGN NO CONTRACTS** Pay only if satisfied—you owe it to yourself to examine the **INDIANA HOME STUDY INSTITUTE COURSE IN ELECTRONIC MATH.** **FREE BONUS**—if you join now, a refresher course in basic arithmetic.

Write for Brochure—No Obligation  
**THE INDIANA HOME STUDY INSTITUTE**  
Dept. RE-7, P.O. Box 1189  
Panama City, Fla. 32402

**ETI** **Engineering Technician**  
A.S. Degree—2 Years  
**Electronics Engineer**  
B.S. Degree  
Evening Courses Available  
**ELECTRONIC TECHNICAL INSTITUTE**  
4863 El Cajon Blvd., San Diego, Calif.

## B.S. degree in 36 months

Small professionally-oriented college. Four-quarter year permits degree completion in three years. Summer attendance optional. **Engineering:** Electrical (electronics or power option), Mechanical, Civil, Chemical, Aeronautical. **Business Administration:** Accounting, General Business, Motor Transport Administration. One-year Drafting and Design Certificate program. Graduate placement outstanding. Founded 1884. Rich heritage. Excellent faculty. Small classes. Well-equipped labs. New library. New residence halls. Attractive 300-acre campus. *Modest costs.* Enter Sept., Jan., March, June. For *Catalog and View Book*, write Director of Admissions.

**TRI-STATE COLLEGE**  
2475 College Avenue, Angola, Indiana

## FREE! NEW CAREER GUIDE TO Success in ELECTRONICS

**Automation, Math—Basic or Advanced**  
Wide choice of new Home Study Programs to prepare you for well paying career or advancement in present job. Choose Service, Broadcasting, Industrial, Automation. We assist you in choosing best program... save time and money. Tuition refund surety. Since 1931. Write today—  
**CENTRAL TECHNICAL INSTITUTE**  
Dept. 03075, 1644 Wyandotte St. Kansas City, MO. 64108

## EARN Electronics Engineering DEGREE

You can earn an A.S.E.E. degree at home. College level **HOME STUDY** courses taught so you can understand them. Continue your education, earn more in the highly paid electronics industry. Missiles, computers, transistors, automation, complete electronics. Over 27,000 graduates now employed. Resident school available at our Chicago campus—Founded 1934. Send for free catalog:  
**American Institute of Engineering & Technology**  
1139 West Fullerton Parkway, Chicago 14, Ill.

Learn Electronics for your **SPACE-AGE EDUCATION** at the center of America's aerospace industry

No matter what your aerospace goal, you can get your training at Northrop Tech. in sunny Southern California.

**COLLEGE OF ENGINEERING.** Get your B.S. degree in engineering in just 36 months by attending classes year round. Most Northrop Tech graduates have a job waiting for them the day they're graduated!

**A & P SCHOOL.** Practical experience on real aircraft. One-year course prepares you for F.A.A. A & P certificate. **WRITE TODAY FOR CATALOG.**

**NORTHROP INSTITUTE OF TECHNOLOGY**  
1199 W. Arbor Vitae, Inglewood, Calif.

## GET INTO ELECTRONICS

V.T.I. training leads to success as technicians, field engineers, specialists in communications, guided missiles, computers, radar and automation. Basic & advanced courses in theory & laboratory. Electronic Engineering Technology and Electronic Technology curricula both available. Assoc. degree in 29 mos. B.S. also obtainable. G.I. approved. Graduates in all branches of electronics with major companies. Start Sept., Feb. Term, campus. High school graduate or equivalent. Catalog.

**VALPARAISO TECHNICAL INSTITUTE**  
Department C, Valparaiso, Indiana

## LEARN ELECTRONICS

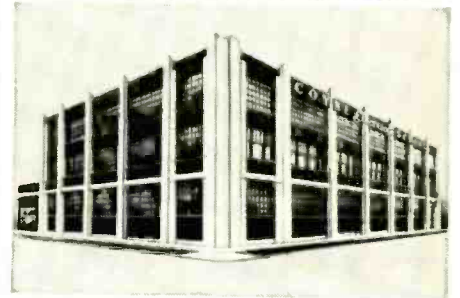

FOUNDED 1899 NOT-FOR-PROFIT

## COYNE ELECTRONICS INSTITUTE

Electronics Engineering Technology	—	Degree (2 Yrs.)
Electrical-Electronics Technician	—	Diploma (40 Wks.)
TV-Radio-Electronics Technician	—	Diploma (40 Wks.)
Combined Electronics Technician	—	Diploma (80 Wks.)
Practical Electrical Maintenance	—	Diploma (32 Wks.)
Practical Refrigeration Air Conditioning and Appliance Repair	—	Diploma (24 Wks.)
Specialized Industrial Electronics	—	Diploma (16 Wks.)
Introduction to Electricity-Electronics	—	Certificate (8 Wks.)
FCC First Class Radiotelephone	—	Certificate (100 Hrs.)

Special finance plans. Part time employment service while in school. Also Free graduate employment service.



Use this coupon to get our **FREE BOOK "YOUR OPPORTUNITIES IN ELECTRONICS"**

**COYNE ELECTRONICS INSTITUTE, Dept. of Electronics 85-N**  
1501 W. Congress Parkway, Chicago, Illinois 60607

Name \_\_\_\_\_ Age \_\_\_\_\_  
Address \_\_\_\_\_ Phone \_\_\_\_\_  
City \_\_\_\_\_ Zone \_\_\_\_\_ State \_\_\_\_\_  
*Unlike most other schools, we do not employ salesmen*

when it's time to think of college you should read this

**FREE CAREER BOOKLET** about electronics at



**MILWAUKEE MS-237 SCHOOL OF ENGINEERING**  
Dept. RE-765, 1025 N. Milwaukee Street  
Milwaukee, Wisconsin 53201

Tell me about an engineering career through residence study in:

Electrical fields  Mechanical fields

Name..... Age.....  
Address.....  
City, State.....

# MARKET CENTER

CASH, SONY TRANSISTOR TV's etc. swapped for G-R, H-P, L&N etc. equipment, special tubes, manuals, military electronics. **ENGINEERING ASSOCIATES**, 428 Patterson Road, Dayton, Ohio 45419.

Military surplus radios ARC-27 ARC-34 ARC-38 ARC-39 ARC-44 ARC-52 ARC-55 ARC-73 ARC-84 R-220C/ARN-21 51X-2/17L-7 RT-68/GRC. Test sets with ARM, URM, UPM. UPM. SG prefixes. Top cash dollar paid. **SLEP ELECTRONICS**, Drawer 178 Ellenton, Florida. 33532

## EMPLOYMENT OPPORTUNITIES

**CALIFORNIA EMPLOYMENT.** Names and addresses of 500 Southern California electronics firms \$3. Air Mail \$4. **SPINDLER**, P.O. Box 103, Canoga Park, California 91305

**OVERSEAS—FOREIGN—U.S.A.** All occupations, trades, helpers. Guaranteed openings. Immediate placement. Steady. Modern Family accommodations. Transportation. Free information. Prompt reply. **GLOBAL EMPLOYERS**, Box 286-G, Oroville, California.

## SERVICES

**METERS—MULTIMETERS REPAIRED** and calibrated. **BIGELOW ELECTRONICS**, Box 71-B, Bluffton, Ohio.

**SPEAKER RECONING.** Satisfaction Guaranteed. **C & M RECONE CO.**, 11 Witherspoon Street, Princeton, New Jersey

**TRANSISTORIZED** products dealers catalog. \$1. **INTERMARKET**, CPO 1717, Tokyo, Japan.

## MOTION PICTURES

**SPECTACULAR '64 Indianapolis "500" Classic.** 188' 8mm Eastman Color including fiery second lap crash \$11.95 postpaid. **SPORTLITE "500" FILMS**, 20-RE North Wacker, Chicago, Illinois 60606

## AUDIO—HI-FI

Component quotations—tapes Mylar 1800' postpaid \$1.59 each. **BAYLA**, Box 131RE Wantagh, N.Y.

## WHEN YOU ORDER MERCHANDISE BY MAIL . . .

- Be sure to include your name and address. Use your zip code number if you know it.
- Type or print if you can—if not, write clearly.
- Don't send cash! Remit by check or money order.
- Include allowances for postage charges if you know the weight of what you're ordering.
- Mention you saw it in **RADIO-ELECTRONICS**

## GENERAL

**TV SERVICE ORDER BOOKS** for use with your rubber stamp. Duplicate or triplicate. Low cost. Write for **FREE 32 PAGE CATALOG** and Special Rubber Stamp Offer. **OELRICH PUBLICATIONS**, 6556 W. Higgins, Chicago, Ill. 60656.

72 page Illustrated Government Surplus Radio, Gadgets Catalog 20¢. **MESHNA**, Nahant, Mass.

**McGEE RADIO COMPANY.** Big 1965 176-page catalog sent free. America's best values hi-fi amplifiers-speakers-electronic parts. 1901 McGee Street, Dept. RE, Kansas City, Mo. 64108.

**Achtung! Das Machine is Nicht fur Gerfingerpoken und Mittengraben.** Is easy Schnappen der Springenwerk, Blowentusen und Poppencorken mit Spitzensparken. Ist Nicht fur Gewerken by das Dummkopfen. Das Rubbernecken Sightseeren Keepen Hands in das Pockets. Relaxen und Watch das Blinkenlights. This attractive Brass plaque only \$2 ea. ppd. **SOUTHWEST AGENTS**, Dept. RE, 8331 Hwy 80 W., Fort Worth, Texas 76116.

**BARGAINS OFFSET** Presses, Varytypers Mimeograph Typewriters. Write **DIXIEGRAPH**, King, North Carolina.

Convert any television to sensitive Big-Screen Oscilloscope. Only minor changes required. No electronic experience necessary. Illustrated plans \$2.00. **RELCO-A25**, Box 10563, Houston 18, Texas.

**BUILD TV CAMERA** cheaper than ever! Send 10¢ for details. **ATV RESEARCH**, Box 396, So. Sioux City, Nebraska 68776.

**TINT-Windshield's.** Windows, Mirrors-Blue, Green, Yellow. \$2.98 Postpaid. Guaranteed. Nationally Advertised. **RUSSO COMPANY**, 209 Carlisle, Spartanburg, S. C.

## Canadians

**GIANT SURPLUS BARGAIN PACKED CATALOGS.** Electronics, Hi-Fi, Shortwave, Amateur, Citizens Radio, Rush \$1.00 (Refunded). **ETCO**, Box 741, Dept. R, Montreal, Canada.

**TRANSISTOR AND SEMICONDUCTOR SPECIAL.** ISTS. Free winter catalogue contains reference data on over 300 types. **J. & J. ELECTRONICS**, Box 1437, Winnipeg, Manitoba.

## WANTED

**QUICK CASH . . .** for Electronic EQUIPMENT, COMPONENTS, unused TUBES. Send list now! **BARRY**, 512 Broadway, New York, N. Y. 10012, 212 WALKER 5-7000.

**CLASSIFIED COMMERCIAL RATE** (for firms or individuals offering commercial products or services): 55¢ per word . . . minimum 10 words.

**NON-COMMERCIAL RATE** (for individuals who want to buy or sell personal items): 30¢ per word . . . no minimum.

Payment must accompany all ads except those placed by accredited advertising agencies. 10% discount on 12 consecutive insertions, if paid in advance. Misleading or objectionable ads not accepted. Copy for September issue must reach us before July 10th.

**WORD COUNT:** Include name and address. Name of city (Des Moines) or of state (New York) counts as one word each. Zone or Zip Code numbers not counted. (We reserve the right to omit Zip Code if space does not permit.) Count each abbreviation, initial, single figure or group of figures or letters as a word. Symbols or groups such as 8x10, COD, AC, etc., count as one word. Hyphenated words count as two words. Minor over-wordage will be edited to match advance payment.

## Rectifiers & Transistors

750 ma Silicon diodes "Epoxy" or "Top Hat"			Silicon Power Diode Studs 3 amps				
PIV	PIV	PIV	PIV	PIV	PIV		
50	5¢	600	21¢	25	6¢	300	25¢
100	7¢	*700	25¢	50	8¢	400	28¢
200	10¢	*800	32¢	100	14¢	500	35¢
400	14¢	*900	40¢	150	16¢	600	40¢
500	18¢	*Top Hat only	200	22¢	All Tests		

Full Leads. Tested. Guaranteed. American made

10 Watt Sil. Zener studs, 6-150v, any voltage	95¢ ea.
1 Watt Zener Diode Axial leads 6v-200v	50¢ ea.
Sil. diode stud 1500 PIV 300ma	50¢ ea.
18 Amp Stud Sil. Rect. 100 PIV	75¢ ea.
Hi-Voltage-Silicon epoxy diode, 2 1/2" x 3/8" x 1/2"	\$1.49 ea.
Hoffman—3000 PIV-200ma.	\$3.49 ea.
Hoffman—6000 PIV-200ma.	
Thermistor, glass bead, 1200 ohms, 600°F, 2/\$1.00	
Sil. Power 2N1724—\$1.50; 85 watts	

20 Watt Germanium (Internal Heat Sink)

2N1038	6 for \$1.00	2N1042	4 for \$1.00
2N1039	4 for \$1.00	2N1043	3 for \$1.00
261040	3 for \$1.00	2N1044	2 for \$1.00
2N1041	2 for \$1.00	*N1045	70¢

Light Sensitive Resistor	
75 ohms—10 meg. 100 volts, 150mw	\$1.75 ea

150 Watt Germanium Power

2N456A	70¢	2N458A	90¢
2N457A	80¢	2N1021	\$1.00

HF Sil. 2N702-100mc 40¢; 2N703-150mc 60¢

Light sensitive Power transistor TO-3 Case with circuit instructions—\$1.95 ea.

Philco Sil., NPN, 2N2479, new 3 for \$1.00  
1N429, 6v Zener 30¢  
HF Silicon tetrode, 3N35—75¢ ea.  
2N243, Silicon power—4 for \$1.00  
Sil. diodes, 1N200 series, assorted, new 15 for \$1.00  
Ger. diodes, glass, new 15 for \$1.00  
Nickel Cadmium Battery 9 1/2" oz. 2 1/4" x 1/4" x 4 1/2", 8 amp-hrs.—\$1.95 ea.

Varicap-voltage variable capacitor—47 pf at 4v., 4:1 new \$1.25 ea.

12 different pots 2-4 W . . . . . \$1.00  
25 different power resistors to 50W . . . . . \$1.00

Silicon Controlled Rectifiers					
PRV	7	16	PRV	7	16
	amp.	amp.		amp.	amp.
25	.28	.48	200	1.05	1.70
50	.48	.70	300	1.60	2.20
100	.70	1.20	400	2.10	2.70
150	.80	1.50	500	2.80	3.30
			600	3.00	3.90

All Tests, Stud Type  
Money back guarantee, \$2.00 min. order. Include postage. Catalogue 25¢

**ELECTRONIC COMPONENTS CO.**  
Box 2902B Baton Rouge, La. 70821

## BIG CATALOG

World's "BEST BUYS" in GOV'T. SURPLUS Electronic Equipment

FULL OF TOP QUALITY ITEMS—  
Transmitters, Receivers, Power Supplies, Inverters, Microphones, Filters, Meters, Cable, Keys, Phones, Antennas, Chokes, Dynamos, Blowers, Switches, Test Equipment, Headsets, Amplifiers, etc., etc. **SEND 25¢** (stamps or coin) for **CATALOG** and receive **50¢ CREDIT** on your first order. Address Dept. RE.

**FAIR RADIO SALES**  
P.O. Box 1105 • LIMA, OHIO • 45802



# ADVERTISING INDEX

RADIO-ELECTRONICS does not assume responsibility for any errors which may appear in the index below.

Amperex Electronic Corp. .... 25, Second Cover  
 Brooks Radio & TV Corp. .... 81  
 Capitol Radio Engineering Institute, The .... 7  
 Castle TV Tuner Service, Inc. .... 75

**CLASSIFIED** ..... 88  
 Cleveland Institute of Electronics ..... 11, 75  
 DeVry Technical Institute ..... 5  
 Electronic Chemical Corp. .... 85  
 Electronic Measurement Corp. (EMC) ..... 79  
 Finney Co. .... 20  
 GC Electronics (Walsco Electronics) ..... 9  
 Gernsback Library, Inc. .... 80, 82-83  
 Heald's Engineering College ..... 85  
 Heath Company ..... 62-63  
 IBM Corporation ..... Third Cover  
 International Crystal Mfg. Co., Inc. .... 92  
 Kinematix, Inc. .... 24  
 Lafayette Radio Electronics ..... 15  
 Lectrotech Inc. .... 76  
 Mallory Distributor Products Company (Div. of P. R. Mallory & Co., Inc.) ..... 1

National Technical Schools ..... 3  
 National Radio Institute ..... 16-19  
 Oxford Transducer Corporation ..... 6  
 Perma-Power Company ..... 14  
 Poly Paks ..... 91  
 Precise Electronics & Development (Div. of Designatronics, Inc.) ..... 21  
 Progressive "Edu-Klts" Inc. .... 78  
 Quam-Nichols Co. .... 12  
 Quietrol Co. .... 74  
 RCA Electronic Components & Devices

Citizens' Band ..... 10  
 Tubes ..... Fourth Cover  
 RCA Institutes, Inc. .... 66-69  
 Reading Improvement Program ..... 80  
 Sams & Co., Inc., Howard W. .... 71  
 Sarkes Tarzian, Inc. (Tuner Service Div.) .. 8  
 Scott, Inc. H. H. .... 21  
 Semitronics Corp. .... 86  
 Sencore ..... 77  
 Shure Brothers, Inc. .... 23  
 Sonar Radio Corporation ..... 74  
 Sonotone Corp. (Electronic Applications Div.) 13  
 Sylvania (Subsidiary of General Telephone & Electronics) ..... 26  
 Tarzian, Inc. Sarkes (Tuner Service Div.) .... 8  
 United Radio Co. .... 89  
 University, LTV (Div. of Ling-Temco-Vought, Inc.) ..... 84  
 Walsco Electronics (Div. of GC Electronics) 9  
 Warren Electronic Components ..... 84  
 Webster ..... 79  
 Winegard Co. .... 75

**MARKET CENTER** ..... 88  
 Edmund Scientific Corp.  
 Electronic Components Co.  
 Fair Radio Sales  
 Music Associated  
 Relco  
 Transistors Unlimited Company

**SCHOOL DIRECTORY** ..... 87  
 American Institute of Engineering & Technology  
 Central Technical Institute  
 Coyne Electronics Institute  
 Electronic Technical Institute  
 Grantham School of Electronics  
 Indiana Home Study Institute, The  
 Milwaukee School of Engineering  
 Northrop Institute of Technology  
 Tri-State College  
 Valparaiso Technical Institute

# MARKET CENTER

## SUB CARRIER DETECTOR



Add programs of commercial-free music thru your FM tuner. Detector, self-powered, plugs into multiplex output of tuner or easily wired into discriminator and permits reception of famous background music programs now transmitted as hidden programs on the FM broadcast band from coast to coast. Use with ANY FM tuner.

**WIRED UNIT \$75.00**  
**KIT, with pretuned coils, no alignment necessary \$49.50**  
 crystal-controlled receivers available

**MUSIC ASSOCIATED**  
 65 Glenwood Road  
 Upper Montclair, New Jersey  
 phone 744-3387 area code 201

## EDUCATION/ INSTRUCTION

**LEARN ELECTRONIC ORGAN SERVICING.** New home study course covering all makes electronic organ including transistors. Experimental kits—schematics—trouble-shooting. Accredited NHSC-GI Approved. Write for free booklet. **NILES BRYANT SCHOOL, 3631 Stockton Blvd., Dept. F, Sacramento 20, Calif.**

**HIGHLY—effective home study review for FCC commercial phone exams. Free literature!** **COOK'S SCHOOL OF ELECTRONICS, Craigmont, Idaho 83523.**

**FCC LICENSE in 6 weeks. First Class Radio Telephone. Results Guaranteed. ELKINS RADIO SCHOOL, 2603E Inwood, Dallas, Tex.**

**SLEEP LEARNING. Hypnotism! Tapes, records, books, equipment. Details, strange catalog FREE. RESEARCH ASSOCIATION, Box 24-RD, Olympia, Wash.**

**BROADCASTING, Communications Electronics taught quickly—resident classes; correspondence. Free details. Write: Dept. 4, GRANTHAM SCHOOLS, 1505 N. Western, Hollywood, Calif. 90027**

**FCC License training through tape recorded instruction. Bob Johnson AUDIO-VISUAL LICENSE PREPARATION, 1201 Ninth, Manhattan Beach, Calif.**

**ELECTRONICS COURSE—\$2.00 A complete basic electronics course for home study. HAMMOND HOME STUDY COURSES, Dept. RE-7, P.O. Box 332, Deland, Florida 32721**

# ZIP

stands for the Post Office Department's new Zoning Improvement Plan. When renewing your RADIO-ELECTRONICS subscription, or sending us a change of address, please let us know what your ZIP Code is. We'll add it to your address mailing plate ... and you'll get speedier delivery



service from the Post Office. By the way, when writing to us, address: **RADIO-ELECTRONICS, 154 West 14 St., New York, N. Y. 10011**



Convert any television to sensitive **BIG-SCREEN OSCILLOSCOPE** with minor, inexpensive changes. Ingenious circuit. No electronic experience needed to follow our clearly illustrated plans. **TECHNICIANS, HAMS, EXPERIMENTERS, BROADCASTERS.** Use in shop, school, lab. Any set—any size screen.

**FULL PLANS \$2**  
 RELCO, Dept. RE-7, Box 10563, Houston 18, Tex.

TUCO	SUMMER SPECIALS	TUCO
Kit -32, S.C.R. Light Dimmer Control:	SCR, rectifiers, etc.	\$4.00
12 volt filament transformer, midket.		\$1.00
150 ma., 1 1/2x1 1/2x1"	FM Front End, dual, miniature. Includes coils, variable capacitors, trimmers, choke, mounted on 2 1/2"x2" metal	\$2.00
FM variable as above, without components		\$1.50
2N384 VHF transistor, TO-3		\$1.50
T-1 Power Transistors, TO-3		.75
NPN, H.F., High HFE, 40 volt transistors, TO-5		5/\$1.00
PNP, H.F., High HFE, 40 volt transistors, TO-5		5/\$1.00
NPN, H.G., Silicon, 50 volt, H.F. transistors, TO-5		4/\$1.00
Diode Assortment, Germanium and silicon		30/\$1.00
Miniature transformer assortment, driver & output		4/\$1.00
Minimum Order \$3.00 prepaid. Postage Free USA. Write for Free Catalog.		
<b>TRANSISTORS UNLIMITED COMPANY</b> 462 Jericho Turnpike, Mineola, N. Y. — PL 7-7221		

**FREE CATALOG!**  
 148 PAGES • NEARLY 4,000 BARGAINS  
 OPTICS • SCIENCE • MATH

Completely new 1965 edition. New items, categories, illustrations. 148 easy-to-read pages packed with nearly 4000 unusual items. Dozens of electrical and electromagnetic parts, accessories. Enormous selection of Astronomical Telescopes, Microscopes, Binoculars, Magnifiers, Magnets, Lenses, Prisms. Many war surplus items: for hobbyists, experimenters, workshop, factory. Write for catalog "EH".

**CLIP AND MAIL COUPON TODAY**

EDMUND SCIENTIFIC CO., Barrington, N. J.  
 PLEASE SEND ME FREE CATALOG "EH"

Name .....

Address .....

City ..... State .....



# ELECTRONICS

FREE! Giant bargain catalog on transistors, diodes, rectifiers, components, valuable parts, equipment. **POLY PAKS**, P. O. Box 942S, Lynnfield, Mass.

METERS—Surplus, new, used, panel and portable. Send for list. **HANCHETT**, Box 1898 Riverside, Calif.

GOVERNMENT SURPLUS JEEPS—\$62.50, Voltmeters—\$1.05, Transmitters—\$6.18, Oscilloscopes, Walkie-Talkies, Multimeters. Typical Surplus Prices. Exciting Details FREE. Write: **ENTERPRISES**, Box 402-F21, Jamaica 30, New York

TV CAMERAS, transmitters, converters, etc. Lowest factory prices. Catalog 10¢. **VANGUARD**, 190-48-99th Ave., Hollis, N.Y. 11423.

PROFESSIONAL ELECTRONICS PROJECTS—Organs, Timers, Computers, etc.—\$1 up. Catalog 25¢, refundable. **PARKS**, Box 2556S, Seattle, Wash. 98125.

DIAGRAMS FOR REPAIRING RADIOS \$1.00. Television \$2.50. Give make, model. **DIAGRAM SERVICE**, Box 1151 RE, Manchester, Conn.

BEFORE You Buy Receiving Tubes, Transistors, Diodes, Electronic Components & Accessories... send for Giant Free Zalytron Current Catalog, featuring all STANDARD BRAND TUBES all Brand New Premium Individually Boxed, One Year Guarantee—all at BIGGEST DISCOUNTS in America! We serve professional servicemen, hobbyists, experimenters, engineers, technicians. WHY PAY MORE? **ZALYTRON TUBE**

**CORP.**, 469R Jericho Turnpike, Mineola, N.Y. 11502

TRANSISTOR IGNITION! Coil, ballast 7.95 Free parts lists. **TRANSFIRE** Carlisle 20, Mass. 01741

ANY TV BONDED TUBE \$23.00. One year warr. (you keep the dud). Immediate delivery send check or money order. **SAMSON KINESCOPIES INC.**, 250 N. Goodman St., Roch. N.Y. 14607

NEED RESISTORS? Factory fresh, NAME BRAND, 1/2 watt, 10% standard carbon resistors. Any regular value from 10 ohms to 2.2 megohms, \$.05 each! Postpaid. Any quantity assorted. Minimum order \$1.00. **TEPCO**, Box 508, Tullahoma, Tenn.

AUTO REVERBERATION Units wholesale, **SIGNAL SYSTEMS**, 31160 Eight Mile, Farmington, Mich. 48024

TRANSISTORS, CAPACITORS, Sub-miniature electronic parts. Send for FREE CATALOG. **ELECTRONIC CONTROL DESIGN COMPANY**, P.O. Box 1432P, Plainfield, N.J.

HIGHEST QUALITY silicon inverter power supplies, to 800 watts, multiple outputs, any voltages. Less than \$90. **HT INSTRUMENTS**, P.O. Box 113, Cranbury, New Jersey.

TUBES jobber boxed 65% off. Free list. **ALL-STATE ELECTRONICS**, P.O. Box 1882, Beverly Hills, California 90213.

APPLIANCE—AUTO—LAMP parts. Wholesale catalogue 25¢. **SECO**, 112 South 20th Street, Birmingham, Alabama 35233.

## Your HEART FUND fights them all

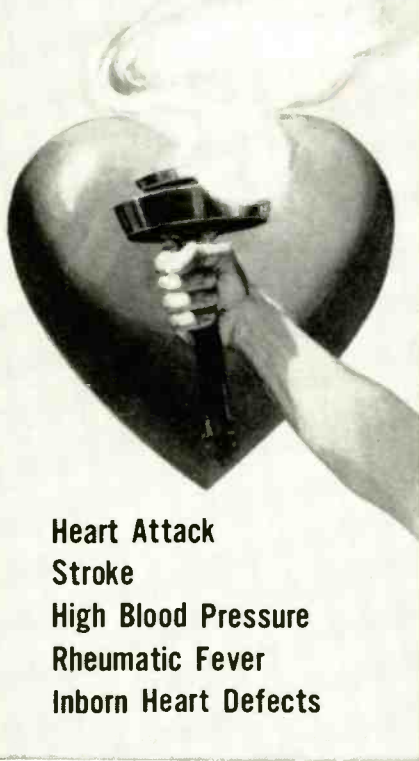

Heart Attack  
Stroke  
High Blood Pressure  
Rheumatic Fever  
Inborn Heart Defects

### CLASSIFIED ADVERTISING ORDER FORM

Please refer to heading at top of classified section for complete data concerning terms, frequency discounts, closing dates, word count, etc.

1	2	3	4	5
6	7	8	9	10
11	12	13	14	15
16	17	18	19	20
21	22	23	24	25
26	27	28	29	30
31	32	33	34	35

No. of Words { @ .30 Non-Commercial Rate } \$ \_\_\_\_\_  
{ @ .55 Commercial Rate } \$ \_\_\_\_\_

Total Enclosed \$ \_\_\_\_\_  
Insert \_\_\_\_\_ time(s)  
Starting with \_\_\_\_\_ issue  
Payment must accompany order unless placed through accredited advertising agency. 56

NAME \_\_\_\_\_  
ADDRESS \_\_\_\_\_  
CITY \_\_\_\_\_ STATE \_\_\_\_\_ ZIP \_\_\_\_\_  
SIGNATURE \_\_\_\_\_

MAIL TO: RADIO-ELECTRONICS, CLASSIFIED AD DEPT., 154 WEST 14TH ST., NEW YORK, N.Y. 10011

### 1,000,000 PARTS SALE

# 1¢ SALE!

- GERMANIUM DIODES .....25 for \$1 50 for 1.01
- TOP HAT RECTIFIERS .....25 for \$1 50 for 1.01
- TRANSISTORS .....30 for \$1 60 for 1.01
- 20-WATT TRANSISTORS .....6 for \$1 12 for 1.01
- 40-WATT TRANSISTORS .....3 for \$1 6 for 1.01
- 25-AMP SCR 100 PRV .....1 for \$1 2 for 1.01
- 10-WATT ZENER 30V .....1 for \$1 2 for 1.01
- 2N1613 100MC TRANS. ....1 for \$1 2 for 1.01
- 4W PLANARS 2N497-98 ..2 for \$1 4 for 1.01
- 3N35 TETRODE TRANS. ....1 for \$1 2 for 1.01
- 25-AMP SCRS .....2 for \$1 4 for 1.01

FREE WORTH OF \$25 PLUS \$1 FREE POLY PAK OF YOUR CHOICE

Include 25¢ for handling

BOTH FREE WITH EVERY \$10 ORDER

### WORLD FAMOUS DOLLAR POLY PAKS

- 3 TRANSISTOR AUDIO AMP, tiny, wired .....\$1
- MAGNETIC REED SWITCH, glass sealed .....\$1
- 40 WORLD'S SMALLEST COND., to .05mf .....\$1
- 4 TRANSISTOR TRANSFORMERS, asst. worth \$25 \$1
- 1 FILAMENT TRANSFORMER, 117 to 6.3vct, 3A \$1
- \$25 RELAY SURPRISE, sealed, tiny types .....\$1
- 3 INFRA-RED DETECTORS, with leads .....\$1
- \$25 SURPRISE PAK: transistors, rect, diodes, etc. \$1
- 40 PRECISION RESISTORS, 1/2, 1, 2W, 1% values \$1
- 30 CORNING "LOW NOISE" resistors, asst. ....\$1
- 60 TUBULAR CONDENSERS, to .5mf, to 1KV, asst \$1
- 40 DISC CONDENSERS, 27mmf to .05mf to 1KV \$1
- 60 TUBE SOCKETS, receptacles, plugs, audio, etc. \$1
- 30 POWER RESISTORS, 5 to 50W, to 24 Kohms. \$1
- 50 MICA CONDENSERS, to .1mf, silvers too! ..\$1
- 10 VOLUME CONTROLS, to 1 meg, switch tool ..\$1
- 10 ELECTROLYTICS, to 500mf, asst FP & tubular \$1
- 50 RADIO & TV KNOBS, asst, colors & styles ..\$1
- 10 TRANSISTOR ELECTROLYTICS: 10mf to 500mf \$1
- 50 COILS & CHOKES, if, rf, ant, osc, & more ..\$1
- 35 TWO WATTERS, asst incl: A.B., 5% too! ..\$1
- 75 HALF WATTERS, asst incl: A.B., 5% too! ..\$1
- 60 HI-Q RESISTORS, 1/2, 1, 2W, 1% & 5% values \$1
- 10 PHONO PLUG & JACK SETS, tuners, amps ..\$1
- 50 TERMINAL STRIPS, 1 to 8 solder lug types ..\$1
- 30 "YELLOW" MYLAR CONDENSERS, asst val \$1
- 60 CERAMIC CONDENSERS, discs, nops, to .05 \$1
- 3 GEIGER COUNTER DETECTOR, tubes, assorted \$1
- 3 TRANSISTOR TRANS'TRS. 2N341, 42, 1W, npn \$1
- 85 WATT 2N424 PLANAR, silicon, TO-53 npn. \$1
- 85 WATT 2N1212 PLANAR, drift, 10mc, npn ....\$1
- 1 CONTROLLED SCR SWITCH, Transistron, TO18, \$1
- 10 SILICON TOP HAT RECTIFIERS, 50 to 400PIV ..\$1
- 2 2N721 PNP PLANAR, 2W, 75MC, TO-18 .....\$1
- 2 2N735 NPN MESA, 500MW, 135MC, TO-18 ..\$1
- 2—CLAIREX PHOTO ELECTRIC CELL, CL607 ..\$1
- 2 500MC TRANS'TRS, 2N964, mesas, pnp, TO18 \$1
- 4 PIN HEAD 2N790 NPN SILICON transtrs. TO18 \$1
- 4 2N43 OUTPUT TRANSISTORS, by GE, pnp, TO5 \$1
- 4 2N333 NPN SILICON transistors, by GE, TO5 \$1
- 8, 2-6Amp RECT's, studs, silicon, 50 to 400V ..\$1
- 10 1000 MC-1N251 GERMANIUM DIODES .....\$1
- 5 30MC TRANSISTORS, like 2N247, Sylvania ..\$1
- 5—2N155 TRANSISTORS, or equals, TO3 cases \$1
- 2—800 MC, 2N709 NPN Silicon planar TO46 ..\$1
- 3 2N711 300MW, 300 MC, PNP MESA, TO18 ..\$1
- 15 1AMP 200V epoxy rectifiers, made by Sylvania \$1
- 2 25-AMP SILICON RECTIFIERS, 1-50V, 1-100V \$1
- 4 ZENER REFERENCES, 1N429, 6-volt, silicon ..\$1
- 10 ZENERS GLASS SILICON DIODES, axial, leads \$1
- 6 2N408 TRANSISTORS, TO1, pnp, driver .....\$1
- 2 2N718 NPN SILICON PLANARS, by Fairchild ..\$1
- 4 2N219 TRANSISTORS, mixer-conv, TO22 ....\$1
- 10 MICRODIODE STABISTORS, epoxy, silicon ..\$1
- 2 2N706 500MW, 300MC NPN PLANAR, TO46 ..\$1
- 10 1000-MIL "CERAMIC" RECT, silicon, 50-400V \$1
- 10 POPULAR CK772 TRANSISTORS, pnp, no test \$1
- 5 2N107 TRANS'TRS, by GE, pnp, pnp, audio pak \$1
- 10 PNP SWITCHING TRANSISTORS, 2N1305, TO6 \$1
- 10 NPN SWITCHING TRANSISTORS, 2N338, 440 \$1
- 15 PNP TRANSISTORS, CK722, 2N335, 107, .....\$1
- 15 NPN TRANSISTORS, 2N335, 170, 440, .....\$1
- 2N998 TYPE, 1000 GAIN, npn silicon, planar ..\$1
- "MICRO-T" TRANSISTOR, like TMT-1613, ..\$1
- 4 2N35 TRANSISTORS, npn, by Sylvania, TO22 ..\$1
- 4 "MICRO" TRANSISTORS, 2N131's, 1/16", rf ..\$1
- 4 CK721 TRANSISTORS, pnp, aluminum case ..\$1

10¢ FOR OUR "SUMMER" BARGAIN CATALOG ON:  
 Semiconductors  Poly Paks  Parts

**POLY PAKS** TERMS: send check, money order, include postage—avg. wt. per pak 1 lb. Rated net 30 days, cops 25%.

P.O. BOX 942R  
SO. LYNNFIELD, MASS.  
"PAK-KING" of the World

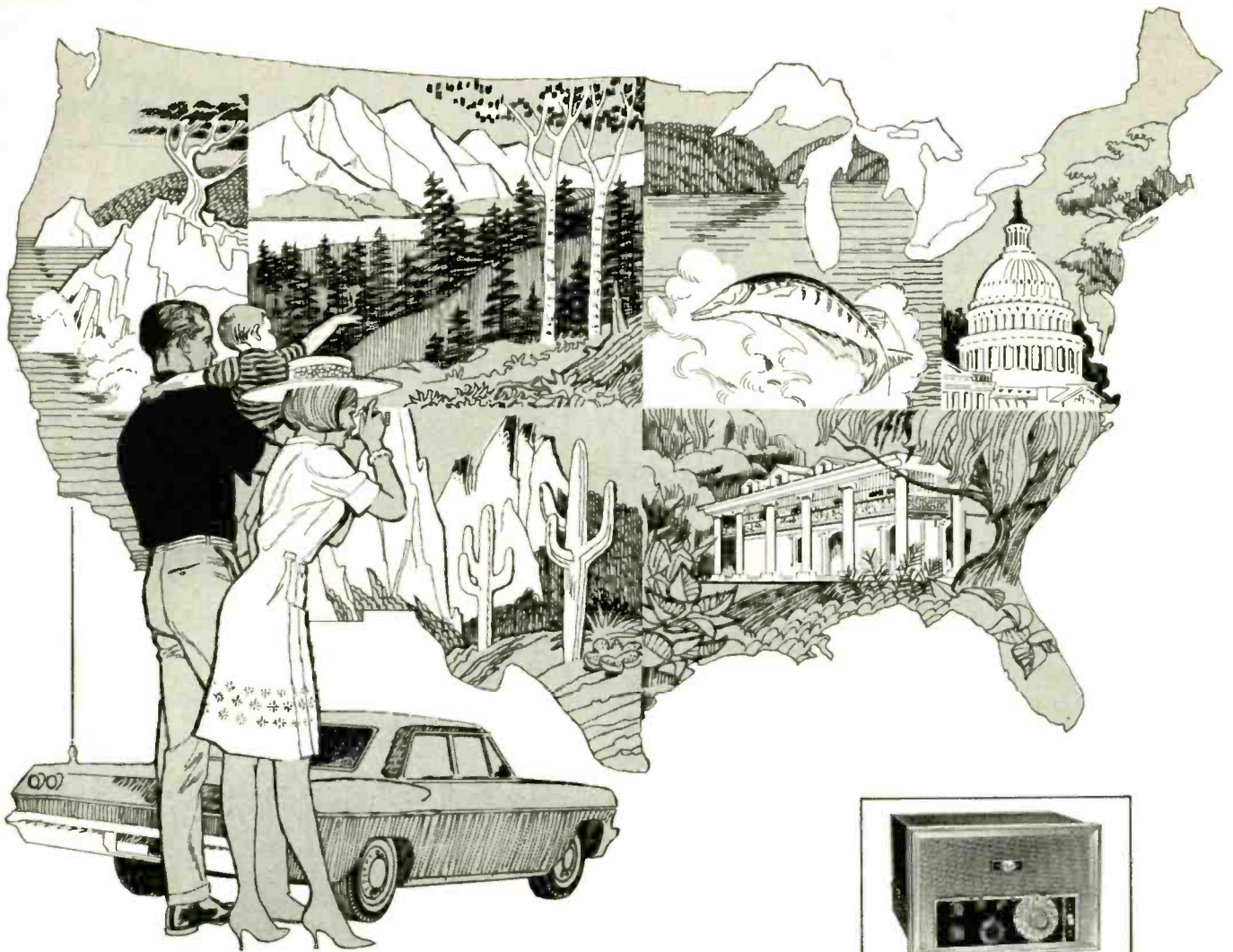

# SEE THE U.S.A.



Traveling by car to the distant corners of this great country of ours is becoming easier and takes less time than ever before. This year see the U.S.A. Visit the great national parks, the towering and majestic Rocky Mountains, historic New England, the seashore or the broad expanse of the midwest. No matter where you travel, International Citizens Radio transceivers can provide rapid emergency communication. International transceivers are designed and engineered to give reliable mobile service day in and day out under all kinds of conditions. The 1965 International transceivers have hybrid circuits which combine transistors and tubes for greater dependability. There is even one model which has built-in test circuits. You will have more fun traveling and a feeling of security with an International transceiver installed in your car for mobile communication. Write today for our catalog of Citizens Radio transceivers and accessories. Then see your nearest International dealer. He will assist you in selecting the best transceiver for your particular requirements.



**MODEL 440**  
Citizens Radio Transceiver

**MODEL 660**  
Citizens Radio Transceiver

**MODEL 880**  
Citizens Radio Transceiver

FCC Citizens Radio license required.  
All use must conform with Part 95,  
FCC Rules and Regulations.

**INTERNATIONAL  
CRYSTAL MFG. CO. INC.**

18 NORTH LEE — OKLA. CITY, OKLA.

# careers for technicians at IBM

To technicians who seek important roles in today's technology, IBM offers careers in the world of computers. Modern computer systems and new solid state technologies have created rewarding jobs for technicians in Research, Development, Manufacturing, and Systems Test. IBM is an Equal Opportunity Employer.

## Owego, New York

**Chemical Technicians:** Experience in chemical technology, engineering physics, or in any of the following: electrochemistry, lamination, adhesives, electroplating, etching, oxide coating, photo-resist, evaporation techniques.

**Electromechanical Technicians:** Experience in assembly and maintenance of automatic production equipment. A thorough understanding of mechanical and electrical technologies is essential.

**Electronic Technicians:** Experience in maintenance, calibration, and repair of complex electronic test equipment and development of high-speed circuitry.

Qualifications: A.A.S. degree or its equivalent in education or experience.

**Please write**, outlining your education and experience, to:

B. A. Goon, Dept. 649G  
IBM Corporation  
Space Guidance Center  
Owego, New York 13827

# IBM

## Burlington, Vermont

**Electromechanical Technicians:** Experienced in assembly and maintenance of automated production equipment. A thorough understanding of mechanical and electrical technologies is essential.

**Vacuum Technicians:** To operate vacuum deposition of cathodic sputtering apparatus. Capable of working with high-voltage and high-power equipment. Experience in thin film measurement, use of delicate instrumentation and magnetics useful.

**Chemical Technicians:** Perform photoetching of thin films, electroplating, and polymer deposition for experimental computer device development. Must be familiar with chemical handling and measurement techniques.

Qualifications: A.A.S. degree or its equivalent in education or experience.

**Please write**, outlining your education and experience, to:

W. T. Rochford, Dept. 649G  
IBM Corporation, Box A  
Essex Junction, Vermont

# IBM

## Endicott, New York

**Computer Systems Test:** To give final systems tests to newly manufactured computers. A.A.S. degree or equivalent in Electrical Technology, with experience and/or courses in mechanical technology and devices. Should understand solid state switching circuits and computer technology.

**Chemical Technicians:** A.A.S. degree in Chemical Technology, with experience in any of the following: electrochemistry, lamination, adhesives, electroplating, etching, oxide coatings, photo-resist.

**Toolmakers:** Must have completed formalized tool and model maker apprentice program; 2 years' experience working to close tolerances on dies, fixtures, gauges, and special machine tools.

This manufacturing and manufacturing research facility is in Endicott, New York, in the Triple-Cities community of the Finger Lakes region.

**Please write**, outlining your education and experience, to:

M. C. Kennedy, Dept. 649G  
IBM Corporation  
1701 North Street  
Endicott, New York

# IBM

## Fishkill, New York

**Electromechanical Technicians:** Experienced in assembly and maintenance of automated production equipment. A thorough understanding of mechanical and electrical technologies is essential.

**Designers:** Electromechanical packaging mechanism design of automated production equipment.

**Electronic Technicians:** Experienced in maintenance, calibration and repair of complex electronic test equipment, and development of high-speed circuitry.

**Semiconductor Technicians:** Experienced in semiconductor process development and manufacturing.

Qualifications: A.A.S. degree or its equivalent in education or experience.

**Please write**, outlining your education and experience, to:

T. R. Edmonds, Dept. 649G  
IBM Corporation  
P. O. Box 110  
Poughkeepsie, New York

# IBM

**Your black and white skills**



**are not enough for Color TV**

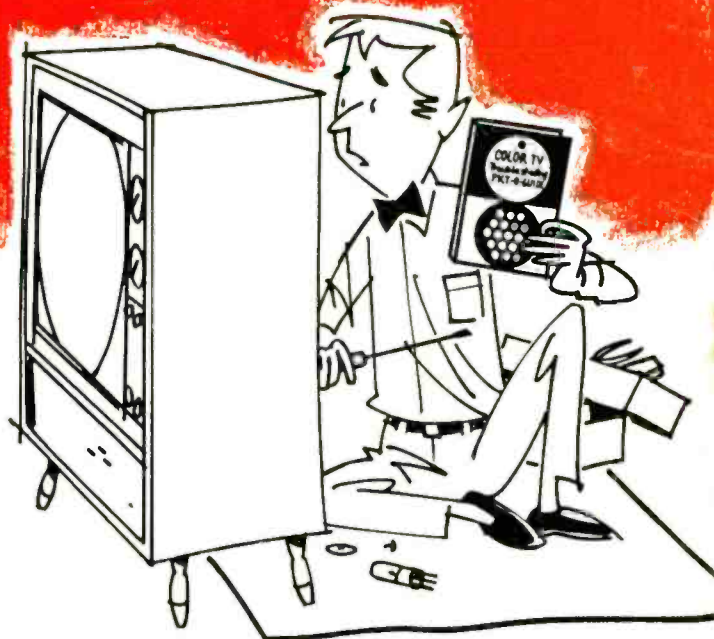

**You need this book  
to help you cash in  
on Color TV business**

NEW RCA COLOR TV TROUBLESHOOTING  
PICT-O-GUIDE, 1A1389

You're missing more and more chances for profit if you're not in color TV service. There are 3 million color sets in use now... and the total should be at least 5 million by the end of the year.

The new, completely revised RCA Color TV Pict-O-Guide, with its many color photos and illustrated step-by-step instructions makes it possible for you to recognize and understand the visible symptoms of troubles and maladjustments in color receivers. Use the Pict-O-Guide whenever you work on a color set.

RCA ELECTRONIC COMPONENTS AND DEVICES, HARRISON, N. J.

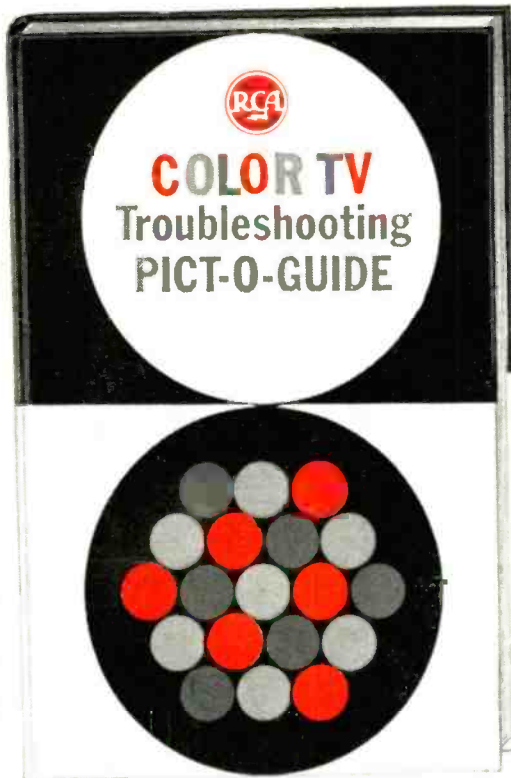

(For a complete course in the principles and practices of color TV you will find the 8 lesson Color TV Home Study Course by RCA Institutes, 1A1325, invaluable.)

WHAT THE  
RCA COLOR TV  
PICT-O-GUIDE  
GIVES YOU:

- Color Fundamentals
- Receiver Set-Up
- Functions of the Color Set Controls
- How to Use Color Test Equipment
- Troubleshooting Color and Black and White Sections of Receiver
- Servicing and Alignment Techniques

...and much, much more. 150 pages. *This book should more than pay for itself the first time you use it.*

**ORDER THROUGH  
YOUR LOCAL  
AUTHORIZED RCA  
TUBE DISTRIBUTOR**



**The Most Trusted Name in Electronics**