

SHIRT-POCKET TRANSISTOR RADIO

JULY 1956

# RADIO — ELECTRONICS

TELEVISION • SERVICING • HIGH FIDELITY

HUGO GERNSBACK, Editor

Questions About  
Crossovers

New Standard Coil  
Neutrode TV Tuner

Build an Improved  
Tape Recording  
Amplifier

Simple Stabilized  
Dot Generator

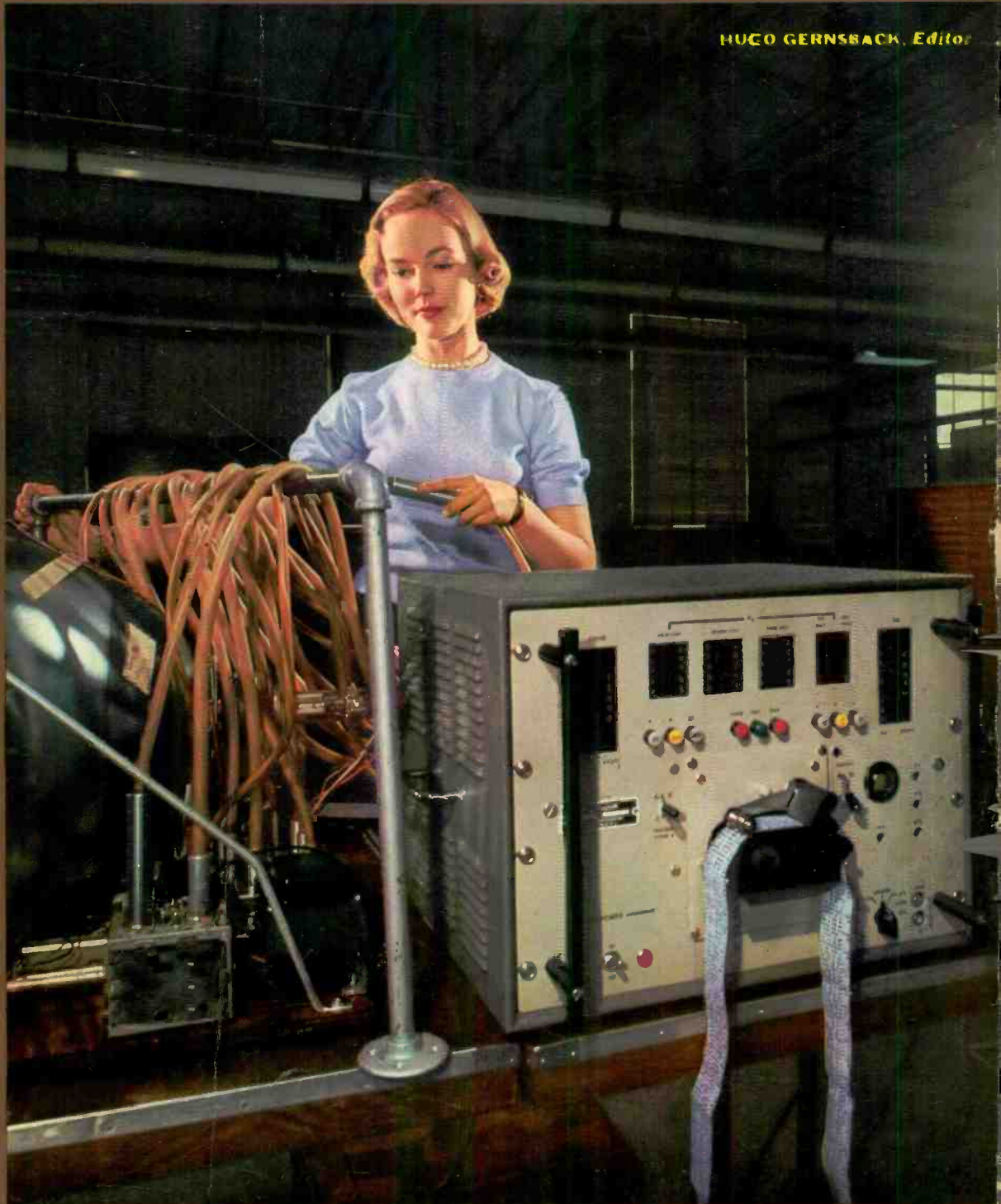

35¢

U. S. and  
CANADA

Electronic Brain Checks Circuits

See page 4



Specialized Engineers and Scientists, highly trained and skilled to devise and develop the best components and processes for manufacturing high quality picture tubes.

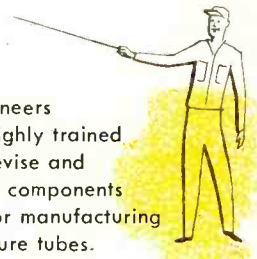

## *Does the picture tube you buy have these built-in features?*

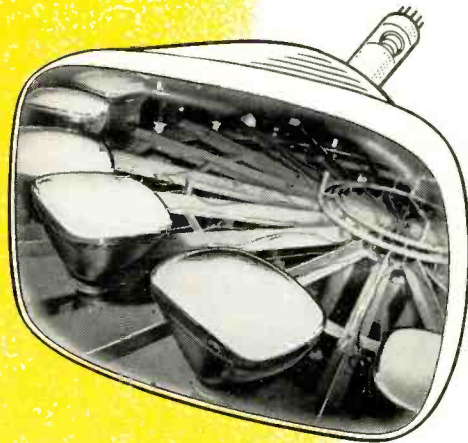

The very latest and up to date manufacturing techniques backed up by modern mass production equipment as illustrated by this mechanized aluminization rack.

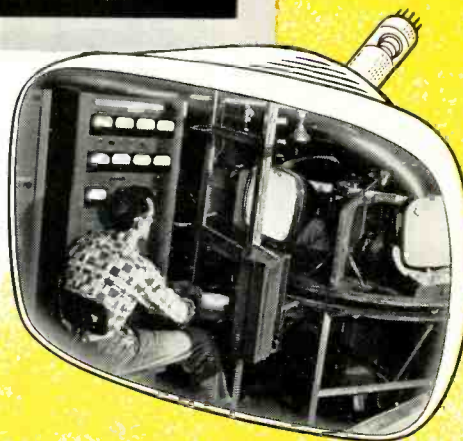

**YOU CAN STAKE YOUR REPUTATION ONLY ON A MANUFACTURER THAT HAS THESE.**

Extremely stringent quality control inspections and tests to assure adherence to the tightest specifications and performance qualifications. Every Du Mont picture tube is thoroughly tested on the most modern equipment as shown here.

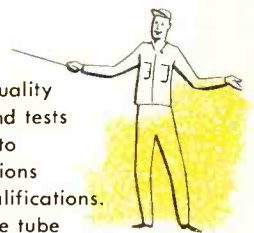

**IT'S DEALERS CHOICE**

**make it...**

**DU MONT**

Cathode-ray Tube Division, ALLEN B. DU MONT LABORATORIES, Inc., 750 Bloomfield Avenue, Clifton, N. J.

## You Practice **SERVICING** with Kits I Send You



Nothing takes the place of PRACTICAL EXPERIENCE. That's why NRI training is based on LEARNING BY DOING. You use parts I send to build many circuits common to Radio and Television. With my Servicing Course you build the modern Radio shown at left. You build a Multitester and use it to help make \$10, \$15 a week fixing sets in spare time while training. All equipment is yours to keep. Coupon below will bring book of important facts. It shows other equipment you build.

## You Practice **BROADCASTING** with Kits I Send You



As part of my Communications Course I send you parts to build low-power Broadcasting Transmitter at left. Use it to get practical experience. You put this station "on the air" ... perform procedures demanded of broadcasting station operators. An FCC Commercial Operator's License can be your ticket to a bright future. My Communications Course trains you to get your license. Mail coupon. Book shows other equipment you build for practical experience.

# I Will Train You at Home in Spare Time to be a **RADIO-TELEVISION** Technician



## TELEVISION

### Making Jobs, Prosperity

25 million homes have Television sets now. Thousands more sold every week. Trained men needed to make, install, service TV sets. About 200 television stations on the air. Hundreds more being built. Good job opportunities here for qualified technicians, operators, etc.



J. E. SMITH, President  
National Radio Institute  
Washington, D. C.

Our 40th Year

## America's Fast Growing Industry Offers You Good Pay, Success

Training PLUS opportunity is the PERFECT COMBINATION for job security, advancement. When times are good, the trained man makes the BETTER PAY, gets PROMOTED. When jobs are scarce, the trained man enjoys GREATER SECURITY. NRI training can help assure you and your family more of the better things of life. Radio is bigger than ever with over 3,000 broadcasting stations and more than 115 MILLION sets in use, and Television is moving ahead fast.

## N.R.I. Training Leads to Good Jobs Like These

### I TRAINED THESE MEN



"I have progressed very rapidly. My present position is Studio Supervisor with KEDD Television, Wichita."—Elmer Frewaldt, 3026 Stadium, Wichita, Kans.

"Fix sets part time in my shop. Made about \$500 first three months of the year. Could have more but this is about all I can handle."—Frank Borer, Lorain, Ohio.



"I've come a long way in Radio and Television since graduating. Have my own business on Main Street."—Joe Travers, Asbury Park, New Jersey.

"I didn't know a thing about Radio. Now have a good job as Studio Engineer at KMMJ."—Bill Delzell, Central City, Nebraska.



**BROADCASTING:** Chief Technician, Chief Operator, Power Monitor, Recording Operator, Remote Control Operator. **SERVICING:** Home and Auto Radios, Television Receivers, FM Radios, P.A. Systems. **IN RADIO PLANTS:** Design Assistant, Technician, Tester, Serviceman, Service Manager. **SHIP AND HARBOR RADIO:** Chief Operator, Radio-Telephone Operator. **GOVERNMENT RADIO:** Operator in Army, Navy, Marine Corps, Forestry Service Dispatcher, Airways Radio Operator. **AVIATION RADIO:** Transmitter Technician, Receiver Technician, Airport Transmitter Operator. **TELEVISION:** Pick-up Operator, Television Technician, Remote Control Operator.



## Start Soon to Make \$10, \$15 a Week Extra Fixing Sets

My training is practical, complete; is backed by 40 years of success training men at home. My well-illustrated lessons give you basic principles you need and my skillfully developed kits of parts "bring to life" things you learn from the lessons. I start sending you special booklets the day you enroll, that show you how to fix sets. Multitester you build with my parts helps you discover and correct set troubles, helps you make money fixing neighbors' sets in spare time while training. Many make \$10, \$15 a week extra this way.

## Mail Coupon — Find Out What Radio-Television Offer You

Act now to get more of the good things of life. I send actual lesson to prove NRI home training is practical, thorough. My 64-page book "How to be a Success in Radio-Television" shows what my graduates are doing and earning. It gives important facts about your opportunities in Radio-

**AVAILABLE to all qualified VETERANS UNDER G. I. BILLS**

Television. Take NRI training for as little as \$5 a month. Many graduates make more than the total cost of my training in two weeks. Mail coupon now to: J. E. SMITH, President, Dept. 6GF, National Radio Institute, Washington 9, D. C. Our 40th year.

## Good for Both—FREE

MR. J. E. SMITH, President, Dept. 6GF  
National Radio Institute, Washington 9, D. C.  
Mail me Sample Lesson and 64-page Book. FREE.  
(No salesman will call. Please write plainly.)

Name.....Age.....

Address.....

City.....Zone...State.....

**VETS** write in date of discharge

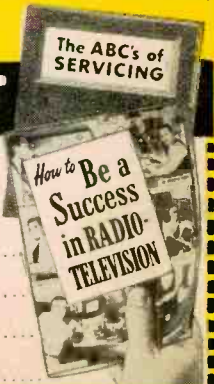

**Mail Today-Tested Way to Better Pay**

# RADIO - ELECTRONICS

Formerly RADIO CRAFT • Incorporating SHORT WAVE CRAFT • TELEVISION NEWS • RADIO & TELEVISION\*

Hugo Gernsback  
Editor and Publisher

M. Harvey Gernsback  
Editorial Director

Fred Shunaman  
Managing Editor

Robert F. Scott  
W2PWG, Technical Editor

Jerome Kass  
Associate Editor

I. Queen  
Editorial Associate

Matthew Mandl  
Television Consultant

Elizabeth Stalcup  
Production Manager

Angie Pascale  
Editorial Production

Wm. Lyon McLaughlin  
Tech. Illustration Director

Sol Ehrlich  
Art Director

Lee Robinson  
General Manager

John J. Lamson  
Sales Manager

G. Aliquo  
Circulation Manager

Adam J. Smith  
Director, Newsstand Sales

Robert Fallath  
Promotion Manager

## GERNSBACK PUBLICATIONS, INC.

Executive, Editorial and Advertising Offices, 154 West 14 St., New York 11, N. Y. Telephone ALgonquin 5-7755.

Hugo Gernsback  
Chairman of the Board

M. Harvey Gernsback  
President

G. Aliquo  
Secretary

## ON THE COVER

(Story on page 55)

How a television receiver would be checked by the Robotester, the new electronic brain that checks circuits at the rate of 100 a minute.

Color original by Tom Carew



Average Paid Circulation over 174,000

JULY 1956

Vol. XXVII, No. 7

## Editorial

The Father of Wireless Ushered in the Radio Age.....by Hugo Gernsback 29

## Television

The Neutrode—New Vhf-Uhf Tuner.....by E. D. Lucas, Jr. 30

Universal TV Service Kit.....by H. A. Highstone 33

Color Demodulator Alignment.....by Walter J. Cerveny 34

TV Service Techniques.....by Robert G. Middleton 36

TV Service Clinic.....Conducted by Jerry Kass 38

Trends in TV Receiver Circuitry.....by Robert F. Scott 40

What's New ..... 43

## Audio—High Fidelity

Questions About Crossovers, Part I .....by Norman H. Crowhurst 44

Improved Tape-Recorder Amplifier.....by George L. Augspurger 47

Transistorized Intercom With 0.6-Watt Output.....by Rufus P. Turner 48

For Golden Ears Only: Marantz audio consolette; Frazier-May Symphony-Diva.....by Monitor 50

## Test Instruments

Stabilized Dot Generator.....by Earl T. Hansen 52

Robot Circuit Tester (Cover Feature).....by Alvin F. Rymsha 55

Waveform Generator.....by Ed. Bukstein 58

## Radio

A True Shirt-Pocket Radio.....by I. Queen 60

Build an Inexpensive Phone Patch.....by John T. Frye 71

Transistor Radios, Part II—Regenerative transistor receivers.....by I. Queen 78

## Electronics

Electronic Sterilization.....by Marion L. Briggs 82

Electromechanical Pulse Producer.....by Arnold R. Shulman 85

## DEPARTMENTS

Abbreviations .....	86	People .....	122
Books .....	126	Question Box .....	108
Business .....	119	Radio Month .....	6
Correspondence .....	12	Radio-Electronic Circuits .....	111
New Devices .....	88	Technical Literature .....	124
New Records .....	92	Technicians' News .....	96
New Tubes and Transistors .....	100	Technotes .....	105
Patents .....	114	Try This One .....	117



Associate Member of Institute of High Fidelity Mfrs., Inc.

RADIO-ELECTRONICS, July, 1956, Vol. XXVII, No. 7. Published monthly at Mt. Morris, Ill., by Gernsback Publications, Inc. Second-class mail privileges authorized at Mt. Morris, Ill. Copyright 1956 by Gernsback Publications, Inc. All rights reserved under Universal, International and Pan-American Copyright Conventions.

SUBSCRIPTIONS: Address correspondence to Radio-Electronics, Subscription Dept., 404 N. Wesley Ave., Mt. Morris, Ill., or 154 West 14 St., New York 11, N. Y. When ordering a change please furnish an address stencil impression from a recent wrapper. Allow one month for change of address.

SUBSCRIPTION RATES: U. S., U. S. possessions and Canada, \$3.50 for one year; \$6.00 for two years; \$8.00 for three years; single copies 35c. Pan-American countries \$4.00 for one year; \$7.00 for two years; \$9.50 for three years. All other countries \$4.50 a year; \$8.00 for two years; \$11.00 for three years.

BRANCH ADVERTISING OFFICES: Chicago: 1413 Howard St. Tel. ROgers Park 4-8000. Los Angeles: Ralph W. Harker and Associates, 600 South New Hampshire, Tel. DUinkirk 7-2328. San Francisco: Ralph W. Harker and Associates, 582 Market St., Tel. GARfield 1-2481. FOREIGN AGENTS: Great Britain: Atlas Publishing and Distributing Co., Ltd., London E.C. 4. Australia: McGill's Agency, Melbourne. France: Brentano's, Paris 2e. Belgium: Agence et Messageries de la Presse, Brussels. Holland: Trilectron, Heemstede. Greece: International Book & News Agency, Athens. So. Africa: Central News Agency Ltd., Johannesburg; Capetown, Natal. Universal Book Agency, Johannesburg. Middle East: Steimatz Middle East Agency, Jerusalem. India: Broadway News Centre, Dadar, Bombay #14. Pakistan: Paradise Book Stall, Karachi 3. POSTMASTER: If undeliverable send form 3578 to: RADIO-ELECTRONICS, 154 West 14 St., New York 11, N. Y. \*Trademark registered U. S. Patent Office.

# NATIONAL SCHOOLS

*proudly presents*

**FOR MEN  
WHO WANT  
TO EARN  
MORE MONEY**

## TELERAMA • ALL 8 BRANCHES OF TELEVISION • ELECTRONICS • RADIO IN ONE DYNAMIC, MODERN SHOP METHOD, HOME TRAINING COURSE

\*Registration applied for

Another great advance in **HOME STUDY TRAINING**. Let National Schools, of Los Angeles, a practical Technical Resident Trade School for over 50 years, train you at home by Shop-Method, for today's unlimited opportunities in **ALL 8 BRANCHES** of the Television, Electronics, Radio Industry

Check all you receive in *One Master Course* at One Low Tuition

1. Television — Including Color TV
2. Radio — FM and AM
3. Industrial Electronics
4. Sound Recording and Hi-Fidelity
5. Preparation for FCC License
6. Automation
7. Radar and Sonar
8. Communications

ALL OF THIS MODERN, NEWEST, PRACTICAL EQUIPMENT IS YOURS TO KEEP!

- Parts to Build a modern TV set, including large screen Picture Tube.
- Parts to build a powerful Superhet Receiver, standard broadcast and short wave.
- Parts to conduct many experiments and build Continuity Checker, RF Oscillator, TV Circuits, Audio Oscillator, TRF Receiver, Signal Generator.
- Professional Multitester
- These are a **MUST** for all technicians:

### YOU DO MANY PRACTICAL JOBS.

You do servicing, circuit analysis and many other down-to-earth experiments. You build a modern TV set from the ground up... with equipment kits we give you, including a new large screen picture tube and professional Multitester, at no additional charge.

**EARN AS YOU LEARN!** Many of our students earn their entire tuition and more in Spare Time jobs we show them how to do while learning. **YOU GET GRADUATE ADVISORY SERVICE, TOO.**

**ALL YOURS  
TO KEEP**

### L. J. ROSENKRANZ

President of NATIONAL SCHOOLS



This Master-Shop-Method course is completely up-to-date. Here in Los Angeles, the TV and Electronics center of the world, we are able to keep in constant touch with the industries' latest developments. As a student, you will quickly master all phases at home... in your spare time. Your earning power will grow with every lesson. Just as thousands of National Schools graduates do every day, you can handle servicing, manufacturing, repairing, hundreds of other jobs, or make good money in your own business. **SECURE YOUR FUTURE—NOW. SEND COUPON BELOW.**



IN THESE MODERN TV STUDIOS, SHOPS AND LABORATORIES, your Shop Method Home Study Course was developed by experienced instructors and engineers. What an advantage that is to you at home — each lesson is tested, proved, easy to understand. You can master the most up-to-date projects, such as color TV set repair, printed circuits — even prepare for F.C.C. License and industrial electronics without taking a special course. **TAKE YOUR FIRST STEP NOW TO A TOP-PAY JOB IN TV, ELECTRONICS, RADIO. SEND COUPON BELOW TODAY.**

**APPROVED FOR  
VETERANS  
AND  
NON-VETERANS**

## NATIONAL SCHOOLS

4000 S. FIGUEROA ST., LOS ANGELES 37, CALIF  
187 N. LA SALLE ST., CHICAGO 1, ILL.

IN CANADA: 811 W. Hastings St., Vancouver, B. C.

**NATIONAL SCHOOLS**  
TECHNICAL TRADE TRAINING SINCE 1905  
Los Angeles, California

**GET FAST SERVICE — MAIL NOW TO OFFICE NEAREST YOU!**

NATIONAL SCHOOLS, DEPT. RG-76

4000 S. FIGUEROA ST. OR 187 N. LA SALLE ST  
LOS ANGELES 37, CALIF. CHICAGO 1, ILL.

Rush free TV-Radio "Opportunity" Book and sample lesson. No salesman will call.

NAME \_\_\_\_\_ BIRTHDAY \_\_\_\_\_ 19 \_\_\_\_\_

ADDRESS \_\_\_\_\_

CITY \_\_\_\_\_ ZONE \_\_\_\_\_ STATE \_\_\_\_\_

VETERANS: Give Date of Discharge \_\_\_\_\_

**FREE!**

Fully illustrated "CAREER" BOOK in TV, Radio, Electronics. AND actual Sample Lesson—yours at no cost, no obligation **SEND COUPON NOW—TODAY!**



MEMBER



TUBES FOR THE  
FINEST IN HI-FI

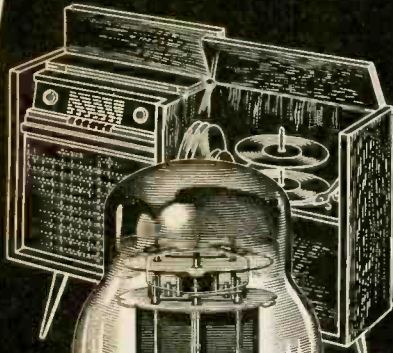

TUNG-SOL

Almost without exception, makers of the finest high-fidelity sets depend upon Tung-Sol Audio Amplifier Tubes to help deliver the performance expected of their products.

Through these tubes—the "5881" and the "6550"—Tung-Sol clearly demonstrates its ability to meet and maintain high-fidelity's critical design requirements in volume production.

This achievement is indicative of the quality and dependability of Tung-Sol Hi-Fi, Radio and TV Tubes . . . products of America's largest independent electron tube manufacturer. Tung-Sol Electric Inc. Newark 4, N. J.



**TUNG-SOL**  
ELECTRON TUBES

**Tung-Sol Automotive & Electronic Products**



Miniature Lamps

Sealed Beam Headlamps

Signal Flashers

Radio And TV Tubes

Aluminized Picture Tubes

Special Purpose Tubes

Semiconductors

the  
**Radio**  
month



**HUNDREDTH ANNIVERSARY** of the birth of Nikola Tesla is being celebrated July 9. Tesla, who was often so far ahead of his contemporaries that his patents had expired before they could be put to practical use, was probably the greatest inventive genius of his generation.

Our whole electric power system rests on Tesla's rotating-field multi-



phase alternating-current concepts, and the Tesla coil, invented about 1890, was the first device to produce noticeable amounts of power at radio frequencies, even lighting electric bulbs miles from the coil. He described a wireless system—with elevated antenna at transmitter and receiver—in 1893, the year before Marconi is said to have become interested in the study of wireless. His radio-guided submarine of the 1890's is the ancestor of all guided missiles.

Because his later years were chiefly occupied with ideas considered fantastic, it is often overlooked that among his more than 900 patents are included some of the most practical of the age. These included mechanical inventions, and his Tesla turbine and clutch working on the viscosity principle introduced the fundamental ideas underlying the design of modern automobile clutches and transmissions.

Further details on the life and works of Tesla appear in the editorial, page 33. Our photo shows the actual death mask of Tesla taken on the day of his death. As all such masks it was made of plaster of Paris. To preserve it for posterity, its owner, Hugo Gernsback, had it heavily copper-plated, a process that took 10 days.

The well-known sculptor Onorio

Ruotolo made the handsome marble-stone base. The memorial mask assembly was unveiled publicly on June 25 in New York by His Excellency, Leo Mates, Ambassador of Yugoslavia, in the offices of RADIO-ELECTRONICS.

**OPERATION ALERT-1956**, a nation-wide war exercise to rehearse what might happen in a nuclear assault, will be held July 20-26. The "attack" is scheduled to take place at 10:00 a.m. on July 20 with 76 targets blasted by nuclear bombs ranging in power from an equivalent of 20,000 to 5,000,000 tons of TNT. Five of the missiles will be fired from submarines, the remainder dropped from aircraft.

The exercise will be a combined Civil Defense and government evacuation maneuver similar to last year's but on a much larger scale. The targets—47 cities in the United States, 5 cities in the territories, 9 air force bases, 4 atomic-energy installations and 11 miscellaneous points—will be serviced by the nation-wide facilities of Civil Defense together with the nation's armed forces and Government agencies.

The first day of the week-long program will be used for emergency relief and assessment of the damage; the remainder of the week for training, integrating information from local, state, regional and national levels, and evaluating effectiveness of communications and other facilities.

**WORLD RADIO CIRCULATION**

exceeds that of daily newspapers for the first time, according to UNESCO (United Nations Educational, Scientific & Cultural Organization). A recent survey found people of the world obtain information from 257 million radio and 44 million television receivers, but only 255 million copies of daily newspapers. This "striking development" is due to the sharp increase in the world total of radio sets—41% in the last 5 years as against a 14% increase in world press circulation.

North Americans own 50% of the world's radio receivers, Europeans 30%. Europeans buy 38% of the world's daily newspapers, North Americans 24%. The United States was credited with 127 million radios, USSR 20 million, United Kingdom 14 million; newspaper circulation was 55, 44 and 31 millions.

**FREQUENCY ASSIGNMENT**

for electronic cooking equipment has put the Federal Communications Commission in "hot water." Both G-E and Westinghouse are pressing for a for-

Prepare Now... in spare time at Home ... for a New,

PROFITABLE, INTERESTING FUTURE



in  
**TELEVISION**  
**RADIO - ELECTRONICS**

RADIO CHIEF OF ILE DE FRANCE  
FRENCH LUXURY LINER PRAISES D T I

Radio Chief—Jean Desmas Says:

"Your Training Organization in Chicago is known not only throughout Europe, but also in many parts of the world as one of America's finest Television, Radio and Electronics training centers."

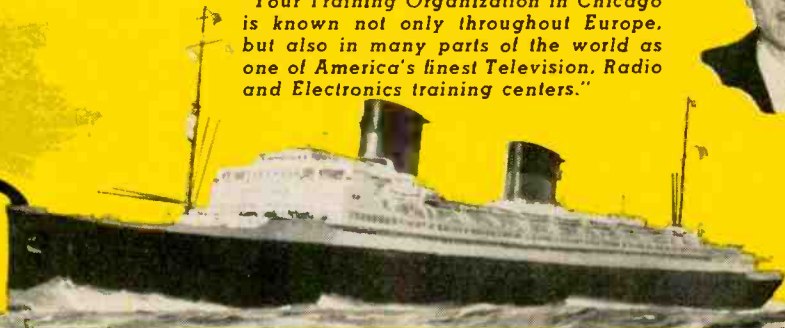

**JACK DEMPSEY**

Former World's Heavyweight Champion  
TELLS WHY HE'S PROUD  
TO BE WITH **D T I**

- I have been greatly impressed with D T I's wonderful spirit of friendliness and sincere determination to help its students make good in Television-Radio-Electronics.
- I admire its remarkable 25 year record of helping men build brighter futures.
- I also admire the business policy of its management and the thoroughness of its large faculty of instructors.
- Never have I heard young men praise a school as enthusiastically as do the students and graduates of D T I. They are its best boosters.

**Prepare At Home Or In Our Chicago Laboratory!**

See for yourself how readily you may prepare at home, or in our modern Chicago laboratories, for a good job or business of your own in one of America's most promising, fast-growing fields—TELEVISION-RADIO-ELECTRONICS.

If you train at home you get (1) the use of a 16-mm. movie projector and 16 reels of animated movies to help you learn important points faster . . . easier, (2) modern, well illustrated lessons and (3) sixteen shipments of electronic parts enabling you to get valuable practical experience from over 300 projects—including building and keeping the electronic equipment shown below. And upon completing training, you have the optional privilege of building and keeping a big 21 INCH TV Set. (D T I offers another home training in Television-Radio-Electronics, but without the TV set.) Get the full story. Mail coupon today!



HOME MOVIES



VACUUM TUBE  
VOLTMETER



OSCILLOSCOPE



Build and keep this BIG DTI Engineered TV set—easily converted to U.H.F. (DTI offers another home training, but without the TV set.)

**LAUD DTI'S HOME MOVIES IN CONGRESS**

DTI's remarkable home training benefit of visual training MOVIES has been praised from the floor of the House of Representatives in Washington, D.C. and recorded in the Congressional Record.



If subject to military service, the information we have for you should prove very helpful. Mail coupon today.

"One of America's Foremost Television Training Centers"



**DEVRY TECHNICAL INSTITUTE**

CHICAGO 41, ILLINOIS

FORMERLY

**DEFOREST'S TRAINING, INC.**

**89 WAYS TO EARN MONEY IN TELEVISION RADIO ELECTRONICS**

MEMBER OF NATIONAL HOME STUDY COUNCIL

**MAIL COUPON TODAY!**

**DEVRY TECHNICAL INSTITUTE**

4141 BELMONT AVE., CHICAGO 41, ILL.

Dept. RE-7-M

I would like your valuable information-packed publication showing how I may get started toward a good job or my own business in Television-Radio-Electronics.

Name \_\_\_\_\_ Age \_\_\_\_\_  
(PLEASE PRINT)  
Street \_\_\_\_\_ Apt. \_\_\_\_\_  
City \_\_\_\_\_ Zone \_\_\_\_\_ State \_\_\_\_\_  
1005 D T I's Training is Available in Canada

MERIT, first in exact and universal replacement transformers, yokes, coils —the only manufacturer of transformers, yokes and coils who has complete production facilities for all parts sold under their brand name.

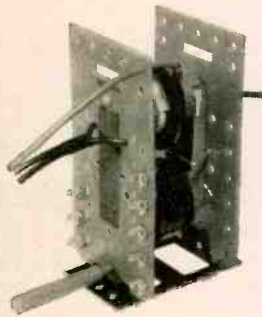

HVO-49 FOR EXACT REPLACEMENT IN AIRLINE, RAYTHEON, TRUETONE. Another in the complete MERIT line of exact and universal replacements —the only single source for all your transformer and coil requirements.

# Merit

MERIT COIL & TRANSFORMER CORP.  
4427 NORTH CLARK STREET  
CHICAGO 40, ILLINOIS



mal decision on the 890-940-mc band. This spectrum was opened in 1947 to be used for industrial, scientific and medical devices, but received very little attention.

Telephone companies, which had secondary rights to share the band with industrial users—at their own risk as far as interference from the latter was concerned—proceeded on a large scale with microwave communications operations. They state they are now well established in the 890-940-mc band and this frequency area should be assigned exclusively to common carriers. To permit operation of devices such as electronic cookers would all but ruin telephone communications facilities due to radiation from the devices.

Westinghouse, in supporting G-E's petition, stated it intended to go into large-scale production of these units and that the 890-940-mc band was far superior, for their purposes, to the 2,450-mc band where most industrial heating devices now operate.

The FCC, conceding that this is a most complicated problem, said it will attempt to establish technical standards for these devices so that they will not interfere with other services in the same vicinity.

### Calendar of Events

Western Electronic Show and Convention (WESCON), Aug. 21-24, Pan Pacific Auditorium, Los Angeles, Calif. (RADIO-ELECTRONICS will exhibit in Booth 1061)  
23d Annual British National Radio Show, Aug. 22-Sept. 1, Earls Court, London, England.  
Southern Arizona Hamfest, Sept. 1-3, Fort Huachuca, Ariz.

### SEVEN NEW TV STATIONS have gone on the air since our last report:

KDWI-TV	Tucson, Ariz. ....	9
KFRE-TV	Fresno, Calif. ....	12
WTVE	Elmira, N. Y. ....	24
WSPA-TV	Spartanburg, S. C. ....	7
WRGP-TV	Chattanooga, Tenn. ....	3
KRIS-TV	Corpus Christi, Tex. ....	6
WITI-TV	Whitefish Bay— Milwaukee, Wis. ....	6

KEDD, Wichita, Kan., channel 16;  
WAIM-TV, Anderson, S. C., channel 40;  
WGVV, Greenville, S. C., channel 23 have gone off the air.

**CLOSED-CIRCUIT TV** made important progress on the scholastic front in two separate projects. At New Lon-

don High School, Wis., what is believed to be the nation's first closed-circuit television study-hall monitoring system was installed. Designed to relieve teachers of study-hall duty, the system consists of a 9-inch television camera weighing only 5 pounds, its lens trained on the 100 seats in the second-floor



study hall (see photo above). A 17-inch television monitor is located in the school's general office on the first floor. Coaxial cable, concealed in the ventilating ducts in the walls, connects camera and monitor. The school's public address system links the study hall and the office.

Superintendent of Schools Paul K. Loofboro is convinced the system will save the school money and at the same time relieve teachers of nonteaching chores. The equipment is made by General Precision Laboratory.

In Chicago, more than 500 educators attending a special session on educational television at the 61st annual meeting of the North Central Association of Colleges & Secondary Schools watched a live telecast on a 9x12-foot projection TV screen (see photo).

The meeting included a tour, by television, of educational TV station WTTW, Chicago. Examples of secondary and college-level programs, telecast especially for the meeting, were shown. The equipment was provided by Dage Television Division, Thompson Products, Inc. END





# ALLIED'S 1956

value-packed 324-page  
**CATALOG**

**FREE**



the only **COMPLETE** catalog  
for everything in electronics

**FEATURING SUPER-VALUE knight-kits**

**BUY DIRECT AND SAVE!** Select from America's top quality equipment in precision-designed kit form—everything in build-your-own Test Instruments, Hi-Fi kits, Hobbyist kits, Ham Gear—easiest to build and you **SAVE MORE!**

**FEATURING EVERYTHING IN HI-FI**

Make your money-saving selections from the world's largest offerings of complete Hi-Fi music systems and components—all the quality lines available for immediate shipment from stock. Own the very best in Hi-Fi for less!

*World's Most Complete Stocks*

**Huge Listings of Parts, Tubes, Transistors, Tools, Books • TV Tubes, Antennas and Accessories**

- Test and Lab Instruments • P. A. Systems and Accessories • Recorders and Supplies
- Amateur Gear • Specialized Industrial Electronic Equipment...

Get every buying advantage at ALLIED: fastest shipment, expert personal help, lowest prices, assured satisfaction. Make your selections from our 324-page 1956 Catalog packed with the world's largest selection of quality electronic equipment.

send for the  
leading electronic  
supply guide

**FREE**

**EASY-PAY TERMS**

Use our liberal Easy Payment Plan—only 10% down, 12 months to pay—no carrying charges if you pay in 60 days. Available on all orders over \$45, including Hi-Fi, P.A., Kits, Recorders, Test Instruments, Amateur Gear, etc.

*Our 35th year*

**ALLIED RADIO**

World's Largest Electronic Supply House



ALLIED RADIO CORP., Dept. 2-G-6  
100 N. Western Ave., Chicago 80, Ill.

Send FREE 324-Page 1956 ALLIED Catalog.

Name \_\_\_\_\_

Address \_\_\_\_\_

City \_\_\_\_\_ Zone \_\_\_\_\_ State \_\_\_\_\_



# Service Dealers!

## FOR YOU

# From Your Raytheon TUBE DISTRIBUTOR

(ask for them!)

These and many, many other valuable sales and shop aids are available to you through your Raytheon Tube Distributor. Many items are free and the rest are priced well below normal cost. All of them are specially designed to help you stimulate sales and increase service business *volume*, and to help you work more efficiently and effectively.

The Raytheon Sales Promotion Booklet is bursting with a magnificent collection of wonderful sales helps.

Ask your Raytheon Tube Distributor for a free copy or write to Department "F", Raytheon Mfg. Co., Receiving and Cathode Ray Tube Operations, Newton 58, Massachusetts.



HEAT-ROTOR SIGN

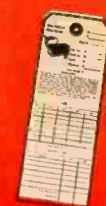

JOB REPAIR TAGS

PHONE CALL REGISTER



BUMPATEL SIGN



DISPLAYS



TUBE AND TOOL CARRYING CASES

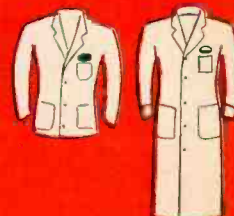

SHOP COATS AND JACKETS



DISPENS-A-AD AND BOOK MATCHES



ILLUMINATED OUTDOOR SIGNS



STATIONERY



QUICK ATTACHABLE COLOR SPOT SIGNS



THEY'RE RIGHT...  
FOR SOUND AND SIGHT

# RAYTHEON MANUFACTURING COMPANY



Receiving and Cathode Ray Tube Operations

Newton, Mass. • Chicago, Ill. • Atlanta, Ga. • Los Angeles, Calif.

Excellence in Electronics



# FREE

tells  
how

## WE GUARANTEE TO TRAIN AND COACH YOU AT HOME IN SPARE TIME UNTIL YOU GET YOUR FCC LICENSE

if you have had any practical experience—Amateur, Army, Navy, Radio repair, or experimenting.

### HERE IS YOUR GUARANTEE

If you fail to pass your Commercial License exam after completing our course, we guarantee to continue your training without additional cost of any kind, until you successfully obtain your Commercial license.

EFFECTIVE  
JOB FINDING  
SERVICE HELPS CIRE  
TRAINEES GET  
BETTER JOBS

### EFFECTIVE JOB FINDING SERVICE HELPS CIRE TRAINEES GET BETTER JOBS Here are a few examples of Job-Finding results:

#### AIRLINES

"I replied to the Job Opportunities you sent me and I am now a radio operator with American Airlines. You have my hearty recommendation for your training and your Job-Finding Service."  
James A. Wright, Beltsville, Md.

by North American Aviation in electronic assembly (final checkout)." Glen A. Furlong, Fresno, Calif.

#### MOBILE SERVICING

"I am now employed by the Permian Basin Communications, Inc. and now manage the service shop in Odessa, Texas for Motorola 2-way communication equipment. I got the job through your Job Finding Services. My sincere thanks."  
Robert W. Cook, Odessa, Texas

#### INDUSTRIAL ELECTRONICS

"Upon my discharge from the Navy I used your Job-Finding Service and as a result I was employed

HERE'S PROOF  
FCC LICENSES  
ARE OFTEN SECURED  
IN A FEW HOURS  
WITH OUR  
COACHING

### HERE'S PROOF FCC LICENSES ARE OFTEN SECURED IN A FEW HOURS WITH OUR COACHING

Name and Address	License	Time
A/1C Ronald H. Person, St. Louis 20, Mo.	1st	25 weeks
Milton L. Geisler, ET3, FPO, San Francisco, Calif.	1st	26 weeks
Marvin F. Kimball, Lafayette, Ind.	2nd	21 weeks
L. M. Bonino, Harlingen AFB, Tex.	2nd	16 weeks
John E. Hutchison, Bluefield, W. Va.	1st	27 weeks

EMPLOYERS  
MAKE JOB OFFERS  
LIKE THESE TO OUR  
GRADUATES EVERY  
MONTH

### EMPLOYERS MAKE JOB OFFERS LIKE THESE TO OUR GRADUATES EVERY MONTH

TRANSCONTINENTAL AIRLINE: "American Airlines is very much interested in receiving applications from CIRE trainees. We have immediate need for technicians in many cities."

WEST COAST MANUFACTURER: "We are currently in need of men with electronics training or experience in radar maintenance, and we would appreciate if you will refer interested persons to us."

OURS IS THE ONLY HOME STUDY COURSE WHICH SUPPLIES FCC-TYPE EXAMINATIONS WITH ALL LESSONS AND FINAL TESTS.

**Your FCC Ticket  
is recognized by  
employers as proof  
of your  
technical ability**

Member, National Home Study Council

**CLEVELAND INSTITUTE OF RADIO ELECTRONICS** Desk RE-93, 4900 Euclid Bldg.  
Carl E. Smith, Consulting Engineer, President Cleveland 3, Ohio

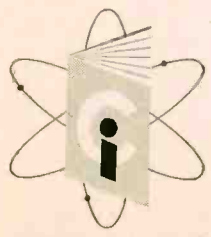

## ACT NOW!



### MAIL COUPON NOW CLEVELAND INSTITUTE OF RADIO ELECTRONICS Desk RE-93, 4900 Euclid Bldg., Cleveland 3, Ohio (Address to Desk No. to avoid delay)

I want to know how I can get my FCC ticket in a minimum of time. Send me your FREE booklet, "How to Pass FCC License Examinations," (does not cover exams for Amateur License), as well as a sample FCC type lesson and the amazing new booklet, "Money-Making FCC License Information."

PLEASE PRINT CLEARLY  
NAME \_\_\_\_\_ AGE \_\_\_\_\_  
ADDRESS \_\_\_\_\_  
CITY \_\_\_\_\_ ZONE \_\_\_\_\_ STATE \_\_\_\_\_

For Prompt Results, Send Air Mail  
Special tuition rates to members of the U. S. Armed Forces  
Electronic Training Available To Canadian Residents

V-M Model 560  
"Fidelis" 4-Speed  
Table Model

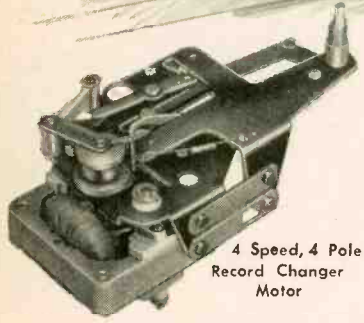

4 Speed, 4 Pole  
Record Changer  
Motor

the **V**oice **M** of Music  
finds that it pays to  
**RELY on GI**  
PHONOMOTORS

**T**here's just no substitute for quality . . . that's why V-M chooses General Industries phonomotors for its brilliant new "Fidelis" table model phonographs. Like other famous manufacturers, V-M knows that for top quality, superior performance and the utmost in economy, it pays to *rely on GI!* General Industries assures prompt, worry-free deliveries, too, so when you have a phonomotor requirement — for original equipment or replacement purposes — take a tip from V-M . . . **RELY on GI!**

Other General Industries AC induction type motors for applications ranging from 1/40 HP to 1/1100 HP.

Write for specifications and quantity-price quotations.

**GI THE GENERAL INDUSTRIES CO.**  
DEPT. GR • ELYRIA, OHIO

**LOOK . . . what RADIO-ELECTRONICS has in store for you in the months ahead . . .**

- V.O.M. SIGNAL-TRACING PROBES IN B & W AND COLOR-TV SERVICING  
By Robert G. Middleton
- UNDERGROUND ANTENNA  
By Harry J. Miller
- INDUSTRIAL TV PULSE GENERATOR  
By Edward M. Noll
- A TRANSISTORIZED SOLAR FLARE INDICATOR  
By David Warshaw
- THE NEW MOTION PICTURE SOUND  
By Aaron Nadell
- THE TELE-CHEK  
By John Potter Shields
- AUDIO TRANSFORMERS  
By Norman H. Crowhurst
- TUBE-TESTER SETTINGS FOR NEW TYPES  
By Basil C. Barbee
- CIVIL-DEFENSE RADIATION METER  
By E. N. Kaufman
- PHOTOELECTRIC LIGHT COMPUTER  
By John R. Satter

The AUGUST issue of RADIO-ELECTRONICS goes on sale July 26th at better parts distributors and newsstands

**SUBSCRIPTION RATES**  
One year \$3.50  
Two years \$6.00  
Three years \$8.00

RADIO-ELECTRONICS 154 West 14th St., New York 11, N.Y.

# Correspondence



## MOCH REBUTS ANTI-LICENSEE

Dear Editor:

We have read the letter by Howard Wolfson in the May issue and are not at all surprised that he still voices the opinions of those he served at the committee hearing at the state capitol the time of enabling legislation hearings.

Opinions on a subject should be limited to those directly affected. From his attitude, he apparently is completely ignorant of the facts of business life as they pertain to TV service. He ignores the complaints in city after city, including his own, and most recently New York and Philadelphia. He sets himself up as a greater authority on the subject than the Federal Fair Trades Commission who very recently put TV service abuses in the top three.

The tears he sheds for a hypothetical "poor abused service technician" are ridiculous. Obviously, anyone who would be "called on the carpet" as often as Wolfson's abused "little man" must either be highly incompetent, immoral or stupid and, frankly, it is this type of undesirable who has made a mess of a \$1.9-billion industry.

Wolfson speaks of licensing as something abominable and rare. Isn't he aware that not only the doctor, lawyer and dentist are licensed, but so are the accountant, clergyman, teacher, engineer, electrician, plumber, barber, yes—we could go on for hours. And they *and* the public are better off for it. What phase of life in our highly industrialized world is not now licensed?

FRANK J. MOCH

President, TESA—Chicagoland  
Chicago, Ill.

## SYMBOLS AND ABBREVIATIONS

Dear Editor:

Your recent publication of a list of symbols and abbreviations is strongly welcomed for it shows a commendable effort toward standardization.

There is no objection regarding abbreviations such as *cont* for control or *lim* for limiter. But if you are free to standardize abbreviations, you hurt international standards when creating symbols of units. There is an International Committee of Electrotechnics charged with standardizing international symbols, and this committee agreed upon the symbols of the principal units and rules of application.

One fundamental is that a basic symbol shall not vary when affected by a multiplying or dividing prefix. Thus, if  $\Omega$  stands for ohm, then meg-

# Learn to Service TV Sets— any make or model—Quickly

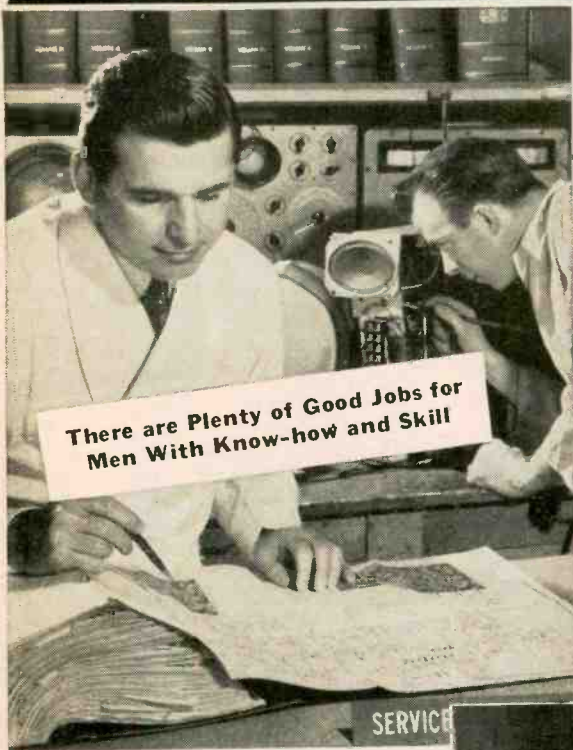

**New ALL PRACTICE Method  
trains you at home to become  
a Professional TV Serviceman**

**You learn the time saving techniques,  
methods used by top TV Servicemen**

This is 100% learn-by-doing, practical training. NRI supplies all necessary equipment, all tubes, including a 17-inch picture tube; and comprehensive manuals covering a thoroughly planned program of practice. You learn how experts diagnose TV receiver defects quickly. You easily learn the causes of defects—audio and video—and how to fix them accurately.

You get actual experience aligning TV receivers, isolating complaints from scope patterns, eliminating interference, using germanium crystals to rectify the TV picture signal, adjusting the ion trap and hundreds of other valuable Professional techniques.

**17" Picture Tube, Components  
for a TV Receiver, Scope,  
Signal Generator, HF Probe—  
all included in introductory  
price under \$200—Easy Terms**

If you want to go places in TV servicing, you will act quickly to find out what you get, what you practice, what you learn and how NRI's new course in Professional Television Servicing will help you advance through better technical knowledge and training. See pictures of equipment supplied, read what you practice in book offered FREE to ambitious men with some knowledge of Radio or TV fundamentals. Find out about this ALL PRACTICE Professional TV Servicing Course now.

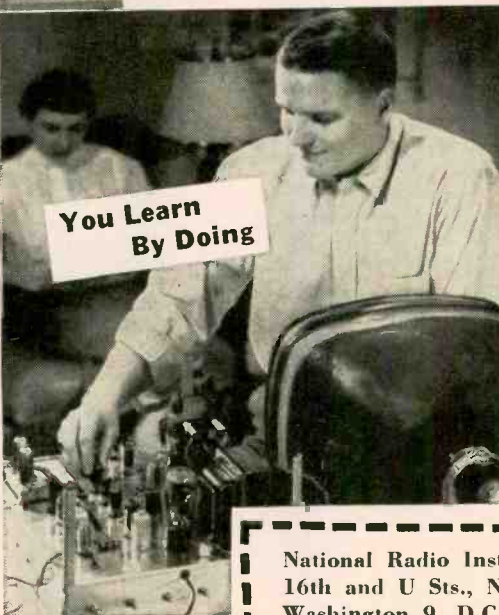

**UHF and COLOR Create  
Growing Opportunities**

To cash in on the present UHF and the coming COLOR TV boom you'll need the kind of knowledge and experience NRI's Course gives. You'll get practice installing front-end channel selector strips in modern UHF-VHF receivers. You learn UHF servicing problems and their solution. Mail the coupon now. Discover how NRI's new course in PROFESSIONAL TELEVISION SERVICING meets the needs of the man who wants to get ahead in TV Servicing.

**Not for Beginners**

If you have some knowledge of Radio-TV fundamentals, or have had some Radio Shop experience or some Radio school training, this course IS FOR YOU. Mail coupon today.

Address National Radio Institute, Dept. 6GFT, 16th and U Sts., N. W., Washington 9, D. C.

**MAIL  
NOW**

National Radio Institute, Dept. 6GFT,  
16th and U Sts., N.W.  
Washington 9, D.C.

Please send my FREE copy of "How to Reach the Top in TV Servicing." I understand no salesman will call.

Name..... Age.....

Address.....

City..... Zone..... State.....

Approved Member National Home Study Council

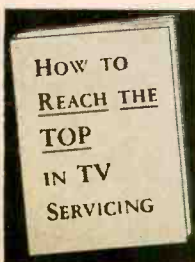

**COUPON BRINGS IMPORTANT  
BOOK FREE**

Get this book and judge for yourself how this course will further your ambition to reach the top in TV Servicing or help to build a more secure business of your own in TV. Many of tomorrow's top TV Servicemen... men who can service any make, any model, UHF, VHF or Color TV... will be graduates of this training. Mail the coupon now. There is no obligation.

# NOW TENNA OFFERS YOU THE FINEST OF ALL CONICAL "DO-IT-YOURSELF KITS!"



**WITH THE AMAZING "PRESTO" INSTANT MOUNT ASSEMBLY**  
All the "Do-It-Yourself" need do is remove the antenna from the box, open elements as he would open an umbrella... and "Presto"... it's ready! Antennas are all aluminum and of highest Tenna quality.

**MODELS DK-801 AND DK-811  
SINGLE ARRAY KITS**

Consist of 1 conical array 50' 300 ohm cable, 1 R-105 Chimney Mount, 1 R-102 Mast Standoff, 3 3/8" Screw-in Standoffs, 1 7" Standoff and 1 5' Galvanized Mast.

**PACKED 4 TO BUNDLE**

**MODELS DK-802 AND DK-812  
STACKED ARRAY KITS**

Consist of 2 conical arrays, 50' 300 ohm cable, 1 R-105 Chimney Mount, 1 R-102 Mast Standoff, 3 3/8" Screw-in Standoffs, 1 7" Standoff, 1 5' Galvanized Mast, plus 2 connecting bars, 1 guy ring and additional crimped mast.

**PACKED 2 TO BUNDLE**

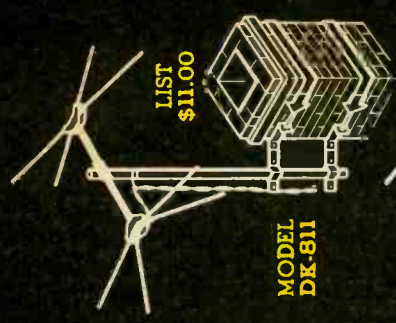

LIST  
\$11.00

MODEL  
DK-811

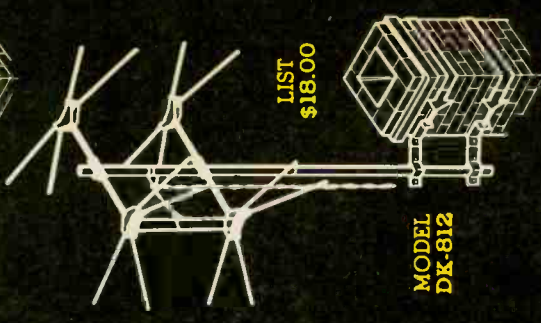

LIST  
\$18.00

MODEL  
DK-812

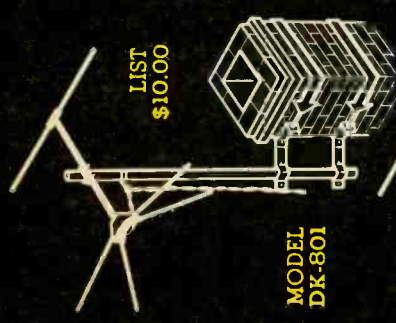

LIST  
\$10.00

MODEL  
DK-801

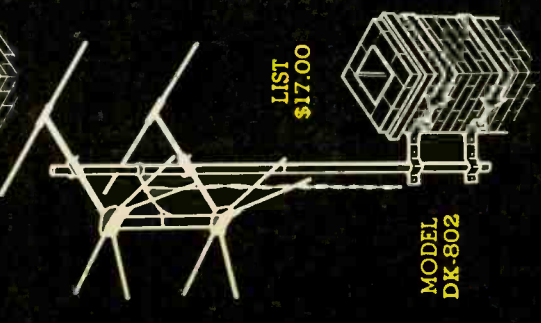

LIST  
\$17.00

MODEL  
DK-802

**THE TENNA MANUFACTURING CO. • CLEVELAND 25, OHIO**

## CORRESPONDENCE

(Continued)

ohm has to be MΩ and not meg. Let me compare some of the principal international standard symbols with yours:

Unit	RE symbol	ICE symbol
ampère	amp	A
milliampère	ma	mA
farad	F	F
microfarad	μf	μf
cycle	cps	Hz, or c/s
megacycle	mc	MHz, or Mc/s
ohm	Ω	Ω
megohm	meg	MΩ
volt	v	V
watt	w	W
kilowatt	kw	kW

European practice is to follow very closely these international recommendations, and maybe this is why we feel hurt by nonstandard symbols.

ALFRED HAAS

Paris, France

(The abbreviations adopted by us represent an effort to follow accepted style as closely as possible, and not to propose new or individualistic symbols or abbreviations. Admittedly, some abbreviations vary so much that no single variant is used by a majority of the technical press; in those cases we have tended to use the simplest or to carry on with the abbreviation or symbol we had been using previously.)

It might seem a good idea to follow European standards with the objective of ultimate international standardization, but unfortunately the ICE does not seem to be much better known there than here. Our review was of schematics—which always vary more than text—but nevertheless indicates very little standardization. In one (Yugoslav) magazine we found M used apparently for both microfarads and megohms, and some capacitors with designations like 1 M 2.

A Danish magazine uses M. for resistors and has capacitors marked μ. The ohms sign appears only in the impedance of the output transformer. Both resistors and capacitors have k's, and we find a capacitor marked 10n. The German magazine *Funkschau* appears to be "correct" though it uses the mysterious nonnafarad (n) freely. An Italian magazine uses 100 pF and 100MMF in the same issue. A French magazine uses pF, nF and μF in one diagram, MFD and MMFD in another.

It would seem that much remains to be done in standardizing European as well as American publications. We note, however, that one or two magazines do follow the European style, and no doubt Mr. Haas and many other authors are careful to use it in their books. Our standardization was an attempt to follow American style as far as such exists. No doubt after further progress has been made, steps can be taken toward worldwide uniformity. —Editor)

## CIRCUIT EXPLANATION

Dear Editor:

In the circuit analysis of the Electro-Voice Circelotron output circuit given



**Train for a secure career  
—not just another job!  
Success ahead for trained men  
only in**



# Radio-TV-Electronics

**Stop Dreaming! Start Planning!**

**START YOUR CREI CAREER TRAINING  
AT HOME TO INSURE MORE INCOME!**

*What would a \$10 or \$20 a week raise mean to you? Only one \$10-a-week raise will repay your investment in CREI training, and leave you a profit of \$200 or more the very first year! Your increases in pay thereafter are all pure profit, and you'll be prepared for many more promotions and pay raises in the future years of your life!*

**WHAT YOU DO NOW**—today, tomorrow, next week—will decide your success in the electronics field. Every day counts because the trained technicians are the ones who get the "plums" when promotions are handed out. How can you be sure to step ahead of competition, to earn more money, to get the position that carries more responsibility—and the pay that goes with it? The answer is contained in a CREI booklet called "Your Future in the New World of Electronics."

## ERA OF COMMUNICATION

This is the era of Communication: aeronautical, marine, police and fire, industrial, land transportation. This is the era of defense orders and a manufacturing industry which last year alone sold billions of dollars worth of electronic equipment, which will top ten billion dollars (without military) this year. This is the era of electronic development, research, design, production, testing, inspection, manufacture, broadcasting, telecasting and servicing. This is the era of electronic careers—well-paid, interesting, and secure.

## PRACTICAL COURSES

Your work is under the supervision of a regular staff instructor who knows and teaches what industry needs. Training is accomplished on your own time, during hours chosen by you.

**KEY TO SUCCESS** — As a graduate you'll find your CREI diploma the key to success in the entire field of electronics. At your service is the Placement Bureau which finds positions for advanced students and graduates. No short cuts are promised; no jobs are guaranteed—but requests for CREI-trained personnel far exceed current supply.



**COLLEGE DEGREE NOT ESSENTIAL**—You don't have to be a college graduate to benefit from CREI's famed courses. You do have to be willing to study at home. You can do it while holding down a full time job. Thousands have. No matter what your level of electronics experience, CREI has a course for you.

CREI's professional guidance is recognized all over the world. Since 1927 CREI has trained technicians; you find them in radio and television stations; you find them in electronics planning and manufacture; you find them everywhere and, generally, near the top. During World War II CREI trained men for the Armed Services. Leading firms choose CREI courses for group training in electronics (among them are United Air Lines, Canadian Broadcasting Corp., Trans-Canada Airlines, Radio Corporation of America and Canadian Marconi).

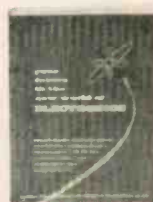

## THIS CAN BE YOUR BIG YEAR!

*Write today for this FREE BOOKLET, just off the press. Tuition is reasonable, terms are easy, information is free. Fill out the coupon and mail it at once. No obligation.*

**AVAILABLE TO VETERANS UNDER GI BILL!**

## FILL OUT AND MAIL TODAY—BEFORE YOU FORGET IT!

### CAPITOL RADIO ENGINEERING INSTITUTE

Accredited Technical Institute Curricula

Dept. 147-C, 3224 16th St., N.W., Washington 10, D. C.

Please send me your course outline and FREE Illustrated Booklet "Your Future in the New World of Electronics" describing opportunities and CREI home study courses in Practical Electronics Engineering.

CHECK FIELD OF GREATEST INTEREST

- Practical Radio Electronic Engineering
- Broadcast Radio Engineering (AM, FM, TV)
- Practical Television Engineering
- Aeronautical Electronic Engineering **E**

Name .....  
Street .....  
City..... Zone..... State.....  
CHECK:  Home Study  Residence School  Korean Veteran

To help us answer your request intelligently, please give the following information:

EMPLOYED BY.....  
TYPE OF PRESENT WORK.....  
SCHOOL BACKGROUND.....  
ELECTRONICS EXPERIENCE.....  
IN WHAT BRANCH OF ELECTRONICS ARE YOU MOST INTERESTED?  
.....

# PRECISION

presents the New Model  
**DOT and BAR  
GENERATOR**

# E-420

for Color Convergence  
and Linearity Patterns

**Compatible  
for COLOR and  
Monochrome TV**



The one Dot and Bar Generator that offers at a reasonable price, every desirable feature for color convergence and linearity pattern testing.

**Model E-420 Deluxe** (illustrated): In blue-grey, hooded steel cabinet and four-color, satin-brushed aluminum panel with dark-blue control knobs. 13 x 11½ x 6½". Complete with tubes, output cables and comprehensive manual. Shipping Weight: 19 lbs. Net Price: \$150.00

**Model E-420 Standard:** In standard black ripple finished cabinet. Shipping Weight: 19 lbs. Net Price: \$145.00

• it's a  
**WHITE DOT**  
generator

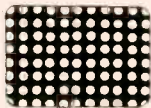

• it has  
**VARIABLE  
DOT SIZE  
and NUMBER**



• it's a  
**VERTICAL BAR**  
generator



• it has  
**VARIABLE 'V'  
and 'H' BAR WIDTH  
and NUMBER**



• it's a  
**HORIZONTAL BAR**  
generator

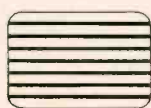

• it provides  
**DIRECT  
VIDEO OUTPUT**

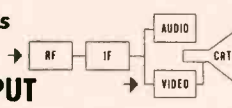

• it's a  
**CROSS HATCH  
PATTERN**  
generator



• it provides  
**MODULATED  
TV CHANNEL  
OUTPUT**

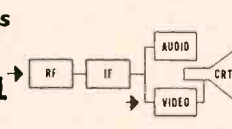

CORRESPONDENCE

(Continued)

by Joseph Marshall in the May issue of *RADIO-ELECTRONICS*, the statement made that one output tube is plate-loaded and the other cathode-loaded is entirely erroneous. This statement connotes that such an arrangement seriously affects distortion and power capabilities at the frequency extremes due to the unbalanced distributed and electrode capacitances of the two sections as well as different feedback loops between the plate-loaded and cathode-loaded sections. (Any cathode loading presents inherent degenerative feedback, plate loading produces none.)

A close look at the Circlotron circuit will show that both output tubes have identical circuitry. Turning the bridge 180°, so to speak, produces the same configuration. Remember the basic fundamentals in analyzing this circuit: plate loads are those in the cathode-plate circuit that do *not* have any portion common to the grid-cathode circuit; cathode loads are those in the cathode-plate circuit that *are* in common with the grid-cathode circuit.

Let us reanalyze the Circlotron circuit. (Refer to Fig. 9-b in the article and consider the batteries as short circuits for ac signals.) The upper output tube has the right half of the output winding in its plate circuit; the left half of the winding is in its cathode circuit. This is due to the fact that the grid-cathode circuit has to go through this section of the load for its completion. There is cathode regeneration for this tube due to the left half of the output transformer winding only.

Conversely, the lower tube has this left half for its plate load and the right half for its cathode load. Here again we have one half of the total load supplying cathode degeneration. However, due to the close coupling of both halves of the transformer, variations in the plate portion of the winding are coupled to the cathode (and hence, feedback) portion of the winding to further decrease distortion, etc. Each tube has a split load, the cathode of one being the plate of the other and vice versa. The arrangement is entirely symmetrical with respect to the two output tubes as well as to ground potential. Thus, the Circlotron circuit has extremely low distortion products and extended range in power and frequency response.

In addition, Joseph Marshall indicates that our circuit "needs two *high-current* power supplies." True, we use two supplies, but the current necessary from each is only one-half that of a single supply circuit of the same power. This dual supply becomes a real advantage at high powers because the regulation problems of each are only one-half that of single supply systems.

Our circuit is a new approach not easy to explain.

DANIEL J. TOMCIK

Chief Engineer, Electronics

Electro-Voice, Inc.  
Buchanan, Mich.

END



**PRECISION Apparatus Company, Inc.**

70-31 84th Street, Glendale 27, L. I., N. Y.

Export: 458 Broadway, New York 13, N.Y., U.S.A. • Cables: MORHANEX  
Canada: Atlas Radio Corp. Ltd. • 50 Wingold Ave., Toronto 10, Ontario



**RCA** offers you the  
 finest training  
 at home in  
 Radio-TV  
 electronics,  
 TV servicing,  
 Color TV

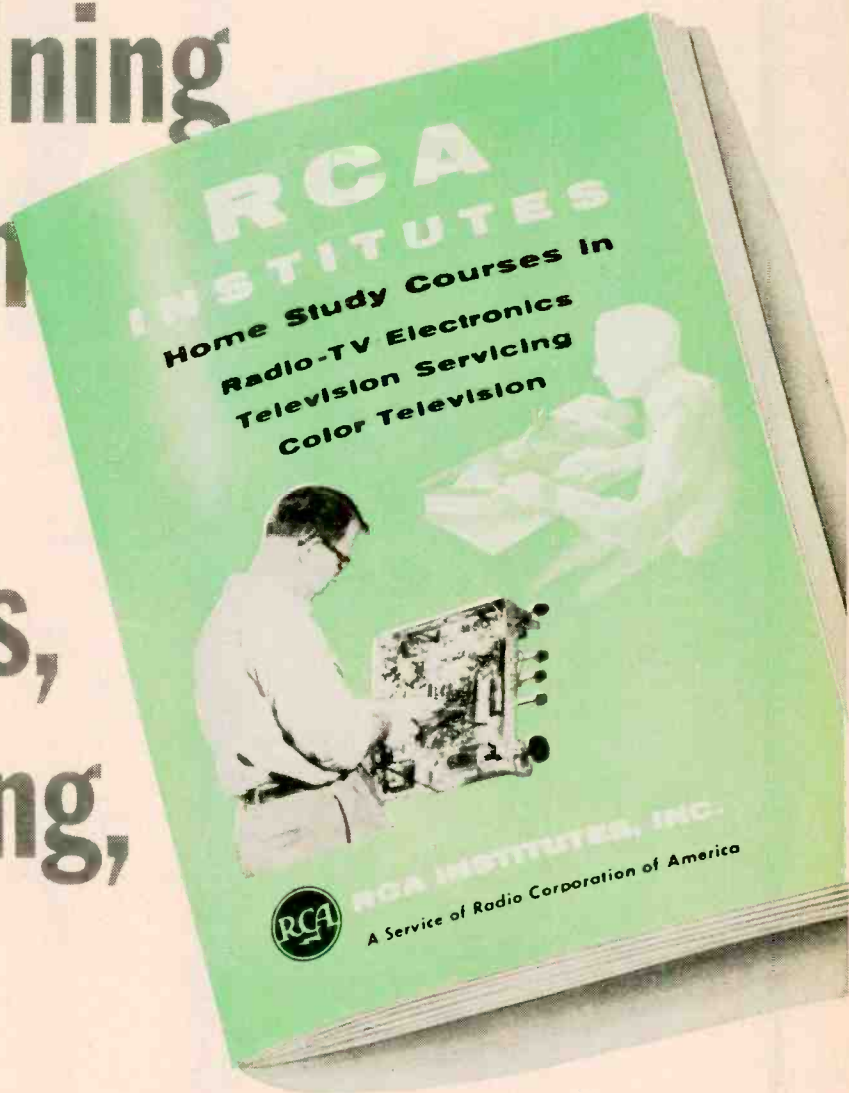

**SEND FOR THIS FREE  
 BOOK NOW!**

The instruction you receive and equipment you get (and keep) will start you on your way. Pay-as-you-learn. You pay for only one study group at a time. This 52 page book contains complete information on Home Study Courses for the beginner and the advanced student.



**RCA INSTITUTES, INC.**  
 A SERVICE OF RADIO CORPORATION OF AMERICA  
 350 WEST FOURTH STREET, NEW YORK 14, N.Y.

RCA Institutes, Inc., Home Study E-76,  
 350 West Fourth Street New York 14, N. Y.  
 Without obligation, send me FREE CATALOG  
 on Home Study Courses in Radio, Television  
 and Color TV. No salesman will call.

Name .....  
 Address .....  
 City ..... Zone ..... State .....

Please Print

**IMPORTANT**  
 Be sure to write  
 for RCA Institutes  
 catalog before  
 signing up for any  
 Radio-TV course



**NEW SERVICE-DESIGNED 1X2-A/B**



**NEW SERVICE-DESIGNED 6AL5**

# NOW G-E SERVICE- 54% OF YOUR

With 20 popular types you cut call-backs,

## Ready: 6 brand-new Service-Designed Tubes for increased volume!

**NEW 1X2-A/B.** *New filament shield post* ("lightning rod") helps to neutralize electrostatic pull of anode, reducing filament pull-outs to a minimum.

- Filament has special new coating that adheres closely, and will not flake off and expose the wire. Cuts tube arc-overs.

- Tubes are life-tested under actual operating conditions, including peak voltages that will be encountered. Assures dependable performance!

PROTECTS AGAINST FILAMENT PULL-OUTS.



**NEW 6AL5.** *New, advanced heater design* limits initial voltage surges when tube is used in early-model series-string receivers. Same advantage applies in parallel-connected circuits. Tube flash burn-outs are greatly reduced. Vertical bars at right show approximate drop in initial voltage surges between heater of old tube and new Service-Designed 6AL5.

- New heater design also minimizes heater-cathode leakage. This is an important "plus" in AGC and video-detector applications.

HEATER VOLTAGE SURGES REDUCED.



**NEW 6BK7-A, 6BQ7-A, 6BZ7.** *Improved heater design* provides better heater-cathode insulation. Cuts shorts to a minimum, acts to prevent tube burn-outs.

- Heater-cathode leakage is greatly reduced. Gives improved tube operation, and stabilizes tube performance.

- High zero-bias Gm. This increases tube gain and improves TV reception in fringe areas, giving a clearer, sharper picture.

YOU CAN CROSS OFF HEATER-CATHODE SHORTS!



**NEW 6CB6.** *New sprayed micas* combat interelement leakage, improving AGC performance by reducing any tube leakage in the controlled 6CB6 stages.

- Special-alloy screen grid gives superior heat dissipation. Result: freedom from G<sub>1</sub> and G<sub>2</sub> grid distortion and shorts.

- High zero-bias Gm, for improved fringe-area reception. Helps make the new 6CB6 a better-performing, more dependable tube!

REGULAR MICA DEPOSITS WILL CAUSE LEAKAGE.

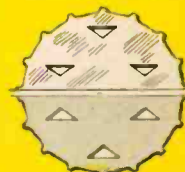

NEW, SPRAYED G-E MICA IS LEAK-AGE-RESISTANT!

**NEW SERVICE-DESIGNED**



**6BK7-A**

**6BQ7-A**

**6BZ7**



**NEW SERVICE-DESIGNED 6CB6**

# DESIGNED TUBES MEET REPLACEMENT NEEDS!

please customers on more than half your TV tube sales!

**E**VERY new General Electric Service-Designed Tube increases your profit opportunity. The 6 new types now available give you 20 Service-Designed Tubes in all . . . and by actual sales count for the year 1955, these 20 tubes meet 54 percent of your total TV replacement requirements!

Customer goodwill gets a big boost when you can put long life, improved performance into over half the tube sockets you fill! Call-back costs drop sharply. Your tube inventory needs are consolidated — for General Electric Service-Designed Tubes give top performance in *all* chassis!

G.E.'s first group of Service-Designed Tubes met 29 percent of all TV replacement needs. Now your sales potential is nearly doubled. Still more Service-Designed Tubes are in development . . . will increase your share of the tube market further.

Stock and install G-E Service-Designed Tubes! They cost no more than other tubes, are fully interchangeable with prototypes. They're widely advertised, nationally popular. Your G-E tube distributor has them. Phone him today! *Tube Department, General Electric Co., Schenectady 5, N. Y.*

THESE 20 TUBES ARE "MONEY IN YOUR POCKET!"

Clip out this list of General Electric Service-Designed Tubes . . . it will fit neatly in your wallet. A handy guide to types available!

1B3-GT	6AV5-GA	6BQ7-A	6CD6-GA
1X2-A/B	6AX4-GT	6BX7-GT	6J6
5U4-GA/GB	6BG6-GA	6BZ7	6SN7-GTB
5Y3-GT	6BK7-A	6CB6	12SN7-GTA
6AL5			25CD6-GB
	6BQ6-GA/6CU6		25BQ6-GA/25CU6

*Progress Is Our Most Important Product*

**GENERAL  ELECTRIC**

161-1A3



# SUMMERTIME is READING TIME

## for Technicians, Industry, Experimenters, Students, Hobbyists, Hams...

### HOW TO SELECT AND USE YOUR TAPE RECORDER

by David Mark

Written for the USER: music lovers, businessmen, lawyers, engineers, teachers, etc. Step-by-step instructions on set-up and using procedures for all applications in the home, office, and professional activities. Also a buyer's guide in selecting a machine to suit individual requirements. Soft cover, 148 pp., 5 1/2 x 8 1/2", illus.

#179.....Only \$2.95

### RADIO RECEIVER LABORATORY MANUAL

by Alex W. Levey, B.A., M.S.

A workbook of experiments designed for students of radio and radio servicing. Covers the construction, analysis, testing, and repair of a radio receiver. Acquaints the student with necessary servicing equipment. There are 33 experiments in all, including 6 demonstration experiments. Soft Cover, 110 pp., 8 1/2 x 11", illus.

#178.....Only \$2.00

### SERVICING TV VERTICAL AND HORIZONTAL OUTPUT SYSTEMS

by Harry Thomas

Technicians and students will here find a complete discussion of vertical and horizontal output systems and their operation. Soft Cover, 176 pp., 5 1/2 x 8 1/2", illus.

#150.....Only \$2.40

### HOW TO LOCATE & ELIMINATE RADIO & TV INTERFERENCE

by Fred D. Rowe

An expertly written text which tells you how to locate and eliminate interference. The approach is not theoretical, but direct and practical. Soft Cover, 128 pp., 5 1/2 x 8 1/2", illus.

#158.....Only \$1.80

### UHF TELEVISION ANTENNAS & CONVERTERS

by Allen Lytel

Covers the function and operation of UHF conversion systems, and explains all details of these in simple, easily understood language. Systems discussed range from simple single-channel to tuners which cover entire band. Soft Cover, 128 pp., 5 1/2 x 8 1/2", illus.

#153.....Only \$1.80



### TELEVISION—HOW IT WORKS (2nd Edition)

by J. Richard Johnson

A completely rewritten, up-to-the-minute edition of an authoritative and informative book. It is the newest and most comprehensive text on the subject, and follows the progress of the received signal from the antenna to the picture tube and loudspeaker. Leather Finish MARCO Cover, 352 pp., 5 1/2 x 8 1/2", illus.

#101.....Only \$4.60  
#101-H, Cloth Bound.....Only \$5.50

### HANDBOOK OF 630-TYPE TV RECEIVERS

by Miller & Bierman

Deals with all versions of the famous 630-type receivers made up to 1955. Explains modifications and circuit improvements made by various manufacturers, and includes 26 pages of troubleshooting charts. A book every technician can use to major advantage! Soft Cover, 200 pp., 5 1/2 x 8 1/2", illus.

#174.....Only \$3.50

### TV TROUBLESHOOTING & REPAIR GUIDE BOOK

by R. G. Middleton

VOLUME 1: For the serviceman requiring practical, down-to-earth servicing information on TV troubles and their cures. Shows how to spot symptoms through the use of picture tube patterns and scope waveforms. Much valuable data on the use of test equipment, as well as simple techniques for troubleshooting outside the service shop. Soft Cover, 204 pp., 8 1/2 x 11", illus.

#140.....Only \$3.90

VOLUME 2: A gold mine of information on troubleshooting front ends, servicing the video I-F strips, faults in video amplifiers, trouble analysis in sound I-F and detector systems, etc. Soft Cover, 160 pp., 8 1/2 x 11", illus.

#140-2.....Only \$3.30



### PICTURE BOOK OF TV TROUBLES

by Rider Lab. Staff

A series of books, each covering a different part of the TV receiver, and showing typical troubles, their symptoms and causes. All material is from actual case histories. These books do your troubleshooting for you! Soft Covers, 5 1/2 x 8 1/2", illus.

### VOL. 1: HORIZONTAL AFC-OSCILLATOR CIRCUITS

#168, 80 pp.....Only \$1.35

### VOL. 2: VERTICAL SWEEP-DEFLECTION CIRCUITS

#168-2, 96 pp.....Only \$1.80

### VOL. 3: VIDEO I-F & VIDEO AMPLIFIER CIRCUITS

#168-3, 96 pp.....Only \$1.80

### VOL. 4: AUTOMATIC GAIN CONTROL CIRCUITS

#168-4, 96 pp.....Only \$1.80

### VOL. 5: HORIZONTAL OUTPUT & H-V CIRCUITS

#168-5, 108 pp.....Only \$1.80

### TV REPAIR QUESTIONS & ANSWERS

by Sidney Platt

A very practical series of questions and answer books on the repair of TV receivers. Each covers a separate section of the receiver, and the series follows the same sequence that the signal itself travels. Soft Covers, 5 1/2 x 8 1/2", illus.

#173, FRONT ENDS: 128 pp.....Only \$2.10

#173-2, VIDEO CIRCUITS: 128 pp.....Only \$2.10

#173-3, SYNC & SWEEP CIRCUITS: 140 pp.....Only \$2.10

#173-4, DEFLECTION & H-V CIRCUITS: 128 pp.....Only \$2.10

#173-5, SOUND & L-V CIRCUITS: 128 pp.....Only \$2.10

### HOW TO TROUBLESHOOT A TV RECEIVER

by J. Richard Johnson

A book written for the newcomer, to aid in a systematic procedure for troubleshooting. An easily understandable, step-by-step guide. Soft Cover, 128 pp., 5 1/2 x 8 1/2", illus.

#152.....Only \$1.80

### HOW TO INSTALL TV ANTENNAS

by S. L. Marshall

This is an illustrated ANTENNA BIBLE you'll refer to every time an installation job comes in. Everything you need to know about installing TV antennas, in one handy reference book. Soft Cover, 128 pp., 5 1/2 x 8 1/2", illus.

#172.....Only \$2.50

### ADVANCED TELEVISION SERVICING TECHNIQUES

by RETMA

A complete advanced TV servicing course, developed by the Radio-Electronics-Television Manufacturers Association, and made available to you at the incredibly low price of \$4.55, complete! Shows you how to use every conceivable type of test equipment, how to service every part of a TV receiver. Soft Cover, 8 1/2 x 11".

MAIN TEXT, 176 pp., illus. #161.....Only \$3.60

LABORATORY WORKBOOK, 32 pp. #161-2.....Only \$ .95

### TV MFGRS' RECEIVER TROUBLE CURES

edited by M. Snitzer

Gives you specific TV receiver troubles, and the cures specified by the set manufacturer. Listings are by manufacturer, model and chassis number. Saves you time, helps you earn more! Soft Cover, 5 1/2 x 8 1/2", illus., each volume over 115 pp.

VOL. 1: Covers complete details on sets produced by mfgs (listed in alphabetical order) from Admiral to Dumont.

#143.....Only \$1.80

VOL. 2: Covers mfgs from Emerson to Jackson. #143-2.....Only \$1.80

VOL. 3: Covers mfgs from Kaye-Halbert to Philco. #143-3.....Only \$1.80

VOL. 4: Covers mfgs from Philharmonic to Shaw. #143-4.....Only \$1.80

VOL. 5: Covers mfgs from Sparton to Zenith. #143-5.....Only \$1.80

VOL. 6: All new coverage, through 1954, no duplications. . . Admiral to Firestone. #143-6.....Only \$1.80

VOL. 7: Just published. New coverage, from General Electric to Raytheon. #143-7.....Only \$1.80



### INTRODUCTION TO COLOR TV (2nd Edition)

by Kaufman & Thomas

A revised, up-to-date edition of a best seller in books on TV. New edition contains full information on the latest and larger screen picture tubes, simplified receiver circuitry, etc. Most up-to-date introduction to color television available. Soft Cover, 160 pp., 5 1/2 x 8 1/2", illus.

#156.....Only \$2.70

### COLOR TELEVISION RECEIVER PRACTICES

by Hazeltine Corp. Lab. Staff

Prepared by experts, this book covers every major aspect of color TV receivers, including the latest 21" picture tube and its required circuitry. For anyone who wishes a solid grounding in color television, this volume is ideal. Destined to become a standard reference work on the subject. Soft Cover, 208 pp., 5 1/2 x 8 1/2", illus.

#162.....Only \$4.50

#162-H, Cloth Bound.....Only \$6.00

### HIGHLIGHTS OF COLOR TV

by John R. Locke, Jr.

A discussion of color television for those who are already familiar with black & white. Based on recommendations of N.T.S.C. Soft Cover, 48 pp., 5 1/2 x 8 1/2", illus.

#157.....Only \$ .99

### COLOR TV DICTIONARY

by J. R. Johnson

Complete explanation of color TV terms, with their definitions. Ideal for anyone interested in color television. Soft Cover, 72 pp., 5 1/2 x 8 1/2", illus.

#164.....Only \$1.25

# JOHN F. RIDER PUBLISHER, INC.

## 480 Canal Street, New York 13, N. Y.

In Canada:

Charles W. Pointon, Ltd.

6 Alcina Ave., Toronto, Ontario

In Canada, all prices approximately 5% higher.

# Let Rider Books Teach You Electronics Know-How!



## BASIC ELECTRICITY BASIC ELECTRONICS

**BASIC SYNCHROS & SERVOMECHANISMS**  
by Van Valkenburgh, Nooger & Neville, Inc.  
The fabulous picture-text books that teach faster and easier! The theory, principals and practice of electricity, electronics, synchros and servos, are here presented in a manner which permits a rapid grasp of the fundamentals of these vitally important subjects. Over 2,000 specially prepared illustrations present, explain and make every topic discussed picture clear.

**BASIC ELECTRICITY**  
#169 Soft Cover: 5 volumes, 624 pp., 6 x 9"  
Only \$9.00 per set  
#169-H Cloth Bound: all 5 volumes in a single binding Only \$10.50

**BASIC ELECTRONICS**  
#170 Soft Cover: 5 volumes, 550 pp., 6 x 9"  
Only \$9.00 per set  
#170-H Cloth Bound: all 5 volumes in a single binding Only \$10.50

**BASIC SYNCHROS & SERVOMECHANISMS**  
#180 Soft Cover: 2 volumes, 270 pp., 6 x 9"  
Only \$5.50 per set  
#180-H Cloth Bound: both volumes in a single binding Only \$6.95

**BASIC VACUUM TUBES & THEIR USES**  
by Rider & Jacobowitz  
Basic information relating to vacuum tubes, with a minimum of mathematics, from the behavior of the elementary electron to the specialized types of tubes. A must book for technicians, engineers, students. 208 pp., 5 1/2 x 8 1/2", illus.  
#171, Soft Cover.....Only \$3.00  
#171-H, Cloth Bound.....Only \$4.50

**FUNDAMENTALS OF TRANSISTORS**  
by Leonard Krugman  
Explains the BIG thing in electronics, today—the transistor! Written by one of the pioneers in transistor development, this book tells you all you need to know about this electronic miracle: basic operation, characteristics, performance, and application. Soft Cover, 144 pp., 5 1/2 x 8 1/2", illus.  
#160.....Only \$2.70

**HOW TO USE SIGNAL & SWEEP GENERATORS**  
by J. Richard Johnson  
Discusses all types of signal and sweep generators, and their applications in AM, FM radio, and TV. Soft Cover, 144 pp., 5 1/2 x 8 1/2", illus.  
#147.....Only \$2.10

**UNDERSTANDING VECTORS & PHASE**  
by Rider & Usilan  
A book which makes for quick and easy understanding of radio theory, written for anyone in radio and electronics who has not had the advantage of technical training. Soft Cover, 160 pp., 5 1/4 x 7 1/4", illus.  
#103.....Only \$ .99

**HOW TO USE TEST PROBES**  
by A. Ghirardi & R. Middleton  
The only book of its kind, it covers all types of test probes used with VOM's, VTVM's, and scopes. Complete step-by-step explanations, with practical examples of results and effects. Soft Cover, 176 pp., 5 1/2 x 8 1/2", illus.  
#165.....Only \$2.90

**FM TRANSMISSION & RECEPTION (2nd Edition)**  
by Rider & Usilan  
Covers FM broadcasting of all kinds, and explains the theory, functioning and servicing of various types of FM receivers, including TV receivers. Cloth Bound, 460 pp., 5 1/2 x 8 1/2", illus.  
#102.....Only \$4.95

**RIDER BOOKS HELP YOU  
DO MORE,  
LEARN MORE,  
EARN MORE...**

**HOW TO USE METERS**  
by John F. Rider  
Explains everything about using meters of all kinds. Tells and shows what to use and what to measure. If you use meters, this is a book you cannot afford to pass by! Soft Cover, 144 pp., 5 1/2 x 8 1/2", illus.  
#144.....Only \$2.40

**OBTAINING & INTERPRETING TEST SCOPE TRACES**  
by John F. Rider  
Explains oscilloscope screen traces in clear, non-mathematical language. Contains over 800 scope traces, and complete instructions on the use of scopes and interpretation of traces. Soft Cover, 190 pp., 5 1/2 x 8 1/2", illus.  
#146.....Only \$2.40

**ENCYCLOPEDIA ON CATHODE-RAY OSCILLOSCOPES & THEIR USES**  
by Rider & Usilan  
Fully and clearly describes the oscilloscope, its construction and capabilities. Covers a wide variety of scopes, including present day models. Profusely (3,000) illustrated. Cloth Bound, 1008 pp., 8 1/2 x 11".  
#133.....Only \$11.50

**RADIO OPERATOR'S LICENSE Q & A MANUAL (5th Edition)**  
by M. Kaufman  
Revised and enlarged 5th edition contains the latest revisions in Elements 1 and 2 (Basic Law, and Basic Operating Practice). Lists questions and answers of past FCC exams, plus discussions of each answer. An indispensable reference volume for the student and operator. Cloth Bound, 766 pp., 5 1/2 x 8 1/2", illus.  
#130.....Only \$6.60

**ELECTRONICS TECHNOLOGY SERIES**  
edited by Alex. Schure, Ph.D., Ed.D.  
An economically priced series. Each thoroughly and clearly explains the basic concepts of an individual phase of electronics technology principles. Review questions at the end of each chapter. Soft covers, 5 1/2" x 8 1/2", illustrated.

- RC & RL TIME CONSTANT**  
#166.....Only \$ .90
- F-M LIMITERS & DETECTORS**  
#166-2.....Only \$ .90
- FREQUENCY MODULATION**  
#166-3.....Only \$ .90
- CRYSTAL OSCILLATORS**  
#166-4.....Only \$1.25
- A-M DETECTORS**  
#166-5.....Only \$1.25
- LIMITERS & CLIPPERS**  
#166-6.....Only \$2.25
- MULTIVIBRATORS**  
#166-7.....Only \$ .90
- R-F TRANSMISSION LINES**  
#166-8.....Only \$1.25
- AMPLITUDE MODULATION**  
#166-9.....Only \$1.25
- BLOCKING OSCILLATORS**  
#166-10.....Only \$1.25

Buy these books at your electronics parts jobber or book store. . . . Look for this Rider Book Seller. If your jobber or book store does not sell the Rider books you want, mail this coupon for prompt delivery. ORDER TODAY! Add state and city sales tax where applicable.



## HI-FI LOUDSPEAKERS & ENCLOSURES

by Abraham B. Cohen

A long-needed book, destined to become a classic volume in hi-fi literature. Completely covers the subject. Answers all your questions about loudspeakers and enclosures, design, cross-over networks, construction of own networks, etc. Leather Finish MARCO Cover, 5 1/2 x 8 1/2", illus.  
#176.....Only \$4.60  
#176-H, Cloth Bound.....Only \$5.50

**GUIDE TO AUDIO REPRODUCTION**  
by David Fidelman  
Fully discusses pick-up devices, loudspeakers and enclosures; explains circuitry of pre-amps and amplifiers; covers construction, assembly and testing of sound reproduction systems. Soft Cover, 240 pp., 5 1/2 x 8 1/2", illus.  
#148.....Only \$3.50

**HIGH FIDELITY SIMPLIFIED**  
by Harold D. Weiler  
Gives you the complete hi-fi story, and answers all questions about tuners, changers, amplifiers, tape recorders, speakers, record players, etc. There is no other book like it. Soft Cover, 224 pp., 5 1/2 x 8 1/2", illus.  
#142.....Only \$2.50

**RIDER'S SPECIALIZED HI-FI AM-FM TUNER MANUAL**  
An informative, factory-accurate manual covering the 20 most popular brands of AM or FM hi-fi tuners. Gives you comparative specifications, characteristics, information on adjustments and servicing, etc. Soft Cover, 192 pp., 8 1/2 x 11", illus.  
#7001.....Only \$3.50

**RIDER'S SPECIALIZED TAPE RECORDER MANUAL, Vol. I**  
Fact-filled pages on every recorder made by the 12 most prominent manufacturers, from 1950 through 1954. All details of operation, adjustments, trouble diagnosis, servicing, etc. Soft Cover, 288 pp., 8 1/2 x 11", illus.  
#6001.....Only \$4.50

**HOW TO SERVICE TAPE RECORDERS**  
by C. A. Tuthill  
Tells you what you need to know about the tape recorder and its operation. Explains the types of circuits, drive mechanisms, troubleshooting and repair. Soft Cover, 160 pp., 5 1/2 x 8 1/2", illus.  
#167.....Only \$2.90

THESE AND MANY  
OTHER RIDER BOOKS  
ARE AVAILABLE...



JOHN F. RIDER PUBLISHER, INC.  
480 Canal Street, New York 13, N. Y.

Enclosed is \$ \_\_\_\_\_ Please rush the books I have circled.

101	140-2	143-6	152	161-2	166-3	166-10	169	173	176-H
101-H	142	143-7	153	162	166-4	167	169-H	173-2	178
102	143	144	156	162-H	166-5	168	170	173-3	179
103	143-2	146	157	164	166-6	168-2	170-H	173-4	180
130	143-3	147	158	165	166-7	168-3	171	173-5	180-H
133	143-4	148	160	166	166-8	168-4	171-H	174	6001
140	143-5	150	161	166-2	166-9	168-5	172	176	7001

Name \_\_\_\_\_  
Address \_\_\_\_\_  
City \_\_\_\_\_ Zone \_\_\_\_\_ State \_\_\_\_\_

RE-7

*At Last...* and for the first time!

## A PICKUP FOR CALIBRATING RECORDS!

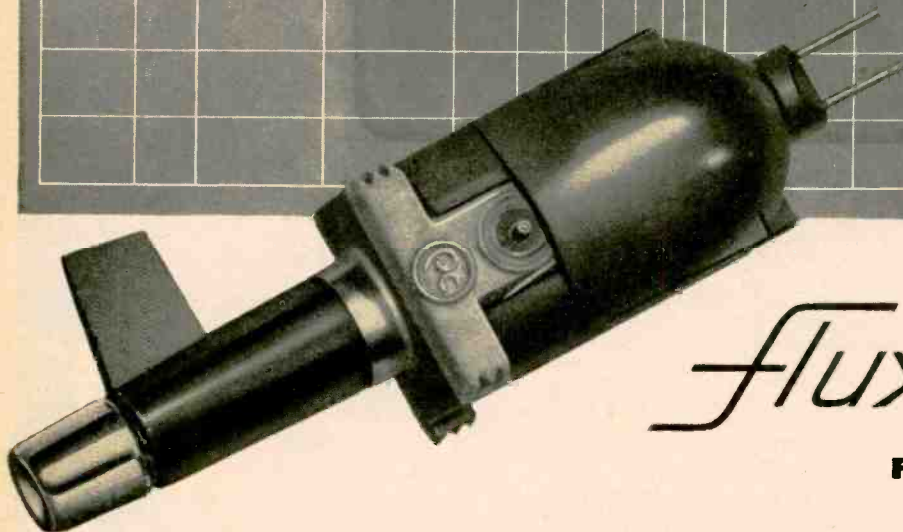
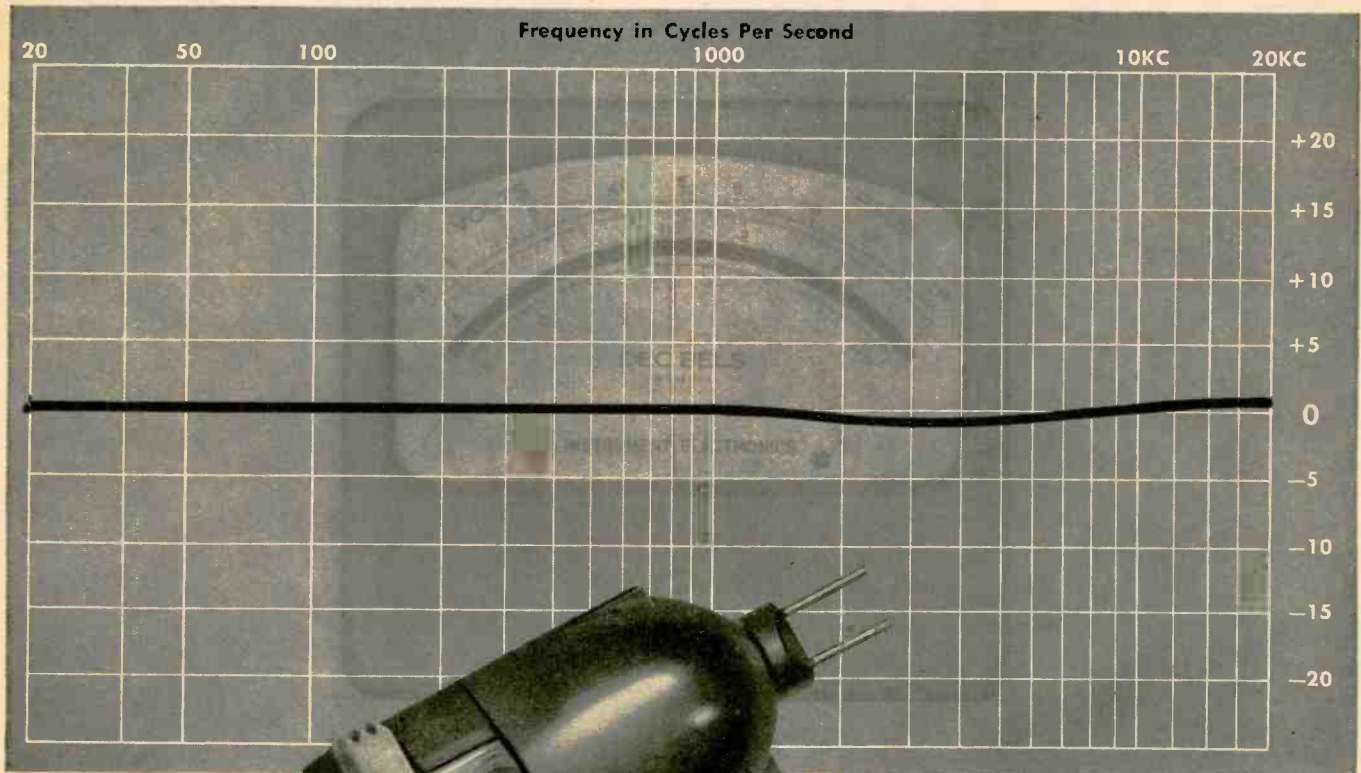

### THE *Fluxvalve* PICKUP

Important as it is to the recording industry, the **FLUXVALVE** offers values never before available to thousands of record playing enthusiasts!

- *Very Wide Range (VWR)*
- *Unequaled transient response*
- *Long record and stylus life*
- *Low overall distortion*
- *Hermetically sealed*
- *Easily replaceable styli \**

\* Less than 1 mil stylus on special order

THE **FLUXVALVE PICKUP** was originally developed for professional applications, particularly recording studios where accurate correlation between lacquer, master and pressings is essential, and has always been difficult. Now with the **FLUXVALVE** magnetic turn-over pickup with which to make precise and *reproducible* record-measurements, a vital control step is simplified.

*For a new listening experience, ask your dealer to demonstrate the new **FLUXVALVE** . . . words cannot describe the difference . . . but you will hear it!*



**PICKERING & CO., INC.** OCEANSIDE, N. Y.

Professional Audio Components

*“For those who can hear the difference”*

. . . Demonstrated and sold by Leading Radio Parts Distributors everywhere. For the one nearest you and for detailed literature: write Dept. P-10  
EXPORT: AD. AURIEMA, INC., 89 BROAD ST., NEW YORK / CANADA: CHARLES W. POINTON LTD., 6 ALCINA AVE., TORONTO

# PUT YOURSELF IN THE Top-Paying TELEVISION PICTURE .....

R  
Radio  
T  
Television  
T  
Training  
A  
Association

Today, when demand for trained men is higher than ever before, pay is higher than ever before, you can train AT HOME in your SPARE TIME to become a Television Technician.



L. C. Lane, B.S., M.A.  
President, Radio-Television Training Association. Executive Director, Pierce School of Radio & Television.

## PREPARE FOR A BRIGHTER FUTURE AS A TV TECHNICIAN

You can hold down a full-time job and still train AT HOME by the same successful methods I used to help hundreds of men—many with no more than grammar school training—master television!

## NO EXPERIENCE NEEDED... I'LL TRAIN YOU AT HOME IN YOUR SPARE TIME

# VETERANS!

My school fully approved to train Veterans under new Korean G.I. Bill. Don't lose your school benefits by waiting too long. Write discharge date on coupon.



As part of your training I give you the equipment you need to set up your own home laboratory and prepare for a BETTER-PAY TV JOB. You build and keep an Electromagnetic TV RECEIVER designed and engineered to take any size picture tube up to 21-inch, (10-inch tube furnished. Slight extra cost for larger sizes.)... also a Super-Het Radio Receiver, AF-RF Signal Generator, Combination Voltmeter-Ammeter-Ohmmeter, C-W Telephone Transmitter, Public Address System, AC-DC Power supply. Everything supplied, including all tubes.

**GOOD SPARE TIME EARNINGS**

Almost from the very start you can earn extra money while learning by repairing radio-TV sets for friends and neighbors. Many of my students earn up to \$25 a week... pay for their entire training from spare time earnings... start their own profitable service business.

**EXPERT FM-TV TECHNICIAN TRAINING**

My FM-TV Technician Course can save you months of training if you have previous Armed Forces or civilian radio experience! Train at home with kits of parts, plus equipment to build BIG SCREEN TV RECEIVER. ALL FURNISHED AT NO EXTRA COST!

**NEW! PRACTICAL TV CAMERAMAN & STUDIO COURSE**

(For men with previous radio & TV training)  
I train you at home for an exciting big pay job as the man behind the TV camera. Work with TV stars in the TV studios or "on location" at remote pick-ups! Available if you want it... one-week course of practical work on TV studio equipment at Pierce School of Radio & TV, our associate resident school in New York City.

**OPTIONAL: 2 WEEKS TRAINING IN NEW YORK CITY AT NO EXTRA COST**

You get two weeks, 50 hours, of intensive laboratory work on modern electronic equipment at our associate school in New York City — Pierce School of Radio and Television. And I give you this AT NO EXTRA COST whatsoever, after you finish your home study training in the Radio-FM-TV Technician Course and FM-TV Technician Course. However, your home study course is complete even without this two-week laboratory session. It is only one of the many Extras available to you from RTTA if you want it.

## FREE FCC COACHING COURSE

Qualifies you for Higher Pay! Given to all my students AT NO EXTRA COST after TV Theory and Practice is completed. Helps you qualify for the TOP JOBS in Radio-TV that demand an FCC License! Full training and preparation at home for your FCC License.

## MY 4 FREE AIDS SHOW YOU HOW AND WHERE TO GET A BETTER PAY JOB IN TELEVISION.

See for yourself how my simple, practical methods can make success as easy for you as they have for my hundreds of graduates.

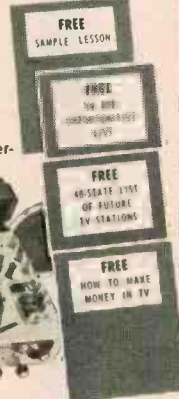

## MAIL THIS COUPON TODAY!

Mr. Leonard C. Lane, President  
RADIO-TELEVISION TRAINING ASSOCIATION R-7C  
52 East 19th Street, New York 3, N. Y.

Dear Mr. Lane: Send me your NEW FREE BOOK, FREE SAMPLE LESSON, and FREE aids that will show me how I can make TOP MONEY IN TELEVISION. I understand I am under no obligation.

(PLEASE PRINT PLAINLY)

Name \_\_\_\_\_ Age \_\_\_\_\_

Address \_\_\_\_\_

City \_\_\_\_\_ Zone \_\_\_\_\_ State \_\_\_\_\_

I AM INTERESTED IN:

Radio-FM-TV Technician Course

FM-TV Technician Course

TV Cameraman & Studio Technician Course

**VETERANS!**  
Write discharge date

**Radio Television Training Association**

52 EAST 19th STREET • NEW YORK 3, N. Y.

Licensed by the State of New York • Approved for Veteran Training

# Transistorized telephone summons you with a musical tone



Above: Experimental model resembles regular "500" set; the only visible departure is a louver in the base through which the musical tone is radiated.

Bell scientists have developed a new musical tone device which may some day replace the telephone bell, if it meets technical standards and customers' approvals.

Because the musical tone equipment uses transistors, the tones will be transmitted with the same amount of power required to transmit a telephone conversation — considerably less than is needed to make a telephone bell ring.

The experimental telephone sets resemble the current "500" sets; the only external difference is a louver at the side of the base through which the tone is radiated by a small loudspeaker mounted inside the telephone's base.

Tests have shown that the musical tone can be heard at great distances. It stands out above general room noise and can be distinguished from such sounds as ringing of doorbells, alarm clocks, and home fire alarms.

This new low-power signaling technique is expected to play an important part in the electronic switching system now under development at Bell Laboratories.

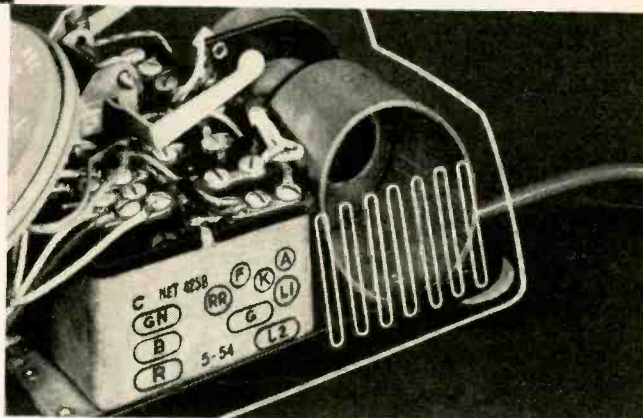

Above: Bell ringer has been displaced by a small loudspeaker in transistorized telephone. Left: L. A. Meacham heads the team of engineers that developed the musical tone ringer. Mr. Meacham holds a B.S. in Electrical Engineering from the University of Washington, Class of '29. He became affiliated with Bell Labs a year after his graduation. In 1939 Mr. Meacham won the "Outstanding Young Electrical Engineer" award of Eta Kappa Nu.



**BELL TELEPHONE LABORATORIES**

*World center of communications research and development*



**NEW! COLOR and Black-&White  
LAB & TV 5" OSCILLOSCOPE #460  
KIT \$79.95. Wired \$129.50**



The **FINEST** professional 5 mc wide-band scope value. Ideal for research, h-f & complex waves, plus Color & Monochrome TV servicing. Flat DC to 3.58 mc  $\pm 1$  db (color burst freq.), flat DC to 4.5 mc +1, -3 db. Vert. sens. 25 rms mv/in. Vert. Z 3 megs. Has the following outstanding features not found in scopes up to several times its price, kit or wired:

**VERTICAL AMPLIFIER:** direct-coupled (DC) thruout to eliminate l-f phase shift; push-pull thruout for negligible distortion; K-follower coupling between push-pull pentode stages for extended h-f resp. (minimizes h-f phase shift, extends useful resp. to 10 mc); full-screen undistorted vert. defl; 4-step freq-compensated decade step attenuator up to 1000:1. **SWEEP CIRCUIT:** perfectly linear sweeps, 10 cps - 100 kc (ext. cap. for down to 1 cps); pre-set TV vert. & hor. positions (30 & 7875 cps); automatic sync. ampl. & limiter eliminates sync amplitude adj. **PLUS:** direct or cap. coupling; bal. or unbal. inputs; edge-lit engraved lucite graph screen; dimmer; anti-glare filter; bezel fits std photo equip. **OTHER IMPORTANT FEATURES:** High intensity trace CRT. Finest sq. wave resp. (.06 usec rise time). Push-pull hor. ampl., flat to 400 kc, sens. 0.6 rms mv/in. Built-in voltage calibration. Intensity mod. Sawtooth & 60 cps outputs. Astigmatism control. Retrace blanking. Instant, drift-free full-screen vert. positioning & 2X full-screen hor. positioning. Bal., cal., astig. adj. externally accessible. 5UP1 CRT, 2-6AU8, 2-6CB6, 1-12AU7A, 2-6J6, 1-6AX5, 1-1V2. Deep-etched satin aluminum panel, rugged grey wrinkle steel cabinet. Designed for easy building at home with no special equipment. 13" x 8 1/2" x 16". 30 lbs.

**SCOPE DIRECT PROBE\* #PD:** KIT \$2.75. Wired \$3.95. Eliminates stray-pick-up & signal re-radiation.

**SCOPE DEMODULATOR PROBE\* #PSD:** KIT \$3.75. Wired \$5.75. Demodulates AM carriers between 150 kc and 250 mc.

**SCOPE LOW CAPACITY PROBE\* #PLC:** KIT \$3.75. Wired \$5.75. For signal tracing in high frequency, high impedance & wide-band circuits (as in TV) without distortion from overloading or frequency discrimination.

for **COLOR** and Monochrome TV servicing

**New! PEAK-to-PEAK VTVM #232  
& UNI-PROBE (pat. pend.)  
KIT \$29.95. Wired \$49.95**



**UNI-PROBE:** exclusive with EICO! Terrific time-saver! Only 1 probe performs all functions—a half-turn of probe-tip selects DC or AC-Ohms.

The new leader in professional peak-to-peak VTVMs. Latest circuitry, high sensitivity & precision, wide ranges & versatility. Calibration without removing from cabinet. New balanced bridge circuit. High Z input for negligible loading. 4 1/2" meter, can't-burn-out circuit. 7 non-skip ranges on every function. 4 functions: +DC Volts, -DC Volts, AC Volts, Ohms.

Uniform 3 to 1 scale ratio for extreme wide-range accuracy. Zero center. One zero-adj. for all functions & ranges. 1% precision ceramic multiplier resistors. Measure directly peak-to-peak voltage of complex & sine waves: 0-4, 14, 42, 140, 420, 1400, 4200. DC/RMS sine volts: 0-1.5, 5, 15, 50, 150, 500, 1500 (up to 30,000 v. with HVP probe, & 250 mc with PRF probe). Ohms: 0.2 ohms to 1000 megs. 12AU7, 6AL5, selenium rectifier; xfmr-operated. 8 1/2" x 5" x 5". Deep-etched satin aluminum panel, rugged grey wrinkle steel cabinet. 7 lbs.

**New! DELUXE PEAK-to-PEAK VTVM #249  
with 7 1/2" METER & UNI-PROBE (pat. pend.)  
KIT \$39.95. Wired \$59.95**

All the advanced & exclusive features of #232—PLUS the extra convenience and readability of its big 7 1/2" meter. Your ideal bench instrument.

**VTVM RF PROBES\* #PRF-11 or PRF-25:** KIT \$3.75. Wired \$4.95. Accuracy  $\pm 10\%$ . Use with any 11 or 25 megohm VTVM.

**VTVM HV PROBE #HVP-2:** Wired \$4.95. Complete with multiplier resistor. Measures up to 30 kv with any VTVM or 20,000 ohms/volt VOM.

† Calibration without removing from cabinet.

† Only EICO Probes have all these features: fully shielded; rugged terminal board parts; mounting; shock-mounted; floating construction; shielded; color-coding; easy parts accessibility.



150 kc to 435 mc  
with **ONE** generator!

**New! RF SIGNAL GENERATOR #324  
KIT \$26.95. Wired \$39.95**

for **COLOR** and Monochrome TV servicing

New wide-range, stable generator — better value than generators selling at 2 or 3 times its cost! Ideal for: IF-RF alignment, signal tracing & trouble-shooting of TV, FM & AM sets; marker gen.; 400 cps audio testing; lab. work. **6 fund. ranges:** 150-400 kc, 400-1200 kc, 1.2-3.5 mc, 3.5-11 mc, 11-37 mc, 37-145 mc; 1 harmonic band 111-435 mc. Freq. accurate to  $\pm 1.5\%$ ; 6:1 vernier tuning & excellent spread at most important alignment freqs. Etched tuning dial, plexiglass windows, edge-lit hairlines. Colpitts RF osc., directly plate-modulated by K-follower for improved mod. Variable depth of int. mod. 0-50% by 400 cps Colpitts osc. Variable gain ext. mod. amplifier; only 3.0 volts needed for 30% mod. Turret-mounted coils slug-tuned for max. accuracy. Fine & Coarse (3-step) RF attenuators. RF output 100,000 uv; AF sine wave output to 10 volts. 50-ohm output Z. 5-way jack-top binding posts for AF in/out; coaxial connector & shielded cable for RF out. Tubes: 12AU7, 12AV7, selenium rectifier; xfmr-operated. Deep-etched satin aluminum panel, rugged grey wrinkle steel cabinet. 8" x 10" x 4 3/4". 10 lbs.

The specs are the proof...

**4 NEW BEST BUYS  
by EICO**

**COMPLETE  
with Preamplifier, Equalizer and Control Section  
New! 20-WATT Ultra-Linear Williamson-  
type HIGH FIDELITY AMPLIFIER #HF20  
KIT \$49.95. Wired \$79.95**

A low-cost, complete-facility amplifier of the highest quality that sets a new standard of performance at the price, kit or wired. Every detail, down to the etched, brushed solid brass control plate, is of the fine quality EICO is famous for.

Rated power output: 20 watts (34 w peak). IM distortion (60 cps: 6 kc/4:1) at rated power: 1.3%. Mid-band harmonic distortion at rated power: 0.3%. Maximum harmonic distortion between 20 and 20,000 cps at 1 db under rated power: approx. 1%. Power response (20w):  $\pm 0.5$  db 20-20,000 cps;  $\pm 1.5$  db 10-40,000 cps. Frequency response (1/4 w):  $\pm 0.5$  db 13-35,000 cps;  $\pm 1.5$  db 7-50,000 cps.

5 feedback equalizations for LP's & 78's including RTAA. Variable turnover feedback tone controls do not affect volume & permit large boosts or cuts at either end of audio spectrum with mid-freqs. unaffected. Loudness control & separate level set control on front panel. Low Z output to tape recorder. 4 hi-level switched inputs: tuner, tv, tape, auxiliary (xtal/ceramic phono or 2nd tuner); 2 low-level inputs for proper loading with all leading magnetic, FM & quality stal cartridges. Hum bal. control. Extremely fine output transformer has interleaved windings, tight coupling, careful balancing & grain-oriented steel. 8 1/2" x 15" x 10". 24 lbs.

These amazing EICO values are **NOW IN STOCK** at your nearest distributor. Examine them side-by-side with ANY competitor. You'll see for yourself why indeed EICO is your **BEST BUY**. Fill out coupon on reverse page.



TURN PAGE FOR MORE EICO VALUES...

84 Withers Street, Brooklyn 11, New York

Prices 5% higher on West Coast.

**the specs are  
the test that tells  
who's best!**

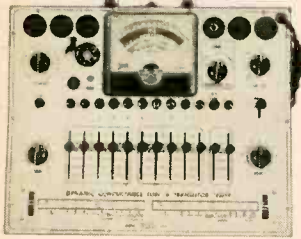

for COLOR & Monochrome  
TV servicing

**NEW! DYNAMIC  
CONDUCTANCE TUBE &  
TRANSISTOR TESTER #666  
KIT \$69.95 WIRED \$109.95**

Unexcelled testing thoroughness & accuracy. Checks transistor collector current & Beta using internal dc power supply. Tests all receiving tubes including subminiatures (& Color & Monochrome tv pic tubes with accessory adapter). Composite indication of mutual conductance, plate conductance, & peak emission. Simultaneous sel. of any 1 of 4 combinations of 3 plate, 3 screen, & 3 ranges of control grid voltage. Grid voltage variable over 3 ranges with 5% accurate pot. New series-string voltages for 600, 450 & 300 ma types. 5 ranges meter sens. with 1% precision shunts & 5% accurate pot. 10 SIX-position lever switches for free-point connection of every tube pin or cap. 10 pushbuttons for rapid insert of any tube element in leakage circuit & speedy sel. of individual tube sections. Direct reading of inter-element leakage in ohms. New gear-driven rollchart. Steel case with cover & handle. Sensitive 200  $\mu$ a meter.

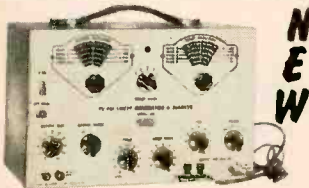

**NEW**

for COLOR & Monochrome  
TV servicing

**TV-FM SWEEP GENERATOR  
& MARKER #368  
KIT \$69.95 WIRED \$119.95**

The FINEST service instrument of this type ever offered in either kit or wired form at ANY price! Outstanding ease & accuracy in FM & TV (including Color) alignment. Entirely electronic sweep circuit with accurately biased Incredutor: superb linearity on both sides of selected center freq. Newly-designed AGC circuit automatically adjusts osc. for max. output on each band with min. amplitude variations. Sweep gen. range 3-216 mc in 5 OVERLAPPING FUND. BANDS. Sweep width continuously variable from 0-3 mc lowest max. deviation to 0-30 mc highest max. deviation. Variable marker gen. range from 5-75 mc in 2 FUND. BANDS plus a calibrated harmonic band (54-225 mc). Variable marker calibrated with int. xtal marker gen. 4.5 mc xtal included. Ext. marker provision. Double pi line filter. Edge-lit hairlines eliminate parallax.

Turn page for other EICO ad



**FREE 1956  
EICO CATALOG!**

Tells you how to SAVE 50% on  
your test equipment costs!



**TUBE TESTER  
#625  
KIT \$34.95  
Wired \$49.95**  
• tests 600  
mil series  
string type  
tubes  
• illuminated  
roll-chart

Pix Tube Test Adapter .....\$4.50

**New! GEIGER COUNTER #803  
KIT \$19.95** Wired \$29.95



(less  
batteries)  
Professional, all-electronic, sensitive,  
rugged—at lowest cost! Indicates by  
neon lamp & headphone clicks.

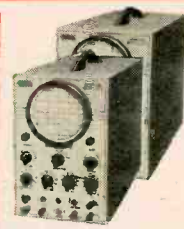

**5" PUSH-PULL  
OSCILLOSCOPE  
#425  
KIT \$44.95  
Wired \$79.95**  
**7" PUSH-PULL  
OSCILLOSCOPE  
#470  
KIT \$79.95  
Wired \$129.50**



**VACUUM TUBE  
VOLTMETER #221  
KIT \$25.95  
Wired \$39.95**  
**DELUXE VTVM  
#214 (7 1/2" METER)  
KIT \$34.95  
Wired \$54.95**



**RF SIGNAL  
GENERATOR  
#320  
KIT \$19.95  
Wired \$29.95**  
150 kc-34 mc,  
calibrated har-  
monics to 102  
mc. Pure or  
mod. RF, &  
Colpitts osc.  
400 cps sine  
outputs.



**NEW!  
UTILITY TESTER  
#540  
KIT \$12.95  
Wired \$15.95**

Multi-range ac/dc  
voltmeter, amme-  
ter, ohmmeter,  
wattmeter, leak-  
age checker for  
home & auto re-  
pairs.



**#944 FLYBACK  
TRANSFORMER &  
YOKE TESTER  
KIT \$23.95  
Wired \$34.95**  
• fast check all  
flybacks & yokes  
in or out of set.  
• spots even 1  
shorted turn!

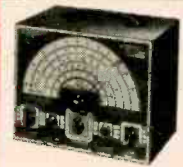

**TV/FM SWEEP GENERATOR #360  
5MC-4.5MC CRYSTAL .....\$3.95 ea.**

Range 500 kc-  
228 mc on fund.  
Cont. sweep  
width control,  
0-30 mc.

**KIT \$34.95  
Wired \$49.95**



1% accuracy on  
all 7 ranges.  
Range 75 kc-  
150 mc.  
Volt reg.

**KIT \$39.95  
Wired \$59.95**

**DELUXE RF SIGNAL GENERATOR #315**



Sep. volt-  
meter &  
ammeter

**KIT  
\$29.95  
Wired  
\$38.95**

**6V & 12V BATTERY ELIMINATOR &  
CHARGER #1050**



**DELUXE MULTI-SIGNAL TRACER #147**

Sep. hi-gain RF  
& lo-gain audio  
inputs.  
Special noise  
locator. Calibra-  
ted wattmeter.

**KIT \$24.95  
Wired \$39.95**



Reads 0.5 ohms  
-500 megohms, 10  
mmfd-5000 mfd  
power factor.

**KIT  
\$19.95  
Wired  
\$29.95**

**R-C BRIDGE & R-C-L COMPARATOR  
#950B**



**HI-FI PREAMPLIFIER #HF-6  
KIT \$24.95. Wired \$37.95. With Power  
Supply: KIT \$29.95. Wired \$44.95**  
Feedback circuitry thruout! Preamp-  
equalizer, tone controls, scratch &  
rumble filters. K-follower output.

**NEW!**



**20,000 Ohms/Volt  
MULTIMETER #565  
KIT \$24.95  
Wired \$29.95**

**1000 Ohms/Volt  
MULTIMETER  
# 536  
KIT \$12.90  
Wired \$14.90**



**VTVM PROBES** KIT Wired  
Peak-to-Peak .....\$4.95 \$6.95  
RF .....\$3.75 \$4.95  
High Voltage Probe-1 .....\$6.95  
High Voltage Probe-2 .....\$4.95

**SCOPE PROBES**  
Demodulator .....\$3.75 \$5.75  
Direct .....\$2.75 \$3.95  
Low Capacity .....\$3.75 \$5.75

For FREE 1956 catalog, mail coupon NOW!



84 Withers St. • Brooklyn 11, N. Y.

Prices 5% higher on West coast ©56  
and subject to change without notice.

EICO, 84 Withers Street  
Brooklyn 11, New York

G-7

Send FREE 1956 Catalog and name of neighborhood  
EICO jobber.

Name.....

Home Address.....

City.....Zone.....State.....

Occupation.....

1945 to 1955: a decade of Know-How & Value Leadership in Kits & Instruments—over 1/2 million sold to date!

## NIKOLA TESLA'S 100th BIRTHDAY

... *The Father of Wireless Ushered in the Radio Age* ...

**O**N July 9, 1856, at midnight, there was born at Smiljan, Croatia (now Yugoslavia), Nikola Tesla, one of the greatest, if not the greatest inventor in history.

He died on Jan. 7, 1943, at the age of 87. He was not only an inventor of note, but a scientist who discovered a number of important new principles as well. He is credited with over 1,000 inventions, 900 of which he patented! It is possible in this space to list only the more outstanding ones.

He was the first to conceive a practical method of utilizing alternating current, now used universally all over the world. In 1888 he patented the induction motor, using neither commutator nor brushes. He discovered and demonstrated the principle of the rotary magnetic field, when he transmitted electrical power from Niagara Falls to run the street cars in Syracuse, 160 miles away.

In his eulogy of Tesla's genius, another outstanding inventor, the late Maj. Edwin H. Armstrong, inventor of the modern superheterodyne and our present system of frequency-modulation broadcasting, wrote these lines in the February, 1943, issue of this magazine: "In Tesla's book published in 1904, titled *Experiments With Alternating Current of High Potential and High Frequency*, there is a remarkable chapter headed 'The Transmission of Electric Energy Without Wires.' Concealed perhaps by its too prophetic style (although a surprising number of the prophecies have come true), there is a complete appreciation of the use of radio in the broadcasting of information, with full emphasis on its social implications."

It was Tesla indeed who antedated Marconi. Said Maj. Gen. T. O. Mauborgne, former head of the Signal Corps, Chief Signal Officer of the U. S. Army, in the February, 1943, issue of this magazine: "Tesla 'the wizard' . . . captured the imagination of my generation with his flights of fancy into the unknown realms of space and electricity . . . [saw] with astounding vision far beyond his contemporaries, very few of whom realized until many years after the work of Marconi that the great Tesla was the first to work out not only the principles of electric tuning or resonance, but actually designed a system of wireless transmission of intelligence in the year 1893."

It was Tesla, too, to whom full credit goes for the invention of the aerial in both transmission and reception of wireless intelligence. The documentation is complete in picture and in word, in the lecture which Tesla delivered before the Franklin Institute and Electric Light Association in February and March, 1893. Here we see the first modern radio diagram, at the left the transmitter with its electrical alternator. It is coupled to a "primary" and "high-potential adjustable resonant secondary circuit." The latter is grounded at one end, the other goes to an "elevated capacity." At the right we have a "resonant adjustable receiving circuit." Its inductance is grounded on one side, the other goes to an "elevated capacity." This circuit,\* now 63 years old, is identical with all fundamental radio and television circuits today, thanks to the genius of Tesla.

But his giant intellect went much further. It was he also who was the first to transmit wireless power—not just sig-

nals, over a distance. This he did in his historic experiments in Colorado in the early 1890's, which caused a world-wide furor. In 1890 he also built a huge Tesla oscillator, which produced 12 million volts at a frequency of 100,000 alternations per second. The primary used over 300 kilowatts. Lightning in huge sparks thrown as far as 22 feet, created such powerful electrical disturbances in the surrounding earth that 1-inch sparks could be drawn from grounded metal parts 300 feet distant. A little later, Tesla was able to obtain lightninglike discharges over 100 feet long. This thus made him the first inventor of artificially created lightning. Then, in 1898, Tesla at Colorado Springs actually succeeded in lighting electrical lamps at a distance of over half a mile, *without any intervening wires*. These were his epoch-making electric high-frequency demonstrations in which most of the wireless energy was transmitted through the earth.

It was Tesla, too, who invented a great variety of filamentless lamps which operated over short distances without a wire connection, merely by being placed in a high-frequency electrical field. They were the first wireless lamps in existence.

The electrical student perhaps is best acquainted with that fascinating instrument, the Tesla coil. This was one of his earliest demonstrations of high-frequency currents. Here a special induction coil coupled with capacitors and special transformers steps up the voltage till it runs into the millions. Nevertheless, such currents are relatively harmless and do not hurt or kill as, due to their "skin effect," they travel over the outside of the body. Hundreds of astonishing and beautiful experiments can be performed with a simple Tesla coil.

In this age of guided missiles, we should never forget that again Tesla was first when he invented his radio-controlled ship in 1898—note particularly this date. Not only did he invent it, but he constructed large-scale operating models. The radio-controlled vessel was really a submarine which could take the form of a guided torpedo for war purposes or of other mobile bodies, all steered and controlled by wireless. It was probably the earliest telemechanical radio-controlled model in existence. The U. S. patent was No. 613,809, granted in 1898.

The model, demonstrated in New York, worked surprisingly well when you consider that Tesla used a special coherer and decoherer at the receiving end.\*

The present writer, who knew Tesla intimately for many years, induced him to write his autobiography for the *Electrical Experimenter*, a magazine published by the author of this article. It can be found in the following issues: February, March, April, May, June and October, 1919.

Said the *New York Times* editorially on the day after his death: "Tesla belongs to the passing age of heroic invention of which Edison was the most distinguished exemplar . . . If that abused word 'genius' ever was applicable to any man, it was to him."

It may indeed be centuries before the world will see again such a prolific inventor of the towering stature of Nikola Tesla. —HG

\* The diagrams will be found in the authoritative and historical work by T. C. Martin, published in 1894 and entitled *Inventions, Researches and Writings of Nikola Tesla*.

See also article "The True Wireless," written by Nikola Tesla and published by Hugo Gernsback in the *Electrical Experimenter*, May, 1919.

\* See full account with photographs of the models, diagrams and technical details in the *Electrical Experimenter*, June, 1916.

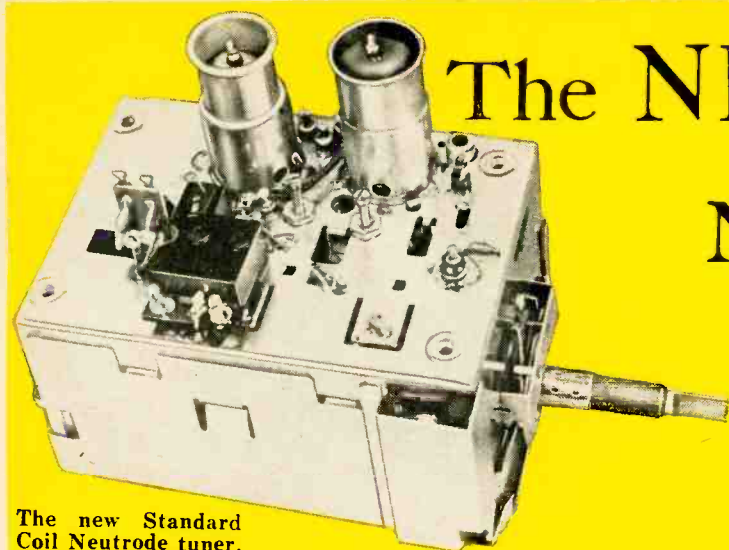

The new Standard Coil Neutrode tuner.

# The NEUTRODE... NEW VHF-UHF TV TUNER

By E. D. LUCAS, JR.

**P**ROBABLY no new television tuner design in recent years has created such widespread interest in the industry as the Neutrode, an ingenious front end (see photo) featuring a neutralized-triode circuit and several other advances.

The Neutrode represents a radical departure from previous cascode and pentode circuitry. It uses two new vacuum tubes developed especially for this tuner, a printed circuit for a major part of the chassis, an unusually simple and effective single-conversion uhf circuit (optional) and many other improvements to be discussed. Field tests indicate substantial performance gains on both vhf and uhf bands.

What has made the gleam in the eyes of TV set manufacturers even brighter is the fact that the Neutrode not only works better—it costs less, because of a number of factors, foremost being the basic simplicity of the neutralized-triode circuit and production efficiency achieved by a blending of printed and conventional circuit elements.

## Advantages of Neutrode design

Field tests in fringe, moderate and strong signal areas indicate that the Neutrode is more consistent in gain and noise figures than previous tuners. Typical levels are over 32-db gain and less than 7-db noise for channels 2 through 6; over 28-db gain and less than 8-db noise, channels 7 through 13. Results using conversion strips for channels in the uhf band show sensitivity and noise figures equal or superior to previous much more complex continuous tuners.

The Neutrode design appears to be less susceptible to overload because of positive age action on the triode amplifier. It has also been found to be less affected by ignition noise and many other sources of electrical interference, thanks to improved filter circuits and shielding.

The printed-circuit board, shown bare in Fig. 1 and with components in Fig. 2, permits considerable automation in Standard Coil's production operations

and has resulted in far more consistently good wiring and better performance. From the standpoint of the service technician, the board, illustrated in position in the tuner (with drum removed) in Fig. 3, is a real timesaver since it makes troubles easier to locate and correct.

Another important advantage, both to the technician responsible for servicing the set and to the owner, is the much longer tube life made possible by the neutralized-triode circuit. This single triode has less than half the dissipation of a dual-triode cascode, and thus will keep operating far longer.

Two new tubes are making their debut in the Neutrode, having been developed specifically to meet the requirements of this novel tuner. The triode amplifier is available in two versions, the 6BN4 for receivers with a 6.3-volt heater supply and the 2BN4 for series-heater models. Similarly the new pentode-triode used as the mixer-oscillator stage is available as the 6CG8 for parallel 6.3-volt heater circuits and the 5CG8 for series-heater designs.

A desirable feature of the Neutrode's circuitry is that it is designed to operate on a relatively low B-plus voltage, as low as 125 volts. This is another aid to the longer life of many components. Also, this tuner is particularly adaptable for use with series-heater receivers not using voltage doublers.

Oscillator circuitry of the Neutrode has been modified for improved drift characteristics. In addition, several design factors help keep oscillator radiation well within FCC limits.

The fine-tuning control is "equalized" providing a fine tuning range of from 2 to 4.5 mc on all channels. Physically, this fine-tuning circuit includes a stator area printed on the right-hand end of the board (Figs. 1 and 2) and a hinged tin-dipped phosphor-bronze plate which combine to form a "book" tuner having essentially equal tuning range on low- and high-band vhf channels.

An advantage from the TV set manufacturer's viewpoint is that simple age systems can be used with the neutral-

ized-triode circuit. The Neutrode design provides improved tilt with bias and better vswr as compared with earlier cascode tuners.

The Neutrode also permits the use of new uhf strips which may be inserted on the tuner drum in place of unused vhf antenna-oscillator coil boards, as has been common practice with previous tuners. However, uhf performance of the Neutrode has been notably improved in two ways: by a separate antenna input for uhf using an accessory bracket, shown in Fig. 4 and visible in the top-view photo, and by an improved uhf circuit on the replaceable strips.

## Circuit details

Let's look first at the operation of the tuner (Fig. 5) when receiving vhf signals. The antenna lead is connected to the terminals of T1, a ferrite-core balun or matching transformer which matches the 300-ohm impedance of the balanced-input antenna lead-in to the unbalanced 75-ohm input of the tuner. This ferrite balun, provides exceptionally good 300-to-75-ohm transformer characteristics over the entire vhf range from 54 to 216 mc.

The input signal then feeds into a pair of if traps—C1 and L1 a parallel trap, C3 and L2 in series. These traps are stagger-tuned to obtain the optimum if rejection over the range from 41 to 46 mc, the Neutrode tuner being designed only for receivers having if within that range.

Between the two traps is feedthrough capacitor C2 (30  $\mu\text{mf}$ ) which is used as low-side capacitive coupling for the pi input circuit. Service technicians, please note: a feedthrough capacitor must be used here—and replaced here, when necessary—to match capacitance correctly over the entire vhf range. A similar caution applies to the other feedthrough capacitors indicated on this schematic: C5, C7, C9 and C12.

The small coupling capacitor C4, while not a part of the pi network, is inserted to minimize oscillator radiation which might feed back to the antenna lead. Because of the capacitance

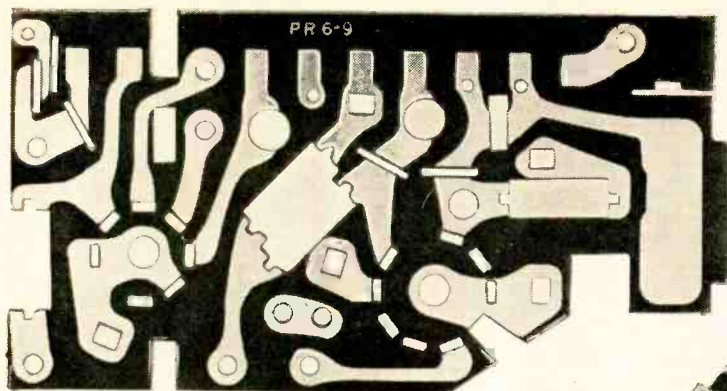

Fig. 1, left—Printed-circuit board contains tube sockets and stator of "book" tuner.

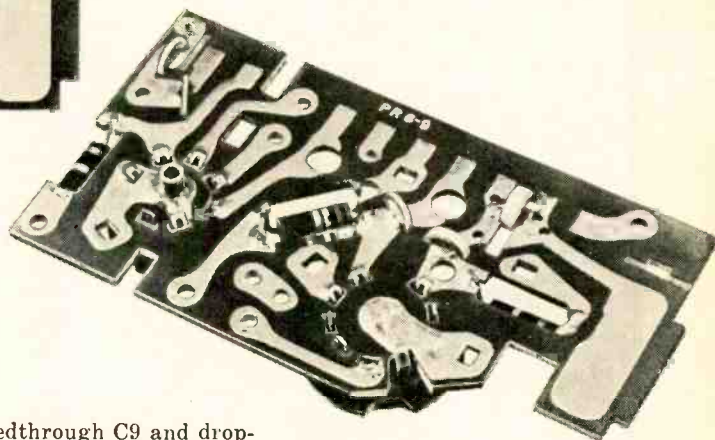

Fig. 2, below—Printed-circuit board of tuner shown with components mounted on it.

provided by C5 it is possible to use an antenna coil (L3) having more turns than previous designs of antenna coils and thus to offer a higher impedance to oscillator radiation.

From antenna coil L3 the input signal is fed to the grid of the triode 6BN4 (or 2BN4); age bias voltage is applied to the same grid through C5 and R1.

Now we come to some of the important features of the neutralized-triode circuit. For one thing, as an aid to neutralizing the tube's internal capacitances over the entire vhf band, there are two cathode leads to ground to minimize the impedance between the cathode and ground of this grounded-cathode amplifier.

The triode's plate has a return lead to the grid through capacitor C7. This plate return capacitor must be a feedthrough, not a regular disc or tubular capacitor, because the action of C7 is to obtain a 180° phase shift of the plate signal. That is, on the lower or grid side of feedthrough capacitor C7—the side nearest variable capacitor C6—the signal from the plate is shifted 180°.

Our objective is to neutralize the triode's plate-to-grid capacitance. Capacitor C7 provides us with a return signal to the grid correctly shifted in phase. By varying C6, we can control the amplitude of the plate return signal arriving at the grid. Thus we can achieve neutralization by using the combination of C7 and C6 to deliver a signal back to the grid which is equal in amplitude and 180° opposite in phase to the plate-to-grid signal voltage, or leakage through the plate-to-grid capacitance.

A further aid in the action of this neutralizing circuit is the use of two grid leads (pins 2 and 7 of the triode) to minimize the inductance of the neutralizing input circuit to the grid. Variable capacitor C6 is adjusted for best performance at the factory.

Without this neutralizing circuit, the triode amplifier has much lower gain and could not be used successfully as the first stage of a high-performance tuner. With the neutralization, the tuner has excellent gain and signal-to-noise ratio over the entire vhf band.

The schematic shows 125 volts sup-

plied through feedthrough C9 and dropping resistor R2 to the triode plate.

The signal amplified by the neutralized triode is fed from plate circuit L4-C8 to the mutually coupled circuit L5-C10 and then through coupling capacitor C11 to the control grid (pin 9) of the pentode mixer section of the 6CG8 (or 5CG8). The coupling of coils L4 and L5 and the values of C8 and C10 are factory-adjusted for the desired bandpass characteristics. A test point for rf response is provided at feedthrough C12, with the signal taken off between R3 and R4 in the mixer grid circuit.

There are two cathode leads for the pentode (as with the 6BN4) to minimize the impedance between the cathode and ground. Another feature of the mixer circuit is the use of a screen peaking coil (L8) to raise the impedance of the pentode input grid over the high-band vhf range (174-216 mc). Dropping resistor R6 feeds B plus to the oscillator.

The local oscillator circuit of the Neutrode tuner is a conventional Colpitts arrangement with "book" fine tuning. The fine-tuning stator area in the plate circuit, shown as a heavy line on the schematic, is printed on the board. A hinged tin-dipped phosphor-bronze plate is separated by insulating tape from this printed loop, and as the fine-tuner cam turns it brings the "book cover" or bronze plate closer to the stator or farther away from it, as desired. The movement of the plate relative to the stator provides capacitive tuning over the vhf band.

The oscillator circuit includes the conventional slug-tuned oscillator coil L6, adjustable through the front of the tuner, and temperature-compensated capacitors C13 and C14 which have been carefully selected to minimize drift.

First if coil L7, through which the tuner's output (from the plate, pin 6, of the mixer) feeds into the first if amplifier stage of the TV receiver, is

slug-tuned and is adjusted by the set manufacturer.

A 6CB6 if stage (Fig. 6) is used by Standard Coil to check overall tuner performance. The output of the Neutrode tuner, through L7, feeds into the grid of the 6CB6.

#### Simple, improved uhf circuit

For optimum uhf reception with the Neutrode tuner, considering that this new front end was designed for better performance at lower price, the engineers came up with several notable improvements over previous designs.

There have been two basic approaches to vhf-uhf tuners. One is to substitute a uhf strip on the tuner drum in place of an unused vhf channel's antenna and oscillator coil boards. This technique, while satisfactory in many cases, has often proved to be a compromise solution—inexpensive but not providing high-quality reception. The second alternative has been continuous tuners with special uhf circuitry, in addition to cascade vhf, giving good results but in a rather large and costly package.

In the Neutrode tuner performance comparable to the best continuous tuners is achieved in uhf reception while using the technique of inserting individual uhf strips or boards for the desired channels.

An important addition has been made. Space is provided for inserting a new auxiliary bracket which slips into a hole on top of the tuner and is fastened by one mounting screw. As indicated in Fig. 7, the block diagram of the circuitry for uhf operation of the Neutrode tuner, this auxiliary bracket acts as a preselector for the uhf signal and includes circuitry to perform four functions:

1. Provides a direct antenna input for the signal from a uhf antenna. Thus, there is no necessity for

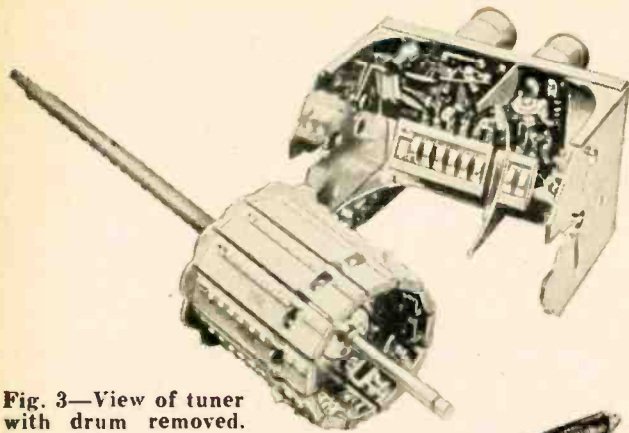

Fig. 3—View of tuner with drum removed.

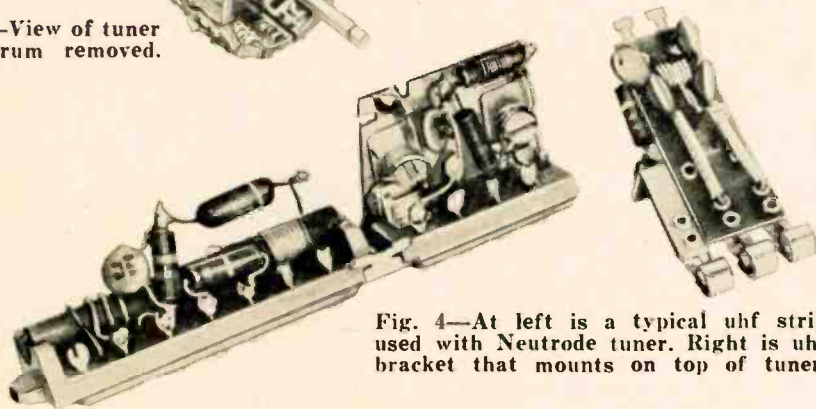

Fig. 4—At left is a typical uhf strip used with Neutrode tuner. Right is uhf bracket that mounts on top of tuner.

compromising between vhf and uhf performance.

2. Includes a high-pass filter which cuts off at 400 mc to minimize interference from vhf stations, aircraft, police and other sources of electrical noise below 400 mc.
3. Provides isolation for the antenna from dc and hence permits use of ac-dc hot-chassis receivers.
4. Has wiper arms which contact only the uhf strips inserted in the tuner drum, since these strips extend farther out than the vhf coil boards.

Examining Fig. 7, the uhf signal goes through the preselector and high-pass

filter on the bracket to a germanium mixer on the uhf strip. Into this mixer is also fed a local oscillator signal obtained in an ingenious way. The regular vhf oscillator (triode section of 6CG8) is used, with the oscillator coil on the vhf strip designed in such a way that the oscillator frequency is a submultiple of the desired uhf oscillator frequency. For example, suppose we want an oscillator frequency of 600 mc to inject into the uhf germanium mixer. Then the oscillator coil on the uhf strip—which is part of the 6CG8 triode circuit—is so designed that the oscillator frequency is 200 mc. The 200-mc signal is then fed into a crystal harmonic

generator (located on the uhf strip) which feeds harmonics of 200 mc into the harmonic selector. The harmonic selector automatically selects the third harmonic of 200 mc and injects a 600-mc signal into the germanium mixer.

The output of the germanium mixer provides us with the desired 41-mc if signal by this single, rather simple conversion. Of course, the exact if desired is specified by the TV receiver manufacturer. This system for uhf conversion is not only simpler and less expensive than previous double-conversion techniques, it also delivers a better signal. By using the vhf oscillator and multiplying its frequency to get a uhf oscillator, improved stability and less drift are achieved.

The 41-mc signal from the germanium mixer is amplified by the 6BN4 neutralized triode, being fed directly into the grid (pin 2). It is then further amplified by the pentode mixer section of the 6CG8 in the Neutrode tuner. The overall result is uhf sensitivity and low noise figures comparable to, and in most cases better than, previous vhf-uhf continuous tuners and far superior to earlier uhf strip designs.

I wish to acknowledge, as the source of technical information for this article, Mr. Robert C. A. Eland, director of research and development of television products, Standard Coil Products, who is responsible for the design of the new Neutrode tuner. Photographs were by James Brown, research engineer for the company END

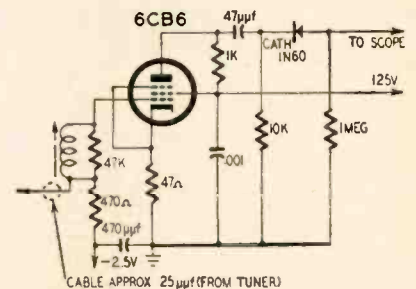

Fig. 6—An if stage for testing tuner.

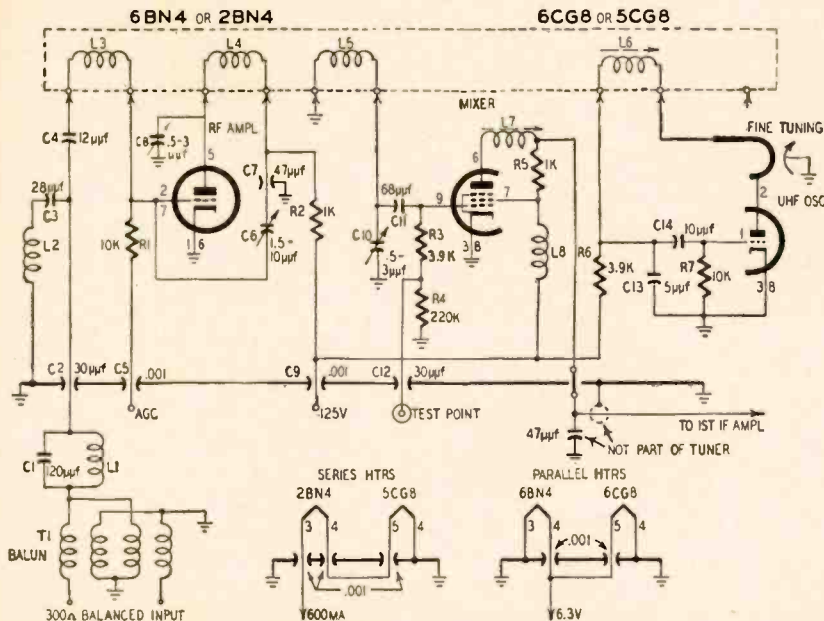

Fig. 5—Schematic diagram of the Neutrode tuner showing manufacturer's coding.

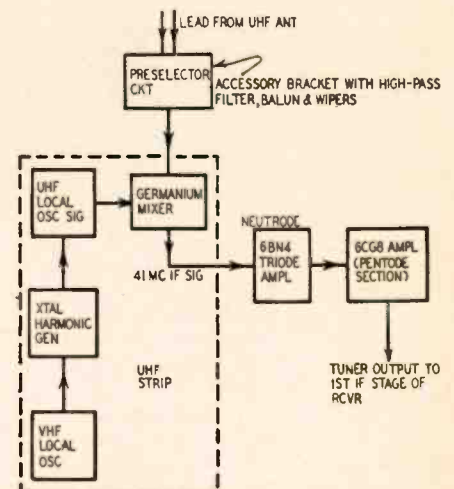

Fig. 7—Block diagram of the uhf circuitry used in the Neutrode tuner.

# UNIVERSAL TV SERVICE KIT

By H. A. HIGHSTONE

**A** FINE way to start one of those well-known days "when you should have stood in bed" is suddenly to discover the tube you need is back in the shop—but you are in a customer's living room, 4 miles and 10 traffic lights removed. The universal service kit (see photo) started out purely as a means of ending this type of snafu. Eventually it developed into a time-saving device which easily repaid its cost (less than \$10) in very short order. For one-man TV shops which take on any and all comers—on the bench or in the home—the kit is about as valuable as transportation.

It is built in a 14 x 24-inch suitcase of the imitation airplane-luggage type. Unbelievably, it safely carries the following list of items, any or all of which are instantly accessible. *Instantly* is the word, too.

- 84 assorted tubes
- Triplet *Load-Chek*
- 7- and 9-pin straighteners
- 7- and 9-pin pullers
- 20 boxes of assorted fuses
- Metal box with hinged top for tools
- Cheater cord
- Battery-powered inspection light and mirror

Gooseneck desk lamp (clipped to outside of case)

Each of the 84 tubes is plugged into either a 7-, 8- or 9-pin socket as required. Sockets are mounted on pieces of 1/4-inch plywood attached to the suitcase by machine screws and nuts. A typewritten identification tag is glued to the plywood opposite each tube socket. A similar tag is Scotch-taped to each tube, stating type number and price. These tags end the squinting so often connected with double-checking type numbers. They also eliminate any unhappy mixups between stock and customer's tubes.

The metal box permanently bolted to the suitcase carries tools such as screwdrivers, pliers and wrenches. The cover of the box serves as a mounting for both pin straighteners and pullers, the pullers being attached by 1-inch-wide strips of black elastic. Fuses and cheater cord fit into a gap left between the *Load-Chek* and tool box. A small prayer rug does double duty as wadding to hold fuses, *Load-Chek*, etc., firmly in place.

The 75 tube types I carry in my service kit (a certain number are duplicated for obvious reasons) meet almost every demand in my area. A smaller stock of more uncommon tubes is kept in a separate container in my car.

Compared to my kit, the conventional tube caddy is as outmoded as an oxcart, merely from the standpoint of inventory alone. The entire tube stock can be checked by raising the lid of the kit and

filling empty tube sockets, if any. This is lots quicker than tediously checking paper cartons, one by one, against an inventory sheet.

Moreover, the possibility of forgetting cheater cord, tools, fuses, tube pullers and the like is reduced almost to zero. Each has its appointed place in the kit; with a little practice, every item can be checked at a glance.

"Front" is an important item in a business as ticklish and touchy as one-man-shop TV servicing. The kit scores heavily here. For instance, 84 tubes lined up in neat, glittering rows induce a far more satisfactory customer reaction than does the familiar hodgepodge of dog-eared paper cartons in the ordinary caddy. Similarly, when the service technician no longer fumbles through this untidy array of cartons for some tube he needs and instead plucks it from a socket in a matter of seconds—when he ceases to hunt through pockets or an auxiliary toolbox for hand tools, pullers, etc., and is instead able to select instantly what he needs from an obviously well-organized tool kit—he cannot help but bolster customer confidence, a most important item. And almost too obvious to mention is the fact that the technician who makes things easy for himself automatically increases his efficiency and his earnings.

I went through quite a few sessions of blundering around in dark corners behind ailing TV sets with a flashlight before I finally hit upon the sensible idea of carrying a desk lamp with me. Mine is the flexible gooseneck type, attached to the outside of my kit by king-sized battery clips. Bringing the lamp along promptly created outlet trouble (with TV set plugged into one part of a wall receptacle and my lamp into the other half, where do we heat up the tube tester, please?). I got around this one by making myself a "double-duplex" receptacle (four plug receptacles in all) attached to a 10-foot extension cord.

The desk lamp and double-duplex extension outfit not only have enough utility value to repay their cost quickly but, also like the kit itself, can add much to the one-man operator's precious "front." And I must say at this point that the service technician who doesn't know what "front" means or is dubious of its value is never going to get to first base until and if he undergoes a change of mind. Many and many a clever lad has been starved out of radio repairing because he didn't keep his shoes shined and his car polished or showed up too often on the job needing a shave. TV servicing is no different; in fact, the demands are even more exacting. You can take



that or leave it from an old fossil who was repairing radios when the Radiola III-A was absolutely the latest word, back in 1923.

The *Load-Chek* (it's an indicating wattmeter, if you didn't know) is much more than window dressing, although it does have value in that direction. It's the only meter I take along with me on a home service call inasmuch as I belong to the school of thought which avoids any and all underchassis work in the customer's home. The full—and considerable—value of an indicating wattmeter in shooting trouble can be fully appreciated only after you have lived with it for a while. It's no crystal ball, of course; but it can save an awful lot of time.

I check high voltage, when required, with a NE-51 neon lamp. After a little practice, anyone can estimate the high voltage pretty closely by observing the length of the arc drawn off the cap of a 1B3 or 1X2-A through the lamp. I said *through* the lamp. I hold it by the glass envelope, touch either contact to the cap of the 1B3, draw it away and note the maximum arc length.

This same NE-51 affords a positive check as to whether a horizontal output tube is being driven or just sitting there doing nothing. Nope, it doesn't even tickle, not even at 15,000 volts, but for safety's sake keep the unoccupied hand in a pocket.

As a final advantage, the kit makes it possible to get every item normally needed on a home service call into the house in one trip—and to get it out in one trip. Specifically, I carry the kit in one hand; in the other is a somewhat larger suitcase containing my tube tester and volume of service notes suitable for the current situation. The larger suitcase also holds the double-duplex extension cord and a clipboard (attached to its exterior) which holds billheads, etc.

One-shot entries and one-shot exits, aside from creating a good impression on the customer, really pay off when servicing a TV set on the third floor of a walkup. Or again, by avoiding that chilly sensation of discovering Junior playing football with a 6CD6G when one returns to the customer's home with something that had been left behind on the initial trip. END

# COLOR DEMODULATOR ALIGNMENT



Hickock 655XC color bar generator.

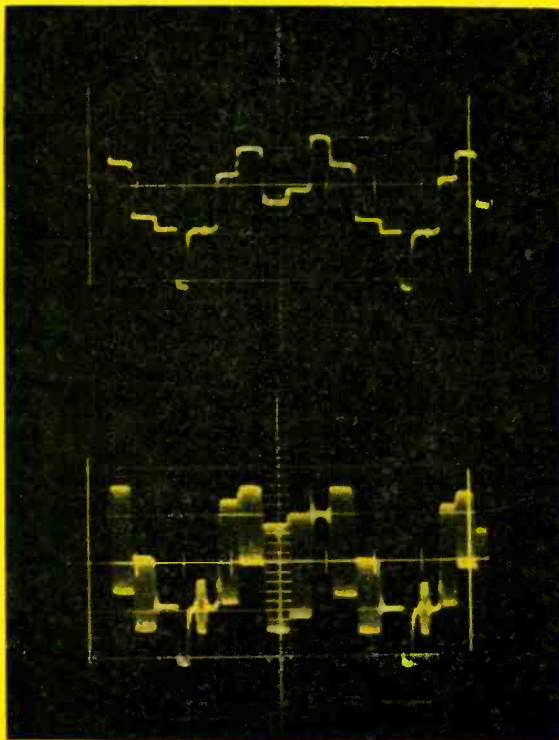

Fig. 1—Standard NTSC signal: above, brightness signal; below, color bar.

*A rapid procedure  
without using  
an oscilloscope*

By WALTER J. CERVENY \*

THE newer color receivers have been simplified considerably, mostly in the demodulator circuits. The receivers of today demodulate along the R - Y, B - Y and G - Y axes instead of the I and Q. This eliminates inverter tubes, amplifiers and a matrix network, making for greater stability and reduced cost.

In recent receivers the R - Y, B - Y and G - Y signals are fed to control grids of the color tube; the Y, or brightness signal, is fed to the cathodes. This means that the Y signal on the cathodes is added to the signal on the grid of each gun. For example, in the red gun Y is added to R - Y and the sum is R, a red signal on the face of the color tube. This holds true for the other two guns. Thus, it is possible to align the demodulator circuits of a color receiver without using an oscilloscope when using a standard NTSC signal generated by a color bar generator.

The standard NTSC signal (Fig. 1) generated by such an instrument produces on the face of a properly aligned color receiver one red, one blue and two green bars. These bars are overlapped to produce the full complement of color bars as shown in Fig. 2.

If the blue and green guns are cut off, a red bar will be seen on the face of the color tube. This can be done by reducing the screen voltage or biasing the control grids to cutoff. In the new sets a jumper wire from the control grid to ground, through a 100,000-ohm resistor, will do the trick because the cathode is usually positive. By viewing only the red bar, composed of R - Y plus Y, we have a check on the R - Y demodulator and the brightness channel.

Let's examine the R - Y and Y

\* Senior electronics engineer, Hickok Electrical Instrument Co.



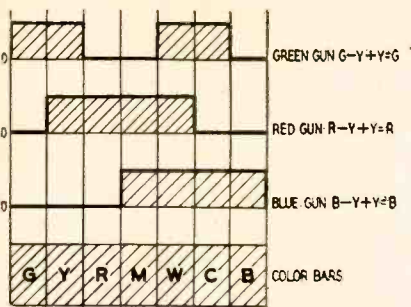

Fig. 2—Diagram shows how color mixing produces green, yellow, red, magenta, white, cyan and blue color bars.

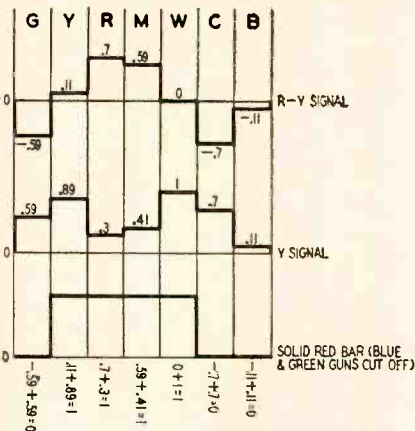

Fig. 3—Diagram shows how R - Y and brightness signals produce red bar.

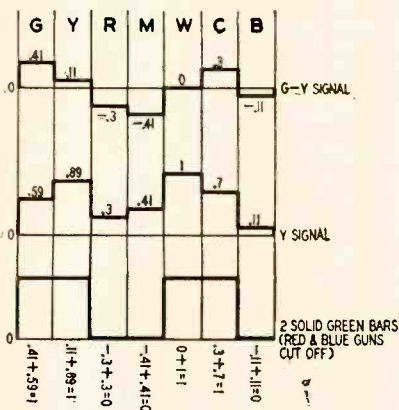

Fig. 4—Diagram shows how G - Y and brightness signals produce green bar.

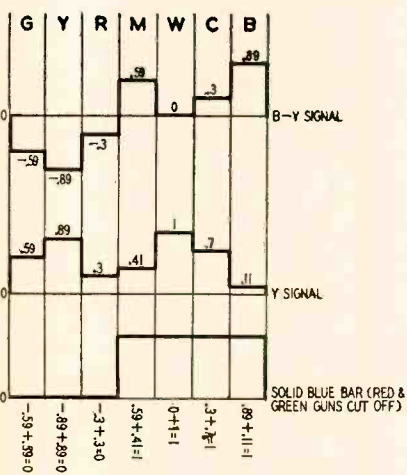

Fig. 5—Diagram shows how B - Y and brightness signals produce blue bar.

signals (Fig. 3) individually. If the two signals on the grid and cathode are not correct, the red bar on the face of the tube will show irregularities such as uneven shading across the bar or even red in regions that should be black. (See Fig. 6-b.)

The brightness or Y channel is usually troublefree and can be assumed correct. This leaves only color signal R - Y to be at fault if a solid red bar is not seen. Its amplitude can be changed by varying the color intensity or saturation control on the TV receiver. Its phase can be changed with the hue control.

Before alignment the monochrome balance has to be set up—the screen and background controls of the color picture adjusted for a neutral black-and-white picture (free of color tinting). This is done as follows: Tune the set to a local station (black-and-white transmission). Adjust the brightness control for a high-level brightness. Adjust the red, blue and green screen controls for neutral high-level grays and whites. Then back off on the brightness control for a very dark picture and adjust the red, blue and green background controls for neutral low-level grays.

These adjustments should be repeated several times until increasing or decreasing brightness and contrast controls produce a true black-and-white picture with no color tints. For more detailed monochrome balance the TV manufacturer's alignment instructions should be followed.

The color-locking circuits are assumed to be operating normally. If not, they should be adjusted according to manufacturer's instructions before continuing.

Now, we can proceed with the alignment: The green and blue guns are cut off. A standard NTSC color-bar signal is fed into the receiver, either video through the second detector or rf through the antenna on channel frequency. A red bar should appear on the face of the color tube. If the red bar has irregularities (Fig. 6-b), the following controls should be adjusted: hue, color saturation or color intensity and contrast. The contrast control is usually set to near maximum. The red and green guns should be cut off and the short jumper for the blue gun removed. Now a blue bar should be visible. If it shows irregularities or uneven shading (Fig. 7-b), adjust the quadrature transformer for a solid blue bar (Fig. 7-a).

The quadrature transformer is a phase-shift unit that drives the B - Y demodulator grid with the CW signal generated by the 3.58-mc color oscillator in the TV receiver. The adjustment is made usually, with a powdered-iron slug. This transformer may not be labeled as such but can be located by tracing back from the B - Y demodulator grid, using a wiring diagram.

Alignment is now complete on most

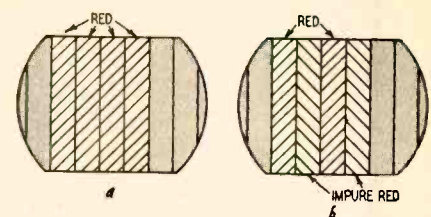

Fig. 6-a—Red bar indicates correct adjustment of R - Y demodulator; b—irregular bar due to misadjustment.

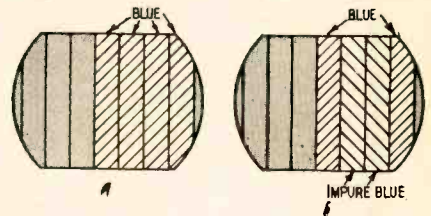

Fig. 7-a—Blue bar indicates correct adjustment of B - Y demodulator; b—irregular bar due to misadjustment.

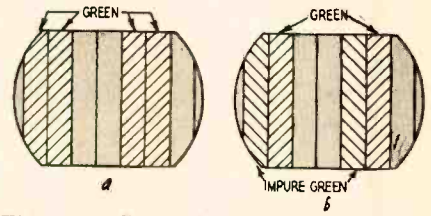

Fig. 8-a—Green bar indicates correct adjustment of G - Y demodulator; b—irregular bar due to misadjustment.

sets because a portion of R - Y and a portion of B - Y are added together to produce G - Y which is fed to the green gun. The G - Y channel is fixed and no adjustment is required. If, however, G - Y channel is adjustable, the red and blue guns are cut off and the short removed from the green gun.

The G - Y adjustment is made for two solid green bars on the face of the color tube (Figs. 4 and 8-a). The hue and saturation controls are varied until a solid red bar is seen (Fig. 6-a).

This means the R - Y demodulator has been adjusted for proper phase and amplitude. Once the above controls are set, they are not touched for the remainder of the alignment.

Next the B - Y demodulator has to be aligned. Here again the B - Y signal is fed to the grid, and the Y signal to the cathode. When added together in the color tube, they produce a blue bar (Fig. 5).

Some manufacturers' TV receivers demodulate R - Y and G - Y and add portions of both to produce B - Y. At any rate, the same method of alignment is used, just the sequence is different. Instead of aligning R - Y, B - Y and then G - Y, the sequence would be R - Y, G - Y and B - Y. The manufacturer's schematic should be consulted for the sequence of demodulation.

This method of demodulator alignment is intended for TV technicians who have had color TV training and are thoroughly familiar with a color set. It's a short-cut that will save time, once you learn it.

END

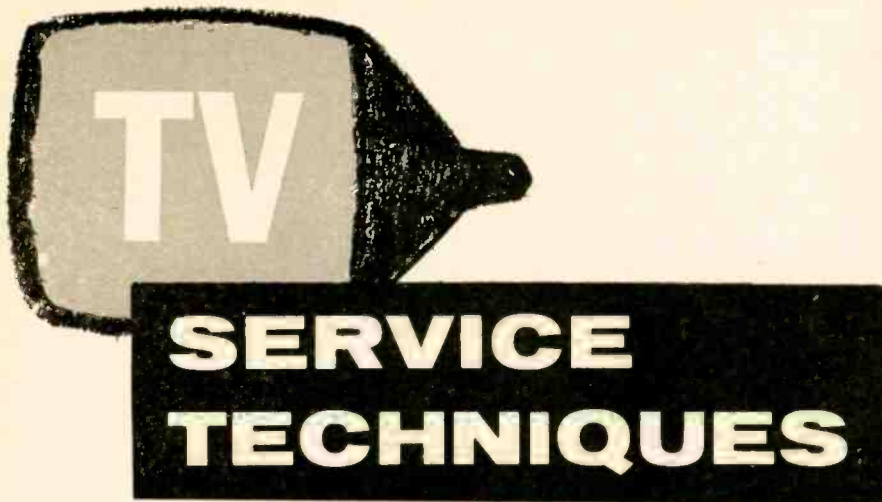

# TV SERVICE TECHNIQUES

*Procedures for reducing troubleshooting time*

By ROBERT G. MIDDLETON\*

UNLESS you have an absolutely complete set of bench test instruments, as well as ample service data, *sectional substitution tests* will simplify the servicing of a "dog" TV receiver. For example, a receiver was brought in with picture and sound separated and with settings of the fine-tuning and contrast controls interdependent. It was a split-sound receiver.

By substituting the sound if and audio channels of another set of the same type, as shown in Fig. 1, it was quickly established that the trouble was

response was obtained as an S curve on the scope screen. As the signal level from the sweep generator was varied it appeared that the S curve moved along the base line from one end to the other; that is, the tuning of the discriminator circuit changed with the signal level. This accounted for the interdependence of the fine-tuning and contrast-control settings. When an attempt was made to peak-align the sound if stages, the amplifier broke into oscillation.

The trouble was clearly due to regenerative feedback. The next step was to check the various components which could cause regeneration. We found that the coil shield in the ratio-detector circuit was missing. The sound if tubes were also unshielded and regeneration was taking place.

Shielding is often critical in high-gain amplifiers and frequently responsible for regenerative trouble. When a shield plate is provided below a 20- or a 40-mc if amplifier, look for trouble if the receiver is operated without it. Receiver manufacturers do not supply shielding unless it's needed—all shielding *must* be in place and properly grounded when checking receiver operation.

### Horizontal-output check point

In case of trouble in the horizontal-oscillator circuit no grid drive will be supplied to the horizontal output tube, hence no sweep deflection or high voltage is developed. Whether drive voltage is present at the grid of the horizontal output tube is quickly determined by checking with a scope. This is usually the first test to be made.

If 75-150 peak-to-peak volts of drive are present, the sweep circuit will be at fault if there is no horizontal sweep or high voltage. But if voltage is absent, don't assume that the trouble necessarily is in the horizontal oscillator circuit. If the damper circuit is faulty, the plate voltage of the oscillator may fall sufficiently in some receivers to stop the horizontal oscillator. So, supply drive to the grid of the horizontal output tube from another receiver to see whether the horizontal sweep circuit resumes operation. This form of sectional substitution is illustrated in Fig. 2.

The grid drive voltage does not have to be supplied from another receiver; various generators available to the service trade provide a satisfactory drive voltage for these tests. However, since most shops do not have such a generator, the sectional-substitution method will be found very useful.

In some receivers a horizontal discharge tube and associated circuitry is placed between the horizontal oscillator and horizontal output tubes. In such case lack of sweep deflection

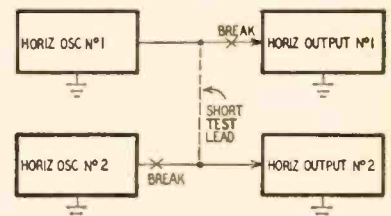

Fig. 2—Drive voltage from receiver No. 1 drives grid of horizontal output tube in defective receiver No. 2.

and high voltage can also be due to faults in the horizontal discharge circuit.

To illustrate, a receiver was brought in with no horizontal sweep or high voltage. A check with a scope at the grid of the horizontal output tube showed no drive. Before applying external drive to it, a low-capacitance probe and scope check was made at the plate of the horizontal oscillator tube—voltage was normal at this point. But this voltage was suddenly attenuated through the grid-coupling capacitor to the horizontal discharge tube. When the capacitor was replaced, the receiver resumed normal operation.

It is sometimes asked whether a direct cable cannot be used to the scope in making such tests, instead of using a low-capacitance probe. Since various circuits in the horizontal oscillator and sync sections of the receiver may be seriously disturbed by the 75- or 100- $\mu\text{f}$  capacitance of a direct cable, good practice dictates that the technician should always use a 10-to-1 low-capacitance probe in troubleshooting procedures of this kind.

Drive voltage to the grid of the horizontal output tube does not necessarily have to be obtained from a generator or from an auxiliary receiver. In some cases an obsolescent scope, which does not have satisfactory frequency re-

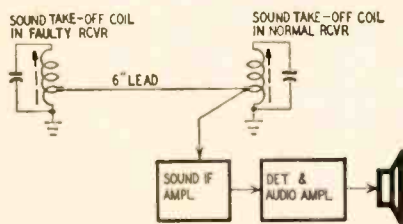

Fig. 1—Substituting sound sections.

in the sound if channel and not in the front end of the faulty receiver. The sound take-off coils were placed within 6 inches of each other by facing the two chassis in opposite directions. A relatively low-impedance coupling was arranged by connecting a short test lead. The sound and picture were no longer separated and the fine-tuning control did not have to be readjusted when the setting of the contrast control was changed.

By applying a sweep signal to a floating tube shield over the mixer tube and applying a scope at the audio-input circuit, the overall sound-channel

\* Chief field engineer, Simpson Electric Co.

sponse for TV troubleshooting work, is available in the shop. The sawtooth voltage from the horizontal deflecting plates of such a scope is more than ample to drive the grid of a horizontal output tube; in most cases, a dropping resistor will be required to avoid over-driving. The horizontal sweep control of the scope should be adjusted, of course, to provide a drive voltage with a frequency of approximately 15,750 cycles.

### Lengthy B-plus check

Trouble in the sweep circuit is sometimes caused by low B-plus voltage. This fault may be missed by the technician if he merely makes a quick check of this voltage soon after the receiver is turned on. It is better practice to leave a voltmeter connected to the B-plus line while other troubleshooting is done. By thus monitoring the B-plus voltage, the operator will sometimes observe that there is a steady dropoff as the receiver warms up, causing the horizontal oscillator to cut out suddenly as a critical voltage is passed.

Weak selenium rectifiers and rectifier tubes, leaky filter and leaky coupling capacitors that apply positive voltage to the grids of power output tubes are common causes of such trouble. The opposite situation will be encountered on occasion—an electrolytic filter or bypass capacitor leaks excessively when the receiver is first turned on but subsequently develops an increasing internal resistance.

Although it is common practice to shunt or bridge suspected electrolytic capacitors with another similar unit, this is a doubtful procedure. The method is effective when the suspected capacitor has a high internal resistance or is open. However, when the capacitor is leaky (as is more often the case), the shunting technique increases the effective capacitance but does not reduce the effective shunt resistance. When the effective shunt resistance is relatively low, the technician may fail to detect any appreciable change in circuit performance and falsely conclude that the faulty capacitor is actually in good condition.

### TV signal level during tests

Voltage measurements on a faulty chassis may be made with or without a TV signal present. Before work is started the receiver service data should be consulted to determine the conditions of measurement as various manufacturers are not consistent in this regard. When the data calls for a signal to be present, a fairly strong signal, which would be regarded as normal, should be used. A weak or a very strong signal requires resetting of the agc threshold control and in turn will change the voltages at the sync separator and sync clipper in many receivers. Likewise, the peak-to-peak signal reaching the phase detector may be changed, causing the technician mis-

takenly to conclude that trouble is present because the measured voltages do not agree with the published data.

Sometimes a pattern generator can be used to facilitate voltage measurements—in areas where a suitable TV signal may not be available or available only for limited intervals—provided the generator supplies horizontal and vertical sync pulses with the pattern. A simple generator which provides pattern voltages only does not energize the sync circuits normally and the measured voltages will not agree in many cases with the voltages developed when sync pulses are present. Generators which provide sync pulses as well as a pattern signal are somewhat more expensive than simple pattern generators, but the additional cost is often justified.

### Use the right voltmeter

When making dc and peak-to-peak voltage measurements in various receiver circuits, the technician must also use the same type of voltmeter—as well as the specified operating conditions—as was used in compiling the service data. Some of the older service data will be found to specify the use of a 20,000-ohms-per-volt meter rather than a vtvm. The distinction is of considerable importance because many TV circuits are loaded appreciably by a 20,000-ohms-per-volt meter and will indicate less voltage under this condition than when an electronic voltmeter is used.

Furthermore, the “do not measure” warning concerning dc voltage measurements at the plate of the horizontal output tube, for example, may be disregarded if suitable test procedures are observed. This warning is included in the service data because of the high-voltage pulse (commonly in the order of 6,000 volts peak to peak) at the plate of the horizontal output tube along with the dc plate voltage of perhaps 350. It is this high-voltage pulse which damages a voltmeter unless a suitable filter network is used between the test point and the meter.

A suitable filter network is provided by a conventional 100-to-1 high-voltage dc probe. Its R-C constants are such as practically to suppress the pulse at the output end of the probe while attenuating the dc voltage only in the ratio of 100 to 1. Hence, the high-voltage probe makes it possible to measure the dc plate voltage with no damage to the meter from the high-amplitude ac pulses.

A conventional ac vtvm cannot be used to measure the pulse voltage at the plate of the horizontal output tube because the voltage at this point exceeds the input rating of the instrument. The most satisfactory method of checking this voltage is to use a 100-to-1 high-voltage capacitance-divider probe in combination with a calibrated oscilloscope. The same precaution usually applies to measurement of the pulse voltage across the horizontal deflection coils. END

## TELEVISION DX

TV dx is looking up! We are now approaching a period of maximum sunspot activity and the results are already becoming apparent in reception of stations new to even the seasoned TV dx observer. Probably the remaining months of this year and most of next year will continue to show significant increases in ranges and our observers may see dx they have never even hoped for in the past.

Observers will remember that some interesting phenomena occurred during the latter period of the last sunspot maximum. Television had hardly started then. Stations were few and concentrated in small areas of the country. Their power was low by today's standards and their program time relatively limited.

Receivers and listeners numbered only a handful by 1956 standards, and the receivers of that day were painfully insensitive. These factors combined to make TV dx observation a hit-and-miss proposition in which the misses must have far outnumbered the hits.

Even under such conditions, our observers gathered much valuable data—so valuable that our first year's reports were studied eagerly by half-a-dozen groups, including two Federal Government bureaus and at least one university.

These reports were possibly the best

perused scientific literature of the period—they left our hands shortly after the final compilation and did not return till after two years of wanderings.

Reports in this new sunspot maximum period will be much more valuable than those older fragmentary observations and our observers are urged to continue sending them in the same detail that has made them so valuable in the past. Reports are solicited from new observers as well. Please be sure to state your location definitely, as well as that of the stations received, their calls and channels, the date and the *exact time* during which the station was visible. Any remarks you may consider pertinent, such as the signal strength and quality, will be welcomed.

Our regular quarterly dx predictions were discontinued during the first part of this year, because our dx editor had pressing business that prevented him from devoting sufficient time to TV dx study. We expect to restore our TV dx column in the near future, possibly in a new and expanded form that may give us room for regular reports on outstanding dx obtained by our observers.

Address all reports to:  
TV DX Editor  
RADIO-ELECTRONICS  
154 West 14th Street  
New York 11, N. Y.

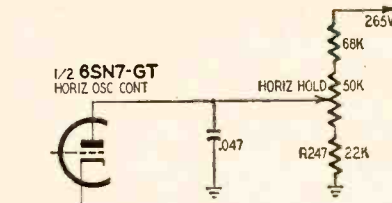

Fig. 2—Horizontal hold control circuit in Admiral 19G1 series chassis.

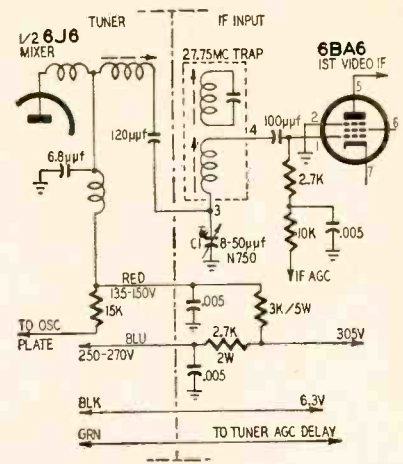

Fig. 3—Adding cascode tuner to Du Mont RA-112 and RA-113 TV receivers.

THE video if amplifier furnishes by far the greatest overall gain and adjacent-channel selectivity in a television receiver. Capable of working with front-end outputs as low as 50–100 microvolts, most if amplifiers normally provide an increase in signal strength of about 20,000 times, producing a signal of approximately 2 volts across the video detector load resistor.

As in most high-gain circuits, there is always the possibility of regeneration—a condition of in-phase (positive) feedback from the output to input circuits. This is due to feedback through a tube, wiring or defective components or circuitry. It greatly increases circuit gain and selectivity. A regenerative circuit may increase noise generated within it and at the same time the increased selectivity reduces the response to noise entering from the tuner or preceding circuits. The amplifier oscillates when feedback increases beyond a critical point. When regeneration or oscillation occurs in a TV receiver, the normally rectangular if response curve (Fig. 1-a) breaks down into a badly distorted waveform having one or more very high voltage peaks (Fig. 1-b). A vtvm placed

across the video detector load resistor may measure as much as 50 volts. Even slight regeneration will peak the response curve at some frequency.

Since regeneration and oscillation vastly change the shape of the if response, this in turn produces many misleading effects on the screen—smearing, buzz, loss of picture detail, poor sync, weak picture, negative picture, ghosts, herringbone stripes, etc. The pattern on the TV screen will vary greatly with the frequency and amplitude of the oscillation. Many of these troubles send the technician searching into front-end, video, sync and sweep circuits. Thus, when the above and similar troubles appear, a good routine to adopt is to apply a sweep signal to the if amplifier and observe its overall waveshape with a scope across the video detector load resistor.

In many cases an oscillating stage can be spotted by bringing your hand close to each circuit and looking for changes in the overall waveshape. The offending stage will change frequency due to hand capacitance and produce a noticeable variation in the output waveform.

Where the hand-capacitance check does not give conclusive results, check the if strip with a vtvm and high-frequency detector probe. Start at the output of the video detector and then move toward the front end, applying the probe to the plate of each tube. When the nonoscillating stage is reached, the high voltage across the detector load will drop to almost zero. In some cases the troublesome stage can be isolated by removing tubes, starting with the first video if amplifier.

Because oscillation is most often caused by two if stages tuned to approximately the same frequency, the first step in correcting this trouble is to align the entire if strip. Here, wherever possible, follow the manufacturers' instructions to a T (because perhaps someone before you didn't).

In checking causes of oscillation in if amplifiers check all trap circuits, look for missing tube or coil shields in closely spaced circuits, check for leaky or open age filter capacitors, look for

defective cathode resistors and open bypass capacitors and poorly dressed rf chokes in heater leads. Interestingly, the cause of regeneration can be an if amplifier tube having too high a mutual conductance—the greater output increases the likelihood of feedback to the input through stray coupling. Try some tube substitution. While less common, trouble could also be caused by defective transformer shunting resistors.

When attempting to eliminate regeneration or oscillation by alignment, place a large, fixed, negative bias to the agc line. If this is not effective, bypass the grids of the first two or three if stages (not the last) to ground with .001-µf capacitors. The signal generator should then be applied to the grid of the last if stage and that stage aligned to its proper frequency. The generator is then connected to the grid of the next-to-last stage, the shunting capacitor removed and that stage aligned. This procedure is followed until the entire if strip is aligned.

Critical lead dress will often produce regeneration, especially coupling between plate and grid leads. When the positions of these leads are altered, realignment is usually necessary. Even adding a few inches in lead length may add enough inductance in a high-gain circuit to produce regeneration. This is very common in replacing if transformers. Some receivers have a metal plate between the input and output terminals at the tube socket—this reduces stray feedback coupling.

When replacing any if components, follow original design in layout. If uncertain, ground components close to the cathode ground point. Even a 1/2 inch of chassis can develop undesirable voltage drops from if currents.

In receivers where the contrast control varies the bias on if tubes, ghosts and a partially negative picture can be checked by turning the control. The varying bias alters the shape of the if response. At low bias (high gain) the response becomes peaked, producing ringing. This condition, also, can be cured by realignment, wiring dress or replacing defective components.

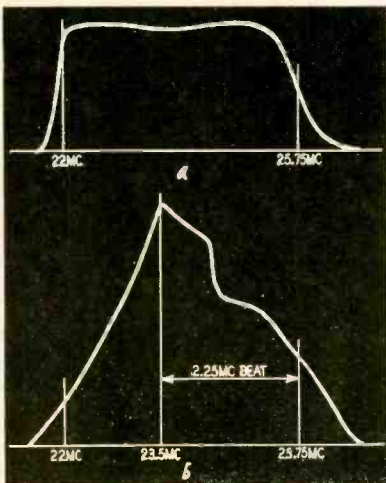

Fig. 1-a—Normal if response curve is almost rectangular; b, curve resulting from regeneration in the if circuits.

Ghosts produced by ringing in the if vary in intensity and spacing when the fine tuning is varied. Those produced by video amplifier ringing do not. This is an important clue to the service technician trying to locate the trouble.

The ringing frequency is usually the difference between the video if and the point at which the response is peaked. Since this difference can be varied by turning the fine-tuning control, observe the vertical wedge of a test pattern on a receiver having this trouble. The beat will be visible on the wedge as a blur and will travel up and down as the fine tuning is varied. This is an excellent check against the video amplifier where peaking often occurs. Here, of course, the peaking cannot be varied by the fine tuning.

In fringe areas some technicians peak the if response for additional gain. In some cases the overall response may be reduced to as low as 1 mc. Surprisingly, the picture is still acceptable. However this peaking often causes ringing, in which case the response will have to be broadened somewhat and the gain reduced. Where bias is controlled by the contrast control, the owner may be instructed to increase bias when ringing occurs.

#### Horizontal jitter

*I have an Admiral 19G1 in the shop with a pretty bad case of horizontal jitter. With the manufacturer's service notes I made a thorough check of all voltages and waveforms in the horizontal oscillator control and oscillator circuits. The voltages are perfect and the incoming sync signal is normal.*

*Adjusting the horizontal circuits only makes things worse. When completing the adjustment, I had to make compromise settings to improve stability. All components check OK, and it appears that the trouble is in the adjustment. I would appreciate it if you can give me some alternate procedure in aligning the horizontal circuits.—G. R., Elmira, N. Y.*

The Admiral service notes for adjusting the horizontal circuits of the 19-series chassis have proven highly accurate. However, the adjustment of the horizontal lock, frequency and lock range trimmer is sometimes very critical. Most likely your technique is not at fault.

Some of these chassis left the factory with the horizontal hold control wired in reverse—the 68,000-ohm resistor (Fig. 2) should be connected to the top (B-plus end) of the 50,000-ohm potentiometer and the lead from R247 (usually blue) to the low end of the same control.

If the horizontal oscillator goes further out of sync when following the adjustment given in the service notes, either rewire the control or turn it clockwise when the instructions call for a counterclockwise turn. When the control is properly wired, maximum voltage is measured on the oscillator

control tube when the horizontal hold is turned completely to the right.

#### Sound if oscillation

*The complaint was distorted sound. A check revealed that the audio amplifier was in good shape and that the trouble was a sort of beat interference. The waveshape at the limiter was extremely distorted and alignment did not help. In fact, while trying to adjust the limiter and discriminator, I noticed hash in the picture. At times the sound and picture could not be tuned in together. Through routine servicing I could not come up with the solution.*

*The set is marked AMC 1C72 and I do not have any information on it. I would appreciate any suggestions you can give.—L. M., Tampa, Fla.*

The model number you list is a department-store brand and is identical to the Olympic 752 model. The symptoms you describe are typical of oscillation in the sound if section. Since you have made routine checks and tried alignment without success, the following will stop the oscillations and permit alignment.

Ground the 150-ohm cathode resistor of the 6AU6 sound if amplifier directly to the center shield of its socket instead of to its present terminal-strip ground. Also, connect a .0015- $\mu$ f capacitor (ceramic) between pin 7 (cathode) and the socket center shield. This done, carefully check the alignment of the sound if circuits, sound traps and the discriminator.

#### High-voltage rectifier

*I have had two callbacks on a Crosley 411-4 chassis with open 1B3-GT filaments. I assume that what is happening is that excessive voltage is being applied to the filament. I tried installing a filament resistor to cut down the voltage, but this creates a great deal of arcing. This set has no drive con-*

*trol to lower the high voltage. I would like to know if you have run into cases similar to this and what has been done about it.—R. T., Pittsfield, Mass.*

This set uses a 24CP4 picture tube with a high-voltage power supply delivering 17,000 volts. The filament of the 1B3-GT is operated near the maximum allowable voltage. In locations where the line voltage is slightly high the filament voltage exceeds the rated value, burning out the filament.

To increase the life of the high-voltage rectifier insert a 2.2-ohm  $\frac{1}{2}$ -watt wirewound resistor in series with the filament. To prevent arcing remove the wire from pin 2 of the 1B3 tube socket and connect it to pin 4. Then connect one of the resistor leads to pin 2 and the other to pin 4. Solder these connections carefully, leaving no sharp points.

#### Installing cascode tuner

*Living in a very weak signal area, I have had great difficulty in receiving snow-free pictures on a Du Mont RA112/113. Most of the sets in this area having cascode tuners receive good pictures, while others with this model set receive poor pictures. I tried to remedy this situation by installing a model TV-2232 Standard Coil cascode tuner. To date I have not been able to get any signals through the if strip. I would like a schematic showing a simple method of connecting this tuner to the Du Mont receiver.—L. T., Ogden, Utah.*

There is no doubt that properly installing the cascode tuner will greatly reduce snow when receiving weak signals because of its lower noise figure. Of course, you will lose the benefit of FM broadcast reception.

Comparatively few changes have to be made in this set. The circuit arrangement is as in Fig. 3. If your chassis does not contain C1, connect such a unit between the first if transformer and ground. Some sets already have it mounted on a standoff. If the 2,700-ohm resistor is not connected in the grid circuit of the first video if, install it.

A 3,000-ohm 5-watt resistor and 2,700-ohm 2-watt unit must be added in the B-plus line. The tuner ends of each resistor must be bypassed to ground with a .005- $\mu$ f ceramic disc capacitor. Make sure the output lead from the tuner is properly insulated.

With the tuner installed, adjust the mixer output, first if coils and trimmer capacitor C1. Follow the regular alignment procedure for the receiver. Inject the signal at the grid of the mixer and connect the scope at the plate of the first video if tube. Adjust C1 for proper bandwidth and adjust the tuner oscillator slugs for proper fine tuning on each channel.

Since your set mounts on its side, you will have to move all the tuner strips three turret positions counterclockwise so that the channel will be indicated at top of the channel selector knob. END

## Watch for the August RADIO-ELECTRONICS On Sale July 26

Read these  
interesting articles—

### THE LABORATORY GOLDEN EAR

By Joseph Marshall, Jr.

Ultimate amplifier of the Golden Ear series—Marshall's own ever-evolving equipment caught at an auspicious stage of its development!

### TRANSISTOR SHORTWAVE REGENERATOR

By Edwin Bohr

A shortwave transistor radio that really works!

# Trends in

# TV RECEIVER CIRCUITRY

*New designs—some may be universally adopted*

By ROBERT F. SCOTT

TECHNICAL EDITOR

IN the January issue we discussed recent design innovations that we felt were well engineered and could become as universally accepted as the flyback transformer and cascade tuner. A further study of recent TV sets shows that designs are not standing still. One change seems to be in the direction that compensates for if circuit detuning by Miller effect, which changes with if bias.

Miller effect usually causes a change in the input capacitance of a tube as the grid bias varies. In TV receivers the if circuits are tuned by a combination of stray and tube capacitances. When age is applied to a tube the change in capacitance detunes the circuit and alters its response. This effect is often counteracted by using an un-bypassed cathode resistor in the amplifier, producing degeneration and reducing stage gain.

In some of their recent sets, Du Mont and Capehart have used Miller effect to alter the if response to peak the video carrier (accentuate the lower video frequencies) and attenuate the higher frequencies. In other words, the if amplifier automatically aligns itself for broad-band operation on strong signals and narrows the bandwidth when the signals are weak. The reduced bandwidth minimizes snow on weak signals.

### Du Mont RA-340

Fig. 1 is the circuit of the video if amplifier in the RA-340 and similar Du Mont chassis. The amplifier is tuned so a normal signal produces an age bias of about 3 volts. Fig. 2-a is the response curve. When signal strength drops, the input capacitance of the second if amplifier stage increases and detunes its input circuit so the overall

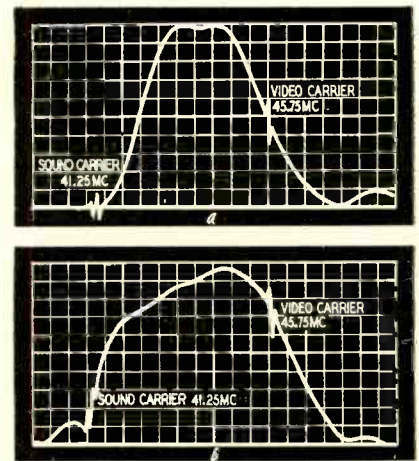

Fig. 2—Weak signal causes video and sound if carriers to rise on curve.

bandpass is like that shown in Fig. 2-b.

### Capehart walking if

Fig. 3 is the Capehart video if circuit whose variable if response the manufacturer calls "walking if." Note its similarity to Fig. 1. Curves a, b and c in Fig. 4 show the change in overall if response as the bias changes. Detuning with a reduction in age bias is confined to the second if stage—tuned to 42.9 mc, the low or sound if side of the curve. Decreasing bias detunes the stage lower in frequency. This raises the gain at 42.5 mc and reduces snow in the picture. A further advantage is to slightly increase the gain at 41.25 mc and provide better sound in fringe

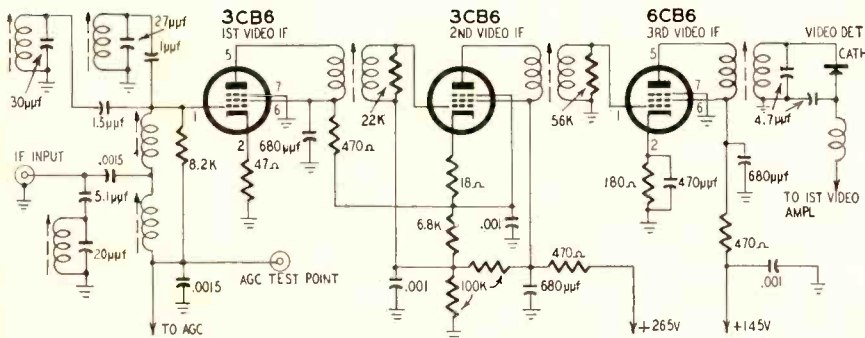

Fig. 1—Diagram of the video if and detector stages in the Du Mont RA-340.

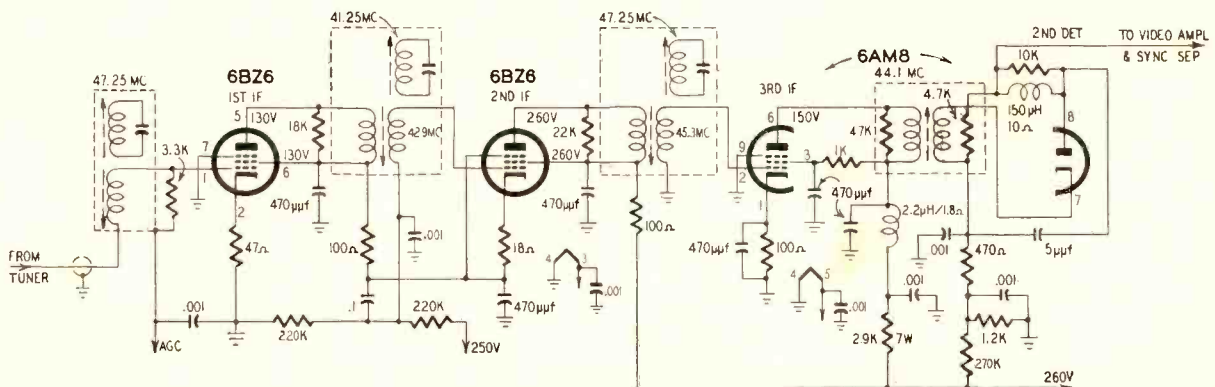

Fig. 3—Schematic diagram of video if section of the Capehart CX-38S.

areas. Curve *a* is the overall response as the set is aligned; *d* is the response of a similar if circuit without walking if.

**Definition control**

The Conrac Fleetwood TV sets have a manual definition control (Fig. 5) that permits the viewer to alter the response of the video if circuit for the most pleasing effect. The control is a small variable capacitor across the secondary of the second video if transformer. Rotating it counterclockwise peaks the video carrier and produces a sharper picture; rotating it in the opposite direction softens the picture.

The manufacturer recommends setting the control while observing the white area immediately to the right of a black object. Rotating the control counterclockwise produces a white smear; clockwise rotation produces a gray smear. Normally, optimum view-

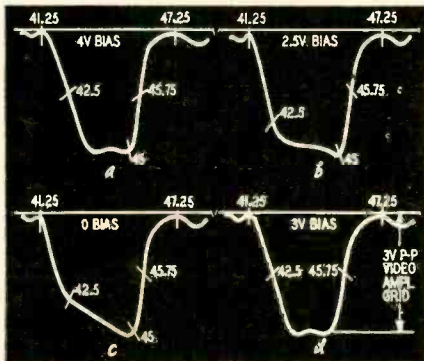

Fig. 4—Bandpass curve variations with changes in the bias voltage.

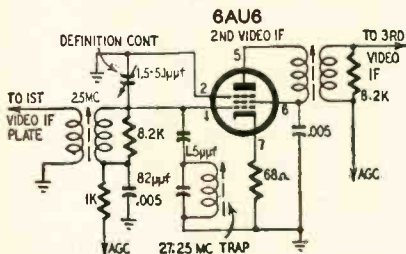

Fig. 5—The definition control is connected across the if secondary.

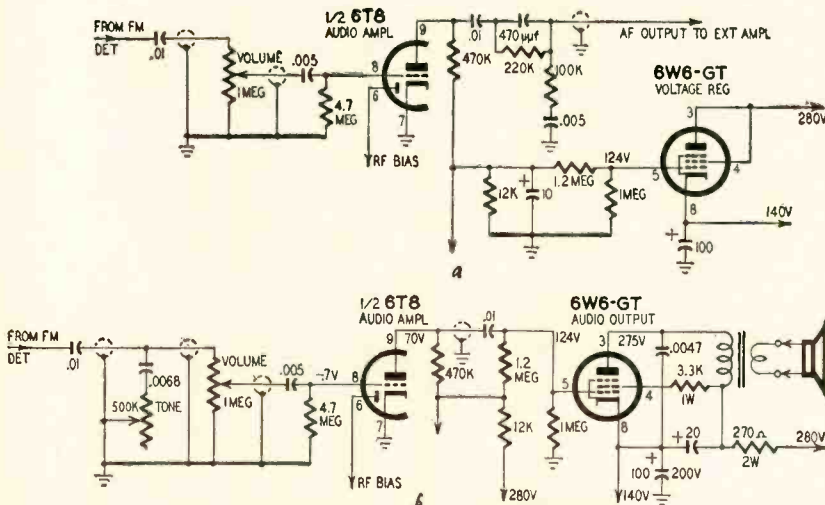

Fig. 6—Diagram shows variations in Magnavox output stage circuitry.

ing is obtained with the control centered to produce a slight white smear.

**Series-connected if's**

In many sets, the load current drawn by an if amplifier varies widely as the set is tuned from a weak channel to a very strong one. This change in the load on the power supply is large enough to affect the set's performance adversely. For example, a pair of 6CB6's in parallel across the power supply will draw about 30 ma when tuned to a weak channel that develops little or no age voltage; total current drops to about 6 ma on strong signals.

Figs. 1 and 3 illustrate video if amplifiers with the first and second stages in series across the power supply. The Du Mont if strip (Fig. 1) draws a maximum cathode current of 15 ma for the first two stages on a weak signal. A strong signal drops the cathode current to 3 ma. Thus, placing the two if stages in series halves the total cathode current and minimizes the changes in the power-supply drain with different signal levels.

As the age voltage is applied to the first stage, its internal resistance increases. This raises the voltage on its plate and on the cathode of the second stage. The grid of the second stage is supplied with a fixed bias so the increased cathode voltage has the same effect as an equal negative bias voltage on its grid.

**Width sleeve**

A number of Zenith TV sets made in the last year or so have used a width control consisting of a metal sleeve around the neck of the picture tube. Now, after several years, Bendix has returned to this system in its series T19 and T20 chassis. Bendix first used it in the T5 chassis. Emerson and several other manufacturers are now using this device in some models.

The sleeve type width control is an insulated cylinder of aluminum or copper foil wrapped around the neck of the tube and slipped between it and the yoke. The amount of sleeve under

the yoke determines the amplitude of the horizontal deflection voltage and thus the picture width. The 15,750-cycle horizontal sweep currents induce eddy currents which affect picture width by developing a magnetic field that opposes the field produced by the horizontal sweep coils. The 60-cycle vertical deflection currents produce almost no eddy currents in the sleeve so height is not affected.

**Voltage regulator**

There is a demand for hifi in everything from automobile polish to cosmetics; some TV manufacturers are making sets for use with external audio amplifiers. Many basic chassis have a single-ended audio output stage that acts as a dropping resistor in the B-plus line to other circuits. Removing this tube so an external amplifier can be used would necessitate several changes in the overall voltage distribution.

Magnavox licks the problem by converting the output tube to a series type voltage regulator as in the CTE and CMUE chassis (Fig. 6-a). Compare this with the circuit of the output stage in the CTA and CMUA chassis in Fig. 6-b. The voltage regulator is triode-connected with circuit constants adjusted to give the same voltage at its cathode as obtained when used as a pentode output stage.

**Selenium sync discriminator**

A dual selenium diode assembly (type 93A5-1) is used interchangeably with the 3AL5 horizontal sync discriminator in the Admiral 17XP3, 17X3Z, 17SX3

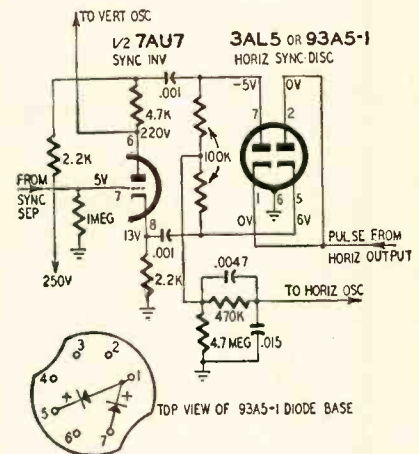

Fig. 7—Diode discriminator variations.

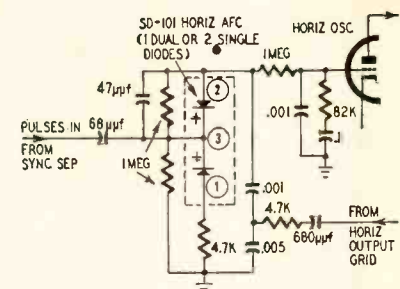

Fig. 8—Selenium rectifiers used in Halli Crafters discriminator circuit.

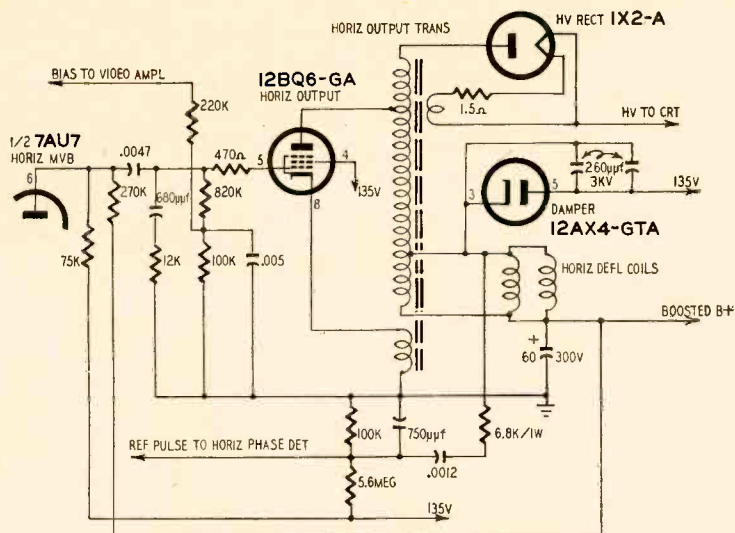

Fig. 9—Horizontal output circuitry used in the G-E series M chassis.

and similar chassis. The diodes are mounted in a standard seven-pin miniature tube base and connected as in Fig. 7. The top view of the rectifier showing internal connections is in the inset drawing. Compare the selenium and vacuum-tube diode connections.

A selenium rectifier pair (Fig. 8) is used in the Hallicrafters model A2003D TV receiver. The circled numbers correspond to the pin numbers of two-thirds of a 6CN7 used in the same circuit in the 2000D series chassis. A similar arrangement is used in late versions of the G-E series M chassis.

G-E horizontal output

A number of new G-E sets, including the series M chassis, use the rather unusual output circuit and yoke connec-

tion shown in Fig. 9. The efficiency and regulation of the high-voltage circuit depend largely on the output tube being completely cut off during the retrace period. Normally, the grid is held at cutoff by rectification of the driving voltage. In this circuit, the grid is given an assist by returning the cathode to ground through a special winding on the flyback transformer. During the retrace interval a positive pulse is developed in this winding and applied to the cathode to insure that the tube is driven to cutoff.

Another unusual feature of this circuit is the connection of the horizontal deflection coils—they are connected in parallel instead of in series and no balancing capacitor is needed. This type of yoke is becoming increasingly popular. It is used in the Sylvania 1-533 chassis and in several other makes and models.

Agc circuits

Recently, two types of agc circuits operating from the sync section have appeared in several makes and models. Fig. 10 is the circuit used in some Philco models.

A part of the amplified composite video signal with positive-going sync is taken from the plate of the video amplifier and fed to grid 3 of the 6CS6 sync separator. Through grid-leak action grid 3 is biased negative and only the sync pulses appear in the plate circuit. Simultaneously, composite video with sync negative is fed from the video detector to grid 1 of the 6CS6. This grid circuit is adjusted so the tube cuts off on any signal exceeding the level of the sync tips. Thus, any noise peaks exceeding the sync level will drive the tube to cutoff and immunize the sweep circuits against disturbances.

When the sync pulses drive grid 3 positive, grid current flows through R1, R2, R3 and R4 and places a negative charge on C1, C2 and C3. The charge on these capacitors is proportional to the peak amplitude of the sync pulses on grid 3; the charge on these capacitors is the source of age voltage. The tuner and if agc voltages are graded and delayed by applying positive bucking voltages. Clamping diodes prevent the age lines from going positive on weak signals. A three-position area control switch adjusts for operation under varying levels.

The system used in some G-E models is shown in Fig. 11. A part of the detector output is amplified and fed to the sync clipper grid. Sync is positive-going at this point. The sync pulses cause grid current to flow through R1, R2, R3 and R4 and place a negative charge on C1 and C2. This cutoff bias voltage varies with signal strength so the grid of the sync clipper can be used as a source of age voltage. Delayed age voltage is applied to the tuner line. The area control sets the level of delay bias and the clamp prevents the line from going positive.

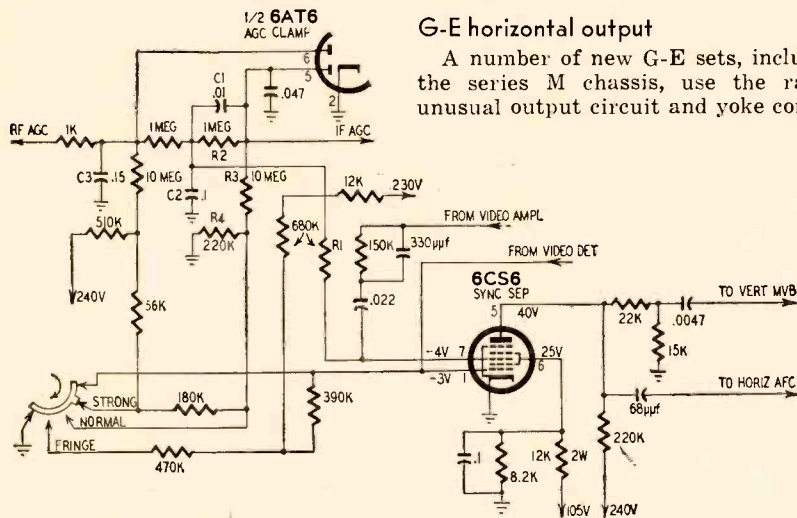

Fig. 10—Philco agc and sync circuitry. High-amplitude noise peaks are clipped.

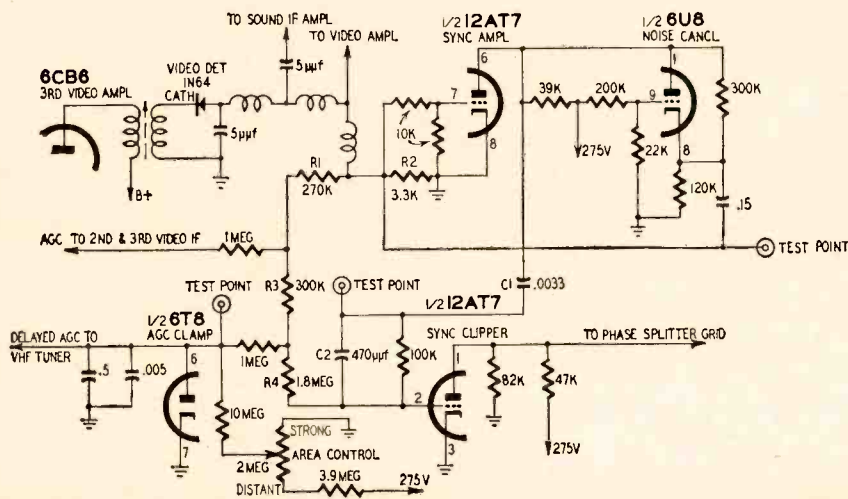
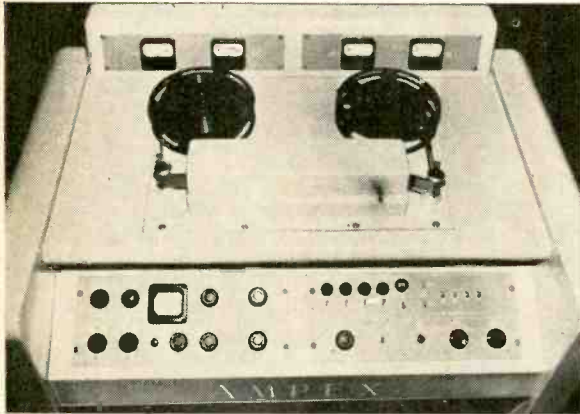
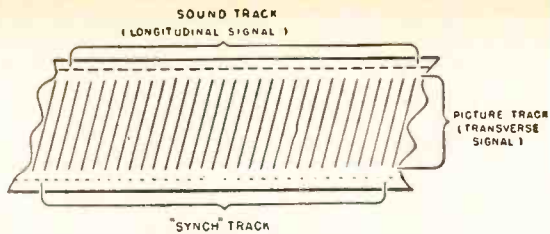

Fig. 11—G-E sync and age circuitry. Area control sets level of delay bias.





what's

new



**THAT TV TAPE RECORDER**

The new TV tape recorder announced last month (RADIO-ELECTRONICS, June, page 8) looks much like an Ampex sound recorder, except for wider tape and more controls. Tape speed is 15 ips, recording 64 minutes of program on a 14-inch reel. The 4-mc bandwidth is made possible by recording *across* the tape. Four rotating heads, so mounted on a drum that one is always in contact with the tape, record the video as shown in exaggerated form in the drawing. Sound is recorded on a single track in the ordinary way. Engineers in charge of its development say the system is inherently capable of better recording than present film methods, since the gradation from black to white (the photographers' "gray scale") is uniform in magnetic recording, though not entirely so in photographic film.

**TV SCOOTER**

Mobile like the locomotive-mounted camera below, this TV helps simplify and speed operations at the Pioneer Bank & Trust Co., Shreveport, La. The bank has two branches three or four miles from the main building. Records are kept at headquarters, where the TV scooter is mounted on tracks in front of files in the bookkeeping department. A dispatcher seated in the scooter, directed by intercom, places files or records before the camera. They are transmitted to monitors in tellers' counter tops or in offices. The equipment, designed and installed by Dage Television Division, is expected to more than pay for itself and the coaxial telephone cables between bank branches in 5 years.

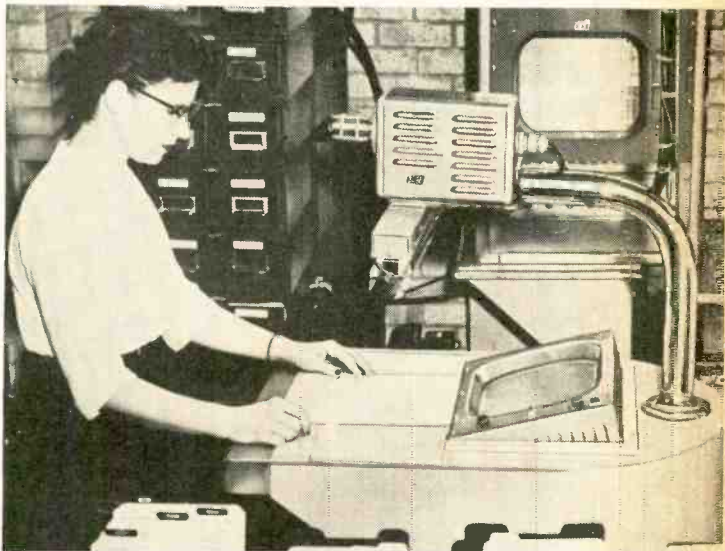

**YOU CAN BUY A SOLAR RADIO**

Several sun-powered radios have been constructed experimentally. This one is on the market, and can be bought by anyone who desires to pay considerably more than the price of the radio for the solar power pack shown beside it. Others

will have to be content with the auxiliary flashlight cells, which operate it in what was called normal fashion in the pre-solar days. The round discs used in the experimental Admiral receiver shown on this page last February have been cut into segments to use the space more efficiently. The pack is priced at \$185 as compared with a price of \$59.95 for the radio with a pack of 6 flashlight cells, which in the absence of sun power will run it for 1,000 hours.



**TV TRACK WATCHER**

This "front window" in a train is a closed-circuit TV installation made by IT&T engineers on the crack Jet Rocket of the Rock Island Line. Passengers are viewing on a Capehart receiver the track ahead on the Chicago-Peoria run as sent over coax cable from a Farnsworth TV camera in the cab. Catering to the instincts of that large group who want to see where they are going, railroad men believe the device may surpass even the dome car as a means of luring travelers back to railroad transportation.

# QUESTIONS

about

# Crossovers

By

NORMAN H. CROWHURST

*Part I—Locating the network, rolloff filters, filter and speaker terminations*

**S**URELY everything that can be written about crossovers for feeding loudspeakers has been written—if the number of articles that have appeared is any criterion. While probably every aspect of this subject has been covered at one time or another, I have been besieged recently with a number of questions about this intriguing subject. This suggests that for many persons crossovers are still considerably vague.

When one considers their historical development, and some of the confusing things that have been said about crossovers, this is perhaps not surprising. Rather than launching into another theoretical article that may well leave many readers as confused as they were previously, I propose to tackle a dozen or so of the more common questions asked.

1. *What is the best position for a crossover network: following a single power amplifier and feeding the two or three loudspeakers intended to cover the frequency band or following a pre-amplifier and feeding into separate power amplifiers for each loudspeaker?*

Obviously the cheapest arrangement is to put the crossover following a single power amplifier feeding the loudspeakers. This will save the cost of additional power amplifiers, as against a possible slight saving in the other arrangement due to the crossover following the preamplifier not having to handle power. There will not be too much difference between the cost of a crossover intended to follow a pre-amplifier and one intended to handle

power. Thus, we must ask what benefits we obtain by placing it ahead of the output power amplifiers—as compared with using a single power amplifier feeding the whole range of loudspeakers through a crossover.

One advantage is that the preamp output position permits each output of the crossover to be resistance-loaded instead of feeding a loudspeaker. This provides accurate termination which some contend is not possible with loudspeakers. It perhaps involves a little more care to insure accurate termination with loudspeakers but it is not by any means impossible—as we shall see in answer to a later question.

The next factor affecting this decision is intermodulation. While not affecting the intermodulation produced by the loudspeakers, a single amplifier may produce more distortion than several separate ones. Of the intermodulation noticeable in the output, as a general rule, a loudspeaker is much more likely than an amplifier, quality for quality, to introduce intermodulation.

Modern amplifiers give very low intermodulation figures. So it would seem very improbable that the overall intermodulation distortion could possibly be reduced by using three amplifiers of a cost comparable to a single one of high quality.

Finally there is a question of power-handling capacity. In theory, by separating the audio band into three channels, say from 20–200 cycles, 200–2,000 cycles and 2–20 kc, it will be possible to develop the full power through each channel independently of the others.

Assume, for simplicity, that this full power is 10 watts per section. Then, the combination can pump out a total of 30 watts. Wouldn't this be giving the same performance that is possible using a single 30-watt amplifier feeding the three channel loudspeakers through a crossover at its output?

In theory there is a difference that can be illustrated as follows: Suppose the load impedance is 10 ohms; 10 watts into 10 ohms equals 10 volts. If the 20–200-cycle unit is getting 10 watts, then it will have 10 volts at some frequency between 20 and 200 cycles. Similarly, the mid band will be receiving 10 volts at some frequency between 200 and 2,000 cycles and the upper 10 volts at some frequency between 2 and 20 kc. If these three components of the composite signal are combined, the frequency between 200 and 2,000 cycles, riding on top of the frequency between 20 and 200 cycles, will produce a maximum amplitude of 20 volts, as illustrated in Fig. 1. On top of this the



Fig. 1—Effect of adding frequencies.

component between 2 and 20 kc will produce a further 10 volts, making a total of 30.

Although the rms power of this composite waveform is only 30 watts, it requires an amplifier capable of delivering 90 watts to amplify it without distortion as a composite wave. By separating the three frequencies into separate channels each power amplifier needs to handle only 10 watts to deliver the total rms power of 30 watts.

This theoretical argument makes it appear that the separate power amplifier is much the better approach. But a little more thought shows that it is rather an idealized case and not likely to represent practice.

Most audio program material contains the bulk of its energy in the 200–2,000-cycle region, with occasional peaks due to drums and suchlike instruments producing large amounts of instantaneous power in the 20–200-cycle region. But the power needed from 2 to 20 kc is seldom more than about 1 watt. This fact washes away some of the theoretical argument by reducing the amount of power we need to handle an rms power of 30 watts from the two channels to only 40 watts instead of 90.

Now realize that in our idealized assumption there is just one frequency amplified in the 20–200-cycle region and just one frequency in the 200–2,000-cycle region. In practice there is much more likely to be a bunch of frequencies from 200–2,000 cycles, representing a chord, and perhaps a single frequency from 20–200 cycles. This means that handling an rms power of 10 watts in the middle region will

require a peak handling capacity of much more than 10 watts for this band alone, while to handle 10 watts in the lower band a 10-watt amplifier would probably be adequate.

So, all in all, the pretty little argument just put forward for three separate amplifiers does not seem to mean very much. It is probably better to use a single amplifier with sufficient peak handling capacity for any kind of audio signal encountered than to go to the expense of providing separate channels for each frequency band.

2. *How sharp a rolloff should the crossover have? Recommendations vary from a minimum of 6 db per octave to 24—and sometimes higher. Does the position of the crossover before or after power amplification have any influence on this decision?*

In the earlier discussions published about the use of multiple speakers with crossovers, the assumption seemed to be that all of the energy at frequencies below crossover was delivered to one unit, all of the energy at frequencies above crossover was delivered to the other unit. Without so stating, this assumed that an ideal crossover would have an infinitely sharp slope and that practical crossovers with a real rolloff slope were only an approximation to ideal.

For a loudspeaker to have a smooth, clean response throughout the entire band of frequencies it is to handle, it needs to have an approximately level response somewhat beyond this band, otherwise it will introduce unnatural effects in the vicinity of crossover. If the loudspeaker fulfills this requirement it should be capable of handling a diminishing amount of energy beyond the crossover point.

The high-frequency unit will be limited as to its low rolloff frequency by the excursion through which the voice-coil assembly can move. When it attempts to handle frequencies lower than rolloff at full power, the excursion would be too great and the unit would run into distortion or injure itself. However, if the excursion is limited to the maximum available, no damage will be done if it travels through this allowable distance at frequencies lower than rolloff.

As the excursion necessary to produce a given air pressure on the diaphragm is inversely proportional to frequency, a 6-db rolloff will take care of this below-crossover frequency if the excursion is within limits at the crossover frequency.

The limitation of the low-frequency unit running up into higher frequencies is usually due to the mass of the diaphragm being incapable of following the higher-frequency driving force. A good loudspeaker does not suddenly cease to reproduce above a certain frequency but has a rolloff of about 6 db per octave above this particular point. Use of a crossover that has a further 6-db-per-octave rolloff should be safe.

Some other questions to be discussed

later, such as phasing and achieving an overall flat response, will show that it is very often advantageous to use a crossover with a rolloff of 12 or 24 db per octave. But these questions are concerned with the acoustical combination of the energy from the different units rather than with the electrical performance of the system.

In answer to the part of the question about whether placing the crossover ahead of the power amplifier or following it affects the decision: Theoretically, at least, there is no difference because the overall performance will depend upon the shape of the overall response curves in the various channels, regardless of how these curves are achieved. This means that if proper care is paid to termination so that the ideal responses are realized, whichever method is used, there is no difference. In practice it is a little easier to be sure of correct termination when it takes the form of resistances instead of loudspeakers. This favors a crossover following the preamplifier and preceding separate power amplifiers for each channel.

3. *Another question related to the sharpness of rolloff concerns the reproduction of transients: Does a crossover make the system ring on transients?*

Any low-pass filter with a rolloff sharper than 12 db per octave is capable of causing ringing on transients below its rolloff frequency.

*Does this apply to crossover type filters or does the fact that there is a high-pass filter allowing the higher frequencies to get through on another channel "fill in" this ringing so it is no longer apparent?*

Actually, this is a theoretical disadvantage inherent in any crossover system. If the overlapping has been correctly taken care of in design, the overall energy response is level throughout the frequency spectrum. This will be shown more in detail in answer to later questions. But, although the response is level, the overall system has a definite phase response through the crossover frequencies.

A 6-db-per-octave crossover produces a phase change through crossover that reaches an ultimate of 90° (Fig. 2). A 12-db-per-octave system reaches an ultimate of 180°, an 18-db-per-octave system reaches 270°, 24 db per octave 360° and so on. More than two-thirds

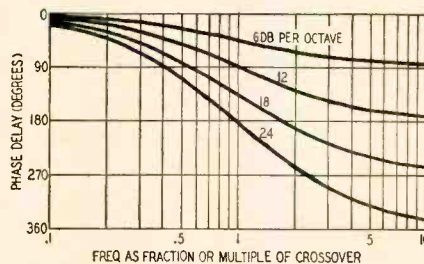

Fig. 2 — Diagram shows progressive phase delays inherent in the constant-resistance type crossovers using different numbers of elements for steepness.

of this total phase change, whichever it is, occurs between frequencies two octaves below and two above the crossover frequency.

If you consider a two-crossover system employing three bands, with a 24-db-per-octave system used for each crossover, there is a total phase transition over the frequency band of 720° or two cycles. This means that the upper frequencies are delivered by the high-frequency units two cycles late (in comparison with the lower tones they are intended to be mixed with). Definitely a form of transient distortion.

But this distortion will not be so noticeable as when the overall response is not flat. The ringing effect attributed to sharp-rolloff low-pass filters is accentuated because frequencies higher than the ringing point are not present. The fact that, in a crossover system, the frequencies at which ringing would be evident occur in the middle of the overall response band tends to minimize their noticeability, as compared with the simple low-pass filter case.

However, the answer to this question is really a good argument in favor of not exceeding 12-db-per-octave rolloff, in the interest of real high-fidelity reproduction.

4. *In design data for crossover networks, we meet the term "constant resistance" or "m-derived." What is the difference between these methods and what effect does each have on crossover performance?*

The meaning of constant-resistance type is fairly easy to explain; the significance of m-derived is a little obscure.

Various textbooks on classical filter theory describe two types of filters—constant-k and m-derived. The constant-k variety is derived from transmission-line theory, which is itself a little bit artificial for application to practical circuits. The classic derivation assumes that the filter is terminated by its *image impedance* which never has a constant value. It depends on whether the derivation is what is termed mid-series or mid-shunt: in one case the image impedance goes from the characteristic or nominal impedance down to zero at the cutoff fre-

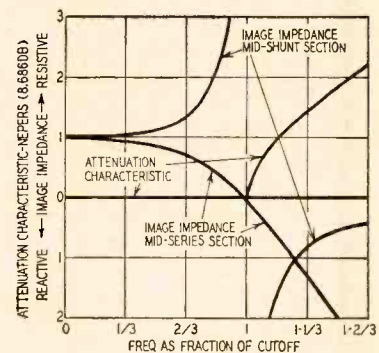

Fig. 3 — Ideal characteristics of constant-k low-pass filter; attenuation curve is theoretical, based on terminating the filter with image impedance.

## AUDIO—HIGH FIDELITY

quency; in the other it rises to infinity (Fig. 3). In either case a practical circuit is not terminated by this extraordinary impedance but by a constant resistance (under ideal conditions) and so the theoretical constant-k attenuation response usually published does not hold.

The m-derivation consists of taking some elements of the constant-k type and modifying them by a specific factor which is designated "m" and then adjusting the remaining elements of the network so that as a result of these various changes the characteristic impedance remains the same. On this basis, an m-derived filter at its simplest looks like one of the configurations shown in Fig. 4. The effect of using appropriate values in these configura-

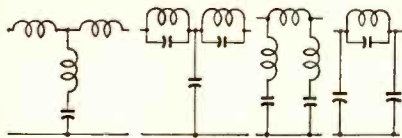

Fig. 4—Simplest forms of complete m-derived section for low-pass filter.

tions is to make the rolloff much sharper than is otherwise possible with the same number of circuit elements, and at the same time to provide a position of infinite attenuation just outside the passband (Fig. 5).

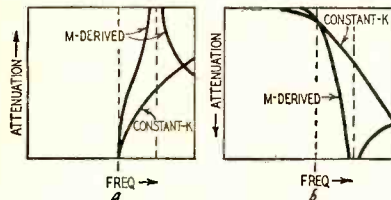

Fig. 5—Frequency characteristic of constant-k and m-derived filters: a, ideal; b, practical response.

But this is not the kind of m-derived filter referred to when talking of crossover networks. The m-derived filters used in crossover networks do not employ as many elements as the simplest true m-derived types. As far as I have been able to find, the explanation of m-derived, as applied to crossover filters, lies in an empirical adjustment of the values obtained from classic filter theory to obtain a response acceptable in practice. Otherwise stated, using a simple filter with values obtained from a quarter section according to constant-k theory, the response wasn't as good as anticipated so the values were adjusted by various experimental factors until a suitable response was achieved. The factor by which the values were eventually adjusted was given a designation m and the filter called an m-derived filter.

(I welcome a correction if this is not the true explanation.)

The constant-resistance method of design uses the same configuration of elements but the values are calculated on the basis of producing complementary impedances in the two arms of the

network, such that, when the two are combined, the resistance measured at the input is constant.

One advantage of this system of design lies in the fact that the total energy delivered to the combined outputs is constant at all frequencies, hence the overall response must be flat. Also, the amplifier is correctly matched at all frequencies by being correctly loaded. Finally, the phase difference between the energy delivered to the two units is constant at all frequencies so that, by attention to acoustical placing and to phasing of the connections, it is possible to avoid any phase interference patterns due to the combined energy from the two units.

These arguments would appear to be conclusively in favor of constant-resistance derivation as opposed to the older methods. However, it appears that the so-called m-derived types have become somewhat entrenched by tradition.

5. *It has been said that it is not possible to terminate crossover filters correctly with loudspeakers because these are not pure resistance. Can anything be done to achieve correct termination using loudspeakers?*

The only point at which the termination of a crossover network is critical is in the vicinity of its crossover frequency. If the loudspeaker produces reactance components at frequencies well away from crossover, this will have no more effect than with the amplifier working directly into the same loudspeaker. So the important thing is to see that the crossover networks are correctly terminated in the vicinity of their crossover frequency.

A low-frequency loudspeaker unit may show an impedance rise near its resonance, although, if it is correctly damped acoustically by the enclosure, this rise will be very small. This resonant frequency of the unit is usually

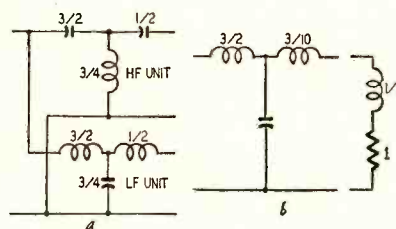

Fig. 6—Constant-resistance crossover for 18-db-per-octave rolloff: a—complete filter design; b—low-frequency section modified for voice coil inductance.

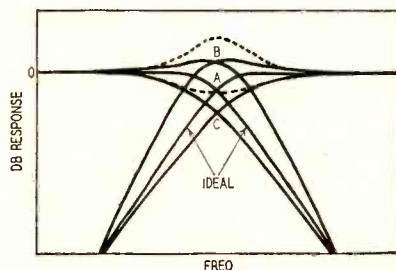

Fig. 7—Effect of input terminations on response of filter-derived crossovers.

well below the crossover frequency at which it is rolled off, so the only component of reactance likely to be present at the crossover frequency is due to the inductance of the voice coil.

The unit fed by the high-pass element of a crossover network is almost invariably resistive at its nominal impedance; the inductive element of its voice coil will not contribute appreciable reactance until a much higher frequency.

Thus the only important adjustment necessary for correct termination is compensation for the voice-coil inductance of speakers fed by the low-pass section of the crossover. To achieve this a network should be used which has a series inductance element in the output leg of the low-pass filter section.

Fig. 6 shows an 18-db constant-resistance crossover configuration which does this. Reactance values are given as fractions of working impedance at crossover frequency. The inductance feeding the low-frequency unit should be calculated on the basis of constant resistance, using the values shown. The inductance of the voice coil should then be measured and its value subtracted from the calculated value to obtain the inductance required in the low-frequency output arm. This means that the ideal or calculated value will be made up of the inductance of the voice coil in series with the actual inductance connected. The impedance reflected for the amplifier to work into will be preserved as a constant resistance.

6. *Is the input termination of a crossover network important?*

The input termination is the source resistance provided by the amplifier. Assuming that the design impedance for the crossover is 16 ohms and the damping factor of the amplifier is 10, the source resistance provided by the amplifier would be 1.6 ohms. The question is asking whether changing the amplifier source resistance from 1.6 to 10 ohms, or 16, or some other value will affect the response of the crossover unit.

This is the significance of one of the advantages of constant-resistance types. Because the impedance reflected, from the loudspeakers through the crossover unit, is a constant resistance, the response will be the same regardless of what impedance the amplifier provides as a source. This is not true with any of the so-called m-derived types and is therefore an additional reason why this type of filter should be avoided.

According to the type of network, changing the source impedance in one direction produces a peak in the response of both units near crossover frequency. In the opposite direction the change causes a considerably rounded rolloff, resulting in loss to the frequencies in the vicinity of crossover (Fig. 7). Curve A represents an ideal condition. B and C are curves for variation of input source impedance on either side of the ideal value. The dashed curves show the total energy output resulting. TO BE CONTINUED

*Redesigned equalizing circuits  
and modified high-frequency  
response provide better performance*

improved

# TAPE-RECORDER AMPLIFIER

By GEORGE L. AUGSPURGER

THE original version of this circuit was published in the July, 1954, issue of RADIO-ELECTRONICS. After more than a year's further experiment, several improvements have been made in the amplifier. The high-frequency response has been altered to give balanced response from the improved magnetic tape now in common use and the equalizing circuits of both recording and playback amplifiers were redesigned so that the unit can be used to play any of the available prerecorded tapes with very little adjustment of amplifier tone controls.

### Recording section

1. The prerecording boost on both ends of the audio spectrum has been reduced. The small amount of bass boost now used serves only to compensate for losses in the head and will not overmodulate the tape on low notes.

2. Small cathode capacitors give additional boost above 5,000 cycles where losses become really severe. The 8,200-ohm bias resistor in the final stage is higher than the recommended value, but it enables the tube to handle high signal levels with less distortion.

### Playback section

1. The first interstage network has been modified to give a playback curve reasonably close to the NARTB standard. Actually, it is a compromise between the different curves used by various professional recorders. Prerecorded tapes play nicely with only a slight main amplifier treble control adjustment.

2. The final equalizer section now gives fixed boost above 5 kc since the single adjustable capacitor can compensate for component tolerances and individual playback-head differences.

The complete circuit gives honest overall response at 7½ ips within 1½ db from 50-7,500 cycles with usable response from 30-9,000 cycles. The curves were run with a 3-mil playback head and the tape recorded 12 db down from normal recording level. The published curve of the original circuit was found to be misleading because the high-frequency response of a magnetic recorder changes according to the signal level. The revised design compensates for this nonlinearity and gives extended high-frequency response for average program material. Although the frequency range does not appear to be as good as that of the

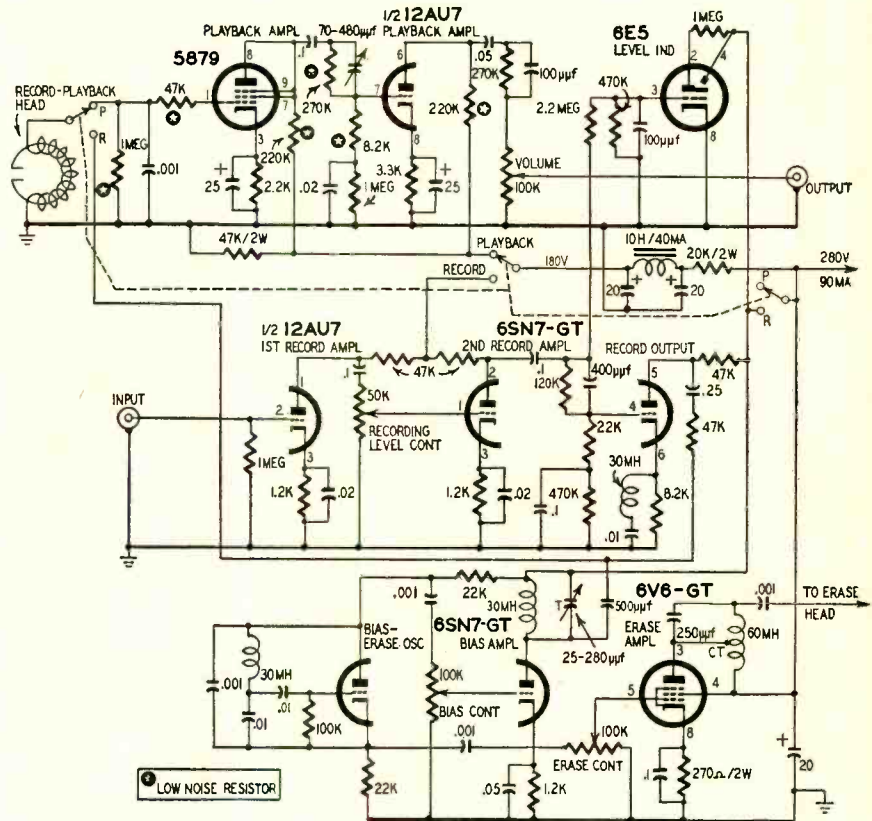

Schematic diagram shows circuitry of the improved tape-recorder amplifier.

original amplifier, in listening tests it is far superior.

Other circuit improvements are:

1. The noise control has been removed. Running a small amount of dc through the recording head works very well but, when the same head is used for playback, it gradually acquires slight magnetization which puts more noise back than we had at first.

2. The recording level control has

been moved to the second stage. This eliminates about 15 inches of shielded wire and conveniently raises the input impedance to 1 megohm.

3. The output impedance of the playback amplifier has been lowered to 100,000 ohms and a volume control added.

4. The 5879 tube was rewired as a triode to give an even lower noise level in the playback section. Since this change reduces the output voltage considerably, the original pentode connection is suggested unless your amplifier will take an input signal of only 0.1 volt.

The flexibility of this circuit permits its use with any high-impedance heads with few or no circuit changes. If one of the new extended-response heads such as the Dynamu is used, the final playback equalizer can be omitted and the cathode of the final recording stage shunted by a single 70-480-μf trimmer capacitor in place of the inductor and capacitor. END

### Parts for tape-recorder amplifier

**Resistors:** 3—1,200, 1—2,200, 1—3,300, 1—8,200, 3—22,000, 4—47,000, 1—100,000, 1—120,000, 1—270,000, 2—470,000 ohms, 3—1—2.2 megohms, ½ watt; 1—8,200, 1—47,000, 2—220,000, 1—270,000 ohms, 1—1 megohm, ½ watt, low-noise type; 1—250, 1—20,000, 1—47,000 ohms, 2 watts; 1—50,000, 3—100,000 ohms, potentiometers.

**Capacitors:** 1—100, 1—250, 1—400, 1—500 μf, mica, 400 volts; 5—.001, 3—.01, 3—.02, 2—.05, 5—0.1, 1—0.25 μf, paper, 400 volts; 1—20-20 μf, 450 volts, 2—25 μf, 25 volts, electrolytics; 1—25-280 μf, 1—70-480 μf, trimmers.

**Miscellaneous:** 1—5879, 1—6E5, 2—6SN7-GT, 1—6V6-GT, 1—12AU7; 6—tube sockets; 1—60-mh coil ct (J. W. Miller 693-T); 2—30-mh coils; 1—filter choke, 10 h, 40 ma; 1—3pdt switch; 1—power supply, dc output of 280 volts at 90 ma (if power supply is to be constructed, see diagram in author's original article on page 56, July, 1954).

**BUILD THIS...**

# TRANSISTORIZED INTERCOM WITH 0.6-WATT OUTPUT

By RUFUS P. TURNER

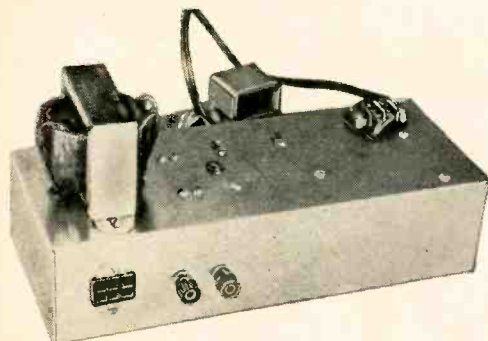

View of cable and battery connectors.



The intercom chassis and loudspeaker.

**T**HE power transistor has lifted many transistorized audio devices out of the toy class. This new unit provides *genuine* loudspeaker operation; it finds a natural application in intercom amplifiers.

The power-transistorized intercom described operates from a single 12-volt dc source. Its audio output is 0.6 watt and its characteristics suit it to portable, temporary and field operations where battery or low-voltage dc generator operation is a desirable feature.

The high audio output is provided by a single Sylvania type 2N102 power transistor. This is a small n-p-n unit (½ inch in diameter and ¾ inch high) capable of 1-watt dissipation in free air at 25°C and 5 watts when provided with a heat sink. In the intercom amplifier the 2N102 is operated class A. The table shows its characteristics in typical operation as a class-A common-emitter amplifier. (A pair of these transistors also will deliver 5 watts output in a push-pull class-B amplifier operated at a collector potential of 12 volts dc.)

While the class-A collector current of 150 milliamperes might appear high, the drain is not as severe as it seems since no current is drawn from the battery except when the transmit-receive switch in the intercom is in its talk (T) position. There is no standby current. In a tube type intercom, at least 150 ma would be drawn *continuously* by the heaters alone. A storage battery or a pair of series-connected hot-shot dry batteries will give extremely long service with the intermittent operation characteristic of an intercom.

In case of sudden emergency even series-connected size-D flashlight cells or two midget 6-volt batteries (such as Burgess F4P1) will operate it for over a month on a 2-hour-per-day *continuous* basis which is much more

severe than the actual intermittent operation of the unit is likely to be.

Fig. 1 shows the complete circuit of a single intercom unit. Two or more units may be connected together as shown in Fig. 2.

A two-stage common-emitter amplifier is used. The input stage has a conventional type 2N35 transistor V1. The output stage uses a type 2N102 power transistor V2. Both transistors are of the n-p-n type which means that their collectors must be biased *positive*. Resistor networks R2-R3-R4 and R5-R6-R7 provide dc bias stabilization. For maximum power gain, transformer coupling is employed between amplifier stages.

The small PM dynamic speaker serves as a microphone when transmitting and as a loudspeaker when listening. The transmit-receive changeover is handled by three-pole two-position, spring-return lever switch S1. This switch rests normally in its listen (L) position where S1-a and S1-c connect the output transformer to the speaker. In the talk position S1-c disconnects the speaker from the amplifier output and S1-a connects it as a microphone to the amplifier input.

Two inexpensive universal output transformers (T1 and T2) are used. Input transformer T1 matches the 3.2-ohm impedance of the speaker voice coil (when used as a microphone) to the input impedance of the first transistor stage. Secondary taps 1 and 4 of this transformer are used for the primary, or microphone, winding. The center tap and one end lead of the normal primary are used as the secondary. Coupling transformer T2 is connected for the stepdown impedance ratio between stages. The entire primary of this transformer is employed and secondary connections are made to taps 1 and 6.

Output transformer T3 is a special unit designed to match the 100-ohm collector of the 2N102 transistor to the 3.2-ohm voice coil. The primary of this transformer must be able to handle the 150-ma collector current. T3 is an Acme type T-24041, developed in close cooperation with the author and now obtainable from Acme Electric Corp. (West Coast Division), 1375 W. Jefferson Blvd., Los Angeles, Calif.

Fig. 2 shows how two intercom units might be connected with a five-wire cable. Changeover switch S1 at each station rests in its listen position and both intercom units are dead. Section S1-b of either switch, however, closes the battery circuit to *both* amplifiers when the switch is in its talk position. When station A is transmitting, its speaker is switched to the amplifier input as a microphone; at station B the speaker is at the amplifier output and the output from station A is applied to the input at station B. Battery voltage is applied to both units. Thus, A talks and B listens. When station B is transmitting the opposite set of conditions results.

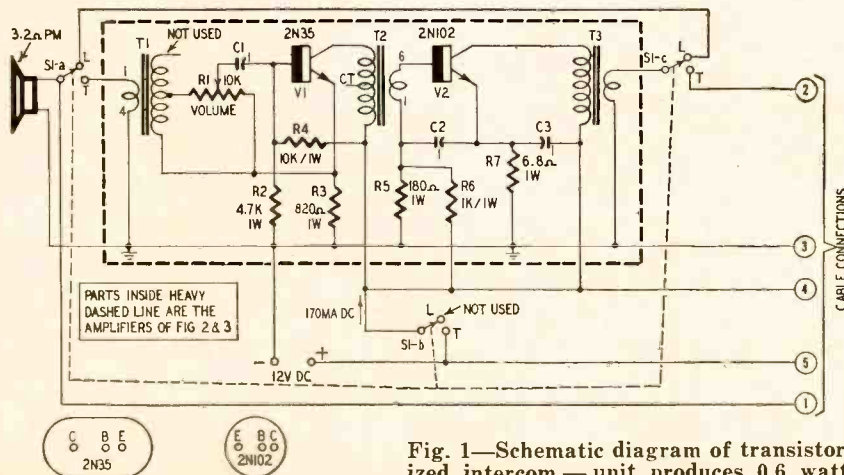

Fig. 1—Schematic diagram of transistorized intercom — unit produces 0.6 watt.

The circled numbers in Fig. 2 refer to terminals of the cable plug and to cable leads. No. 1 of station A is connected to No. 2 of station B, 2 to 1, 3 to 3, 4 to 4 and 5 to 5. Additional stations may be connected by running No. 1 of station A to No. 2 of the new station, 2 to 1, 3 to 3, 4 to 4 and 5 to 5. With this arrangement any station can communicate with any other.

Fig. 3 shows a simpler and less effective system. Nevertheless, it is entirely satisfactory for use over short distances. Here only one intercom amplifier is used and the remote installation (station B) consists only of a speaker and changeover switch. The switches at each station in this setup are of the double-pole double-throw type. When station A is transmitting, speaker A becomes the microphone and speaker B is switched to the output circuit of the amplifier. When station B is transmitting, speaker B is switched to the amplifier input to serve as the microphone, while speaker A is transferred to the amplifier output.

In any of the installations (Fig. 2 or 3) only one battery is required and this can be installed at any of the stations which is most convenient.

I used a 3-inch speaker for size convenience (see photos). However, a 4- or 5-inch speaker possibly will be more effective both as a microphone and as a loudspeaker.

**Mechanical construction**

The photos show constructional details of one of the units. The metal chassis has been removed from the wooden case which houses it and the speaker.

A type P-406-AB Jones plug is connected to each end of the cable to mate with the sockets. One terminal of each plug and socket is not used since a five-wire cable is used but five-contact

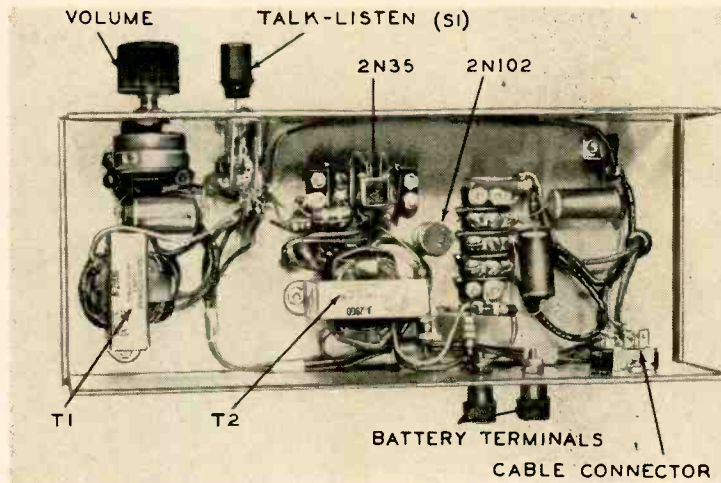

An underchassis view of the intercom.

sockets and plugs were not readily available.

The changeover switch is a four-pole two-position, spring-return, non-shorting, lever type (Centralab type 1457). One pole and the corresponding pair of contacts are not used.

As shown in the outline drawing in the table, the 2N102 power transistor has a 1/4-inch-deep 10-32 threaded

mounting hole in one end. This transistor must be bolted to the chassis which carries away heat from it. But, at the same time, the transistor must be insulated electrically from the chassis because the metal shell of the 2N102 is connected internally to the collector electrode. This can be done by placing a washer, cut from 2-mil-thick mica, between the transistor and the chassis and using a fiber shoulder type washer on the other side of the chassis to insulate the 10-32 mounting screw from the chassis. The mica washer is a good electrical insulator but is thin enough to allow most of the heat to pass from the transistor into the chassis.

The pigtailed of both transistors are held under the screws of three-screw terminal blocks (Cinch-Jones type 3-140). This makes a good, solderless connection. The 2N102 is mounted close to one of the terminal blocks. The 2N35 is mounted by hanging it from the second terminal block by its pigtailed.

**Parts for transistorized intercom**

**Resistors:** 1—6.8, 1—180, 1—820, 1—1,000, 1—4,700, 1—10,000 ohms, 1 watt; 1—10,000-ohm potentiometer.

**Transformers:** T1, primary impedance (as per diagram) 3 ohms, secondary (in circuit) 2,500 ohms (Merit A-2900, Stancor A-3823 universal output types, or equivalent); T2, primary impedance 12,000 ohms, secondary 32 ohms (same type as T1); T3, primary impedance 100 ohms at 150 ma, secondary 3.2 ohms (Acme T-24041).

**Miscellaneous:** 3—1- $\mu$ f, 200-volt, miniature, metallized-paper capacitors; 1—3-pole, 2-position, spring-return, non-shorting, lever type switch (Centralab 1457—one section not used—or equivalent); 1—2N35 n-p-n junction transistor; 1—2N102 n-p-n junction transistor; 2—3-screw terminal blocks; 2—insulated binding posts; 1—aluminum chassis, approximately 10 x 4 x 2 1/2 inches; 1—3- or 4-inch PM dynamic speaker, 3.2 ohms; 1—2-screw terminal block; 1—12-volt battery; 1—cable socket, (Cinch-Jones S-406-AB or equivalent); 1—length of 5-conductor cable.

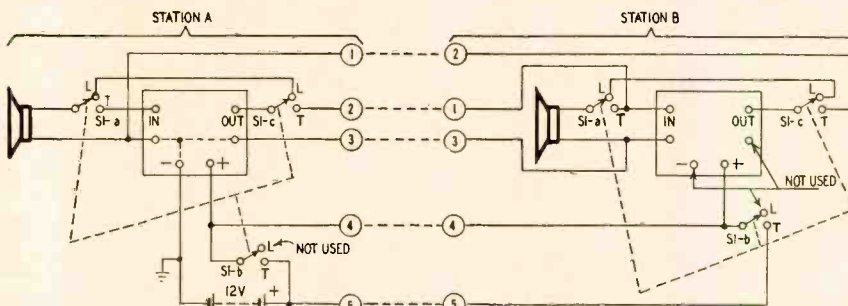

Fig. 2—Diagram shows a typical two-station intercom installation.

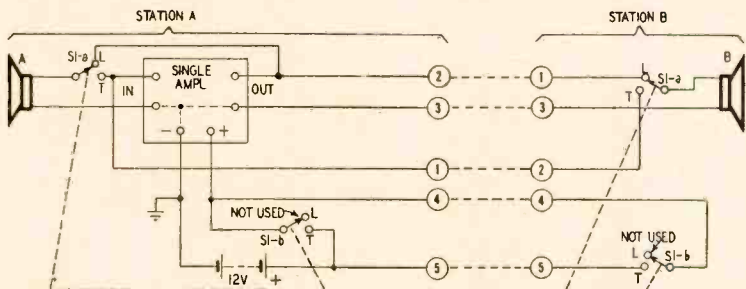

Fig. 3—Schematic of an economy two-station, short-distance installation.

OPERATION *	
$E_c$	12 v
$I_c$	150 ma
$I_b$	5.0 ma
$R_{in}$	75 ohms
$R_L$	100 ohms
Output	600 mw
Gain	23 db

\* As class-A amplifier, common-emitter circuit.

Mechanical details and table of operating characteristics — Sylvania 2N102.

# FOR GOLDEN EARS ONLY

*Marantz audio consolette;  
Frazier-May Symphony-Diva  
By MONITOR*

PERHAPS I'm not the one to review the Marantz consolette objectively—perhaps it just happens to suit my particular tastes or prejudices—but it has pleased me so completely that I can offer no adverse criticism.

Without imputing to myself any qualification for membership in the class, this is a control unit for the real connoisseur who owns the best obtainable speakers, amplifiers and record playback components. There is nothing startling about its performance as

measured either by instrument or ear, except its unprecedented smoothness and freedom from any aberration. For that matter, many people may be disappointed in the first few minutes of use—neither the bass nor treble boosts or cuts produce any violent results. Indeed, when used with speaker systems whose response on both ends is limited, the controls may have to be turned all the way to produce a really notable result, and it would be wiser with such systems to use a control unit with sharper, more definite effects.

But with top-notch equipment it provides exactly the compensation needed to get the most from them. The loudness control, for example, has a sliding crossover; except in the final positions, most of its bass boost occurs in the region of the final two octaves where it is most needed. This brings up the fundamentals of the low bass rather than the harmonics. Most loudness controls achieve a spectacular bass boost but usually only at the expense of definition and naturalness. The Marantz manages to improve the nat-

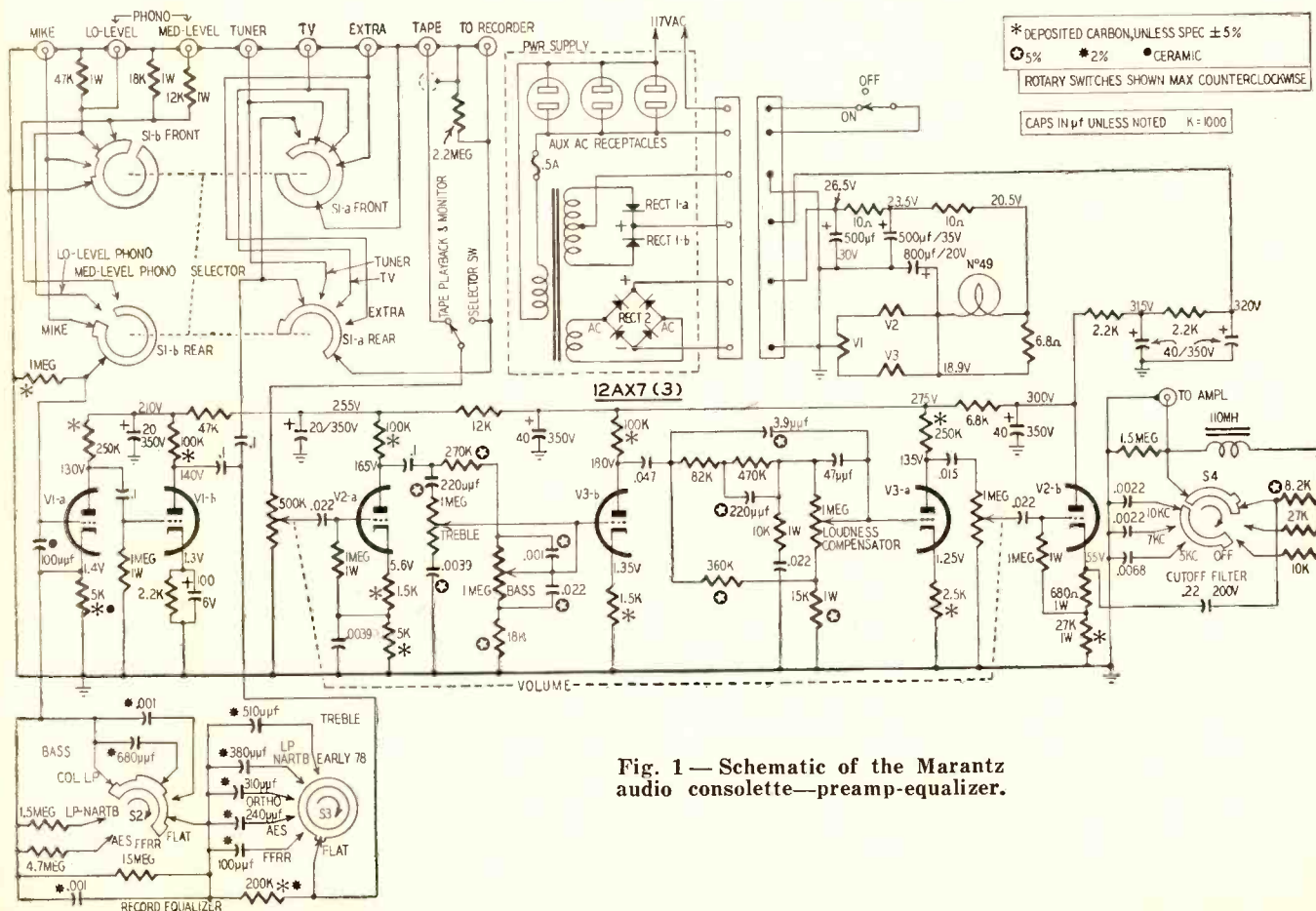



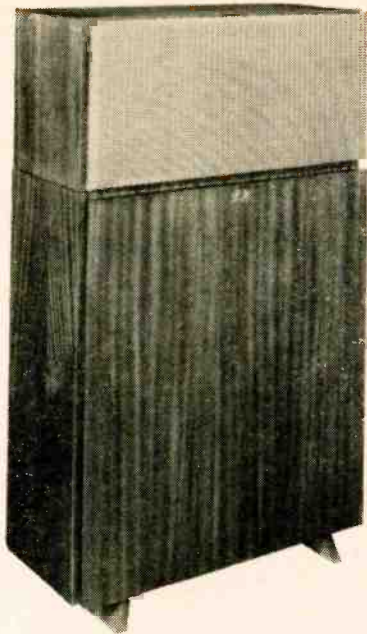

Left, the Frazier-May Symphony-Diva.

uralness by helping to bring the fundamentals of the low bass up without muddying them with overboosted mid-bass and harmonics.

The bass boost and cut is hinged at 375 cycles and over most of its range its effect is also below 100 cycles with similar virtues. The treble turns over at 2,500 cycles, rather than 1,000 or 500. As a result most of the boost or cut occurs in the high-high range around 10 kc, which again is where it is most needed. Thus, when necessary, the high highs can be boosted without also boosting the distortion, record scratch, etc., whose most annoying components center around 3,000 cycles.

Personally, I seldom need any treble boost. I find more records which need a judicious rolloff to reduce overcutting distortion and few clean enough to stand much boost even at 10 kc. The rolloff on the Marantz is extremely effective and smooth. But again its effects are likely not to be appreciated at first hearing—even in the most extreme position, only the high-highs are cut off.

The phono equalizer has independent bass and treble equalization and these are most exact. There are six bass turnovers (Fig. 1), including flat, and six treble rolloffs, including flat. They will take care of practically every recording curve used and very smoothly too. The source switch takes care of six inputs, including a mike, a low-level magnetic cartridge with a 47,000-ohm input and a medium-level one with a 30,000-ohm voltage dividing input.

In addition there are high-level inputs for tuner, tape and TV and a spare for crystal phono cartridge. The latest model also has a slide switch to permit monitoring either the input or the output of three-head tape recorders. The output is from a cathode follower.

Smoothness is the word for the operating characteristics. Not only are the effects achieved smoothly, but the knobs, switches, etc., operate without betraying



The Marantz audio console—separate power supply is shown at left.

any evidence to the ear that they are there. There are no clicks or pops and if properly installed to a pickup and turntable reasonably free of hum, there is no hum. The power supply is in a separate case.

The console is priced right at the top of control units, but those who can afford it, who possess other equipment of comparably fine quality and have the taste and experience to appreciate its fine performance, will have no regrets about the cost.

#### Frazier-May Symphony-Diva

Messrs. Frazier and May have not been afraid to investigate new means for achieving fine speaker performance. In the past 2 years they have been developing an interesting and very different series of enclosures in which one side of the speaker works into a 360° radial slot about 1 inch wide, and the other into a folded horn which, in the larger models, works in turn into a room corner. There is no point source—except for the tweeter covering the top two octaves or so—since both the slot and the horn radiate in a plane, as it were.

I have been using the higher-priced combination consisting of the Symphony woofer and the Diva for mid and high frequencies. They form a very compact combination in a corner, being about 42 inches high, 22 inches wide and protruding about 21 inches into the room from the apex of the corner.

The combination belongs in the top category of speaker systems and possesses some points of superiority over most others. The most notable characteristic is the high amount of presence or pseudo-stereophonic effect achieved by using the radial slots—the typical hole-in-the-wall effect is absent. The music seems to spread through the room or is heard as if through a very large door. In this respect the system is just about the equal of my own vertical bank of four loudspeakers in a wall, which also has a very wide radiation pattern. The difference is largely in the tweeter performance.

The single, direct-radiating Frazier-May tweeter is much more markedly directional than my wall-mounted system which uses no separate tweeter (each of the four individual speakers is wide range).

The bass should please everybody but those who chase that final octave down to 16 cycles. The response seems reasonably flat down to about 40 cycles, maintains a respectable efficiency down to 30 and then cuts off pretty sharply. The quality of the bass, too, is extremely good, both in color and in hangover characteristics. I have no doubt that A-B comparison with a genuine organ bass or the final octave of the counter bassoon and double bass will show some coloration. This is due to a less efficient radiation of the fundamental which has the effect of emphasizing the harmonics and producing a "rounder" or brighter—as opposed to dull—bass presentation.

But I think it will take such comparisons to notice this and I'm not sure there is any commercial portable system of which the same could not be said. Certainly, nobody can complain about lack of bass, for the system appears to be very efficient. And even at low levels it takes very little bass boost or loudness control to produce all the bass even a jukebox hound can tolerate. The definition of the bass is excellent. There appears to be very little hangover at any normal playing level, and there is no difficulty recognizing bass instruments clearly or handling sharp bass transients like rapid beats produced by the kettle-drums.

The combination has one characteristic which will probably please most audiophiles more than it did me: Because of the high efficiency of the bass and high-high ends, the middle, especially the region between 1,000 and 5,000 cycles, seems somewhat suppressed. In other words, the response is somewhat like that of a system with both treble and bass boosts advanced. You might call it built-in Fletcher-Munson compensation. END

# A Stabilized Dot Generator

*A must for color TV adjustment; unit produces high-definition dots that are positively locked in*

By EARL T. HANSEN

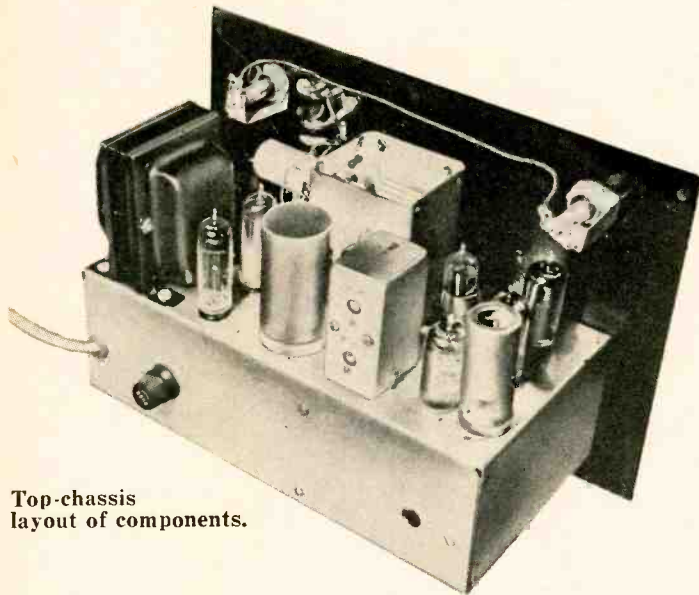

Top-chassis layout of components.



Panel view.

**T**O adjust convergence rapidly on a color television receiver a white dot generator is needed. It should be able to produce small and sharply defined dots without ringing or smear; be connected to the receiver with a minimum of cables and adjustments; provide dots locked in sync—both horizontal and vertical—and free of wiggles due to slight ac leakage or fields within the receiver.

The unit (block diagram, page 54) also contains a chrominance oscillator that provides color bars for checking the color circuits in a receiver. The theory and application of the chroma oscillator principle are thoroughly covered in "Rainbow Generator" (January, 1955) and "Chroma Signal Generator" (January, 1956), and will not be discussed.

This dot generator feeds directly into the antenna terminals of a TV set through its 300-ohm output lead. Though the unit tunes to channels 2 through 5 only, it is unnecessary to select an unused channel if the external antenna is removed from the receiver.

The generator output is not variable, being fixed at approximately 2,000 microvolts. The dots can be sharpened with the fine-tuning control on the set, but it is preferable to use the channel tuning on the generator. To observe the dot pattern turn the receiver brightness down—in most cases, all the way. The contrast will probably have to be lowered to darken the background sufficiently (Fig. 1). When the brightness and contrast are advanced, a cross-hatch pattern is visible (Fig. 2).

A stable oscillator at 220.5 kc ( $14 \times 15,750$ ) produces 14 vertical rows or bars. Two occur during retrace time and thereby reduce the number of visible rows to 12—provided others are not obscured by excessive width. Narrow pulses, sharpened by L2 (Fig. 3), are taken from the cathode of V1-a and fed to inverter V2-b. Positive pulses, taken from the cathode of V2-b, sync the horizontal blocking oscillator V1-b at 15,750 cycles. Negative pulses from the plate of V2-b are fed to the cathode of coincidence amplifier modulator V4-a. Pulses from the plate of hori-

zontal blocking oscillator V1-b are fed through clipper mixer diode V5 to the grid of sync amplifier modulator V4-b.

The 60-cycle ac voltage from the power transformer secondary is clipped to a square wave by the action of the neon bulb. The square wave is differentiated to form sharp pulses which are fed to V6. Buffer-inverters V6-a and V6-b are biased to cutoff and therefore amplify only the positive-going portion of these pulses. Two sections are needed to isolate multivibrators V7 and V8.

V8 is an asymmetrical multivibrator producing relatively narrow 60-cycle pulses for vertical frame synchronization. This tube is triggered by the pulses from V6 and thus the vertical sync is positively locked with the ac line frequency. This prevents the distracting weaving of vertical lines or rows on the TV screen as caused by unavoidable hum leakage in various receiver sections. The output of V8 is fed through a clipper diode to the sync amplifier modulator along with the horizontal pulse from V1-b. The plate voltage of V4-b rises momentarily, to

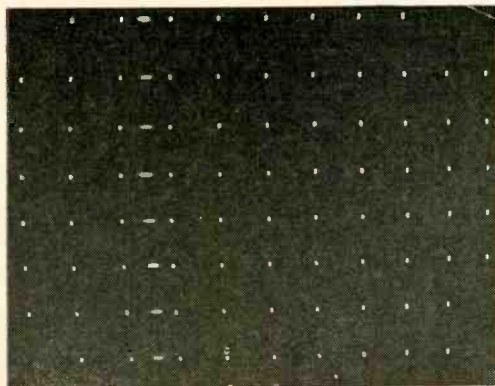
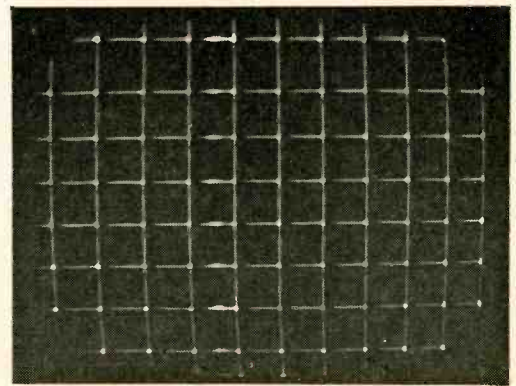

Fig. 1 — Pattern of white dots as seen on a black-and-white television set.



Fig. 2 — Increasing the brightness makes the cross-hatch pattern visible.



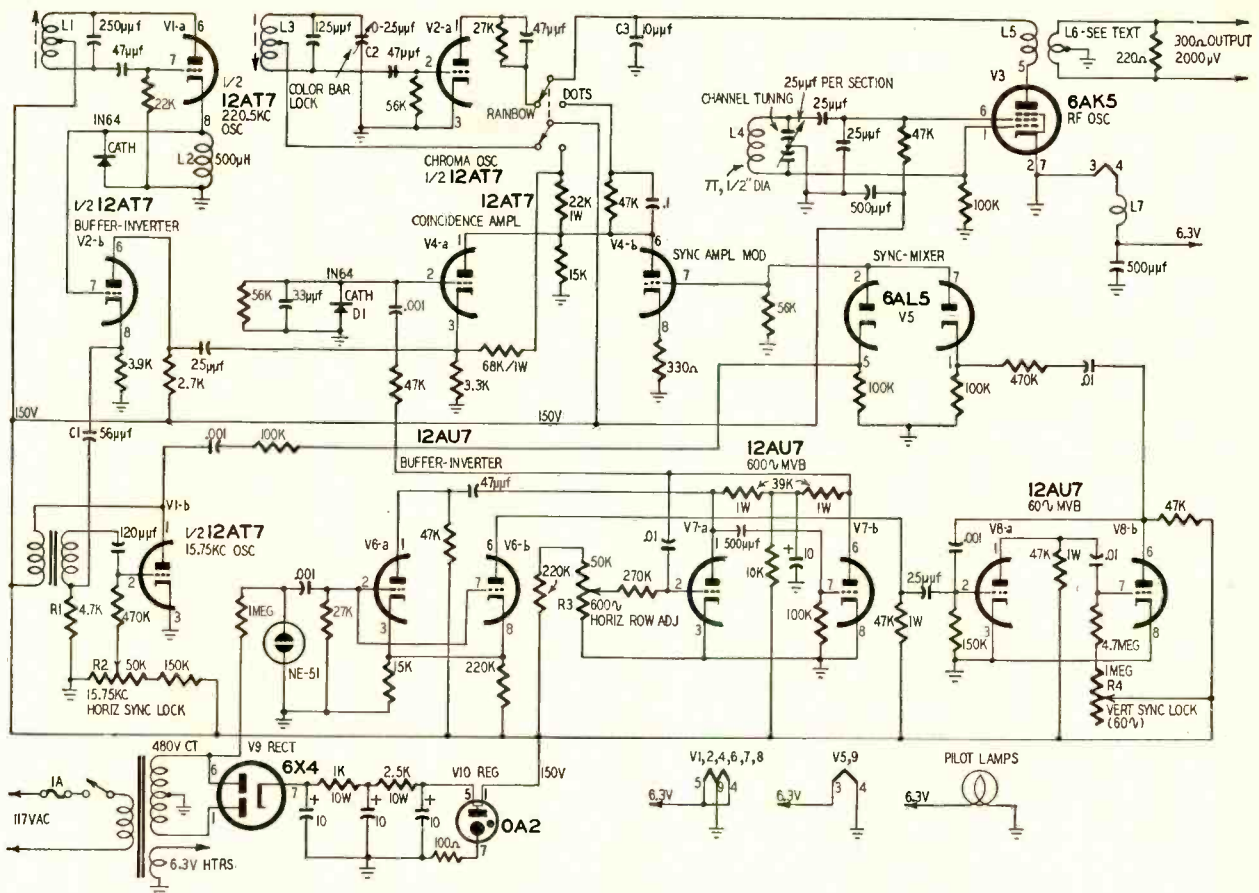

Fig. 3—Schematic diagram of the stabilized dot generator. Instrument feeds directly into receiver input.

a certain limited value, with the application of either a horizontal or vertical negative pulse to the grid, modulating the rf oscillator (V3) accordingly.

Multivibrator V7 operates at 600 cycles or some other multiple of 60, depending on the number of horizontal rows desired. This tube is also triggered by a pulse from one section of V6. Since this multivibrator is being triggered by a pulse occurring at a much slower rate than the natural free-running speed, the spacing between the triggered pulse and the preceding one may be greatly reduced. This is of no importance, as it occurs at the bottom of the raster; therefore the row spacing from top to bottom is regular and not affected. The result is horizontal dot rows which are locked to the line frequency and rock-steady. Output of this tube is fed to the coincidence amplifier

grid (V4-a), pulse tips being clamped by diode D1.

Coincidence amplifier V4-a is normally biased considerably beyond cutoff so that plate current does not flow except during the simultaneous application of a negative 220.5-kc pulse to the cathode and a positive 600-cycle pulse to the grid. The resulting current flow (Fig. 4) causes a negative pulse on the plate which is used to modulate the rf oscillator plate downward when producing a white dot at that instant in the receiver. In actual practice there is a slight current flow in the coincidence amplifier when either one of the two pulses is applied. This explains why bars as well as dots can be seen with increased brightness on the receiver.

Several types of modulated oscillators were tried but the one used proved best, especially with regard to modulation

depth, rise time (sharpness of dots) and modulation linearity. The grid and screen of V3 are connected as a Hartley oscillator which operates at a relatively fixed amplitude, regardless of plate voltage. The output, taken off the plate, however, varies with applied plate voltage and thus allows the rf output to be modulated conveniently.

The plate supply voltage as applied to all stages is regulated by gas-discharge tube V10 and further improves the stability of the generator.

Circuit layout is not critical, except in the rf oscillator. Detailed layout of the original working model is not given because it was the result of much trial and error and builders can do a far nicer job.

Coil L1 for the 220.5-kc oscillator was one used in the ART-13 50-kc marker generator. However, any coil-capacitor

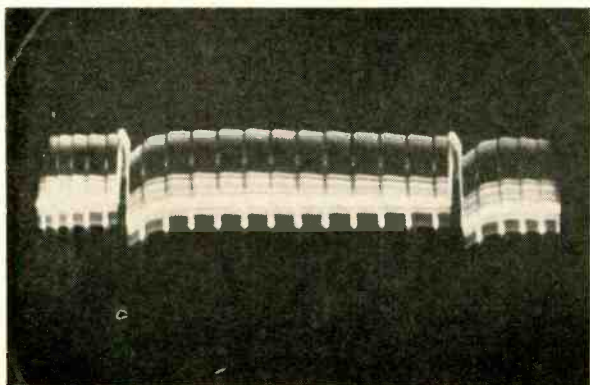

Fig. 4—Composite waveform on plates of V4 during normal dot generation.

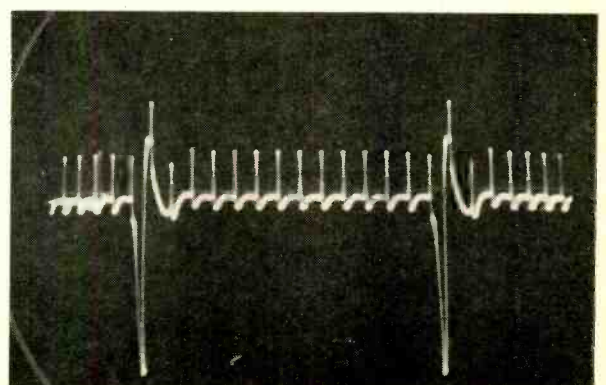

Fig. 5—Waveform at junction of C1 and R1 when the horizontal sync lock is correctly adjusted to a 14:1 ratio.

## TEST INSTRUMENTS

combination covering the correct frequency could be used. A crystal would be still more desirable, provided one could be obtained within 500 cycles of the frequency. Preliminary adjustment of this oscillator can be made with the aid of a frequency meter or by listening to harmonics on the broadcast band. Final adjustment of this oscillator is made, when the generator is completed, by coupling the generator to a set receiving a normal TV picture and tuning the generator just near enough to the received signal to cause interference bars—probably diagonal. The 220.5-kc oscillator is then adjusted until the bars are vertical and steady (or just moving from side to side slowly).

Speed control R2 for the 15,750-cycle oscillator is brought out the front panel as a screwdriver adjustment. The lock-in range of this control is narrow, but stable once set. By connecting an oscilloscope to the junction of R1 and C1 we can observe both the 220.5-kc and 15,750-cycle pulses. When there are 14 of the small pulses for each one of the larger ones, it is adjusted correctly (Fig. 5). However, you may find it simpler to adjust this control while watching the dot or bar pattern on a screen of a TV set.

The speed control for the vertical sync pulse (R4) was brought out the front as a screwdriver adjustment. However, this was not necessary due to the very wide lock-in range of this multivibrator. It is easily adjusted by connecting the scope to pin 1 of V6. Use a 60-cycle sine-wave sweep on the scope and when the observed single pulse is stationary the adjustment is correct (Fig. 6).

The speed control of the 600-cycle multivibrator (R3) is also a front screwdriver adjustment. This changes the number of horizontal rows as desired.

Chroma oscillator coil L3 is adjusted with a frequency meter or by listening to it on a communications receiver. An accurate grid dip meter would do as well. Front panel control C2 (color bar lock) must be able to vary the frequency a minimum of 32 kc either above or below the color subcarrier frequency of 3.58 mc. For greater accuracy and ease of operation it could be crystal-controlled as described in the January, 1956, issue of RADIO-ELECTRONICS.

In constructing the rf oscillator, care

should be taken to isolate output coils L5 and L6 from the grid and screen components of V3 to keep the output as low as possible when the plate voltage is at zero. It was found this could best be done by shielding coil L4 and its associated components. Plate voltage and filament leads are bypassed to minimize unwanted radiation further.

Plate coupling coil L5 consists of two turns of hookup wire, 1/2 inch in diameter; L6 is also two turns with the center tap grounded to balance the output and reduce electrostatic pickup. The coupling between L5 and L6 is adjusted to give an output of approximately 2,000 microvolts—about 1/2-inch spacing. Capacitor C3 should be placed as near L5 as possible and with short leads to ground.

When viewing the dots on a black-and-white receiver, close examination may reveal that the scanning lines within each dot have a tendency to crawl up or down. This is because there is no lock between 60 cycles and the 220.5-kc oscillator. Therefore, the exact harmonic relationship doesn't always exist. However, this is in no way objectionable and is mentioned as an explanation of this phenomenon only. On color receivers this is not noticeable since the scanning-line structure is not

### Parts for dot generator

**Resistors:** 1—100, 1—220, 1—330, 1—2,700, 1—3,300, 1—3,900, 1—4,700, 1—10,000, 2—15,000, 1—22,000, 2—27,000, 1—39,000, 6—47,000, 3—56,000, 1—68,000, 5—100,000, 2—150,000, 2—220,000, 1—270,000, 2—470,000 ohms, 1—1, 1—4.7 megohms, 1/2 watt; 1—22,000, 1—39,000, 1—47,000 ohms, 1 watt; 1—1,000, 1—2,500 ohms, 10 watts; 2—50,000, 1—1 megohm, potentiometers (linear).

**Capacitors:** 1—10, 4—25, 4—47, 1—33, 1—56  $\mu$ f, mica or ceramic; 1—125, 1—500  $\mu$ f, mica; 1—120  $\mu$ f, silver mica; 1—250  $\mu$ f, zero temperature coefficient; 2—500  $\mu$ f, disc ceramic; 4—001, 3—01, 1—0.1  $\mu$ f, 400 volts, paper tubular; 1—10—10—10  $\mu$ f, 450 volts, electrolytic; 1—0—25  $\mu$ f, variable; 1—0—25  $\mu$ f, 2 sections, variable.

**Coils and transformers:** L1, 220.5-kc, center-tapped, slug-tuned oscillator coil (see text); L2, 500- $\mu$ h rf choke or video peaking coil; L3, 3.58-mc slug-tuned, center-tapped oscillator coil—44 turns of No. 30 wire on 1/4-inch form; L4, 7 turns of No. 18 solid hookup wire—1/2-inch diameter, air-wound, spaced to cover correct channels; L5, 2 turns of hookup wire on 1/2-inch form; L6, 2 turns of hookup wire on 1/2-inch form, spaced 1/2-inch from L5; L7, filament choke, 20 turns of No. 26 wire on 1/4-inch form; 1—power transformer, 480 volts ct at 50 ma, 6.3 volts at 2.5 amps (Merit P-3147 or equivalent); 1—horizontal blocking oscillator transformer (Stancor A-8110 or equivalent).

**Miscellaneous:** 3—12AT7, 3—12AU7, 1—6AL5, 6AK5, 6X4, 1—0A2, 6—9-pin, 4—7-pin miniature sockets; 1—NE-51 and socket; 1—1-ampere fuse and holder; 2—diodes, 1N64 or 1N34, or equivalent; 1—5-foot length of 300-ohm lead and clip; 1—line cord; 1—spst, 1-dpdt switch; 1—chassis, approximately 3 x 5 x 10 inches; 1—cabinet; pilot-light assemblies.

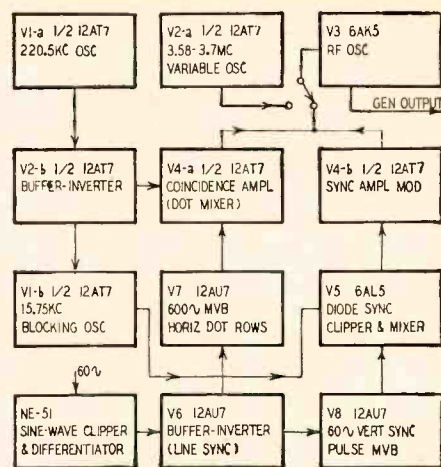

Block diagram of the stabilized dot generator shows layout of stages.

visible, particularly on shadow-mask type tubes.

Should you want to improve this characteristic and give the dots the appearance of good interlace, a front panel *interlace control* can be added. This consists of a small variable capacitor (approximately 0—35  $\mu$ f), rotor grounded, stator connected to the 220.5-kc oscillator plate (pin 6 of V1-a). The oscillator should be adjusted to the correct frequency with the capacitor half closed. Adjustment of this control is effective but not critical. I highly recommend that the chroma oscillator (V2-a) be crystal-controlled with a 3,563.8-kc crystal. (Available from International Crystal Manufacturing Co., Oklahoma City, Okla., for \$2.80 post-paid—suggested circuit included.) If this is done it will free C2 to be used as the interlace control.

Many manufacturers are now recommending that a white crosshatch pattern be used for convergence adjustment. The crosshatch pattern from this generator can be made sharper and more uniform in shading by adding a switch (Fig. 7) to change from dots to crosshatch (Fig. 8). END

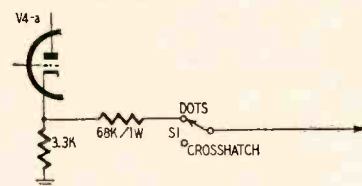

Fig. 7—Improving crosshatch pattern.

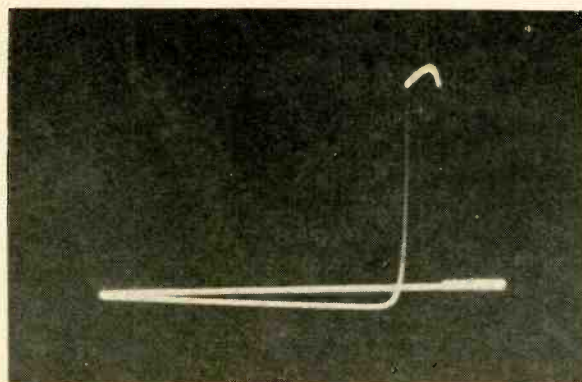

Fig. 6—Wave form on Pin 1 of V5 when vertical sync lock is correctly set. Scope uses a 60-cycle sine-wave sweep.

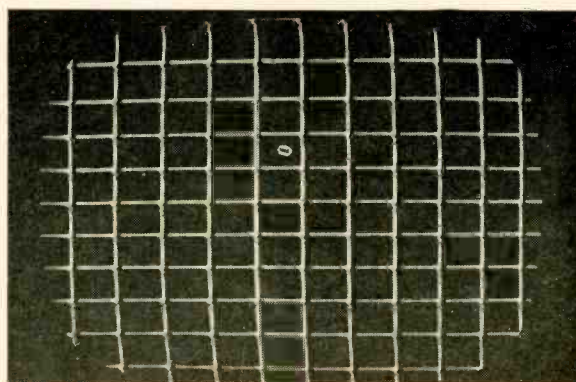
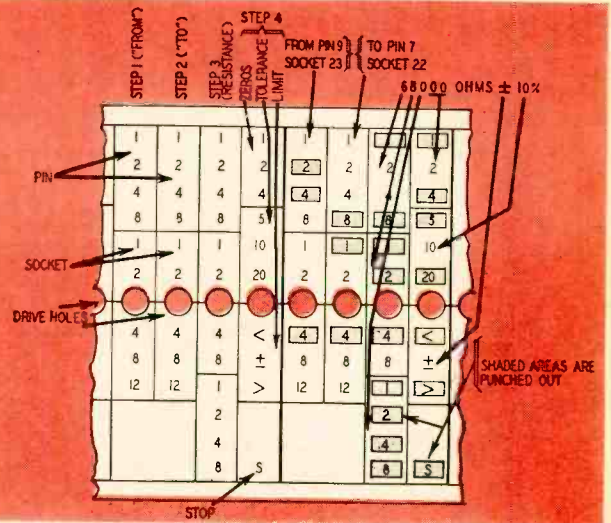
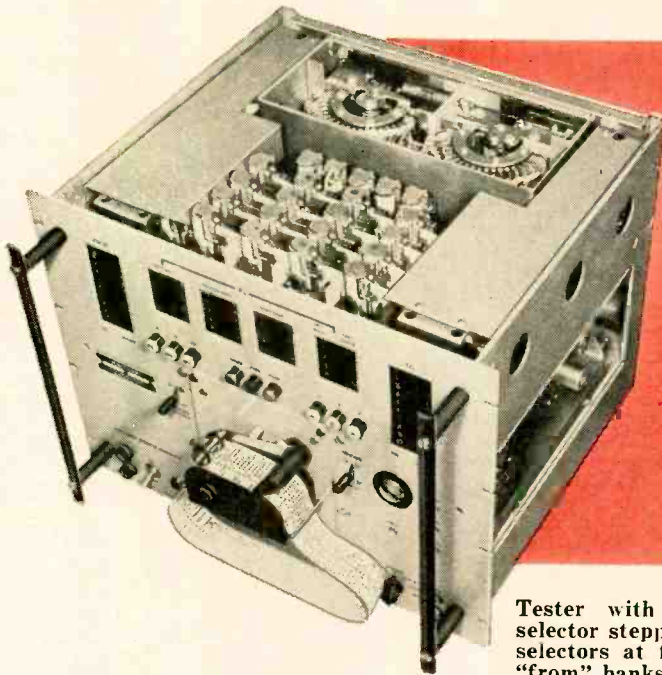

Fig. 8—Cross-hatch pattern obtained by opening switch S1 in Fig. 7.

# ROBOT CIRCUIT TESTER

By ALVIN F. RYMSHA \*



Tester with covers removed. Point-selector steppers are at rear, resistance selectors at front-center and "to" and "from" banks under covers along right and left sides.

Fig. 1—A section of tape showing the method of punching program material.

SINCE the advent of automatic assembly of radio and TV chassis, methods for automatic testing and circuit checking have been investigated by the electronics industry. Techniques that 10 years ago were impractical novelties are today used by every manufacturer to keep his production costs down to those of his competitor.

At least half a dozen automatic circuit checkers are now in common use throughout the industry, each with its particular appeal and advantage. This article describes the circuits and operation of one of the latest, the Robotester, manufactured by Lavoie Laboratories.

The Robotester is essentially a resistance-measuring instrument, capable of measuring dc resistance in the range of from 1 ohm to 10 megohms and determining whether the resistance under test is within the tolerance specified. The instrument can select any 2 points out of a maximum of 240, in any order, and may be plugged into the tube sockets of a chassis to check resistance or continuity between any 2 pins on the chassis.

## Programmed by tape

This unit differs from its competitors in that it is programmed by a punched paper tape (Fig. 1). The tape tells the instrument what points to select, what resistance to find between them, what tolerance (5%, 10% or 20%) is permissible and whether the passing limit

\* Engineer, Lavoie Laboratories, Morganville, N. J.

should be less-than, plus-or-minus, or more-than. The paper tape may be punched by a simple hand punch somewhat resembling a desk stapler, by anyone capable of operating a typewriter on the hunt-and-peck system. The average tape for a 16-tube chassis would require about 90 minutes to punch out. About 4½ hours would be required to prepare the program for the tape, working from the schematic diagram of the chassis to be checked. At the present time, the instrument has not found application in the independent servicing field, but as more set manufacturers begin to use them on production lines, prepunched tapes may become available.

A binary code is used to punch in the numerical information in the point and socket selection areas, the resistance significant figures and the decimal place. The tape is read by a row of grounded brushes, which contact copper strips beneath the tape when a hole appears in it. Fig. 1 shows the significance of the punching code. The areas shown shaded are punched out. A tape may be used tens of thousands of times.

The Robotester contains 63 telephone type armature relays, four 8-bank, 20-position steppers and one Ledex rotary relay, but the functions performed break down into relatively simple circuits. The Ledex is gear-connected to the sprocket wheel that pulls the tape through the brush assembly, one step at a time. Starting from the first row of the tape (four rows are used per test), the 12 brushes read the holes in

the tape and current passes from the point-selection relays through the brushes to ground. Those relays corresponding to grounded (holes-in-tape) contacts are energized; others remain de-energized.

For circuit simplicity, the de-energized relays carry the significant information. The rotary relay is also coupled to a switch wafer that energizes one of four relays on each step. These four relays determine which banks of information relays are to be energized; that is, in step 1, current is supplied only to those relays responsible for setting up the "from" point and no others. In step 2, another bank is energized and so forth. The relays connected for steps 1, 2 and 3 have make-before-break contacts in addition to their other contacts so that, once energized, they hold in until the main bus power is cut. As the relays are pulled in by the current through the brushes, another circuit is made to a 115-volt dc line, and the contact to the brushes is broken. Approximately 50 milliseconds after the initial contact is made, a delayed relay in the bank makes its contact and the rotary relay is stepped to its next position. The delay allows all the setup relays to operate before the step is made.

Step 2 is a duplicate of step 1, utilizing another identical bank of relays to set up the "to" point and socket. Step 3 sets up the three significant figures of the resistance to be measured. When the Ledex relay reaches step 4, the zeros are set in by the

## TEST INSTRUMENTS

operation of one or more of the three "zeros" relays (or none, if no zero is to be added), the tolerance selected by operation of a relay to vary the gain of the bridge amplifier (described later) and the limit selected by blocking either or neither of the "under-reject" or "over-reject" relays. At the conclusion of the test at step 4, the 115-volt bus is momentarily interrupted and the relays all drop out to wait for a new sequence.

In setting up a point (either "to" or "from") 6 of the 8 banks on 2 of the stepping relays are used, each bank having 20 contacts. The total of individual contacts is therefore 240. Each contact is connected to a pin on one of the 24 10-pin sockets on the rear of the chassis. These sockets receive the cables from the set under test. (The sockets actually have 11 contacts, with No. 11 grounded.) By causing the steppers to move to a certain position, like a rotary switch, and then connecting to one of the banks, we can select any of the 240 contacts. The remaining two banks on each stepper are used to light the front-panel indicators and operate positioning circuits that stop the relay at the desired point. The second point (to) circuits are identical and go to the same socket contacts, so it is possible to have both circuits connected to the same point. (This is not a usable condition, of course.) By the same token, a check can be made from any point to any other point, in any order.

Fig. 2 shows the circuit that positions the steppers in the "to" and "from" circuits to select one of the 240 pins on the 24 cable connectors. By opening and closing the various relays, only one path is complete and the rotor contact will move until that

circuit is completed, removing voltage from the stepper coil. Since 8 of these rotors are mechanically ganged to the stepper, the pin-selector rotors are pulled around with the positioning rotor. The rotor may stop in either the first or second half of the 20-step sequence, depending upon the position of the "add-1" relay. This relay is part of the socket-selecting circuit.

The socket-selecting circuit is shown in simplified form in Fig. 3. The "to" and "from" circuits are mirror images of each other and are wired as in Fig. 3-a. Fig. 3-b shows the connections between pins on two connector sockets and one wafer of one of the "to" steppers. These same connector pins go to a similar wafer in the "from" circuit. This circuit is represented by boxes in Fig. 3-a.

By energizing or de-energizing certain of the relays, any socket number from 0 to 23 may be selected. Steps of one are supplied by the "add-1" relay in the pin-selector circuit. The circuit is somewhat asymmetrical because the full binary range is not used. Normally, a 5-step binary code permits 32 numbers to be selected, whereas here only 24 are needed. The pin-selector relays do not carry signal information, but only relay operating voltages. The socket-selector relays carry signal voltages to the bridge. When the path is set up, the information travels from the unknown through the patchcord to a socket on the Robotester; from the socket to a stator contact on a stepper; from the corresponding rotor through the socket selector relays to the bridge.

Step 3 sets up the three significant figures of the resistance. As can be seen from Fig. 4, the resistance bank consists of 60 precision resistors

arranged in series banks, with shorting contacts across them. The first group to the left in the bottom row has a low-resistance string using resistors of 100, 200, 400 and 800 ohms. The middle-bank low-value string is set for 10, 20, 40 and 80 ohms; the right string is 1, 2, 4 and 8 ohms. By opening or closing the contacts across these resistors, any value from 1 to 999 ohms may be had, and by the use of only 12 relays. Now notice that there are five such strings mounted one above the other, brought out to separate terminals. By selecting one of these terminals with a bank of relays on step 4, we may move the decimal place, since the strings differ in resistance by a factor of 10. Once the proper relays have pulled in, they are held in by their holding contacts. Thus, in step 3, three figures are set up which may represent 4.70 megohms, 470,000 or even 470 ohms. If all the contacts are closed, 0 ohms is set up. However, the bridge will not balance this condition.

In step 4, one of the five resistance strings is selected by operation of one of the three "zeros" relays. Now both the unknown resistance  $R_x$ , selected by the steppers, and standard resistance  $R_s$ , selected by the resistance selectors, have been connected into the bridge circuit, Fig. 5. Since 6 volts ( $E_{dc}$ ) is applied across the bridge, then a 3-volt level exists across the lower 20-ohm resistor. The voltage across  $R_x$  depends on the balance of the bridge. When  $R_x$  and  $R_s$  are equal, 3 volts is present across  $R_x$ . A mercury relay switches between the two points at a fast rate (about 20 cps), remaining across the 20-ohm resistor much the longest time. The other contact is made before the first is broken. If a difference of potential exists, the output of the relay armature is a pulse, riding on a 3-volt level. If unknown resistance  $R_x$  is less than standard  $R_s$ , and therefore negative; if more than the standard, the pulse will be more than 3 volts and positive.

This pulse, or lack of it when the bridge is balanced, is applied to a grid of the first amplifier tube (Fig. 6). A type 5915 is used with grid 1 grounded and grid 3 used as signal grid. This

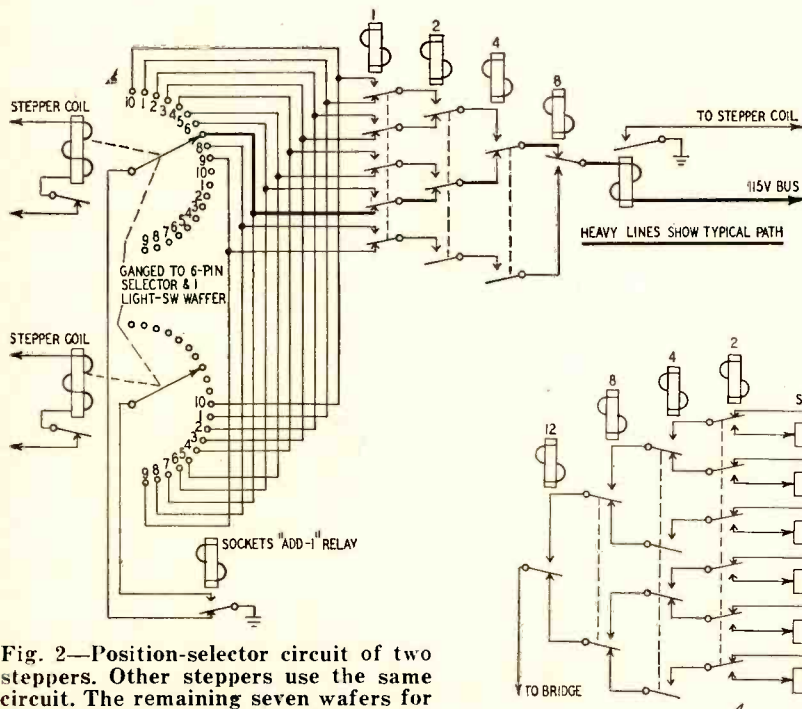

Fig. 2—Position-selector circuit of two steppers. Other steppers use the same circuit. The remaining seven wafers for pin selection and front-panel indicator lights are not shown.

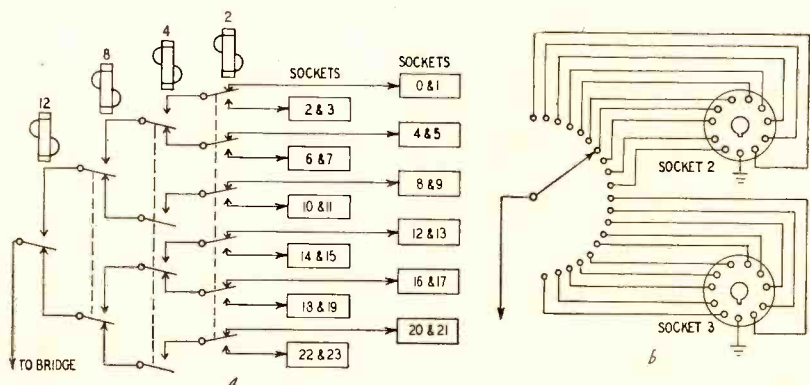
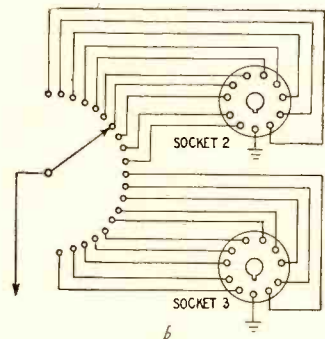

Fig. 3-a—Simplified socket-selector circuit. Boxes represent circuit at b.



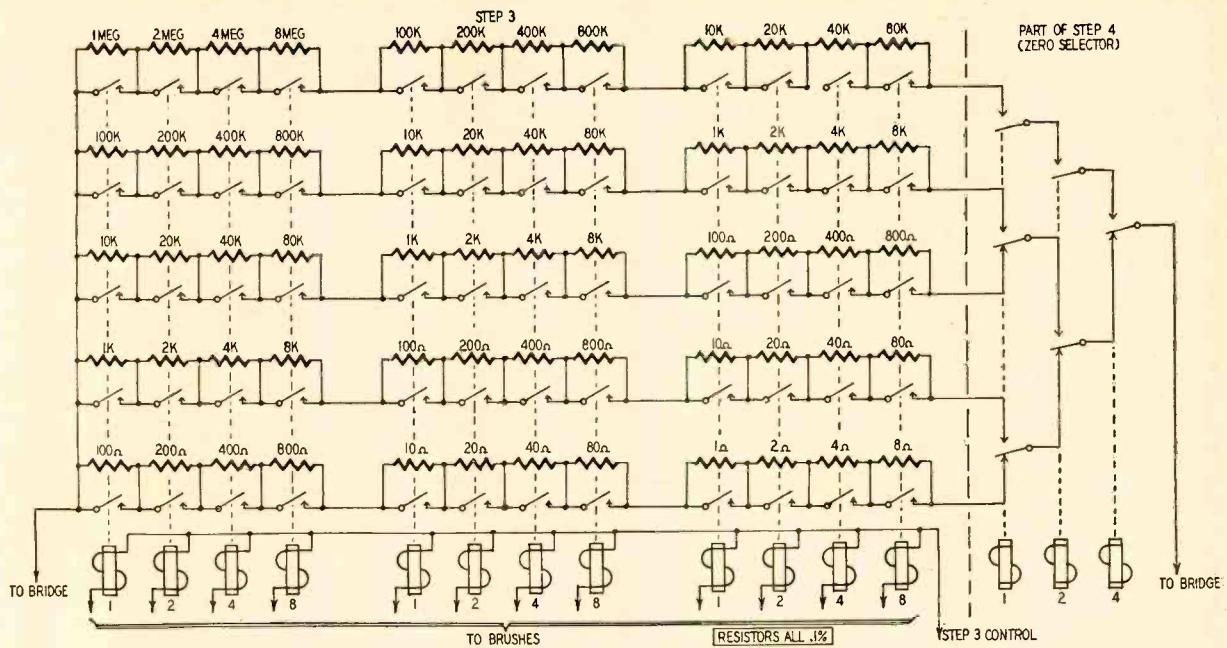

Fig. 4—Circuit selects standard resistances used in bridge measurements.

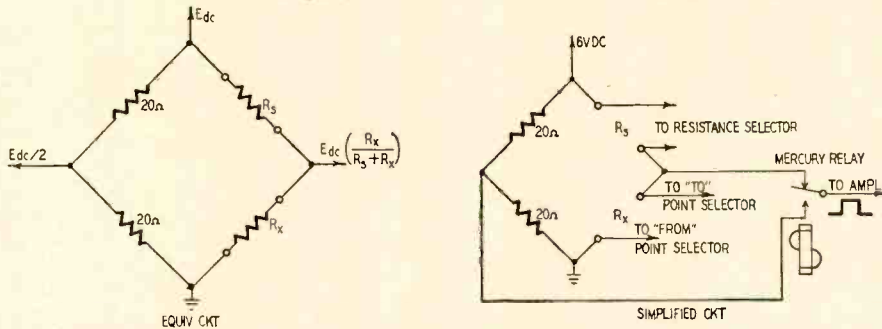

Fig. 5—Diagrams of the equivalent and simplified basic bridge circuit.

arrangement provides extremely low grid current. Remember that only 1 microampere of grid current across possibly 10 megohms could represent 10 volts. The pulse is amplified and applied to the second amplifier with a variable grid resistance. By changing this grid resistance in three steps, the gain of the amplifier may be changed, so that a 5%, 10% or 20% pulse will each be represented by the same voltage at the grid of the 6AU6. The grid resistance is selected by relays in the tolerance circuit.

The positive or negative pulse from the second stage is routed to one of the hold-reject relays through the 6AL5

to de-energize one of the reject relays if the pulse amplitude exceeds the bias condition of the 6AU8's. If the pulse is large, the 6AU8 will cut off each time it is applied and the relay in its plate circuit will fall out at each pulse. The relays are connected to both an indicator light on the front panel and a hold-reject circuit that prevents the tape from stepping along to the next test. The operator is thereby warned of a defect in the electronic equipment being tested.

If a limit is selected to permit any value below the specified resistance to pass, the hold-reject circuit is blocked on the "under" relay and the tape will

step along even though the "under" signal lights. The same applies to the "over" circuit. This feature allows tests for opens, shorts or diodes.

The entire sequence of tests takes place in approximately 0.6 second and the timing of the relays is of utmost importance to the operation of the Robotester. The circuit is arranged to prevent the sequence from advancing until all connections have been properly made. Interlocking relay contacts provide protection against setting up impossible combinations and a front-panel indicator lights when such a combination is made. The tape is automatically stopped at the defective position and the indicator tells the operator what column is at fault. A front-panel control permits the operator to advance the tape to position 4 regardless of an error. This permits the equipment to move on to the next test.

In normal operation, the instrument pauses only briefly in step 4 and, after blinking the PASS light, steps to the next test. If the test is outside the tolerance setup, either the OVER or UNDER signal is lit and the drive is held in position until the operator manually advances it. END

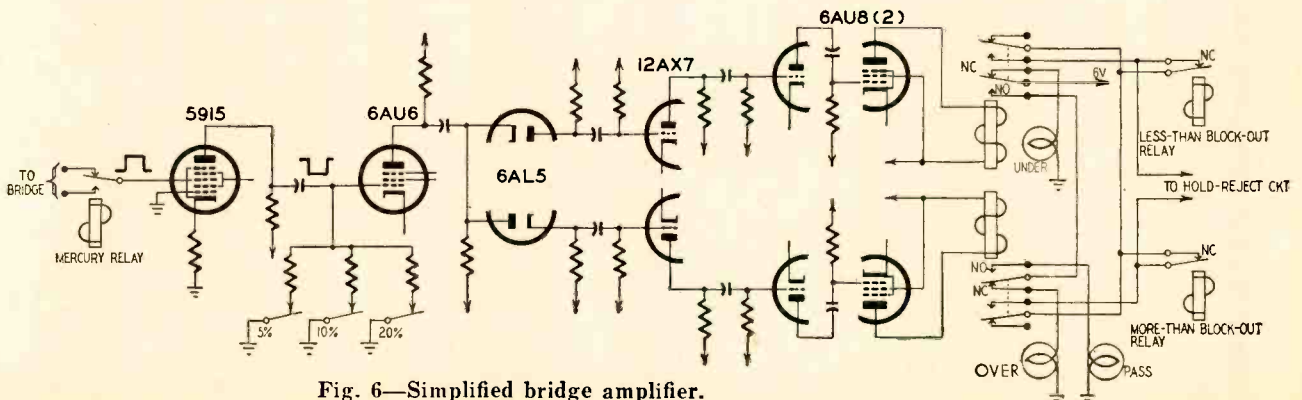
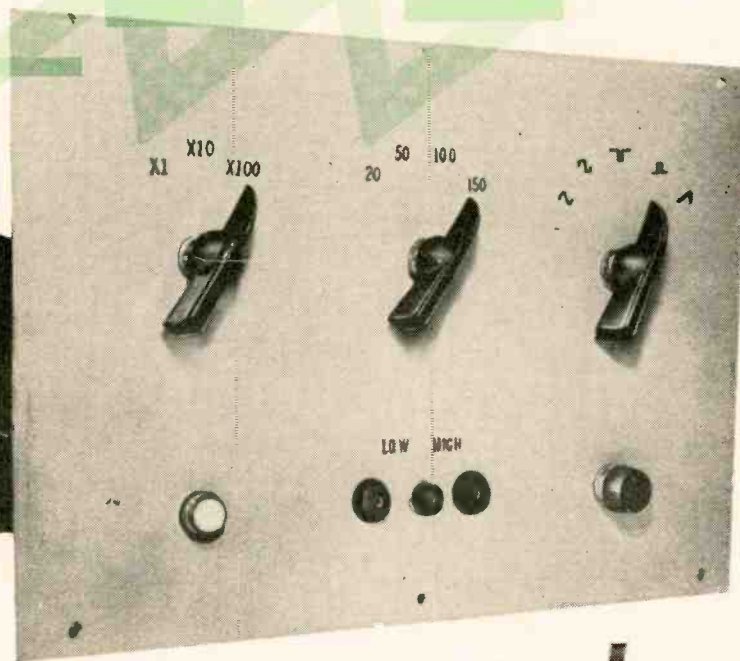

Fig. 6—Simplified bridge amplifier.

# WAVEFORM GENERATOR

By ED BUKSTEIN\*

*Unit features sine-wave, square-wave, negative-pulse, positive-pulse and sawtooth outputs at 12 spot frequencies*



Panel

Underchassis

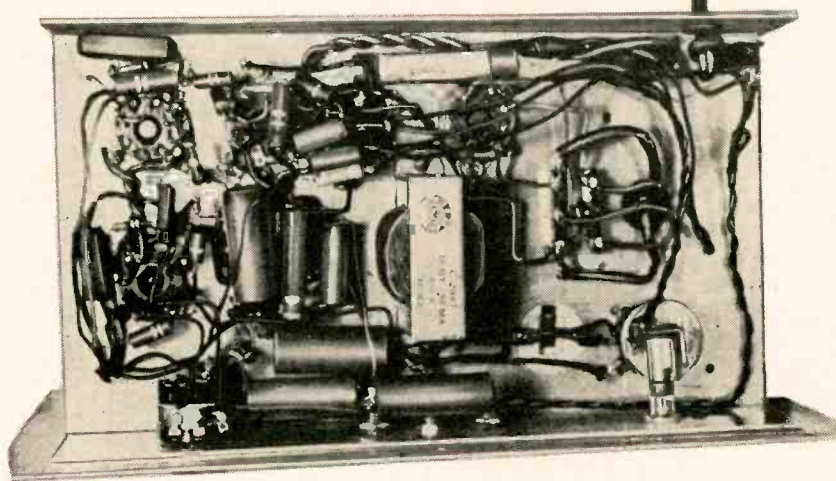

ONE factor impairing the usefulness of audio generators is that they are limited to sine waves. Some models provide a square-wave output but these are useful for only a limited range of applications. Many circuits are pulse-operated and cannot be satisfactorily tested or calibrated with an ordinary generator. The waveform generator described in this article is designed to overcome these limitations.

Using four tubes, plus rectifier, it provides sine-wave, square-wave, negative-pulse, positive-pulse and sawtooth output at any of 12 different spot frequencies ranging from 20-15,000 cycles. These 60 waveform-frequency combinations give the instrument a versatility far beyond that of conventional audio generators.

The sine-wave output of the instrument is provided by a Wien-bridge oscillator. This circuit consists of a two-stage amplifier with both negative and positive feedback. The negative feedback, from the plate of V1-b to the cathode of V1-a is made through a resistive network and is therefore independent of frequency. The positive feedback, from the plate of V1-b to the grid of V1-a, is through an R-C network and is therefore a function of

frequency. The positive feedback is maximum at a frequency determined by the values of R and C. At this frequency, the positive exceeds the negative feedback and the circuit oscillates. The frequency of oscillation can be calculated from

$$f = \frac{1}{2\pi RC}$$

where R and C are the values of the resistor and capacitor in either of the two equivalent R-C combinations in the positive feedback network.

The four basic frequencies of the

oscillator are 20, 50, 100 and 150 cycles, selected by switching different pairs of resistors into the positive feedback network. The odd-valued resistors required can be obtained either by series and parallel combinations of standard-value components or by measuring a group of resistors of the closest standard value and selecting those which most closely approach the desired values.

A three-position switch provides multiples of 10 and 100 of the four basic frequencies. This switch changes the capacitors in the positive feedback network. The capacitors in the  $\times 100$  posi-

\* Northwestern Vocational Institute, Minneapolis, Minn.



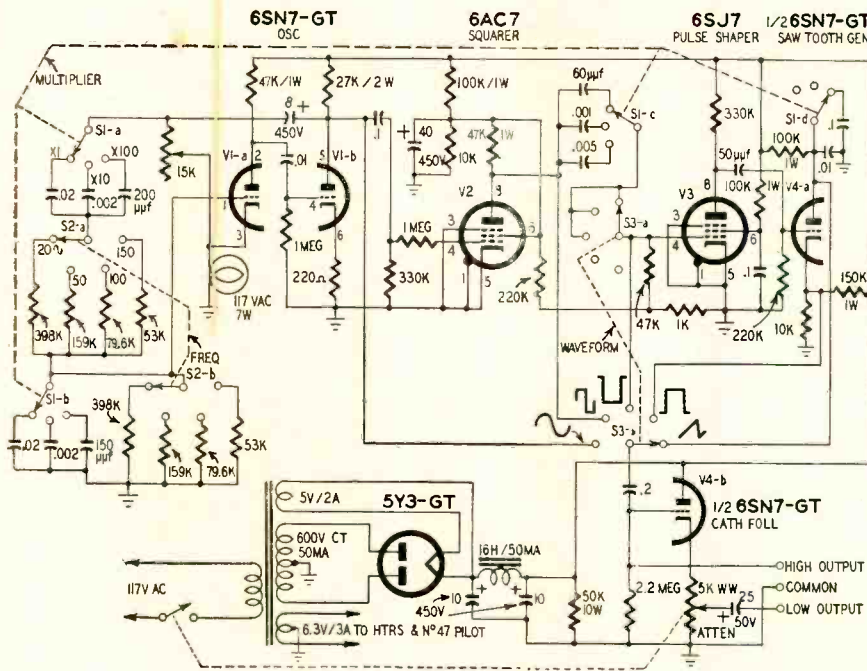

Schematic diagram of the waveform generator using a Wien-bridge oscillator.

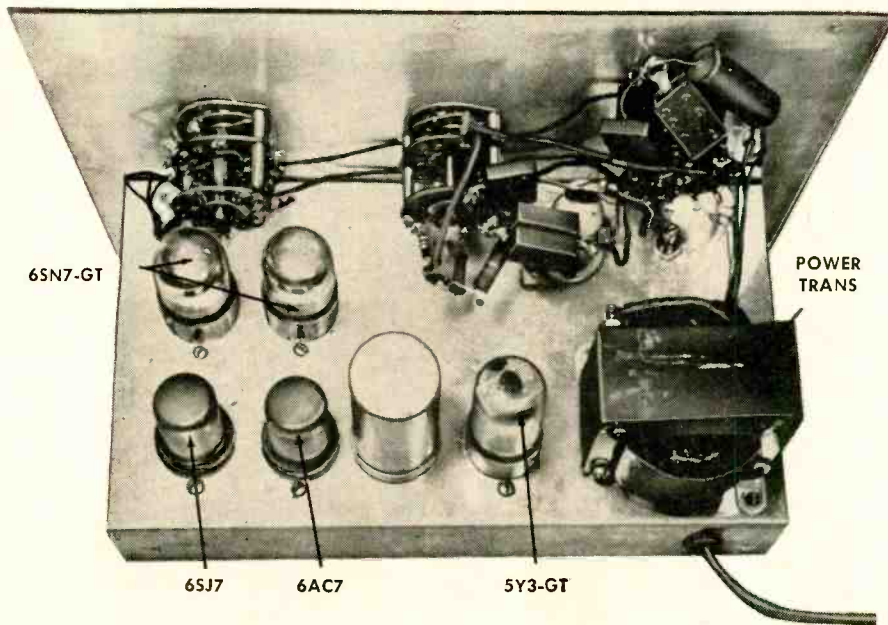

Layout of the top-chassis components.

tion are made unequal to compensate for the input capacitance of the tube.

A 7-watt Mazda lamp is used as the cathode resistor of the first tube in the Wien-bridge circuit. This bulb, by stabilizing the output amplitude, assures a good waveshape at all frequencies. Should the signal amplitude increase, the resistance of the bulb also increases. The resulting degeneration counteracts the increase in signal.

The sine-wave output of the Wien-bridge oscillator is fed to a 6AC7 squaring circuit. This tube is operated at zero bias (grounded cathode). Con-

sequently, the positive alternation of the sine-wave input causes grid-current flow. The resulting IR drop across the 1-megohm resistor in series with the grid is of such polarity that it cancels the positive alternation of the input. In effect, the grid and cathode of the tube act as a diode and the waveform at the grid is a half-wave pattern composed of negative alternations. These alternations are of sufficient amplitude to drive the grid beyond cutoff. The sine-wave input applied to this stage has its positive alternations eliminated by the diode action of the grid-cathode circuit; the

negative peaks are clipped at cutoff. Thus, the remaining portion of the waveform, as it appears in the plate circuit, is essentially a square wave.

The square-wave output of V2 is coupled to the pulse-shaping circuit of V3. This coupling exists only when the waveform selector switch is set to either pulse or sawtooth output. On sine or square output, the coupling circuit is opened to minimize loading of the squaring circuit. This arrangement helps to preserve the sharpness of the square wave. The R-C coupling to the grid of V3 has a very short time constant. As a result, it acts as a differentiator and converts the square wave to a series of narrow positive and negative pulses.

Since V3 is operated at saturation, the positive pulses applied to its grid are clipped as a result of grid-current flow. The negative pulses applied to the grid are amplified and appear as positive pulses in the plate circuit. These positive pulses are applied to the grid of V4-a, the sawtooth generator. V4-a is biased beyond cutoff by applying a positive potential to its cathode. With the tube at cutoff, the capacitor in the plate circuit charges from the B supply. Each time a positive pulse reaches the grid of V4-a, the cutoff bias is overcome and the tube conducts. The plate capacitor now discharges through the tube. This charging and discharging process produces a sawtooth voltage across the capacitor. Each time V4-a conducts, the positive voltage at the cathode increases. This provides the positive-pulse output of the instrument.

With the waveform selector switch any of the five waveforms generated in the instrument may be fed through cathode-follower stage V4-b. A low-impedance output is taken from the cathode of this stage and a high-impedance output from the grid. Both outputs are available through pin jacks on the front panel.

**Parts for waveform generator**

**Resistors for oscillator:** 2—53,000, 2—79,600, 2—159,000, 2—398,000 ohms, 1/2 watt (values obtained from series and parallel combinations or measuring standard units for variation).

**Resistors:** 1—220, 1—1,000, 2—10,000, 1—47,000, 2—220,000, 2—330,000 ohms, 2—1 megohm, 1—2.2 megohms, 1/2 watt; 2—47,000, 3—100,000, 1—150,000 ohms, 1 watt; 1—27,000 ohms, 2 watts; 1—50,000 ohms, 10 watts, bleeder; 1—5,000 ohms, wirewound potentiometer (with switch); 1—15,000 ohms, potentiometer.

**Capacitors:** 1—50, 1—60, 1—150 μf, 1—.0002, 1—.001, 2—.002, 1—.005, 2—.01, 2—.02, 3—.01, 1—0.2 μf, 600 volts; 1—8, 2—10, 1—40 μf, 450 volts, electrolytic; 1—25 μf, 50 volts, electrolytic.

**Miscellaneous:** 1—3-position 4-pole, 1—4-position 2-pole, 1—5-position 2-pole rotary switches; 1—spst switch (on 5,000-ohm pot); 1—power transformer, 600 volts ct at 50 ma, 5 volts at 2 amps, 6.3 volts at 3 amps; 1—filter choke, 16 henries at 50 ma; 1—No. 47 pilot lamp; 1—7-watt 117-volt Mazda lamp; 2—6SN7-GT, 1—6AC7, 1—6SJ7, 1—5Y3-GT; 5—octal sockets, 1—chassis; 1—line cord; 1—pilot lamp holder.

In addition to amplifier testing and troubleshooting, the waveform generator is suitable for such applications as beam-dotting an oscilloscope trace with marker pips, a calibrated sweep generator, and testing univibrators, scalars, counters and other pulse-triggered circuits.

END

# A True Shirt-Pocket Radio

*Transistorized converter,  
if and detector circuits  
make sensitive,  
ultra-compact unit*

By I. QUEEN  
EDITORIAL ASSOCIATE



The ultra-compact radio;  
back and front views.

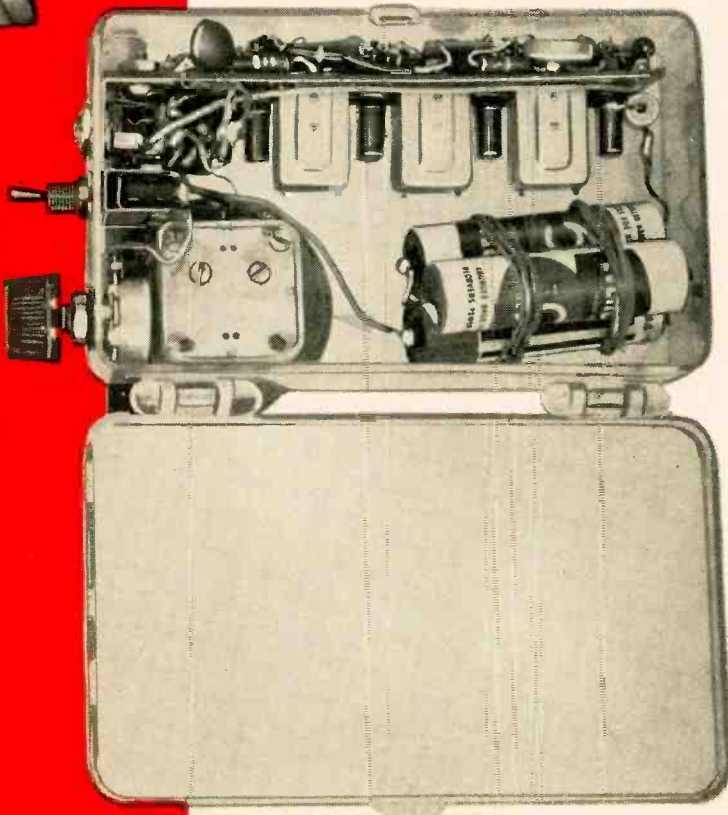

SEVERAL years ago, when transistors were first introduced, it was predicted that they would eventually replace *all* tubes in broadcast radios. Progress has been gradual but definite. Early "transistor radios" simply had transistor af amplifiers tacked on to crystal detectors. The Tiny Tuner (RADIO-ELECTRONICS, October, 1955) is a high-gain superhet using tubes in the high-frequency circuits and a transistor in the audio portion. During the past year all-transistor superhets with 455-kc if's have been placed on the market and several were displayed at the 1956 IRE radio engineering show in New York. Now, at last, experimenters and hobbyists may construct their personal all-transistor radio—one that can fit into a *shirt pocket!* This is it!

The receiver described requires only 4.5 volts, supplied by 3 penlight cells. These should last more than 600 hours of normal use, so the operating cost is about 1 cent for 24 hours. Fidelity is very good because of the reduced sideband cutting of a transistor amplifier. The entire set is housed in a transparent plastic box (see photos) with hinged cover. This is a  $4\frac{1}{2} \times 2\frac{3}{4} \times 1\frac{1}{8}$ -inch box, now on sale at many hardware and department stores for about 20 cents. The set weighs less than 7 ounces. It delivers a strong signal to its earpiece. Actually, the receiver will operate well with as little as 2 volts at less than 1 ma. Perhaps this is a good chore for a group of sun batteries!

Tested in many localities and under different conditions, the set seems to work anywhere. Carrying it in a shirt pocket, you can walk along the street, in a steel building . . . even in a cellar, yet pick up stations loud and clear. Unlike some other "self-contained" sets which may also work well but require a 10- or 20-foot antenna, this radio depends entirely on its own.

Two important problems had to be worked out—the converter stage and the if amplifier. In each case the result was completely successful, providing a

very efficient and sensitive radio. Full earpiece volume is obtained without a separate audio stage.

Six separate units make up this receiver: the antenna loop, battery control, variable capacitor, converter-if amplifier, battery and switch.

### Constructing the receiver

The first component to be mounted in the box is the loop antenna. It is Lafayette part MS-166, slightly modified. Remove 25 turns from the larger winding of the loop, that is, starting with the white lead (Fig. 1). Then tape or cement the ends so that there will be no further unwinding.

Saw off part of the form which is nearly 3½ inches long—the plastic box is only 2¾ inches wide. Saw the form (preferably a little from each end) until its total length is about 3 inches. This will leave some of the form extending from each side of the box for support. A hacksaw will do the job nicely.

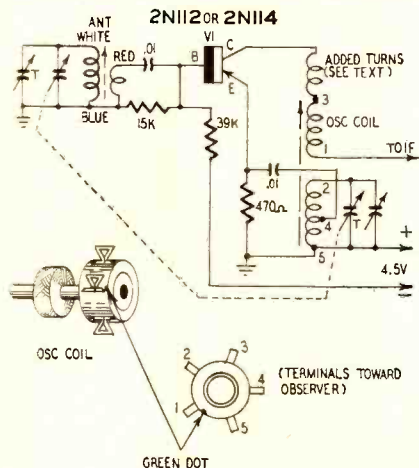

Fig. 1 — Diagram of converter stage.

The words "horizontal," "top," "side," etc., refer to directions with the box standing on end as when placed within a shirt pocket.

Holes for the loop should be only slightly larger than ¼ inch in diameter. I drilled them with a ¼-inch drill, then filed a little. These holes should be as near the top and front of the box as possible. (The front is the side opposite the hinged cover and is farthest from the person wearing it in his shirt pocket.) To insert the loop, open the box cover and push one end of the core into one of the holes until the other end can pass through the hole in the opposite side.

Next mount the battery control. This is Lafayette part VC-32, a 1,000-ohm potentiometer. It requires a ¼-inch hole through the top of the box and as far to the left as possible. This unit has a diameter of ¾ inch so there is plenty of space for it and the loop, also. Before mounting this control cut off part of its long shaft (to less than 5/16 inch) and solder leads to its terminals—soldering is more difficult later.

The variable capacitor is mounted just below the battery control and also to the left as far as possible. This

capacitor is Lafayette part MS-270, one of the most unusual items made available to experimenters in recent years. Only 11/16 inches square and ⅝ inch deep behind the panel, it is a complete two-gang capacitor with a cut-plate type oscillator section and built-in trimmers. The two columns in the center of the table show the capacitance of the tuning sections as

DIAL (%)	ANT (μmf)	OSC (μmf)	FREQ (kc)
0	211.0	101.0	535.00
10	189.4	94.8	562.35
20	168.9	88.2	594.03
30	148.0	81.1	631.70
40	126.9	73.3	678.15
50	105.4	64.6	737.71
60	83.8	54.9	816.66
70	61.8	43.7	930.76
80	41.6	31.8	1093.59
90	23.9	19.7	1336.73
97	13.0	11.0	1605.00

the shaft is rotated through 180 degrees from its maximum-capacitance (plates fully meshed) position. The column at the extreme right shows corresponding frequencies tuned in when using an antenna coil with an inductance of 327 μh and an oscillator coil of 221 μh.

You can use a dial calibrated like the one in the photograph or you can make your own and calibrate it in terms of frequency or use station call signs. (Before mounting the capacitor, you may wish to cut the shaft to ⅜ inch or less.) The unit is mounted on the front of the box by two tiny screws supplied with it. Now, solder the white and blue antenna leads across corresponding terminals of the dual capacitor. (See Fig. 1.)

The converter-if amplifier is the heart of the receiver. The converter stage is shown in Fig. 1 and the amplifier in Fig. 2. Actually, these circuits (except loop and battery control) are mounted together on a strip of Bakelite or other strong plastic.

The converter uses a 2N114 Raytheon transistor for maximum gain. A type 2N112 may be substituted but with lower amplification. The oscillator transformer is Lafayette part MS-265 and requires a slight modification. The terminal arrangement of this transformer is shown in Fig. 1.

As used in this converter, the collector winding needs 14 additional

turns. These are easily added. Use No. 30 enameled wire or smaller. Holding the transformer with the terminals toward you, solder one end of the fine wire to terminal 3. Now wind 14 turns counterclockwise on the form (not over the existing coil). You may use Polystyrene cement to hold the winding in place. The free end of the winding connects to the V1 collector. No other connection is to be added to terminal 3.

The oscillator transformer, all transistors and if transformers are mounted on a piece of thin Bakelite or hard plastic measuring 1/16 inch thick, 4½ inches long, 15/16 inch wide. Such a strip is easy to machine and there is no difficulty in drilling, filing or sawing.

If you compare Fig. 2 with other diagrams you have seen, you may conclude that the transformer connections are not correct. All previous schematics I have seen (and this includes manufacturers' data) specify that terminal 5 is the collector output and terminal 2 is the base input. Here both windings have been reversed and for an excellent reason. If you try to wire the circuit according to previous instructions, you will run into difficulties and will need long leads between transformers and transistors. If you follow Fig. 2, your work will be greatly simplified. This is an important feature where components are so close together and so tiny! The reversed windings produce no noticeable loss.

The if transformers are mounted in square holes. First, cut a hole about 7/16 inch in the sheet of Bakelite. Then file the sides a little at a time until the opening is large enough for the transformer to drop into place and fit snugly. The adjustment screw is accessible from the bottom. Holes for the five-pin transistor sockets are best made by drilling two or three small holes and then enlarging and joining them with a file, until the socket fits through. The oscillator transformer requires a ¼-inch mounting hole. It is held in place (with terminals upward) by its own leads passing through the Bakelite strip.

Here are some dimensions for mounting the parts: The oscillator transformer hole is located ¼ inch from one end of the Bakelite strip. The if transformers are spaced ⅞ inch apart (center-to-center), the last one being ¾ inch from the other end of the Bakelite strip. A small portion of the strip  
(Continued on page 70)

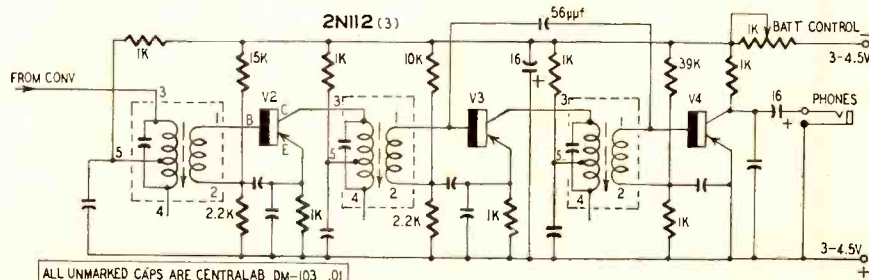

Fig. 2 — Schematic diagram of the high-gain transistorized if strip.

# HEATHKIT®

... world's finest  
electronic equipment  
in kit form



A MODEL O-10

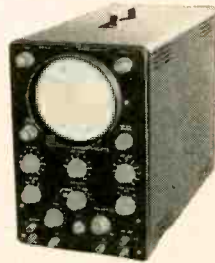

B MODEL OM-1



C MODEL OL-1



MODEL MM-1  
VOM



MODEL M-1  
HANDITESTER



MODEL V-7A  
VTVM

A **Heathkit ETCHED CIRCUIT** COLOR TV  
**5" OSCILLOSCOPE KIT**

Amplifier response essentially flat (+2 db -5 db) from 5 mc down to 2 cps without extra switching. Sweep oscillator allows single-cycle observation up to 500,000 cps, and will sync signals even higher. Uses etched metal circuit boards. Push-pull vertical and horizontal amplifiers—built in peak-to-peak calibrating source—step attenuated input—preformed and cabled wiring harness. A professional scope ideal for color TV work in the lab or service shop. 11-tube circuit features 5U1 CRT.

MODEL O-10  
**\$69<sup>50</sup>**

Shpg. Wt.  
21 Lbs.

B **Heathkit ETCHED CIRCUIT**  
**5" OSCILLOSCOPE KIT**

The OM-1 has many big scope features, including 5", 5BP1 cathode ray tube, and yet it is priced reasonably. Features etched metal circuit boards. Incorporates 3 step input attenuator—phasing control—built-in peak-to-peak voltage calibrator—and push-pull vertical and horizontal amplifiers. Vertical amplifier flat within ±3 db from 2 cps to 200 kc. Sweep circuit functions from 20 cps to 100,000 cps. An excellent general purpose scope for service shop or lab.

MODEL OM-1  
**\$49<sup>50</sup>**

Shpg. Wt.  
21 Lbs.

C **Heathkit ETCHED CIRCUIT**  
**3" OSCILLOSCOPE KIT**

Has many of the features of the Model OM-1, yet is smaller in physical size for portability, and for use in the home workshop. Employs etched metal circuit boards. Vertical frequency response within ±3 db from 2 cps to 200 kc. Sweep generator operates from 20 to 100,000 cps. The 8-tube circuit features a type 3GP1 cathode ray tube. Measures only 9½" h. x 6½" w. x 11¾" d.

MODEL OL-1  
**\$29<sup>50</sup>**

Shpg. Wt.  
14 Lbs.

**Heathkit 20,000 OHMS/VOLT  
VOM KIT**

Requires no external power. Sensitivity is 20,000 ohms/v. DC and 5,000 ohms/v. AC. Black Bakelite case—4½" 50 ua. meter—1% precision resistors. AC and DC ranges are 0-1.5, 5, 50, 150, 500, 1500, and 5000 volts. Direct current ranges are 0-150 ua., 15 ma., 150 ma., 500 ma., and 15 a. Resistance multipliers are X1, X100, and X10,000. DB range from -10 db to +65 db. Especially valuable in portable applications.

MODEL MM-1  
**\$29<sup>50</sup>**

Shpg. Wt.  
6 Lbs.

**Heathkit HANDITESTER KIT**

This compact model easily slips into tool box, glove compartment, or coat pocket. Valuable as "extra" instrument in service shop, and ideal for the home experimenter. Very popular with appliance repairmen, and electricians. Measures AC or DC voltage at 0-10, 30, 300, 100, and 5000 volts. Direct current ranges are 0-10 ma., and 0-100 ma. Attractive black Bakelite case.

MODEL M-1  
**\$14<sup>50</sup>**

Shpg. Wt.  
3 Lbs.

**Heathkit ETCHED CIRCUIT VACUUM TUBE  
VOLTMETER KIT**

The V-7A is used in scientific laboratories, technical schools, service shops, ham shacks, and in the home workshop. Features 200 ua. meter, 1% precision resistors, and etched metal circuit board. Measures DC voltage, ACV (rms), AVC (peak-to-peak), and resistance. AC (rms) and DC voltage ranges are 0-1.5, 5, 15, 50, 150, 500, and 1500 volts. Peak-to-peak ranges are 4, 14, 40, 140, 400, 1400, and 4000 volts. Ohmmeter ranges provide multipliers of X1, X10, X100, X1000, X10K, X100K, and X 1 megohm. DB scale also provided. 11 megohm input impedance.

MODEL V-7A  
**\$24<sup>50</sup>**

Shpg. Wt.  
7 Lbs.

**NEW**

**Heathkit PROFESSIONAL RADIATION COUNTER KIT**



- ▶ Modern circuit design for maximum sensitivity and reliability.
- ▶ Employs 900 volt Bismuth tube in beta/gamma sensitive probe.
- ▶ Both visual and aural indicators for radiation level.

This radiation counter features ranges of 0-100, 600, 6000, and 60,000 counts per minute and 0-.02, .1, 1, and 10 milliroentgens per hour. The probe uses a 6306 Bismuth tube. The 5-tube circuit employs a 4½", 200 ua. meter, calibrated in cpm, and mR/hr. Also aural signal provided from panel-mounted speaker. Simple to build from the instructions supplied, even for a beginner.

MODEL RC-1  
**\$79<sup>95</sup>**

Shpg. Wt.  
8 Lbs.



**HEATH COMPANY** A Subsidiary of Daystrom, Inc. **BENTON HARBOR 20, MICH.**



### Heathkit PROBE KITS



### ETCHED CIRCUIT PEAK-TO-PEAK

No. 338-C. \$5.50  
Shpg. Wt. 2 Lbs.  
Use to read peak-to-peak voltages on DC scale of 11-megohm VTVM. Read direct on VTVM scales from 5 kc to 5 mc.

### ETCHED CIRCUIT RF

No. 309-C. \$3.50  
Shpg. Wt. 1 Lb.  
Use with any 11 megohm VTVM for RF measurements up to 250 mc with  $\pm 10\%$  accuracy. Employs etched circuit.

### 30,000 VOLT D.C. HIGH VOLTAGE

No. 336. \$4.50  
Shpg. Wt. 2 Lbs.  
Use to measure high DC voltage with VTVM. Precision multiplier resistor mounted inside plastic probe. Multiplication factor of 100 on Heathkit 11-megohm VTVM.



PROBES FOR VTVM

### PROBES FOR SCOPE



### LOW CAPACITY

No. 342. \$3.50  
Shpg. Wt. 1 Lb.  
Low capacity probe prevents circuit loading. Features variable capacitor for correct impedance matching. Ratio of attenuation can be controlled.



### SCOPE DEMODULATOR

No. 337-C. \$3.50  
Shpg. Wt. 1 Lb.  
This probe functions like detector to pass only modulation of signal, and not signal itself. Applied voltage limits are 30 volts rms, and 500 VDC.

## Heathkit ELECTRONIC SWITCH KIT

This instrument allows simultaneous oscilloscope observation of two input signals by producing both signals, alternately, at its output. All-electronic circuit provides 4 switching rates, selected by panel switch. Provides gain for input signals, and features frequency response of  $\pm 1$  db 0-100 kc. Employs seven miniature tubes. Sync output provided to control scope sweep. Functions at signal levels as low as 0.1 volt.

MODEL S-3

**\$21.95**

Shpg. Wt. 8 Lbs.

## Heathkit VARIABLE VOLTAGE REGULATED POWER SUPPLY KIT

This power supply provides regulated DC output that can be manually controlled from 0 to 500 volts. Supplies up to 130 ma at 200 VDC, and up to 10 ma at 450 VDC. Large panel meter monitors output voltage or current. Supplies filament voltage at 6.3 volts AC (4 amperes). Filament and B+ circuits isolated from ground. Ideal lab power supply for use in experimental work.

MODEL PS-3

**\$35.50**

Shpg. Wt. 17 Lbs.

## Heathkit ISOLATION TRANSFORMER KIT

Provides isolation between the power line and equipment under test. No direct connection between primary and secondary. Keeps chassis of AC-DC sets "cold." Fused in the primary circuit. Also provides manual voltage control from 90 volts to 130 volts for test purposes. Rated at 100 volt-amperes continuously. Panel meter monitors output voltage.

MODEL IT-1

**\$16.50**

Shpg. Wt. 9 Lbs.

## Heathkit DIRECT READING CAPACITY METER KIT

This unique instrument indicates capacity in mmf, or mfd, directly on a  $4\frac{1}{2}$ " 50 ua. meter. Ranges are 0 to 100 mmf, 0-1000 mmf, 0-.01 mfd, and 0-.1 mfd. Residual capacity less than 1 mmf. Scales are linear. Instrument not susceptible to hand capacity effects. Will measure even small value trimmers or variable air capacitors.

MODEL CM-1

**\$29.50**

Shpg. Wt. 7 Lbs.

## Heathkit VIBRATOR TESTER KIT

Checks condition of vibrators under operating conditions. Tests 6-volt vibrators only. Use in conjunction with BE-4 battery eliminator, or similar variable power source. Indicates vibrator quality on large "good-bad" scale. Tests both inter-rupter and self-rectifier types. 5 different sockets.

MODEL VT-1

**\$14.50**

Shpg. Wt. 6 Lbs.

## Photographers! Heathkit ENLARGER TIMER KIT

Use to time photographic enlarger. "Time" dial allows settings of from 5 to 60 seconds. Will also control safe-light "on" when enlarger is "off." Enlarger and safelight plug into recepticals on front panel. Handles up to 350 watts. Ideal device to free operator for other operations, and very simple to build. Compact plastic case.

MODEL ET-1

**\$11.50**

Shpg. Wt. 3 Lbs.



MODEL S-3 ELECTRONIC SWITCH KIT



MODEL PS-3 VARIABLE VOLTAGE REGULATED POWER SUPPLY KIT



MODEL IT-1 ISOLATION TRANSFORMER KIT



MODEL CM-1 CAPACITY METER KIT



MODEL VT-1 VIBRATOR TESTER KIT

**HEATH COMPANY** A Subsidiary of Daystrom, Inc. **BENTON HARBOR 20, MICH.**



MODEL TS-4  
TV SWEEP GENERATOR KIT



MODEL LG-1  
LABORATORY GENERATOR KIT

# HEATHKIT®

## instruments

CONTAIN HIGH QUALITY  
COMPONENTS THROUGHOUT.  
EACH AN OUTSTANDING DOLLAR  
VALUE IN TEST EQUIPMENT.



MODEL LP-2  
LINEARITY PATTERN  
GENERATOR KIT



MODEL  
SG-8  
RF SIGNAL  
GENERATOR  
KIT

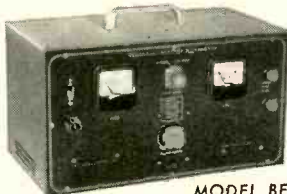

MODEL BE-4  
6-12 VOLT BATTERY ELIMINATOR  
KIT

### Heathkit TV SWEEP GENERATOR KIT

All-electronic sweep circuit eliminates mechanical hum and vibration. Features improved linearity—effective AGC—flat output—0 to 40 mc sweep. Covers all frequencies for black and white or color TV work, as well as FM. High output for alignment of tuners, 1F strips, boosters, etc. Fundamental output from 4 to 220 mc in four bands. Has crystal oscillator (4.5 mc and multiples thereof), and variable marker covering 19 to 60 mc—up to 180 mc on harmonics. Provision for external marker. Effective two-way blanking.

MODEL TS-4  
**\$495<sup>0</sup>**

Shpg. Wt.  
16 Lbs.

### Heathkit LABORATORY GENERATOR KIT

This signal generator covers from 100 kc to 30 mc on fundamentals in 5 bands. 400 cycle modulation variable from 0 to 50%. RF output up to 100,000 microvolts. Meter reads RF output or percentage of modulation. Fixed step and variable output attenuation. Voltage regulation, double copper-plated shielding for stability, and other "extras." Provision for external modulation. Output impedance 50 ohms.

MODEL LG-1  
**\$395<sup>0</sup>**

Shpg. Wt.  
16 Lbs.

### Heathkit LINEARITY PATTERN GENERATOR KIT

Supplies information for white dots, cross-hatch pattern, horizontal bar pattern, or vertical bar pattern. Use for adjustment of vertical and horizontal linearity, picture size, aspect ratio, and focus. Dot pattern is a *must* for color convergence adjustments. Clip merely connects to antenna terminals of TV set. Panel provision for external sync if desired. Covers channels 2 to 13. 5 to 6 vert. bars and 4 to 5 hor. bars.

MODEL LP-2  
**\$225<sup>0</sup>**

Shpg. Wt.  
7 Lbs.

### Heathkit SIGNAL GENERATOR KIT

This tried and proven generator covers 160 kc to 110 mc on fundamentals in five bands, and calibrated harmonics extend to 220 mc. Very popular in service shops, laboratories, and home workshops. RF output is in excess of 100,000 microvolts, controlled by a variable and a fixed-step attenuator. Output is pure RF, RF modulated at 400 cps, or 400 cps audio for amplifier testing.

MODEL SG-8  
**\$195<sup>0</sup>**

Shpg. Wt.  
8 Lbs.

### Heathkit BATTERY ELIMINATOR KIT

6-12 volt

This up-to-date battery eliminator will supply either 6 or 12-volt output to take care of auto radios from even the most modern automobiles. Output voltage is variable 0-8 volts DC or 0-16 volts DC. Will deliver up to 15 amperes at 6 volts or up to 7 amperes at 12 volts. Two 10,000 microfarad output filter capacitors insure smooth DC output. Panel meters monitor output current. Will double as a battery charger. Definitely required for automobile radio service work.

MODEL BE-4  
**\$315<sup>0</sup>**

Shpg. Wt.  
17 Lbs.

### Heathkit CONDENSER CHECKER KIT



Measures paper, mica, ceramic, and electrolytic capacitors in 4 ranges from .00001 to 1,000 microfarads. Indicates condenser value and quality. Also measures resistance from 100 ohms to 5 megohms. All values indicated directly on panel scale, after adjusting for null on electron beam "eye" tube. No calculations necessary. A valuable instrument in service or laboratory applications.

MODEL C-3  
**\$195<sup>0</sup>**

Shpg. Wt.  
7 Lbs.

### Heathkit SUBSTITUTION BOX KITS

Model CS-1 **\$55<sup>0</sup>** Shpg. Wt. 2 Lbs.



This unit provides switch selection of capacitor values from .001 mfd. to .22 mfd, in 18 RTMA standard values. Kit includes 18" flexible leads with alligator clips.

Model RS-1 **\$55<sup>0</sup>** Shpg. Wt. 2 Lbs.



Provides switch selection of resistances from 15 ohms to 10 megohms, in 36 RTMA values. Resistors are 1 watt, 10%. Extremely valuable in all types of electronic activity.

**HEATH COMPANY** A Subsidiary of Daystrom, Inc. **BENTON HARBOR 20, MICH.**

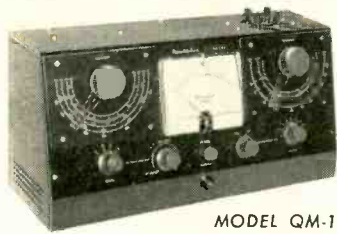

MODEL QM-1  
"Q" METER KIT

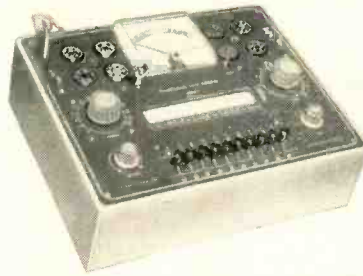

MODEL TC-2  
TUBE  
CHECKER  
KIT



MODEL CC-1  
CATHODE RAY TUBE CHECKER KIT



MODEL DR-1  
DECADE RESISTANCE  
KIT



MODEL DC-1  
DECADE CONDENSER  
KIT



MODEL IB-2  
IMPEDANCE BRIDGE KIT



MODEL TC-2P  
PORTABLE  
TUBE CHECKER  
KIT

### Heathkit "Q" METER KIT

The model QM-1 measures the Q of inductances and the RF resistance and distributed capacity of coils. Employs a 4½" 50 microampere meter for direct indication. Features built-in signal source for tests at frequencies of 150 kc to 18 mc in four ranges. Measures capacity from 40 mmf to 450 mmf within ±3 mmf. Indispensable for coil winding, and determining unknown capacitor values. A worthwhile addition to the laboratory or ham shack at a very low price.

MODEL QM-1  
**\$44.50**

Shpg. Wt.  
14 Lbs.

### Heathkit DECADE RESISTANCE KIT

Provides 20 1% precision resistors that are switched to provide values from 1 to 99,999 ohms, in 1-ohm steps. High quality components for precision lab work.

MODEL DR-1  
**\$19.50**

Shpg. Wt.  
4 Lbs.

### Heathkit DECADE CONDENSER KIT

Employs high precision 1% silver-mica capacitors for switch selection of values from 100 mmf to 0.111 mfd. in steps of 100 mmf. Employs ceramic switches for reduced leakage. Invaluable in the laboratory.

MODEL DC-1  
**\$16.50**

Shpg. Wt.  
3 Lbs.

### Heathkit IMPEDANCE BRIDGE KIT

This bridge features built-in oscillator and amplifier. Measures resistance, capacitance, inductance, dissipation factors of condensers, and storage factor of inductance. D, Q, and DQ functions combined in one control. Employs ½% resistors and ½% silver-mica capacitors. 100-0-100 ua. meter indicates null. Two-section CRL dial provides ten separate "units" with accuracy of .5%. Fractions of units read on variable control.

MODEL IB-2  
**\$59.50**

Shpg. Wt.  
12 Lbs.

### Heathkit TUBE CHECKER KIT

You can afford your own tube tester, even if you are an experimenter, or only do part time service work. Uses a 4½" meter with 3-color meter face for simple "good-bad" indications of tube

quality, on the basis of emission. Will test all tubes commonly encountered in radio and TV service work. 14 different filament voltage values provided. Built-in roll chart—ten 3 position lever switches for open or short tests on each tube element. Space provided for future socket addition.

MODEL TC-2  
**\$29.50**

Shpg. Wt.  
12 Lbs.

### Heathkit PORTABLE TUBE CHECKER KIT

The Model TC-2P is identical to the Model TC-2 except that it is housed in a rugged carrying case. This two-tone case is finished in proxylin impregnated fabric. The cover is detachable, and the hardware is brass plated. Ideal for home service calls.

MODEL TC-2P  
**\$34.50**

Shpg. Wt.  
15 Lbs.



MODEL 355  
Shpg. Wt. **\$4.50**  
1 Lb.

### Heathkit TV PICTURE TUBE TESTER ADAPTER

Use with TC-2. Tests picture tubes for emission and shorts. 12-pin socket, 4 ft. cable, octal connector, and technical data. Not a kit.

### Heathkit CATHODE RAY TUBE CHECKER KIT

Indicates condition of CRT on large "good-bad" scale. Spring-loaded switches protect operator. Checks all electro-magnetic deflection picture tubes normally encountered in TV servicing. Housed in portable case for service calls. Supplies all operating potentials. Tests for shorts, leakage, and emission. Checks tubes on the work bench, in the carton, or in the set. Features shadowgraph test (spot of light on the screen).

MODEL CC-1  
**\$22.50**

Shpg. Wt.  
10 Lbs.

### Heathkit AC VACUUM TUBE VOLTMETER KIT

Here is a VTVM designed especially for audio work. Combines high impedance, wide frequency range, and high sensitivity. Frequency response, substantially flat from 10 cps to 50 kc. Sensitivity allows measurements as low as 1 mv at high impedance. Ranges are .01, .03, .1, .3, 1, 3, 10, 30, 100, and 300 volts rms. Total db range -52 to +52 db. 1 megohm input impedance at 1 kc.

MODEL AV-2  
**\$29.50**

Shpg. Wt.  
5 Lbs.

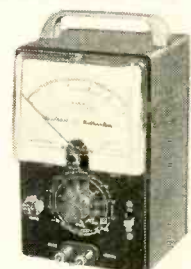

**HEATH COMPANY** A Subsidiary of Daystrom, Inc. **BENTON HARBOR 20, MICH.**



MODEL HD-1  
HARMONIC DISTORTION METER KIT



MODEL CR-1  
CRYSTAL RECEIVER KIT



MODEL AG-9  
AUDIO GENERATOR KIT



MODEL AG-8  
AUDIO GENERATOR KIT



MODEL AG-1  
AUDIO OSCILLATOR KIT



MODEL AA-1  
AUDIO ANALYZER KIT



MODEL BR-2  
BROADCAST BAND RECEIVER KIT



MODEL T-3  
SIGNAL TRACER KIT

### Heathkit HARMONIC DISTORTION METER KIT

Designed for use with low distortion audio generator, (such as the Model AG-9). Measures harmonic distortion of audio amplifiers under a variety of conditions. Reads distortion on meter as percentage of input signal. Operates between 20 and 20,000 cps. High impedance VTVM built in for initial reference settings and final distortion readings. VTVM ranges are 0-1, 3, 10, and 30 volts full scale. 1% precision resistors employed. Distortion scales are 0-1, 3, 10, 30, and 100% full scale.

MODEL HD-1  
**\$49<sup>50</sup>**  
Shpg. Wt.  
13 Lbs.

### Heathkit CRYSTAL RECEIVER KIT

This crystal radio covers standard broadcast band (540 to 1600 kc). Employs two high-Q tank circuits. A sealed germanium diode is used for detection—no critical "cat's whisker" adjustment. Kit includes pair of high impedance headsets, and is easy to build, even for a beginner. Requires no external power.

MODEL CR-1  
**\$7<sup>95</sup>**  
Shpg. Wt.  
3 Lbs.

### Heathkit AUDIO GENERATOR KIT

Low distortion audio generator (less than .1%). Ideal for use with Model HD-1, or in other applications requiring low signal distortion. Frequency accuracy within  $\pm 5\%$ . Features step-type tuning from 10 cps to 100 kc, with three rotary switches that provide two significant figures and a multiplier. Output monitored on large  $4\frac{1}{2}$ " meter. Meter calibrated for output voltage or db. Output ranges are 0-.003, .01, .03, .1, .3, 1, 3, and 10 volts.

MODEL AG-9  
**\$34<sup>50</sup>**  
Shpg. Wt.  
8 Lbs.

### Heathkit AUDIO GENERATOR KIT

This generator covers from 20 cps to 1 mc in 5 ranges. Output constant within  $\pm 1$  db from 20 cps to 400 kc, and down only 3 db at 600 kc. Produces good sine wave with distortion percentage below .4% from 100 cps through the audio range. Provides 10 volts output under no load conditions. Has continuously variable and step-type attenuator with settings of 1 millivolt, 100 millivolts, 1 volt, and 10 volts. Cathode follower output.

MODEL AG-8  
**\$29<sup>50</sup>**  
Shpg. Wt.  
11 Lbs.

### Heathkit AUDIO OSCILLATOR KIT (Sine Wave—Square Wave)

Produces sine wave or square wave signals from 20 to 20,000 cps in 3 ranges. Designed for use in service shop, or home workshop. Employs thermistor for output regulation. Features high level output, low distortion, and low impedance output. Produces sine waves for audio testing, or will produce good clean square waves with a rise time of only 2 microseconds. Very simple to build from complete instructions supplied.

MODEL AO-1  
**\$24<sup>50</sup>**  
Shpg. Wt.  
10 Lbs.

### Heathkit AUDIO ANALYZER KIT

Combines AC VTVM, audio wattmeter, and intermodulation distortion analyzer in one instrument. Includes built-in high and low frequency oscillators for IM tests. VTVM ranges are .01, .03, .1, .3, 1, 3, 10, 30, 100, and 300 volts rms. Wattmeter ranges are .15 mw, 1.5 mw, 15 mw, 150 mw, 1.5 w, 15 w, and 150 w. IM scales are 1%, 3%, 10%, 30%, and 100%. Provides internal loads of 4, 8, 16, or 600 ohms. An extremely valuable instrument for the audio engineer, or for the serious audiophile.

MODEL AA-1  
**\$59<sup>50</sup>**  
Shpg. Wt.  
13 Lbs.

### Heathkit BROADCAST BAND RECEIVER KIT

Build your own radio with confidence, even if you are a beginner. Features transformer power supply, miniature tubes, built-in antenna,  $5\frac{1}{2}$ " PM speaker, and planetary tuning from 550 kc to 1600 kc. Complete step-by-step instructions supplied.

Cabinet, as shown, available separately.

MODEL BR-2  
**\$17<sup>50</sup>**  
(less cabinet)  
Shpg. Wt.  
10 Lbs.

### Heathkit VISUAL-AURAL SIGNAL TRACER KIT

Features a high-gain RF input channel for signal tracing and troubleshooting from the receiver antenna input clear through all RF and IF stages. Separate low-gain channel for audio circuit exploration. Built-in loudspeaker provides audio response, while electron beam "eye" tube gives visual indication. Ideal for signal tracing in AM, FM, and TV receivers. Built-in wattmeter and noise locating circuit.

MODEL T-3  
**\$23<sup>50</sup>**  
Shpg. Wt.  
9 Lbs.

**HEATH COMPANY** A Subsidiary of Daystrom, Inc. BENTON HARBOR 20, MICH.



**Heathkit DX-100  
PHONE & CW TRANSMITTER KIT**

This transmitter is rapidly becoming the accepted standard in its price class. 100 watts RF output—built-in power supplies—built-in VFO and modulator—bandswitching on 160, 80, 40, 20, 15, 11, and 10 meters—phone or CW operation. 100 watts output on phone, and 120 watts on CW. TVI suppressed—pi network output coupling—extensive shielding—matches 50 to 600 ohms—high quality components. Uses 1625 tubes in push-pull to modulate 6146 tubes in parallel. Schematic and specifications available on request.

MODEL  
DX-100  
**\$189<sup>50</sup>**  
Shpg. Wt.  
107 Lbs.



MODEL DX-100  
PHONE & CW TRANSMITTER KIT

**Heathkit DX-35  
PHONE & CW TRANSMITTER KIT**

This exciting new kit features bandswitching phone and CW operation on 80, 40, 20, 15, 11, and 10 meters. Plate power input to 65 watts on CW, with controlled-carrier modulation peaks to 50 watts on phone. Features built-in modulator, power supplies, pi network output circuit. Panel meter reads grid or plate current for 6146 final. Schematic and specifications on request.

MODEL DX-35  
**\$56<sup>95</sup>**  
Shpg. Wt.  
24 Lbs.



MODEL DX-35  
PHONE & CW TRANSMITTER KIT

**Heathkit CW AMATEUR TRANSMITTER KIT**

Outstanding dollar-per-watt value! 30-35 watts plate power input, bandswitching for 80, 40, 20, 15, 11, and 10 meters. Crystal or external VFO excitation. 52 ohm output—key click filter—copper-plated chassis—pre-wound coils. Uses 6AG7 oscillator, 6L6 final.

MODEL AT-1  
**\$29<sup>50</sup>**  
Shpg. Wt.  
15 Lbs.



MODEL AT-1  
CW AMATEUR TRANSMITTER KIT

**Heathkit VFO KIT**

Go VFO for added convenience and flexibility. Covers 160-80-40-20-15-11 and 10 meters. Three basic oscillator frequencies provide better than 10 volt average RF output. Plug for crystal socket of transmitter. VR tube for stability. Requires only 250 VDC at 20 ma, and 6.3 VAC at 0.45 A.

MODEL VF-1  
**\$19<sup>50</sup>**  
Shpg. Wt.  
7 Lbs.



MODEL VF-1  
VFO KIT

**Heathkit ANTENNA COUPLER KIT**

Matches between transmitter and a long-wire, end-fed antenna. Incorporates an L-type filter to attenuate signals above 36 mc and reduce TVI. 52-ohm coaxial input. Tapped inductor and variable capacitor. Neon RF indicator—simple to build. Handles up to 75 watts, 10 through 80 meters. Use with AT-1 or DX-35.

MODEL AC-1  
**\$14<sup>50</sup>**  
Shpg. Wt.  
4 Lbs.



MODEL AC-1  
ANTENNA  
COUPLER KIT

**Heathkit "Q" MULTIPLIER KIT**

Tunes any signal within 1F of receiver, with effective Q of approximately 4,000. Sharp "peak" or "null" surpasses crystal filter in operation. Use with 450-460 kc IF. Will not function with AC-DC receivers. Requires 6.3 VAC at 300 ma, and 150-250 VDC at 2 ma. Cable and plugs supplied.

MODEL QF-1  
**\$9<sup>95</sup>**  
Shpg. Wt.  
3 Lbs.



MODEL QF-1  
"Q" MULTIPLIER  
KIT

**Heathkit COMMUNICATIONS TYPE  
ALL BAND RECEIVER KIT**

Unusual sensitivity and selectivity for price. Covers 550 kc to 30 mc in 4 bands. AC power supply—electrical bandspread—antenna trimmer—separate RF and AF gain controls—noise limiter—headphone jacks—AGC—BFO. Cabinet available separately as shown. Part 91-15A, shipping weight 5 lbs. \$4.50.

MODEL AR-3  
**\$27<sup>95</sup>**  
(Less Cabinet)  
Shpg. Wt.  
12 Lbs.

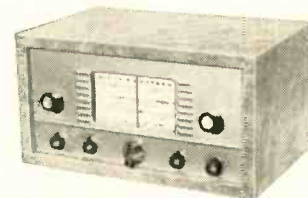

MODEL AR-3  
ALL BAND RECEIVER KIT

**Heathkit GRID DIP METER KIT**

Use for determining unknown frequency, for checking resonance of tuned circuits, or for adjusting wave traps. Equally valuable in ham shack, service shop, or laboratory. Features 500 ua. meter with sensitivity control. Covers 2 mc to 250 mc with five coils, supplied with kit. Coils pre-wound, dial scale pre-calibrated.



MODEL  
GD-1B  
**\$19<sup>50</sup>**  
Shpg. Wt.  
4 Lbs.

**Heathkit  
ANTENNA IMPEDANCE METER KIT**



MODEL AM-1  
**\$14<sup>50</sup>** Shpg. Wt.  
2 Lbs.

Use this instrument, with a source of RF signal, to determine antenna impedance, line impedance, and to solve impedance matching problems with fixed or mobile antennas or transmission lines. Also, will double as a field strength indicator, or phone monitor. Uses 100 ua. meter. Covers 0 to 600 ohms.

**HEATH COMPANY** A Subsidiary of Daystrom, Inc. BENTON HARBOR 20, MICH.



MODEL W-5M

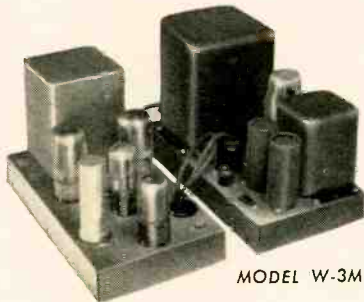

MODEL W-3M



MODEL W-4M



MODEL A-9B



MODEL A-7D

## Heathkit ADVANCE-DESIGN HIGH FIDELITY AMPLIFIER KIT

This 25 watt amplifier incorporates the "extra" features required for really outstanding performance, and yet is priced within the range of the average audiophile. Employs K T66 output tubes in push-pull, and features the famous Peerless output transformer. Response is within  $\pm 1$  db from 5 cps to 160 kc at 1 watt. Harmonic distortion only 1% at 25 watts, 20 to 20,000 cps. IM distortion only 1% at 20 watts. Output impedance is 4, 8, or 16 ohms. Hum and noise are 99 db below rated output. Features "tweeter saver," and unique balancing circuit. Handles power peaks up to 42 watts.

### KIT COMBINATIONS:

**W-5M Amplifier Kit:** Consists of main amplifier and power supply, all on one chassis. Complete with all necessary parts, tubes, and comprehensive manual.

**W-5 Combination Amplifier Kit:** Consists of W-5M Amplifier Kit listed above plus Heathkit Model WA-P2 Preamplifier Kit. Complete with all necessary parts, tubes, and construction manuals.

Express only—Shipping weight 38 lbs. . . . . \$79.50

Express only

**\$59.75**

Shpg. Wt.  
31 Lbs.

## Heathkit DUAL-CHASSIS HIGH FIDELITY AMPLIFIER KIT

The Model W-3M features the famous Acrosound TO-300 "ultra linear" output transformer. It uses 5881 tubes and has a frequency response within  $\pm 1$  db from 6 cps to 150 kc at 1 watt. Harmonic distortion only 1% at 21 watts. IM distortion at 20 watts only 1.3% at 60 and 3,000 cps. Power output is 20 watts. Output impedance is 4, 8, or 16 ohms. Hum and noise is 88 db below 20 watts. A very popular high fidelity unit. Main amplifier and power supply on separate chassis.

### KIT COMBINATIONS:

**W-3M:** Consists of main amplifier and power supply for separate chassis construction. Includes all tubes and components necessary for assembly.

**W-3:** Consists of W-3M Kit listed above plus Heathkit Model WA-P2 Preamplifier described on opposite page.

Express only—Shipping weight 37 lbs. . . . . \$69.50

Express only

**\$49.75**

Shpg. Wt.  
29 Lbs.

## Heathkit SINGLE-CHASSIS HIGH FIDELITY AMPLIFIER KIT

Model W-4A is the original low-priced Williamson Amplifier Kit. A Chicago output transformer and 5881 output tubes are featured. Frequency response is  $\pm 1$  db from 10 cps to 100 kc at 1 watt. Harmonic distortion only 1.5% at 20 watts. IM distortion only 2.7%. 20 watts output at 4, 8, or 16 ohms. Hum and noise 95 db below 20 watts. A tried and proven unit featuring a "polished" circuit that may be depended on for reliable high fidelity performance.

### KIT COMBINATIONS:

**W-4AM:** Consists of main amplifier and power supply for single chassis construction. Includes all tubes and components necessary for assembly.

**W-4A:** Consists of W-4AM Kit listed above plus Heathkit Model WA-P2 Preamplifier described on opposite page.

Express only—Shipping weight 35 lbs. . . . . \$59.50

Express only

**\$39.75**

Shpg. Wt.  
28 Lbs.

## Heathkit 20-WATT HIGH FIDELITY AMPLIFIER KIT

This amplifier can provide you with high fidelity at a surprisingly low price. Preamplifier built into same chassis as main amplifier. Four switch selected, compensated inputs are available, as are bass and treble tone controls, providing necessary flexibility for home or public address installations at a minimum investment. Features full 20-watt output using push-pull 6L6 tubes. Employs miniature tube types in preamp for low hum and noise. Frequency response is  $\pm 1$  db from 20 to 20,000 cps. Harmonic distortion only 1% at full output. Shop and compare—a real "best buy" for you.

MODEL A-9B

**\$35.50**

Shpg. Wt.  
23 Lbs.

## Heathkit 7-WATT AMPLIFIER KIT

The 7-watt output of this amazing little amplifier is more than adequate for normal home installations. Using a tapped-screen output transformer of new design, its frequency response is  $\pm 1\frac{1}{2}$  db from 20 to 20,000 cps. It provides good sensitivity, with surprisingly low distortion. Transformer tapped at 4, 8, and 16 ohms. Push-pull output. Separate bass and treble tone controls are provided.

**MODEL A-7E:** Same as Model A-7D, but with stage of preamplification. Extra gain for low level cartridges. RIAA compensation.

Shipping weight 10 lbs. . . . . \$18.50

MODEL A-7D

**\$16.95**

Shpg. Wt.  
10 Lbs.

**SPECIAL NOTE:** Don't overlook the possibilities of a hi-fi system consisting of the FM-3, the Model A-7E, and the Model SS-1 Speaker System. For only \$82.95, you can have high fidelity in your home.

**HEATH COMPANY** A Subsidiary of Daystrom, Inc. **BENTON HARBOR 20, MICH.**

## Heathkit HIGH FIDELITY PREAMPLIFIER KIT

Designed specifically for use with Heathkit main amplifiers. Features five separate switch-selected input channels, each with its own input level control. Four-position turnover and roll-off controls for record equalization. Separate bass and treble tone controls. Special hum control to insure minimum hum level. Will do justice to finest program sources. Beautiful satin-gold finish.

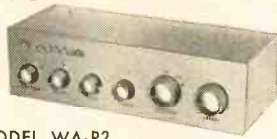

MODEL WA-P2  
**\$197<sup>5</sup>** (with cabinet)  
Shpg. Wt. 7 Lbs.

## Heathkit AM TUNER KIT

Designed for use with high fidelity systems. Low distortion voltage-doubler detector. Covers 550 to 1600 kc. 20 kc IF bandwidth. Audio response  $\pm 1$  db from 20 cps to 2 kc. 6 db signal-to-noise ratio at 2.5 microvolts. RF and IF coils pre-aligned. Power supply built-in. Efficient, modern circuit. Matches WA-P2 and FM-3 in color and style.

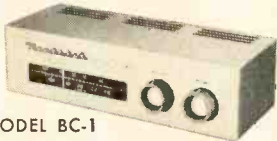

MODEL BC-1  
**\$245<sup>0</sup>** (with cabinet)  
Shpg. Wt. 8 Lbs.

## Heathkit HIGH FIDELITY FM TUNER KIT

This FM tuner offers sensitivity, selectivity, and stability, not expected at this price level. Efficient 7-tube circuit is entirely new, and incorporates AGC, cascode front end, temperature compensated oscillator, built-in power supply, and other outstanding design features. Only minimum adjustments required after assembly with pre-aligned IF and ratio transformers. Sensitivity is better than 10 microvolts for 20 db of quieting. Covers 88 to 108 mc.



MODEL FM-3  
**\$245<sup>0</sup>** (with cabinet)  
Shpg. Wt. 7 Lbs.

## Heathkit ELECTRONIC CROSS-OVER KIT



MODEL XO-1  
**\$189<sup>5</sup>** Shpg. Wt. 6 Lbs.

The XO-1 separates high and low frequencies at selectable crossover points, to feed two separate power amplifiers, one for high frequencies and one for low frequencies. Speakers are then connected to the amplifiers directly, without the usual LC crossover. Separate level controls provided for both outputs. The XO-1 consumes no audio power. Crossover frequencies are 100, 200, 400, 700, 1200, 2000, and 3500 cps. Attenuation is 12 db per octave.

# HEATHKIT<sup>®</sup>

## HIGH FIDELITY SPEAKER SYSTEM

The Models SS-1 and SS-1B are matched so that when the smaller unit is placed on top of the larger unit, the appearance of a single piece of furniture is achieved. They form an integrated 4-speaker system.

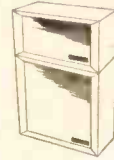

## Heathkit HIGH FIDELITY SS-1 SPEAKER SYSTEM KIT



MODEL SS-1  
**\$399<sup>5</sup>** Shpg. Wt. 30 Lbs.

This speaker system employs two Jensen speakers to cover the frequency range from 50 to 12,000 cps. Response is within  $\pm 5$  db through this range. Built-in crossover functions at 1600 cps. System rated at 25 watts, with nominal impedance of 16 ohms. Enclosure is a ducted-port bass reflex type. The attractive "picture frame" molding blends with any decorating scheme. You merely assemble the cabinet, wire the speakers and crossover network, and treat the furniture-grade plywood in the finish of your choice.

## Heathkit HIGH FIDELITY SS-1B SPEAKER SYSTEM KIT

This Range Extending Speaker System employs a 15" woofer and a super tweeter to cover the frequencies between 35 and 600 cps, and between 4000 and 16,000 cps. When used with the Model SS-1, it extends the frequency range at both ends of the spectrum for a total coverage of  $\pm 5$  db from 35 to 16,000 cps. Provides unbelievably rich sound over the audio range.

Exposed panels are furniture grade plywood, suitable for light or dark finish of your choice. All parts are pre-cut and ready for assembly. The kit includes necessary crossover circuits and balance control. Crossover frequencies are 600, 1600, and 4,000. Power rating is 35 watts for speech and music. Nominal impedance is 16 ohms.

The SS-1B, alone, measures 29" high by 23" wide by 17 $\frac{1}{2}$ " deep.

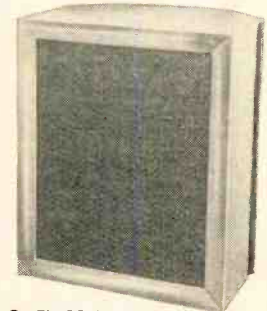

MODEL SS-1B  
**\$999<sup>5</sup>** Shpg. Wt. 80 Lbs.

## ORDER BLANK

NOTE: All prices subject to change without notice.

Enclosed find ( ) check ( ) money order for \_\_\_\_\_

Please ship C.O.D. ( ) postage enclosed for \_\_\_\_\_ pounds.

On Express orders do not include transportation charges — they will be collected by the express agency at time of delivery.

ON PARCEL POST ORDERS include postage for weight shown. ORDERS FROM CANADA and APO's must include full remittance.

Name \_\_\_\_\_

Address \_\_\_\_\_

City & Zone \_\_\_\_\_ State \_\_\_\_\_

(PLEASE PRINT)

SHIP VIA

- Parcel Post  
 Express  
 Freight  
 Best Way

QUANTITY	ITEM	MODEL NO.	PRICE

**HEATH COMPANY** A Subsidiary of Daystrom, Inc. BENTON HARBOR 20, MICH.

## RADIO

must be cut away where it interferes with the antenna loop.

Fig. 3 shows typical connections to an if stage. It is a bottom view of the Bakelite strip with the converter stage (not shown) at the left. Each if transformer is mounted with its brown dot on the bottom. This places three of its terminals on the left, two on the right. Each transistor socket is mounted with its collector terminal at the top. Remember: Fig. 3 is a *bottom* view. Note the coding dots.

The transformer terminal numbers are marked in the diagram. Terminal 3 connects *directly* to the collector of the previous transistor. This is made possible by carefully bending out the terminals of the transformer and transistor until they meet! Likewise, terminal 1 is soldered directly to the base of the following transistor. Terminal

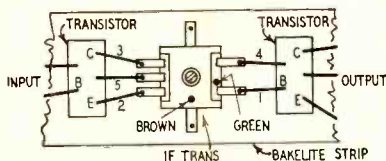

Fig. 3 — Connections to if transformer.

4 is not connected electrically but is soldered to a dummy terminal of the following transistor for support and to keep it from moving. In the same way, terminal 5 is soldered to a dummy terminal of the preceding transistor. Terminals 5 and 2 are connected to other components as indicated in Fig. 2.

To make this convenient wiring (or rather, lack of wiring) possible, the transistor sockets must be mounted just as shown in Fig. 3. If the socket is turned around, wiring becomes more difficult.

Neutralization is generally required in a transistor if amplifier because transistors are triodes with no shielding between input and output. Without neutralization the amplifier may oscillate and generate whistles as each station is tuned in. A 56- $\mu\text{f}$  capacitor was found necessary between the bases of V3 and V4. Strangely enough, none was found necessary between V2 and V3.

One other component is needed on the amplifier assembly. It is a miniature earpiece jack, such as made by Telex. Either a *closed-* or *open-*circuit jack may be used. This jack should come out of the box at the *top* for easy plug-in. A small aluminum angle bracket can be made up for this. It may be  $\frac{1}{2}$  inch on each side and  $\frac{1}{2}$  inch wide. A  $\frac{1}{4}$ -inch hole at one end takes the jack. Two small screws mount the other end (of the bracket) onto the Bakelite sheet.

Before mounting the amplifier you may wish to test it. With the power on you should hear a buzz when the amplifier is brought near a fluorescent lamp. This shows that the if amplifier is working. The oscillator may be checked by listening to its signal in a

nearby receiver. Connect a capacitor temporarily, across the coil for tuning. You should be able to cover from approximately 1—2 mc; that is, 455 kc higher than the broadcast band limits.

To mount the amplifier, remove the screw from the earpiece jack and insert the jack into a hole drilled for it in the box top. Tightening the screw on the jack is sufficient to hold the entire amplifier unit in place. If desired, the unit may also be supported near the bottom of the box.

The power supply for this receiver is composed of three penlight cells held together by a rubber band. Connections are soldered directly to the cells as required.

The battery switch problem is more difficult than might be supposed. The only satisfactory solution I have found is a tiny toggle switch made by Milliswitch of Los Angeles, a very expensive item costing nearly \$4. Unfortunately, there is no miniature earpiece jack that can close a battery circuit when the earpiece is plugged in. This would solve the problem nicely. Other substitutes might be a miniature four-position switch (sold by Lafayette) or a potentiometer with switch instead of the battery control used here.

After all parts are mounted and connected in the plastic box the receiver should be aligned. If you have no signal generator, try using the fluorescent buzz mentioned before. This buzz will grow in strength as you approach correct alignment. Also, you may use a loud station to help your alignment. Alignment with a signal generator is much better, of course, and in some cases will make the difference between excellent and erratic operation.

The oscillator core may be adjusted for maximum pickup at low broadcast frequencies. Tune the antenna trimmer of the dual capacitor for maximum pickup at high frequencies. With my set I am able to cover more than the broadcast band. At the high end I re-

ceive a station on 1.6 mc; at the other end a station on .57 mc comes in. In fact, below the latter I can pick up a code station continually repeating NSC in code. Evidently this is a beacon or other navigational aid station in the New York City area. The radio picks up more than 20 broadcast stations clearly in this area.

The battery control has only slight control over gain. Actually, it is useful to cut down drain from the battery and also acts as a filter in conjunction with the 16- $\mu\text{f}$  capacitor. As batteries grow old, it may be necessary to turn this control up to compensate for added

### Parts for shirt-pocket radio

1—470, 7—1,000, 2—2,200, 1—10,000, 2—15,000, 2—39,000 ohms,  $\frac{1}{2}$  watt, resistors; 1—1,000-ohm potentiometer (Lafayette VC-32 or equivalent); 1—56- $\mu\text{f}$  capacitor; 11—.01- $\mu\text{f}$  capacitors (Centralab DM-103 or equivalent); 2—16- $\mu\text{f}$  6-volt capacitors, electrolytic; 1—2-gang tuning capacitor, rf tuning range approximately 10—208  $\mu\text{f}$ , oscillator 10—100  $\mu\text{f}$  (Lafayette MS-270 or equivalent); 4—2N112 transistors and sockets; 1—oscillator coil, Lafayette MS-265; 1—loop antenna, Lafayette MS-166; 3—if transformers, Lafayette MS-126; 3—1.5-volt penlight cells; 1—tuning dial; 1—earphone; 1—switch (see text); 1—jack for earphone; 1—plastic case, approximately  $\frac{1}{2}$  x  $2\frac{3}{4}$  x  $1\frac{1}{4}$  inches.

resistance in the battery. With full resistance in the circuit, the battery drain should be about 2.5 ma. This control also prevents overloading on the more powerful local stations.

Don't hesitate to build this transistor radio. You will find plenty of use for it since you can keep in touch with the ball games, news flashes, your favorite concerts, etc. When carried in a shirt pocket, everything remains hidden except for the hearing-aid earpiece. The sound fidelity is far better than provided by most tube radios and the tuning is much less critical. Yet there remains sufficient selectivity to separate even the closest locals. As for volume, the stronger stations may be heard as much as a foot or two from the earpiece!

END

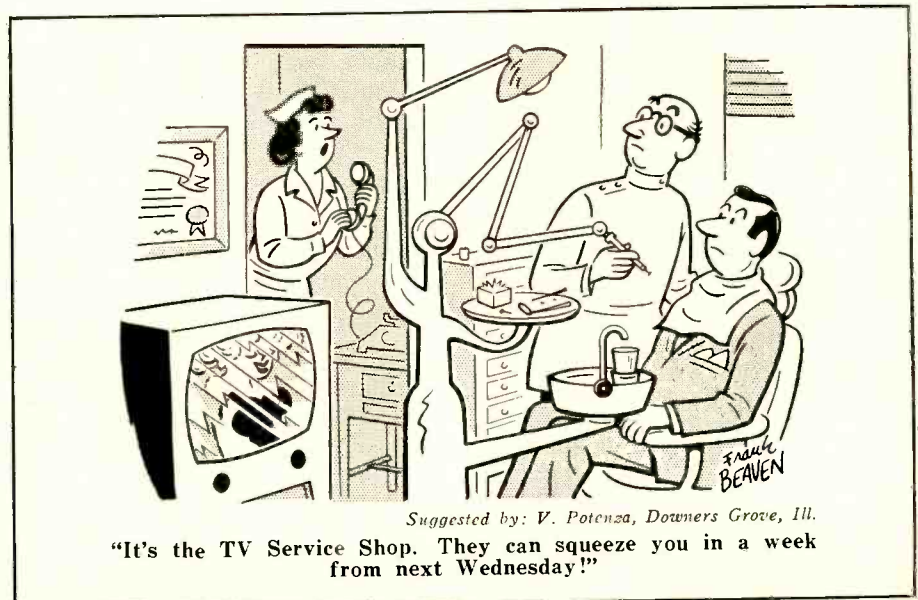

Suggested by: V. Potenza, Downers Grove, Ill.

"It's the TV Service Shop. They can squeeze you in a week from next Wednesday!"

# BUILD THIS...

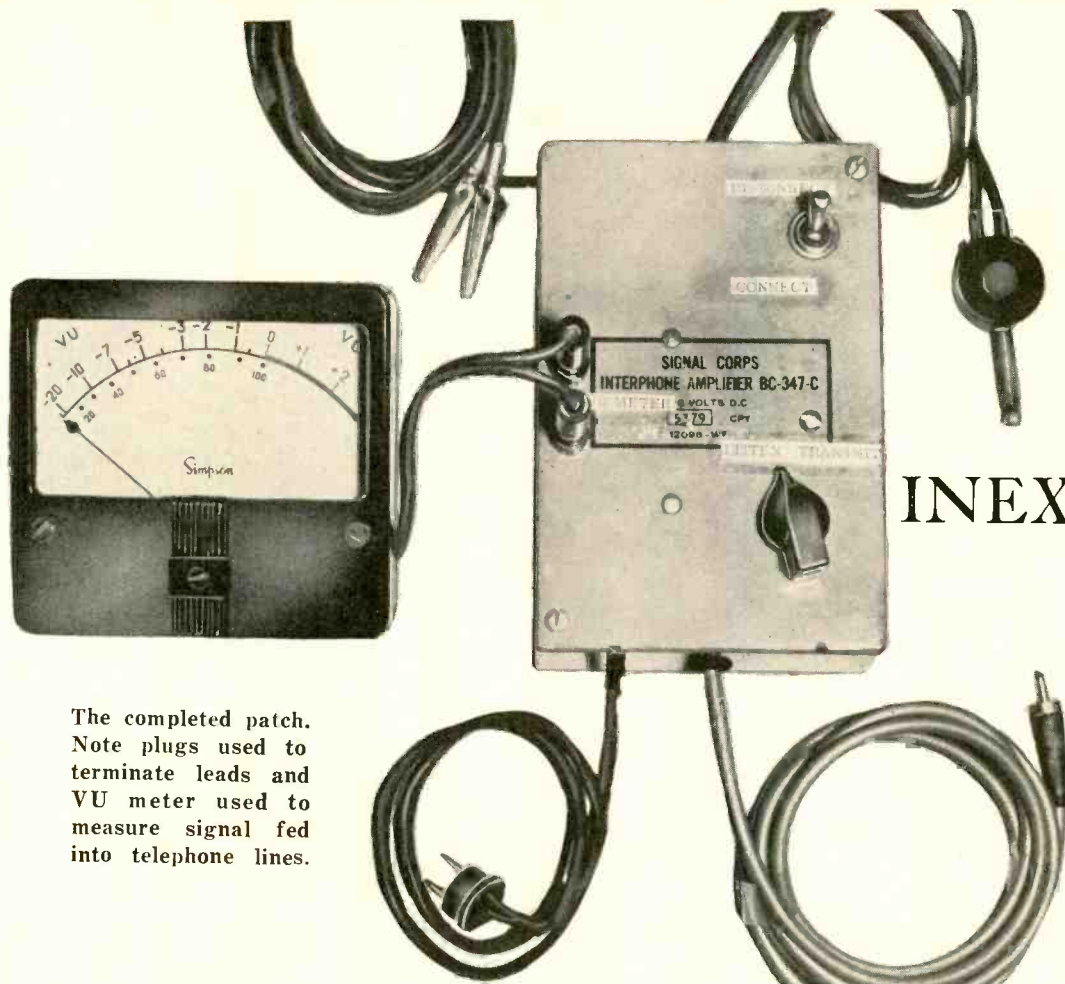

The completed patch. Note plugs used to terminate leads and VU meter used to measure signal fed into telephone lines.

## INEXPENSIVE PHONE PATCH

By JOHN T. FRYE, W9EGV

**Y**OUR attitude toward phone patches and their use has a lot to do with the kind of patch you build; so right at the beginning let me explain how I feel about this device.

There is not the slightest doubt in my mind that the radio amateur uses a phone patch only through the sufferance of the telephone company. He has no right to use the instrument at all; yet anyone listening on the amateur bands these days must realize the telephone people are not making strenuous objections at this time.

Practical considerations undoubtedly contribute to this "negative consent" attitude; the telephone company realizes the radio amateur is communications-minded and a good customer of theirs. Few ham shacks are without a telephone. In time of disaster the telephone company and the radio amateurs have worked together time and again for their mutual benefit and the benefit of the community. Second, a great deal of present phone patching is done to enable servicemen abroad to talk with their families here at home. This builds up a tremendous amount of goodwill for the radio amateur and the telephone company. Refusing to permit such patches would harvest an equal amount

of illwill for the company—something no public service concern wants. Finally, a great many of these phone-patch contacts embrace extensive use of toll lines with consequent increased income for Bell.

Another very important need for a phone patch is likely to arise in any communications emergency. At such a time, making it possible for CD, Red Cross, police and telephone officials to use the facilities of your amateur station without having to come to the station can be a real help. This single consideration should cause every amateur to think about building a patch.

In building and using one of these devices, however, the ham should guard zealously this privilege the telephone company has tacitly granted. Under no circumstances should the patch be used so as to deprive the telephone company of revenue. Neither should it be used at every possible opportunity just to show off. Still more important, its use must in no way interfere with the normal operation of telephone equipment.

These considerations automatically impose certain practical limitations on design. Since it will probably be used only rarely, the patch should be inexpensive and simple to build, compact

so as to take up a minimum of room in the ham shack, easily and quickly connected and disconnected, not interfere with the normal operation of the station.

To insure against interference with telephone equipment the patch should have provision for isolating it from the dc "common-battery" voltage in the line; provide for disconnecting the device instantly when the patched conversation is over so low-frequency ringing voltages will not be short-circuited; have means to prevent rf being fed into the line from the transmitter and have a means of measuring constantly the amount of audio voltage fed from the receiver into the line.

The phone patch in Fig. 1 does all of these things without sacrificing either intelligibility or operational ease. The case, measuring only about 6 x 4 x 2½ inches, and transformer T1 are parts of the common surplus item known as the Signal Corps Interphone Amplifier BC-347-C, often available in used condition for less than \$2. Two switches, four capacitors, a couple of 2.5-mh rf chokes and some miscellaneous wire and hardware complete the equipment used. The usual amateur junkbox is almost certain to provide some of these items.

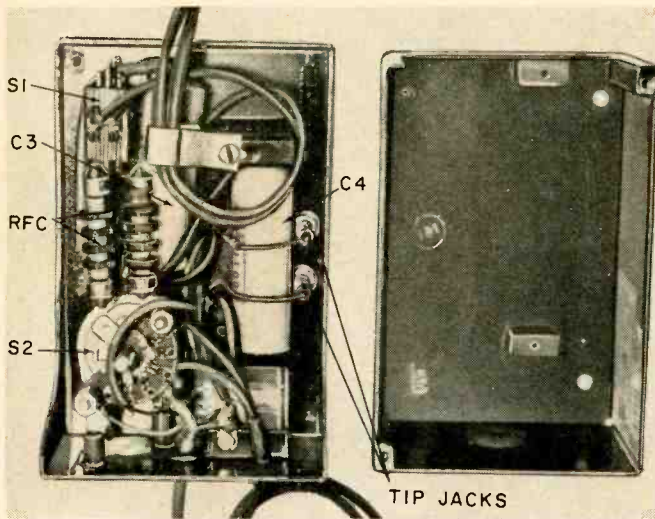

Inside view of patch. While S1 is seen to be a dpdt switch, it is used as dpst.

S1 connects or disconnects the unit to the telephone line. Ordinary line cord leads from this switch are equipped with small alligator clips for connecting to the telephone terminal block usually mounted on the baseboard. The two rf chokes and capacitors C1 and C2 prevent rf from feeding into the line from the transmitter speech equipment; C3 and C4 serve as coupling capacitors between the line and the transformer winding but they block the dc voltage in the line from this winding. T1 is really the output transformer used in the interphone amplifier. It bears the part number C-429 and has terminals marked as shown. Actual measurements taken at 1,000 cycles show that when a resistance of 125,000 ohms is connected across the original primary of this transformer, the secondary impedance is almost exactly 600 ohms. The turns ratio of this transformer as originally used is 10 to 1; so when it is used backward in this application, it affords a voltage boost of 10 times to the signal fed in from the line.

With S2 in the position shown in Fig. 1, this stepped-up signal is fed through the shielded lead to the grid of the second tube of the speech amplifier. Fig. 2 shows the simple changes necessary to arrange this input. Added components are in dashed lines. The shielded line terminates in a phono type plug and a matching jack is mounted on the speech amplifier.

When S2 is thrown to its other position, the P-P winding of T1 is connected by a length of ordinary line cord and a phone plug to the earphone jack of the receiver. The signal from the receiver is stepped down and fed through the coupling capacitors into the line. When a VU meter is connected to the two phone-tip jacks, the resistor value is correct to make this meter read 0 VU or 100 on peaks that represent a value of 4 db above zero reference level. This 4-dbm level is what the telephone company usually designates as the maximum to be fed into a pair of its lines.

Amateurs not having a standard VU meter should leave out the resistor and use any low-voltage rectifier type of ac meter. Call a friend on the telephone and have him listen while you talk—in somewhat stronger than usual tones—and simultaneously feed a signal into the line from the receiver. Keep advancing the receiver volume control until your friend decides the signal from it and that from your own voice are of equal loudness. Note how far the receiver signals kick the ac voltmeter pointer at this setting and consider that signal level the maximum to be fed into the line in the future.

The other portion of S2 simply short-circuits a length of line cord terminated in the male portion of a phono

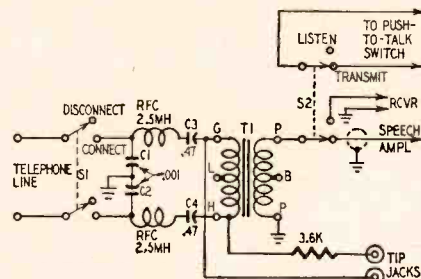

Fig. 1—Schematic of the phone patch.

motor connector in the TRANSMIT position and removes this short circuit in the LISTEN position. This plug fits into a female counterpart that bridges the push-to-talk switch of the amateur station and allows S2 to take over the function of this switch.

Phone patches labeled "nonswitching" offer no advantages over this unit. With them you do not have to throw a phone-patch switch each time one party or the other talks, but you do have to operate the station changeover switch. With this unit, the phone-patch switch also operates the changeover relays, and you still retain the decided isolating advantage of having the patch connect just to the receiver or the speech amplifier at the proper time.

It is assumed the push-to-talk switch of the station does not have to carry any considerable amount of current for

the contacts of wafer switch S2 are not designed for heavy amperage. Normally, this push-to-talk switch simply actuates a relay that handles the heavier currents. If this is not now the case with your station, such a relay should be installed.

Construction

No difficulties should be encountered in building the unit. Start by removing everything from the amplifier case except the pair of insulated solder lugs riveted to the top portion. Leave these in place. Replace transformer T1 in its original location but turn it half around so terminals P-B-P are toward the near end of the case. Break off the wirewound resistor bracket molded into the case near the top center for it appears where one of the coupling capacitors must lie. S1 and S2 are mounted in the positions shown. Instead of striving for a symmetrical layout, the controls have been placed so as to be easily operated with the right hand while the telephone receiver is held in the left.

A two-terminal tie point is mounted just above the wafer switch and the rf chokes are supported between it and a pair of S1 terminals. The leads of the coupling capacitors also connect to these tie points, while their other leads go to the pair of insulated solder lugs previously mentioned as riveted to the case. C1, C2 are beneath the chokes.

The shielded lead is brought out through a 1/4-inch grommet in the end of the case. The transmitter control lead comes out the same end. The leads to the telephone line and the receiver are both fed through the large grommet-lined hole already in the end of the cover. Strain relief for these two leads is provided as shown. The phone tip jacks for the meter are of the insulated type and have no connection to the case. The back cover has four holes in which woodscrews can be used for mounting it solidly to a wall or table.

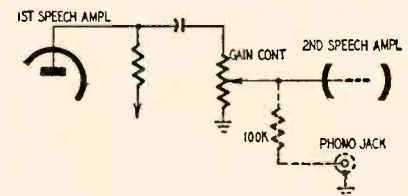
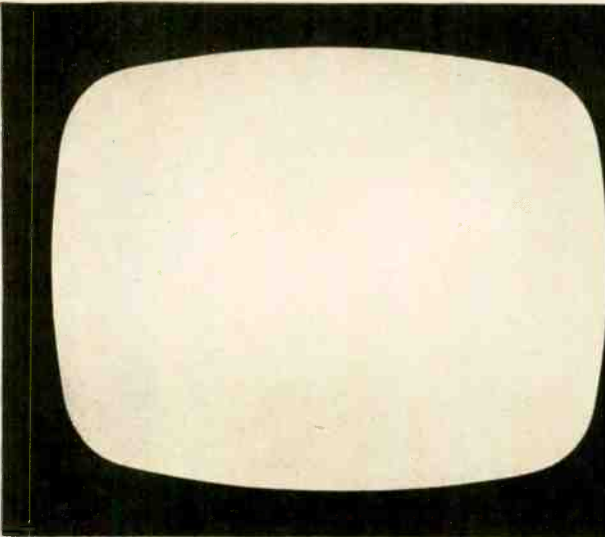

Fig. 2—Method of connecting the phone patch to the speech amplifier.

Two machine screws hold the case proper in this cover.

All tests of this device were run on the telephone on my desk, representative of modern telephones. There was a steady dc voltage of 48 across the line when the receiver was hung up. This voltage dropped considerably when the handset was removed from the cradle. A peak-reading vtvm showed that the ringing voltage had a peak-to-peak value of about 280 volts. This discouraged the use of low-voltage coup-

(Continued on page 76)



# how long would it take you to solve this service problem?

## SYMPTOM:

No picture is obtained. Sound is distorted. Raster is okay.

There's no telling how long it might take to solve this problem with hit-or-miss methods or incomplete service data. With a PHOTOFACT Folder by your side, the job takes just minutes. Here's why:

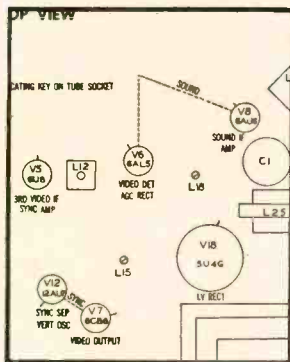

1. In just seconds, you locate the tubes most likely to cause this symptom by referring to the Tube Placement Chart\* and Tube Failure Check Chart\* you'll always find in each PHOTOFACT TV Folder.

In this case the trouble wasn't caused by tube failure. So checking further...

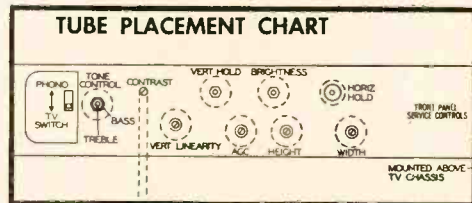

2. Adjustment of the AGC Control caused a weak picture to appear. Operation of the contrast control had no effect (control identification and location appear right on the Tube Placement Chart\*). Next logical step:

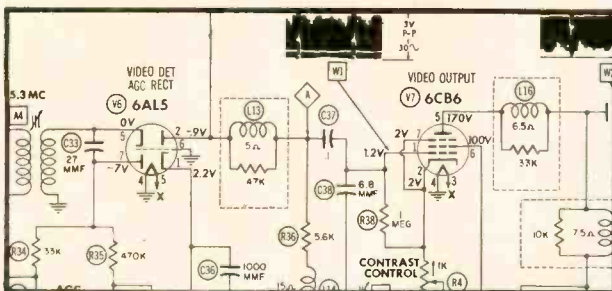

3. In just seconds, you refer to the Video and AGC circuits on the Standard Notation Schematic\* featured exclusively in PHOTOFACT Folders. (Circuits are always laid out in the same uniform manner—easy to locate—easy to trace.) In a matter of minutes, you check waveforms and/or voltages—they're right on the schematic. In those same few minutes, you pinpoint the trouble. You make a resistance check using the handy Resistance Chart\* and you have the answer to your problem in this case history: A cold solder connection at the center lug of the Contrast control.

\*One of 32 features found exclusively in PHOTOFACT—the world's finest service data—the data that gives you the most for your money.

With PHOTOFACT by your side,  
you solve your service problems in just minutes—you  
service more sets and earn more daily!



## MONEY BACK GUARANTEE!

Got a tough repair? Try this—at Howard W. Sams' own risk: see your Parts Distributor and buy the proper PHOTOFACT Folder Set covering the receiver. Then use it on the actual repair. If PHOTOFACT doesn't save you time, doesn't make the job easier and more profitable for you, Howard W. Sams wants you to return the complete Folder Set direct to him and he'll refund your purchase price promptly. GET THE PROOF FOR YOURSELF—TRY PHOTOFACT NOW!

free



Send for Sams' INDEX TO PHOTOFACT FOLDERS—your guide to virtually any receiver model ever to come into your shop; helps you locate the proper PHOTOFACT Folder you need to solve any service problem on any model. You'll want this valuable reference guide. Send coupon now.

## HOWARD W. SAMS & CO., INC.

Howard W. Sams & Co., Inc.  
2205 E. 46th St., Indianapolis 5, Ind.

Send FREE Index to PHOTOFACT Folders  
 I am a Service Technician: \_\_\_full time; \_\_\_part time.  
 Student. Other: \_\_\_\_\_

Shop Name: .....

Attn.: .....

Address: .....

City: ..... Zone: ..... State: .....

Superior's New Model TC-55



# New! SICO Streamlined TUBE TESTERS

**FOR**

The Experimenter or Part-time Serviceman, who has delayed purchasing a higher priced Tube Tester. The Professional Serviceman, who needs an extra Tube Tester for outside calls. The busy TV Service Organization, which needs extra Tube Testers for its field men.

- You can't insert a tube in wrong socket. Separate sockets are used, one for each type of tube base.
- "Free-point" element switching system. Any pin may be used as a filament pin and the voltage applied between that pin and any other pin, or even the "top-cap".
- Checks for shorts and leakages between all elements. Provides a super sensitive method of checking for shorts and leakages up to 5 Megohms between any and all of the terminals. Continuity between various sections is individually indicated.
- Elemental switches are numbered in strict accordance with R.M.A. specification. The 4 position fast-action snap switches are all numbered in exact accordance with the standard R.M.A. numbering system.

Speedy, yet efficient operation is accomplished by: Elimination of old style sockets used for testing obsolete tubes (26, 27, 57, 59, etc.) and providing sockets and circuits for efficiently testing the new Noval and Sub-Minar types.

Model TC-55 comes complete with operating instructions and charts and streamlined carrying case.

**\$26<sup>95</sup> NET**

## PICTURE TUBE TESTER



Superior's New Model TV-40



- Tests all magnetically deflected tubes . . . in the set . . . out of the set . . . in the carton!!
- A complete picture tube tester for little more than the price of a "make-shift" adapter!!

The Model TV-40 is absolutely complete! Self-contained, including built-in power supply, it tests picture tubes in the only practical way to efficiently test such tubes; that is by the use of a separate instrument which is designed exclusively to test the ever increasing number of picture tubes!

### SPECIFICATIONS

Tests all magnetically deflected picture tubes from 7 inch to 30 inch types. Tests for quality by the well established emission method. All readings on "Good-Bad" scale. Tests for inter-element shorts and leakages up to 5 megohms. Test for open elements.

Model TV-40 comes absolutely complete — nothing else to buy. Housed in round, cornered, molded bakelite case. Only . . .

**\$15<sup>85</sup> NET**

Superior's New Model TV-11 Standard Professional

## TUBE TESTER



- ★ Uses the new self-cleaning Lever Action Switches for individual element testing. Because all elements are numbered according to pin-number in the RMA base numbering system, the user can instantly identify which element is under test. Tubes having tapped filaments and tubes with filaments terminating in more than one pin are truly tested with the Model TV-11 as any of the pins may be placed in the neutral position when necessary.
- ★ The Model TV-11 does not use any combination type sockets. Instead individual sockets are used for each type of tube. Thus it is impossible to damage a tube by inserting it in the wrong socket.
- ★ Free-moving built-in roll chart provides complete data for all tubes.
- ★ NOISE TEST: Phono-jack on front panel for plugging in either phones or external amplifier will detect microphonic tubes or noise due to faulty elements and loose internal connections.

**EXTRA SERVICE** — The Model TV-11 may be used as an extremely sensitive Condenser Leakage Checker. A relaxation type oscillator incorporated in this model will detect leakages even when the frequency is one per minute.

The model TV-11 operates on 105-130 Volt 60 Cycles A.C. Comes housed in a beautiful hand-rubbed oak cabinet complete with portable cover.

**\$47<sup>50</sup> NET**

## TRANS-CONDUCTANCE TUBE TESTER

Superior's New Model TV-12



### TESTING TUBES

- ★ Employs improved TRANS-CONDUCTANCE circuit. An in-phase signal is impressed on the input section of a tube and the resultant plate current change is measured. This provides the most suitable method of simulating the manner in which tubes actually operate in Radio & TV receivers, amplifiers and other circuits. Amplification factor, plate resistance and cathode emission are all correlated in one meter reading.
- ★ NEW LINE VOLTAGE ADJUSTING SYSTEM. A tapped transformer makes it possible to compensate for line voltage variations to a tolerance of better than 2%.
- ★ SAFETY BUTTON—protects both the tube under test and the instrument meter against damage due to overload or other form of improper switching.

- ★ NEWLY DESIGNED FIVE POSITION LEVER SWITCH ASSEMBLY. Permits application of separate voltages as required for both plate and grid of tube under test, resulting in improved Trans-Conductance circuit.

### TESTING TRANSISTORS

A transistor can be safely and adequately tested only under dynamic conditions. The Model TV-12 will test all transistors in that approved manner, and quality is read directly on a special "transistor only" meter scale.

Model TV-12 housed in handsome rugged portable cabinet sells for only

**\$72<sup>50</sup> NET**

**ALSO TESTS TRANSISTORS!**

**EXAMINE BEFORE YOU BUY!  
USE APPROVAL FORM ON NEXT PAGE**



New!



# Superior's New Model 670-A SUPER-METER



**SPECIFICATIONS**

D.C. VOLTS: 0 to 7.5/15/75/150/750/1,500/7,500 Volts  
 A.C. VOLTS: 0 to 15/30/150/300/1,500/3,000 Volts  
 OUTPUT VOLTS: 0 to 15/30/150/300/1,500/3,000 Volts  
 D.C. CURRENT: 0 to 1.5/15/150 Ma. 0 to 1.5/15 Amperes  
 RESISTANCE: 0 to 1,000/100,000 Ohms 0 to 10 Megohms  
 CAPACITY: .001 to 1 Mfd. 1 to 50 Mfd. (Good-Bad scale for checking quality of electrolytic condensers.)  
 REACTANCE: 50 to 2,500 Ohms 2,500 Ohms to 2.5 Megohms  
 INDUCTANCE: .15 to 7 Henries 7 to 7,000 Henries  
 DECIBELS: -6 to +18 +14 to +38 +34 to +58

**ADDED FEATURE:**

Built-in ISOLATION TRANSFORMER reduces possibility of burning out meter through misuse.

The Model 670-A comes housed in a rugged crackle-finished steel cabinet complete with test leads and operating instructions.

**\$28<sup>40</sup> NET**



## Superior's New Model TV-60 20,000 OHMS PER VOLT ALLMETER



Includes services never before provided by an instrument of this type. Read and compare features and specifications below!

**FEATURES**

- Giant recessed 6 1/2 inch 40 Microampere meter with mirrored scale.

- Built-in Isolation Transformer.
- Use of the latest type printed circuit and 1% multipliers assure unchanging accurate readings.

**SPECIFICATIONS**

8 D.C. VOLTAGE RANGES: (At a sensitivity of 20,000 Ohms per Volt) 0 to 15/75/150/300/750/1500/7500/30,000 Volts.  
 7 A.C. VOLTAGE RANGES: (At a sensitivity of 5,000 Ohms per Volt) 0 to 15/75/150/300/750/1500/7500 Volts.  
 3 RESISTANCE RANGES: 0 to 2,000/200,000 Ohms, 0-20 Megohms  
 2 CAPACITY RANGES: .00025 Mfd. to 30 Mfd.  
 5 D.C. CURRENT RANGES: 0-75 Microamperes, 0 to 7.5/75/750 Milliampers, 0 to 15 Amperes.  
 3 DECIBEL RANGES: -6 db to +58 db  
**RF SIGNAL TRACER SERVICE:** Enables following the R.F. signal from the antenna to speaker of any radio or TV receiver and using that signal as a basis of measurement to first isolate the faulty stage and finally the component or circuit condition causing the trouble.  
**AUDIO SIGNAL TRACER SERVICE:** Functions in the same manner as the R.F. Signal Tracing service specified above except that it is used for the location of cause of trouble in all audio and amplifier systems.

Model TV-60 comes complete with book of instructions; pair of standard test leads; high-voltage probe; detachable line cord; R.F. Signal Tracer Probe and Audio Signal Tracer Probe. Pliofilm bag for all above accessories is also included. Price complete. Nothing else to buy. ONLY

**\$52<sup>50</sup>**



## Superior's New Model TV-50 GENOMETER

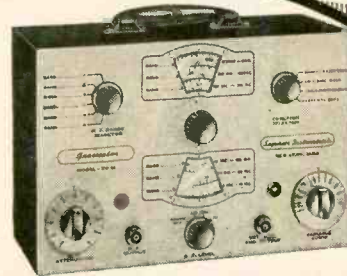

A versatile all-inclusive GENERATOR which provides ALL the outputs for servicing: A.M. Radio • F.M. Radio • Amplifiers • Black and White TV • Color TV

**R. F. SIGNAL GENERATOR:** Provides complete coverage for A.M. and F.M. alignment. Generates Radio Frequencies from 100 Kilocycles to 60 Megacycles on fundamentals and from 60 Megacycles to 180 Megacycles on powerful harmonics. • **VARIABLE AUDIO FREQUENCY GENERATOR:** In addition to a fixed 400 cycle sine-wave audio, the Genometer provides a variable 300 cycle to 20,000 cycle peaked wave audio signal. • **BAR GENERATOR:** Projects an actual Bar Pattern on any TV Receiver Screen. Pattern will consist of 4 to 16 horizontal bars or 7 to 20 vertical bars. • **CROSS HATCH GENERATOR:** Genometer will project a cross-hatch pattern on any TV picture tube. The pattern will consist of non-shifting horizontal and vertical lines interlaced to provide a stable cross-hatch effect. • **DOT PATTERN GENERATOR (FOR COLOR TV):** The Dot Pattern projected on any color TV Receiver tube by the Model TV-50 will enable you to adjust for proper color convergence. • **MARKER GENERATOR:** The following markers are provided: 189 Kc., 262.5 Kc., 456 Kc., 600 Kc., 1000 Kc., 1400 Kc., 1600 Kc., 2000 Kc., 2500 Kc., 3579 Kc., 4.5 Mc., 5 Mc., 10.7 Mc., (3579 Kc. is the color burst frequency.)

MODEL TV-50 comes absolutely complete with shielded leads and operating instructions.

**\$47<sup>50</sup> NET**

Only

# SHIPPED ON APPROVAL NO MONEY WITH ORDER - NO C.O.D.

**TRY ANY** of the instruments on this page, for 10 days before you buy. If completely satisfied **then** send down payment and pay balance as indicated on coupon. **No Interest or Finance Charges added!** If not completely satisfied return unit to us, no explanation necessary.

**MOSS ELECTRONIC DISTRIBUTING CO., INC.**  
 Dept. D-246, 3849 Tenth Ave. New York 34, N.Y.

Please send me the units checked. I agree to pay down payment within 10 days and to pay the monthly balance as shown. It is understood there will be no finance or interest charges added. It is further understood that should I fail to make payment when due, the full unpaid balance shall become immediately due and payable.

Name .....  
 Address .....  
 City ..... Zone ..... State .....

All Prices net, F.O.B., N.Y.C.

<input type="checkbox"/> Model TC-55.....	Total Price \$26.95
\$6.95 within 10 days.	Balance \$5.00
monthly for 4 months.	
<input type="checkbox"/> Model TV-12.....	Total Price \$72.50
\$22.50 within 10 days.	Balance \$10.00
monthly for 5 months.	
<input type="checkbox"/> Model 670-A.....	Total Price \$28.40
\$7.40 within 10 days.	Balance \$3.50
monthly for 6 months.	
<input type="checkbox"/> Model TV-11.....	Total Price \$47.50
\$11.50 within 10 days.	Balance \$6.00
monthly for 6 months.	
<input type="checkbox"/> Model TV-40.....	Total Price \$15.85
\$3.85 within 10 days.	Balance \$4.00
monthly for 3 months.	
<input type="checkbox"/> Model TV-50.....	Total Price \$47.50
\$11.50 within 10 days.	Balance \$6.00
monthly for 6 months.	
<input type="checkbox"/> Model TV-60.....	Total Price \$52.50
\$12.50 within 10 days.	Balance \$8.00
monthly for 5 months.	

# ONE SPEAKER THE NORELCO

*\*F.R.S.*

*covers the audio  
frequency range*

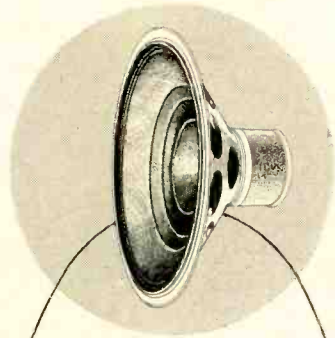

In a single twin-cone design—Norelco Full Resonance Speakers provide quality equal to most elaborate multi-unit sound systems.

Both high range and low range cones are operated by one magnet and one voice coil. Cones are always in phase and operate in harmony. Coupling designs give unexcelled spatial distribution throughout entire audio-frequency range.

Priced from \$59.98 to \$6.75 in all standard impedances and sizes from 12 inches to 5 inches.

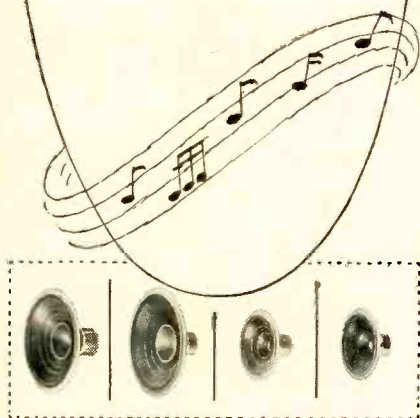

ADD TO...and improve any sound system with **Norelco®**  
\*FULL RESONANCE SPEAKERS



Send to Dept. D-7 for more details  
North American Philips Co., Inc.  
100 East 42nd Street  
New York 17, N. Y.

## RADIO

ling capacitors such as are sometimes recommended. The rms values of incoming audio voltages varied tremendously with different voices; but all of them fell between 0.1 and 0.5 volt during normal conversation. Feminine voices gave higher readings than masculine ones.

Fig. 3 shows the overall frequency response curves run on the patch. The low frequencies are sharply attenuated. This low-frequency response could be effectively extended, as shown, at the expense of the high frequencies by placing a .001- $\mu$ f capacitor across the high-impedance winding of T1. At first hearing, this seemed to produce a more pleasing and natural tone. But when a friend speaking Spanish—with which I have such a tenuous acquaintance that I must hear *every* syllable if I am to make sense of it—was run from the telephone through the patch into a tape recorder, it was immediately apparent greater intelligibility was had when this capacitor was omitted.

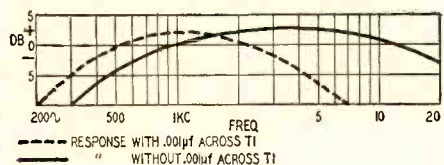

Fig. 3—Response curves of patch.

This finding agrees completely with authorities who say that removing all frequencies below 1,000 cycles impairs the natural quality of a voice but does little harm to intelligibility while cutting off everything above 1,000 cycles destroys intelligibility but leaves the volume level about the same.

Those who have heard the patch in operation describe it as clear, crisp and of excellent telephone quality. There is a definite advantage in having a phone patch sound like a telephone. Frequency jumpers, who hold nothing else sacred, apparently hesitate to sit down on a phone-patch conversation when they recognize it as such.

Using the patch is simple. The alligator clips are fastened to the two live wires of the telephone terminal button while S1 is set to DISCONNECT. The three other leads are plugged into their proper receptacles and since no two plugs are alike it is impossible to make a mistake here. Leave the patch disconnected while you dial the telephone and get the person on the wire. If he is new to the business, explain that he will have to say "over" or something like that when he is through talking and wants to listen and that he cannot cut in while the other party is talking. (He will try it anyway, but tell him.)

Then throw the switch to CONNECT and turn S2 to TRANSMIT. Call the other amateur station with the telephone microphone. Depending somewhat on the quality of your voice, you may find it necessary to speak lower than usual or farther away from the

telephone mouthpiece to avoid over-modulating. The person's voice on the other end of the wire is attenuated by the wire between you, but your own voice suffers no such attenuation.

Throw the switch back to LISTEN and quickly adjust the receiver volume so that the meter plugged into the phone patch indicates the proper level. From then on all you have to do is operate S2 and sign the station on and off. You can inject a comment whenever you wish. When the conversation is over, throw S1 to DISCONNECT before hanging up the receiver. This will avoid the possibility of having the ringing voltage applied to the patch.

With S1 disconnected, you can no longer use the telephone microphone to modulate your transmitter, but you have only to pick up the station microphone and carry on as usual. It is not necessary to remove the plug from the speech amplifier. If S2 is left in the LISTEN position, the push-to-talk switch will work normally. Of course, the plug will have to be removed from the earphone jack to activate the receiver speaker. At my station the gain control can be left at the same point when using either the patch or the station microphone. As soon as convenient, unclip the leads from the phone terminals to avoid any chance of short-circuiting the line.

### Parts for phone patch

1—3,600-ohm resistor, 1/2 watt, 5% (see text); 2—.001- $\mu$ f ceramic disc capacitors, 500 volts; 2—.047- $\mu$ f plastic tubular paper capacitors, 400 volts; 2—2.5-mh rf chokes; 1—dpst switch; 1—dpdt wafer switch; 1—p-p output-to-line transformer from BC-347-C interphone amplifier (see text); 2—pin jacks; 1—chassis (see text).

You do not have to stick slavishly to the patch described. It could just as well be housed in another case; a conventional line-to-grid transformer could be used for T1 and the parts could be rearranged. However, it is hoped that whatever patch you build, some of the measurements and observations made here will be helpful.

If you feel as I do that every ham should have a dependable patch at hand for emergency use but that too much time or money should not be tied up in such a piece of equipment, the phone patch described will be found hard to beat. END



"Is there any high voltage?"

# ALLIED knight-kits

**FINEST ELECTRONIC EQUIPMENT  
IN LOWEST-COST KIT FORM**

- ★ Latest Advanced Design ★ Quality Components  
★ Easiest to Assemble ★ Save Up To 50%

**BUY DIRECT...YOU SAVE MORE**

**free 1956 CATALOG**

Send for it! Describes the famous KNIGHT-KITS in detail—shows you how you can easily assemble your own instruments and get performance and appearance equal to equipment selling for several times the KNIGHT-KIT price. The 324-page ALLIED Catalog is the leading buying guide to *everything* in Electronics—write for your copy.



**SAVE ON THESE QUALITY knight-kit TEST INSTRUMENTS**

 5" Wide-Band Oscilloscope Kit F-144 69.00	 Printed Circuit VTVM Kit F-125 24.95	 Tube Tester Kit F-143 counter type 29.75 F-142 portable type 34.75	 VOM Kit 1000 Ohms/Volt F-128 15.95	 VOM Kit 20,000 Ohms/Volt F-140 28.50	 In-Circuit Capacitor Checker Kit F-119 11.65
 Audio Generator Kit F-137 31.50	 Resistance-Capacitance Tester Kit F-124 18.75	 High-Gain Signal Tracer Kit F-135 23.75	 RF Signal Generator Kit F-145 19.75	 Resistance Substitution Box Kit F-139 5.95	 Capacitance Substitution Box Kit F-138 5.50

**FAMOUS knight-kits FOR THE HOBBYIST**

 "Space Spanner" 2-Band Receiver Kit S-243 13.95 S-247 cabinet, 2.85	 "10-in-1" Lab Kit S-265 12.45	 "Ranger" Superhet Receiver Kit S-735 14.85
--	---	--

**TOP QUALITY HIGH FIDELITY knight-kits**

 Basic 25-Watt Deluxe Amplifier Kit S-755 41.50	 10-Watt Hi-Fi Amplifier Kit S-234 22.95	 20-Watt Hi-Fi Amplifier Kit S-750 35.75
---	---	---

**LOW-COST knight-kits FOR THE AMATEUR**

 "Ocean Hopper" Receiver Kit S-740 10.75	 Transistor Radio Kit S-765 3.95	 Geiger Counter Kit S-242 15.95
 3-Way Portable Radio Kit S-730 19.95	 Photoflash Kit S-244 28.50 S-246 AC supply, 3.40	 Wireless Broadcaster Kit S-705 8.75

 50-Watt CW Transmitter Kit S-255 42.50	 Self-Powered VFO Kit S-725 27.50	 Code Practice Oscillator Kit S-239 3.95
--	--	---

**FREE** Send for the 324-page ALLIED Catalog describing all KNIGHT-KITS—and your buying guide to everything in Electronics.

ALLIED RADIO CORP., Dept. 2-G-6  
100 N. Western Ave., Chicago 80, Ill.  
Please ship the following Knight-Kits:.....

My check , money order  for \$.....enclosed  
 Please send FREE 1956 Catalog.

Name.....  
Address.....  
City..... Zone..... State.....

All Prices Net F.O.B. Chicago  
ORDER FROM

**ALLIED RADIO**

100 N. Western Ave., Chicago 80, Ill.

## RADIO

The LEL transistorized wrist radio.

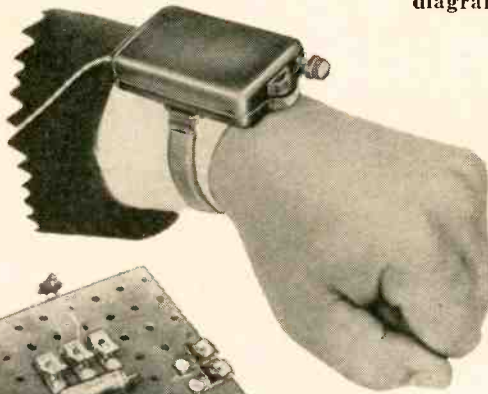

The Lafayette regenerator kit KT-70.

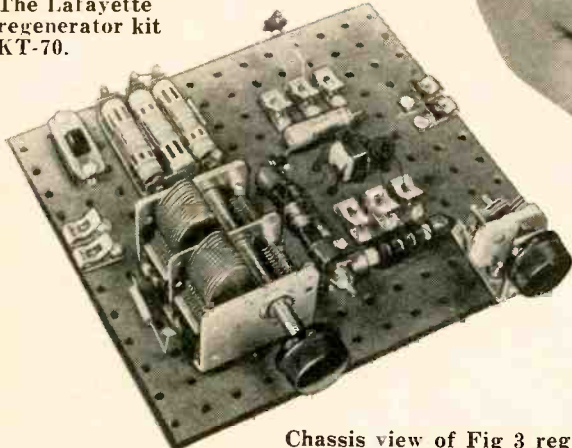

Chassis view of Fig 3 regenerator. Transistors are near ends of mounting strip.

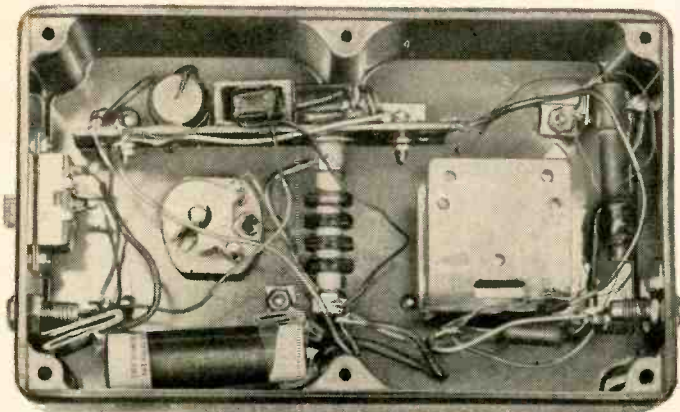

The regenerator kit diagrammed in Fig. 1.

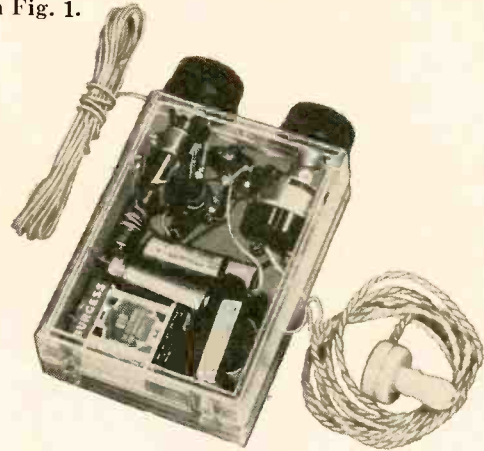

# TRANSISTOR RADIOS

By I. QUEEN  
EDITORIAL ASSOCIATE

## Part II—Regenerative transistor receivers

We have discussed the simple crystal-plus-one-stage-audio type of receiver. The crystal may have been an external diode or the transistor itself may have performed the function of detection as well as that of amplification. A regenerator differs in many respects from this type of set. It is more complicated to build, more tricky to tune. In return, it offers far greater selectivity and considerably more gain. Under good conditions, reception over hundreds of miles is possible. Many old-timers will remember the accomplishments of early single-tube regenerators. Substituting a transistor for the tube does not affect results much but reduces power-supply requirement.

Every regenerator includes an arrangement for producing positive feedback and some means for controlling it. Energy is fed back from the output to the input to reinforce the original rf signal. The greater the feedback, the higher the gain and selectivity. But this can be carried only to the point where regeneration becomes oscilla-

tion; therefore the feedback control is important. It should be smooth and not critical, otherwise the signal may be smothered under noises, howls and whistles.

Fig. 1 shows a regenerator (designed by Edwin Bohr) with one audio stage. Feedback is obtained by coupling between the collector and emitter coils. L1 is a Loopstick over which five to seven turns are wound to make L2 (Fig. 2). The coils must be correctly phased or the feedback energy

will be *negative* instead of positive.

The regeneration control is a potentiometer which adjusts the transistor bias—that is, the gain. For broadcast reception it is set just under the point where the circuit oscillates (whistles).

The antenna signal is coupled from L1 to L2 which feeds it to the emitter. After amplification, the rf is fed back to L2 via L1. The amplified signal is rectified by the diode which charges a large 25- $\mu$ f capacitor. The action here is similar to that described for Fig. 2

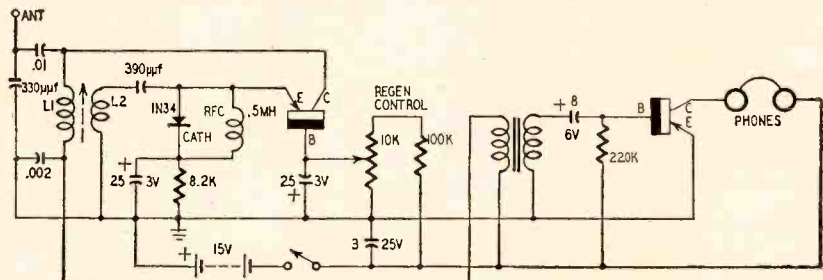

Fig. 1—Schematic of regenerator using one stage of audio amplification.

# RCA

# SELENIUM

# RECTIFIERS

**-one comprehensive line for virtually all replacement requirements!**

Now, RCA offers you a top-grade line of selenium rectifiers for general replacement use in TV, radio receivers, and phonographs. Advanced design, select raw materials, and superior workmanship give you a *dependable line of selenium rectifiers for virtually all service jobs.*

### Advanced Design for Dependable Performance and Long Life

Note the wide-open plate spacing for elimination of solid center "hot spot." Design utilizes corrugated spacers for *excellent heat dissipation and rigid construction for rugged service.*



**NEW**—smaller size . . . for any given current, they are smaller than other types.

**NEW**—quicker installation . . . integral mounting stud.

**NEW**—wide-open design . . . insures maximum heat dissipation, cooler operation . . . no center "hot spots."

**NEW**—rigid construction . . . for rugged service.

**RCA SELENIUM RECTIFIERS**—a *comprehensive line*—for consistently good performance, easier installation, longer life and customer satisfaction. **ORDER FROM YOUR RCA DISTRIBUTOR TODAY!**

#### WIDE SELECTION OF 12 TYPES

Max. Output ma	Max. Input volts	RCA Type
65	130	205G1
75	130	200G1
100	130	206G1
150	130	201G1
200	130	207G1
250	130	208G1
300	130	202G1
350	130	209G1
400	130	203G1
500	130	204G1
400*	130	210G1
500*	130	211G1

\*Special thin types for use where available space will not permit the use of type 203G1 or 204G1.



**RADIO CORPORATION of AMERICA**  
ELECTRONIC COMPONENTS

HARRISON, N. J.

# LOOK FOR THIS RACK

at your Jobber . . .



In this rack you will find  
The Biggest Service Help  
The Largest Value  
In These Perfect Partners

Dave Rice's Official Pricing Digest  
—a quick check for over 60,000  
prices—revised 4 times every year.  
Pocket sized.

and  
Dave Rice's Official TV-Radio  
Service Order Book which  
provides separate listings for picture  
tubes, receiving tubes, parts and  
components, serial numbers, labor  
and state and local taxes. 5 1/2 x 8 1/2  
—50 sets of triplicate orders—  
carbons bound in.

**ELECTRONIC PUBLISHING CO. INC.**  
180 North Wacker Drive Chicago 6, Illinois

## RADIO

last month in Part I of this article.

The rf is bypassed by the capacitor, but the af component of the signal builds up a voltage across it. Stated another way, the large capacitor cannot follow the individual rapid fluctuations of the signal. Instead, it smooths out the voltage, leaving only the audio envelope of the carrier wave. This biases the transistor.

Now the af must be separated from the rf, both of which are present in the transistor output. The rf is present across L1 but it cannot flow through the high inductance of the audio-transformer primary. A .002- $\mu$ f capacitor bypasses it to ground. The af finds little impedance across L1 so it flows into the audio transformer and is amplified in a conventional transistor stage.

This circuit is available in kit form (Lafayette KT-68). All parts, except the earpiece, fit into a small plastic box for pocket use.

Another regenerator is drawn in Fig. 3. This one was designed by Dr. William H. Grace, Jr., and originally appeared in RADIO-ELECTRONICS (August, 1954). Here the feedback is developed between collector and base coils, with a 50- $\mu$ f variable capacitor providing the control. The rf component flows into C, being blocked from the audio transformer by a choke coil. The audio modulation cannot pass through small capacitor C, so it appears across P. The audio transformer is the usual stepdown type (ordinarily 25,000 to approximately 1,000 ohms) to

couple the high-impedance collector properly to a low impedance base. Lafayette No. KT-70 is available for those who prefer kits.

### Portable wrist radio

A novel receiver has been announced recently by LEL, Inc., 380 Oak St., Copiague, N. Y. Designed to be worn on the wrist as shown in the photo, it is 2 3/4 inches long, 1 1/4 inches wide and 3/4 inch thick, and weighs only 2.5 ounces. In favorable locations it requires no external antenna since its sensitivity is 200  $\mu$ v per meter. The power supply is made up of five button-size mercury cells. Their life is about 100 hours, giving an operating cost less than 2 cents per hour.

The receiver (Fig. 4) has a regenerative detector and two stages of audio. The antenna coil is tuned over the broadcast band. The emitter tank is tuned below this band, so it appears as an effective capacitance.

The detector of the wrist radio may be compared with a Colpitts oscillator (Fig. 5). Note the tapped capacitance between plate and grid with the tap going to the cathode. An ultraudion oscillator is like the Colpitts, except that one or both voltage-dividing capacitors are omitted. The equivalent effect is supplied by internal capacitance between tube elements. A simplified diagram of the wrist radio shows its similarity to the Colpitts or ultraudion (Fig. 6). Here the collector acts like a plate, the base like a grid and the emitter like a cathode.

Capacitor C1 is the effective capacitance of the emitter network; C2 is the internal capacitance between base and emitter. These function as the voltage-dividing capacitance. The base potentiometer controls the gain of the transistor and determines the amount of feedback and regeneration. The two audio stages are conventional. They provide plenty of sound output for the earpiece.

TO BE CONTINUED

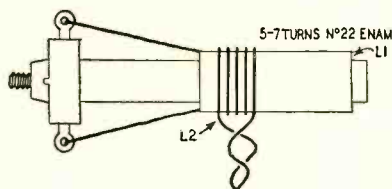

Fig. 2—Layout of Fig. 1 loopstick.

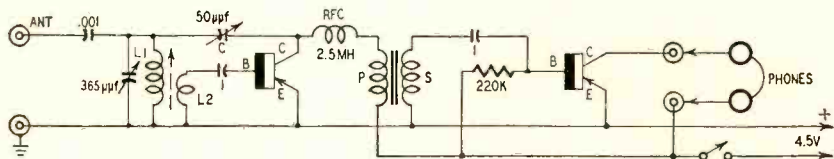

Fig. 3—Diagram of two-transistor radio using grounded-emitter circuit.

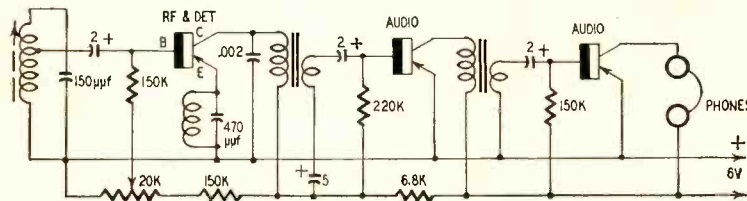

Fig. 4—Wrist receiver uses regenerator detector and two audio stages.

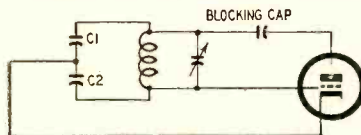

Fig. 5—Basic Colpitts oscillator.

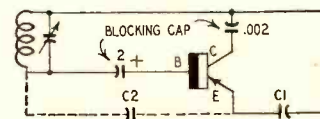

Fig. 6—Transistor equivalent of Fig. 13.



## who sells Mrs. America?

### Garry Moore, that's who!

He sells her because she likes him and has confidence in him. Nearly five million of her watch and listen to him weekdays on the CBS



Television Network. She *believes* what Garry says about his sponsors' products. And she buys them.

As a CBS tube dealer, you . . . yes, you . . . are one of Garry Moore's sponsors. He tells your customers that there are no better tubes made than your CBS tubes, and that they have the Good Housekeeping Guaranty Seal. He also tells the ladies about your technical training and equipment, and why they can rely on your expert service.

So remember, when you call at Mrs. America's home to repair her TV set, you . . . and CBS tubes . . . are welcome because Garry Moore has already convinced her that she can have confidence in both you and CBS tubes.



Show her the CBS carton with the Good Housekeeping Guaranty Seal.



### CBS-HYTRON

Danvers, Massachusetts

A Division of Columbia Broadcasting System, Inc.



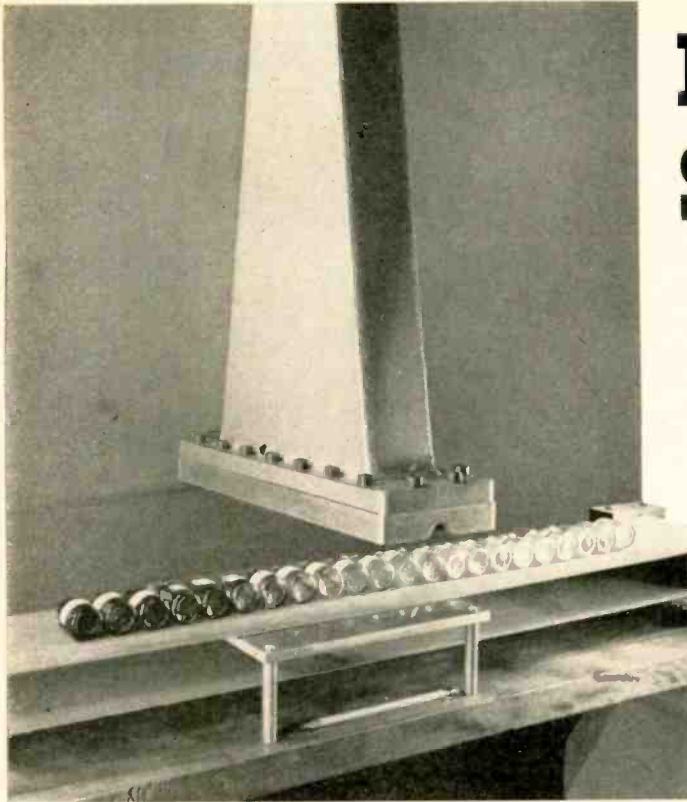

# ELECTRONIC STERILIZATION

*Particle accelerator  
destroys bacteria,  
examines metals*

By MARION L. BRIGGS

**Pharmaceutical  
plastic containers  
and packaged  
drugs passing  
beneath electron  
beam from target  
end of evacuation  
tube**

**A** 2,000,000-VOLT Van de Graaf electrostatic particle accelerator has been put to work sterilizing drugs and pharmaceuticals or their plastic containers at the Bradley Container Corp. in Maynard, Mass. This machine, manufactured by the High Voltage Engineering Corp., generates a powerful beam of electrons which destroys bacteria as materials pass under its rays on a conveyor.

The equipment is a two-story installation. Except for remote controls, high-vacuum pumping system and minor accessories, the accelerator is self-contained within a pressurized steel housing. Its pressurized steel tank—which covers the guts of the machine—and accompanying mercury diffusion pump, are on the upper floor. The accelerator evacuation tube extends down through the ceiling to the first floor, leading into an electromagnetic scanning system over the package conveyor belt.

Within the grounded steel tank, about 3 feet in diameter and 7 feet high, is a mixture of nitrogen and carbon dioxide at 27 atmospheres. Since the purpose of the machine is to accelerate electrons unimpeded across a 2,000,000-volt potential, the high-voltage terminal inside the tank is insulated from the shell of the accelerator by an atmosphere of compressed nitrogen, to prevent arcover.

A voltage of 220 is fed to the machine and then stepped up to 30,000 volts. At the bottom of the tank the high voltage is sprayed on the insulating surface of the grounded end of a 6-inch multiple rubber-fabric charge-conveyor belt from a row of corona points extended across the width of the belt and

directed at its lower pulley. Therefore, between the corona points and the lower pulley, the corona spray voltage produces gaseous ionization and a transfer toward the pulley of the electric charge, which deposits on the intervening insulating belt.

The belt carries this electric charge mechanically at the rate of 4,000 feet a minute upward to the insulated high-voltage terminal at the top of the tank. Here the charge piles up to 2,000,000 volts because it cannot leak off due to the highly polished inner surface of the terminal dome.

More specifically, the high-voltage terminal is a hemispherical stainless-steel shell, 15 inches round, supported on a 33-inch active-length insulating column. This column is composed of 40 alternate equipotential spherical aluminum diaphragms and glass insulators.

Along the outside of the insulating column, high-value resistors between the aluminum diaphragms divide the terminal voltage uniformly. In this way the electric field in the region of the conveyor belt and between the high-voltage terminal and the ground plane is maintained substantially uniform.

Within the insulating column, on both sides of the conveyor belt and parallel to each face of the belt, are gradient control rods connected to the metal equipotential planes—a set for each plane. These reduce to a slight value the variation in potential in the transverse plane and confine the electric field of the belt charge.

When the electric charge carried by the ascending conveyor belt reaches the high-voltage terminal, it is removed from the belt by a corona-point collec-

tor connected to the terminal. It then spreads itself evenly around the inside dome of the smooth-surface steel terminal, which prevents its sparking off and allows it to stack up a potential of 2,000,000 volts. Aiding this also is the fact that the outside of the terminal dome is kept highly polished so no protrusion will provide a corona point from which the charge could bleed off.

Located in the area of the high-voltage terminal is a cathode vacuum tube containing a heated tungsten filament that gives off electrons. As these negatively charged particles are emitted, they take on the 2,000,000-volt potential accumulated within the terminal. The electrons then seek a positive ground and spill down—like water running downhill—to the bottom of a multiple-acceleration tube.

This acceleration tube is divided into 40 sections by the aluminum diaphragms, open at their centers to permit the ions to pass down the tube and to shape the electric field along the axis of the tube so as to accelerate and focus the charged particles.

The aluminum diaphragms in the acceleration tube are separated by ring-shaped glass insulators. Each electrode is at the same potential because of direct connection with the corresponding equipotential plane in the insulating column through the high-value resistors. This uniform electric field aids in speeding the electrons down the accelerator tube and increasing their energy.

At the end of the acceleration tube the high-energy cathode rays pass first through an electromagnetic scanning system which spreads their beam. Then they go through a 6-inch aluminum window, with little loss of energy or scattering, and contact the pharmaceutical supplies (which are moving along on a conveyor belt beneath the window) to be sterilized. This window also helps maintain the vacuum in the evacuation tube.

*(Continued on page 84)*





putting your business in HIGH GEAR



**CONTROLS**  
by  
**CLAROSTAT**

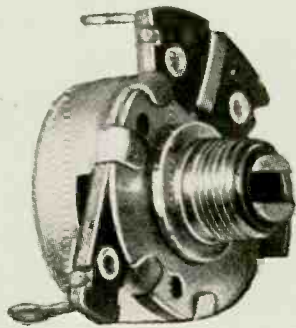

When that replacement job calls for a new control,  
just ask for a CLAROSTAT Composition-element  
Control, available in 1/2 and 1 watt ratings.

Or for a CLAROSTAT Wire-wound Control, available  
in 1, 2, 3 and 4 watt ratings.

For these CLAROSTAT controls provide the quality,  
performance and dependability required in the  
satisfactory servicing of customer sets,  
and relieve you of any needless call-backs.

Ask your distributor for the latest CLAROSTAT CATALOG.

CLAROSTAT MFG. CO., INC., DOVER, NEW HAMPSHIRE In Canada: Canadian Marcon Co., Ltd., Toronto 4, Ont.

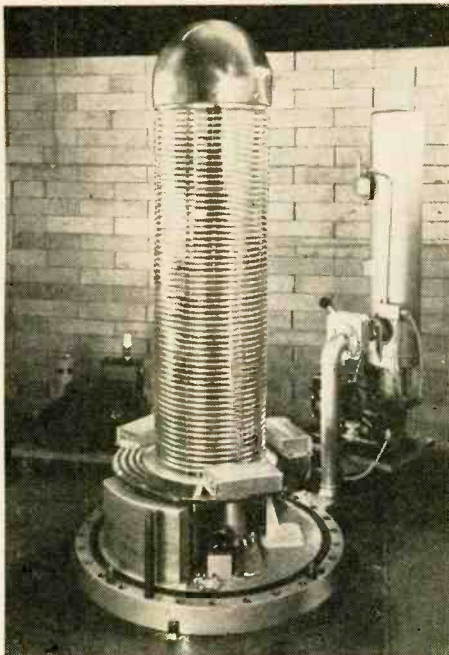

High Voltage Engineering Corporation photos  
Stainless-steel high-voltage shell, insulating column and mercury pump.

Cross-sectional view of 2,000,000-volt Van de Graaff accelerator.

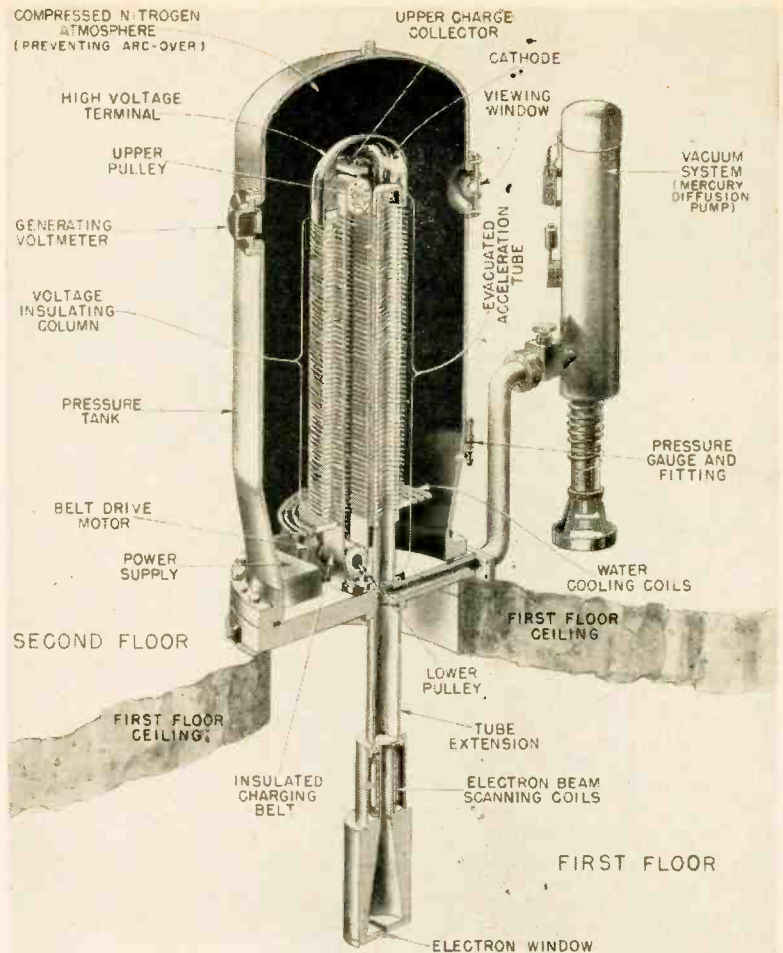

The power output of the machine is equal to the product of the electron current and voltage, about 500 watts. This amount of electron energy at 2,000,000 volts is able to sterilize completely 200-250 gross pounds of plastic pharmaceutical containers and their contents per hour.

In the flat, metal, 6 x 12-inch single-layer trays, in which the materials to be sterilized move along on conveyor belt beneath the electron beam, the amount of content varies. It depends upon whether the plastic containers to be sterilized are filled or empty and upon their size. The penetrating power of the electron beam varies inversely with the specific gravity of the material being irradiated and directly with the voltage used. A 2,000,000-volt electron beam can penetrate 0.3 inch into materials of a water-equivalent density. And if materials are irradiated from opposite sides, the total penetration can be increased to 0.7 inch.

A larger 12,000,000-volt Van de Graaf electrostatic positive-ion accelerator has been built which will penetrate materials and sterilize them to a depth equivalent to 2 inches of water. Its electric beam can sterilize 2,850 pounds of material an hour.

**Applications**

Drug firms are planning to use the particle accelerator for cold sterilization of their pharmaceuticals. It would be particularly valuable, for example, for an antibiotic like penicillin, which undergoes some damage under the usual method of heat sterilization. And

these companies are investigating the effectiveness of the accelerator for sterilizing surgical sutures, surgical gauze, segments of body tissues and a variety of biologic materials.

Massachusetts General Hospital in Boston is using cold sterilization for the preservation of blood vessels, bone and corneal transplants principally.

The particle accelerator machine is also used industrially to discover defects in metals. In this case, when X-rays instead of cathode rays are wanted, they are obtained by replacing the aluminum window at the end of the acceleration tube with a water-cooled gold target which produces a stream of X-rays.

The Wilkes-Barre plant of the Foster Wheeler Corp. is now using the apparatus for this purpose. It shows clear detail in steel sections up to 12 inches thick, and this X-ray inspection is faster than any conventional methods.

The Van de Graaf electrostatic accelerator machine, in addition to being a two-story unit, uses a third room, adjoining the lower-floor installation, for a remote control panel and scanning control cabinet. No one can enter the area near where the electron beam comes out of the machine while the accelerator is in operation.

In the lower-floor installation is the lower end of the accelerator tube, with the electron-beam scanning coils and the electron window from which the beam leaves the machine and falls on the materials to be sterilized. This

room is enclosed with concrete walls 2 feet thick. The conveyor belt enters the radiation chamber through the wall on one side and goes out the opposite side. When the machine is not in operation, the room is not lethal.

On the upper-floor portion of the installation is the remainder of the machine and its accompanying mercury diffusion pump that maintains a high vacuum in the evacuation tube.

The remote control console contains the necessary operating controls, together with instruments, to give continuous readings of generator voltage, electron-beam current and vacuum-system conditions. The beam-scanning control cabinet includes means for adjusting the scan width.

The vacuum equipment includes not only the mercury diffusion pump, but a dry-ice trap, a mechanical fore-vacuum pump, vacuum protective circuits and pressure gauge. Ultimate pressure with the vacuum pump blanked off is 10<sup>-6</sup> mm (.00001) of mercury at the pump entrance. If the mercury diffusion pump breaks down, it must be repaired immediately. The pump requires a constant supply of 15 pounds of dry ice a day in the dry-ice trap to condense the mercury.

Also necessary is a constant water supply up to 2 gallons a minute hooked in on the regular water line, with pressure not less than 60 pounds per square inch, to cool the vacuum system. Maximum allowable inlet temperature is 75° and heat rise about 20°. END

# ELECTROMECHANICAL ---P-U-L-S-E--- PRODUCER

**W**HEN the pulse width, frequency and amplitude of a square wave are to be varied independently, electromechanical square-wave generators have a decided advantage over the electronic type. This is especially true where long pulse widths and low frequencies are needed. Furthermore, power drawn from an electromechanical square-wave generator will not overload the unit and distort the waveshape, so this type of generator can be used as a sequence timer to energize devices such as relays and motors.

To make an electromechanical square-wave generator, two timers—such as used in photographic work—are needed. Tandem recycling timers may be purchased from the Industrial Time Corp., 131 Ogden St., Newark, N. J.

This timer consists of two separate and variable timing units that can control the operation of a relay. One controls the length of time a relay is energized, the other the length of time the relay is de-energized. Index pointers set the respective time intervals and each cycle of operation follows the other in regular sequence. The timing units are available with a range from approximately .085 to 5 seconds to from 2 minutes to 3 hours. By using the appropriate timers a range from .085 second to 3 hours can be obtained.

Since the timers control only the length of time a relay is energized or de-energized, the pulses are obtained from an external power supply. This may be a d.c. or a.c. source, as required. The relay operation interrupts the power supply voltage to the output circuit. The power and amplitude of the pulses delivered to the load are limited only by the capabilities of the power supply. To duplicate the above ranges electronically would be impractical.

## Or make it yourself

Constructing an electromechanical square-wave generator is simple. One solution is shown in Fig. 1. A cam is driven by a slow-speed reversible motor. Three sensitive switches are located so that all are initially energized by contact with the cam.

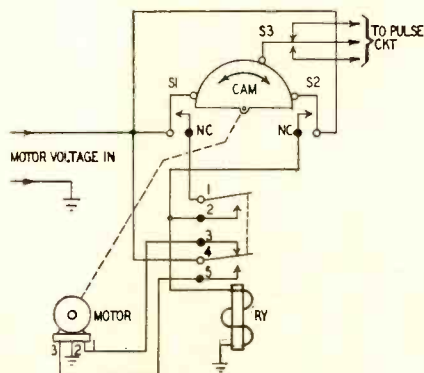

Fig. 2—Circuit produces square waves.

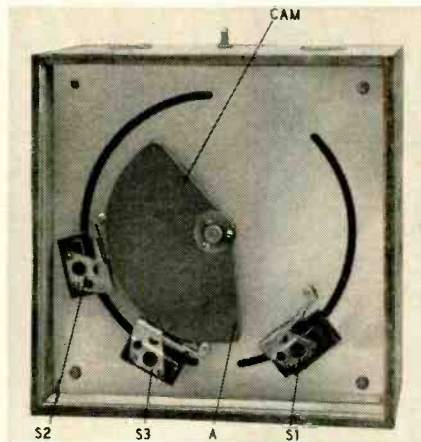

Fig. 1—Simple electromechanical generator with switches, motor and cam.

The portion marked A of the cam rotates clockwise from switch S1 to switch S2. As A reaches S2 the direction of the motor is reversed. The cam then rotates in a counterclockwise direction until S1 is contacted. This again reverses the cam and the cycle repeats. Switch S3 is located so as to give the desired output cycle. For example if S3 is located half-way between S1 and S2, S3 will be actuated half the time. Frequency is increased by moving S1 and S2 closer together.

A schematic of the circuit is shown in Fig. 2. Switches S1, S2, which are normally closed, are held open. The motor is fed through leads 1-2 and moves clockwise. When the cam does not contact S1, it closes on relay contact 1. The cam continues to move clockwise until it passes S2. At this point S2 closes and energizes the relay which in turn feeds current through motor leads 2-3. This reverses the motor and the cam now moves counterclockwise.

Switch S2 is immediately opened by

*A different and versatile approach to producing square waves*

By ARNOLD R. SHULMAN

the cam but the relay remains energized because of current flow through contacts 1 and 2 of the relay. When the cam reaches S1, the relay is de-energized and the cycle repeats.

This circuit lends itself to many variations. Fig. 3 shows a layout making use of two cams, one to actuate S1 and S2, the other for S3. The size and position of the cams can be varied, and doing so varies the output frequency and pulse duration.

Although the mechanical arrangement of Fig. 3 is different from that in Fig. 2, the electrical circuit of Fig. 3 can be used with the mechanical arrangement of Fig. 2. In both diagrams, the motors and relays are selected to operate from the same motor voltage supply.

These are but a few electromechanical solutions. It is hoped that this article will show the versatility of the electromechanical approach and will offset some of the natural reluctance of electronic workers to use electromechanical equipment. END

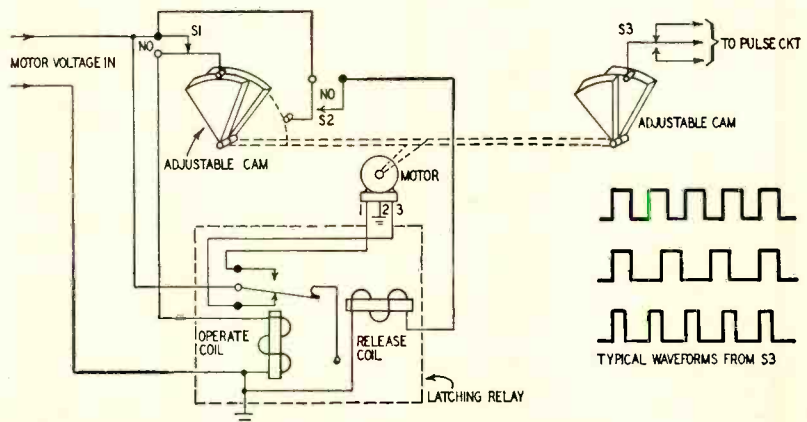

Fig. 3—Two cams are used in hookup.

**DETERIORATION PROOF**

**DETERIORATION PROOF**

**DETERIORATION PROOF**

*Columbia*

**PERMALINE**

**TV TRANSMISSION LINE**

**Guaranteed up to 25 years**

★ Reduces Nuisance Calls  
for Servicemen

★ Provides Longer Life

★ Resists Deterioration

*Send for Sample  
and Descriptive Literature*

Available at leading distributors!

*Columbia*

**WIRE & SUPPLY CO.**

**2850 IRVING PARK ROAD**

**CHICAGO 18, ILLINOIS**

## MISCELLANY

### REVISED ABBREVIATIONS

It has been pointed out that a number of abbreviations commonly used in the magazine do not appear on our list of abbreviations printed in the March issue, page 108 (also on page 138, Jan., 1956). For this reason and for the benefit of those who may not have seen the earlier abbreviations, we are reprinting the list herewith.

These abbreviations are indexed by symbol, with Greek letters treated like the English phonetic equivalent. As pointed out in previous issues, many terms are abbreviated in art work only and are usually spelled out in the text. Periods are omitted except where the omission would cause confusion. Abbreviations in lower-case letters are so printed in text—are capitalized in art work. Those printed in capitals are capitalized in both text and art work. Most abbreviations not confined to electronics (ft, lb, rpm, etc.) are not listed.

ABBREVIATION	ELECTRONIC TERM
ac	alternating current
acc	automatic chroma control
ADJ	adjacent
af	audio frequency
af choke	automatic frequency control
AFT	audio-frequency choke
afc	audio-frequency transformer
AM	automatic gain control
amp	amplitude modulation
AMPL	ampere(s)
ANT	antenna
apc	automatic phase control
ATTEN	attenuator
AUTOTRANS	autotransformer
avc	automatic volume control
AWG	American wire gauge
b or base	base (of transistors)
BAL MOD	balanced modulator
BALUN	balance-to-unbalance transformer
BATT	battery
BCI	broadcast interference
bfo	beat frequency oscillator
B0	Barkhausen oscillation
BTO	blocking tube oscillation
e (of transistors)	collector
C, CAP	capacitor (capacitance)
CALIB	calibrate
cath (K on tube diagrams)	cathode
CATH FOLL	cathode follower
CH (or CHOKE)	choke
CHAN	channel
CHG	charge
CKT	circuit
CKT BRKR	circuit breaker
coax	coaxial
COM	common
COND	conductor
CONN	connection
CONT	control
CONV	convergence
CONVTR	converter
counter emf	counter electromotive force
C-R	cathode-ray (tube, etc.)
CRO	cathode-ray oscilloscope
CW	continuous wave
d	diode
db	decibel
dc	direct current
dcc	double cotton covered (wire)
DC REST	direct current restorer
DEFL	deflection
DEMOD	demodulator
DET	detector
df	direction finder
DIELEC	dielectric
DIFF	differentiator
DISCH	discharge
DISCRIM	discriminator
dpdt	double pole double throw
dst	double note single throw
dsc	double silk covered (wire)
DYN	dynamic
dx	distance
e	emitter (transistor)
E	potential
E (sometimes V in transistor diagrams)	voltage
ECO	electrons coupled oscillator
ELEC	electric; electrolytic
ELECT	electrode
emf	electromotive force
ENAM	enamelled (wire)
EQIV	equivalent
ERASE HD	erase head
ERP	effective radiated power
EXT	external or extension
F (f as suffix)	farad(s)
f, FREQ	frequency
FIL (F in tube diagrams)	filament
FM	frequency modulation
FOLL	follower (ing)

ABBREVIATION	ELECTRONIC TERM
G (in tube diagrams)	grid
GCA	ground controlled approach
GDO	grid dip oscillator
GEN	generator
GND	ground
h	henry
HD	head
hf	high frequency
HORIZ	horizontal
HTR (H)	heater
I	current
if	intermediate frequency
ILS	instrument landing system
IM	intermodulation
IN	input
INT	integrator
INV	inverter
ips	inches per second
K	thousand
K	cathode (on diodes)
kc	kilocycle
kw	kilowatt
λ (lambda)	wavelength
L	inductor
L	coil
lf	low frequency
LIN	linearity
LIM	limiter
μ (mu)	micro- (one-millionth)
uf	microfarads
uh	microhenry(ies)
uuf	micromicrofarad(s)
usec	microseconds
M	meter
M	million
ma	milliampere(s)
max	maximum
mc	megacycle(s)
meg	megohm
mh	millihenry(ies)
niike	microphone
MIN	minimum
MOD	modulation (modulator)
MULT	multiplier
MVB	multivibrator
NBFM	narrow-band FM
NC	neutralizing capacitor
NE	neon
NEG	negative
NET	network
n-p-n	negative-positive-negative (transistors)
OSC	oscillator
OUT	output
P	plate
PA	public address
PC	photocell
PERM	permanent
PHONE(S)	telephone
PHOTO MULT	photomultiplier
pix	picture (TV)
PL	pilot lamp
PM	permanent magnet (speaker)
PM	phase modulation
p-n-p	positive-negative-positive (transistors)
POS	positive
POT	potentiometer
PP	peak-to-peak
PPI	plan position indicator (radar)
pps	pulses per second
preamp	preamplifier
prf	pulse repetition frequency
PRI	primary
PT	phototube
Q	reactance-resistance ratio
QUAD	quadrature
R	resistance (resistor)
RCDG	recording
RCDR	recorder
RECT	rectifier
REG	regulator
regen	regeneration
rf	radio frequency
RFC	radio-frequency choke
RFT	radio-frequency transformer
rms	root mean square
RY	relay
S	switch
sec	single cotton covered (wire)
SEC	secondary
SEL (RECT)	selenium (rectifier)
SEP	separator
SG	screen grid
SIG	signal
SLD	solenoid
spdt	single pole double throw
SPKR	speaker
spst	single pole single throw
SSB	single sideband
ssc	single silk covered (wire)
SW	shortwave
SWR	standing wave ratio
T1, T2, etc.	synchronization transformer
TELEG	telegraph
TERM	terminal
tpt	tuned plate tuned grid
TRANS	transformer
trf	tuned radio frequency
TVJ	television interference
uhf	ultra-high frequency
v	volt(s)
V	tube, transistor
va	volt-ampere
vac. vdc	vacuum tube
VAR	variable
VC	voice coil
VERT	vertical
VFO	variable frequency oscillator
vhf	very high frequency
VIB	vibrator
VOL	volume
VOM	volt-ohmmeter
VR	voltage regulator (tube)
vswr	voltage standing wave ratio
vtvm	vacuum-tube voltmeter
VU	volume units(s)
W	watt(s)
X	reactance
xstal	crystal
Z	impedance

—END—

THOUSANDS OF SERVICE DEALERS

SATISFY CUSTOMERS  
SAVE REPEAT CALLS

# MAKE MONEY EVERY DAY with B&K



## DYNA-QUIK MODEL 500 DYNAMIC MUTUAL CONDUCTANCE TUBE TESTER

### Tests over 95%

**OF ALL POPULAR TV TUBES\*— IN SECONDS**  
It's easy and profitable to check all the tubes in a TV set with DYNA-QUIK—on every service call. Cuts servicing time. Creates more on-the-spot tube sales. Saves repeat calls, protects service guarantee.

DYNA-QUIK 500 measures true dynamic mutual conductance, completely checks tubes with laboratory accuracy under actual operating conditions right in the home.

Tests each tube for shorts, grid emission, gas content, leakage, dynamic mutual conductance and life expectancy. One switch tests everything. No roll charts. No multiple switching. Makes complete tube test in as little as 12 seconds. Large 4½-inch plastic meter shows tube condition on "Good-Bad" scale or in micromhos on scales calibrated 0-6,000 and 0-18,000. Used in home or shop, DYNA-QUIK is a proved money-maker!

\*Including new 600 mil series tubes.

NET \$109<sup>95</sup>

Dyna-Quik 500. Easily portable in luggage-style carrying case. Size: 15¼ x 14¼ x 5¼ in. Weighs only 12 lbs. Has 7-pin and 9-pin straighteners on panel.

DELUXE—PORTABLE

## CRT MODEL 400

Tests and repairs  
TV Picture Tubes



## CATHODE REJUVENATOR TESTER



NET \$54<sup>95</sup>

Deluxe CRT 400. With 4½-in. plastic meter. Weighs only 5 lbs. Luggage style carrying case. Size: 11 x 7½ x 5".

Also available in economy model CRT 200 with 3-in. meter at \$39.95 net.

Quickly spots and corrects picture tube troubles right in the home, without removing tube from set. Restores emission, stops leakage, repairs inter-element shorts and open circuits. Life test checks gas content and predicts remaining useful life. Grid cut-off reading indicates picture quality customer can expect. Eliminates tube transportation, cuts service-operating costs. Also saves money on TV set trade-in reconditioning. Earns dollars in minutes—pays for itself over and over again.

Proved In Use by Servicemen Everywhere.

See your B & K Distributor or send for facts on "Profitable TV Servicing in the Home" and informative Bulletins 500-104-E.



**B & K MANUFACTURING CO.**  
3726 N. Southport Ave. • Chicago 13, Illinois

# new Devices



**EQUIPMENT-SPEAKER CABINET, model 35.** Unfinished in smooth, sanded birch veneer ply; finished in blonde or cordovan mahogany on birch ply. Tuner-



amplifier compartment 10% x 16% x 14 1/2 inches; changer compartment 16 1/4 x 14 1/2 inches, height above player base 6% inches. Below drop-front door is bass reflex speaker enclosure 13 1/4 x 34 x 14 1/4 inches. Overall 32 1/2 x 35 1/2 x 16.—Cabinart, 99 N. 11 St., Brooklyn 11, N. Y.

**FM-AM TUNER, model S-2000.** FM sensitivity 1.2  $\mu$ v for 20-db quieting. 6B8S input amplifier with balanced-input transformer. 16-kc hi-fi bandpass or sharply selective 5-kc bandwidth for listening to weaker stations without noise or interference.

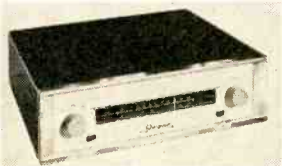

Bridged-T filter traps 10-kc interstation hum. Ferrite-rod AM antenna. 14 x 10 1/2 x 4 inches.—Sherwood Electronic Labs., Inc., 2802 W. Cullom Ave., Chicago 18.

**PORTABLE DISC RECORDER, K-11,** replaces K-10 model. 3-speed drive and 8-ohm cutting head. Records standard and micro-groove discs to 1 3/4 inches in diameter at 33 1/3, 45 and 78 rpm, without adapters. Drive mechanism with either hysteresis synchronous motor or shaded 4-pole motor. Control panel, record and playback amplifier, pickup arm with turnover cartridge for playback and 2 speakers for high- and low-frequency response. In



compact carrying case weight about 40 pounds with speakers mounted in cover.

Frequency response within 2 db from 50-8,000 cycles. Mechanical noise in system at least

30 db below recording level.—Presto Recording Corp., Paramus, N. J.

**REPLACEMENT CARTRIDGE KIT, RK56,** for 217 cartridges of seven manufacturers. Contains model WC10 ceramic extended-range for 132 3-speed, plastic-cased cartridges, crystal or ceramic, single needle or turnover; model W70 crystal all-purpose



single-needle cartridge for Webster C and CX series and model W72 crystal dual-voltage 3-speed turnover cartridge for Webster FX and Astatic LQD series.—Shure Brothers, 22 Hartrey Ave., Evanston, Ill.

**35-WATT WIDE-BAND AMPLIFIER, 341A,** low-distortion general-purpose type. Similar to 340A used in hi-fi systems. Accessory plug-in transformer adapts amplifier to low-impedance inputs. Total harmonic distortion less than 0.5% from



25-20,000 cycles. Frequency response  $\pm$ 0.5 db from 5-50,000 cycles. Source impedance of 30-50, 125-150, 250-300, 500-600 with plug-in transformer. Load impedance of 8, 16 ohms and 70-volt line. Output impedance less than 3.5% of nominal load impedance. Noise level 85 db below full output.—Altec Lansing Corp., 9356 Santa Monica Blvd., Beverly Hills, Calif.

**2 1/4-INCH MINIATURE SPEAKER, Generic design XS-7834,** PM type. 2 1/4 inches along sides, less than 3/4 inch deep. Handles 250-mw input. Magnetic structure



within shell surrounds cone. For transistorized receivers and other miniaturized equipment. 12-ohm voice coil impedance at 1,000

cycles,  $\pm$ 10%; resonant frequency 375 cycles.—RCA Tube Div., Harrison, N. J.

**SILICON POWER DIODES,** rated for 300-ma dc rectified output current when mounted by leads in free air at ambient temperatures to 100°C. Mounted



on cooling fins, can be rated for 1.25 amps rectified output current at case temperature to 150°C. Peak inverse voltage ratings 50-600 volts. Rectifying barrier of silicon diode formed by fused-junction principle. Hermetically sealed. Power supply types for industrial applications; magnetic amplifier types for special low-leakage applications. 2 current ratings for each style. Pigtail-lead and stud-mount constructions.—International Rectifier Corp., El Segundo, Calif.

**STUD-MOUNTED RECTIFIERS** added to line of medium-power GI silicon rectifiers which include a wide range of pigtail units. Both types have extremely low reverse leakage current. Hermetically sealed. Complete



line handles peak inverse voltages from 100 to 1,000, with average dc output currents of 300 ma for pigtail units and 500 ma for stud-mounted. Occupy .03 cubic inch, weigh .07 ounce.—Automatic Mfg. Div., General Instrument Corp., 65 Gouverneur St., Newark 4, N. J.

**PLUG-IN FUSE-TYPE RESISTOR, Fuzohm FZ1,** 5.6 ohms.



Withstands repeated high surge currents, but will fuse when surge endangers components.—Clarostat Mfg. Co., Inc., Dover, N. H.

**3-WATT AXIAL-LEAD RESISTORS, 1-10,000 ohms.** 1/4-inch diameter, 3/8 inch long. Mount by tinned wire leads. Very small sizes suited for printed circuits, terminal board and point-to-



point wiring. Wirewound units with steatite cores and vitreous-enamel coating. Core, resistance wire, vitreous-enamel coating and terminal bands thermally balanced to expand and contract as unit.—Ohmite Mfg. Co., 3677 Howard St., Skokie, Ill.

**COLOR DISPLAY GENERATOR, model 660.** Checks receiver ability to produce color in proper hue—even in absence of station signal. 10 1/2 x 10 1/2 x 5 1/4 inches; weighs 15 pounds. Provides white-line crosshatch, white dot (small size) and crystal-accurate color display patterns. Rf output frequency preset—channels 2 through 6. Chrominance (color)

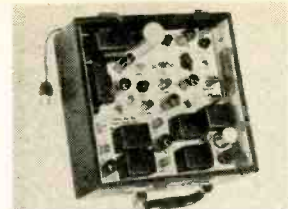

signal crystal-controlled. Video output 0-4 volts peak to peak, 300-ohm output impedance, black positive or negative, 300 white dots less than those in blanking. Color frequency crystal 3.563795-mc output, 1 volt peak to peak. Rf output voltage .05 volt maximum; .001 volt minimum; rf modulated by all video outputs (60% modulation).—Hickok Electrical Instrument Co., 10531 Dupont Ave., Cleveland 8, Ohio.

**SINE-WAVE GENERATOR, model 1200,** generates pure sinusoids from 1 cycle to 1 mc (plus



overlap) in 6 decade ranges. Distortion less than 0.1% for any frequency or amplitude. 600-ohm output impedance constant for any setting of amplitude control. Signal 0 to 8 volts contains no dc component. Stable amplitude, freedom from drift, and high calibration accuracy insured by fully regulated power supply and negative feedback. Weighs 23 pounds. 7 1/2 x 10 1/2 x 13 1/2 inches. For wherever high-quality sine waves are essential as in communications, audio and laboratory testing.—Donner Scientific Co., 2829 Seventh St., Berkeley 10, Calif.

**CONVERSION KIT** for installing 21-inch and other 70° tubes in early 630's and other small-screen sets. Todd 70° yoke and matching flyback, 20-kv high-



voltage filter capacitor, linearity coil, horizontal drive trimmer, step-by-step instruction manual and assortment of resistors and capacitors.—Brooks Radio & Television Corp., 84 Vesey St., New York 7, N. Y.

**DC POWER SUPPLY, model D612T,** operates, tests and services transistor auto radios and 6- and 12-volt tube radios. Filter keeps ac ripple low for testing transistor auto radios. Also used to service or operate aircraft and marine radios, phone circuits and relays.—Electro Prod-



# abacus



昨日之最好者

## honorable ancestor of the UNIVAC

In theory many centuries have gone into the development of the Univac. Only recently, at Remington Rand Univac, has it achieved product perfection. The tremendous strides forward in the past few years are due to the imagination and creative genius of the scientists and engineers of Univac. Recognized leaders in the field of electronic computer systems, they are the men *who set the standards for others to follow*. You can become a member of this team

. . . where ambition and professional skill find their reward in limitless opportunities in an expanding organization.

### Immediate openings for:

**FIELD LOCATION ENGINEERS** with a college degree in a scientific or engineering field and experience in electronics. Extensive electronic background may substitute for some college. Many opportunities for rapid advancement.

**FIELD LOCATION TECHNICIANS** with technical school background and preferably some experience in electronics. These positions can lead to full engineering responsibility.



Send complete resumé to

## **Remington Rand Univac**

DIVISION OF SPERRY RAND CORPORATION

AT ANY ONE OF THESE THREE PLANT LOCATIONS

MR. D. A. BOWDOIN  
Dept. MP-10  
2300 W. Allegheny Ave.  
Philadelphia, Pa.

MR. KURT PINKE  
Dept. MS-10  
1902 W. Minnehaha Ave.  
St. Paul W4, Minn.

MR. FRANK KING  
Dept. MN-10  
Wilson Avenue  
South Norwalk, Conn.

© Registered in U. S. Patent Office

Note the space-saving compact design of this 150 volt DC 5 amperes Sola power supply for computer circuits. Panel height is only 7".

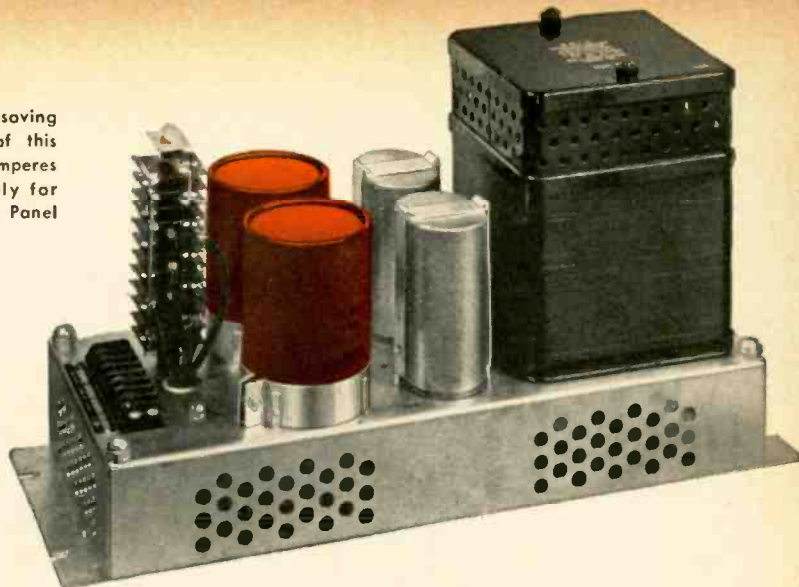

**SO LA**

## chooses Sangamo Capacitors for Germanium Power Supplies

Space-saving compactness and light weight... features assured by the exacting demands of Sola engineers... are among the many advantages of Sola Constant Voltage DC Power Supplies for intermittent, variable, pulse or high current loads. That's why they specify Sangamo Type DCM Electrolytic Capacitors for the high-capacitance filter section of these power supplies.

Besides contributing to the space-saving, weight-reducing design of the "Sola CV DC," Sangamo Capacitors minimize ripple voltage and insure steady, stable DC voltage. No further need for heavy, bulky choke components with their substantial and often-varying load voltage drops.

Just as Sangamo Capacitors meet the exacting specifications of Sola design engineers, they can meet yours... no matter how demanding—regardless of how specialized.

Sangamo DCM Electrolytic Capacitors provide excellent capacity stability with long life... exceptionally low equivalent series resistance... extremely high capacity for case size in low voltage ranges. Special design permits high ripple current without overheating. Can be supplied in maximum energy content rating of 80-watt seconds with maximum voltage rating of 450 VDC. Maximum capacity value of 33,000 mfd. can be supplied at 15 WVDC.



The Sangamo DCM Electrolytic Capacitor is housed in a seamless, drawn aluminum container with gasket-sealed molded alkyd resin base thermosetting plastic cover. Detail of cover construction insures minimum contact resistance in current carrying members and provides an adequate safety vent in case of heavy overload.

**SANGAMO ELECTRIC COMPANY**  
CAPACITOR DIVISION • SPRINGFIELD, ILLINOIS



ucts Labs., 4500 N. Ravenswood Ave., Chicago 40, Ill.

**ELECTRONIC SWITCH KIT, model S-3**, redesigned model S-2. Allows simultaneous scope observation of 2 input signals by producing both signals, alternately,



at its output. 4 switching rates; gain for input signals. Frequency response  $\pm 1$  db 0-100 kc. 7 miniature tubes.—Heath Co., Benton Harbor, Mich.

**RANGE-SPLITTER PROBE, type 264** for high accuracy and convenient dc voltage measurements from 250 to 500, such as in B-plus checks. Can be used

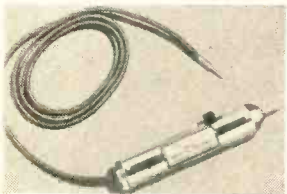

with any 20,000-ohms-per-volt voltohmmeter having 50- and 250-volt dc scales. Additional 500-volt scale indication by switch in probe housing.—Futuramic Co., 2500 W. 23 St., Chicago 8.

**GROUND-UP MOUNT, model GU-3**, where chimney mounts are illegal or impractical and all TV antennas must be either tower or ground-up mast instal-

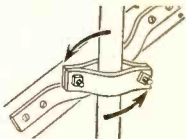

lations. For masts 1 1/4 to 3 1/4 inches, and largest base section of 50-foot telescoping mast.—South River Metal Products Co., Inc., 377-379 Turnpike, South River, N. J.

**ANTENNAS**, vhf Delta multi-Yagi types. Delta King model

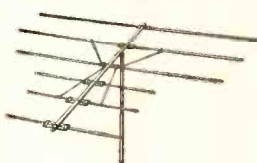

DK60 for bad weather, Delta Queen DQ60 for normal weather-wind areas, Delta Prince model DP60 for primary and first fringe areas.—Lance Antenna Mfg. Co., 1802 First St., San Fernando, Calif.

**ROTARY BEAM, Super Ten** 3-element beam using full-length director and reflector and shortened driven element for use with coupling transformer. Gain 7.9 db, 20-db front-to-back ratio; 1.2 to 1 swr at resonant frequency. 17 1/4 feet maximum element length, 8 1/2-foot boom. 20 lbs.—Mosley Electronics Inc., 8622 St. Charles Rock Rd., St. Louis 14, Mo.

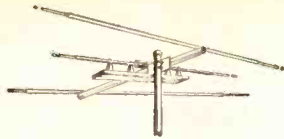

**2 UHF TV ANTENNAS, UHF410**, all-aluminum corner-reflector type. High front-to-back and front-to-side ratios. Dipole is spaced for maximum gain, optimum corner angle maintained by castings. Reflector of No. 8 solid aluminum rods stacked into side pieces. UHF202, 4-stack array. Wide-band bowtie

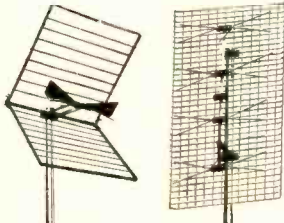

type radiators backed by reflector grid of No. 12 galvanized wire.—JFD Mfg. Co., 6101 16th Ave., Brooklyn 4, N.Y.

**2-METER HAM BEAM, 11M2-10AK**, 5-over-5 Yagi type cut to 146 mc. Covers 144-148 mc. SWR at resonance 1.1 or less—broad band for low SWR at band

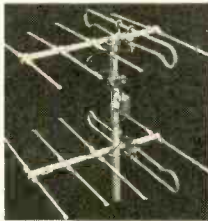

ends. Harness 1-kw ribbon lead, terminating in coaxial socket in weather-resistant connector box. Fed from 52-ohm coaxial cable.—Skysweeper, Inc., P.O. Box 92, McHenry, Ill.

**SOLDERLESS TERMINAL KIT, No. 395**. 8-inch cutting, strip-



ping, crimping tool, heavily plated to resist rust. Front of jaws for crimping. Wire sizes engraved opposite each crimping slot. Wire cutter behind jaw rivet; 6 graduated openings for stripping wire No. 10 to 22. Assorted terminals. Plastic handle screwdriver and plastic pouch.—Vaco Products Co., 317 E. Ontario St., Chicago 11, Ill.

**SOLDERING AID**, pencil-shaped colored plastic holder, one pointed metal-probing, one slotted wiring end. Holds work raised to soldering heat, twists wires into tight connections, untwists wires to be resoldered, holds components clear of solder, etc.—Weller Electric Corp., 601 Stone's Crossing Rd., Easton, Pa. END



All specifications given on these pages are from manufacturers' data.

## Now . . . From KAY ELECTRIC

A New, Low-Cost  
Lab Quality All-Electronic  
Sweeping Oscillator

For Service Use

*Ligna-Sweep*

MODEL C



### FOR ALIGNMENT OF TV, FM RADIO, VIDEO AND COMPLETE VHF BANDPASS WITH AUTOMATIC GAIN CONTROL

Designed and manufactured to the same high quality standards which have made Kay the leader in instruments for laboratory and production line, the new Kay Ligna-Sweep, Model "C" gives variable center frequency and sweep width with high output automatically held constant over frequency sweep and frequency band. The following frequency ranges are covered by six switched bands.

**Television:** All IF and VHF channels with fundamental frequency output of 1.0 V rms into 75 ohms. Sweep width variable to at least 20 mc at VHF, 15 mc at IF.

**FM Radio:** Range 80-120 mc with fundamental frequency output of 1.0 V rms into 75 ohms. Sweep width variable 100 kc to at least 20 mc. 10.7 mc bandpass with beat frequency output of 0.25 V rms into 75 ohms sweep width variable 100 kc to 2 mc.

**VHF Band:** Range 30 to 220 mc with fundamental frequency output of 1.0 V rms into 75 ohms. Sweep width variable to at least 15 mc.

**Video:** Range 100 kc to 12 mc with beat frequency output 0.25 V rms into 75 ohms. Sweep width variable 100 kc to 12 mc.

#### OTHER SPECIFICATIONS:

**Flatness:** Flat within  $\pm 0.4$  db over widest sweep.

**Sweep rate:** Variable around 60 cps. Locks to line frequency.

**Attenuators:** Switched 20 db, 20 db, 10 db and 6 db, plus continuously variable 6 db.

**Frequency Indication:** Direct reading calibrated dial.

**Deflection Voltage:** Linear sawtooth separately available. No phasing control.

**Power Supply:** Electronically regulated 105 to 125 volts ac, 50-60 cycles.

Price: \$350.00 F.O.B. Plant

WRITE FOR NEW KAY CATALOG

## KAY ELECTRIC COMPANY

Dept. R-7, 14 Maple Ave., Pine Brook, N. J., CAldwell 6-4000

Watch  
for the  
August  
RADIO-  
ELECTRONICS

On Sale

July 26

Always

mention

RADIO-

ELECTRONICS

when you

answer

advertisers.

**COYNE**  
TRAINS YOU  
IN SPARETIME  
AT HOME

COYNE QUALITY TRAINING AT LOWEST COST

**TELEVISION**  
RADIO-COLOR TV

Only from famous COYNE do you get this modern up-to-the minute TV Home Training. Easy to follow instructions—fully illustrated with 2150 photos and diagrams. Not an old Radio Course with Television tacked on. Includes UHF and COLOR TV. Personal guidance by Coyne Staff. *Practical Job Guides* to help you EARN MONEY QUICKLY IN A TV-RADIO SALES AND SERVICE BUSINESS—part time or full time. COSTS MUCH LESS—pay only for training—no costly "put together kits."

SEND COUPON FOR FREE BOOK

SEND COUPON BELOW for Free Book and full details including EASY PAYMENT PLAN. NO COST OR OBLIGATION—NO SALESMAN WILL CALL.



B. W. COOKE, Pres. **COYNE** FOUNDED 1899  
ELECTRICAL SCHOOL

A TECHNICAL TRADE INSTITUTE OPERATED NOT FOR PROFIT  
500 S. Paulina Dept. B6-H74 Chicago 12, Illinois

COYNE ELECTRICAL SCHOOL  
Television Home Training Div.  
500 S. Paulina St., Chicago 12, Ill., Dept. B6-H74

Send FREE BOOK and details of your Television Home Training offer.

Name \_\_\_\_\_

Address \_\_\_\_\_

City \_\_\_\_\_ State \_\_\_\_\_

# NEW



## PHAOSTRON NONE FINER

# "777"

V. T. V. M.

(VACUUM TUBE VOLTMETER)

YOUR KEY TO EXCELLENCE

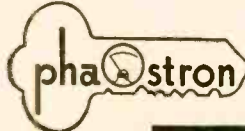

The MODEL "777" V.T.V.M. is a completely self-contained, ready-to-use test instrument. Its accessories and the HF co-ax cable, DC Probe, AC line cord and instruction book all fit in the genuine California Saddle Leather carrying case that is furnished with the instrument.

- 42 Unduplicated Ranges
- Illuminated Dial (5000 hour self-contained lamps)
- Die Cast Chrome Finished Bezel
- Metal Case, unbreakable, ultra compact
- Doubly Shielded, time proven 200 microamp movement
- Permanent Accuracy . . . 3% DC, 5% AC
- Large, Easy to Read Scales 4 7/8" Long
- Color Coded Scales: green—ohms; black—AC, DC; Red—P. to P.
- 2 Zero Center Scales for FM Discriminator Alignment
- Separate Range and Function Switches
- Only 2 Jacks for All Measurements
- New, High Style, Easy-to-Use Chrome Bar Knobs
- Dual Purpose Handle also serves as AC line cord reel

"777" V.T.V.M. complete with Coaxial Cable, DC Probes and Leather Case at your PARTS DISTRIBUTOR

# \$69<sup>95</sup>

**PHAOSTRON INSTRUMENT AND ELECTRONIC COMPANY**  
151 PASADENA AVE., SOUTH PASADENA, CALIF.

# new Records



After years of extravagant claims, speculation and abortive trials, prerecorded tapes are beginning to become a factor in home reproduction of music. About a dozen producers are offering a total of several hundred selections in both the popular and classical fields. In the last several months activity has been stepped up greatly and the presumption is that next year prerecorded tapes will provide a still wider and more representative selection of program material to the home listener.

As of now, very little prerecorded tape possesses any special high-fidelity interest. Most tapes have clearly been programmed with an eye to the Muzak type of market. Lately, however, there has been a move to some more spectacular stuff. RCA-Victor has announced a series which will include, for example, the Toscanini-NBC Orchestra version of Moussorgski's *Pictures at an Exhibition* which in disc form provides very spectacular hi-fi test, demonstration and showoff material. Livingston, which is gathering a stable of the lesser-known but high-quality recording labels and issuing tape versions of their catalogs, has reportedly closed a deal to put Vanguard recordings on tape.

How good is the quality of prerecorded tapes, especially in comparison with high-fidelity disc recordings? There is the rub. Some reviewers have made startlingly favorable commentaries. Perhaps something is wrong with my ears but I have yet to hear anything on tape that threatens discs. Let me put it this way: The best tapes I have heard, played back on semiprofessional recorders costing \$500 or more are not much better than the *average* disc recording played on a top-notch system. And I have heard nothing as good as the best disc recordings reproduced on the best equipment. When you play the same tapes on the home type tape machines costing around \$100 to \$200, there is no comparison with disc recordings played on *average* hi-fi systems. An investment of \$100 or \$150 in turntable and pickup will yield very much higher quality than the same sum invested in tape reproducing equipment.

Inasmuch as tape has been touted as infinitely superior to discs and is actually used for the master recordings for discs, this seeming paradox needs a little explanation. For one thing, master tapes are made at 15 or 30 ips; prerecorded tapes at 7 1/2 ips. In the past year the characteristics of 7 1/2-ips tape recording have improved but that improvement merely *matches* the improvement in disc recording. The 15- or 30-ips tapes are unquestionably superior to the discs cut from them; but the 7 1/2-inch tapes dubbed from the masters are merely on a par with the discs.

The distortion standards for tape recorders are still very much more tolerant than for disc-playback equipment. The *best* tape recorders are rated at 1% harmonic distortion which is equivalent to between 3 or 4% IM distortion. This applies to the original recording and playback. The distortion is multiplied in the dubbing and playback so that the average tape is likely to have at least as much distortion as the average disc, and possibly more. Lately, some tapes have been recorded 10 or 20 db below the so-called standard output level. This does reduce the distortion but unfortunately it increases the noise level. As for noise level, the best tapes played on the best machines yield a noise figure of -55-60 db; this is no better than the noise figure of the best discs played back with the best pickups on the best turntables. When the

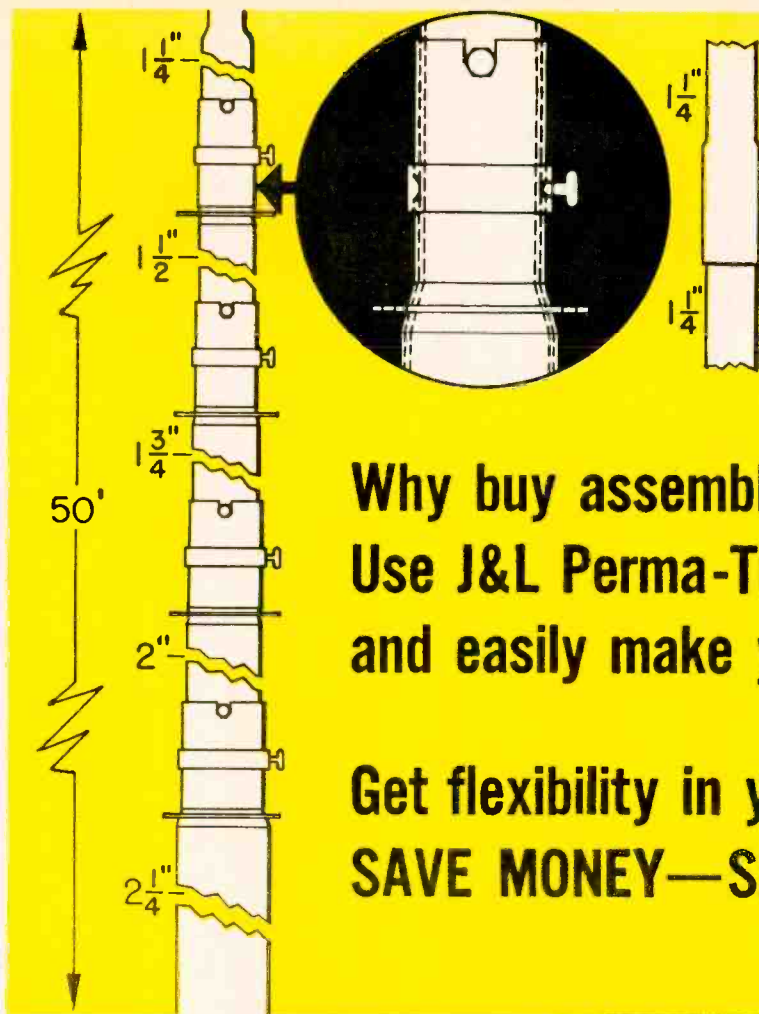

Same 1/4-inch piece of Perma-Tube can be used for telescoping masts or with another 1/4-inch piece to make smaller 2-piece masts.

**Why buy assembled telescoping masts?  
Use J&L Perma-Tube in 10-foot lengths  
and easily make your own**

**Get flexibility in your stock  
SAVE MONEY—SAVE SPACE**

### Only J&L Perma-Tube offers:

- Joint design which provides instant field assembly.
- Machine-fitted joints that insure close tolerance for high strength and rigidity.
- Guy wire ring position that eliminates all binding and guy wire interference.

Buy only a carton each of five different sizes of Perma-Tube (1 1/4 to 2 1/4-inch) and make any telescoping TV mast up to 50 feet in height. Hardware—cotter keys or bolts, clamps and guy rings—may also be secured from your distributor.

You can now "tailor-make" your own TV masts up to 50 feet high by using standard 10-foot lengths of 16-gage Perma-Tube—and save money. Five diameters are available in easily-handled cartons from your local distributor. Largest base section OD is 2 1/4 inches and each telescoping section is 1/4-inch smaller, the smallest section having an OD of 1 1/4 inches.

Corrosion-resistant Perma-Tube is treated with Vinsynite—then coated both inside and outside with a metallic vinyl resin base. It's made of a special, high-strength, J&L steel tubing. A 10-foot section of 1 1/4 inch diameter by 16 gage is capable of supporting a weight at its center point of 200 pounds with a minimum of deflection and permanent set.

**J&L Perma-Tube — best for strength and rust protection**

**Jones & Laughlin**  
STEEL CORPORATION · PITTSBURGH

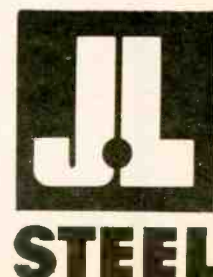

# Having trouble with AGC or SWEEP systems?



**"Servicing AGC Systems"**  
by  
Henry A. Carter and  
Thomas A. Lesh

This practical book describes in detail the operation of the various types of Automatic Gain Control systems used in commercial TV receivers. Provides a clear explanation of AGC circuitry and describes the best servicing techniques to be applied toward finding and correcting AGC troubles. Symptoms of AGC troubles are shown in actual photographs as they show up on the picture tube. An invaluable book for TV Service Technicians. 132 pages; fully illustrated; 5 1/2 x 8 1/2". **\$1.75**  
Order today; postpaid only.....



**"Servicing TV Sweep Systems"**  
by  
Jesse Dines

Describes the operation, circuit function and circuit variation of the different types of vertical and horizontal sweep systems common to most TV receivers. Describes best methods for analyzing circuits and for troubleshooting the vertical and horizontal sweep systems; fully supported by helpful photographs, waveforms and service hints covering specific troubles. Also discusses construction of sweep transformers, coils and deflection yokes. 212 p., 5 1/2 x 8 1/2". **\$2.75**  
fully illustrated. Postpaid, only.....

**USE HANDY ORDER FORM BELOW**

Sams books cover every phase of Electronics for the service technician, engineer, student or experimenter. Listed below are a few of the many valuable Sams books available at electronic parts distributors and leading book stores.

**SAMS BOOKS**  
keep you ahead in  
**ELECTRONICS**

**USE THIS ORDER FORM**

**SERVICING AGC SYSTEMS.....\$1.75**

**Color TV Training Manual.** Prepares the Technician for Color TV service work. Covers principles of the Color TV system; Color receiver circuits; installation and servicing sets. Includes color blocks outlining the use of color test equipment. 260 pages; 8 1/2 x 11"; 300 illustrations. **\$6.95**

**TV Test Instruments.** Revised and enlarged to include latest data on instruments used in Color TV servicing. Tells clearly how to operate each type of test instrument used in TV service work. 180 pages; 8 1/2 x 11"; illustrated..... **\$3.50**

**Key Checkpoints in TV Receivers.** Prepared by the Howard W. Sams engineering staff. Provides many applications for general TV service work, including time-saving information on how to make quick tests at key points to determine where trouble lies, and how to check overall performance of the receiver after repair, to insure against callbacks. 182 pages; 5 1/2 x 8 1/2"; illustrated..... **\$2.00**

**Analyzing and Tracing TV Circuits.** Presents a new approach to TV servicing. 168 pages, 8 1/2 x 11"..... **\$3.00**

**Photofact Television Course.** Gives a clear complete understanding of TV principles, operation, practice. Used by thousands of students. 208 pages, 8 1/2 x 11"..... **\$3.00**

**Radio Receiver Servicing.** Covers the basic receiver types—gives time-saving hints for solving basic troubles, such as dead set, weak set, noisy set, etc. 192 pages; 5 1/2 x 8 1/2"..... **\$2.50**

**Technical Dictionary.** Over 4,000 definitions of radio, television, electronic, electrical and radar terms. Includes valuable charts, graphs, diagrams and symbols. Flexible binding for "on-the-job" use. 160 pages; 6 1/2 x 8 1/2"..... **\$2.00**

**SERVICING TV SWEEP SYSTEMS.....\$2.75**

**Tape Recorders—How They Work.** Explains recording theory, tape characteristics, motorboard mechanisms, drive motors, amplifiers, magnetic heads, volume indicators, equalization circuits—covers everything you want to know about recorders. 176 pages; 5 1/2 x 8 1/2". **\$2.75**

**The Recording and Reproduction of Sound.** Oliver Read's best-seller on audio and Hi-Fi. Covers theory of sound, basic recording methods, phono reproducers, amplifiers, speakers and enclosures, attenuators and mixers, tuners, home music and P.A. systems. 810 pages; 6 x 9"..... **\$7.95**

**Transistors—Their Application in Television-Radio-Electronics.** The first practical, complete book on transistors; explains circuitry, installation, testing techniques, theory and servicing. 100 pages; 5 1/2 x 8 1/2" illustrated..... **\$1.50**

**So You Want to Be a Ham.** Tells you what you need to know about getting your license and acquiring equipment. Covers such subjects as: Conquering the Code; Getting Your Ticket; Going on the Air; Electronics as a Career; etc. 196 pages; 5 1/2 x 8 1/2"; illustrated..... **\$2.50**

**Principles & Practices of Telecasting Operations.** Discusses equipment and techniques. Covers such subjects as: TV Cameras; Control Rooms; Fundamentals of Studio Lighting; Relay Systems; Maintenance Practices; Technical Production; etc. 600 pages; 6 x 9"; illustrated..... **\$7.95**

There is an authoritative Sams book on virtually any Electronic subject in which you're interested. Check below for **FREE Book List** describing all Sams books.

**Send Book List**



Look for  
**SAMS BOOKS**  
on the  
**"Book Tree"**  
at your Parts  
Distributor

**HOWARD W. SAMS & CO., INC.**

Order from your Parts Jobber today, or mail to Howard W. Sams & Co., Inc., Dept. 2-G6, 2201 East 46th St., Indianapolis 5, Indiana.

Send books checked above. My (check) (money order) for \$..... is enclosed.

Name.....

Address.....

City..... Zone..... State.....

(outside U.S.A. priced slightly higher)

**NEW RECORDS**

(Continued)

same tapes are played back on average tape reproducers, the noise figure is by no means that good and no better than the noise figure of discs on average disc reproducing systems—and it can be much worse.

Finally, tapes are a great deal more expensive than the same music on discs. Until comes the revolution (as it surely will eventually) the same amount of money invested in disc equipment and disc recordings will deliver at least as good and probably better overall quality and offer much wider choice of program material.

This explains why prerecorded tapes haven't made the headway enthusiastic proponents anticipated; but it does not make a down payment on a tombstone. Prerecorded tapes are in their childhood. Disc recording has had a big head start, partly thanks to the use of tape for masters. Enough money and brains are invested in the tape recording industry to insure rapid progress and I have no doubt that the above comments will be considered very amusingly reactionary a year or two from now. The possibilities of tape are still largely unrealized whereas discs have been forced far beyond what we once thought possible. The progress in tape should be very much more rapid whereas discs are likely to hold a status quo level. Furthermore, the road toward complete reproduction fidelity will call for tapes, rather than discs. All this is without mentioning stereophonic sound which may well be the next step toward the millenium. In this field tape has such great theoretical and practical superiorities over discs that the race cannot help being a runaway for tape. This year will see the introduction of several complete stereophonic tape reproducing systems and the catalog of stereophonic tapes is growing most interestingly.

Some cautions are in order for those who intend to invest in tapes: Be sure your equipment is in good shape and particularly be sure the heads are not magnetized. Magnetized heads can erase the high frequencies on prerecorded tapes faster than a chipped needle can ruin a disc recording. Many home type machines have heads which are permanently magnetized because they permit the dc plate current of the output tube to go through them. There is no point whatever, if one owns such a machine, to wasting any money on prerecorded tapes. Even if you own the finest available machine, have the heads demagnetized and make demagnetization at least a quarterly and preferably a monthly routine, otherwise you'll wipe away the best part of your investment in tapes.

Continued playback of tapes theoretically has no effect on their noise level. In practice, continued playback on poor machines can, not only increase the noise, but actually record additional noise on the tape. This is the effect of frequency modulation caused by very minute variations in speed or friction of the tape as it passes through the machine. If you're going to invest much money in prerecorded tapes, buy insurance against ruining them by using the best playback tape machine you can afford and keeping it clean and adjusted to minimize FM noise.

Finally, tapes can deteriorate much faster in storage than discs. Beware particularly of high temperature and extreme dryness. Extreme dryness can make the tapes brittle so that they break continually. High temperature can accelerate print-through (similar to groove echo) tremendously.

The equalization problem is just about as plaguesome in tape as it was a year or two ago on discs. There is a NARTB tape recording standard and most of the prerecorded tapes of the past 18 months are equalized to it (also called Ampex equalization). Played back on most semiprofessional machines (but not Magnecord) these tapes will yield a reasonably flat response. On Magnecord recorders the highs are rather severely attenuated. The inexpensive home type machines are something else. Each of these has its own playback curve because designers juggle both the recording and playback curves to compensate for inherent differences and inadequacies of recording heads, equalization methods, etc. Since manufacturers say nothing about the playback curve, there is no way of telling whether they will equalize a commercial tape except by trying them out. In hi-fi systems with good tone controls the equalization can usually be corrected to give a reasonably balanced, but not really flat, response.

I asked a number of producers for samples which would be most interesting from a hi-fi

**NEW RECORDS**

(Continued)

point of view. I review them below but the list offers mighty poor pickings for test, demonstration or showoff material. I urge producers to hurry up with some more spectacular tapes. After all, how in the world are you going to sell tape recordings until you have material which makes a spectacular impact on the possible buyer?

**Classical tapes**

**DVORAK: Symphony No. 4**

**SIBELIUS: Origin of Fire**

*Song of My Heart*

*Finlandia*

*Pohjola's Daughter*

Cincinnati Symphony and Helsinki

University Chorus

AV Tape Library

AV-1030E (7½ ips 7½ inches) \$10.95

An excellent sample of current tape quality. *Pohjola's Daughter* is spectacular in spots with excellent string basses and sharp brassy horns. Compared to a recent London disc, the bass below 50 cycles is notably better. The chorus in the first three Sibelius pieces is highly natural. The Dvorak is not spectacular but has excellent quality throughout. It is recorded about 10 db below NARTB standard level and is notably low in distortion.

**FRANCK: Chorale in A Minor**

*Chorale in B Minor*

**BRAHMS: Blessed Are Ye Faithful Souls**

Robert Owen at the organ.

AV-1505B (7½ ips 5 inches) \$7.95

Good clean recording of the romantic organ with good pedal bass.

**MOZART: Piano Concerto No. 21 in C**

*Major*

London Mozart Ensemble

Sergio Fiorentino, piano

Omegatape

5007 (7½ ips 5 inches) \$5.95

Though the lowest priced of current tapes, Omegetapes appear to be right up there with the rest in quality. Nothing sensational in this one but there is a good piano and plenty of sharp strings.

**DVORAK: Quartet in F Major**

(American)

**HAYDN: Adagio Cantabile**

**BARTOK: Rumanian Dances**

**BLOCH: Prayer**

**DE FALLA: Jota**

**DINICU-HEIFETZ: Hora Stoccata**

**RAVEL: Habanera**

**GLUCK-KREISLER: Melodie**

**SAINT-SAENS: Allegro Appassionata**

Fine Arts Quartet

Webcor 2923-3 (7½ ips 7 inches)

Another good example, though not as clean as A-V's because it is recorded above the NARTB level. The quartet music has excellent presence. The group of solo violin and solo cello works on track B does these instruments justice. The music is entirely pleasant. There is some flutter and rumble.

**VIVALDI: Concerto Grosso in D Minor**

**MOZART: Eine Kleine Nachtmusik**

**TCHAIKOWSKI: Serenade for Strings**

**BACH-STOESEL: Prelude in E Major**

**BOLZONI: Minuet**

Sorkin Symphonette

Webcor 2923-3 (7½ ips 7 inches)

A larger string orchestra gives this a more opulent sound and still maintains the feeling of presence. The music is all pleasant and easy to take, though it does not try system quality.

END

Name and address of any manufacturer of records mentioned in this column may be obtained by writing Records, RADIO-ELECTRONICS, 154 West 14th St., New York 11, N.Y.

Use  
Your  
Military  
Training

The time was never more opportune than now for becoming associated with the field of advanced electronics. Because of military emphasis this is the most rapidly growing and promising sphere of endeavor for the young electrical engineer or physicist.

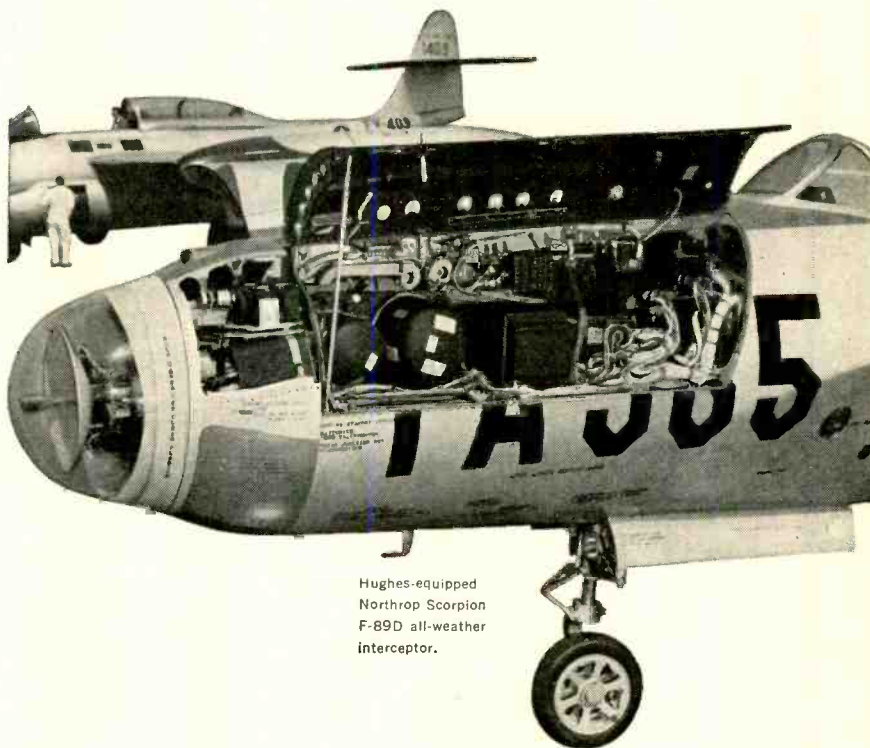

Hughes-equipped Northrop Scorpion F-89D all-weather interceptor.

**E.E. or PHYSICS GRADUATES**

with experience in

**RADAR or ELECTRONICS**

or those desiring to enter these areas...

Since 1948 Hughes Research and Development Laboratories have been engaged in an expanding program for design, development and manufacture of highly complex radar fire control systems for fighter and interceptor aircraft. This requires Hughes technical advisors in the field to serve companies and military agencies employing the equipment.

As one of these field engineers you will become familiar with the entire systems involved, including the most advanced electronic computers. With this advantage you will be ideally situated to broaden your experience and learning more quickly for future application to advanced electronics activity in either the military or the commercial field.

Positions are available in the continental United States for married and single men under 35 years of age. Overseas assignments are open to single men only.

Scientific Staff  
Relations

**Hughes**

RESEARCH AND  
DEVELOPMENT  
LABORATORIES

Culver City  
Los Angeles County  
California

# LOOK TO TRIAD

to fill your  
TV replacement  
needs

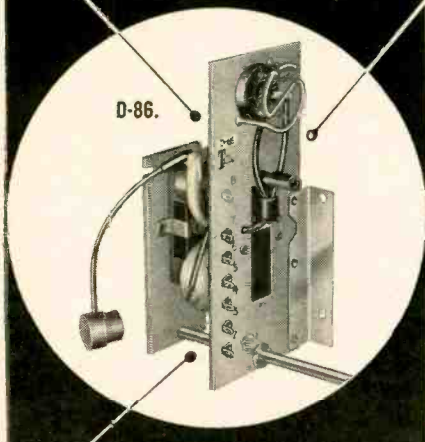

With the addition of the 8 new flybacks (Horizontal Output transformers) listed below, you can depend on TRIAD to supply all your Television replacement transformer requirements.

- D-78. List Price \$11.60. Correct Replacement for Sylvania 241-0011.
- D-79. List Price \$12.35. Correct Replacement for CBS and Firestone FC-10137.
- D-80. List Price \$12.35. Correct Replacement for CBS and Firestone FC-10147, G.
- D-83. List Price \$11.80. Correct Replacement for Raytheon 12E-24612, 12E-24612-1 and 12E-25040.
- D-84. List Price \$13.90. Correct Replacement for Raytheon and Air line C201-22396B, 201-22396-1.
- D-85. List Price \$12.70. Correct Replacement for Air line MW22E67 and Sentinel 22E67.
- D-86. List Price \$15.50. Correct Replacement for Air line MW22E75 and Sentinel 22E75.
- D-87. List Price \$12.70. Correct Replacement for Air line and Sentinel 20E947, B.

Write for Catalog TV-56



4055 Redwood Ave., Venice, California



# Technicians' News



## ESFETA DISCUSSES COLOR

A discussion of color servicing problems with Dan Creato, vice president of RCA Service Co., was the main feature of the Empire State Federation of Electronic Technicians held in Binghamton, N. Y., April 29. Earlier business of the meeting included discussion of Jamestown's and Radio-Television Guild's self-licensing or certification plans. The possibility of making the plan statewide was noted. There was lively comment also on the possibility of General Electric entering into centralized service in connection with their new color set.

Elected for the 1956-57 term were: president, Gordon Vrooman, Syracuse Television Technicians Association; vice president, Harold Hazzard, Southern Tier Chapter, Radio Service Association; secretary, John A. Wheaton, Radio-Television Guild of Long Island; treasurer, Pat Pratt, Radio-Television Service Association of Western New York (re-elected); sergeant-at-arms, Herman Seehausen, Electronic Technicians Association of Jamestown.

Following the election, Jack Wheaton welcomed Mr. Dan Creato and Mr. Weber of RCA Service Co., expressing the delegates' appreciation for the program at Cherry Hill and other activities. He also welcomed the technical press through their representatives present for their efforts to keep the service technicians and dealers informed. Mr. Creato then gave the background of the activities of his company, explaining how the \$99.50 color service contract figure was arrived at and pointing out that it was based on a production figure of 100,000 sets to be produced by RCA's color division in 1956.

Dan Hurley of Syracuse TTA pointed out that it was impossible for the independent service organization, lacking assurance of volume, to compete at that price. Mr. Creato rejoined that as in all new things, profits might be small or even losses sustained while gaining proficiency, and suggested that the history of black-and-white servicing might foreshadow the progress of color. He pointed out that less than 10% of RCA black-and-white sets are serviced by RCA Service Co. and implied that the history of color TV might follow the same lines. At the conclusion of the discussion he expressed appreciation for the opportunity to extend some of the thinking of RCA Service Co. to members of independent

service and to receive some of their observations and criticisms in return.

Ben de Young, ESFETA's first treasurer, attended as observer for a new group forming in the Ithaca area and Leon Helk, secretary of FTRSAP, acquainted ESFETA delegates with some of the Pennsylvania federation's activities. The trade press was represented by Robert Stanton of *Retailing Daily* and Fred Shunaman of RADIO-ELECTRONICS.

## NATESA VOTES CHANGES

Several important constitutional changes were adopted at the National Alliance of Television & Electronic Service Associations held in Omaha in late April. Henceforth, the voting power of each local NATESA affiliate will be based on the number of its members. The director of each local or its convention delegate shall cast one vote for each member he represents. Locals with less than 10 members will cast 10 votes. Voting power was also extended to associate members not affiliated to any local group. Henceforth, each such member will have one vote.

Due to the growth of NATESA and the increased distances covered, to expedite meetings the quorum was set at 25% of the membership in good standing.

Recognizing the tremendous load which the growth of the organization has of necessity imposed on the president, the directors unanimously voted to reaffirm the fact that the president is also the chief executive director and at the same time voted compensation to him on a sliding scale beginning with \$5,000 plus expenses, to cover the last half of the fiscal year ending Aug. 31, 1956. The great strides made by NATESA were credited to the efficient and sincere efforts of President Moch and his regime.

A committee was established to work out ways and means, including organizational changes, to free the executive director of some of his duties to enable him to devote more time to top-level executive duties. As steps in this direction, three governors were named. Albert C. W. Saunders will serve in dual offices, as educational director and as New England zone governor; Gordon Vrooman of Syracuse, N. Y., Central Atlantic zone; Robert L. Kidd of Norfolk, Va., South Atlantic zone. The resignation of Fred Colton of Columbus, Ohio, who is leaving the service busi-

**SERVICEMEN:** NOW YOU CAN REDUCE  
YOUR RECTIFIER NEEDS TO **4** TYPES WITH

*Federal's*

# HI-DENSITY

## SELENIUM RECTIFIERS

Engineered to handle  
**90%** of your radio-tv  
replacements!

Nearly

**50%**

**SMALLER...!**

More compact packages increase  
rectifier capacity of your kit  
... save time on service calls!

SEE YOUR  
FEDERAL DISTRIBUTOR!



ACTUAL SIZE

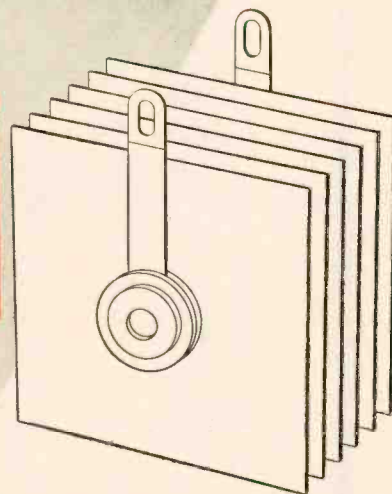

**COMPARE—**

Compare, Mr. Serviceman, Federal's new 250-300 Ma. HI-DENSITY stack with its larger predecessor of the same rating!

Just 4 types—ranging up to 600 Ma.—are needed to meet 90% of your requirements for radio-tv replacements.

Now you can really simplify rectifier replacement ... with these smaller, lighter, higher-temperature, longer-lasting, more versatile HI-DENSITY stacks. Get the facts!

**A Research and Development Triumph of Federal**

Federal Selenium Rectifiers are listed in  
Howard W. Sam's Counter-Facts and Photo Facts

**Federal Telephone and Radio Company**

A Division of INTERNATIONAL TELEPHONE AND TELEGRAPH CORPORATION  
COMPONENTS DIVISION • 100 KINGSLAND ROAD • CLIFTON, N. J.

In Canada: Standard Telephones and Cables Mfg. Co. (Canada) Ltd., Montreal, P. Q.  
Export Distributors: International Standard Electric Corp., 67 Broad St., New York

**Federal**



A DIVISION OF



# BENCO'S

## SENSATIONAL LOW-PRICED

# Super "20"



## MAST-MOUNTED BOOSTER

### OUTSTANDING FEATURES:

- Very Low Noise Cascode Circuit Brings Weak Snowy Pictures to Entertainment Level.
- Automatic ON-OFF from TV Receiver
- Easily mounted on Mast
- Supplied Complete with all Connectors (Solderless)
- 20 DB Gain
- Contains separate 3-tube Amplifiers for High and Low Bands (3 Dual Triodes).
- Amazing Low Price

**\$59.<sup>50</sup>**  
Canadian List

Write for the name of your nearest U.S. or Canadian Distributor

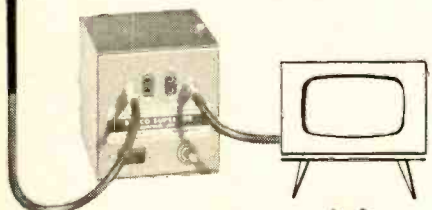

### USE THIS HANDY COUPON

Benco Television Associates Ltd.,  
278 Bridgeland Ave. Downsview  
TORONTO, Canada.

- Please send me complete details on the SUPER "20"  
 New equipment CATALOG

Name .....

Address .....

City..... Prov.....

### TECHNICIANS' NEWS

ness to undertake a new venture on the West Coast, was accepted with regrets and his post of Great Lakes governor was assigned to his former business partner, John Graham.

Very serious consideration was given to such subjects as insurance, licensing, parts jobber relations and factory service operations. The insurance plan was advanced to the point where it is expected that it will be put in force at the next meeting. Resentment was expressed against those segments of the industry that have seen fit to oppose the justified wishes of service people on the subject of achieving stability in the industry, particularly through licensing where local affiliates feel it to be highly desirable. Hope was expressed that parts jobbers will find a way to bring a halt to perversion of wholesale practices and interference with the wishes of service people. NATESA expressed eternal willingness to enter into discussions with parts jobbers toward this end, particularly since the jobbers group has recently made changes which bring about a better climate for solutions. The growing signs of monopolistic practices by a growing number of set manufacturers, especially as they apply to factory service operations at retail, brought condemnation.

The application of MINTSE (Minnesota Institute of Service Engineers) for affiliation with NATESA was rejected since the group does not, at present, fulfill requirements of membership.

### FTRSAP PLAQUE TO WEBB

The Federation of Television-Radio Service Associations of Pennsylvania has awarded Jack Webb of the Dragnet program a plaque for his efforts in behalf of the independent service technician. The award is made annually by the FTRSAP to the person or organization deemed by a vote of the individual chapters of the federation to have done the most for independent service during the year.

Arrangements were made to have the plaque presented by the California State Federation as a deputy for FTRSAP. It had earlier been expected that the award could have been made in the East but Mr. Webb found that his commitments did not permit that.

### HOUSTON WANTS LICENSE

The Houston Association of Television Electronics Servicemen approved unanimously a proposal for the licensing of TV and electronic service technicians. The proposal was for a House bill to be introduced at the next session of the Texas legislature, to provide for a nine-member commission to be appointed from service technicians and from leading Texas universities which would investigate, examine and certify service technicians.

The proposed bill would require, for the protection of customers, a \$500 bond for any shop or person doing

business in TV or electronic servicing. It would also provide for licensing apprentices, to work under the supervision of a licensed technician.

### COUNCIL ADOPTS STANDARDS

The Philadelphia Council of Radio & Television Service Associations has approved a resolution requiring each of its member associations to set forth a certified statement that it is composed of a minimum of seven active members, holds regular meetings and to list its authorized authors. The step was taken, it was stated, to strengthen the council's position as representative of organized service in Philadelphia. Members not complying with the resolution will be dropped from membership.

The council is composed of the Television Service Dealers Association, the Northeast Television Service Dealers Association, the Television Service Dealers Association of Delaware County and the Allied Television Technicians Association of New Jersey. A different member presides as chairman at each council meeting.

Council spokesmen point out that it is largely responsible for the drive by the District Attorney's office against fraudulent TV servicing and used-tube racketeering.

### UPGRADING IN CHICAGO

The Television Electronic Service Association of Chicagoland is engaged in a concentrated series of lectures for the upgrading of technical personnel.

A group of lectures and seminars on color TV was opened May 9 by Joseph Kalivoda of Motorola, who lectured on circuitry analysis and latest developments in color TV. It was to be followed on May 16 by a special seminar on RCA color sets by Rudy Phillips, and by other lectures and seminars open exclusively to members of TESA-Chicagoland. A series of business lectures, designed to bring information even more important to the success of the members than even technical pointers, was initiated at the March meeting of the organization.

Frank Moch, TESA-Chicagoland president, reports that the activity of the organization and the growing awareness of the need of cooperative action are bringing in new members regularly and that applications for 10 additional memberships were accepted by the board of directors at the latest meeting.

### ARTS CHANGES NAME

The Associated Radio & Television Servicemen (Chicago) announce that from May 1 the name of the group is Associated Radio & Television Servicemen, Illinois, the association having recently been incorporated with that name under the laws of Illinois.

Chairman Howard Wolfson reports that the association has retained all its charter members but one into this its fourth year. END



# John Winegard says:

**30,000,000 TV antennas  
can be replaced in the next 5 years.  
8,000,000 worn out or antiquated antennas  
are spoiling TV reception now when  
Republican and Democratic conventions  
are the greatest drawing cards of all TV history.**

At WINEGARD we are quadrupling our manufacturing capacity because we absolutely believe that our new Color'ceptor, Color Beam and Minute Mount are the antennas that will create a new standard of TV reception and make good color reception a reality for everybody.

## Let me tell you about these new antennas:



The Color'ceptor is the first high gain, fringe area antenna particularly engineered for color reception. Based on world-famous WINEGARD Interceptor design, the Color'ceptor (18 elements) with "Power-Pack" has up to 47% more gain than the Interceptor and the highest front-to-back ratio of any single-bay, all-channel antenna in the industry.

The two Color Beams are the world's first fully assembled and boxed complete antenna installations. Mast, lead-in, insulators, mounts, clothespin on lead-in clip are all assembled (in box). Not a kit. Foolproof to install, the Color Beam can even be sold like an appliance for Do-It-Yourself customers. The Color Beam is intended for 50-mile reception radius. The DeLuxe Color Beam has an average reception radius of 100 miles and is equipped with the "Jigger Mount," the only universal mount for all types of roofs and buildings.

A brand new approach, the Minute-Mount is a completely factory-assembled tripod tower with high-gain antenna for extremely rugged fringe area service—particularly suited for terrain with high winds. The complete package consists of 10-foot non-corrosive all aluminum fold-out assembly mast with high gain antenna incorporating the patented WINEGARD Electro-Lens focusing, attached high-quality lead-in, 7 insulators (3 attached on mount), lightning arrester, ground-wire and ground-rod.

We design every WINEGARD ANTENNA to make you, Servicemen of America, more money, more easily, with more satisfied customers. Ask any leading Electronic Parts Distributor for complete information or writeme.

*John R. Winegard*

**FAMOUS WINEGARD ANTENNAS FOR ONE-MAN SEVEN-MINUTE  
INSTALLATION FOR BLACK AND WHITE OR COLOR.**



**WINEGARD COMPANY**  
Burlington, Iowa

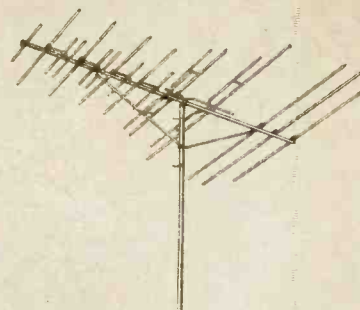

COLOR 'CEPTOR CL-4X \$39.95

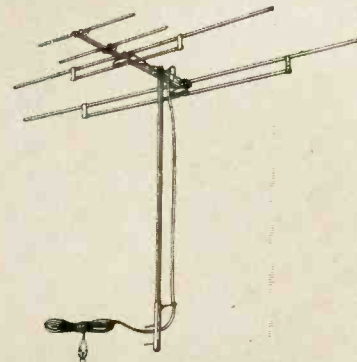

COLOR BEAM TCB-300 (STANDARD) \$14.95

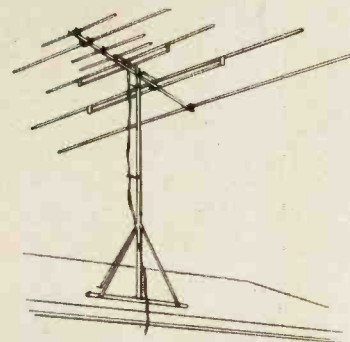

COLOR BEAM TCB-310 (DELUXE) \$29.95

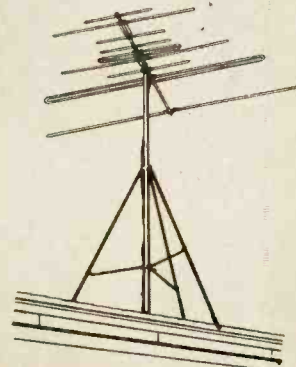

MINUTE-MOUNT M-1 \$37.50 LIST

BURTON BROWNE ADVERTISING

when it's a  
**QUAM**  
*Adjust-a-Cone*<sup>®</sup>  
**SPEAKER**

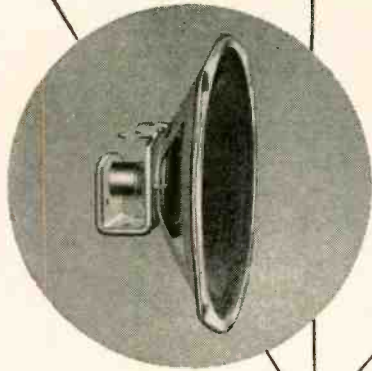

you can  
**SELL IT**  
and  
**FORGET IT!**

Quam Speakers just don't come back. Ask any serviceman or distributor who handles them. The patented Adjust-a-Cone suspension and the patented U-shaped coil pot, combined with Quam's advanced production and inspection procedures, are your assurance that every Quam Speaker is a trouble-free speaker.

A FREE copy of the latest Quam Catalog, listing over 100 replacement speakers, is available from your distributor, or from the Quam-Nichols Company.

ask for **QUAM** the quality line for all your speaker needs

**QUAM-NICHOLS COMPANY**

234 EAST MARQUETTE RD. ♦ CHICAGO 37, ILLINOIS

new

**Tubes**

**Transistors**



An unusually wide variety of new tubes, transistors and crystal diodes make up this month's fare. Highlighting the group are an improved color TV picture tube, a 1¼-inch oscilloscope tube and a tiny semiconductor twin diode.

**21AXP22-A**

This tube, like the 21AXP22, is a directly viewed metal-shell picture tube for color television receivers.

The 21AXP22-A has the unique feature of an internal neck coating having a high resistance which eliminates the need for an external resistor between the ultor power supply and the tube to protect the tube against damage caused by a momentary internal arc. The neck-coating resistance also permits use of a tube insulating boot with an external conductive coating which, with the metal envelope of the tube, forms a supplementary filter capacitor. As a result of improved production techniques the new tube provides increased light output.

The 21AXP22-A (announced by RCA) may be used to replace the 21AXP22.

**6CH8**

A general-purpose multiunit tube of the nine-pin miniature type, the 6CH8,

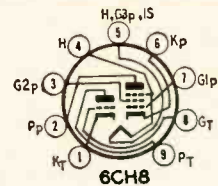

also an RCA tube, contains a medium-mu triode and a sharp-cutoff pentode in one envelope. It is intended for a wide variety of applications in black-and-white and color TV receivers.

The pentode unit features high transconductance (6,200 micromhos) and low grid-1-to-plate capacitance (.025 μf) and may be used as an if amplifier, video amplifier, agc amplifier and reactance tube. The triode section, which has a relatively high zero-bias plate current (13 ma), is well suited for use in low-frequency oscillator, sync separator, sync clipper and phase splitter circuits.

The pentode unit of the 6CH8 has a separate base-pin terminal (see base diagram) for both grid 3 and cathode. This permits the use of an unbypassed cathode resistor to minimize changes in input resistance and input capacitance with bias without causing oscillation

RADIO-ELECTRONICS

new!



**Arkay Model Hi-Fi FL-10 Amp-Preamp Kit**  
Williamson type super-linear amplifier with built-in pre-amp. Pushpull 12 watt output frequency response ±1 db, 10 to 40,000 cps with extremely low IM and harmonic distortion. An amplifier to be proud of. **\$28.95**

twins by **ARKAY**



**Arkay Model HFT-7 Hi-Fi AM-FM Tuner Kit**  
Matching tuner which offers less than 1% distortion and a -70db hum level. Sensitivity is 6 uv for 20 db quieting on FM and 20 uv on AM.

With AFC control and defeat **\$29.95**  
Available in FM only **\$23.95**  
Less Cover

Visit your local distributor for these wonderful kits and write today for the special FREE Radio Kits Catalogue and list of dealers. Your copy will be sent by return mail with no obligation. Write to...

**Radio Kits Inc., Dept. 10 120 Cedar Street, New York City**

# Rohn

only complete line of

## TV and COMMUNICATION TOWERS

### proven in Profits and Customer Satisfaction

• • • • HIGHLIGHTS OF THE ROHN LINE • • • •

look at these  
ROHN exclusives

#### ● HOT DIPPED GALVANIZED

The finest, most durable finish is available for ROHN Towers and accessories... all done entirely on the ROHN premises under careful ROHN supervision.

#### ● UNEQUALLED DESIGN AND ENGINEERING

ROHN is the only design that has stood up over the years. ROHN has been first and foremost... and always the leader in new products to meet the changing demands.

#### ● MASS PRODUCTION FOR LOW COSTS

ROHN was the first to utilize mass production techniques to build a superior tower at the most competitive prices. This means no sacrifice in quality yet far greater profits for you.

#### ● UNIVERSAL CUSTOMER ACCEPTANCE

Thousands and thousands of installations prove the ROHN line first in customer satisfaction.

#### ● PIONEER MANUFACTURERS

Pioneers in tower manufacturing—and today one of the world's largest manufacturers of this type equipment. The ROHN Company was built on satisfaction on the part of distributor, dealer and customer alike.

#### ● COMPLETE LINE

Only ROHN offers a full line—one dependable one-stop source for all TV installation equipment. Save headaches, save shipping costs, save time... use ROHN unequalled service *exclusively*.

### ALSO a full line of ROHN ACCESSORIES

Rotor posts, house brackets, eave brackets, peak and flat roof mounts, instant drive-in bases, hinged base sections, telescoping mast bases, guying brackets, UHF antenna mounts, erection fixtures, variety of mounts and supports for masts or tubing,

tower installation accessories, TV service tables, mast and TV hot-dipped galvanized tubing, guy rings, "twister-anchors", rubber tower grommets, insulator sections, hinged rotor platform, accessory shelf and platform and dozens of other items. Get the complete catalog TODAY!

## ROHN Manufacturing Company

116 LIMESTONE, BELLEVUE  
PEORIA, ILLINOIS

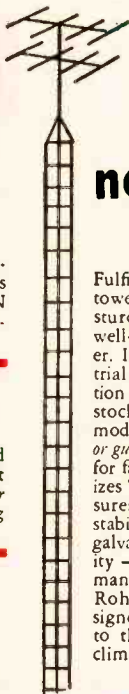

### no. 6 tower

"All-Purpose" tower.

Fulfills 75% of your general tower needs—is structurally as sturdy—yet costs less than the well-known Rohn No. 10 Tower. Ideal for home and industrial installations, communication requirements... eliminates stocking many different tower models. *Self-supporting to 50 ft. or guyed to 120 ft.!* Easy to climb for fast, efficient servicing. Utilizes "Magic Triangle" which insures far greater strength and stability. Permanent hot-dipped galvanized coating. Dependability — a feature customers demand — is assured with the Rohn No. 6 Tower... designed to "stand up" for years to the rigors of weather and climatic conditions.

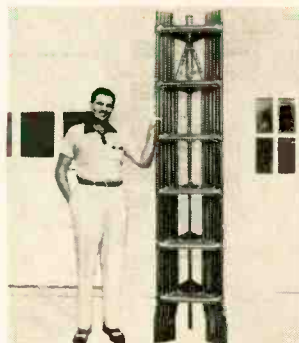

### Package Tower

"Space Saver" — cuts storage space 300% or more!

Popular PT-48 has almost 50' of sturdy tower within a compact 8' x 20" package! "Magic Triangle" design is adapted to a pyramid shape using a wide 19" base with progressively decreasing size upward. Decreases your overhead... easy to transport and assemble — cuts shipping costs. Galvanized throughout. Available in heights of 24, 32, 40, 48, 56 and 64 feet!

### COMMUNICATIONS TOWER

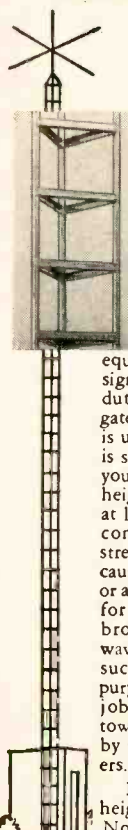

For extreme heights and communication purposes of all kinds, the Rohn No. 40 gives you strength and durability on which you can depend. The time tested and proven equilateral triangle design using extra heavy duty tubing and corrugated steel cross-bracing is utilized. The No. 40 is structurally sound so you can install it for heights up to 300'; or at lesser heights when considerably greater strength is required because of excessive wind or antenna loading. Use for radio telephone, broadcasting, microwave relay and all other such communication purposes. If a particular job calls for this type tower, save real money by using ROHN towers.

Note: For lesser heights, use the Rohn No. 20 or No. 30 Tower.



### Both Towers Feature THE ROHN MAGIC TRIANGLE

For structural superiority, famed wrap-around "magic triangle" design is featured in these all-steel towers. Towers have full 2 1/4" wide corrugated cross-bracing welded to tubular steel legs. The exclusive design assures dependable strength and permanence.



### Telescoping Masts

Heavy-duty hot-dipped galvanized steel tubing and rigid joints give extraordinary strength. *Quick installation*... mast attached to base—antenna fixed, then mast hoisted quickly to desired height. Utilizes special clamp and guy ring arrangement. Flanged interior section; crimped exterior section gives mast stability that can't be beat. Complete with guy rings and necessary erection parts. In 20, 30, 40 and 50 ft. sizes. Bases and ground mounts available.

### ROHN FOLD-OVER TOWERS

These unique fold-over towers are perfect for experimentation, TV service departments, amateur use, and special purposes. Uses regular ROHN tower sections with kit. Now available in standard No. 10 tower to 50', and in ROHN No. 30 & No. 40 towers for heavy-duty use.



### MAIL THIS COUPON FOR FREE LITERATURE!

Rohn Manufacturing Company  
116 Limestone, Bellevue  
Peoria, Illinois

Gentlemen: Please rush me complete details on the full line of Rohn Towers and Accessories.

Firm \_\_\_\_\_

Name \_\_\_\_\_ Title \_\_\_\_\_

Address \_\_\_\_\_

City \_\_\_\_\_ State \_\_\_\_\_

this TV serviceman uses

# STANCOR

## EXACT REPLACEMENT TRANSFORMERS



There are now 59 Stancor exact replacement flybacks covering all major TV set manufacturers and many private label brands. The latest units include 6 new Zenith replacements that give you

**71% ZENITH EXACT REPLACEMENT FLYBACK COVERAGE**

and 6 new General Electric replacements that give you

**79% G. E. EXACT REPLACEMENT FLYBACK COVERAGE**

You too can take life easy and have time to spare when you use Stancor exact replacements. No changing of circuits, no drilling of holes . . . you just take out the defective unit and replace it with a Stancor Transformer that exactly duplicates the original.

**FREE** The New Stancor TV Transformer Replacement Guide, listing accurate replacement data on almost 8500 TV models and chassis of 116 manufacturers. If you haven't received your copy see your Stancor distributor or write Chicago Standard Transformer Corporation.

### CHICAGO STANDARD TRANSFORMER CORPORATION

3509 ADDISON STREET  
CHICAGO 18, ILLINOIS

Export Sales:  
Roburn Agencies, Inc.  
431 Greenwich Street  
New York 13, N. Y.



## For Your Protection

RADIO-ELECTRONICS is continually alert to maintain a high level of integrity in our advertising columns. In the case of tube advertising—which has suffered special abuses—we insist that all advertisers must warrant that their tubes are:

- New and unused
- Not mechanical or electrical rejects
- Not washed or rebranded
- (See page 57 of the January, 1956, issue)

We investigate carefully when we have grounds to suspect that any advertiser is not living strictly up to these rules.

### NEW TUBES AND RESISTORS (Continued)

which might otherwise occur if grid 3 was internally connected to the cathode.

Each section of the 6CH8 has its own cathode with individual base-pin terminals. In addition, the basing arrangement and internal connections are designed so that coupling between the triode unit and the pentode is virtually eliminated. Heater voltage for the 6CH8 is 6.3 and the current drain is 450 ma.

### RCA 6CB5-A

A high-perveance beam power tube of the glass octal type, the 6CB5-A is designed especially for use as a horizontal-deflection amplifier tube in color television receivers. It is smaller and more compact than the 6CB5 with which it is electrically interchangeable.

The 6CB5-A has a maximum plate dissipation of 23 watts and a maximum grid-2 input of 3.6 watts. These ratings, in addition to a peak positive-pulse plate voltage rating of 6,800 (absolute), enable a single 6CB5-A, in suitable circuits, to provide full deflection for the 21AXP22 color picture tube. Heater voltage is 6.3; heater current requirements are 2.5 amperes.

### Tiny rectifier

A new twin diode, a miniature Vac-u-Sel rectifier, has been announced by G-E. The selenium unit (see photo) is designed for use as a horizontal phase

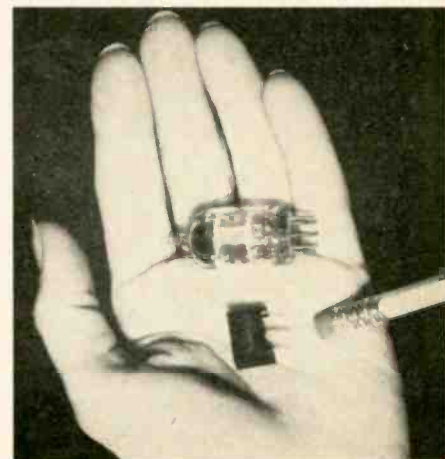

detector in place of the popular 6AL5 (shown above it) in television receivers. The new semi-conductor is especially adapted for automatic assembly operations using printed circuits. Costing about half as much as the tube it replaces, the rectifier is built to last many times longer.

Typical electrical characteristics are a minimum forward current of 0.5 ma dc at 2 volts and a maximum reverse current of 25 microamperes at -20 volts. The characteristic capacitance per section is approximately 50  $\mu\text{mf}$ , with negligible unbalance.

### 1EP1

A new oscilloscope tube, the 1EP1 (see photo), having a diameter of only



# STACKPOLE CARBON RESISTORS

Now In Modern New Self-Service Packages!

Scientifically Packaged to Prevent Bent Soldering Leads!

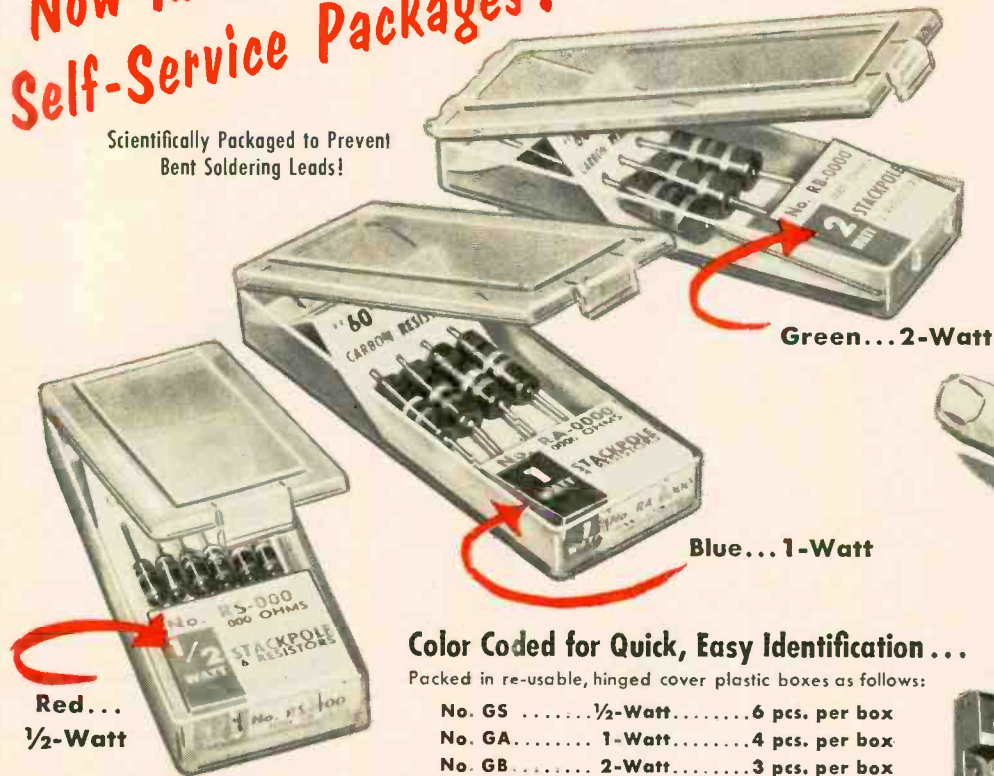

Red... 1/2-Watt

Green... 2-Watt

Blue... 1-Watt

### Color Coded for Quick, Easy Identification...

Packed in re-usable, hinged cover plastic boxes as follows:

- No. GS ..... 1/2-Watt..... 6 pcs. per box
- No. GA..... 1-Watt..... 4 pcs. per box
- No. GB..... 2-Watt..... 3 pcs. per box

**G-C 60 LINE**

## CARBON RESISTORS

ALL ONE PRICE... ONE STANDARD PACKAGE

LIST \$1.00 per BOX

DEALER NET **60¢** PER BOX

THE SIGN OF FASTER, BETTER RESISTOR SERVICE!

### COMPLETE, COMPACT CARBON RESISTOR "DEPARTMENT" IN THIS G-C DISPLAY!

All G-C Stackpole Carbon Resistors available in this unit... 78 values from 10 ohm through 22 megohm of 1/2-watt and 1-watt resistors, plus 26 most frequently used 2-watt resistors. Clearly marked for easy selection of types and values... no mix-ups!

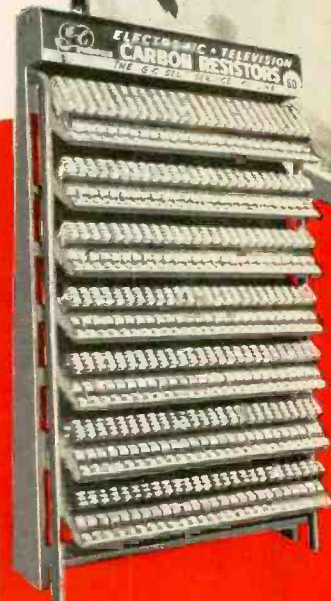

## G-C ELECTRONICS MFG. CO.

Division of General Cement—Textron American  
910 Taylor Avenue Rockford, Illinois



### ATTENTION SERVICEMEN: SAVE THE COUPONS!

Coupon in every G-C Stackpole Resistor box. Save them and get handy steel resistor storage rack!

...another  
**MALLORY**  
service-engineered  
product

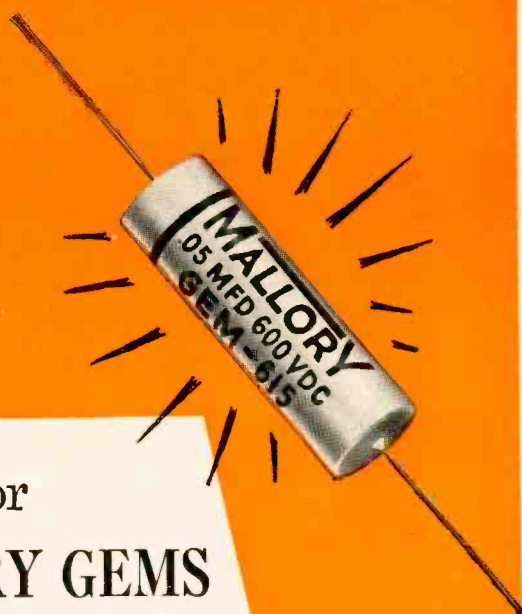

## You'll go for **MALLORY GEMS** —the new plastic tubular capacitors

For replacement of paper tubulars, you can't beat new Mallory "Gems." Compare these value features—yours *without* premium price:

- **Locked-in leads** can't loosen from soldering iron heat or vibration.
- **Real humidity protection**, using a high grade mica-filled bakelite case, ends possibilities of premature shorts.
- **Uniform quality** of each capacitor is assured by true-center construction, which protects the element from damage during assembly.

Try Mallory "Gems"—and you'll never settle for less. Get your stock now, from your local Mallory distributor.

P. R. MALLORY & CO. Inc.  
**MALLORY**

P. R. MALLORY & CO. Inc., INDIANAPOLIS 6, INDIANA

- Capacitors
- Vibrators
- Resistors
- Power Supplies
- Controls
- Switches
- Rectifiers
- Filters
- Mercury Batteries

### NEW TUBES AND TRANSISTORS (Continued)

1¼ inches, has been announced by RCA. It is intended primarily for use in lightweight portable equipment, aircraft and in continuous monitoring service for large electronic equipment such as computers and transmitters.

The 1EP1 uses electrostatic focus

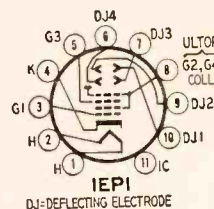

and deflection. It has a flat face, a minimum useful screen diameter of 11/16 inches, a maximum overall length of only 4 1/16 inches and weighs 2 ounces. There are separate base-pin terminals (see base diagram) for each deflecting electrode to permit use of balanced deflection. The tube provides



a trace having high brightness at relatively low ultor voltage; maximum ultor voltage is 1,500. Heater voltage is 6.3; heater current 600 ma. The type P1 screen phosphor provides medium persistence. END

### Thirty-Five Years Ago In Gernsback Publications

#### HUGO GERNSBACK, Founder

Modern Electrics	1908
Wireless Association of America	1908
Electrical Experimenter	1913
Radio News	1919
Science & Invention	1920
Television	1927
Radio-Craft	1929
Short-Wave Craft	1930
Television News	1931

Some larger libraries still have copies of ELECTRICAL EXPERIMENTER on file for interested readers.

#### In July 1922 Science and Invention (formerly Electrical Experimenter)

The Radiophot. Television by Radio, by H. Gernsback.

Freaks of Railroad Radiophony, by A. P. Peck.

French Radio Station at Night.

Radio for the Beginner, No. 5, by Armstrong Perry.

Radio Amplification by Robert E. Lacault. Simplest Radiophone Receiver, \$50 Prize Winner, by Leon Webster.

Secret Radio Messages.

Radio Oracle.

# Technotes



## MOTOROLA TS 292

So-called Barkhausen lines may appear at the left side of the raster with their wavy, mostly black, pepper and salt effect. The real trouble is parasitic oscillation at the grid of the horizontal output tube rather than Barkhausen oscillation within it. (A magnet brought near the tube will cause true Barkhausen oscillation to change frequency or

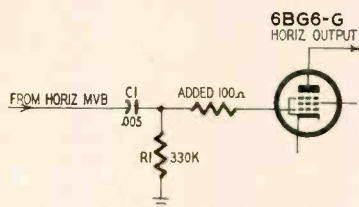

to cease.) The cure is to disconnect the leads from the control grid of the 6BG6 and insert a 100-ohm  $\frac{1}{2}$ - or 1-watt resistor between the grid terminal and the junction of C1 and R1 as indicated on the diagram. This antiparasitic resistor will squelch the oscillation which may be present with some 6BG6 tubes although not with others.—*Alfred Roberts*

## TELETONE 149

This model will usually give a fuzzy picture due to the 4.5-mc beat signal, used for intercarrier sound, getting into the picture circuits. This occurs only on weak signals and can be cured by connecting a small mica capacitor from pin 3 of the ratio detector tube to the chassis. This prevents the signal from feeding through the filament wiring and other parts of the circuit.—*Ernie Gig*

## RCA KCS96, KCS97

A considerable increase in sound gain can be obtained in models using the above chassis by removing the ground connection on the cathode of the 6U8 sound if amplifier and inserting an 82-ohm  $\frac{1}{2}$ -watt resistor between cathode and ground. The resistor should be bypassed with a .01- $\mu$ f ceramic disc capacitor. This change has been made in late production receivers. When the change is made, the adjustment of the sound takeoff transformer (T101) should be checked by tuning in a weak signal and adjusting T101 for maximum sound.—*RCA Television Service Tips*

## AM RECEIVER ALIGNMENT

In emergencies you can use an ordinary voltmeter as an output meter for AM set alignment. Connect it from



...another  
**MALLORY**  
service-engineered  
product

More than  
60 Million  
Vibrators  
worth of  
experience  
...to bring you  
the best!

Yes, it has taken 26 years of pioneering development... plus the manufacturing know-how gained by making more than 60 million vibrators—60 million units worth of experience—to bring you Mallory's long-lived, premium performance vibrators.

Unique Mallory features have reduced mechanical hum to levels thought impossible a few years ago. They have extended vibrator life, and established new standards of reliability and service.

As in the past, Mallory will continue to lead the vibrator field in design and development... bringing you the finest in performance... the utmost in economy and efficiency.

Give your customers *the best*. Be certain you order Mallory from your distributor.

P. R. MALLORY & CO. Inc.  
**MALLORY**

- Capacitors
- Controls
- Vibrators
- Switches
- Resistors
- Rectifiers
- Power Supplies
- Filters
- Mercury Batteries

P. R. MALLORY & CO. Inc., INDIANAPOLIS 6, INDIANA

**COMMUNICATION  
AND RADAR  
PERSONNEL**  
Electronic Background

**WANTED  
NOW**

# PHILCO . . . World's Largest Field Service Organization

. . . is the pioneer in the servicing of electronic equipment for BOTH industry and government. In all areas of the United States, and in nearly every section of the world, PHILCO men are at work on vital communications installations.

## ELECTRICAL ENGINEERS and TECHNICIANS

. . . at all levels and in all fields of electronics are needed for long range, challenging and really interesting assignments, guaranteed to utilize the fullest skills of men who are specialists in the Design, Maintenance and/or Instruction of others in Communication, Radar and Sonar Equipment.

Men . . . who can qualify for our important projects are assured that there is no other company offering more fully paid benefits to its employees . . . PLUS valuable family insurance and hospitalization programs . . . PLUS top pay, special assignment bonuses and a planned, fully integrated program for merit and faithful service salary increases.

**TODAY . . . is the time to evaluate your  
past and present growth potential  
against the FUTURE. Write NOW for the  
PHILCO EMPLOYMENT STORY.**

# PHILCO

## TECHREP DIVISION

22nd & Lehigh Ave., Philadelphia 32, Pa.

*First* In Income and Employee Benefits!

### DeRO All Purpose DeRO-Juvenator



One rejuvenator replaces all! Model RU-5—universal 5 wire, for use on all series or parallel filament TV sets, both electrostatic and electromagnetic. Restores brilliance and contrast \$3.95 to pix tube. . . . LIST

AT ALL LEADING JOBBERS • FREE FOLDER  
DeRO • 134 Nassau Rd., Roosevelt, L. I., N. Y.

## INVENTORS

Send for  
**PATENT INFORMATION**  
Book and  
**INVENTORS RECORD**  
without obligation  
**GUSTAVE MILLER**  
76 RE WARNER BUILDING  
WASHINGTON 4, D. C.

**REGISTERED PATENT  
ATTORNEY**  
ASSOCIATE EXAMINER  
U.S. PAT. OFF. 1922-1929  
Patent Attorney & Advisor  
U.S. Navy Dept. 1930-1947  
**PATENT LAWYER**

### We Are Precise Distributors

New Ultra Fast 116K Tube Checker .....\$69.95  
The 111K—Winner in Independent Survey .....\$79.95  
7" Voltmeter Model 9071K .....\$35.95

If you already own the 111K we offer a solid 5/16-inch Hardwood Case in a choice of Walnut-Mahogany or Oak. \$16.00 Net FOB Norfolk. It is not necessary to remove the Tester from the metal case.

Write for Bargain Circular

**ELECTRONIC PARTS CO.**  
9303 Granby Street  
Norfolk 3, Va.

### LMB BOX CHASSIS OFFERS FREE

inside LMB boxes

10 tested kit diagram projects for the builder. Each one of these kit diagrams built by a recognized expert. Kit projects are complete in every detail. Circuit diagram, photo of project both front and rear photo. Rear photo shows wiring and parts. Detailed instructions for building, complete parts list and approximate cost. Complete to build except parts and your distributor can supply the parts. Ask your distributor for the list of LMB kit Diagram Projects. If he does not have them, write to

**LMB** 1011 Venice Blvd.  
Los Angeles 15, Calif.

TECHNOTES

(Continued)

ground to the screen grid of an if or rf amplifier tube—if the screen grid is fed from a dropping resistor. When the signal strength increases, the avc voltage goes up, reducing the screen current and the drop across the resistor. This increases the screen voltage read by the meter.—Charles Erwin Cohn

### COMMON-GROUND HUM

Wires carrying ac heater current are connected to the terminal strip, one side being grounded (see photo). The bare lead from the molded capacitor is the ac ground path from the volume control.

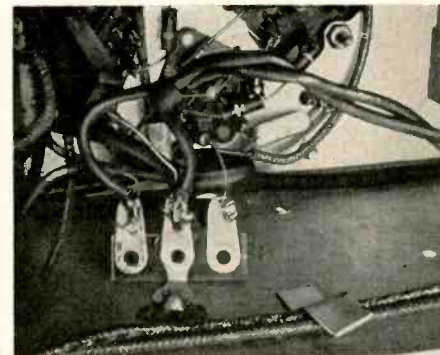

Sufficient common impedance was present to cause noticeable hum in the audio which was cured by grounding the capacitor elsewhere.—Lawrence Shaw

### PHILCO 46-1201 RADIO

The chassis of this set is mounted in a vertical position with the second if transformer located directly above the rectifier and beam-power amplifier tubes. Early runs of this model used a wax-impregnated if transformer. The heat from the tubes melts the wax, causing it to run into the trimmers. The cure here is to replace this transformer with a conventional unit.—John Jones, Jr.

### ARVIN MODEL 7214CM

This set displayed an almost complete tone reversal coupled with an excessive high-frequency response—ringing on all stations. Signal input to the grid of the first 6AU6 first video amplifier was O.K. The plate waveform was distorted and low in amplitude.

Resistance checks located short-cir-

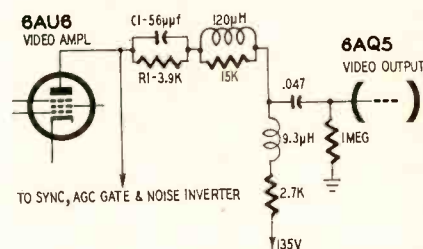

cuted capacitor C1 (56  $\mu$ f) in shunt with resistor R-1. This defect reduced the low-frequency response, producing considerable smear and the other symptoms due to excessive high-frequency response. Although not too apparent, the sync was somewhat critical.—A. R. Clawson



## TECHNOTES

(Continued)

## REGENCY TRANSISTOR RADIO

Complaints of intermittent and noisy reception in this miniature (model TR-1) have been traced to two separate defects:

The on-off switch is not of the self-cleaning type and a minute deposit of wax between the contacts prevents its operation. Remove the wax with solvent and burnish the contacts to cure this trouble.

Also, the plastic insulated lead from the loop to the stator of the tuning capacitor may short to the capacitor frame. A fast cure for this is to loosen one mounting screw on the tuning capacitor and slip a small piece of insulating paper between the panel and the capacitor frame. Tighten the mounting screw and dress the loop lead between the insulating paper and the plastic panel.—*Roy E. Pafenberg*

## DU MONT RA 164

This chassis did not maintain horizontal sync during program changes. The trouble was traced to an increase in the value of R236, a 100,000-ohm resistor (see diagram). It must closely match its mate R237 in the load of the phase detector tube so that the voltages

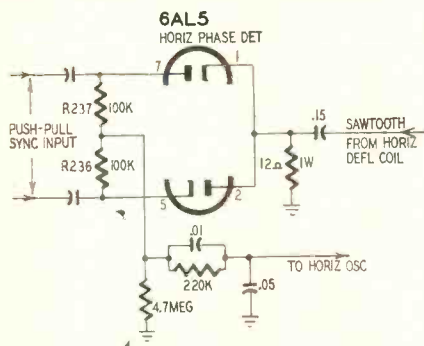

developed across them will be equal at the on-frequency condition of the horizontal oscillator. R236 had increased in this chassis to 240,000 ohms. The replacement resistor was soldered in with longer leads than the original unit since the shortness of the leads of both R236 and R237 together with the heat of soldering produced the change in value. R237 was also replaced with long leads— $\frac{3}{4}$  inch.—*Lawrence Shaw*

## PHILCO 938K RADIO

Weak reception or none at all is often due to a defective 1-megohm volume control. This has a special shaft and must be ordered from a Philco distributor.

If oscillations occur when the set is jarred, check the avc bypass capacitor—it often opens intermittently. Replace it with a .05- $\mu$ f unit.

When the motor tuning does not function correctly, inspect the wire that grounds one side of the pushbutton switch contacts—it sometimes comes loose. When this happens, solder it to the lug that is riveted to the case of the receiver.

In several of these sets weak and distorted reception was due to a loose speaker plug.—*Milo Bannister* END

## MY PROFITS JUST BEGIN ..... WITH THE INSTALLATION

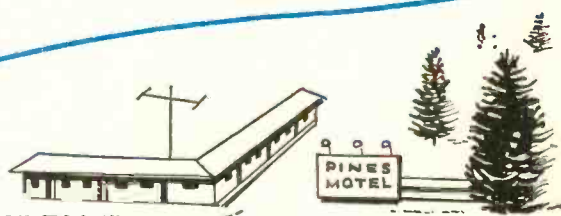

### JERROLD MASTER TV SYSTEMS

Smart service technicians and dealers realize that the profit they make on the sale and installation of a Jerrold Master TV System is only the beginning! For the sharp, snow-free pictures delivered by a Jerrold system is their key to mass receiver orders . . . more receiver servicing jobs . . . more frequent Master TV installations as other businessmen become Jerrold-conscious.

Cash-in on the growing demand for Jerrold Master TV Systems in motels, apartments, clubs, and small hotels. With a Jerrold system there are no installation headaches . . . no guesswork about profits. Every installation step is figured out for you in advance.

Discover how easy it is to get beautiful, snow-free pictures at 5, 10, 20, or more receivers from a *single antenna*—even in ultra-fringe areas. Send 25c today for the big illustration-packed booklet, "INSTALLATION MADE EASY." It shows how to profitably sell, estimate costs, install, and service any TV System.

**JERROLD**

... the complete Master TV Line.  
Sold by leading distributors.

De-Snower® pre-amplifiers  
UHF Master Converters  
Distribution Amplifiers  
Line Splitters  
Line Tap Impedance Matchers  
Solderless Coaxial Connectors  
Interference Traps  
Attenuator Pads

**JERROLD ELECTRONICS CORP.**

2216 Chestnut Street, Philadelphia 3, Pa.

In Canada: JERROLD ELECTRONICS (Canada) Ltd.  
50 Wingold Ave., Toronto 10, Ontario

# JERROLD

**ATLAS SOUND CORP.**

1443 — 39 St., Brooklyn 18, N. Y.

Send FREE Buyer's Guide to save me money on public address Loudspeakers, Microphone Stands and accessories.

Name \_\_\_\_\_ Title \_\_\_\_\_

Firm \_\_\_\_\_

Type of Business \_\_\_\_\_

Address \_\_\_\_\_

City \_\_\_\_\_ Zone \_\_\_\_\_ State \_\_\_\_\_

**HOW TO SAVE MONEY  
on LOUDSPEAKERS  
and MIKE STANDS**



Fill in coupon and find out how ATLAS proves that better know-how can produce better products at lower cost to you. Depend on world-famous ATLAS—the complete quality line with specialist know-how since 1930.



**ATLAS SOUND CORP.**  
1443-39th Street, Brooklyn 18, New York  
In Canada: Atlas Radio Corp., Ltd., Toronto, Ont.

**Question  
Box**



**115-230-VOLT AMPLIFIER**

A low-cost high-fidelity amplifier using two 6SQ7's and two 50L6-GT's is described in a Sarkes Tarzian selenium rectifier application sheet. It uses a transformerless voltage-doubler type supply operating from a 117-volt line. I'd like to replace the 6SQ7's with a

verts the power supply from a 115-volt voltage doubler to a half-wave rectifier for 220-volt operation. When the amplifier is operated from a dc source, the line plug must be polarized so the B-minus bus connects to the grounded or negative side of the line.

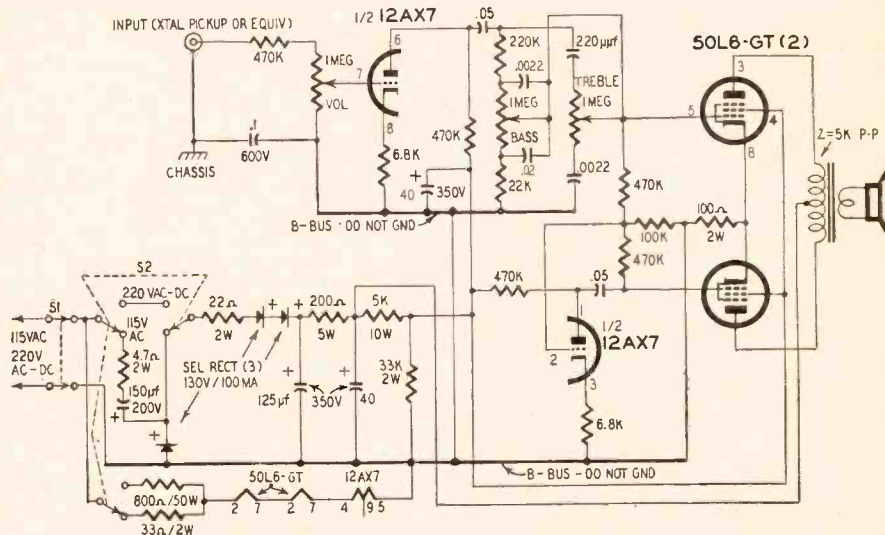

twin triode and modify the power supply to operate from 115-volt ac and 230-volt ac or dc lines that I expect to find while traveling abroad. Please show how I can make these modifications.—I. S. F., Brooklyn, N. Y.

The diagram shows how the amplifier can be modified. A 12AX7 replaces the 6SQ7's. The power supply is converted to provide approximately 200 volts dc on the output plates when operated from 115 volts ac or 220 volts ac or dc. S1 is a dpst line switch. S2 is a three-circuit double-throw switch that selects the correct line-dropping resistor for the heater string and con-

Three 130-volt 100-ma selenium rectifiers are used. Two are in series to handle the applied voltage when operating from 220 volts.

Be especially careful when constructing the amplifier. Isolate the B-minus bus from the chassis and be sure to insulate the shafts of the volume and tone controls and take care that the microphone, phono pickup or other accessory does not come in direct contact with the B-minus bus.

The plate current drain of the 12AX7 is very low, as with the 6SQ7's, and insignificant when compared to that of the two 50L6 output tubes.

**27.255-MC TRANSMITTER**

I plan to build the miniature model control receiver described in the April issue and would like plans for a transmitter to go with it. Where can I get construction details?—W. K. G., Cleveland, Ohio.

This diagram was taken from *Radio-Control Handbook* by Howard G. McEntee. In it you will find details on transmitters and receivers for R-C fans from the newest novice to the most advanced amateur.

Grid coil L1 consists of 30 turns of No. 22 dcc wire wound on a 1/4-inch-diameter Bakelite rod. Tap 3 turns from the low end. Plate tank coil L2 is an

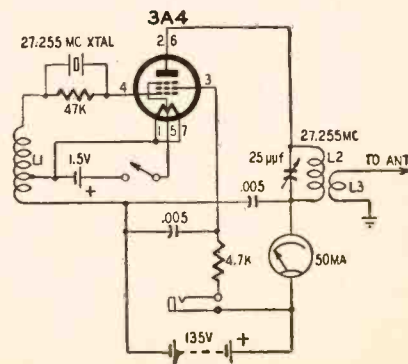

airwound coil of 11 turns of No. 14 enameled wire with an inside diameter of 3/4 inch and spaced to a length of 1 1/8 inches. L3 is 5 turns of No. 14 solid hookup wire closewound with an inside diameter of 3/4 inch. It is mounted on the same axis and close to the ground end of L2.

With the antenna connected, the spacing between L2 and L3 should be adjusted for about 12 ma plate current when the transmitter is resting on the ground and the plate circuit is tuned to resonance.

**LOUDNESS CONTROL**

I am planning to build the three-channel mixer-equalizer described in the November, 1955, issue. Before I start construction I'd like to have a sketch showing how a loudness control can be added.—F. F. V., Glendale, N. Y.

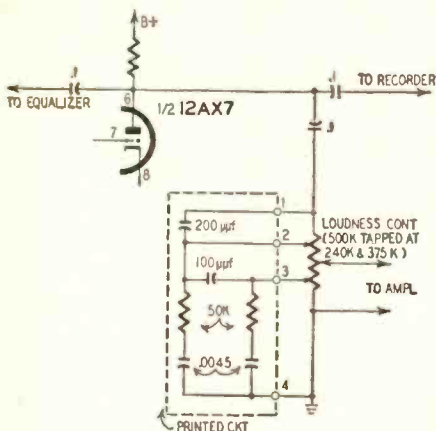

The diagram shows a Centralab type C1-60 Junior Compentrol in place of the master gain control. This consists of a 500,000-ohm volume control with taps at 240,000 and 375,000 ohms and a printed-circuit R-C network. The numbered terminals are those on the printed-circuit plate.

**ECHO FOR TAPE RECORDINGS**

Please show me how I can use the echo unit in the February, 1956, issue to add reverberation to sounds being recorded on tape or discs.—T. J. D., Worcester, Mass.

The diagram shows a basic arrange-

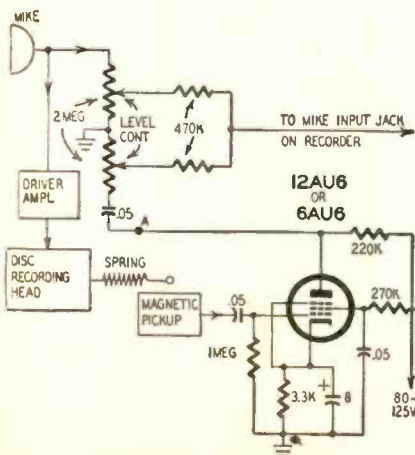

**"Blue Beaver"® Electrolytics**

Cornell-Dubilier's "Blue Beavers" are the serviceman's very own. They're sold only through authorized C-D Distributors. Full profit and complete customer satisfaction comes only with "Blue Beaver" Electrolytics. They are a truly exclusive capacitor—exclusive in quality and long life performance—and made only by C-D, exclusively for the service trade. Ask your nearby C-D Distributor for catalog or write direct to Cornell-Dubilier Electric Corporation, South Plainfield, N. J.



**Cornell-Dubilier capacitors**

South Plainfield, N. J.; New Bedford, Worcester & Cambridge, Mass.; Providence & Hope Valley, R. I.; Indianapolis, Ind., Sanford, Fuquay Springs & Varina, N. C.; Venice, Calif., & subsidiary, The Radiant Corporation, Cleveland, Ohio.

**Always Mention Radio-Electronics When Answering Advertisements**

Si vous lisez le français technique, vous devez lire

**ELECTRONIQUE INDUSTRIELLE**

la grande revue française de technique moderne  
Specimen gratuit sur demande

**EDITIONS RADIO**

9, rue Jacob — Paris 6<sup>e</sup> — France

**ENGINEERING**

Prepare for unlimited opportunities of the **B. S. DEGREE IN 27 MONTHS**



Electronic Age! Earn your B.S. degree in 27 months at Indiana Technical College, intensive, specialized course. Comprehensive training in math and electrical engineering, advanced radio theory and design, television, electronics. Modern laboratories. Low rate. Also B.S. DEGREE IN 27 MONTHS in Aeronautical, Chemical, Civil, Electrical and Mechanical Engineering. G.I. approved. Enter September, December, March, June. Earn part of your expenses in Fort Wayne while studying. Write for catalog.

**INDIANA TECHNICAL COLLEGE**

1776 E. Washington Blvd., Fort Wayne 2, Ind.

Please send me free information on B.S. ENGINEERING DEGREE IN 27 MONTHS as checked.

- Electronics  Chemical  Aeronautical
- Civil  Mechanical  Electrical

Name \_\_\_\_\_

Address \_\_\_\_\_

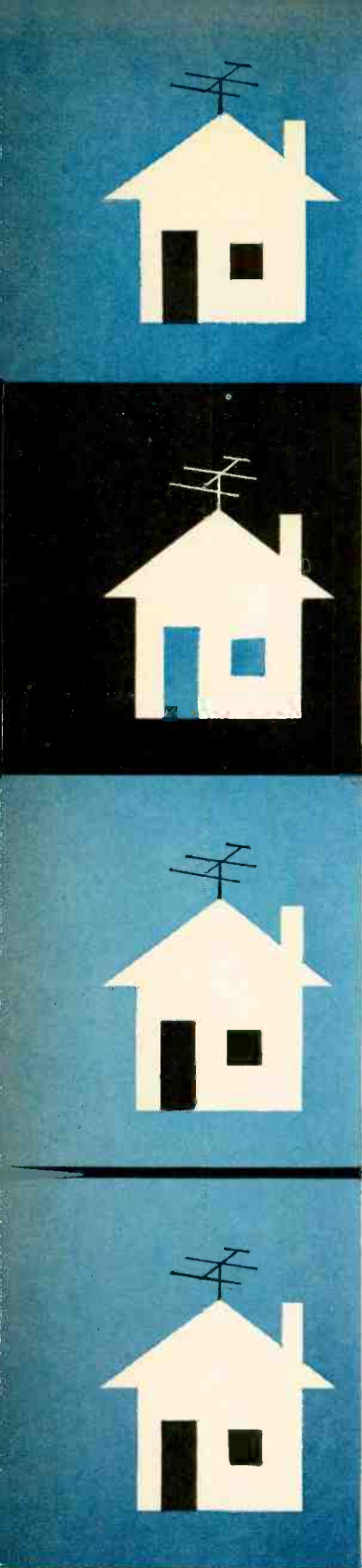

# 1 out of 4

outdoor installations

are made with



# TWIN LEAD!

More than 25% of all outdoor tv installations—more than 5,000,000 installations in the United States alone—have been made with AMPHENOL Twin Lead! These tremendous sales figures prove the popularity of AMPHENOL Twin Lead with Dealers, who know these important advantages:

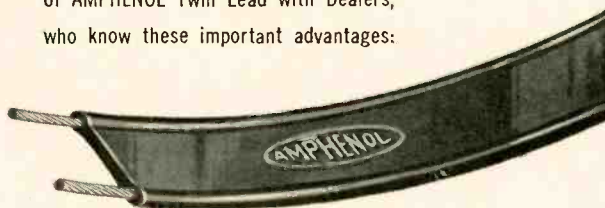

**CUSTOMER SATISFACTION.** The quality of AMPHENOL Twin Lead has always provided the complete customer satisfaction important to you for *repeat sales*.

**EASY-TO-USE HANKS.** Neat packages of pre-cut, pre-assembled 50, 75 and 100 foot lengths make AMPHENOL Twin Lead *easy to handle and install*.

**GREATER PROFITS.** Good mark-ups to fair selling prices make AMPHENOL Twin Lead the *plus profit lead-in*.

*Today MORE Dealers sell MORE AMPHENOL Twin Lead than ever before—Sell and promote the LEADER!*

AMPHENOL ELECTRONICS CORPORATION  
chicago 50, illinois  
AMPHENOL CANADA LIMITED toronto 9, ontario



## QUESTION BOX

(Continued)

ment that you can use. The output of the microphone is fed simultaneously to the recorder and to a delay unit that feeds its output into the recorder input. The driver amplifier may be the same as that in Fig. 2 of the original article.

We do know how the amplitude of the signal from the pickup will compare with that of the microphone. You may find that the pickup output is high enough to provide satisfactory operation when fed directly into the resistive mixer at point A. If the output is too low, then you can use a simple voltage amplifier like that in the diagram. The output of this stage is then fed to the mixer. The level controls set the amplitudes of the direct and delayed signals.

### ELECTRONIC BELL SYSTEM

*I am designing a signal bell system for a school and would like to have your help. I want an electronic control system that will ring a bell for 15 seconds 5 minutes before and 5 minutes after each hour, starting at 8:55 a.m. and stopping at 4:55 p.m. The system is to work on a 5-day week (Monday through Friday).—D. S., Windsor Locks, Conn.*

Many operations are simpler, more economical and less likely to develop trouble when performed mechanically or electrically rather than electronically. This is a prime example of an application where electronics would be impractical. An electronic system for this purpose would be complex and would be likely to consist of a number of interlocked time-delay circuits or an intricate counting system. It would be an expensive project and would require regular maintenance. Our suggestion is that you contact a manufacturer of time clocks or time switches designed for this purpose.

He could make, comparatively easy, a virtually sure-fire electromechanical system extremely simple compared to an electronic network. END

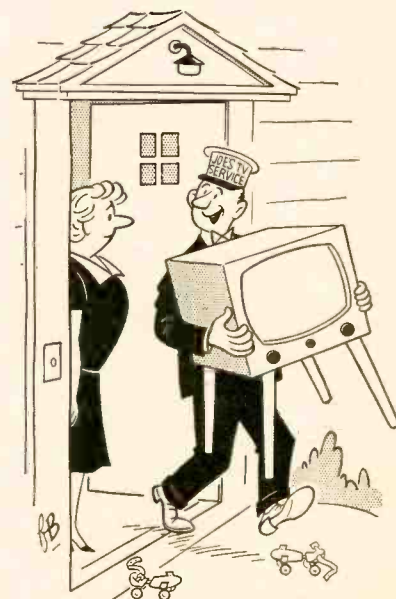

"Don't worry Mrs. Jones—we'll take care of your set."

RADIO-ELECTRONICS



# Examine FREE



## Prentice-Hall ELECTRONICS & UHF LIBRARY

Edited by  
**W. L. EVERITT**

**5 VOLUMES 1662 ILLUSTRATIONS**

Pay Easy Installments If You Keep the Set

Turn to this new, up-to-date Library with complete confidence, for dependable facts on any phase of modern electronic theory and practice. These volumes, by outstanding authorities, give you thorough guidance—clearly written, logically arranged, profusely illustrated.

### Electronic Fundamentals and Applications

By Prof. John D. Ryder,

Dean, College of Engineering, Michigan State College

Complete, logical, easy-to-follow treatment of (a) physical principles underlying electron tubes, (b) characteristics of vacuum tubes, (c) all basic tube circuits. Includes: Electron Ballistics, Cathode-Ray Tubes, Emission of Electrons, Space Charge in Vacuum Tubes, Diode Rectifiers, Triodes, Multi-Element Tubes, Small-Signal Amplifier Circuits, Audio-Frequency Amplifiers, Radio-Frequency Amplifiers, Oscillator Circuits, Modulation Systems, Wave-Shaping Circuits, Gaseous Conduction, Gas Diodes, Gas Control Tubes and Circuits, Photoelectric Cells, Solid-State Electronics.

### Electromagnetic Waves and Radiating Systems

By Prof. Edward C. Jordan,

Head, Dept. Electrical Engineering, Univ. of Illinois

Covers entire field of electromagnetic engineering. Includes propagation as well as radiation and transmission. Full treatment of UHF transmission lines, wave guides, antennas, slot antennas, radiation and diffraction, ground-wave and sky-wave propagation.

### Ultra High Frequency Engineering

By Thomas L. Martin

Head Dept. of Electrical Engineering, Univ. of Arizona  
Theory and technique of ALL the new fields of electronic engineering: Radar, Telemetering, Electronic computing, Facsimile, Television, Blind landing systems, Pulse-time modulation, Ionosphere measurements . . . and the others.

### Networks, Lines and Fields

By Prof. John D. Ryder,

Dean, College of Engineering, Michigan State College

Network transformations and theorems, Resonance, Impedance transformation and coupled circuits, Filters, General transmission line, High-frequency line, Equations of the electromagnetic field, Radiation, Transmission and reflection of plane waves at boundaries, Guided waves between parallel planes. Wave guides.

### Elements of Television Systems

By George E. Anner, University of Illinois

Complete basic theory, plus current practice, covering: Closed TV systems, Commercial Teletexting Systems, Color TV Systems. Gives clear exposition of all phases of picture transmission, including the new technique of dot interlace.

## SEND NO MONEY—EXAMINE FREE

Just mail coupon below to get complete 5-Volume Set on 10 DAYS' FREE TRIAL. If not completely satisfactory, return in ten days and owe nothing. Or keep the set and pay only \$7.50 down and \$8 a month for five months until full price of \$47.50 is paid. Decide for yourself—without risk of obligation—just mail coupon to examine Library ten days free.

Prentice-Hall, Inc., Dept. 5744-J1  
Englewood Cliffs, N.J.

Send me the Prentice-Hall ELECTRONICS & UHF LIBRARY (5 Volumes) for ten days' free examination. If fully satisfied in ten days I will send you \$7.50 plus few cents postage and then \$8 a month for five months until full price of \$47.50 is paid. Or I will return the Library in ten days and owe nothing.

Name.....

Address.....

City and State.....

## RADIO-ELECTRONIC CIRCUITS

one or more of the capacitors selected by the coarse frequency control. When the tube cuts off, the capacitor discharges through the fine frequency control in its cathode circuit. The linear portion of the discharge curve drives the horizontal deflection amplifiers.

When the triode is conducting to charge the frequency-determining capacitor, its plate voltage is in the form of a negative-going pulse whose duration is short compared to the sweep interval. This negative pulse is amplified and inverted and used for blanking.

The diagram shows a simplified section of the multivibrator with the frequency controls. The negative pulse at the plate is fed to a 6AB4 amplifier-inverter to produce a large positive pulse that is applied across a 220,000-ohm resistor inserted between the cathode of the C-R tube and the arm of the intensity control. This pulse biases the C-R tube to cutoff during the retrace interval.

The circuit is effective on all but the highest sweep range where only partial blanking occurs. This is because the gain of the 6AB4 drops off at higher frequencies and because the gain is limited by the resistor in the cathode return of the C-R tube. If this resistor is made larger, screen brightness will be reduced. About 220,000 ohms seem to be a good compromise value. The use of a single triode as an amplifier minimizes the added drain on the power supply.

Now is a good time to add a circuit for external intensity modulation. Connect a 270,000-ohm resistor between the control grid and the high side of the intensity control and a .02- $\mu$ f 1600-volt blocking capacitor between the grid and an external intensity modulation terminal. Added components are shown in dashed lines on the diagram. Because of the pulse type voltages used in this circuit it is best to use over-rated components. As indicated in the diagram, two of the capacitors are 1,600-volt units. The resistors should be rated at 1 watt.—Paul S. Lederer

## RADIATION ALARM

Individual radiation monitors are vital to the health of personnel working with radioactive materials. Normally these are either portable ionization chambers or film badges. In each case, the monitor is checked in a laboratory at the end of each day or shift. Thus, the worker may receive an overdose of radiation and not know it until too late.

Patent 2,728,861, issued to Floyd M. Glass, describes a pocket radiation monitor that enables the worker to determine at any time the dosage that he has received and sounds an alarm when the accumulated dosage exceeds a predetermined level. This monitor is shown in Figs. 1 and 2.

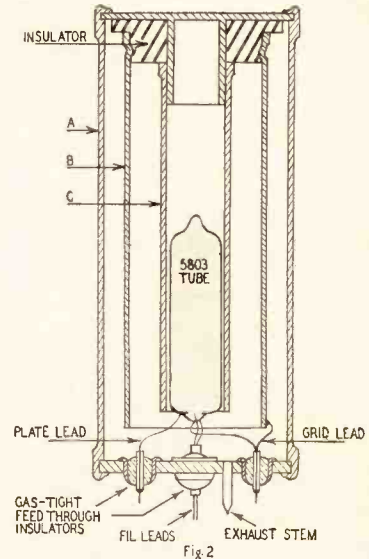

The device is built around a triode such as the Victoreen 5803 with its grid tied to the collector of an ionization chamber. Initially, the interelectrode capacitance of the chamber is charged from a source of positive voltage and then S1 is thrown to NORMAL. Thus the grid of the tube is biased below ground by the amount of charge across the capacitor.

The capacitance of the chamber, its volume and the charging voltage determine the maximum dose that the monitor will handle. When a critical total amount of radiation has fallen on the chamber, the triode comes out of cutoff and conducts. The tube is supplied by a 30-volt battery.

A crystal headphone (with resistor and capacitor removed) and a neon lamp are connected as shown across the 60-volt battery. The .005- $\mu$ f capacitor blocks dc across the crystal. When the tube conducts its plate voltage drops—because of the 10-megohm resistor—and increases the voltage across the neon lamp to the point where it fires.

The crystal phone and neon lamp form a relaxation oscillator whose frequency is controlled by the voltage on the triode plate. The triode plate voltage decreases as radiation increases so the capacitance of the crystal charges and discharges more rapidly and the frequency increases. The charge and discharge of the crystal produces an audible note.

To measure the dose received, the user turns the arm of the potentiometer to the ground end and throws S1 to

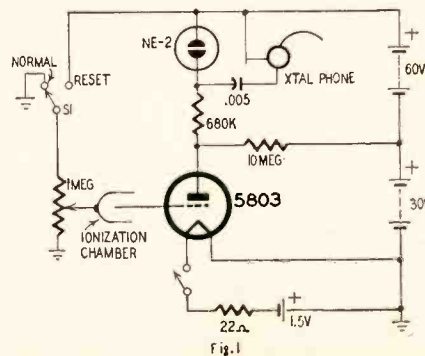

RADIO-ELECTRONIC CIRCUITS (Continued)

RESET, thus connecting the control across the 30- and 60-volt batteries in series. The control is then advanced until the alarm sounds. A calibrated dial on the potentiometer indicates the dosage received. The switch is then thrown to NORMAL to continue monitoring.

Ordinary two-electrode ionization chambers do not have enough capacitance for this application so the design in Fig. 2 is recommended. Aluminum is preferable for the concentric tubes but brass or other metals may be used. Tubes A and C form the outer electrode of the chamber and B is the inner (collector) electrode. The capacitance is about 20  $\mu\text{f}$  and the volume is 34 cc. A dry gas such as nitrogen fills the chamber to about 1 atmosphere. This chamber has a maximum dosage of about 100 milliroentgens. The triode tube may be mounted in the chamber as shown in Fig. 2.

TRANSISTOR TRANSCIEVERS?

Here are two experimental transistor oscillators that I feel can be adapted for use as a low-powered transceiver. I have not had time for further experiments but I am confident that fellow readers will be able to modify and improve the circuits. One novel feature is that they oscillate with voltages as low as 3.

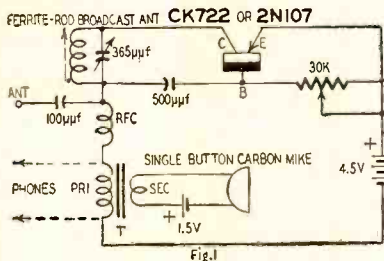

Fig. 1

Both circuits can probably be used as home broadcasters or low-powered transmitters. The circuit in Fig. 1 has a single-button carbon microphone transistor-coupled to the collector circuit. The transformer that I used is an af output type with unknown impedance ratios. When used as a transmitter in the broadcast band, the unit has a range of around 35 feet.

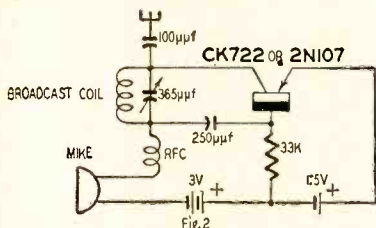

Fig. 2

When the transformer is replaced by a pair of headphones, the unit becomes a regenerative detector with regeneration controlled by the variable resistor between base and emitter. Station WGN in Chicago and Mexican station XEG were received here in Wichita, Kan., on a 50-foot antenna.

Fig. 2 is a similar oscillator or transmitter using a tapped battery and the microphone directly in series with the collector.—W. G. Eslick

END

# IBM WANTS ENGINEERS AND TECHNICIANS FOR PROJECT SAGE

*(Continental air defense for 165,000,000 Americans)*

Project SAGE, America's air defense warning system, offers opportunities to challenge your ability. Equipped with more than 50,000 vacuum tubes, the SAGE computer is the result of the most advanced electronic concepts. Make your own career with SAGE, and the world's largest computer.

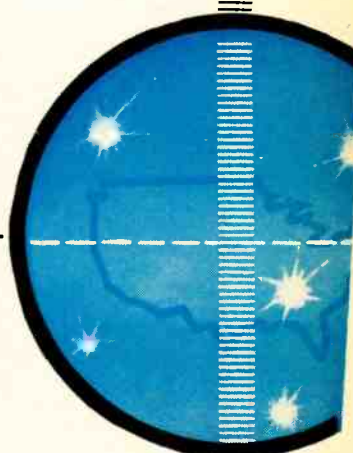

## SYSTEMS ENGINEERS

You will be responsible for the performance, evaluation, reliability testing and maintenance of the entire system.

**Requirement:** Degree or equivalent with emphasis in electronics.

## FIELD TECHNICIANS

Actual maintenance and component analysis. Assume high-level responsibility

**Requirement:** Two-year technical school training in electronics, or equivalent.

## NOW is the time to investigate

- Permanent Employment
- Full Employee Benefits
- Training at Full Salary
- Relocation Expense Allowance

## Assignments in:

- Portland, Me.
- Richmond, Va.
- Syracuse, N. Y.

... and other desirable locations

Write, giving details of education and experience, to: Nelson O. Heyer, IBM, Department 3107, Military Products Division, Kingston, New York



INTERNATIONAL BUSINESS MACHINES CORPORATION

DATA PROCESSING  
ELECTRIC TYPEWRITERS  
TIME EQUIPMENT  
MILITARY PRODUCTS

# NEW-NEW-NEW

Get your copy of the

## ERIE

### D-56 CATALOG

Now Available at  
**ERIE DISTRIBUTORS**  
Everywhere

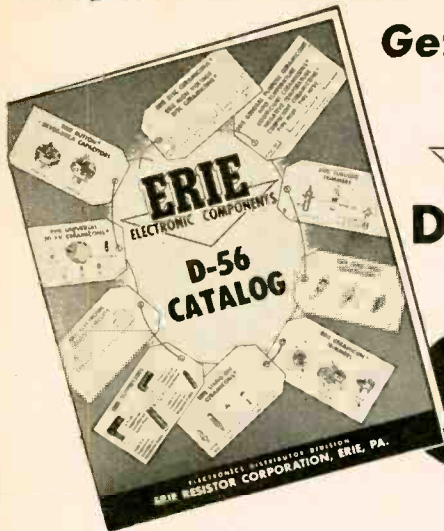

More complete than ever, the new ERIE D-56 Catalog not only describes and illustrates the complete line of ERIE Electronic Components but also includes CORNING GLASS and ERIE-

TEFLON items, that are available through ERIE Distributors. Get your copy of the ERIE D-56 Catalog now at your ERIE Distributor; if he cannot supply it, write us, giving his name.



ERIE ELECTRONICS DISTRIBUTOR DIVISION

ERIE RESISTOR CORPORATION  
Main Offices: ERIE, PA.

Factories: ERIE, PA. • LONDON, ENGLAND • TRENTON, ONTARIO

# Patents



## CRYSTAL COUNTER Patent No. 2,717,964

Vozcan Lawrence Parsegian, Brooklyn, N. Y.  
and Ralph Carrol Maninger, Montvale, N. J.

(Assigned to United States of America as represented by U. S. Atomic Energy Commission)

Several types of crystal counters have been developed for detecting radiation. Their chief advantages are small size and high counting speeds. These inventors have found that a thin sulphur film has an additional feature—very high sensitivity. It is approximately five times more sensitive than previous crystal counters for detecting radiation.

The counter is simplicity itself. A film of sulphur is sandwiched between conductive layers or electrodes and the whole assembly is mounted

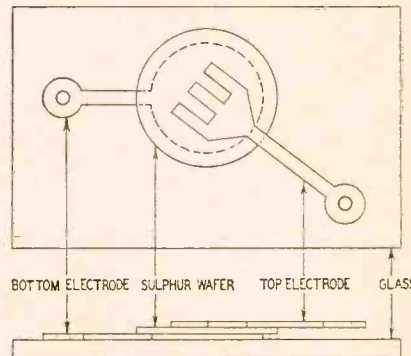

on a glass plate as in the drawing. The upper conductive layer is fork-shaped to reduce capacitance across the sulphur.

Radioactive particles excite the sulphur and form ion pairs. Therefore a conducting path is provided through the film (which is normally an insulator). The pulses that result are amplified.

When the sulphur film is very thin (20 microns, for example) it can discriminate between various particles. Beta and gamma particles pass completely through it without ionizing crystal atoms. Alpha particles cannot penetrate the film. They are absorbed and form ions so they may be counted.

## THYRATRON DISCHARGE CIRCUIT Patent No. 2,716,211

Eugene A. Aas, Albuquerque, N. M.

(Assigned to the United States of America as represented by the U. S. Atomic Energy Commission)

This trigger supplies pulses powerful enough to energize a relay. For example, a typical pulse discharge may be a 50-ma current lasting 25 milliseconds. Any signal that will fire a thyatron can operate this circuit. Thus, a wide variety of thyratrons could be used, depending upon the amplitude of the trigger pulse.

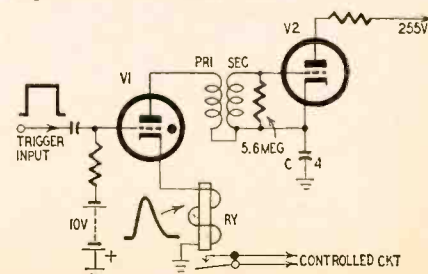

RADIO-ELECTRONICS

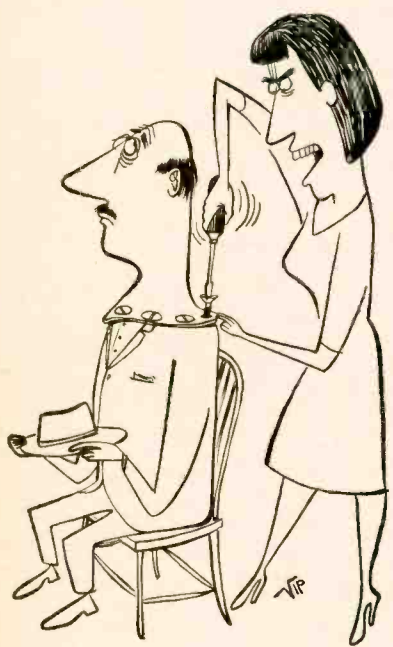

"Now let's see if you can remember to bring home those JENSEN NEEDLES tonight!"

## GET MORE WORK OUT OF YOUR OSCILLOSCOPE!

Learn to service  
ANY radio or TV  
easier and  
faster!

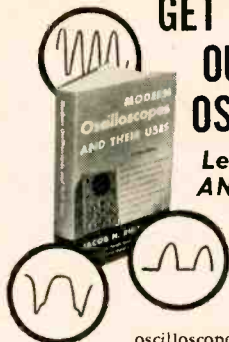

Here, in a brand new 2nd edition, is THE book that really shows you how to use

oscilloscopes!

Clearly as A-B-C. MODERN OSCILLOSCOPES AND THEIR USES tells you exactly when, where and how. You learn to locate either AM or FM radio or television troubles in a jiffy. Even tough realignment jobs are made easy. No involved mathematics! Every detail is clearly explained—from making connections to adjusting circuit components and setting the oscilloscope controls. And you learn to analyze patterns fast and RIGHT!

### NEW 2nd EDITION!

Includes latest data on use of 'scopes in color TV, industrial electronics, teaching... even in atomic energy work. Over 400 pages and over 400 clear pictures. Dozens of pattern photos make things doubly clear.

PRACTICE 10 DAYS FREE!

Dept. RE-76. RINEHART & CO., Inc.  
232 Madison Ave., New York 16, N. Y.

Send new 2nd edition of MODERN OSCILLOSCOPES AND THEIR USES for 10-day examination. If I like book, I will then send \$6.50 (plus postage) in full payment, or return book postpaid and owe you nothing.

Name.....

Address.....

City, Zone, State.....

OUTSIDE U.S.A.—Price \$7.00, cash with order only. Money back if you return book in 10 days.



Thyratron V1 is normally blocked by the 10-volt bias on its grid. The bias on V2 is zero so it conducts and charges C nearly to B-plus potential. Now when a positive pulse arrives at the thyratron grid, it fires the tube and C discharges through V1 and the primary of the coupling transformer. The current induces a negative pulse in the secondary that blocks V2. Two things happen at this time. C ceases to charge and V1 begins to de-ionize. The circuit is primed for another signal after a short interval.

C, a rather large capacitance, discharges a large, fat pulse through the relay winding. This trigger is fast-acting. It can respond to as many as 5,000 signal pulses each second.

**MAGNETOSTRICTIVE GENERATOR**

Patent No. 2,717,981

Maurice Apstein, Bethesda, Md.

(Assigned to United States of America as represented by the Secretary of Commerce)

In previous magnetostrictive generators the frequency was determined by the dimensions of a core. This generator has no such limit! A mechanical vibration is started at one end of a magnetostrictive core. As the wave travels it

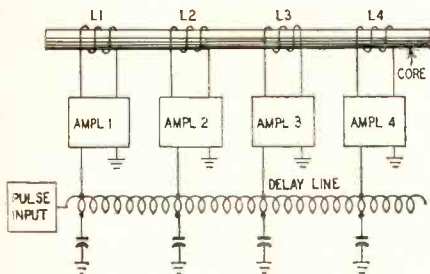

is reinforced from time to time until the desired amplitude is built up.

Pulses are fed into a delay line (see diagram) and amplifiers are tapped in at various points along it. The first amplifier delivers the pulse to L1, which sets up vibrations in the core. When the vibration reaches L2, the second amplifier reinforces it and so on. As the wave travels to the right, it increases in power.

Vibrations which travel in the reverse direction (to the left) are not in correct timing and are not strengthened. This condition is further assured by terminating the core to absorb energy and prevent reflecting the vibrations back along the rod.

**NEGATIVE-RESISTANCE CIRCUIT**

Patent No. 2,728,053

John T. Bangert, Summit, N. J.

(Assigned to Bell Telephone Labs, Inc., New York, N. Y.)

This two-terminal circuit provides negative resistance which may be used to cancel the usual positive resistance in a network. The circuit uses two n-p-n transistors in a regenerative arrangement (Fig. 1).

Each grounded-emitter stage provides gain and also reverses polarity. The output is fed back to the input through C1 and R1. Since the output has the same phase as the input, this coupling produces regeneration or oscillation, depending on the adjustment of R1. As a result, the resistance between terminals 1 and 2 may be set to be negative or zero as desired.

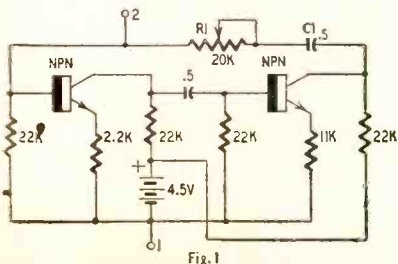

Fig. 1

**INDEPENDENT SCIENTIFIC SURVEY  
AND LAB TESTS PROVE  
PRECISE MODEL #111---"BEST  
COMMERCIAL TUBE TESTER  
AT ANY PRICE"...**



Now You Can Check Tubes  
The Manufacturer's Way

- Checks both emission and mutual conductance
- Checks all tubes including hearing aid, miniatures
- Six different plate voltages
- Different grid signals
- Simplified Short check
- Gas check
- New type switches
- Deeply etched aluminum panel
- Three different screen voltages
- Latest roll chart
- Measures filament current
- Measures grid bias

**precise**  
Model #111

111K (kit form) **NOW ONLY \$ 79.95**  
111W (factory wired) ..... \$139.95  
incl. carrying case and cover

**Mutual Conductance and Emission TUBE TESTER**

An independent scientific survey conducted by an impartial testing laboratory confirms what purchasers already know: "The most advanced, the most complete tube tester and the best priced is made by PRECISE DEVELOPMENT CORP., Oceanside, N. Y."

**CHECK THESE ADDITIONAL 'specs' ... TALK TO YOUR JOBBER AND TO ANYONE WHO HAS THIS OUTSTANDING TUBE TESTER...**

The Model 111 is the only single commercial tube tester that checks all tubes for both EMISSION and MUTUAL CONDUCTANCE separately. Filament current is measured directly on large meter when checking a VOLTAGE SAPPER tube. NEW, MODERN DESIGNED ROTARY SWITCHES allow you to check each tube element individually. NEW TYPE Single Rotary switch for complete short checks. The 111 makes all BIAS,

FILAMENT VOLTAGE, GAS, LIFE checks visually on large meter ... 5 individually calibrated ranges and scales for mutual conductance tests. NEWLY DESIGNED "NO BACKLASH" ROLL CHART lists all tubes including the new type 600-mil series tubes. Provisions are made for testing many color tubes. All CRT's can be checked with accessory adaptor, Model PTA.

**ASK YOUR DISTRIBUTOR ABOUT THE FAMOUS MODEL No. 116 QUICK-TEST VERSION OF THE MODEL No. 111 ... TESTS 5 TUBES IN 4 SECONDS EACH ... ACCURATELY**

**precise DEVELOPMENT CORP., OCEANSIDE, NEW YORK**



**Read Gernsback Library Books**

See advertisements on  
Pages 121 and 125

**RADIO-ELECTRONICS**

For Libraries

Current yearly volume to be available on microfilm. Write for information.

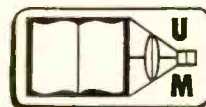

**UNIVERSITY MICROFILMS  
ANN ARBOR, MICHIGAN**

# 6 CONNECTOR TYPE SERIES

for  
**LOW LEVEL  
SOUND**

*Cannon Plug*

**UA**



**XL**

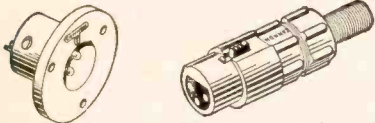

**P**



**O**



**X**

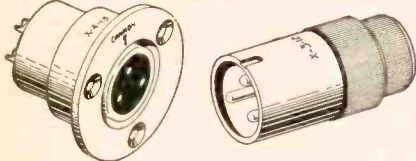

**XK**



Write for Miniature—Sub-Miniature Bulletin

Please Refer to Dept. 144

**CANNON ELECTRIC COMPANY**, 3209  
Humboldt St., Los Angeles 31, Calif.  
Representatives and Cannon dis-  
tributors in all principal cities.



Since 1915

**CANNON ELECTRIC**

PATENTS

(Continued)

Fig. 2 shows the negative-resistance circuit (N) combined with a conventional high-pass

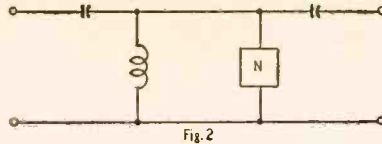

Fig. 2

filter. Losses in the coil are cancelled by the negative resistance of N. Such a filter will show sharper cutoffs, reduced loss in the pass band as well as deeper attenuation in the suppression band.

## SUPERCONDUCTOR OSCILLATOR Patent No. 2,725,474

*Eric Arvid Ericsson, Stockholm;  
Anders Ossian Jorgensen, Traneberg;  
Sune Lambert Overby, Stockholm, Sweden*

(Assigned to Telefonaktiebolaget L. M. Ericsson, Stockholm, Sweden)

This oscillator needs a battery, coil, capacitor and superconductor. The latter is niobiumtride or similar material whose resistance falls sharply with decreasing magnetic fields. The superconductor must be maintained at a very low temperature—for example, the temperature of liquid oxygen.

Originally S, the superconductor, has almost zero resistance because it is in a very weak magnetic field. When the switch is closed, current rises through the coils and through S, and C

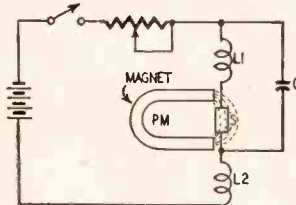

begins to charge. The magnetic field of L1, the smaller of the coils, opposes that of the permanent magnet, P.M. L2 aids it. As current increases through L2, the magnetic field is strengthened and soon the resistance of S becomes considerable. Therefore the flow through L2 drops off and C begins to discharge through L1. These two effects are opposite so far as the magnetic field is concerned. As the discharge current begins to taper off, however, the only field left is that of the permanent magnet. So S returns to superconductivity and all currents are nearly zero. These being the original conditions, the cycle starts again.

This type of oscillator requires few components and is useful even at microwave frequencies. Since it depends largely on extremely cold temperatures, it may be very useful on the proposed satellite platform for communications and other purposes. **END**



F. H. C. C. K.



**Series or Parallel  
Booster!**



At All  
Distributors

manufactured by

**PermaPower COMPANY**

4727 N. Damen Ave., Chicago 25, Ill.

manufacturers of electronic equipment since 1920

Export: SCHEEL INT., Chicago

## HOUSE CURRENT Anywhere

Now, while fishing, camping, business trips, anywhere you drive, you can enjoy many of the conveniences usually available only at home, shop, or office:



- Electric Shavers
- Car Polishers
- Radios—Lights
- Phonographs
- Dictation Machines
- Tape Recorders
- Hand Vacuum Cleaners
- Small Do-It-Yourself Tools
- Heating Pads



"101" USES



## Trav-Electric CONVERTERS

No installations. Just plug into cigar lighter. That is all. Priced as low as \$11.95.



See your Electronic  
Parts Jobber or Dealer;  
or write direct to  
us.

**TERADO COMPANY**  
1057 Raymond Ave. St. Paul 14, Minn.

RADIO-ELECTRONICS



### PEAK-READING PROBE

Demodulator probes used with oscilloscopes to observe waveforms prior to detection (such as in the video if stages) may be converted to peak-reading probes for use with a voltmeter.

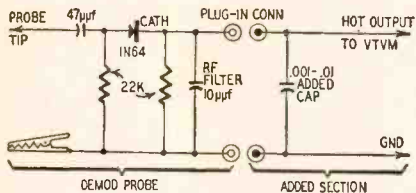

A schematic of a typical demodulator probe is shown in the diagram. A capacitor is placed across the output, making it a peak-reading probe for use with the meter. The shunting (added) capacitor may be enclosed in a shield with terminals to match the output terminals of the probe—a plug-in arrangement. The output of the capacitor may be provided with terminals for the meter.—Lucian Palmer

### NOVEL SOUND EFFECTS

A recent public-address installation for a dramatic production posed a problem that was solved in a simple and interesting way. The play called for off-stage band music to approach the stage gradually from the rear right, move from right to left and disappear slowly into the rear left. The circuit in Fig. 1 was used to achieve this effect.

R1 permits finely graduated control

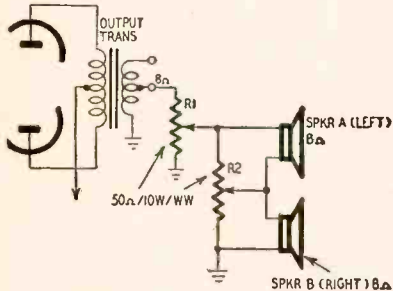

of speaker level. Using a 30-watt PA amplifier, it was found that one-quarter turn of the phono gain control provided all the volume needed. As speaker fading was to be spread over a 2-minute period, R1 was added so that fading could be spread over the full turn (about 300°) of a potentiometer.

R1 has two additional assets: It permits shutting off the speaker when the amplifier or other equipment is being turned on or off, thereby preventing the speakers from reproducing electrical

Tel. Cliffside 4-7345

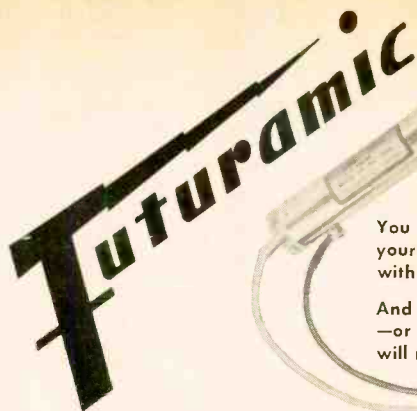

You will be amazed at how much more useful your VOM will become when you supplement it with a Futuramic probe.

And remember—YOU MUST be satisfied—or you may return the probe and we will refund your money.

### NEW TYPE 265

- TYPE 261** VTVM HI-OHMS PROBE—Opens up an entirely new field of measurement with any VTVM which has an Rx1meg scale, an input resistance of 10 megohms and an internal battery of 1.5 volts. Most popular serviceman's VTVMs fall in this category and with this probe can be used to make measurements up to 20,000 MEGOHMS! **Net price \$9.95**
- TYPE 262** VOM HI-OHMS PROBE—Used with the most popular types of VOMs of 20,000 ohms-per-volt sensitivity and 12 ohm center scale indication to extend the resistance range to read 200 MEGOHMS. **Net \$9.95**
- TYPE 263** SIGNAL TRACING PROBE—Signal trace with your VOM! Accurately diagnose TV troubles without removing chassis. Faster than tube changing, and better. Reads RF, IF, AF and some voltages. **Net \$9.95**
- TYPE 264** POLARITY REVERSING PROBE—End the annoyance of changing leads when reading both positive and negative voltages. Just flip the switch at your finger tip. May be used with any VOM. **Net \$6.95**
- TYPE 265** VOM RANGE SPLITTER PROBE—Converts the 250 volt D.C. range to a 500 volt range at the flip of a switch. Use with any VOM of 20,000 ohms-per-volt sensitivity and having a 250 and 50 volt range. **Net \$9.95**

All Futuramic probes are gold plated, with high grade components throughout. Complete with full operating instructions. Nothing else to buy. Satisfaction Guaranteed. Stocked by leading jobbers. If your local jobber does not carry the Futuramic line, send us his name with your order.

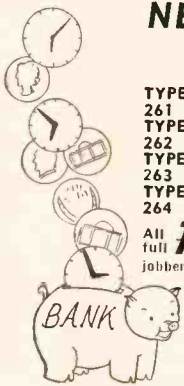

### TIME IS MONEY!

Save Time — Save Money with a Futuramic probe



Endorsed by  
**R. G. Middleton**  
For Black and White,  
Color Television

## AUDEL TV TELLS HOW TO ANSWER RADIO T.V. QUESTIONS SERVICE LIBRARY

HERE IS LATE INFORMATION IN A HANDY FORM FOR TELEVISION AND RADIO REPAIRMEN, SERVICEMEN AND STUDENTS

AUDEL'S T.V. RADIO SERVICE LIBRARY—Highly Endorsed—Over 1500 Pages—1048 Illustrations & Diagrams. 1001 Important Facts & Figures on Modern Television, Radio, Electronic Devices at your finger ends.

INCLUDES TRANSISTORS & Transistor Circuits, Record Changers, Rectifiers, P.A. Systems, Tape Recorders, Phonograph Pick-ups, F.M., Auto Radio; Radio Compass, Short Wave, Radar, etc.

ASK TO SEE IT! IT WILL PAY TO KNOW—The Basic Principles—Construction—Installation—Operation—Repairs—Trouble Shooting—Shows How to get Sharp, Clear T.V. Pictures. Install Aerials—How to Test. Explains Color Systems, Methods of Conversion, Terms, etc. Includes Ultra High Frequency—Valuable for Quick Ready Reference and Home Study.

**\$6 COMPLETE 2 VOLUMES** Get this Information for Yourself. **7 DAY TEST—PAY ONLY \$1 A Month** MAIL ORDER

AUDEL, Publishers, 49 W. 23 St., N.Y. 10, N.Y. Mail AUDEL'S T.V. RADIO SERVICE LIBRARY (2 Volumes) \$6 on 7 days free trial. If O.K. I will remit \$1 in 7 days and \$1 monthly until \$6 is paid. Otherwise I will return them.

Name \_\_\_\_\_  
Address \_\_\_\_\_  
Occupation \_\_\_\_\_  
Employed by \_\_\_\_\_

## GET INTO ONE OF THESE TOP OPPORTUNITY FIELDS

# ELECTRICITY

— Electronics or TELEVISION

# — Radio-Color TV

TRAIN IN THE GREAT SHOPS OF **COYNE** OLDEST, BEST EQUIPPED SCHOOL OF ITS KIND IN U.S.

Veterans and Non-Veterans—Prepare for a better job NOW that offers a real future, too! Get practical training in TELEVISION—RADIO—ELECTRICITY—ELECTRONICS—(Refrigeration & Electric Appliance Repair can be included). Learn on real equipment—no advanced education or previous experience needed. Lifetime employment service to graduates.

Finance Plan—enroll now, pay most of tuition later. Part time employment help to students.

FREE BOOK Clip coupon for Big Free Illustrated Book. No salesman will call. Act NOW.

B. W. COOKE FOUNDED 1893  
President **COYNE ELECTRICAL SCHOOL**

A TECHNICAL TRADE INSTITUTE OPERATED NOT FOR PROFIT  
500 S. PAULINA ST., CHICAGO, Dept. B6-81H  
ELECTRICITY • TELEVISION • RADIO • REFRIGERATION • ELECTRONICS

B. W. COOKE, Pres., COYNE ELECTRICAL School  
500 S. Paulina St., Chicago 12, Ill., Dept. B6-81H  
Send FREE BOOK and details on:

TELEVISION-RADIO  
 ELECTRICITY-ELECTRONICS

NAME \_\_\_\_\_  
ADDRESS \_\_\_\_\_  
CITY \_\_\_\_\_ STATE \_\_\_\_\_

# STAN-BURN EDDARKE

## CATHODE RAY TUBE SPECIALS ONE YEAR GUARANTEE

G.E.	Type	STAN-BURN	G.E.	Type	STAN-BURN
\$13.25	10BP4	\$10.20	\$31.25	17GP4	\$20.75
18.00	10FP4	14.00	32.25	19AP4A	22.50
16.25	12CP4A	13.50	27.40	20CP4	18.95
	12QP4	10.50	33.00	21AP4	22.25
28.95	12UP4	14.50	27.40	21EP4	20.15
18.15	14CP4	13.40	33.25	21MP4	23.50
	15DP4	14.50	90.75	24AP4	49.00
31.25	16AP4A	18.50	<b>DUMONT TUBES</b>		
26.25	16KP4	15.75	12QP4A	\$23.75	
31.25	16GP4	18.50	15BP4	26.55	
29.00	16LP4	15.25	16DP4A	31.00	
29.00	16WP4	15.25	16FP4	26.00	
22.50	17BP4	15.75	17KP4	25.00	
28.15	17CP4	19.50	19AP4A/B	33.25	
			21KP4	38.50	

PRICES SUBJECT TO CHANGE WITHOUT NOTICE  
\$20 WORTH OF ELECTRONIC PARTS IN GRAB-BAG consisting of: Porcelain sockets, coils, speaker, transformers, resistors, condensers, etc.  
ONLY \$1.98 (plus 50c postage)

**TAPE RECORDERS—Famous Brand**  
List Pr. \$249.95 \$169.00 List Pr. \$129.95 \$79.95  
List Pr. \$99.95 \$29.00 List Pr. \$79.95 \$9.95  
Write for complete illustrated details.

**WINDOW FANS**  
VORNADO—18" Blade—Reversible—list \$89.95 net  
RIGID—20" Blade—6 speed—Reversible with Thermostat control—list \$89.95 SPECIAL \$47.95 net  
WESTINGHOUSE in stock. Write for full details.

**AIR CONDITIONERS—Famous Brand**  
84 TON 110V.....\$199.95  
G.E., Fedders, Mitchell, Westinghouse in stock.  
Write for full details and prices.

**Sensational VOCALINE TRANSCEIVER**—New low-priced 2 way radio—transmits and receives upwards of 10 miles—OPERATES on AC or DC—PORTABLE—COMPACT (9"x3"x5")—PCC approved—(station license easily obtained).  
**WRITE FOR ILLUSTRATED DETAILS AND PRICES NOW!**  
TRANS-ATOMIC Transistor Radio—KIT \$6.95; WIRED \$7.95  
SEMPHONIC EARPHONES.....Single \$1.50; Double \$2.50  
GERMANIUM DIODE Loopstick Radio Kit.....\$3.25

**AM-FM-SW AUTO RADIO**  
Drift Free FM—World's Finest—Becker LeMans For PUSH BUTTON—\$179.95. For SIGNAL SEEKER—\$239.95 Includes: GE SPEAKER with GRILLE and AUTOMATIC ELECTRIC ANTENNA. Simple installation for all cars. Specify 6 or 12 Volt system.  
VM 3 SPEED HI-FI CHANGER—Model 950 with Ronette Sonotone or Astatic flipover cartridge—BRAND NEW ORIGINAL CARTONS.....\$21.49  
VM 4 SPEED HI-FI CHANGER—Model 1210 with Ronette, Sonotone or Astatic flip-over cartridge.....\$22.95  
RC456 4-speed Collaro, Brand-new, Special.....\$29.95  
45-RPM SPINDLE.....\$2.98  
WEBSTER Model 140—3-SPEED Automatic with Ronette Sonotone or Astatic flip-over cartridge.....\$22.49  
MONARCH 3 SPEED AUTO, INTERMIX CHANGER with crystal cartridge.....\$21.95  
Same with British variable reluctance.....24.95  
45 RPM SPINDLE.....1.88  
TU-8 MONARCH 3 Speed MOTOR & TURNTABLE UNIT (less arm).....\$ 4.95  
3 SPEED PORTABLE RECORD PLAYER with MONARCH CHANGER—Ronette cartridge—Portable Two Tone Carrying Case.....\$32.95  
PEERLESS PORTABLE BATTERY OPERATED RADIO—Colors—Green, White, Red or Blue—5 TUBE IMPORT.....\$14.95 less batteries  
BATTERY KIT for above.....\$ 2.00  
JEWEL—Model 5200—5 TUBE.....\$12.50  
AC DC RADIO.

**RECORDING TAPE**—Top quality 1200 Feet Famous brand BOXED—1 to 5—\$1.69 ea. 6 to 11 \$1.59 ea. 12 or more \$1.49 ea.  
**HALLICRAFTERS TV**  
17" Portable TV.....Dealers net \$103.95  
Model 17T5700M—Table Model—Dealers net.....\$91.95  
Model 21T5460M—Table Model—Dealers net.....\$129.46  
SETCHELL-CARLSON 17" PORTABLE TV.....\$119.95

**HI-FI PACKAGE DEAL**  
Includes: JENSEN K210 SPEAKER MONARCH AUTOMATIC CHANGER with GE HFX-050 12" SPEAKER ENCLOSURE in BLOND or MAHOGANY WOOD (Specify color) MATCHING BASE FOR CHANGER. 10 WATT HI-FI BOGEN AMPLIFIER. Complete, ready to play. \$99.50 net  
\$135.00 Value for Only  
or Your choice of similar units at relative package price. Write for prices.

**DEALERS:** Write for low cost prices and catalogs on 56 models—HALLICRAFTERS, CRESCENT, CANNON, SONORA, WILCOX-GAY, TECHMASTER, G.E., WESTINGHOUSE, TUNG-SOL, DEWALD, MAJESTIC, GRUNDIG, ARKAY KITS, DELCO, GEN. MOTORS. Address all inquiries to Dept. RE-7.

**COMPLETE HIGH FIDELITY DEPARTMENT. SEND US YOUR LIST FOR LOWEST QUOTATIONS ON ANY ITEM.**  
We invite export inquiries and offers. Our export department will give special attention to expediting foreign orders at minimum commissions. We are authorized distributors for United Motors, all Delco and Gen. Motors Auto Radio parts in stock.  
We also carry a complete line of popular makes of Radio Tubes, 50/10 diodes, and other electronic special Purpose and transmitting types, and all electronic parts and equipment at lowest prices. Send us a list of your requirements for prompt quotations. Terms: 20% with order. Balance C.O.D. All prices F.O.B. NEW YORK Warehouse. Minimum order \$5.00. Write for our latest Price list and Hi-Fi Catalog RE-7.

**STAN-BURN RADIO and ELECTRONICS CO.**  
558 CONEY ISLAND AVE. • B'KLYN 18, N. Y.

## TRY THIS ONE

clicks. Two inputs are used simultaneously—a second phono input supplies crowd noise—so R1 permits gradual change of volume level with one speaker control rather than two input gain controls.

R2 divides the audio power equally between speakers A and B in mid-position and supplies power to only one speaker at either extreme of rotation. In passing from one speaker to the second, the total power fed to the speakers remains virtually constant. When only one speaker is fed, the power supplied is 3.6 db below the amount available at the 8-ohm tap of the amplifier. When both speakers are fed equally, the total power supplied them is 3.9 db below the available amount. The difference of 0.3 db in power fed to one speaker against two speakers is of course negligible. The roughly 4-db power loss through the network is unimportant for the purpose at hand as only a fraction of the amplifier's rated power is required.—*Herman Burstein*

## CONTROL GUIDES

Potentiometers with short, slotted shafts are frequently used for preset adjustments in commercial and home-constructed equipment. Adjusting these may sometimes be difficult if the shaft is closely surrounded by other compo-

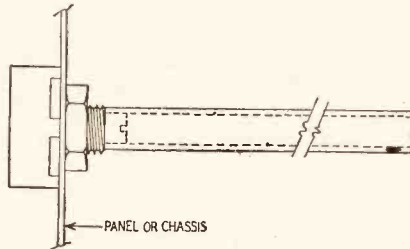

nents. A guide consisting of a suitable length of 1/4-inch-diameter vinyl tubing or insulating spaghetti slipped over the short shaft stub permanently will guide and insulate the screwdriver.—*R. J. Sandretto*

## SERVICE GIMMICK

Nothing seems to look worse in a living room than a TV cabinet with the chassis removed. To overcome this, I carry several good color scenes and fasten these inside the safety glass with Scotch or masking tape every time I take a set out for repair. The customer reaction to this gimmick has been so enthusiastic that I am going to have a quantity made up especially for the job with an imprint in the corner—something like: "Sorry, gone to A-1 TV Service for repairs." This is just another little extra that seems to pay off and you'd be surprised how much better the cabinet looks.—*Don L. Roberts*

## USING AC WATTMETER

When a defective receiver is first placed on the bench, it is a good idea to check its power consumption with a wattmeter and compare it with the manufacturer's input wattage rating.

## (Continued)

It is a great help to leave the wattmeter in the circuit while tapping and probing around to find intermittent or faulty connections. Poor grounds and temperamental parts often make good contact momentarily and cause a change in the power drain. The meter immediately indicates that you have hit a "tender spot."

If you don't have a wattmeter, a 1-ampere 115-volt ac meter with a 1-ampere fuse in series is sensitive enough for checking most radios. A 3- or 5-ampere meter with an adequate fuse is recommended for TV sets and high-powered amplifiers.—*Van H. Ferguson*

## INSULATED FILTERS

Many TV sets, ac-dc receivers and amplifiers use can type electrolytic capacitors with the cans insulated by a heavy cardboard sleeve. These are used when the can forms one lead of the capacitor and is hot with respect to the chassis or ground. This type of capacitor is not as widely used as the un-insulated type so it is often difficult to obtain a replacement in the correct value.

An un-insulated type can be used by covering the can with a tight-fitting mailing tube or by spraying it with a heavy coating of one of the spray-on insulating lacquers or plastics.—*Wil-lard W. Hansen*

## 6BQ7 SUBSTITUTE

Many times during the past year I have found it hard to obtain 6BQ7 and 6BZ7 tubes for replacements. This led to the thought of substituting in order to give quick service and thus hold the customer. I found that the type 12AT7 could be used if the right steps were taken. A little conversion is necessary in the job; however, it is worth while when in a pinch.

To make the substitution, tie pins 4 and 5 of the 12AT7 together and clip off pin 4 or 5, whichever one is grounded in the socket. This will place both halves of the 12AT7 heater in parallel. Be sure the pin is clipped off short enough to prevent it from going into the socket, as this would cause a short in the heater circuit. Take care in tying the pins together as the glass of the tube is very easily broken. Take care too to plug the tube into the socket the right way, as it will fit two ways when pin 4 or 5 is clipped. This conversion will work with any set that has pin 9 of the 6BQ7 tube socket and one side of the heater circuit grounded. Although this is a fringe area, there has been no noticeable signal drop after conversion.—*Geo. R. Anglado*

## LUCITE SCRATCHES

Light scratches on Lucite TV masks can be removed with pumice. I rub pumice dry over these scratches with a fingertip, using a gentle, circular motion until the scratch disappears or until it becomes less conspicuous.—*B. W. Welz*

# Business



## Merchandising and Promotion

Simpson Electric Co., Chicago, is issuing distributors a placard commemorating the 50th anniversary of its founder, Ray R. Simpson, in the electronics instrument industry.

United Motors Service Division of General Motors, Detroit, Mich., is now



packaging its line of Delco electron tubes in a colorful new carton.

JFD Manufacturing Co., Brooklyn,

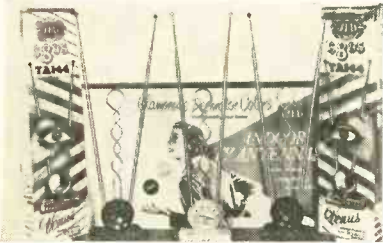

N. Y., designed a new display for its Venus indoor TV antennas.

Thompson Products, Electronics Division, Cleveland, Ohio, produced a series of full color movie films promoting its automatic Superotor antenna rotator.

P. R. Mallory & Co. Inc., Indianapolis, Ind., designed a new point-of-sale self-merchandising kit for its mercury bat-



teries for miniature transistorized portable radios. The kit includes 20 batteries in 6 voltages and sizes.

Blonder-Tongue Laboratories, Westfield, N. J., is now publishing a bi-monthly newsletter for distributors and service technicians.

Walsco Electronics Corp., Los An-

JULY, 1956

THE VERY BEST IN CUSTOM TELEVISION

BY **TECH-MASTER**

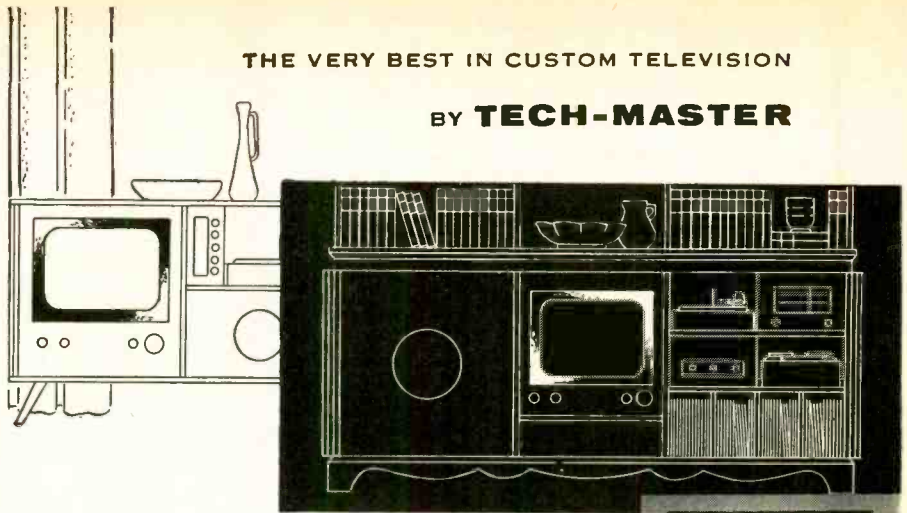

## FOUND IN THE FINEST OF INTERIORS

As the custom installation signifies the ultimate in well-chosen decor . . . so the name Tech-Master stands for the utmost in Custom television. The reputation established with the manufacture of the renowned Model 630 chassis is further enhanced by the outstanding Tech-Master Audiophile and Sound Theatre.

See your Custom hi-fi dealer today . . . or write

**TECH-MASTER CORPORATION**  
75 FRONT STREET, BROOKLYN, NEW YORK

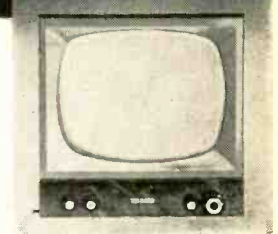

**ONLY TECH-MASTER HAS THESE OUTSTANDING PLUS FEATURES:**

- World-famous 3 tube synchrolok picture circuit for constant picture stability. • 30 tubes fully used. • "Full Frame Mounting" . . . just a simple cutout is required for installation.
- High fidelity picture as well as exceptional audio reproduction.



## DON'T THROW OLD RADIOS AWAY!

Here's the data you need to fix old sets FAST—good as new

Just look up the how-to-do-it data on that old radio you want to fix!

Four times out of 5, this giant, 3½-pound, 714-page Chirardi **RADIO TROUBLESHOOTER'S HANDBOOK** gives exactly the information you need to fix it in a jiffy. Tells what is likely to be causing the trouble . . . shows how to fix it. No useless testing. No wasted time. Handbook covers common troubles and their remedies in practically every radio receiver model made by 202 manufacturers between 1925 and 1942. Using it, even beginners can easily fix old sets which might otherwise be thrown away because service information is lacking. With simple repairs, most of these old sets can be made to operate perfectly for years to come.

### THE ONLY GUIDE OF ITS KIND! Cuts service time in half!

Included are common trouble symptoms and their remedies for over 4,800 models of old home, auto radios and record changers: Airline, Apex, Arvin, Atwater Kent, Belmont, Bosch, Brunswick, Clarion, Crosley, Emerson, Fada, G-E, Kolster, Majestic, Motorola, Philco, Pilot, RCA, Silverstone, Spartan, Stromberg and dozens more. Gives how-to-do-it data on SPECIFIC jobs—NOT general theory. Includes hundreds of pages of tube and component data, service short cuts, etc., no longer available from any other source still in print.

...TRY IT 10 DAYS . . . at our risk!...

Dept. R.E.-76, RINEHART & CO., Inc.,  
232 Madison Ave., New York 16, N. Y.  
Send Girardi's **RADIO TROUBLESHOOTER'S HANDBOOK** for 10-day free examination. If I decide to keep book, I will then remit the full price of only \$6.50 plus a few cents postage. Otherwise, I will return book postpaid and owe you nothing.

NAME.....  
ADDRESS.....  
CITY, ZONE, STATE.....  
Outside U. S. A.—Price \$7.00, cash only. Same return privilege  
Rinehart Books are sold by leading book stores

Miss Quietrole Says...



"You can forget 'em all when you have..."



## QUIETROLE

TRADE MARK REG. U.S. PAT. OFF.

the quality product that does all the lubricating and cleaning jobs on TV and radio . . . nothing does the job as well as Quietrole . . . and you can depend on that."

"A First in the Industry"  
"Choice of Better Service Dealers Everywhere"

**QUIETROLE COMPANY inc.**  
Spartanburg, South Carolina

In Canada  
**ACTIVE RADIO & T.V. DISTRIBUTORS**  
58 Spadina Avenue • Toronto 2B Ontario

**EXCLUSIVE!!**  
**3 TRANSISTOR RADIO KITS**  
 by "KIT KING"

\*DUAL POWERED, SUN POWERED OR CELL

KIT #1 "SOLAR CELL". Dual-powered, pocket size unit; sensitive with ample volume Sun Battery for daylight (works on 100W lamp, too), Mercury Cell for night operation outlasts regular batteries five times! Pre-drilled plastic cabinet; stop by stop instructions; hi-grain transistor, diode, loopstick, variable condenser, socket, phone jacks, switch, wire, knob, hardware. Wt. 6 oz. **\$7.88** COMPLETE

KIT #2 "SOLAR". Sun battery powered. (Kit #1 less mercury cell & switch). Wt. 5 oz. only **\$6.88**

KIT #3 "CELL". Mercury cell powered. (Kit #1 less sun battery). Wt. 5 oz. only **\$5.55**

HI-IMPEDANCE PHONES |  SOLDERING IRON with for above sets only \$1.95 | solder included, only \$1

**FREE! ANY \$1 KIT WITH EACH \$10 ORDER!**

**FAMOUS "KIT KING" \$1 KITS**

- 8-PC. NUTDRIVER KIT. Plastic handle; 3/16, 7/32, 1/4, 5/16, 11/32, 3/4, 7/16" steel socket wrenches in plastic case. Wt. 1/2 lb. \$3.50 value. **\$1**
- 60 MICA CONDENSERS. Postage stamp types, 25 values; .00001 to .01 mf to 1200 WVDC Silver. 5% too! Wt. 1/2 lb. Reg. **\$1**
- 60 CARBON RESISTORS. Insulated. 35 values! 15 ohms to 10 megs; 1/4, 1 & 2 w. 1 & 5% too! Wt. 1/2 lb. Reg. \$18. **\$1**
- 40 MOLDED CONDENSERS. Best known makes! Asstd. values. .0005 to .01 mf up to 1000V. Wt. 1/2 lb. Reg. **\$13.**
- 25 TUBE SOCKETS. Sub-miniatures. 7, 9-pin, 4 to 8-pins. Mica-filled and ceramic. Some shield and base. Wt. 1 lb. Reg. \$9. **\$1**
- 50 CERAMIC CONDENSERS. Discs, tubular, cartwheel standoff types, 5 mmf to .01 mf up to 1000V. Wt. 1/2 lb. Reg. **\$14.**
- 30 DISC CONDENSERS. Ceramic. 47 mmf to .01 mf up to 1000V. As sorted values. Reg. **\$12.**
- 50 RF COILS & CHOKES. 20 types RF coils, chokes & slug-tuned coils for radio. TV lab. Wt. 1 lb. Reg. **\$15.**
- 60 TUBULAR CONDENSERS. 25 values; .00035 to 1 mf up to 6000V. Oils. too! Wt. 2 lbs. Reg. **\$10.**
- DIODE KIT #1. Four of the most used types: 1N21, 1N22, 1N23, 1N34A. shop lab must! Reg. **\$11.**
- DIODE KIT #2. Three popular diodes in poly bag: 1N34, 1N48, 1N51. Reg. **\$4.16.**
- 2000 PCS. HARDWARE. Woodworking, radio-TV, shop screws, springs, grommets, etc. Hundreds of items. Wt. 2 1/2 lbs. Reg. **\$15.**
- 60 TERMINAL STRIPS. Asstd. solder terminal strips & clips; 1 to 7 lugs. Reg. \$4. Wt. 1/2 lb. **\$1**
- 7 ROLLS HOOKUP WIRE. Seven 25-ft. rolls #18 to 24. Asstd. stranding, insulation, colors. Wt. 1/2 lb. Reg. **\$4.**
- 12 AC-DC LINE CORDS for all electrical equipment. 14" long w/molded plugs. Stock up now! Wt. 1 lb. Reg. **\$3.**
- 125 RESISTORS, insulated and non-insulated. 35 values. 56 ohms to 1 meg; 1/4, 1 & 2 w. A.B. & 5%. too! Wt. 1/2 lb. Reg. **\$15.**
- CRYSTAL RADIO kit—lowest price anywhere! Complete with 1N34 diode, loopstick, cabinet, condenser, wire, hardware, instructions. Reg. **\$2.50.**
- 15 VARIABLE CONDENSERS. Famous make 10 values. Singles and duals. Wt. 1/2 lb. Reg. **\$12.**
- 15 VOLUME CONTROLS. Asstd. values to 1/2 meg. WW. too! Wt. 1 lb. Reg. **\$12.**
- 150 PARTS! Large asst. resistors, discs, tubulars, chokes, fuses, slugs, wire, etc. A rare buy! Wt. 2 lbs. Reg. **\$15.**
- 20 WW. POWER RESISTORS; 5 to 50 W. 20 values to 20,000 ohms. Tubular, candohm, sanded. Wt. 2 lbs. Reg. **\$9.**
- POWER SUPPLY SET. Includes transformer; 115 to 6.3V @ 0.6A; 150V @ 15 ma; plus sel. rect. 65 ma. Wt. 3 lbs. Reg. **\$4.50.**
- 12 PANEL SWITCHES. 8 types—micro, A.C., car, push rotary. Reg. **\$12.** Wt. 2 lbs.
- 7 PANEL LIGHTS for miniature bayonet bulbs. Enclosed, adl., amber jewels. Panel mtg. Wt. 1/2 lb. Reg. **\$5.**
- 10 "POLY" BOXES. Asstd. sizes, hinged & snap lock clear plastic boxes for pocket radios, parts. Hundreds of uses. **\$1** Reg. \$2.50.
- SCOOP! 40 SUBMINIATURE RESISTORS. Size: 7/64" x 1/16" 56 ohms to 4.7 meg. 12 values. Plastic cased! 1 & 5% too. Reg. **\$8.**
- 20 PRECISION RESISTORS. Asstd. to 10 megs. Carbofilm, too! Well known, makes, with production leads. Wt. 1/2 lb. Reg. **\$8.**
- 20 Instrument KNOBS. Quilted, tiered, precision instrument and equipment types; 10 styles, brass insert w/set screws. **\$1** Reg. \$9.
- 15 CERAMIC TRIMMERS. Famous make, 10 values; singles & duals. Reg. **\$12.** Wt. 1/2 lb.

**FREE! GIANT BARGAIN FLYER!**

**HOW TO ORDER**

Check items wanted. Return entire ad with check or M.O. Include sufficient postage, excess returned. C.O.D. orders, 25% down. Rated. net 30 days.

RE-7

Name..... (Please print)  
 Street.....  
 City..... Zone..... State.....  
 Enclosed \$..... for items; \$..... for postage.

**Lektron Specialties**  
 28 GARDENER ST. CHELSEA 50, MASS.  
 Visit our salesroom at 131 Everett Ave., Chelsea

BUSINESS

(Continued)



geles, introduced new point-of-sale displays including self-service units for its hardware and chemicals and displays for its switches and a new phonorecorder drive.

B&K Manufacturing Co., Chicago, stepped up advertising and sales promotion on its Dyna-Quik model 500 tube tester and model 400 cathode rejuvenator tester.

Futuramic Co., Chicago, designed a new Probe Pak counter display, which will hold four probes.

Kester Solder Co., Chicago, is mar-



keting its TV radio solder in a special package for the servicing industry.

RETMA High-Fidelity Subcommittee is considering industry-wide standards for high-fidelity advertising.

**Production and Sales**

RETMA reported production of 1,844,632 TV sets and 3,532,243 radios for the first three months of 1956. It reported manufacturers' sale of 2,638,503 TV picture and 120,420,000 receiving tubes for the same period.

RETMA reported retail sales of 530,554 TV receivers and 454,857 radios, exclusive of automobile sets, for February, 1956, compared with 626,613 TV sets and 317,908 radios in February, 1955.

**New Plants and Expansions**

Daystrom Inc., Elizabeth, N. J., established the Daystrom International Division to handle export sales of its electronic companies. It succeeds the Export Department of Weston Electrical Instrument Corp., a Daystrom subsidiary. William H. Westphal, formerly with Minneapolis-Honeywell Regulator Co., heads the division, with temporary headquarters in Weston's plant in Newark, N. J.

Sylvania Electric Products purchased a modern plant in Hillsboro, N. H., for expanded manufacturing facilities for transistors and crystal diodes. Elmer J. Perry, transistor manufacturing superintendent of the Electronics Division, Woburn, Mass., will be in charge. Sylvania also leased 33,000 square feet of warehouse space in Denver, Colo., for its radio and TV picture tubes and lighting products.

ORRadio Industries is building a new plant in Opelika, Ala., for manufacturing magnetic recording tape for sound, color TV and electronic computers.

**Quickly locates "TOUGH DOGS"**

**Senco Tube and Capacitor Leakage Checker**  
 Model LC-2

**Dealer Net \$24.95** wired Complete with test leads. Simple to operate. \$19.95 Kit

**"Two Testers In One"**  
 Now—checks 70 critical tube types

- Quickly locates tubes with gas, grid to cathode or heater to cathode leakage, and grid emission in RF, IF and AGC Circuits.
- Only type tester that finds all tubes causing picture overload, low sensitivity, poor sync, etc.
- Checks all capacitors for leakage with voltage applied.

At Leading Distributors!  
 Mfg by **SERVICE INSTRUMENTS COMPANY**  
 171 OFFICIAL ROAD • ADDISON, ILL.

**E-Z WAY TOWERS**

Looking for a tower that is easy to erect yet strong enough to withstand severe winds? This is it! E-Z Way Towers will stand a wind load of 40-60 lbs. per sq. ft. And with the new E-Z Way portable gin pole it's easy to erect a 120 ft. tower in one piece *without leaving the ground*. Unbelievable, isn't it? But E-Z Way Towers have been tested and proven. Thousands of E-Z Way Towers are giving outstanding service in all parts of the country and abroad. That's why E-Z Way is the Industry's New Leader. Find out about E-Z Way now!

**SEND TODAY FOR FREE CATALOG**

Dept. CE, E-Z Way Towers  
 P. O. Box 5491, Tampa, Florida

Send me your FREE catalogue on the following towers:

AM Radio  Television  
 Ham Radio  Two-Way Communication

I am interested in a tower ..... ft. high.  
 I will use a ..... antenna.  
 (State type and model)

Type of Rotor.....  
 Name.....  
 Address.....  
 City..... State.....

**E-Z WAY TOWERS Inc.**  
 P. O. Box 5491 • Tampa, Fla.  
 Telephone 4-2171

Radio Receptor Co. has located its Semiconductor Sales Department in Brooklyn, N. Y. The New York office is occupied entirely by the Thermatron Division.

Claremont Tube Corp., Long Island City, N. Y., picture-tube manufacturer, opened new warehouses in Atlanta, Ga., and Philadelphia, Pa.

Granco Products, Inc., Long Island City, N. Y., established a subsidiary, Granco Sales Corp., to handle sales in the New York metropolitan area for the time being and later branch out nationally.

TelAutograph Corp., New York, parent company of Walseo Electronics and Walter L. Schott Co., launched a million-dollar building program which will include two new plants in Los Angeles; one for TelAutograph and the other for its two subsidiaries. The New York plant will be vacated when the new units are completed.

Minneapolis - Honeywell Regulator Co., Minneapolis, is planning to transfer its expanding Transistor Division to new quarters in Boston.

**Business Briefs**

Utah Radio Products Corp., Huntington, Ind., purchased the Electronics Division of Utah Radio Products Co., Inc. of the same city, manufacturer of radio and TV loudspeakers and other electrical and electronic assemblies. Frank L. Pyle, vice president in charge of the Electronic Division for the past

7 years, is president of the company. Operations will continue without interruption or change.

P. R. Mallory & Co., Indianapolis, Ind., was presented with the NATESA Friends of Service Award for 1955 at the April meeting of the organization



in Omaha, Neb. J. Earl Templeton, Mallory Distributor Division manager (center) is shown accepting the award from Vincent J. Lutz, West Central vice president of NATESA (left). Frank J. Moch, NATESA president, looks on.

RCA made available complete blueprints and mass production techniques for color TV sets to other manufacturers. It simultaneously announced a price reduction on its 255-square-inch color television picture tube from \$100 to \$85.

Amphenol Electronics Corp. is the new name of American Phenolic Corp., Chicago. The change was approved by stockholders at their annual meeting in Chicago recently as more descriptive of the company's functions. END

## A FANTASTIC BUY

### HI-IMPEDANCE MINIATURE CRYSTAL MICROPHONES

An extremely efficient mike (made by Brush and other leading manufacturers) used, from hearing aids. Individually tested and guaranteed. Ideal for ham use, P.A. systems, home recorders, etc.

Order by Type No. **\$1.00** ea.  
Postage FREE in U.S. if money with order

TYPE A

TYPE C  
Specify Round or Square

TYPE B

(ILLUSTRATIONS ACTUAL SIZE)

## M. SWEDGAL

258 BROADWAY NEW YORK, N. Y. WO 2-5485

## NOW—MAKE EXTRA MONEY SERVICING RECORD CHANGERS

Servicing Record Changers  
By Harry Mileaf  
Gernsback Library Book No. 59. 224 pages. Illustrated.  
Paper cover ed. \$2.90  
Hard cover ed. \$4.60

## JUST OFF THE PRESS!

There's money in servicing record changers, and this new Gernsback Library book shows you how to get it! Discusses each functional assembly as a unit, so that even if you're a rank beginner as far as changers go, in no time at all you'll be able to tackle any and all types. Many special line drawings illustrate all the details of automatic record-changer mechanisms. A basic book, it is nevertheless an excellent reference for those familiar with changers. Put in your bid for that extra servicing money now—order your copy today.

**Servicing Record Changers—Partial list of contents**

- Sequence of operation • Motors • Drive assemblies • Turntables • Pickup arm, cartridges • Trip Mechanisms • The Cycle Drive • Arm Lift and Pull-Back
- Record Release • Record Indexing and Arm • Set-Down • Automatic Shutoff • Care and Handling • Trouble Shooting Charts.

**THE COMPLETE GERNSBACK LIBRARY—PAPER-COVERED EDITIONS**

Basic Audio Course. No. 66.....\$2.75	Transistors—Theory and Practice. No. 51.....\$2.00
Hard cover ed.....\$5.00	TV Repair Techniques. No. 50.....\$1.50
Maintaining Hi-Fi Equipment. No. 58.....\$2.90	Radio & TV Test Instruments. No. 49.....\$1.50
Hard cover ed.....\$5.00	High-Fidelity—Design Construction. Measurements. No. 48.....\$1.50
The V.T.V.M. No. 57.....\$2.50	Radio & TV Hints. No. 47.....\$1.00
Hard cover ed.....\$4.60	Television Technotes. No. 46.....\$1.50
High-Fidelity Circuit Design. No. 56. Deluxe hard cover ed. only.....\$5.95	Radio Tube Fundamentals. No. 45.....\$1.00
Sweep and Marker Generators. No. 55.....\$2.50	Hard cover ed.....\$4.60
Hard cover ed.....\$4.60	Basic Radio Course No. 44.....\$2.25
Probs. No. 54.....\$2.50	Hard cover ed.....\$4.60
Hard cover ed.....\$4.60	Model Control By Radio. No. 43.....\$1.00
Radio-Control Handbook. No. 53.....\$2.25	High-Fidelity Techniques. No. 42.....\$1.00
The Oscilloscope. No. 52.....\$2.25	Practical Disc Recording. No. 39......75
Hard cover ed.....\$4.60	

**ON SALE DATE  
FOR AUGUST ISSUE  
JULY 26th**

## TAPE RECORDERS

Tapes—Accessories  
Nationally Advertised Brands  
**UNUSUAL VALUES**  
Send for Free Catalog  
**DRESSNER**  
69-02 RE 174 St.  
Flushing 65, N.Y.

**MERITAPE**

Low Cost. High Quality Record. ing Tapes—in boxes or cans.

# Don't just say capacitors

Ask For Sprague By  
Catalog Number

Know what you're getting... get exactly what you want. Don't be vague... insist on Sprague. Use complete radio-TV service catalog C-610. Write Sprague Products Company, 81 Marshall Street, North Adams, Mass.

## SPRAGUE

WORLD'S LARGEST  
CAPACITOR MANUFACTURER

## GERNSBACK LIBRARY, INC.

154 West 14th Street, New York 11, N. Y.

<input type="checkbox"/> 39	<input type="checkbox"/> 42	<input type="checkbox"/> 43	<input type="checkbox"/> 44	76
<input type="checkbox"/> 45	<input type="checkbox"/> 46	<input type="checkbox"/> 47	<input type="checkbox"/> 48	
<input type="checkbox"/> 49	<input type="checkbox"/> 50	<input type="checkbox"/> 51	<input type="checkbox"/> 52	
<input type="checkbox"/> 53	<input type="checkbox"/> 54	<input type="checkbox"/> 55	<input type="checkbox"/> 56	
<input type="checkbox"/> 57	<input type="checkbox"/> 58	<input type="checkbox"/> 59	<input type="checkbox"/> 66	
Hard cover editions				
By mail only				
<input type="checkbox"/> 52H	<input type="checkbox"/> 54H	<input type="checkbox"/> 55H		
<input type="checkbox"/> 57H	<input type="checkbox"/> 58H	<input type="checkbox"/> 59H		
<input type="checkbox"/> 66H				

Enclosed is my remittance of \$.....

Please send me the books checked postpaid.  
Prices 10% higher in Canada.

Name..... please print

Street.....

City..... State.....

# BUILD 16 RADIO CIRCUITS AT HOME \$19.95

With the New Deluxe PROGRESSIVE RADIO "EDU-KIT" only  
**A PRACTICAL HOME RADIO COURSE**

Now Includes **SOLDERING IRON, TESTER, HIGH FIDELITY, SIGNAL TRACER, CODE OSCILLATOR, PRINTED CIRCUITRY**

## FREE TOOLS

- No Knowledge of Radio Necessary
- No Additional Parts or Tools Needed
- Excellent Background for TV
- Unconditional Money-Back Guarantee



Reg. U.S. Pat. Off.

**FREE** Hi-Fi Radio & TV Servicing Manuals on Request. (See Coupon Below).

## WHAT THE "EDU-KIT" OFFERS YOU

The "Edu-Kit" offers you an outstanding PRACTICAL HOME RADIO COURSE at a rock-bottom price. You will learn radio theory, construction and servicing. You will learn how to build radios, using regular schematics; how to solder and wire in a professional manner; how to service and trouble-shoot radios. You will learn how to work with punched metal chassis as well as the new Printed Circuit chassis. You will learn the principles of RF and AF amplifiers and oscillators, detectors, rectifiers, test equipment. You will learn and practice code, using the Progressive Code Oscillator. You will build 16 Receiver, Transmitter, Code Oscillator, Signal Tracer and Signal Injector circuits, and learn how to operate them. You will receive an excellent background for TV. In brief, you will receive a basic education in Electronics and Radio, worth many times the small price you pay.

## PROGRESSIVE TEACHING METHOD

The Progressive Radio "Edu-Kit" is the foremost educational radio kit in the world, and is universally accepted as the standard in the field of electronics training. The "Edu-Kit" uses the modern educational principle of "Learn by Doing." You begin by building a simple radio. Gradually, in a progressive manner, and at your own rate, you construct more advanced multi-tube radio circuits, learn more advanced theory and techniques, and do work like a professional radio technician.

## THE KIT FOR EVERYONE

You do not need the slightest background in radio or science. The "Edu-Kit" is used by young and old, schools and clubs, by Armed Forces Personnel and Veterans Administration for training and rehabilitation. The "Edu-Kit" is used in 79 countries throughout the world. Designed for universal use, the "Edu-Kit" operates on any voltage from 105 to 125 volts, AC and DC. For use in countries employing higher line voltages, a 210-250 Volt AC/DC model is available.

## THE "EDU-KIT" IS COMPLETE

You will receive all parts and instructions necessary to build 16 different radio and electronics circuits each guaranteed to operate. Our kits contain tubes, tube sockets, variable electrolytic and paper dielectric condensers, resistors, the string coils, hot-draw tubing, punched metal chassis, Instruction Manuals, etc. In addition, you receive Printed Circuit materials, including Printed Circuit chassis, screw-in tube sockets, hardware and instructions. You also receive a useful set of tools, a professional electric soldering iron, and a self-powered, dynamic Radio and Electronics Tester. The "Edu-Kit" also includes Code Instructions and the Progressive Code Oscillator. You will also receive lessons for servicing with the Progressive Signal Tracer and the Progressive Signal Injector, a High Fidelity Guide, FCC Amateur License Training Book and a Quiz Book.

All parts, components, etc., of the "Edu-Kit" are 100% unconditionally guaranteed, brand new, carefully selected, tested and matched. Everything is yours to keep. The complete price of this practical home radio and Electronics course is only \$19.95.

## TROUBLE-SHOOTING LESSONS

You will learn to trouble-shoot and service radios, using the professional Signal Tracer, the unique Signal Injector, and the dynamic Radio and Electronics Tester. Our Consultation Service will help you with any technical problems.

J. Stasitis, of 25 Poplar Pl., Waterbury, Conn., writes: "I have repaired several sets for my friends, and made money. The 'Edu-Kit' paid for itself. I was ready to spend \$240 for a course, but I found your ad and sent for your kit."

## FREE EXTRAS

- Radio and Electronics Tester
- Electric Soldering Iron
- Set of Tools
- Tester Instruction Book
- Hi-Fi Book
- TV Book
- Quiz Book
- Membership in Radio-TV Club
- Consultation Service
- FCC Amateur License Training
- Printed Circuitry

ORDER FROM AD—RECEIVE FREE BONUS RESISTOR KIT WORTH \$5

UNCONDITIONAL MONEY-BACK GUARANTEE  
"Edu-Kit" Postpaid. Enclose full payment of \$19.95.  
"Edu-Kit" C.O.D. I will pay \$19.95 plus postage.  
Send me FREE additional information describing "Edu-Kit" Include FREE valuable Hi-Fi, Radio & TV Servicing Manuals. No obligation.  
(Outside U.S.A.—No C.O.D.'s. "Edu-Kit" for 105-125 V. AC/DC \$20.95; 210-250 V. AC/DC \$23.45.)

Name.....  
Address.....

## PROGRESSIVE "EDU-KITS" INC.

497 Union Ave., Room 118G, Brooklyn 11, N.Y.

# People



Brig. Gen. David Sarnoff, chairman of the board and chief executive officer of RCA, is celebrating his 50th anniversary in the industry this year. On Sept. 30, 1906, at the age of 15, he started as an office boy with the Marconi Wire & Telegraph Co. of America, predecessor of RCA. In 1912 while on duty as a telegraph operator, he handled a large



part of the traffic from the sinking Titanic. During World War II he served overseas with the Army as a special consultant on communications at SHAEF. The photo shows Gen. Sarnoff cutting the 3-foot high cake presented to him by Frank M. Folsom, RCA president, at the stockholders' meeting in New York last May as a salute to his 50 productive years in the industry.

Dr. Bennett S. Ellefson (left) and Marion E. Pettigrew were elected vice president—engineering and research, and vice president—tungsten-chemical and parts operations, respectively, for



Sylvania Electric Products. Dr. Ellefson had been technical director of Sylvania, and Pettigrew general manager of the Parts and the Tungsten and Chemical Divisions.



Joe C. Harmony, former plant manager of the CBS-Hytron Danvers, Mass., plant, was promoted to the newly created post of manager of receiving tube operations. Charles E. Coffin, heretofore production superintendent, succeeds to Harmony's former position.

## OPPORTUNITY ADLETS

Rates—15c per word (including name, address and initials) Minimum ad 10 words. Cash must accompany all ads except those placed by accredited agencies. Discount, 10% for 12 consecutive issues. Misleading or objectionable ads not accepted. Copy for Sept. issue must reach us before July 15, 1956.

**RADIO-ELECTRONICS,**  
154 West 14 St., New York 11, N. Y.

PRINTING—250 Letterheads 8 1/2 x 11, quality printed \$2.95. Envelopes same postpaid. 3-Line Rubber Stamp. \$1. ACE PRINTERS, CORNING, ARK.

INFORMATION any manufacturer, product or address. \$1.00. AGENTSERVICE, Box 1039, New Haven, Connecticut.

HIGH-FIDELITY SPEAKERS REPAIRED. Amprito Speaker Service, 70 Vesey St., New York 7, N.Y. BA 7-2580.

SPEAKER RECONING: Guaranteed workmanship. C&M Recone Co., 255 Tioiga St., Trenton 9, N.J.

CHASSIS & panels cut and punched to your specifications, panels engraved. Send sketch for estimate. Chicago Electronics, 1214 West Madison Street, Chicago, Illinois.

TELEVISION Tuner Repairs, DAN'S TELEVISION LABORATORY, 606 Sunnyside Highway, Babylon, N. Y.

RULE OTHERS WITH THOUGHTS! Incredible power. (Details—10c) DELMAR WISDOM, 846-85 Sunnyside Ave., Chicago 40, Ill.

DIAGRAMS FOR REPAIRING RADIOS \$1.00. Television \$2.00. Give Make, Model, Diagram Service, Box 672-RE, Hartford 1, Conn.

SUPERHET Pocket Radio, No Antenna Required! Wired With Batteries \$24.50, Kit-Form \$15.85; T-17 Microphones \$3.95; IN34-A Diode \$3.00; Four Microphone Buttons \$1.00; Postpaid. ELECTRONIC OUTLET, 5-B Wolcott Avenue, Lawrence, Mass.

FREE PLASTIC CARD CASE!  
WITH YOUR ORDER FOR 1000 PROCESS EMBOSSED BUSINESS CARDS. AS YOU LIKE! ONE OR TWO COLORS!

Every business man—and professional man as well—knows the impression created by his appearance. Most important is the card you present. A "Showmanship" Business Card is an important factor. You know the right impression is created when you proudly present—an Exclusive, Distinctive, Expensive-Looking EMBOSSED Card. Raised printing—done by Mastercraftsmen—with "know how" A card with Raised Letters—with the "feel" and Character of Fine Engraving. Leading Executives use Showmanship Cards, creating the impression of Position, Prestige and SUCCESS! Yet—our cards cost you less than the ordinary cheaply printed cards. It's easy to order cards from us. Simply PRINT or TYPE whatever you want to appear on the card—on any hard-rod or paper. Fill in a money order or check for just \$4.95—and rush it to us—by fast mail. You'll get prompt service. Cards will be rushed to you prepaid. With your FREE Plastic Card Case. Get your order in the mail—NOW! FAULTLESS ORGANIZATION, 684 N. Sangamon St., Chicago 22, Ill. 62 PAGES! Illustrated Radio Beginner's Booklet, 25c, FRANKS, 3121R South Racine, Chicago 8, Ill.

FOR SALE: 1-Clough Bregma Company Vacuum Tube Voltmeter, Type 88; 1-Cathode Ray Oscilloscope, Type 1550; 2-Signal Corp Oscillator VO-3-B, Mfd. by Amplifier Co. of America, Box OA, R. GELB & SONS, INC. U.S. Highway No. 22, Union, N. J.

TUBES—TV, RADIO, TRANSMITTING, AND SPECIAL PURPOSE TYPES BOUGHT, SOLD AND EXCHANGED. Send details to R. E. Gensler W2LN1, 512 Broadway, N.Y. 12, N.Y.

ALL MAKES OF ELECTRICAL INSTRUMENTS AND TESTING equipment repaired. Write for free catalogue on new and used instruments at a savings. Hazelton Instrument Co., 128 Liberty Street, New York, N.Y.

TRADE IN TV SETS \$14 up. JONES RADIO, 1115 Rambler, Pottstown, Pa.

WANTED: AN/APR 4, other, "APR", "TS-", "JE-", ARC-1, ARC-3, ART-13, BC-348, etc. Microwave Equipment. Everything Surplus. Special tubes, Tee Manuals, Lab Quality Equipment, Meters, Fast Action, Fair Treatment. Top Dollar! Littell, Fairhills Box 26, Dayton 9, Ohio.

DIAGRAMS: Professional Model Timers, Counters, Intercoms, Organs, etc. \$1.00 each. List free. Parks, 101 S.E. 57th, Portland 15, Oregon.

RADIO, RADAR, TELEVISION instruction leading to Licenses. Port Arthur (Texas) College.

WANT A VERY LOW RESONANCE SPEAKER? Ask your dealer to demonstrate the RACON "hi-compliance", floating cone, foam-suspension loud-speaker, or write for literature and prices to RACON ELECTRIC CO., 1201 Broadway, New York 1, N. Y.

FOREIGN jobs list. Technicians needed. \$1. RATHE, Box 26131, Los Angeles 26, California.

WANTED—ALL TYPES OF ELECTRONIC TUBES: Broadcast (water and air cooled), transmitting, receiving, Magnetrons, Klystrons, also all kinds of airborne equipment: ADP-70; ARC-1, -2, -3, -4, -12, -15, -27, -33; ARN-6, -7, -12, -14, -18; BC-312, -342, -610E, -789C, -2121; F-152; ID-48; MN-24C, -310, -336, -42, -53, -58, -61, -85, -97P, -100A; RA-18; TA-18; 17-LB; 51-R, -R3; 51-VI, etc. TOP DOLLAR PAID. Write to ROBERT E. SANNETT, W6REXm 1524 S. Edris Dr., Los Angeles 35, Calif.

SOUND MART FOR ALL YOUR HI-FI REQUIREMENTS: AMPLIFIERS, TUNERS, TURNTABLES, SPEAKERS, Full line. Shipments prepaid and insured. Write for free bulletin. SOUND MART UNLIMITED, 63-03 39th Ave., Woodside 77, N. Y.

OLD wall telephones, working order. Oak cabinets, hand crank for ringing, \$5 each. FOB. TELEPHONE COMPANY, Turtle Lake, Wis.

MINIATURIZED reference voltage device calibrated against standard cell, 1.0193 volts dc. \$9.50. TRANSMITTER THERMOCONTROL S CO., South Pasadena, Calif.

CHICAGO PERSONAL MAIL ADDRESS \$1 MONTHLY. Business Address for small concerns \$2. Confidential. Receiving, Forwarding, Write—FI. ORGANIZATION—684 N. Sangamon St., Chicago 22, Ill.



always buy  
**RAD-TEL**  
for HIGHEST QUALITY  
**TUBES**  
at lowest prices

SAME DAY SERVICE. FULL 1 YEAR GUARANTEE.  
INDIVIDUALLY BOXED. BRAND-NEW. NO REJECTS. NO  
REBRANDS OR REWASHED

Another Rad-Tel Super-Special!

**5F7P CATHODE RAY TUBE**

Magnetic focus and deflection. 53° deflection angle, neck diameter 1 3/8 inch. Base shell octal 8-pin. Special features: long persistence for either low speed non-recurring signals or high speed recurring signals; two or more signals can be observed with suitable switching.

single 95c ea. Lots of 3 **79c** ea.



**CLOSE OUT! RT-24/APX-2 IFF EQUIPMENT**

Brand new 44 tube transceiver - govt. unit - in sealed overseas carton. Contains:

- 11-5A05 1-5V3
- 19-6C4 1-2C26
- 7-676 1-2D21
- 1-0D3/VRI05 4-9006



Also, these useable parts: tube sockets, relays, coax fittings, condensers, resistors, etc. 24-volt blower motor, gear train motor, power transformer 400 to 2400 cycles.

Lots of 3 **\$12.95** ea.

Single unit, **\$13.95**

Imagine - list price on tubes alone is \$81! PLUS the parts listed! What value! A Rad-Tel close-out special!

FREE Tube & Parts Catalog Listing 400 High Quality Tube Types. Write Dept. RE7.

**EXPORT INQUIRIES INVITED**

TERMS: 25% deposit must accompany all orders—balance C.O.D. All shipments F.O.B. Irvington warehouse.

**Rad-Tel TUBE CO.**

Orders Under \$5.00—50c Handling Charge.  
PLEASE: Send full remittance. Allow for postage and save C.O.D. charges. Unused money refunded. Subject to prior sale.

115 COIT ST., IRVINGTON II, N. J.

**Read RADIO-ELECTRONICS Every Month**

Subscription Rates  
One Year \$3.00 Two Years \$6.00  
Three Years \$8.00

154 West 14th St.  
New York 11, N. Y.

**DON'T JUST SAY CAPACITORS**

Ask For Sprague By Catalog Number

Know what you're getting... get exactly what you want. Don't be vague... insist on Sprague. Use complete radio-TV service catalog C-610. Write Sprague Products Company, 81 Marshall Street, North Adams, Massachusetts.

**SPRAGUE**  
WORLD'S LARGEST CAPACITOR MANUFACTURER

**PEOPLE**

(Continued)

William T. Warrender, manager of the RCA Tube Division plant in Marion, Ind., was appointed general manager of the new Components Division, Camden, N. J. Leonard Gillon, manufacturing manager of the Marion plant, succeeds Warrender as plant manager.



Roger S. Whitlock, Chicago sales representative for Tung-Sol Electric, Inc., was promoted to manager of the Western Equipment Sales Division for electron tubes. He will make his headquarters in Melrose Park, Ill.

Melvin E. Krumrey joined Quam-Nichols Co., Chicago loudspeaker and electronic components manufacturer, in the newly created post of assistant manager of the Distributor Division. He comes to the company from Shure Bros.



Frank Apple joined Centralab, a division of Globe Union, Inc., Milwaukee, as advertising manager. He has been active in graphic arts and industrial advertising for the past 11 years and was at one time associated with Potter & Brumfield and P. R. Mallory Co.

**Obituaries**

William H. Harrison, president of International Telephone & Telegraph Corp., of a heart attack at his home in Garden City, N. Y.

Bennett Wellington Cooke, president since 1919 of Coyne Electrical School, Chicago, at his home in Glencoe, Ill.

Frank Adams, Eastern sales manager of ORRadio Industries, Opelika, Ala., in Philadelphia, after a long illness.

**Personnel Notes**

... Dause L. Bibby, executive vice president of Daystrom, Inc., Elizabeth, N. J., and Bradford T. Blauvelt, vice president of finance, were elected directors. They replace Henry W. Dodge, consultant, and Edward F. Weston, chairman of the board of Weston Electrical Instrument Corp., a Daystrom subsidiary, who resigned.

... Harold S. Renne, who joined Bell Telephone Labs., New York, as technical information supervisor, was technical electronics editor of Ziff-Davis Publishing Co.

END

the **PanaSonic**

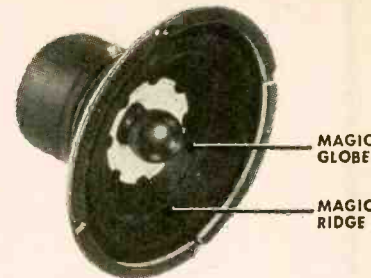

At \$247<sup>5</sup>... "An Unqualified Bargain" says "High Fidelity Magazine"

"...Equivalent to Many Larger and More Costly Speakers..." says "Audio Magazine"

Complete findings of experts, as reported in above publications, will be gladly sent to you upon request. Better yet... hear for yourself performance never before achieved by an 8" speaker, thanks to splendid craftsmanship and patented features like "Magic Globe" and "Magic Ridge."

Try the PanaSonic, a product of the world-renowned Matsushita Industries, at OUR risk in YOUR home with YOUR equipment. Take advantage of this opportunity.

**NOW SAVE 20%— Send only \$19<sup>80</sup>**

Windsor International Co., Inc. P.O. Box 15  
Riverside, Connecticut

Enclosed find \$ for PanaSonic Speaker[s] at \$19.80 each, postage paid, together with complete "High Fidelity" and "Audio" test reports, descriptive pamphlet and enclosure recommendations. Money back guaranteed if returned within ten days.

NAME \_\_\_\_\_

ADDRESS \_\_\_\_\_

CITY & STATE \_\_\_\_\_

**BE QUALITY WISE**

Hi-Fi AM-FM Tuner Kit \$28.95  
Every kit complete with 28 page fully illustrated, instruction and assembly manual.  
Write today for FREE catalogue and name of nearest dealer carrying these remarkable units.

**COVER AND LEGS OPTIONAL**

**QUALITY-ELECTRONICS, Dept. E-7**  
319 Church Street New York 13, N.Y.

**EASY TO LEARN CODE**

It is easy to learn or increase speed with an Instructograph Code Teacher. Affords the quickest and most practical method yet developed. For beginners or advanced students. Available tapes from beginner's alphabet to typical messages on all subjects. Speed range 5 to 40 W.P.M. Always ready—no QRM.

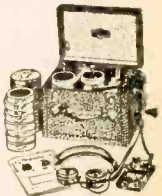

**ENDORSED BY THOUSANDS!**

The Instructograph Code Teacher literally takes the place of an operator-instructor and enables anyone to learn and master code without further assistance. Thousands of successful operators have "acquired the code" with the Instructograph System. Write today for convenient rental and purchase plans.

**INSTRUCTOGRAPH COMPANY**

4701 Sheridan Rd., Dept. RC, Chicago 40, Ill.

# to be SURE!

buy  
**VOKAR**  
the original-  
equipment  
**VIBRATOR**



Leading manufacturers of original-equipment auto-radios specify Vokar vibrators as components for installation on the production-line. Why? They're *sure* Vokar quality never varies —will always contribute to top performance demanded of today's radios.

You too can depend on Vokar vibrators—for sure starts, longer life, silent operation. For all replacement jobs, buy Vokar Imperial or Quality Brand vibrators to be *sure* of satisfied customers.

Now is the time to stock up on 12-volt vibrators—**ONLY TWO VOKAR IMPERIALS ARE NEEDED TO FILL ALL REPLACEMENTS!**



VOKAR—preferred by leading manufacturers of auto-radios.

## VOKAR

VOKAR CORPORATION  
DEXTER 2, MICHIGAN

## technical Literature

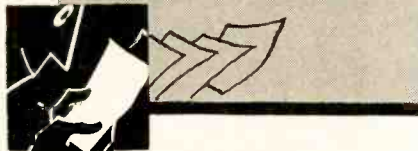

### REPLACEMENT GUIDE

A dual-purpose radio battery replacement guide and comparative slide chart has a bead-chain holder. The slide chart shows the new and old Ray-O-Vac radio battery numbers and the numbering systems of other major radio battery manufacturers. The comparative guide permits immediate identification by type (A, B, AB, etc.) of batteries. On the reverse side of the chart is the replacement guide showing what battery to use in portable set models for 34 brands of radios, including Admiral, Emerson, G-E, RCA, Philco, Zenith.

Ray-O-Vac Co., 212 E. Washington Ave., Madison, Wis.

### TRANSISTOR BROCHURE

A 32-page transistor brochure *Transistors—the Miracle of the Electronic Age* features miniaturized parts and lists practically every transistor on the market. Whole pages are devoted to transistor specifications.

Lafayette Radio, 100 Sixth Ave., New York 13, N. Y.

### HI-FI AMPLIFIERS

*Bulletin 222* on Circotron high-fidelity power amplifiers, amplifiers with controls and music control centers with preamplifiers tells about the advantages of the Circotron circuit, critical damping control and vital presence control. It gives complete data, specifications and prices on Electro-Voice 15-, 20-, 30- and 50-watt high-fidelity power amplifiers, 15- and 20-watt enclosed low-boy amplifiers with external controls in modular, decorator styling and enclosed modular music control centers for use with Electro-Voice power amplifiers and AM-FM tuners. Also includes information on the new 100-watt high-fidelity amplifier.

Electro-Voice, Inc., Buchanan, Mich.

### MICROPHONES

*Catalog No. 47* on American microphones and phonograph cartridges lists prices, specifications and characteristics. One section of the 20-page catalog is devoted to ceramic turnover and single-needle phonograph cartridges.

Elgin National Watch Co., Elgin, Ill.

Any or all of these catalogs, bulletins or periodicals are available to you on request direct to the manufacturers, whose addresses are listed at the end of each item. Use your letterhead—do not use postcards. To facilitate identification, mention the issue and page of RADIO-ELECTRONICS on which the item appears. UNLESS OTHERWISE STATED, ALL ITEMS ARE GRATIS. ALL LITERATURE OFFERS ARE VOID AFTER SIX MONTHS.

## 6-VOLT BATTERY SOLDERING IRON AND WELDER

U.S. Army release. Brand New—Never Used. Fully Guaranteed. This soldering iron can be used to solder or weld when connected to any six-volt storage battery. Uses approximately 200 to 300 watts. The high intensity arc created between the metal to be soldered and the carbon electrode (carbons supplied free with iron) can be used to heat tin or aluminum solder. Suitable also for light brazing and spot welding. Arc can be used

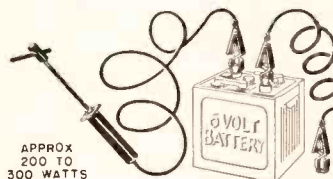

APPROX  
200 TO  
300 WATTS

for melting metals, cutting holes and soldering seams in chassis. Also useful for analyzing metals and minerals. Battery soldering iron outfit includes 2 carbons, 3 heavy duty spring clips, 2 pieces 5 ft. heavy duty wire cable. (Battery not included.) Ideal for use where current is not available. Ship wt. 4 lbs.

ITEM NO. 126  
UNUSUAL BUY .....(P.P. & Hdq. Chgs. 50c)

### WATT HOUR METER



(P.P. & Hdq. Chgs. \$1.25)

Leading makes—reconditioned. Ideal for trailer parks. 100-110 volts, 60 cycles, 2-wire A.C. 5 amp. Heavy metal case 8 1/2" x 6 1/4" x 5". Easy to install. Ship. wt. 14 lbs.

ITEM NO. 33  
NOW ONLY \$4.50

### POWERFUL ALL PURPOSE MOTOR

Sturdy shaded pole A.C. induction motor. 15 watts, 3000 rpm. 3"x2"x1 1/4"; 4 mounting studs; 7/8" shaft, 3/16" diameter; 110-120 volts, 50-60 cycles. A.C. only. UNUSUAL BUY



ITEM NO. 147  
UNUSUAL BUY .....(P.P. & Hdq. Chgs. 35c)

### 250 POWER TELESCOPE LENS KIT

Make your own high powered 6 ft. telescope! Kit contains 2" diam., 75" focal length, ground and polished objective lens and necessary eye pieces. Magnifies 50x to 250x. Full instructions.



ITEM NO. 123  
(Shp. Chgs. 10c) \$2.95

### AMAZING BLACK LIGHT

250-watt ultra-violet light source. Makes fluorescent articles glow in the dark. Fits any lamp socket. For experimenting, entertaining, unusual lighting effects.



Ship. wt. 2 lbs. \$2.45  
ITEM NO. 87  
(P.P. & Hdq. Chgs. 35c)

### BLAK-RAY SELF-FILTERING



### ULTRA-VIOLET LAMP

BLAK-RAY 4-watt lamp, model X-4, with U-V tube. Lamp has a wave-length of 3654 to 4000 angstrom units. Some of the substances made to fluoresce are certain woods, oils, minerals, milkstone, cloth, paints, plastics, waxes, dyes, crayons, etc. Self-filtering and harmless.

Equipped with aluminum reflector. 110 volt 50-60 cycle A.C. 2000 to 3000 hours of service. Approved by Underwriters has a built-in transformer. \$16.75  
ITEM NO. 125  
(Shp. Chgs. 80c)

### HUDSON SPECIALTIES CO.

25 West Broadway, Dept. RE 7-56  
New York 7, N. Y.

I am enclosing full remittance for items checked below. (Be sure to include shipping charges.)

OR, my deposit of \$..... Ship balance C.O.D.  
MINIMUM C.O.D. ORDER \$5.00.

C.O.D. ORDERS ACCEPTED ONLY WITH 20% DEPOSIT. INCLUDE SHIPPING CHARGES.  
87 147 33 126 123 125

Name .....  
Please Print Clearly

Address .....

City ..... Zone ..... State .....

RADIO-ELECTRONICS

**TECHNICAL WRITING**

*How to Write Technical Reports and Still Maintain Your Sanity* gives the technical writer some suggestions, tips and aids. The department head or other person responsible for technical writing by others is also offered a few ideas.

*Technical Marketing Associates, Inc., Concord, Mass., 25 cents.*

**RECORD CHANGERS**

Analysis sheet *No 104* describes the model RC-121, *No. 105* the deluxe RC-88 and *No. 106* super RC-98 auto-manual three-speed record changers. A wall chart also describes these changers and includes close-up photos of interchangeable spindles and plug-in heads, reinforced automatic muting switch, silent free-wheeling ball-bearing turntable mount, mono-built unit plate, etc.

*Gerrard Sales Corp., Port Washington, N. Y.*

**RECTIFIERS**

Selenium rectifiers designed for use in printed circuitry are described in *Information Bulletin M1*. It contains complete physical and electrical characteristic charts, together with diagrams giving the exact dimensions of each type of rectifier.

A 4-page folder *Federal Germanium Diffused-Junction Power Rectifiers* describes the 1N91, 1N92, 1N93 and 1N368 series.

A 12-page booklet *Federal Diffused-Junction Power Stacks* describes a series of over 100 germanium stacks employing diffused-junction rectifiers to obtain higher power.

*Federal Telephone & Radio Co., Components Div., 100 Kingsland Rd., Clifton, N. J.*

**HI-FI AUDIO GUIDE**

Terminal's *1956 High Fidelity Audio Guide* contains pertinent data on phonograph equipment and accessories, radio tuners, amplifiers, speakers, tape recorders, microphones, public-address equipment, intercom systems, etc.

*Terminal Radio Corp., 85 Cortlandt St., New York 7, N. Y.*

**TV TUBE CHART**

A TV tube interchangeability chart lists every popular type of picture tube plus the corresponding Haydu types. Tube types and a description of face type, external conductive coating and ion-trap magnet are listed for all tubes. Tube types and descriptions of Haydu equivalents follow each listing. The chart can be folded and carried in the technician's kit or mounted on a wall.

*Sales Dept., Haydu Brothers, Plainfield, N. J.*

**TRANSISTOR RADIO**

Bulletin *ECG-118* tells how to build a transistorized portable radio with the G-E 2N107. All pertinent information on it as well as other transistor circuits is given.

*General Electric distributors. END*

# Save 27%!

## On This Matched Library Series. . . Covering Every Phase of Servicing!

Imagine! You actually save 27% on vitally important books written by the world's best known electronics experts! You save 27% on beautiful, hard-cover cloth-bound books that give you ALL the latest, most up-to-date information on every phase of servicing!



Never Again will you have to search through old files to get the vital know-how you need on a particularly tough servicing job . . . all the answers to ALL your problems will be right at your fingertips! Now, for the first time the inside know-how of world-famous authorities will help you solve all servicing

problems better, faster . . . actually help you make up to twice as much money as ever before!

**THE GERNSBACK TECHNICIANS' LIBRARY**

Here is the complete-in-one-series reference library you've always wanted. And, best of all, YOU ONLY BUY ONE VOLUME AT A TIME! Not only do you save 27% on each and every book, BUT YOU DON'T HAVE TO BUY ANY BOOK YOU DON'T WANT. Yes, that's right! Each book in the series is sent to you for a 10 DAY FREE HOME TRIAL! If you don't want that particular book, return it at no charge!

**SERVICING RECORD CHANGERS**

*The Newest Book in the Library*  
One of the brand-new books you can't afford to miss is **SERVICING RECORD CHANGERS** by Harry Mileaf. Here in one handy book is all the information you will need to repair record changers. Clear, sharply drawn illustrations show you how each part works—takes the mystery out of how record changers operate. Full information on how to repair changers, what to look for when servicing, and how to order replacement parts, is included. Your purchase of this book is an investment that will pay for itself many times over!

**THESE BOOKS ARE ALSO AVAILABLE FOR YOU NOW!**

THE OSCILLOSCOPE by George Zwick; PROBES by Bruno Zucconi and Martin Clifford; SWEEP and MARKER GENERATORS for TELEVISION and RADIO by Robert G. Middleton; THE V.T.V. M. by Rhys Samuel.

**AND THESE BOOKS ARE IN PREPARATION!**

RAPID TV REPAIR by G. Warren Heath; COLOR TV CIRCUITS: HOW TO SERVICE COLOR TV RECEIVERS by Robert G. Middleton; TV and RADIO TUBE TROUBLES by Sol Heller; TELEVISION—IT'S A CINCH by E. Aisberg . . . and many others.

**Join the Money-Saving, No-Risk Gernsback Technicians' Library and Save 27%**

You may buy any or all of these books at the low retail price of only \$4.60 per copy. OR, as a member of the Library Plan you pay the special member's low price of only \$3.35—YOU SAVE 27%.

**HOW THE LIBRARY PLAN WORKS**

- 1) Each book is sent to you for a 10 day FREE EXAMINATION. If you don't like it, return it . . . it doesn't cost a penny!
- 2) One new book will be sent to you for your FREE TRIAL every three months.
- 3) You pay only \$3.35 per book if you agree to take a total of 4 or more of the books.

**JOIN TODAY**

Hurry! Get all the up-to-date, inside information you need to make more money, faster! Fill out the coupon and mail it NOW!

**NO-RISK COUPON**

**GERNSBACK LIBRARY, INC., DEPT. 756  
154 West 14 St., New York 11, N.Y.**

- Start my membership with one of the books checked below at \$3.35 postpaid.
- SERVICING RECORD CHANGERS  
 THE OSCILLOSCOPE       PROBES  
 SWEEP GENERATORS       THE V.T.V.M.

I have 10 days in which to return the book if I am not satisfied, otherwise I will pay promptly when I get your bill.

Send me more information about the GERNSBACK TECHNICIAN'S LIBRARY

NAME \_\_\_\_\_ (please print)  
 STREET ADDRESS \_\_\_\_\_  
 CITY \_\_\_\_\_ STATE \_\_\_\_\_

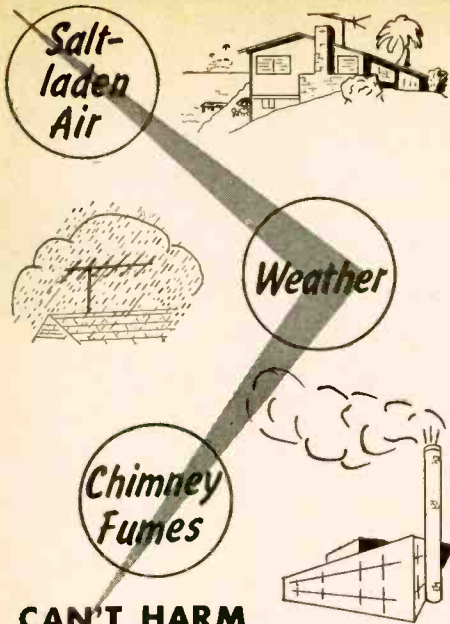

**CAN'T HARM  
TV Antennas • Hardware**

*Protected with*



ALSO IDEAL FOR:

- Masts
- Rotor Housings
- Terminals
- Ham Beams

MOSLEY ANTENNA COAT keeps TV and FM antenna installations in brand new operating condition—For Years!

Easy to apply with brush or spray. Forms tough, long-lasting protective coat that resists all corrosive atmospheric conditions.

No. E-101 — ANTENNA COAT. Enough to protect Several antennas.

Dealer Net, \$1.94

*At Radio and Television Parts  
Distributors, Coast-to-Coast.*

**Mosley Electronics, Inc.**

8627 ST CHARLES ROCK ROAD, ST LOUIS 14, MISSOURI

**UNIVERSAL SUPERHET KIT**  
Learn Practical Radio at Home

only **\$14.95**

**FREE RADIO-TV ALIGNMENT TOOL**



The Universal Superhet Kit is designed for the beginner. You learn theory and construction Practice, schematics. In brief, you receive a Practical, basic education in Radio, worth much more than the small price you pay. You "learn by doing" with the Universal Superhet Kit. You build in simple, progressive steps. Every part of the kit is clearly illustrated and explained. The Job Sheets teach you superheterodynes in a new, easy-to-learn manner. The Universal Superhet Kit contains all the components that you need to build this modern Superheterodyne Receiver—beautiful plastic cabinet, chassis, powerful Alnico 5 PM speaker, matched output transformer, matched IF transformers, matched coils, loop antenna, hardware, selected and matched resistors and condensers, five tubes, Instruction Manual.

Complete price only \$14.95, plus additional charge for postage and handling (\$1.00 U.S.A., \$2.00 outside U.S.A.) Send payment with order; we'll ship postpaid. COD orders accepted in U.S.A.; you pay COD charges. Unconditional money-back guarantee. ORDER NOW, or write for additional information.

**UNIVERSAL KITS CORP.**  
Dept. 201-G, 16 Skillman Ave., Brooklyn, N.Y.

# Books

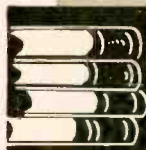

**TRANSISTORS (I).** RCA Laboratories, Princeton, N. J. 6 x 9 inches, 676 pages. \$4.50.

Prepared by RCA scientists and engineers, this volume contains more than 40 papers on transistors, most of them previously unpublished. A few deal with manufacture and quality. Many others show how to design and construct practical amplifiers, receivers, control and test circuits.

Many papers are concerned with transistor applications. Some circuits use experimental type transistors but in most cases conventional types may be substituted. One paper describes an eight-transistor pocket radio. Others discuss audio circuits, covering everything from a hi-fi preamplifier to a 20-watt power amplifier for phono and mike. TV is well represented also with circuits for sync separators, vertical deflection and afc.

A fine book for advanced experimenters and technicians who wish to learn the latest developments in the field.—*IQ*

**MOST-OFTEN-NEEDED 1956 RADIO DIAGRAMS AND SERVICING INFORMATION (Vol. 16),** compiled by M. N. Beitman, Supreme Publications, 1760 Balsam Road, Highland Park, Ill. 8½ x 10¾ inches, 192 pages. \$2.50.

For years diagrams of AM radios have been pretty much alike, and experienced service technicians seldom had need to refer to circuit diagrams or manufacturers' service data. Now that transistorized receivers are showing up in ever-increasing numbers, the most experienced technician may need all the help he can get. He must be familiar with trends in transistorization and manufacturers' diagrams are essential to rapid, efficient servicing.

Since fully one-fourth of its 64 schematic diagrams of record players, audio amplifiers and AM radios are partially or wholly transistorized, we feel this volume is perhaps the most valuable of the series. Transistor fans and experimenters will find it a valuable reference.—*RFS*

**TV RECEIVER SERVICING, Vol. 2, Receiver and Power Supply Circuits,** by E. A. W. Spreadbury, Distributed by Iliffe & Sons, Ltd., London, England. 5½ x 8½ inches, 308 pages. 21s net.

This second volume of a series on TV servicing is presented like the first (on time-base circuits) in a practical, easily understood manner and in a way to supply maximum information. Schematics and photos appear frequently.

British TV differs in some ways from the system used here, but basic principles and circuits are similar.

Some books on TV show distorted patterns and try to relate them to causes. Such procedure is intended to save time, but must be limited to relatively few defects. This book relies on detailed description of circuits, what faults they may develop and how to find the cure.—*IQ*

**COLOR TV RECEIVER PRACTICES,** by Hazeltine Corp. Laboratories Staff. Edited by Charles E. Dean. John F. Rider Publisher, Inc., 480 Canal St., New York, N. Y. 5½ x 8½ inches. 200 pages. \$4.50 paper, \$6 cloth.

Much has been written about color TV, sometimes not too clearly. This book, written to give a good understanding of basic practices, is easy to understand and covers a wide range of topics. Based on a series of lectures by experts, it will be found useful by engineers and technicians.

The book starts by noting the requirements for a good color picture, then shows how all required signals are crammed into the available band. Following chapters describe color signals, three-gun kinescope, decoders, synchronization and amplification in detail. The final chapter on lab apparatus describes generators, scopes, transmitter circuits.

The authors have included many schematics. They list recommended adjustments and operating problems wherever called for.

**AUTOMATIC RECORD CHANGER SERVICE MANUAL WITH TAPE RECORDER SERVICE DATA (Vol. 7).** Howard W. Sams & Co., Indianapolis, Ind. Pages not numbered. \$3.

A compilation of 1954-55 Photofact folders containing diagrams, photographs, parts lists, detailed drawings and service data on 46 record changers and tape recorders of 16 manufacturers. A comprehensive index of changers and magnetic recorders from Vol. 1 (1947) through Vol. 7 is included.

**TV FIELD SERVICE MANUAL WITH TUBE LOCATIONS (Vol. 5).** John F. Rider Publisher, New York. 137 pages, \$2.40.

Covering 1949-55 Motorola and Philco TV sets, this book lists trouble symptoms and their most common causes along with tube and control location charts, dial-stringing guides, diagrams of series-heater strings and tabulations of key voltages. END

# School Directory

Your choice of school is highly important to your career in



INDUSTRIAL ELECTRONICS



RADIO



TELEVISION

## LEARN TV

'At the most practical school in the west'

Work on late model sets—using modern equipment and service techniques: under qualified technician instructors. Short resident and correspondence courses—no unnecessary math or theory—also UHF and Color TV.

APPROVED FOR VETERANS . . . day and nite classes.  
Write for free literature, Dept. 1A for residence—Dept. IAC for correspondence.

### V.S.I. TELEVISION SCHOOL

4570 Firestone Blvd.  
South Gate, California



### RCA INSTITUTES, INC.

A service of Radio Corporation of America  
350 West 4th St., New York 14, N. Y.

OFFERS COURSES IN ALL TECHNICAL PHASES OF RADIO, TELEVISION, ELECTRONICS

Approved for Veterans  
Write Dept. RE-56 for Catalog

## SENDING CODE RECEIVING SPEED

Be a "key" man. Learn how to send and receive messages in code by telegraph and radio. Commerce needs thousands of men for jobs. Good pay, adventure, interesting work. Learn at home quickly through famous Candler System. Qualify for Amateur or Commercial License. Write for FREE BOOK.

CANDLER SYSTEM CO.  
Dept. 3-H, Box 928, Denver 1, Colo., U.S.A.

## GET INTO ELECTRONICS

You can enter this uncrowded, interesting field. Defense expansion, new developments demand trained specialists. Study all phases radio & electronics theory and practice: TV; FM; broadcasting; servicing; aviation, marine, police radio. 18-month course. Graduates in demand by major companies. H.S. or equivalent required. Begin January, March, June, September. Campus life. Write for catalog.

VALPARAISO TECHNICAL INSTITUTE  
Dept. C Valparaiso, Indiana



## TELEVISION

PREPARE FOR A GOOD JOB!  
BROADCAST ENGINEER  
ELECTRONICS  
RADIO SERVICING

### Television Servicing

(Approved for Veterans)  
BUILDING AIRCONDITIONED  
SEND FOR FREE LITERATURE  
BALTIMORE TECHNICAL INSTITUTE  
1425 EUTAW PLACE, BALTIMORE 17, MD.



### wanted career men

Train for a career instead of a job. Demand for our graduates exceeds supply. Effective placement. Modest costs. Small classes. Well-equipped labs. Beautiful campus. Approved for Vets. Enter Sept., Jan., March, June.

BACH. SCI. DEGREE IN 27 MONTHS  
Complete Radio Eng. courses: TV, UHF, FM, Electronics. Also Mech., Civil, Elec., Chem., Aero. Eng. 36-month B.S. in Bus. Adm. (Gen. Bus., Acctg., Motor Transport Mgt.) . . . capable students faster. Prep courses. Write Jean McCarthy, Dir. Adm., for catalog and "Your Career in Engineering & Commerce."



## TRI-STATE COLLEGE

2476 College Avenue, Angola, Indiana



### TV REPAIRMEN EARN TOP MONEY!

IN JUST 12 MONTHS, COMPLETE TV SERVICE TRAINING, INCLUDING COLOR TV. Streamlined course gives you all essentials for a good job as service technician. Graduates in great demand; jobs are plentiful in this growing field. Other electronic courses in radio operation and maintenance. Day or evening classes. Opportunity for employment in local industry. Approved for Korean veterans.

Write for Catalog 111 Today

INDIANAPOLIS ELECTRONIC SCHOOL  
312 E. Washington, Indianapolis 4, Indiana



## FINISH HIGH SCHOOL AT HOME!

No classes to attend. Easy spare-time training covers big choice of subjects. Friendly instructors; standard texts. Full credit for previous schooling. Diploma awarded. Write now for FREE catalog!

WAYNE SCHOOL Catalog HKE-6  
2527 Sheffield Ave., Chicago 14, Illinois

## ENGINEERING

Prepare for unlimited opportunities in electronics! B.S. degree in 27 mo. Intensive, specialized courses. Math, electrical engineering, TV, advanced radio theory & design. Modern labs. Low rate. Earn board. Also Aeronautical, Chemical, Civil, Electrical, Mechanical Engineering. G. I. approved. Enter September, December, March, June. Catalog.

INDIANA TECHNICAL COLLEGE  
1576 E. Washington Blvd., Fort Wayne 2, Indiana



### Can you afford not to get an F.C.C. LICENSE ?

A commercial FCC license means higher pay, greater prestige, and job security.

We train you for a first class FCC license in 12 weeks!

Resident Classes or Home Study  
—Write or phone—

GRANTHAM SCHOOL  
of ELECTRONICS, Desk 4-D

821-19th Street NW Washington 6, D.C. OR 5910 Sunset Blvd. Hollywood 28, Calif.  
(Phone ST 3-3614) (Phone HO 2-1411)

## LEARN TV SERVICING UHF—COLOR—VHF

Master the latest, up-to-the-minute TV and Color TV developments.

You can Earn to \$5,000-\$10,000 a year in TV servicing after a few short months. Education or age is no barrier. Find out how you can EARN WHILE YOU LEARN in our big Shops and Laboratories. You work with the latest equipment. Waste no time with Non-Essentials, Math or Design Theory. Complete information in our new FREE booklet. Address Dept. E-756. Approved for veterans. Free Placement Service.

WESTERN TELEVISION INSTITUTE  
341 W. 18th St. Los Angeles, Calif.  
Dept. E-756  
Mail me information about training.  
Name \_\_\_\_\_  
Address \_\_\_\_\_



TERMS OPEN JULY, SEPTEMBER, JANUARY, APRIL

Choose wisely — your future depends on it. Write for more information today!

## MILWAUKEE

SCHOOL OF ENGINEERING  
Dept. RE-756, 1025 N. Milwaukee St.  
Milwaukee 1, Wisconsin

Send FREE career booklets on:  
 Electrical Engineering  Radio-Television

I am interested in \_\_\_\_\_ (Name of course)  
Name \_\_\_\_\_ Age \_\_\_\_\_  
Address \_\_\_\_\_  
City \_\_\_\_\_ Zone \_\_\_\_\_ State \_\_\_\_\_  
If veteran, give discharge date \_\_\_\_\_ MS-31

Only the 5 TOP QUALITY brands of

# STANDARD BRAND TUBES

AT SENSIBLE PRICES!

- Individually boxed ● First quality only
- Brand New ● 90-DAY RETMA guarantee
- No private brands ● No rejects
- No rebrands or rewashed bargains

Write for complete price list. Over 1000 tube types in stock.

## TRANSMITTING TUBE SPECIALS

(Brand New Surplus)

4PR60A	\$50.00	803	\$ 2.00
304TH	10.75	807	1.20
307A	.80	807W/5933	2.85
450TH	47.50	866-A (RCA)	1.25
750TL	50.00	872A	1.25

## 2 COLOR TUBE CARTONS

Keeps your tube stock neat. New safety partition prevents tube breakage. Distinctively lithographed in glossy red and black. The most distinctive tube carton available today. Minimum quantity: 100 of any one size. Write for case lot prices.

SIZE	FOR TUBE	PER 100
Miniature	.6AUG, etc.	\$1.00
GT	.65A7, etc.	1.25
Large GT	.1B3, etc.	1.50
Large G	.5U4G, etc.	2.00

### WHITE GLOSSY BOXES

Completely blank. No printing or color. Otherwise same as above. Same high quality, same low prices. Specify "WHITE" when ordering. When color is not stated, 2 color cartons will be shipped.

### TUBE STACKERS

White glossy only. Ministacker holds 10 Mini tube cartons; "GT" stacker holds 10 "GT" cartons.

SIZE	PER 100
Ministacker	\$2.50
GT	2.00

SAVE ON STACKERS. Either size only \$10.00 per case of 1,000, F.O.B., New York!



## DIRECTRON SELENIUM RECTIFIERS

Full Wave Bridge Type

Max. Amps.	18VAC 14VDC	36 VAC 28 VDC	54 VAC 42 VDC	72 VAC 56 VDC	130 VAC 100 VDC
1	\$1.35	\$2.30	\$3.70	\$4.50	\$7.40
2	2.00	2.75	5.30	5.90	9.15
2 1/2	2.90	4.10	5.75	7.85	12.70
3	3.50	6.40	11.25	14.35	21.70
4	3.95	7.70	12.75	17.30	29.65
10	5.85	11.35	19.40	24.80	41.25
12	7.20	14.25	22.00	29.75	43.85
20	13.05	25.05	37.25	48.75	78.50
24	14.25	28.75	44.50	57.65	81.00

Complete line of new rectifier transformers, chokes and filter capacitors in stock at all times. May be ordered at same time as selenium rectifiers above for immediate delivery. Write for complete price list.

We build other Selenium Rectifiers, Transformers and Chokes to your specifications.

## NEW RECTIFIER TRANSFORMERS

Continuous Ratings	1 Amp.	2 Amps.	\$ 5.75
PRI: 115V. 60 cycles input	2 Amps.	4 Amps.	6.75
SEC: 9, 12, 18, 24 and 36 volts.	12 Amps.	24 Amps.	16.65
	24 Amps.		35.65

## NEW RECTIFIER CHOKES

Continuous Ratings	1.5 ohm	9 ohm	14.95
1 Amp.	.04 Hy.	.6 ohm	7.95
2 Amps.	.07 Hy.	.1 ohm	14.95
4 Amps.	.01 Hy.	.025 ohm	29.95
12 Amps.	.004 Hy.		

## FILTER CAPACITORS

Capacity	W Voltage	Each
400 MFD (in cans, on octal bases)	25 V.	\$1.00
500 MFD	200 V.	1.95
500 MFD	50 V.	.85
1000 MFD	15 V.	.85
1000 MFD	35 V.	1.50
2000 MFD	50 V.	2.25
6000 MFD	15 V.	2.50

GET A U. S. NAVY

## SNOOPERSCOPE

The Infra-red device that

LETS YOU SEE IN TOTAL DARKNESS!!

BRAND \$160.00

NEW

Write for details

WRITE FOR "BARRY'S GREEN SHEET" ISSUED MONTHLY. FREE!

TERMS: 25% deposit with order, balance C.O.D. All merchandise guaranteed. F.O.B. N.Y.C.

**BARRY ELECTRONICS CORP.**  
512 Broadway, Dept. RE, N.Y. 12, N.Y.

Call Us Day or Night  
24-Hour Phone Service  
Phone: Walker 5-7000

# ADVERTISING INDEX

Radio-Electronics does not assume responsibility for any errors appearing in the index below.

Allied Radio Corp.	9, 77	Moss Electronics Distributing	74-75
Amphenol Electronics Corp.	110	National Radio Institute	3, 13
Arkay Radio Kits, Inc.	100	National Schools	5
Atlas Sound Corp.	108	North American Philips Co., Inc.	76
Audel Publishers	117	Opportunity Adlets	122
B & K Manufacturing Co.	87	Perma-Power Co.	116
Barry Electronics	128	Phaotron Instrument & Electronic Co.	92
Bell Telephone Labs.	26	Phileo Corp.	106
Benco Television Associates Ltd.	98	Pickering & Co., Inc.	24
Brooks Radio & Television Corp.	129	Precise Development Corp.	115
CBS-Hytron	81	Precision Apparatus Co.	16
Cannon Electric Co.	116	Prentice-Hall, Inc.	112
Capitol Radio Engineering Institute	15	Progressive Edu-Kits, Inc.	122
Chicago Standard Transformer Co.	102	Quality Electronics	123
Clarostat Manufacturing Co.	83	Quam-Nichols	100
Cleveland Institute of Radio Electronics	11	Quietrole Co.	119
Columbia Wire & Supply Co.	86	RCA Institutes, Inc.	17
Cornell-Dubilier Electric Corp.	22, 109	RCA Tube Division	Back Cover
Coyne Electrical School	91, 117	RCA Components Division	79
DeRo Electronics	106	Radiart Corp.	22
DeVry Technical Institute	7, 23	Radio Television Training Association	25
Dressner	121	Rad-Tel Tube Co.	123
Du Mont (Allen B.) Labs.	Inside Front Cover	Raytheon Manufacturing Co.	10
Editions Radio	109	Remington-Rand Univac	89
Electro-Voice Inc.	Inside Back Cover	Rider (John F.), Inc.	20-21
Electronic Instrument Co. (EICO)	27, 28	Rinehart Books, Inc.	114, 119
Electronic Parts Co.	106	Rohn Manufacturing Co.	101
Electronic Publishing Co.	80	Sams (Howard W.) & Co., Inc.	73, 94
Erie Resistor Corp.	114	Sangamo Electric Co.	90
E-Z Way Towers, Inc.	120	Service Instruments Co.	120
Federal Telephone & Radio	97	Sprague Products Co.	121, 123, 128
Futuramic	117	Stan-Burn Radio & Electronics	118
General Cement Manufacturing Co.	103	Swedgal (M.)	121
G-C Electronics Mfg. Co.	103	Techmaster Corp.	119
General Electric Co. (Electronics Div.)	18-19	Tenna Manufacturing Co.	14
General Industries Co.	12	Terado Co.	116
Gernsback Library, Inc.	121, 125	Triad Transformer Corp.	96
Hallcrafters Co.	111	Tung Sol Electric Co.	6
Heath Co.	62-69	Universal Kits Corp.	126
Hudson Specialties Co.	124	University Microfilms	115
Hughes Research & Development Labs.	95	Vokar Corp.	124
Indiana Technical College	109	Windsor International Co.	123
Instructograph Co.	123	Winegard Co.	99
International Business Machines	113		
Jensen Industries	114		
Jerrold Electronics Corp.	107		
Jones & Laughlin Steel Corp.	98		
Kay Electric Co.	91		
Kedman Co.	128		
LMB	106		
Lafayette Radio	130		
Lektron Specialties	120		
Mallory (P.R.) & Co., Inc.	104, 105		
Merit Coil & Transformer Corp.	8		
Miller (Gustave)	106		
Mosley Electronics, Inc.	126		

## SCHOOL DIRECTORY PAGE 127

Baltimore Technical Institute  
Candler System Co.  
Grantham School  
Indiana Technical College  
Indianapolis Electronic School  
Milwaukee School of Engineering  
RCA Institutes, Inc.  
Tri-State College  
Valparaiso Technical Institute  
V.S.I. Television School  
Wayne School  
Western Television Institute

# JULY is HOT... but THIS SALE is HOTTER!

\$75,000.00 Stock of Standard Radio & Television Parts—All Brand New—Money Back Guarantee.

### ASSORTMENTS for ONE BUCK

100 - 1/2 WATT RESISTORS	\$1
75 - 1 WATT RESISTORS	\$1
50 - 2 WATT RESISTORS	\$1
10 - WIRE WOUND PWR. RESISTORS	\$1
50 - TUBULAR CONDENSERS	\$1
30 - CERAMIC CONDENSERS	\$1
30 - MICA CONDENSERS	\$1
3 - TV ELECTROLYTIC COND.	\$1
5 - RADIO ELECTROLYTIC COND.	\$1
50 - SOCKETS, octal & miniature	\$1
50 - RADIO KNOBS, screw & push on	\$1
50 - TERMINAL STRIPS	\$1
10 - VOLUME CONTROLS L/s	\$1
5 - VOLUME CONTROLS w/s	\$1
10 - TV COILS, width, peaking, etc.	\$1
TV WIRE & SOLDER KIT	\$1
SCREWS, RIVETS & WASHERS KIT	\$1

**WE ARE OVERSTOCKED ON THESE BRAND NEW CONDENSERS**—Closing them out at **2¢ each**

Large quantities — Order Plenty

.01—100v	.003—400v
.02—100v	.004—400v
.25—100v	.006—400v
.002—200v	.02—400v
.15—200v	.001—600v
.002—400v	.0022—600v

### RADIO & TV TUBES

Brand New. No Rejects. No Rebrands or Rewashed. Bargains!

**ALL GOOD NUMBERS**

**YOUR DISCOUNT 60% OFF LIST**

**FREE GIFT with every order of \$5 or over**

### TUBULAR CONDENSERS—85°C

TOP QUALITY—Equally as good for TV or Radio Work

example of Value we offer	.047—600v lists at 36c	
.005—100v	.047—600v	9c
.01—400v	.1—600v	14c
.03—400v	.25—600v	12c
.047—400v	.001—1000v	11c
.1—100v	.01—1000v	14c
.25—100v	.035—1000v	16c
.005—600v	.05—1000v	18c
.01—600v	.1—1000v	22c
.02—600v	.5—400v	28c
20 mfd—150v	8 mfd—150v	26c
40/40 mfd—150v	40 mfd—150v	49c
50/30 mfd—150v	80 mfd—450v	56c

### ANY OF THESE MICA CONDENSERS

60, 100, 120, 150, 220, 330, 470, 510, 680, 820, 1000, 2000, and 3000 mmf at **5¢ each**

### ANY OF THESE CERAMIC CONDENSERS

1, 2, 5, 6, 10, 25, 47, 51, 56, 82, 100, 120, 220, 270, 470, 1200 and 1500 mmf. at **5¢ each**

### POPULAR TV ELEC CONDENSERS

40/40/4/4 mfd—450v/450v/450v/450v  
List \$3.50 Sale price **49c**

### TUBE CARTONS IN LOTS OF 100

SMALL PEANUT 1" x 1" x 2 1/8"	\$ .79
LARGE PEANUT 1" x 1" x 2 3/4"	.94
GT TYPE 1 1/4" x 1 1/4" x 3 3/8"	1.04
SMALL G 1 1/2" x 1 1/2" x 4 1/2"	1.29
LARGE G 2" x 2" x 5"	1.59
EXTRA LARGE 2 1/4" x 2 1/4" x 6 1/2"	2.67

**ONE POUND OF ROSIN CORE SOLDER 56¢**

### \$24.95 SUPER-HET RADIO

Can be installed in a #630 TV or in any other TV, Phonograph or Amplifier. Complete with tubes **\$6.99**

### CUSTOM-BUILT AUTO RADIOS

\$60.00 List Price—Write us what year FORD, DODGE, PLYMOUTH, CHEVROLET, HUDSON, HENRY J, MERCURY. **\$29.77**

If we have it, your price is.....Complete

### \$24.95 REGAL AC-DC RADIO

5-Tube Superheterodyne **\$11.49**

Built-in Antenna  
Beautiful Plastic Cabinet complete

### 3-SPEED PORTABLE PHONOGRAPH

Beautiful two-tone leatherette case. Complete ready to play... **\$13.78**

### THREE SPEED WEBSTER CHANGER

Intermixes all records  
Complete with Pick up flip-over cartridge **\$21.79**

PHONO AMPLIFIER, including 3 tubes... \$4.68  
3 SPEED PHONO MOTOR, complete... 4.47  
3 SPEED PICKUP, incl. flipover cartridge... 3.98  
\$2 PHONO SAPPHIRE NEEDLE... .46

### 12" PM SPEAKER

only 100 in stock  
limit 6 to a customer **\$3.42 each**

### 5" PM SPEAKER (Alnico #5)

case of 30..... 99c each  
smaller lots..... \$1.14 each

### 50L6 OUTPUT TRANSFORMERS

2,000 in stock  
First come, First served **29¢ each**  
List price \$1.25

AUDIO OUTPUT TRANSFORMER, (6K6)... \$ .34  
I.F. TRANSFORMER COIL, 456kc... .39  
I.F. TRANSFORMER COIL, 10.7mc... .39  
LOOPSTICK ANTENNA... .39

### ASTATIC CRYSTAL #L82

fits most pickups, list \$5.55 only **\$1.67**

### 6-FOOT LINE CORD with Plug 10c

### 4 PRONG AUTO VIBRATOR

Non Synchronous type that fits most auto sets **99¢**

TV COMPLETE SET OF DECALS..... .09

\$ 6.50 INDOOR V-type TV ANTENNA... \$1.49  
9.85 INDOOR ANTENNA with selector... 2.99  
12.00 INVERTED V ROOF ANTENNA... 3.46  
20.00 DOUBLE CONICAL ANTENNA... 5.44

### SELENIUM RECTIFIERS

75ma ... \$ .49	250ma ... \$ .88
100ma ... .56	350ma ... 1.26
150ma ... .69	450ma ... 1.49

### LATEST TYPE TV ION TRAPS

for all TV Sets **10¢**  
List price \$1.00 only

### TV CARTWHEEL CONDENSERS

10KV—list price \$1.75.....your price 9c
20KV—list price 2.25.....your price 39c
30KV—list price 4.50.....your price 69c

### \*630 SUPER DeLUXE 31-TUBE TV KIT

You receive a COMPLETE SET OF PARTS AND TUBES, everything needed is included. You will enjoy building it with "LIFE-SIZE" easy to follow step-by-step instructions.

Send this coupon with order and deduct..... **\$5.00 extra**

**\$99.99** less CRT

### AMERICAN STANDARD CRT's

17BP4	\$17.56	21EP4	\$23.18
17HP4	19.95	24CP4	39.89
20CP4	22.74	27EP4	54.72

### VOGUE TABLE MODEL TV CABINET

in mahogany or walnut (blond 10% extra). Ready drilled for any #630 TV chassis and cutout for any 16", 17", 19", 20", or 21" picture tube at no extra in price • Also supplied with undrilled knob panel for any TV set... **\$35.91**

### UNIVERSAL PICTURE TUBE MOUNTING BRACKETS

Fits all 12 1/2" to 21" picture tubes **\$4.97**

Complete—Including band that holds picture tube

### UNIVERSAL TV POWER TRANSFORMER

250ma The type most sets use. **\$5.89**  
List price \$24.50..... only

### TV FLYBACK TRANSFORMER

Latest type using IB3 with schematic & instructions for all TV Sets only **\$2.97**

### 70° COSINE DEFL. YOKE

Complete with wired network. Top make brand..... **\$2.97**  
Incl. instructions and diagrams

### VERTICAL OUTPUT TRANSFORMER

Universal type 10 to 1 Ratio **99¢**  
List Price \$6.00 Sale Price

### VERTICAL BLOCKING TRANS.

Good for most TV sets  
List Price \$3.25 only **47¢**

### PULSE KEYED AGC KIT

Finest, most accurate and the easiest kit to install in a #630 or in any other make TV receiver.  
COMPLETE SET OF PARTS Including 6AU6 tube & Instructions **\$2.99**

### TV CHEATER LINE CORD

Regular price 69c  
with both plugs Sale Price **21¢**

### TV PICTURE TUBE BOOSTER

Brightens, adds life to any CRT  
Lists for \$3.75 only **69¢**

### CONDENSER with 1000 uses

for TV, RADIO & PHONOGRAPHS  
has 2 sections 100mfd-50v 25mfd-50v  
List price \$2.75 Sale price **24¢**

### STANDARD CASCADE TUNER

For better all around performance  
Complete with tubes and Brooks CASCADE MANUAL with step-by-step instructions and all extra parts needed. **\$15.97**

### COSINE DEFLECTION YOKE

New 90° TYPE, with complete wired network. It solves all problems formerly sought for in 90° Yokes, for undistorted clear pictures and ease of overall sweep. Instructions and schematic diagrams included for building, replacing and converting..... **\$5.98**

### 18KV FLYBACK TRANSF.

This new Flyback Transformer now makes 90° conversions easy on any make TV Set. Customers report excellence on 24" and 27" TV sets built or converted with this Transformer.  
Instructions and schematic diagrams included..... **\$5.24**

**BROOKS RADIO & TV CORP., 84 Vesey St., Dept. A, New York 7, N.Y.**

only

# LAFAYETTE

can do it!

SAVE 33 1/3-50%

## PROFESSIONAL TRANSCRIPTION TURNTABLE AND VISCOUS-DAMPED TONE ARM

THE FINEST TRANSCRIPTION TURNTABLE AND TONE ARM FOR THE PROFESSIONAL USER AND THE AUDIOPHILE



**PK-100 TRANSCRIPTION TURNTABLE**  
New 3-speed instrument to delight the connoisseur, is precision engineered to provide dynamic balance and "wow-free" operation. A heavy-duty, constant speed 4-pole induction motor has a variable speed control to permit instant adjustment of the individual speeds to within  $\pm 7\%$  to compensate for power source voltage variations. The motor is freely suspended and isolated by shock-mountings to eliminate vibration transfer. The heavy, cast aluminum turntable is rim-driven and has an extra-heavy rim for smooth, effective flywheel action. Idler disengaged in "off" position. Meets professional standards for wow, flutter content, etc. Size:  $13\frac{1}{2} \times 14$ " and requires  $2\frac{3}{4}$ " clearance above and  $3\frac{3}{4}$ " below motorboard. For 110-130V 60/50 cycle AC. Supplied with removable 3-speed stroboscopic disc and 45 rpm adapter. Handsome hammertone gray finish. Shpg. wt., 20 lbs. **Net 49.50**

**PK-90 VISCOUS-DAMPED TONE ARM**  
This transcription arm assures dependable and stable operation, utilizing the "floating action" principle of "viscous-damping." The arm is supported at a single point by a pivot and jewel bearing having negligible friction. Damping is accomplished by a silicone fluid occupying the gap between a ball and socket. This damping control permits high compliance and negligible tracking error, and prevents damage to either record or stylus should the tone arm be accidentally dropped. Low frequency resonance, skidding and groove-jumping are likewise minimized. The tone arm accepts all records up to 16" and accommodates virtually all hi-fi cartridges by means of precisely engineered adapters which simplify installation and provide proper stylus pressure.  
This tone arm is a quality companion to the PK-100 with matching finish. Shpg. wt.,  $2\frac{1}{2}$  lbs. **Net 19.50**

### FM-AM TUNER KIT



**Basic FM-AM Tuner** having outstanding specifications and delivering astonishing performance — all at a budget price in easily assembled kit form.

- AFC DEFEAT CIRCUIT WITH FRONT PANEL CONTROL
- FOSTER-SEELEY DISCRIMINATOR CIRCUIT
- GROUNDED GRID TRIODE AMPLIFIER
- 20-20,000 CPS RESPONSE

Choose this 7 tube compact high-fidelity FM-AM tuner whose characteristic features are found in units costing many times as much, and whose performance is unheard of at this low price. There are two front panel controls, a function control for AM, FM, PHONO, TV and a tuning/AFC defeat control. Features Armstrong FM circuit with limiter and Foster-Seeley discriminator. Simplified tuning with slide-rule dial and flywheel counterweighted mechanism, high impedance phono input and high impedance audio output.

**SPECIFICATIONS**  
FREQUENCY RANGE: FM, 88-108MC, AM, 530-1650 KC. ANTENNA INPUT: FM, 300 ohms. AM Ferrite loopstick and high impedance external antenna. **DISTORTION:** Less than 1% at rated output. **FREQUENCY RESPONSE:** FM,  $\pm 5$  db 20 to 20,000 cps, AM  $\pm 3$  db 20 to 5000 cps. **SENSITIVITY:** FM, 5 UV for 30 db quieting, AM, Loop sensitivity 80 UV/meter. **SELECTIVITY:** FM, 200 KC bandwidth, 6 db down 375 KC FM discriminator peak to peak separation, AM, 8 KC bandwidth, 6 db down. **IMAGE REJECTION:** 30 db minimum. **HUM LEVEL:** 60 db below 100% modulation. **TUBE COMPLEMENT:** 2-12AT7, 1-6BE6, 1-6BA6, 2-6AU6, 1-6AL5 plus selenium rectifier. **SIZE:**  $5\frac{1}{4} \times 9\frac{1}{2} \times 9\frac{1}{2}$ " high  $\times 9\frac{1}{2}$ " wide  $\times 9\frac{1}{2}$ " deep (excluding knobs). **CONSUMPTION:** 30 watts. For 110-120V 60 cycles AC. Attractive etched copper-plated and lacquered finish. Less metal case. Shpg. wt., 9 lbs. **NET 32.50**

**KT-100** Metal cage for above, Shpg. wt., 3 lbs. **NET 5.00**

### LAFAYETTE SIGNAL GENERATOR



**NEVER BEFORE HAS A COMPLETELY WIRED AND TESTED INSTRUMENT OF SUCH ACCURACY AND QUALITY BEEN OFFERED AT SUCH A PRICE!**

- FREQUENCY 120 KC TO 260 MC
- 120 KC TO 130 MC ON FUNDAMENTALS
- LABORATORY ACCURACY AND QUALITY

A completely wired and tested instrument not to be confused with units sold in kit form at almost the same price, but with a quality and accuracy of instruments 3 to 4 times its price. Six overlapping ranges generate signals of 120KC — 320KC, 320KC — 1000KC, 1MC — 3.2MC — 11MC, 11MC — 38MC and 37MC — 130MC all on fundamentals with calibrated harmonics from 120MC to 260MC. Selector switch gives instant choice of ranges. Switch gives choice of internal modulation of 400 CPS or use of any external source at other frequencies. For audio testing the 400 cycle signal can be used separately. Outputs are unmodulated RF, modulated RF and 400 CPS audio. RF output is in excess of 100,000 microvolts and jacks are provided for choice of either high or low RF output. Stability is insured by special circuit design. Has a fine adjustment RF control. AF output is 2-3 volts, AF input is 4 volts across 1 megohm. Large clear 5 inch etched dial plate and pointer are protected by transparent plastic bezel. Common AF terminals for EXT-MOD input and INT-AF for audio tests eliminate need for special connectors. Machine engraved panel lettering. Handsome gray metal case with carrying handle. Measures  $6\frac{1}{2} \times 10 \times 4\frac{1}{2}$ ". Comes complete with pair of leads. AC line cord and plug. Operates on 105-125V 50-60 cycle AC. Shpg. wt., 8 lbs. **LAFAYETTE LSG-10 SIGNAL GENERATOR 22.50**

### SLIM HIGH OUTPUT DYNAMIC MICROPHONE



**NEW!**  
A pencil-slim design, high output PA Dynamic Microphone of exceptional quality, at a price that is  $\frac{1}{2}$  of the price of any comparable microphone on the market today. Very smooth response, 60-10,000 cycles. Omnidirectional, tiltable head. Switch on side gives choice of either high impedance (50,000 ohms) or low impedance (250 ohms). Instantly removable bracket permits use either on stand or as hand mike. Features exceptional mechanical strength. Cast case with satin chrome finish,  $\frac{3}{8}$ "-27 thread, Acoustically-treated grille head,  $8\frac{1}{2}$ " long;  $1\frac{1}{4}$ " barrel diameter. Shipping weight, 2 lbs. **PA-29** In lots of 3, Each **9.25** Singly, Each **9.95**

### R/C RECEIVER AND TRANSMITTER

RANGE OF APPROXIMATELY 1 MILE

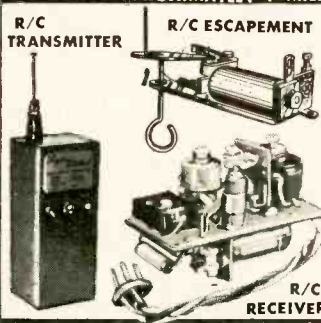

**R/C TRANSMITTER**  
**R/C ESCAPEMENT**

**R/C Receiver** is completely assembled and wired, with tube and ready to operate on exam-free 27.255 MC remote control band. Size:  $1\frac{3}{8} \times 1\frac{15}{16} \times 3\frac{1}{2}$ ". Requires one 1.5 volt and one 45 volt battery. **F-208** **Net 7.95**

**R/C Transmitter** is completely assembled, tested and guaranteed, and includes tube and 27.255 MC crystal. 5 section telescoping antenna. Size:  $4 \times 4 \times 12$ ". Less batteries. Shpg. wt. 3 lbs. **F-249** **Net 19.95**

**TRANSMITTER** 1 Burgess, 2D or RCA VSO69 Net. Ea. **.45**  
**BATTERIES:** 2 Burgess XX45 or RCA VSO16 **Net. Ea. 2.28**

**R/C Escapement** is completely wired, sturdy and self-neutralizing. Weighs  $\frac{1}{2}$  oz. Low current drain. Size:  $1\frac{5}{8} \times 1 \times 1\frac{1}{2}$ " W. Shpg. wt. 5 oz. **F-194** **Net 2.45**

### SPECIAL COMBINATION OFFER

Consists of R/C Transmitter (F-249), R/C Receiver (F-208) and Escapement (F-194). All three at a super special **F-250** **Net 28.95**

### LAFAYETTE GEIGER COUNTER KIT WITH HIGH SENSITIVITY VICTOREEN TUBE 1B85



Lafayette Geiger Counter Kit with High Sensitivity Victoreen 1B85 tube, makes this one of the most outstanding kit buys in the country. This tube is used only in the most expensive equipment. Easy to build, at only a fraction of the price, of commercial instruments of this type. Just turn it on, flip the high voltage switch and listen to the clicks. Kit includes all parts, tube, carrying case,  $22\frac{1}{2}$ " and  $1\frac{1}{2}$ " volt Batteries. Complete instructions for quick assembly. Shpg. wt.,  $1\frac{1}{2}$  lbs. **KT-75** **Net 14.95**

### CRYSTAL MICROPHONE



**COMPARE IT WITH ANY MIKE AT 2 TO 3 TIMES THE PRICE**  
A quality crystal microphone for PA systems, house recorders, etc. Frequency response 30 to 10,000 cycles. Output level — 52 db. Provides simple output for use with low gain amplifiers. Complete with 3 ft. of shielded cable. Shpg. wt.,  $3\frac{1}{2}$  lbs. **PA-24** in lots of 3, each **3.95** singly, each **4.25**

### IMPORTED BINOCULARS



All have coated lenses — clamped in prism — light weight metal bodies. Complete with case and straps.

F-182	6x.15	I.F.	NET 10.75
F-105	8x.30	I.F.	NET 14.95
F-15	7x.35	I.F.	NET 17.95
F-183	7x.35	C.F.	NET 20.95
F-103	7x.50	I.F.	NET 21.50
F-164	7x.50	C.F.	NET 24.95
F-17	8x.50	I.F.	NET 25.95
F-104	12x.50	I.F.	NET 27.95
F-118	10x.60	C.F.	NET 31.50
F-185	20x.50	C.F.	NET 37.50

Add 10% Fed. Tax to Above Prices

### IMPORTED 12 HI-FI COAX. SPEAKER



Reg. Price **44.50**  
**Net 29.50**

- FREQUENCY RANGE 30-15000 CPS
- HANDLES 20 WATTS OF POWER
- COMPLETE WITH LEVEL CONTROL
- POWERFUL TSK-5 MAGNETS
- SPECIAL SHEEPSKIN-EDGED CONE

A Lafayette exclusive import and exceptional value. Consists of a 12" woofer, coaxially mounted  $2\frac{1}{2}$ " tweeter and a built-in crossover network. The specially processed fibre cone has a sheepskin edge to suppress unwanted nodal vibrations and insure beautiful tone quality. Highly efficient TSK-5 magnets. Level control provides variation to 6 db cut. Maximum input 20 watts. Impedance 8 ohms. Rugged all-metal frame. If made in this country, would cost at least \$49.50. Shpg. wt., 11 lbs. **SK-58** **Net 29.50**

### REMOTE CONTROL FOR SILENT TV VIEWING

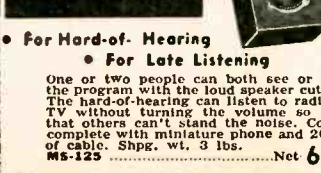

• For Hard-of-Hearing  
• For Late Listening

One or two people can both see or hear the program with the loud speaker cut-on. The hard-of-hearing can listen to radio or TV without turning the volume so high that others can't stand the noise. Comes complete with miniature phone and 20 ft. of cable. Shpg. wt. 3 lbs. **MS-125** **Net 6.50**

**Lafayette Radio** DEPT. JG  
BRONX, N.Y. 542 E. Fordham Rd  
NEWARK, N.J. 24 Central Ave.  
PLAINFIELD, N.J. 139 West 2nd St.  
NEW YORK, N.Y. BOSTON, MASS. 110 Federal St.  
Include postage with order.

Send FREE 132-Page Lafayette Catalog

Name \_\_\_\_\_  
Address \_\_\_\_\_  
City \_\_\_\_\_ Zone \_\_\_\_\_ State \_\_\_\_\_



10 PLANES

NOW  
**2 SIZES**  
cover  
every need



**CDP**<sup>®</sup>  
COMPOUND  
DIFFRACTION  
PROJECTOR\*

**NO DEAD SPOTS NO HOT SPOTS**

Coverage is clear, penetrating, uniform, **OFF AXIS** and **ON AXIS**

**COAXIAL WIDE-RANGE DESIGN**

Two coaxially mounted diffraction horns work from opposite sides of a single diaphragm. Each horn is designed for optimum reproduction within its own range.

**PHENOMENAL POLAR PATTERN**

Smooth, peak-free, wide-range response with over 120° sound distribution at all frequencies up to 10,000 cps.

**OPTICAL SLIT DIFFRACTION PRINCIPLE**

Uses acoustic application of optical slit diffraction for perfected smooth, uniform sound dispersion over entire listening area, virtually independent of frequency. No pin-pointing effect. Unit may be mounted horizontally or vertically to vary polar pattern for desired dispersion.

**TOUGH—PRACTICALLY INDESTRUCTIBLE**

Molded of fiberglass for improved acoustic properties and extra strength. Weatherproof, blast-proof, splash-proof.

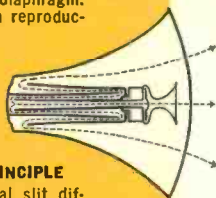

Success of the CDP is in the record of public address installations. Now in addition to the "848," E-V brings you the new, smaller, lower-cost "847." Both now make it easy to take advantage of superior CDP wide-range performance for the smallest paging job as well as the largest stadium application, indoors and outdoors. Unique coaxial design, with its two specialized horn sections, provides smooth, extended high-frequency response and unusual low-frequency balance. Diffraction principle gives smooth, wide, uniform dispersion, without any cellular pin-pointing effect. Low distortion and high articulation improve speech intelligibility. Musicasting is full-bodied and clean. High efficiency and sensitivity provide superior coverage of the listening area with fewer units and at far less cost. There's no wasted power. Compare the CDP with any other unit in the environment in which it actually will be used—and *hear* the difference.

For broadcast quality in public address, use E-V 664 cardioid dynamic microphone.

\*Pat. D169, 904 and Pat. Pend.



Model 847 CDP. 12 watts. 16 ohms. Response 250 to 10,000 cps. RETMA sensitivity rating 51 db. Crossover at 1500 cps. Size 7¾ in. wide, 11¼ in. high, 10-7/32 in. deep over-all. Includes mounting bracket. Net wt. 6½ lbs. List, \$43.50 Net, \$26.10

Model 848 CDP. 25 watts. 16 ohms. Response 175 to 10,000 cps. Crossover at 1000 cps. Sensitivity rating 52 db. Size 10½ in. wide, 20½ in. high, 20 in. deep over-all. Includes mounting bracket. Net wt. 12 lbs. List, \$69.50 Net, \$41.70

No Finer Choice than

**Electro-Voice**<sup>®</sup>

Ask for a demonstration or get full facts. Send for CDP Bulletin No. 221. N64

ELECTRO-VOICE, INC. • BUCHANAN, MICHIGAN

HIGH-FIDELITY SPEAKER SYSTEMS, MICROPHONES, AMPLIFIERS, TUNERS, PHONO-CARTRIDGES

www.americanradiohistory.com

MISS COLOR-TV OF 1956 AND YOUR RCA TUBE DISTRIBUTOR



present:  
*The Famous RCA Institutes'*

# COLOR-TV HOME STUDY COURSE\*

free of extra charge when  
you buy RCA Receiving Tubes



*Expanded RCA course—includes  
two new lessons, never before  
offered, giving you all the  
latest information on "Big Color" TV*

Now is the time to enroll in RCA's extended Color-TV Home Study Course. Be set to cash in on the tremendous opportunity Color-TV holds for you. It is a practical and down-to-earth course—prepared by Color-TV experts just for service technicians.

Go to your regular RCA Tube Distributor and ask for full details.

P.S.: If you're one of the thousands who has completed RCA's previous 9-lesson course, bring yourself up-to-date with the new advanced lessons. Special "Certificate" awarded.

## 11 Steps to Profit in Color-TV Servicing

### THE BASIC 9 LESSONS

- 1 Introduction to Color-TV
- 2 Principles of Two-Phase Modulation and Colorimetry
- 3 Principles of Color-TV Receivers
- 4 Color Kinescopes
- 5 The Color-TV System
- 6 Color-TV Receiver Circuits
- 7 Set-up and Adjustment of Color-TV Receivers
- 8 Servicing and Alignment of Color-TV Receivers
- 9 Test Equipment for Color-TV Servicing

### PLUS 2 Brand New Advanced Lessons

- 10 Large Screen Color
- 11 New Color-TV Circuitry



**RCA RECEIVING TUBES**  
RADIO CORPORATION OF AMERICA HARRISON, N. J.