

*Deben Ford*

JUNE 1953

# RADIO — ELECTRONICS

T.V.  
ISSUE

**LATEST IN TELEVISION • SERVICING • AUDIO**

**ROBES**

*5/15/26*

*27*

*7*  
*189*

*92*  
*2*  
*184*

**5-TONE  
CONTROLS** *Audio*

**4 SIGNAL  
TRACING (TV)**

*91*  
**76-P-A  
HOOKUPS + FIX**

**30¢**

U. S. and  
CANADA

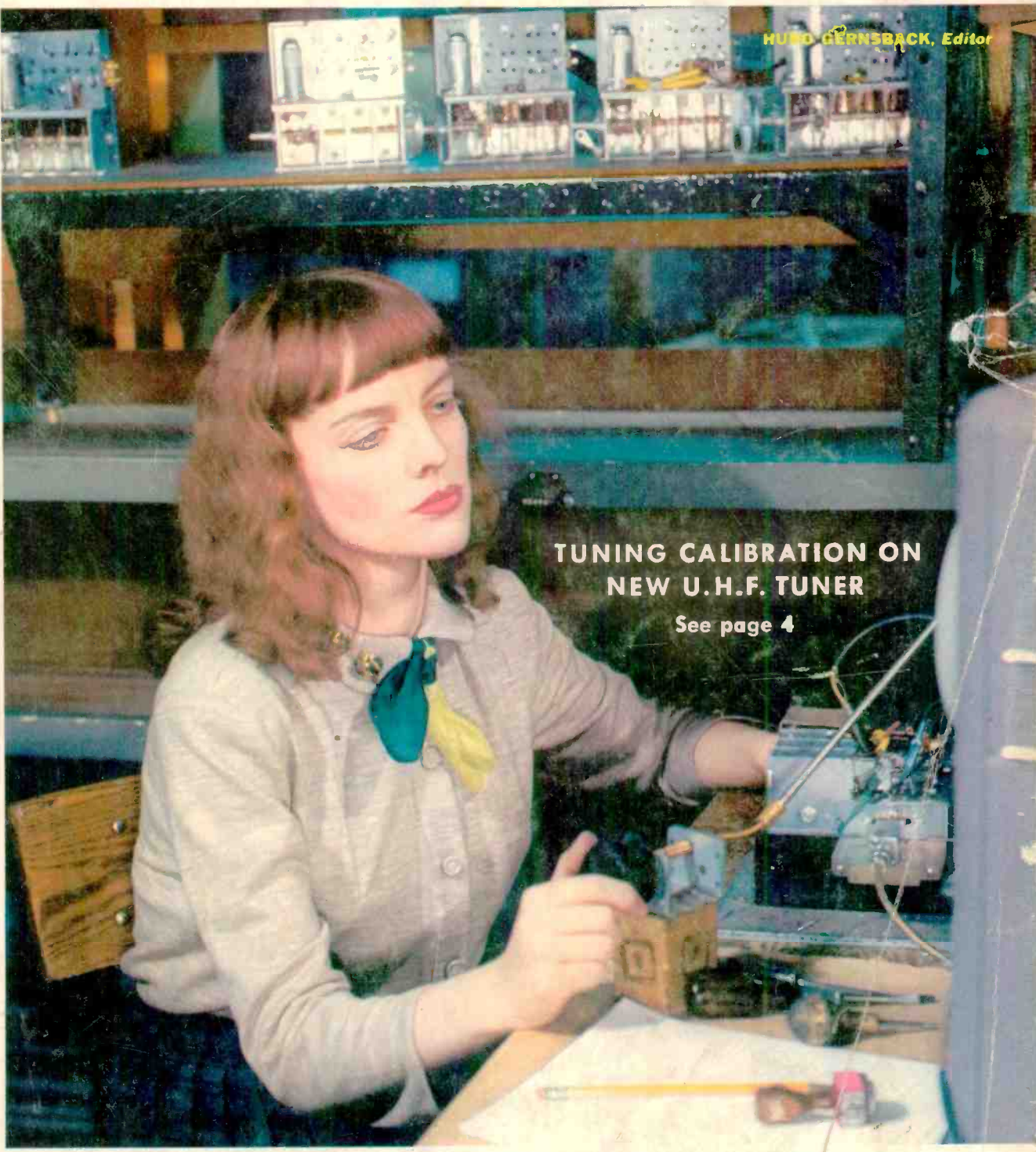

**TUNING CALIBRATION ON  
NEW U.H.F. TUNER**

See page 4

**In this issue: New TV Boosters from Old Tuners •  
Transistor Fundamentals • PA Hookup Problems**





**"Naturally I like to sell RCA Radio Batteries—**  
*they're my brand. When my customers think of  
 RCA—they remember the local radio dealers and  
 servicemen selling RCA tubes and batteries. That's  
 why my steady business grows when I sell RCA  
 Batteries—my customers look to a radio dealer  
 for RCA Radio Batteries."*



**"My battery inventory  
 problems were licked** when I started  
*to concentrate on RCA Radio Batteries.  
 I found that with ten RCA Battery types  
 I can do 95% of my dollar volume in  
 batteries. And what's more . . . with the  
 complete line of RCA Batteries I have a  
 type to sell for all leading portable radio  
 models in use today. Last year my RCA  
 Battery inventory turned over 15 TIMES."*



**"National television  
 and radio advertising** plus out-  
*standing merchandising and promo-  
 tional backing make RCA Batteries  
 my fast-selling profit makers. By  
 publicizing my store as local RCA  
 Battery headquarters, I find I'm  
 attracting many new customers for  
 my other radio products and services.  
 It sure pays to sell RCA Batteries."*



**"Every radio dealer and  
 serviceman** should stock and  
*sell RCA Batteries . . . the radio  
 battery for the radio trade. RCA  
 Batteries have brought me more  
 sales, more profits and more  
 satisfied customers."*



**RADIO CORPORATION of AMERICA**  
 RADIO BATTERIES  
 HARRISON, N. J.





# I'LL TRAIN YOU FOR YOUR FCC LICENSE

A Federal Communications Commission Commercial Operator's License puts you in line for a good job in Radio or Television Broadcasting, Police, Marine, Aviation, Two-way, Mobile or Micro-wave Relay Radio. Mail coupon below for 64-page book FREE. It will give you complete facts about my NEW Communications course.



## YOU BUILD THIS TRANSMITTER

with parts I send. With this Transmitter you practice how to put a station "on the air." You perform procedures demanded of Broadcast Station Operators, conduct many experiments, make many practical tests.

# LEARN COMMUNICATIONS by PRACTICING at Home in Spare Time

## Get Practical Experience on Circuits Common to Radio & TV

Ever think HOW FAST Radio-Television Communications is changing, developing, growing? Have you considered what this amazing progress can mean to you? Even without Television the industry is bigger than ever before. 105 million home and auto radios, 2900 Radio Broadcasting Stations, 108 TV Stations with 1800 more now authorized. Expanding use of Aviation and Police Radio, Micro-Wave Relay, Two-Way Radio for buses, taxis, etc. makes opportunities for Communications Technicians and FCC Licensed Operators. New jobs, more jobs for beginners! Better jobs, better pay for experienced men!

## Television Is Today's Good Job Maker

In 1952, over 18,000,000 homes had TV sets. More are being sold every day. The "freeze" on building new TV stations has been lifted. The time to act is NOW! Start learning Radio-TV communications. America's fast growing industry offers good pay, a bright future, security. If you are a beginner, my course can help you get FCC License, prepare for the job you

J. E. SMITH, President  
National Radio Institute  
Washington, D. C.  
For 33 years, the leader  
in training men for  
Radio-Television.



## MY COURSE INCLUDES TELEVISION

want. If you've had some training in Radio or Radar, or as a Licensed Operator, my course modernizes, increases the value of your knowledge.

## Includes New Developments

Mail coupon now for facts about my practical course in Radio-Television Communications. Let me send you my FREE book. See the nine big Kits of Parts I send that "bring to life" theory you learn. You get practical experience by working on circuits common to both Radio and Television; also lessons on TV principles. Read about the Transmitter you build and operate, about the Electronic Multitester you get. All equipment is yours to keep.

My graduates are filling jobs, making good money in both Radio and Television. Remember, the way to a successful career in Television is through experience in Radio.



**YOU BUILD** this Transmitter Power Supply used in the basic experiments in RF and AF amplifiers, frequency multipliers, buffers, etc.



**YOU MEASURE** current, voltage (AC, DC and RF), resistance and impedance in circuits with Electronic Multitester you build. Shows how basic transmitter circuits behave; needed to maintain station operation.



**YOU PRACTICE** setting up code, amplitude and frequency modulation circuits (put voice, music, etc., on "carrier signals" you produce). You learn how to get best performance.

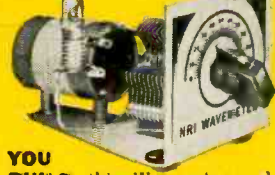

**YOU BUILD** this Wavemeter and use it to determine frequency of operation, make other tests on transmitter currents.

## Training Leads to Jobs Like These

- |   |   |   |  |
|---|---|---|--|
| <b>BROADCASTING</b><br>Chief Technician<br>Chief Operator<br>Power Monitor<br>Recording Operator<br>Remote Control Operator | <b>SHIP AND HARBOR RADIO</b><br>Chief Operator<br>Assistant Operator<br>Radiotelephone Operator | <b>GOVERNMENT RADIO</b><br>Operator in Army, Navy, Marine Corps, Coast Guard<br>Forestry Service<br>Dispatcher<br>Airways Radio Operator<br><b>POLICE RADIO</b><br>Transmitter Operator<br>Service Technician | <b>AVIATION RADIO</b><br>Plane Radio Operator<br>Airport Transmitter Operator<br><b>TELEVISION</b><br>Pick-Up Operator<br>Voice Transmitter Operator<br>TV Technician<br>Remote Control Operator |
|---|---|---|--|

## TRAINED THESE MEN

**WARREN DEEM**  
"My position with WNBT is video control engineer on the RCA color project. I owe a lot of my success to your textbooks."—Warren Deem, Malverne, N. Y.

**JOHN BRITTO**  
"I am a technician at WTOP in Washington and I like it very much. Most of my radio knowledge was from N.R.I."—John Britto, Hyattsville, Md.

AVAILABLE TO **VETERANS** UNDER G.I. BILLS

**ALBERT HERR**  
"A former employer recommended N.R.I. training. Now employed as transmitter operator at WKBO."—Albert Herr, New Cumberland, Pa.

## Servicing Training Also Offered by N. R. I.

If you prefer a good-pay job in Radio-Television Servicing or your own money-making Radio-Television Sales and Service Shop, I'll train you at home. My famous Servicing Course also includes many Kits of Radio Parts. You use them to get PRACTICAL EXPERIENCE with circuits common to Radio and Television. I also show you how to make \$5. \$10 a week or more EXTRA MONEY fixing neighbors' Radios while training. Full information in my 64-page book. Mail coupon.

## Mail Coupon for Book FREE

Send today! See what my Communications course is like. Find out how I get you ready for a brighter future, better earnings, more security in Radio-Television. Send coupon now in envelope or paste on postal **NO OBLIGATION, NO SALESMAN WILL CALL!** My book, sent to you FREE, tells the full story. J. E. SMITH, President, Dept. 3FF, National Radio Institute, Washington 9, D. C. Our 39th year.

## MAIL NOW-BOOK FREE

MR. J. E. SMITH, President, Dept. 3FF  
National Radio Institute, Washington 9, D. C.  
Mail me Sample Lesson and 64-page Book, FREE. (No salesman will call. Please write plainly.)

Name ..... Age .....

Address .....

City ..... Zone ..... State .....

**VETS** write in date of discharge .....

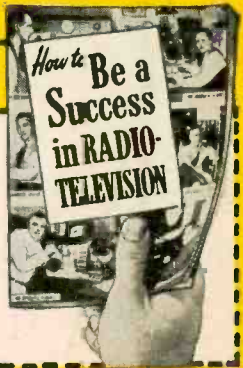

KING



# RADIO - ELECTRONICS

Formerly RADIO-CRAFT • Incorporating SHORT WAVE CRAFT • TELEVISION NEWS\* • RADIO & TELEVISION\*

## CONTENTS

JUNE, 1953

Hugo Gernsback  
Editor and Publisher

M. Harvey Gernsback  
Editorial Director

Fred Shunaman  
Managing Editor

Robert F. Scott  
W2PWG, Technical Editor

Mortimer Bernstein  
Associate Editor

I. Queen  
Editorial Associate

Matthew Mandl  
Television Consultant

Angie Pascale  
Production Manager

Wm. Lyon McLaughlin  
Tech. Illustration Director

Sol Ehrlich  
Art Director

Lee Robinson  
General Manager

John J. Lamson  
Sales Manager

G. Aliquo  
Circulation Manager

Robert Fallath  
Promotion Manager



Member  
Magazine Publishers  
Association

ON THE COVER (See page 32) Barbara Reid makes tuning adjustments on the G.I. u.h.f. front end. Scene is the General Instrument factory in Elizabeth, N. J.  
*Color original by Avery Slack*

### Editorial (Page 27)

Closed-Circuit Television .....by Hugo Gernsback 27

### Television (Pages 28-41)

New Boosters from Old Tuners.....by Joseph Morsholl 28

Design Data on Video Amplifiers, Part IV.....by Alan G. Sorensen 31

Model 60 u.h.f. Tuner .....by Fred M. Borr 32

Signal Tracing in TV, Part III.....by Engineering Staff, Scalo Radio Co. 34

Television?—it's a Cinch—Fourth Conversation.....by E. Aisberg 36

TV Service Clinic .....conducted by Matthew Mandl 40

### Electronics (Pages 42-44)

Transistors.....by John R. Pierce 42

### Audio (Pages 45-48)

A Bridged-T Audio Control.....by Wm. Austin 45

Overcoming PA Hookup Problems.....by N. H. Crowhurst 46

### Servicing—Test Instruments (Pages 49-53)

Transistor Microammeter.....by Nathaniel Rhita 49

TV Chassis Simplified..... 50

Stubs.....by Jesse Dines 52

### Theory and Engineering (Pages 54-56)

The Effect of Sporadic E on TV Reception.....by Ernest K. Smith, Jr. 54

### Construction (Pages 58-64)

Sensitive Capacity Relay.....by E. W. Scott 58

### Amateur (Page 66)

1N34 NBFM-PM Modulator.....by George W. Maki 66

### New Design (Pages 68-83)

IRE Convention 1953.....by Fred Shunaman 68

New Tubes..... 79

### Departments

The Radio Month 8 Radio-Electronic People ..... 113

Radio Business... 14 Circuits ..... 96 Communications ..... 115

With the Technician ... 84 Try This One... 101 Electronic ... 118

New Devices... 89 Question Box... 104 Literature ... 118

New Patents... 93 Technotes ..... 108 Book Reviews... 119

Miscellany ..... 111



MEMBER Audit Bureau of Circulations

Vol. XXIV, No. 6

RADIO-ELECTRONICS, June 1953, Vol. XXIV, No. 6. Published monthly at Erie Ave., F to G Sts., Philadelphia 32, Pa., by Gernsback Publications, Inc. Entered as Second Class matter September 27, 1948, at the Post Office at Philadelphia, Pa., under the Act of March 3, 1879.

SUBSCRIPTION RATES: In U. S. and Canada, In U. S. possessions, Mexico, South and Central American countries, \$3.50 for one year; \$6.00 for two years; \$8.00 for three years; single copies 30c. All other foreign countries \$4.50 a year, \$8.00 for two years; \$11.00 for three years.

EXECUTIVE, EDITORIAL and ADVERTISING OFFICES: 25 West Broadway, New York 7, N. Y. Telephone REctor 2-8630. Gernsback Publications, Inc. Hugo Gernsback, President; M. Harvey Gernsback, Vice-President; G. Aliquo, Secretary.

SUBSCRIPTIONS: Address correspondence to Radio-Electronics, Subscription Dept., Erie Avenue, F to G Sts., Philadelphia 32, Pa., or 25 West Broadway, New York 7, N. Y. When ordering a change please furnish an address stencil impression from a recent wrapper. Allow one month for change of address.

BRANCH ADVERTISING OFFICES: Chicago: 100 E. Ohio St., Tel. Superior 7-1796. Los Angeles: Ralph W. Harker, 1127 Wilshire Blvd., Tel. MAdison 6-1271. San Francisco: Ralph W. Harker, 582 Market St., Tel. GARfield 1-2481. FOREIGN AGENTS: Great Britain: Atlas Publishing and Distributing Co., Ltd., London E.C.4. Australia: McGill's Agency, Melbourne. France: Brentano's, Paris 2e. Belgium: Agence et Messageries de la Presse, Brussels. Holland: Trilectron, Heemstede. Greece: International Book & News Agency, Athens. So Africa: Central News Agency, Ltd., Johannesburg; Capetown; Durban, Natal. Universal Book Agency, Johannesburg. Middle East: Steimatzky Middle East Agency, Jerusalem. India: Broadway New Centre, Dadar, Bombay #14. Pakistan: Paradise Book Stall, Karachi 3. Copyright 1953 by Gernsback Publications, Inc. Text and illustrations must not be reproduced without permission of copyright owners. POSTMASTER: If undeliverable send form 3578 to: RADIO-ELECTRONICS, 25 West Broadway, New York 7, N. Y. \*Trademark registered U.S. Patent Office.

RADIO-ELECTRONICS



# ADVANCE! Raise your earning power—learn RADIO-TELEVISION-ELECTRONICS by SHOP-METHOD HOME TRAINING

## GOOD JOBS AWAIT THE TRAINED RADIO-TV TECHNICIAN

There is a place for you in the great Radio-Television-Electronics industry when you are trained as National Schools will train you at home!

Trained technicians are in growing demand at good pay—in manufacturing, broadcasting, television, communications, radar, research laboratories, home Radio-TV service, and other branches of the field. National Schools Master Shop-Method Home Training, with newly added lessons and equipment, trains you in your spare time, right in your own home, for these fascinating opportunities. OUR METHOD IS PROVED BY THE SUCCESS OF NATIONAL SCHOOLS TRAINED MEN, ALL OVER THE WORLD, SINCE 1905.

## EARN WHILE YOU LEARN

Many National students pay for all or part of their training with spare time earnings. We'll show you how you can do the same! Early in your training, you receive "Spare-time Work" Lessons which will enable you to earn extra money servicing neighbors' and friends' Radio and Television receivers, appliances, etc.



Signal Generator

Audio Oscillator

T. R. F. Receiver

## National Schools Training is All-Embracing

National Schools prepares you for your choice of many job opportunities. Thousands of home, portable, and auto radios are being sold daily—more than ever before. Television is sweeping the country, too. Co-axial cables are now bringing Television to more cities, towns, and farms every day! National Schools' complete training program qualifies you in all fields. Read this partial list of opportunities for trained technicians:

- Business of Your Own • Broadcasting
- Radio Manufacturing, Sales, Service • Telecasting
- Television Manufacturing, Sales, Service
- Laboratories: Installation, Maintenance of Electronic Equipment
- Electrolysis, Call Systems
- Garages: Auto Radio Sales, Service
- Sound Systems and Telephone Companies, Engineering Firms
- Theatre Sound Systems, Police Radio
- And scores of other good jobs in many related fields.

## TELEVISION TRAINING

You get a complete series of up-to-the-minute lessons covering all phases of repairing, servicing and construction. The same lesson texts used by resident students in our modern and complete Television broadcast studios, laboratories and classrooms!



**MASTER ALL PHASES!**  
Get Master Shop-Method Home Training from an Established Practical Resident School with its own Training Shops, Laboratories, Studios — almost 50 Years of Successful Experience in Training Ambitious Men.  
**We Bring National Schools To You!**



You also receive this Multitester

Superheterodyne Receiver

## LEARN BY DOING

You receive and keep all the modern equipment shown above, including tubes and valuable, professional quality Multitester. No extra charges.

## FREE! RADIO-TV BOOK AND SAMPLE LESSON!

Send today for National Schools' new, illustrated Book of Opportunity in Radio-Television-Electronics, and an actual Sample Lesson. No cost—no obligation. Use the coupon now—we'll answer by return airmail.

**APPROVED FOR VETERANS AND NON-VETERANS**  
Check coupon below

Both Resident and Home Study Courses Offered!



## NATIONAL SCHOOLS

LOS ANGELES 37, CALIFORNIA • ESTABLISHED 1905  
IN CANADA: 193 E. HASTINGS STREET, VANCOUVER, B.C.

## FIND OUT NOW—MAIL COUPON TODAY!

NATIONAL SCHOOLS, Dept. RG-63  
4000 South Figueroa Street  
Los Angeles 37, California

Mail in envelope or paste on postal card.

Send FREE Radio-TV Electronics book and FREE sample lesson. I understand no salesman will call on me.

NAME \_\_\_\_\_ AGE \_\_\_\_\_  
ADDRESS \_\_\_\_\_  
CITY \_\_\_\_\_ ZONE \_\_\_\_\_ STATE \_\_\_\_\_

- Check here if released from service less than 4 years ago.
- Check here if interested in Resident School Training.



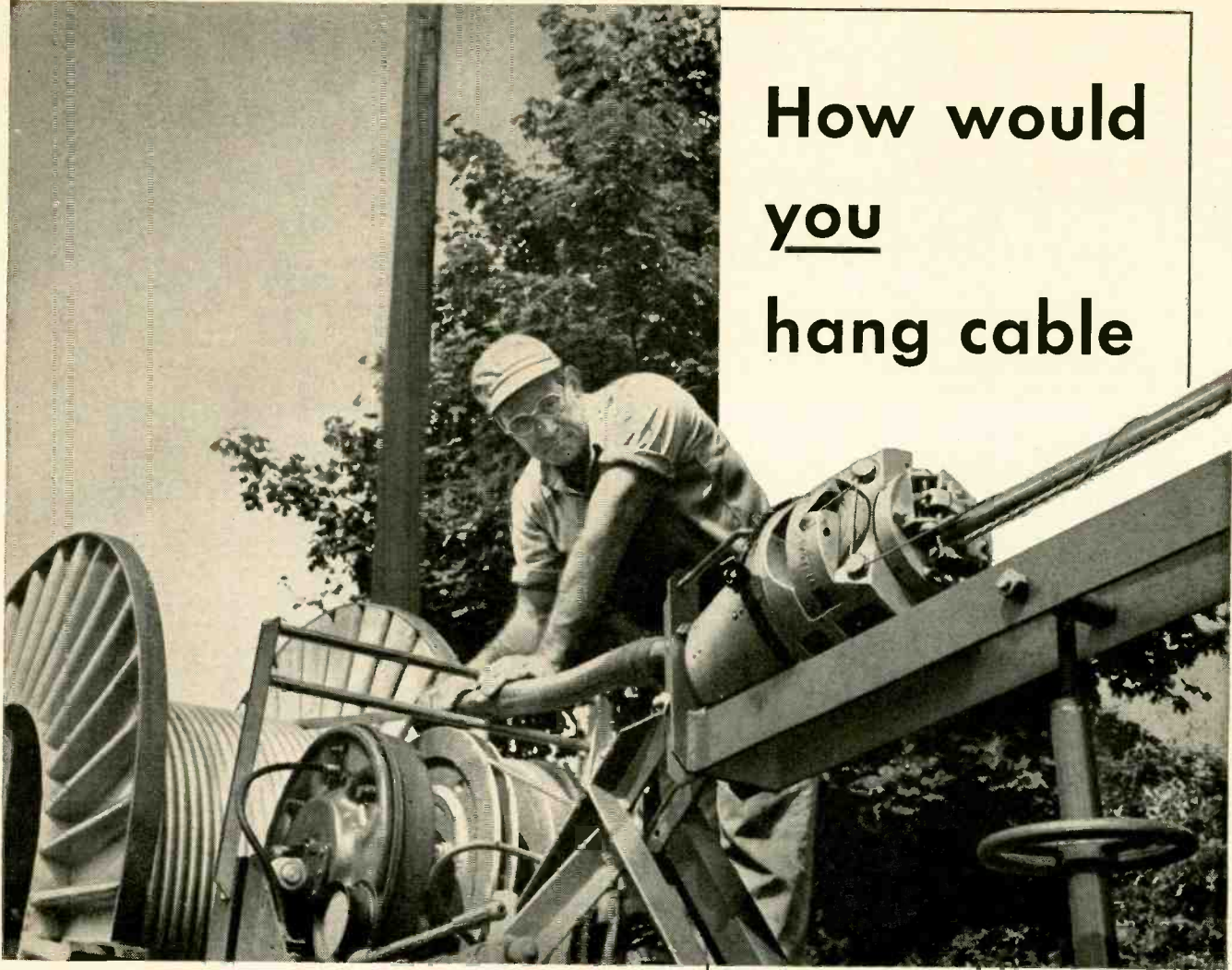

Cable lasher appears to right of workman. As the cable and supporting strand feed through, the machine rotates, binding them together with steel lashing wire. Meanwhile, a winch hauls the lashed cable into position.

## How would you hang cable

...by the  
mile?

It is a job your telephone company faces every day. Thousands of miles of cable go up each year—all secured to steel strand running from pole to pole. The best way to secure cable is to *lash* it to the strand with a spiral binding of wire.

One way to do this is to raise cable and strand separately, then lash them together by a rotating machine pulled along by workmen on the ground. This produces a strong, tight support for the cable. But each pole has to be climbed as many as four times. So Bell Laboratories engineers devised an easier way.

Now, lashing can be done *on the ground* so that cable, strand and lashing wire may be pulled into position as a complete assembly. Usually workmen need make only two trips up each pole.

For telephone users, the new way means that cable can be installed faster, while costs are kept down. It shows again how work at Bell Telephone Laboratories improves each part of your telephone system.

## Bell Telephone Laboratories



IMPROVING TELEPHONE SERVICE FOR  
AMERICA PROVIDES CAREERS FOR CREATIVE  
MEN IN MECHANICAL ENGINEERING

RADIO-ELECTRONICS



# What's your goal in TV-ELECTRONICS and how close to it are you?

Free CREI booklet lists opportunities  
and shows how to grasp them



**D**O YOU HAVE a career time-table? Do you know how much you should or could be earning two years from now? Five years? Many men are plodders without a plan. They wander through life never doing what they want to do, never receiving enough pay, never achieving true career satisfaction. Because they never knew ahead of time where they should or could be at a given date, they never planned ahead. When an opening arises, somebody else is promoted. When January 1st rolls around, they're just where they were a year before. Their *error*, failure to plan, can be the lesson which shows you the secret of future success. In this expanding, bustling TV-Electronics world, there is a whole lifetime of happiness and high earnings waiting for you, if you name your goals, and take steps to reach them. Thousands of ambitious young men have found success in TV-Electronics through the aid of the CREI booklet, "Your Future in the New World of Electronics." The newest edition tells of electronics' golden opportunities. 152 TV stations are now on the air with 2,000 more coming. There are over 23,000,000 TV sets and over 100 million radios in use.

This is the era of Communication: aeronautical, marine, police and fire, industrial, land transportation communications; this is the era of defense orders and a manufacturing industry which last year alone sold 3.8 billion dollars worth of electronic equipment, and is expected to do no less than 10 billion dollars worth excluding military orders. All these developments mean positions; in development, research, design, production, testing, inspection, manufacture, broadcasting, telecasting and servicing. Who will get these positions? You—if you have a career time-table; if you can foresee your future in electronics; if you are willing to advance your knowledge; if you spend 2 minutes to write for your copy of "Your Future In the New World of Electronics," and follow the plan it describes.

This is the booklet that shows you how CREI home study leads the way to greater earnings. However, being an accredited technical school, CREI promises you no short-cuts. You must translate your willingness to learn into salable technical knowledge via study. CREI knows what it means to grow along with a booming industry. This year CREI is celebrating its 26th Anniversary, having started in 1927 in the early days of radio. Since then CREI has provided thousands of professional radiomen with technical educations. During World War II, CREI trained thousands for the Armed Services. Leading firms use CREI courses for group training in electronics at company expense; among them are United Air Lines, Canadian Broadcasting Cor-

poration, Trans-Canada Airlines, Sears Roebuck & Co., Bendix Products Division, All-American Cables and Radio, Inc., RCA-Victor Division and Machlett Laboratories. CREI courses, prepared by recognized experts, are constantly revised to keep them up-to-date. Student work is under the personal supervision of a CREI Staff Instructor who knows and teaches what industry needs.

You choose your own hours when you study at home. Upon completion you join the many CREI graduates who have found their diplomas keys-to-success in Radio, TV and Electronics. CREI alumni hold many top positions in America's leading firms.

At your service is the CREI Placement Bureau which helps find positions for students and graduates. Although CREI does not guarantee jobs, the bureau now has many more requests for personal than can be filled. Talk to men in the field and check up on CREI's high standing in electronics instruction. Determine for yourself right now that your earnings are going to rise with your knowledge—and that you will rise with this booming industry. All this CREI offers you, provided you sincerely want to learn. Fill out the coupon and mail it today. We'll promptly send you your free copy of "Your Future in the New World of Electronics." The rest—your future—is up to you.

CREI resident instruction (day or night) is offered in Washington, D.C. New Classes start once a month.  
**VETERANS:** If you were discharged after June 27, 1950—check the coupon for full information about the new G.I. Bill of Rights.

## MAIL COUPON FOR FREE BOOKLET

### CAPITOL RADIO ENGINEERING INSTITUTE

Dept. 146 3224 16th St., N.W., Washington 10, D. C.  
Send booklet "Your Future in the New World of Electronics" and course outline.

CHECK FIELD OF GREATEST INTEREST }  TV, FM & Advanced AM Servicing  Aeronautical Radio Engineering  
 Practical Television Engineering  
 Broadcast Radio Engineering (AM, FM, TV)  
 Practical Radio Engineering

Name .....

Street .....

City ..... Zone ..... State .....

Check  Residence School  G.I.



take the  
kick  
out of  
TV

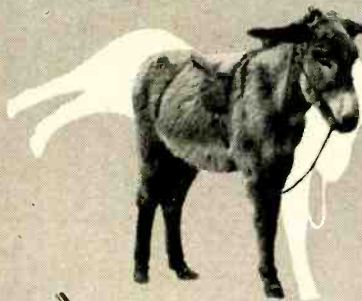

Burton Browne advertising



## CORONA FREE HVO-X7 FLYBACK TRANSFORMER

Merit's famous HV07 is now treated to a miracle-tough, new non-hygroscopic insulation. Liquid-molded, this latest development in insulating materials encloses the high voltage winding, is impervious to moisture and high humidity and forms a watertight seal for the high voltage lead. Unaffected physically or electrically by cycles of heat and cold, it will withstand operating temperatures 50% above normal without change. Its high dielectric constant affords maximum protection with minimum distributive capacity.

MERIT COIL AND TRANSFORMER CORP.  
4425 NORTH CLARK ST., CHICAGO 40

# MERIT

**ALFENOL**, new alloy of approximately 16% aluminum and 84% iron, may help to produce lighter and better transformers and other "iron-core" components. The new metal has high permeability and low retentivity, is magnetizable by very low currents and holds very little of its magnetism after the current is turned off.

**NINETEEN NEW TV STATIONS** on the air between March 14 and April 25 brought the U. S. total to 167—59 since the end of the freeze. The five new stations in the v.h.f. bands: KDZA-TV, Pueblo, Col., 3; KFDX-TV, Wichita Falls, Texas, 3; KTTS-TV, Springfield, Mo., 10; KFDA-TV, Amarillo, Texas, 10; KTYL-TV Mesa, Ariz., 12; and KCJB-TV, Minot, N. D., 13.

The thirteen new u.h.f. stations: KRTV, Little Rock, Ark., 17; WPAG-TV, Ann Arbor, Mich., 20; WCOV-TV, Montgomery, Ala., 20; WFTL-TV, Ft. Lauderdale, Fla., 23; WCOS-TV, Columbia, S. C., 25; WAFB-TV, Baton Rouge, La., 28; WEEV-TV, Reading, Pa., 33; WICC-TV, Bridgeport, Conn., 43; WKST-TV, New Castle, Pa., 45; WLEV-TV, Bethlehem, Pa., 51; WHP-TV, Harrisburg, Pa., 55; WKNX-TV, Saginaw, Mich., 57; and WLOK-TV, Lima, Ohio, 73.

**EDUCATIONAL TV FAILURE** would be "a second American tragedy in broadcasting," according to a speech by ex-FCC Chairman Paul A. Walker at Boston University. Mr. Walker said the educators must meet the challenge of "this new medium of a new day" and unite with citizens in "an aggressive battle" for educational channels. He called attention to "the lost opportunity in aural broadcasting."

Dr. W. R. G. Baker, vice president of G-E and general manager of the company's Electronics Division, said in a speech at Philadelphia that those who claim educational television would provide state thought control "are themselves using one of propaganda's oldest weapons, the catchphrase which damns without sound reason behind it."

Actually, he pointed out, "any mother sitting at home would be able to monitor what is being shown her children at school."

Referring to a report by a New York State temporary commission on educational television which rejected a proposal for establishment of a 10-station educational television network, Dr. Baker cited criticism which described the commission's report as an "incredibly clumsy and shocking document."

On the question of competition with commercial television stations, Dr. Baker pointed out that "owning a commercial station obviously is not a license to chain people in front of their television sets and hypnotize them from turning to any other channel."

"If education can be made interesting enough to compete with entertainment . . . some educational programs might even end up as sponsored programs on commercial stations," Dr. Baker concluded.

## SELF-REPRODUCING MACHINES

are already in the planning stage. Dr. Claude E. Shannon of Bell Telephone Laboratories told an audience at Case Institute of Technology in Cleveland that an abstract model of such a machine has been set up by John Von Neumann, one of the world's leading mathematicians. According to Dr. Shannon, the machine will collect parts from its environment and assemble them into another machine identical with itself. The new machine will then repeat the process, so that by the time each machine wears out, it has already built a new one to take its place.

**THREE SCIENTISTS** at the University of California have developed an electronic vacuum pump without moving parts. Gases to be removed are first ionized by bombarding them with electrons from an incandescent cathode. A super-powerful electromagnet drawing 5,000 amperes then propels the ionized gases to a cold condensing plate. The new pump can be used alone, or as an auxiliary to existing pumping equipment.

**THE CORONATION** of Queen Elizabeth II on June 2 has created a tremendous demand for television receivers and radios throughout Great Britain, but rigid Government restrictions on installment sales have shut out many would-be buyers. One large manufacturer has apparently solved the problem of legally meeting the requirement of one third the selling price on delivery and the balance in 18 months. Customers were offered the opportunity of paying the first third in advance installments up to the end of May, with delivery guaranteed in time for the Coronation.

Would this type of sales promotion work in the United States? We doubt it. When similar credit restrictions were in force here last year many people who could not afford the required down payment were able to get sets immediately through heavy price-cutting and fantastic trade-in allowances on anything from a 1925-model Atwater Kent to a burned-out toaster.

**CONFLICTING STATEMENTS** on the dependability of transistor hearing aids have been made by Zenith and Sonotone, two of the largest producers in this field. In announcing that Zenith has suspended production of the new-type aids, president E. F. McDonald Jr. said that despite their superior performance in laboratory models, transistors had failed after only a few weeks service in every aid sold by his company except one. He attributed the failures to body humidity, and stated that Zenith would continue tests with hermetically sealed types.

Irving I. Schactel, president of Sonotone, disagreed with Mr. McDonald, and claimed that thousands of transistor hearing aids sold by Sonotone are giving better service than any previous type made by his company.

(PLEASE TURN TO PAGE 12)





# D.T.I.'s EXCLUSIVE METHOD\*

HERE'S ALL YOU NEED

CAN SPEED YOU TOWARD THE PROFITABLE... INTERESTING FIELD OF...



# TELEVISION

RADIO • ELECTRONICS

### 5-INCH "SCOPE"

**RIGHT:** As part of your home training, you build and keep this big, FIVE-INCH commercial-type Oscilloscope—one of the most useful test units used in TV today. **BELOW:** You also build and keep this highly versatile jewel-bearing Multi-Meter. Here is ideal equipment to help you EARN while you learn.



MULTI-METER

### 16mm. MOVIES AT HOME

**BELOW:** You also get the loan of a 16mm. motion picture projector and many reels of instructive film to help you grasp important basic points faster... easier... An EXCLUSIVE D.T.I. home feature.

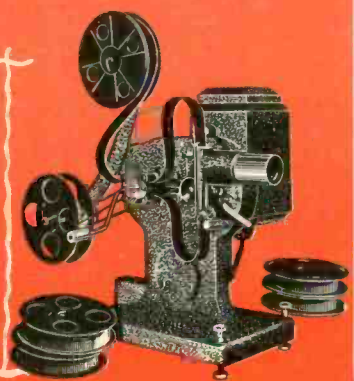

### MILITARY SERVICE

If subject to military service, the training information we have for you should prove very helpful. Mail coupon today.

## Earn a Bright Future in Spare Time at Home or in Our Big Chicago Laboratory!

America's amazing billion-dollar Television field now offers you a chance of a lifetime to get started toward a good job or your own profitable business. With the TV station limit now raised from over 100 to 2053, Television is headed for many communities. Mail coupon today. See how you may prepare to earn real money.

shipments of electronic parts, enabling you to get the all-important practical experience you need. Your projects include building and keeping a commercial-type 5-Inch Oscilloscope and jewel-bearing Multi-Meter, described to the left. And to provide added practical experience, you can build and keep a 21-Inch Television Receiver. DTI also offers another home training in Television-Radio-Electronics, but without the TV set.

### TRAIN AT HOME

You can get all of your training at home, using DTI's EXCLUSIVE THREE-WAY COMBINATION METHOD\* that provides everything you need. You learn by (1) studying lessons, (2) by seeing instructive movies and (3) by working over 300 construction and test procedures from 16 big

### TRAIN IN DTI'S GREAT CHICAGO LABORATORIES

If you prefer, you can get all of your training in DTI's wonderfully equipped Chicago Training Laboratories, where you get a thorough, practical training in the shortest possible time. Part time student employment assistance can help you pay your way while in training.

### EMPLOYMENT SERVICE

Upon completing either the Chicago Laboratory or Home Training, DTI's long-established, effective Employment Service is ready to help you start earning real money. Thousands of successful graduates. Get full facts. Mail coupon today.



# 21 INCH

Build and keep this BIG DTI engineered TV set—easily converted to U.H.F.

**89 WAYS TO EARN MONEY**  
IN TELEVISION  
RADIO ELECTRONICS

"ONE OF AMERICA'S FOREMOST TELEVISION TRAINING CENTERS"  
— Established 1931 —



*Act now!*  
Fill in, mail the coupon today, for the complete facts.

### MAIL COUPON TODAY!

DeFOREST'S TRAINING, INC.,  
2533 N. ASHLAND AVENUE,  
CHICAGO 14, ILLINOIS  
DEPT. RE-6-J

I would like your Opportunity Bulletin showing "89 Ways To Earn Money In Television-Radio-Electronics"; also, complete facts about the training opportunities made possible by your organization.

Name \_\_\_\_\_ Age \_\_\_\_\_  
Address \_\_\_\_\_ Apt. \_\_\_\_\_  
City \_\_\_\_\_ Zone \_\_\_\_\_ State \_\_\_\_\_

**DeFOREST'S TRAINING, INC.**  
AFFILIATED WITH  
**DEVRY Technical INSTITUTE**  
CHICAGO 14, ILLINOIS



World's most powerful TV ANTENNA!

**22 Db gain**

over tuned dipole!

motorless all-direction  
**UHF-VHF-FM**  
reception

**MONEY BACK GUARANTEE**

to outperform all other  
antennas using rotor motors on

**UHF-VHF & FM**

- Guaranteed 10 times more powerful than stacked 10 element Yagis.
- Receives channel 2-83 from all directions without a rotor.
- Broadband UHF-VHF and FM, motorless all direction reception.
- All aluminum flip-out assembly.

The only TV antenna that instantly beams the television set directly to the signal without a rotor. This antenna brings strong UHF & VHF signals from all directions to weak signal areas instantly . . . with a flick of the nine position switch located near the television set.

**MONEY BACK GUARANTEE** To out-perform all other antennas (using rotor motors) on both UHF and VHF, including stacked ten element Yagis, stacked corner and bow-tie reflectors, four bay conicals, etc.

Approx. 300 Ohms  
between every  
two of the  
four conductors.

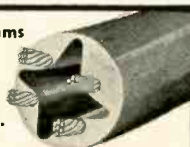

Four conductor air-dielectric,  
tubular, matched impedance  
transmission line.

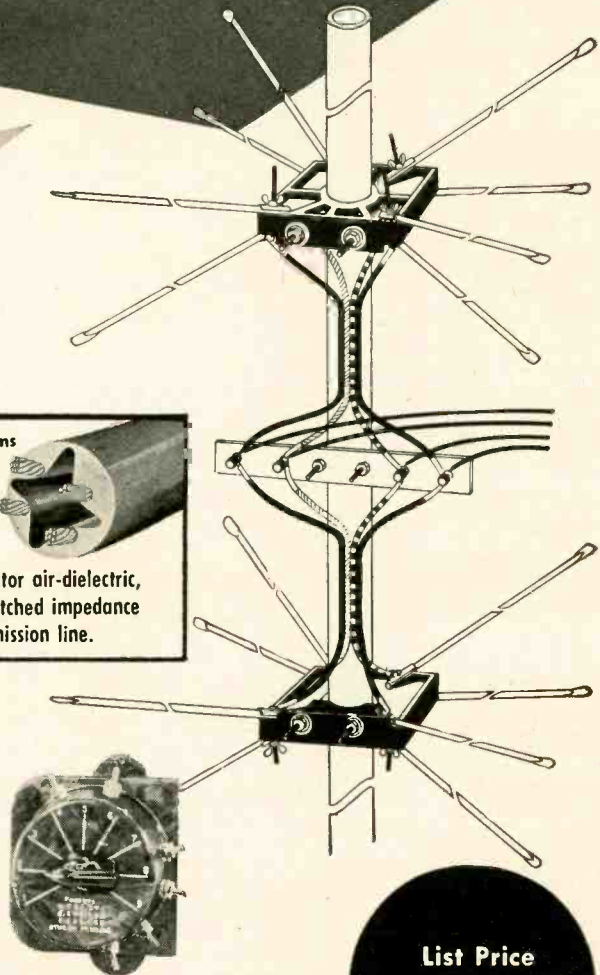

**Model A D 2-8**

Includes Stacked Antenna Array.  
9 Position Switch. Completely  
Wired Stacking Harness. A.I.M.—  
Automatic. Impedance Matching  
Coupler.

List Price  
**\$36<sup>50</sup>**

see us at . . .

THE ELECTRONIC PARTS SHOW, CHICAGO ROOMS 647A & 648A

**ALL CHANNEL ANTENNA CORP.**

70-07 Queens Blvd.,  
Woodside 77, N.Y. Hickory 6-2304

RADIO-ELECTRONICS





# Get yourself on the beam to the **BIG MONEY** in **RADIO AND TV**

That's the way to become an expert Radio or Television service man. Study the bedrock theories and principles. These are vitally important. Nothing can take their place—not even the most elaborate kits.

Listen to what radioman R. G. Hamlin of Bay City, Michigan, says, "There's no royal road to learning. I am convinced more than ever after examining the lessons of friends who were lured by the alleged short-cut methods of competitors . . . 'understandability' and 'rememberability' are of utmost importance and I.C.S. lessons qualify on both counts."

I.C.S. offers you two new courses in radio and television servicing—one for beginners, the other for experienced amateurs.

The beginner's course, Radio and Television Servicing with training Equipment, is extremely thorough. You get extra texts featuring experiments and job assignments. You get equipment second to none. Matched parts for an excellent 5-tube superheterodyne receiver. Your own professional-quality multitester. A complete single generator kit. High-grade servicemen's tools. "Rider's Perpetual Troubleshooter's Manual." The principles of Television including the most up-to-date developments (VHF and Color TV, for example).

The second course quickly reviews the essentials then goes step by step into advanced phases of Radio and Television, including modern methods of installation and repair. Course contains valuable supplementary material. For example, you get a special book giving characteristics of all tubes used in Radio and Television receivers.

Learn by doing! That's the world-famous I.C.S. method. Thoroughly practical. Completely modern. Success proved. The coupon below brings you full details—on Radio and Television Servicing or any of the more than 400 I.C.S. Courses. Mark and mail it *today!*

## INTERNATIONAL CORRESPONDENCE SCHOOLS



BOX 2884-H, SCRANTON 9, PENNA.

Without cost or obligation, send me "HOW TO SUCCEED" and the booklet about the course BEFORE which I have marked X:

- |   |   |   |   |   |
|---|---|---|---|---|
| <p><b>ART</b></p> <ul style="list-style-type: none"> <li><input type="checkbox"/> Commercial Art</li> <li><input type="checkbox"/> Magazine and Book Illustrating</li> <li><input type="checkbox"/> Cartooning</li> <li><input type="checkbox"/> Show Card and Sign Lettering</li> <li><input type="checkbox"/> Fashion Illustrating</li> <li><b>AUTOMOTIVE</b></li> <li><input type="checkbox"/> Automobile, Mechanic</li> <li><input type="checkbox"/> Auto-Elec. Technician</li> <li><input type="checkbox"/> Auto Body Rebuilding and Refinishing</li> <li><input type="checkbox"/> Diesel—Gas Engines</li> <li><b>AVIATION</b></li> <li><input type="checkbox"/> Aeronautical Engineering Jr.</li> <li><input type="checkbox"/> Aircraft Engine Mechanic</li> <li><input type="checkbox"/> Airplane Drafting</li> <li><b>BUILDING</b></li> <li><input type="checkbox"/> Architecture</li> <li><input type="checkbox"/> Arch. Drafting</li> <li><input type="checkbox"/> Building Contractor</li> <li><input type="checkbox"/> Estimating</li> <li><input type="checkbox"/> Carpenter and Mill Work</li> <li><input type="checkbox"/> Carpenter Foreman</li> <li><input type="checkbox"/> Reading Blueprints</li> <li><input type="checkbox"/> House Planning</li> <li><input type="checkbox"/> Plumbing</li> </ul> | <ul style="list-style-type: none"> <li><input type="checkbox"/> Heating</li> <li><input type="checkbox"/> Steam Fitting</li> <li><input type="checkbox"/> Air Conditioning</li> <li><input type="checkbox"/> Electrician</li> <li><b>BUSINESS</b></li> <li><input type="checkbox"/> Business Administration</li> <li><input type="checkbox"/> Certified Public Accountant</li> <li><input type="checkbox"/> Accounting</li> <li><input type="checkbox"/> Bookkeeping</li> <li><input type="checkbox"/> Stenography and Typing</li> <li><input type="checkbox"/> Secretarial</li> <li><input type="checkbox"/> Federal Tax</li> <li><input type="checkbox"/> Business Correspondence</li> <li><input type="checkbox"/> Personnel and Labor Relations</li> <li><input type="checkbox"/> Advertising</li> <li><input type="checkbox"/> Retail Business Management</li> <li><input type="checkbox"/> Managing Small Business</li> <li><input type="checkbox"/> Sales Management</li> <li><input type="checkbox"/> Salesmanship</li> <li><input type="checkbox"/> Traffic Management</li> <li><b>CHEMISTRY</b></li> <li><input type="checkbox"/> Chemical Engineering</li> <li><input type="checkbox"/> Chemistry</li> <li><input type="checkbox"/> Analytical Chemistry</li> <li><input type="checkbox"/> Petroleum—Nat'l Gas</li> <li><input type="checkbox"/> Pulp and Paper Making</li> <li><input type="checkbox"/> Plastics</li> </ul> | <p><b>CIVIL, STRUCTURAL ENGINEERING</b></p> <ul style="list-style-type: none"> <li><input type="checkbox"/> Civil Engineering</li> <li><input type="checkbox"/> Structural Engineering</li> <li><input type="checkbox"/> Surveying and Mapping</li> <li><input type="checkbox"/> Structural Drafting</li> <li><input type="checkbox"/> Highway Engineering</li> <li><input type="checkbox"/> Reading Blueprints</li> <li><input type="checkbox"/> Concrete Construction</li> <li><input type="checkbox"/> Sanitary Engineering</li> <li><b>DRAFTING</b></li> <li><input type="checkbox"/> Aircraft Drafting</li> <li><input type="checkbox"/> Architectural Drafting</li> <li><input type="checkbox"/> Electrical Drafting</li> <li><input type="checkbox"/> Mechanical Drafting</li> <li><input type="checkbox"/> Structural Drafting</li> <li><input type="checkbox"/> Sheet Metal Drafting</li> <li><input type="checkbox"/> Mine Surveying and Drafting</li> <li><b>ELECTRICAL</b></li> <li><input type="checkbox"/> Electrical Engineering</li> <li><input type="checkbox"/> Electrician</li> <li><input type="checkbox"/> Electrical Maintenance</li> <li><input type="checkbox"/> Electrical Drafting</li> <li><input type="checkbox"/> Electric Power and Light</li> <li><input type="checkbox"/> Lineman</li> <li><b>HIGH SCHOOL</b></li> <li><input type="checkbox"/> High School Subjects</li> </ul> | <ul style="list-style-type: none"> <li><input type="checkbox"/> College Preparatory</li> <li><input type="checkbox"/> Mathematics</li> <li><input type="checkbox"/> Commercial</li> <li><input type="checkbox"/> Good English</li> <li><b>MECHANICAL AND SHOP</b></li> <li><input type="checkbox"/> Mechanical Engineering</li> <li><input type="checkbox"/> Industrial Engineering</li> <li><input type="checkbox"/> Industrial Supervision</li> <li><input type="checkbox"/> Foremanship</li> <li><input type="checkbox"/> Mechanical Drafting</li> <li><input type="checkbox"/> Machine Design-Drafting</li> <li><input type="checkbox"/> Machine Shop Practice</li> <li><input type="checkbox"/> Tool Design</li> <li><input type="checkbox"/> Industrial Instrumentation</li> <li><input type="checkbox"/> Machine Shop Inspection</li> <li><input type="checkbox"/> Reading Blueprints</li> <li><input type="checkbox"/> Toolmaking</li> <li><input type="checkbox"/> Gas—Electric Welding</li> <li><input type="checkbox"/> Heat Treatment—Metallurgy</li> <li><input type="checkbox"/> Sheet Metal Work</li> <li><input type="checkbox"/> Sheet Metal Pattern Drafting</li> <li><input type="checkbox"/> Refrigeration</li> <li><b>POWER</b></li> <li><input type="checkbox"/> Combustion Engineering</li> <li><input type="checkbox"/> Diesel—Electric</li> <li><input type="checkbox"/> Electric Light and Power</li> </ul> | <ul style="list-style-type: none"> <li><input type="checkbox"/> Stationary Steam Engineering</li> <li><input type="checkbox"/> Stationary Fireman</li> <li><b>RADIO, TELEVISION, COMMUNICATIONS</b></li> <li><input type="checkbox"/> General Radio</li> <li><input type="checkbox"/> Radio Operation</li> <li><input type="checkbox"/> Radio Servicing—FM</li> <li><input type="checkbox"/> Television</li> <li><input type="checkbox"/> Electronics</li> <li><input type="checkbox"/> Telephone Work</li> <li><b>RAILROAD</b></li> <li><input type="checkbox"/> Locomotive Engineer</li> <li><input type="checkbox"/> Diesel Locomotive</li> <li><input type="checkbox"/> Air Brakes <input type="checkbox"/> Car Inspector</li> <li><input type="checkbox"/> Railroad Administration</li> <li><b>TEXTILE</b></li> <li><input type="checkbox"/> Textile Engineering</li> <li><input type="checkbox"/> Cotton Manufacture</li> <li><input type="checkbox"/> Rayon Manufacture</li> <li><input type="checkbox"/> Woolen Manufacture</li> <li><input type="checkbox"/> Loom Fixing</li> <li><input type="checkbox"/> Finishing and Dyeing</li> <li><input type="checkbox"/> Textile Designing</li> </ul> |
|---|---|---|---|---|

**YEAR OF THE SIX  
MILLIONTH STUDENT**

Name \_\_\_\_\_ Age \_\_\_\_\_ Home Address \_\_\_\_\_  
 City \_\_\_\_\_ Zone \_\_\_\_\_ State \_\_\_\_\_ Working Hours \_\_\_\_\_ A.M. to \_\_\_\_\_ P.M.  
 Occupation \_\_\_\_\_

Special tuition rates to members of the Armed Forces. Canadian residents send coupon to International Correspondence Schools Canadian, Ltd., Montreal, Canada



# HERE ARE 4 LEADS\*

## For a Real Boost in BOOSTER Sales

with the **B-T** Model HA-3  
**BOOSTER**

in excess of 16db gain

**Fully Automatic**

only \$39.50  
LIST



**1. The Man With An Old Set**  
He'll be thrilled at the amazing improvement you will demonstrate with the B-T Booster. You will show him how to get new set picture quality at a fraction of the cost of a new set.

**2. The Man With An Indoor Antenna**  
He will laugh at his landlord problems when you show him the clear pictures to be had with the B-T Booster... whether he has a new set or old.

**3. The Man With An Old-Fashioned Tunable Booster**  
He will be amazed at the performance and by the new "hands-off" convenience. His wife need no longer complain about the box on the receiver and the extra knobs to tune, because with the Model HA-3 there is no tuning, no band-switching... there are no knobs to turn and no switches to set.

**4. The Man in the Fringe Area**  
He will welcome the channels he never received, and the elimination of snow and fading on the ones he did get. That is because the B-T Booster Model HA-3 increases the strength of the signal at least 6x before it reaches the set.

\* These are only four of the many prospects for B-T BOOSTER Sales. There is a real profit in every B-T BOOSTER sale you make because it takes only one easy demonstration to close a sale.  
Write for Free TV Installation Folder to Department HF-3

Available at Leading Distributors

Blonder-Tongue Laboratories make a complete line of TV amplifiers for signal distribution, line amplification, signal mixing and a complete line of accessories for all installations of low cost Master TV Systems.

**B-T  
LABS**

**BLONDER-TONGUE LABORATORIES, INC.**  
WESTFIELD, NEW JERSEY



No statement was made by the General Electric Company, who throughout the whole I.R.E. show last spring operated a transistor transmitter in a glass coffee-maker full of boiling water.

**WHEN A CAMERAMAN** follows the horses, it's merely an occupational disease; but when the horses follow the cameraman, it's an invention. Eric A. Black, of Red Bank, N. J. has just received U. S. Patent No. 2,633,054 on an aerial cableway for racetracks. A car suspended from the cableway carries a TV or movie camera and crew. Travelling just ahead of the horses at all times, it not only lets viewers see the race in complete detail, but provides track officials with an unquestionable, permanent record where fouls are claimed.

**GANO DUNN**, internationally famous engineer, financier, and educator, died April 10 in New York City at the age of 82. The first man in the United States to receive a degree in electrical engineering, Mr. Dunn's career spanned almost the entire history of electrical power transmission, communications, and engineering education in this country.

Mr. Dunn was president of J. G. White Engineering Corp., a director of RCA and NBC, chairman of trustees and former president of Cooper Union in New York City, and a director or trustee of many other industrial, financial, and educational institutions. He was a Fellow of the Institute of Radio Engineers, honorary secretary for the United States of the I.E.E. of Great Britain, a member of the American Academy of Arts and Sciences, the American Society of Civil Engineers, and had received many honorary degrees in this country and abroad.

**DR. RONALD W. GURNEY**, noted British-born electronic physicist whose pioneer research on semiconductors was one of the factors which led to the development of the transistor, died suddenly on April 14th in New York City. Dr. Gurney had made his home in the United States since 1941, conducting research in ballistics during World War II at the Army's Aberdeen Proving Grounds, and later as research professor at the University of Maryland.

**NEW LOW-COST COMPOUNDS** of aluminum, antimony, and other common metals may revolutionize transistor manufacture by replacing germanium as the basic material. The new semiconductors have already proved themselves as rectifiers, and further tests are being carried on at the National Bureau of Standards, Bell Telephone Laboratories, and Battelle Memorial Institute in Columbus, Ohio.

The aluminum-antimony compound may even outperform germanium at high operating temperatures, and as for cost—aluminum and antimony sell for less than 50 cents a pound. A pound of germanium costs \$350! ——— END



# 10 TIMES MORE POWERFUL THAN STACKED 10 ELEMENT YAGIS

**PHILCO**  
*All-Purpose  
TV Antenna*

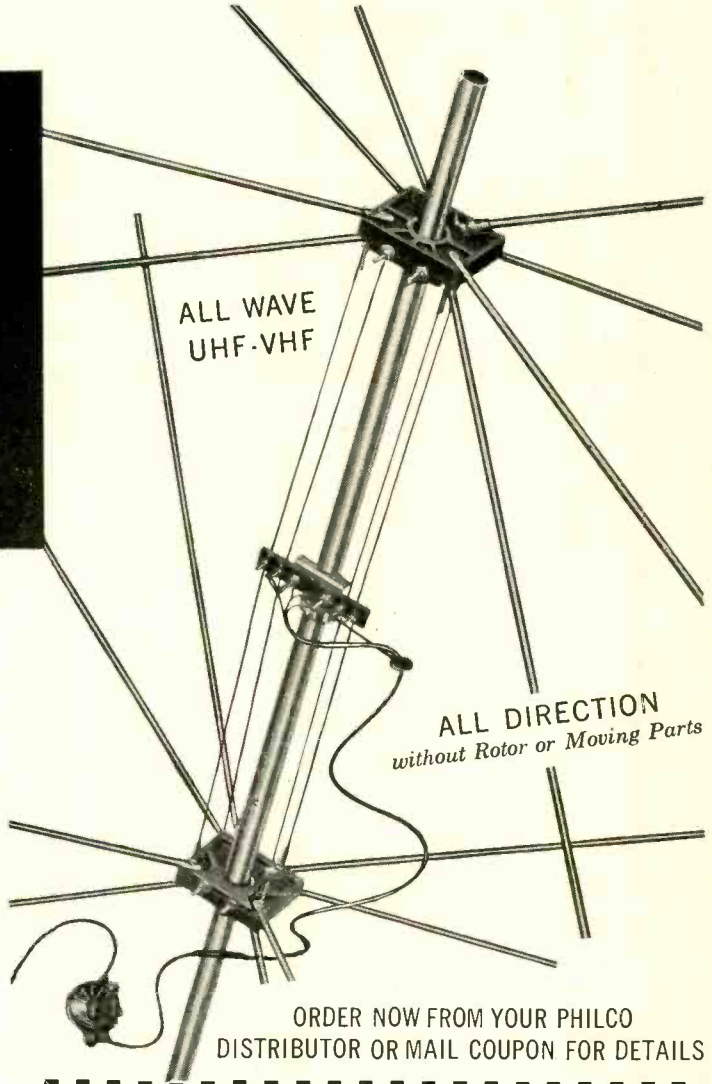

## NEW Design and Principle

By far the most powerful TV antenna on the market today . . . a sales value unsurpassed at its popular price. With the mere flip of a switch this exclusive all-purpose Philco antenna without rotor or moving parts of any kind instantly and automatically beams the set to the best possible signal for both UHF and VHF reception. No attenuators are necessary in strong signal areas since an off position of the switch will automatically attenuate the signal. Available in preassembled aluminum dowel reinforced elements of single bank and stacked arrays for metropolitan and fringe areas at your Philco distributor now.

### Up to 22.3 DB Gain over Tuned Dipole

DB GAIN OVER A TUNED DIPOLE CUT FOR EACH CHANNEL FREQUENCY

	2	3	4	5	6	7	8	9	10	11	12	13
Single Array	7.8	14.0	6.7	-1.7	16.3	2.5	6.0	9.6	12.1	10.8	15.0	12.8
Gain Chart	36"	18.8	3.5	7.4	17.3	0.0	-1.3	6.0	8.4	11.5	13.0	12.5
using	45"	6.5	14.3	6.0	-6.0	18.6	6.7	8.5	18.2	18.1	13.2	14.3
different	60"	5.8	2.2	9.6	-1.0	-2.0	1.5	-4.0	10.3	4.0	15.4	7.0
spacing	82"	8.4	15.5	13.0	10.5	21.3	3.0	14.0	-2.0	1.6	10.0	6.0
between	98"	2.5	8.0	9.5	-4.5	17.0	6.0	2.0	4.0	1.0	10.0	7.0
two single	114"	21.0	19.0	7.4	22.3	0.0	6.0	8.2	10.4	11.5	14.0	14.1
arrays	122"	7.4	17.0	13.4	2.5	21.5	8.5	17.3	16.2	12.1	14.8	15.6

The above tests were made using a 40-foot lead-in. However amazing results have been obtained on installations using a lead-in up to 150 feet without any appreciable difference in gain. These tests were made in real fringe areas.

For maximum gain in outer fringe areas, orient the antenna for the weakest channel desired. Location will determine the number of elements to be used.

ORDER NOW FROM YOUR PHILCO  
DISTRIBUTOR OR MAIL COUPON FOR DETAILS

PHILCO CORPORATION, Accessory Division  
Allegheny and A Streets  
Philadelphia 34, Pa.

Please send me information about the Philco All Purpose  
Antenna, with current trade price list.

NAME .....

STORE NAME .....

CITY ..... ZONE ..... STATE .....

Please check in space below

I am a Retail Dealer

I am a TV Serviceman



E-V ADDS THE **MAGIC TOUCH**  
TO TV RECEPTION

**NEW**  
all channel **UHF**  
TV CONVERTER

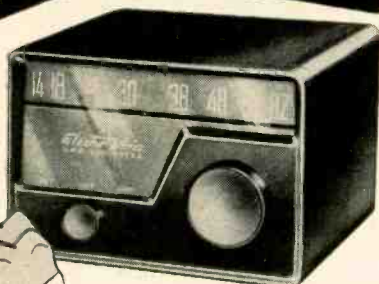

**MODEL 3300**

Truly the ultimate in a UHF TV Converter. Engineered and built by Electro-Voice, the E-V 3300 combines the finest in design, construction and performance. It is thoroughly field proved.

### Adds all UHF Channels to VHF Sets

Non-slip micrometer type tuning system\* provides smooth, accurate, continuous tuning of all UHF channels 14-83. No band switches, strips or coils. New high-efficiency low-loss circuit. Operates with either separate UHF and VHF antennas or on all-channel (2-83) antenna. Adequate shielding. One control turns Converter and TV set "on" or "off" and switches to correct antenna. Utilizes channels 5 or 6 of VHF TV set as Intermediate Frequency. Does not affect VHF reception.

Installation is simple—connect to antenna input of VHF TV set and just plug in. For 105-125 volts, 50-60 cycles AC. Housed in small, attractive dark brown cabinet, 7 $\frac{3}{4}$ " x 5 $\frac{1}{4}$ " x 6 $\frac{1}{4}$ ". Completely self-contained, ready for installation.

**MODEL 3300. List Price, \$39.50**

\*Patent Applied For

Send for Bulletin  
No. 188

**Electro-Voice**

ELECTRO-VOICE, INC.  
421 CARROLL STREET • BUCHANAN, MICH.  
Export: 13 E. 40th St., New York 16, U.S.A. Cables: Arlab



## BAROMETER of the PARTS INDUSTRY

During April, 64 of the leading 400 manufacturers of Radio-Television-Electronic parts and equipment made changes in their lines. Actually there was a decrease in "change activity" as compared to March.

In price revisions by the number of manufacturers and products affected, the following summary illustrates the comparative trend for the months of March and April.

	No. of Manufacturers			No. of Products	
	March	April		March	April
Increased prices	23	22	Increased prices	350	907
Decreased prices	18	8	Decreased prices	179	466

For a summary of the most active product categories, see the following tables:

Product Group	Increased Prices		Decreased Prices		New Products		Discontinued Products	
	No. of Mfrs.	No. of Products	No. of Mfrs.	No. of Products	No. of Mfrs.	No. of Products	No. of Mfrs.	No. of Products
Antennas & Access.	4	30**	1	2**	14	129**	9	147*
Capacitors	1	31**	3	404*	4	778*	2	57**
Controls & Resistors	0	0**	0	0**	1	1**	1	1**
Sound & Audio Prod.	2	98*	0	0	11	65*	12	84*
Test Equipment	5	35*	0	0**	6	19*	5	9*
Transformers	1	8*	0	0**	2	8**	0	0**
Tubes	6	85**	3	14*	9	57*	4	21*
Wire & Cable	3	680*	1	46*	1	1**	2	7*

\* Increase over March  
\*\* Decrease from March

\* Increase over March  
\*\* Decrease from March

**COMMENT:** Showing only a slight decrease in the number of manufacturers reporting changes since last month, over-all product activity continues to be heavy. While tube, antenna, and sound manufacturers once again dominate this "change activity" scene, we note that several capacitor and wire manufacturers have made considerable revisions in their lines.

This data is prepared by the staff of United Catalog Publishers, Inc., 110 Lafayette Street, New York, publishers of RADIO'S MASTER, the Official Buying Guide of the Parts Industry.

### Merchandising and Promotion

I.D.E.A., Indianapolis, has prepared a colorful broadside which it mailed to distributors of its *Regency* v.h.f. boosters. A letter describing the company's



Earl H. Kirk shows *Regency* sales aid.

Card-of-the-Month campaign accompanied the broadside. Each card will contain a pertinent suggestion on new methods of realizing greater profits on *Regency* boosters.

Tel-A-Ray Enterprises, Inc., Henderson, Ky., has prepared a u.h.f. antenna selector indicating the various types of Tel-A-Ray u.h.f. antennas for good reception at different distances.

Sylvania Electric Products is offering radio-TV service technicians a personalized home calendar for 1954. The cal-

endar, which serves as a Christmas greeting and features recipes and home care hints, may be imprinted with the service technician's name, address, and phone number.

Walter L. Schott Co., Los Angeles, has built its new distributor promotion around the theme, "When you buy, sell, or install Walsco, it's like money in the bank." In addition to 150,000 mailing pieces made available to distributors, three-minute recordings and miniature banks are also being used.

Channel Master Corp., Ellenville, N. Y., designed a new package for its Katy-B television booster which doubles as a two-color pop-up counter display.



Electro-Voice, Inc., Buchanan, Mich., launched a new program to help service technicians cash in on the huge phono-cartridge replacement market. (PLEASE TURN TO PAGE 18)



**big values  
new releases**

# in ALLIED'S latest Catalog & Supplement!

**FREE: SEND FOR BOTH**



**KNIGHT PORTABLE RADIO KIT**

Build this powerful 3-way superhet portable for AC, DC or battery operation. Tunes 535-1650 kc broadcast band; has built-in antenna, PM speaker, printed audio circuit, handsome carrying case. Easy to assemble from illustrated manual. High-quality kit includes all parts, tubes and case (less batteries). Shpg. wt., 6 lbs.  
83-730. Only.....\$18.75  
Battery Kit.....\$3.64

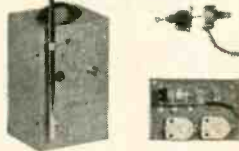

**PHILMORE RADIO CONTROL KIT**

Build your own remote-control transmitter and receiver. Operates model airplanes, boats, autos, etc. Crystal-controlled transmitter for 27.255 mc (requires easily obtained FCC operating permit). High-gain super-regenerative receiver. Easy to build. Complete with all parts, telescoping antenna, crystal and cabinet (less batteries). 4 1/2 lbs.  
83-034. Only.....\$41.47  
Complete Set of Batteries.....\$7.15



**KNIGHT SELF-CHARGING PORTABLE**

Deluxe superhet portable for AC, DC or battery operation. With battery "Rejuvenator" circuit which extends normal "B" battery life 2 to 4 times! Covers full broadcast band; has tuned RF amp, loop antenna, AVC, 5" PM speaker. Attractive carrying case, 10 x 12 3/4 x 4 3/4". Complete with tubes, less batteries. 9 lbs.  
6K-718. Only.....\$35.75  
80-652. Battery Kit.....\$4.36



**WELLER SOLDERING GUNS**

Squeeze the trigger—you're ready to solder in 5 seconds. Latest heavy-duty, instant-heat gun; with 2 spotlights that light up working area. Air-cooled transformer. 3 lbs.  
46-642. Single-heat, only...\$9.75  
46-641. Dual-heat, only...\$11.71



**PET 1/4" DRILL VALUE**

Precision gear-type chuck drill with pistol grip. Instant-release lock-type trigger switch built into grip. Forced ventilation; runs cool. Speed: no-load, 1600 rpm; full-load, 900 rpm. Capacity: 1/4" in steel, 1/2" in hardwood. 6-ft. cord. For 110-120 v. AC or DC. 4 lbs.  
46-280. Only.....\$17.21



**TV BOOSTER BARGAIN**

Famous Standard Coil printed circuit TV booster at less than half original price. Provides uniform gain on all 12 VHF channels. Easy to tune; use with indoor antenna in primary areas, with outdoor antenna in near-fringe areas. Improves reception markedly. For 110-120 v., 60 cy. AC. Shpg. wt., 4 lbs.  
97-233. While they last, Only.....\$9.95



**ELECTRO-VOICE UHF CONVERTER**

New! Micrometer tuning for smooth, continuous reception of all UHF channels. Just connect to antenna input of any VHF TV set and plug in. Operates with all-channel antenna or separate VHF and UHF types. Single-knob, easy control. Uses VHF channels 5 or 6 as IF. 300 ohms input and output imp. Complete with tubes. For 110-120 v., 60 cy. AC. 5 lbs.  
98-097. Only.....\$33.96

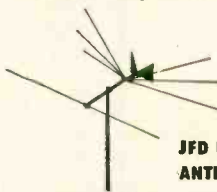

**JFD UHF-VHF ANTENNA**

Wonderfully efficient; uses conical element and reflector for VHF and "bow-tie" for UHF. Equipped with printed circuit antenna coupler for excellent signal transfer into single transmission line. Easy to install. (Less mast and 300-ohm twin line.) Shpg. wt., 6 lbs.  
98-368. Only.....\$11.20



**EQUIPTO "LITTLE GEM" CABINET**

New! Drawer cabinet for small parts. Contains 4 drawers, with dividers for 48 compartments (dividers adjustable on 1 1/2" centers). Each drawer 1 1/2" h, 11" w, 11" d. Cabinet overall, 6 1/2 x 11 x 11". Olive green baked enamel finish. Shpg. wt., 20 lbs.  
86-066. Only.....\$17.80



**TRAV-ELECTRIC SENIOR CONVERTER**

Ultra-compact 60 cycle converter for changing 6 volts DC to 110 volts AC. Capacity: 30 watts continuous, 40-45 watts intermittent. Simply plugs into auto cigarette lighter. Permits mobile use of broadcast and SW radios, recorders, dictating machines, fluorescent lamps, etc. Fully filtered. Only 2 1/2 x 2 1/2 x 3 1/2". 3 1/4 lbs.  
80-272. Only.....\$10.63



**TV CASTER BASE**

Easy to install under any TV console—permits quick and easy rolling to any desired location. Rolls smoothly in any direction. Steel frame is adjustable to 30' wide, 27" deep to fit practically any console. No tools required for installation. Shpg. wt., 11 1/2 lbs.  
98-989. Only.....\$5.95

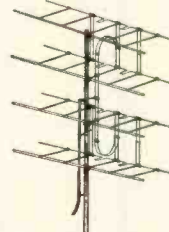

**FINNEY 400A UHF-VHF ANTENNA**

New! Double lateral UHF-VHF antenna featuring 32 driven elements for high gain and directivity, with superior signal-to-noise ratio. Superb for fringe-area reception—good for VHF up to 150 miles or more. Rugged; corrosion-proof; pre-assembled, lightweight. Requires 10-ft. mast and 300-ohm twinline. 14 lbs.  
97-104. Only.....\$32.34



**TAP-A-LINE**

New type electrical line outlet, powering as many as 8 separate appliances from any wall outlet. Plastic cased; 12" long, 1" square. With 6-ft. cord and plug. Rated 1000 watts. 1 1/2 lbs.  
52-636. Only.....\$1.47



**KNIGHT VT VOLT-OHM-MILLIAMMETER KIT**

Terrific Value! Response to 2.5 mc. Bridge-type circuit; 1% resistors. Input res.: DC, 20 megs; AC, 1.5 megs. 4 1/2" meter. Ranges: AC p-to-p volts, 0-8-28-84-280-840-2800; AC rms & DC volts, 0-3-10-30-100-300-1000; DC ma. 0-3-10-30-100-300-1000; res. 0-1000-10K-100K ohms & 0-1-10-1000 megs; cap., .005-.5, .05-.5, .5-50, 5-500, 50-5000 mfd. With tubes, leads, case, instructions. For 110-120 v. DC or 60 cy. AC.  
83-120. Only.....\$24.95  
83-121. Hi-V Probe; extends DC range to 30 KV \$6.95  
83-122. Hi-Frequency Probe for AC range to 200mc \$5.95

**FREE  
Catalog and  
Supplement**

ALLIED RADIO CORP., Dept. 2-F-3  
833 W. Jackson Blvd., Chicago 7, Ill.

Send FREE ALLIED Catalog and Supplement  
 Enter order for \_\_\_\_\_ \$\_\_\_\_\_ enclosed.

Name \_\_\_\_\_  
Address \_\_\_\_\_  
City \_\_\_\_\_ Zone \_\_\_\_\_ State \_\_\_\_\_

**ALLIED RADIO**



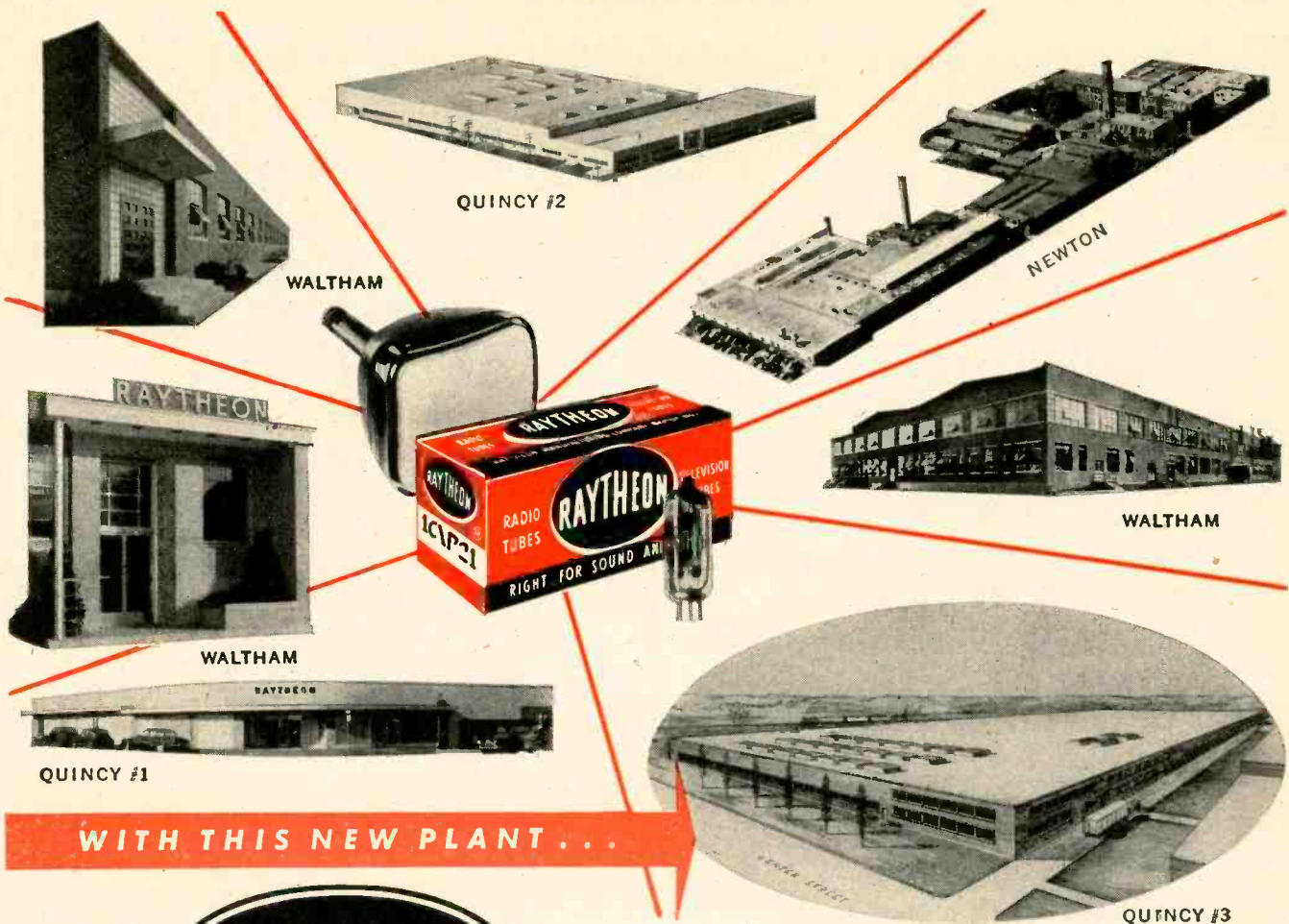

**WITH THIS NEW PLANT . . .**

the **RAYTHEON** resources

**DEVOTED EXCLUSIVELY TO ELECTRON TUBES**

- consist of **more than 1,000,000 sq. ft. of manufacturing area**
- **more than 10,000 skilled tube craftsmen**
- **backed by 30 years of tube engineering, development and production experience**

Raytheon's newest plant at Quincy, Massachusetts is expressly designed to economically manufacture 24 inch and larger Raytheon Picture Tubes. It will employ the very last word in modern engineering and manufacturing techniques. It will be devoted exclusively to the making of tubes worthy of the Raytheon reputation for quality and dependability. With *Raytheon* Radio and Television Tubes you are *Right . . . for Sound and Sight.*



**RAYTHEON MANUFACTURING COMPANY**

Receiving Tube Division  
 Newton, Mass., Chicago, Ill., Atlanta, Ga., Los Angeles, Calif.

*Excellence in Electronics*

RAYTHEON MAKES ALL THESE:  
 RECEIVING AND PICTURE TUBES • RELIABLE SUBMINIATURE AND MINIATURE TUBES • GERMANIUM DIODES AND TRANSISTORS • NUCLEONIC TUBES • MICROWAVE TUBES

RADIO-ELECTRONICS



5"  
RCA WO-88A  
\$169.50  
Suggested User Price



You can believe  
what you see  
with an RCA  
oscilloscope



The RCA WO-88A 5-inch and WO-56A 7-inch oscilloscopes have the facilities you need for precise *qualitative analysis* and accurate *quantitative measurements* . . . thanks to advanced engineering design.

For instance, one of the outstanding features of these instruments is their *remarkably true square wave* response . . . obtained by adequate band width, negligible phase shift, fast rise time, frequency-compensated attenuators, and a complete absence of peaking circuits.

Equally important are the peak-to-peak *voltage-measurement features*—obtained through the use of voltage-calibrated attenuators, front-panel calibrating-voltage terminals, calibrated graph screens, and good amplifier linearity.

Other quality features common to both designs include . . . push-pull direct-coupled amplifiers . . . extra fast retrace . . . shielded CRT gun . . . plus and minus sync . . . line-frequency sweep with phasing . . . and a set of matched probes and cables including a high impedance probe having an input resistance of 10 megohms and an input capacitance of less than 10 uuf!

Before selecting a 'scope for your special needs, be sure to get the full details on the WO-88A and WO-56A from your RCA Test Equipment Distributor . . . or write RCA, Commercial Engineering, Section 49FX, Harrison, New Jersey.



7"  
RCA WO-56A  
\$237.50  
Suggested User Price



**RADIO CORPORATION of AMERICA**  
TEST EQUIPMENT

HARRISON, N. J.





## be an expert on AUTO RADIO SERVICING!

Get the only authoritative compilation of its kind—complete Auto Radio Service Data coverage of all important models since 1946—in 3 great PHOTOFACT Manuals! All data complete, accurate, uniform—based on lab analysis of the actual auto radios covered. Helps you service any model quicker, easier—for greater profits. Get the complete Library!



### VOL. 1. AUTO RADIO SERVICE MANUAL

Covers over 100 models made from 1946 to 1949 by 24 manufacturers. Each receiver is completely covered in uniform format; includes schematics, chassis photo views, replacement parts data, service hints, etc. All data based on actual lab analysis. 396 pages, 8½ x 11".

ORDER AR-1. Only \$4.95



### VOL. 2. AUTO RADIO SERVICE MANUAL

Covers 60 different chassis (40 models) used in 1948, 1949 and 1950 auto radio receivers. Authoritative, complete service data that makes your work quicker, easier and more profitable. 288 pages, 8½ x 11".

ORDER AR-2. Only \$3.00



### VOL. 3. AUTO RADIO SERVICE MANUAL

Covers 47 different chassis (80 models) used in 1950, 1951 and 1952 auto radio receivers. Absolutely the most complete, accurate and easy-to-use data available—uniform and practically presented to

make you an expert on the repair of any auto radio. 288 pages, 8½ x 11".

ORDER AR-3. Only \$3.00



### SPECIAL OFFER!

All 3 Volumes, Yours for Only \$9.95  
Save on the Complete Library—see your PHOTOFACT Distributor

**HOWARD W. SAMS & CO., INC.**

Order from your Parts Jobber today, or write direct to HOWARD W. SAMS & CO., Inc. 2205 E. 46th Street, Indianapolis 5, Ind.

My (check) (money order) for \$... encl. Send:

AR-1 \$4.95  AR-2 \$3.00  AR-3 \$3.00

Complete 3-Volume Library \$9.95

Name .....

Address .....

City..... State.....

The program, "Your Profit Key to '53," offers an all-metal six-unit cartridge



dispenser, a Professional Phonographic Service decal and a Set Model Phono-Cartridge Replacement Guide with every purchase of six Electro-Voice cartridges through E-V distributors.

Permoflux Corp., Chicago, designed a new point-of-sale display carton as a promotional aid for the Permoflux telephone pickup attachment which picks



up both sides of a telephone conversation without electrical connection to the phone. The new display is printed in three colors and holds six pickup units.

John F. Rider, Publisher, Inc., New York City, is offering purchasers of its book "High Fidelity Simplified" an opportunity to buy a special Columbia LP high-fidelity test record. The offer expires September 1st.

The RCA Victor Tube Department, Harrison, N. J., is pointing its spring-summer advertising campaign toward the establishment of local RCA battery dealers as radio battery and service headquarters for portable-radio owners. National radio, TV, and magazine advertising will be used as well as in-store display material and a variety of sales aids including a battery tester and display unit.



RCA's new battery-tester sales aid.

### New Plants and Expansions

United Motors Service Division of General Motors Corp., Detroit, is planning an expanded distribution of radio and TV service parts and additions to

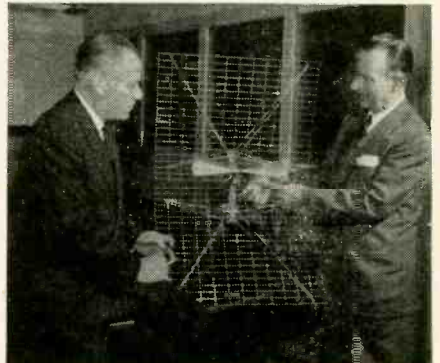

Executives view Delco u.h.f. antenna.

these lines, according to W. N. Potter, general manager of the division. TV antennas and picture tubes will be marketed under the Delco name and sold through electronics parts distributors. Formerly, Delco radio parts were sold almost exclusively through automobile parts distributors.

International Resistance Co., Philadelphia, has begun production in its new plant in Asheville, N. C. Various types of volume controls for radios, TV sets, phonographs, test equipment, and military and other devices will be made in the new \$200,000 plant.

Quam-Nichols expects to be in full production in its new 75,000-square-foot plant on Chicago's South Side by mid-July. The new plant has more than double the productive capacity of the old plant.

Westinghouse Electric Corp. recently held the official public opening of its new Electronic Tube Division plants in Bath and Elmira, N. Y.

Permo, Inc., Chicago, now maintains a large warehouse of Fidelitone and Permo-Point products in Los Angeles, according to Gail S. Carter, vice-president.

Krylon, Inc., has moved its executive and sales offices to 1422 Chestnut St., Philadelphia 2. Plant, warehouse, and general offices remain at 2038 Washington Ave., Philadelphia 46. END



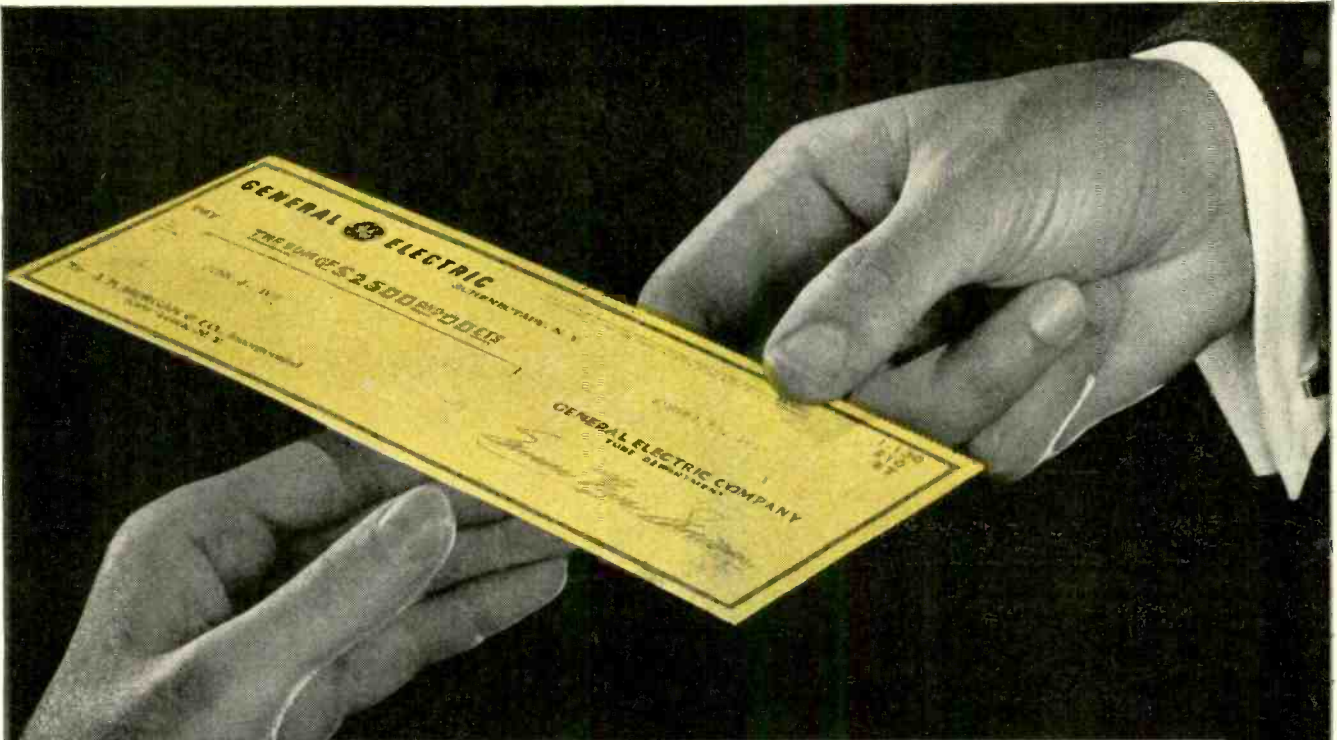

140 PRIZES FOR SERVICE DEALERS!

## FOR YOU... \$2500!

Win it in cash! Tell in 50 words or less how you would spend \$2,500 to increase your service business! 139 other cash prizes. Total \$7,125.

**T**HIS is a real big-money contest—and ABC-easy to enter! No figures to put down, no reports, no documents to attach. You win dollars simply by telling how to spend them wisely and profitably. You "Write your own ticket!"

Contest is open to all TV-radio service dealers and their employees. Rules are easy:

- Between June 15 and August 31, secure an entry blank from your G-E tube distributor. One blank with every purchase of 25 G-E receiving tubes or 1 G-E picture tube.
- Tell in the space provided on the blank how you would spend \$2,500 to increase service business. Would you buy new equipment... remodel your store... run a hard-hitting advertising campaign... or invest the money in some other way?
- Fill out and mail as many entries as you choose. They must be postmarked not later than midnight, August 31, 1953.

- Winners will be selected on the basis of originality, business judgment, and clear thinking. An impartial board of judges will make the selections.

First prize, \$2,500  
4 prizes, each \$500  
10 prizes, each \$50  
25 prizes, each \$25  
100 prizes, each \$15

All prizes are cash!

### Use the helps G.E. makes available!

If you're looking for ideas, they're waiting for you in G.E.'s new 12-page promotion catalog, ETR-589-A. Learn what you can obtain in identification and advertising aids of all types... business helps... service aids... technical manuals and publications.

Get your copy from your G-E tube distributor when you obtain your contest entry blank. Tube Department, General Electric Company, Schenectady 5, N. Y.

161-106



*Diamond Anniversary*

GENERAL  ELECTRIC



# Two heads are better than one!

And that's exactly why  
**CHANNEL MASTER'S**  
 amazing new

## TWIN CORNER REFLECTOR (Model No. 406)

is the most sensitive fringe-area antenna ever developed for UHF!

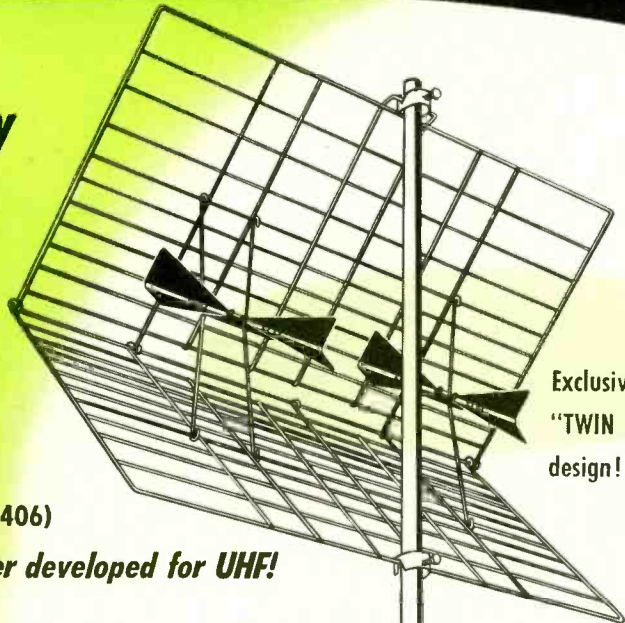

Exclusive  
 "TWIN DIPOLE"  
 design!

### TWO DIPOLES—HIGHER GAIN

The two dipoles of the Twin Corner Reflector provide TWICE as much gain as standard-type Corner Reflectors!

This two-dipole construction is an original Channel Master idea which successfully combines two separate Corner Reflectors into ONE ANTENNA STRUCTURE — requiring ONE simple installation.

This 2-in-1 combination gives you:

- ... the economy of one antenna.
- ... the convenience of one antenna.
- ... BUT the combined performance of TWO separate high gain antennas.

Model No. 406 furnishes far better picture quality — at far greater distances — on every UHF channel.

Eliminates UHF's "Twin Terrors." 100% vibration-proof construction prevents picture flicker. "Free space" terminals prevent dirt and rain water from shorting out the picture.

up to  
**16 DB gain**

gain above tuned  
 reference dipole

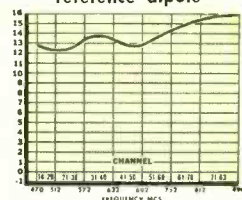

## 2 antennas in 1

The Twin Corner Reflector furnishes the performance of 2 antennas because it really is 2 separate antennas . . .

stacked side by side . . .



into 1 simple structure . . . with just a single down-lead to the set.

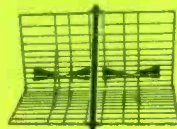

**CHANNEL MASTER**  
 engineering  
 pays off on **UHF!**



**CHANNEL MASTER CORP.**  
 ELLENVILLE, N. C.

horizontal  
 polar pattern  
 (relative voltage)

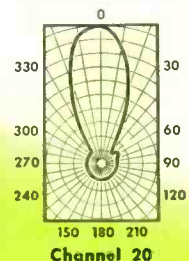

Extremely narrow  
 "Yagi-type" forward  
 lobe; no side lobes;  
 very high front-to-  
 back ratio



# At Last! a YAGI for the ENTIRE LOW BAND!

## CHANNEL MASTER'S Newest futuramic

Completely covers every low band channel—2 through 6

**Now** the extraordinary high gain of a Yagi . . . the razor-sharp directivity of a Yagi . . . *Not on just one channel — but clear across the entire Low Band!*

Designed for service TODAY and TOMORROW in these 3 booming VHF markets:

**Areas in which present VHF stations are changing channels (on the Low Band).**

The Futuramic Yagi provides better reception than conventional Yagis on the present channels — and when the shift occurs this superior reception will continue on the new channel WITHOUT INTERRUPTION. And you can make your change-over installations NOW.

**Areas in which a new VHF station is being added to the present one (on the Low Band).**

The great number of single channel Yagis now in use will not bring in the new channel. If an additional Yagi is installed it will have to be tied into the present installation with separate leads and a switching system. However, one Futuramic will do the job of BOTH antennas — at lower cost — with better results on BOTH channels.

**Areas served at present by two or more VHF stations on the Low Band.**

You no longer have to compromise between conventional broad band antennas, and separate Yagis for each channel. The Futuramic gives you the full advantages of both. It combines highest gain and sharpest directivity with simple, economical installation.

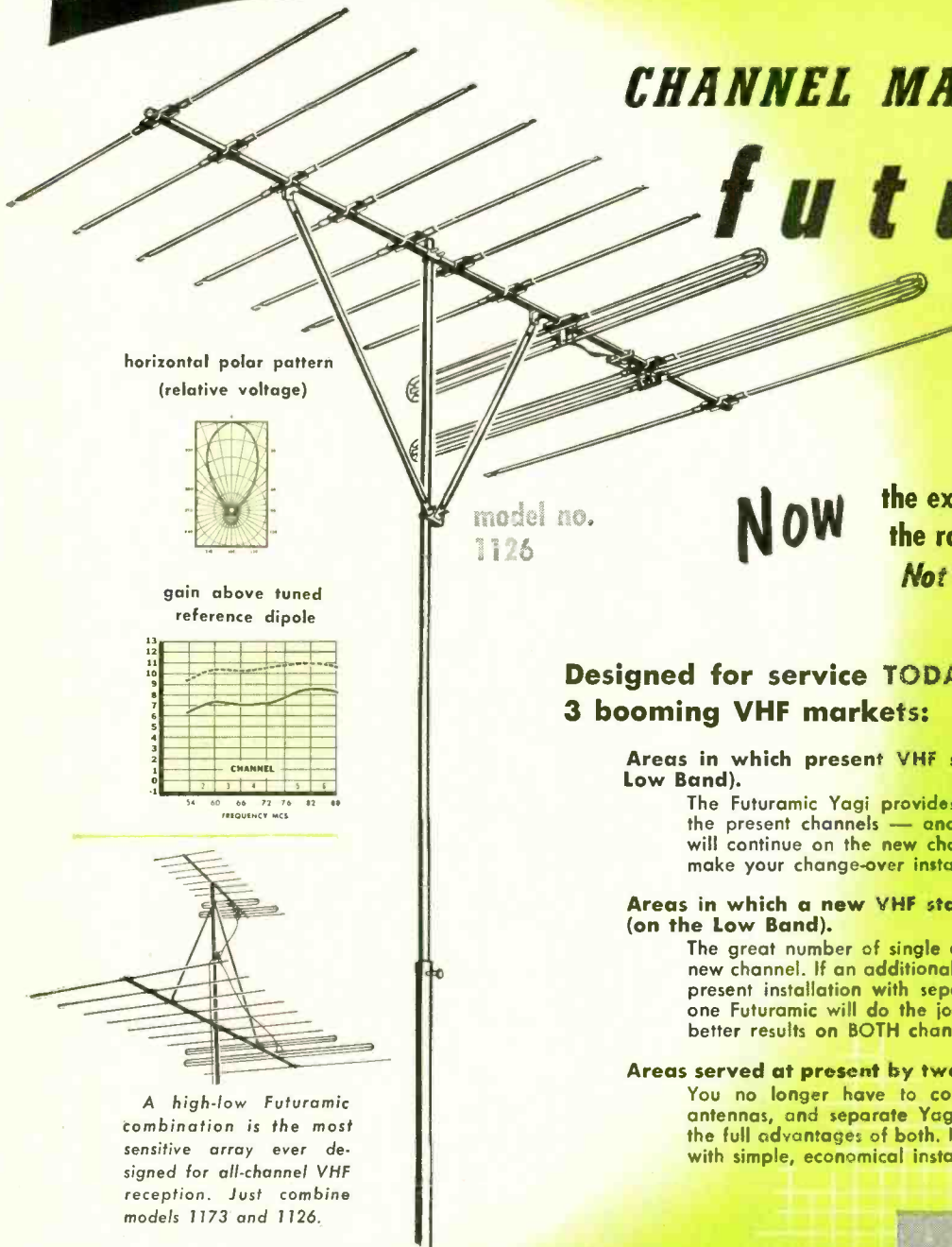

horizontal polar pattern (relative voltage)

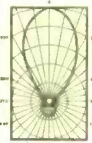

gain above tuned reference dipole

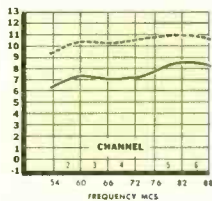

model no. 1126

A high-low Futuramic combination is the most sensitive array ever designed for all-channel VHF reception. Just combine models 1173 and 1126.

Now — 6 great Futuramic models, designed for every reception area:

model no.	channels covered	list price
1173	7 — 13	\$20 <sup>00</sup>
1124	2, 3, and 4	
1125	2, 3, 4, and 5	
1136	3, 4, 5, and 6	\$40 <sup>00</sup>
1146	4, 5, and 6	
1126	2, 3, 4, 5, and 6	

CHANNEL MASTER  
engineering  
pays off on VHF!



CHANNEL MASTER CORP. MILLERSVILLE, N. C.





Be Sure of Your Installations...Next Year

Use

*Aptitude-Tested*

**MIKE  
CABLE**  
*Now!*

Now, you can be sure of your installations with Belden Microphone Cables. They are *Aptitude-Tested* and rated to give you safe and complete knowledge of their characteristics. Furthermore, Belden Mike Cables are built for maximum service. Put them to work for you now—and be sure... specify Belden.

Belden Manufacturing Co., 4623 W. Van Buren Street  
Chicago 44, Illinois



To You,  
Belden's Golden Anniversary  
Means

—product performance that can come only from a "know-how" that has grown through actual service since the inception of Radio.

—an ability to co-operate in pioneering new wires to meet or anticipate industry's growing needs.

In the years that follow

This Belden Program Is—

— TO BE CONTINUED

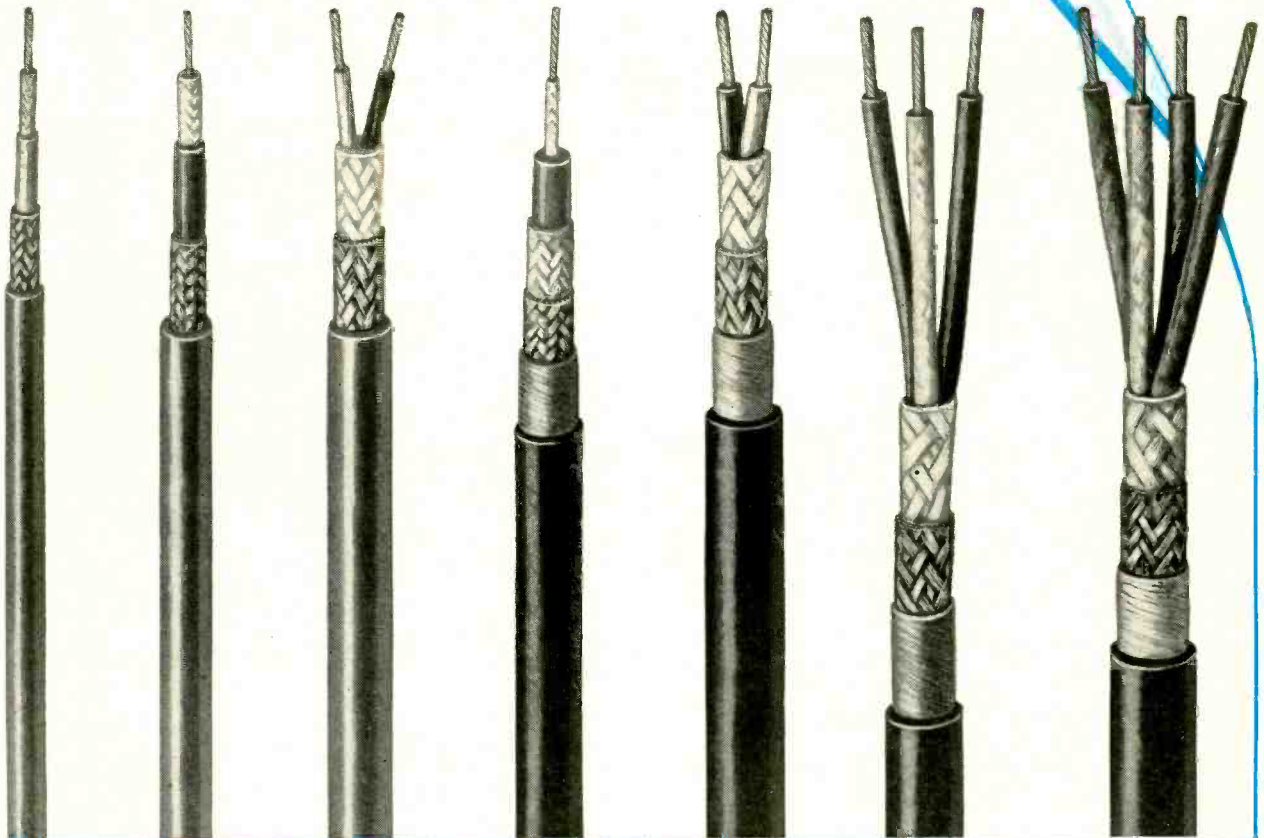

**No. 8411**  
Nominal Capacitance 37 mmf per ft. Use particularly for lapel microphone.

**No. 8401**  
Nominal Capacitance 25 mmf per ft. For crystal, ribbon, carbon microphones.

**No. 8422**  
Nominal Capacitance 32 mmf per ft. Use specially for carbon microphones.

**No. 8410**  
Nominal Capacitance 33 mmf per ft. For crystal, ribbon, carbon microphones.

**No. 8412**  
Nominal Capacitance 68 mmf per ft. Use specially for carbon microphones.

**No. 8423**  
Nominal Capacitance 54 mmf per ft. Use particularly for carbon microphones.

**No. 8424**  
Use for interconnecting power cable for all electronic uses. Also microphone cable.

**Belden**  
*Radio WIRE*

The  
*Aptitude-Tested* **LINE**





Leonard C. Lane, B.S., M.A.  
President of Radio-Television  
Training Association, Exec. Dir.  
of Pierce School of Radio and  
Television.



**I GIVE YOU  
MORE EQUIPMENT  
TO TRAIN YOU BETTER**

Set up your own home laboratory with the 15 BIG TV-Radio Kits we send you. You build AND KEEP your own complete BIG SCREEN TV RECEIVER, Super-Het Radio Receiver, R.F. Signal Generator, Combination Voltmeter-Ammeter-Ohmmeter, C-W Telephone Receiver, AC-DC Power Supply. Everything is furnished complete, including all tubes, plus big TV picture tube.

**GET MORE!**

**LEARN MORE!**

**EARN MORE!**

TAKES UP TO  
**21 in.**  
PICTURE TUBE

**THOUSANDS OF NEW JOBS IN**

# TELEVISION

**I PREPARE YOU AT HOME IN YOUR SPARE TIME**

**MORE**

**TRAINING TO FIT YOU  
FOR THE BETTER PAY JOBS**

Thousands of new jobs will open up right in your own state now that the government has lifted restrictions on new TV stations. My simple, successful methods have helped hundreds of men — most of them with NO PREVIOUS TRAINING — find places in America's booming TELEVISION and Electronics industries. You too can get the success and happiness you always wanted out of life within months... studying at home... as I train you to become a full-fledged TV TECHNICIAN. Many of my students make as much as \$25.00 a week repairing Radio TV sets in their spare time while learning... pay their entire training almost from the very beginning from spare time earnings... start their own profitable service business.

But I don't stop after I qualify you as a TV Technician... although right there you can choose from among dozens of fascinating careers! I continue to train you — AT NO EXTRA COST — to qualify for even better pay in the BETTER JOBS that demand FCC licenses, with my...

**FREE FCC COACHING COURSE**

PREPARES YOU AT HOME FOR YOUR FCC LICENSE.  
THE BEST JOBS IN TV AND RADIO REQUIRE AN FCC LICENSE.  
Given at NO EXTRA COST after TV Theory and Practice is completed.

**NOW! ADVANCED FM-TV TRAINING**

If you have previous Armed Forces or civilian radio experience—my ADVANCED COURSE can save you months of training. Full theory and practical training... complete with kits, including BIG SCREEN TV RECEIVER and FREE FCC License Coaching Course.

**FREE EMPLOYMENT ASSISTANCE**

My vocational adviser will help you obtain a good-paying job in the locality of your choice.

**RADIO-TELEVISION TRAINING ASSOCIATION**

1629 Broadway, Radio City Station, New York City 19, N. Y.  
LICENSED BY THE STATE OF NEW YORK

**MORE VALUE!**

**YOU GET A ROUND TRIP TO  
NEW YORK CITY  
AT NO EXTRA COST**

FROM ANYWHERE IN THE U.S. OR CANADA — I pay your way to New York and return, PLUS 2 FREE weeks, 50 hours of advanced instruction and shop training at the PIERCE SCHOOL OF RADIO & TELEVISION. You use modern electronics equipment, including student-operated TV and Radio stations. You go behind the scenes of New York's big Radio-TV centers, to study first hand. And I give you all this AT NO EXTRA COST! (Applies to complete Radio-TV course only.)

Only RTTA makes this amazing offer.

**I GET MY**

**GRADUATES GOOD PAYING JOBS**

"Thanks to your training, I qualified for a good job as a Receiver Tester at Federal Telephone and Radio."  
— Paul Frank Seier



"I'm making good money in my own business, repairing and installing radio and TV sets — thanks to your training."  
— Irwin Polansky



"Your excellent instruction helped me get my present job as an airport radio mechanic for American Airlines."  
— Eugene E. Basko



"I'll always be grateful to your training which helped me get my present fine position as Assistant Parts Manager."  
— Norman Weston



Many others working at NBC, RCA, CBS, DuMont, Philco, Emerson, Admiral and other leading firms.

# VETERANS!



MY SCHOOLS FULLY APPROVED TO TRAIN VETERANS UNDER NEW G.I. BILL! If discharged after June 27, 1950 — CHECK COUPON BELOW!

Also approved for RESIDENT TRAINING in New York City... qualifies you for full subsistence allowance up to \$160 per month.

**MAIL COUPON TODAY!**

**BOTH FREE!** New Illustrated Book and Sample Lesson. Learn How My Simple Methods Make Success Easy!



**NO SALESMAN WILL CALL!**

Mr. Leonard C. Lane, President  
RADIO-TELEVISION TRAINING ASSOCIATION  
1629 Broadway, Radio City Station  
New York 19, N. Y.

Dept. R-6

Dear Mr. Lane: Mail me your NEW FREE BOOK and SAMPLE LESSON that will show me how I can make BIG MONEY in TELEVISION. I understand I am under no obligation and no salesman will call.

(PLEASE PRINT PLAINLY)

Name \_\_\_\_\_ Age \_\_\_\_\_  
Address \_\_\_\_\_  
City \_\_\_\_\_ Zone \_\_\_\_\_ State \_\_\_\_\_

I am interested in:  Radio-TV  Advanced FM-TV.  
VETERANS: If qualified under new G.I. Bill, check your choice:  Home Study  Resident Study.



# \$10,000.00

## IN PRIZES

### ENTER RAYTHEON'S TRANSISTOR APPLICATION CONTEST!

Here's the chance-of-a-lifetime to win a big cash prize while gaining valuable "know-how" on the latest electronic development — transistors. Raytheon is offering 17 cash prizes to the seventeen contestants who produce the most ingenious applications of the Raytheon CK722 Junction TRANSISTOR.

**Here's all you have to do!** Simply build equipment that uses one or more Raytheon CK722 Transistors which you have purchased from your local Raytheon Tube Distributor. Then send a photograph of the unit you have built, a completed official entry blank and a 500 word minimum, 1000 word maximum constructional article on the equipment to Raytheon, P. O. Box 6, Newton 58, Mass. All entries will be carefully judged and prizes will be awarded on the basis of ingenuity of application. Duplicate equipment to be judged on basis of descriptive material. Decision of the judges is final and all entries and their ideas become the exclusive property of Raytheon.

**Here's how to enter!** Go to your nearest Raytheon Special Purpose Tube Distributor. Get your official entry blank which *must* accompany each entry and which contains complete contest rules or get the official entry blank by writing directly to Raytheon, P. O. Box 6, Newton 58, Mass. Enter today — the contest closes on Midnight August 31, 1953.



Excellence in Electronics

**RAYTHEON MANUFACTURING CO.**

Receiving Tube Division

POST OFFICE BOX 6, NEWTON 58, MASSACHUSETTS

PRIZES	
1st.....	\$5000.00
2nd.....	2000.00
3rd.....	1000.00
4th.....	500.00
5th.....	300.00
6th to 17th	100.00

RADIO-ELECTRONICS



**For opportunities within your reach**

# See what the RCA TV Servicing Course offers you

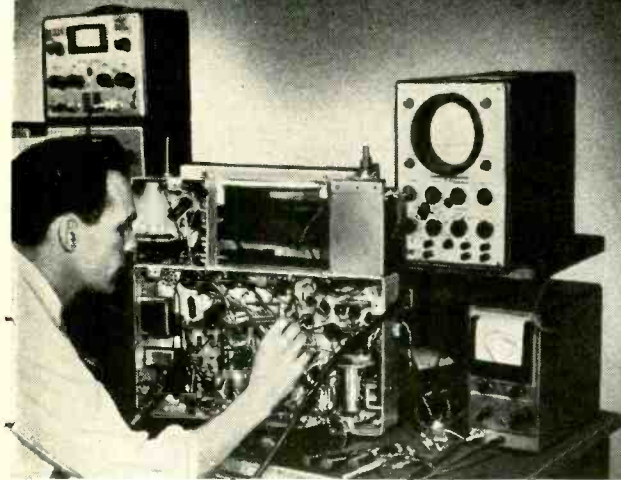

## Good-pay jobs. A business of your own.

OPPORTUNITIES FOR GOOD-PAY JOBS in Television are within your reach when you study TV Servicing by the RCA Institutes Home Study Method. Or perhaps you would like to start a TV Service business of your own.

If you are not satisfied with the way your future now stacks up, see how easily

you can change the course of your career. RCA Institutes Home Study Course in TV Servicing is helping thousands of other people to better jobs. It can help you. Right now thousands of opportunities are going begging. There is a critical shortage of trained TV servicemen. This is *your* big opportunity.

## Easy-to-understand, illustrated lessons



The entire course is divided into ten units of several individual lessons. You study them at home in your spare time.

Lesson-by-lesson you learn the theory and step-by-step procedures of installing TV antennas, of servicing and trouble-shooting TV receivers. Hundreds of pictures and diagrams help you understand the how-it-works information and the how-to-do-it techniques. You will be amazed how easily you absorb the knowledge of each lesson, how quickly you train yourself to become an experienced technician.

## Experienced engineers and faculty prepared the course, grade your lessons



The RCA Institutes course was written and planned by instructors with years of specialized

experience in training men by home-study and resident-school methods. The course embodies RCA's background of television experience plus knowledge gained in training several thousand technicians. A study of the course parallels an apprentice's training. Your lessons are carefully examined and accurately graded by friendly teachers who are interested in helping you to succeed.

## One of the leading and oldest Radio-Television training schools



Founded in 1909, RCA Institutes, Inc. has been in continuous operation for the past 44 years. Its

wide experience and extensive educational facilities give students, just like you, unsurpassed technical training in the highly specialized field of radio-television-electronics.

RCA Institutes is licensed by the University of the State of New York . . . an affiliate member of the American Society for Engineering Education . . . approved by the Veterans Administration . . . approved by leading Radio-Television Service Organizations.

## It costs so little to gain so much

RCA Institutes makes it easy for you to take advantage of the big opportunities in TV Servicing. The cost of the TV Servicing Home Study Course has been cut to a minimum. You pay for the course on a pay-as-you-learn unit lesson basis. No other home study course in TV Servicing offers so much for so little cost to you.

RCA Institutes conducts a resident school in New York City offering day and evening courses in Radio and TV Servicing, Radio Code and Radio Operating, Radio Broadcasting, Advanced Technology. Write for free catalog on resident courses.



**RCA INSTITUTES, INC.**  
A SERVICE OF RADIO CORPORATION of AMERICA  
350 WEST FOURTH STREET, NEW YORK 14, N.Y.

**SEND FOR FREE BOOKLET**—Mail the coupon—today. Get complete information on the RCA INSTITUTES Home Study Course in Television Servicing. Booklet gives you a general outline of the course by units. See how this practical home study course trains you quickly, easily. Mail coupon in envelope or paste on postal card.



### MAIL COUPON NOW!

RCA INSTITUTES, INC., Home Study Dept. RE-653  
350 West Fourth Street, New York 14, N.Y.

Without obligation on my part, please send me copy of booklet "RCA INSTITUTES Home Study Course in TELEVISION SERVICING." (No salesman will call.)

Name \_\_\_\_\_ (please print)

Address \_\_\_\_\_

City \_\_\_\_\_ Zone \_\_\_\_\_ State \_\_\_\_\_





320K SIG. GEN. KIT \$19.95 WIRED \$29.95

145K SIG. TRACER KIT \$19.95 WIRED \$28.95

950K R-C BRIDGE & R-C-L COMP. KIT \$19.95 WIRED \$29.95

360K SWEEP GEN. KIT \$34.95 WIRED \$49.95

New 214K VTVM KIT \$34.95 WIRED \$54.95



New 377K SINE & SQUARE WAVE AUDIO GEN. KIT \$31.95 WIRED \$49.95

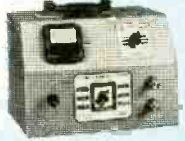

1040K BATTERY ELIM. KIT \$25.95 WIRED \$34.95



**OVER 1/4 MILLION**  
**EICO INSTRUMENTS**  
**in use the world over!**

*EICO* new modern facilities for research, development and production—your greater assurance of . . .

**LABORATORY PRECISION AT LOWEST COST**

**NEW 7" Push-Pull OSCILLOSCOPE**

- Boosted vert. sensitivity: 10 mv rms/in.
- Extended flat freq. response: 10 cps—1 MC ( $\pm 2$  db).
- 3-step freq.-compensated attenuator; cathode follower input.
- Internal voltage calibrator; dir.-cal. screen.
- Extended sweep range: 15 cps—100 kc.
- Int. pos. or neg., ext. & line sync.
- On front panel; sawtooth, 60 cps outputs; intensity mod. & ext. sync inputs.
- Var. phasing of int. 60 cps sweep.
- Direct connection to CRT plates.

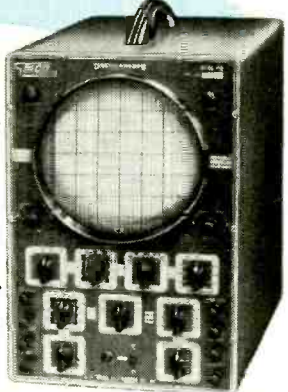

470K KIT \$79.95 WIRED \$129.50



1171K RES. DECADE BOX KIT \$19.95 WIRED \$24.95



625K TUBE TESTER KIT \$34.95 WIRED \$49.95



CRA PIX TUBE ADAPTOR for Tube Tester \$4.50

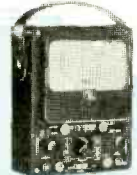

New 565K MULTIMETER KIT \$24.95 WIRED \$29.95 20,000  $\Omega/v$ ; 31 ranges

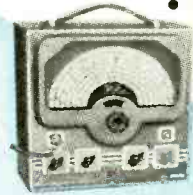

315K DELUXE SIG. GEN. KIT \$39.95 WIRED \$59.95



HIGH VOLTAGE PROBE \$6.95



221K VTVM KIT \$25.95 WIRED \$49.95



425K 5" PUSH-PULL SCOPE KIT \$44.95 WIRED \$79.95

**You Build EICO Kits in One Evening, but . . . They last a Lifetime! and You SAVE OVER 50%**

YOU be the judge. See the famous EICO line TODAY—in stock at your local jobber—and SAVE!

Write NOW for FREE newest Catalog 6-C.

America's greatest instrument values bear the name—



ELECTRONIC INSTRUMENT CO., Inc., 84 Withers Street, Brooklyn 11, N. Y.



**NEW!**  
 MODEL 495-K SCOPE VOLTAGE CALIBRATOR IN KIT AND WIRED FORM



# CLOSED-CIRCUIT TELEVISION

... A new booming field for video ...

By HUGO GERNSBACH

CLOSED-CIRCUIT television has been with us for a number of years. We have mentioned the subject on this page several times in the past and we will attempt to give as complete a list of the new uses of television as is feasible in this limited space.

General Sarnoff, Chairman of the Board of the Radio Corporation of America, recently stated: "The dimensions of industrial television may surpass the growth in broadcast television we are now witnessing."

By far the most publicized use of closed-circuit television is that for educational purposes in colleges, universities, and other institutions of learning. This new field is bound to grow by leaps and bounds, and while it will never supplant the classroom, there is a great future ahead for it.

Sarnoff is also of the opinion that television in the office, factory, and home will rank soon with voice communication between rooms in the same house and offices in the same building. He is of the opinion that when the cost of camera attachments becomes low enough to permit their use in homes, *the television receiver will become the control center of the home*. By turning a switch, the receiver, instead of showing broadcast programs, will be used to view the children asleep or at play in the yard or in the nursery, to view the cooking in the kitchen, and to see callers before the door is opened.

Industrial television has already achieved many wonders. Seventeen years ago, the writer predicted one of the important improvements in the art, namely stereoscopic television, now popularly called 3-D (three-dimensional viewing)\*. Quietly, without fanfare, it has already arrived. The Allen B. Du Mont Laboratories, Inc., are making a stereoscopic television camera which is used at the Argonne National Laboratories in atomic research work. The stereoscopic camera is focussed on a mechanical manipulator used to work with radioactive "hot" materials. At a safe distance away, a chemist views a stereoscopic image on a receiving screen through spectacles fitted with polarized glasses as he co-ordinates the mechanical manipulator. The receiver which he watches has two identical pictures side by side on the same screen. This, with his polarized glasses, gives stereoscopic vision at a distance.

An accountant with pencil poised now can watch freight yards from his office with a camera mounted in a railway yard. Thus, he can check off the serial numbers on the freight cars as the train passes by the camera.

Railroads now also use television to guide switching of incoming and outgoing trains.

An electronic eye can now see into a furnace and observe fuel combustion and do away with smoke pollution.

In London, England, airports can now check on taxiing planes and planes aloft by means of television.

At the New York Savings Bank, customers' signatures and balance cards are viewed by a television camera. The result is flashed to the teller's cage and he instantly sees the customer's balance. He thus can verify the customer's signature and tell whether a check might overdraw the

\* Oct. 1936 issue SHORT WAVE CRAFT.

account. This system greatly speeds banking transactions.

The British use underwater television cameras routinely in locating sunken ships. The camera is remotely controlled. It can be swung through a variety of angles for horizontal and vertical shots, or shots of any given angle.

During the 1952 Radio Exhibition at London, a radio-controlled crane was operated by an engineer using television. He saw only the crane on a screen; all operations were performed by remote-control.

Operations performed by surgeons via television are becoming commonplace. A new idea however for lecturing purposes by the medical profession now makes it possible to bring home anatomical details by throwing a greatly enlarged television image on the screen. A recent English demonstration showed only a live human eye, the pupil of which was enlarged to such an extent that it was bigger than the lecturer. Standing before the screen he used a long lecturing stick to show the eye's pathological points to the assembled physicians.

Supervisors of factories can now view almost any operation in any plant for which they are responsible. Thus, for instance, if he wishes to see plant No. 2, fifth floor, center of the Stamping Department, all the supervisor has to do is flip a switch. If he wishes to see Plant No. 8, two miles away, and wants to watch a certain operation on the assembly line, he simply flips another switch. In this manner the supervisor or operating manager can visit any part of a huge factory, and can cover more ground in fifteen minutes than he previously could in 3 hours.

It is also possible now for salesmen in widely scattered areas to see a new product demonstrated and familiarize themselves with all its important points.

John Gallagher, Industrial Television Sales Development Coordinator of Du Mont, recently spoke at length on closed-circuit television. Among other things, he stated that such a system can now be used to guard banks, industrial plants, and department stores, to supervise commercial operations at a distance, to protect documents and signatures, to control traffic in tunnels and crowded highways, and to read all types of meters and gauges on boilers on industrial installations.

It will also soon be possible for publishers to see final proofs and check corrections via closed-circuit television. One of the time-consuming nuisances in publishing today is that proofs must either be transported from the distant printer to the publisher. Or the editor or editorial worker must go to the printing plant. By closed-circuit television, it will be possible to read proofs from a television screen and verify corrections, with vast saving of time.

Closed-circuit video will really start booming when color television becomes of age. This is particularly true in surgery and many manufacturing processes where color control is of vast importance, such as textiles, foods, and color printing, to mention a few. Color television now being in the last stages of development, it is certain that in the next ten years industrial television will rise to unimagined heights.



# NEW BOOSTERS from OLD TUNERS

*Convert junk-box front ends*

*to cascodes—and into cash*

By JOSEPH MARSHALL

Fig. 1—Before and after. Unretouched photos of the picture received without (left) and with (right) a home-built cascode booster made from a 98¢ tuner.

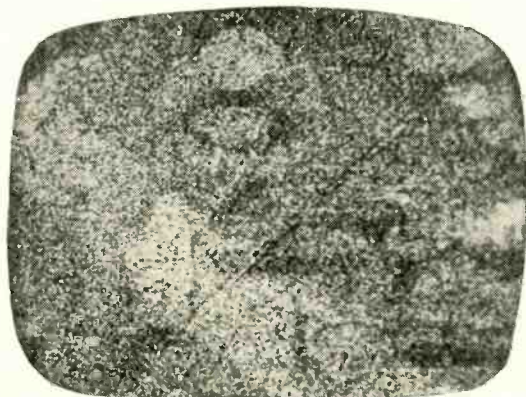

THE cascode circuit is unquestionably the biggest improvement in high-frequency amplifier design of the past decade. Incorporating it in the front-ends of TV receivers has vastly improved their performance in near-fringe areas; but it has also brought problems in the far-fringe areas. The new tuners work very well where the signal strength is great enough to give good contrast without a booster, since the "snow" of the cascode circuit is small enough not to be annoying. But trouble ensues when a booster must be added, for unless the noise figure of the booster is at least as good as that of the cascode front-end, a stronger picture is obtained only at the expense of more snow.

Most pre-cascode boosters have an inferior noise figure. It takes a booster with a cascode input stage to improve the over-all picture quality. Technical magazines have had articles describing many types of single-channel boosters; but there have been no descriptions of cheap home-built boosters for all-channel performance, for the simple reason that the headaches involved in winding and switching the multiplicity of coils are enough to try the patience of a whole factory engineering staff, let alone a lone experimenter or amateur. But in the past year the near-obsolence of pre-cascode tuners has thrown many varieties of front-ends on the market at bargain prices—some as low as \$1.00 and most of them under \$10.00. Many of these can be rebuilt easily into excellent all-channel cascode boosters, with performance at least as good as high-priced commercial versions. The author has constructed several in the past few months.

The two unretouched photos in Fig. 1—taken within a few seconds of each

other—show the improvement on channel 2 effected by the addition of one of these boosters at a distance of 140 air-line miles from the transmitter. Although the receiver did not have a cascode r.f. stage, the improvement with the new-style tuner is nearly as dramatic. The booster responsible for this performance was made in a total of three hours out of a tuner of unknown make purchased from Burstein-Applebee for 98¢. We have also made very successful boosters out of Du Mont *Inputuner* front-ends. Although we have not actually converted one, old models of the Standard Coil tuner should also make very satisfactory boosters.

Most conversions are simple and do not take more than a few hours of work. The re-wiring is practically all confined to the tube sockets; the tuned circuits are not disturbed. In most cases the only additional parts needed are a pair of 100-ohm resistors and possibly two new tubes. The circuit is not at all critical and if reasonable care is taken in construction no trouble should follow. Adjustments are also simple, since the original alignment is not disturbed much.

## Choosing the tuner

Some of the old tuners had push-pull-triode r.f. amplifiers and tuned-line resonant circuits. Although it is possible to convert these, I have not tried it, and I do not recommend the attempt except to those who have had considerable experience fooling around with v.h.f.-amplifier circuits. The best types are those with a pentode r.f. stage and a 6J6 mixer-oscillator. All the Du Mont *Inputuners* are convertible into extremely good boosters, whether they have pentode or grounded-grid-triode r.f. stages. In fact, any tuner that has

parallel-tuned antenna and output circuits, and two 7-pin miniature sockets fairly close together, will work in this circuit.

## The circuit

The circuit of Fig. 2 uses a 6AK5 (though a 6CB6 will probably work as well) and a 6J6 in a direct-coupled cascode circuit. The new twin-triodes (6BK7-A, 6BQ7-A, and 6BZ7) would also work here; but unfortunately they call for replacing the 7-pin sockets with larger 9-pin sockets and this involves real labor. This two-tube circuit works even better, and requires no physical modification of the tuner chassis. The circuit is actually very simple, despite the presence of coils in unfamiliar places.

The cascode circuit combines a grounded-cathode-triode input section and a grounded-grid-triode output section. For several reasons this combination produces an incredibly good combination of low noise and high gain. Its high input impedance permits the use of an impedance-stepup transformer in the antenna circuit. This gives a better input-signal to tube-noise ratio, and the gain becomes very much higher, approaching—and in some cases surpassing—the gain of a pentode. The grounded-grid 6J6 loads the first section very heavily, reducing the gain of the 6AK5 to unity or a little better, eliminating the instability and oscillating tendency of a triode. Though the 6AK5 has very little gain, it transfers the favorable signal-to-noise ratio of the first section to the grounded-grid second stage. The combination has the high stability of a grounded-grid triode and the favorable noise figure of a grounded-cathode triode. The over-all noise figure is equivalent to that of the



input tube alone, and the over-all gain is as good as or better than that of a pentode.

**Interstage coupling**

Several methods of coupling between the two stages are possible. The simplest—and in many ways the most effective—is the direct coupling made possible by putting the second section in series with the first one. The interstage impedance to ground is very high and the number of tuned circuits is reduced to a minimum. This is the method used in this booster. The schematic is given in Fig. 2.

There are two variable tuned circuits, one at the antenna input and the other in the output of the second stage. These tuned circuits are the antenna (L1)

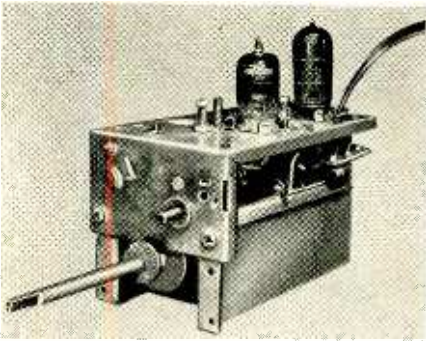

Two-tube *Inputtuners* are easy to convert. See circuit changes in Fig. 5.

and amplifier-plate (L4) coils of the original tuner, and need little or no modification. Before going into that, however, it might be well to explain the function of the two *unfamiliar* coils L2 and L3 which appear in the circuit diagram.

The purpose of L2 is to neutralize the grid-plate capacitance of the 6AK5. This is normally only about 2 or 3  $\mu\text{mf}$ , but this is increased by the Miller effect and by circuit capacitance. This capacitance offers very little impedance to the high TV-signal frequencies, and has two bad effects. On one hand, part of the input signal bypasses the grid of the first section completely, going through the interelectrode capacitance directly to the second section; on the other hand, part of the output signal at the plate of the first section feeds back through this capacitance to the input grid. Since the first section in a cascode circuit has little if any voltage gain, the feedback effect does not cause oscillation—at least not when the input is loaded with an antenna. But it does result in some loss of signal. On the other hand, the *feed-through* around the first section reduces the noise figure of the amplifier because the low input impedance of the grounded-grid second section loads the antenna input more heavily than the grounded-cathode first section. In any event, we get slightly more gain and a noticeably better noise figure—especially on the high-band channels—by preventing this feedback and feed-through in the first section of the amplifier.

We achieve both of these aims by adding an inductance (L2) to form a parallel-resonant circuit with the plate-grid and circuit capacitance at the signal frequency. As we know, such a parallel circuit forms a rejection trap, preventing signals from going through it in either direction. We also have to add a blocking capacitor (C1) to prevent grounding the plate voltage. Although at first glance the result looks like a series resonant circuit, it is actually the parallel-tuned circuit shown in Fig. 3-a. (The reactance of the 250- $\mu\text{mf}$  blocking capacitor at TV-channel frequencies is so small that L2 is effectively connected directly to the 6AK5 plate.) The inductance of L2 is not critical. Where there is room, it can be 5 to 10 turns of No. 22 *Formvar* wire, wound on a 1/4-inch slug-tuned form. Where space is at a premium (as in the Standard Coil tuner) it can be a self-supporting coil of 15 to 20 turns of the same wire, wound on a 1/8-inch drill stem. It is best to resonate this on a high-band channel or the weakest station received.

Now let's look at L3. It neutralizes the plate-to-ground capacitance of the first tube. In a triode-connected 6AK5 this capacitance is around 2 or 3  $\mu\text{mf}$ . The capacitance is increased if the tube is shielded, and no shield should be used on this section. It is also increased by wiring capacitance. With one thing and another, we end up with nearly 10  $\mu\text{mf}$  plate-to-ground capacitance. In the ordinary r.f. amplifier, where the load is a tuned circuit between plate and ground, this capacitance is put to work as part of the resonant circuit. But in the cascode circuit, the load is *in series* between the plate and the output of the next tube. So the plate-ground capacitance—instead of being part of the load—bypasses the signal *before* the load, and unless it is neutralized a good portion of the signal will be bypassed to ground instead of going into the load and being amplified in the process. Once again we neutralize by installing an inductance. L3 forms a

parallel-resonant circuit. See Fig. 3-b. Incidentally L3 and C2 also form a series-resonant circuit at a frequency much lower than the signal frequency. This can be tuned to form an interference-rejection trap by changing the value of C2. For instance, if the receiver has an i.f. in the 40–50 mc range, this coil can be made to do double duty by choosing a value of C2 which forms a series-resonant circuit with L3 at 40–50 mc.

Ordinarily we think of neutralization as an expedient to prevent oscillation. In the case of the cascode circuit, however, we use neutralization not for that purpose (for the circuit is extremely stable as is) but to keep the signal within the amplifying channel and prevent its loss through bypassing to ground. For this reason, L3 has a much greater effect on the gain than L2. Fortunately, L3 is not very critical and can be a duplicate of L2, adjusted for maximum gain on the high band or on the weakest station.

Otherwise, and in spite of these neutralizing coils, the cascode circuit is very simple. Putting in the wrong-size neutralizing coil will not ordinarily make the circuit inoperative; it simply will not give all the gain and the ideal noise-figure that can be obtained with the right values.

The two tubes are actually in series between the antenna input at the grid of the first tube and the booster output at the plate of the second section. About half the supply voltage appears at the plate of the 6AK5. The full supply voltage is applied to the plate of the 6J6, but the effective plate-to-cathode voltage is only half the supply voltage, because the grid is returned to the bottom of the cathode-bias resistor, as in ordinary circuits.

**Circuit tuning**

Now to get back to the tuned circuits. We need two of them, one at the antenna input and the other at the output of the second tube. All tuners can supply these circuits with more or less

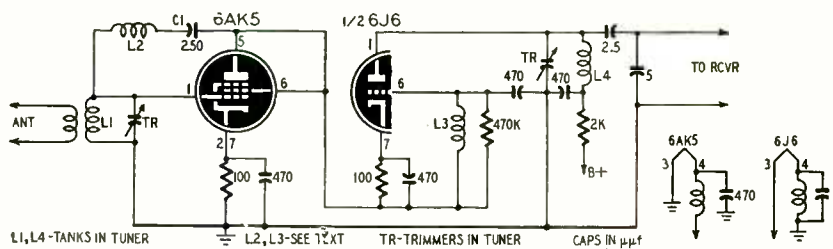

Fig. 2—Circuit of the cascode booster. L2 and L3 are neutralizing coils.

parallel-tuned circuit with the plate-ground capacitance at the signal frequency and therefore obstructs the passage of the signal to ground. Once again we must block this circuit to d.c. by putting a capacitor in series. We kill two birds with one stone by returning the ground end of L3 to the second grid. The 470- $\mu\text{mf}$  capacitor thus serves two purposes. Although here, too, the circuit looks like a series-resonant circuit at first glance, it is also actually a

modification. The input circuit is usually no trouble at all, except in the case of some Du Mont tuners, whose case is considered separately later on. Most tuners provide a link-coupled input coil between the antenna terminals and the grid of the r.f. stage. If your tuner has one, leave it as is. If the tuner does not have link coupling, you will have to provide it. One way is to purchase a replacement input transformer for a Du Mont *Inputtuner* and use it as indicated



in the section on Du Mont tuners. A simpler method is to use the capacitive transformation provided by the "R-9'er" input circuit. This is diagrammed in Fig. 4 and would replace the input circuit in Fig. 2.

The tuned output circuit is more of a problem. The simplest solution is to use the "R-9'er" capacitive transformer again, and this is the method diagrammed in Fig. 2. Tuners like the Standard Coil type which have transformer coupling between the r.f. stage and the converter, offer an alternative. In these, the oscillator winding on each channel can be either removed or open-circuited. The converter-grid winding can be reduced to 3 or 4 turns and used as an output link. This involves considerable work and offers only doubtful improvement in performance. So the capacitive output transformer is the most practical. It can be used with either 300-ohm or 72-ohm cable. The output impedance can be varied by increasing or decreasing the value of the 5- $\mu$ f capacitor in Fig. 3. But the two fixed values given will work adequately as is.

There is only one really critical factor in converting a tuner into a booster. That is to keep the inductance of the leads to the tuned circuits unchanged. In tuners with a pentode r.f. stage, the antenna coil presents no problem at all. The r.f.-amplifier socket is already oriented for the best lead length from grid to coil or switch, and since this circuit is retained without change, the antenna tuned circuit is not disturbed at all. However, we must shift the output tank from the plate of the first tube to the plate of the second tube. To keep

this connection as short as it is now, it will probably be necessary to drill out the mounting rivets on the converter socket, and turn this socket so that the plate terminal is as close as possible to the coil terminal. If the resulting lead is a little longer than the original, make it of heavy wire or brass strap to reduce the inductance. In any case, dress this lead well away from the chassis—especially if it is a strap.

If the r.f. amplifier in the tuner was a pentode, usually the only changes needed in this circuit are to remove the tank circuit, tie the screen to the plate (removing the screen-bypass capacitor and voltage-supply lead), and connect the plate to the second-section cathode through the cathode resistor. In most tuners, however, the mixer circuit will have to be rewired completely, except for the heater circuit. Although certain values of bypass capacitance are suggested in Fig. 2, these are not critical. The best thing is to use the original capacitors in the tuner. The same is true of heater chokes, and that is why no values are given for them.

The converted circuit should not require much if any re-alignment. Any changes caused by rewiring can be compensated for with the trimmers already in the circuit. Since the individual coils in any tuner have already been adjusted for each channel at the factory, the alignment at one point—usually the weakest station—will suffice for all channels. The only other adjustment is peaking the neutralizing coils. This should also be done on the weakest channel, or on one of the high channels. If the coils are wound over iron cores, the slugs can be adjusted to peak them. If the coils are self-supporting, they can be adjusted by spreading or compressing the turns. The neutralization will be fully effective over only part of the range; but this is ordinarily enough to provide good gain on all channels.

**Du Mont tuners**

Du Mont tuners can make the best boosters but offer some special conversion problems. Those with 3-section spiral tuners have a pentode r.f. stage, but use an untuned antenna input, with two-section bandpass tuning between r.f. amplifier and converter. Others use a 6J6 ground-grid input stage. In any event the best way to convert them is to take them apart completely and rewire from beginning to end. Both sockets may require re-orientation to provide short leads to tuned circuits.

The bandpass circuit is not used in the converted booster (Fig. 5). A more normal circuit with a tuned antenna stage is employed instead. The end inductances will be shifted around. The one wound with flat strap is used in the r.f. stage (L2); the one on the rear section (converter-oscillator), is moved to the front section. The untuned antenna-input transformer is retained and rewired as indicated in Fig. 5.

The middle section of the *Inductuner* is used as a continuously variable neutralizing coil (L7). (This accounts for the superior performance of boosters made from Du Mont tuners.) The end winding (L105) can be the one formerly used as the end inductance for the oscillator tank. Do all the wiring on the chassis with the *Inductuner* removed. Solder the end inductances in place on the chassis, so that only the connections to the *Inductuner* have to be made when this is fastened in place again. These can be soldered through the various openings in the chassis shield divisions. Now you can align the three tuned circuits on the highest channel by adjusting the brass slugs in the coils, and then on the weakest channel by adjusting the trimmers.

**Standard Coil tuners**

Standard Coil tuners are very well suited for conversion to boosters. The r.f. stage can remain almost intact. Merely remove the screen wiring and connect the screen to the plate. The r.f. plate tank must be moved to the plate of the second section. It should be possible to do this without changing the socket; but even re-orienting the socket poses no problem. The Standard tuner does not provide for continuous tuning of the neutralizing coil. At first thought the use of the oscillator winding suggests itself. However, it must be remembered that this coil is on the same form as the plate tank and coupled to it. The result would be an absorption trap, at least partly, rather than a rejection trap. The best thing to do is merely to open the leads to the unused oscillator coils at the strip terminals. The Standard tuner is neutralized at only one point—with coils which have to be added—but it should give excellent performance as a booster on all channels.

**Conclusion**

There are many obsolete tuners of various types now available at very low cost—some for free out of the junk-box—which can be converted into cascode boosters. If normal precautions are taken, the resulting boosters can equal or surpass in performance commercial versions of the same circuit selling for \$25 and up. Such boosters will bring higher gain without added snow to receivers already equipped with a cascode r.f. stage. In remote-fringe areas where one booster is not enough, the addition of a cascode booster may make all the difference between a snowy picture and one with local-station quality.

END

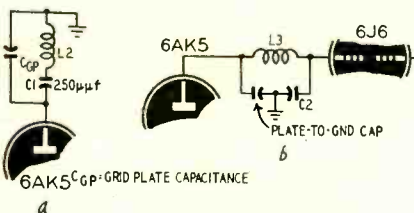

Fig. 3—Equivalent parallel-resonant rejection traps formed by the neutralizing coils and associated circuit capacitances.

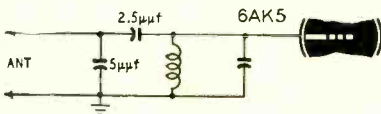

Fig. 4—Circuit of the "R-9'er" capacitive impedance-matching transformer.

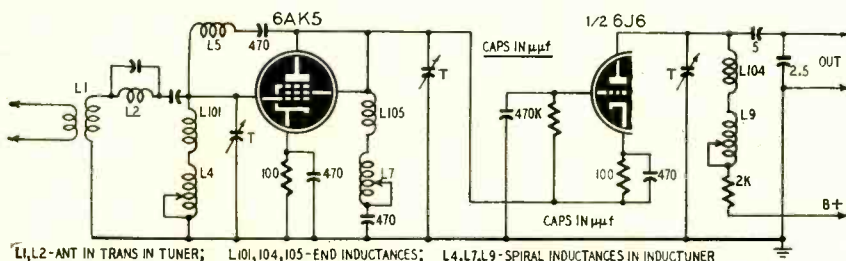

Fig. 5—Converting a Du Mont *Inputuner* to a highly effective cascode booster. L101, L105, L104 are coil numbers used in Du Mont schematic for RA-103 *Teleset*.



# Design Data

By ALAN G. SORENSEN

## ON VIDEO AMPLIFIERS

### Part IV—Peaking-coil design

**W**INDING your own peaking coils introduces a number of problems. There are formulas for winding a coil to a given inductance, but there are so many variables that calculation is very complex. Cut-and-try is needed to get the desired results. An inductance bridge or Q-meter is the ideal tool for the peaking-coil constructor to use, but you can just check the high-frequency response curve and go by it.

It is easier to get accurate inductance values if you wind the coils on one of the small permeability-tuned forms such as the Millen 6900 series, the National XR-50 type, or Cambridge Thermionic type LS. These make high-Q, efficient coils, and the inductance can be adjusted easily by turning the slug in or out of the coil. When the slug is "all in" (near the center of the coil) the inductance is nearly double the value when the slug is all the way out. Thus a point can be found where the desired inductance is equal to the computed value.

In most cases a single-layer coil may be used (Fig. 1-a). However, when the desired inductance is over about 100 microhenries, it will be necessary to use a multilayer winding. A point of caution here. The distributed capacitance of a peaking coil must be kept at a minimum. It would be best to use a bank-type winding, as shown in Fig. 1-b. In this way adjacent turns represent parts of the coil that are close together while the ends of the winding are far apart physically, as well as electrically. The formulas below are used for calculating inductance:

$$L = \frac{(rN)^2}{9r + 10l}$$

$$N = \frac{\sqrt{L(9r + 10l)}}{r}$$

$$L = \frac{0.8(rN)^2}{6r + 9l + 10d}$$

where L=inductance in microhenries; N=number of turns; r=radius in inches; l=length of coil in inches; and d=depth of coil in inches.

The first two equations may be used for small single-layer air-core coils, and

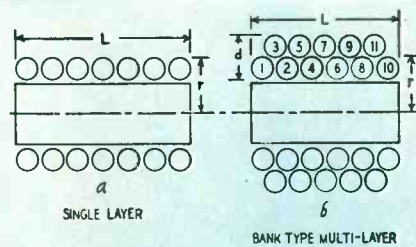

Fig. 1—Cross-section views of single-layer (a) and bank-wound (b) coils, with dimensions used in computations.

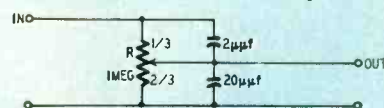

Fig. 2—Shunt capacitances associated with a typical volume-control potentiometer at an intermediate setting. The upper capacitance increases as the arm approaches the high end and bypasses more h.f. energy around the resistance.

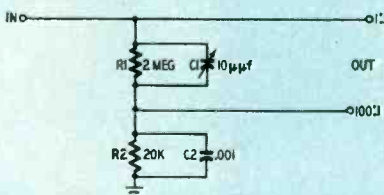

Fig. 3—Two-step attenuator used in many oscilloscope input circuits. The trimmer is adjusted to equalize the capacitance and resistance voltage-division ratios.

will be accurate to about 1%, if the coil is not too short. The length  $l$  must be greater than  $0.8r$ . The third equation is for multilayer coils. With an iron core in close proximity to the coil, as it is in this case, the minimum inductance will be somewhat greater than this computed value. All dimensions are in inches, and  $N$  is the number of turns. The answer is in microhenries.

About the easiest way to wind one of these coils is to first set the slug to its mid-point. Next, wind on several more turns of wire than will probably be needed. Connect the unit to an inductance bridge and remove turns until the inductance is close to the required value. Final adjustments are made by wiring the coil into the circuit and observing the frequency response of the amplifier. Most any size or type of wire may be used, so long as it will handle the plate current of the tube without overheating. These coils should be impregnated

with a good coil dope to keep out any moisture. (Adjustable peaking coils are available from several manufacturers. Almost any value required can be obtained.—Editor)

### Gain control

Controlling the gain of a video amplifier presents a serious problem. Ordinary grid-circuit potentiometers cannot be used for two reasons:

1. The ring-shaped construction of a typical potentiometer brings the opposite ends of the resistance element close together. This proximity, plus the usual terminal arrangement, metal dust cover, and grounded shaft, creates a relatively high total shunt capacitance across the input side of the control. The capacitance has negligible effect at low frequencies, but above a few kilocycles it bypasses most of the signal.

2. The capacitance between the slider and the ends of the resistance element shunts the output circuit. This capacitance varies, of course, with the position of the slider, and actually reduces the high-frequency response more at high-gain settings than at lower values.

Refer to Fig. 2 and assume a 1-megohm control set at two-thirds of its resistance. At low frequencies the output will be two-thirds the input, but as the frequency is increased, the voltage at the center arm will drop off.

A typical compensated attenuator circuit is shown in Fig. 3. Using the values shown, the attenuation factor will be 100. However, the equations may be used to find values for other ratios.

$$C1 = \frac{R2 \times C2}{R1}$$

$$\text{The reduction ratio is equal to} \frac{R2}{R1 + R2}$$

These circuits compensate for the input capacitance of the wiring and of the tube, which are included in C2.

Oscilloscopes use these attenuator circuits in their probes to reduce circuit loading to a minimum. The trimmer capacitor C1 will be mounted in the probe; so will resistors R1 and R2. C2 will consist of the capacitance of the cable and the input circuit of the scope in parallel with the additional capacitance required to maintain the proper C1:C2 ratio. Most good oscilloscopes then have a switch attenuator with ratios of 1:1, 10:1 and 100:1. END



# Model 60 uhf Tuner

*One-tube continuous-tuning converter has 41-mc output.*

By FRED M. BARR\*

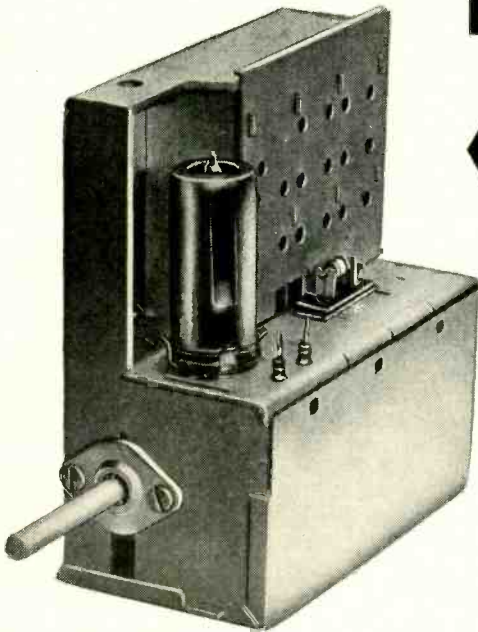

Photo A—The model 60 u.h.f. tuner.

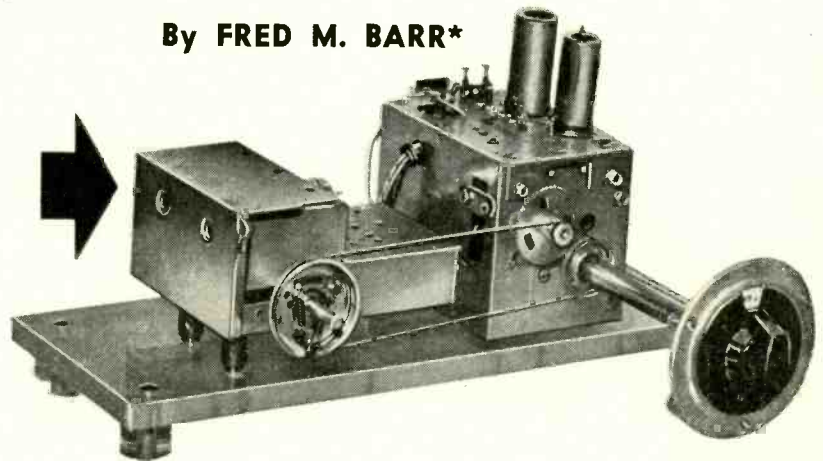

Photo B—Model 60 and 48 tuners set up for single-knob u.h.f.-v.h.f. tuning.

THE u.h.f. television band (470–890 mc), is considered an awkward band of frequencies. It is too low for microwave and radar techniques and circuitry to be fully applicable, and it is too high for convenient use of lumped-constant circuitry. Therefore it has been advantageous to combine both techniques in the General Instrument Corporation model 60 u.h.f.-TV tuner. The resulting tuning element is an end-tuned quarter-wave coaxial line.

This quarter-wave coaxial line is capacitance-tuned at its open-circuit end, as shown in Fig. 1. This arrangement yields a tuning range of 2 to 1 or greater, providing continuous coverage of the entire u.h.f.-TV band. Inherently, the unloaded  $Q$  to loaded  $Q$  ratio of the tuning element is very high, leading automatically to a low dissipation circuit. Since the  $Q$  of end-tuned quarter-wave elements increases with increasing frequency, as opposed to the  $Q$  of lumped-element circuits where it normally decreases with increasing frequency, their use has permitted the design of a tuner with constant bandwidth and insertion loss over the entire band. A further advantage of end-tuned quarter-wave lines is the mechanical construction of a ganged-rotor tuning device, whose construction is similar to that of a variable capacitor. In addition, this device permits shaping the rotor plates to give a straight-line frequency characteristic with the u.h.f. channels spaced equally over the dial.

The model 60 tuner consists of two tuned r.f. circuits, a half-frequency oscillator, an oscillator-doubler circuit, and a crystal mixer. The output of the tuner is a 41-mc i.f. signal which may be fed through a low-noise i.f. pre-amplifier into the i.f. system of the

TV receiver. A complete schematic of the model 60 is shown in Fig. 2.

The two r.f. sections and the oscillator doubler employ the end-tuned quarter-wave lines. The rotor for each of these sections contains four plates. These are adjusted during alignment for continuous tracking over the band. The r.f. and oscillator-doubler rotors are on the same shaft as the oscillator rotor. The capacitance of the lines at the high-frequency end of the band is adjusted by a small trimmer strap at the open end of each line.

The antenna input is a balanced 300-ohm circuit which is reasonably well matched over the entire band. The first r.f. section is coupled to the second through a window in the shield between the two lines. This coupling provides an overcoupled r.f. characteristic over the entire band. (An earlier version of the model 60, see Photo C, uses closed loops instead of a window for coupling between the first and second r.f. lines. The larger loop provides coupling at the low-frequency end of the band and

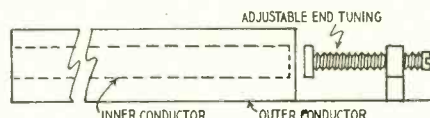

Fig. 1—End-tuned quarter-wave line. Capacitor slug controls the tuning.

(The small loop works at the high end.) The 1N82 mixer crystal is connected to the 2nd r.f. and oscillator-doubler lines through r.f. chokes whose self-resonant frequency is below the low end of the u.h.f. band. The antenna, r.f., and crystal coupling are adjusted to give uniform loading through the tuning range, yielding a bandwidth of about 10 to 18 mc over the band.

### The oscillator circuit

The oscillator employs a 6J6, operat-

ing in a push-pull circuit at half the frequency required to give a 41-mc i.f. output. Its circuit is shown in the right-hand side of Fig. 2. The plate inductor of the oscillator is a horseshoe-shaped stamping rigidly mounted to the tuning capacitor support by eyelets and attached to the tube socket by lugs which are a part of the stamping. The center-tapped grid-to-grid inductor is adjusted to resonate at the low end of the band and maintains relatively uniform oscillator drive over the tuning range. The characteristics of this circuit are such that replacing the 6J6 tube normally requires only slight adjustment of the oscillator trimmer to compensate for small capacitance differences.

The use of a half-frequency oscillator makes it necessary to use a frequency-doubling device. An end-tuned quarter-wave line is tuned to twice the oscillator frequency, and excited by a loop which is proximity-coupled to the oscillator plate loop. The efficiency of this doubling action has been increased by including a G7 harmonic-multiplier crystal diode and a biasing circuit. This biasing circuit, consisting of a parallel resistor-capacitor combination in series with the coupling loop and crystal, increases the second-harmonic content of the coupling loop current.

### Tuner output circuits

The u.h.f. tuner may be provided with either a link-coupled or a low-side capacitance-coupled i.f. output circuit as shown in Fig. 3. In each of these, the mixer crystal is bypassed directly at its i.f. end with a 33- $\mu$ f capacitor. A test or "looker" point is also provided at the i.f. end of the crystal to permit checking the r.f. pass-band with an oscilloscope during production alignment.

In production, a milliammeter is con-

\*General Instrument Corp.



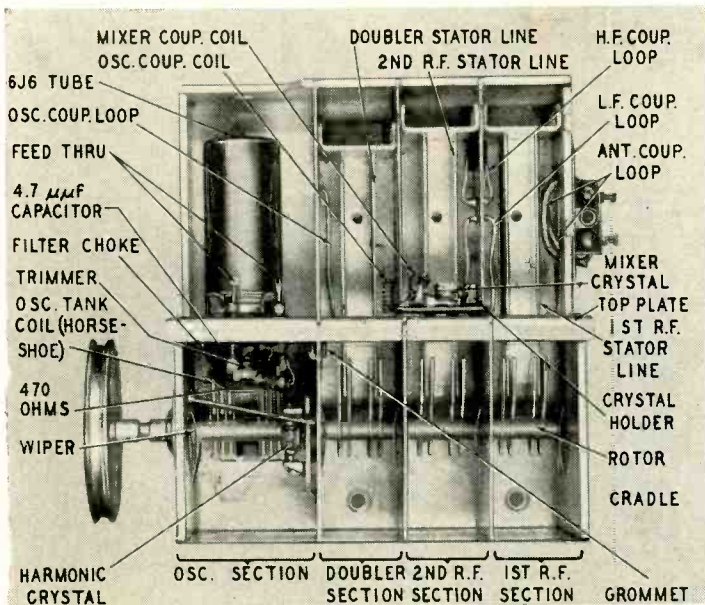

Photo C—An experimental form of the model-60 u.h.f. tuner with the side cover removed. Windows now replace the coupling loops.

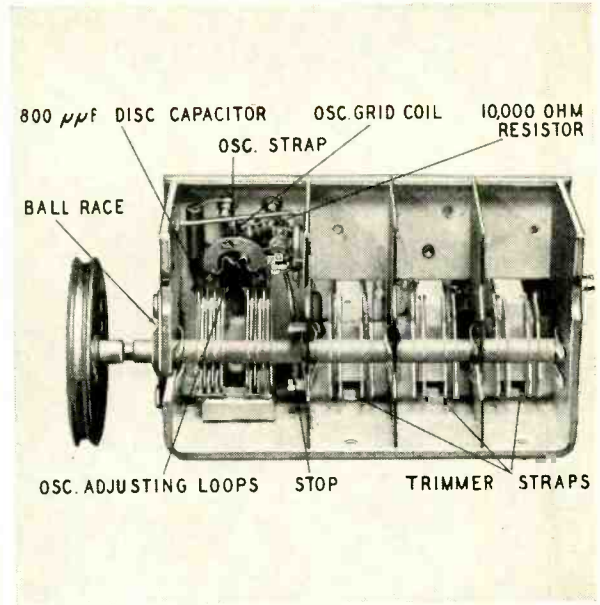

Photo D—Under the model-60 tuner. Ends of quarter-wave lines form capacitor stators.

nected from the test point to the chassis ground to measure the crystal injection current while the oscillator and doubler sections are tuned and calibrated. The oscillator-doubler coupling loop and the doubler and mixer coupling coils have been optimized to give a mixer crystal current consistent with low noise figure and low conversion loss. In servicing, the crystal current may be used to check the operation of the oscillator, doubler crystal, and mixer crystal. The i.f. circuits and mixer crystal are mounted on the tuner top plate, and are enclosed by a small shield which is easily removed.

The 41-mc i.f. signal is coupled from the i.f. coil through a short length of 75-ohm cable to an i.f. preamplifier. The use of the link-coupled or low-side capacitance-coupled i.f. circuit depends on the type of circuit the tuner feeds. The link-coupled circuit is used with the General Instrument Corporation model 48 13-position v.h.f. turret tuner.

In the 13th position, the v.h.f. tuner is converted into a low-noise 41-mc preamplifier which uses the cascade amplifier as the first stage, and the mixer as the second amplifier stage with the B plus removed from the v.h.f. oscillator.

Setting the v.h.f. tuner in the 13th position operates a slide switch which performs the necessary operations to convert from v.h.f. to u.h.f. operation. This switch is mounted on the v.h.f. tuner and is operated by a cam connected to the rear of the turret shaft. In the u.h.f. position, the switch connects B plus to the u.h.f. tuner, connects the i.f. output to the v.h.f. tuner antenna terminals, and disconnects the v.h.f. antenna from the system. If a common v.h.f.-u.h.f. antenna is used, the switch transfers the antenna lead to the u.h.f. tuner.

### Model 60 installation

Several radio manufacturers are using the model 60 u.h.f. tuner in their

TV receivers. The tuner may be purchased with the control shaft extending from the front as in Photo A or from the rear as in Photo B to provide more flexibility in the design of the TV receiver. The Du Mont application of the model 60 u.h.f. tuner was discussed in "Circuit Shorts" in the May, 1953, issue.

When installed in the television receiver, the u.h.f. tuner shaft is usually connected to the fine-tuning control of the v.h.f. tuner by a string drive. This provides one-knob tuning for v.h.f. and u.h.f. channels. The fine-tuning control must be a 360-degree type, without stops, when used for this purpose. The u.h.f. channel-selector dial is fastened

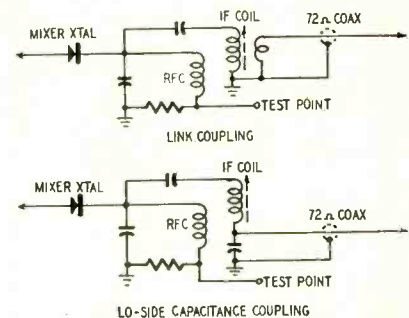

Fig. 3—Either link coupling or low-side capacitive coupling can be used to match the v.h.f.-amplifier input requirements.

to an additional sleeve and pulley on the v.h.f. tuner shaft. The dial cord drives this sleeve. The drive connections are shown in Photo B.

The model 60 u.h.f. tuner is mechanically rugged and stable, so its electrical performance is unaffected by forces which would tend to distort the unit. In addition, there are no moving contacts in high-current tuning circuits which can wear or collect dirt, thereby reducing the possibility of intermittent or noisy contacts.

END

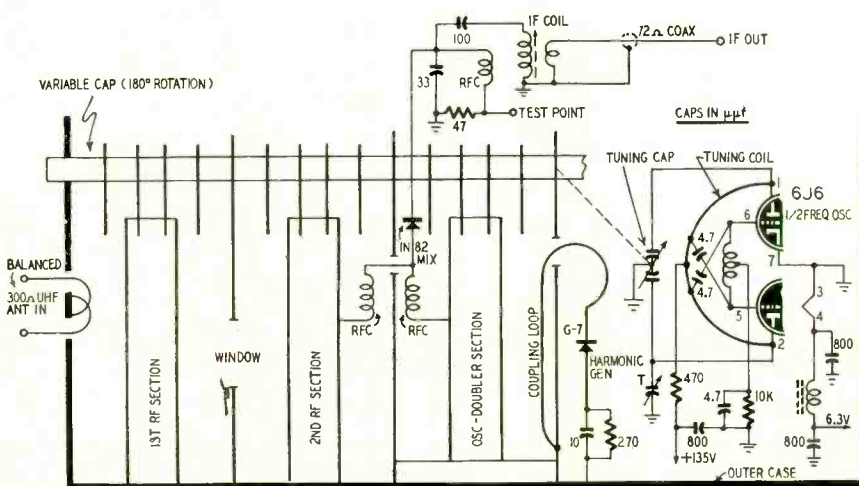

Fig. 2—Schematic of the model 60. See Fig. 3 for alternative output circuits.



# SIGNAL TRACING in TV

By Engineering Staff, Scala Radio Co.

## PART III A real time saver —the 100:1 high-voltage capacitance-divider probe

WHEN alternate light- and dark-gray vertical bars appear at the left side of the raster it may be difficult to tell at a glance whether the difficulty is due to ripple in the high-voltage supply, or to some other cause. But with a high-voltage capacitance-divider probe the technician can see the high-voltage ripple on his scope screen, and measure its peak-to-peak voltage. He is then in a position to discuss matters in practical terms. A commercial high-voltage capacitance-divider probe is shown in Fig. 1.

Similarly, when there are slight rapid fluctuations in picture brightness, you may suspect intermittent leakage in a high-voltage filter capacitor. Of course, a substitution test will answer the question, but you can save time and difficulty with a capacitance-divider probe and scope. In the case of an intermittent leak in a high-voltage filter capacitor, the a.c. ripple across the capacitor will jump substantially during the brightness fluctuations. This test is more accurate than using a v.t.v.m. and high-voltage d.c. probe, because the pointer response of a v.t.v.m. is very sluggish compared with the inertialess response of the electron beam in the cathode-ray tube. These rapid voltage variations are almost completely smoothed out by the mechanical inertia of the meter movement in the v.t.v.m., but they are reproduced faithfully on the scope screen when you use a capacitance-divider probe.

A high-voltage capacitance-divider probe is almost an absolute necessity for checking the shape and peak-to-peak value of the voltage waveform at the plate of the horizontal output tube. This is a key test point in cases of sweep-circuit trouble, and the alert technician usually starts his troubleshooting here. We cannot hook the scope directly to the plate of the horizontal output tube. The high a.c. voltage at this point would promptly burn out the scope input circuit, as the blocking capacitor in the average scope is rated at only 600 volts.

We cannot use a low-capacitance 10-to-1 probe (Fig. 2) at the plate of the horizontal output tube because the 6,000 to 7,500 volts peak-to-peak at this point invariably flash across the probe network, which is not rated for this type of testing. Some technicians

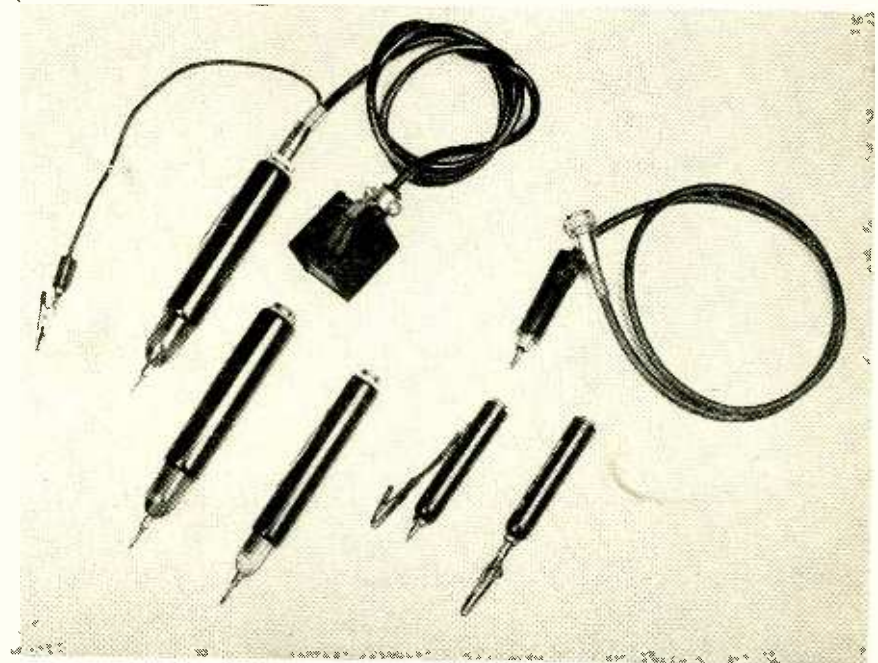

Two sets of matched signal-tracing probes. Three at left are Precision Apparatus Company's kit of 10:1 capacitance divider, crystal demodulator, and direct probe, with universal cable. RCA set at right includes direct probe (on cable), with plug-in crystal-demodulator and low-capacitance heads. Precision probes have color-coded heads and a shielded plug-in connector for the scope termination.

make a practice of using a gimmick for this purpose, or merely hold the tip of a 10-to-1 low-capacitance probe near the insulated lead to the plate of the horizontal output tube. Although these expedients will show the a.c. voltage waveform on the scope screen, they are worthless for checking peak-to-peak voltage, and in most cases we must know the exact value of this voltage to get a true picture of conditions in the circuit.

Another highly questionable expedient in making these tests is to use a high-voltage d.c. probe (actually intended for use with a v.t.v.m.) with the scope. This is even less satisfactory than a 10-to-1 low-capacitance probe, because the unshielded multiplier resistor in the high-voltage d.c. probe is highly susceptible to hand-capacitance effects and 60-cycle stray fields. Besides, the scope pattern changes with the slightest movement of the probe.

### Spotting flyback defects

A typical normal waveform at the plate of the horizontal output tube is shown in Fig. 3. The shape of the wave helps the technician identify certain defects in the flyback transformer, and the peak-to-peak voltage shows the condition of the drive circuit.

For example, a large negative undershoot in the waveform (Fig. 4) indicates excessive leakage reactance between the primary and secondary windings of the transformer. This

undershoot may cause Barkhausen oscillations, which show up as one or two vertical black lines at the left side of the picture.

If the transformer has other defects, the undershoot may be followed by a large voltage ripple. This will modulate the intensity of the beam in the picture tube, especially if the receiver has no high-voltage filter network. This form of intensity modulation appears as a series of light- and dark-gray vertical bars starting at the left side of the raster and becoming weaker toward the center. The same screen symptoms can arise also from several other causes, so the scope check of the horizontal output waveform saves valuable time by eliminating certain sources of trouble.

### High-voltage buzz

Experienced technicians have found many other uses for the high-voltage capacitance-divider probe. One of these uses is checking the output of the high-voltage filter system for regulation buzz. This should not be confused with sync buzz. Regulation buzz is caused by the limited current-output capability of most flyback and pulse-operated high-voltage systems—especially those that have voltage-doubler circuits. Since the picture-tube beam current is cut off for approximately 1,100  $\mu$ sec 60 times a second by the vertical blanking pulse, it follows that the output voltage from the unloaded high-voltage supply will rise several hundred volts for the dura-



tion of the blanking pulse, and will then drop several hundred volts when the pulse ends and unblanks the screen. If the audio circuits and picture tube are adequately shielded, and if there are no serious faults in the audio system or FM-sound detector, this regulation buzz is ordinarily below the threshold of audibility. But TV receivers often develop buzz in service, and the test described must then be made.

**Probe design**

The essential elements of a high-voltage capacitance-divider probe are shown in Fig. 5. This type of probe is not frequency-compensated like conventional low-capacitance probes (Fig. 6). The chief reason for this omission is that high-voltage tests are made in horizontal sweep circuits where the highest frequency involved is only about the 10th harmonic of 15,750 cycles.

The input impedance of a high-voltage capacitance-divider probe is made as high as possible, and depends, of course, on the frequency. In order to withstand the high voltages encountered in TV test work, the first capacitor in the probe network (C1) is usually a high-voltage rectifier tube, such as a 1X2-A. The plate-to-filament capacitance of these tubes ranges between 0.85 to 1.5  $\mu\text{mf}$ . Thus, the input impedance of the probe at the fundamental frequency of the flyback pulse (15,750 cycles) is approximately 6 megohms, and approximately 0.6 megohm at the 10th harmonic. Since the probe impedance even at the 10th harmonic is still much higher than the internal impedance of the circuit under test, the flyback pulse is reproduced essentially without distortion.

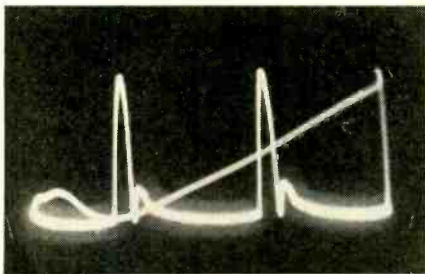

Fig. 3—Normal sweep waveform at plate of horizontal-output tube, seen with the aid of a 100-to-1 capacitance-divider probe. Diagonal line is scope retrace. Peaks are about 6,000 volts high.

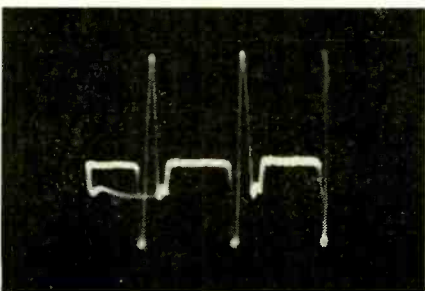

Fig. 4—Negative pulse in sweep-output waveform indicates excessive leakage reactance in flyback transformer, may also generate Barkhausen oscillations.

Fig. 1—A commercial 100-to-1 high-voltage capacitance-divider probe. The head is made of special insulating material to withstand severe stress potentials in TV high-voltage supply networks.

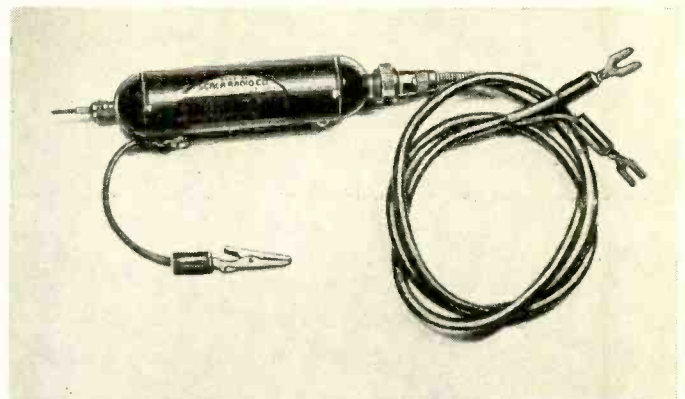
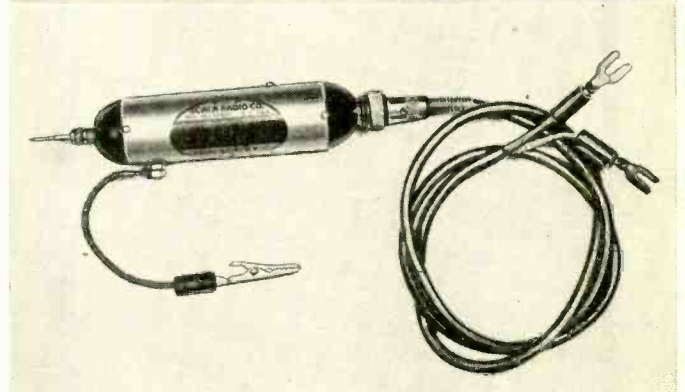

Fig. 2—A 10-to-1 low-capacitance signal-tracing probe. Two screw adjustments are provided to compensate for cable capacitance and scope terminal impedance.



In addition to being able to withstand applied voltages up to 12 or 15 kv, this capacitor must have a physical shape that will not encourage corona discharge in the probe head.

A trimmer capacitor is provided so that the capacitance ratio C2/C1 can be adjusted to exactly 100-to-1. This attenuation factor makes it easy to measure peak-to-peak voltages. Once the scope has been calibrated for a given peak-to-peak deflection sensitivity, it is necessary only to multiply the scope reading by 100.

The calibrating trimmer capacitor is mounted in the probe head and does not have to be a high-voltage type. With a 100-to-1 ratio the calibrating capacitor need withstand only 1% of the signal voltage applied to the probe tip. The highest a.c. voltage likely to be encountered in TV work is about 15,000 volts, so that the trimmer capacitor need withstand only 150 volts.

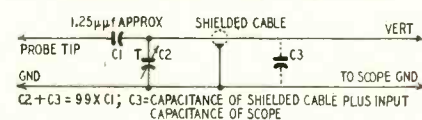

Fig. 5—Circuit of a high-voltage capacitance-divider probe. C1 may be the plate-filament capacitance of a 1X2-A high-voltage rectifier. Trimmer capacitor C2 is adjusted for a 100-to-1 voltage ratio with a given cable and scope.

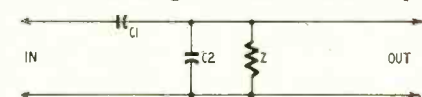

Fig. 6—Capacitance-divider probe circuit for signal tracing in low-level circuits. The scope-input impedance Z limits the high-frequency response unless compensating components and adjustments are provided in the circuit.

Commercial probes are shielded to avoid hand-capacitance effects and stray-field pickup that may confuse the scope trace. Since the probe is calibrated for a given shielded-cable capacitance the calibrating capacitor C2 must be readjusted if the probe is used with different cables and scopes.

**Other probe uses**

A high-voltage capacitance-divider can give more accurate results than a 10-to-1 capacitance-divider probe in many circuits where the technician ordinarily uses a 10-to-1 type. It is much better, for example, for checking the waveform and peak-to-peak voltage at the plate of the damper tube or at the plate of the horizontal oscillator. The input impedance of the 100-to-1 probe is higher than the input impedance of the 10-to-1 probe, hence, imposes less loading on the circuit. On the other hand, it may be impossible to get usable vertical deflection in low-level circuits with the 100-to-1 probe.

Most typical service scopes have vertical-deflection sensitivity of approximately 0.02 volt r.m.s. per inch at full gain, corresponding to a sensitivity of 0.057 volt peak-to-peak per inch. Under these conditions the 100-to-1 probe will provide 1 inch of deflection with an input signal of 5.7 volts peak-to-peak. If the signal voltage is less than this, the 10-to-1 probe will probably have to be used.

Although it would be possible to provide an individual shielded output cable for each probe, the present trend is to provide a single universal shielded input cable which may be used with any one of an entire kit of probes. END



# TELEVISION . . . it's a cinch!

By E. AISBERG

## Fourth conversation: Electrostatic and electromagnetic fields; how the beam is deflected and focused magnetically

**W**ILL—This damned television is keeping me awake nights! There are about a hundred questions going round in my head: Just what kind of waves do you put on the horizontal and vertical electrodes of your cathode-ray tube? How do you generate them? How big do they have to be? Why . . . ?

**KEN**—Hold it! Let's have your questions one at a time. Last time we talked about cathode-ray tubes that focused and deflected the beam with electrostatic fields. Those tubes are used only in oscilloscopes, or in the old 7-inch sets. Practically all sets bigger than that use *magnetic deflection*.

**WILL**—I can't see how. An electron has a negative charge, so a positively charged plate attracts it, and a negative charge repels it. But a magnetic field has no effect on an electrostatic charge.

### From one field to another

**KEN**—If your electron was standing still, you'd be right; it would be just a negative charge and nothing else. But when it starts moving, it sets up its own magnetic field.

**WILL**—This isn't what you used to tell me. In other days, when I was learning about radio, you explained that an electric current creates a magnetic field around its conductor, and the field could be thought of as concentric lines of force with the conductor as a center.

**KEN**—I don't think you ever lost much sleep figuring out the explanation. Otherwise, mightn't it have occurred to you that an electric current is nothing but a lot of electrons going in the same direction?

**WILL**—I never thought of that! Of course, it's not the conductor, but the moving electron, that has the field around it! If we have electrons in movement we must have magnetism.

**KEN**—Good! But sometimes we get so wrapped up in this electromagnetic field that accompanies the moving electron that we completely forget it has an electrostatic field, too. Now, what about that?

**WILL**—That's easy enough. We know the electron is a charged particle. This charge we talk about is an electrostatic charge. And when the electron starts moving, we have an electrostatic charge *and* an electromagnetic field.

**KEN**—You've got it! Now, have you noticed that the assumed lines of the electric field radiate in a certain way from the electron, so they are always at right angles to the "lines of force" of the magnetic field? That is something worth remembering: *Lines of electric and magnetic fields produced by the same cause are always at right angles.*

### Inside the magnetic field

**WILL**—Then what happens when you have two magnetic fields produced by two different causes?

**KEN**—Haven't you seen it happen? When you bring two magnets toward each other . . .

**WILL**—They attract each other—that is, if you have two north poles against two south poles. If two poles of the same kind are brought close together, they repel each other, the same as two electric fields of the same sign.

**KEN**—Then we can say that parallel magnetic lines going in the same direction repel each other, but when they go in

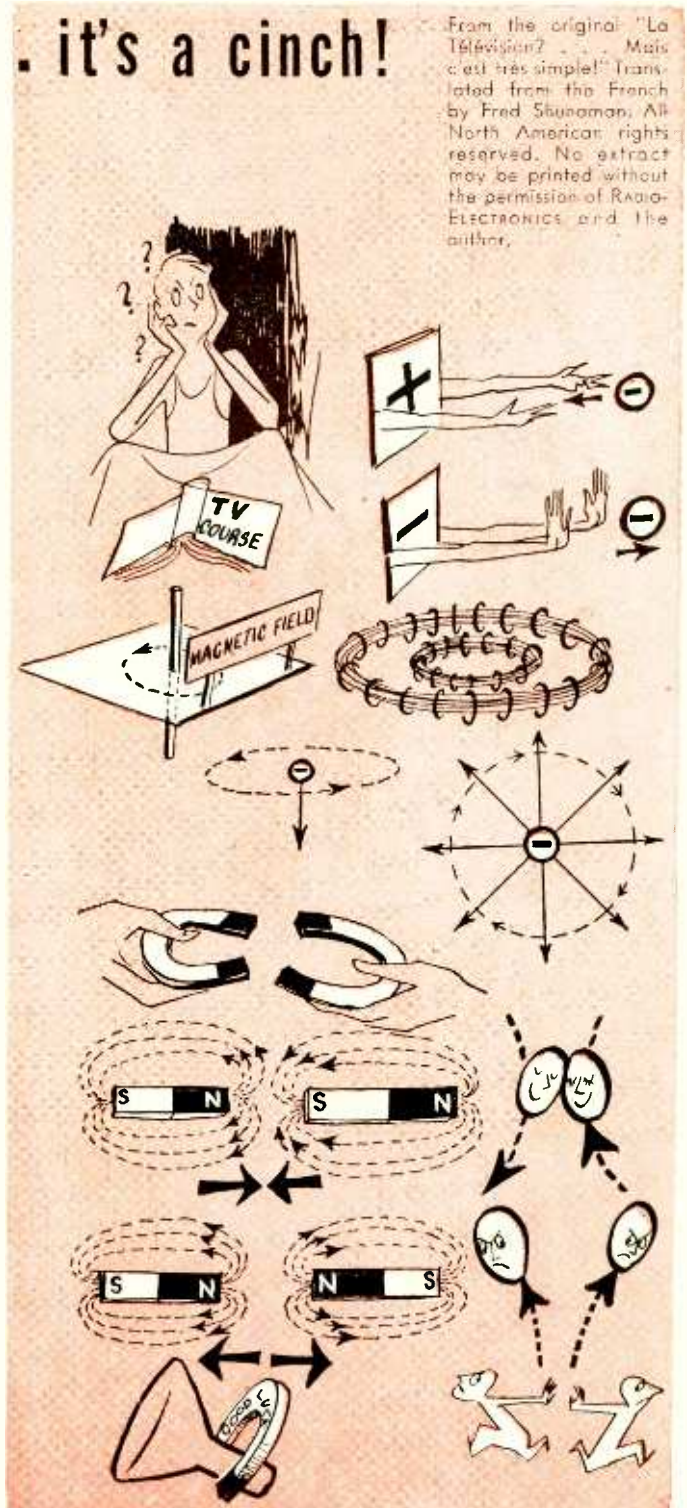

opposite directions, they attract.

**WILL**—These magnetic lines of force are like a lot of people—the less you see of them the better. If you try to travel the same road with them, you just can't get along!

### The magnetic theater

**KEN**—Now you've got that straight, you won't have any trouble figuring out how magnetic deflection works.

**WILL**—Let me think. It would work all right to put a horseshoe magnet over the neck of the tube so the electrons would pass through its magnetic field.

**KEN**—And which way would the electrons be deflected?



WILL—Why, they'd be attracted by one pole and repelled by the other, of course.

KEN—Oh, well, I suppose this is what you get for trying to use analogies on people without brains! But, Will, even you should know better than that. Have you been wandering off on a tangent ever since I pointed out that the electric and magnetic fields around an electron are perpendicular to each other at all points?

WILL—Are you trying to insinuate that the electrons are deviated at a right angle to the magnetic lines?

KEN—I'm not insinuating anything. I'm just trying to get you to think a little. Now, just to give us a better look at things, I'll draw a cathode-ray tube in a rather uncommon way. We'll cut the neck off just ahead of the magnet and show a cross-section. We won't bother drawing any electrodes, either. Now, imagine your eye in place of the fluorescent screen. The black dot at the center is an electron coming directly at you.

WILL—Quite a setup! Now that we've got all the scenery set and the actors in place, when does the show start?

KEN—At once. We're going to stage a scene of conflict presented by two forces. One of them is the field of the magnet (the parallel lines) and the other is the magnetic field around the electron in motion. We'll represent that field by circles around the electron. Now, how will these two fields interact?

WILL—At each side the circle cuts the straight lines more or less at a right angle. So there'll be no interaction. But at the top the lines are going in opposite directions, so they'll attract each other. And on the bottom they're going in the same direction, so they'll repel.

KEN—So how is our play going to end?

WILL—The electron will have to go up. It's pulled from above and pushed from below.

KEN—Exactly. And if we reverse the magnet?

WILL—The electron will be deflected downward. But it bothers me a little to see a horizontal field deflecting the electron beam up and down.

KEN—It tangles up a lot of television students. But you shouldn't have any trouble if you keep in mind that an electron always moves at right angles to a magnetic field. And besides, remember the deflection plates on the electrostatic cathode-ray tube. Didn't the plates in the vertical plane produce the horizontal deflection, and the horizontal plates . . . ?

WILL—I remember. The horizontally mounted plates deflected the beam vertically. I guess the trouble is that I've just got to stop and think about it.

### Making magnetic fields

KEN—You'll have no trouble in seeing, Will, that if we want to keep our spot in continuous movement, we have to keep the value and the direction of the magnetic field changing continuously. And we can't do that by juggling with permanent magnets.

WILL—I suppose you could use electromagnets—coils carrying currents of the right size and direction to make the magnetic fields you need.

KEN—That's the way it's done! And, since we used two pairs of plates for electrostatic deflection, if we want to get horizontal and vertical movement of the beam with magnetic fields, we need . . .

WILL—. . . two pairs of electromagnets; one pair mounted vertically to give the horizontal deflection and the other pair with a horizontal axis for the vertical deflection.

KEN—That's right, Will. The two coils are usually placed right where the neck of the tube joins the cone.

WILL—Are they iron- or air-cored coils?

KEN—They can be air-cored, but in modern sets usually powdered-iron- or ferrite-cored. They are wound in rectangular form, then shaped to fit tight to the glass of the tube. In cases where iron-core coils are used, the pole pieces are usually shaped to keep them as close to the glass as possible.

WILL—This may be dumb, but I've been wondering if the electrons couldn't be focused just as well by a magnetic

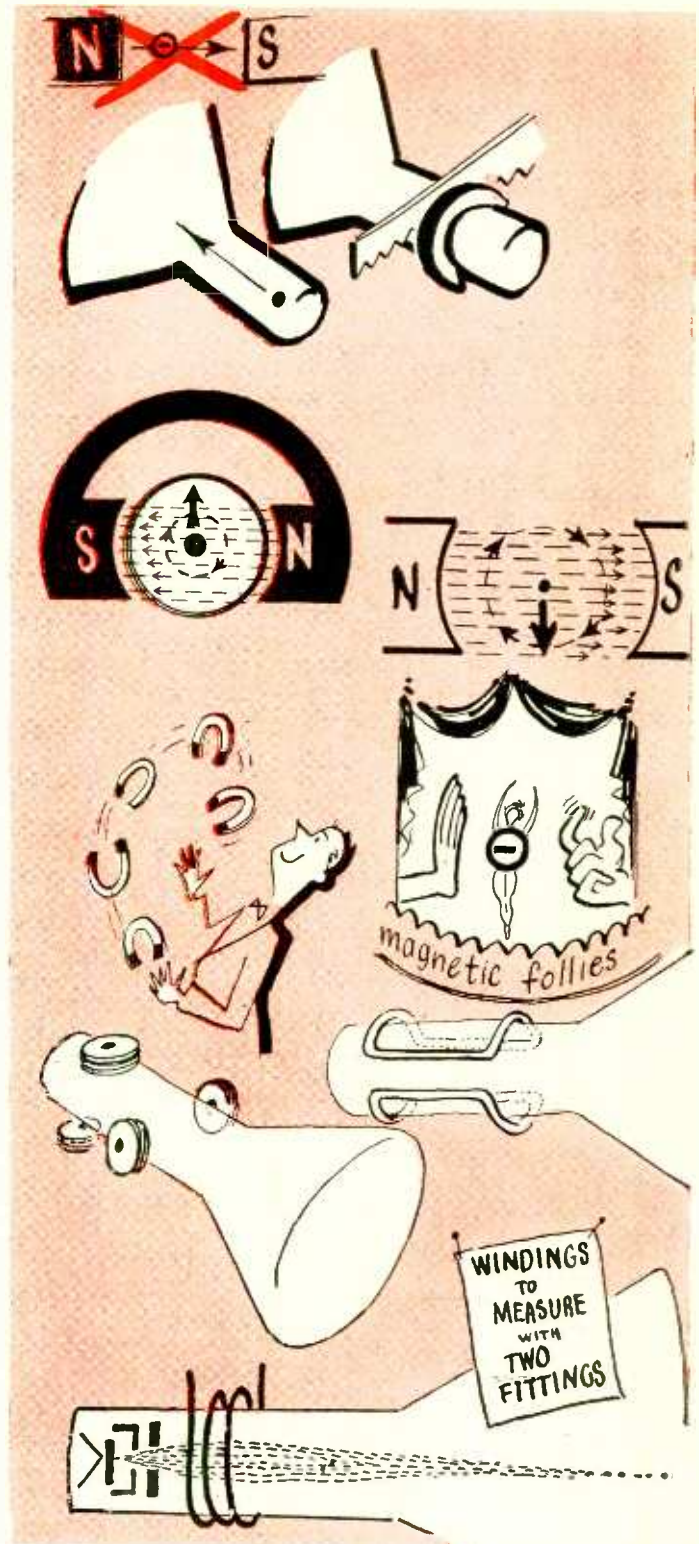

field as by what you call "an electronic lens"?

KEN—Nothing dumb about that! When we were talking about electrostatic focusing, I told you that most tubes use a different kind. Well, this is it! Just as magnetic deflection makes it possible to get rid of the two pairs of deflection plates and simplify the tube construction, so does magnetic focusing permit us to get rid of the focusing electrodes. That makes life easier for the tube manufacturers.

WILL—H'm—if we keep on throwing out surplus electrodes, pretty soon we won't even be able to call it a tube. But how do we make a "magnetic lens"?

KEN—What's needed is a field in which the magnetic



lines run along the tube in the same direction as the electrons. So all you have to do is put a simple coil around the neck of the tube.

WILL—And I suppose you adjust the focus by varying the strength of the current through the coil?

KEN—Exactly! And, because this field has to be constant, the electromagnet can be replaced by a permanent magnet placed around the neck of the tube, or by much smaller ones, placed inside it.

### Dance of the electrons

WILL—I sort of understand how—if we have a uniform magnetic field along the axis of the tube—the electrons would be concentrated in a beam along the same axis. Each electron that left the center of the tube would—if I have the idea right—be sort of taken by the hand and led gently back to the electronic path of virtue.

KEN—Your instinct is O.K. But what really happens is a lot more complex. Suppose an electron in a uniform field starts to move downward. We'll cut out this circle of paper and let the center represent an electron, and the edge its magnetic field. Then if the electron moves downward as well as forward, our circle leans ahead. If this bothers you, remember the magnetic field must always be at right angles to the electron's motion. The upper and lower edges of our leaning field are still at right angles to the lines of force in the uniform field it's traveling in, but its sides are no longer at right angles to the lines in the uniform field. So, you have attraction on one side, repulsion on the other. Result . . .

WILL—The electron is pushed sideways. Nothing ever happens the way you'd expect it in one of these magnetic fields! So, if our electron moves to the left . . .

KEN—The same reasoning shows it will be shoved upward.

WILL—And then the field will push it to the right. And so on! Our electron is traveling in circles around the tube's axis. But how does all this end?

KEN—The circles just get smaller till the electron gets back to the axis and decides to follow it without making any more trouble. You can say the electron follows a spiral—or even better, a corkscrew—path.

WILL—This magnetic focusing makes me think of a scalp dance.

KEN—Now, where did you get that . . .?

WILL—Well, the Indians tied their prisoner to a stake, then danced around him in smaller and smaller circles, till . . .

KEN— . . . at the last moment, some providential intervention saved the brave hero's scalp! I was brought up on Mayne Reid and Fenimore Cooper, too!

### Question of sensitivity

WILL—Now just how does magnetic shape up against electrostatic focusing? Magnetic-focus tubes should be a lot easier to make. But it should be easier to deflect and focus electrostatic tubes, because all you have to do is apply simple voltages to set up your electric fields. With magnetic deflection and focusing, you have to pass currents through coils. That means some loss of energy, so you must need some power, at least.

KEN—At first glance, all you say is absolutely right. But in practice, it applies only to small tubes—7-inchers or thereabouts. You just didn't think of the sensitivity factor.

WILL—What's a cathode-ray tube got to be sensitive about?

KEN—What I'm talking about is deflection sensitivity. It's a value you get—for any particular tube—by finding out how far the spot moves if you change the voltage on the deflection plates by 1 volt or change the strength of the magnetic field by 1 gauss.

WILL—If the spot moves further across the screen for a given voltage or current change, I suppose the tube is more sensitive?

KEN—That's the way it goes. Or you can say that the more sensitive a tube is, the smaller the voltage (or magnetic field strength) it takes to move the spot a given amount—say an inch.

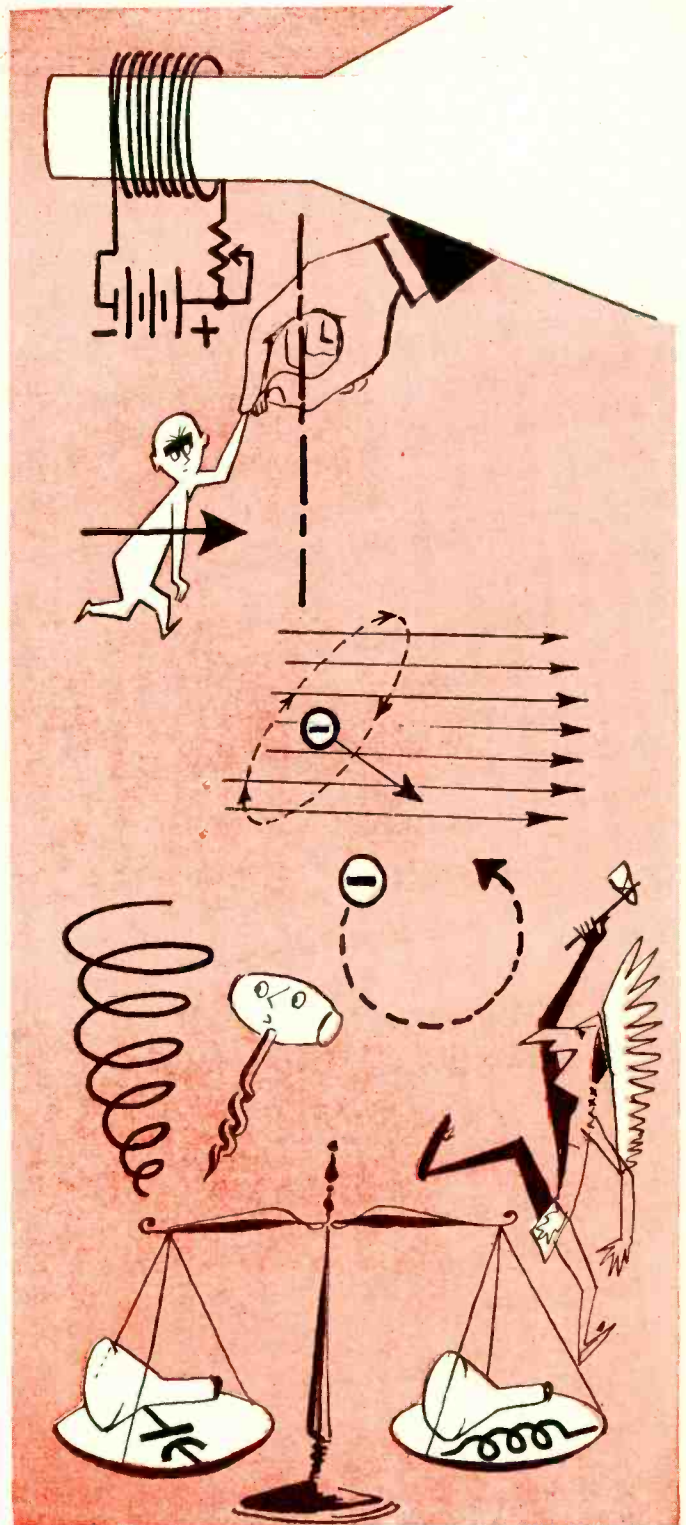

WILL—And what does the sensitivity of an electrostatic tube depend on?

KEN—The longer the electrons are in the deflecting field, the greater is the deflection. So the longer the plates are, the greater is the sensitivity. At the same time the sensitivity increases as the plates are brought closer together, because that makes the field stronger.

WILL—So you can make very high-sensitivity tubes by making the deflection plates very long and cutting the distance between them down to a minimum?

KEN—You can't get very far along that path. With



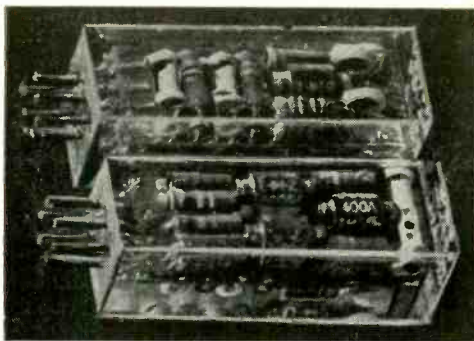

Complete amplifiers, oscillators, and other transistor-operated circuit assemblies, hermetically sealed in clear plastic plug-in packets.

Assembling experimental transistors in a dust- and moisture-proof box.

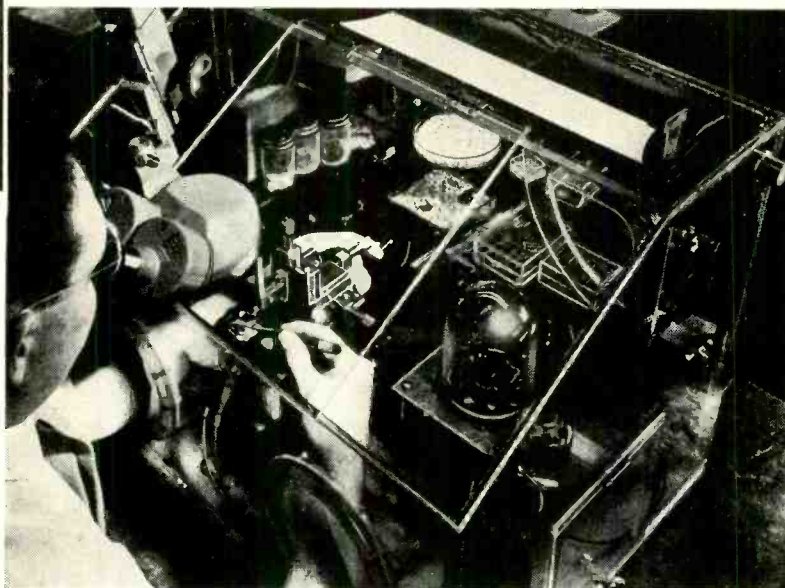

A little phosphorus, arsenic, or antimony will produce excess electrons in germanium, and these can move about and make the material a conductor. But what happens when one adds instead a little boron, aluminum, gallium, or indium, which have *one less* outer electron per atom than germanium has? The cloud of electrons surrounding the nuclei now has fewer than the normal number of electrons; we say it has *holes* in it. The *holes* can move about freely, acting just as if they were *positive* charges! Don't let anyone tell you that this is easy to see. Authoritative books take long mathematical chapters to prove it. But at least we know it is so, because experiment bears out the theory.

Thus we can make one kind of germanium with *excess electrons*, which are negative charges free to move and carry current. This is called n-type germanium, because the current-carriers are negative. Or we can make another kind—a germanium with *holes* that act like positive charges. This is called p-type germanium because the carriers are, in effect, positive.

Now electrons and holes can get into

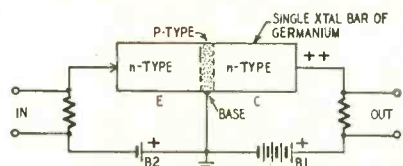

Fig. 2—A junction-transistor circuit. Some of the electrons driven from the n-type emitter by B1 are absorbed by positive holes in the p-type base layer, and cannot reach the collector. The input signal varies the number of electrons released by the emitter, modulating the collector current. The additional drop across B2 amplifies the signal.

germanium in more ways than by being built in. They can be injected into the germanium. Suppose a fine pointed wire touches a strip of n-type germanium. If the wire is made positive, *holes* will be injected. How do we know? By making the experiment shown in Fig. 1. Here we have a long strip of n-type germanium and a battery (B1) that makes the right end negative. This end will attract *holes*. (Of course, the polarity of the battery also makes a current of *electrons* flow through the strip from right to left.)

Near the left end, we feed a positive

pulse to a pointed wire touching the strip. This injects *holes*. Near the right end we have another wire touching the strip. B2 makes this point a little more negative than the extreme end of the strip. Thus *electrons* flowing from *right to left* detour around this point, but *holes* moving from *left to right* are attracted to it. We connect this point to an oscilloscope.

What do we see on the scope? A small replica of the positive input pulse just when the pulse is applied, caused by a movement of electrons away from the collector and toward the positive emitter. Then—a fraction of a millisecond later—we see a stronger, broader pulse. This second pulse is the arrival at the collector of the injected holes which have been drifting through the germanium. As they drifted they banged repeatedly against irregularities in the crystal, reaching the collector by various paths, some shorter, some longer. This caused the spreading of the pulse. Some of the injected holes were lost en route by combining with free electrons, but most of them managed to reach the collector, and we can see their effect.

### Junction transistors

The type of transistor easiest to understand is the *junction transistor*, first described by Shockley and others in 1951. This type, shown in Fig. 2, is a single-crystal bar of n-type germanium, with a thin layer of p-type about 1 mil thick dividing it at the center. The left-hand end is called the *emitter*; in this circuit it is used as the *input* electrode. The center slab of p-type germanium is called the *base* (by analogy with earlier types of transistors). In this case the base is grounded. The right-hand end is called the *collector*;

in this instance it forms the output electrode of the circuit.

In Fig. 2 the collector is positive, so as to attract *electrons*. Why doesn't it draw a lot of current from the base? Because the p-type base is full of *positive holes*, which the positive collector repels; but it has *no free electrons*. Thus a negligible electron current flows from base to collector.

The *emitter*, however, has lots of free electrons, and because B2 holds it a little negative with respect to the base, electrons flow from the emitter into the base. There they are free to move through the thin p-layer and, attracted by the positive collector, they go to it and form the output current.

You will see that this n-p-n transistor works just like a grounded-grid triode. The emitter supplies electrons, just as does the cathode of the triode. The base acts just like a biased grid (*positive*

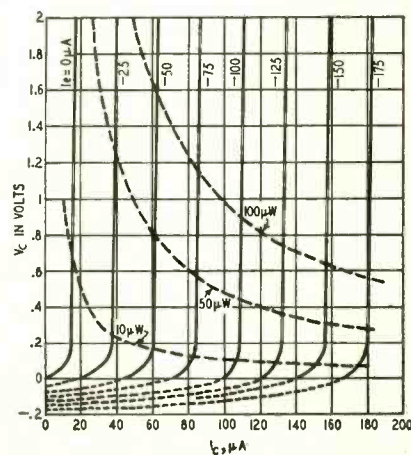

Fig. 3—Characteristics of a commercial junction transistor (Bell Laboratories type M-1752). See text for explanation.



in this case), which has complete control over the emitter current. The collector, of course, acts like the plate, and can attract only electrons which have passed through the base. We can make *p-n-p* transistors—*p*-type at the ends and *n*-type in the middle—which operate with a *negative collector* and have an output current of *holes*, not of electrons!

There are differences of performance,

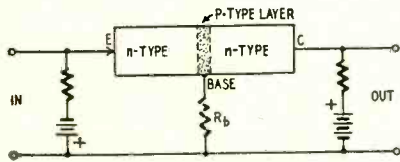

Fig. 4—One undesirable effect of the ultra-thin *p*-layer required for high-frequency junction transistors is equivalent to inserting a large resistor ( $R_b$ ) in the base-circuit return lead.

as well. Some of the electrons traveling through the center *p*-type layer combine with *holes*. Thus the collector current is less than the emitter current, and the difference flows in the base electrode and corresponds to grid current in a triode. The ratio of collector current to emitter current is called *alpha* and is designated by the Greek letter  $\alpha$ . If *alpha* were 1, there would be no base current. *Alpha* usually ranges from 0.95 to 0.995. When *alpha* is very high (approaching 1) the transistor can be used satisfactorily in a grounded-emitter circuit, corresponding to the usual grounded-cathode vacuum-tube circuit. This is important because a grounded-grid circuit requires resonant circuits or transformers of some sort between stages to get voltage gain, but with grounded-emitter circuits one can get gain merely by coupling the collector (plate) to the next base (grid).

**Power supply**

The astounding thing about the low-frequency characteristics of junction transistors is that their characteristics stay good down to very low operating voltages. Fig. 3 shows the characteristics of the Bell Laboratories M-1752 junction transistor. The collector voltage is plotted against emitter current for various values of collector current. We see that when the collector voltage is above 0.2 volt, the collector current is almost independent of collector voltage. This corresponds to a very high plate resistance.

Some dashed curves are drawn on Fig. 3 corresponding to power inputs (collector voltage times collector current) of 100, 50, and 10 microwatts. We see that with 10 microwatts power supplied, the characteristics are pretty good at a collector voltage of around 0.2 volt. This makes it possible to run junction-transistor oscillators from batteries made of a coin and a paper clip separated by saliva-moistened paper, or even from the output of the photocell of an exposure meter.

Transistors for high-power applications are not as good yet as for low

power, but powers of several watts have been attained with experimental models.

**Transistor problems**

What about noise in transistors? There is noise, of course. At audio frequencies, the noise is worse than in vacuum tubes, but transistor noise varies approximately *inversely* with frequency—that is, twice the frequency, half the noise—and in the megacycle range (if the particular transistor can get there) it is pretty good.

Transistors do have their troubles at high frequencies. The electrons drift through the *p*-layer of the *n-p-n* junction transistor of Fig. 2, colliding here and there with imperfections in the crystal. This stop-and-go, zig-zag motion prolongs the time it takes for an electron to reach the collector, and different electrons follow different paths and take different times. If the frequency of the input signal is high enough, the injected electrons may reach the collector spread all over the cycle, so that there is little effective a.c. output current. Because the ratio of

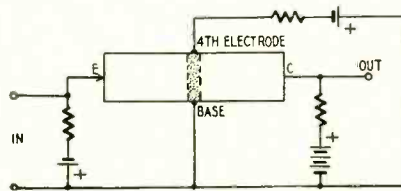

Fig. 5—Reducing the thickness of the germanium bar, and biasing the side of the *p*-layer opposite the base connection *negative*, forces electrons to pass through the layer in a narrow region close to the base lead. This reduces *p*-layer high-frequency losses by 90%.

the output (collector) current to emitter current is designated by *alpha*, this falling off in the ratio with increasing frequency is called *alpha cutoff*. The *alpha* cutoff may range from 1 or 2 mc to around 100 mc. What controls it? The thickness of the layer of *p*-type germanium which forms the base electrode. To increase the *alpha* cutoff we make the layer very thin.

Not only is this hard to do, but it introduces another problem as well. The resistance of the thin *p*-layer becomes very high crosswise to the slab. The wire connected to one side of the *p*-layer no longer grounds the whole layer effectively. It is as if we had a resistance of perhaps 1,000 ohms in the base lead, and this of course introduces considerable degeneration. See Fig. 4.

R. L. Wallace of the Bell Laboratories figured out a way of overcoming this defect by making a *tetrode transistor*, as shown in Fig. 5. First, he made the cross-section of the germanium bar as small as he could—about 1/100 of an inch square. Then he added a fourth lead, connected to the *p*-layer *opposite the base lead*. He biased this fourth lead *negative* with respect to the base lead, so as to repel electrons. As a result, the electrons from the emitter had to pass through the *p*-layer in the region

near the base lead, so there couldn't be much resistance between the point where they crossed and the base lead. In this way, Wallace reduced the base resistance from over 1,000 ohms to around 100 ohms. With these tetrode transistors we can make video amplifiers that are good up to 10 mc, and tuned amplifiers or oscillators that will work at frequencies up around 100 mc.

**Contact transistors**

Of course, not all transistors are of the junction type. The original point-contact type is still more common. In this type (Fig. 6), a small piece of germanium, the base, is soldered to a metal electrode. The emitter and collector are two pointed wires, touching the germanium close to one another. The operation of the point-contact transistor is the same as that of the *p-n-p* junction transistor, for, by an electrical *forming* operation, small islands of *p*-type germanium are formed about the emitter and collector points, and these regions of *p*-type material act just like the emitter and collector of a junction transistor.

Point-contact transistors behave differently from junction transistors in one way. Because the area of the collector is very small, the charge of the electrons which form the collector current affects the electric potential in the germanium near the collector. Thus, when the collector current changes, the potential inside the germanium changes, and this tends to change the collector current more. In fact, when the emitter current is changed the collector current may change as greatly as 50 times as much, giving an *alpha* of 50. Thus, unlike junction transistors, point-contact transistors can have current gain even in grounded-base circuits, but they will

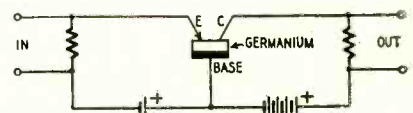

Fig. 6—Circuit of a contact transistor.

not operate at as low voltages as the junction type will.

Transistors come in many forms, and I have included pictures of several. Particularly interesting are tiny assemblies containing transistors, capacitors, resistors, and other circuit elements, all embedded in plastic. These are just the stuff for equipment which must be operated and serviced by people who can follow a manual but who don't know much about circuits.

What will newer, better, and cheaper transistors make possible? Radios no bigger than a match box or even a wrist watch seem feasible. But transistors mean a lot more than that. Because they are small and take little power, they will be used where vacuum tubes are impractical. Think of a "thinking machine" with all the vacuum tubes torn out and their spaces filled completely with transistors. Surely the machine would have a lot more brains! END



*A simple network  
to help maintain  
tonal balance at  
low volume levels*

# A BRIDGED-T AUDIO CONTROL

By WM. AUSTIN

THE loudness control, which boosts the bass and treble frequencies as the volume is reduced, thus compensating for the loudness-frequency characteristics of the human ear, has become an important element of a large number of high-fidelity audio systems.

Most loudness controls operate by adding low-pass filter sections as volume is decreased. This calls for an expensive step-by-step control, or multiple taps on a potentiometer. Tap switches

are cumbersome and costly, and potentiometers with the required number of taps are special jobs.

By using the bridged-T circuit—together with the regular bass and treble controls of the amplifier—an effect approaching that of a loudness control may be obtained with an ordinary potentiometer, three small capacitors, and three fixed resistors.

Fig. 1 shows the basic bridged-T circuit. It presents nearly infinite impedance at a frequency  $f$  (where  $f = 1/2\pi RC$ ) with rising response above and below this frequency. All that is needed to use it to control loudness is to choose values giving maximum impedance at a frequency near the center of the audio range (1,000 to 3,000 cycles), and to provide a means of varying this impedance as volume is changed.

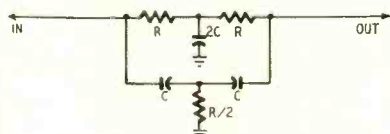

Fig. 1—Basic bridged-T filter circuit.

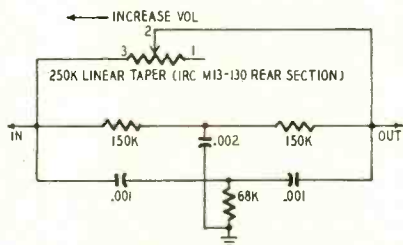

Fig. 2—Circuit of the bridged-T control.

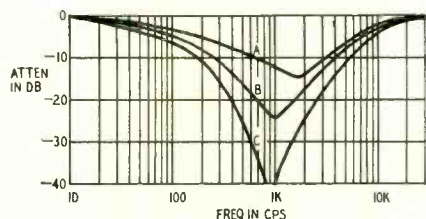

Fig. 3—Frequency-response characteristics of the bridged-T control. A, B, and C show the response at three-quarters, one-half, and minimum-volume potentiometer settings respectively.

## A practical hookup

Fig. 2 is the circuit. The component values give maximum attenuation at about 1,000 cycles. Fig. 3 shows the effect of the control on the frequency response at various volume levels. As volume is increased, the bridge is shunted gradually, until at full volume the response is flat except for a small amount of bass boost. This can be minimized by using a fairly low value of plate-load resistance in the stage preceding the loudness control. Since this

circuit provides considerably more treble boost than the Fletcher-Munson curve indicates is necessary at low volume levels, it is desirable to use a simple treble-cut tone control to reduce the high end.

## Don't discard tone controls

This unit is *not* a substitute for individual bass and treble controls. Individual tastes and the characteristics of program sources vary and it is still desirable to have both ends under control. The Fletcher-Munson curves show that the ratio of bass to treble boost varies with loudness. An ideal arrangement is to retain the individual bass and treble controls and use the loudness control in tandem with the regular volume control. The 250,000-ohm linear potentiometer can then be the rear section of a dual control and the front section can be a standard audio-taper volume control of whatever value is desired. An on-off switch also can be added if desired.

I use this setup in a *Radio Craftsmen* RC10 tuner with excellent results. This tuner has a bass-treble control circuit between the two audio stages. See Fig. 4. The bridged-T control is between the plate circuit of the first stage and the bass-treble control (point X in Fig. 4). The original volume control follows the plate circuit of the second stage. END

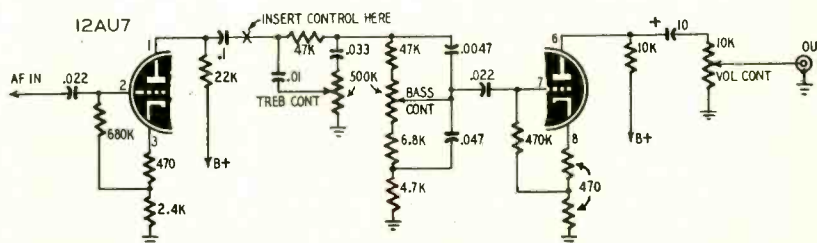
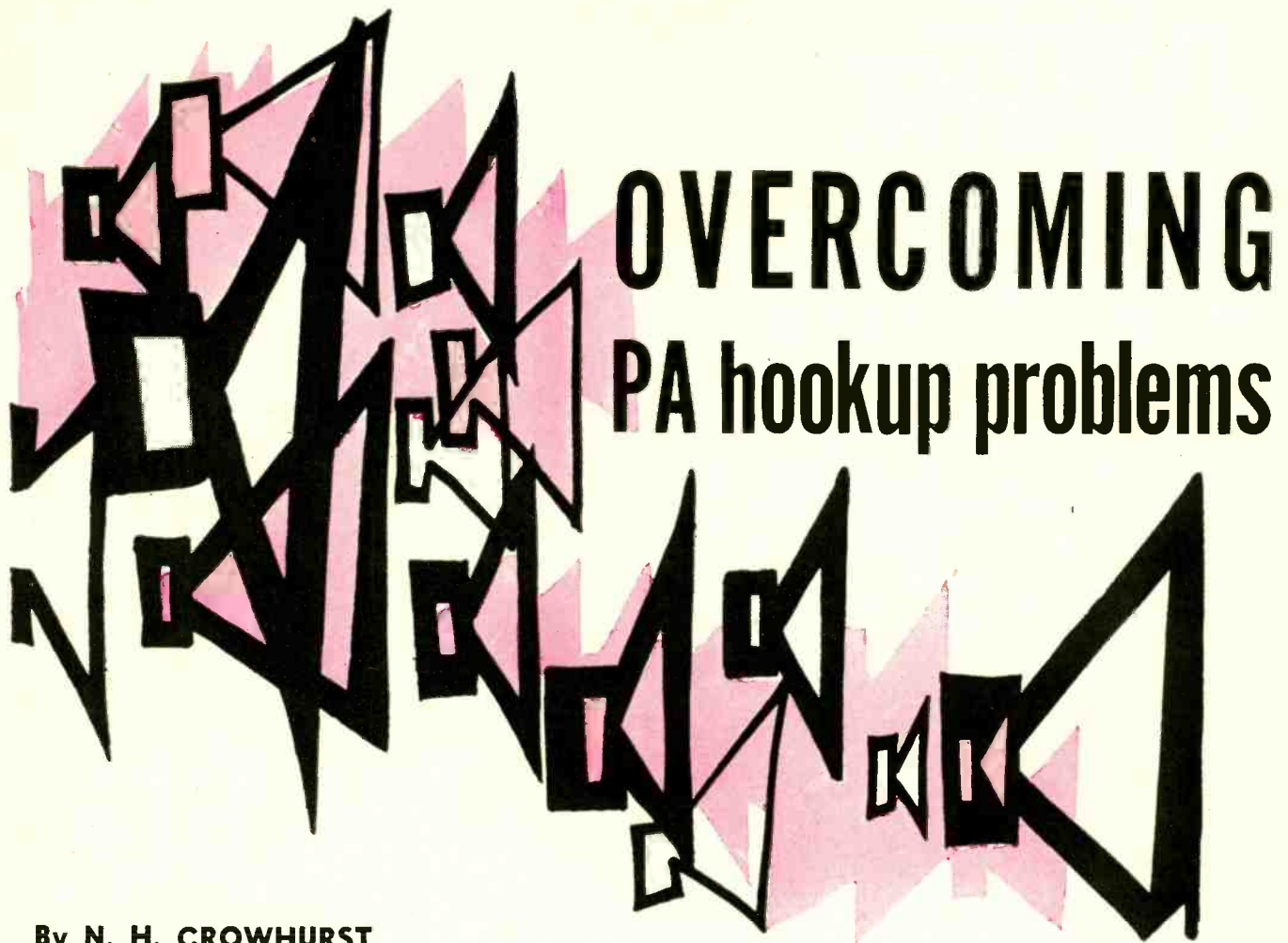

Fig. 4—Applying the bridged-T control to a commercial audio amplifier (*Radio Craftsmen* RC10 AM-FM tuner). Control is inserted at point X in the diagram.





By N. H. CROWHURST

**O**CCASIONS frequently arise where the PA engineer has to feed two or more independent sound systems from the same program source. Electrical hookup between separate systems is often fraught with various difficulties, so the most common method is to run out a separate microphone for each system to be tied in, resulting in the veritable battery of microphones often seen when a celebrity speaks on an important occasion. This method has serious disadvantages, the greatest of which is the variation of level, whenever the speaker moves or turns his head, on some of the systems whose microphones are not so well placed as others.

Obviously the best approach to the problem would be to use only one high-quality microphone (with an extra one as a stand-by), to supply all the different systems. This would simplify program pickup, as well as monitoring problems on each of the systems hooked together. There would still be problems, but they need not be insurmountable once they are understood.

The chief problems may be listed under four headings:

1. When two systems are coupled together, a severe line hum often develops in one or both systems, that

was not present in either before the connection was made.

2. It may be difficult to provide the right impedance match between the two systems without affecting the volume level in one or both.
3. Where several systems are fed from a common source there may be interaction between controls on the different systems. One operator altering his volume or tone-control settings may affect the volume and quality of the signals delivered to other parts of the hookup.
4. One or more systems in the hookup—recording units for example—may not require the entire program, and may adopt different methods of cutting in and out of the network. Precautions must be taken to see that any such circuit modifications in one part of the system do not interfere with the rest of the hookup.

#### 500-ohm bus system

By far the most versatile method is to set up a 500- or 600-ohm balanced line that serves as a basic interconnecting bus. The best arrangement is to have a microphone amplifier that will deliver an output level of about 1 volt into a balanced 600-ohm line (0 vu), but this is by no means essential; any

good amplifier with the necessary microphone-control facilities can generally be made to serve this purpose by padding the output to 500 ohms.

With this system not only can a program from a single source be fed into a number of systems, but also various program sources can be brought into the hookup by using separate local amplifiers to feed into the 500-ohm bus at the desired points. Much of the hum trouble can be eliminated by careful attention to impedance and level matching. However, an important cause of hum that cannot be taken care of in this way is that due to differences in potential between the ground connections of the individual systems.

#### Ground potentials

In the interests of public safety, all power circuits are connected to ground somewhere, and a ground connection also is provided on some power-supply outlets as a safety precaution. The association between the ground connections of the various supply circuits in the building sets up small currents at the line frequency in the grounded framework. These currents in turn set up slight potential differences, usually only a small fraction of a volt, but even such a minute potential can create



a serious hum if it gets into any high-gain amplifier. This often happens when two systems are coupled together, so the solution rests in careful selection of ground-connection points.

While on this subject, it is well to mention that a good-quality PA amplifier should operate well *with or without* a ground connection, and the effect of breaking or making this connection should be almost inaudible—even with the volume turned up to maximum and the ear close to the loudspeaker. If an amplifier does not satisfy these require-

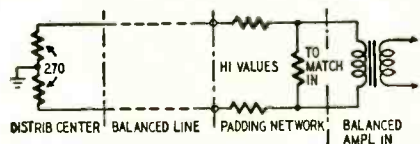

Fig. 1—Method of connecting a balanced-input amplifier to a balanced 500-ohm line. Series resistors in padding network reduce loading, and allow several amplifiers to be fed from one line.

ments, it is wiser to leave it out of any hookup system and look for a better one. If no better amplifier is available, then careful treatment may produce passable results, as explained later in this article.

**Getting on the bus**

Assume that we have a microphone amplifier delivering an output of 1 volt into a 500-ohm balanced line, and we are going to feed a number of sound systems from this line. Most PA amplifiers are provided with separate microphone and phono inputs; the microphone input is generally the best one to match the 500-ohm line to, because it will have adequate reserve of gain, whereas the phono input may not. Microphone inputs are usually low-impedance, between 10 and 50 ohms; some are balanced to ground; some may be floating; and some may have one side connected to chassis.

Fig. 1 shows the simplest method of connecting the line to a balanced microphone input. For a single-ended input it may be possible to unhook the ground connection inside the amplifier, but this may give rise to trouble because the ground connection is probably included to maintain stability in the amplifier. If this is removed, and the input circuit is grounded only at some remote point, hum trouble will probably appear.

Fig. 2 shows one method of connection where one side of the amplifier input is grounded. This may give trouble for two reasons: the unbalanced line is likely to pick up hum or cross-

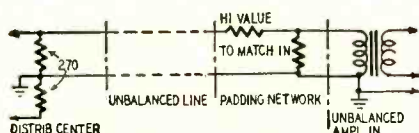

Fig. 2—Feeding an unbalanced-input amplifier from a balanced line. Potential differences between the two grounds may introduce hum at power frequency.

talk from telephone lines or other speech circuits that may run near it; and the small potential difference between the two ground connections may inject a line-frequency hum.

Fig. 3 shows an alternative method of connection that avoids strapping the two ground connections together as in Fig. 2, and also provides a balanced connecting line. One of these two methods of connection should prove satisfactory. When going into low-level low-impedance inputs, the resistor values should be adjusted so the resistance from both lines to ground is equal at the distributing center. If this is checked by d.c.-resistance measurement, all amplifier inputs and outputs should be disconnected, or the winding resistance of their input and output transformers will invalidate the result.

Most high-impedance phono or crystal-microphone inputs are *unbalanced*. Fig. 4 shows the simpler method of connection here corresponding to Fig. 2 for low impedance, while Fig. 5 shows the method to adopt where a balanced line is necessary.

**Line impedance**

An important feature to realize about these circuits is that the impedance of

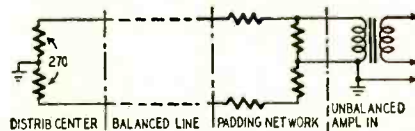

Fig. 3—One method of reducing line hum by the insertion of an isolating resistance between the two ground points

the connecting lines must be in the vicinity of 500 ohms. This is achieved in each of the circuits shown by inserting padding resistors at the receiving end of the line. Two factors feature in the reason for this precaution: (a) transmission losses; (b) pickup of hum or cross-talk.

Lines run at low impedance—that is, by putting the resistor networks at the output end of the line as in Figs. 1, 2, and 3—introduce line loss due to the fact that the line-conductor resistance may be an appreciable fraction of the operating impedance. Such low-impedance circuits are also more susceptible to inductive pickup from magnetic hum fields through which the line may pass. The currents induced in the line will be of the same magnitude whether the line is 500 ohms or low impedance, but in the case of the 500-ohm line they will be attenuated by the padding network at the receiving end.

Lines run at high impedance—that is, by placing the padding resistors of Figs. 4 and 5 at the opposite end of the line, cause excessive loss of high frequencies due to line capacitance. The line is also prone to pick up noise from electrostatic fields. Of the two extremes a low-impedance line is preferable because the inductive components it picks up predominate at very low audio frequencies, which may not get through the average PA amplifier-speaker com-

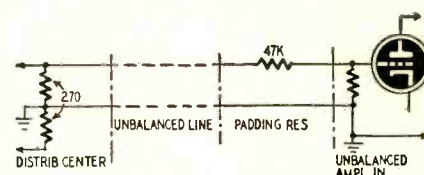

Fig. 4—A simple method of feeding an unbalanced high-impedance input from a low-impedance unbalanced audio line.

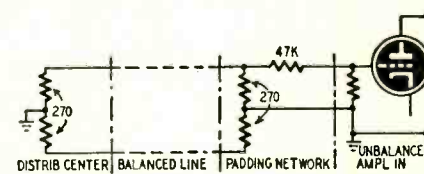

Fig. 5—Connecting a balanced low-impedance line to a high-impedance single-ended amplifier input. If additional units are fed from the same line the value of the shunt resistors in the padding network should be increased.

ination; while the static pickup in a high-impedance line contains high-frequency components with a greater annoyance potential, and loss of high-frequency signal components in the high-impedance line interferes with program quality.

Physically a balanced 500-ohm line is generally made up of a twisted pair run inside flexible shielding. High-impedance lines are usually single-conductor shielded wire, coaxial line, or an unshielded twisted pair with one of the conductors grounded.

Besides providing good program quality with freedom from spurious pickup, the correct padding network, properly placed, will usually take care of problems 3 and 4 listed at the beginning. The values of the padding network should be chosen so that whatever happens at the outlet end will not materially affect signal voltages at the input end.

For example, phone plugs and jacks are sometimes used as input connections to an amplifier. When a plug of this type is inserted into its jack, the line connected to the plug is shorted momentarily. If the main 500-ohm line is connected to the plug, then insertion or removal of the plug would momentarily short-circuit the whole program. Inserting a padding network between the line and the plug avoids this. In some tape recorders inserting the input plug disconnects the playback head, so that if an operator wishes to listen to a section of recording on his tape he has to remove the input plug. Unless the foregoing precaution is observed this operation could involve interference with the program.

Another wise precaution is to see that all padding resistors are soldered securely to the lines (once the values have been satisfactorily determined by experiment), and are suitably covered with insulating tape or otherwise protected against any possibility of accidental short-circuit or contact that might interfere with the program in any way.



**Improvising outputs**

The foregoing assumes that a suitable microphone amplifier with a balanced 500-ohm output is the signal source for the entire network. If such an amplifier is not available, additional padding will be necessary to match the output of the microphone amplifier to the 500-ohm bus. If the amplifier has the usual low-impedance voice-coil output, a dummy load equal to the proper voice-coil impedance should be connected across the output, after which resistors of 270 ohms should be connected in series with each side of the line as shown in Fig. 6.

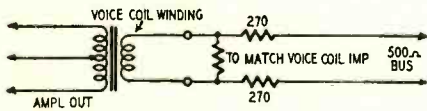

Fig. 6—Padding out a low-impedance output winding to feed a 500-ohm line.

The voice-coil winding should not be connected to ground on either side, or the line will not be balanced. If the amplifier requires a ground connection to the voice-coil winding for satisfactory operation, the dummy load resistor

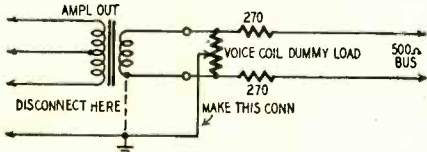

Fig. 7—Changes required where one side of the voice-coil winding is grounded.

should be center-tapped and made up of two equal resistors and the ground connection made to the center tap as in Fig. 7. If the secondary of the output transformer is used for feedback purposes, one side will be connected to the internal amplifier ground and the other side through a suitable resistor to the appropriate feedback point. In this case the modification of Fig. 7 would

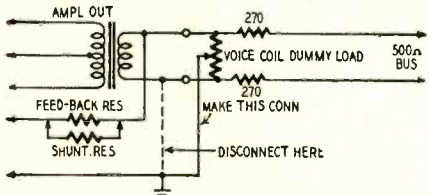

Fig. 8—Circuit modifications where output-transformer secondary is part of feedback network. See details in text.

cut the feedback in half. To rectify this, the feedback resistor also should be halved. The simplest procedure in this case, involving minimum alteration to the amplifier (this is something that must always be borne in mind, because the amplifier must be put back to normal after the hookup), is to disconnect the ground connection from one side of the transformer secondary and connect it to the center-tap of the dummy-load resistor. Then shunt the feedback resistor with another resistor of the same value. These changes are shown in Fig. 8.

Most amplifiers can be treated in this way to supply the necessary 500-ohm

output, but you may find one that has high-impedance output, above 500 ohms. I have frequently used an amplifier with 2,000-ohm output (intended for constant-voltage-line work) for this purpose. The procedure is similar in this case, but the series resistors will have to be much higher than the line impedance. This type of network is shown in Fig. 9.

**Multiple signal sources**

Where programs are to be taken from more than one source in the system, it will be advantageous to feed the 500-ohm bus from a local microphone amplifier at each point of origin. If

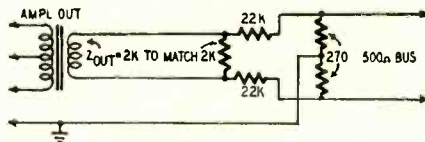

Fig. 9—Padding a network for matching a high-impedance output transformer to feed a balanced 500-ohm line.

the amplifier is one specially designed to feed a 500-ohm balanced line, additional precautions are necessary to see that its operation will not interfere with programs originating from other amplifiers. The plate resistance of the output stage is usually much lower than its load resistance, which means that, even though it is connected to a 500-ohm output circuit, when the amplifier is warmed up, a signal from another source will "see" this output circuit as 500 ohms shunted by the plate resistance, or much less than 500 ohms. Now suppose the amplifier is switched off: The shunting effect of the plate resistance disappears and the other amplifier will be feeding into a circuit that has now risen to its true 500 ohms. Thus, switching the first amplifier on and off, although it may not be carrying any program, will affect the output from a second amplifier, changing its volume level by from 10 to 20 db.

From this viewpoint, amplifiers with padding networks may be better than those specifically designed for 500-ohm output. For the correctly designed amplifier the best plan is to insert a resistor of 150 ohms in series with each side of the line at the output, to limit the reduction in shunt impedance when the amplifier is on, as viewed from another amplifier feeding the 500-ohm bus. This will take care of impedance matching, but may still leave a pos-

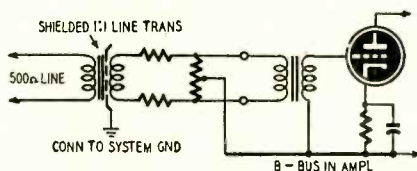

Fig. 10—An isolation transformer may be needed to reduce hum when feeding an a.c.-d.c. amplifier with a floating B minus return from an audio line.

sible change of level of about 6 db, should the amplifier be switched on and off while the program is coming from other source. A wise precaution is to establish a recognized rule, that

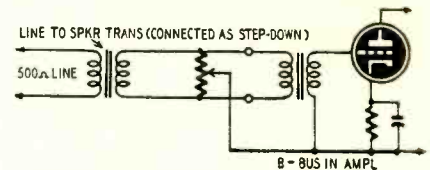

Fig. 11—Another method of connecting an a.c.-d.c. amplifier to a 500-ohm line. The potentiometer across the input terminals is for balancing out line hum.

the amplifier must be kept running throughout the whole program, whenever any part of the system is being used. This rule may not be necessary with amplifiers padded out from lower or higher impedance to 500 ohms.

**Isolating grounds**

The padding arrangements shown in Figs. 1 through 5 usually prove perfectly adequate with good amplifiers. Sometimes, however, an amplifier must be pressed into service which does not meet the conditions specified earlier, of satisfactory operation with or without a ground connection. Many amplifiers designed for universal operation come in this category. Complete isolation must be provided between the system ground and the chassis (or ground bus) of this particular amplifier.

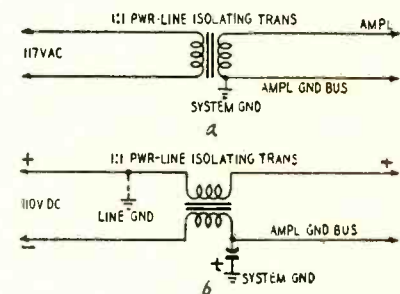

Fig. 12—Isolating the a.c.-d.c. amplifier from the power line. (a) A 1:1 power transformer for a.c. operation. (b) The same transformer connected as a dual choke for operation from d.c. power lines. See the text for further details.

Several methods of attack can be tried, and the choice will be controlled by the equipment available. If a shielded line-to-line transformer is available, the method shown in Fig. 10 should be satisfactory. If only a line-to-speaker matching transformer or some such component is available, the circuit of Fig. 11 can be used. The potentiometer may be almost any value, as long as it is higher than the other components in the circuit. It is used to balance out hum pickup.

An alternative approach is to use an isolating transformer between the power line and the amplifier in question. See Fig. 12-a. An isolating transformer also can be used as shown in Fig. 12-b when the supply is d.c. with the wrong side grounded. END



# TRANSISTOR MICROAMMETER

BY NATHANIEL RHITA

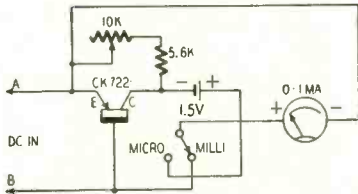

This simple transistor amplifier has a current gain of approximately 10:1.

THE transistor is to current what a triode tube is to voltage. A transistor makes an excellent current amplifier. We have constructed a circuit using Raytheon's type CK722 that gives a gain of 10 with about 100 microamperes input to the emitter. When the transistor feeds into a 0.1 ma meter, we can actually measure 0-100 microamperes full scale. The advantage of this circuit is that we can measure weak currents with an inexpensive, rugged instrument.

The photos and schematic show a 2-range micrometer using a 1-ma movement. When the switch is thrown to MILLI the range is 0-1 ma since the meter itself is across the input. With the switch in MICRO the 10-to-1 current amplifier precedes the meter so the range is 0-100 microamperes. To avoid unnecessary battery drain leave the range switch in the MILLI position when the meter is not in use.

Actually the transistor amplification is not constant all over the scale. It is slightly higher than 10 near full scale, and less than 10 near the bottom of the scale. To reduce error, a compensating circuit is included. Adjust the variable resistor for exact reading near 0.8 on the meter. Then accuracy will hold

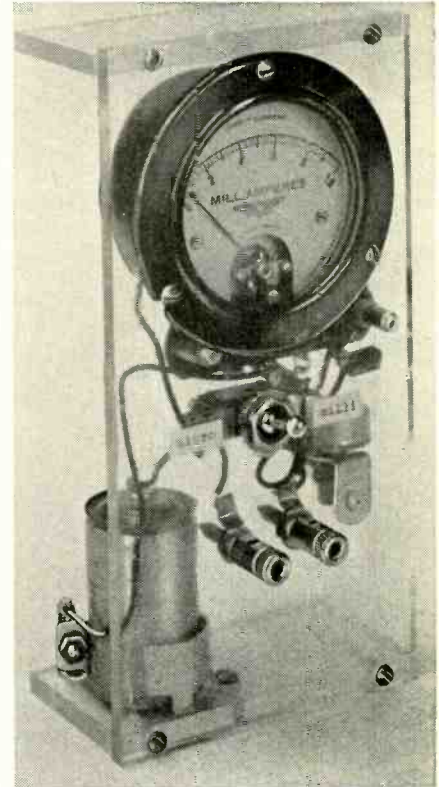
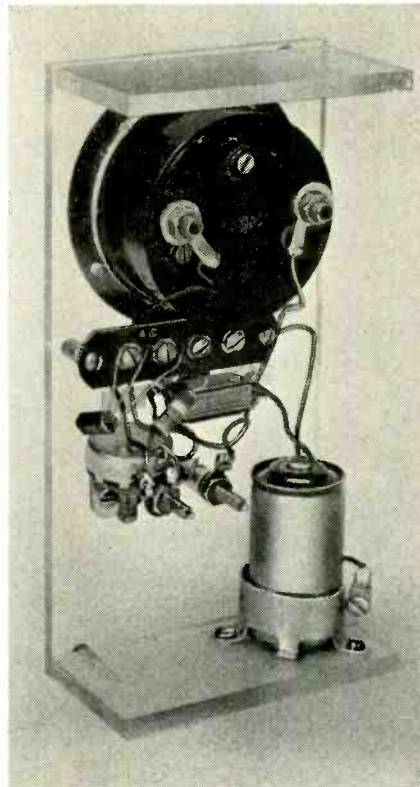

Inside and outside views of the transistor microammeter. The two-way switch allows the meter to be used alone where 100- $\mu$ amp sensitivity is not required.

over most of the range. We find that the error is only 2% or 3% from .2 ma on the meter (20 microamperes input) right up to full scale. Readings near zero have greater error, but this is not serious.

As a microammeter, the positive in-

put terminal is A which ties to the emitter. As a milliammeter, the positive terminal is B. Note that in the MILLI position, the 1.5-v cell is disconnected but that the transistor input circuit is left across terminals A and B. This produces negligible error. END

## The Wench With the Wrench

Pretty Celeste Mogab wasn't too sure at first about the right way to install a simple thing like a new *Platinum-Plate* u.h.f.-v.h.f.-AM-FM-TV tuner and needle-scratch filter with overdrive and deep-freeze attachments—but Raytheon's new TV servicing television program showed her all she needed to know. This novel method of delivering the latest dope on u.h.f. techniques was devised by Raytheon as a means of reaching the maximum number of technicians in a given area with minimum inconvenience to busy shops' service activities. Another advantage is that it gives everyone a front-row view of what's going on. Technicians who tuned in the first broadcast over WFPG-TV, Atlantic City's new channel-46 station, agreed enthusiastically that Raytheon's new model has several interesting features.





# TV CHASSIS SIMPLIFIED

**M**ANUFACTURERS realize that TV receivers have to be serviced. At least two of the 1953 series reflect that realization in chassis design. The Stewart-Warner 9300 chassis pictured here is possibly the best example of the trend toward a "serviceable" TV chassis.

The 9300 under-chassis view, contrasted with that of an older receiver, shows what can be done when engineers want to simplify a TV set. The top views shows a "unitized" construction in which all parts are readily accessible, and no tubes are mounted under the kinescope (or under the chassis!). Power and high-voltage fuses are both mounted in top-chassis, easily accessible positions.

A bridge support at the rear of the chassis makes it possible to rest it on either side, or to turn it upside down on the bench, with complete safety. The flyback transformer—a high-mortality-rate component, and one which the service technician often wishes to check—is mounted with plug-in connectors instead of soldered leads. A transformer can be removed by unscrewing two sheet-metal screws and pulling out five connectors. A complete replacement takes less than five minutes, in the customer's home.

Another striking difference between old and new TV models is visible in the two Sonora chassis illustrated. They are the company's 1952 and 1953 21-inch models. The same number of components are to be found in each set, but there is a striking difference in the way they are arranged in the 1953 model.

The distribution of parts above-chassis does not show quite the same advantages of convenience and accessibility as the below-chassis arrangement. A couple of the tubes are hard to see or to get at while the chassis is in the cabinet, and the rectifier tube on top of the transformer is not an aid to easy replacement of tubes on that side of the chassis. The setup is a decided improvement in heat dissipation, however. The power transformer has been removed to the top of the chassis, and the position of the rectifier tube is excellent from the radiation point of view. A number of the larger capacitors are mounted on a vertical subpanel in a cooler part of the chassis area.

Slight differences in chassis layout and component accessibility may well mean the difference between a simple repair job and a heart-breaker. Service technicians will watch with great interest for further indications of this trend toward simplification. **END**

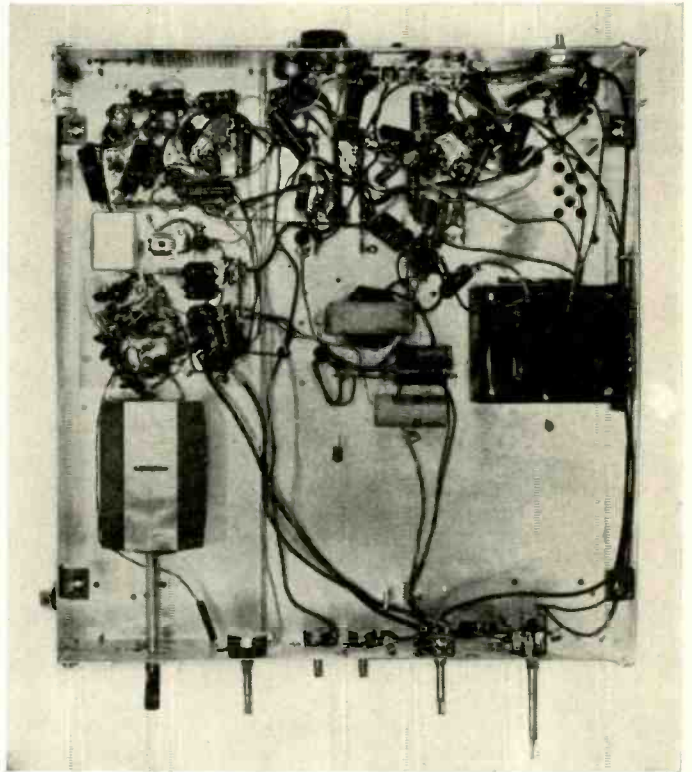

Underchassis view of S-W 9300 (above) compared to old standard chassis shows new inspection and servicing ease.

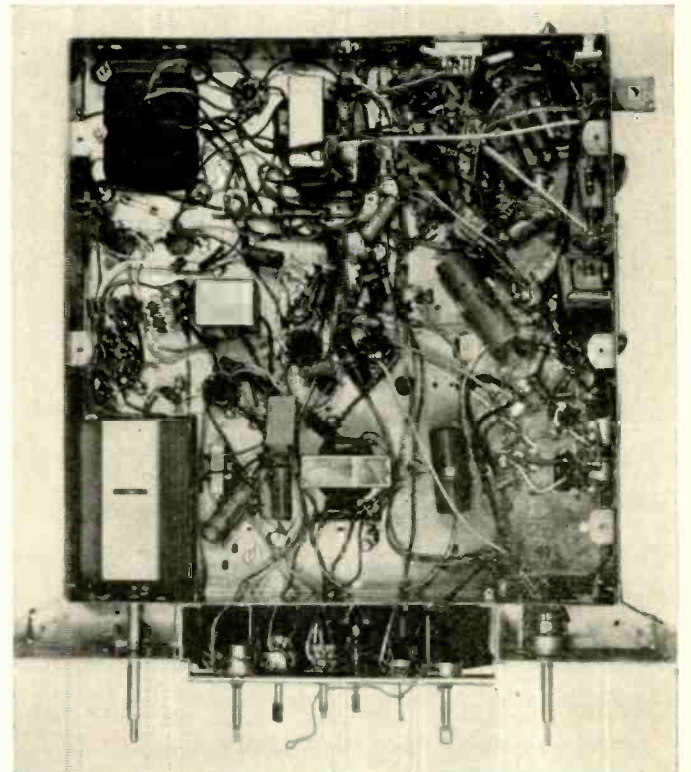



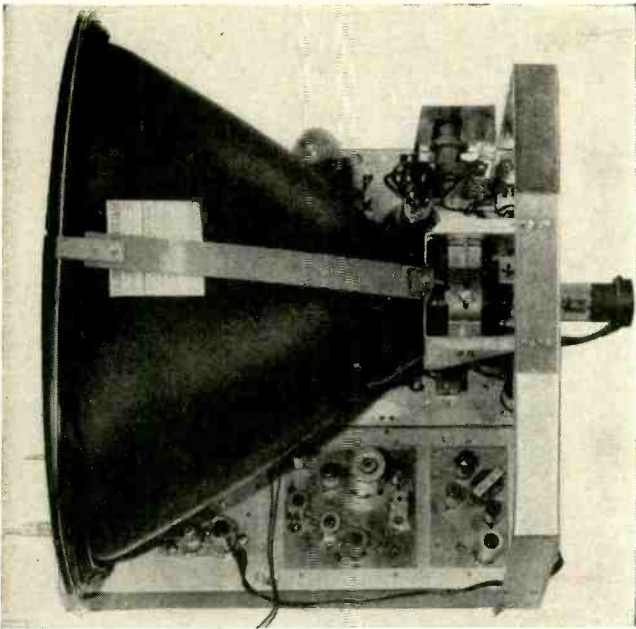

Top view of the 9300. High-voltage can (top) is removed. Note support at rear.

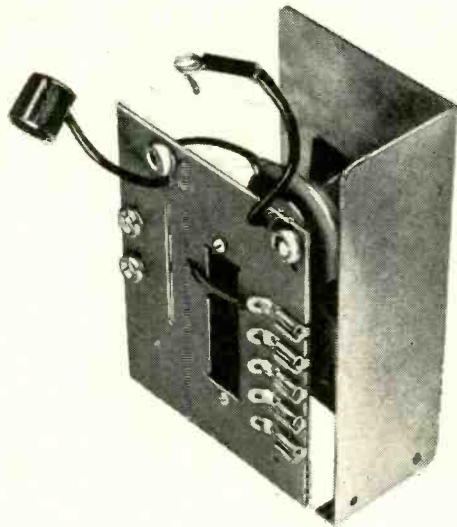

A transformer with plug-in terminals.

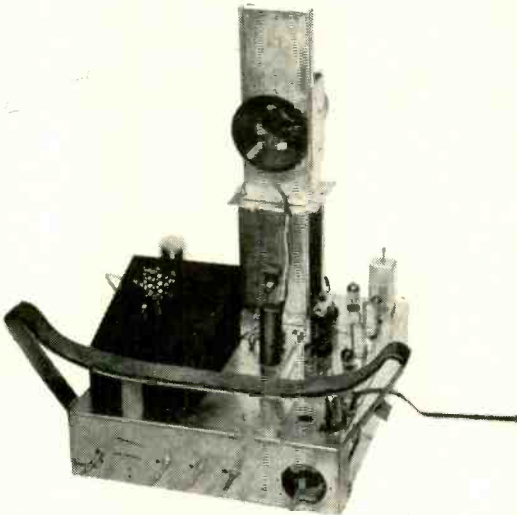

The above-chassis views of two Sonoras show improvement in heat radiation. Capacitors are mounted in cool area.

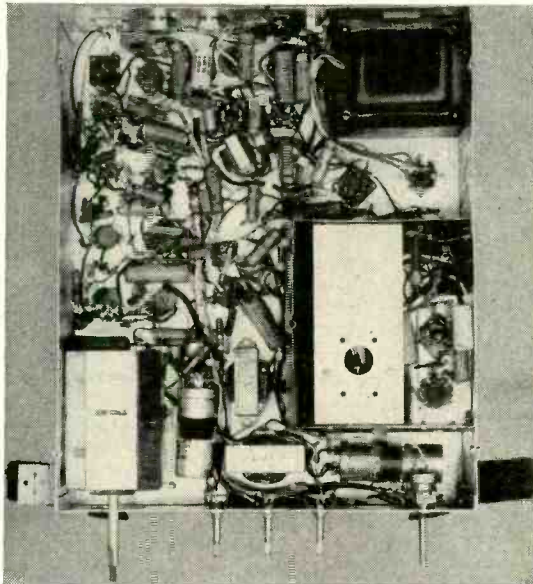

Old (above) and new (below) 21-inch Sonoras compared. Tuner and power transformer were put above chassis and parts layout much improved in the newer model.

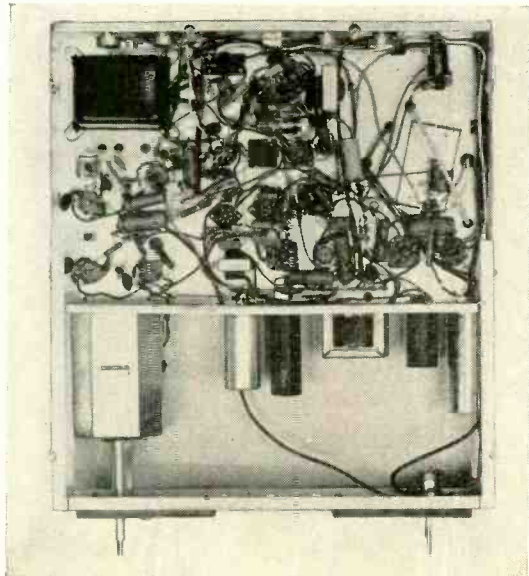



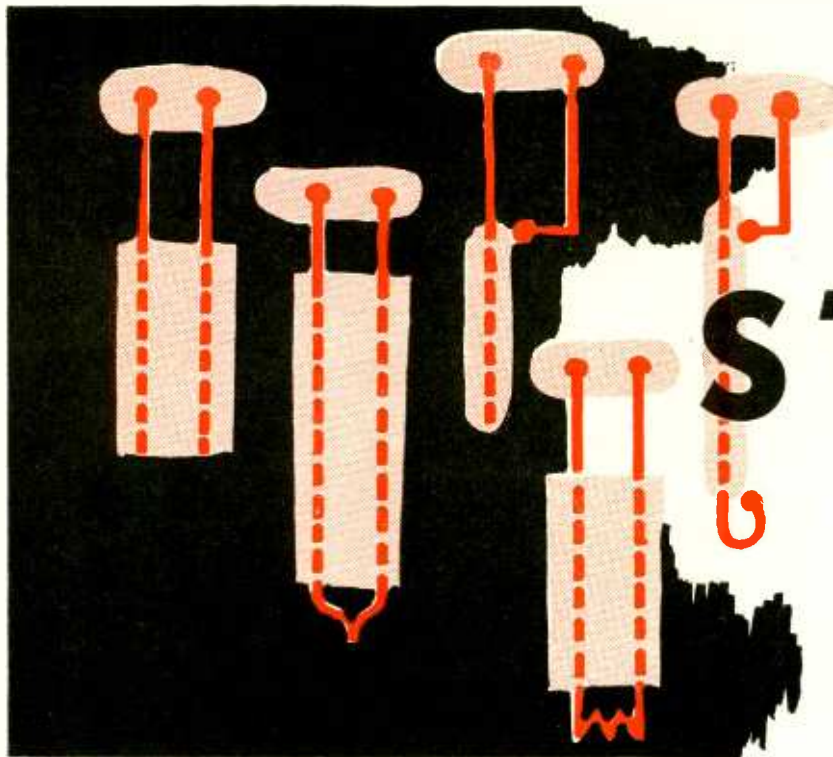

# STUBS

*make excellent traps for  
reducing TV interference*

By JESSE DINES\*

WHERE interference enters a TV receiver through the antenna or transmission line, stubs provide a reliable and permanent solution. Several factors favor their use: They are easy to make and install, their cost is very low, and they can reject almost all types of outside interference except co-channel interference (two stations picked up on the same channel) and broad-band noise. Generally speaking, stubs have a limited bandpass characteristic, which especially favors their use for elimi-

\* Editorial Dep't., John F. Rider Publisher.

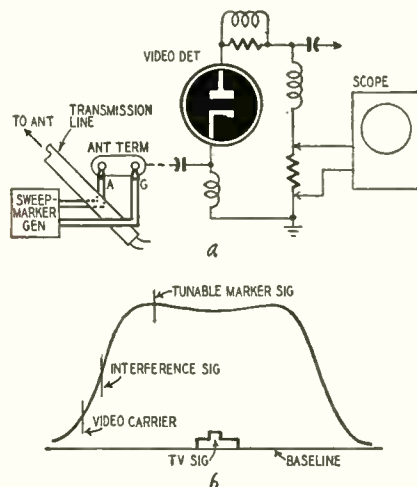

Fig. 1—(a) Equipment setup for finding interference frequency. Generator output must be kept low to avoid overloading. (b) Typical scope trace. The interference frequency can be read directly from the marker dial when both pips coincide. See text for details.

nating FM-broadcast interference (88 to 108 mc). This characteristic, however, becomes a handicap when we want to eliminate adjacent-channel interference; but even this limitation can be overcome. Steps to alleviate this condition are given later.

Before we can make a stub, we must first know the interference frequency. One of the most accurate methods is to use a standard sweep-marker generator and oscilloscope, arranged as shown in Fig. 1-a. Disconnect the transmission line from the receiver, and couple it loosely to the output leads of the marker generator, as shown. Connect the marker generator to the antenna terminals of the receiver and hook the scope across the video-detector load resistor. The next step is to turn to the channel where the interference is most severe and adjust the fine-tuning control of the receiver for maximum interference. Cover this channel with about a 10-mc sweep from the generator to obtain a response curve similar to Fig. 1-b. Three pips should appear on the curve: the video-carrier signal, the generator-marker signal, and the interference signal. Vary the marker-frequency control of the generator so that the marker pip lines up with the interference pip. At this point, the marker-frequency dial of the generator gives you the interference frequency.

When the frequencies of the marker and interference signals are not exactly equal, a sine wave appears on the base-line. This is the frequency difference between the two signals. The frequency of the beat decreases as the signals are brought closer together. The beat disappears completely when the two signals are equal.

## Open and shorted stubs

The quarter-wave open and half-wave shorted stubs are the easiest to construct and install. Both types are equally effective for all practical purposes, and either may be used. They are constructed from the same material as the transmission line of the receiver. Four examples of stubs for both 300-ohm ribbon lead and 75-ohm coaxial lines are shown in Fig. 2. Their lengths,  $l$ , are computed from the formulas given in Table I. The length of the stub,  $l$ , is in inches and  $f$  is the interference frequency in megacycles. As an example, consider the case where we want to find the length of a shorted half-wave stub to eliminate 200-mc interference from a receiver with 300-ohm input. The length of the stub is then determined from the formula given in the chart. That is,

$$l = \frac{4,850}{f} = \frac{4,850}{200} \text{ or } 24.25 \text{ inches}$$

or a little over 2 feet.

Always cut a stub several inches longer than its calculated length to allow for final adjustments after the stub is installed. With quarter-wave open stubs, cut off  $\frac{1}{4}$ -inch sections from the open end until interference rejection is maximum. In the case of half-wave, shorted stubs, short out  $\frac{1}{4}$ -inch sections by cutting through the insulation and shorting the wires with a razor blade or fine knife. Twist and solder the wires at the point where the least amount of interference is observed. On coaxial lines, puncture the insulation with a needle or thumb-tack, thereby shorting the inner and outer conductors.

Stubs may be taped, tacked (use



fiber-head tacks), or stapled to wood receiver cabinets. (With ribbon line the staple must lie parallel to the stub wires—never across them.) If the cabinet is plastic or steel, fasten the stub firmly to some nearby wooden structure such as a table or chair. *Never bend or twist stubs.* Doing so may change their natural resonant frequencies.

An important point to remember is that the quarter-wave stub greatly attenuates second harmonics and the half-wave does the same to third harmonics. For example, if a quarter-wave stub is cut to eliminate 91-mc interference from an FM station, then it will also eliminate 182 mc. This will attenuate the video signal on channel 8 (180–186 mc). A half-wave stub cut to 91 mc will attenuate 273 mc. This is well above the television spectrum.

**Stub switching**

After a stub has been installed and trimmed for maximum interference rejection, turn to all other channels to make sure it does not have any detrimental effects on them. If it does (which is most likely in fringe or weak-signal areas), then add a switching arrangement to take the stub out of the circuit except when it is needed. A d.p.s.t. switch, as shown in Fig. 3, may be used. A rotary switch is preferable since the capacitance between the contacts of most types is fairly low.

**Reducing stub Q**

Stub switching may not be necessary if the interference is much weaker than the channel being viewed. A stub having a lower Q and, therefore, less interference rejection, may be used instead. To reduce Q, we add a series resistor to the quarter-wave open stub or a parallel resistor to the half-wave shorted stub. The connections for these resistors are shown in Fig. 4. Their ability to reject varies inversely with

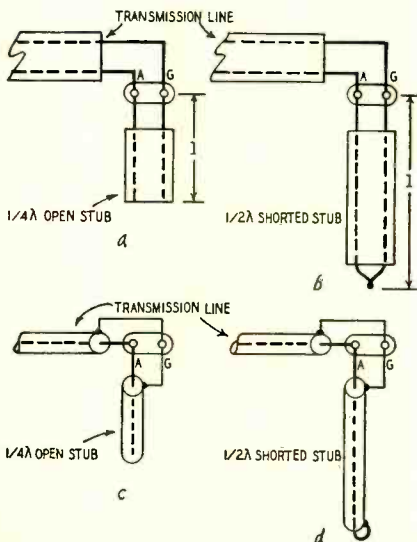

Fig. 2—Four types of stubs. (a) 300-ohm, quarter-wave open stub. (b) 300-ohm half-wave shorted stub. (c) Coaxial-line quarter-wave open stub. (d) Coaxial-line half-wave shorted stub.

their ohmic values. That is, the larger the ohmic value, the less the interference rejection; conversely, the smaller the ohmic value, the greater the interference rejection. The resistor for any particular installation is best determined by experiment. In an actual case a carbon resistor of about 25 ohms gave a 2-to-1 reduction in interference.

TABLE I

Stub Type	LENGTH (l) IN INCHES
Quarter-wave open (300-ohm lead)	$l = \frac{2,425}{f}$
Half-wave shorted (300-ohm lead)	$l = \frac{4,850}{f}$
Quarter-wave open (75-ohm coaxial)	$l = \frac{1,950}{f}$
Half-wave shorted (75-ohm coaxial)	$l = \frac{3,900}{f}$

**Tunable stubs**

A type of stub used quite often for its greater efficiency and its comparatively short length, is the tunable absorption stub. Assuming that the receiver uses 300-ohm transmission line, the stub is constructed from two pieces of the same line. The pieces are cut to a length slightly longer than that computed from the approximate formula

$$l = \frac{450}{f}$$

where  $l$  is the length of each piece in inches and  $f$  is the interference frequency in megacycles.

After cutting off about an inch of insulation from both ends of each piece, they are placed parallel to each other, as shown in Fig. 5-a, leaving enough room between the pieces to permit the transmission line to the receiver to pass through. Referring to the figure, wire 1 is soldered to 2, 3 to 4, 5 to 6, and 7 to 8. Make sure that the calculated length  $l$  is not changed when soldering the wires. The finished stub is shown in Fig. 5-b. Two capacitors are inserted across the parallel connection. One is a 7-45- $\mu$ f variable ceramic (zero temperature coefficient) to make the stub tunable; and the other is a 15- or 20- $\mu$ f fixed ceramic capacitor.

To install the stub, disconnect the transmission line temporarily from the receiver antenna terminals and run it through the center of the stub, as shown in Fig. 6. The stub should be at least one foot from the antenna terminals of the receiver, because the stub has a tendency to re-radiate.

If the interference is very strong, one stub may not reject it completely. In such a case, more than one absorption stub can be used, along the transmission line. The spacing between stubs is not critical, although they should not be too close to one another. Each stub is tuned separately to the interference frequency. When tuning one stub, all others must be made inactive by wrapping them tightly with tin or aluminum foil.

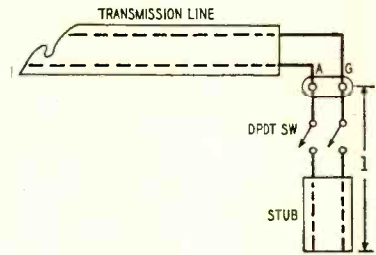

Fig. 3—Stubs may be switched out of circuit if harmonics fall on desired channel frequencies. Switch must have low capacitance between contacts for minimum absorption in open position.

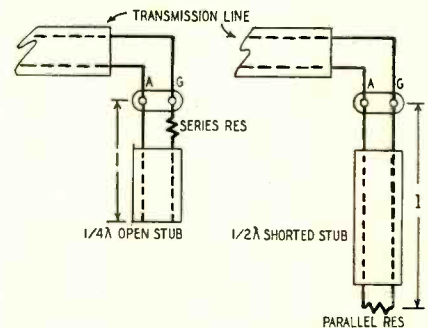

Fig. 4—Inserting resistance as shown reduces stub Q. See text for details.

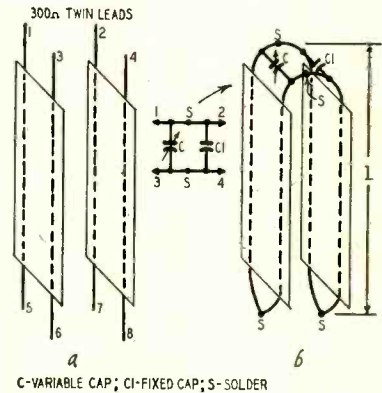

Fig. 5—Steps in constructing a tunable absorption-type stub. (a) Identical "sandwich" layers before joining. (b) Connections of completed stub. Formula for length  $l$  is given in text.

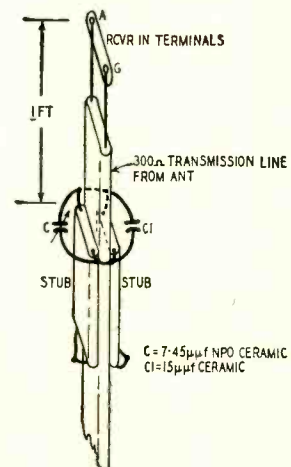

Fig. 6—Stub installed on transmission line. Note spacing from receiver input.



# THE EFFECT OF SPORADIC E

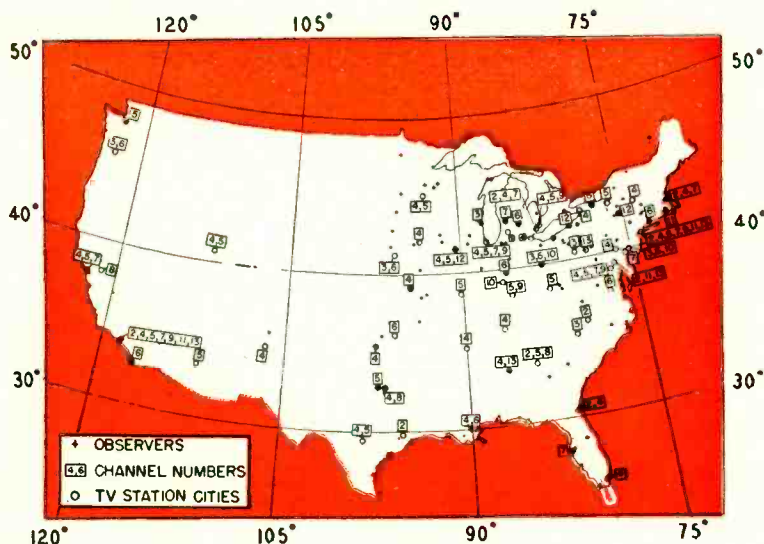

Fig. 1—Locations of observers reporting TV dx reception.

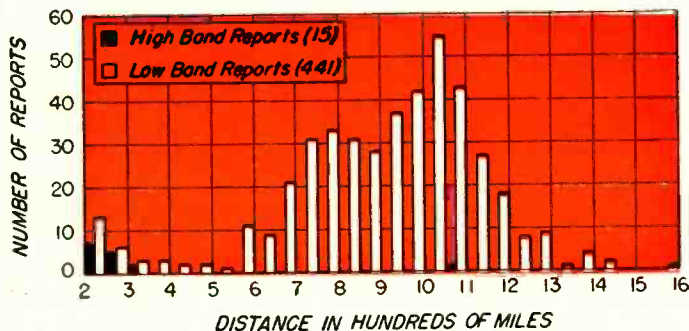
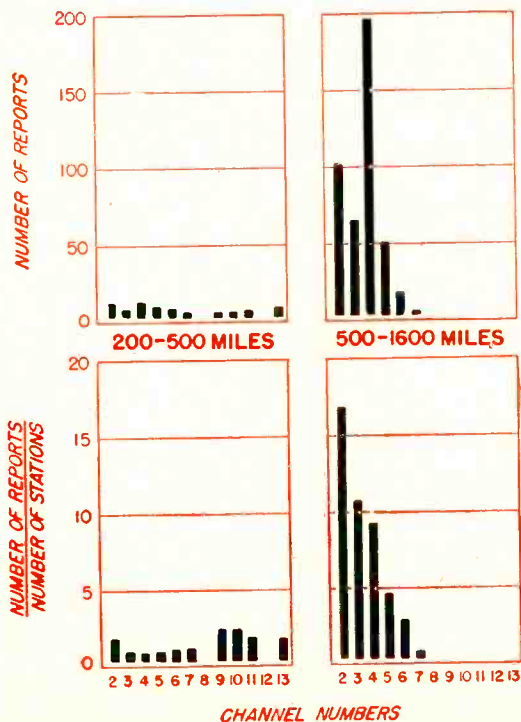

Fig. 2—Average of TV dx reports by band and distance.

Fig. 3 — (Above) Total number of dx reports received for each channel at various distances. (Below) Relation between number of dx reports for each channel and total number of active stations on that channel.



FOR several years reports of long distance reception have been coming in from television viewers. Most frequently these receptions have spanned distances of around 1,000 miles. There has been considerable speculation as to whether such abnormal reception is tropospheric in origin or transmitted via the sporadic-E region of the ionosphere. The type of evidence considered here leads one to conclude that transmission paths up to 500 miles can, roughly speaking, be attributed to tropospheric propagation, while sporadic-E accounts for transmissions between 500 and 1,600 miles. The importance of such reception to television service in the United States lies not so much in the service gained through the long-distance reception itself but in possible interference to a station's fringe area from distant co-channel stations.

Some expected differences between tropospheric and sporadic-E transmission:

First, skip distance does not apply to tropospheric propagation, while it does apply to sporadic-E. Tropospheric phenomena become more important as frequency increases, while sporadic-E reflections decrease with increasing frequency. Signals supported by the troposphere decrease with path length, whereas those due to sporadic-E will be most numerous at distances of around 1,000 miles. This is due to the fact that although the skip distance curve would give us an increasing number of possible receptions up to the maximum distance for single-hop propagation, low radiation angles of transmitting and receiving antennas have an opposite effect.

Extraordinary tropospheric propagation over long paths depends on conditions obtaining over a large extent of the path, whereas sporadic-E transmission depends on the ionospheric conditions over the path mid-point only. Sporadic-E can be a highly localized phenomenon, so if mid-points for a short time interval form a tight cluster on a map, sporadic-E rather than tropospheric propagation is indicated. Further evidence that sporadic-E is responsible for abnormal reception is obtained when reception mid-points are found falling close to the location of an ionosphere sounding station and when at the time of the television reception sporadic-E is identified on the ionosphere sounder.

### R-E TV dx reports used

The data utilized in this study were taken from the file of listener reports of RADIO-ELECTRONICS magazine.



# ON TV RECEPTION

By ERNEST K. SMITH, JR.\*

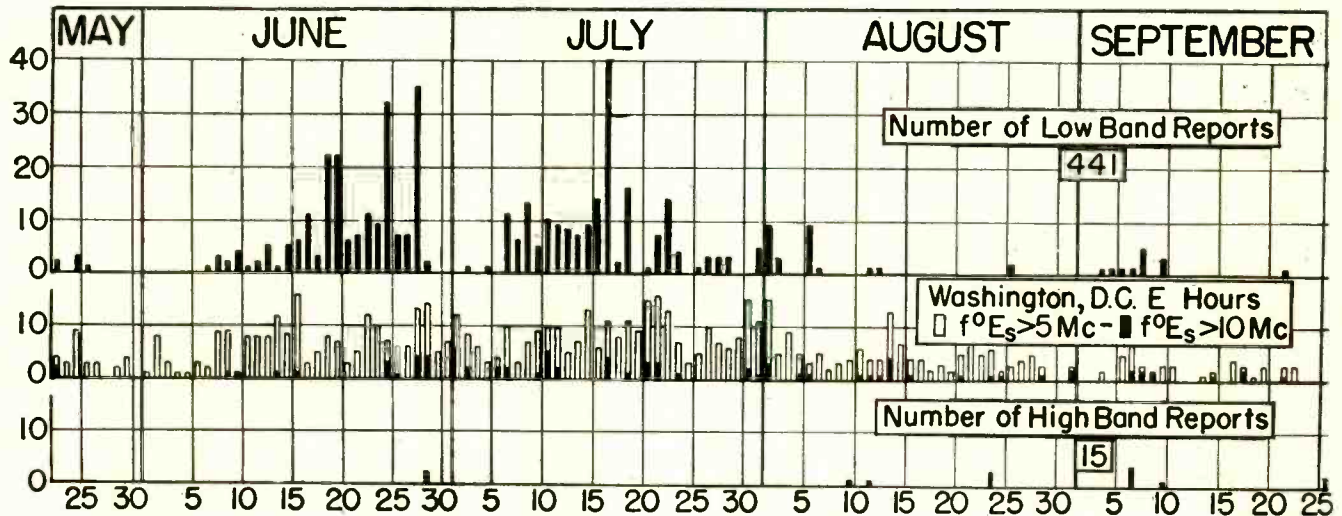

Fig. 4—TV dx reports by days for the period May 22-September 25, compared with the hours per day of vertical-incidence sporadic-E reflections at Washington, D.C. Note low-band peaks in June and July, months of maximum sporadic-E.

These data contained 456 reports of receptions of stations on the various TV channels over distances of greater than 200 miles. These reports were submitted by 103 persons and covered the period from May 22 to September 25, 1950. The crosses on Fig. 1 mark the locations of the observers. Cities with operating television stations are shown by circles. The channel numbers of operating television stations are shown for each city.

Shown in Fig. 2 is a histogram of the number of reports falling in the various class intervals of distance. The vast majority of reports are seen to fall in the 500- to 1,600-miles grouping and to consist almost wholly of reception of low-band (54-88 mc) stations. Note that in the 200- to 500-mile range there are receptions of high-band (174-216 mc) as well as low-band stations and that there is a decrease with distance, so that reports on both bands drop to a minimum at 500 miles. The former (high-band) group is believed to be troposphere-propagated; sporadic-E reflections could be responsible for the latter.

When the number of reports in the two distance divisions are plotted by channel as shown in Fig. 3, two apparent difficulties arise. In the 200- to 500-mile grouping, at the top, the number of reports appears to decrease with increasing channel frequency. The reverse would be expected for tropospheric transmission. In the 500-1,600-mile grouping, channel 4 rather than channel 2 received the greatest number of reports. However, there are more stations on channel 4 than on any other channel and also more low-band than

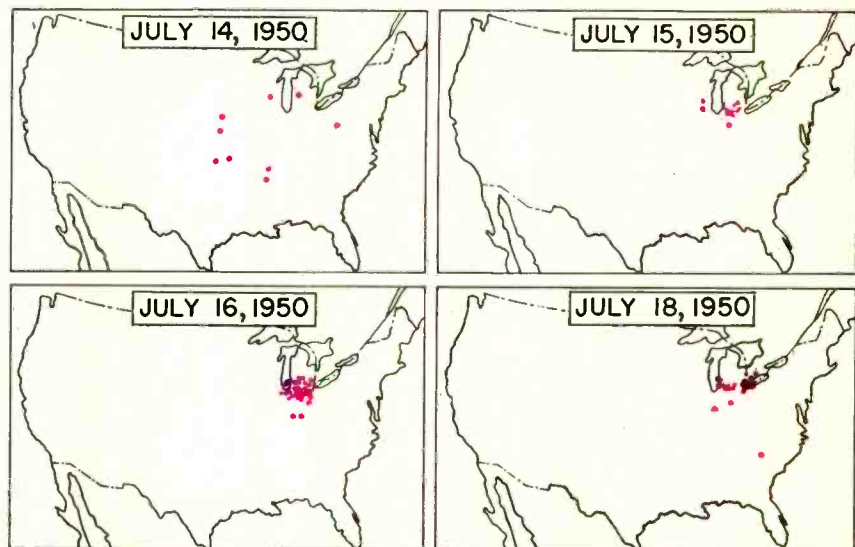

Fig. 5—Geographical distribution of path mid-points during period of maximum low-band dx activity. Note concentration in Great Lakes area, corresponding to path of sporadic-E cloud cited by Ferrell and Gerson. See text and footnotes.

high-band stations. If the number of reports for each channel is prorated by the number of stations operating on the channel, the distribution seen in the lower two charts is obtained. The high-band values now exceed the low-band ones for the 200- to 500-mile range, as would be expected for tropospheric transmission, and the values decrease with channel frequency in the 500- to 1,600-mile range as would be expected for sporadic-E<sup>1</sup>.

Fig. 4 is a chart of the number of reports per day for the period (May 22 to Sept. 25). The low-band reports are plotted in the upper histogram, the few high-band reports in the lower one. The number of hours of vertical-incidence sporadic-E reflections at Wash-

ington, D. C., obtained at frequencies above 5 and 10 mc is shown in the center histogram. As the separation of the average mid-point from the Washington ionosphere sounder is almost a thousand miles, the day-by-day correlation between low-band reports and sporadic-E is about as good as could be expected. On a monthly basis, it should be noted that the greatest numbers of low-band reports occur in the months of June and July. These are also the months of greatest incidence of sporadic-E over Washington, D. C.

There are several days with an exceptionally large number of low-band reports. July 16 in particular has 40. Note in Fig. 5 that on July 16 the mid-points form a dense cluster be-

\*National Bureau of Standards  
Boulder, Colorado



tween Lake Michigan and Lake Erie. This looks like a sporadic-E cloud of the type reported by Ferrell and Gerson<sup>2</sup>. The cloud appears to have persisted for about four days from July 15 through July 18.

Shown on the upper map in Fig. 6 are points representing the loci of all possible mid-points between the 103

observers and the cities in or near which the television stations are located. The circles on the two maps represent the locations of ionosphere sounding stations from which overhead sporadic-E data might be available. In the lower map the mid-points of the reported TV dx receptions are presented. Also a certain number of the

mid-points seem to be located close to the Washington ionosphere sounder. Four of these fall on the same day, June 27.

The location of these four mid-points is indicated in Fig. 7 with the location of the ionosphere station at Washington. Fig. 8 is a 1-day chart of sporadic-E recorded at Washington, D. C. (solid curve), along with the occurrence times for the mid-points plotted at their equivalent vertical critical frequencies. The coincidence is certainly striking.

**Summary of results**

To summarize the findings then: the distribution of reception reports by distance indicates that two distinct types of propagation are indicated for transmissions greater than 200 miles. One type seems to disappear at around 500 miles, which happens to be the point at which the other type becomes noticeable. This second grouping contains about 90% of the reception reports over distances greater than 200 miles. When plotted as number of reception reports per station operating on the channel, the distribution by channel predominates in the high band for the 200- to 500-mile grouping as expected for tropospheric propagation, and decreases progressively with channel frequency for the 500- to 1,600-mile group as would be expected for sporadic-E. When compared to sporadic-E at Washington, D. C., on a day-to-day basis, the low-band reports and sporadic-E are seen to have a similar seasonal distribution. Not so the high-band reports. This is as expected, for they appear (with a single exception) in the 200- to 500-mile group. The path mid-points of the day for which the maximum number of receptions were reported are seen to form a tight cluster as they would if reflected from a slowly moving sporadic-E cloud. A coincidence test for a day when four of the reception paths over 500 miles in length resulted in mid-points near Washington, D. C., showed excellent simultaneity with observed sporadic-E in three of the four cases. END

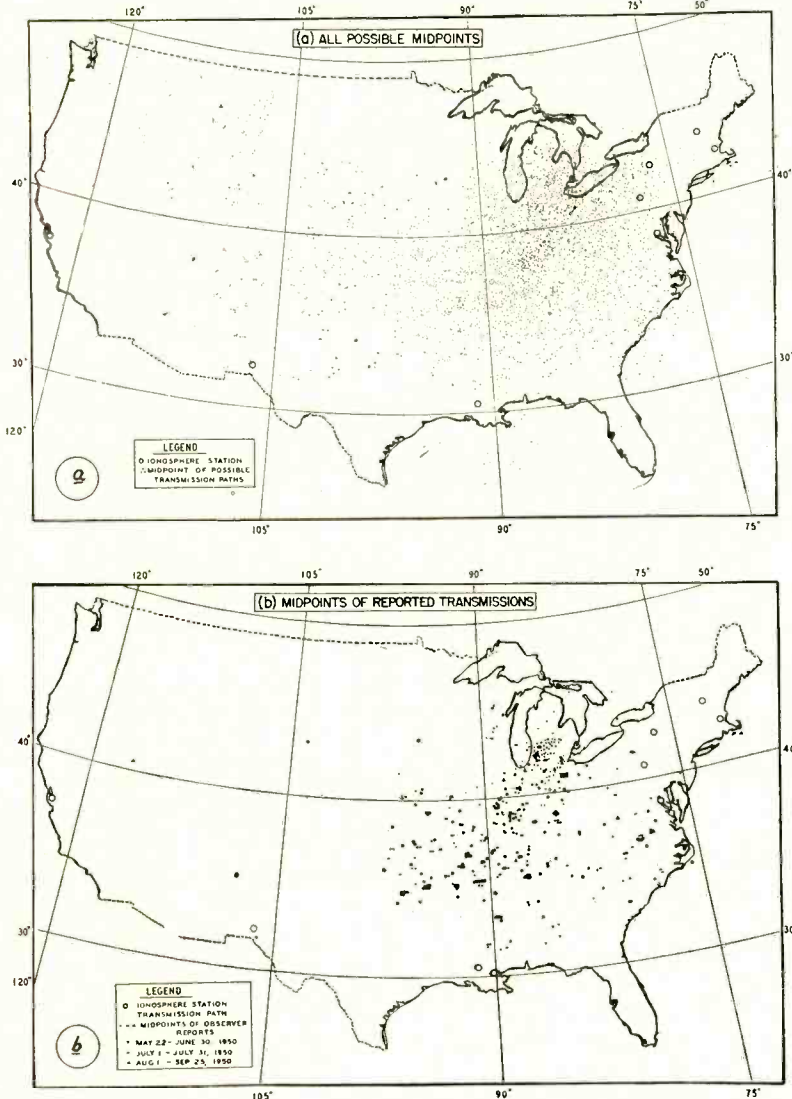

Fig. 6—(a) Locations of all possible path mid-points between dx observers and TV stations. (b) Path mid-points of actual dx receptions reported. Circles on both maps indicate the locations of U. S. Government ionosphere-sounding stations.

**List of References**

<sup>1</sup>For a similar chart see E. P. Tilton, RADIO-ELECTRONICS, Vol. 22, No. 8, 28 (May, 1951).  
<sup>2</sup>O. P. Ferrell, Proc. IRE, 35, 493 (1947); 36, 879 (1948).  
 N. C. Gerson, Nature, 116, 316 (August 19, 1950); Proc. Conf. Ionosph. Phys., Pennsylvania State College, 2, 20CC (1950).

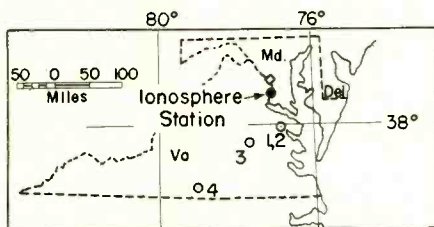
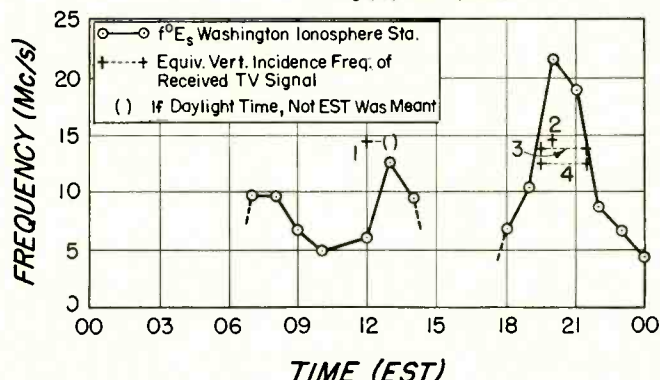
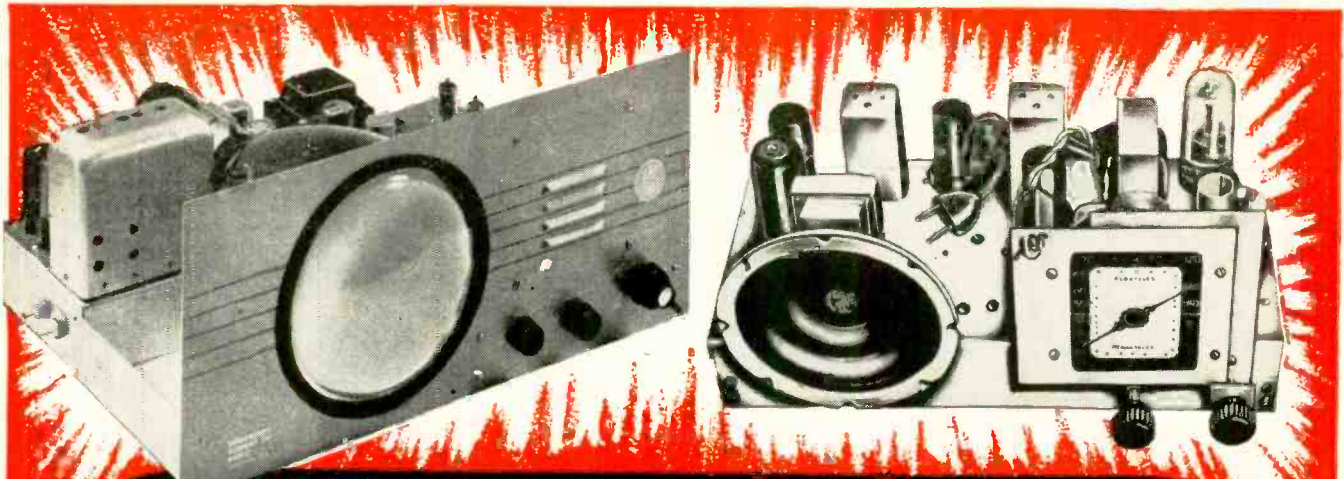

Fig. 7 (above)—Four path mid-points of TV dx reported in one day near Washington, D.C. Fig. 8 (right)—Hourly record of sporadic-E on the same day.







**TRAIN FASTER—TRAIN BETTER—TRAIN EASIER  
 IN 10 MONTHS—OR LESS—FOR  
**RADIO-TELEVISION****

Our 21st Year Training Men for Greater Incomes and Security in Radio-Television

**I SEND YOU  
 18 BIG KITS**

of Radio-Television parts and equipment. Much of your training will be actual construction and experimentation . . . the kind of truly PRACTICAL instruction that prepares you for your Radio-Television career.



Frank L. Sprayberry  
 President  
 Sprayberry Academy  
 of Radio

**NEW! NO OBLIGATION PLAN**

**You Have No Monthly Payment Contract to Sign  
 Pay For Your Training as You Earn and Learn**

You can get into Radio-Television, today's fastest growing big money opportunity field, in *months* instead of years! My completely new "package unit" training plan prepares you in as little as 10 months or even less! *No monthly payment contract to sign—thus NO RISK to you!* This is America's finest, most complete, practical training—gets you ready to handle any practical job in the booming Radio-Television industry. Start your own profitable Radio-Television shop . . . or accept a good paying job. I have trained hundreds of successful Radio-Television technicians during the past 21 years—and stand ready to train you, even if you have no previous experience! Mail coupon and get all the facts—FREE!



**Valuable Equipment Included  
 With Training**

The new Sprayberry "package" plan includes many big kits of genuine, professional Radio-Television equipment. You perform over 300 demonstrations, experiments and construction projects. You build a powerful 6-tube 2-band radio set, multi-range test meter, signal generator, signal tracer, many other projects. All equipment and lessons are yours to keep . . . you have practically everything you need to set up your own profitable Radio-Television service shop.

**Earn Extra Money While You Learn!**

All your 10 months of training is IN YOUR HOME in spare hours. Keep on with your present job and income while learning. With each training "package" unit, you receive extra plans and "Business Builder" ideas for spare time Radio-Television jobs. New television stations everywhere, open vast new opportunities for trained Radio-Television Technicians—and those in training. If you expect to be in the armed forces later, there is no better preparation than practical Sprayberry Radio-Television training.

**YOU BUILD** the Television set and the powerful superhet radio receiver shown above. IN ADDITION to the other test units shown here (many are not shown because of lack of space). All equipment I send you is **YOURS TO KEEP.**

**SPRAYBERRY ACADEMY OF RADIO 111 NORTH CANAL ST.  
 Dept. 20-X, Chicago 6, Ill.**

**MAIL COUPON  
 TODAY!  
 NO OBLIGATION**

**SPRAYBERRY ACADEMY OF RADIO, Dept. 20-X,  
 111 North Canal St., Chicago 6, Ill.**

Please rush to me all information on your 10-MONTH Radio-Television Training Plan. I understand this does not obligate me and that no salesman will call upon me. Be sure to include 3 books FREE.

Name..... Age.....

Address.....

City..... Zone..... State.....

**I invite you to get all the facts—  
 FREE TO YOU 3 BIG  
 RADIO-TELEVISION BOOKS**

I want you to have ALL the facts about my new 10-MONTH Radio-Television Training—without cost! Rush coupon for my three big Radio-Television books: "How to Make Money in Radio-Television," PLUS my new illustrated Television Bulletin PLUS an actual sample Sprayberry Lesson—ALL FREE. No obligation and no salesman will call. Mail coupon NOW!





# SENSITIVE CAPACITY RELAY

By E. W. SCOTT

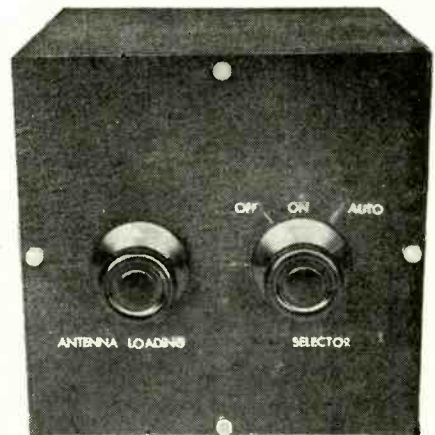
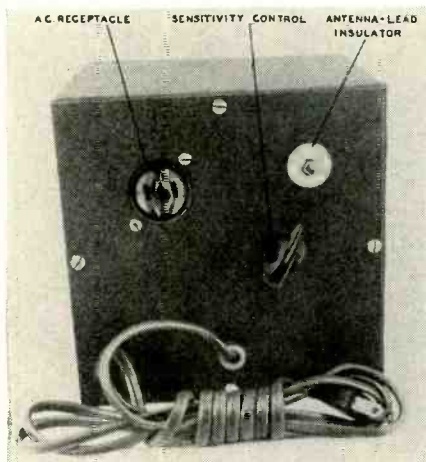

The front panel of the capacity relay.

*provides protection against intrusion or accident—control of industrial operations —or just plain fun*

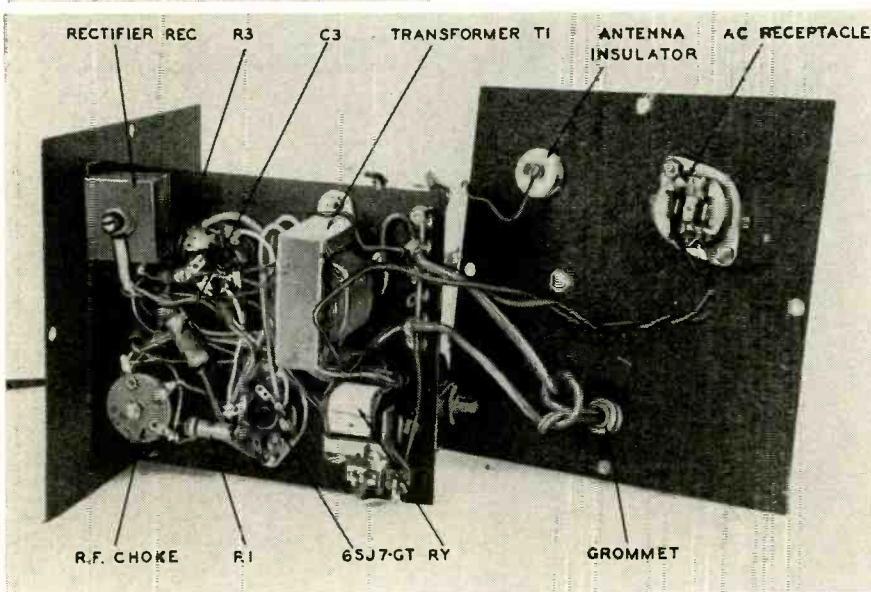

**T**HIS inexpensive little electronic gadget can perform innumerable tasks in your home, office, plant, or store; or provide entertainment for you and your friends. Called a "capacity relay"—the home-front equivalent of a proximity fuse—it will close an electric-alarm circuit the instant any person, large animal, or any large metallic or nonmetallic object enters the electric field surrounding its antenna or "feeler."

The unit operates from standard 117-volt, 60-cycle a.c. lines, and the parts are obtainable at any well-stocked radio supply house. The foundation is a 6 x 6 x 6-inch metal utility box with attached chassis (Bud type C-1798 or equivalent). The general layout is shown in the photographs. Drill holes in the front panel for the shafts of the variable capacitor (ANTENNA LOADING control) and the rotary (SELECTOR) switch. Be sure to use an insulated bushing when mounting the variable capacitor because it must be insulated from the panel and chassis.

If the 6.3-volt filament transformer T1 and the relay RY that you purchase differ in size and shape from the ones used in this particular job, mount these components wherever they fit best. The position of these components is not critical, so any convenient spot will do. If your relay is a large one, mount it on the rear cover and connect it to the circuit with flexible hookup wire. Study the photos for the locations of the other components. If you must shift the positions of some of them, the holes for the receptacle, sensitivity control, antenna, and line cord may have to be relocated.

After mounting all the components, wire the circuit as shown in the schematic diagram (Fig. 1).

RADIO-ELECTRONICS

Top photo—The back cover of the relay housing carries input and output connections and the sensitivity control. Center photo—Internal assembly of the relay unit. Large components may be mounted wherever convenient. Bottom photo—Arrangement of components and controls on the chassis top.

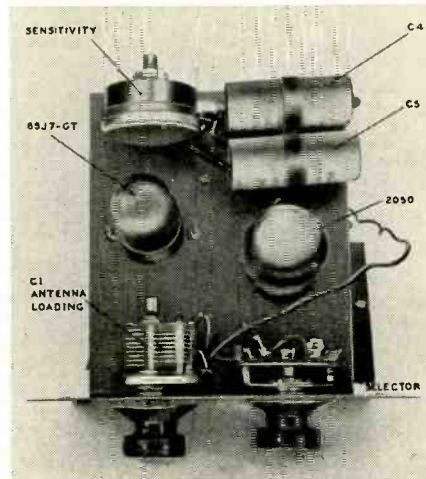



# BUILD YOUR OWN Heathkits

- TEST INSTRUMENTS
- AMPLIFIERS
- RECEIVERS, etc.

- 1 Save by ordering direct from manufacturer.
- 2 All high quality standard band components
- 3 Increased knowledge through actual construction
- 4 Sound engineering insures excellent performance
- 5 Kit construction is fascinating and enjoyable

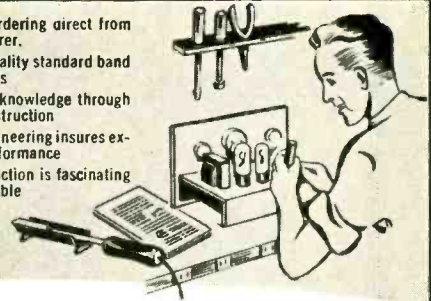

**\$43.50**

Shipping  
Wt. 26 lbs.

## Heathkit MODEL O-8 OSCILLOSCOPE KIT

The outstanding new 1953 model O-8 Heathkit Oscilloscope features the finest performance ever offered in this extremely popular kit instrument. Primarily intended as a general purpose oscilloscope for the faithful reproduction of actual wave forms and other electrical phenomena, it's vastly improved band width, good 100 KC square wave reproduction, three step vertical input attenuator, .025 volts per inch vertical sensitivity, etc., admirably qualify this instrument for TV and radio servicing, laboratory use, ham application and all general electronic development work. Improved vertical band width is obtained through the use of shunt peaking chokes with proper cathode compensation in the push-pull output stage. For additional flexibility of operation, provisions have been made for direct connections to the deflection plates, a Z axis input and a spot shape control for really fine focusing.

This beautiful kit is complete with all 10 tubes, including a 5" cathode ray tube, calibrated graph screen and flexible test leads. All necessary construction components, such as hardware, chassis, transformer, etc., and a detailed step by step construction manual, greatly simplify the assembly of this instrument.

### Heathkit VOLTAGE CALIBRATOR KIT

The use of a Voltage Calibrator will greatly increase oscilloscope usefulness. Provides a convenient method of making peak to peak voltage measurements by establishing a relationship between the unknown wave shape and the Voltage Calibrator. Voltage ranges .01-100 volts peak to peak. The Voltage Calibrator features direct reading scales and a regulated power supply system.



MODEL VC-2

**\$11.50**

Shipping Wt. 4 lbs.

### Heathkit ELECTRONIC SWITCH KIT

The Heathkit Electronic Switch Kit will further extend scope usefulness by permitting simultaneous observation of two individually controlled traces. Continuously variable switching rates 10 cps to 2,000 cps in three ranges. Will also serve as a square wave generator over the range of switching frequencies.

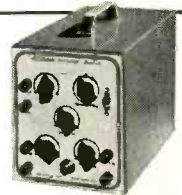

MODEL S-2

**\$19.50**

Shipping  
Wt. 11 lbs.

## Heathkit VACUUM TUBE VOLTMETER KIT

The beautiful new 1953 Heathkit Model V-6 VTVM, the world's most popular kit instrument, now offers many outstanding new features in addition to retaining all of the refinements developed and proven through the production of over 70,000 VTVM kits. The Heathkit VTVM now features extended voltage ranges with 50% greater coverage on the DC range. New 1 1/2 volt low scale provides well over 2 1/2 inches of scale length per volt permitting faster measurements with greater accuracy. AC and DC ranges are 0-1.5-5-15-50-150-500-1500 volts (1,000 volts maximum on AC). Ohmmeter ranges are X1, X10, X100, X1,000, X10K, X100K X1 meg. Measures .1 ohm to 1,000 megohms. Other features are db scale, center scale zero adjust and polarity reversal switch. High 11 megohm input resistance virtually eliminates circuit loading.

The low anti-inflation price of this tremendously popular kit includes all tubes, necessary constructional material, test leads and the construction manual.

MODEL V-6

**\$24.50**

Shipping  
Wt. 6 lbs.

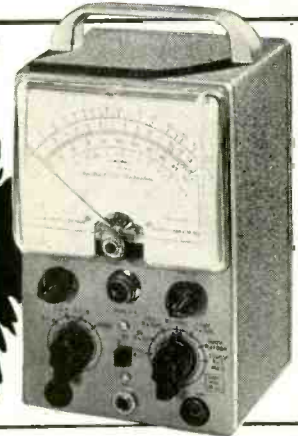

### Heathkit AC VACUUM TUBE VOLTMETER KIT



MODEL AV-2

**\$29.50**

Shipping  
Wt. 5 lbs.

A new amplifier type AC VTVM that makes possible those sensitive measurements so essential in laboratory or audio work. Ten voltage ranges covering from .01 RMS full scale to 300 volts RMS full scale. Input impedance 1 megohm with frequency response 20-50,000 cycles. Ten dB ranges from -52 to +52 DB. Four diodes in meter bridge circuit for maximum linearity.

### Heathkit HANDITESTER KIT



MODEL M-1

**\$13.50**

Shipping  
Wt. 3 lbs.

The ever popular Handitester is now supplied with a Simpson 400 microampere meter movement. Provides AC and DC voltage ranges 0-10-30-300-1,000-5,000 volts. Ohmmeter ranges 0-3,000 and 0-300,000 ohms. DC current measurements 0-10 and 0-100 milliamperes. A completely self contained portable instrument.

EXPORT AGENT  
ROCKE INTERNATIONAL CORP.  
15 E 40th ST.  
NEW YORK CITY (16)  
CABLE: ARLAB N Y

The **HEATH COMPANY**

... BENTON HARBOR 20, MICHIGAN



# HEATHKITS for the ENGINEER

## Heathkit VISUAL AURAL SIGNAL TRACER KIT



MODEL T-3  
**\$22<sup>50</sup>**  
 Shipping  
 Wt. 10 lbs.

Designed especially for service applications in AM-SW-FM-TV repair work. RF and audio two channel input. More than adequate sensitivity—new noise locator circuit—calibrated wattmeter—substitution speaker—visual signal indication. Can be used with scope and VTVM, checks phono cartridges, phono mechanisms, microphones, tuners, etc. Let the Heathkit Visual Aural Signal Tracer help you.

## Heathkit RESISTANCE SUBSTITUTION BOX KIT



MODEL RS-1  
 Ship. Wt. **\$5<sup>50</sup>**  
 2 lbs.

Choice of 36 switch selected resistance values 15 ohms to 10 megohms. All standard RTMA 1 watt 10% resistors. Buy several for those lab and service applications.

## Heathkit AMATEUR TRANSMITTER KIT

MODEL AT-1  
**\$29<sup>50</sup>**

Shipping Wt. 15 lbs.



Here is the long awaited Heathkit entry into the amateur radio field. The Heathkit AT-1 Transmitter kit is a well designed basic transmitter incorporating many desirable features and providing maximum over-all performance.

Convenient band switching eliminates the bother and annoyance of plug in coils. It is merely necessary to switch to the desired frequency and plug in your favorite crystal or VFO. This transmitter features a self-contained power supply mounted on the same chassis and cabinet enclosed to minimize TVI. AC line by-passed to reduce radiation.

The coils supplied with the Heathkit AT-1 are pre-wound and adjusted for the necessary frequency coverage of 80 40-20-10 meters. The entire kit is supplied complete with all tubes, coils, punched and formed chassis and cabinet, as well as all constructional material required. A detailed assembly and operation manual is also furnished.

## Heathkit CONDENSER CHECKER KIT

An instrument designed solely for its particular job. Not a "sideline" of a multiple function instrument. Measures value and quality of unknown condensers and resistors. Capacity range .00001 mfd to 1,000 mfd. Resistance range 100 ohms to 5 megohms. Sensitive electron beam indicator—five polarizing test voltages—safety spring return leakage test switch. An amazingly accurate instrument at this low price.



MODEL C-3  
**\$19<sup>50</sup>** Shipping  
 Wt. 8 lbs.

## Heathkit SIGNAL GENERATOR KIT



MODEL SG-7  
**\$19<sup>50</sup>**  
 Ship. Wt. 8 lbs.

A service "must" is a reliable source of modulated (400 cycles) or unmodulated RF output. Frequency range 150 KC to 150 MC. Step attenuated and variable output—internal or external modulation. High output level and performance with low cost.

## Heathkit GRID DIP METER KIT



MODEL GD-1A  
**\$19<sup>50</sup>**  
 Ship. Wt. 4 lbs.

World's largest selling Grid Dip Meter. Five pre-wound coils—frequency coverage 2-250 mc. Simplified construction and operation.

## Heathkit TUBE CHECKER KIT



MODEL TC-1  
**\$29<sup>50</sup>**  
 Shipping Wt. 12 lbs.

Make those all important tube tests quickly and accurately. Checks all tube types encountered in radio and TV work. Simplified setup and switching system provides fast checks for shorts, opens, individual elements and over-all quality. Portable cabinet available at slight additional cost. TV picture tube adapter also available. See order blank.

Revised Roll Chart .50

## Heathkit SQUARE WAVE GENERATOR KIT



MODEL SQ-1  
**\$29<sup>50</sup>** Ship. Wt. 12 lbs.

True square wave output with frequency range 10 cycles to 100 KC. High variable output voltage level 0-20 volts at 600 ohms output impedance. Provisions for external synchronization. The ideal instrument for TV service work and wide band amplifier circuit development.

## Heathkit LABORATORY REGULATED POWER SUPPLY KIT



MODEL PS-2  
**\$29<sup>50</sup>**  
 Ship. Wt. 17 lbs.

A regulated variable 160-450 volt DC output power supply for the lab or service shop. Accurate voltage and current measurements with large Simpson meter. AC supply 6.3 volts at 4 amperes—standby switch eliminates warmup time. Low hum content—5 tube circuit. AC and DC output voltages isolated from panel for maximum operational flexibility.

## Heathkit VIBRATOR TESTER KIT

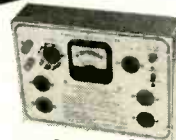

MODEL VT-1  
**\$14<sup>50</sup>**  
 Shipping Wt. 6 lbs.

Checks for starting and quality of interrupter and self rectifier type vibrators. Five sockets—checks hundreds of types. Operates from continuously variable type battery eliminator.

EXPORT AGENT  
 ROCKE INTERNATIONAL CORP.  
 12 E. 40th ST.  
 NEW YORK CITY (16)  
 CAEIE ARLAN N.Y.

# The HEATH COMPANY

... BENTON HARBOR 20, MICHIGAN



# SERVICEMAN · AMATEUR · STUDENT

## Heathkit IMPEDANCE BRIDGE KIT

Provides choice of Wheatstone, Capacitance Comparison, Maxwell or Hay bridge circuits. Measurement of resistance-capacity-inductance-dissipation factor-storage factor. 1% precision silver mica capacitance standard 1/4% precision resistors.

MODEL IB-1B  
**\$69.50**

Shipping Wt. 15 lbs.

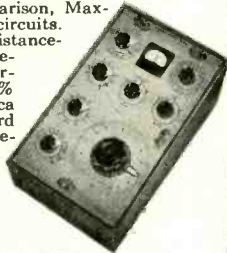

## Heathkit INTERMODULATION ANALYZER KIT



MODEL IM-1  
Shipping Wt. 17 lbs. **\$39.50**

Intermodulation distortion analysis is one of the most satisfactory methods of checking audio equipment. The IM-1 features two self contained high frequency generators (3,000 and 7,000 cycles) a 60 cycle low frequency source, intermodulation section, AC VTVM, and power supply all in one complete unit. Direct reading IM percentages on 3 calibrated scales 30%—10%—3%.

## Heathkit AUDIO OSCILLATOR KIT

MODEL AO-1  
**\$24.50**

Ship. Wt. 11 lbs.

Features sine or square wave coverage from 20-20,000 cycles in 3 ranges. Variable 10 volt output level at 600 ohms impedance. Thermistor controlled linearity—precision multiplier resistors—distortion less than .6%. An outstanding instrument value at this amazing low price.



## Heathkit DECADE RESISTANCE KIT

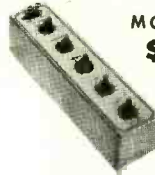

MODEL DR-1  
**\$19.50**

Ship. Wt. 4 lbs.

Individual switch selection of twenty 1% precision resistors in 1 ohm steps from 1 to 99,999 ohms. Sturdy ceramic wafer switches featuring silver plated contacts and smooth positive detent action.

## Heathkit Q METER KIT

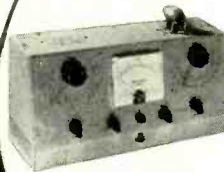

MODEL QM-1  
Shipping Wt. 14 lbs. **\$39.50**

A typical Heathkit invasion of the laboratory instrument field. Here is the first successful low priced Q meter ever offered in kit form. Oscillator supplies RF in the range of 150 KC to 18 mc. Reads Q directly on calibrated meter scales. Measures Q of condensers, RF resistance and distributed capacity of coils. Calibrate capacitor with range of 40 mmf to 450 mmf with vernier ±3 mmf. All measurements made at the operating frequency.

## Heathkit AUDIO FREQUENCY METER KIT



MODEL AF-1  
**\$34.50**

Ship. Wt. 12 lbs.

Indicates audio frequency on large 4 1/2" Simpson meter. Ranges 10 cycles to 100 kc at input voltage level of 3-300 volts RMS. The input wave shape is not at all critical. Useful in production line testing—indicating square wave frequency—determining generator output. Operation entirely electronic, no vibrating reeds.

## Heathkit BAR GENERATOR KIT



MODEL BG-1  
**\$14.50**

Ship. Wt. 6 lbs.

The Heathkit BG-1 Bar Generator represents another welcome addition to the fast growing line of popular Heathkits. The station transmitted test pattern is rapidly disappearing and the Bar Generator is the logical answer to the TV serviceman's problem in obtaining quick accurate adjustment information.

The Bar Generator produces a series of horizontal or vertical bars on the TV screen. These bars are equally spaced and will quickly indicate picture linearity of the receiver under test. Since picture linearity is independent of transmitting frequency, it is unnecessary to provide coverage throughout the VHF range, thereby holding down instrument cost.

The Heathkit Bar generator is simple to use and is extremely portable, providing a quick means of checking the television receiver either in your workshop or in the customer's home.

## Heathkit DECADE CONDENSER KIT

Switch selected 1% silver mica precision condensers providing capacity range of 100 mmf. to 0.111 mfd. in steps of 100 mmf.

MODEL DC-  
**\$16.50**

Shipping Wt. 4 lbs.



## Heathkit AUDIO GENERATOR KIT

A new extended range 18 cycles—1 megacycle audio instrument at a remarkably low price. Five continuously variable output ranges—600 ohm output impedance—low distortion figure, less than .4% from 100 cps through audible range.



MODEL AG-8  
**\$29.50**

Ship. Wt. 11 lbs.

## Heathkit TELEVISION SWEEP GENERATOR KIT

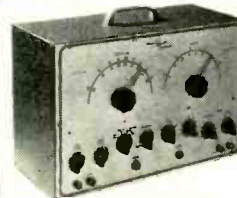

Frequency coverage 10-90 mc and 150-230 mc. Variable sweep width 0-12 mc, built in absorption type marker, step and continuously variable output and blanking circuit.

MODEL TS-2  
Ship. Wt. 20 lbs. **\$39.50**

## Heathkit BATTERY ELIMINATOR KIT



MODEL BE-3  
Ship. Wt. 17 lbs. **\$24.50**

A variable 0-8 volt DC supply source rated at 10 amperes continuously and up to 15 amperes intermittently. Voltmeter, ammeter, automatic overload relay, fuse protection—heavy duty Mallory 17 disc rectifier.

## WRITE FOR Free CATALOG

New 32 page 1953 Catalog lists all kits, specifications, schematics and latest price information.

EXPORT AGENT  
ROCKE INTERNATIONAL CORP.  
13 E. 40th ST.  
NEW YORK CITY (16)  
CABLE: ARLAB-N.Y.

# The HEATH COMPANY

... BENTON HARBOR 20, MICHIGAN



### Heathkit SUPERHETERODYNE RECEIVER KITS

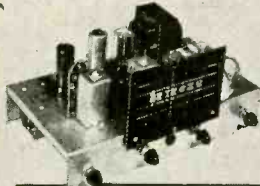

Broadcast Model BR-1 5 Tube-Broadcast Band 550 to 1600 KC coverage. Shipping Weight 11 lbs.  
**\$19.50**

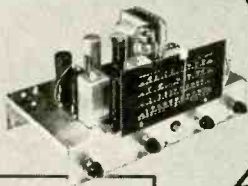

Three Band Model AR-1 6 Tube all wave circuit 3 Ranges, continuous coverage 550 KC to over 20 MC. Shipping Weight 11 lbs.  
**\$23.50**

### NEW HEATHKIT WILLIAMSON TYPE AMPLIFIER KIT

The ideal amplifier for custom high fidelity audio installations. Tops in performance, value, and flexibility of operation. Either Altec Lansing Peerless or Acrosound output transformers available. First Williamson type amplifier supplied with a matching preamplifier.

#### PRICES OF VARIOUS COMBINATIONS

- W-2 Amplifier Kit (Incl. Main Amplifier with Peerless Output Transformer, Power Supply and WA-P1 Preamplifier Kit) Shipping Weight 29 lbs. Shipped express only **\$69.50**
- W-2M Amplifier Kit (Incl. Main Amplifier with Peerless Output Transformer and Power Supply) Shipping Weight 29 lbs. Shipped express only **\$49.75**
- W-3 Amplifier Kit (Incl. Main Amplifier with Acrosound Output Transformer, Power supply and WA-P1 Preamplifier Kit) Shipping Weight 37 lbs. Shipped express only **\$69.50**
- W-3M Amplifier Kit (Incl. Main Amplifier with Acrosound Output Transformer and Power Supply) Shipping Weight 29 lbs. Shipped express only **\$49.75**
- WA-P1 Preamplifier Kit only Shipping Weight 6 lbs. Shipped express or parcel post. **\$19.75**

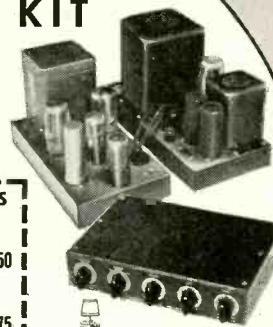

### Heathkit FM TUNER KIT

MODEL FM-2

**\$22.50**

Shipping Wt. 9 lbs.

Sensitive transformer operated 8 tube circuit. Frequency coverage 88-108 mc. Pre-assembled and tuned "front end." Vernier tuning with slide rule type dial.

### Heathkit ECONOMY 6 WATT AMPLIFIER KIT

MODEL A-7

**\$14.50**

Dual inputs—separate bass and treble tone controls—output impedances 4-8-15 ohms.

Ship. Wt. 10 lbs.

A-7A Amplifier with pre-amplifier stage for low level inputs. **\$16.50**

### Heathkit HIGH FIDELITY 20 WATT AMPLIFIER KIT

MODEL A-8

**\$33.50**

Shipping Wt. 16 lbs.

A high fidelity full 20 watt general purpose amplifier. Dual inputs and separate tone controls for maximum flexibility. Peerless output transformer 4, 8 and 16 ohms.

A-8A with additional preamplifier stage for low level cartridge, microphone, etc. **\$35.50**

# HEATH COMPANY • Benton Harbor 20, Mich.

## ORDER BLANK



From \_\_\_\_\_

SHIP VIA

- Parcel Post
- Express
- Freight
- Best Way

(PLEASE PRINT)

QUANTITY	ITEM	PRICE	QUANTITY	ITEM	PRICE
	Heathkit Oscilloscope Kit—Model O-8 (26 lbs.)	\$43.50		Heathkit Square Wave Generator—Model SQ-1 (12 lbs.)	29.50
	Heathkit Amateur Transmitter Kit—Model AT-1 (15 lbs.)	29.50		Heathkit AC VTVM Kit—Model AV-2 (5 lbs.)	29.50
	Heathkit Bar Generator Kit—Model BG-1 (6 lbs.)	14.50		Heathkit Intermodulation Analyzer Kit—Model IM-1 (17 lbs.)	39.50
	Heathkit Voltage Calibrator Kit Model VC-2 (4 lbs.)	11.50		Heathkit Regulated Power Supply Kit—Model PS-2 (17 lbs.)	29.50
	Heathkit Electronic Switch Kit—Model S-2 (11 lbs.)	19.50		Heathkit Handitester Kit—Model M-1 (3 lbs.)	13.50
	Heathkit TV Alignment Generator Kit—Model TS-2 (20 lbs.)	39.50		Heathkit Decade Resistance Kit—Model DR-1 (4 lbs.)	19.50
	Heathkit Q Meter Kit—Model QM-1 (14 lbs.)	39.50		Heathkit Decade Condenser Kit—Model DC-1 (4 lbs.)	16.50
	Heathkit Grid Dip Meter Kit—Model GD-1A (4 lbs.)	19.50		Heathkit Impedance Bridge Kit—Model IB-1B (15 lbs.)	69.50
	Heathkit VTVM Kit—Model V-6 (6 lbs.)	24.50		Heathkit Resistance Substitution Box Kit—Model RS-1 (2 lbs.)	5.50
	Heathkit Visual-Aural Signal Tracer Kit—Model T-3 (10 lbs.)	22.50		Heathkit F.M. Tuner Kit—Model FM-2 (9 lbs.)	22.50
	Heathkit Condenser Checker Kit—Model C-3 (8 lbs.)	19.50		Heathkit Broadcast Receiver Kit—Model BR-1 (11 lbs.)	19.50
	Heathkit RF Signal Generator Kit—Model SG-7 (8 lbs.)	19.50		Heathkit Three Band Receiver Kit—Model AR-1 (11 lbs.)	23.50
	Heathkit Tube Checker Kit—Model TC-1 (12 lbs.)	29.50		Heathkit Amplifier Kit—Model A-7 (10 lbs.)	14.50
	Heathkit Portable Tube Checker Kit—Model TC-1P (15 lbs.)	34.50		Heathkit Amplifier Kit—Model A-7A (10 lbs.)	16.50
	Heathkit Portable Tube Checker Cab. only No. 365 (8 lbs.)	7.50		Heathkit Amplifier Kit—Model A-8 (16 lbs.)	33.50
	Heathkit TV Tube Adapter No. 355 (1 lb.)	4.50		Heathkit Amplifier Kit—Model A-8A (16 lbs.)	35.50
	Heathkit Battery Eliminator Kit—Model BE-3 (17 lbs.)	24.50		Williamson Type Amplifier Kit (Type: )	
	Heathkit Vibrator Tester Kit—Model VT-1 (6 lbs.)	14.50		Shipped express only	
	Heathkit Audio Generator Kit—Model AG-8 (11 lbs.)	29.50		WA-P1 Preamplifier Kit (6 lbs.) (Shipped exp. or p.p.)	
	Heathkit Audio Oscillator Kit—Model AO-1 (11 lbs.)	24.50			
	Heathkit Audio Frequency Meter Kit—Model AF-1 (12 lbs.)	34.50			

Enclosed find ( ) check ( ) money order for  
Please ship C.O.D. ( ) postage enclosed for \_\_\_\_\_ pounds.

On Express orders do not include transportation charges—they will be collected by the express agency at time of delivery.

ON PARCEL POST ORDERS include postage for weight shown. . . . . ORDERS FROM CANADA must include full remittance for merchandise.



**Adjustments**

To operate the unit, plug in the line cord and plug a test lamp—an ordinary table lamp will do—into the receptacle on the rear of the relay. Throw the SELECTOR to ON. Allow about 15 seconds for the unit to warm up. The test lamp will probably come on and remain lighted for a few seconds, and then go off. Connect a length of flexible wire—about 6 feet—to the antenna terminal on the rear. Rotate the SENSITIVITY CONTROL so its arm, the No. 2 terminal, is against the No. 1 terminal. Back off the control until the relay opens and the light goes out. Now adjust the ANTENNA LOADING control slowly so the light comes on again. Back off the control a hair so the light goes off. Bring your hand near the wire and the light will come on and remain lighted until you remove your hand. Make fine adjustments with the two controls for maximum sensitivity. The light should come on when your hand is within 12 inches of the wire.

**Alarm circuits**

Take a longer wire and form it into an inverted U around the casing of a door. Connect one end of the wire to the antenna post and adjust the loading control to the point where the light comes on. Back off the control until the light goes out again. Walk toward the door. The light should come on when

you are about 4 feet away. If you must be much closer before the relay operates, make minor adjustments with the SENSITIVITY and ANTENNA LOADING controls until you get the desired sensitivity.

As long as the SELECTOR is set at ON, the light should go off when you back away from the door. To have the light remain on even after you leave the door, throw the SELECTOR to AUTO. When it is in this position, the alarm circuit will remain closed until you open it by throwing the SELECTOR to ON or OFF.

After adjusting the relay to your satisfaction, you can connect it to a doorbell alarm as shown in Fig. 2-a or 2-b. In Fig. 2-a the alarm bell is operated from the power line. If an intruder should manage to cut the

power lines outside the house, the alarm will not ring. In Fig. 2-b the power for the alarm circuit comes from four No. 6 dry cells in series. If the power fails, the relay will open and start the alarm ringing.

If you are an apartment dweller in fear of having an intruder enter through a window on a fire escape, this little gadget will do much to reassure you. All you need do is place the antenna in a loop around the window casing or connect it to an ungrounded wire window screen. Connect the doorbell alarm as shown in Fig. 2 and your fears are over. In some installations, it may be possible to connect the antenna directly to the fire escape so the alarm sounds the instant anyone places a foot on it. In one installation, this

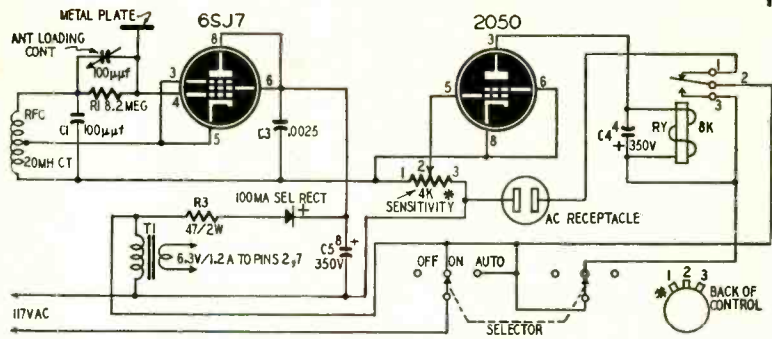

Fig. 1—Schematic of the capacity relay. Parts layout is shown in the photographs.

Get This Valuable Book Just for Examining COYNE'S New 6-Volume Set

**FREE**



*Applied Practical Radio-Television*

ON 7 DAY FREE TRIAL!

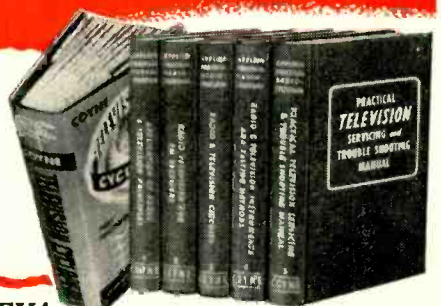

Yes, you get this big, brand new book, "150 Radio-Television Picture Patterns and Diagrams Explained", absolutely FREE! Just off the press! Gives complete wiring circuits and diagrams on the latest Radio and Television Sets. Easy-to-read, large 8½ x 11" pages, with full instructions on how to read and use the diagrams. A "must" in every Radio and Television service-man's repair kit. You get this valuable book as a FREE Gift for asking to see Coyne's great new 6-book set, "Applied Practical Radio-Television"!

**Here's "Know-How" That Makes You Worth More!**

Coyne's great new 6-volume set gives you all the answers to servicing problems—quickly! For basic "know-how" that is easy to understand, you'll find everything you want in volumes 1 to 5 which contain over 5000 practical facts and data. They cover every step from principles to installing, servicing, trouble-shooting and aligning all types of radio and TV sets. So up-to-date it includes COLOR TV and UHF, adaptors and converters. Also covers very latest information on TRANSISTORS.

**802-Page Television Cyclopedic Included**

And then, for speedy on-the-job use, you get volume 6—the famous Coyne TELEVISION CYCLOPEDIA. It answers today's television problems on servicing, alignment, installation and others. In easy-to-find ABC order, cross indexed. Use this 6 volume TV-RADIO LIBRARY free for 7 days; get the valuable Servicing Book ABSOLUTELY FREE!

**SEND NO MONEY!** Just mail coupon for 6-volume set on 7 days free trial. We'll include book of 150 TV-Radio Patterns & Diagrams. If you keep the set, pay \$3 in 7 days and \$3 per month until \$22.50 plus postage is paid. (Cash price \$20.95). Or you can return the library at our expense in 7 days and owe nothing. YOU BE THE JUDGE. Either way, the book of TV-Radio Patterns is yours FREE to keep! Offer is limited. Act NOW!

**FREE BOOK—FREE TRIAL COUPON!**

COYNE ELECTRICAL & TELEVISION-RADIO SCHOOL, Dept. 63-T1  
500 S. Paulina St., Chicago 12, Ill.

YES! Send 6-volume "Applied Practical Radio-Television" for 7 days FREE TRIAL per your offer. Include TV-Radio Patterns & Diagram Book FREE.

Name..... Age.....  
Address.....  
City..... Zone..... State.....  
Where Employed.....  
( ) Check here if you want library sent COD. You pay postman \$20.95 plus COD postage on delivery. 7-day money-back guarantee.

**COYNE** ELECTRICAL & TELEVISION-RADIO SCHOOL  
500 S. Paulina St., Dept. 63-T1 Chicago 12, Ill.



# Best! for UHF Fringes!

## TEL-A-RAY Fringemaster

Looking for good UHF reception in the fringe areas? Try the Fringemaster, Tel-a-Ray's new collinear-type, cut to channel array built from noncorrosive Dural. Effectively covers 20 channels.

The Fringemaster's all-grounded construction gives positive lightning protection, reduces noise and permits a high front-to-back ratio. Also, there is no insulator loss!

List prices: No. 800 (not assembled) \$10.95; No. 800A (completely assembled ready for mounting on mast) \$12.95; No. 800D (two-bay array not assembled) \$24.95; No. 800DA (two-bay array completely assembled) \$27.50.

Write today for information on the complete line of Tel-a-Ray UHF antennas. Tel-a-Ray has a UHF antenna for every installation problem.



TRADE MARK

**Tel-a-Ray**  
ENTERPRISES INCORPORATED  
BOX 332E • HENDERSON • KENTUCKY

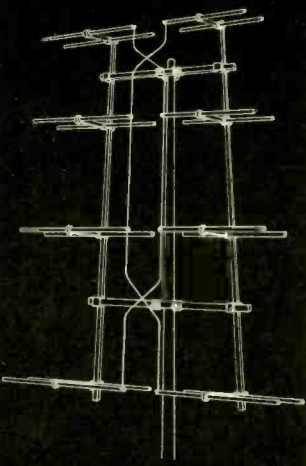

## WINCHARGER Telescoping TV ANTENNA SUPPORT

**SAFE** *one man can install*

**FAST**

**INSTALLATION**

No more "high climbs" with this modern, rugged Telescoping Mast. One man can do the whole job right from the bottom 10' section.



EXCLUSIVE 3-POINT SAFETY CLAMPING RING



AUTOMATIC SAFETY CLIP

Provides maximum rigidity against tubes twisting and loosening due to high winds. Has smoother guying surface, aids in erecting a straighter mast.

This unique Wincharger assembly tool safety feature warns you with a "click" when the tube has been pulled out as far as it can safely go.

**HOT-DIPPED GALVANIZED**

inside and out for maximum rust resistance. 18 gauge welded tubing — all hardware plated. Properly guyed, this Mast will support large antenna arrays in high winds and under heavy ice loads.

**A WINCHARGER BASE FOR EVERY TYPE ROOF**



HINGED FOOT for flat and sloping roofs.

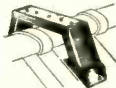

RIDGE STRADDLER for broad or ridged roofs.



RIDGE STRAPS... where there is no ridge roll to bridge.

WINCHARGER CORP., 2111 East 7th, SIOUX CITY 2, IOWA

## CONSTRUCTION

device controlled a powerful spotlight and alarm bell mounted on the edge of the roof. When anyone mounted the fire-escape ladder, the bell sounded and the light lit up the entire area.

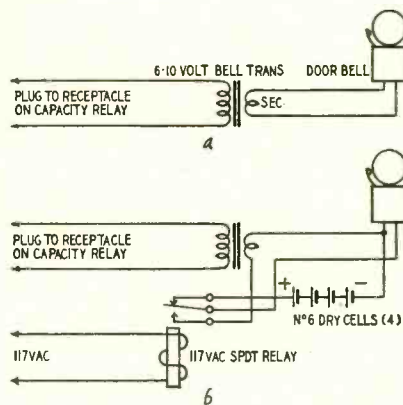

Fig. 2—(a) Bell-alarm unit for use with capacity relay. (b) Auxiliary alarm circuit. Dry cells ring alarm bell if a.c. power-line wires are cut.

**Materials for relay**

- Resistors: 1—8.2 megohms, 1/2 watt; 1—47 ohms, 2 watts; 1—4,000-ohm wirewound potentiometer.
- Capacitors: 1—100 μf, mica or ceramic; 1—.0025 μf paper; 1—4 μf, 1—8-μf, 350 volts, electrolytic; 1—100- or 140-μf air variable.
- Miscellaneous: 1—100-ma selenium rectifier; 1—6SJ7; 1—2050; 1 d.c.-operated relay, 8,000-ohm coil, s.p.d.t. contacts; 1—2-pole, 3-position, shorting-type selector switch; 1—6.3-volt, 1.2-amp filament transformer; 1—20-mh, center-tapped r.f. choke (J. W. Miller type 691-T or equivalent); 2 octal sockets; 1—a.c. power receptacle; cabinet; line cord and plug; terminals, hardware, wire, solder.
- Optional parts (Fig. 2) 1—6-10-volt doorbell; 1—6-10-volt bell transformer; 4—No. 6 dry cells; 1—a.c.-operated relay, 117-volt coil, s.p.d.t. contacts; line cord and plug.

Of course, the capacity relay can be hooked up to other types of indicators, or applied as a safety device in industrial operations. For example, anyone approaching a dangerous part of a machine tool or a high-voltage electrical installation would actuate the device automatically and shut off the power.

For maximum sensitivity, the antenna should be as short as practical. For this reason, always install the relay unit as close as possible to the area to be protected. If you must use a long antenna or if you have it connected to a large metallic body, the relay may not operate properly unless you connect a 100- or 200-μf mica capacitor in parallel with the ANTENNA LOADING control, or in series with the feeler wire.

END



"Don't these phony hypnotists kill you, Florence?"

RADIO-ELECTRONICS



A N O T H E R C B S - H Y T R O N F I R S T

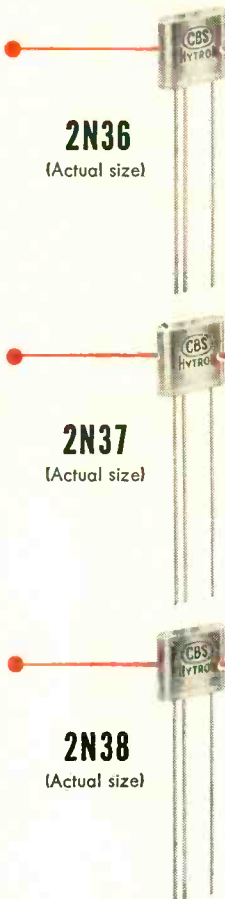

**2N36**  
(Actual size)

**2N37**  
(Actual size)

**2N38**  
(Actual size)

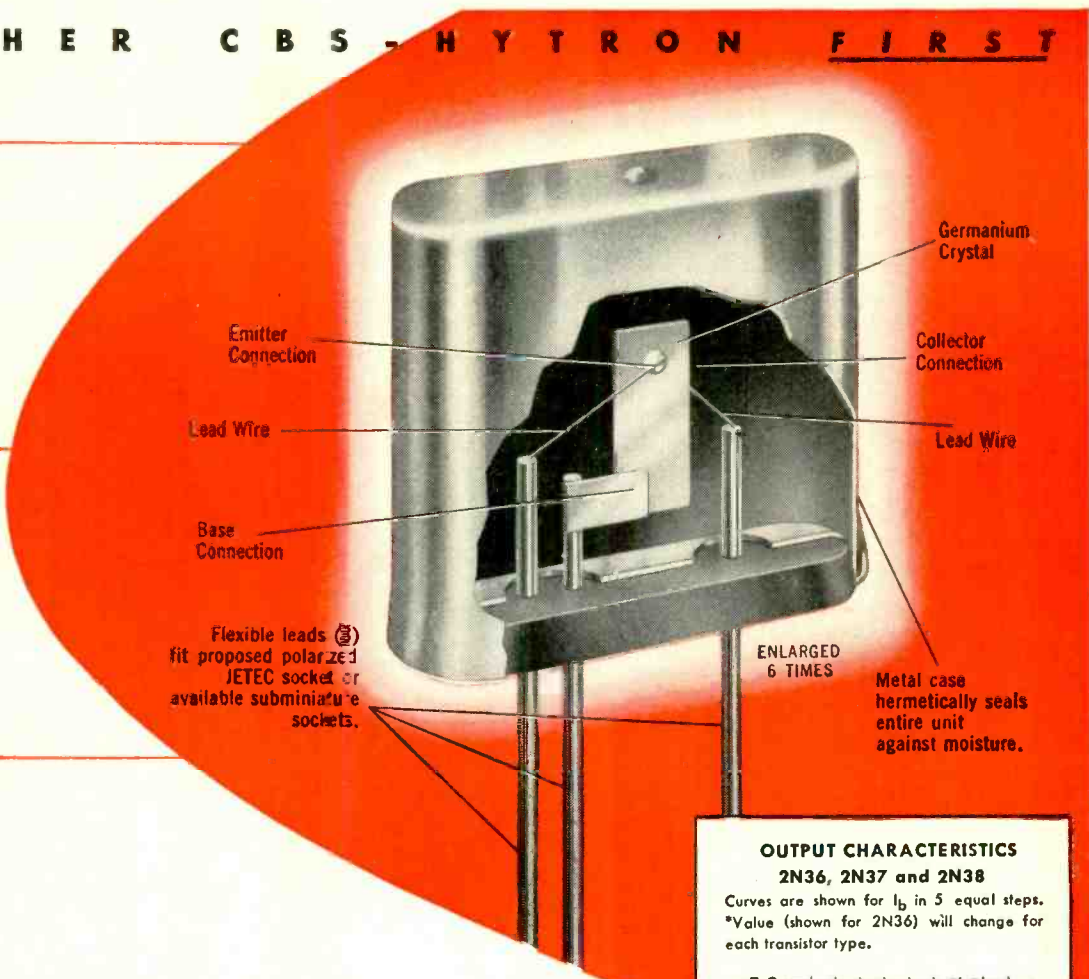

Flexible leads (E) fit proposed polarized JETEC socket or available subminiature sockets.

ENLARGED 6 TIMES

Metal case hermetically seals entire unit against moisture.

# NOW...HERMETICALLY SEALED CBS-HYTRON JUNCTION TRANSISTORS

In junction transistors, the surfaces are extremely sensitive to moisture. For dependability, they must be completely moisture-proofed. CBS-Hytron, recognizing this, is the first to offer you the new *hermetically sealed* 2N36, 2N37, and 2N38 junction transistors. Each is uniquely sealed in a metal case . . . moisture-proof, contamination-proof, light-proof. (See drawing.)

You can buy these new hermetically sealed P-N-P junction types immediately. All are amplifier types. Have similar characteristics, except for current amplification and power gain. You may operate the 2N36, 2N37, 2N38 up to 55°C. Their in-line design gives you: Compact, flat mounting . . . easily identified polarity . . . solder-in or plug-in (with clipped leads) convenience.

In addition to their unique moisture-proof feature, these CBS-Hytron junction types offer: (1) High gain. (2) Low noise figure. (3) Operation at low voltages. As well as other advantages characteristic of transistors: Compactness . . . light weight . . . ruggedness . . . instantaneous operation . . . and long life.

Remember, CBS-Hytron hermetically sealed 2N36, 2N37, 2N38 transistors are available at once. Write for complete data. Or order now for prompt delivery.

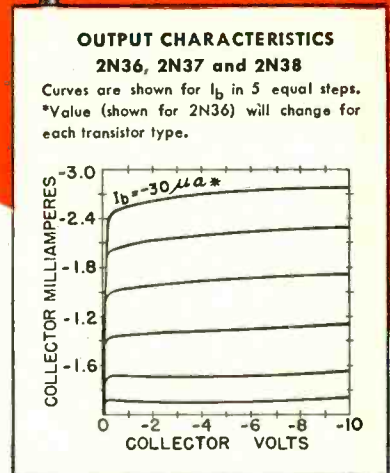

**ELECTRICAL CHARACTERISTICS †**  
CBS-Hytron P-N-P Junction Transistors

Characteristic	2N36	2N37	2N38
Collector voltage	-6	-6	-6 v
Collector current	-1	-1	-1 ma.
Current amplification factor #	45	30	15
Power gain #	40	36	32 db

†Typical values at 25°C. #Grounded emitter connection.



**NOW 3 CBS-HYTRON TEST ADAPTERS.** By popular demand. Three sizes now available at these net prices: 7-Pin Miniature, \$1.45; 8-Pin Octal, \$2.25; 9-Pin Miniature, \$1.75. Take advantage of e-a-s-y "topside" testing. Order your Test Adapters today from your CBS-Hytron jobber.

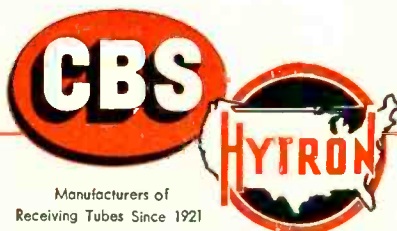

**CBS-HYTRON** Main Office: Danvers, Massachusetts

A Division of Columbia Broadcasting System, Inc.

RECEIVING . . . TRANSMITTING . . . SPECIAL-PURPOSE AND TV PICTURE TUBES • GERMANIUM DIODES AND TRANSISTORS



**1N34 NBFM-PM MODULATOR**

By **GEORGE W. MAKI**

A narrow-band FM signal that tunes and sounds like AM on an ordinary receiver is certainly most desirable. With a signal like this, the operator at the other end can tune in your carrier on the nose rather than tuning to one side and losing signal strength as he has to do with most NBFM stations. Also desirable is a simple, inexpensive modulator that provides good, understandable speech with enough punch to cut through QRM.

This germanium-diode FM-PM modulator comes closer to accomplishing this than anything that I've tried before. For the modulator all you need is an r.f. choke, three fixed capacitors, and a 1N34 diode. Of course, you'll need a speech amplifier. I used an 8-watt unit with a 600-ohm output. Its gain control was hardly ever more than one-quarter open. A speech clipper set for about 6 db is a decided advantage but the germanium-crystal modulator works well without it.

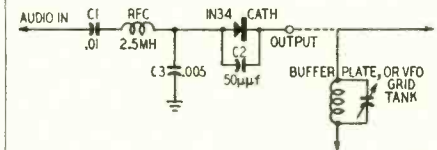

To illustrate how easily the NBFM-PM modulator can be connected to most transmitters, I pulled the driver and modulator tubes in the rig. Next, I twisted a piece of wire around the plate pin of the driver tube and pushed it back into its socket, leaving the modulator tubes out. The other end of the wire lead was connected to the audio input terminal of the diode modulator. The modulator output terminal was connected to the cathode pin of the oscillator tube in the BC-459-A used as a 40-meter v.f.o. The installation was completed by grounding the modulator to the v.f.o. chassis. Using this connection, I tried NBFM on 20. The results were quite satisfactory.

Next, I tried phase modulation (PM) by connecting the output of the crystal modulator across the plate tank of the buffer amplifier. We could not get enough swing since there was but one doubler between the buffer and the final. However, it did prove to my satisfaction that the circuit can be used successfully for PM if you have enough frequency multiplication. For 20-meter operation, you would probably have to run the oscillator and buffer in the 160-meter band.

The capacitor values are not critical. Modulation swing increases as C2 and C3 are made larger. Since these capacitors are effectively paralleled across the oscillator grid or buffer plate tank circuits (for NBFM or PM, respectively), you will have to compensate for the circuit detuning which occurs when the diode modulator is connected. The detuning is particularly noticeable by a change in the calibration of the v.f.o. END

**NEW** 12,080 HOURS OF ENGINEERING TO BRING YOU THE **precise OSCILLOSCOPE** (IN KIT AND WIRED FORM) **THE FASTEST-GROWING KIT MANUFACTURER IN THE WORLD**

The Oscilloscope you've been seeking . . . No other oscilloscope at any price — high or low — with these desirable features — in both Kit and Wired Form:

**SPECIFICATIONS: PRECISE MODEL 300 OSCILLOSCOPE —**  
**VERTICAL** — Vertical-flat (3db) DC through 5 megacycles with sensitivity of greater than 10 millivolts push-pull (3.94 Millivolts/cm); Constant Resistance; Push-pull input immediately converted to single-ended normal or reverse phase by shorting bar at inputs 1 and 2; Frequency compensated vertical stepping attenuator selects AC or DC inputs; Push-pull DC amplifiers from input through output; Internal electronic mixing through inputs 1 and 2; five-way blinding posts.  
**POSITIONING** — Bridge type positioning on vertical and horizontal does not vary tube characteristics.  
**HORIZONTAL** — Frequency compensated stepping attenuator in horizontal amplifier; Push-pull Horizontal out.  
**BLANKING** — Internal (return trace blanked), external (return trace not blanked), 60 cycle or 120 cycle Blanking through Blanking amplifier circuit.  
**SYNCHRONIZATION** — External, Internal Positive, Internal Negative, Internal 60 cycle or Internal 120 cycle synchronization.  
**SWEEP RATE** — Driven or non-driven linear sweeps from 1 cycle to 80KC in five ranges (1-10 cycles uses external C circuit); Trigger potentiometer.  
**MAGNIFIER** — Electronic magnifier and magnifier positioner allows any part of a signal to be magnified up to ten times (equivalent to 10 inches of horizontal deflection).  
**CALIBRATION** — Internal square wave calibrator and potentiometer for using oscilloscope at a VVM on Peak to Peak measurements.  
**CALIBRATION SCREEN** — Edge-illuminated scale and graticule may be turned on or off; filtered screen.  
**OUTPUTS ON FRONT PANEL** — Plus Gate output; Sawtooth output; 60 cycle phasing output; 60 cycle unphased output; Calibration output.  
**FOCUSING** — Astigmatism, focus and intensity control.  
**CRT** — NEW 7" Tube, normally supplied in medium persistence type 7J1P (oscilloscope green trace) — High persistence types available at additional cost.  
**DIRECT** — Deflection plates available from rear of cabinet.  
**INTENSITY MODULATION** — Z modulation through modulation amplifier.  
**GENERAL** — Low loss components; Dues-designed fused power supply for additional circuitry; Deeply etched aluminum panel; New parts from original manufacturers — (NO SURPLUS); Steel cabinet; 11" x 14" x 17"; complete with instruction book and all components; Accessories: Model 912T(MM) Demodulator Probe and Model 960 Capacity Attenuator Probe available at extra cost.  
 There are many additional features and circuits in kit form, which may be added to the Model 300. Please write us for descriptive literature.

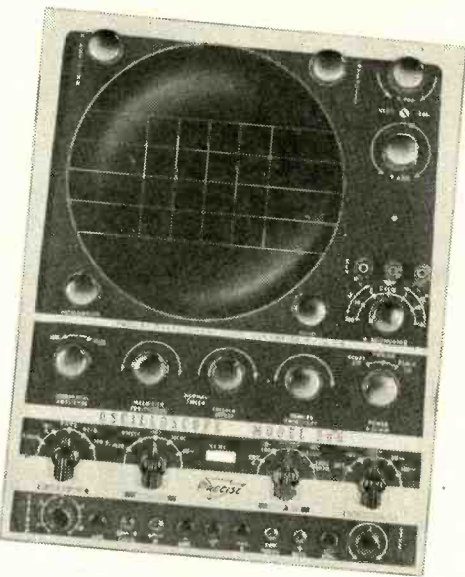

300K—kit form **\$94.95**  
 300W—factory wired **\$199.50**



**MODEL 630 RF-AF-TV AND MARKER GENERATOR.** For the first time in the history of the industry . . . **SO MUCH FOR SO LITTLE.** 50 MC on fundamentals, 330 MC on harmonics; Pre-tuned RF (within 1%) head; AF from 20 to 20,000 cycles; variable % and Ext. Mod.; Cathode-follower and Constant Z output; Stepping attenuator; Speech Amp; Xtal Marker with Amp. control; RF and AF Standby; Wien Bridge AF; Colpitts RF; Illuminated Drum Dials; Coax outputs; Separately tuned coils; Filtered AC; Vernier tuning; Separate RF; Shielded; 8" x 11" x 5"; Etched panel.  
 Model 630KA . . . \$38.95 (pre-assembled head) **\$33.95**  
 Model 630W . . . \$53.95 (Factory wired)



**MODEL 610 RF SIGNAL GENERATOR.** The lowest priced signal generator in the field offering—Same RF head as Model 630; 110 MC on fundamentals; 330 MC on harmonics; 60 and 400 cycle AF; Cathode-follower output; Ext. Mod.; Speech Amp.; Individually tuned coils.  
 Model 610KA . . . \$28.95 (pre-assembled head) **\$23.95**  
 Model 610W . . . \$39.95 (wired)



**MODEL 909 VACUUM TUBE VOLTMETER.** 1% Ceramic precision Resistors; Coax DC connector; FM zero alignment scale; burn-out proof circuit. Rugged oversize 4 1/2" meter **\$25.98**  
 Factory wired . . . \$44.98



**MODEL 999 HIGH VOLTAGE PROBE.** Designed for high voltage measurements with special emphasis on Safety, Operational Simplicity and Rugged Construction. Exclusive Features: MULTIPLE INSULATION, MECHANICALLY SHOCKPROOF, CHANGEABLE TIPS; SWIVEL connection. Odds are billions of billions to 1 that no breakdown will occur! INTERCHANGEABLE RESISTORS . . . Wired Only **\$6.98**

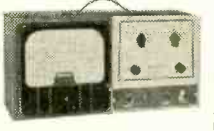

**MODEL 912 RF PROBE.** LOWEST PRICED, factory wired Probe in the industry. Individually calibrated at 75 MC for accuracy, impedance and shunt capacity.  
 Wired Only . . . **\$4.25**



**MODEL 960 CAPACITY ATTENUATOR PROBE.** Reduces Input C. and loading effects of an oscilloscope by 10 to 1. Adjustable for any scope. Lowest priced in the field, but still using highest quality components.  
 Wired Only . . . **\$5.95**

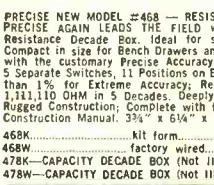

**MODEL 907 DELUXE VACUUM TUBE VOLTMETER.** Another PRECISE first! Vertical or Horizontal construction. GIGANTIC 7 1/2" meter movement; all the unusual values and features of Model 909 in a really DELUXE version **\$38.98**  
 Factory wired . . . \$57.98

**MODEL 635 UNIVERSAL AF SINE, SQUARE AND PULSE GENERATOR.** For accurate testing audio and video circuits. 1% Ceramic precision resistors; Wien Bridge; variable Z and cathode-follower output; minimum overshoot and roundoff through 100,000 cycles; sine waves through 200 KC **\$33.50**  
 Factory wired . . . \$52.50

Prices slightly higher in the West. Prices and specifications subject to change without notice.

**PRECISE DEVELOPMENT CORP.** Dept. RE-18  
 999 LONG BEACH ROAD • OCEANSIDE, L. I., NEW YORK  
 GENTLEMEN: Without any obligation on my part, kindly send me the following:  
 PRECISE CATALOG  
 NAME OF DISTRIBUTOR NEAREST ME

NAME \_\_\_\_\_  
 ADDRESS \_\_\_\_\_  
 CITY \_\_\_\_\_ ZONE \_\_\_\_\_ STATE \_\_\_\_\_

**precise DEVELOPMENT CORP.**  
 OCEANSIDE, NEW YORK



# FREE!

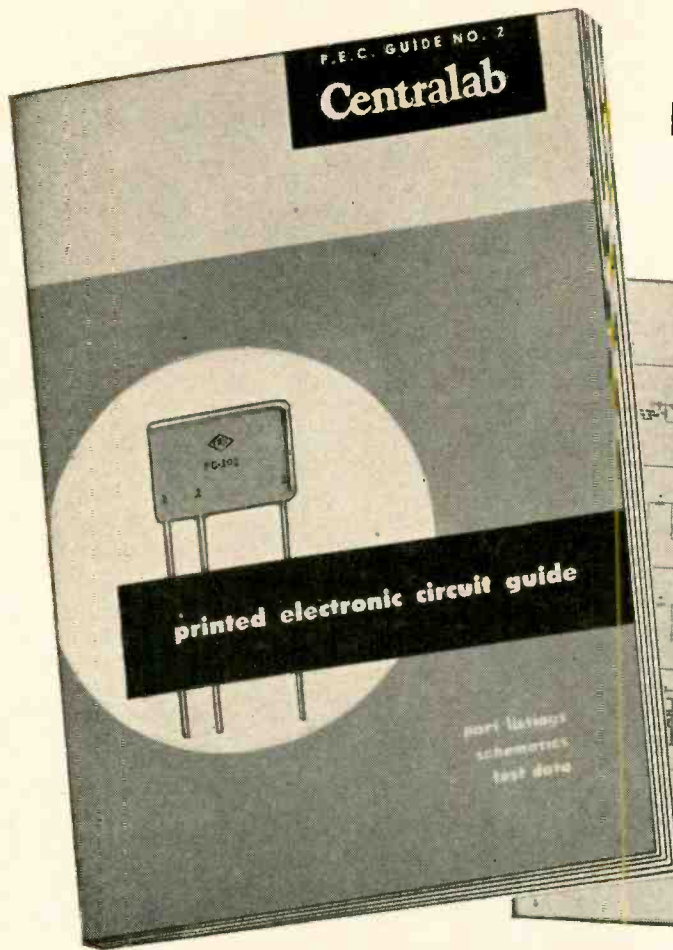

## PRINTED ELECTRONIC CIRCUIT GUIDE NO. 2

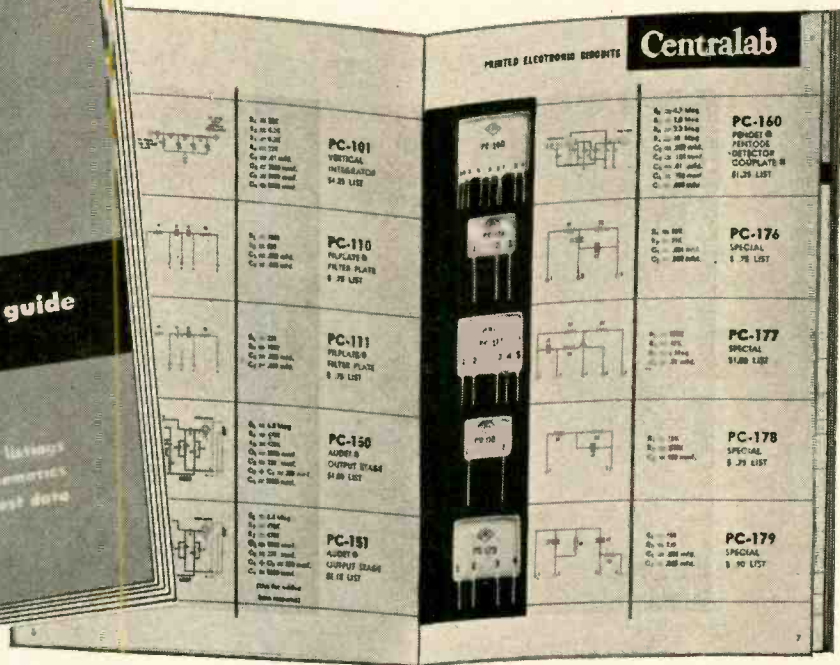

### 1953 CENTRALAB PEC GUIDE BIGGER — EVEN MORE COMPLETE

includes 445 PEC applications — 21 stock parts covering  
25,000,000 PEC's now in use — lists 119 set manufacturers

HERE'S the only practical PEC service guide. It's a must for every service shop. And it's yours absolutely free. Original equipment manufacturers have marveled at the extremely low failure percentage of PEC units as compared to individual standard components. But there are many millions of older sets in use that were produced prior to the use of PEC. Standard components in these sets can be replaced quickly and inexpensively by a single Printed Electronic Circuit Plate. If trouble is located in a certain section of a circuit, for instance, the vertical integrator in a TV set, or the Audio Detector in a radio set, instead of taking costly time to locate the exact component failure, replace the entire section with a vertical integrator or audio detector PEC plate.

Printed Electronic Circuits, originated and developed by Centralab, are in use on 60% of today's radio and television sets. Be sure you have the new 1953 guide for fast, positive information — where and when you need it.

## Centralab

A Division of GLOBE-UNION INC., Milwaukee 1, Wisconsin  
In Canada, 635 Queen Street East, Toronto, Ontario

Your parts distributor has this guide — ask him for a copy. If he can't supply you — use the coupon.

FOR FREE GUIDE, CLIP THIS COUPON AND MAIL TODAY

CENTRALAB, Division of Globe-Union Inc.  
922F E. Keefe Avenue, Milwaukee 1, Wisconsin

Please send me without delay, a copy of Centralab's Printed Electronic Circuit Guide No. 2.

Jobber's Name.....

Jobber's Address.....

Name.....

Firm.....

Address.....

City..... Zone..... State.....



# IRE CONVENTION 1953

By **FRED SHUNAMAN**  
Managing Editor

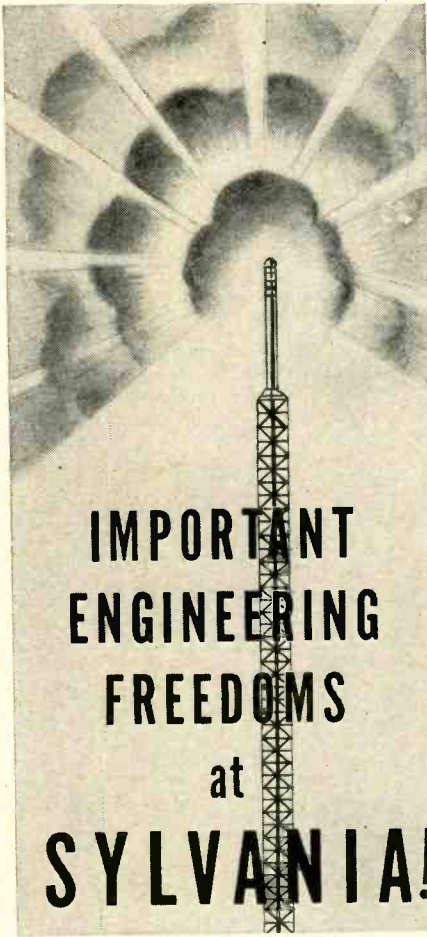

**IMPORTANT  
ENGINEERING  
FREEDOMS  
at  
SYLVANIA!**

All too often, farsighted engineering ideas and aims are held in check by everyday job requirements. Engineers made of the right "stuff" hold a secret yearning to break the shackles of today — to think in terms of the possibilities of **tomorrow**.

Sylvania thinks that way, too — has thought so for years. As a result, Sylvania encourages its engineers to pioneer, develop, follow through on their ideas, write and speak on their chosen subject to gain professional recognition.

If you are looking for a stimulating challenge that will last a lifetime — investigate the splendid career opportunities with fast-growing Sylvania.

Send your resume to:

**JOHN C. WELD**  
Supervisor of Employment  
254 Rano Street, Buffalo 7, New York

**DONALD BRADLEY**  
Personnel Supervisor  
70 Forsyth Street  
Boston, Mass.

**SYLVANIA**  
**ELECTRIC PRODUCTS INC.**  
RADIO AND TELEVISION DIVISION  
254 RANO STREET  
BUFFALO 7, NEW YORK

**T**HE official slogan of the 1953 National Convention of the Institute of Radio Engineers was "Radio-Electronics, a Preview of Progress." But even before the first day of the convention was over it had been displaced by the unofficial slogan, "The Year of the Transistor," which remained the real theme of the convention till the end. Though transistors were the subject of only two of the convention's 43 sessions, they kept bobbing up in audio, in television, in military equipment, and in most of the other subjects of the convention sessions.

Not only were new transistor circuits described, but also new types of transistors to use the new circuits. Some of them were so small that a whole audio amplifier—transistors, components, and all—could be installed in a 1-inch piece of medium-sized spaghetti. Others were comparative giants with cooling vanes. These ranged up to three-quarters of an inch in diameter and were capable of dissipating several watts of power.

Although transistors have barely just arrived, it's evident that they're already going places.

The transistorized convention was the biggest the Institute has ever held. More than 35,000 engineers were present, as contrasted with 28,600 last year. Six parallel sessions ran for three and a half days to read and discuss more than 200 technical papers, which in turn were divided into 43 sessions, ranging through subjects as diverse as microwave antennas and acoustics.

Most popular of all sessions were those dealing with the new theme of the convention. The first session on transistors overflowed before half the intended audience had got into the hall. It had to be repeated the next morning—coincidentally just when the overflow meeting would take pressure off the second transistor circuitry session.

### Push-pull transistors

The most impressive new information on transistors was that on *symmetrical circuits*. Already described to a limited extent by RCA, the symmetrical circuit was the subject of a paper and a demonstration by Dr. George Sziklai of the RCA laboratories. As explained by Dr. Sziklai, the symmetrical circuit

(CONTINUED ON PAGE 72)



Dr. George Sziklai of RCA holding model of the all-transistor audio power amplifier.

Fig. 1 Below—Symmetrical transistor audio amplifier. Push-pull output is obtained by feeding a p-n-p and an n-p-n transistor from a single-ended signal source. The low impedance of the power-type transistors matches the speaker voice coil, and eliminates the output transformer. Note the different symbols for n-p-n and p-n-p transistors.

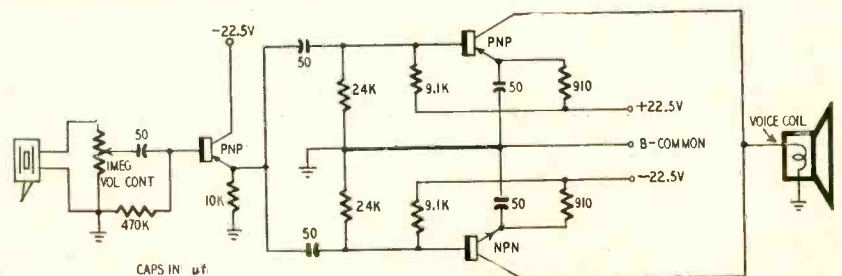





*the NEW*  
**more PROFITABLE**  
*way to sell more*  
**RADIART**  
**VIBRATORS**  
**FASTER!**



*this is the way it looks fully packed*



*here is the re-usable box with dividers for a hundred uses at home or work*

- ★ The BEST Vibrator Money Can Buy.
- ★ BIGGER Unit Sales . . . Sell NINE at a time instead of 2 or 3.
- ★ A "BONUS" For Your Customers in the re-usable Plastic Box.
- ★ MORE Sales Faster . . . MORE PROFITABLY for you.

Here's an unusual merchandising plan that means EXTRA volume and FASTER profits for you! RADIART vibrators sell fast and well on their own . . . NOW . . . with this KIT PLAN . . . you will sell even MORE vibrators . . . FASTER, and with a bigger UNIT SALE! Each kit contains 9 vibrators, the 5 basic types that serve 60% of replacement applications . . . 2,5300 . . . 2,5301 . . . 2,5326 . . . 2,5342 and 1,5335. The original supply is limited . . . so act fast and get your order in now to protect your allocation. This is too good to miss!



**THE RADIART CORPORATION CLEVELAND 13, OHIO**  
 VIBRATORS • AUTO AERIALS • TV ANTENNAS • ROTATORS • POWER SUPPLIES



# BUY TEST EQUIPMENT ON THIS RADICALLY NEW TIME PAYMENT PLAN

**NO INTEREST!! - NO CARRYING CHARGES!!**

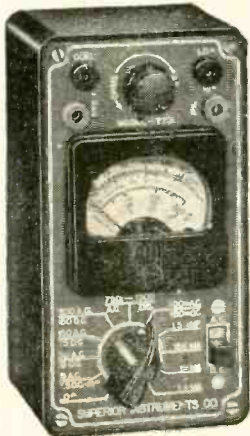

Superior's new model 770 AN ACCURATE POCKET-SIZE

## VOLT-OHM MILLIAMMETER

(SENSITIVITY—1000 OHMS PER VOLT)

**FEATURES:**

- ★ Compact—measures 3 1/8" x 5 7/8" x 2 1/4".
- ★ Uses latest design 2% accurate 1 Mil. D'Arsonval type meter.
- ★ Same zero adjustment holds for both resistance ranges. It is not necessary to readjust when switching from one resistance range to another. This is an important time-saving feature never before included in a V.O.M. in this price range.
- ★ Housed in round-cornered, molded case.
- ★ Beautiful black etched panel. Depressed letters filled with permanent white, insures long-life even with constant use.

The Model 770 comes complete with self-contained batteries, test leads and all operating instructions.

**SPECIFICATIONS:**

- 6 A.C. VOLTAGE RANGES: 0—15/30/150/300/1500/3000 VOLTS
- 6 D.C. VOLTAGE RANGES: 0—7.5/15/75/150/750/1500 VOLTS
- 5 D.C. CURRENT RANGES: 0—1.5/15/150 MA. 0—1.5 AMPS.
- 2 RESISTANCE RANGES: 0—500 OHMS 0—1 MEGOHM

**\$14<sup>90</sup>**  
NET



Superior's new  
Model 670-A

## SUPER METER

A COMBINATION VOLT-OHM MILLIAMMETER PLUS  
CAPACITY REACTANCE INDUCTANCE AND DECIBEL MEASUREMENTS

**SPECIFICATIONS:**

- D.C. VOLTS: 0 to 7.5/15/75/150/750/1,500/7,500 Volts
- A.C. VOLTS: 0 to 15/30/150/300/1,500/3,000 Volts
- OUTPUT VOLTS: 0 to 15/30/150/300/1,500/3,000 Volts
- D.C. CURRENT: 0 to 1.5/15/150 Ma. 0 to 1.5/15 Amperes
- RESISTANCE: 0 to 1,000/100,000 Ohms 0 to 10 Megohms
- CAPACITY: .001 to 1 Mfd. 1 to 50 Mfd. (Quality test for electrolytics)
- REACTANCE: 50 to 2,500 Ohms 2,500 Ohms to 2.5 Megohms
- INDUCTANCE: .15 to 7 Henrys 7 to 7,000 Henrys
- DECIBELS: —6 to +18 +14 to +38 —34 to —58

**ADDED FEATURE:**

The Model 670-A includes a special GOOD-BAD scale for checking the quality of electrolytic condensers at a test potential of 150 Volts.

The Model 670-A comes housed in a rugged, crackle-finished steel cabinet complete with test leads and operating instructions.

**\$28<sup>40</sup>**  
NET

Measures 6 1/4" x 9 1/2" x 4 1/2"



Superior's new  
Model TV-11

## TUBE TESTER

**SPECIFICATIONS:**

- ★ Tests all tubes including 4, 5, 6, 7, Octal, Lock-in, Peanut, Bantam, Hearing Aid, Thyatron, Miniatures, Sub-miniatures, Novals, Sub-minars, Proximity fuse types, etc.
- ★ Uses the new self-cleaning Lever Action Switches for individual element testing. Because all elements are numbered according to pin-number in the RMA base numbering system, the user can instantly identify which element is under test. Tubes having tapped filaments and tubes with filaments terminating in more than one pin are truly tested with the Model TV-11 as any of the pins may be placed in the neutral position when necessary.
- ★ The Model TV-11 does not use any combination type sockets. Instead individual sockets are used for each type of tube. Thus it is impossible to damage a tube by inserting it in the wrong socket.
- ★ Free-moving built-in roll chart provides complete data for all tubes.
- ★ Newly designed Line Voltage Control compensates for variation of any Line Voltage between 105 Volts and 130 Volts.
- ★ NOISE TEST: Phono-jack on front panel for plugging in either phones or external amplifier will detect microphonic tubes or noise due to faulty elements and loose internal connections.

The model TV-11 operates on 105-130 Volt 60 Cycles A.C. Comes housed in a beautiful hand-rubbed oak cabinet complete with portable cover

**\$47<sup>50</sup>**  
NET

**EXTRA SERVICE**—The Model TV-11 may be used as an extremely sensitive Condenser Leakage Checker. A relaxation type oscillator incorporated in this model will detect leakages even when the frequency is one per minute.

**USE CONVENIENT TIME PAYMENT COUPON ON OPPOSITE PAGE** ➔



# BUY ON EASY PAYMENTS AT THE NET CASH PRICE

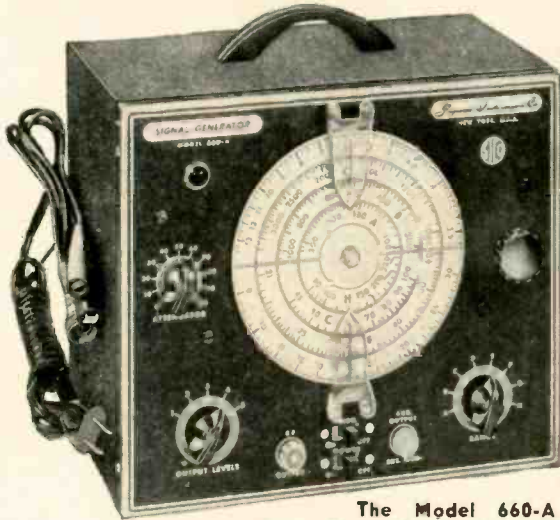

The Model 660-A comes complete with coaxial cable test lead and instructions.

## Superior's New Model 660-A AN AC OPERATED SIGNAL GENERATOR

PROVIDES COMPLETE COVERAGE for AM-FM & TV Alignment

### SPECIFICATIONS:

• Generates Radio Frequencies from 100 Kilocycles to 60 Megacycles on fundamentals and from 60 Megacycles to 220 Megacycles on powerful harmonics. • Accuracy and Stability are assured by the use of permeability trimmed Hi-Q coils. • R.F. available separately or modulated by the internal audio oscillator. — Built in 400 cycle sine wave audio oscillator used to modulate the R.F. signal also available separately for audio testing of receivers, amplifiers, hard of hearing aids, etc. • R.F. Oscillator Circuit: A high transconductance hep-

tode is used as an R.F. oscillator, mixer and amplifier. Modulation is effected by electron coupling in the mixer section thus isolating the oscillator from load changes and affording high stability. • A.F. Oscillator Circuit: A high transconductance heptode connected as a high- $\mu$  triode is used as an audio oscillator in a High-C Colpitts Circuit. The output (over 1 Volt) is nearly pure sine wave. • Attenuator: A 5 step ladder type of attenuator is used.

Tubes used: 1—6BE6 as R.F. Oscillator, mixer and amplifier. 1—6BE6 as Audio Oscillator. 1—6H6 as Power Rectifier.

\$ **42<sup>95</sup>** NET



## Superior's New TELEVISION BAR GENERATOR

THROWS AN ACTUAL BAR PATTERN ON ANY TV RECEIVER SCREEN!!

### FEATURES:

#### Two Simple Steps

1. Connect Bar Generator to Antenna Post of any TV Receiver.
2. Plug Line Cord into A.C. Outlet and Throw Switch.

Result: A stable never-shifting vertical or horizontal pattern projected on the screen of the TV receiver under test.

1. Provides linear pattern to adjust VERTICAL linearity, height, centering.
2. Provides linear pattern to adjust HORIZONTAL drive, width, peaking, linearity, centering.
3. Provides vertical sweep signal for adjusting and synchronizing vertical oscillator discharge and output tubes.
4. Provides vertical signal to replace vertical oscillator to check vertical amplifier operation.
5. Provides horizontal sweep signal for adjusting and synchronizing horizontal oscillator A.F.C. and output tubes.
6. Provides horizontal sweep signal to check H.V. section of fly-back and pulse operating power supplies.
7. Provides signal for testing video amplifiers.
8. Can be used when no stations are on the air.

### SPECIFICATIONS:

Power Supply: 105-125 Volt 60 Cycles  
Power Consumption: 20 Watts  
Channels: 2-5 on panel, 7-13 by harmonics

Horizontal lines: 4 to 12 (Variable)  
Vertical lines: 12 (Fixed)  
Vertical sweep output: 60 Cycles  
Horizontal sweep output: 15,750 Cycles

TV BAR GENERATOR COMES COMPLETE WITH SHIELDED LEADS AND DETAILED OPERATING INSTRUCTIONS. ONLY

\$ **39<sup>95</sup>** NET

**NEW TIME PAYMENT PLAN ORDER BLANK**

MOSS ELECTRONIC DISTRIBUTING CO., INC.  
Dept. E-60, 38 Murray Street, New York 7, N. Y.

Please send me the units checked. I am enclosing the down payment with order and agree to pay the monthly balance as shown. It is understood there will be no carrying, interest or any other charges, provided I send my monthly payments when due. It is further understood that should I fail to make payment when due, the full unpaid balance shall become immediately due and payable.

Signature .....

Name .....

Address .....

City ..... Zone ..... State .....

- MODEL 770 ..... Total Price \$14.90  
\$2.90 down payment. Balance \$2.00 monthly for 6 months.
- MODEL TV-11 ..... Total Price \$47.50  
\$11.50 down payment. Balance \$6.00 monthly for 6 months.
- MODEL 670-A ..... Total Price \$28.40  
\$7.40 down payment. Balance \$3.50 monthly for 6 months.
- TELEVISION BAR GENERATOR ..... Total Price \$39.95  
\$9.95 down payment. Balance \$5.00 monthly for 6 months.
- MODEL 660-A ..... Total Price \$42.95  
\$12.95 down payment. Balance \$5.00 monthly for 6 months.
- I enclose \$..... as down payment.
- Ship C.O.D. for the down payment.



# RIDER TEK- FILE\*

packaged

tv

service

information—

factory-

authorized

factory-

approved

for easy

tv servicing...

taylor-made

for over

2800

receivers...

only

\$2 per pack

(at your jobbers)

\*dependable replacement parts listing beginning with Pack 57

## JOHN F. RIDER

Publisher, Inc.

480 Canal Street  
New York 13, N. Y.

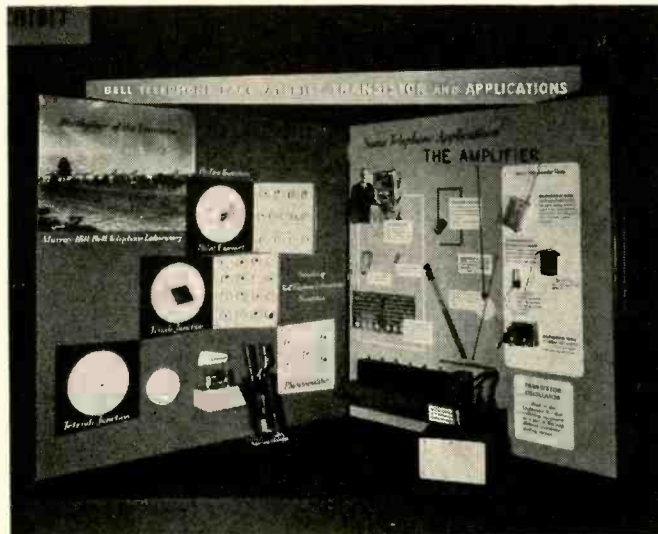

Part of Bell Telephone Laboratories' transistor exhibit at the 1953 I.R.E. convention. The tiny amplifier described in the text is circled at the right.

is based on two dissimilar junction transistors. One is an n-p-n unit, a junction transistor with the ends negative and the narrow central "base" positive. The other is a p-n-p transistor. If these two are hooked up with their inputs in parallel, the output is push-pull. (See Fig. 1.)

These stages can be cascaded, said Dr. Sziklai, by varying the three fundamental ways (grounded-base, grounded-emitter and grounded-collector) in which a transistor can be hooked up. An amplifier which contains practically nothing but the transistors and their batteries can thus be constructed. He demonstrated a six-transistor amplifier which dispensed even with the output transformer, feeding direct into the voice coil of a speaker and supplying music loud enough for dancing. Dr. Sziklai was also co-author of a paper which showed how transistors can be used in many sections of a television receiver.

Another transistor amplifier—intended for telephone use—was exhib-

ited by Bell Laboratories. Little larger than a match, it occupied (with 11 other components) a piece of cable about  $\frac{1}{8}$  inch in diameter and less than 2 inches long. It was designed to replace a 2-inch section of conductor in multiple telephone cable. Power for the transistor amplifiers can be carried easily by one of the conductors in the cable, and their small size would permit their insertion at many points where vacuum-tube amplifiers are now impractical. This should make it possible to improve the quality of telephone transmission over many existing and future circuits.

Transistor receivers and transmitters were exhibited by RCA and General Electric Co. Frequency meters, Geiger counters, and a display of printed circuits for further miniaturization and ruggedization of transistor equipment were displayed by the Signal Corps. Raytheon showed seven brands of hearing aids using Raytheon junction transistors, and Bell Laboratories exhibited (along with the match-sized amplifier) transistor telephone-dialing equipment and three experimental transmitters, one an FM job.



Professor Grant Fairbanks (left) and Dean W. L. Everitt of the University of Illinois, demonstrate the "speech compressor".



General Electric's new hermetically-sealed junction transistor operates even in boiling water. J. H. Sweeney and Conrad H. Zierdt, Jr. of G-E demonstrate the new transistor in a miniature transmitter atop the coffee-maker kettle.

RADIO-ELECTRONICS



# Sylvania's New 1954 Calendar

for Service Dealers . . . sells all through the Year!

They'll read your super-service story every month!

Filled with ideas and recipes your prospects will want to keep

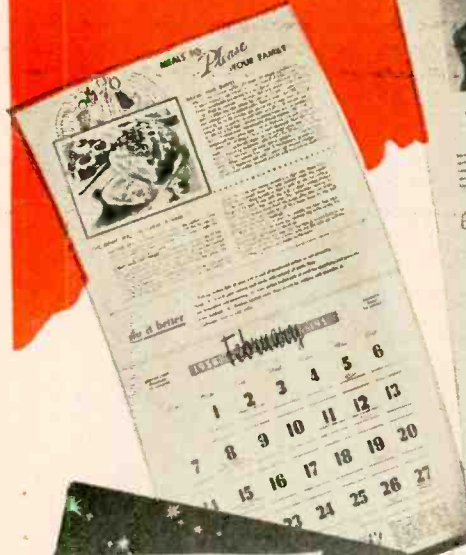

It's your personal Christmas greeting, too

Don't miss this Dramatically Different Business Builder!

Here's the hardest-selling, custom-made Home Calendar ever offered to Radio-TV Service Dealers! It's tailor-made just for you! Features an appealing illustration painted exclusively for Sylvania by a famous cover artist. Reproduced in full color and imprinted with your name and address.

Your prospects simply can't overlook this calendar. It's filled with timely hints and valuable household suggestions they'll want to keep handy. And, every time they turn the page they'll be reminded of your dependable service, skill, and experience.

Order now . . . supply limited! At only 1 1/2¢ per customer per month (in lots of one hundred or more), this calendar

is truly the smartest advertising buy ever offered. But don't delay, the supply is limited! Order a couple of hundred from your regular Sylvania distributor . . . TODAY! If he is out of stock, write to: Sylvania Electric Products Inc., Dept. 3R-1706, 1740 Broadway, N. Y. 19, N. Y.

# SYLVANIA





Brand New- Just Off The Press!

**FREE**

**TO ANY RADIOMAN WHO WANTS A BIGGER INCOME**

There's **MONEY FOR YOU**

**IN 2-WAY MOBILE RADIO SERVICING**

1st EDITION MARCH 1953

Booklet E

- Learn what 2-way mobile systems are.
- Learn how servicing of 2-way mobile equipment has become a million dollar business.
- Learn what the latest authentic FCC statistics about the growing 2-way mobile radio systems mean to your future in radio servicing.
- Learn how smart radio servicemen are cashing in.
- Learn how you can get in on the ground floor, what the profits are, every step you take in this expanding market. This is opportunity knocking at your door. Don't miss out.

**Servicing 2-way Mobile Radio Systems PAYS BIG MONEY**

**Here's Your Opportunity . . .**

. . . over 425,000 fixed and Mobile Transmitters in use now . . . more than 72,000 new ones licensed each year.

2-way mobile communication systems are growing at a phenomenal rate. The Federal Communication Commission, in its latest annual report states that there is a total of 24,595 fixed transmitters, and 300,627 mobile transmitters. Fixed transmitters are now increasing at the rate of approximately 6,000 per year, and mobile stations are increasing at the rate of 72,000 per year.

Here in this field is your opportunity to get in on the ground floor—earn top pay—establish your own business—become independent!

**Here's the Proof THAT OTHER ALERT RADIOMEN ARE CASHING IN RIGHT NOW**

"I know you will be pleased to learn that I have received my Radiotelephone 2nd class license, number P2-12-1026. The examination seemed easier than I expected, also I know that you will be glad to learn that I am changing jobs. Am going to work with the Pacific Tel. and Tel. Company in their Mobile Division. Have been trying to get this

job for over a year and am convinced that only the license did the trick." **Chaparral St., Salinas, Calif.**

"I want you to know that I have employment using my 2nd class license. I am employed in Janesville, Wisc., and I am now installing and servicing two-way radios in taxi cabs and in Wisconsin Light and Power trucks. This type of work is very interesting and the pay is very good also." **Lee R. Andrews, Box 485, Liberal, Kansas**

"I just received a much better job with my company and the transfer was due entirely to my ability to get my 2nd class Radiotelephone license. From now on, I'll be installing and repairing on our Mobile Radio sets which we have in this district." **Alan N. Sterland, Box 113, Prentice, Wisconsin**

"I would like to inform you that I have made the change in employment contemplated some time ago. I am now employed by the South Carolina Electric & Gas Co., distribution office, Mr. D. M. White, Supt. My responsibilities now entail some 84 mobile units along with five base stations within the State. I am very much pleased with this new job." **Henry A. Coleman, 617 Medway Rd., Riverland Terr., South Carolina**

**We will tell you How To Cash In—no obligation SEND COUPON FOR FULL INFORMATION**

**CLEVELAND INSTITUTE OF RADIO ELECTRONICS**  
4900 EUCLID AVENUE, DESK RE-53  
CLEVELAND 3, OHIO  
(ADDRESS TO DESK NO. TO AVOID DELAY)

I want to know the facts, without obligation, about the profit opportunity in 2-way mobile radio servicing. Rush me your FREE booklet: "There's MONEY FOR YOU IN 2-WAY MOBILE RADIO SERVICING," and give me the details about this tremendously expanding new radio field.

NAME \_\_\_\_\_

ADDRESS \_\_\_\_\_

CITY \_\_\_\_\_

ZONE \_\_\_\_\_

STATE \_\_\_\_\_

**D**

(Paste on a 2 cent postcard)

If you are owner or manager of a radio-TV service shop check here for Employers Plan and enclose this coupon with your business card or letterhead.

**A speech compressor**

Leaving transistors (with difficulty) the visitor noted few of the startling disclosures and devices of earlier meetings. No radio to the moon, no dx microwave transmission. The emphasis was on solid progress along lines already partly explored. One of the most important innovations was the internal-magnetic-focus TV tube, in which both the ion-trap and the focus magnets are inside the tube. This tube was announced in last month's RADIO-ELECTRONICS and is discussed elsewhere in this issue.

Another new instrument was the speech compressor described by Grant Fairbanks, W. L. Everitt, and R. P. Jaeger of the University of Illinois. This device is as simple in construction as it is remarkable in operation. It is a machine which will take 10 minutes of speech or music, and turn out a tape which can be played back in a shorter time—say 8 minutes—with no apparent change in the frequencies or other characteristics of the original speech or music.

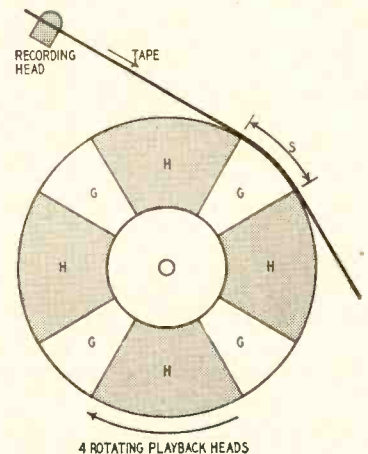

4 ROTATING PLAYBACK HEADS  
H-HEAD; S-SECTION OF TAPE NOT RE-RECORDED;  
G-GAP BETWEEN HEADS

**Fig. 2—Basic mechanism of the "speech compressor" developed at the University of Illinois. The rotating playback head contains four pickup units which move in the same direction as the tape, but at a lower speed. Program material picked up by the heads is re-recorded on a second tape. Original program in gaps between pickup heads is not re-recorded, thus cutting playback time.**

Tape editors know that pieces can be cut from a tape—preferably between words but even in the middle of long vowels—when it is necessary to shorten a recording. If the pieces cut out are short enough, they have no effect on the intelligibility of the final record. This principle is used in multiplex telephony, where the system is known as "sampling" (RADIO-ELECTRONICS, February, 1948).

Researchers in a psychology project at the University of Illinois had been studying certain aspects of speech by a method which required snipping little pieces out of the tape at regular short intervals. Cutting the tape by hand was





PATENT APPLIED FOR

# "ULTRATUBE"

## PROOF OF PERFORMANCE:

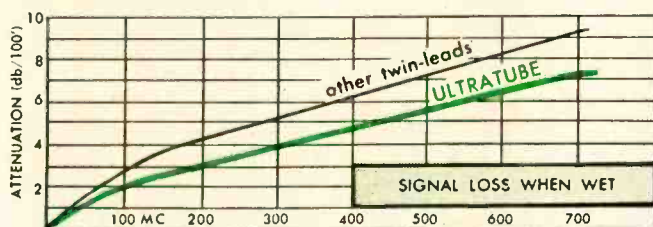

ULTRATUBE and other twin-lead constructions were tested under both wet and dry conditions. The data clearly show that for clear, strong signals under adverse weather conditions, no transmission line gives better reception than Synkote ULTRATUBE.

## SEALING THE ENDS:

To seal the inside of "ULTRATUBE" against moisture, simply heat the ends with match or cigarette lighter, then clamp shut with pliers. This must be done or reception will deteriorate.

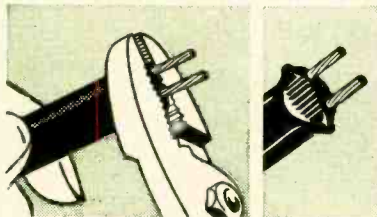

## For Unexcelled UHF Transmission Under All Weather Conditions

Look at this cross-section of Synkote "ULTRATUBE". Note how the conductors are spaced equidistant from the outer insulation by *several millimeters*. This means that no matter how encrusted with salt or moisture the insulation becomes, the magnetic field between the two leads is practically unaffected — and signal strength is undiminished all the way down the line. For UHF — for better VHF — for fringe area reception, — there's nothing finer than Synkote "ULTRATUBE"!

Ask your Plastoid representative for samples of Synkote "ULTRATUBE" — for ultra-high frequency but *not* at ultra-high prices. Catalog No. PP 4911.



"Manufactured by the mile - tested by the inch"

PLASTOID  
Corporation

42-61 24th St., Long Island City, N.Y.



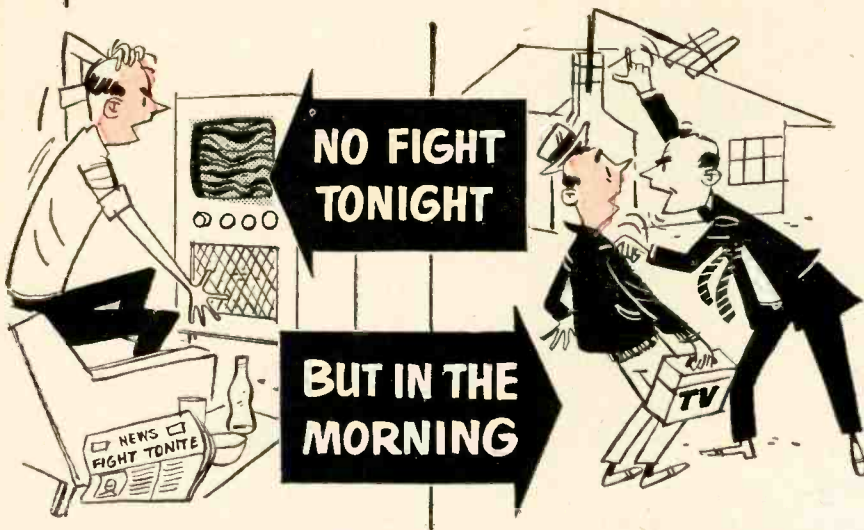

That's Why Top Service Men  
Install **PERMA-TUBE**  
the Mast that's UP TO STAY

Television set owners aren't happy when the set goes out on a big night and the antenna is ruined because an inferior mast failed from inside corrosion or high winds during a storm.

That's why more and more smart service men are protecting their reputations for good work by installing J&L Perma-tube TV masts. They've found that—1. PERMA-TUBE is made of special high-strength J&L steel that stays up in storms that flatten masts of conduit or other types of tubing. 2. PERMA-TUBE is pretreated with vinsynite and then coated inside and out with a metallic vinyl resin base. The result—corrosion proof masting that doesn't weaken or cause ugly rust streaks on the customer's home. 3. PERMA-TUBE is easy and economical to install—the only mast with both ends of the joint machine fitted.

You can get PERMA-TUBE in standard lengths, diameters and wall thicknesses. Write today for complete information and the name of your nearest distributor.

HERE'S INSIDE INFORMATION ON WHAT CORROSION DOES

Section of ordinary conduit tubing used for TV masts after 96 hours in a salt spray test (A.S.T.M. Designation B-117-49T) to accelerate corrosion. Extensive rust inside the mast has reduced strength—caused rusty water to drain onto the owner's home.

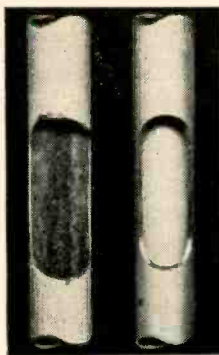

Section of PERMA-TUBE after 500 hours salt spray test shows no evidence of corrosion. Strength has been retained and the chance of rust streaks on owner's home are eliminated. Note sturdier wall thickness of Perma-tube sample.

FOR COMPLETE INFORMATION MAIL THIS COUPON TODAY

Jones & Laughlin Steel Corporation  
496 Gateway Center  
Pittsburgh 30, Pa.

Without charge, please send me:  Name of nearest distributor  
 Complete information on Perma-tube

Name \_\_\_\_\_

Company \_\_\_\_\_

Address \_\_\_\_\_

NEW DESIGN

slow and difficult work, and they sought a way of doing it automatically. The result of their search was a machine which does far more than they had originally expected.

The instrument is a much modified tape recorder. It has a standard recording head, on which a tape can be recorded in the usual way. This tape then passes over a rotating playback unit. The signal picked off the tape by this playback unit is not fed to a loudspeaker, but recorded on a second tape.

It is the rotating playback unit that does the compressing. It carries four playback heads (Fig. 2) so that one of them is in contact with the tape nearly all the time. If this unit is kept stationary, so that a single playback unit is in contact with the tape, it will act like a standard head, and the program of the second tape will be a faithful reproduction of the first. If it revolves at the same speed as the tape, there will be no relative motion of tape with respect to the head (the tape will be stationary as far as the head is concerned), and nothing will be recorded. But, if the unit revolves slowly in the direction of the tape, the effect is just the same as if the tape is slowed down. For instance, if it moves one-fifth as fast as the tape, it will take any part of the tape 20% longer to pass the head. Four-fifths of an inch of recording on the original tape will then be recorded over a full inch of the second one. Of course, the frequencies of the voice and music recorded on the second tape also will be 20% lower than on the original one.

When one of the four heads reaches that point in its rotation where it leaves the tape, the one behind it comes into contact with the tape and starts recording, so the recording of the second tape is uninterrupted. But there is a slight gap in the first tape between the point where one of the heads cuts out and the next takes over, so that regularly spaced little bits of the first tape will not be recorded on the second tape. These bits are effectively "cut out" of the tape.

Now if tape No. 2 is speeded up and played back in four-fifths of the time



"I told you television wasn't here to stay."

RADIO-ELECTRONICS



# Here's how to increase your Auto Radio Repair Business!



There's one sure way to get ahead in the car radio repair business, and that's to be in a position to tap the vast market of Delco Radio-equipped cars and trucks that daily passes your door! To do this you need only sign up with Delco Radio, through your United Motors Electronics Distributor. Then, automatically, you have a reliable source for Delco Radio original equipment replacement parts, and for universal replacement parts. You will receive a complete and comprehensive Delco Radio Service Manual. You will regularly receive monthly issues of "Testing Tips," a bulletin giving the very latest factory information on testing and repairing Delco car radios. So if you want to increase your business—permanently—get on the Delco Radio team. Don't delay . . . contact your United Motors Electronics Distributor right away!

DISTRIBUTED BY  
ELECTRONICS  
WHOLESALEERS  
EVERYWHERE

**DELCO RADIO**  
DIVISION OF GENERAL MOTORS CORPORATION, KOKOMO, INDIANA

A GENERAL MOTORS PRODUCT  SERVICE  A UNITED MOTORS LINE





to

## ELECTRO-MECHANICAL ENGINEERS and DESIGNERS

with experience in

### SMALL PRECISION DEVICES

#### HUGHES RESEARCH AND DEVELOPMENT LABORATORIES,

one of the nation's leading electronics organizations, are now creating a number of new openings for qualified electro-mechanical engineers and designers in important phases of its operations.

#### THE COMPANY

The Hughes Laboratories, located in Southern California, are presently engaged in the development and production of advanced radar devices, electronic computers and guided missiles.

#### THE OPPORTUNITIES

Opportunities are offered for men who will perform interesting work on development of intricate new devices in close association with outstanding scientists. Activities em-

brace a variety of challenging problems which require originality and afford unusual possibilities of progress in learning.

#### FIELDS OF WORK

The work includes such fields as those involving Servo Mechanisms, Computers, Microwave Tubes, Pulse Circuitry, Solid-State Physics, Miniaturization, Antennas—Waveguides, Heat Transfer, Hydraulics—Gyros, Test Equipment, Subminiatur-

ization, Stress Analysis, Instrumentation, Structures, and Precision Production Mechanisms.

#### YOUR FUTURE

Working experience in advanced techniques employing the above fields will increase your value to the Company as it further expands in development of electro-mechanical devices. Large-scale use of electronically controlled systems in business and industry is a certainty within the next few years.

## HUGHES

Research and Development Laboratories  
Scientific and Engineering Staff

How to apply

CULVER CITY  
LOS ANGELES COUNTY  
CALIFORNIA

Write today to address at left, giving details of qualifications and experience. Assurance is required that any relocation of an applicant will not cause disruption of an urgent military project.

it took to record, the lowered tones come back to the original frequencies, and the replay takes 20% less time than the original recording. The space discarded on the first tape is turned into discarded time on the second one.

The compressor is likely to be a god-send to radio directors faced with programs that run over appointed time. It will have a use also in speeding up military messages, and at the same time make them harder to read. Worked in reverse as a "speech stretcher," it will enable students of foreign languages or musical compositions to slow down their subject matter without changing the frequencies of the original.

#### Everybody's TV transmitter

Television was the subject of a number of sessions in the convention, but the most impressive TV development described used no new principles, but rather made old ones available in a new and ingenious way. This was a midget television camera that can make any home television receiver into a closed-circuit TV system. It includes a control box with a number of plugs which fit in certain tube sockets on an ordinary TV receiver.

The camera can be set up near a child's crib, in a nursery, or even pointing at the glass door of the kitchen oven. A switch on the receiver enables the viewer to watch either regular TV programs or the scene on which the camera is trained. Thus a housewife could watch TV while making sure that everything was normal in the nursery (or that the roast was progressing normally) by switching to closed-circuit every few minutes.

Dr. Zworykin, who considered the device important enough to present in person, said that though the research laboratory could not guess how soon the device might be placed on the market, or what the price would be, he could see no reason why the cost of the control unit and camera should be greater than that of the TV receiver itself.

The applications to education, business, and low-cost industrial uses are almost too obvious to need mention. Dr. Zworykin mentioned especially the small shop or store, where the sole proprietor might be doing work away from the store area (for example, at a service bench). The viewer could keep him informed of all customers, saving needless trips to the front of the store.

Speech stretchers, home-TV closed-circuit systems, and internal-focus picture tubes made the greatest impression on the less scientific of the convention's visitors. Engineers and physicists were attracted even more by information theory, computer problems, telemetry, and instrumentation. Acoustics and medical electronics also received more attention than at any previous convention. While nothing startling came out of any of those sessions, it is safe to say that they are the groundwork for new discoveries and new inventions that will be announced at future IRE meetings. END

RADIO-ELECTRONICS



**THE NEW WONDER OF ELECTRONIC CONTROL CAN BE YOURS FOR PRACTICALLY NOTHING**

You get the complete outfit, including cabinet, 3 tubes (12SL7GT, GL-5662, GL-5610) and wiring diagram.

Single—each \$5.99  
Lots of 3—each **\$4.98**

Can easily and quickly be modified for Electronic Remote Control of Transmitters, Turn Radio and TV on and off; Open and Close Garage Doors from your car, etc. Schematic diagram included at No Extra Cost.

**MANUEL KLEIN CO.**

### RED HOT ELECTRIFYING BARGAIN! THYRATRON REMOTE CONTROL

**SERVICEMEN - HOBBYISTS - HAMS - EXPERIMENTERS - RADIO SCHOOLS**

Here's the chance of a lifetime to own a genuine Thyatron Electronic Remote Control of your own at a fraction of its regular price! This mighty handoff (only 5 3/4 x 5 x 3 1/4) of miracle control can be made to perform hundreds of practical, fascinating feats of remote control. A complete schematic showing the circuit is included with each unit.

**IT'S A STEAL!** Buy it just for the parts alone. Take it apart! Look what you get: Valuable parts and tubes galore that you can so easily use in any other radio, Amplifier, etc.—or for experimenting.

#### LOOK AT ALL THE PARTS YOU GET

- |                               |                             |                        |
|-------------------------------|-----------------------------|------------------------|
| • 12SL7GT                     | • 3K-ohm—1 Watt Wirewound   | • Filament Transformer |
| • GL-5610                     | • 925-ohm—1 Watt Wirewound  | • Control Relay        |
| • GL-5662                     | • 8K-ohm—10 Watt Wirewound  | • Switch—SPST          |
| • 16mfd @ 150 volts           | • 2600-ohm—1 Watt Wirewound | • Pilot Lamp, Type 44  |
| • 1Mfd @ 200 volts            | • 75K-ohm—1/2 Watt          | • Neon Bulb—NE-2       |
| • .02Mfd @ 200 volts          | • 1 Megohm—1/2 Watt Carbon  | • Control Housing      |
| • .25Mfd @ 600 volts          | • 150K-ohm—1/2 Watt         | • Bottom Plate         |
| • 125Mfd @ 600 volts          | • 1 Megohm—1/2 Watt Carbon  | • Escutcheon           |
| • 125 Ohm Variable Control    | • 47K-ohm—1/2 Watt Carbon   |                        |
| • 600 Ohm Calibration Control | • 2 Megohm—1/2 Watt Carbon  |                        |
| • 1 Megohm—1/2 Watt           | • 1 Megohm—1/2 Watt Carbon  |                        |
|                               | • 1 Megohm—1/2 Watt Carbon  |                        |
|                               | • 24 ohm—2 Watt Wirewound   |                        |

**HOW CAN YOU LOSE?** These parts are certainly worth THREE TIMES this amazing low cost. The General Electric Thyatron Type GL-5662 tube alone costs \$3.30 wholesale. Besides consider the plate sensitive relay, filament transformer, tubes, condensers, resistors (many of them 1% precision). No matter how you use it, here's a great, great red-hot Bargain. Operates on 115V AC.

94 Chambers St., New York 7, N. Y.

REctor 2-6460



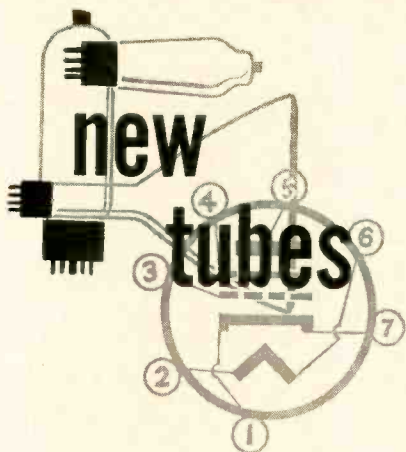

HERE are additional details on the new G-E internal-magnetic-focus picture tube described in the "Radio Month" column of the May issue. The first type in production—the 21JP4—is an all-glass rectangular tube with standard 70° deflection and a 19½ x 13¾-inch picture. The 21JP4 has an external conductive coating and standard 5-pin duodecal basing. The maximum ultor-voltage rating is 20,000, but the value recommended for TV operation is 14,000 ± 2,000 volts. The built-in Alnico-V focusing and ion-trap magnets will give optimum spot size and brightness over this range.

A small magnetic shunt can be mounted on the neck of the picture tube for extremely critical focusing, or for operation at ultor voltages higher or lower than the recommended values.

The 5AW4 announced last month by CBS-Hytron is a full-wave, filament-type rectifier intended as an extra-heavy-duty replacement for the 5U4-G. In addition to higher average and peak current ratings than the 5U4-G, the 5AW4 has a heavier filament and a new plate structure which reduces the possibility of plate-filament shorts when the set is operated on its side. Tentative ratings of the 5AW4 are: Filament, 5 volts at 4 amp; average d.c. output current, 250 ma max.; peak d.c. output current, 750 ma.

Both CBS-Hytron and Sylvania have announced the 6T4, a 7-pin miniature

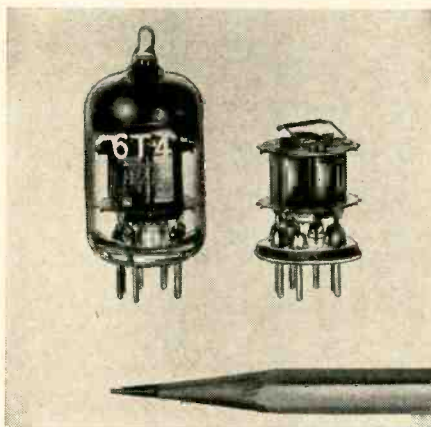

6T4 miniature u.h.f. oscillator triode.

JUNE, 1953

# IT'S HERE! The NEW IMPROVED DAVIS SUPER-VISION

ALL-CHANNEL TELEVISION ANTENNA  
For FRINGE AREA and DX

Brings in the Signals STRONG  
and CLEAR up to 125 Miles and  
More Away from the Station

The NEW DAVIS  
SUPER-VISION  
has been  
WIND-TESTED  
and  
WEATHERIZED

...STURDY BUILT and  
STRENGTH-INCREASED  
so it will stand the gaff in  
any part of the country

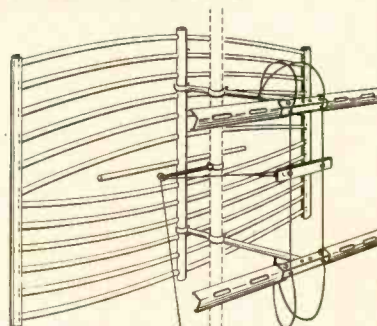

"The Original Antenna Sold With A  
Money-Back Guarantee"

Built By America's Fastest Growing  
Antenna Manufacturer

AT YOUR JOBBERS, or MAIL COUPON TO:

DAVIS ELECTRONICS 1-34  
4313 West Magnolia Blvd., Burbank, California  
SIRS: RUSH INFORMATION TO ME AS CHECKED  
BELOW:  
 Send Free Technical Data on new SUPER-  
VISION ANTENNA.  
 Send Name and Address of NEAREST JOBBER.  
Name \_\_\_\_\_  
Street \_\_\_\_\_  
City \_\_\_\_\_ State \_\_\_\_\_



**IT'S TERRIFIC!**

**GREYLOCK'S**

**BIG NEW BARGAIN FLYER**

**JUST OUT!**

for every

- RADIO & TV SERVICEMAN
- AMATEUR
- EXPERIMENTER
- TECHNICIAN

Shop the NEW GREYLOCK Bargain Flyer #200-1 and save a bundle of DOLLARS!

**Typical Greylock Values:  
Picture Tube Specials**

10BP4.....\$12.00	14CP4.....\$16.80
12LP4.....\$14.40	16RP4.....\$19.20
14BP4.....\$16.80	16KP4.....\$19.20

F.O.B. NYC.

Full 1-year Guarantee from date of Purchase.

FREE — Big 68-page GREYLOCK 1953 CATALOG "The essential Buying Guide" of the Radio & TV Industries — free to all purchasers from our new Bargain Flyer.

**GET YOUR FREE COPY TODAY!**

**GREYLOCK**  
ELECTRONICS SUPPLY CO.  
115 Liberty St., N. Y. 6  
Phone BE. 3-0224

GREYLOCK ELECTRONICS Dept. C-6  
115 Liberty St., N. Y. 6  
Send FREE Bargain Flyer #200-1 at once to:  
Name \_\_\_\_\_  
Address \_\_\_\_\_  
City \_\_\_\_\_ State \_\_\_\_\_

## SAVE MONEY ON INSTRUMENTS!

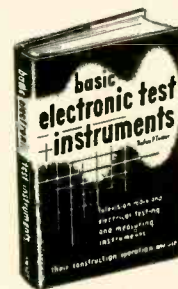

How to test with fewer instruments . . .

How to use old instruments in new ways . . .

How to select the instruments you need . . .

How to evaluate instrument readings and put them to practical use.

### BASIC ELECTRONIC TEST INSTRUMENTS

by Rufus P. Turner

254 pages, 171 illus., Price \$4.00

Written especially for servicemen, amateurs and experimenters, this new book is a complete training course in instruments. Over 60 instruments—from the most modern TV pattern generators to grid-dip oscillators and special-purpose bridges—are fully explained. Work-saving short cuts are outlined. You learn how to put your old instruments to new uses and thus avoid buying costly new ones. Tells all about current and voltage meters; ohm-meters and V-O-M's; V-T voltmeters; power meters; oscilloscopes; r-f test oscillators; signal tracers; tube testers; TV linearity pattern generators and dozens more.

#### READ IT 10 DAYS . . . at our risk

Dept. RE-63, Rinehart Books, Inc.,  
Technical Division,  
232 Madison Ave., New York 16, N.Y.

Send Turner's BASIC ELECTRONIC TEST INSTRUMENTS for 10-day examination. If I decide to keep book, I will then remit \$4.00 plus postage in full payment. Otherwise, I will return book postpaid and owe you nothing.

Name \_\_\_\_\_  
Address \_\_\_\_\_  
City, Zone, State \_\_\_\_\_





## Sangamo's dry tubular electrolytic capacitor *that fits anywhere*

Type MT and MTD electrolytic capacitors, "Chieftains" of the Sangamo line, are contained in hermetically-sealed round aluminum cans and are tightly encased in heavy cardboard sleeves on which polarity is clearly indicated. Double, pure paper spacers assure adequate breakdown characteristics and all sections are tightly held in place within the container. Multiple staking connects the terminal tabs to

the electrodes, providing permanent low resistance contact throughout the life of the capacitor. The low voltage units are supplied with etched cathodes to maintain uniform capacity when the capacitor is subjected to heat and high ripple currents. The small size of the "Chieftains" makes them a "natural" for application in tight spots beneath a chassis, and the bare tinned-copper wire leads make them easy to mount.



*Arrowhead*



*Warrior*



*Mohican*

Your own trial-use will convince you that new standards of dependability and longevity have been built into Sangamo Electrolytics. Order from the new Sangamo Capacitor Catalog No. 800A which is yours for the asking, and without obligation.

*Those who know... choose Sangamo*



**SANGAMO ELECTRIC CO.** MARION ILLINOIS

### Used Recording Tape (plastic base)



1.99 for 7" 1200 foot.  
1.09 for 5" 670 ft.  
.59 for 4" 300 ft.  
.29 for 3" 150 ft.  
(plastic reel included with all above sizes)

Money cheerfully refunded if you do not find this tape cleanly erased and as good as new. (If you are skeptical and from Missouri send us 12¢ in stamps and we'll roll you a sample).

New empty plastic reels in boxes for easy labeling 3"-10¢; 4"-22¢; 5"-24¢; 7"-30¢ each. EMPTY BOXES. 3"-3¢; 4"-5¢; 5"-5¢; 7"-10¢.

• We carry new recorders, recording blanks, tape, tape recorders, etc., at large savings. PLEASE INCLUDE SUFFICIENT POSTAGE.

**COMMISSIONED ELECTRONICS CO.**

2503 Champlain Street, N.W., Washington, 9, D.C.

### PRES-PROBE CONDENSER TESTER



**Finds Intermittent  
Condensers Instantly**

Pres-probe's sliding tip with variable resistance prevents condenser heating. Tests with power on. Requires no adjustment. Stops guesswork. Saves time. Convenient probe size (7 1/8" long). Satisfaction guaranteed.

See Your Dist. or Order Direct

**PRES-PROBE CO.**

4034 N. Sixth St., Milwaukee 12, Wisc.

**795**  
NET  
Postpaid  
U. S. A.

triode oscillator for u.h.f. television receivers. The 6T4 can deliver 160 mw at 950 mc with 100 volts on the plate and 4 volts of bias across a 10,000-ohm grid leak. Plate current under these conditions is 22 ma, and grid current 0.4 ma. The 6T4 has a 6.3-volt, 0.225-amp heater. Basing is given in the accompanying diagram.

Relief from u.h.f.-converter interference may be in sight with the introduction of the 6AJ4 u.h.f. amplifier triode. The 6AJ4, announced by General Electric, Raytheon, and other manufacturers, is a 9-pin miniature grounded-grid amplifier with a power gain of 7 db and a noise figure of 15 db at 900 mc.



G-E 6AJ4 grounded-grid u.h.f. triode.

Recommended operating conditions and characteristics in u.h.f.-amplifier service: Plate voltage, 125; plate current, 16 ma; cathode resistor, 68 ohms; gm, 10,000  $\mu$ hos;  $\mu$ , 42; plate resistance, 4,200 ohms (approx.); bandwidth, 10 mc. In u.h.f. service all five grid pins (see basing diagram) should be grounded to reduce lead inductance.

The Sylvania 6V3 is a new 9-pin miniature damper tube that has been incorporated in several late 1952 and 1953 TV receivers. The 6V3 has exceptionally high heater-cathode insulation (6,750 volts peak) made possible by bringing the cathode connection to a top cap, to handle the large-amplitude

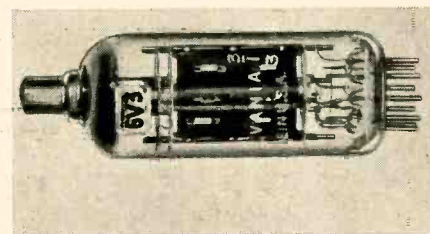

Sylvania 6V3 miniature damper diode.

flyback pulses in modern high-efficiency horizontal sweep circuits. Heater rating is 6.3 volts at 1.75 amp, and the 6V3 can supply a boosted B plus load of 135 ma. See the accompanying diagram for base connections.

Sylvania has introduced a new horizontal-deflection stabilizer tube—the 40B2—with different current and voltage ratings than the earlier 40A1. These tubes contain a special nonlinear resistance element which can be used

RADIO-ELECTRONICS





# The Picture Tells the Story

TV Antennas exist for one reason — to provide a clear, strong, sharp picture!

TRIO ZIG-ZAG\* TV Antennas perform so well in this all important respect that they are America's most wanted.

Yes, a picture — the TV picture — tells the TRIO story more eloquently than anything else! Where all other antenna designs fail, high gain TRIO ZIG-ZAG TV Antennas consistently lock in sharp, clear pictures — from Maine to Texas, in city or country!

TRIO TV antennas look different, work different — provide a magnificent DIFFERENCE in picture quality!

\*Patent Pending



## Also in the Picture

The TRIO Rotator and Direction Indicator are the most dependable ever built. Developed after \$50,000. research. Fully guaranteed for a FULL two years!

\*New insulating sleeve, with longer leakage path and elimination of air, does away with assembly errors — elements cannot short out. For maximum strength, new steel, electro-plated element clamps have been introduced.

## Best Buy in UHF Antennas LOW IN COST — HIGH IN PERFORMANCE

### NEW TRIO UHF BOW-TIE with reflector

Sturdy, broadband antennas of uniformly high gain that have been thoroughly field tested. Phasing strips installed. pre-assembled — a jiffy to attach reflector screen. Available in one, two and four bay models. Usual high-quality TRIO construction.

Model UBT-4  
Supplied With  
4 Foot Mast



Model UBT-1  
Supplied With  
2 Foot Mast

Model UBT-2  
Supplied With  
3 Foot Mast

## NEW TRIO UHF MULTI-CHANNEL YAGI ANTENNAS

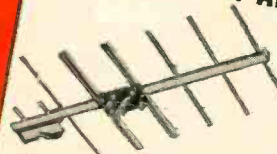

Broadband yagis developed by TRIO now successfully applied to UHF. Four models cover all UHF channels, rarely any one area.

These high gain six element yagis have sharper directivity, thereby eliminating ghosts. Thoroughly field tested. Entire antenna mounted in front field of reflectors or antenna elements. Mast clamp supplied. Completely assembled.

- Model 6-UBY 14-26 for Channels 14-26
- Model 6-UBY 27-42 for Channels 27-42
- Model 6-UBY 43-60 for Channels 43-60
- Model 6-UBY 61-83 for Channels 61-83



# TRIO MANUFACTURING CO.

GRIGGSVILLE, ILLINOIS



# STANCOR *Exact* REPLACEMENT

## FLYBACK TRANSFORMERS

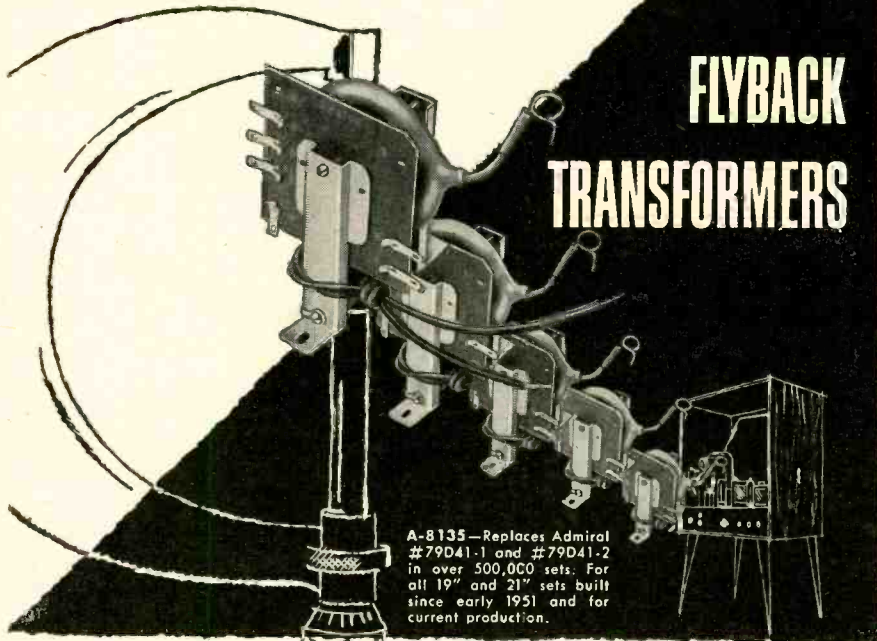

**A-8135**—Replaces Admiral #79D41-1 and #79D41-2 in over 500,000 sets. For all 19" and 21" sets built since early 1951 and for current production.

Ask your distributor for Stancor bulletins 461 and 465, listing replacement applications of these transformers—or write directly to Stancor for your free copy.



**A-8132**—Replaces Muntz #TO-0031; used in 1951 and 1952 production. Covers approximately 300,000 Muntz sets.

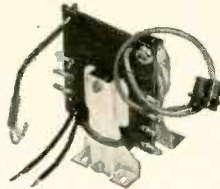

**A-8136**—Replaces Philharmonic #80-263, #80-265-2 and #80-265. Used in all sets built since early 1951 including AMC, Pathe, Silvertone, and other "private label" sets.

Stancor Transformers are listed in Howard W. Sams' Photofact Folders, John W. Rider's Tek-Files, and the Howard Company's Counterfacts.

### STANDARD TRANSFORMER CORPORATION



3592 ELSTON AVENUE • CHICAGO 18, ILLINOIS  
EXPORT SALES—  
Roburn Agencies, Inc., 39 Warren St., New York 7, N.Y.

### NEW DESIGN

as the cathode resistor of the horizontal output tube. The nonlinear resistance characteristic holds the total cathode current constant over a wide range of line-voltage variations. This stabilizes the horizontal sweep and high-voltage outputs, and makes it possible to get full picture width and brightness at low line voltage without exceeding the maximum ratings of the output tube when the line voltage is normal or high. The 40B2 is designed to maintain an average current of 150 ma at a 40-volt drop. Both types have a 5-pin octal

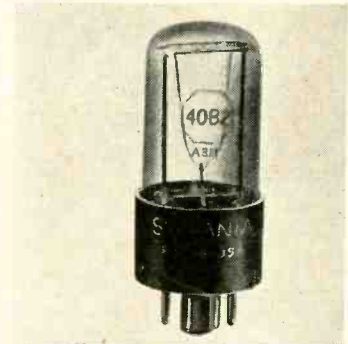

Sylvania 40B2 sweep-regulator tube.

base, with the resistance element connected to pins 2 and 7.

### Special-purpose tubes

Du Mont announces two new 10-stage photomultiplier tubes of special value in nuclear-physics work. The 6291 and 6292 have identical straight-line dynode structures which give maximum physical separation between photocathode and anode, and differ only in diameter.

The new photomultipliers are designed to have higher stability over long periods than previous types, through the use of silver-magnesium for the dynode elements and improvements in the internal structure. The photocathode has an average sensitivity

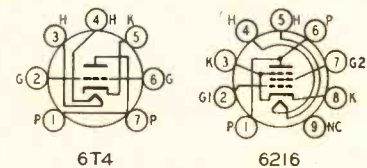
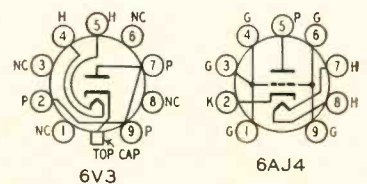

#### MINIATURES

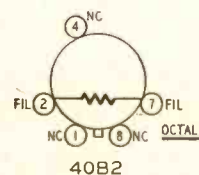

Basing diagrams of new tube types.

RADIO-ELECTRONICS

OVER 50,000 TECHNICIANS HAVE LEARNED

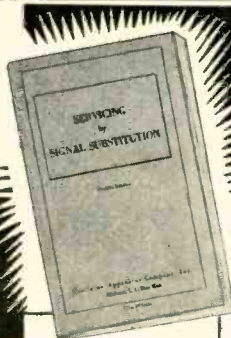

HOW TO GET THE MOST OUT OF BASIC TEST EQUIPMENT

ONLY 40¢

103 pages. Invaluable information that will help you re-double the value of your basic test equipment.

for A.M. - F.M. - TV

**'SERVICING BY SIGNAL SUBSTITUTION'**  
A BEST SELLER FOR OVER 12 YEARS!  
(NEW, UP-TO-DATE, 12th EDITION)

The Modern, Simplified, Dynamic Approach to Receiver Adjustment & Alignment Problems.

- ★ Nothing complicated to learn
- ★ No extra equipment to purchase
- ★ Universal... non-obsolescent
- ★ Employs only Basic Test Instruments

Ask for "S.S.S." at your local Radio Parts Jobber or remit 40¢ in small stamps or coin directly to factory.

**PRECISION APPARATUS COMPANY, INC.**  
92-27 HORACE HARDING BLVD., ELMHURST 4, N. Y.



of 60  $\mu$ amp per lumen, with maximum response in the visible portion of the light spectrum.

While their small size (the 6291 is only 1½ inches and the 6292 is 2 inches in diameter) makes them specially suitable for portable scintillation counters, the new tubes have numerous other applications in astronomy, biology, and industrial electronic equipment. Where maximum gain is the prime requirement the tubes can be operated at dynode potentials as high as 190 volts per stage.

The CBS-Hytron 6216 is a new 9-pin miniature beam-power amplifier developed primarily as a filter-reactor tube for airborne and mobile equipment. In the circuit shown it provides the same filtering as a 12-henry, 100-ma, iron-core choke with a d.c. resistance of 350

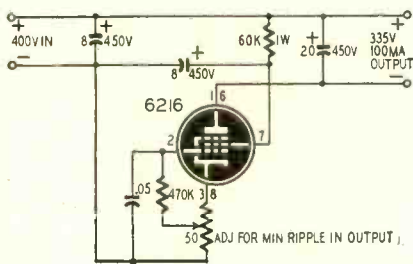

Circuit for 6216 filter-reactor tube.

ohms, at a tremendous saving in weight and space. These characteristics may also make it popular in TV receiver circuits which use the audio output tube as a combined dropping resistor and isolating filter between the full B supply voltage and the 135-volt line to the i.f.'s and other stages.

The 6216 has a 6.3-volt, 1.2-amp heater, with maximum heater-cathode rating of 150 volts. The output ripple in the filter-reactor circuit shown is approximately 210 mv.

The 6216 can also be used as an audio amplifier, class-C oscillator-amplifier, or frequency multiplier. Basing is shown in the diagram. END

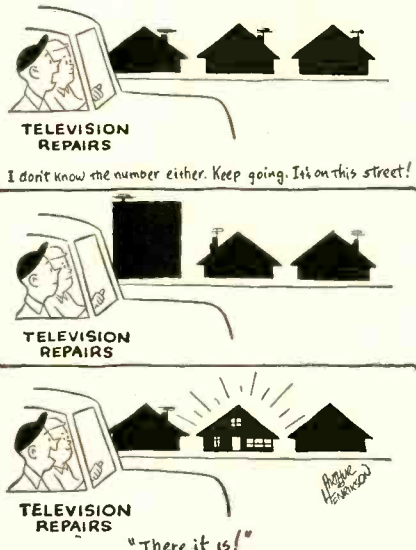

JUNE, 1953

# NOW! TEST, SERVICE 12 or 6 volt AUTO RADIOS



Only 3% Ripple at Full Load

Completely variable output makes it possible to test equipment under any voltage input condition. Provides filtered adjustable DC voltage for testing and servicing 12 volt and 6 volt auto radios from AC lines...no special connecting line needed. Operates electronic equipment used on trucks, tanks and other mobile units and low voltage devices. Utilizes Superior Powerstat Voltage Control (Model 10) for extremely fine voltage adjustments.

Another Better-Than-Rated EPL Product!

Write for Free Bulletin

**ELECTRO PRODUCTS LABORATORIES**

4501-Rc North Ravenswood Ave. Chicago 40, Ill.

CANADA: ATLAS RADIO CORP., LTD., Toronto, Ont.

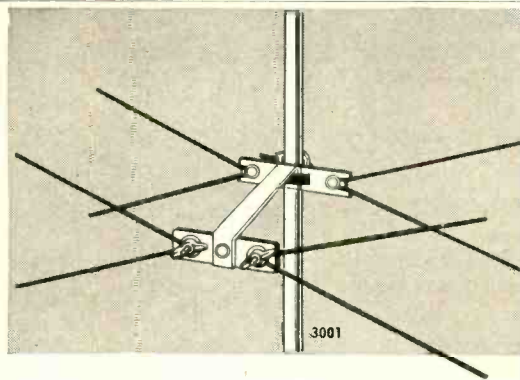

# THE BASIC UHF ANTENNA

No matter what the specific requirement of an installation is—a Taco Bow Tie will fill it...

Taco's Bow Tie is the proved top performer. Now you can carry a single antenna with assurance that it will fill all your UHF needs with the easy adaptation of screen-type reflectors.

Fill all your needs with the best UHF antenna—the Taco Bow Tie.

*Best for  
any UHF  
installation*

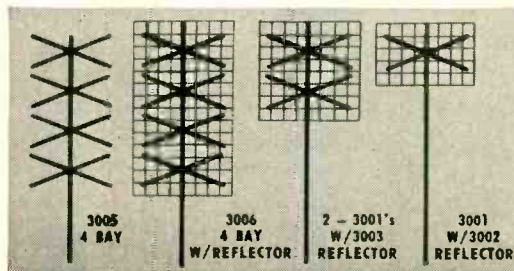

**TACO**

Technical Appliance Corporation,  
Sherburne, N. Y.

In Canada: Hackbusch Electronics, Ltd.,  
Toronto 4, Ont.

Get the complete story on the  
Taco UHF Team from your Taco  
distributor.



Linearity adjustments in the palm of your hand...

**with the CREST TV BAR GENERATOR**  
Provides actual bar pattern on TV receiver screen

A highly efficient, portable, lightweight unit provides servicemen with the sensibly engineered Television Bar Generator. On the spot accurate linearity adjustments.

- Can be used when no stations are on the air.
- Produces horizontal or vertical bars.
- Adjustable number of vertical and horizontal bars.
- Simple self-powered plug-in unit . . . fits picture tube . . . no tools required for this 10-second installation.
- Vest pocket size . . . stow conveniently in tool box.



Model MA-4

**\$10<sup>95</sup>**  
LIST PRICE

When ACCURATE voltage boost is required  
**CREST LVB-117**

The LVB 117 is engineered to safely and accurately restore required voltage to any TV set or electrical appliance. Insures full strength and proper width and height of TV picture when low line voltage weakens and shrinks picture. Corrects low line voltage sync and oscillator drift troubles.

6 unique features for the ultimate in accurate voltage boost!

- ✓ 350-Watt Rating . . . ample for most requirements on line voltages from 90 to 135 volts.
- ✓ Simple External Plug-in . . . 10-second installation.
- ✓ Automatically Operated . . . turns on and off with set or appliance.
- ✓ Multi-Tap Selector Switch . . . permits exact voltage boost.
- ✓ Overload Fuse Protection . . . protects against unsafe line voltage increase.



**\$17<sup>95</sup>**  
LIST PRICE

Now available in the CREST LVB "Jr."  
Single Switch Control . . . for 10 volt boost or straight-thru line. 350 watts rating.

- |                                |                                  |
|--------------------------------|----------------------------------|
| Inadequate picture width       | Tube failures                    |
| Insufficient height            | Low sensitivity in fringe areas  |
| Weak picture brightness        | When caused by low line voltage. |
| Poor sync and oscillator drift |                                  |

Catalog No. 3021

**\$9<sup>75</sup>**

LIST PRICE

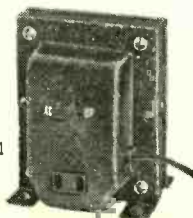

See us at the Electronics Parts Show, Chicago, Booth 120

**CREST**

LABORATORIES INC.

84-11 Rockaway Beach Blvd., Rockaway Beach, N. Y.

ANNOUNCING THE NEW . . . . .

*Scala*

**VOLTAGE DOUBLER PROBE (BZ-4)**

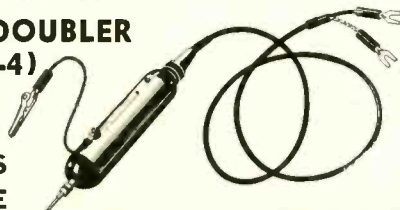

**NO PROBE MARKETED IN THIS PRICE FIELD OFFERS A RANGE ANYWHERE NEAR THE RANGE OF THE BZ-4 . . . \$10.75**

Check with your local distributor or write about the BZ-4 and the other Scala probes:

- |  |                                 |
|--|---------------------------------|
| BZ-1 Signal Tracing Probe, \$9.75        | BZ-2 Low Capacity Probe, \$9.75 |
| BZ-3 100:1 Voltage Divider Probe, \$9.75 |                                 |

**SCALA RADIO CO. 2814 19th St., San Francisco 10, California**

**NEW YORK SEES FILMS**

Members of the Associated Radio-Television Servicemen of New York (City) heard preliminary plans for an extended educational program for the city, state, and possibly national organization at a well attended meeting Thursday, April 16.

During the meeting Zenith representatives showed two films, "Fog Over Portland", summary of the difficulties which accompanied the commencement of commercial u.h.f. TV broadcasting in the United States, and "Phone-vision", a descriptive piece showing how Zenith's proposed subscription TV system would work.

**EASTERN GROUPS MEET**

A two-day conference of TV service group representatives was held April 11 and 12 at Paterson, N. J. The conference was organized by a joint meeting (at Trenton, March 8) of representatives of the National Electronics and Service Dealers Associations (NETSDA), the Federation of Radio Servicemen's Associations of Pennsylvania (FRSAP) and the Radio Associations of New Jersey (RANJ).

The conference was attended by more than 30 delegates and visitors, and discussed such problems as flat-rate racketeering competition, retail sales by jobbers, the service contract, licensing for control or revenue, and other points of importance to the service dealer. Papers on business insurance, credit bureaus and u.h.f. were heard by the assembled service dealers.

The April 12 meeting passed resolutions urging the establishment of local associations; interchange of information through such associations; and establishing a plan for a sustained public relations program, to be drafted by the conference secretary. The broadcasting industry was thanked for the favorable notice taken of the television service industry by broadcasters, and an expression of appreciation was drafted to the New Jersey group and the Tennessee delegates for their actions in laying the groundwork for association federation in their states.

**LICENSE BILL IN PA.**

A new proposal to license radio and TV technicians has been introduced in the State Legislature by Representative Vincent F. Guttendorf of Luzerne.

Two bills were introduced. Under the terms of HB 838, a state board of examiners of radio and TV service technicians would be set up and their duties defined. A companion bill, HB 839, would regulate TV and radio service.

According to Dave Krantz, chairman of the Federation of Radio Servicemen's Associations of Pennsylvania, the new bill is an improvement on one presented to the Legislature last year but not acted on, in that it provides for more participation by the service technicians and more representation by them on boards established by the acts. The State Federation is supporting the bills, Mr. Krantz stated.

RADIO-ELECTRONICS



# TeleSound CORPORATION CUSTOM-BUILT TV CABINETS

Direct from MANUFACTURER to YOU!

**WHY PAY MORE? COMPARE!** Don't be misled by other offerings of cabinets somewhat similar to these original TELESOUND creations in outside appearance—but NOT in quality! TeleSound Cabinets are massively constructed, fully reinforced, smartly styled in the modern manner, polished to a high gloss piano finish, very rich and substantial in appearance. Compare price AND quality—then buy with confidence from TeleSound. Our Factory-to-You shipments, at lowest wholesale prices, are your guarantee of satisfaction!



**MODEL 500** H:25", D:21½", W: 25". 50 lbs. **\$4200**

As above but for 24" & 27" CRT. Have removable front frames and recessed chassis panels.

24" Model H:31" D:24", W:27" **\$5950**  
27" Model H:31" D:24", W:31"



**MODEL 800**  
G: 40½", D: 24", W: 25". 100 lbs. **\$8250**

All TeleSound Cabinets illustrated are available in Ribbon Stripe Mahogany. Model 200 also available in Walnut. All cabinets can be had in Blonde Korina at 10% additional. These cabinets are custom built and drilled to fit standard 630 type TV chassis. We can supply them with undrilled panel to fit any other chassi you specify. **NEW COMPLETE ILLUSTRATED TELESOUND CABINET CATALOG JUST OUT! SEND TODAY FOR YOUR FREE COPY!**

\*\*\*\*\*  
 \* AUTHENTICALLY STYLED Pagoda Credenza with a pair of removable matching side cabinets suitable for built in bar, record player, radio, etc. A complete home entertainment center. This authentic piece is the ultimate in superior craftsmanship—a luxurious centerpiece that is sure to be the center of attraction in your home!  
 \* Center Piece: H:36", W:42" D:24"  
 \* End Pieces: H:36", W:18" D:22"  
 \* **MODEL 1300 Pagoda Style Complete with Two Side Cabinets ...\$475.00**  
 \* Model 1300C Centerpiece only .....\$237.50  
 \* Model 1300L Left End Piece \$118.75  
 \* Model 1300R Right End Piece \$118.75  
 \* Model 1350 Same as above except with straight top in place of the pagoda style top illustrated above.  
 \*\*\*\*\*



**MODEL 200** H:40¼", D:22½", W: 25¼", Wt. 60 lbs. **\$4950**



**MODEL 250** H:40¼", D:22½", W:25¼". Wt. 60 lbs. **\$5750**



**MODEL 1050** H: 40", W: 32½", D: 23½". 100 lbs. **\$8900**  
Adaptable for 27" Picture Tube.

**STANDARD BRAND PICTURE TUBES**  
Full ONE-YEAR Guarantee

17" 17BP4A	\$28.90
20" 20CP4A	\$38.05
21" 21EP4A	\$40.25
24" 24BP4	\$76.00
27" 27GP4 (Electro magnetic)	\$90.00

ACCLAIMED BY TELEVISION TECHNICIANS!

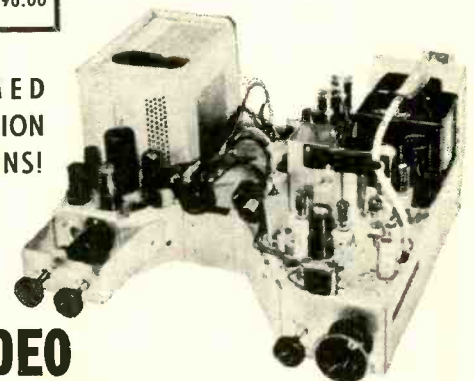

**VIDEO 630 TV CHASSIS \$14950**  
Super-DeLuxe—operates all 16" to 24" Picture Tubes—Extra power for fringe area reception. OUR LOW PRICE..... Less Pix Tube

- VIDEO 630-DX TV Chassis ..... \$159.50
- SPECIAL! VIDEO 530DXC-27 TV Chassis** For 27" Picture Tube **\$189.50**
- TECHMASTER Model C-30 TV Chassis ..... \$149.50
- TECHMASTER Model 1930 TV Chassis ..... 179.50
- TECHMASTER Model 2431-P TV Chassis ..... 199.50
- TECHMASTER Model 2430-9 (only 630 type 27" chassis on the market today!) ..... \$262.50**

Please include 25% deposit with orders, balance C.O.D. All shipments F.O.B. NYC. Prices Subject to change without notice.

**TeleSound CORPORATION** "Designers and Manufacturers of Custom TV and Radio Furniture"  
421 West 28th Street New York 1, N. Y.  
Phone: WI 7-0719

**FAMOUS SUPER-POWERED VIDEO 530DX TV CHASSIS**

High sensitivity, for excellent performance in both fringe and strong signal areas. Complete with receiving tubes, ready to play. OUR LOW PRICE.....

**\$13950** Less Pix Tube

**TELESOUND "PACKAGE DEAL"**

Save a bundle of dollars! Order the TeleSound Cabinet of your choice in combination with either Video or Regal TV chassis listed above, 12" PM Speaker, and your choice of Picture Tube, at the MONEY-SAVING prices shown below.

CABINET STYLE	Combined with Video or Regal TV Chassis, 12" Speaker, and				
	17" CRT	20" CRT	21" CRT	24" CRT	27" CRT
200	\$211.25	\$220.00	\$222.25	.....	.....
250	\$218.75	\$227.75	\$229.75	.....	.....
500	\$204.00	\$212.95	\$215.00	\$266.50	\$329.00
800	\$242.50	\$251.50	\$253.50	.....	.....
1050	\$248.75	\$257.50	\$259.75	\$294.50	\$357.00
1300	\$615.25	\$624.25	\$626.50	\$661.25	\$723.75

FOR OTHER TV CHASSIS ADD: For Video 630, \$10; for Video 630DX, \$20; Techmaster C-30, \$10; 1930, \$40; 2431-P, \$60. (27" CRT Cabinets use Video Model 530DXC-27. For Techmaster 2430-9 add \$73.00.)



# new

## MANUALLY-OPERATED

### Three-Speed Phonomotors by General Industries

#### MODEL SS (2-pole motor)

Very compact 3-speed phonomotor incorporating vertical idler shifting principle. Idler wheel drives the turntable directly from appropriate step on motor shaft. Moving shift lever to "OFF" position automatically disengages idler wheel from motor shaft during non-operating periods.

Features include ribbed mounting plate, oilless bearing and dynamically-balanced rotor. Turntable shaft revolves with turntable and is grooved for turntable clip. Furnished with 8" turntable.

Dimension: Length: 5"; Width:  $4\frac{23}{32}$ "; Depth:  $2\frac{15}{32}$ " below mounting plate.

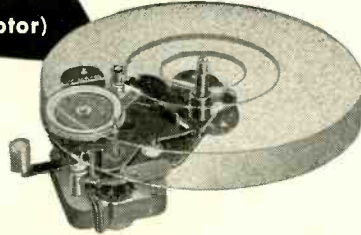

#### MODEL DSS (4-pole motor)

For applications in which compactness is secondary to need for absolute minimum of stray field radiation. Ideally suited for magnetic pickups.

Speed change is accomplished by vertical movement of idler wheel to appropriate diameter of motor shaft for desired turntable speed. Moving shift lever to "OFF" position automatically disengages idler wheel from

motor shaft, and cuts off the current to the motor.

Features include precision construction throughout, oilless motor and turntable bearings, dynamically-balanced rotor. Furnished with 10" turntable.

Dimensions: Length:  $6\frac{5}{8}$ "; Width:  $6\frac{1}{16}$ "; Depth:  $2\frac{1}{32}$ " below mounting plate.

Both models available for immediate delivery. Write for quantity price quotations on these and other G.I. phonomotors.



**THE GENERAL INDUSTRIES CO.**  
DEPARTMENT MK • ELYRIA, OHIO

**New 5 in 1  
MULTITESTER**  
for CAPACITORS  
RESISTORS  
VOLTAGE

Employs DC Power Supply, Glowtube and Oscillator which:

1. Detects any shorted, open or leaky capacitor
2. Estimates resistance from 0 to 200 megohms
3. Measures capacity from .001 to 50  $\mu$ f
4. Indicates AC Voltage from 55 to 550 volts
5. Indicates DC Voltage from 70 to 700 volts

**FULLY GUARANTEED**

Send Cash or Money Order to:  
**BARRETT ELECTRONICS CO.**  
4248 1/2 WEST 104 STREET  
INGLEWOOD, CALIFORNIA

**\$595** Post Paid

### EASY TO LEARN CODE

It is easy to learn or increase speed with an Instructograph Code Teacher. Affords the quickest and most practical method yet developed. For beginners or advanced students. Available tapes for beginner's alphabet to typical messages on all subjects. Speed range 5 to 40 WPM. Always ready—no QRM.

#### ENDORSED BY THOUSANDS!

The Instructograph Code Teacher literally takes the place of an operator-instructor and enables anyone to learn and master code without further assistance. Thousands of successful operators have "acquired the code" with the Instructograph System. Write today for convenient rental and purchase plans.

**INSTRUCTOGRAPH COMPANY**

4701 Sheridan Rd., Dept. RC, Chicago 40, Ill.

### AGAINST LICENSING

The Northeast Television Service Dealers Association of Philadelphia has rejected the pending state bill to license TV technicians. Mr. Albert Haas, spokesman for the group, stated that the bill, HB 839, had been read at a meeting, and that the members felt there were too many loopholes in the wording.

### U.H.F. PROBLEM

The manner in which the local u.h.f. situation was being used for advertising purposes was the subject of the March meeting of the Radio and Television Association of Springfield and Vicinity (Ohio).

A letter pointing out the difficulties of the dealer and technician faced with the problem of selling sets in spite of alarmist statements about color and misleading claims on indoor antennas was sent to local distributors, newspapers, broadcast stations, and chambers of commerce. It summarized the situation existing at the time (March) and offered the following suggestions to local advertisers and publishers or broadcasters of advertising copy:

1. Keep to the facts!
2. U.h.f. is not here (in Springfield—*Editor*) today.
3. Stop keeping the public in suspense by saying it's "gonna" be on anytime now; give us a specific date instead.
4. Think of your numerous fringe viewers. Remind them that built-in antennas are for metropolitan use only, and usually not effective 25 miles from the station.
5. When advertising u.h.f. sets, antennas, attachments etc., state calculated coverage also.
6. Refrain from advertising "trouble-free TV", but instead inform the viewer that maintenance (don't call it repair) will be necessary on a TV set and amounts to a yearly average of about \$40.00 (estimated).
7. For such maintenance, refer the viewer to a franchised dealer. Warn him to stay away from wildcat outfits which have neither the capital nor the equipment to do a serious job, and usually get their victims by advertising night and Sunday service, often at ridiculously low fees.

### ESFETA ELECTS

The annual meeting of the Empire State Federation of Electronic Technicians took place at Binghamton, N. Y., April 19.

The new slate of officers is: Max Leibowitz, ARTSNY, New York City, president; Jack Wheaton, Long Island Radio Technicians Guild, vice-president; Chas. Kohl, UETA, Kingston, treasurer; Wayne Shaw, RSA, Binghamton, secretary; and Andrew Wentworth, RTG, Rochester, sergeant-at-arms.

Organizational and other problems were discussed, and arrangements made for a technical lecture program, to include material on transistors, u.h.f. and color TV.

RADIO-ELECTRONICS



# Automatic CUSTOM BUILT Radio



## MANUAL TUNING MODELS

These soundly engineered sets can be installed in just a few minutes. All are 6 tube. Automatic volume control, 4x6 PM Speakers, except where indicated otherwise. Easy vision slide-rule dial. Beautiful hammertone finish. Wt. 11 lbs.

'49-'50 Chevrolet	'49-'50 Plymouth-
'53 Chevrolet**	Dodge
'51-'52 Plymouth*	'51-'52 Dodge
'53 Plymouth**	'49-'50 Ford
'52-'53 Mercury**	'51 Ford
'53 Dodge**	'52-'53 Ford
*Includes Chrome Grille.	'51-'52 Chevrolet
**Have 6x9" Speaker and Tone Control	'50-'51-'52 Studebaker
COMPLETE READY TO INSTALL. List Price \$59.95. CHOICE	'48-'49-'50-'51-'52-
EACH ABOVE <b>\$41.97</b>	Hudson
10% cash with orders	COMPLETE READY TO INSTALL. List Price \$59.95. CHOICE
	EACH ABOVE <b>\$39.97</b>

**ALMO RADIO CO.**  
 509 ARCH ST. & 3205 MARKET ST. Philadelphia, Pa.  
 6th & ORANGE STS. • Wilmington, Del.  
 4401 VENTNOR AVE. • Atlantic City, N. J.  
 1133 HADDON AVE. • Camden, N. J.  
 219 Highland Ave. • Salisbury, Md.

## TV HIGH VOLTAGE DETECTO PROBE

**SAFE!! QUICK!!**

TO INDICATE PRESENCE OR ABSENCE OF HIGH VOLTAGE: Place Lamp end of DETECTO PROBE near the plate lead (top-can) of rectifier tube. Failure of Lamp to light indicates lack of High Voltage.

TO CHECK IF HIGH VOLTAGE SUPPLY IS OPERATING PROPERLY: Touch tip end of DETECTO PROBE to plate connection (top-can) of rectifier tube. If the High Voltage supply is operating properly, a hot spark at least  $\frac{1}{8}$ " long will be result.

ONLY **49¢**

TO CHECK OPERATION OF HORIZONTAL AMPLIFIER: Place Lamp end of DETECTO PROBE near plate end of horizontal output tube. If Lamp lights, the horizontal amplifier is operating properly.

TO CHECK OPERATION OF HIGH VOLTAGE TRANSFORMER: Place Lamp end of DETECTO PROBE near plate of the horizontal output tube. Lamp should glow. Now place Lamp end of PROBE near the plate of rectifier tube. If High Voltage transformer is operating correctly, the Lamp will now glow more brightly.

ORDER DIRECT FROM YOUR RADIO PARTS JOBBER. If he cannot supply you, send 50¢ coin or stamps, direct to: KAPNER HARDWARE, INC., Dept. RC-6, 2248 Second Ave., New York 29, N. Y.

## TELEVISION

Big demand for graduates

**B.S. DEGREE IN 27 MONTHS** in radio including TV engineering—VHF, UHF, AM and FM. Students use over \$100,000 worth of equipment including 2 large commercial type transmitters in new TV lab. Intense specialized course includes strong basis in mathematics, science and advanced design in radio and TV.

Hundreds of young men each year are earning engineering degrees in this recognized institution. Start any quarter. Many earn a major part of expenses in this industrial center. Low tuition. Competent instruction. Thorough intense, practical program.

Also **B.S. DEGREE IN 27 MO.** in Aeronautical, Chemical, Civil, Electrical and Mechanical Engineering. G.I. Gov't approved. Enter June, Sept., Dec., March. Free catalog. **ENROLL NOW.**

**INDIANA TECHNICAL COLLEGE**  
 1763 E. Washington Blvd., Fort Wayne 2, Indiana

JUNE, 1953

## NEW CHICAGO GROUP

More than 100 service firms meeting in Chicago March 19 agreed to contribute 1% of their wholesale parts purchases toward a Greater Chicago consumer education campaign. Each of the firms also agreed to set aside \$10 as an annual membership fee in a new organization, which was not given a name at the meeting.

A rough draft of the campaign, worked out by a Chicago advertising agency, was presented to the meeting. Details of the campaign, it was stated, would not be worked out till it becomes clear how much money would be available for the work. No actual cost figures were presented, but it was understood that the temporary officers of the group were thinking in terms of an annual cost of \$200,000 to \$250,000 for the campaign.

## NATESA CONVENTION

The Natesa Convention and Exhibition at Kansas City, April 10-12, was attended by just under 500 people, who registered from 35 states and more than 60 cities.

Thirty exhibitors had large display booths of various types of equipment and working exhibits. There were addresses by John Thompson of G-E, Frank Mansfield of Sylvania, Lloyd Austin of Simpson Electric, Harold Rieth of Regency, Robert Artman of Empire Coil, Larry Kearney of La-Pointe Electronics, Chet Jur of Merit, Al Saunders of Saunders Radio and Electronic School (Boston), and Louis Calamaras of NEDA.

A very comprehensive business meeting was held, at which the subject of consumer relations was explored fully. A plan was established to obtain the cooperation of public utilities in the consumer relations program. The services of the FTC are to be enlisted to establish definitions and practices for the service trades. The theme of the convention was "Reciprocal Cooperation".

Arrangements are in progress for the September convention to be held in the city of Chicago.

## EMERGENCY CALLS

According to Penny Martin, of the Television Service Association, Pittsburgh, Pa., the new Pittsburgh telephone directories will list the following emergency calls:

FIRE POLICE  
 DOCTOR TV REPAIRMAN

## NEW JERSEY COUNCIL

TV service organizations met on the evening of Saturday, April 11, to form the New Jersey Council of Television Service Associations, as the nucleus for a state-wide group to assist local associations in public relations, education and legislation. A steering committee composed of Harold B. (Dusty) Rhodes, Paterson, Roger K. Haines, Haddonfield, and David Van Nest, Trenton, was appointed to get the new state council under way. The N. J. groups were attending the Paterson conference.

END

**Heard... but not Seen**

*American's*  
 25th year of leadership  
 in the design and manufacture of quality microphones. Pioneers of the attractive "full-vision" design of quality microphones to be heard but not seen. Enjoy perfect performance... plus... full vision for both artist and audience.

**D 33 BROADCAST D 22 P.A.**

**DR 330 BROADCAST DR 332 P.A.**  
 RIBBON & DYNAMIC CAROID

Write for Free Catalog 46

**American MICROPHONE CO.**  
 370 S. FAIR OAKS AVE., PASADENA 1, CALIF.



# BUILD 15 RADIOS ONLY AT HOME \$19.95

With the New Improved 1953  
Progressive Radio "EDU-KIT"

NOW INCLUDES  
SIGNAL TRACER  
and  
CODE OSCILLATOR

- FREE TOOLS WITH KIT
- ABSOLUTELY NO KNOWLEDGE OF RADIO NECESSARY
- NO ADDITIONAL PARTS NEEDED
- EXCELLENT BACKGROUND FOR TELEVISION
- 10 DAY MONEY-BACK GUARANTEE



## WHAT THE PROGRESSIVE RADIO "EDU-KIT" OFFERS YOU

The Progressive Radio "Edu-Kit" offers you a home study course at a rock bottom price. Our Kit is designed to train Radio Technicians, with the basic facts of Radio Theory and Construction Practice expressed simply and clearly. You will gain a knowledge of basic Radio Principles involved in Radio Reception, Radio Transmission and Audio Amplification.

You will learn how to identify Radio Symbols and Diagrams; how to build radios, using regular radio circuit schematics; how to mount various radio parts; how to wire and solder in a professional manner. You will learn how to operate Receivers, Transmitters, and Audio Amplifiers. You will learn how to service and trouble-shoot radios. You will learn code. You will receive training for F.C.C. license.

In brief, you will receive a basic education in Radio exactly like the kind you would expect to receive in a Radio Course costing several hundreds of dollars.

## THE KIT FOR EVERYONE

The Progressive Radio "Edu-Kit" was specifically prepared for any person who has a desire to learn radio. The Kit has been used successfully by young and old in all parts of the world. It is not necessary that you have even the slightest background in science or radio.

The Progressive Radio "Edu-Kit" is used by many Radio Schools and Clubs in this country and abroad. It is used by the Veterans Administration for Vocational Guidance and Training.

The Progressive Radio "Edu-Kit" requires no instructor. All instructions are included. All parts are individually boxed, and identified by name, photograph and diagram. Every step involved in building these sets is carefully explained. You cannot make a mistake.

## PROGRESSIVE TEACHING METHOD

The Progressive Radio "Edu-Kit" comes complete with instructions. These instructions are arranged in a clear, simple and progressive manner. The theory of Radio Transmission, Radio Reception, Audio Amplification and servicing by Signal Tracing is clearly explained. Every part is identified by photograph and diagram. You will learn the function and theory of every part used.

The Progressive Radio "Edu-Kit" uses the principle of "Learn by Doing". Therefore you will build radios to illustrate the principles which you learn. These radios are designed in a modern manner, according to the best principles of present-day educational practice. You begin by building a simple radio. The next set that you build is slightly more advanced. Gradually, in a progressive manner, you will find yourself constructing still more advanced radio sets, and doing work like a professional Radio Technician. Altogether you will build fifteen radios, including Receivers, Transmitters, Amplifiers, Code Oscillator and Signal Tracer.

## The Progressive Radio "EDU-KIT" Is Complete

you will receive every part necessary to build 15 different radio sets. Our kits contain tubes, tube sockets, chassis, variable condensers, electrolytic condensers, mica condensers, paper condensers, resistors, line cards, selenium rectifiers, tie strips, coils, hardware, tubing, hook-up wire, solder, etc.

Every part that you need is included. These parts are individually packaged, so that you can easily identify every item. Tools are included, as well as an Electrical and Radio Tester. Complete, easy-to-follow instructions are provided.

In addition, the "Edu-Kit" now contains lessons for servicing with the Progressive Signal Tracer, F.C.C. instructions, quizzes. The "Edu-Kit" is a complete radio course, down to the smallest detail.

## TROUBLE-SHOOTING LESSONS

Trouble-shooting and servicing are included. You will be taught to recognize and repair troubles. You will build and learn to operate a professional Signal Tracer. You receive an Electrical and Radio Tester, and learn to use it for radio repairs. While you are learning in this practical way, you will be able to do many a repair job for your neighbors and friends, and charge fees which will far exceed the cost of the "Edu-Kit". Here is your opportunity to learn radio quickly and easily, and have others pay for it. Our Consultation Service will help you with any technical problems which you may have.

## FREE EXTRAS IN 1953

- ELECTRICAL AND RADIO TESTER
- ELECTRIC SOLDERING IRON
- BOOK ON TELEVISION
- RADIO TROUBLE-SHOOTING GUIDE
- MEMBERSHIP IN RADIO-TELEVISION CLUB
- CONSULTATION SERVICE
- QUIZZES
- TRAINING FOR F.C.C. LICENSE

The Progressive Radio "Edu-Kit" is sold with a 10-day money-back guarantee. Order your Progressive Radio "EDU-KIT" Today, or send for further information.

We pay shipping charges all over the world. If you send check or money order with your order. On COD orders, you pay cost of delivery.

**PROGRESSIVE ELECTRONICS CO.**

497 UNION AVE., Dept. RE-72, Brooklyn 11, N. Y.

# IT'S A SHAME

to throw away  
that beautiful old  
Console . . . replace the  
obsolete radio with a  
modern, easily-installed

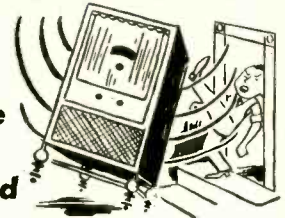

## ESPEY AM / FM CHASSIS

Enjoy Hi-Fidelity Reception

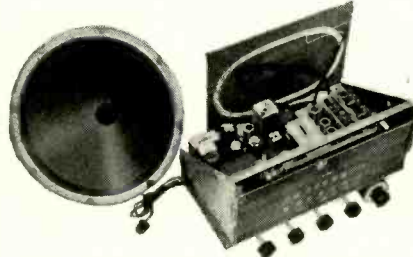

It is not necessary to spend a large sum of money to modernize your old radio or to become a "High Fidelity" enthusiast. ESPEY chassis provide the Highest Quality at moderate prices.

Fully licensed under RCA and Hazeltine patents. The photo shows the Espey Model 511-C, supplied ready to play. Equipped with tubes, antenna, speaker, and all necessary hardware for mounting.

NEW FEATURES—Improved Frequency modulation circuit, drift compensated • 12 tubes plus rectifier, and pre-amplifier 12AT7 tube • 4 dual purpose tubes • High quality AM-FM reception • Push-pull beam power audio output 10 watts • Switch for easy changing to crystal or variable reluctance pick-ups • Multi-tap audio output transformer supplying 3.2—8—500 ohms.

Makers of fine radios since 1928.

Write Dept. RE-6 for literature and complete specifications on Model 511-C and others.

**ESPEY**

MANUFACTURING COMPANY, INC.

528 EAST 72nd STREET, NEW YORK 21, N. Y.

## See the AUGUST issue of SCIENCE-FICTION + —a new adventure in reading

### THE END OF THE MOON

Gustav Albrecht, eminent physicist, tells what will happen when our moon breaks up. Dramatically illustrated with color covers and interiors by Frank R. Paul.

### THE SPACEBRED GENERATIONS

An absorbing novelette by Clifford D. Simak, one of the best of today's science fiction writers.



PLUS—many other stories and articles

This new Gernsback Magazine  
ON SALE JUNE 10

Reserve a copy at your favorite newsstand now.

Don't say science fiction—say  
**SCIENCE-FICTION PLUS**



**NEW AUDIO COMPONENTS**

Sargent-Rayment Co., 1401 Middle Harbor Rd., Oakland, Calif., has added four new items to its "building-block" series of high-fidelity audio components. The new units are the SR-68 AM-FM tuner, the SR-58 AM tuner, SR-38 phono preamplifier and



tone control, and the SR-9 Ultra-Linear Williamson-type power amplifier. Full specifications on these and previously announced components in the line can be obtained from the manufacturer.

**NEW ELECTRO-VOICE TWEETER**

Electro-Voice, Inc., Buchanan, Mich., has developed the new T-35 high-frequency driver unit and diffraction horn. The tweeter may be used with sound systems handling up to 40 watts. The voice-coil impedance is 16 ohms, potentiometer diameter is 2 1/2 inches, overall depth 3 1/4 inches, weight 2

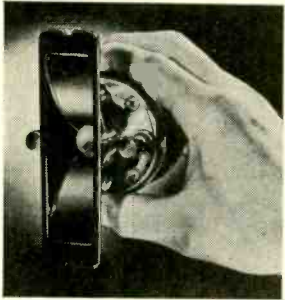

pounds. The horn cutoff is at 1,500 cycles. The driver takes over from 3,500 cycles to the limits of audibility. The AT-37 level control and X-36-1 crossover network may be used to connect the T-35 to existing high-fidelity systems.

**SPEAKER CROSSOVER**

Hermon Hosmer Scott, Inc., 385 Putnam Ave., Cambridge 39, Mass., is offering a variable speaker crossover. With the 214-XB, speaker woofers and tweeters can operate under the best conditions of speaker damping, relative output balance, and without interposition of L-C crossover networks. Speakers may be connected directly to the amplifiers, with optimum damping. Resistive-capacitive, the unit eliminates all effects of resonant under-damping.

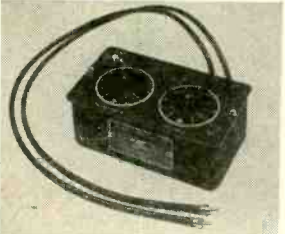

There are two controls. One provides continuous adjustment of crossover frequency from 175 to 3,000 cycles, and the other allows continuous adjustment of acoustical balance between woofer and tweeter to compensate for different speaker efficiencies.

**TV ATTENUATOR**

Vidaire Electronics Mfg. Co., Lynbrook, N. Y., has introduced a television attenuator that eliminates overloading due to strong signals. The Tel-Atten was designed to reduce buzz

in intercarrier sets, and most cross-modulation effects. It also features

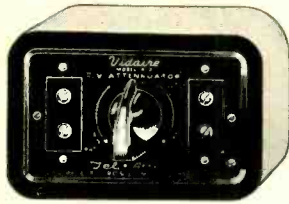

1,000-to-1 change in signal reaching antenna posts, and vernier adjustment for all signal areas.

Model A-2 measures 3-5/8 x 2-3/8 x 1-1/4 inches and is suitable for mounting on the set itself or on a nearby wall.

**UHF DEVICES**

Channel Master Corp., Ellenville, N. Y., has announced three products for u.h.f.

The Delta-Weld Yagi, a 10-element u.h.f. antenna, provides up to 11 db gain single and 14 db gain stacked.

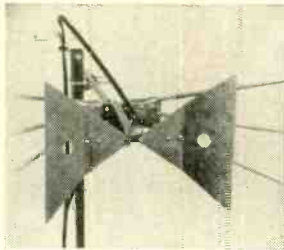

The Ultra-Tie, model 9034, combines separate antennas into a single u.h.f.-v.h.f. system. It joins them together at the mast for use with a single transmission line and separates the signals at the set or converter.

The model 415 u.h.f. antenna adapter, the Econo-dapter, is an all-chan-

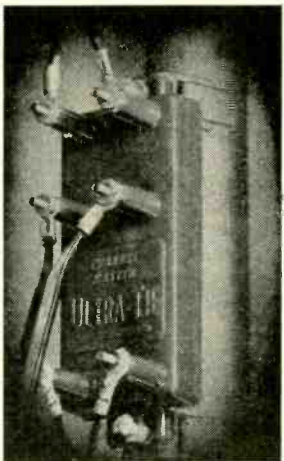

nel u.h.f. triangular dipole for adding u.h.f. to v.h.f. Super Fan installations. It is designed for use with separate v.h.f. and u.h.f. leads to the TV set or converter.

**UHF ANTENNA**

The Hi-Lo TV Antenna Corp., 3540 N. Ravenswood Ave., Chicago 13, Ill., has announced the indoor u.h.f. Spiral-Tenna, model 202 U-V. It can be used for all channels (u.h.f. and v.h.f.) with Hi-Lo's u.h.f. antenna adapter. The unit measures 20 x 32 inches.

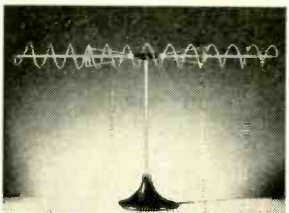

*Compare...*  
**prove EMC superiority**

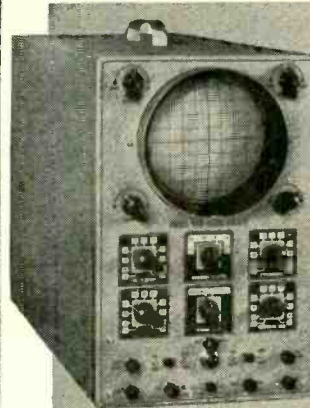

**model 600**

EMC MODEL 600 SCOPE features the use of a 5U1 new 5 inch scope tube. The 2-stage, push pull, vertical amplifier has a sensitivity of .02 volts per inch and can be used up to 5 megacycles. A two step attenuator input is available. Synchronization is available on either positive or negative phase of input voltage through the vertical amplifier or from an external source. A multi-vibrator type of sweep from 15 cycles to 75 kilocycles is incorporated. Direct connections to scope plate available.

MODEL 600 (completely wired and tested)..... **\$99.50**

**model 106**  
**VACUUM TUBE VOLTMETER**

Check these features  
**SPECIFICATIONS**



All functions completely electronic — meter cannot burn out.

DC VOLTAGE: Input resistance 16.5 megs or 1 1/2 megohms per volt. Ranges 0 to .3, 10, 100, 300, 1000 up to 30,000 volts (with accessory probe).

AC VOLTAGE: Input resistance 2 megohms. Ranges 0 to .5, 10, 100, 300, 1000. Frequency response flat from: 25-100,000 cycles.

OHMS: 1000 — 10,000 — 100,000 — 10 megohms, 1000 megohms.

COMPACT, portable bakelite case measures 4 1/4 x 5 1/4 x 2 3/8"

MODEL 106 (complete with 1 meg isolating probe) **\$35.90**

IN KIT FORM ..... **23.90**

MODEL HVP, 30000 Volt Probe for Model 106 ..... **8.75**

MODEL RFP, High Frequency Probe (useful to 200 megacycles) ..... **6.95**

— See them at your Jobber —



Write Dept. RE-6 for Free Complete Catalogue of these and other Instruments.

**ELECTRONIC MEASUREMENTS CORPORATION**  
280 LAFAYETTE STREET • NEW YORK 12, N. Y.

EXPORT DEPARTMENT 136 LIBERTY STREET, N. Y. C. 6, N. Y.



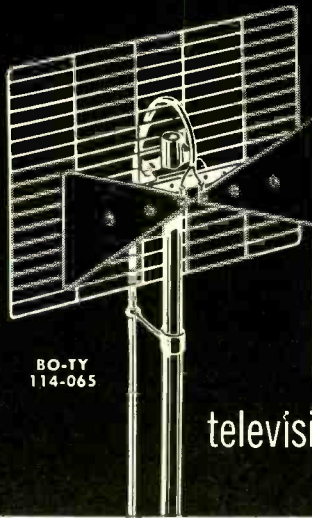

AMPHENOL

BO-TY

UHF

television antennas

BO-TY  
114-065

now packaged  
preassembled



The AMPHENOL 300 ohm BO-TY Antenna, 114-065, is a UHF antenna and reflector that intercepts any of the UHF channels, 14 through 83. High signal gains of 5 db to 8 db plus excellent front-to-back ratio make the BO-TY Antenna ideal for both strong and weak signal areas. For extremely weak signal areas, two BO-TYs can be easily stacked. One stacking rod is provided with each 114-065 BO-TY making the necessary pair when two are bought for stacking.

All components of the AMPHENOL 114-065 BO-TY Antenna are completely preassembled for quick and easy mounting on the mast. Installation is a simple matter of tightening two wing nuts.

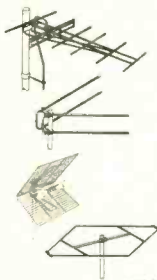

**OTHER UHF TYPES AVAILABLE SOON.** Designed and field tested by the same engineers who developed the famous INLINE VHF Antennas, the UHF Antennas previewed here will shortly be added to the AMPHENOL line. **YAGI** UHF Antenna for high gain on specific channels. **STACKED-V** combination UHF and VHF Antenna. **CORNER REFLECTOR** all-channel, high gain UHF Antenna. **RHOMBIC** Antenna for high gain, broadband UHF reception.

U.S. Pat. No. 2,543,696

AMPHENOL tubular twin-lead

Moisture, one of the greatest enemies of UHF signal strength, does not materially affect the impedance or electrical efficiency of AMPHENOL Tubular Twin-Lead. As illustrated, the concentrated field of energy is largely contained and protected by the tubular construction. Because flat twin-lead does not afford this protection, it is not recommended for UHF installations.

AMPHENOL

AMERICAN PHENOLIC CORPORATION *chicago 50, illinois*

## NEW DEVICES

### PORTABLE RECORDER

Amplifier Corp. of America, 398 Broadway, New York 13, N. Y., has announced a portable tape recorder, the 110-volt a.c. *Magnetomatic*. The recorder weighs 19 pounds and attains a frequency response of 50 to 15,000 cycles at 7 1/2 i.p.s. (inches per second).



It is completely operated by push-button control, and features a solenoid-operated clutch-controlled capstan drive to start and stop tape travel within 1/20th of a second. The unit incorporates relay-operated modified Geneva movement to control high-speed rewind and 60 i.p.s. fast-forward movements. The *Magnetomatic* uses 5-inch plastic or metal reels of standard 1/4-inch tape and has provision for headphone monitoring and optional erase.

### INDOOR UHF ANTENNA

Radion Corp., 1130 W. Wisconsin Ave., Chicago, Ill., is producing an indoor u.h.f. antenna, the *Bullseye*. It is a full-wave loop, engineered for broadband coverage, low standing wave ratio and low Q.

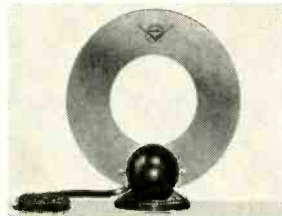

The antenna is 10 inches high and 9 inches wide and weighs under 1 pound. The loop is of rose-gold colored anodized aluminum with a mahogany phenolic base weighted to prevent tipping. The unit is shipped fully assembled, with lead-in and instructions.

### U.H.F. PRODUCTS

RMS (Radio Merchandise Sales, Inc.), 2016 Bronxdale Ave., New York 60, N. Y., has introduced a bow-tie antenna, a Yagi series, and a lightning arrester for u.h.f.

The bow-tie element and reflector section of the *Bo-Tenna* model BT-10 are standard fitted units, each of which is available separately. The reflector is made up of tuned elements instead of wire mesh, to minimize ghost pickup. Stacked models are designated BT-20.

The 6-element all-aluminum Yagis use a 3-wire folded dipole transformer.

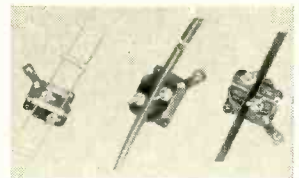
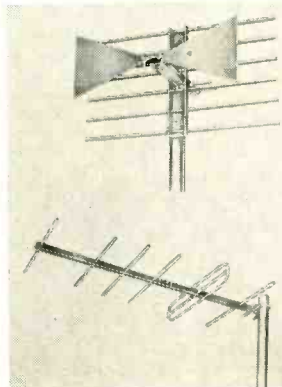

The elements are of 3/16-inch aluminum rod, force-fitted to the crossarm. There are 6 models in this 6Y series. Stacked models are also available.

The model LA-UH3 lightning arrester has specially designed filter networks to isolate r.f. from ground potential. It accommodates all types of commonly used transmission lines and can be mounted flat or to the mast.

### SUBSTITUTION KIT

Crest Laboratories, Inc., 84-11 Rockaway Beach Blvd., Rockaway Beach, N. Y., has introduced a variable-inductance, universal substitution kit. It consists of eight variable-inductance coils, covering a range from 1 to 590  $\mu$ h, for video peaking, r.f., and i.f. circuitry. Full data sheets are



enclosed. Individual calibration charts permit adjustment to required inductance value without test equipment.

### OSCILLOSCOPE PROBES

Precision Apparatus Co., Inc., Elmhurst, N. Y., is producing an oscilloscope test probe set, the series SP-5, which includes four probes for general purpose as well as specialized TV signal-tracing, alignment, trouble-shooting and waveform analysis. The four probes are (1) high impedance - low capacitance; (2) signal-tracing; (3) resistive-isolating; and (4) shielded-direct.



### UHF CONVERTER

Electro-Voice, Inc., Buchanan, Mich., has announced the model 3300 u.h.f. TV converter. Nonslip micrometer-type tuning mechanism provides continuous tuning of all u.h.f. channels 14-83. No band switches, strips, or coils are used.



The unit operates with either separate u.h.f. and v.h.f. antennas or on all channel (2-83) antennas. It uses channels 5 or 6 of v.h.f. TV as i.f. The model 3300 operates from 105-125 volts, 50-60 cycles a.c. and has input and output impedances of 300 ohms.

### VOLTAGE BOOSTER

The Service Instruments Co., 422 S. Dearborn St., Chicago 5, Ill., has announced the *Up-Down* voltage booster. The unit increases or reduces line vol-

RADIO-ELECTRONICS



## NEW DEVICES

tage and is usable with any TV set or appliance up to 300 watts. It eliminates inadequate picture width, insufficient height, and low picture brightness. An off-on switch adds or subtracts 10 volts from existing line voltage.



### V.H.F.-U.H.F. ANTENNAS

Kay-Townes Antenna Co., Rome, Ga., has announced its new BJU antenna series. They are assembled in kits of 2-, 3-, and 4-bay units for channels 2 to 83. They provide high gain.

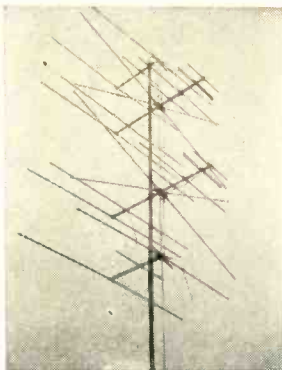

Only one lead-in wire is required. No isolation filters, matching pads, coils, capacitors, or other boosters are used.

### TV CLARIFIER

Precision Electronics, 9101 King Ave., Franklin Park, Ill., has announced a new model of its *Television Clarifier*. It is designed to trap interference from FM, amateurs, short-wave diathermy, ignition, and adjacent chan-



nels, without disturbing the standing wave ratio of the antenna system.

When installed, the receiver is tuned to the channel where interference is received, and the trimmers on the clarifier are adjusted one at a time until the interfering signal is removed.

### VINYL ADHESIVE

Chemical Development Corp., Danvers, Mass., has introduced CD Cement No. 203, for bonding vinyl film and molded articles or rigid sheets to metal, glass acrylics, ceramics, paper, cloth, cork, and many other surfaces. It produces a quick initial bond and is very fast setting. It consists of vinyl resins, plasticizers, tackifiers, stabilizers, and other ingredients. May be applied by brush or machine.

JUNE, 1953

### ALL-CHANNEL ANTENNA

Payo Engineering Labs, 2834 Hampshire St., Quincy, Ill., has announced an all-channel antenna. Typical gain figures for u.h.f. are: channel 82, 12.5 db; channel 52, 11.0 db; channel 18, 11.6 db; channel 13, 4.3 db. The antenna is highly directional, free from minor lobes, and wind resistant.

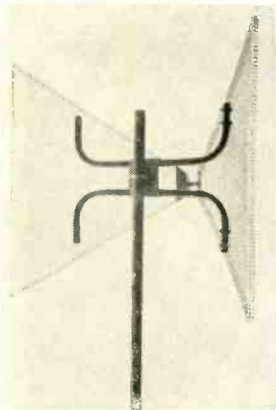

### NEW VOLTMETER

American Research Corp., 1504 11th St., Santa Monica, Calif., has developed a portable voltmeter which measures from 4,000 to 25,000 volts.

The *Voltprobe* is 10 inches long and needs no outside current to operate. To function, an alligator clip is connected to the chassis of the TV set. The probe end of the unit is connected to the second anode by piercing through the rubber protective cap. Measurements can be made without removing the tube or chassis from the cabinet.

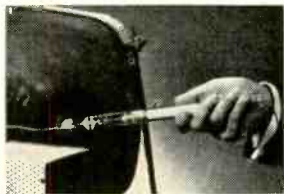

### TINY TRANSFORMER

Standard Transformer Corp., 3580 Elston Ave., Chicago, Ill., has introduced an ultra-miniature transistor transformer.

Weighing less than 1/10 ounce, the units measure 1/4 x 3/8 x 3/8 inches and are no larger than the transistors they are designed to power. Intended primarily for transistor audio applications, the ultra-miniature transformers can be used wherever power is low. They are useful below the 1-mw level. Construction is of extremely fine wire wound on molded nylon bobbins with nickel-alloy steel laminations.

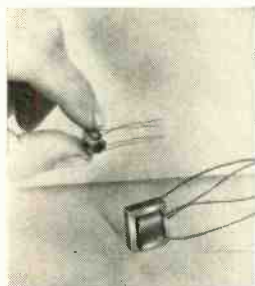

### RECTIFIER KIT

Federal Telephone and Radio Corp., Clifton, N. J., has designed a selenium rectifier kit with the necessary components for assembling any one of four selenium rectifiers—half-wave rectifier, full-wave center-tap rectifier, full-wave

AMPHENOL  
-INLINE-  
VHF  
television antennas

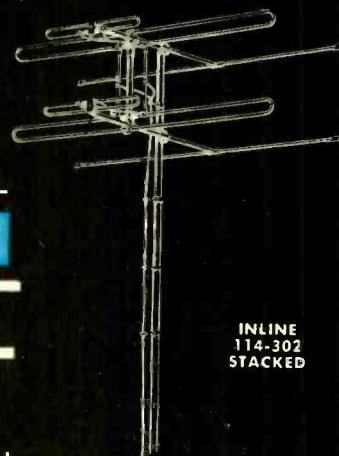

INLINE  
114-302  
STACKED

proven 10 ways better . . .

- 1 Wide, single forward lobe.
- 2 High front-to-back and front-to-side ratios.
- 3 No lobes off the sides—negligible ones off the back.
- 4 Uniformity of lobes at all frequencies.
- 5 High, uniform gain.
- 6 300 ohm impedance.
- 7 All-aluminum antenna construction.
- 8 3/4" Thinwall galvanized steel conduit mast.
- 9 Quick-Up assembly takes three minutes to erect.
- 10 Conveniently packaged with everything needed for the installation—antenna, mast, insulators, guy ring, mounting bracket and Twin-Lead (two bays and connecting rods included with stacked arrays).

\*Reissue Pat. No. 23,273

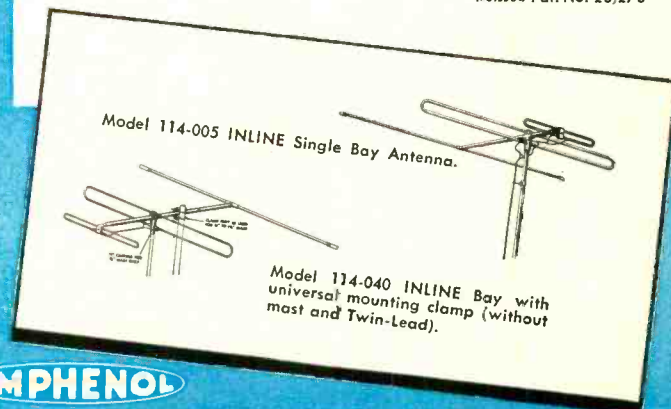

AMPHENOL

AMERICAN PHENOLIC CORPORATION Chicago 50, Illinois



# TIME . . . is all you have to sell!

Save time hunting for the "bugs" with Videc Speed Servicing Val. I data sheets. This sensational new servicing aid tells you what actually goes wrong, not what *might* go wrong. The information is accurate and reliable because it is based on the experience of television-servicemen, factory and distributor servicing departments.

## SAMPLE DATA ITEM (1/3 OF ACTUAL SIZE)

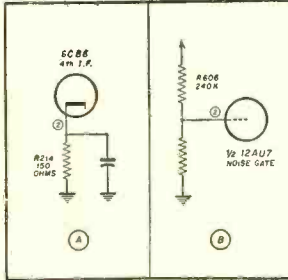

**Mfg:** Philco Model No. 51-T1601T  
**Card No.** A-51-5 **Code No.** 121 and 122  
**Section Affected:** Sync  
**Symptom:** Unstable sync in strong signal areas.  
**Cause or Reason for Change:** To improve sync performance in strong signal areas.  
**What To Do:**  
 1. Change R214 from 150 ohms to 220 ohms. Fig. A.  
 2. Change R606 from 240K to 180 K. Fig. B.

## HERE IS WHY YOU NEED THIS BOOK:

- 600 actual service data items (3 to a page).
- Handy schematic of only the actual circuits involved.
- 25 TV set manufacturers represented with over 50 chassis models.
- Loose-leaf bound in a 3-ring binder of finest quality, large enough to accommodate additional VSSS Data Sheets.
- Book lies open flat on your service bench, with all material plainly visible.
- Cross-indexed by manufacturer, chassis and cabinet model.
- Costs less than 1¢ per item.
- 2 Hours of your time saved more than pays for the entire book!

Order Direct From:

**\$4.95**  
Postpaid

## TV CIRCUITS CO.

P. O. Box 1210, Grand Central Station, New York 17, N. Y.

# Custom-Styled for Hi-fidelity

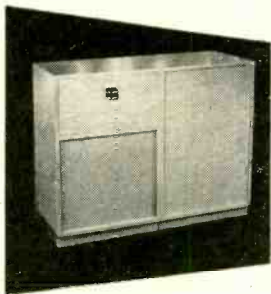

by **Cabinart**

Designed for the audiophile, these handsome cabinets will accommodate any combination of high fidelity components. Panels are replaceable for future changes of equipment. The loudspeaker cabinet is acoustically correct, tuned for the average 12" or 15" loudspeaker, pre-cut as requested. Construction is of select birch, with a fine lacquer finish hand-rubbed to a high gloss. All joints are glued and screwed, and lock-joint miters are used throughout, affording utmost rigidity.

Dimensions: 35 1/2" H., 23 1/2" W., 18" D.

Finishes: Blond Birch, Cordovan Mahogany on Birch.

Baffle Area: 6 1/2 cubic feet.



**MODEL 28**  
Equipment Cabinet  
**72.00**  
net



**MODEL 27**  
Speaker Cabinet  
**48.00**  
net

Sold through leading radio parts distributors. Write for free catalog RE-6.

**G & H WOOD PRODUCTS COMPANY 75 N.11th ST. BKLYN. 11, N. Y.**  
Pioneers in radio furniture for high fidelity equipment.

bridge type, and full-wave battery charger. Any one of 12 rectifier stacks for use in a wide range of a.c.-d.c. applications also may be built.



## LINE SPLICER

Mosley Electronics, Inc., 2125 Lockland Road, Overland 14, Mo., has designed a solderless transmission line splicer to provide a constant impedance splice of tubular-type 300-ohm line to flat-type. The new splicer (Catalog No. 29-S) is intended for use with any of the tubular or oval types used for u.h.f. television installations.



The polystyrene splicer is so designed that the ends of the polyethylene transmission line insulation are completely covered, thus providing minimum strain on the conductors and considerable protection from the weather.

## MINIATURE RELAY

The Phasotron Co., Pasadena Ave., S. Pasadena, Calif., has announced a miniature double-pole, double-throw relay, weighing only 3 1/2 ounces. The unit meets the shock requirements of MIL-E-5400.

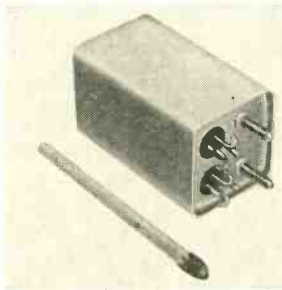

u.h.f. antenna, the U-4, to its present line. The manufacturer claims broad-band coverage with uniform gains over the entire u.h.f. spectrum, uniform gain with low vertical radiation and low standing wave ratio, and 300-ohm internal impedance. Units are 12 x 12 x 5 inches, and may be stacked.

## ANTENNA MOUNTS

T-V Products Co., Springfield Gardens, Long Island, N. Y., has announced a new chimney and a new wall mount. Both are made of steel 1/8 inch thick and heavily plated to withstand corrosion. They are individually packaged with all necessary hardware.

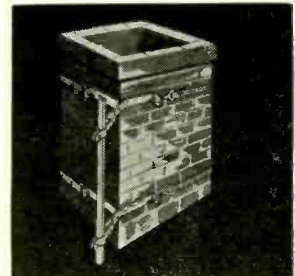

## ALL-BAND ANTENNA

RMS (Radio Merchandise Sales), 2016 Bronxdale Ave., New York 60, N. Y., has announced an adjustable all-TV-band conical-V antenna, model AAV-100, a high-gain end-fire array. Its adjustable bracket arrangement permits positioning of any one or all of the 8 elements to 45° (u.h.f.), 60° (u.h.f.-v.h.f.), 90° (v.h.f.), and 180° (v.h.f. where stations come from widely separated points, but are in the same general direction). The pin bracket which retains the elements can be rotated so that the pin snaps into the hole positions giving the desired angle.

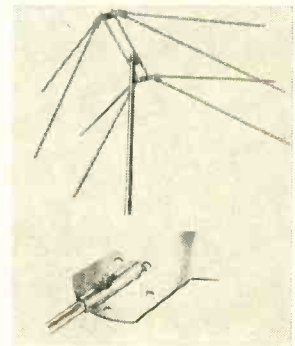

## TRANSMISSION LINE

All-Channel Antenna Corp., 70-07 Queens Blvd., Woodside 77, N. Y., is producing a 4-conductor tubular transmission line for use with their u.h.f.-v.h.f. all-direction antennas. The line has an impedance of ap-

Certain contact combinations can be furnished with a required coil power as low as 20 milliwatts and any relay in this series can be obtained with a coil resistance as high as 15,000 ohms.

## UHF ANTENNA

Cornell-Dubilier Electric Corp., South Plainfield, N. J., has added another

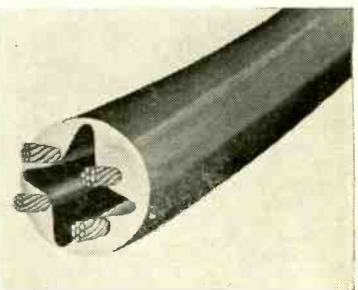
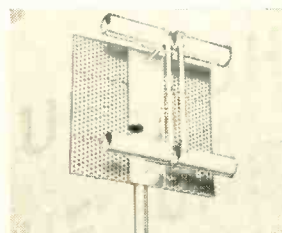

proximately 300 ohms between every 2 of the 4 conductors. It is about 3/8-inch in diameter. The 4 conductors each consist of 7 strands of No. 28 copper wire. Attenuation loss is claimed to be less than 4.1 db per 100 ft at 900 mc when wet. END

All specifications given on these pages are from manufacturers' data.



**STOP!**  
**TV INTERFERENCE**



Eliminates interference caused by Short Wave...F.M. Hams...Diathermy...Atmospheric disturbances, etc.

With a **TELEMATIC Full Range FILTER KIT**

**SIMPLE — SPEEDY — EFFICIENT**

- Eliminates antenna-fed interference!
- Covers full-range both I.F. and R.F. Sharper, steadier picture!
- Fewer service recalls!
- Any filter in kit replaceable separately!

**FILTER KIT**  
contains 2 Hi-Pass Filters, 4 WAVE TRAPS covering full range of interference signals.

Send for **FREE** Booklet on TV-INTERFERENCE

**TELEMATIC**  
ONE JOSEPHSON ST. BROOKLYN 2, N. Y.

**GAS-TUBE AMPLIFIER**

Patent No. 2,619,622

Edward Oscar Johnson, Princeton, N. J.  
(assigned to Radio Corp. of America)

This amplifier is based on a recently designed gas tube with special characteristics. This tube is shown in the figure as V2. It has a triode section, as well as an auxiliary cathode which is surrounded by a shield. The auxiliary (shown at the left of V2) keeps the gas ionized. This element is isolated from the triode elements so it cannot affect the work circuit.

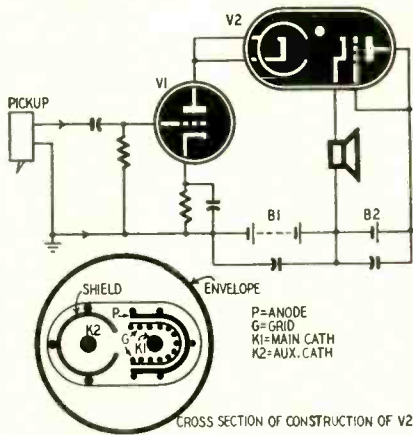

The circuit shown here is adapted for a.f. amplification. PICKUP is a phonograph or other audio source. The signal is first amplified by a vacuum tube V1. Then it flows into V2 to modulate the plate current of the gas tube. The control grid of V2 is not utilized in this particular circuit, so it is tied to the anode.

Two power supplies are shown, each suitably bypassed. B1 is the plate supply for V1 and also the ionization supply for V2. It keeps the gas tube filled with plasma, a mixture of electrons and positive ions. B2 energizes the work circuit of the gas tube. It can be quite small, considerably below the ionization potential.

The input signal modulates the plasma density of V2 and controls the output voltage. Since the gas tube has low impedance, it is permissible to connect the speaker directly into its cathode circuit without a matching transformer. This improves the fidelity and reduces power loss. The tube can handle high power without difficulty. The plate current may be 150 ma or more. Efficiency is high since there is no filament. Furthermore, the tube drop between main cathode and anode is negligible.

Another audio circuit with this tube is shown in U.S. Patent 2,603,766, described on page 113 of our March issue.

**STABILIZED ELECTROMETER**

Patent No. 2,617,946

Barton L. Weller, Richland, Wash.

(assigned to the United States of America as represented by the U. S. Atomic Energy Comm.)

This amplifier is stabilized against the effects of transient disturbances. It is shown here amplifying the output of an ion chamber (shown within the solid line). The chamber has a collector B surrounded by a cylindrical anode A, and is filled with gas. Between these elements is the grounded shield S. The chamber is energized by high-voltage d.c.

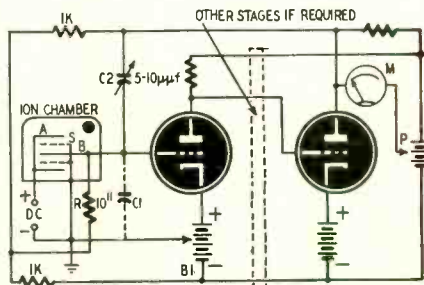

**YOUR HIGH-PAYING**  
*interesting career in*  
**TELEVISION**  
*starts here!*

**HOME STUDY COURSE**

with one of America's **LARGEST** schools



**COMPLETE PARTS KIT INCLUDED. BUILD YOUR OWN TV SET!**

There's a place for YOU in the tremendous, billion-dollar Television, Radio & Electronics industry! It's so easy to get started with the famous CRESCENT

SCHOOL course. Learn at home, in your spare time. Illustrated, simplified lessons and kits to practice on. No previous training needed. Send for **FREE** sample lesson... make this day the day you started on your way to a brilliant profitable career!

APPROVED FOR KOREAN VETS

Also Day & Eve. Classes  
Trained at Our School

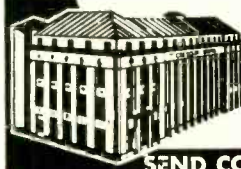

**CRESCENT SCHOOL**

"One of the Largest of its kind"

**SEND COUPON TODAY!**

**CRESCENT SCHOOL** Dept. E6  
500 Pacific Street, Bklyn. 17, N.Y.

Sirs: Rush your **FREE** sample lesson and full details about the CRESCENT SCHOOL Course—at no obligation to me!

Home Study Course  Residential Course

NAME \_\_\_\_\_

ADDRESS \_\_\_\_\_

CITY \_\_\_\_\_ ZONE \_\_\_\_\_ STATE \_\_\_\_\_

**FREE! U.H.F. and**  
**"THE VERSATILE CRYSTAL PROBE"**

Solve your **U. H. F. ANTENNA PLACEMENT** and **ORIENTATION** problems the easy way!

Get maximum picture strength - eliminate ghosts - no more roof-top shouting - no expensive field strength meters needed!  
**ONE MAN CAN DO IT!**

Write for **FREE** bulletin today and other information about **KLIPZON** products.

**UNITED TECHNICAL LABORATORIES**  
204 LITTLETON RD. ★ MORRISTOWN, N. J.

**ALNICO MAGNET SPECIALS!** "U" Type (3/4" sq. x 5/8), 3/16 gap. Exc. for Wire or Tape Erase, spkr. or phone magnet. ea. 49c 12/5.00 polished. ea. 39c 12/4.00

**BAR MAGNET** (3/4"x3/4"x1/4") ea. 39c 12/4.00

**ROUND BAR** (1 1/4"x5/8" O.D.) pol. ea. 69c 6/3.50

**ALNICO "CHIP" MAGNETS** sm. irregular shapes. (approx. 30 pcs. per oz.) Per Oz. 15c 1/5.00/lb.

**ALNICO MAGNET KIT** 10 powerful Bar, Block, "U", Rod, etc. KIT ea. 98c 6/5.00 (WRITE FOR LATEST "ALNICO" SUPPLEMENT)

**MAGNET WIRE** 100 ft. 29c 4/1.00 12 oz. spool. ea. 58c 6/5.00 50 ft. 1/29 100 ft. 1.98

**SOUND POWER PHONE UNITS (ANBH-1A)** Use as mike or revr. Sealed metal case ea. 1.95 2/3.49

**HB-7 HEADBANDS** leather, less plug ea. 69c 10/5.95

**EXPERIMENTAL TUBES**... for Test, Research, etc. Fil. tested. Kit of 40 asstd. revr. types 1.98

**STEP-DOWN XFMR** 115V. to 50V, 75ma; 6.3V, 300ma, 2 3/4" sq. 2" 1.49

**TWISTED PAIR INTERCOM WIRE** #22 tinned; plastic insul. Ass'd. colors 100 ft. 1.79 1000 ft. 15.00

**1/17 H.P. G-E MOTOR** (Type SD) 1725 RPM 110VDC, .7 amp. Dble. 3/8" shaft. O.D. 4 3/4" x 5 1/2". Shpg. wt. 13 lbs. 3.95

**HI-FI CRYSTAL MIKE** hi-imped., rubber shock mtd. 1 3/4" O.D. x 1 1/4" 1.29

**ALUMINUM HOUSING** for xtal mike 1.5c

**DPDT 12VDC RELAY** (1 1/2"x2") 70 ohm coil 98c

**G-E PLATE RELAY (SPDT)** 10K ohm coil. 1.29

**3PST KEVING RELAY (RBM)** 230 ohm coil (N.O.) 3/4" x 1 1/2" x 1 3/4" 1.29

**115VAC ELECTROMAGNET** 6 oz. pull, cont. duty O.D. 1" x 7/8" ea. 98c 6/5.00

**CO-AXIAL ANGLE PLUG 83-1AP (M359)** ea. 29c 10/2.50

**PL-54/JK-25 CONNECTORS** set 35c 10/3.50

**RADIO HARDWARE TREASURE** FULL LB. CAN of: Nuts, Screws, Washers, Lubs, etc. 89c 3 lbs/2.49

**METAL UTILITY CAN** (4"x3 1/2"x1") for sm. components. Moisture-sealed snap lid ea. 10c 12/1.00

**"SUPER \$\$\$ SAVINGS!"** with the NEW "JUMBO RADIO-ELECTRONICS PARTS KIT!" "Gold-Mine" of inventory odds & ends: WIRE, COILS, RESISTORS, CONDENSERS, SWITCHES, CONTROLS, SOCKETS & MUCH, MUCH, MORE! (Shpg. Wt. 20 lbs.) 3.95

**CABINET DRAW SLIDES** Silent, ball-bearing 13" (9" ext) 2.10 pr.; 15" (11" ext) 2.25 pr.; 16 1/2" (12 1/2" ext) 2.79 pr.; Hvy. Duty all-steel 16 1/2" / 12 1/2" slides 3.25 pr.

**MOULDED BAKELITE CONDENSERS** (Micamold) 20 mmf. 2. 1.98 100/2.98

**CARBON RESISTORS** 1/2-W 100 asstd. 1.98

**ROTARY SELECTOR SWITCHES** incl multi-deck. All with 12 shafts. Kit of 6 asstd. 1.75

**"DIRECT FACTORY SPEAKER REPAIRS SINCE 1927"** FREE "SPEAKER PARTS MANUAL" NOW READY

**SPECIALISTS ON ALL TYPES OF "HIGH FIDELITY" UNITS.** Min. Order \$3.00. 20% deposit req. on all C.O.D.'s. Full remittance with foreign orders. Please add sufficient postage—excess refunded.

**LEOTONE RADIO CORP.**  
67 Dey Street  
New York 7, N. Y.



for every  
audio  
need

**CANNON  
PLUGS**



you can hear  
the difference

P SERIES

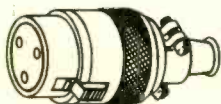

XL SERIES



In addition to the lines illustrated, the 45E Test Point Jacks and connectors in the GB, U, and M1-4 series are available through the 130 selected franchised distributors for Cannon Electric. Other electronic-electric distributors also sell certain items in the Cannon line, including XL, M1-4, and GB series connectors, and a variety of Cannon Specialty Lights. Write for the RJC and Audio Connector Bulletins.

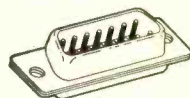

UA SERIES

D SERIES



O SERIES

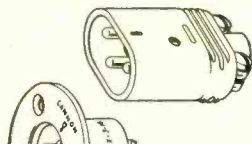

K (TV) SERIES

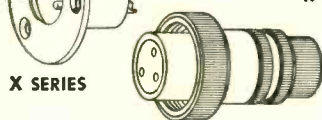

X SERIES

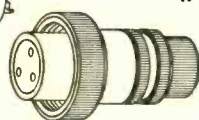

XK SERIES

**CANNON ELECTRIC**

Since 1915

Factories in Los Angeles, Toronto, New Haven  
Representatives in principal cities. Address inquiries to Cannon Electric Co., Dept. F-144, Los Angeles 31, California.

**NEW PATENTS**

When gamma radiation acts on the chamber, the gas is ionized. Positive ions are attracted to cathode B and flow through the large resistor R. This generates a voltage drop which is amplified by direct-coupled stages. M indicates the radiation intensity, and P is the zero-set adjustment for balancing out the voltage drop across the meter due to the static plate current of the output tube.

Voltages on B and S are equalized by adjusting the contact on B1. Unless this is done, the signal charges and discharges capacitance C1 between the elements B and S. This slows the amplifier response because of the large time constant of R and C1.

Feedback exists between the output and input of the amplifier. Each stage reverses phase by 180°, so the 3 stages provide *negative* feedback. This stabilizes the circuit against most circuit and power variations, but cannot act against transients. This is due to the large time constant of R, C1, which prevents the feedback from acting quickly enough. Lowering R is undesirable since it would kill some of the high gain. This invention utilizes an auxiliary capacitor C2 to neutralize the effect of C1.

C2 couples the input grid to the high end of the feedback circuit. Thus feedback is applied directly to the grid instead of having to pass through R. Speeding up the feedback action means that it can balance out the most rapid transients likely to occur in this type of circuit.

**ORNAMENTAL TV ANTENNA**

Patent No. 2,621,293

Elmer Guy Hills, Des Plaines, Ill.

(assigned one-half to J. N. Marks, J. Tunkl, I. Rosenthal, and E. Lichtenstein, doing business as Tricraft Products Co., Chicago, Ill.)

An outdoor antenna is usually better for TV, but sometimes an indoor installation is needed. Results will be good if there is enough signal strength. TV owners often object to an indoor antenna because it uses too much space and may clash with the living-room furniture. This invention is a compact antenna built for beauty as well as utility. It looks like an attractive model of a sailboat.

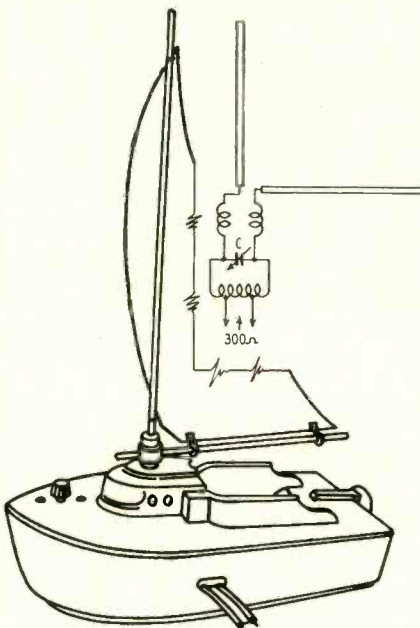

The mast and boom of the boat are the pickup conductors. The mast is 17 inches long, the boom 15½ inches. They are supported by a polystyrene sail. A knob on the forward part of the deck tunes the antenna. For optimum directivity, the boom may be rotated through any angle. The lead-in comes out through an opening in one side of the ceramic hull.

The insert shows the equivalent electrical network. The vertical and horizontal conductors are the mast and boom. They feed two coils which resonate the system on the low band. C, the tuning capacitor, shunts an autotransformer. This coil matches a 300-ohm transmission line which feeds the receiver. **END**

Preferred  
for Original  
Equipment

Proven  
for  
Replacement

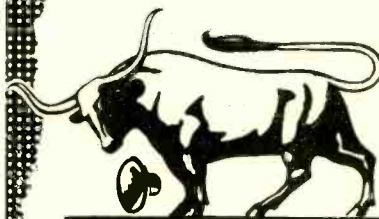
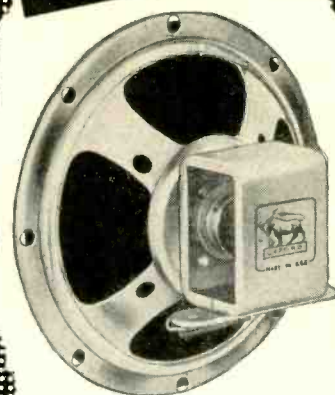

**OXFORD**

**Speakers**

There is an application for every Oxford Speaker... and an Oxford Speaker for every application.

**OXFORD  
ELECTRIC  
CORPORATION**

3911 S. Michigan Ave.  
Chicago 15, Illinois

EXPORT: ROBURN AGENCIES, NEW YORK CITY  
In Canada: Atlas Radio Corp., Ltd.,  
560 King Street, Toronto, Ontario.



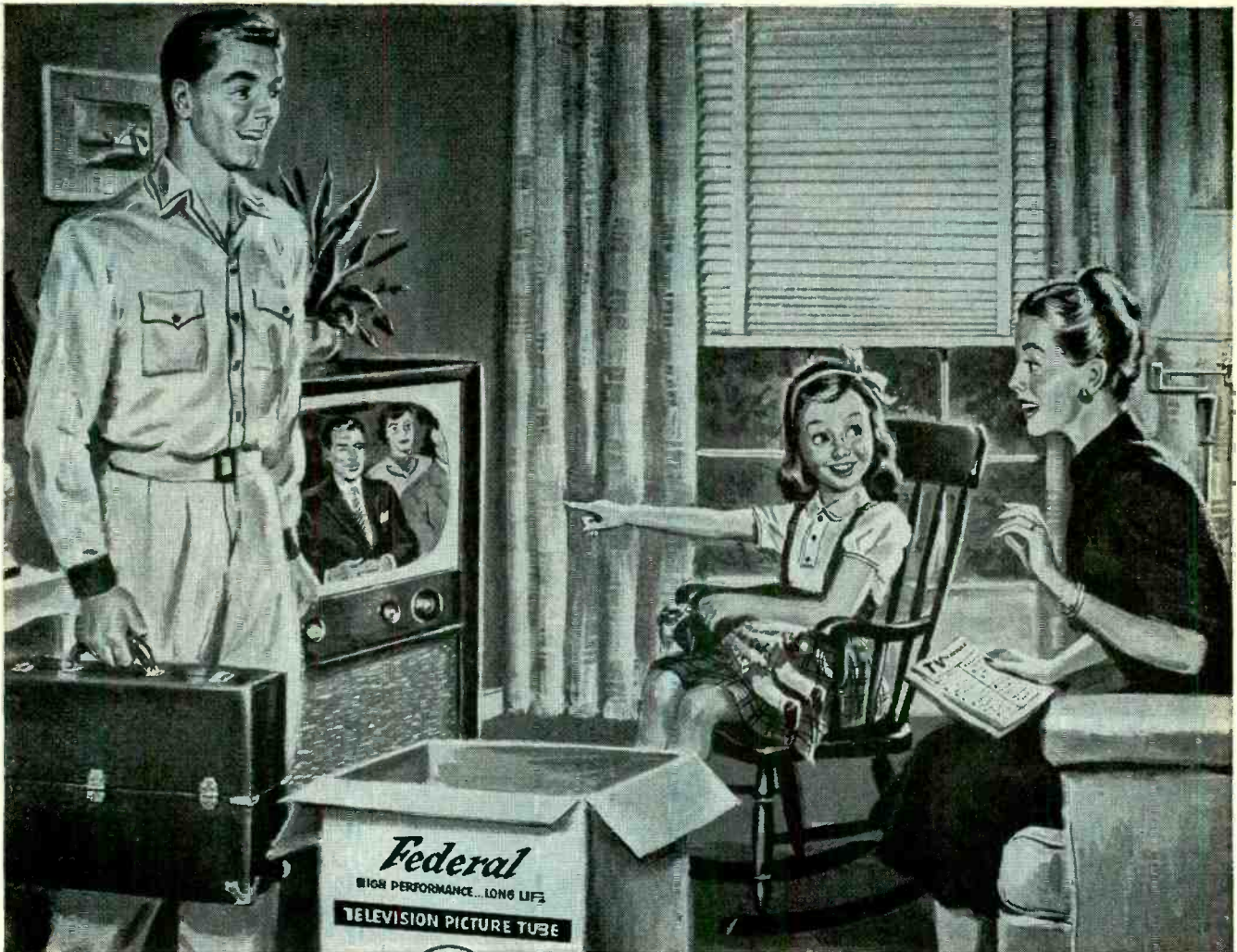

## The man who brought back a smile

**EXCITED?** Cynthia was practically bursting! Last thing Dad said was "Now you look close, Cindy. You'll see me right there in the audience tonight, and I'll wave to you." (They always do!) Long about three o'clock Cynthia's mother turned on the set . . . "just to make sure." Well, there was a picture, if you could call it that . . . but so dim and fuzzy they'd never even recognize Dad that evening. And Cindy . . . disappointed? She was brokenhearted! But, you know the happy ending . . . the serviceman's competent analysis . . . replacement of a worn-out tube with a Federal "Best-in-Sight" Picture Tube . . . and there are smiles again.



*Federal's*

Line of Popular-Size Picture Tubes will take care of over 90% of all TV replacements. Write for free copy of Federal's TV Picture Tube Data Book, Dept. N-263

**THE SERVICEMAN** gives his customers years of experience and expert technical ability. His business is knowing what's best . . . and giving the best. Customers rely on his judgment just as thoroughly as he relies on Federal "Best-in-Sight" Picture Tubes for the sharpest, brightest, clean-cut pictures possible. He *knows* that when he picks up the carton with the blue and white Federal label, he's going to make some customer a lot happier for a long, long time.



Consult your local Federal Distributor or write to

**Federal Telephone and Radio Corporation**

VACUUM TUBE DIVISION

100 KINGSLAND ROAD, CLIFTON, N. J.

In Canada: Federal Electric Manufacturing Company, Ltd., Montreal, P. Q.  
Export Distributors: International Standard Electric Corp., 67 Broad St., N. Y.



**BETTER PICTURES... BETTER SOUND  
PEAK PERFORMANCE ALL AROUND!**

the **NEW**  
**SKYLINE UHF-VHF**

- ▶ ONE LEAD-IN
- ▶ ALL CHANNELS
- ▶ ALL FREQUENCIES

▶ PARTS AND PERFORMANCE  
WARRANTY!

▶ PRE-ASSEMBLED

▶ QUICK RIG

▶ NOW 32 ELEMENTS

▶ SEPARATE UHF-VHF  
CIRCUITS

▶ AMAZING RECEPTION TO  
150 MILES AND MORE!

IT'S TOMORROW'S ANTENNA **TODAY!**

SKYLINE MFG. CO., 1458 E. 17th Street, Cleveland 14, Ohio

### ONE-TUBE TRANSCEIVER

The simplest form of v.h.f. or u.h.f. transceiver consists of a single-tube unit designed to receive and transmit on the same frequency. The tube is used as a superregenerative detector when receiving and as a plate- or grid-modulated oscillator when transmitting.

One particularly annoying characteristic of this type of equipment is that it is virtually impossible to maintain the same frequency for transmitting as for receiving. When the equipment is switched from one mode of operation to the other, the differences in circuitry and operating potentials cause the frequency to shift despite the fact that the same tuned circuits are used for receiving and transmitting.

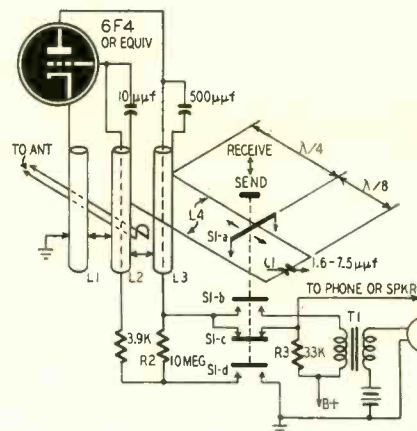

Above is a transceiver circuit incorporating an invention (covered in patent 2,611,858 issued to Robert E. Samuelson) which permits the equipment to operate as a transmitter preset to one frequency and as a receiver tunable over a range of frequencies within a band.

L1, L2, and L3 are coaxial-line tuning elements. The grid-cathode circuit is tuned by the movable shorting bar between L1 and L2, and the plate-grid circuit is tuned by adjusting the shorting bar between L2 and L3. Feedback necessary for oscillation is obtained through the coupling between L2 and L3. The antenna is coupled to the transceiver by a hairpin loop placed close to L2 and L3.

L4 is a  $\frac{3}{8}$ -wavelength parallel-wire transmission line shunted across sections of L2 and L3 with a variable capacitor C1 connected across its outer end. The combination of L4 and C1 acts as a type of bandspread tuning circuit connected across L2 and L3.

The SEND-RECEIVE switch S1 is a relay or a manually operated switch of any convenient type. It may be an insulated rod with metal flanges or rings which serve as S1-a, S1-b, S1-c, and S1-d. The switch is shown in the RECEIVE position. In this position, L4 and C1 form a parallel-tuned circuit which permits the receiver to be tuned over a range of frequencies.

R3 is the detector load. The audio



voltage may be taken off the plate side of the resistor and fed into headphones or a power amplifier for a speaker. R1 and R2 are connected in series as the receiving grid leak.

When S1 is switched to SEND, S1-a acts as a shorting bar connected across L4 at the quarter-wavelength point. C1 is now shorted out and the frequency is determined by the position of S1-a on L4 and by the tuning of the coaxial lines. S1-b and S1-c switch the secondary of the modulation transformer T1 into the plate circuit and disconnect R3. S1-d grounds the junction of R1 and R2, so R1 is used alone as the transmitting grid leak.

**SELECTIVE CRYSTAL TUNER**

To increase the usefulness of my phono amplifier, I constructed a simple crystal broadcast tuner for receiving two local stations on 730 and 850 kc. The stations were selected by switching preset trimmer capacitors across a coil. With this simple arrangement, the circuit was not selective enough to prevent both stations from being heard at the same time. The unwanted station could still be heard in the background even when separate coil and capacitor combinations were used for each station. Finally, the problem was solved by using the circuit arrangement shown in the schematic.

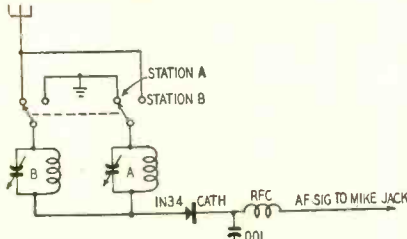

Fig. 1—Two-channel crystal tuner.

Circuit A is pretuned to station A and circuit B to station B. When station A is selected—as drawn in the schematic of Fig. 1—parallel-tuned circuit B is in series with the antenna circuit so it rejects station-B signals. Signals from station A pass through circuit B and are applied to circuit A and the detector. When station B is

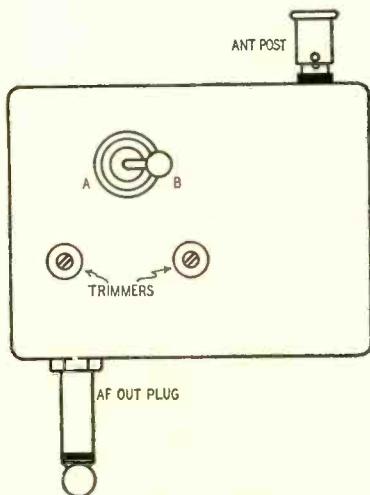

Fig. 2—Tuner assembly is compact.

**Now! HANDLE UP TO 90% OF TV TROUBLES**



by the easy **PICTURE ANALYSIS METHOD!**

Cut hours of tedious TV troubleshooting to minutes! Make repairs twice as fast! Operation of Ghirardi's new PIX-O-FIX TV TROUBLE FINDER GUIDE is simplicity itself. Covers all TV receivers. Just turn dial until actual TV screen photo appearing in PIX-O-FIX "window" matches distorted picture on set being repaired. PIX-O-FIX then gives you all possible causes for this trouble and just where they're likely to be found.

**PIX-O-FIX TV TROUBLE FINDER GUIDE**

By Ghirard, & Middleton

**Only \$1.**

Covers 24 common troubles identified by actual screen photos

- • • 190 possible causes of these troubles localized to receiver stage or section where they are most likely to occur.
- • • 253 step-by-step remedies.
- • • 4,500 words in CAUSE AND REMEDY section to show just what to do.

**WHAT TO DO—HOW TO DO IT**

Step-by-step repair instructions follow. Components likely to be faulty are specified. Quick tests are outlined. PIX-O-FIX guides you every step of the way! Remember! PIX-O-FIX is NOT a "fix-it-yourself" gadget for consumers. It is a truly professional device for servicemen, apprentices and students—prepared by two of the nation's foremost service instructors—A. A. Ghirardi and H. G. Middleton.

**MONEY BACK IF YOU'RE NOT SATISFIED!**

Simply pin a \$1 bill to this ad. Mail with your name and address to the publisher. If not satisfactory, return PIX-O-FIX in 10 days and your \$1 will be refunded promptly. (Price outside U.S.A. \$1.25, same money-back guarantee).

Dept. RE-63, RINEHART BOOKS, Inc., Technical Div., 232 Madison Ave., New York 16, New York

**LITTELFUSE**  
means  
qual-i-ty  
and  
ser-vice  
IN FUSES

**LITTELFUSE, INC.**  
DES PLAINES, ILLINOIS

Ask your jobber for  
Littelfuse TV  
Replacement Guide

**PAY LESS FOR TUBES**  
INDIVIDUALLY BOXED • FULLY TESTED • EACH TUBE GUARANTEED FOR SIX MONTHS

Type	Price	Type	Price	Type	Price	Type	Price
1B3GT	\$ .69	6A55	\$ .50	6L6C	80	12BA6	\$ .45
1B5GT	.46	6AT6	.38	6L6GA	.46	12BE6	.47
1L4	.57	6AU6	.43	6S4	.80	12BH7	.63
1N5GT	.57	6AV6	.38	6SA7GT	.52	12BZ7	.75
1R5	.56	6B4G	.96	6S7GT	.47	12SA7GT	.52
1S5	.47	6BA6	.45	6SK7GT	.50	12SK7GT	.50
1T4	.56	6BC5	.53	6SL7GT	.62	12SL7GT	.61
1T5GT	.71	6BD5GT	.89	6SN7GT	.54	12SN7GT	.54
1X2	.67	6BE6	.47	6S7GT	.42	12SQ7GT	.44
3Q5GT	.65	6BF5	.60	6T8	.78	19BG6	1.39
354	.55	6BG6	1.34	6UR	.85	19CR	.94
3V4	.56	6BH6	.57	6V6GT	.46	19T8	.79
5U4G	.43	6BJ6	.48	6W4GT	.45	25BQ6	.89
5V4G	.77	6BK7	1.10	6W5GT	.57	25L6GT	.48
5Y3G	.34	6BL7	.81	6X4	.34	25Z6GT	.42
5Y3GT	.30	6BQ6	.89	6X5GT	.33	35A5	.48
6AR4	.46	6BZ7	1.10	6Y6G	.59	35B5	.47
6AF4	1.40	6C4	.34	7N7	.52	35C5	.47
6AQ5	.54	6CB6	.53	12AT6	.38	35L6GT	.47
6AK5	.95	6CD6	1.85	12AT7	.68	35W4	.31
6AK6	.63	6F6GT	.45	12AU6	.43	35Z5GT	.30
6AL5	.40	6HG6T	.49	12A7U7	.55	50B5	.47
6AN4	1.30	6J5GT	.40	12AV6	.38	50C5	.47
6AQ5	.46	6J6	.62	12AV7	.80	50L6	.47
6AQ6	.42	6K6GT	.41	12AX7	.61	11Z23	.39
6AR5	.38			12AZ7	.70	11Z26	.68

Motorola Ballast Tube #17A485459..... .30

Each tube is performance-proven. 25% deposit must accompany all orders. Balance C.O.D. All prices F.O.B. N.Y.C. If remittance is made with order, you can deduct 2%. \$1.00 handling charge for orders under \$10.00. Subject to Prior Sale. Importer inquiries invited.

**PHILLIPS TUBE CO.** 2281 1/2 Nostrand Ave. Brooklyn 10, N. Y. CLoverdale 3-8010-1-2

**LEARN WITH "AMECO" COURSES**  
Simple, Low Cost, Home-Study Courses prepare you to pass F.C.C. Code and Theory license examinations.

**BECOME A RADIO AMATEUR**

Write for details and receive free sample F.C.C.-type questions and answers for all amateur examinations.

**FREE** →

**AMERICAN ELECTRONICS CO.**  
1205 Bryant Ave., New York 59, N. Y.

**ENJOY 3 COLOR TELEVISION FILTER SCREEN NOW**

Changes dull eye-straining black-white pictures into beautiful color tones. Seconds to attach. Send \$1.50 for 16" or under, \$2 size 17", \$2.50 size 20", \$3 size 21", \$4.00 size 24". Money back guarantee if not delighted.

**Zingo Products, Johnstown 13, New York**





**Poof!**  
there goes  
**NOISE!**

with

## SPRA-KLEEN

contact cleaner & lubricant

- No More Eyedroppers
- Can't Break
- Can't Evaporate
- Cleans & lubricates in one operation
- Can't Spill

Available thru jobbers

**WARD E. RICE INDUSTRIES**  
P.O. Box 1705, Glen Park Sta., Gary, Ind.

Only  
**\$1.00**  
Net  
6 full ounces

### OPPORTUNITY ADLETS

Rates—45¢ per word (including name, address and initials). Minimum ad 10 words. Cash must accompany all ads except those placed by accredited agencies. Discount, 10% for 12 issues. Misleading or objectionable ads not accepted. Copy for August issue must reach us before July 21, 1953.  
Radio-Electronics, 25 W. Broadway, New York 7, N. Y.

**SELL USED TELEVISION RECEIVERS.** Large market. Prices start at \$10 and up. Buy direct from us. Up to 24 inch sets available. Send forty cents for price lists and descriptions. Ace Television, 401 N. Burdick St., Kalamazoo, Michigan.

**SPEAKERS REPAIRED** at wholesale prices. Guaranteed workmanship. Fast service. Amprite Speakers Service, 70 Vesey St., New York 7, N. Y.

**ISOLATION TRANSFORMER** 35w 117v sec 117 or 135 plus 6.3v 45a. 2 1/2 x 2 1/2 x 3. \$2.45 include postage 3 lbs. Bulletin available. Sell us your surplus material. Empire Electronics Co., 409b Ave. L, Brooklyn 30, N. Y.

### One-Fingered Pianists

Build your own 3-octave electronic keyboard and play everything! Uses 8 octal tubes, 16 steps, 2-octave extension & variable attack. Guitar, cello, flute, trumpet are all easy. Imitates almost whole orchestral range. Six full data sheets & booklet detail simple instructions. \$4.50 Air Post paid. Money orders to . . .

H. R. McDermott, 10 Duke Street  
Darlington, Co. Durham, England.

**TUBES AND EQUIPMENT BOUGHT, SOLD AND EXCHANGED.** For a fair deal send details to B. N. Gensler W2LN1, 136 Liberty, N. Y. 6, N. Y.

**1000 THERMOGRAPHED (EMBOSSSED) BUSINESS CARDS—\$1.50.** Free Sample. Klein, 980 Simpson Street, New York 58.

**WANTED: AN/APR-4, other "APR-", "TS-", "TE-", ARC-1, ARC-3, ART-13, BC-348, etc.** Microwave Equipment, everything Surplus. Special tubes, Tec Manuals, Lab Quality Equipment, Meters, Fast Action. Fair Treatment. Top Dollar! Littell, Farhills Box 26, Dayton 9, Ohio.

**ALL TYPES OF ANTENNAS FOR AMATEUR AND TV.** Aluminum Tubing. Willard Radcliff, Fostoria, Ohio.

**RECONDITIONED TELEVISIONS, \$30 UP.** W4API, 1420 South Randolph, Arlington, Virginia.

**TV-FM ANTENNAS, ALL TYPES INCLUDING UHF.** Mounts, accessories. Lowest prices. Wholesale Supply Co. Lunenburg 2, Mass.

### PHOTOGRAPHS

**RADIO-ELECTRONICS** can use good photographs of service benches, service shops, high-fidelity audio layouts, and any other interesting and original radio-electronic devices. We will pay \$6.00 each for good professional photos or equivalent, suitable for reproduction. Full information on subject photographed will increase their acceptability.

The Editor, **RADIO-ELECTRONICS**  
25 West Broadway, New York 7, N. Y.

## RADIO-ELECTRONIC CIRCUITS

selected, circuit A is switched in series with the antenna lead to reject signals from station A.

The circuit was built into the case of a surplus type MC-385 headset adapter as shown in the drawing at Fig. 2. I simply plug it into the microphone jack on the amplifier and connect an antenna whenever I want to receive either of the two predetermined local stations.—R. B. Dhuru

### U.H.F. YAGI ANTENNA

Many TV set owners have had good results with v.h.f. TV Yagis and are now planning to construct similar ones for u.h.f. TV channels which have opened or are about to open in their localities.

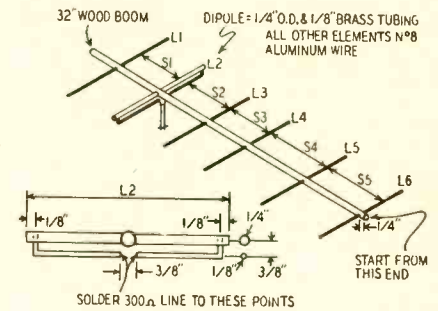

A six-element Yagi designed for a forward gain of 9 db with a good front-to-back ratio on u.h.f. TV channels is described in *Sylvania News*. Its construction and design constants are shown on the diagram. The table gives element lengths and spacings in decimal parts of the wavelength. On u.h.f. channels, one wavelength (in inches) at the center of a given TV channel can be derived from the formula:

$$\lambda \text{ (inches)} = \frac{11,800}{(6 \times \text{u.h.f. channel No.}) + 389}$$

Or refer to the chart on P. 38 of **RADIO-ELECTRONICS**, January, 1953.  
The boom is a 3/4 x 3/4 x 32-inch piece

**Regency**  
**LARGEST SELLING BOOSTER**  
at any price!

burton browne advertising







# This Month Only—TAKE 5% OFF EVERYTHING!

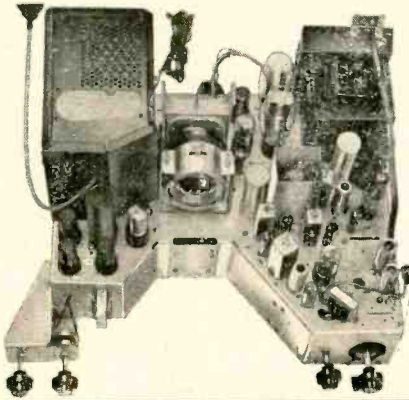

## NOW! #630 SUPER DELUXE 31-TUBE TV KIT WITH U.H.F.

ONE SET U.H.F. STRIPS INCLUDED FOR ANY U.H.F. STATION—NO EXTRA CHARGE

OPERATES ALL 16" TO 24" PICTURE TUBES

Engineered in strict adherence to the genuine RCA #630, plus added features ★ ★ ★ ★ ★

### NOTHING BETTER AT ANY PRICE!

- Standard Cascode Turret Tuner for DX
- Cosine 70° Deflection Yoke for Definition
- Original 630 Synch. Chain for Stability
- 16 KV for Clarity and Brilliance
- Fast Action Pulse Keyed AGC
- Large Concert-tone 12" PM Speaker

**COMPLETE SET OF PARTS** including the components of the STANDARD KIT plus added features, more tubes, doubler components, AGC components. Cascode tuner, Cosine 70° deflection yoke, 12" speaker, etc., and the Brooks LIFE-SIZE instructions (less CRT & wire)

only... **\$119.44**

## NOW! #630 SUPER DELUXE 31-TUBE TV CHASSIS WITH U.H.F. —

Licensed under RCA patents

ONE SET U.H.F. STRIPS INCLUDED FOR ANY U.H.F. STATION—NO EXTRA CHARGE

**COMPLETE READY TO PLUG IN AND PLAY** including all tubes, CRT mounting brackets, 12" speaker, etc. No charges for extras of any kind. Each set is factory aligned and air tested. All parts are guaranteed 3 months. Our booklet "HINTS FOR BETTER PERFORMANCE ON YOUR #630 TV RECEIVER" is supplied with each set. Your best buy at

**\$167.97**

(less C.R. Tube)

### A PLAN TO SAVE YOU MONEY

**PACKAGE DEALS**—Each containing an assortment of the most desirable types and sizes to enable you to get the most amount of repairs done, with the least investment in parts, at a cost of only 1/3 than if bought separately!

**RESISTOR and CONDENSER CODE CHARTS FREE** with EACH ORDER

### ASSORTED TUBULAR 100 CONDENSERS

All are Standard Brands & Desirable Sizes  
\$15.00 Value Only **\$4.69**

### ASSORTED 1/2 WATT 100 RESISTORS

Just what you use in Radio & TV Repairs  
\$12.00 Value Only **3.97**

### 15 ASST. RADIO ELECTROLYTIC CONDENSERS 4.74

### 15 ASSORTED TV ELECTROLYTIC CONDENSERS 6.88

### 100 ASSORTED MICA CONDENSERS 4.99

### 100 ASSORTED CERAMIC CONDENSERS 4.99

### 100 ASSORTED 1 WATT RESISTORS 5.89

### 100 ASST. PILOT LIGHTS 4.83

### 100 ASSORTED SOCKETS 3.92

### 100 ASSORTED KNOBS 3.97

### 10 VOLUME CONTROLS 2.94

### 10 VOLUME CONTROLS 1.94

### STANDARD PICTURE TUBES

BRAND NEW — With a Full Year Guarantee

16"	16AP4A	(Round, Metal, Black)...	\$28.97
16"	16GP4A	(Round, Metal, Black)...	28.97
16"	16TP4	(Rectangular, Black)...	28.97
17"	17BP4A	(Rectangular, Black)...	29.63
19"	19AP4A	(Round, Metal, Black)...	39.82
20"	20CP4	(Rectangular, Black)...	39.74
21"	21EP4A	(Rectangular, Black)...	44.68
24"	24AP4	(Round, Metal, Black)...	79.49

### #630 Parts in COMPLETE SETS

TV WIRE & SOLDER KIT, for any Set	\$1.49
630-KIT, screws, nuts, rivets, washers, etc.	1.69
TERMINAL STRIP KIT, set of 30	.98
VIDEO AND I.F. KIT, 19 items	7.84
AGC KIT, complete with instructions	4.59
VARIABLE CONTROL KIT, 9 controls	5.83
CARBON RESISTOR KIT, 107 resistors	6.98
WIREWOUND RESISTOR KIT, 4 resistors	2.31
BACKET AND SHIELD KIT, 18 items	8.63
ELECTROLYTIC CONDENSER KIT, 6 cond.	7.37
TUBULAR CONDENSER KIT, 38 condensers	4.28
CERAMIC CONDENSER KIT, 28 condensers	3.37
MICA CONDENSER KIT, 11 condensers	1.38
COMPLETE SOCKET KIT, 25 sockets	1.57
SET UNIVERSAL CRT MOUNTING BRACKETS	6.97
COMPLETE SET OF TUBES, 29 tubes	30.31

### PARTS For #630 TV SETS

PUNCHED CHASSIS PAN, cadmium plated	\$ 4.87
STANDARD CASCODE TUNER, incl. tubes	22.49
ESCUTCHEON PLATE, for tuner	.69
COMPLETE SET OF KNOBS, incl. decals	1.34
POWER TRANSFORMER, 295ma. 201T6	9.97
VERTICAL OUTPUT TRANS. 204T2	2.69
VERTICAL BLOCKING TRANS. 208T2	1.32
HORIZONTAL OUTPUT TRANS. 211T1	2.47
HORIZONTAL OUTPUT TRANS. 211T5	3.98
FOCUS COIL, 247 ohms, 202D1	2.29
FOCUS COIL, 470 ohms, 202D2	3.42
DEFLECTION YOKE, 60°, 201D1	2.97
DEFLECTION YOKE, Cosine 70° 206D1	3.98
SOUND DISCRIMINATOR TRANS. 203K1	1.12
1st PIX I.F. TRANSFORMER, 202K2	1.08
2nd PIX I.F. TRANSFORMER, 202K3	1.08
1st or 2nd SOUND I.F. TRANS. 201K1	1.02
HORIZONTAL DISCRIM. TRANS. 208T8	1.49
FILTER CHOKE, 62 ohms 202K4	1.47
CATHODE TRAP COIL, 202K4	1.08
WIDTH CONTROL COIL, keyed AGC	.79
ION TRAP BEAM BENDER, double 203D3	.98
ION TRAP BEAM BENDER, single 203D1	.79
HI VOLTAGE CAGE ASSEMBLY, complete	3.73
VOLTAGE DIVIDER SHIELD & COVER	1.79
HV RECTIFIER, SOCKET ASSEMBLY, single	.79
HV RECTIFIER, SOCKET ASSEMBLY, double	1.37
TV 6' LINE CORD, with both plugs	.29
AGC BRACKET & SOCKET	.39
CATHODE RAY TUBE SOCKET, 18" leads	.39
HV KINESCOPE LEAD, with clip	.39
FILTER CONDENSER 15kv-500mmf(cartwheel)	.67
FILTER CONDENSER 20kv-500mmf(cartwheel)	.79
FILTER CONDENSER 30kv-500mmf(cartwheel)	1.49
AUDIO OUTPUT TRANSFORMER (6K6)	.69
12" PM SPEAKER, heavy alnico #5 magnet	6.94

### CUSTOM-BUILT CABINETS

2 LEADING STYLES in genuine mahogany or walnut Ready drilled for any #630 TV chassis and cutout for any 14" to 21" picture tube at no extras in price. Also supplied with undrilled knob panel for any other TV set. Delivered complete as pictured.

**The VOGUE**  
Most Popular Table Model.

**The MANHATTAN**  
Style, Quality, Price

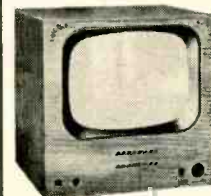

H-25", W-26", D-22"

**\$39.89**

VOGUE also available for 24" or 27" picture tube  
H-31", W-27", D-23"



H-41", W-25", D-23"

**\$59.37**

### Brooks LIFE-SIZE Edition

**#630 TV KIT BUILDER-SET of INSTRUCTIONS**  
BUILDING YOUR OWN #630 TV CHASSIS is now simplified with this COMPLETE SET OF BUILDING & WIRING INSTRUCTIONS. Covers all #630's, from the RCA 10" SET to the latest SUPER DE LUXE 31-tube 16" to 24" RECEIVER. EVERYTHING AT A GLANCE—LAYOUT CHARTS show chassis and components in actual LIFE-SIZE with instructions alongside the illustrations.

INDISPENSABLE for BUILDING, CONVERTING or TROUBLE SHOOTING any #630 TV SET.

Popular priced at only... **\$2.49** Postpaid

- 1—HINTS FOR BETTER PICTURES ON 630 TV
  - 2—630 TV DIAGRAM WITH MODIFICATIONS
  - 3—ILLUSTRATED TV CONVERSION MANUAL
  - 4—PULSE KEYED AGC CIRCUIT DIAGRAM
  - 5—RMA RESISTOR & MICA CODE CHARTS
- All for only... **\$1.00** Postpaid

Brooks CASCODE MANUAL. How to install Cascode Tuner in any make TV set **50¢** Postpaid

"Highlights of TV Offers for 1953" included with each order.

**BROOKS RADIO & TV CORP., 84 Vesey St., Dept. A, New York 7, N.Y.**

TELEPHONE  
COrtland 7-2359



**EXPERIMENTERS SPECIALS**



**1 RPM MOTOR**  
115 volts, 60 cycles. Syn-  
chron model 600. Use for  
timing devices models,  
displays, gadgets, etc.  
Stock No. RE-5  
Price \$2.95 each



**AMPERE DEMAND METER**  
Stewart Warner-748A. In-  
dicates up to 20 Amperes  
long time average current  
draw. High time lag—  
follows heating effect of  
supply transformers. Use  
to check motor and line  
overload as well as peak  
average demand. Indicating  
average and average  
peak recorder pointers.  
Stock No. RE-119  
Special @ \$3.95 each



**Redmond 6 Volt DC Motor**  
—An ideal small dc motor  
for the experimenter. Oper-  
ates from 6 volts dc at  
3000 rpm. Requires 1.75  
amperes for 1/100 horse-  
power.  
Stock No. RE-137  
Special \$2.95 each



**RESISTOR KIT**  
A miracle of value. 99 car-  
bon-on-ceramic deposited  
resistors. German made.  
10% tolerance. 11 popu-  
lar values 100 ohms to  
100 K. Assorted 1/4, 1/2  
and 1 watt. 9 compartment  
hinged covered clear plas-  
tic box.  
Stock No. RE-1002  
Special at only \$1.98

**Drafting Machine—Manufactured by Star Watch  
Case Co. as Vector Plotting Machine Type AN-  
5748. Converted by us with two 18" arms, adjustable  
angle between arms. Arms do not have inch scales.  
Ideal for electrical drafting. Stock #RE-249.  
Price \$27.50**

Write for free catalogue of Electronic, Aircraft, Hy-  
draulic, and other equipment.

**ELECTRO DEVICES, INC.**

4-6 Godwin Ave. Paterson, N. J.

**FREE!**

**THE HOTTEST VALUE-  
PACKED BULLETIN  
IN THE MAILS!**

Over 153,000 subscribers  
buy and save through  
**WHOLESALE RADIO'S  
F. Y. I.  
BULLETIN  
EVERYTHING  
IN RADIO • TV  
HI-FI SOUND**

Write for  
New FYI  
# 102  
Just Off  
The Press

**WHOLESALE  
RADIO PARTS  
COMPANY, Inc.**  
311 W. Baltimore St.  
Baltimore-T, Md.

**C-R TUBE CHECKER ADAPTER**

The three drawings show the wiring of harnesses which I use to check some common types of oscilloscope and television picture tubes in my Jackson model 636 and Precision 954-G tube checkers. The tube checker supplies the necessary voltages and the C-R tubes can be checked without removing them from the equipment in which they are installed.

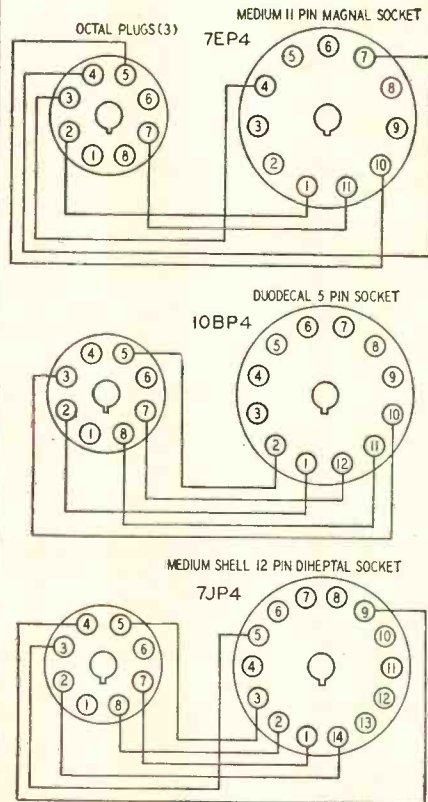

The settings for the Precision 954-G are: 6-6-15-5-1-1-D and settings for the Jackson 636 are: Normal-6.3-30-4JKR. These settings are used for all types of tubes. The checkers will indicate low emission, shorts, and slow heating.

The adapter-harnesses are made from octal plugs and cathode-ray tube sockets. Tubes which use base connections and dimensions the same as the 7EP4, 7JP4, and 10BP4 can be checked with these harnesses.—Hyman Herman

**DIODE NOISE CLIPPER**

One plate of the duo-diode-triode second detector and a.f. amplifier tube is grounded or left floating in many small receivers. This diode can be used as an effective noise clipper. The common procedure is to tie the unused diode directly, or through a switch, to the control grid of the audio output tube. Although the diode clips the noise peaks, this connection is often unsatisfactory because it causes severe distortion on peaks of the audio signal.

The diode may be used for noise clipping without distortion by modifying the circuit as shown by the heavy lines in the diagram. The effectiveness and smoothness of this circuit is the

**for dependable sound,  
INDUSTRY relies on  
ATLAS**



DR Double-Reentrant Projectors

**DEPENDABLE QUALITY:**

The latest electro-acoustic research and engineering—and over 20 years of manufacturing know-how—are behind every ATLAS product.

**DEPENDABLE SERVICE:**

Coast-to-coast and around the world today—in every Industrial, Marine, Railroad, Military, Educational, Civic, U.S. and Foreign Government application—under every kind of climate and noise condition—ATLAS sound equipment is famous for highest efficiency and durability. That's the proof of ATLAS performance dependability.

**DEPENDABLE DELIVERY:**

Yes, ATLAS gives our Government highest priority. And yes, we too feel the pinch of material shortages. But our customers will continue to get our usual dependable delivery—because we believe in equitable and dependable distribution to all ATLAS users.

**DEPENDABLE PROFITS:**

Completeness of line, excellence of product, dependable delivery, right prices—that's the ATLAS combination that means high, steady Industrial Sound profits for You!

JUDGE for yourself, COMPARE ATLAS at your local Jobber today. See why ATLAS is the preferred line for utmost dependability. Write NOW for FREE latest Catalog 551.



Paging & Talk-Back Speakers



ALNICO-V-PLUS Driver Units



Dual Speakers



FULL-GRIP, VELVET-ACTION Mike Stands



**ATLAS  
SOUND CORP.**

1443-39th Street, Brooklyn 18, N. Y.  
In Canada: Atlas Radio Corp., Ltd., Toronto, Ont.

**OSCIL-O-PEN**

Extremely convenient test oscillator for all radio servicing; alignment • Small as a pen • Self powered • Range from 700 cycles audio to over 600 megacycles u.h.f. • Output from zero to 150 v. • Low in cost • Used by Signal Corps • Write for information.

**GENERAL TEST EQUIPMENT  
38 Argyle Ave. Buffalo 9, N. Y.**

**RYTEL—another name for QUALITY**

Manufacturers of VHF and UHF ANTENNAS, AIM (automatic impedance match), UNIVERSAL tube pullers, antenna connectors, vent pipe clamps and auto speaker grill kits.

**RYTEL ELECTRONICS MFG. CO.**

9820 Irwin Ave.  
Inglewood, Calif.



# New Portable Battery-Operated Spring-Motor Tape Recorder



## The Magnemite\*

For all field recording without AC power! Smaller and lighter than a portable type-writer, the Magnemite\* actually makes field recordings that can be played on any studio console equipment. Completely self-powered, the Magnemite\* does away with bulky and cumbersome generators, storage batteries and rechargers.

Just check these unusual features:

- Noiseless and vibrationless governor-controlled spring-motor assures constant tape speed.
- 100 operating hours per set of inexpensive flashlight-type dry cell batteries.
- Earphone monitoring while recording, and earphone playback for immediate quality check.
- Operates in any position, and is unaffected by movement or vibration during operation.
- Warning indicator tells when to rewind, and shows when amplifier is on.
- Broadcast models weigh 15 pounds. Slow-speed models weigh only 10 pounds.
- Requires no more desk space than a letter-head, measuring only 11 x 8½ x 5½ inches.

There's a choice of 5 different models for any recording need. High fidelity units, meeting primary and secondary NARTB standards, which record and play back frequencies up to 15,000 cycles, are available for broadcast stations, critical music lovers, and scientific research. For investigation, missionaries, reporters, and general dictation while traveling, there are units which play up to 2 hours per reel of tape.

Write Dept. 10 for complete descriptive literature and direct factory prices.



**AMPLIFIER CORP.**  
of AMERICA

398 Broadway, N. Y. 13, N. Y.

\*Trade Mark Reg.

### TRY THIS ONE

result of the addition of two inverse feedback loops. One loop feeds back some signal from the output plate to the cathode of the preceding stage. The other loop is connected between the

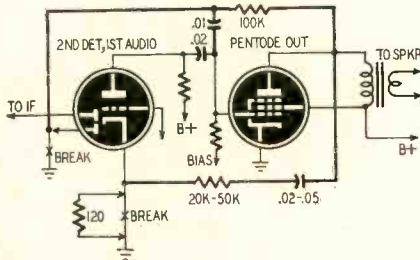
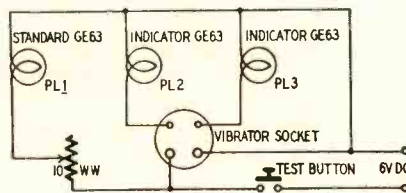

plate and grid of the output stage. The cathode of the triode is disconnected from ground and a 120-ohm resistor is inserted in series with the cathode return.—George D. Philpott

### VIBRATOR TESTER

The diagram shows the construction of a simple tester for 4-prong vibrators of either the shunt-coil or separate-driver types. The tester uses one 4-prong vibrator socket; three G-E type 63 automobile license-plate lamps; three single-contact bayonet sockets; a normally-open push-button switch; and a 10-ohm wirewound potentiometer (an ancient filament rheostat will do).

To calibrate the tester, plug a new vibrator into the socket, press the test button, and adjust the variable resistor until the standard lamp PL1 has the same brightness as the indicator lamps PL2 and PL3. The tester is now ready for use.



To check a questionable vibrator, plug it in, press the switch, and watch the lamps. The brightness of the lamps indicates the condition of the vibrator. Indicators PL2 and PL3 should be just as bright as PL1. You can familiarize yourself with the operation of this unit by testing vibrators which you know are bad.

I've used this tester for more than a year. It spots defective vibrators in seconds.—Benito Tan

### BAD SPOTS IN TV CONTROLS

Sometimes you may run across a TV set in which a centering control or similar potentiometer on the back has a bad spot at the proper operating position. When a replacement is not available or the job does not warrant a replacement, you may be able to improve the operation of the defective control by reversing its two outside connections. This will switch the optimum operation to the opposite end of the range and eliminate the erratic operation which is usually caused by the bad spot on the resistance element.—Leonard Pfeiffer

## ENGINEERS!!!

OPEN THIS DOOR TO A bright future!

Test & Inspection Engineers

Radar Field Eng.

Electronics Engineers

Components Engineers

TV Receiver Design Eng.

You're needed to work on: Radar, G.C.A., Mobile Radio, Auto Radio, Airborne Communication & Navigation Equipment, Television, Antennas, Microwave Equipment, Servo Mechanisms and Guided Missiles.

You benefit from high wages, modern, air-conditioned plant, paid vacations and holidays, group insurance and good chance for advancement. Housing immediately available in beautiful suburban and country areas that surround our plant. Write, wire or phone MR. L. H. NOGGLE, Dept. R.

### Bendix Radio

DIVISION OF BENDIX AVIATION CORPORATION  
BALTIMORE-4, MD. Phone: TOWSON 2200

### NEW, UHF BOW-TIE ANTENNA

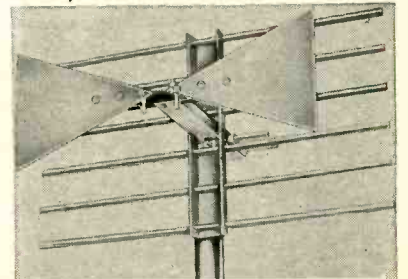

The only flexibly constructed Bow-Tie and Reflector Antenna made for all UHF channels. Average 7 db gain for all UHF channels.

\$3.95 lots of 3  
\$4.45 ea.

### ANTENNA SPECIALS

Double "V", ea.	\$2.95	300 ohm wire, per 100 ft.	\$1.95
10 element conical ea.	3.95	300 ohm wire, per 1,000 ft.	14.95
New UHF-VHF conical "V", very hi-gain, ea.	8.95	UHF Hi-gain wire, per ft.	5¢
		72 ohm wire, per ft.	5¢
60° Yoke, ea.	\$1.29	U.L. Approved Lightning Arrestor, ea.	\$0.69
70° Cosine yoke, ea.	3.95	Chimney Mount, pr.	1.79

### LATEST MODEL 630 DX CHASSIS

Complete, with all tubes, 12" speaker and Cascade tuner \$145.50 (less CRT)

Don't Throw Away Your Old Picture Tube!

PICTURE TUBE BRIGHTENER \$1.49 ea. lots of 3

Gives picture tube new brightness and extends its life. \$1.69 ea. FREE: Ask for new catalog. Min. Order: \$5. 25% deposit with order. All mdse. subject to prior sale, F.O.B. N.Y. Prices subject to change without notice.

New address:

The ROSE Co. 76 Vesey St. Dept. E-6 New York 7, N. Y. COrtlandt 7-6195



**INDOOR YAGI FOR TV**

Recently, I moved into an apartment house where the landlord did not permit TV antennas to be attached to the roof or any other part of the building. Since I live in the deep fringe area—about 95 miles from the nearest TV station—it seemed that an indoor antenna would be entirely useless. In desperation, I installed a rabbit-ears antenna and a Regency booster. I received weak sound and no picture on channel 5 and a very weak picture and sound on channel 2.

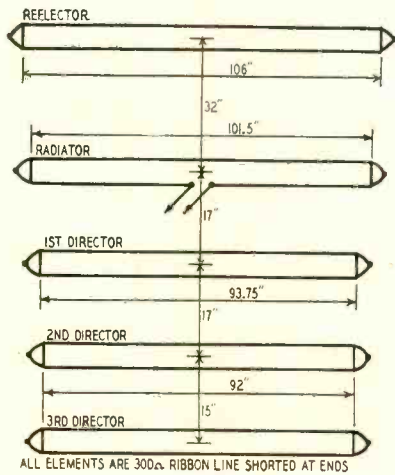

The next step was to cut a folded dipole for channel 2, using 300-ohm ribbon line. After attaching a lead-in, I held the dipole as high as possible, moved it around the room until I found where the signal was strongest, and taped it to the ceiling at this point. This antenna (with the booster) provided a signal which was much stronger than the rabbit-ears but not strong enough to provide a picture which could be viewed comfortably.

Next, I decided to convert the antenna to a Yagi to obtain more signal with less interference. Shorted lengths of 300-ohm line were taped to the ceiling and used as parasitic elements. The diagram shows the dimensions which gave the best results. The optimum element spacing is the result of a lot of trial-and-error experiment in an effort to feed the strongest possible signal into the receiver. Reception was further improved by wrapping a tinfoil slider around the lead-in and positioning it for the clearest picture.

This antenna, together with the booster, provided a much stronger signal than was expected. The picture was not excellent but it was good enough to watch and enjoy. Late in the evenings the signal strength often increases to the point where the picture compares favorably with those received in primary service areas.

After completing the Yagi, I obtained permission to install an outdoor TV antenna in the back yard. I now have a 4-bay conical mounted 20 feet high on a pole. With this array, reception on channel 2 is only slightly better than that obtained with the indoor Yagi, but has the advantage of also providing fairly good reception on channels 5 and 8.—G.N. Manning. END



70% to 90% off list!  
**TOP TUBE BUYS**

All Tubes Individually Boxed! Check this list for Rigidly-Tested, Full 1-Year Guaranteed Tubes.

Type	Price	Type	Price	Type	Price	Type	Price	Type	Price
1A5GT	.30	3V4	.47	6B6GG	1.25	6U5	.44	14J7	.30
1A6G	.30	5U4G	.45	6BH6	.46	6U6	.63	14W7	.30
1A7GT	.47	5V4	.73	6BJ6	.39	6U8	.61	19B6G	.95
1AB5	.30	5W4	.50	6BK7	.59	6V6GT	.39	19C8	.70
1B3	.65	5X4	.40	6BL7	.59	6W4GT	.44	19T8	.79
1B5	.30	5Y3G	.32	6BQ6T	.59	6W6GT	.44	19V8	.89
1B7GT	.30	5Y3GT	.32	6BQ7	.95	6X4	.37	24A	.63
1C5GT	.43	5Y4G	.35	6BZ7	.95	6X5GT	.37	25AV5	.83
1E7	.29	5Z3	.46	6C4	.37	6X8	.61	25BQ6GT	.62
1G4GT	.24	6A7	.62	6C5GT	.39	6Y6G	.48	25L6GT	.39
1G6	.30	6A8	.59	6C6	.58	7A4	.47	25W4	.56
1H4G	.30	6AB4	.44	6C8G	.24	7AF7	.53	25Z5	.40
1H5GT	.40	6AG5	.43	6C86	.44	7B4	.44	25Z6GT	.37
1H6	.24	6AJ5	.90	6CD6G	1.11	7C6	.40	26	.45
1J6	.24	6AK5	.75	6D6	.45	7E6	.30	27	.39
1L4	.46	6AL5	.38	6E5	.48	7K7	.70	32L7	.89
1LC5	.51	6AQ5	.39	6F5GT	.39	12A8	.61	35B5	.40
1N5	.46	6AQ6	.37	6F6	.37	12AL5	.37	35C5	.39
1P5	.57	6AR5	.37	6F8G	.24	12AT6	.37	35L6GT	.41
1Q5	.58	6AS5	.50	6GG6	.52	12AT7	.56	35W4	.37
1R5	.45	6AT6	.37	6H6GT	.41	12AU6	.38	35Z4	.39
1S5	.39	6AU6	.38	6J5GT	.37	12AU7	.43	35Z5GT	.37
1T4	.45	6AV5	.83	6J6	.52	12AV6	.39	35Z6	.60
1T5	.53	6AV6	.37	6J7G	.43	12AV7	.59	41	.42
1U4	.45	6AX4	.57	6J8	.30	12AX4	.48	42	.42
1U5	.39	6AX6G	.24	6K5	.47	12AX7	.48	43X5	.55
1V	.60	6B4G	.64	6K6GT	.37	12AZ7	.69	45	.45
1X2	.63	6BA6	.39	6K7	.44	12BA6	.38	45Z5	.49
2A3	.70	6BA7	.57	6L5	.24	12BA7	.60	50B5	.39
2A4G	.24	6BC5	.44	6L6	.64	12B6	.45	50C6	.59
2X2	1.50	6BC7	.59	6Q7	.45	12B6	.39	50L6GT	.41
3A4	.45	6BD5GT	.34	6S4	.38	12B6	.39	50Y7	.50
3E5	.46	6BD6	.45	6S8	.53	12BH7	.63	53	.24
2Q4	.48	6BE6	.39	6SA7GT	.43	12B7	.65	56	.24
3Q5GT	.49	6BF5	.41	6SD7GT	.41	12C8	.34	58	.60
354	.46	6BF6	.37	6SF5GT	.46	12F5GT	.34	70L7GT	1.09
				6SG7GT	.41	12J6GT	.42	75	.41
				6SH7	.73	12J7GT	.34	76	.44
				6SJ7GT	.41	12K7GT	.34	77	.57
				6SK7GT	.41	12S8	.70	78	.47
				6SL7GT	.48	12S7GT	.44	80	.35
				6SN7GT	.52	12S7	.50	83V	.68
				6SQ7GT	.37	12S7GT	.52	85	.59
				6SR7GT	.45	12S7	.44	117L7	.99
				6SS7	.42	12SK7GT	.48	117Z3	.37
				6T8	.56	12SL7GT	.47	807	.99
				6U4	.60	12SN7GT	.52	1274	.99
						12S7	.44	2050	1.85
						12SR7	.49	6113	1.00

**Rad Tel TUBE CO.**

"Integrity Is Our Chief Asset"  
Phone: Essex 5-2947

TERMS: A 25% deposit must accompany all orders—balance C.O.D. All shipments F.O.B. Irvington warehouse. Orders under \$10—\$1.00 handling charge. Subject to prior sale. Don't Delay... Order Today!

115 COIT ST.  
Dept. RE 6  
IRVINGTON II, N. J.

**SUBSCRIBERS**

If you're moving, please don't forget to send us your address as it appears on the copy of the magazine, including the numbers shown beside your name, as well as your new address.

If we receive this information before the 20th of the month, you will continue getting the magazine without interruption.

Your cooperation will be most helpful and greatly appreciated.

**THE NEW DYNATRACER\***

Designed To  
**DOUBLE YOUR PROFITS**  
CHECK SETS IN THE HOME  
Makes TV servicing easier,  
faster and more accurate at  
LOW COST.

Trace signals and voltages—  
Locate defective components  
instantly.

Requires No  
Additional Equipment  
"DYNATRACER" is a portable self-  
powered quality instrument that is used  
under actual operating conditions.  
"DYNATRACER" is designed to  
trace signals through any video  
sound, sync, AFC, vertical or horizon-  
tal sweep circuit and instantly isolate  
trouble to a stage or component.

**ADDED FEATURE:—**

With a flick of the switch, the  
"DYNATRACER" will also trace voltages and in-  
stantly locate open, shorted or intermittent condensers,  
resistors, coils, speakers, transformers, etc.  
Complete Instructions and Trouble-Shooting Methods  
Enclosed. Satisfaction guaranteed.  
Century instruments are quality engineered for ac-  
curate and efficient servicing.

**CENTURY ELECTRONICS CO.**  
8509-21st Ave., Dept. 103, Brooklyn 14, N. Y.



\$4.95

Postpaid  
or COD  
plus postage

PLEASE MENTION RADIO-ELECTRONICS WHEN WRITING ADVERTISERS



Let me show you how EASY it is to

# LEARN TV

the practical way--

## ASSEMBLE A TRANSVISION TV KIT

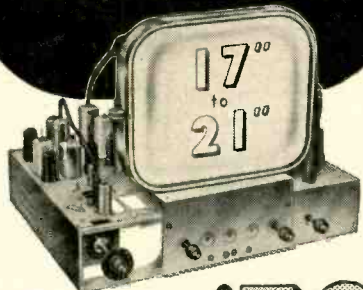

Pay as You Wire

**\$39**

Down Payment

I WILL HELP YOU to start learning TV the practical way — by assembling a TRANSVISION TV KIT in EASY STAGES. For only \$39 you get PACKAGE #1 (standard first pkg. for all of our kits). This package gives you the BASIC CHASSIS and over 450 TV COMPONENTS with complete Instructions. When ready, you order the next stage (pkg. #2), etc. All stages (or packages) are low priced, making your complete kit a terrific buy! Your completed chassis is a superb 25 tube set (22 tubes and 3 rectifier tubes) with 6" x 9" p.m. speaker — a custom-chassis worth up to 100% above your investment.

**EDUCATIONAL:**

No previous technical knowledge required.

With PACKAGE #1, you get my handy 70-page plastic-bound Instruction Book which includes a 20-page Service Section. Also 12 full size (17" x 22") Drawings and Photographs, a 64 page Service Booklet, and 1 year's subscription to my "TV and Electronics Notes".

**AIDS CAREER:**

Do you plan to be a TV Technician, Service-Dealer, or Engineer? You'll benefit by assembling a Transvision TV Kit.

**PROFIT 3 WAYS:**

You profit by gaining valuable practical knowledge... by saving on servicing costs... and by producing a TV chassis worth up to 100% above your cost.

Used in Naval Reserve Training Program.

FAMOUS EDITOR of a national science magazine says: "... my own assembly (of the kit) produced top-quality results, comparable with any set I've seen and better than most..."

**FREE CATALOG** describes 6 great new Transvision TV Kits.

Write to D. GNESSIN, EDUCATIONAL DIRECTOR, at: TRANSVISION, INC., Dept. RE6K NEW ROCHELLE, N. Y.

MAIL THIS COUPON TODAY

Mr. D. Gnessin, Educational Director  
TRANSVISION, INC., NEW ROCHELLE, N. Y. Dept. RE6K

I'm enclosing \$\_\_\_\_\_ deposit. Send standard kit PACKAGE #1, with all Instruction Material. I'll pay the balance C.O.D.

Send FREE copy of your new TV Kit Catalog, Cabinet Folder, and Price Lists.

Name \_\_\_\_\_  
Address \_\_\_\_\_  
City \_\_\_\_\_ State \_\_\_\_\_



**FEATURES**

given only in new Transvision TV Kits:  
No previous technical knowledge required... Easiest to assemble... New A4 circuit gives finest picture and sound... Ideal for fringe areas... Has Automatic Frequency Control... Automatic Gain Control... Retrace Elimination... Never obsolete because color and other developments can be added easily... Choice of 6 Kits.

UHF and REMOTE CONTROL may be had at small additional cost.

EXPORTERS: Foreign system of 625 lines can be accommodated.

For complete line of TV Cabinets, ask for folder.



**CONVERTING THE JFM-90**

? I have an old G-E JFM-90 FM tuner that I would like to convert to operate on the 88 to 108-mc FM broadcast band. I will appreciate any help that you can give me.—J. J. McG., Fitchburg, Mass.

A. Fig. 1 shows the changes which may be made in the front-end of the JFM-90 tuner and similar G-E receivers to permit operation on the FM broadcast band. Coded components have the same values and occupy the same positions as in the manufacturer's schematic.

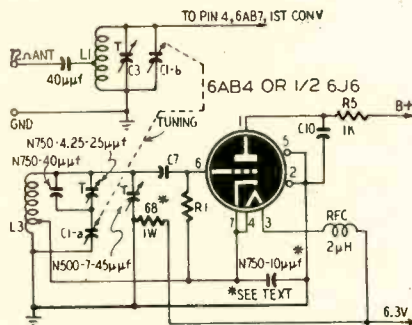

Fig. 1—G-E JFM-90 circuit revisions.

Replace the 7A4 oscillator with a 6AB4 or 6J6 to minimize drift. The 7-pin miniature oscillator socket connections permit the use of either type without change. Solder the 10- $\mu$ f N750 ceramic cathode capacitor directly between socket terminals 4 and 7 at one end, and 5 and 2 at the other. Ground terminals 5 and 2.

Rewind the antenna and oscillator coils L1 and L3 on a polystyrene or mica-filled rod the same length and diameter as the original form. L1 consists of 2 turns of No. 18 bare wire spaced to a winding length of  $\frac{5}{16}$  inch. L3 has 6 turns of No. 20 enameled wire closewound and spaced  $\frac{1}{8}$  inch from L1. Tap L3 at  $1\frac{3}{4}$  turns.

Fig. 2 shows the method of mounting L1 and L3 and connecting one end of L1 to the 72-ohm antenna-input terminal. Instead of connecting the an-

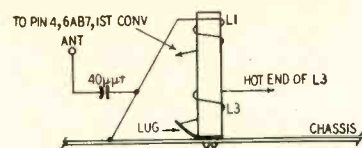

Fig. 2—New coil-mounting arrangement.

tenna to a tap on L1, connect it to a point on the ground lead which gives maximum signal and minimum noise. For a 300-ohm lead-in, the optimum tapping point will be somewhere on L1.

Connect the 40- $\mu$ f fixed and 25- $\mu$ f new variable ceramic capacitors in series with the stator of the oscillator tuning gang C1-a. Connect a 7-45- $\mu$ f N500 ceramic trimmer across C1-a. Mount the 68-ohm resistor under and in direct contact with the 7-45- $\mu$ f trimmer so it will warm the trimmer.

Replace the r.f.-trimmer capacitors (C3 and C4 on the manufacturer's diagram) in the grid circuits of the first and second converters with 2-20- $\mu$ f NPO ceramic types.



L. Veltri, busy service-dealer of Westchester, N. Y., reports:

**I SAVED \$940\***

by making a \$59 INVESTMENT  
in a Transvision  
**FIELD STRENGTH METER**

\*Says Mr. Veltri: "... The way I figure, in the last 6 months I saved that much money in installation time alone..."



**FIELD STRENGTH METER**  
Saves 50% of Installation Cost  
Pays for itself on 3 or 4 jobs

**NO TV SET NEEDED**

Works from antenna... Measures actual picture signal strength directly from antenna. Shows antenna orientation maxima. Compares gain of antenna systems. Measures TVI on all channels. Checks receiver re-radiation (local oscillator). Permits one man antenna installation.



Eliminate variables, insure accuracy with direct meter readings on the FSM.

**PREVENT WASTE OF SERVICING TIME!** By checking antenna performance with the Field Strength Meter, the serviceman can determine whether the TV set or antenna, or both, are the source of trouble. Call backs are eliminated.



Don't lug sets. The Transvision FSM makes installation easy.

**Wide range:** Measures field strength from 10-50,000 microvolts. Has Fringe Area Switch for weak signal areas. 13 channel selector. Individually calibrated on every channel.

**ADAPTABLE for UHF**

Model FSM-2, for 110V AC only. Complete with tubes. Wt. 13 lbs. net \$59.

Model FSM-3B, for 110V AC and Battery Operation (all batteries and cables included). Wt. 22 lbs. net \$79.

Order direct from factory:

TRANSVISION INC., NEW ROCHELLE, N. Y.

FREE: Sample copy of "TV and Electronics Notes". Or send 50¢ for year's subscription.



**10 DAY TRIAL**

Buy and try this fine instrument for 10 DAYS. Then, if you wish, you may return it. Your purchase price less 10% (our cost of handling and re-packaging) will be promptly refunded.

TRANSVISION, INC. NEW ROCHELLE, N. Y.

DEPT. RE-6F

( ) Send me \_\_\_\_\_ Model FSM-2; \_\_\_\_\_ FSM-3B

( ) Enclosed find \$\_\_\_\_\_ deposit. Balance C.O.D.

( ) Enclosed find \$\_\_\_\_\_ in full.

I accept your 10 Day Trial terms.

Name \_\_\_\_\_

Address \_\_\_\_\_

City \_\_\_\_\_ State \_\_\_\_\_



# BIG PROFITS:

## Repair CRTs this Easy Way

- EVERY SERVICE SHOP CAN MAKE BIG MONEY with these PATENTED INSTRUMENTS for
1. TESTING picture tubes accurately.
  2. REACTIVATING dim or worn out tubes.
  3. SPARKING OUT electrical leakage.

### CRT TESTER—REACTIVATOR—SPARKER

3 Instruments in 1, making a complete CRT testing and repair unit... It's a combination of the Transvision Tester-Reactivator and a Sparker in one handy unit. It TESTS picture tubes—measures Cathode emission, locates shorts between elements, locates high resistance shorts or leakage as high as 3 megohms. REACTIVATES dim tubes. SPARKS OUT electrical leakage.



\$34.95 net

Featured in "N. Y. Times" article

### CRT TESTER—REACTIVATOR

2 Instruments in 1... As a REACTIVATOR it renews brightness and detail of dim CR Tubes, without removal of tube from set. It's also an accurate TESTER same as the above. 110V-60 cycles; wt. 3 lbs.

only \$19.95 net

### CRT TESTER—SPARKER

2 Instruments in 1... As a SPARKER, it sparks out electrical leakage between

elements. Saves many picture tubes and small tubes which would usually be discarded. Cathode-grid leakage is an especially common occurrence. The Sparker also gives a rapid check of gas condition of the tube.

As a TESTER it provides a variable 8,000-14,000 V D.C. supply—useful for analyzing hard-to-solve deflection problems... \$25.95 net



Order direct from factory:

TRANSVISION INC., NEW ROCHELLE, N. Y.

FREE: Sample copy of "TV and Electronics Notes". Or send 50c for year's subscription.

**10 DAY TRIAL:** Buy and try these fine instruments for 10 DAYS. Then, if you wish, you may return them. Your purchase price less 10% (our cost of handling and re-packaging) will be promptly refunded.



TRANSVISION, INC.  
DEPT. RE-5R NEW ROCHELLE, N. Y.

( ) Send me \_\_\_\_\_

( ) Enclosed find \$\_\_\_\_\_ deposit. Balance C.O.D.

( ) Enclosed find \$\_\_\_\_\_ in full.

I accept your 10 Day Trial terms.

Name \_\_\_\_\_

Address \_\_\_\_\_

City \_\_\_\_\_ State \_\_\_\_\_

Replace the first-converter plate coil with a National type AR-5 slug-tuned v.h.f. coil.

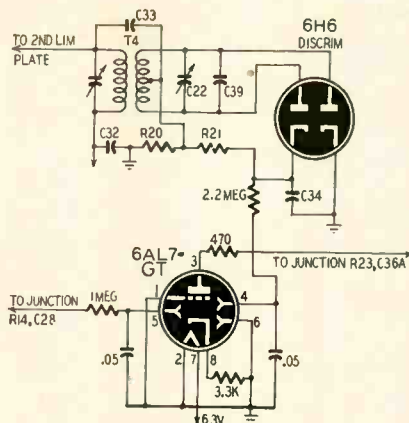

Fig. 3—Tuning indicator for JFM-90.

Fig. 3 shows the connections for adding a 6AL7 tuning-indicator tube.

### MODULATING SCR-274-N RIGS

I have converted several SCR-274-N and ARC-5 transmitters into 120-watt ham rigs. My trouble is that when I try to plate-modulate them, distortion is heavy when the modulation exceeds about 50%. The 80-watt modulator does not distort when operating into dummy load or when used with other rigs. Why do I get distortion with these rigs? How can I eliminate it? The final-amplifier B plus lead connects to the secondary of the modulation transformer.—N. C., Bronx, N. Y.

A. Pentodes and beam-power amplifiers should be modulated by applying the audio signal simultaneously to the screen and plate. The diagram shows a simplified circuit of the power-amplifier stage in the SCR-274-N transmitters.

Disconnect the screen supply lead from pin 4 of the power plug on the rear of the chassis. Substitute a 50,000-

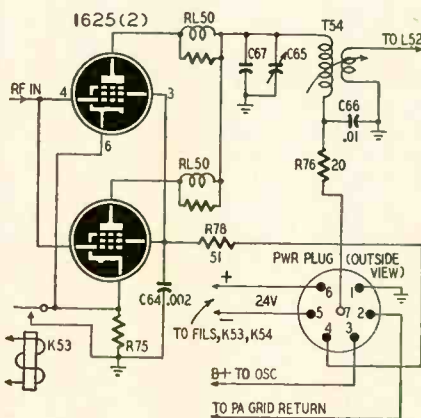

ohm, 20-watt resistor for R78 and connect the screen supply lead to pin 7 on the power plug. Substitute a 300-ma, 2.5-mh r.f. choke for R76 in the plate supply lead. Replace the plate bypass capacitor (C66) with a .002- $\mu$ f, 2,000-volt unit. Connect pin 7 of the power socket to the top of the secondary on the modulation transformer.

The distortion was probably caused by failure to modulate the screens and

Now... INSURE BEST RECEPTION with the

# FINEST TV CHASSIS EVER DESIGNED

## TRANSVISION

### 630 De Luxe

TYPE TV CHASSIS

with High-Fidelity Sound

Mfr. licensed under RCA patents



Embodies the latest and finest improvements, notably:

- Super Fringe Area Circuit
- Redesigned for Peak UHF Performance
- Hi-Fidelity Push-Pull Audio (40-13,000 Cycles)
- 12" Hi-Fidelity Speaker

**\$139** net  
Plus 10% Fed. Tax  
CRT EXTRA

In this space we can mention only a few of the other great features of this DeLux Chassis: 31 tubes (28 tubes, 3 rectifier tubes—plus CRT makes 32 tubes) . . . Only Sprague "Black Beauty" Molded Condensers used throughout . . . Allen Bradley and IRC Resistors . . . Handles up to 24" picture tube . . . Layout of most efficient type for ease of servicing . . . Carries standard RMA Guarantee . . . The choice of those who want the finest in chassis.

**CABINETS:** For details on Transvision's famous beautiful line of TV Cabinets, write for information on Agents Program.

### 1 YEAR GUARANTEE ON CRTs

- 17" Rectangular Glass CRT.....net \$22.25
- 20" Rectangular Glass CRT.....net \$31.95
- 21" Rectangular Glass CRT.....net \$36.95

Order direct from factory:

TRANSVISION INC., New Rochelle, N. Y.

FREE: Sample copy of "TV and Electronics Notes". Or send 50c for year's subscription.

### MONEY-BACK GUARANTEE:

**10-DAY TRIAL:** Buy and try the Transvision 630 Type De Luxe Chassis for 10 days. Then, if you wish, you may return it. Your purchase price less 10% (our cost of handling and re-packaging) will be promptly refunded.



TRANSVISION, INC.  
DEPT. RE630 NEW ROCHELLE, N. Y.

( ) Send me 630 Circuit and Technical Data.

( ) Enclosed find \$\_\_\_\_\_ deposit. Balance C.O.D. Ship \_\_\_\_\_ chassis, \_\_\_\_\_ CRTs

( ) Enclosed find \$\_\_\_\_\_ in full.

I accept your 10 Day Trial terms.

Name \_\_\_\_\_

Address \_\_\_\_\_

City \_\_\_\_\_ State \_\_\_\_\_



**PERSONAL MUSIC**

CHROME MUSIC BOX containing 5" Speaker and Coin Timer Motor. Can be used for remote speaker in Home, Car, Shop, Boat, Office, etc. Timer Motor operates from 24 Volt 60 cycle. Prices:

With 5" Dynamic Speaker ..... \$3.55  
 With 5" PM Speaker ..... \$4.95  
 TRANSFORMER—24 Volt to operate Timer Motor from 110 V. 60 cycle **\$1.50**

---

**PE-101C DYNAMOTOR**  
**6 OR 12 VOLT**

(Reprints of original CQ conversion articles, Oct. and Dec., 1952 issues, furnished.)

• This is the Dynamotor the Hams have been talking about. Easily adapted to supply 625V. @ 150 MA. and 325V. 125 MA. at 12V.—or 300V. 90 MA. and 160V. 110 MA. at 6V. **\$4.95** (Illustration shows modified) NEW:

---

**BATTERY SWITCHING UNIT & METER**  
 Used to switch load from one battery to another, or 6 to 12 Volts. Contains Weston 2" Meter, 0-15 Volt DC Scale for reading battery voltage, 20 Amp DPDT Switch & Indicator. Case size: 4" x 6 1/4" x 2 3/4". NEW: **\$2.95**

---

**RECEIVER AND TRANSMITTER**  
 RECEIVER BC-229—TRF Receiver with 3 Plug in Coils to cover Freq. Range 201 to 398, 2500-4700, 4150-7700 KC. With 6 Tubes: 1/37 - 1/38 - 3/39 Power Supply required 6 or 12 Volt & 250 Volts. Size: 16" x 8" x 7". Schematic included. **\$8.95**  
 TRANSMITTER BC-230—Voice modulated Trans. with 5 Plug in Coils to cover Freq. Range 2500 to 7700 KC with 4 Tubes: 2/10y - 2/45 & RF Meter 0-1.5 Amps. Power Supply required 6 or 12 Volt and 350 Volts. Size: 13" x 8" x 7". Schematic included. **\$8.95**

---

**SPECIAL BUY—FOR BOTH ABOVE RECEIVER & TRANSMITTER \$15.00**

PLUG PL-64 For Receiver or Transmitter, 75c Each.  
 SHOCK MOUNTING For Receiver or Transmitter, 75c Each.

Address Dept. RE • Minimum Order \$5.00  
 Prices F.O.B. Lima, O. 25% Deposit on C.O.D. Orders

**FAIR RADIO SALES**  
 132 SOUTH MAIN ST. • LIMA, OHIO

**WALDOM**

**TV Conversion Kit**  
**Mask and Escutcheon Assemblies**



For a professional conversion or custom installation

- 1 Metal Mask tailored for perfect fit. Green Sprayed Finish.
- 2 1/4" Tempered Safety Glass.
- 3 Beautiful Gold Finished Metal Escutcheon.

All popular sizes: 14", 16", 17", 20" and 21". Rectangular Tubes only. Easy to install instructions included.

See your distributor

---

Send for **COMPLETE CATALOG**  
 Waldom carries a complete line of Electronic Components and Crame Products.

**WALDOM ELECTRONICS, INC.**  
 911 Larrabee St. Chicago 10, Illinois

by the fact that an appreciable portion of the modulating voltage was bypassed to ground by C66. Reducing the value of C66 and making the other changes indicated should enable you to modulate up to 100% without distortion. If you find that there is still some distortion, make sure that the taps on the modulation transformer are set for a good match between the modulator and final amplifier. If the impedance match is O.K., try bypassing the 50,000-ohm screen resistor with a mica capacitor having a value between 200  $\mu$ f and .002  $\mu$ f.

The ARC-5 transmitters are almost identical to those in the SCR-274-N series. The major differences are in the power-plug connections and in the method of feeding the amplifier plate circuit. Series feeding is used in the SCR-274-N units and shunt feeding is used on the ARC-5. The latter was designed for plate and screen modulation, so you won't have as many conversion problems as in the SCR-274-N, which was designed for screen modulation. On the ARC-5, power-plug connections are as follows: Pin 1 is not used; pin 2 is oscillator B plus; pins 3 and 5 connect the 24-volt line to heaters and relays; pin 4 is ground; pin 6 is the power-amplifier screen B plus; and pin 7 is B plus to amplifier plate.

When converting ARC-5 units, increase the screen-dropping resistor to 50,000 ohms and move the screen lead from pin 6 to pin 7. If you use a common power supply for the modulator and final amplifier, you may have trouble with r.f. feeding back into the audio circuits through the power supply. In this case, connect a .001- $\mu$ f, 2,000-volt mica bypass capacitor between the B plus end of the plate r.f. choke and ground.

**INTERCOM FROM AMPLIFIER**

? In describing the multipurpose audio amplifier on page 64 of the February, 1953, issue, the author stated that the amplifier can be converted into a two-station intercom by adding a d.p.d.t. switch. Please show how this can be done. What type of transformer shall I use in the input circuit?—E. R., St. Albans, L. I., N. Y.

A. The partial schematic shows how the TALK-LISTEN switch is connected be-

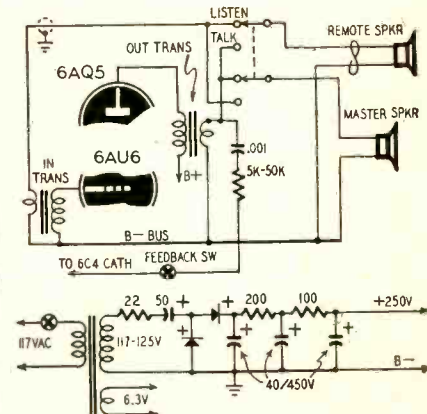

**IMPOSSIBLE BUT TRUE!**

**SINGLE CHANNEL 5 ELEMENT DELTA-MATCH YAGIS**

**ONLY \$200**  
 each  
 LOTS OF 5



We know it's hard to believe, and we hardly believe it ourselves — but here it is, so make the most of it! These beautifully fabricated Yagis usually sell for 3 to 5 times our price!

Delta-Match principle insures flat response over entire channel bandwidth, providing maximum fidelity in both picture and audio portion of TV signal. These Yagis available for channels 2, 3, 4, 5 and 6, together with detailed instructions for cutting to channels 7, 8, 9, 10, 11, 12 or 13. Sorry, no less than 5 antennas of one channel. SPECIFY CHANNEL WHEN ORDERING.

Free with each order of 5 antennas 1 all-purpose hack-saw with blade and complete instructions for simple conversion of lower frequency Yagis to high frequency Yagis.

Stock No. YDM5—Packages of 5 Yagis. Wt. 40 lbs. Net \$10.00

**Concord Radio**  
 55 Vesey Street. New York 7, N. Y.  
 Phone DLgby 9-1132

**REVOLUTIONARY RADAR-TUNED**

**GRANCO**

**UHF CONVERTER BOOSTER**

**DEALERS' NET MODEL CTU \$29.97**



Adds all 70 channels to Television Receivers. Proved best by field tests and side-by-side comparisons, the Coaxial Resonant Cavity Tuned Granco UHF Converter employs engineering advances that made Radar possible. Design features continuous tuning over entire UHF range 465 to 900 Mc; avoids moving contacts; minimizes oscillator radiation by inherent shielding. Self contained in handsome cabinet 7 1/4 x 5 1/2 x 5 1/2". Wt. 5 lbs. No. CTU.....Net \$37.46

Minimum Order \$5.00 25% Deposit with C.O.D. orders. All shipments F.O.B., N.Y.C.

**CONCORD RADIO, 55 Vesey St., N. Y. 7, N. Y. Dept. C6**

Send FREE Literature on Granco UHF Converter.  
 Put my name on your "Special Bargain Mailing List."

Name .....  
 Address .....  
 City..... State.....



tween the input and output circuits. Use an anti-capacity type switch and shielding as indicated to minimize feedback within the amplifier. The input transformer may be a standard output transformer having a primary impedance of 20,000 ohms or more, or a standard intercom input transformer such as the Stancor A-4744.

Connect a switch in the feedback loop so that it can be opened for more gain when used as an intercom.

The original model uses a transformerless B supply. We recommend that you use a half-wave transformer, connected as shown to supply the B voltage.

**REPLACING 12WP4 TUBE**

? I have a Philco TV set with a burned-out 12WP4 picture tube. I could not get an exact replacement so I bought a 12JP4 which was recommended as a replacement. The new socket of the 12JP4 has five leads, the one for the 12WP4 has only four. Please tell me how to install my new tube in the receiver, a Philco 51-PT-1208.—C. F. B., St. Louis, Mo.

A. The local Philco representative has informed us that it is not practical to use any other tube as a replacement for the 12WP4. This is a special tube which has a thin neck which requires a special deflection yoke and associated equipment. A standard tube cannot be fitted into the assembly.

Circuits using this tube develop only about one-fourth of the deflection power required for standard tubes, and the boosted B plus voltage is only about 225—one-third to one-half less than that developed by sets using standard 12-inch tubes. Thus, in addition to the mechanical alterations, you would have to redesign the horizontal and vertical deflection circuits to operate from a higher B voltage and to supply the deflection power required for the larger tube. Many of the components would probably have to be changed to insure proper operation and freedom from breakdown. Considering these factors, we believe that it will be less expensive and far less trouble to use another 12WP4 as a replacement. You can obtain one through your local Philco distributor. **END**



**"Save with confidence"**

**Special! Custom Built  
AUTOMOBILE RADIOS**

For 1949, 1950, 1951, 1952 & 1953 Models, Famous Make

**Electro-Touch Tuning**

Every auto radio is powerfully built, 6-tube superhet. With RF stage and 3-gang condenser for sensitive, long distance reception. Latest miniature tubes used with

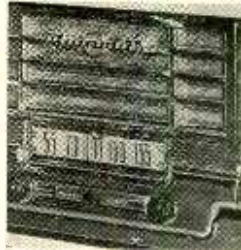

beam-power output and oversized Alnico V speaker, offering plenty of volume with excellent tone. Includes Automatic Volume Control and has extra low battery drain. Each model is Custom-Built, designed for the individual automobile and can be mounted within 4 minutes without cables or brackets. No holes to drill. *Indicate make and year of automobile when ordering.*

A mere touch of the finger and your radio's electronically tuned to a station with absolute precision . . . and not to just a few pre-set stations. Your eyes never have to leave the road



for tuning is completely automatic. Ideal performance is yours with this custom-built, 7-tube, 3-gang radio. Assures top reception wherever you go. Superhet. circuit with a rectifier, operates on a 6-V. storage battery. Includes Automatic Volume control, permanent magnet dynamic speaker and gives 8-tube performance. Beautifully finished to match your car, can be easily installed in a few minutes. No holes to

For: Ford, Mercury, Dodge, Plymouth, Chevrolet, Hudson, Studebaker and Henry J.

**\$39.17**

Far: Ford, Chevrolet and Dodge. Be sure to mention make and year of car when ordering.

**THE ANSWER TO LOW LINE VOLTAGE PROBLEMS**



The Regency VB-1 Voltage Booster can maintain a 117 volt power supply to any TV set regardless of line voltage variations from 90 to 130 volts. Performs for any TV set or electrical device drawing 350 watts or less.

**\$11.95**

**REGENCY MODEL RC-600**

U. H. F. Television Converter. Designed to permit reception of the U.H.F. Television signals on receivers designed for V.H.F. channels 2 thru 13. Frequency coverage 470-890 megacycles. Price



**\$37.46**

**The Lowest Priced Kits on the Market!**

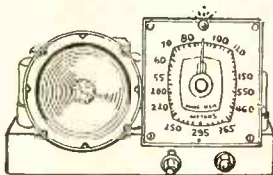

**6-TUBE RADIO KIT**

Kit #2—A low-priced 6 TUBE KIT designed for high sensitivity, excellent selectivity and good tone quality. Uses 25L6, 25Z6, 6SQ7, 6SA7, 6SK7, 6SK7 in an easily constructed circuit. The 6 Tube Kit is shipped with all parts, including punched chassis, resistors, condensers, coils, sockets, PM Speaker, hardware, etc.

And at a closeout price of only (less tubes and cabinet) **\$6.95**

Matched set of six tubes for kit **\$3.25**

**3-TUBE PHONO AMPLIFIER**

Not a Kit!

An assembled unit ready for installation using tone and volume control and six feet of rubber **\$2.95** cord (Not including Tubes)

With Complete Set of Tubes....\$3.95

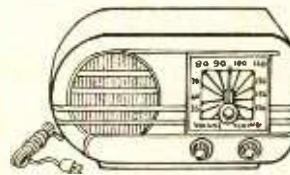

**5 TUBE AC-DC SUPERHET KIT**

Kit #1—Five Tube superheterodyne kit, A.C.-D.C. contains all components required to construct this latest design, highly sensitive superheterodyne broadcast receiver, complete with black bakelite cabinet (excludes wire and solder) .... Only **\$7.95**

Kit of 5 tubes (12AT6, 12BA6, 12BE6, 35WA, 50C5). Only \$3.25.

**PHONO OSCILLATOR**

Not a Kit!

Wireless phono oscillator transmits recording for crystal pickups or voice from carbon mike through radio without wires. Can also be used as an intercomm by using P.M. speaker as mike. Price (excluding tubes) **\$2.95**

With Complete Set of Tubes....\$3.95

**Electronic Code Practice Oscillator & Blinker Kit**

AC/DC or Battery Operated!

Kit #3—One of the most practical Code Practice Oscillators ever designed, yet one of the simplest to build and operate.

Can be used with any number of headphones. Adjustable Pitch Control can be used. No warmup time—ready to operate instantly. Simple and safe to operate.

Operates anywhere—with AC or DC power, or from a 90 volt Miniature Battery. Learn Blinker Code with flashing light.

Blinker can be used as signaling device. International Morse Code included.

Kit **\$1.95** Assembled **2.95** each Med

Terms: All merchandise shipped F.O.B. New York City. prices are subject to change without notice. Include 20% deposit for C.O.D.'s.

**WRITE FOR NEW CATALOG—Free!**

**EDLIE Electronics**

154 Greenwich St.  
DI 9-3143  
New York 6, N. Y.



# THESE BOOKS HELP YOU EARN MORE IN TV SERVICING

## "How to Understand and Use TV Test Instruments"



Provides basic explanations of how each test instrument operates. Covers: VT Voltmeters, AM Signal Generators, Sweep Signal Generators, Oscilloscopes, Video Signal Generators, Field Intensity Meters, Voltage Calibrators. Describes each in detail; explains functions; tells proper use in actual servicing; shows how to avoid improper indications. Helps you get the most from your instruments; saves you time, helps you earn more. 148 pages, 8 1/2 x 11". ORDER TN-1. Only.....\$3.00

## "TV Servicing Short-Cuts"

Describes a series of actual TV service case histories, giving step-by-step explanations of how the service technician localized and tracked down each problem. Shows how these frequently recurring troubles can be tracked down and solved in any set. Explains how to apply proper time-saving servicing techniques — gives you the successful experience of experts, to make your service work easier, quicker, more profitable. 100 pages, 5 1/2 x 8 1/2". ORDER TK-1. Only.....\$1.50



## "Servicing TV in the Customer's Home"

Saves you time, work and chassis-hauling on outside TV service calls. Shows you how to make successful repairs on the spot using these methods: employing VTVM and capacitor probe to trace down trouble; "tube-pulling" to diagnose trouble by observing audio and picture effects; performance tests through analysis of test pattern; adjustment techniques developed for field servicing. Saves time, avoids chassis removal. 96 pages, 5 1/2 x 8 1/2". ORDER TC-1. Only.....\$1.50



## "Television Tube Location Guides"

**VOL. 3.** Shows tube positions and functions in hundreds of important TV sets. Helps save servicing time. Often, looking at the picture or listening to the sound, provides the clue to the trouble. Frequently, a tube failure is the cause. This guide, with its clear, accurate tube placement and function diagrams, makes trouble diagnosis and tube replacement quick and easy, without removing chassis. 192 pages. All new diagrams continuing coverage from Vol. 2. ORDER TGL-3. Only.....\$2.00  
**VOL. 2.** Over 200 pages of tube placement diagrams not included in Vols. 1 and 3. ORDER TGL-2. Only.....\$2.00  
**VOL. 1.** Over 200 pages of diagrams not in Vols. 2 and 3. ORDER TGL-1. Only.....\$1.50



## "Photofact Television Course"

A full, easy-to-understand explanation of TV principles, operation and practice. Covers Cathode Beam Formations and Control, Beam Deflection Systems, Beam Mod. and Synch.; analyzes CR tubes, camera tubes, voltage supplies, saw-tooth generators, sync. circuits, control functions, antenna circuits, RF input tuning, IF systems, AGC, DC restoration, etc.; with full bibliography and glossary. 208 pages, 8 1/2 x 11". ORDER TV-1. Only.....\$3.00



### HOWARD W. SAMS & CO., INC.

Order from your Parts Jobber today, or write direct to Howard W. Sams & Co., Inc. 2205 East 46th Street, Indianapolis 5, Ind.

My (check) (money order) for \$..... enclosed. Send the following books:

- TN-1     TK-1     TC-1  
 TGL-3    TGL-2    TGL-1    TV-1

Name.....

Address.....

City..... Zone..... State.....

## CROSLLEY 1950-1953 TV SETS

If humidity is suspected as the cause of horizontal drift in Crosley 1950-1953 custom line of TV sets, replace the .01- $\mu$ f capacitor which parallels the 22,000-ohm resistor connected between lugs 5 and 6 on the horizontal oscillator transformer T106 (see diagram). The new replacement capacitor is treated with a special glazed coating easy to identify, and has the part number 148813-2.

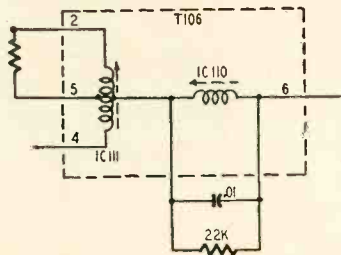

Replacement capacitors (parts 148813-1 or 148813-2 still in dealer's stock) which do not have the glazed coating may be used in less critical positions in the receiver circuits.—Crosley Service Department

## NOTES ON FRONT-END ALIGNMENT

The various leads to a TV tuner are often critical with respect to frequency. Even the power supply leads form loops which couple to the tuned circuits. If they resonate at any of the tuner frequencies, they may absorb power or cause feedback and difficulty. In receiver design, the undesirable resonant loops are shifted away in frequency to eliminate trouble. This permits reasonable latitude in components and physical arrangement.

When the r.f. unit is aligned in the receiver, there should be no trouble from resonant loops. However, if the unit is aligned external to the receiver, care must be taken that unwanted resonance does not cause errors during the measurement or alignment procedure.

A resonant circuit can exist between the r.f. tuner chassis and the outer shield box. This causes coupling to the antenna and r.f. plate circuits. The resonant frequency depends upon the physical structure of the shield box and upon the capacitance between the tuner chassis and the front plate. In the RCA KRK8 units, this resonance should fall between 120 and 135 mc, and is controlled in this design by using insulating washers of different thicknesses (in the front plate to tuner chassis mounting).

The washers are installed to compensate for differences in the shield boxes of different models of receivers. The performance of the tuner—particularly on channels 7 and 8—will be impaired if the proper washers (for the particular shield box involved) are not used. If the r.f. unit is removed for service, the washers should be replaced in the correct order when the unit is replaced, to restore normal operation.—RCA Service Data

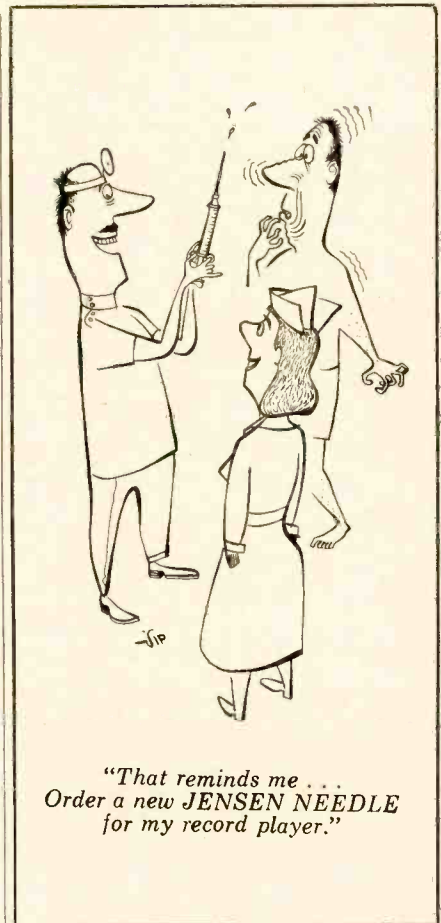

"That reminds me... Order a new JENSEN NEEDLE for my record player."

Nationally Famous

# T.V. SETS

20" CONSOLETTA

**\$149<sup>95</sup>**

PI. \$15.00  
Fed. Excise Tax

17" Table

**\$122.68**

PI. \$12.27 Fed. Excise Tax

20" Table

**\$134.50**

PI. \$13.45 Fed. Excise Tax

**Also TV CHASSIS**

Available

Ready to Operate. Complete with Picture Tube and Speaker.

17" SET

**\$99<sup>95</sup>**

PI. \$9.99 Fed. Excise Tax

20" SET

**\$112.50**

PI. \$11.25 Fed. Excise Tax

All sets have full 1 yr. factory picture tube warranty, and standard 90 day RTMA parts warranty.

Mail and Phone Orders Filled. \$25 deposit, balance C.O.D., Shipping Charges Add'l.

**STEPHEN SALES CORP.**

45 Crosby St., N.Y. 12, N.Y. Phone: WO 4-8233

Dealer Inquiries Invited



**CRYSTAL-PICKUP WRENCH**

A convenient socket wrench for replacing the stylus of RCA *Silent Sapphire* crystal pickups can be made from a 1¼-inch long 10-32 Allen-type set-screw modified as follows:

1. Grind off the threads for a distance of approximately ¾ inch from the hexagon socket end.

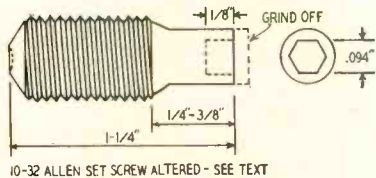

10-32 ALLEN SET SCREW ALTERED - SEE TEXT

2. Grind off the hexagon socket end so that the hole is only about ¼ inch deep—or partially fill the hole so that the nut just goes in until its outer surface is flush with the end. Refer to the drawing for details.—*RCA Radio Phono TV Tips*

**INTERMITTENTS IN TV SETS**

Many hard-to-find intermittents in TV sets are caused by unsoldered connections which slipped through factory inspections and by high-resistance riveted ground connections. When I run into a set which is particularly troublesome, I take time out to examine all connections and grounds. If any rivet grounds show the slightest trace of corrosion I clean and solder the chassis.

I use breadboard-mounted horizontal and vertical oscillators to drive the vertical and horizontal output tubes when checking intermittents in the sweep or high-voltage circuits. In this way, I save a lot of time localizing intermittents in the yoke, output transformers, and oscillator circuits.—*J. Perkinson, Jr.*

**1B3-GT'S IN SENTINEL SETS**

G-E 1B3-GT high-voltage rectifiers may have short life when installed in Sentinel models 462 and 463 TV receivers. All 1B3-GT's except those made by General Electric have pin 5 floating. G-E 1B3's have pins 5 and 7 internally connected.

Sentinel model 462 and 463 TV sets have an 8.2-ohm filament-current limiting resistor connected between pins 5 and 7 on the 1B3-GT socket. G-E 1B3's short out the limiting resistor, resulting in excessive filament voltage and reduced tube life.

G-E will soon be distributing 1B3's which do not have pins 5 and 7 internally connected. However, until these tubes are available and are definitely identifiable, always clip pin 5 off the tube base before using G-E 1B3-GT's in models 462 and 463.

Sentinel models 454, 455, 456, and 457 have a 2.2-ohm limiting resistor between pins 5 and 7 on the rectifier socket. Shorting out this resistor will not seriously affect tube life but it is recommended that pin 5 be clipped off the base of all G-E 1B3's before using them as replacements.—*Sentinel Bulletin*

**STANDARD BRANDS TUBES INDIVIDUALLY BOXED**  
**STANDARD WARRANTY NEW LOW PRICES BRAND NEW!!**

0Z4 ... \$ .54	5Y3GT ... \$ .39	6BA6 ... \$ .54	6F6GT ... \$ .54	6W4GT ... \$ .49	12SQ7GT5 ... .63
1B3GT ... .69	6AB4 ... .61	6BA7 ... .76	6H6 ... .57	6W4GT ... .59	198G6G ... 1.75
1L4 ... .65	6AC7 ... .98	6BC5 ... .65	6J5GT ... .39	6X4 ... .49	19T8 ... .87
1R5 ... .59	6AG5 ... .64	6BE6 ... .49	6J6 ... .59	6X5GT ... .43	25AV5GT ... 1.05
1S4 ... .76	6AG7 ... 1.19	6BF5 ... .69	6K6GT ... .54	12AT6 ... .47	25BQ6GT ... 1.08
1S5 ... .64	6AH6 ... .77	6BG6G ... 1.69	6L6GA ... .88	12AT7 ... .69	25L6GT ... .54
1T4 ... .64	6AK5 ... .88	6BM6 ... .59	6SA7GT ... .61	12AU6 ... .54	25Z6GT ... .49
1U4 ... .69	6AL5 ... .50	6BJ6 ... .49	6SC7 ... .76	12AU7 ... .59	35B5 ... .61
1U5 ... .61	6AQ5 ... .54	6BL7 ... .98	6SF5 ... .58	12AV7 ... .88	35C5 ... .61
3Q4 ... .75	6AR5 ... .69	6BN6 ... .72	6SH7 ... .65	12BA6 ... .54	35L6GT ... .61
3O5GT ... .72	6AS5 ... .62	6BQ6 ... .79	6SJ7 ... .54	12BE6 ... .58	35W4 ... .41
3S4 ... .49	6AT6 ... .46	6C4 ... .49	6SL7GT ... .64	12BH7 ... .82	35Z5GT ... .39
3V4 ... .65	6AU6 ... .54	6C5 ... .57	6SN7GT ... .59	12SA7GT ... .62	50B5 ... .61
5T4 ... 1.31	6AV5GT ... 1.05	6CB6 ... .59	6SQ7GT ... .49	12SG7 ... .61	50C5 ... .61
5U4G ... .49	6AV6 ... .46	6CD6G ... 1.29	6SR7 ... .49	12SH7 ... .49	50L6GT ... .59
5V4G ... .98	6B4G ... .98	6E5 ... .76	6V6GT ... .57	12SK7GT ... .63	117Z3 ... .54

Many other types equally low priced—include all your tube needs with your order. One of the largest stocks in the country!  
 Terms: 25% with order, balance C.O.D.  
 All prices subject to change without notice. F.O.B. New York City. Mail order division.

**TeleVision Materials Corp.**  
 120 LIBERTY ST., NEW YORK 6, N.Y. • COrtlandt 7-4307

**opportunities AT BELL TELEPHONE LABORATORIES**

A career for you with one of the nation's leaders in research and development in communications and military electronics.

**ELECTRONIC TECHNICIANS DRAFTSMEN**  
**ELECTROMECHANICAL TECHNICIANS**

Openings require previous training at high school, armed service school, or technical institute level and in general 2 or more years of applicable industrial or military experience.

Other positions generally open for experienced Wiremen and Machinists for experimental development work.

Send your name and address for application, telephone collect within 100 miles for information, or visit us Monday through Saturday. Evening interviews arranged.

**BELL TELEPHONE LABORATORIES**  
 WHIPPANY, N. J. (Near Morristown) EXTS. 326, 300  
 MURRAY HILL, N. J. (Near Summit)  
 SUMMIT 6-6000 EXTS. 3259, 3381

**TRAIN At Home FOR OPPORTUNITIES IN UHF-TV SERVICING**

Get in on the ground floor of this fast-growing field, with proven, practical T.C.I. training. Here is complete, non-mathematical training you take in your spare time without leaving your present job! You learn TV set conversion, master antenna installation, the latest in UHF-TV, money-making short cuts and much more. You learn to trouble shoot, test and repair TV sets the only practical way by doing the work yourself!

**LEARN BY DOING!** You work on a large screen, modern TV receiver furnished with the course and yours to keep. As an optional feature, you get two weeks of field experience with one of Chicago's largest independent TV servicing organizations. Age is no barrier. Many T.C.I. students are over 40! Send for facts NOW!

**MAIL NOW FOR FREE BOOKLET**

**TELEVISION COMMUNICATIONS INST. Dept. RE-18, 205 W. Wacker Dr., Chicago 6, Ill.**

Name.....  
 Veterans Check Here  
 Address.....  
 City & Zone.....State.....  
 BEGINNERS: Check for facts on Pre-TV Course.

**TELEVISION COMMUNICATIONS INSTITUTE**  
 205 W. Wacker Dr., Dept. RE-18, Chicago 6, Ill.



**Insure Yourself FASTER, EASIER**

**NEW SUPER-FRINGE MOTORLESS DIRECTRONIC**

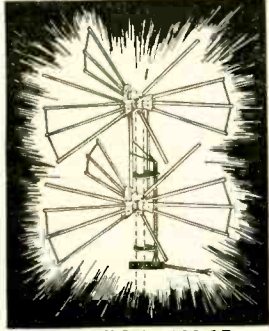

- 24 ELEMENTS
- NEW HIGH GAIN
- CLEARER, SHARPER PICTURES
- ELECTRONICALLY BEAMED IN ALL DIRECTIONS
- NEW LOW-LOSS TUBULAR TRI-X CABLE
- ELIMINATES GHOSTS—INTERFERENCE

New improved Hi-Gain Super Directronic offers sensational advantages over motorized antennas—less installation cost—less upkeep. The new 24-element Directronic is beamed to any transmitter in fringe range by new 6-position Directronic Switch located at receiver. Twenty-four elements provide high gain in all directions. New Tri-X low-loss tubular cable minimizes attenuation. Serviceman's kit contains 24 hi-tensil aluminum elements, including 6 reflectors, Directronic 6-position switch, 100 ft. Tubular Tri-X, 3 matched stacking bars, Universal U-Clamps.

Model AX-524 \$26.95 as shown

Model AX-524 \$26.95 as shown. New improved Hi-Gain Super Directronic offers sensational advantages over motorized antennas—less installation cost—less upkeep. The new 24-element Directronic is beamed to any transmitter in fringe range by new 6-position Directronic Switch located at receiver. Twenty-four elements provide high gain in all directions. New Tri-X low-loss tubular cable minimizes attenuation. Serviceman's kit contains 24 hi-tensil aluminum elements, including 6 reflectors, Directronic 6-position switch, 100 ft. Tubular Tri-X, 3 matched stacking bars, Universal U-Clamps.

**FOR ULTRA-FRINGE RECEPTION, USE THE "POWER MASTER"**

New 48-element Motorless Directronic provides higher gain than any other broad band antenna. Proved reception at 100 miles from transmitter in average location. Serviceman's kit provides 48 aluminum elements, 150 tubular TRI-X, 6-position Beam Selector, matched stacking harness, Universal U-Clamps.

Model AX-548 \$44.95

**SAVE WITH ROCKET 35 FT. MAST KITS**  
 Economy mast kit contains 3-10" seamless TRI-COATED 1/4" O.D. masts, one 5' mast, 300 feet of 6/20 galvanized steel guy wire, and everything else needed including guy rings, mast connectors, insulators, cable clamps, guy hooks, and swivel mounting base.  
 35-foot Mast Kit \$15.95 25-foot Mast Kit \$11.95

- Lowest Prices on Antenna Accessories**
- Mast Steel (Dualcoated 5' crimped) 1/4" O.D. \$1.05
  - Mast Steel (Dualcoated 10' crimped) 1/4" O.D. 1.95
  - Mast Connectors for 1/4" O.D. Mast .59
  - Chimney Mount Complete with Straps 1.19
  - Peak Roof Saddle (will take up to 1 1/2" O.D.) 1.59
  - Lightning Arrestor—TV .69
  - Galvanized Steel Guy Wire—6/20 3/4c ft.
  - Rocket Twin-Lead—7/28 stranded 2c ft.
  - Mast Stand-Off Insulators—3" .10
  - Screw Type Stand-Off Insulators—3" .03

**Installations AT LOWEST COST**

**Buy From NATIONAL ELECTRONICS**  
 —Country's Leading TV SPECIALIST

**SENSATIONAL NEW HI-GAIN UHF YAGI**

Good UHF reception in fringe areas now assured with new Rocket Broad-band UHF Yagis. Compact, easy to stack for all the gain required anywhere. Three models cover all UHF channels. Rocket UHF Yagis are completely pre-assembled. You simply tighten mast clamp. Serviceman's array includes two reflectors, 2 dipoles, 4 directors and Universal mast clamp.



Model UHF-1A—Ch. 14 thru 48 \$4.25  
 UHF-1B—Ch. 27 thru 62 3.75  
 UHF-1C—Ch. 47 thru 83 Single 6' .75  
 Lots of 6' 3.75  
 Matched stacking bars—1/2 wave. .75 pr.

**ROCKET BROAD BAND YAGIS**

- SENSATIONAL GAIN
- SENSATIONAL PICTURES IN FRINGE AND ULTRA FRINGE AREAS

Switch to Yagi Broad Band Hi-Gain Antennas! These new Yagis give you Yagi reception on the 5 low-band and 7 hi-band channels—no restriction to one single channel. A two-bay array will outperform even a 10 or 12 element single channel Yagi. Price is sensationally low. Complete serviceman's array includes 1 double reflector, 2 folded dipoles, 3 directors, universal mast clamp. Easy-to-assemble quick rig construction.



Model RB26—Ch. 2 thru 6 \$10.95 Ea.  
 Model RB713—Ch. 7 thru 13 \$3.95 Ea.  
 Matched stacking bars 1.25 Pr.

**Hi-Gain Single Channel Yagis**

5 element—Ch. 2, 3, 4, 5, 6 \$7.95 Ch. 5 or 6 \$6.95  
 Ch. 7-13 \$3.95  
 Specially exact channel desired

NEW SPRING SUMMER CATALOG AVAILABLE

ALL PRICES F.O.B. CLEVELAND, OHIO  
 Do not remit more than complete purchase price. Pay shipping charges on receipt of goods. 25% deposit on all C.O.D. orders, please. Money-back guarantee. Prices Subject to Change Without Notice.

**National Electronics OF CLEVELAND**  
**THE HOUSE OF TV VALUES**  
 206 Delco Building Cleveland 3, Ohio

**G-E MODEL 150**

Parasitic oscillations on strong signals and distortion on high volume may be noticed on this portable receiver. This trouble is caused by overloading of the 1T4 i.f. amplifier.

To eliminate this trouble, locate the i.f. amplifier grid return lead which runs from lug 2 of the first i.f. transformer to pin 5 of the 1T4 i.f. amplifier. Remove this lead from pin 5 of the i.f. amplifier socket and run it to pin 5 of the 1T4 r.f. amplifier. This changes the i.f. amplifier bias from 0 to -1.4 volts and minimizes overloading and oscillations.—Wayne Miller

**A CURE FOR MOTORBOATING**

If you have trouble with motorboating in an audio amplifier or receiver, it may be caused by the use of dual electrolytics as cathode bypass capacitors. Many of these dual units have a large amount of stray capacitance between sections. If the sections are used to bypass the cathodes of cascade stages, the stray capacitance may cause motorboating by introducing positive feedback between the cathodes. The solution is to eliminate the dual capacitors or use them an odd number of stages apart so the feedback will be negative rather than positive.—Charles Erwin Cohn

**NO HORIZONTAL DEFLECTION**

The complaint was little or no horizontal deflection; there was a vertical line or band in the center of the screen; and second-anode voltage was low. This is a rather rare trouble which is likely to give you considerable difficulty. Trouble is probably caused by an open capacitor (0.1 µf or so) connecting one end of the horizontal deflection coil to B plus. The horizontal yoke aids in producing the kickback and boosted voltages used for supplying the picture-tube second anode and B plus to the horizontal output and other stages. When this capacitor opens, the yoke is effectively disconnected from the circuit and the anode and boosted voltages are too low. Replacing the capacitor clears up the trouble.—DeLoss Tanner

(In some sets, one side of the yoke connects directly to B plus and the linearity coil and the other end to the damper-tube plate through the capacitor mentioned above.—Editor) END

**ELECTRONIC'S LATEST TROUBLE-SHOOTER**

A compact—complete—circuit analyzer

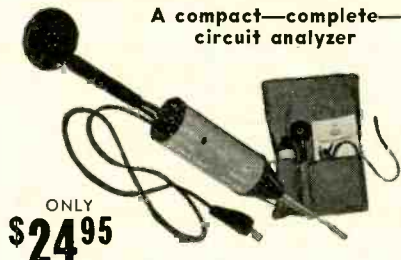

ONLY \$24.95

Model E-C (Pat. Pending)

**THE AMAZING TV SERVISSET**

A precision engineered professional quality electronic test instrument. Ideal for field or bench servicing of Radio, Television, Radar, Communications gear, etc.

Now—Quickly—Conveniently—At Low Cost

CHECKS: sync, sweep, video, audio circuits, TV high voltage supplies (DC, RF, or Pulse), low voltage supplies, coils, condensers, resistors, tubes, transformers, speakers, etc. Will localize trouble to a particular stage, determine defective component and can actually be clamped in circuit to restore circuit operation temporarily in 80% of component or tube defects. Ideal for locating and confirming intermittents.

**SPECIFICATIONS:**

RF & AF Signal Tracer, RF & AF Signal Injector, AC & DC Voltage Indicator 0/60/550/20,000, DC Polarity Indicator 60/550/20,000 volts, Lo ohms 0-5, Hi ohms 0-500k-20 megohms, Tests Condensers .0025-12 mfd., Tests Resistors 2 ohms-20 megohms, 2 Capacitance Sub ranges .01-1 & 4-40 mfd., 3 Resistance Sub ranges 50-500 ohms, 5k-25k, 100k-1 meg.

Will complement your existing equipment and will outperform other testers costing many times more. A MUST FOR THE MODERN TV AND ELECTRONICS SERVICE ENGINEER.

Comes in handy cloth pouch, complete with all accessories including ALNICO phone, TV high voltage adapter, phone extension cord, test lead, Klipzon adapter and complete detailed instruction manual, disclosing latest TV trouble-shooting techniques.

See Serviset at your distributor today. If he can't supply, order direct from factory. \$24.95 postpaid.

**LEE ELECTRONIC LABS., INC.**  
 Dept. RE-4, 233 Dudley Street Boston 19, Mass.

**EXAMINE FREE!**

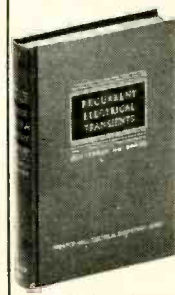

**Recurrent Electrical Transients**

by L. W. Von Tersch and A. W. Swago

This new book gives you a thorough coverage of the basic concepts of recurrent electrical transients, and their application in television, nuclear instrumentation, radar, computing devices, and industrial controls. Just published—contains up-to-the-minute data. Latest volume in the Prentice-Hall Electrical Engineering series, edited by William L. Everitt. The book is designed primarily to provide a technique of analysis, and to acquaint you with presentative types of circuits in which the steady-state waveform may be considered as a series of recurring transients. The analysis stresses the time-constant concept in preference to frequency consideration. Rationalized mks units have been used. Many illustrative examples are fully worked out to demonstrate the points being made.

**CONTENTS**

1. Fundamental Concepts
2. Basic Combinations of Resistive, Capacitive and Inductive Elements
3. Response of Basic Circuits to Simple Wave Forms
4. Clamping Circuits
5. Clipping Circuits
6. Circuits for the Electric Deflection of Cathode-Ray Tubes
7. Circuits for the Magnetic Deflection of Cathode-Ray Tubes
8. Trigger Circuits
9. Multivibrators

**MAIL COUPON TODAY**

Prentice-Hall, Inc. Dept. M-RE-663  
 70 Fifth Avenue, New York 11, N. Y.  
 Please send me a copy of RECURRENT ELECTRICAL TRANSIENTS for 10 days' FREE Examination. Within 10 days I will either return the book and owe nothing, or keep it and remit \$3.75 down (plus postage) and then \$4.00 in thirty days, in full payment.

Name \_\_\_\_\_  
 Address \_\_\_\_\_  
 City \_\_\_\_\_ State \_\_\_\_\_  
 SAVE! Send \$1.75 with this coupon and we will pay postage. Same return and refund guarantee.

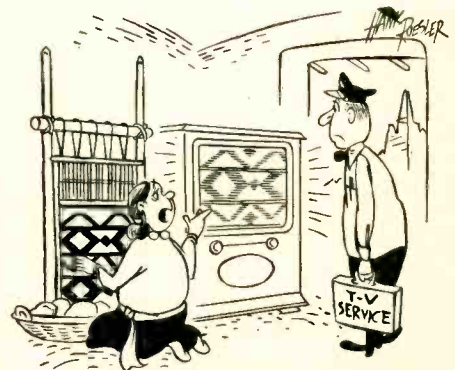

"All the time pick up crazy pattern."

RADIO-ELECTRONICS



THE FUND REACHES  
\$10,664.09



**HELP -  
FREDDIE-WALK  
FUND**

When the Help-Freddie-Walk Fund was organized several years ago in an effort to give aid to little Freddie Thomason, five-year-old son of Herschel Thomason, radio technician of Magnolia, Arkansas, we anticipated the enthusiastic and friendly support of hundred of our readers whom it has been our good fortune to know. What we did not foresee, however, was that the keen interest and encouragement would continue, as the following excerpts indicate:

From W. L. Barth, York, Pennsylvania: "Enclosed is another 'Buck' for Freddie. . . . More later." And from Lt. Sammy J. Spiadlin, Ashland, Kentucky: "It has been quite some time since I sent my last contribution. In the meantime, I have been recalled to active duty with the Air Force. But I hope to continue my donations. Hope this will help."

Clevis T. Svetlik, of Cleveland, Ohio, writes: "This dollar and many others are the best use of money I can think of." Jack Goldstein, of Philadelphia, Pa., is a new contributor, who says: "I read your article in the March issue, pertaining to your noble effort in regard to the Help-Freddie-Walk Fund. I deem it a great privilege to offer my contribution and enclose my check for \$10.00. May it help to make his future a bit brighter."

The Television Service Department of the Lee Wholesale Company (Admiral Distributor), of Kansas City, Missouri, donated \$23.50, and sent along this letter: "Please add this to the Help-Freddie-Walk Fund. We hope that it will in some small measure help in the future struggle that Freddie will have, but with the courage that he must have along with that winning smile, we are sure that he will make the grade."

"Now that Freddie is about to start his education, please print more information about him."

We most certainly will print all the information we can get about Freddie's activities and progress, as long as his many friends continue to register their interest and encouragement, verbally as well as financially, thereby insuring the "life" of the Fund. And we hope to win more friends for Freddie, for we are certain there is no more worthy cause.

Throughout his life, Freddie, who was born armless and legless, will have to depend upon artificial limbs, and these will cost thousands upon thousands of dollars before the grown Freddie can be permanently fitted. Therefore, we urge each and every reader to send in his contribution, no matter how small, as soon and as often as he can.

A new company, out to make new friends  
with new KITS and PARTS at

**NEW LOW - LOW PRICES**

**Terrific Buy! COSINE YOKE**

1/2 Cosine Direct Drive Yoke. Exact replacement for Emerson, Capehart, RCA. Replaces RCA part No. 74952. Standard No. YD10. This improved version eliminates causes of failures in the old models!  
Order Now! **\$2.95 ea.**

**TUBULAR TWIN LEAD**

300 ohm, heavy duty, low-loss cable. Perfect for UHF & VHF.  
Terrific savings!  
**\$15.49 500 ft. roll.**  
**\$29.95 1,000 ft.**

**5W. AC AMPLIFIER**

With excellent tone, includes volume and tone controls. Takes any 3.2 ohm voice coil speaker. Complete with tubes.  
Save! **\$15.95**

**RADIO KITS**

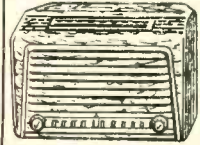

5-Tube, AC/DC, Superhet. Slide-rule type dial. Latest style with all new designing. Complete with glistening plastic cabinet, all tubes and easy-to-follow instructions. Nothing else to buy. Includes standard brands tubes: 50L6, 3Z5, 12SK7, 12SQ7, 12SA7. Ship'g. wt.: 6 lbs.  
Low priced for quick sale! **\$12.98**

**Serviceman's Must**

Solar C.F. Exameter. Complete, new, with instruction manual. Every TV serviceman needs one for a quick checking.  
Only **\$69.95**

Solar C.F. power transformer for above. **\$6.49**

**Save on TV ANTENNAS**

New conical TV antenna, famous make. Mfr. will not permit using his name.  
Reduced to: **\$2.95**

**TV PICTURE TUBES**

At Lowest Prices!

Rebuilt, fully guaranteed for a year. No dud required.  
10BP4 . \$13.95 | 17BP4 . \$22.95  
12LP4 . \$15.49 | 20CP4 . \$29.95  
21EP4 . . . . . **\$35.95**  
all new manufacture

**PHONO OSCILLATOR**

Low priced to make Friends! Phono Oscillator plays your record player through your radio. Complete with instructions. **\$6.49**

Special!  
TERMS: Min. Order: \$10.00. F.O.B. New York City. 20% deposit with C.O.D.'s.

**TUBES**

024 .... .53	6T8 .... .78	6F6GT .. .53
1R5 .... .58	6V6GT .. .56	6H6 .... .56
1S4 .... .75	6W4GT .. .53	6J5GT .. .53
1S5 .... .63	6X5GT .. .42	6J6 .... .75
1T4 .... .64	12AT6 .. .46	6K6 .... .53
1U4 .... .68	12AT7 .. .75	6L6GA .. 1.04
1U5 .... .60	12AU6 .. .53	12BE6 .. .57
1X2A .... .74	12AU7 .. .64	12BH7 .. .81
1B3GT .. .86	12BA6 .. .53	12SA7 .. .61
3Q5 .... .71	6AL5 .. .48	12SK7 .. .62
3S4 .... .64	6AQ5 .. .53	12SN7 .. .72
5U4G .... .53	6AT6 .... .45	12SQ7 .. .62
5Y3 .... .38	6AU6 .... .53	25BQ6 .. 1.07
6AG5 .... .63	6BC5 .... .53	25L6GT .. .53
6AK5 .... .88	6B6G .. 1.65	35W4 .... .40
6SA7GT .. .60	6BQ6 .. 1.08	35Z5GT .. .38
6SN7GT .. .68	6C4 .... .48	50B5 .... .60
6SF5 .... .57	6C5 .... .55	50C5 .... .69
6S7 .... .53	6BC6 .. .65	50L6GT .. .58
6SQ7GT .. .48	6E5 .... .75	

**SPECIAL INTRODUCTORY OFFER:**  
7193 Hi-Freq. Tube . . . . . **19¢ ea.**  
Many more types in stocks, too many to list. Send us all your requirements, we'll meet or beat competition!

WRITE FOR NEW CATALOG FOR "Kits and Parts of Top Quality" at terrific savings!

Easy as ABC

**Kits and Parts of Top Quality**  
**Educational Electronic Enterprises Corp.**  
135 Liberty Street • New York 6, N. Y. • WOrth 4-5442

**COMPARISON PROVES  
EICO OFFERS  
GREATEST V-O-M values!**

GET the MOST for your money — Before you buy, see chart below!  
World-renowned **EICO**  
**VOLT-OHM-MILLIAMMETERS**  
\* #536 KIT \$12.90. Wired \$14.90  
#526 KIT (with 1% multipliers) only \$13.90. Wired \$16.90

VERIFY AT YOUR DEALER'S	EICO \$2.90 up (KIT)	Co. A	Co. B	Co. C	Co. D	EICO price range
31 ranges?	YES	No	No	No	No	
Full-size 3-inch meter?	YES	Yes	Yes	Yes	No	
400 ua sensitivity?	YES	Yes	Yes	Yes	No	
Zero to 1 v. range on both AC and DC?	YES	No	No	No	No	
5000 v. range on both AC and DC?	YES	Yes	No	Yes	No	
AC/DC sens: 1000 n/v.?	YES	Yes	Yes	Yes	No	
DC and AC Current Ranges?	YES	No	No	No	No	
In KIT and Wired Form?	YES	Wired Only	Wired Only	Wired Only	Wired Only	
Lowest cost in the Industry?	YES *see Above	No	No	No	No	

All over \$24.00 EICO price range

Write for FREE Catalog MC-6 & name of local dealer. Prices 5% higher on West Coast.  
**ELECTRONIC INSTRUMENT CO., Inc.**  
84 WITHERS STREET, BROOKLYN 11, N. Y.

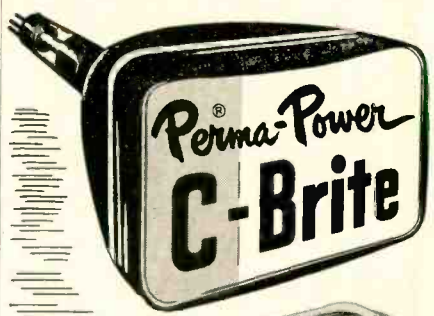

to add increased  
brilliance to any  
TV PICTURE TUBE

manufactured by  
**Perma-Power COMPANY**  
Chicago 25, Illinois  
Manufacturers of Electronic Equipment Since 1928



# POSITIVE CURES

for TV TROUBLES!



## TV MANUFACTURERS' RECEIVER TROUBLE CURES

A brand new series of practical books. Gives you exact directions for correcting TV receiver performance "bugs". Each cure is official, factory-authorized, direct from the receiver's manufacturer. It is positive! Listings by manufacturer and model or chassis number. Helps correct the most difficult faults—picture jitter, hum, instability, buzz, tearing, etc.

### 1 VOLUME 1

Covers 12 prominent brands — ADMIRAL, AIR-KING, ANDREA, ARVIN, BELMONT-RAYTHEON, BENDIX, CALBEST, CAPEHART-FARNSWORTH, CBS-COLUMBIA, CERTIFIED, CROSLEY, DUMONT. Over 120 pages (5 1/4 x 8 1/4"), illus. .... **\$1.80**

### 2 VOLUME 2

Covers — EMERSON, FADA, FIRESTONE, FREED, GAMBLE, SKOGMO, GENERAL ELECTRIC, HALL-CRAFTERS, HOFFMAN, INDUSTRIAL, INTERNATIONAL, JACKSON. Over 120 pages (5 1/4 x 8 1/4"), illus. .... **\$1.80**

### 3 VOLUME 3

Covers — KAYE-HALBERT, KENT, MAGNAVOX, MAJESTIC, MECK, MERCURY, MIDWEST, MONTGOMERY WARD, MOTOROLA, MUNTZ, NATIONAL, NORTH AMERICAN PHILIPS, OLYMPIC, PACIFIC-MERCURY, PACKARD-BELL, PHILCO. Over 120 pages (5 1/2 x 8 1/2"), illus. .... **\$1.80**

### VOLUMES 4 and 5

Coming soon! Covers prominent manufacturers not included in the first three volumes.

**One service job will more than pay the cost of this series of books!**

*Buy these books now at your jobbers ... leading bookstores ... or —*

**MAIL THIS COUPON — TODAY —**

**JOHN F. RIDER, Publisher, Inc.**  
480 Canal Street, New York 13, N. Y.

Please send me book(s) circled. I understand, if not satisfied, I may return them within 10 days for full refund. 1 2 3

NAME \_\_\_\_\_  
ADDRESS \_\_\_\_\_  
CITY \_\_\_\_\_ ZONE \_\_\_\_\_  
STATE \_\_\_\_\_ 6 RE \_\_\_\_\_  
(Please Print)

No amount is too small to receive our sincere thanks and appreciation, as well as the appreciation of Freddie and his parents. *Make all checks, money orders, etc., payable to Herschel Thomson.* Address all letters to:

**HELP-FREDDIE-WALK FUND**  
**RADIO-ELECTRONICS**  
25 West Broadway  
New York 7, N. Y.

**FAMILY CIRCLE CONTRIBUTIONS**  
Balance as of March 18, 1953..... **\$590.50**

**FAMILY CIRCLE contributions as of April 16, 1953..... \$590.50**

**RADIO-ELECTRONICS CONTRIBUTIONS**

Balance as of March 18, 1953..... **\$10,001.09**

W. L. Barth, York, Pa. ....	1.00
Wesley Brittin, Audubon, N. J. ....	2.00
A Friend, Feeding Hills, Mass. ....	1.00
Van H. Ferguson, Tallahassee, Fla. ....	5.00
Herbert Goldstein, New York, N. Y. ....	5.00
Jack Galdstein, Philadelphia, Pa. ....	10.00
Lee Wholesale Co., Television Service Dept., Kansas City, Mo. ....	23.50
Mr. & Mrs. E. Little, Toledo, Ohio ..	2.00
Tony Maday, Chicago, Ill., on behalf of Ted Jablonski, Tony Maday, Joe Palacz, Ken Petersen, Al Zaccanti, Dave Ashley, Ted Rattmann, Steve Choma, Joe Jaltuch, Tom Gruszka, Ed Miller, Wilbur O'Leary, Andy Lubarda, Nick Verallo, Herb LaRue, Chas. Menard, Ray Dati, who donated 1.00 each .....	17.00
Lt. Sammy J. Spiadlin, Ashland, Ky. ....	5.00
Clevis T. Svetlik, Cleveland, Ohio. ....	1.00

**RADIO-ELECTRONICS contributions as of April 16, 1953..... \$10,073.59**  
**FAMILY CIRCLE contributions .... \$90.50**

**TOTAL contributions as of April 16, 1953 .....** **\$10,664.09**

**Radio Thirty-Five Years Ago**  
In Gernsback Publications

**HUGO GERNSBACK**  
*Founder*

Modern Electrics .....	1908
Wireless Association of America .....	1908
Electrical Experimenter .....	1913
Radio News .....	1919
Science & Invention .....	1920
Television .....	1927
Radio-Craft .....	1929
Short-Wave Craft .....	1930
Television News .....	1931

Some of the larger libraries still have copies of **ELECTRICAL EXPERIMENTER** on file for interested readers.

### JUNE 1919 ELECTRICAL EXPERIMENTER

- My Inventions, by Nikola Tesla
- V. The Magnifying Transmitter
- "Stove Pipe" Radio
- Amateur Radio Restored, by H. Gernsback
- E. F. W. Alexanderson's "Barrage" Receiver
- Rogers Underground Aerial, by James Harris Rogers
- Learning the Code, by Howard D. Wildman
- Use of Contact Detectors in Radio Measurements, by Dr. L. W. Austin
- Automatic Code Transmitter, by George Harrington
- New Type of Transformer
- The Evolution of the Stars, by Isabel M. Lewis
- Hunting Submarines by Sound, by Brewster S. Beach

**Standard Brand Radio & T.V. TUBES**

Convince yourself. Send TODAY for our bi-weekly Bulletin of Excellent Tube Values. Dept. "C-3"

RMA Guarantees Current Protection

RCA • GE • Philco • Hytron  
Ken-Rad • Sylvania • Tung-Sol • Raytheon  
Westinghouse

**MANNFRED Electronics Corporation**

BARCLAY 7-6565 6566

EFFECTIVE IMMEDIATELY: ALL TUBES INDIVIDUALLY BOXED IN ATTRACTIVE TWO COLOR BOXES AT NO EXTRA CHARGE!

136 LIBERTY STREET N. Y.

PLEASE MENTION **RADIO-ELECTRONICS** when answering advertisements

## AUDELS TV-RADIO SERVICE LIBRARY

HERE IS LATE INFORMATION IN A HANDY FORM FOR RADIO & TELEVISION REPAIRMEN, SERVICEMEN & STUDENTS

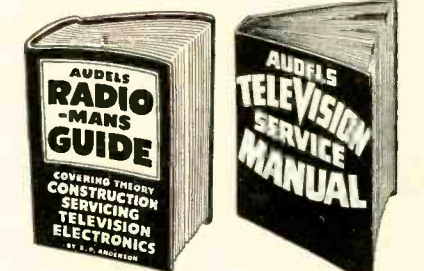

**2 VOLS. \$6 COMPLETE \$1 MO. IT PAYS TO KNOW!**

AUDELS T.V.-RADIO SERVICE LIBRARY presents the important subjects of Modern Radio, Television, Industrial Electronics, F.M. Public Address Systems, Auto, Marine & Aircraft Radio, Phonograph Pick-Ups, etc. Covers Basic Principles—Construction—Installation — Operation — Repairs — Trouble Shooting. Shows How to get Sharp, Clear T.V. Pictures. Install Aerials—How to Test. Explains Color Systems & Methods of Conversion. 1001 Facts—Over 1260 Pages—625 Illustrations—Parts & Diagrams—Valuable for Quick Ready Reference & Home Study. Tells How to Solve T.V. & Radio Troubles—Answers T.V. & Radio Questions.

Get this information for Yourself. **7 DAY TEST — ASK TO SEE IT!**

### MAIL ORDER

AUDELS Publishers, 49 W. 23 St., N.Y. 10  
Mail AUDELS T.V.-RADIO SERVICE LIBRARY 2 Vols. \$6 on 7 days free trial. If O. K. I will remit \$1 in 7 days and \$1 monthly until \$6 is paid. Otherwise I will return them.

Name \_\_\_\_\_  
Address \_\_\_\_\_  
Occupation \_\_\_\_\_  
Employed by \_\_\_\_\_ RE \_\_\_\_\_



Harry C. Crawford was elected president of RADIART CORP., succeeding L. K. Wildberg. Mr. Crawford has been associated with Radiart and its parent company, Cornell-Dubilier, for the past eight years as works manager and comptroller and assistant



H. C. Crawford

H. A. Triplett joined LITTELFUSE, INC., Des Plaines, Ill., as research director.



Left—H. A. Triplett, Right—E. V. Sundt

He was formerly chief staff engineer for Pacific Oerlikon.

Edward C. Hughes, Jr., was promoted to assistant to L. W. Teegarden, executive vice-president of the RADIO CORPORATION OF AMERICA. Mr. Hughes joined RCA in 1930 as a member of the staff of the Tube Advertising and Sales Promotion Department and has been associated with Mr. Teegarden since 1937. He was most recently assistant to Mr. Teegarden when the latter was vice-president in charge of technical products of the RCA Victor Division.

Raymond C. Cosgrove was named management consultant of NATIONAL Co., Malden, Mass. He was formerly executive vice-president of Avco Manufacturing Co., and for four terms president of the RMA (now RTMA). William A. Ready, until now president of National, was elected chairman of the Board and Charles C. Hornbostel was named president and treasurer. A new executive committee consisting of William A. Ready, Charles C. Hornbostel, Louis C. Lerner, Daniel V. McNamee, Jr., and Joseph H. Quick was also announced.

**Obituaries**

George Kenneth Throckmorton, former vice-president of the RADIO CORPORATION OF AMERICA, died in Clearwater, Fla. He was at one time president of E. T. Cunningham, Inc., famed radio tube firm in the '20's, and executive vice-president of RCA-Radiotron, an RCA Victor affiliate.

Bayard H. Clark, Lombard, Ill., head of the advertising agency bearing his name, died of a heart ailment. He had been associated with the phonograph

**yours for the asking...**

**NEW**

**CLAROSTAT CATALOG**

Hot off the press! Presents exceptional choice of resistors, controls and resistance devices.

Expanded listings. Carbon and wire-wound controls include Pick-A-Shaft types taking 12 different shafts, plus non-metallic shaft and high-voltage coupler.

Also aircraft-type metal-cased power rheostats, miniaturized carbon and wire-wound controls, sound system controls, power resistors, Glasohms, etc.

Ask your Clarostat distributor for your copy. Or write us.



**Controls and Resistors**

CLAROSTAT MFG. CO., INC., DOVER, NEW HAMPSHIRE

In Canada: Canadian Marconi Co., Ltd., Toronto, Ontario

**Windsor TUBES**

RADIO & TV RECEIVING

TESTED and GUARANTEED for **PEAK** PERFORMANCE

TYPE	PRICE	TYPE	PRICE	TYPE	PRICE
1A7GT	\$.61	6BC5	.53	6X4	.34
1B3GT	.63	6BD5GT	.89	6X5GT	.33
1L4	.57	6BE6	.46	6Y6G	.58
1N5GT	.57	6BF5	.60	12A7G	.48
1R5	.56	6BF6	.39	12A7T	.68
1S4	.61	6BG6G	1.34	12A7U	.43
1S5	.47	6BH6	.57	12A7V	.53
1T4	.56	6BJ6	.48	12A7W	.37
1T5GT	.71	6BK7	.88	12A7Y	.79
1U4	.55	6BQ6GT	.89	12AX7	.61
1U5	.46	6BQ7	.84	12BA6	.45
1X2A	.67	6C4	.37	12BD6	.46
2X2	1.50	6CB6	.53	12BE6	.47
3Q4	.60	6CD6G	1.85	12BH7	.63
3Q5GT	.65	6J5GT	.40	12SA7GT	.52
3S4	.55	6J6	.62	12SK7GT	.50
3V4	.56	6K6GT	.41	12SL7GT	.61
5R4GY	.91	6L6GA	.80	12SN7GT	.54
5U4G	.40	6L7GT	.50	12SQ7GT	.42
5V4G	.75	6S4	.46	19BG6G	1.39
5Y3GT	.29	6S8GT	.68	19T8	.79
5Y4G	.39	6SA7GT	.52	25B06GT	.89
6AB4	.46	6SF5GT	.60	25L6GT	.48
6AG5	.54	6SH7GT	.47	25W4GT	.48
6AK5	.95	6SK7GT	.50	25Z6GT	.42
6AL5	.40	6SL7GT	.62	35B5	.48
6AQ5	.46	6SN7GT	.54	35C5	.48
6AR5	.38	6SQ7GT	.42	35L6GT	.47
6AS5	.50	6T8	.77	35Z5GT	.30
6AT6	.38	6U8	.78	50B5	.47
6AU6	.43	6V6GT	.46	50C5	.47
6AV6	.37	6W4GT	.45	50L6GT	.47
6BA6	.45	6W6GT	.57	11Z23GT	.39
6BA7	.60				

0A2 ..... .88      5654 ..... 1.50

**Windsor ELECTRONIC TUBE CO.**  
1515-C SHEEPSHEAD BAY ROAD, BROOKLYN 35, N. Y.

You can't beat  
**Radio-Electronics**  
for complete coverage of  
**Radio, Television and Audio**

**ARKAY**  
world's finest radio kits  
Write for free Brochure  
RADIO KITS, INC., 120 Cedar St., N. Y. 6



get out ahead in **uhf**

THESE PRACTICAL BOOKS GIVE YOU THE "KNOW-HOW"

**"UHF ANTENNAS, CONVERTERS AND TUNERS"**



Milton S. Kiver gives you all the answers on:

**UHF Antennas:** Full analysis of each UHF type—design, operation, directional characteristics, input impedance, gain—tells you type best suited for any given location and conditions.

**Transmission Lines, Matching Networks:** tells how to select proper line to deliver maximum signal to receiver.

**Installation Practices:** Practical advice on proper antenna location and routing of line to set; tells how to check for antenna mismatch, how to determine whether system is properly installed.

**UHF Converters:** Full analysis of all existing self-contained types, including turret tuner strips.

**UHF Tuners:** Covers tuner design and operation, ranging from parallel-wire to "butterfly" types—tells how they work.

This book keeps you ahead in TV, makes you a UHF expert, for extra profits. Get your copy today.

ORDER UHF-1 Only ..... \$1.50

**"UHF CONVERTERS"**

**Covers 21 Models**  
Be among the first to understand the design and operation of the new UHF converters and tuners. This book describes all the popular units and tells how they work with present VHF sets. Covers the following makes: Arvin, Crosley, Dumont, G.E., Mallory, Motorola, RCA, Raytheon, Regency, Sarkes-Tarzian, Standard Coil, Stromberg, Sutco, Sylvania. To stay ahead in TV, you'll want this essential book.



ORDER UC-1. Only ..... \$1.00

ORDER THESE BOOKS TODAY!

**HOWARD W. SAMS & CO., INC.**

Order from your Parts Jobber today, or write direct to Howard W. Sams & Co., Inc. 2205 E. 46th Street, Indianapolis 5, Ind.

My (check) (money order) for \$..... enclosed. Send the following books.

UHF-1 (\$1.50)     UC-1 (\$1.00)

Name .....

Address .....

City..... Zone..... State.....

and radio industries for over 25 years as advertising manager of several prominent companies including MAGNAVOX and JENSEN MANUFACTURING.

**Personnel Notes**

... Robert C. Sprague, chairman of the board of SPRAGUE ELECTRIC, North Adams, Mass., was elected a director of United-Carr Fastener Corp.

... Brig. General David Sarnoff, chairman of the Board of the RADIO CORPORATION OF AMERICA, received the first Founders Award of the IRE at its annual banquet in New York City.

... Richard E. Hall was named New York Industrial sales manager of AMERICAN PHENOLIC CORP., Chicago, with headquarters in the Amphenol offices in the Empire State Building, New York. He was formerly Boston district manager. William H. Rous, vice-president in charge of sales for Amphenol, also announced the appointment of James Schaefer, formerly of the General Engineering Section in Chicago, as Hall's successor in Boston.

... Kenneth A. Hoagland was named chief engineer of the Cathode-Ray Tube Division of ALLEN B. DU MONT LABORATORIES, Clifton, N. J. Formerly assistant engineering manager of the Tube Div., he succeeds Alfred Y. Bentley who was upped to chief engineer of the Television Receiver Division. Eric Pohle, formerly head of the division's Product Engineering Section, was named assistant engineering manager of the Cathode-Ray Tube Division.

... Robert T. Rees was appointed advertising manager of TRIO MANUFACTURING Co., Griggsville, Ill., manufacturer of TV antennas and rotators.

... Glenn Clark was appointed to the staff of K. F. Boltdt, advertising manager of AMERICAN PHENOLIC CORP., Chicago.

... Norman C. Owen and Herbert A. Gumz were named vice-president in charge of sales and executive vice-president respectively of WEBSTER-CHICAGO CORP.

... Hiram Prince was named Fidelitone Division Sales Manager of PERMO, INC., Chicago, to handle the Fidelitone and Perno Point lines in Texas, Oklahoma, Arkansas, Nebraska, Iowa, Kansas City, Mo. Howard West, Fidelitone Southwestern Division sales manager, now takes over Louisiana in addition to his present territory

... Charles E. Saltzman, John H. P. Gould, Henry Sears, and Henry L. Shepherd were elected to the Board of Directors of LA POINTE ELECTRONICS, INC., Rockville, Conn., representing the additional 100,000 shares of common stock issued to Henry Sears & Co. and Bartram Bros., New York City investment bankers. END

*Editors and Engineers*  
PUBLICATIONS

IT'S NEW!

IT COVERS ALL YOU WANT TO KNOW ABOUT EQUIVALENT AND NEAR EQUIVALENT TUBES, AMERICAN AND FOREIGN.

ASK FOR **WORLD'S EQUIVALENT RADIO TUBES**

(Equivalents Vade Mecum)

A simple index marker makes it easy to find direct replacement tubes for a given type, either completely equivalent or tubes having a few differences and, in the latter case, what these differences are.

**\$5.00** PER COPY plus any tax



A COMPANION VOLUME  
**WORLD'S RADIO TUBES**  
(Radio Tube Vade Mecum)

Lists over 15,000 transmitting and receiving tubes from 253 manufacturers. The only book of its kind in the world. Available in 16 languages.

**\$5.00** PER COPY plus any tax



**For Additional Coverage**

Write for free folder describing these famous books: Radiotelephone License Manual, Better TV Reception, Antenna Manual, Radio Handbook and Surplus Radio Conversion Manuals.

**BUY FROM YOUR DISTRIBUTOR**  
ADD 10% ON DIRECT MAIL ORDERS TO  
EDITORS and ENGINEERS, Ltd.  
BOX 6898, SANTA BARBARA, CALIF.  
Bookstore order from BAKER & TAYLOR, Hillside, Ill.

First...  
and Still  
Best!



The original -  
**QUIETROLE**

TRADE MARK REG. U.S. PAT. OFF.

Available in 3 sizes:  
2 oz., 4 oz., 8 oz.

Take the noise out of controls and switches with the FIRST... the non-conductive, non-flammable product.

Here is the original, most reliable lubricant-cleaner on the market today... developed after years of research... not a cheap imitation. There is no substitute for QUALITY, try QUIETROLE TODAY!

Carried by recognized jobbers... everywhere.



manufactured by  
**QUIETROLE COMPANY**

Spartanburg, South Carolina

RADIO-ELECTRONICS



**A REAL CONSTRUCTOR**

Dear Editor:

I recently completed the "High Quality AM Tuner" described by John Potter Shields in the February issue. I found the circuit simple and easy to follow. The clear and concise text is a tribute to Mr. Shields.

I did not have a *Ferri-Loopstick* at the time, so used a standard antenna and coil, connected in the ordinary manner. Neither did I have a 6BD6, so I referred to the tube manual and found that a 6SK7 could be substituted. I replaced the potentiometer with a 100,000-ohm, 1-watt resistor, as I did not want a volume control in the tuner. I also placed an 8- $\mu$ f capacitor between the plate of the 6C4 infinite impedance detector and ground, for further filtering and decoupling. I substituted a 1N35 for the 1N34 germanium diode. No apparent changes in a.v.c.

The 47,000-ohm, 1-watt resistor in the 6BE6 plate circuit tended to overheat, and was changed to 2 watts.

The 220,000-ohm swamping resistors in the i.f.'s were not used. I find the quality of reception has not suffered.

This tuner is feeding a home-built Williamson amplifier using 807's, which in turn feeds a Jensen 12-inch coaxial speaker in a bass reflex cabinet. The tuner fits my needs exactly.

I have only one difficulty. I pick up a continuous-wave signal I cannot eliminate. How can I get rid of it?

ROBERT H. DUNBAR

Niantic, Conn.

(Rather hard to clear up interference by remote diagnosis, but we'd try an i.f. trap for a start. Incidentally, Mr. Dunbar is losing highs by omitting his swamping resistors.

This letter is an example of what a skilled constructor can do with an article, and is a striking contrast to some sent in by would-be constructors, who complain that they can't go ahead because the article said an 8- $\mu$ f filter capacitor was used, but one of the photos showed a 16- $\mu$ f unit! Mr. Dunbar has adapted the circuit to his needs, to his stock-on-hand, and apparently even to his own musical tastes. Truly, as the author of one of the most popular articles printed in this magazine once stated, common sense is the most important component!—*Editor*)



"OH SURE, a TEN-inch screen will be large enough, you said . . . why do we need a TWENTY-ONE inch screen, you said . . ."

JUNE, 1953

# MONEY MAKERS

**FOR MOBILE-RADIO SERVICE ENGINEERS!**

In this profitable, rapidly expanding field, be sure your frequency- and modulation-test equipment is LAMPKIN, with continuous coverage! Don't be limited to just a few frequency channels!



**The Type 105-B MFM. For Any Number of Frequencies, AM or FM**

The Type 105-B Micrometer Frequency Meter, or MFM, measures center-frequency on any number of nearby transmitters, AM or FM, 0.1 MC. to 175 MC. Performs as signal generator for mobile receivers, 20 MC. up. Meets FCC requirements for mobile services, with accuracy guaranteed better than 0.0025%. Can be checked against WWV. Price \$220.00 net.



**The Type 205 FM Modulation Meter For Multiple Mobile Frequencies.**

Instantly tunable anywhere, 25 MC. to 200 MC., the Type 205 measures maximum FM deviation due to modulation, as required by the FCC. Indicates 0-25 KC. deviation. Simple to use, easy to carry. No charts or tables. Price \$240.00 net.

Send name and address for literature.

Name .....  
 Address .....  
 City ..... State .....

**LAMPKIN LABORATORIES, INC.**  
 METER DIVISION  
 BRADENTON, FLORIDA



## AMPERITE

**Studio Microphones at P.A. Prices**

Ideal for  
**BROADCASTING  
 RECORDING  
 PUBLIC ADDRESS**

"The ultimate in microphone quality," says Evan Rushing, sound engineer of the Hotel New Yorker.

- Shout right into the new Amperite Microphone—or stand 2 feet away—reproduction is always perfect.
- Not affected by any climatic conditions.
- Guaranteed to withstand severe "knocking around."



Models  
 RBLG—200 ohms  
 RBHG—Hi-imp.  
 List \$42.00



"Kontok" Mikes  
 Model SKH, list \$12.00  
 Model KKH, list \$18.00

**Special Offer:** Write for Special Introductory Offer, and 4-page illustrated folder.

**AMPERITE Company, Inc.**

561 BROADWAY • NEW YORK 12, N. Y.  
 Canada: Atlas Radio Corp., Ltd., 560 King St. W., Toronto

**GET INTO ONE OF THESE GREATER OPPORTUNITY FIELDS**

# Electricity or Radio-Television

**TRAIN IN THE GREAT SHOPS OF**

**COYNE** OLDEST, BEST EQUIPPED SCHOOL OF ITS KIND IN U. S.

Come to the Great shops of Coyne in Chicago. Get practical training in TELEVISION—RADIO—ELECTRICITY—ELECTRONICS—vital in Defense Program. Prepare now for a better job in Industry or higher rating in Armed Forces.

**Approved for Veterans—finance plan—enroll now, pay most of tuition later. Part time employment service while training if needed. Special tuition plan for men of Draft Age.**

**FREE BOOK** Clip coupon for Big Free Illustrated Book. No obligation. No salesman will call. Act NOW.

B. W. Cooke, President  
**COYNE SCHOOL** A TECHNICAL TRADE INSTITUTE CHARTERED NOT FOR PROFIT Established 1939  
 500 S. Paulina, Chicago  
**RADIO ★ REFRIGERATION ★ ELECTRONICS**

**B. W. COOKE, Pres.**  
 COYNE School  
 500 S. Paulina St., Chicago 12, Ill. Dept. A3-81H  
 Send FREE BOOK and details on:  
 RADIO-TELEVISION  ELECTRICITY

NAME.....  
 ADDRESS.....  
 CITY..... STATE.....



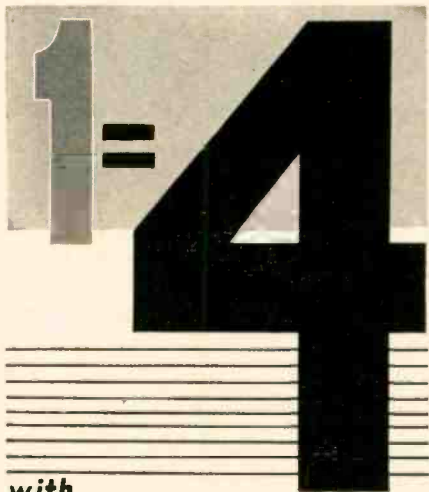

with

**RCP**

MODEL 324

Because the Radio City Products Model 324 "DO-ALL" Tube and Battery Tester packs into one instrument the performance of four



**Sufficient Facilities to Test**

- 1. All TV and Radio Tubes**  
Sockets for all standard 4,5,6,7, octal, loctal, miniature and subminiature are provided. Tests transmitting, hearing aid, ballast, pilot light, gaseous rectifiers and tuning indicator types. All readings are indicated on a large easily read meter.
- 2. Cathode Ray Tube**  
Checks all magnetic deflection types right in the set or carton. Will locate and isolate all shorts or leaks.
- 3. Batteries**  
Tests popular portable battery types under load. Indicates true condition of battery under check.
- 4. All This and a Reactivator Too**  
Gives extra life to otherwise dim or bad picture tubes.

Adds a professional note to any service bench or store counter. Available in both counter and portable models, complete with CR Tube Adapter Cable.

Two Styles To Meet Your Service Needs—

**Model 324C**—Counter model with open style metal case. Size: 13 3/4" x 12 1/4" x 4" Weight: 10 lbs. Price... \$69.95

**Model 324P**—Combination portable-counter model. Smart looking, hand-rubbed carrying case with slip-hinge cover—includes battery test leads. Size: 16 1/4" x 14 1/4" x 5" Weight: 12 lbs. Price... \$79.50

Remember You Can Do More With A "DO-ALL"  
See It at Your Parts Distributor  
Write Dept. RE-6 for RCP '53 catalogue.

**RADIO CITY PRODUCTS CO., INC.**

152 West 25th Street **RCP** New York 1, N. Y.

**A CORRECTION**

Dear Editor:

May I call to your attention errors which, through no fault of yours, appeared in a patent announcement on page 113 of the November, 1952, issue of RADIO-ELECTRONICS, under the caption, "Sine Computer?" The error curve and circuit configuration are correct, but the actual resistance values are not

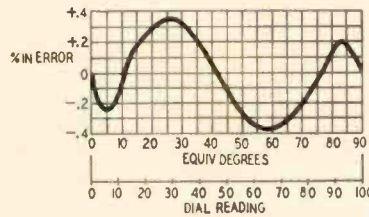
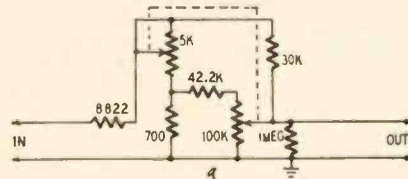

the ones for this curve. The correct values are shown in the accompanying diagram.

Unfortunately, I did not see a copy of the final application nor receive a copy of the patent. My attention was called to the errors by one of your readers, Mr. Ross M. Chiles of Northrup Aircraft, Inc., Hawthorne, Calif.

C. C. SHUMARD

RCA Laboratories Div.  
Princeton, N. J.

**MORE ON TUBE KITS**

Dear Editor:

The circuit below, an exact duplicate of one encountered while repairing the spasmodic glimmer of the heterodyne, with its special tube, has presented certain troubles to the expectant owners of "Tube Kits, Inc."

Though being the proud possessor of one of these extra fine kits, I have been unable to duplicate the above tube, due, perhaps, to its fly-back characteristics, plus the fact that the filament current has not been included with the kit.

Therefore, as a convenient means of clearing the good name of Tube Kits, Inc. why don't you, of RADIO-ELECTRONICS, have Prof. Adolph Glockenspiel market an advanced version of this remarkable phenomenon, a kit which includes component parts such as quarter-moon cathodes, saw-tooth grids, and plates with the low-mu already sprayed on them? If this were done, I firmly believe the qualified technician would encounter no further difficulties in the construction of radio tubes that would really do things, nor would I ever again run afoul of a circuit which in its entirety stumped me and the diversified abilities of the tube kit of Tube Kits, Inc.

Gentlemen: Without qualms and quibbles, Tube Kits Inc. has shown the service technician and others, proof; proof not only that it is very possible to do it, but that sometimes even the man without previous experience tends



**\* CATHODE RAY TUBE SPECIALS \***

ONE YEAR GUARANTEE			
G. E.	STAN-BURN		
STP4 .....	\$44.95	10BP4A .....	\$11.00
71P4 .....	17.10	12LP4A .....	14.20
10BP4A .....	19.25	14CP4 .....	17.00
10FP4A .....	24.00	15DP4 .....	19.50
12KP4A .....	27.10	16AP4 .....	21.60
12LP4A .....	21.70	16FP4 .....	19.60
12UP4B .....	28.25	16GP4 .....	21.80
14CP4 .....	24.50	16HP4 .....	22.60
16X84A .....	30.95	16DP/HP4 .....	19.60
16DP4A .....	28.20	16DP/HP4A .....	20.60
16GP4 .....	31.25	16KP4 .....	18.50
16KP4/16RP4 .....	28.20	16LP4 .....	20.60
17BP4A .....	23.90	16LP4A .....	21.60
17CP4 .....	23.90	17BP4 .....	18.50
18AP4 .....	39.45	17CP4 .....	21.60
20CP4 .....	24.75	19AP4 .....	23.90
20LP4 .....	37.50	19AP4A .....	25.90
21EP4A .....	79.50	20CP4 .....	25.90
24AP4 A .....	79.50	21EP4 .....	32.50

**ANTENNAE SPECIALS**

DOUBLE V 3/4" Dowel .....	1-11	12 or more
DOUBLE V 1/2" Dowel .....	3.45	2.45
DOUBLE V 1/2" Dowel .....	3.95	2.95
10 Element Conical 3/4" .....	3.55	2.55
Folded HI Straight Low Quick Rig .....		
1/2" elements .....	4.25	3.25
WINDOW CONICALS .....	4.95	3.75
MASTS 5 FOOT SWEGED .....	.79	.69
10 FOOT PLAIN .....	1.39	1.29
TV WIRE 42 Mil. 300 OHM .....	\$9.95 M FL	
55 Mil. 300 OHM .....	14.95 M FL	
72 OHM COAXIAL .....	38.00 M FL	
4 Prong Vibrators, each .....	\$ 1.29	
Lots of 12 or more .....	1.19	
12" Heavy Slug Speaker .....	Special 3.98	
CHASSIS 630 REGAL with Cascade Tuner .....	\$149.50	
OPEN FACE CABINET .....	39.00	

**WIRE RECORDERS IN STOCK**

PENTRON—Model 9T3C—2-speed Tape Recorder .....	Write for Price.
RADIO CRAFTSMAN Model C400—Hi Fi Amplifier .....	Net \$42.90
Model RC10—AM-FM Tuner .....	Net 131.50
Model C500—Williamson Amplifier .....	Net 99.50
Revs—Pre-Amps, FM Tuners and WEBSTER Tape Recorders .....	
6"x9" PM SPEAKER .....	\$3.98
7" PM SPEAKER .....	3.98
77J G.E. Flyback .....	1.98
70" Yoke .....	1.98
630 Vert. Output Upright .....	1.98
630 Vert. Output Potted .....	1.29
630 Vert. Blocking Osc. Xform. .....	.89
CASCADE TUNERS .....	19.95
STANDARD TUNERS .....	17.95
DUMONT 21.25mc .....	14.95

**AUTHORIZED DISTRIBUTORS for:** General Electric, Kenrad, Tung-Sol, National Union, De Wald, Regal, Automatic and General Motors.

We carry a complete stock of HI-FIDELITY and SOUND EQUIPMENT. Send us your requests. We also carry a complete line of popular makes of Radio tubes at 50/10% discount. Also many other special purpose and transmitting types, and all electronic parts and equipment at lowest prices. Send us a list of your requirements for prompt quotations. Terms: 20% with order. Balance COD. All prices FOB. NEW YORK Warehouse. Minimum order \$5.00.

Write for our latest price list and Hi-Fi Catalog to Dept. RE-6

**STAN-BURN** RADIO and ELECTRONICS CO.  
(C.B.S. THEATRE BLDG.)  
1697 BROADWAY • NEW YORK 19, N. Y.

**Holds the Screw!  
Drives it too!**



**Quick-Wedge  
SCREW-HOLDING  
SCREWDRIVER**

Unconditionally Guaranteed

Ask for it at your Dealer  
Kedman Co., 233 S. 5 W., Salt Lake City, Utah



to wish he had.

In closing, may I ask that you of RADIO-ELECTRONICS, and of that great German Noisivelet outlet, in Krause-kopf-f-f-f-f-on-the-Rhine, get together

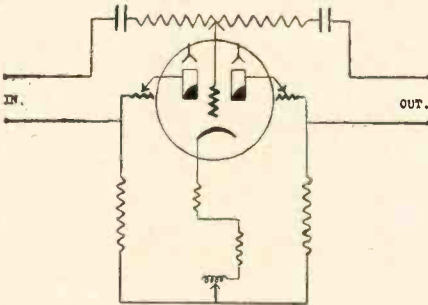

and publish this documented circuit, along with the information necessary for me to construct the above-shown tube from the kit.

GEORGE D. PHILPOTT

Columbus, Ohio

**WATCH THAT BOOSTER!**

Dear Editor:

This is not meant to discredit any make of television booster, but simply to point out how important it is—especially in fringe areas—to pick the right type for each job.

In my service work I run across many cases where full-time bricklayers picking up a little side money with alleged TV installations have hooked up 6J6 boosters to sets with cascode front ends. The results are generally pretty miserable.

The point is, the booster must be at least as good as the TV tuner if you expect to get decent pictures. If the set has a cascode front end it's a waste of time and money to hook up anything but a *cascode booster*. The higher noise level of a pentode or grounded-grid-triode booster stage cancels all the benefits of the cascode input stage in the receiver.

JOHN J. WHITE

Lewes, Delaware

**CORRECTION**

A new video tape recorder is discussed in an item on page 16 of the April issue. In the discussion, 100 and 15 feet per second are given as comparative speeds for video and audio tape recorders, respectively. The standard of measurement should be inches per second instead of feet per second as stated. Our thanks to Mr. R. Waterstripe of Hattiesburg, Miss., for detecting the error and calling it to our attention.

WATCH FOR THE JULY ISSUE OF  
RADIO-ELECTRONICS  
ON THE NEWSSTANDS  
JUNE 26

**BARGAINS · BARGAINS · BARGAINS**

You can depend on STEVE-EL to come up with "terrific buys"! Our latest catalog is chock full of 'em. WRITE TODAY!

**BARGAINS · BARGAINS · BARGAINS**

**BARGAINS · BARGAINS · BARGAINS**

**TUBE REJUVENATOR** \$149

**CASCADE TUNER** \$19.95

Factory aligned ready to use. Complete with tubes and instructions.

**8 Element Super Fan Conical Antenna. Heavy Aluminum construction** \$2.95

**SUPREME TESTERS** World's finest equipment

#600 Tube and Set Tester \$89.95  
#616 Tube and Battery Tester 69.95

**WEN Soldering Gun** \$9.71

250 Watts  
UL Approved. Choice of colors Red, Green and Black  
(Minimum Order \$5.00)

**Steve-El Brand TUBES**

Brand new, individually boxed. Many FAR BELOW WHOLESALE COST!

1A7	.62	6SL7	.52
1B3	.63	6SN7	.54
1P5	.64	6SQ7	.42
1R5	.49	6T8	.74
1T4	.49	6U6	.57
1U4	.48	6UB	.78
1U5	.48	6V6	.46
5U4	.47	6V8	.83
5W4	.46	6W4	.45
5Y3	.29	6W6	.52
6A7	.62	6X4	.34
6A8	.51	7C6	.42
6AQ5	.62	7X7	.62
6AK5	1.14	12AT6	.48
6AK6	.64	12AU6	.48
6AL5	.41	12AU7	.56
6AU6	.43	12AV6	.52
6AX4	.59	12AX4	.59
6BA6	.48	12AZ7	.94
6BC5	.58	12BA6	.47
6BC7	.86	12BE6	.47
6BE6	.48	12SA7	.52
6BG6	1.21	12SK7	.49
6BH6	.62	12SL7	.57
6BJ6	.53	12SN7	.54
6BK7	.86	12SQ7	.42
6BQ6	.76	14AF7	.59
6BQ7	.86	19T8	.78
6CB6	.48	25BQ6	.47
6CD6	1.79	25W4	.48
6F6	.49	25L6	.48
6J6	.79	25Z6	.42
6K6	.41	32L7	.91
6L6A	.89	35Z5	.33
6L6G	.89	35L6	.48
6S7	.52	50L6	.48
6SG7	.49	80	.38
6SK7	.49		

**SPECIAL DISCOUNTS**  
50 Asst. {5% 100 Asst. {10%

**STEVE-EL ELECTRONICS CORP.**

Dept. E-6 61 Reade St., New York 7, N. Y. COrtlandt 7-0086

**OSCILLOSCOPES ARE "GOLD MINES"!**

... if you learn how to use them fully on all types of service jobs!



Learn to handle the oscilloscope fully on all types of AM, FM and TV service work—and watch your efficiency and earnings soar!

**MODERN OSCILLOSCOPES AND THEIR USES**, a fact-jammed 326-page book by Jacob H. Ruiter, Jr., of the Allen B. DuMont Laboratories, contains exactly the help you need—written in a way you can clearly understand. It shows you how to use your 'scope for fast accurate work on all types of jobs from troubleshooting to realigning; how to make connections; how to adjust circuit components; how to set controls and how to analyze patterns fast and accurately. 370 helpful illustrations including dozens of pattern photos make things doubly clear.

- ✓ When, where, why and exactly how to use your oscilloscope
- ✓ How to interpret patterns
- ✓ How to handle tough jobs in less time

**MAIL ORDER 10-DAY FREE EXAMINATION**

Dept. RE-63, RINEHART BOOKS, Inc. Technical Division, 232 Madison Ave., New York 16, N. Y.

Send **MODERN OSCILLOSCOPES AND THEIR USES** for 10-DAY EXAMINATION. If I decide to keep the book, I will then remit \$6.00 plus a few cents postage in full payment. If not, I will return book post-paid and owe you nothing.

Name \_\_\_\_\_  
Address \_\_\_\_\_  
City, Zone State \_\_\_\_\_  
Employer's Name & Address \_\_\_\_\_  
OUTSIDE U.S.A.—Price \$8.50, cash only. Money back if book is returned in 10 days.

**FREE**

FREE — the latest issue of our "TV and ELECTRONICS NOTES". It presents

**IMPORTANT FACTS EVERY SERVICEMAN MUST KNOW** about

**UHF**

Vital Serviceman's information regarding Installation, Reception, Converting existing Sets, Tuners, etc.

**FRINGE AREA RECEPTION**

How to get best results at lower costs, improve performance, AND—OTHER IMPORTANT SUBJECTS

Get this special FREE copy, or for regular subscription to "TV and Electronics Notes" send 50c.

**RUSH THIS COUPON NOW**

TRANSMISSION, INC., NEW ROCHELLE, N. Y. Dept. RE

- Send FREE, the latest issue of "TV and Electronics Notes" on UHF, Fringe Area Recep., etc.
- Enclosed find 50c for regular subscription.

Name \_\_\_\_\_  
Address \_\_\_\_\_  
City \_\_\_\_\_ State \_\_\_\_\_



# GO TESCO!

for **UHF**

For greater gain in UHF

**ULTRA BOW-TENNA**  
Model 704

**ULTRA V-TENNA**  
Model 703

Stronger reception  
Ruggedly built

**VHF-UHF ULTRA-ROCKETENNA**  
PRL-742

Covers Channels 2 thru 83

Tesco engineers developed the ULTRA-TENNA series for VHF-UHF, or UHF alone, to solve all antenna problems. Write now for complete information.

it's the cats' whiskers... and just as sensitive!

# TESCO

TV PRODUCTS CO. SPRINGFIELD GARDENS  
NEW YORK, 13, N. Y.  
NEW YORK TO 'FRISCO, ... IT'S TESCO

Any or all of these catalogs, bulletins, or periodicals are available to you on request direct to the manufacturers, whose addresses are listed at the end of each item. Use your letterhead—do not use postcards. To facilitate identification, mention the issue and page of Radio-Electronics on which the item appears. All literature offers void after six months.

### PRINTED CIRCUITS

*RCA Printed-Circuit IF Transformers, Coils, and Traps* is an 8-page booklet describing printed-circuit components designed for use in television receivers with intercarrier-sound systems and picture i.f. and sound i.f. carriers of 45.75 and 41.25 mc respectively.

Copies free on request from Commercial Engineering Section, RCA Tube Department, Harrison, N. J.

### RECEIVING TUBES

The RCA Tube Department has brought out a revised edition of *RCA Receiving Tubes for AM, FM, and Television Broadcast*. The 24-page booklet covers more than 495 RCA receiving tubes including 45 kinescopes. It provides quick and easy reference to the characteristics and socket connections for each tube type, as well as a classification chart which facilitates the selection of the proper tube type for a desired purpose.

Request Form 1275-F from your distributor or send 15¢ to Commercial Engineering Section, RCA Tube Department, Harrison, N.J.

### TV REPLACEMENT GUIDE

TV Replacement Guide No. 405 gives recommendations for replacing i.f.-r.f. coils and transformers in over 6,000 models and chassis, plus exact replacements where required.

Available free of charge from Merit Coil & Transformer Corp., 4425 N. Clark St., Chicago 40, Ill.

### ANTENNA TIPS

TV antenna installations are the subject of a booklet issued by Snyder. Edward M. Noll and Matt Mandl have prepared the 37-page *Tenna Tips* which gives basic information on fundamental antenna types, includes hints on many phases of installation, and factors involving reception at the ultra-high frequencies.

Copies can be obtained without charge by writing to Dick Morris, Snyder Mfg. Co., 22nd & Ontario Sts., Phila. 40, Pa.

### PHONO FACTS

Audak's 1953 *Electronic Phono Facts* is a 20-page booklet by Maximilian Weil, answering more than 100 questions on audio-electronic music systems. Among the topics discussed in non-technical language are the pickup, stylus, tone arm, turntable, and other components, and care of records.

Free on letterhead request to Audak Co., 500 Fifth Ave., New York 36, N. Y.



have been identified with **QUALITY** since the swaddling days of Radio. The era of Television finds them, more than ever, the Serviceman's Friend.

## GLUTTONS for PUNISHMENT

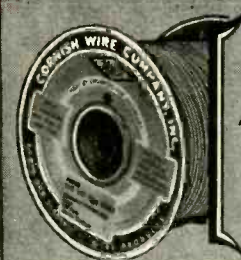

Preferred for their Absolute Uniformity, Superior Qualities and Ultimate Economy

**CORNISH WIRE COMPANY, INC.**  
50 Church Street, New York 7, N. Y.

## ASSEMBLE YOUR OWN ELECTRONIC ORGAN

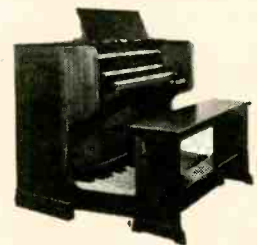

SAVE HUNDREDS OF DOLLARS WITH OUR COMPLETE KITS AND STEP-BY-STEP INSTRUCTIONS.

- Tone Generators
- Keyboards
- Power Supplies
- Tremolos
- Amplifiers
- Tone Cabinets
- Consoles

For Details Write Today To:

### ELECTRONIC ORGAN ARTS

Box 16454, Dept. RE-1  
Vine Station, Los Angeles 38, Calif.



**VACUUM-TUBE OSCILLATORS** by William A. Edson. Published by John Wiley & Sons, Inc., New York, N. Y. 6 x 9 inches, 476 pages. Price \$7.50.

There has been much talk of transistors lately, but tubes will continue as oscillator elements for a long time. This volume presents an orderly and clear description of tube oscillators. It discusses not only oscillators, but also numerous topics related to them. It stresses design and is written for graduate engineers.

Nyquist plots are described early and used often. Feedback, negative resistance, resonators, and circuit elements are described. Crystal-controlled, relaxation, phase-shift, and bridge-type oscillators are among those included here. Among related topics treated are frequency multiplication (by tubes and magnetic circuits), tube noise, modulation (of oscillators), synchronization, a.f.c., and magnetostriction.—IQ

**REMOTE CONTROL BY RADIO**, by A. H. Bruinsma. Published by Philips Technical Library. 6 x 8 inches, 95 pages. Distributed in U.S. by Elsevier Press Inc., 402 Lovett Blvd., Houston 6, Texas. Price \$1.95.

This book was written to describe two actually constructed ship models controlled by radio. Photos, diagrams and design data tell the whole story. The simpler model uses seven tubes and works through two independent channels. It is amplitude modulated. The second model uses 44 tubes and is supplied with eight different channels. It is pulse-modulated. It controls a rudder, screws, lifeboats, crane, catapult, and other equipment, all by remote control. Its engine room contains twelve relays and six motors!

This manual will, of course, interest experimenters who have made remote-controlled units or plan to do so. Aside from model building, it also contains valuable data and practical information on modulation, sync pulse circuits, crosstalk elimination, etc.

The tubes used in the models are all European types. However, the appendix contains data on them (14 different types).—IQ

**THE USE OF A.F. TRANSFORMERS** by N. H. Crowhurst. Distributed by British Radio Electronics, 1 Thomas Circle, Washington 5, D.C. 5 1/2 x 8 1/2 inches, 63 pages. Price \$1.00.

Many technicians and music-lovers have been led to believe that a.f. transformers are obsolete and not adapted to hi-fi applications. A glance through the latest catalogs shows this to be untrue. Modern transformers (when properly used) are designed for excellent fidelity, efficiency and compactness. This book shows how to choose transformers for optimum results and how to test their performance.

The handbook is written in clear language with numerous diagrams and charts. It describes measurements for distortion, power handling capability, insertion loss and efficiency. It explains what happens to the "highs" and the "lows" when circuit values are varied. Charts help to calculate reactances, load impedances, response curves, etc.—IQ

Unlimited Opportunities in  
**RADIO ENGINEERING**

**DEGREE IN 27 MONTHS**  
Complete Radio Engineering course including Telev., U. H. F. and F. M. Bachelor of Science Degree also in Mech., Civil, Elect., Chem., and Aero. Eng.; Bus. Adm., Acct. Extensive campus, modern buildings, well equipped labs. Low cost. Prep courses. Personalized, practical instruction. Founded 1884. Placement service. Growing shortage of engineers. Prepare now. Approved for Korean vets. Enter June, September, January, March. Write for catalog.



**TRI-STATE COLLEGE**

2463 College Ave. ANGOLA, IND.

**GET INTO ELECTRONICS**

You can enter this unovercrowded, interesting field. Defense expansion, new developments demand trained specialists. Study all phases radio & electronics theory and practice: TV, FM; broadcasting; servicing; aviation, marine, police radio, 18-month course. Graduates in demand by major companies. H.S. or equivalent required. Begin Jan., March, June, Sept. Campus life. Write for catalog. VALPARAISO TECHNICAL INSTITUTE Dept. C Valparaiso, Ind.



**RCA INSTITUTES, INC.**

A service of Radio Corporation of America  
350 West 4th St., New York 14, N. Y.

**OFFERS COURSES IN ALL TECHNICAL PHASES OF RADIO, TELEVISION, ELECTRONICS**

Approved for Veterans  
Write Dept. RC-53 for Catalog

**GET INTO TV SERVICING**

Send for free 24-page illustrated booklet which tells you how to become a successful TV technician. America's leading TV servicing school offers you a specialized training program that omits non-essential math & design theory. You concentrate on radio & TV servicing only. You get professional training & experience right in our fully-equipped shops & laboratories. Send for this booklet today. Write Dept. E-63. No obligation—no salesman will call. Approved for Veterans

**WESTERN TELEVISION INSTITUTE**

341 W. 18th St. Los Angeles 15, Calif.



**TV REPAIRMEN MAKE TOP MONEY!**

In just 39 weeks, you can get complete TV service training! Streamlined course gives you all essentials for a good job as service technician. Graduates in great demand; jobs are plentiful in this growing field. Other courses in electronics, radio operation and maintenance. Day or evening classes; modern equipment. Opportunity for employment in local industry.

Write for Catalog 111 Today

**INDIANAPOLIS ELECTRONIC SCHOOL**  
312 E. Washington, Indianapolis 4, Ind.

**SENDING CODE RECEIVING SPEED**

Be a "key" man. Learn how to send and receive messages in code by telegraph and radio. Commerce needs thousands of men for jobs. Good pay, adventure, interesting work. Learn at home quickly through famous Candler System. Qualify for Amateur or Commercial License. Write for FREE BOOK. **CANDLER SYSTEM CO.** Dept. 3-G, Box 928, Denver 1, Colo., U.S.A.

**RADIO ENGINEERING DEGREE IN 27 MONTHS**

Intensive, specialized course including strong basis in mathematics and electrical engineering, advanced radio theory and design, television. Modern lab. Low tuition. Self-help opportunities. Also B.S. degree in 27 months in Aeronautical, Chemical, Civil, Electrical, and Mechanical Engineering. G.I. Gov't approved. Enter June, September, December, March. Catalog.

**INDIANA TECHNICAL COLLEGE**  
156 E. Washington Blvd., Fort Wayne 2, Indiana

BECOME AN

**ELECTRICAL ENGINEER**

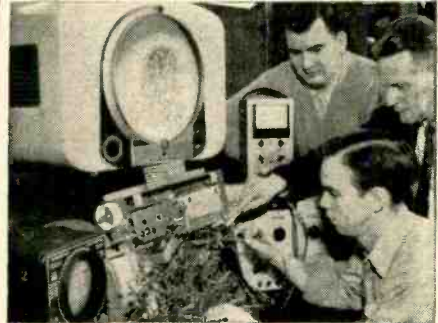

**Bachelor of Science Degree in 36 months.**

Major in Electronics or Power. Now, prepare for a career in these rapidly expanding fields.

This school will prepare you to become an engineer, technician or service man. Previous military, academic or practical training may be evaluated for advanced credit.

**Enter Both Radio and Television**

In 12 months you can attain the Radio-Technician's certificate. An added 6 months course qualifies you for the Radio-TV Technician's certificate and the Degree of "Associate in Applied Science." The Technician's course is the first third of the program leading to a Bachelor of Science Degree in Electrical Engineering with a major in Electronics.

Also offered: 12-month Radio-TV service course; 12-month Electronics or Electro Technician Courses; 6-month Electrical Service Course and 3-month refresher and general preparatory classes.

Terms Open April, July, Oct., Jan.

Famous for its Concentric Curriculum. Faculty of specialists. 50,000 former students. Annual enrollment from 48 states and 23 overseas countries. Non-profit. 50th year. Courses approved for Veterans.

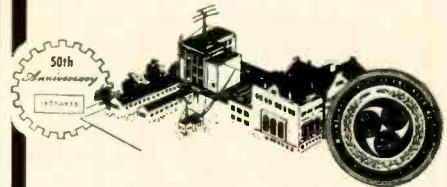

**MILWAUKEE**

**SCHOOL OF ENGINEERING**

MILWAUKEE SCHOOL OF ENGINEERING  
Dept. RE-653, 1025 N. Milwaukee  
Milwaukee 1, Wisconsin

Send:  Free 160-page Catalog describing Electrical Engineering Courses;  Booklet on Careers in Radio-TV.

I am interested in \_\_\_\_\_ name of course

Name \_\_\_\_\_ Age \_\_\_\_\_

Address \_\_\_\_\_

City \_\_\_\_\_ Zone \_\_\_\_\_ State \_\_\_\_\_

If veteran, indicate date of discharge \_\_\_\_\_



ADVERTISING INDEX

NEED TUBES?

Bury for FAST-DELIVERY on all types. Tubes individually cartoned and carry Standard RMA GUARANTEE.

Tube Orders Over \$8.00 with full remittance Prepaid To You in USA.

All tubes INDIVIDUALLY retested (not just spot-checked) on our Hickok Mutual-Conductance Tube-Testers to insure you 100% perfect merchandise. For your maximum money's worth buy in full confidence from TUBE-SPECIALISTS. Here is a partial listing of our large stocks. You may order types not listed at approx. same savings. Phone Rector 2-2562 for fast delivery. Most of our Special-Purpose Types not listed.

0A2	.90	6BM6	.60	12BH7	1.15
0A4-G	1.00	6B8	.85	12SA7	.75
0B4	1.00	6BK7	1.45	12SF5	.70
0C3/VR105	1.10	6BN6	1.30	12SG7	.80
0D3/VR150	1.05	6BQ6	1.20	12SJ7	.69
0Z4	.66	6BZ7	1.48	12SK7	.70
1A7GT	.89	6C4	.45	12SL7GT	.65
1A64	.90	6CB6	.55	12SN7GT	.70
1AX2	1.10	6CD5-G	1.50	12SQ7GT	.63
1B3GT	.80	6H6	.60	12SR7	.60
1L4	.60	6F6-M	.69	14A7/12B7	.90
1LA6	.98	.80	1486	.90	
1L84	.98	6G6-G	.85	14Q7	.90
1LN5	1.15	6J5GT	.45	19AP4-A	44.00
1NSGT	.87	6J6	.60	19BG6-G	1.95
1N23-A	2.27	6K4	3.50	19TH	1.30
1N34	1.60	6K4	.59	25AV5	1.25
1N34A	.73	6K6GT	.49	25BQ6GT	1.00
1N48	.57	6L5-G	1.19	25L6GT	.64
1N54	.75	6L5-G	.85	25W4	.82
1R5	.65	6L6-G	1.95	25Z5	.67
1S5	.66	6L6-GA	.80	25Z6	.67
1T4	.60	6L6-M	.80	35B5	.40
1U4	.88	6L7	.80	35C5	.40
1U5	.78	6N7-M	1.20	35L6	.69
1V2	.67	6Q7GT	.76	35W4	.52
1X2-A	.90	6S7-M	.98	35Y4	.73
2C43	13.95	6S8GT	.72	35Z5GT	.49
2E24	1.95	6SA7GT	.88	50A5	.90
2E30	1.95	6SC7	.78	50B5	.82
2X2	.45	6SG7	.62	50C5	.50
3A9	.65	6M7	.62	50D5GT	.55
3AP1	9.00	6S7J	.69	50A5	.90
3BP11	9.50	6SK7GT	.62	50B5	.82
3C23	9.50	6SL7GT	.65	50C5	.50
3C24/24-G	1.35	6SN7GT	.70	50D5GT	.55
3D6/1299	5.00	6SQ7GT	.68	117Z3	.66
3E29/829B	8.95	6T8	1.30	117Z6	1.00
3Q4	2.27	6V6	.87	42F-TM	17.00
3Q5GT/G	.99	6U8	.78	274 A & B	2.95
3S4	.60	6V6GT	.85	304-TM	7.00
3V4	.80	6W6GT	.80	310-TL	8.75
4X150A	25.00	6W6GT	.85	310-A	5.50
5D21	16.75	6X4	.65	311A	6.50
5R4GY	1.25	6X6GT	.37	311-B	.85
5U4G	.95	6Y6-G	.88	311-A	.88
5V4-G	.95	7A4 (XXL)	.82	725-A	5.50
5Y3GT	.42	7A7	.79	805	3.25
5A8	.88	7B8	.80	805	1.50
6B4	.75	7B5	.76	866-A	1.55
6B7	.98	7B7	.80	955	.35
6AC7	.77	7B8	.80	1613	.75
6AF4	1.40	7C5	.80	1616	.75
6AG5	.65	7C6	.69	1622(6L6M)	1.95
6AG7	1.20	7D7	.80	1625	.35
6AH6	.60	7E7	.69	1626	.22
6AJ5	1.30	7F8	1.35	1631	.70
6AK5	.70	7H7	.72	1632	.70
6AK5-W	.85	7H7	.90	2050	1.10
6AK6	.98	7Q7	.87	2051	1.10
6AL5	.50	7Y4	.76	5514	4.50
6AN5	2.25	7Z4	.76	5608-A	3.95
6AQ5	.60	12A6	.50	5654	2.00
6AQ6	.78	12A7	.65	5654	2.00
6AT6	.60	12A7	.76	CK-3744	2.25
6AUB	.59	12AU6	.62	CK-5886	2.95
6AV6	.50	12AV7	.62	CK-5886	2.95
6AX4GT	1.00	12AU6	1.35	5910	.75
6AX5GT	.70	12AV7	.85	8020	.98
6BA6	.50	12AX7	1.00	8022	.98
6RE6	.75	12BA6	.57	9004	.35
6CS5	.75	12BA6	.57	9006	.25
6RG6-G	1.35	12BE6	.57	9006	.25

**CBS-HYTRON CATHODE-RAY PICTURE TUBES**  
 First Quality in factory-sealed cartons. Full Year Warranty Card on each tube. Remember... no seconds; no reprints. Prices include Fed. Tax.  
 C.R. Tubes via Express Collect

71P4	18.75	16KP4	28.75	17HP4	25.50
10BP4A	21.00	16RP4	30.00	20CP4A	38.50
12LP4A	21.50	16TP4	30.00	21EP4A	38.95
14CP4	24.00	17BP4A	24.75	21FP4A	38.95
16AP4	31.00	17CP4	25.25	21FP4A	36.00

**SELENIUM RECTIFIERS Full-Wave Bridge Types**

Current (Continuous)	18/14 Volts	36/28 Volts	54/42 Volts	130/100 Volts
1 Amp.	\$1.35	\$2.15	\$3.70	\$7.50
2 Amps.	2.20	3.60	5.40	10.50
2 1/2 Amps.			6.00	13.00
4 Amps.	4.25	7.95	12.95	25.25
6 Amps.	4.75	9.00	13.50	33.00
10 Amps.	6.75	12.75	20.00	40.00
12 Amps.	8.50	16.25	25.50	45.00
20 Amps.	13.25	25.50	39.00	79.50
24 Amps.	16.25	32.50	45.00	90.00
30 Amps.	20.00	38.50		
36 Amps.	25.00	48.50		

• New, Selenium Rectifier Transformers  
 (PHI: 115 V., 60 cycles in.)  
 SEC: 9, 12, 18, 24, and 30 volts

4 Amps.	\$ 8.75
12 Amps.	16.75
24 Amps.	35.75
50 Amps.	59.75

• New Selenium Rectifier Chokes  
 4 Amps.—.07 hy.—6 ohm ..... \$7.95  
 12 Amps.—.01 hy.—1 ohm ..... \$14.95  
 24 Amps.—.004 hy.—.25 ohm ..... \$28.95  
 For other types of rectifiers, Xfms & Chokes—write.

• CARTER DYNAMOTORS  
 600 Volts out. @ 170 MA. from your 6 Volt battery.  
 Compact. Only \$28.00

Trimm. Model 100 "Featherweight" Headsets \$495  
 & Band. New, in orig. mfr.'s carton



136 Liberty Street, N.Y. 6, N.Y. Rector 2-2562  
 Terms: 25% with order, balance C.O.D.—Send a few cents for postage—All merchandise guaranteed, F.O.B. N.Y.C. "Please, minimum order \$20".

All Channel Antenna Corp.	10
Allied Radio Corp.	15
Aimo Radio Co.	87
American Electronics Co.	97
American Microphone Co.	87
American Phenolic Corp.	90, 91
American Television and Radio Co.	99
Amperite Co., Inc.	115
Amplifier Corporation of America	102
Arky Radio Kits, Inc.	113
Atlas Sound Corp.	101
Audel Publishers	112
Barrett Electronics Co.	120
Bary Electronics	22
Belden Manufacturing Co.	6, 109, 102
Bell Telephone Labs.	76
Bendix Radio	100
Blonder-Tongue Labs.	121
Brooks Radio and TV Corp.	65
Buchan Co. (Richard J.)	94
CBS-Hytron (Div. of Columbia Broadcasting System)	67
Cannon Electric Co.	103
Channel Master Corp.	20, 72
Centralab-Div. of Globe Union	74
Century Electronics Co.	113
Channel Engineering Institute	107
Claroat Manufacturing Co., Inc.	108
Cleveland Institute of Radio Electronics	80
Commissioned Electronics	106
Concord Radio	118
Cornish Wire Co.	115
Coyne Electrical and TV Radio School	63, 93
Crescent Radio	84
Crest Laboratories, Inc.	9
Davis Electronics	77
DeFord's Training, Inc.	114
Delco Radio Div. (General Motors Corp.)	107
Editors and Engineers	111
Edlie Electronic Corp.	101
Educational Electronic Enterprises	83
Electro Devices	14
Electro Products Labs.	111
Electro-Vision, Inc.	26, 98
Electronic Instrument Co., Inc.	118
Electronic Measurements Co.	88
Electronic Organ Arts, Inc.	106
Espey Manufacturing Co., Inc.	95
Fair Radio Sales	92
Federal Telephone and Radio Corp.	86
G and H Wood Products Co.	101
General Electric Co.	75
General Industries Co.	108
General Test Equipment	87
Greylock Electronic Supply Co.	116
Health Co.	115
Hughes Research and Development Labs.	110
Indiana Technical College	93
Instructograph Co.	97
International Correspondence Schools	112
Jensen Industries	121
Jones and Laughlin Steel Corp.	8
Kaolner and Co.	70, 71
Kedman Co.	110
Klein Industries, Manual	93
Lampkin Laboratories, Inc.	98
Lee Electronic Labs.	110
Leotone Radio Corp.	93
Littelfuse, Inc.	97
Mallory and Co., Inc., P. R.	Inside Back Cover
Manfred Electronics	112
McDonald, M. E.	12
McGraw-Hill Book Co.	121
Merit Coil and Transformer Co.	8
Moss Electronic Distributing Co.	70, 71
National Electronics of Cleveland	110
National Radio Institute	3
National Schools	98
Opportunity Aids	94
Oxford Electric Corp.	113
Perma-Power Co.	93
Philo Corp.	137
Phillips Tube Co.	97
Plastoid Corp.	66
Precision Development Corp.	82
Precision Apparatus Co., Inc.	110
Prentice-Hall, Inc.	96
Pre-Pipe Co.	88
Progressive Electronics	114
Queltrick Co.	25
RCA Institutes, Inc.	17
RCA Victor Division (Radio Corporation of America)	Inside Front Cover
Rad-Tel Tube Co.	Inside Back Cover
Radiart Corp.	69
Radio City Products	116

RADIO SCHOOL DIRECTORY

Candler System Co.	
Indiana Technical College	
Indianapolis Electronic School	
Milwaukee School of Engineering	
RCA Institutes	
Tri-State College	
Valparaiso Technical Institute	
Western Television Institute	
Radio-Television Training Assn.	23
Raytheon Manufacturing Co.	16, 94
Regency Div. (I.O.E.A., Inc.)	98
Relay Sales	120
Rice Industries, Ward E.	98
Rider, John F.	72, 112
Rinehart Books, Inc.	79, 97, 102
Rose Co.	101
Ryle Electronic Manufacturing Co.	101
Sams and Co., Howard W.	18, 108, 114
Sangamo Electr. Co.	84
Scala Radio Co.	80
Science-Fiction	88
Skyline Manufacturing Co.	96
Spraberry Academy of Radio	57
Stan-Burn Radio and Electronics Co.	116
Standard Transformer Corp.	82
Stephen Sales Co.	108
Steve-El Co.	117
Sylvania Electric Products	68, 73
TV Circuits Co.	92
TV Products Co.	118
Tab	122
Tallen Co., Inc.	121
Technical Appliance Co.	83
Tel-A-Ray Enterprises, Inc.	64
Telematic Industries, Inc.	96
Telesound Corp.	85
Television Communications Institute	109
Television Materials, Inc.	109
Transvision, Inc.	104, 105, 117
Trio Manufacturing Co.	81
United Technical Labs	92
Waldom Electronic Co.	106
Wholesale Radio Parts Co., Inc.	101
Wincharger Corp.	64
Windsor Electric Tube Co.	113
Zingo Products	97



RELAYS

Our stock of more than a million relays — in over a thousand different types — is the world's largest. Don't delay your production for want of large or small quantities of relays of any type.

Telephone, wire or write for quotations.

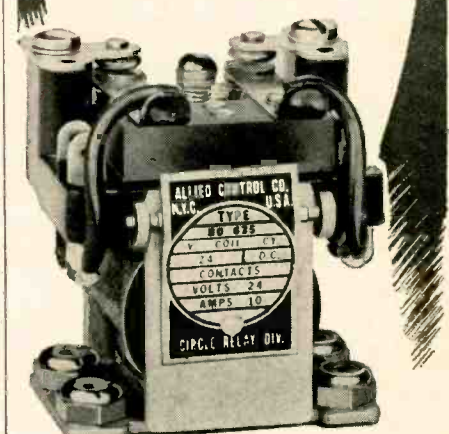

NEW AND MORE COMPREHENSIVE 1953 RELAY SALES CATALOG NOW READY  
 Be sure to send for your copy



Telephone SEeley 8-4146  
 833 W. CHICAGO AVE.  
 DEPT. 10, CHICAGO 22, ILL.  
 RADIO-ELECTRONICS



**NOW! BECOME EXPERT AT  
RADIO-TELEVISION  
IN 4 EASY STEPS!**

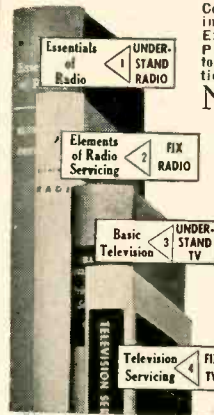

Complete Self-Training Library in RADIO and TV by Famous Experts—Takes You BY SIMPLE STEPS From Basic Theory to Problems of Repair, Installation, Color TV, etc.

Now you can do ANY Radio-TV installation, service, or repair job like an expert; operate field-testing equipment; understand problems of TV, FM-AM transmission, etc. Step into a good-paying job—or start your own service business. Train yourself AT HOME... IN SPARE TIME... with the McGraw-Hill Radio and Television Servicing Library.

2296 Pages—1611 Illustrations

The men who wrote this complete 4-volume Library are among the outstanding radio and TV instructors in America today. Every detail is clearly explained in over TWO THOUSAND PAGES of step-by-step instruction and over SIXTEEN HUNDRED "how-to-do-it" illustrations, cross-section diagrams, etc. The review questions and answers "nail down" everything you learn. At-a-glance "trouble-shooting" charts show how to diagnose instantly any radio or TV breakdown... and how to repair it expertly and quickly.

The Library will pay for itself many times over. It gives all you need to know for FM and TV in the FCC's 1st-class license exam; gives an experienced technician more confidence and skill.

**SEND NO MONEY**

Mail coupon below to examine complete four-volume Library FREE for 10 days. No obligation. Or you may examine individual books FREE for 10 days by checking the proper boxes in coupon.

**PARTIAL CONTENTS**  
**ESSENTIALS OF RADIO.**  
800 pages, 433 illus.  
Circuit Analysis • Vacuum Tubes • Circuits: Detector • Amplifier • Tube Oscillator • Power Supply • Transmitting, Receiving • Etc.  
**ELEMENTS OF RADIO SERVICING.**  
475 pages, 375 illus.  
Multimeters • AC Power Supply • Speakers • Antennas • Auto Radios • Push-Pull Output Stage  
**BASIC TELEVISION.**  
592 pages, 415 illus.  
Scanning • Synchronizing • Video Signal • Brightness Control • DC Reinsertion • Picture • FM Alignment • Picture Tubes • VHF and UHF transmission • Reception  
**TELEVISION SERVICING.**  
429 pages, 388 illus.  
Antennas • Transmission Lines • Test-pattern and Picture Analysis • Localizing Reception Troubles • Interference Remedies • Deflection Circuits... AND MUCH MORE!

**FREE 10-DAY TRIAL COUPON**

McGraw-Hill Book Co., Inc., Dept. RE-6  
327 West 41st St., New York 36, N. Y.

Send me for 10 day free examination the Radio and TV Servicing Library, 4 Vols. (Regular retail price is \$26.75; Special Course Price only \$21.95 in easy installments.) If not satisfied with Course, I will return it, pay nothing. Otherwise, I'll send \$1.95 plus delivery charges then and only \$4.00 monthly for 5 months.

If you wish to examine any of these books individually, check below the ones you wish us to send you for 10 Days' FREE EXAMINATION:

- Essentials of Radio, \$7.50
- Elements of Radio Servicing, \$5.25
- Basic Television, \$7.50
- Television Servicing, \$6.50

For any book I keep, I'll send \$2.00 plus delivery charges in 10 days, balance in easy monthly installments.

Name.....

Address.....

City..... Zone..... State.....

Employed by..... RE-6

WE PAY FOR DELIVERY if you send first payment of \$1.95 when ordering Library or full price when ordering individual books (prices above). Same return privilege. (This offer applies to U.S. only.)

**FOR VHF UHF TV INSTALLATIONS**

LOW LOSS 300 OHM

**"LL300"**

OPEN WIRE LINE  
PATENT APPLIED FOR

**... 300 OHMS IMPEDANCE**

Correct size wire and spacing results in 300 ohms characteristic impedance.

**... PERFECT IMPEDANCE MATCH**

This means maximum signal transfer from the antenna to set.

**... 1/12 THE RADIATION LOSS**

1/4 the spacing means 1/12 the radiation loss of 450 ohms open wire lines.

**... EXTREMELY LOW LOSS**

Air dielectric plus clear polystyrene spacers results in the lowest possible loss of signal.

**... LESS NOISE PICKUP**

Perfect impedance match eliminates standing waves—this plus close spacing results in the lowest possible noise pickup.

**... EASILY INSTALLED**

Uses conventional stand-offs—no special hardware needed. Enters home through 1/2" hole.

**... EXTREMELY LONG LIFE**

No. 18 copperweld conductors, polystyrene spacers combined with very low wind resistance means virtually indefinite life.

**... HIGH MECHANICAL STRENGTH**

Copperweld construction plus light weight and low wind resistance make 200' unsupported spans possible.

**... EASY TO USE SPOOLS**

Packaged on 100, 150, 200, 250' convenient, easy to use spools.

All the above features mean: BETTER RECEPTION—LONG LIFE—EASE OF INSTALLATION PLUS LOW COST when you use LL-300 OPEN WIRE. Order through your Jobbers or write for free circular.

R. J. BUCHAN CO. BRICELYN 2, MINN.

**RADIO SPECTRUM CONSERVATION, A Report of the Joint Technical Advisory Committee of the IRE and RTMA.** Published by McGraw-Hill Book Co., Inc., New York, N. Y. 5 1/2 x 8 inches, 221 pages. Price \$5.00.

Radio channel assignments are as important to the general public as traffic control is to a large city. Whether you run a ham shack, watch TV, listen to the radio, send radiograms, rely on navigation and aircraft safety signals, or utilize diathermy, you need intelligent allocation that permits a maximum of services with minimum interference. This report covers past allocations, offers a critique of present assignments, and presents an ideal plan for the future.

Aside from material pertaining directly to allocations, the volume also contains an excellent exposition of propagation characteristics. Almost 100 pages are devoted to this subject. It discusses such topics as receiver and atmospheric noise, maximum usable frequencies, skip distance, mechanism of propagation, and effects of rain. Hams, engineers, and the general public will find interesting and important data here.

An extensive bibliography is provided.—IQ

**STORAGE TUBES AND THEIR BASIC PRINCIPLES,** by Max Knoll and Benjamin Kazan. Published by John Wiley & Sons, Inc., 440 Fourth Ave., New York 16, N. Y. 6 x 9 inches, 143 pages. Price \$3.00.

This is the first book on a new and important field: charge-controlled storage tubes. These are used in TV, radar, computing, and communications.

The first part describes generation of potentials under the action of light or electron bombardment. This is followed by a chapter on "writing" (establishing a charge pattern) and "reading" (interpreting the pattern). Succeeding chapters describe the principles of various conversion tubes: electrical-electrical; electrical-visual; visual-electrical. A bibliography completes the volume.—IQ. END



"That reminds me—our television set needs fixing."

**WANTED**

**WE NEED YOUR SURPLUS ELECTRONIC EQUIPMENT**

**WE PAY TOP \$\$\$ FOR:**

- ★ RADIO RECEIVERS
- ★ TRANSMITTERS
- ★ ARC-1
- ★ ARC-3
- ★ ART-13
- ★ CONTROL BOXES
- ★ INDICATORS
- ★ CLAMPS
- ★ PLUGS
- ★ CORDS
- ★ RELAYS
- ★ TELEPHONE MATERIALS
- ★ AN CONNECTORS
- ★ WE BUY ANYTHING!

Write, Wire today! Tell us what you have.

TALLEN CO., Inc., Dept. RE  
159 Carlton Ave., Brooklyn 5, N. Y.



SOCKET ASSEMBLIES
PILOT LIGHT SOCKET, Bayonet with 1/2" jewel. As shown, 5 for \$1.25

RELAY BARGAINS
SP5T mini size 115VAC 3A cts. . . . .98c; 3 for \$2.75

TOGGLE SWITCHES
SP5T GE 3A/250V . . . . .29c; 4 for \$1.18

CIRCUIT BREAKER FUSES
Amps 5-7-10-15-20
Sq. Ed. 27c; 4 for \$4.00.

CHEST SET & MIKE
Navy Type Xtal Mike \$3.98
RCA Head & Chest Set, Sound

12FD ANTENNA RESISTOR
For 12FD Antenna CQ Elm 53, Globar-Non-Inductive "RP" 400 Ohm Resistor & Mtg Clips

100 WATT SEC PHOTOFLASH KIT
Includes 1X Flash Lamp Rated 150 Watt. Sec. Flash Lamp Holder & Reflector & Cable

PHOTOFLASH CONDENSERS
100MFD/500VDC . . . . . \$1.98
200MFD/450VDC . . . . . 2.89

TAB "SUN-FLASH" LAMPS
"Tab" W-5cc.
USW No. 100 1.00 \$8.69

STORAGE BATTERIES
36 Volt WILLIAMS NEW: 5 oz.
Designed Portable Equip. Models: 98c; 4 for \$3.50

SOLDERING GUNS AND IRONS
"Weller" 115VAC/100 Watt.
"Wen" 115VAC/250 W \$9.49, 3 for 25.50

TEST CORDS
Precision Feeler Gauge TL147 Ideal Setting. Cont. Pts.
Removable Gauges .012, .018, .025, .035, .037, .055

TAB THAT'S A BUY

OIL CONDENSERS WAREHOUSE CLEARANCE SALE

RECTANGULAR CASE
5MFD 1500VDC . . . . .95c; 2 for \$1.50
2MFD 1000VDC . . . . .75c; 4 for 1.95

POWER TRANSFORMERS
2500V for Crt 6.3V/.6A.
2.5V/1.75A cnd Hvlins
1.6A/12 replmt. . . . . \$7.98

FILTER CHOKES
12Hy/80ma/H'sid/3Kvins 2.25
10Hy/125ma/UTC/Csd/
H'sid/1Kvins . . . . . 1.49

FILAMENT TRANS.
2.5V/2A @ 79c; 2 for \$1.49, 10 for \$6.49
2.5VCT/10A 5KVINS 3.59

TOOL KIT
High Quality Forged, Tempered Tool Steel, 6 1/2" Adj. Wrench, 5 1/2" Long Nose Pliers, 3 1/4" Cutters, With Carry Case \$22.95

TUBES
0A2 . . . . .95
0A3/Vr75 . . . . .1.37
0B3/Vr90 . . . . .1.09

RECYCLED TUBES
0A2 . . . . .95
0A3/Vr75 . . . . .1.37
0B3/Vr90 . . . . .1.09

DC POWER SUPPLY
0 to 12 VDC/2 Amp. Variable DC supply. 115VAC, 1.00 cased and completely built-inpt. 115V/60 cy. Usable LAB supply. Element D. C. plating, battery charging, model railroad, includes voltage speed control and center of reversing sw. Ideal for two "HO" locomotives. . . . . \$10.95 2 for \$20.00

FEDERAL RECTIFIER KIT
"Federal" All Purpose Selenium Rectifier Kit. You can make 24 different Rectifiers 1/2 Wave/FW/CT or Bridge. 8 Plates Rated 18V/12Amp each. All Hardware & Tools. . . . . \$19.59

SELENIUM RECTIFIERS
We specialize in Rectifiers. Power supplies to specifications. Immediate delivery.
Current 18/14 36/28 54/40 180/100 (cont. Volts Volts Volts)

RECTIFIER XFMRs
18-12-0-CT-9-12-18V/4amp. . . . . \$8.75
18-12-0-CT-9-12-18V/2amp. . . . . 16.85

BATTERY CHARGER RECTIFIER
10-0-10V (CT) 100 Amp., fan cooled. Replace your old inefficient sulfide rectifier w/new selenium type. SILENT. . . . . \$11.98

866A KIT and XFORMER
2 Tubes, Sects. xmfr., 115V60cy Inpt, output 2.5vct/10A. . . . . \$4.98

TELEVISION COMPONENT BUYS
Horiz Def Output & Hvlouts xmfr. SIM RCA 21T5, for 12" picture tubes. \$1.98

RHEOSTATS
Check these newly reduced prices
6 ohm 25W Model JH . . . . . 1.49; 2 for 2.49

TABOGRAM
WRITE FOR IT
WE STOCK LARGE VARIETY OF COMPONENTS. TELL US YOUR NEEDS. SELL US YOUR TUBES & EQUIPMENT.

\*From This Special List We Ship \$10.00 and Up Tube Orders At Our Expense (Post-paid) Within Continental Limits of U.S.A. 90 Day Gtd. When Ordering Mention 6RE

Table listing various electronic components and their prices, including tubes, capacitors, and resistors.

ELECTROLYTIC CONDENSERS
50mf/350vdc 1.00
30-15-10mf/250vdc . . . . . 5 for 1.00

INFRARED SNOOPERSCOPE
Image-Converter Tube Hensitivity simplified design 2" dia. Willemitte screen-data & tube, ea. . . . . \$4.98; 2 for \$9.49

AUDIO COMPONENTS
GE RPX041 Phono Cart. . . . . \$4.49
12" ER5041 Triple Ply Cart 5.69

ULTRA FIDELITY AUDIO
PHILMORE 20-3000CY HI-FI 20W Kit. Complete Ready to Build. Incd Pre Amp & Cabinet. 12" ER5041 Triple Ply Cart. \$51.00

AUDIO AMPLIFIERS READY TO GO
Model 305MP 5 Watt Ampl. as Pictured Above. Features Mike & Phono Input. 15" Speaker. 4" Woofer. Latest Compensated Tone Control. Detachable 12" Phono Tube. . . . . \$14.98

RM29 REMOTE CONTROL
Can be used as field phone of control of transmitter from a distant point. 15 mfd. 3 wire operation, good for TV antenna installation. New . . . . . \$10.95

RM53
Remote control of transmitter or intercom. Less Relay, Switch, & Sigs. Includes trans. mike to grid, line to line, line to grid. In metal box approx. 7x4x2. . . . . \$4.98

CHROME VANADIUM SPEED DRILLS
SPEED STEEL Top Quality for Machinists for all purpose use. Standard Full Length 1/16" to 3/4" diam. With Hilt. . . . . \$9.69

TELEVISION ANTENNA
TV CONICAL ANTENNA All Channel, Sturdy. Includes 8 elements & 100 ft. Twines. \$9.25

FL5 FILTER & BAND PASS XFMR
Range or Voice, Filters 1020cy Audio. Exc for CW Work. . . . . \$9c; 2 for \$1.00

KITS AND COMPONENTS
SILVER MIC COND. 50 ohm to 2 Meg. . . . . 10 for 2.50

REDUCED METER SPECIALS
0-5 MA DC Tuning Meter . . . . . \$1.79
0-30VDC "AN" Type for 2.49

MONEY BACK GUARANTEE
Money Back Guarantee (Cost of Mfg. Only) \$5 Min. Order F.O.B. N.Y.C. Add Shpg. Charges & 25% Dep. Tubes Gtd. via R-Exp. only. Prices subject to Change Without Notice. Phone Rector 2-6245.

RADIO-ELECTRONICS
PRINTED IN THE U. S. A. BY THE CUNEO PRESS, INC.

THAT'S TAB THAT'S A BUY
DEPT. 6RE 111 LIBERTY STREET NEW YORK 6, N. Y. U.S.A.

www.americanradiohistory.com



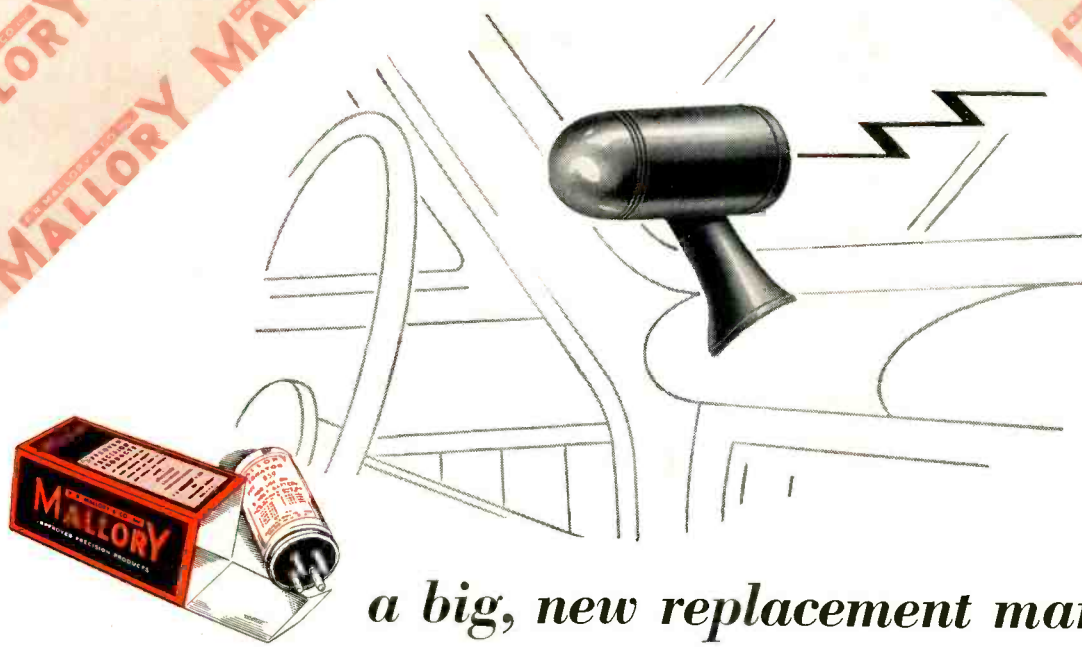

*a big, new replacement market for*  
**Mallory Vibrators... ELECTRONIC HEADLIGHT DIMMERS**

**THE MARKET** Already, over a hundred thousand new automobiles are equipped with automatic, electronic headlight dimmers. By the end of the year this figure will be multiplied several times . . . and the first of them are beginning to need service.

**THE OPPORTUNITY** This can be big business for you . . . business that may grow even larger than automobile radio service. But, if you are to get full benefit of this new market, automotive shops must be told that these are *electronic devices . . . devices that should be serviced by qualified radio service men*. Explain it, now, to every car dealer and shop for which you do service work.

**THE PRECISION PARTS** Automatic headlight dimmers depend on a vibrator power supply unit. When it is time for vibrator replacement, you can be sure the job is right if you use Mallory. As in the case of automobile radios, Mallory worked closely with the manufacturer and played an important part in this new development by supplying the first original equipment vibrators. With just three Mallory Vibrators you can service any unit now on the market.

P. R. MALLORY & CO. Inc.  
**MALLORY**

CAPACITORS • CONTROLS • VIBRATORS • SWITCHES • RESISTORS  
RECTIFIERS • POWER SUPPLIES • FILTERS • MERCURY BATTERIES

**APPROVED PRECISION PRODUCTS**

**P. R. MALLORY & CO., Inc., INDIANAPOLIS 6, INDIANA**

*Depend on Mallory  
for  
Approved Precision Quality*



# How's your

# "welcome" rating?

**Y**OU can measure *your* "welcome rating" on the basis of how many times you have to visit a customer to satisfactorily complete one service call. The *less frequently* you are called back, the *more* your good services are appreciated. Fewer call-backs cut overhead . . . build confidence . . . leave you *more* time for *more* satisfied customers. Cutting call-backs is the most effective way of snowballing your profits.

The RCA trade-mark makes your call doubly effective. First, because customers have confidence in products bearing the RCA trade-mark. Second, because experience has proven that the superior quality of RCA Receiving Tubes and Kinescopes is your best measure of protection against costly call-backs due to premature tube failures. You can be sure that, with RCA Tubes, the job is well done.

Helping you to safeguard your reputation is a vital, everyday service of RCA Tubes. And that protection is yours at no extra cost.

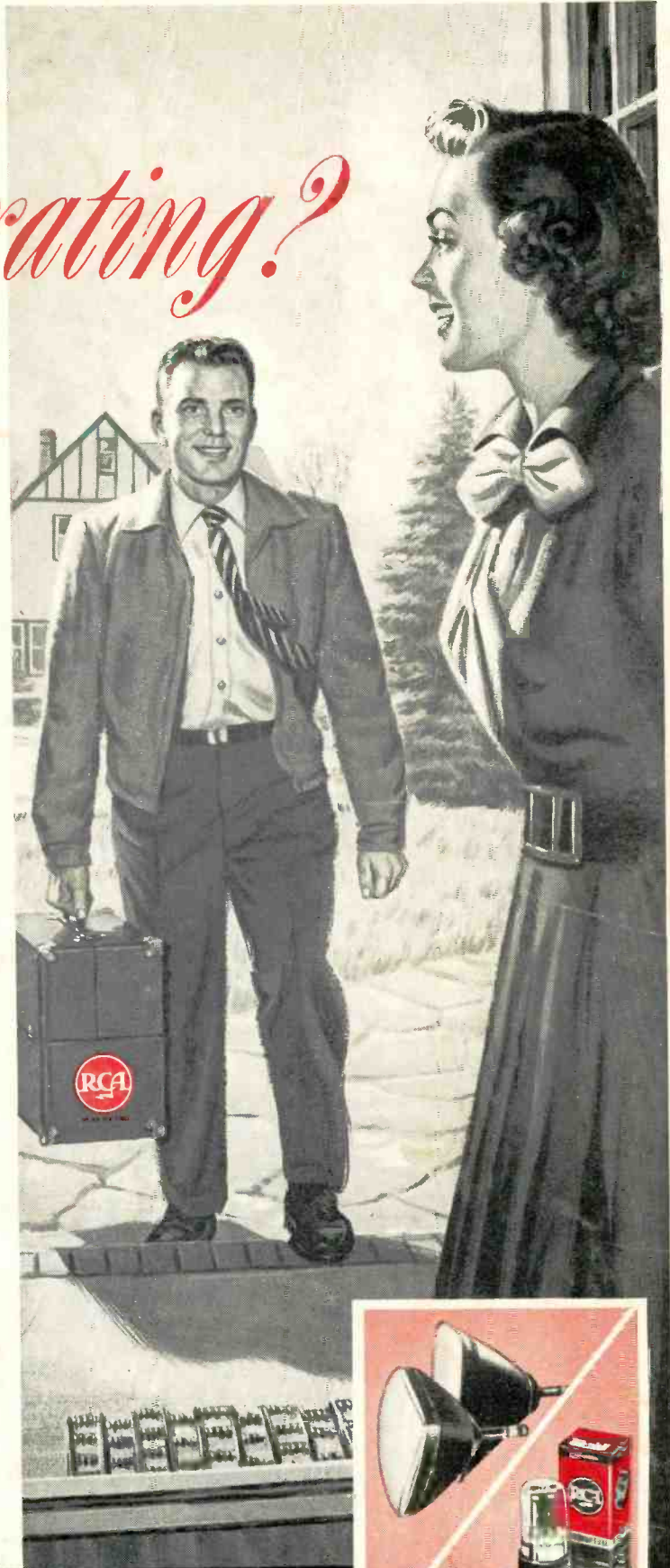

Unlock the  
door to  
bigger profits

Here's *your* key to better business . . . RCA's dynamic Dealer Identification Program. Ask your **RCA Tube Distributor** for your copy of the colorful, 16-page booklet "A Magic Pass-Key to Customer Confidence." It tells you how—for the first time—you can become a Registered Dealer . . . and get *extra* sales benefits.



**RADIO CORPORATION of AMERICA**  
ELECTRON TUBES  
HARRISON, N. J.