

# RADIO - ELECTRONICS

NOVEMBER 1952

LATEST IN TELEVISION • SERVICING • AUDIO



HUGO GERNSBACH, Editor

**TRANSISTOR-OPERATED  
SAWTOOTH OSCILLATOR**

See page 4

30¢

U. S. and  
CANADA

**In this issue: Calibrating Audio  
Bridges in Speech Circ**

EDW C BERGER 11-54  
434 OCEAN AVE  
JERSEY CITY, N J

's



**NOW...**

*Quality Matched*

**TV REPLACEMENTS BY**

**DU MONT**

**COMPLETE INFORMATION  
ON  
REQUEST**

**REPLACEMENT SALES**

Cathode-ray Tube Division  
Allen B. Du Mont  
Laboratories, Inc.  
Clifton, New Jersey

**DEFLECTION YOKE ...**

Type Y2A1 with distributed winding provides edge-to-edge focus. Built to withstand conditions of high temperature and humidity. Short overall length.



**FLYBACK TRANSFORMER**

Type H1A1 - with universal mounting bracket. Mount it on its side or bottom. "Matched" for use with the Type Y2A1 Deflection Yoke. Ferrite core insures high efficiency.

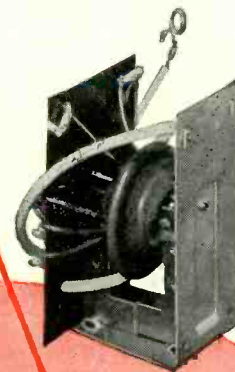

**WIDTH AND LINEARITY COILS ...**

For use with H1A1 and Y2A1 and complete the "universal" deflection system. Designed to withstand heavy pulses required to sweep wide angle picture tubes. Utilize adjustable iron cores.



**ORIGINAL TELEVISION PARTS ...**

A complete line of replacement television parts incorporated in Du Mont Telesets. Ask your local distributor for cross-reference literature, or write. Look for the package with "original television part," your only guarantee of fitness.

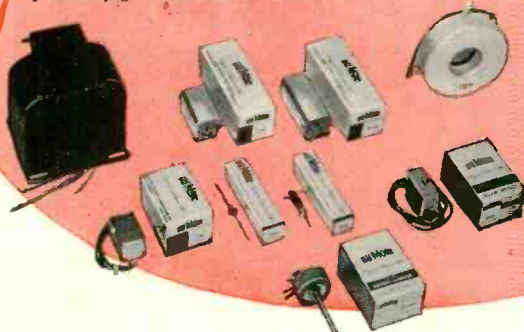

**TELETRONS ...**

Quality standard of the industry. Electromagnetic, low-voltage electrostatic focus, and exclusive Selfocus. Complete line of popular sizes.





# TRAIN

# for Security! Good-Paying Jobs!

## MAKE THE MONEY YOU'VE ALWAYS DREAMED OF!



# LEARN RADIO -TELEVISION

## AND ELECTRONICS BY EASY SHOP METHOD TRAINING AT HOME!

**You get all the parts—even tubes!—** for this modern Superheterodyne Receiver. You learn to build it step by step. And you keep it! Get all the facts. Mail coupon now.

Let **NATIONAL SCHOOLS**—a resident-training school for nearly 50 years—train you at home for today's unlimited opportunities in Radio-Television-Electronics. National Schools is one of the largest schools of its kind. It is located in Los Angeles—the center of Radio and TV world! It has four large buildings of modern shops and labs. Its faculty is considered tops in the business.



You learn from lessons prepared by experienced instructors and engineers. Men who are successful Radio and Television technicians. Men who have trained 100's of men like YOU!



### FREE BOOK TELLS YOU HOW!

Page after page—in color—tells you everything you want to know. Mail the coupon. Get this valuable book today. And if you hurry—YOU GET A FREE SAMPLE LESSON, TOO! Shows how easy National Schools Home Training is. Mail the coupon today.

### You Train At Home—In Your Spare Time

National Schools Shop Method Home Training gives you basic and advanced instruction in all phases of Radio-TV-Electronics. And remember—your training is based on resident school training principles. You learn *fast*: from hundreds of diagrams and pictures. All instructions are written by experienced technicians who work in Radio and TV every day. All instructions have been developed and tested in National Schools' own labs and studios, which are equipped with the latest RCA equipment. No wonder this National Schools course is so up-to-date, practical, interesting. And so easy to learn! And no wonder it is held in such high regard by leaders of American industry! Approved for eligible Veterans.

### We Teach You How To Make Welcome Extra Money—While You Learn!

Many National Schools students—men like you—make plenty of extra dollars each week in spare time! Fixing neighbors' radios, appliances—and other ways we teach you. You start learning and earning from the day you enroll. From the very first lesson!

### WE SEND YOU LOTS OF PARTS LIKE THIS!

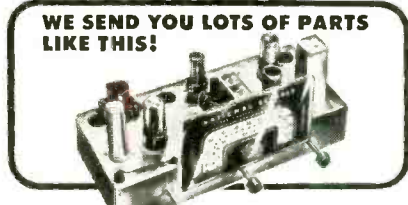

With National Schools Shop Method Home Training, you get basic principles and plenty of practical training. You learn by doing. No wonder you learn so fast! We send you many parts—all of professional, modern quality. You do lots of practical experiments. You advance day by day, step by step. Until you can even build the modern Superheterodyne Receiver you see above—plus other important testing units. The free book tells you all about it. The free sample lesson shows how easy the training is. Use the coupon. Send today—without fail!

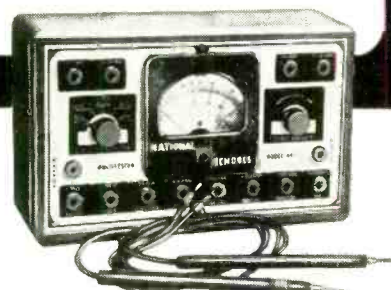

### Only National Schools Gives You This Professional Multi-Tester!

You get this amazing, new testing instrument—factory-made and tested—complete—ready to use! Simple to operate. Accurate and dependable. An instrument every Radio-TV man needs. Light enough to carry around—so you can use it at home or on service calls. You'll be proud to own this valuable equipment.

Here are only a few of the Good-Paying Jobs You Can Choose  
Radio Station Engineer, District Service Manager, Aircraft Radio Inspector, Own Your Own Repair Shop, Inspector Technician, Service Specialist, Special Government Jobs, Complete TV Service, Sound Truck Operator. Many more!  
National Schools graduates have secure, good-paying jobs like these! So don't wait—mail the coupon today. Now—while you're thinking about it!

### Attention! Men Going into Service Soon!

National Schools' course quickly prepares you for many important jobs in the Armed Services. With National Schools Training you have an opportunity to get into special service classifications—with higher pay and grade—immediately!

**FREE SERVICE FOR GRADUATES**  
National Schools uses its great influence and prestige to help you find your place in the field of your choice. Don't put it off! Start yourself toward a skilled trade! Get the big pay you've always wanted!

## NATIONAL SCHOOLS

LOS ANGELES 37, CALIFORNIA • ESTABLISHED 1905  
In Canada: 194 E. Hastings St. Vancouver, B. C.

### Today's Shortage of Trained Technicians Creates Chance of a Lifetime For You!

Think of it! With guided missiles, radar, and other electronic devices so important to national defense! With big, new developments in TV. With over 90,000,000 home and auto radios, over 12,000,000 TV sets. With more than 3100 radio stations...over 100 TV stations—and more building every day...yes, imagine the great opportunity you have today!  
YOU are wanted in Radio-Television-Electronics! America's fastest-growing field. High-pay jobs—the kind you've always wanted—are waiting for YOU!

### Job Security! Big Money! For YOU! in Today's Expanding Industries!

Trained Radio and Television technicians really make important money these days. Thousands of National Schools graduates—men just like you—are earning good money all over the country. Why not you? And—National Schools graduates get the personal satisfaction of being highly-skilled technicians. Men people respect. Men who enjoy their work—rather than having to drag along in just any old job.

### National Schools Has Trained 1000's of Successful Men! Why Not YOU?

In almost every state—and many foreign countries—National Schools graduates are filling big jobs with famous companies. Or running their own successful businesses. What are YOU waiting for? National Schools training is complete training. So when you graduate you can take advantage of today's big opportunities in Radio-Television-Electronics—fast.

**DON'T PUT IT OFF! GET THE BIG SALARY YOU HAVE ALWAYS WANTED!**

### MAIL THIS COUPON TODAY—WITHOUT FAIL!

NATIONAL SCHOOLS, Dept. RG-112  
4000 South Figueroa Street  
Los Angeles 37, California

Mail in envelope or paste on penny post card.

Mail me FREE the book mentioned in this ad. Also a free sample lesson. I understand no salesman will call on me.

NAME \_\_\_\_\_ AGE \_\_\_\_\_

ADDRESS \_\_\_\_\_

CITY \_\_\_\_\_ ZONE \_\_\_\_\_ STATE \_\_\_\_\_

Check here if you were released from the Service less than 4 years ago.

RADIO-ELECTRONICS is published monthly by Gernsback Publications, Inc., at Erie Ave., F to G Streets, Philadelphia 32, Pa. Entered as second class matter September 27, 1948 at the Post Office at Philadelphia, Pa., under the Act of March 3, 1879. Copyright 1952 by Gernsback Publications, Inc. Text and illustrations must not be reproduced without permission of copyright owners.  
POSTMASTER: If undeliverable send form 3578 to: RADIO-ELECTRONICS, 25 West Broadway, New York 7, N. Y.

# RADIO - ELECTRONICS

Formerly RADIO-CRAFT • Incorporating SHORT WAVE CRAFT • TELEVISION NEWS • RADIO & TELEVISION\*

Hugo Gernsback  
Editor-in-Chief

M. Harvey Gernsback  
Editorial Director

Fred Shunaman  
Managing Editor

Robert F. Scott  
W2PWG, Technical Editor

Mortimer Bernstein  
Associate Editor

I. Queen  
Editorial Associate

Matthew Mandl  
Television Consultant

Angie Pascale  
Production Manager

Wm. Lyon McLaughlin  
Tech. Illustration Director

Sol Ehrlich  
Art Director

Lee Robinson  
General Manager

John J. Lamson  
Sales Manager

G. Aliqua  
Circulation Manager

Robert Fallath  
Promotion Manager



**ON THE COVER** (See page 50)  
The transistor sawtooth oscillator which was developed by Dr. H. Gunther Rudenberg for Raytheon. The transistor is behind the magnifying glass and its output is delineated on the cathode-ray scope screen.

Color original courtesy of Raytheon Mfg. Co.



MEMBER Audit Bureau of Circulations

NOVEMBER 1952

## CONTENTS

<b>Cover Feature</b> .....	50
<b>Editorial (Page 29)</b>	
Magnetic Tape TV Recording .....	29
<b>Audio (Pages 30-41)</b>	
Calibrating Audio Oscillators .....	30
Loudspeaker Network Inductors .....	32
Short Circuits .....	34
Check Audio Response with a Neon Glow Tube .....	36
Phono Oscillator for FM and Split-Sound TV Sets .....	37
Tape Recording, Part IV .....	38
<b>Television (Pages 42-48)</b>	
TV Service Clinic .....	42
TV Signal-Traces TV's .....	44
TV Service Notes .....	46
Antenna Balancing Unit .....	48
TV DX Reports .....	48
<b>Electronics (Pages 49-51)</b>	
Relaxacisar .....	49
Transistor Sawtooth Oscillator (Cover Story) .....	50
<b>Servicing—Test Instruments (Pages 52-57)</b>	
Telepacket .....	52
Antenna Lesson .....	53
Navel Beat Frequency Oscillator .....	54
How to Lick a Serious Problem .....	57
Unexpected Solution to Service Puzzler .....	57
<b>Construction (Pages 58-60)</b>	
Flip-Flap Counter .....	58
<b>Theory and Engineering (Pages 72-76)</b>	
You Can Understand Reactance! .....	72
<b>Broadcasting and Communications (Pages 78-88)</b>	
Bridges in Speech Circuits .....	78
Simplified Remote Control for Transmitter .....	86
<b>New Design (Pages 92-100)</b>	
Screen Metal Chassis for Fast Test Setups .....	92
New Tubes .....	94
<b>Departments</b>	
The Radio Month .....	8
Radio Business .....	14
With the Technician .....	102
New Devices .....	106
New Patents .....	109
Radio-Electronic Circuits .....	114
Try This One .....	118
Question Box .....	122
People .....	128
Technotes .....	126
Miscellany .....	130
Communications .....	132
Electronic Literature .....	134
Book Reviews .....	136

**EXECUTIVE, EDITORIAL and ADVERTISING OFFICES:** 25 West Broadway, New York 7, N. Y. Telephone REctor 2-8630. Gernsback Publications, Inc.: Hugo Gernsback, President; M. Harvey Gernsback, Vice-President; G. Aliqua, Secretary.

**SUBSCRIPTIONS:** Address Correspondence to Radio-Electronics, Subscription Dept., Erie Avenue, F to G Sts., Philadelphia 32, Pa., or 25 West Broadway, New York 7, N. Y. When ordering a change please furnish an address stencil impression from a recent wrapper. Allow one month for change of address.

**SUBSCRIPTION RATES:** In U. S. and Canada, In U. S. possessions, Mexico, South and Central American countries, \$3.50 for one year; \$6.00 for two years; \$8.00 for three years; single copies 30¢. All other foreign countries \$4.50 a year, \$8.00 for two years; \$11.00 for three years.

**BRANCH ADVERTISING OFFICES:** Chicago: 100 E. Ohio St., Tel. Superior 7-1796. Los Angeles: Ralph W. Harker, 1127 Wilshire Blvd., Tel. Madison 6-1271. San Francisco: Ralph W. Harker, 582 Market St., Tel. GARfield 1-2481. **FOREIGN AGENTS:** Great Britain: Atlas Publishing and Distributing Co., Ltd., London E.C.4. Australia: McGill's Agency, Melbourne. France: Brentano's, Paris 2e. Holland: Trillectron, Heemstede, Greece: International Book & News Agency, Athens. So. Africa: Central News Agency, Ltd., Johannesburg; Capetown; Durban, Natal. Universal Book Agency, Johannesburg. Middle East: Steimatzky Middle East Agency, Jerusalem. India: Broadway News Centre, Dadar, Bombay #14. K. L. Kannappa Mudaliar, Madras 2. Pakistan: Paradise Book Stall, Karachi 3. \*Trademark registered U.S. Patent Office.

RADIO-ELECTRONICS



# Where Are You Heading in TV-ELECTRONICS

*and how soon will you get there?*



Free CREI booklet lists opportunities  
and shows how to grasp them

**D**O YOU HAVE a career time-table? Do you know how much you should or could be earning two years from now? Five years? Many men are plodders without a plan. They wander through life never doing what they want to do, never receiving enough pay, never achieving true career satisfaction. Because they never knew ahead of time where they should or could be at a given date, they never planned ahead. When an opening arises, somebody else is promoted. When January 1st rolls around, they're just where they were a year before. Their *error*, failure to plan, can be the lesson which shows you the *secret* of future success. In this expanding, bustling TV-Electronics world, there is a whole lifetime of happiness and high earnings waiting for you, if you name your goals, and take steps to reach them. Thousands of ambitious young men have found success in TV-Electronics through the aid of the CREI booklet, "Your Future in the New World of Electronics." The newest edition tells of electronics' golden opportunities. 110 TV stations are now on the air. 2,000 more are made possible by the recent freeze lifting. There are over 18,300,000 TV sets and over 100 million radios in use.

This is the era of Communication: aeronautical, marine, police and fire, industrial, land transportation communications; this is the era of defense orders and a manufacturing industry which last year alone sold 3.8 billion dollars worth of electronic equipment, and is expected to do no less than 10 billion dollars worth excluding military orders. All these developments mean positions; in development, research, design, production, testing, inspection, manufacture, broadcasting, telecasting and servicing. Who will get these positions? You—if you have a career time-table; if you can foresee your future in electronics; if you are willing to advance your knowledge; if you spend 2 minutes to write for your copy of "Your Future In the New World of Electronics," and follow the plan it describes.

This is the booklet that shows you how CREI home study leads the way to greater earnings. However, being an accredited technical school, CREI promises you no short-cuts. You must translate your willingness to learn into salable technical knowledge via study. CREI knows what it means to grow along with a booming industry. This year CREI is celebrating its 25th Anniversary, having started in 1927 in the early days of radio. Since then CREI has provided thousands of professional radiomen with technical educations. During World War II, CREI trained thousands for the Armed Services. Leading firms use CREI courses for group training in electronics at company expense; among them are United Air Lines, Canadian Broadcasting Cor-

poration, Trans-Canada Airlines, Sears Roebuck & Co., Bendix Products Division, All-American Cables and Radio, Inc., RCA-Victor Division and Machlett Laboratories. CREI courses, prepared by recognized experts, are constantly revised to keep them up-to-date. Student work is under the personal supervision of a CREI Staff Instructor who knows and teaches what industry needs.

You choose your own hours when you study at home. Upon completion you join the many CREI graduates who have found their diplomas keys-to-success in Radio, TV and Electronics. CREI alumni hold many top positions in America's leading firms.

At your service is the CREI Placement Bureau which helps find positions for students and graduates. Although CREI does not guarantee jobs, the bureau now has many more requests for personnel than can be filled. Talk to men in the field and check up on CREI's high standing in electronics instruction. Determine for yourself right now that your earnings are going to rise with your knowledge—and that you will rise with this booming industry. All this CREI offers you, provided you sincerely want to learn. Fill out the coupon and mail it today. We'll promptly send you your free copy of "Your Future in the New World of Electronics." The rest—your future—is up to you.

CREI resident instruction (day or night) is offered in Washington, D. C. New classes start once a month. **VETERANS:** If you were discharged after June 27, 1950—check the coupon for full information about the new G.I. Bill of Rights.

## MAIL COUPON FOR FREE BOOKLET

**CAPITOL RADIO ENGINEERING INSTITUTE**  
Dept. 1411D 3224 16th St., N.W., Washington 10, D. C.  
Send booklet "Your Future in the New World of Electronics" and course outline.  
CHECK FIELD OF GREATEST INTEREST )  TV, FM & Advanced AM Servicing  Aeronautical Radio Engineering  
 Practical Television Engineering  
 Broadcast Radio Engineering (AM, FM, TV)  
 Practical Radio Engineering  
Name.....  
Street.....  
City..... Zone..... State.....  
If residence school in Wash., D. C. preferred, check here



**GIVE YOUR BUSINESS A LIFT...**

**with the**

**RAYTHEON Bonded Electronic Technician Program !**

The above seal means a good deal to every Service Dealer who can display it. Thanks to Raytheon's national magazine and radio advertising, the public accepts this seal as the mark of a capable, reliable thoroughly honest Service shop — a shop whose technical ability, business ethics and *Bond* are above reproach.

Once a Service Dealer gains this consumer confidence he has cleared the biggest hurdle in the race for more volume and profit.

And here's the best part of all. If you can qualify as a Raytheon Bonded Electronic Technician, this priceless sales stimulator *is yours without cost*.

Raytheon has financed this program for over six years as their investment in your future.

Better contact your Raytheon Tube Distributor today, and see if you can qualify for this exclusive sales advantage.



RIGHT... FOR SOUND AND SIGHT®



**RAYTHEON MANUFACTURING COMPANY**

Receiving Tube Division

Newton, Mass., Chicago, Ill., Atlanta, Ga., Los Angeles, Calif.

*Excellence in Electronics*

RAYTHEON MAKES ALL THESE:

RECEIVING AND PICTURE TUBES • RELIABLE SUBMINIATURE AND MINIATURE TUBES • GERMANIUM DIODES AND TRANSISTORS • NUCLEONIC TUBES • MICROWAVE TUBES

RADIO-ELECTRONICS



**NOW...get EVERYTHING YOU NEED to help you EARN while you LEARN**

# TELEVISION

**RADIO - ELECTRONICS**

THOUSANDS of successful graduates PROVE that here is one of today's most **EFFECTIVE WAYS** to master Television

- (1) at HOME . . . or
- (2) in one of nation's finest TV training laboratories

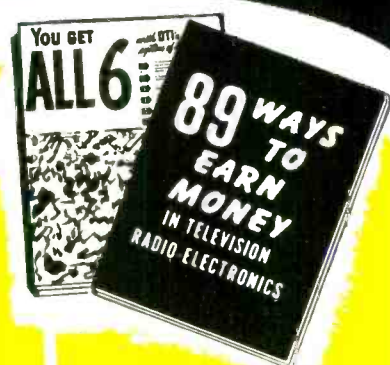

Mail coupon today for these FREE publications showing HOW and Where real money is being made in TELEVISION

Looking for a chance to earn REAL MONEY . . . to get a really interesting job or your own business . . . and above all, to enjoy the peace of mind and satisfaction that comes from knowing your future is tied in with one of America's most promising opportunity fields? Then mail the coupon at once! Find out about one of today's most WONDERFULLY EFFECTIVE ways to prepare you to enjoy all of these advantages in America's amazing, multi-billion dollar opportunity field of Television-Radio-Electronics.

**Now you can have your own HOME LABORATORY**

Using the D.T.I. Way, no previous experience is needed. You can get laboratory type training (1) at home in spare time—or (2) full time training in one of nation's finest TV training laboratories. The home method includes EVERYTHING YOU NEED to learn-by-doing. You work over 300 experiments from 16 big shipments of parts which you keep. This includes building and keeping the valuable commercial type test equipment shown at the left—ideal for helping you EARN while you learn. You also get easy-to-read, well-illustrated lessons. And to help you master important fundamentals faster, easier, better, you get D.T.I.'s remarkable and exclusive home training advantage—learn-by-seeing HOME MOVIES.

**Mail Coupon TODAY!**

But why not get ALL the facts about D.T.I.'s wonderful training programs . . . about the top flight Employment Service available to all graduates . . . about the special advantage that may be yours if called to military service? Mail coupon today. We believe the late facts we have are really going to surprise you.

ONE OF AMERICA'S FOREMOST TV TRAINING CENTERS  
— Established 1931 —

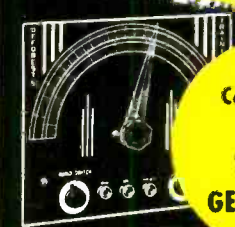

Commercial type SIGNAL GENERATOR



Jewel Bearing MULTI-METER



High Quality OSCILLOSCOPE a "must" for TV service

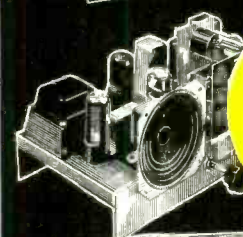

6 tube Superheterodyne RADIO SET



Optional at moderate added cost

MOVIE PROJECTOR and FILMS

**De FOREST'S TRAINING, INC.**  
AFFILIATED WITH  
**De VRY Technical INSTITUTE**  
CHICAGO 14, ILLINOIS

DeFOREST'S TRAINING, INC., Dept.—RE-11-1  
2533 N. Ashland Ave., Chicago 14, Ill.

I would like valuable, information-packed folders showing how I may get started toward a good job or my own business in Television-Radio-Electronics.

**MAIL TODAY**

Name \_\_\_\_\_ Age \_\_\_\_\_  
Street \_\_\_\_\_ Apt. \_\_\_\_\_  
City \_\_\_\_\_ Zone \_\_\_\_\_ State \_\_\_\_\_



"NUMERICAL FORECASTING," pioneered at the Institute for Advanced Studies in Princeton, N. J., will predict the general weather pattern over the United States for 24 hours ahead.

Meteorologists at the U. S. Weather Bureau are now making plans to install an electronic computer into which information on present weather conditions over a large area will be fed, together with complicated mathematical formulas. Out will come a picture of the same chart as it will look 24 hours later.

Eight charts will be prepared each 24 hours. These will represent eight horizontal slices of the atmosphere, beginning at sea level and extending up to about 13,000 feet. Thus vertical as well as horizontal changes will be indicated on the chart.

Numerical forecasting can take into account very many more pieces of information about weather conditions than a human forecaster can hold in his brain. With its aid, local weathermen should be able to make more accurate predictions in the future.

**ROBOT MILLING MACHINE**, developed at M.I.T. for the Air Materiel Command, does in minutes many tasks that normally take hours.

Numbers for directing the machine are derived directly from drawings and specifications of the parts to be worked, coded, and punched on a paper tape. The instructions may be of unlimited precision.

Three decoding servos convert the commands of the tape to shaft rotations.

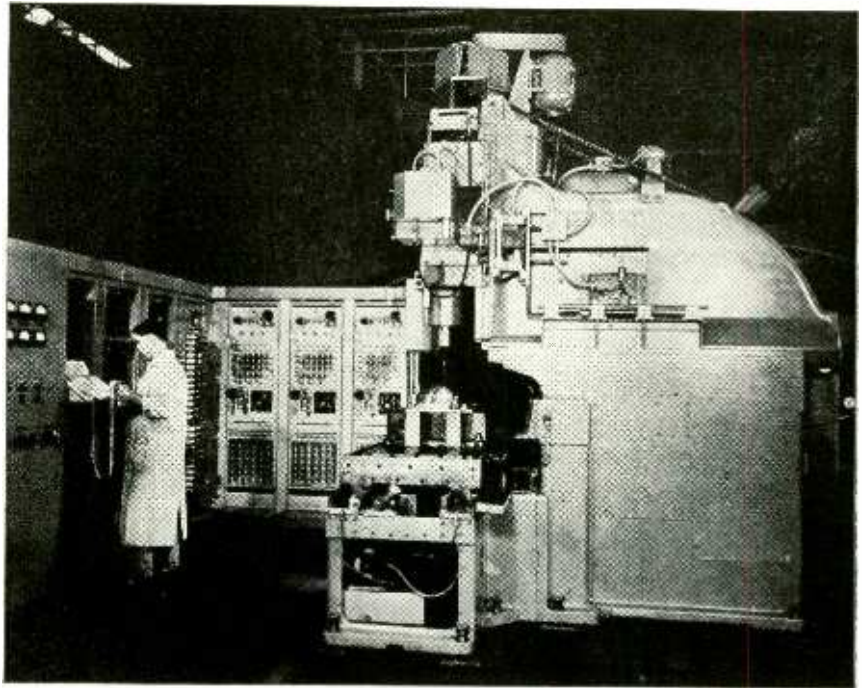

Coded tapes guide high-speed milling machine through errorless operations.

These are transmitted electrically to power servos which control the milling operation. Errors are eliminated by a continuous interchange of information between the power servos and the decoders.

The tape provides a permanent control record which may be used at any

time for milling duplicate parts.

Development of the machine was supervised by James O. McDonough, project engineer, under the direction of Professor William M. Pease, Director of the Servomechanisms Laboratory.

**FORD GIVES \$5 MILLION** for study of educational TV. The Fund for Adult Education, recipient of the gift from the Ford Foundation, will investigate means of financing non-profit community stations on new TV channels, and sources of high-quality cultural and educational program material.

This gift fulfills almost to the letter the suggestion made by Benjamin Abrams, president of Emerson Radio and Television, reported in this column for September.

**HOME TV RECEIVER SALES** will continue at high levels, says the Federal Reserve System's 1952 *Survey of Consumer Finances*. Predicted purchases by income groups range uniformly from 33 new sets per 100 families with earnings over \$5,000, down to 5 per 100 for families whose incomes are less than \$1,000. TV set sales in 1952 should total 2,900,000, compared with 6,300,000 in 1951.

An interesting sidelight in the survey shows that in 1951, families with incomes between \$3,000 and \$4,000 bought more television receivers than those in the next higher income group.

**A RADIOACTIVE GOLD** antenna at G-E's Research Laboratory shows the electrical activity generated by weather changes on a sensitive photoelectric recorder. Even shifting winds and variations in light reflected from clouds sometimes register noticeable changes in the potential developed between

(Please turn to page 12)

RADIO-ELECTRONICS

Merit's TV full-line offers the most complete line possible for universal replacement plus exact replacements where required. A new Merit TV Replacement Guide No. 405— including universal components and exact replacements for over 6000 models and chassis—can be obtained from your Jobber or by writing: MERIT COIL AND TRANSFORMER CORP., 4425 N. Clark Street, Chicago 40.

Merit IF-RF Coils include a complete line of TV replacements.



**MERIT FOR MAXIMUM COVERAGE  
WITH MINIMUM STOCK**

New in the Merit line of practical recommendations is the Model HVO-9 AUTOFORMER for exact replacement in RCA Hoffman and Hallicrafters. Designed for picture tubes 21" and up.

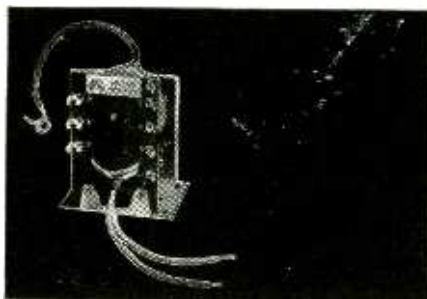

BURTON BROWNE ADVERTISING



# Six Months from Today Which will YOU hold?

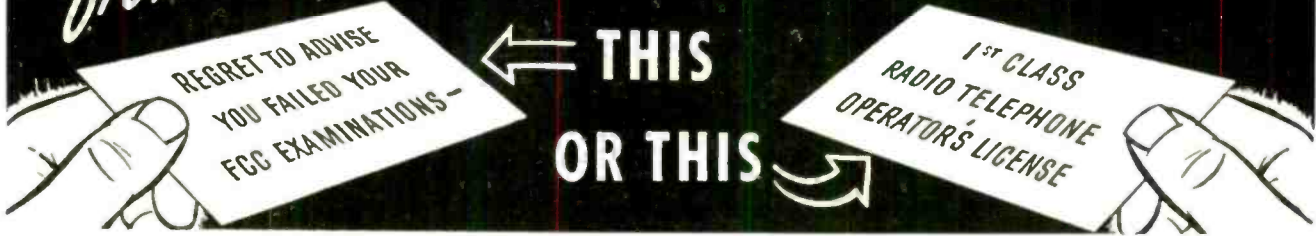

ADD TECHNICAL TRAINING TO YOUR PRACTICAL EXPERIENCE

## GET YOUR FCC LICENSE IN A HURRY!

Then use our Amazingly Effective  
JOB-FINDING SERVICE

Get this Valuable Booklet **FREE**



**TELEVISION ENGINEERING** included in our Training and Coaching

### HERE IS YOUR GUARANTEE

**TELLS HOW —**

If you fail to pass your Commercial License exam after completing our course, we guarantee to continue your training without additional cost of any kind, until you successfully obtain your Commercial license, provided you first sit for this examination within 90 days after completing your course.

**WE GUARANTEE**

**TO TRAIN AND COACH YOU AT HOME**

**IN SPARE TIME UNTIL YOU GET YOUR FCC LICENSE**

If you have had any practical experience—Amateur, Army, Navy, radio repair, or experimenting.

**TELLS HOW —**

**Employers make**

**JOB OFFERS Like These to Our Graduates Every Month**

Letter from Chief Engineer, Broadcast Station, North Carolina. "Need men with radio-telephone 1st class licenses, no experience necessary. Will learn more than at average station for we are equipped with Diesel Electric power, transmitting and studio equipment."

Telegram from Chief Engineer, Broadcast Station, Wyoming. "Please send latest list available first class operators. Have November 10th opening for two combo men."

These are just a few samples of the job offers that come to our office periodically. Some licensed radioman filled each of these jobs . . . it might have been you!

**HERE'S PROOF FCC LICENSES ARE OFTEN SECURED IN A FEW HOURS OF STUDY With OUR Coaching AT HOME in Spare Time.**

Name and Address	License	Lessons
Lee Worthy 2219 1/2 Wilshire St., Bakersfield, California	2nd Phone	16
Clifford E. Vogt Box 1016, Ocala, Florida	1st Phone	20
Francis X. Forch 38 Heuler Pl., Bergenfield, New Jersey	1st Phone	38
S/Sgt. Ben H. Davis 317 North Roosevelt, Lebanon, Illinois	1st Phone	38
Albert Schoell 110 West 11th St., Escondido, California	2nd Phone	23

**CLEVELAND INSTITUTE OF RADIO ELECTRONICS**

CARL E. SMITH, E. E., Consulting Engineer, President  
Desk RE-46, 4900 Euclid Bldg., Cleveland 3, Ohio

**TELLS HOW —**

**Our Amazingly Effective JOB-FINDING SERVICE**

**Helps CIRE Students Get Better Jobs**

Here are a few recent examples of Job-Finding results:

**GETS CIVIL SERVICE JOB**

"Thanks to your course I obtained my 2nd phone license, and am now employed by Civil Service at Great Lakes Naval Training Station as an Equipment Specialist."

Kenneth R. Leiser, Fair Oaks, Mt. Del., McHenry, Ill.

**GETS STATE POLICE JOB**

"I have obtained my 1st class ticket (thanks to your school) and since receiving same I have held good jobs at all times. I am now Chief Radio Operator with the Kentucky State Police."

Edwin P. Healy, 264 E. 3rd St., London, Ky.

**GETS BROADCAST JOB**

"I wish to thank your Job-Finding Service for the help in securing for me the position of transmitter operator here at WCAE, in Pittsburgh."

Walter Kosechik, 1442 Ridge Ave., N. Braddock, Pa.

**GETS AIRLINES JOB**

"Due to your Job-Finding Service, I have been getting many offers from all over the country, and I have taken a job with Capital Airlines in Chicago, as a Radio Mechanic."

Harry Clare, 4537 S. Drexel Blvd., Chicago, Ill.

Your FCC Ticket is recognized in all radio fields as proof of your technical ability

OURS IS THE ONLY HOME STUDY COURSE WHICH SUPPLIES FCC-TYPE EXAMINATIONS WITH ALL LESSONS AND FINAL TESTS.



**Get All 3 FREE**

**MAIL COUPON NOW**

CLEVELAND INSTITUTE OF RADIO ELECTRONICS  
Desk RE-46—4900 Euclid Bldg., Cleveland 3, Ohio  
(Address to Desk No. to avoid delay)

I want to know how I can get my FCC ticket in a minimum of time. Send me your FREE booklet, "How to Pass FCC License Examinations" (does not cover exams for Amateur License), as well as a sample FCC-type exam and the valuable booklet, "Money-Making FCC License Information."

Tell me about your Television Engineering Course.

NAME .....

ADDRESS .....

CITY ..... ZONE ..... STATE .....

Paste on two-cent postcard or send air mail

# Westinghouse

announces a great new division for full-scale manufacture of  
**RELIATRON<sup>T.M.</sup> ELECTRONIC TUBES**  
 To Produce and Market A Complete Line of Tubes

**RECEIVING • TELEVISION PICTURE • TRANSMITTING • INDUSTRIAL • SPECIAL PURPOSE**

Westinghouse proudly announces a completely new division of the Westinghouse Electric Corporation—the **ELECTRONIC TUBE DIVISION**, with headquarters at Elmira, New York.

This division is pledged to become **THE** leader in research, development, manufacture and marketing of electronic tubes. To achieve this aim rapidly and surely, Westinghouse has built two of the most magnificent, modern electronic tube plants in the world at Elmira and Bath, New York.

**OLD IN EXPERIENCE; NEW IN FACILITIES, EQUIPMENT, TECHNIQUES**

It has collected at these plants one of the greatest electronic tube engineering and production teams ever assembled. This experienced team was recruited from the most talented of Westinghouse's 100,000 employees and augmented by key experts from throughout the industry.

The Westinghouse Electric Corporation, too, is a veteran of wide electronic tube experience. To cite only a few instances:

- ★ Westinghouse produced the first dry-battery operated vacuum tube in America—the WD-11.
- ★ Westinghouse developed and produced the first vacuum tubes utilizing an indirectly heated cathode, introducing ac radio operation.
- ★ Westinghouse pioneered in high-powered transmitting tubes for use in both pulsed and CW radar applications. The famous Westinghouse Type WL-530 was in the Pearl Harbor radar set which gave the warning of the approach of Japanese planes in 1941. These tubes led the way to all subsequent radars.
- ★ Basic development of the cathode ray television system was performed in Westinghouse Laboratories.



RADIO-ELECTRONICS



**RELIATRON Tubes are backed by Westinghouse Reliability**

Because of Westinghouse experience and the unlimited resources and facilities of its new Electronic Tube Division, it is now producing electronic tubes which are the finest ever made... Westinghouse RELIATRON Tubes.

**TUBE RESEARCH AND DEVELOPMENT**

Westinghouse tube leadership is based on the untiring efforts of its research staff. These men are now improving present tube types and developing new types for superior service and new applications, including UHF.

**QUALITY CONTROL**

RELIATRON Tube performance is assured by exacting quality control. Every step in the manufacture of RELIATRON Tubes—from raw materials to finished product—must meet standards which are the highest in the industry.

**ENGINEERING AND SALES SERVICES**

Whatever your tube problem, you will find Westinghouse electronic tube sales representatives and application engineers at your service. Sales and engineering offices are strategically located throughout the country to serve you.

**ADVERTISING**

Trade acceptance of Westinghouse RELIATRON Tubes will be aided by a nationwide advertising campaign second to none. Sales promotion programs for distributors and service dealers will be hard-hitting sales builders. Your product or service will profit from the fullest consumer acceptance.

**DISTRIBUTORS, EQUIPMENT MANUFACTURERS, WRITE NOW**

For complete information on the Westinghouse line of RELIATRON Receiving Tubes, Television Picture Tubes, and transmitting, industrial, and special purpose tubes, write or wire Westinghouse Electric Corporation, Dept. H-11, Elmira, New York. Or call your nearest Westinghouse Electronic Tube Division Sales office.

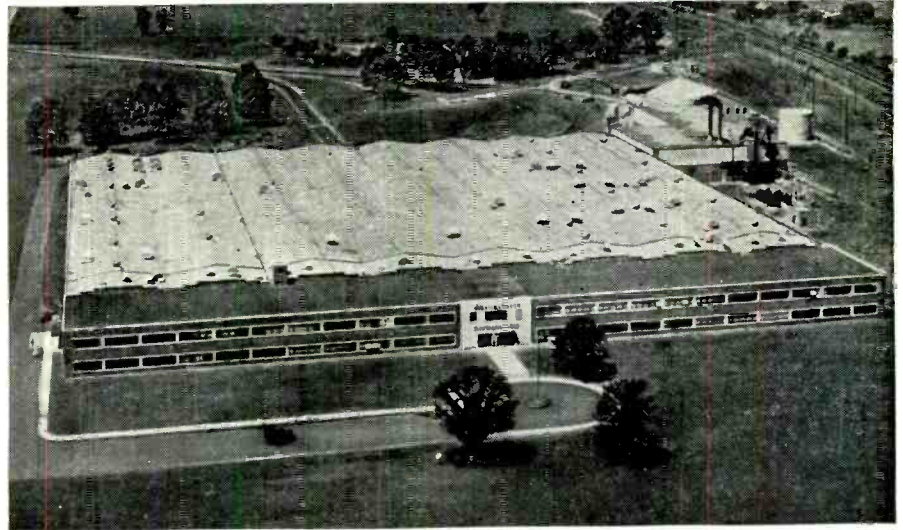

**WESTINGHOUSE IN ELMIRA, NEW YORK**

360,000 square feet of steel, glass and brick designed for one thing—to house the most efficient electronic tube production in the world. Here are produced Westinghouse RELIATRON television picture tubes, transmitting tubes, industrial tubes, special purpose tubes—all of unsurpassed quality. Here, too, is located the headquarters of the Westinghouse Electronic Tube Division with sales, engineering and production management ready to extend a warm welcome to you.

**WESTINGHOUSE IN BATH, NEW YORK**

This Westinghouse Receiving Tube plant is another 220,000 square feet of modern production efficiency. It lies only a few miles from a major source of glass tube envelopes. It is served by all modern transportation media to assure prompt shipment of your requirements—only hours away from all principal markets. Here at Bath the most modern equipment is operated by the industry's leading craftsmen. From it are shipped the finest receiving tubes in the industry—Westinghouse RELIATRON Tubes.

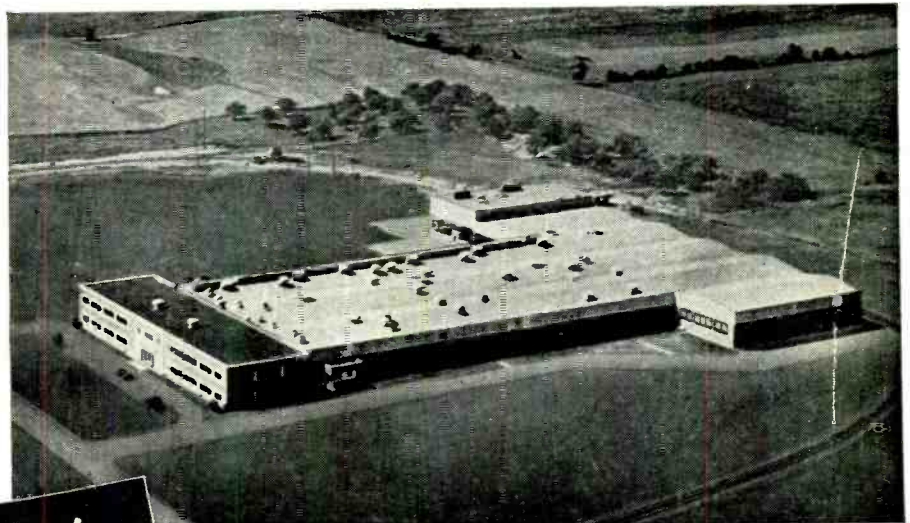

**YOU CAN BE SURE...IF IT'S  
Westinghouse**

**ELECTRONIC  
TUBE DIVISION**

WESTINGHOUSE ELECTRIC CORPORATION, ELMIRA, N. Y.



Complete  
control of  
materials and  
manufacturing  
procedures

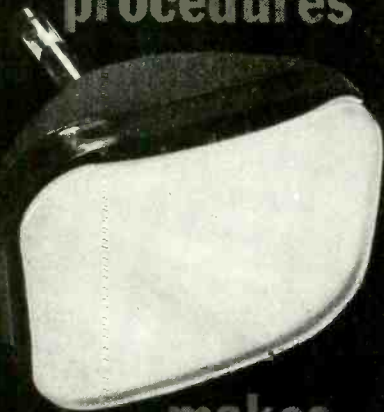

makes  
Tung-Sol Tubes  
dependable!

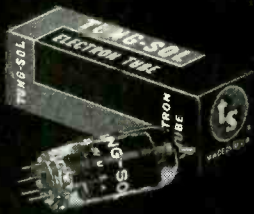

You can build  
a reputation  
on Tung-Sol  
Quality

**TUNG-SOL®**  
RADIO, TV TUBES, DIAL LAMPS

TUNG-SOL ELECTRIC INC., Newark 4, N. J.  
Sales Offices: Atlanta • Chicago • Culver City  
Dallas • Denver • Detroit • Newark

Tung-Sol makes All-Glass Sealed Beam Lamps,  
Miniature Lamps, Signal Flashers, Picture Tubes,  
Radio, TV and Special Purpose Electron Tubes.

the earth and the upper atmosphere.

The stylus moves left when negative charges grow on the outside antenna. Positive charges move the pen to the right. On clear days the pen stays close to the center line of the chart. The approach of a storm consistently builds up a negative charge, sending the red line far to the left. Lightning flashes reverse the pen. It moves quickly to zero, and at times swings over to a positive position. The approach or passage of cold and warm fronts write easily identified patterns.

With clear skies overhead, small deflections correlate well with the outbreak of showers within 450 miles.

The equipment can tip off weathermen about disturbances which could be found otherwise only by radar. The G-E device costs only a fraction of the price for radar equipment.

Work with the equipment was started in 1943 by Dr. Vincent J. Schaefer, the G-E scientist who discovered that artificial cloud seeding could cause rain.

**CANADIAN TELEVISION** had its formal opening on September 6 at station CBFT, Montreal, and on September 8 at CBLT, Toronto. Both stations had been on the air experimentally since July. The Ottawa station and the Toronto - Ottawa - Montreal microwave link will be completed next year.

Construction thus far has been financed by an \$8 million loan from the Canadian government, which the CBC expects to repay out of advertising revenue and a proposed \$15 license fee on each TV receiver.

French-language programs will predominate over the Montreal station, although an all-English outlet is planned for that city after TV stations have been established in other parts of Canada.

S. D. Brownlee, executive secretary of the Canadian RTMA, estimates that at least 85,000 television receivers will be sold in Canada before the end of 1952.

**BRITISH RADIO ASTRONOMERS** have recorded a drop in signals from a noisy radio star as the sun passed between the star and the earth.

The first reported "radio occultation" was of star static from the Crab nebula, remnants of a star which exploded almost a thousand years ago in the constellation Taurus. Measurements made during June at the Cavendish Laboratory, Cambridge University, showed that hisses on 81.5 and 38 megacycles diminished as the southern limb of the sun approached the radio star to within even ten times the sun's apparent radius.

**U.H.F. TELEVISION** had its debut Saturday, September 20, when KPTV, the country's first regular commercial u.h.f. TV station went on the air in Portland, Ore. on channel 27. The new station's equipment was brought across the country from Bridgeport, Connecticut, where it had operated as RCA-NBC's pioneer u.h.f. experimental television transmitter. The equipment was dismantled at Bridgeport on August 25 and was again on the air for tests on September 18.

**HENRY LADNER**, president of Ballantine Laboratories, Inc., died September 10 of a heart ailment. Mr. Ladner was 51. A graduate *cum laude* of Brooklyn Polytechnic Institute, he was an outstanding research engineer with American Telephone & Telegraph Co. from 1922 to 1932. In the next three years Mr. Ladner studied law at New York University, and from 1935 to 1949 was a member of NBC's legal department.

Mr. Ladner had been president of Ballantine since 1950. He was a member of the I.R.E., the New York Bar Association, and was a former national director of Alpha Chi Rho.

**DIATHERMY DEADLINE**, outlawing non-approved equipment after July 1, 1952, has been extended one year by the FCC. The extension is probably based on defense orders and material shortages preventing manufacturers from supplying the required number of interference-free units by the original date. (See "Frequency-Stabilized Diathermy" in our September issue.)

**THE FOURTH STATION** in Western Canada's new French-language radio network (The Radio Month, September issue), went on the air late in September. CFNS, Saskatoon, Saskatchewan, will furnish CBC network programs and local broadcasts to about 30,000 French-speaking inhabitants in the northern half of the province.

**BBC'S NEWEST TV** transmitter, at Wenvoe, Wales, completes the first phase in Britain's program for nationwide TV coverage. Opened on August 15, the 750-foot antenna tower on a hilltop near Cardiff marks the fifth high-power station in a TV network which now reaches 78% of the United Kingdom's population. (This is the highest degree of coverage in any country, at the present time.) In addition to the main installation, Wenvoe has a complete medium-power transmitter and a 150-foot antenna (not shown in the photo) for emergency operation. END

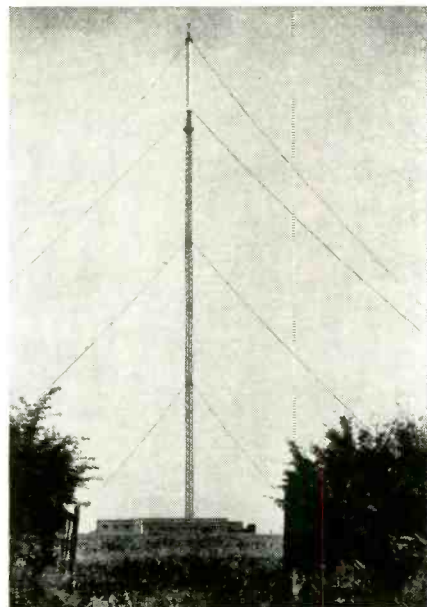

RADIO-ELECTRONICS



**THE ONLY COMPLETE CATALOG FOR EVERYTHING IN TELEVISION, RADIO AND INDUSTRIAL ELECTRONICS**

**your 1953  
ALLIED free!  
236-PAGE CATALOG  
complete...value-packed**

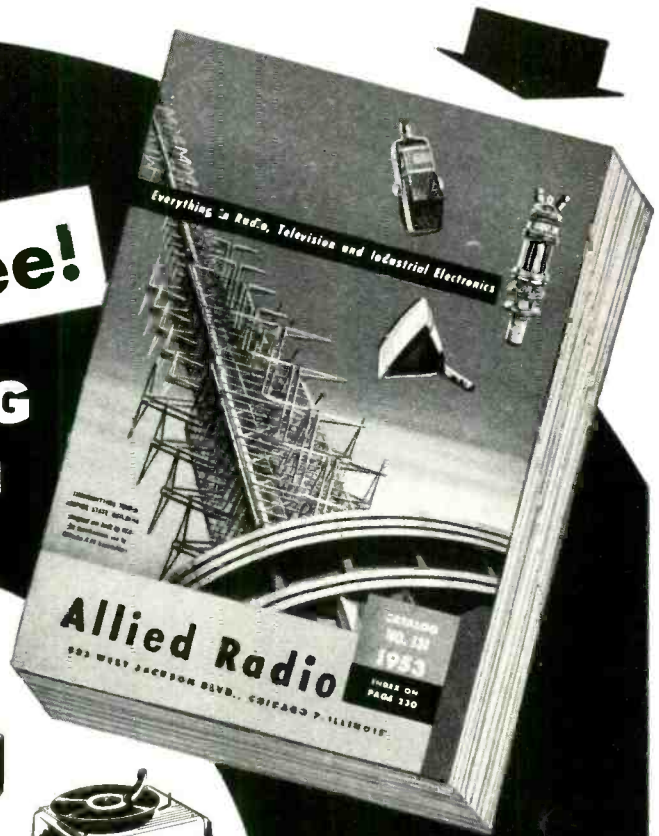

**Send for it Today!**

Here's the *one* authoritative, complete Buying Guide to *Everything in Electronics*—packed with the world's largest selections of quality equipment at lowest, money-saving prices. See the latest in TV, AM and FM receivers; High-Fidelity Custom Sound components; latest P.A. Systems and accessories; recorders; Amateur receivers, transmitters and station gear; specialized industrial electronic equipment; test instruments; builders' kits; huge listings of parts, tubes, tools, books—the world's *most complete stocks* of quality equipment.

ALLIED gives you every buying advantage: speedy delivery, expert personal help, lowest prices, liberal time payment terms, assured satisfaction. Get the latest 1953 ALLIED Catalog. Keep it handy—and save time and money. Send for your FREE copy today!

**the world's largest stocks**

- TV and Radio Parts
- Test Instruments
- Hi-Fi and P.A. Equipment
- Television & Home Radios
- Recorders and Supplies
- Amateur Station Gear
- Builders' Supplies
- Equipment for Industry

**quick, expert service**

**EVERYTHING IN ELECTRONICS**

**ALLIED RADIO**  
World's Largest Radio Supply House

**free**

Send Today for Radio's Leading Buying Guide

**EASY-PAY TERMS**

Take advantage of ALLIED'S liberal Easy Payment Plan—Radio's best terms—only 10% down, 12 months to pay—no interest if you pay in 60 days. Available on Hi-Fi and P.A. units, recorders, TV chassis, test instruments, Amateur gear, etc.

**TV & HI-FI SPECIALISTS**

To keep up with developments in TV and High-Fidelity, look to ALLIED! Count on us for *all* the latest releases and largest stocks of equipment in these important fields. If it's *anything* in Television or High-Fidelity equipment—we have it in stock!

ALLIED RADIO CORP., Dept. 2-L-2  
833 W. Jackson Blvd., Chicago 7, Illinois

Send FREE 236-Page 1953 ALLIED Catalog

Name \_\_\_\_\_

Address \_\_\_\_\_

City \_\_\_\_\_ Zone \_\_\_\_\_ State \_\_\_\_\_



How to use



to cut down contract service calls

Krylon is a tough, quick-drying Acrylic coating with many important TV applications. To apply, just push the button on the aerosol can and spray—that's all you do!



Because of its high dielectric strength, Krylon helps prevent corona. Here technician Bernard Vanella—on the staff of dealer Mort Farr, Philadelphia—"Krylon-izes" high voltage coil and insulation, the socket of the high voltage rectifier, component parts of the rectifier circuit.



Edward Weigand, Farr service man, sprays Krylon on entire antenna. Krylon shuts out moisture, rain, salt spray—prevents corrosion and pitting—keeps picture quality at peak.

**"Krylon-izing" increases your customer's satisfaction and jumps your own profits! Nationally advertised to your customers!**

**TECHNICAL CHARACTERISTICS**

- Dielectric constant—2.8 to 2.4 (1,000 cycles)
- Dielectric strength—400 to 800 (number of volts necessary to cause electric arc through Krylon coat one mil thick)
- Electrical resistance —  $10^{10}$  ohms/cm<sup>3</sup>

See your jobber, or write direct.

**KRYLON, Inc., Dept. 3111**  
2601 N. Broad St., Phila. 32, Pa.



**BAROMETER of the PARTS INDUSTRY**

During September, 43 of the leading manufacturers of Radio-Television-Electronic parts and equipment made changes in their lines. Actually there was an increase in "change activity" as compared to August. In price revisions by the number of manufacturers and products affected, the following summary illustrates the comparative trend for the months of August and September:

	No. of Manufacturers			No. of Products	
	August	September		August	September
Increased prices	5	6	Increased prices	9	454
Decreased prices	14	8	Decreased prices	515	21

For a summary of the most active product categories, see the following table:

Product Group	Increased Prices		Decreased Prices		New Products		Discontinued Products	
	No. of Mfrs.	No. of Products	No. of Mfrs.	No. of Products	No. of Mfrs.	No. of Products	No. of Mfrs.	No. of Products
Antennas & Access.	1	2*	1	2**	7	53*	1	9**
Capacitors	0	0	0	0**	2	117*	0	0**
Coils, Filters, Chokes	1	195	0	0	1	3	0	0
Sound & Audio Prod.	1	1*	0	0**	9	61*	3	4**
Test Equipment	1	66*	1	1	1	1**	0	0**
Transformers	1	187*	0	0**	5	161*	1	5**
Tubes	0	0**	3	5**	7	20**	2	5**
Wire & Cable	1	3*	3	13**	1	26*	1	13*

\* Increase over August  
\*\* Decrease from August

\* Increase over August  
\*\* Decrease from August

**Comment:** The trend, as previously noted, continues to center upon the introduction of new products, with leaders in all replacement fields taking part. This has been in evidence now for the past four months. Price increases and decreases remain quite spotty. The 454 price increase figure in the above chart was accounted for by only three manufacturers who showed slight increases on their entire line.

*This data is prepared by the staff of United Catalog Publishers, Inc., 110 Lafayette Street, New York, publishers of RADIO'S MASTER, the Official Buying Guide of the Parts Industry.*

**Merchandising and Promotion**

Radiart Corp., Cleveland, designed a new kit containing nine vibrators, including five types which serve over

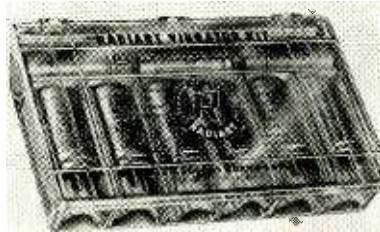

60% of replacement applications. The vibrators are packaged in a hinged plastic box.

Electro-Voice, Inc., Buchanan, Mich., launched what it calls one of the most unique and powerful promotions in



phono-cartridge history in an attempt to acquaint distributors and service technicians with profit opportunities in the \$70,000,000 phono-cartridge replacement market. Based on the theme,

"\$4.00 opens up new business for you", the promotion includes complete new packaging for Electro-Voice cartridges, a metal merchandiser for point-of-sale display, a sales aid kit, and direct mail material.

Insuline Corp. of America, Long Island City, N. Y., is offering distributors a counter display cabinet, the "Tele-



Bin", for television servicing tools containing 165 alignment and adjusting tools.

M. A. Miller Mfg. Co., Libertyville, Ill., designed new front end labels for the Miller Counter Dispenser which show a large illustration of leading needle designs and are arranged according to cartridge manufacturers.

Permoflux Corp., Chicago, designed a corner display unit. It is, in effect, a ready-built corner to provide distributors. (Please turn to page 18)





"WHY SHOULD I INSIST  
ON **CBS-HYTRON**?"

"**YOU PROFIT MORE!**  
HERE ARE  
**5 BIG REASONS WHY**"



**1. CBS-HYTRON IS FAMOUS . . . EASY TO SELL.** The magic letters "CBS" are plugged for you on radio and TV station breaks . . . 102 BILLION times a year! CBS is known and respected by *all* your customers. CBS-Hytron is the profitable brand with endless sales assistance.



**2. CBS-HYTRON SPECIALIZES IN RECEIVING TUBES.** Since 1921, CBS-Hytron has concentrated on receiving types. Practice makes perfect. Put those years of know-how to work for you. Let time-proved CBS-Hytron dependability cut call-backs . . . make more money for you.



**3. CBS-HYTRON LEADS IN TV TUBES.** You know them. CBS-Hytron TV originals: 1AX2, 1X2A, 6BQ6GT, 12A4, 12B4, 12BH7, 12BY7, 12BZ7, 25BQ6GT, and the original rectangular 16RP4. Even CBS-Hytron standard TV tubes are designed-for-TV . . . tested-for-TV . . . to give you peak performance and profit.



**4. CBS-HYTRON IS ULTRAMODERN.** CBS-Hytron is the tube of the future. Made in the world's most modern plants. On manufacturing equipment years ahead of the rest of the industry. CBS-Hytron advanced design and precision construction keep you always ahead. Give you tomorrow's trouble-free performance today.

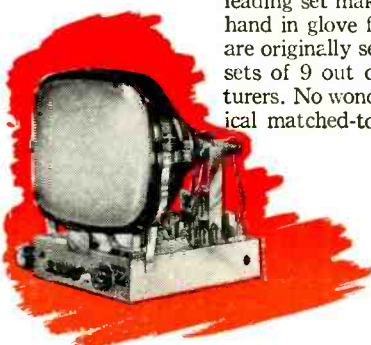

**5. CBS-HYTRON IS MATCHED-TO-THE-SET.** Combined engineering skills of leading set makers and CBS-Hytron work hand in glove for you. CBS-Hytron tubes are originally set-engineered right into the sets of 9 out of 10 leading set manufacturers. No wonder CBS-Hytron is your logical matched-to-the-set replacement tube.

**IT PAYS TO BE FUSSY!** Just any standard brand won't do. If you want: Trouble-free, advanced performance. Maximum customer satisfaction. Minimum call-backs. More profit. Five big reasons point the way: Insist on CBS-Hytron!



**CBS-HYTRON**  
Germanium Diodes

Complete data yours for the asking. Write  
CBS-Hytron, DANVERS, MASS., today.



for the brightest profit picture  
of the year

**CREST**\*

# PICTURE TUBE REJUVENATOR



*Increases cathode filament emission — restores brilliance, sharpness, and detail to weak, dim Cathode Ray Tubes. RESULTS ARE AMAZING!*

85% of weak, low emission tubes can be revived—prevents costly replacements of CRT's on service contracts and warranties.

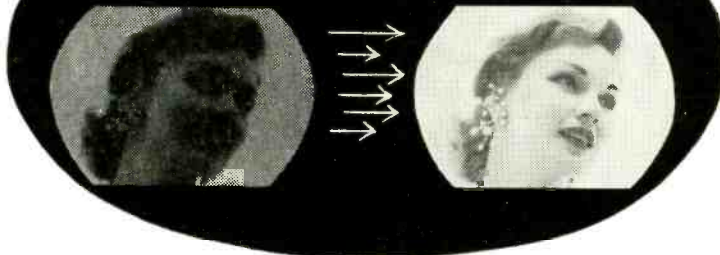

- ✓ Simple Plug-in Unit — installed in less than 1 minute
- ✓ Permanent Hook-Up
- ✓ Attractive, colorful packaging complete with easy instructions
- ✓ No Exposed Wires
- ✓ Fits all Size Tubes
- ✓ Automatically Operated—turns on and off with set
- ✓ Standard RTMA Guarantee

**INSTALLED IN 10 SECONDS:** Simple plug-in installation for use as a flasher type reactivator or as a permanent rejuvenator.

**HOW IT WORKS:** In low emission CR Tubes the barium oxide coated cathode has become contaminated by the occluded gases in the tube. The Crest Rejuvenator steps up filament voltage slightly, raising cathode temperature to increase the electron kinetic energy thus permitting easier escape from the cathode — reduces impure barium oxide layer. RESULT: Brighter Picture.

The Crest Picture Tube rejuvenator carefully increases voltage 25%; and this slight step up is far below the 100% and greater overload the filament is designed to withstand. Double the normal voltage is administered for prolonged periods by CR Tube manufacturers

HEAVY DUTY MODEL "B" FOR STANDARD AS WELL AS FOR ELECTROSTATIC FOCUS TUBES. DEALER NET **\$3.40**

to cure cathode emitting surfaces, during initial manufacture.

Contamination of the barium oxide layer will form as early as three months after normal set use — Loss of picture brightness will be noted after 6 to 8 months' normal set use.

**HOW IT SAVES:** Reduce risk on Service Contract and Warrantees. Save the difference between the price of a CRT and the low \$3.40 for the Heavy duty Model B Rejuvenator . . . for standard or electrostatic focus tubes.

**PERFORMANCE IS PROOF:** \*CREST LABORATORIES — a leading manufacturer of transformers pioneered in the development of CRT Rejuvenators. Your guarantee of a quality product, proven performance, and profitable satisfaction.

MODEL "C" FOR STANDARD TUBES. DEALER NET **\$2.79**

Now available the NEW MODEL D for A.C.-D.C. series filament receivers.

**CREST**

**LABORATORIES, INC.**

Whitehall Building, Far Rockaway, N. Y.

Write for FREE literature on Picture Tube Rejuvenation.  
Available at Local Jobbers, or inquire



The only lightning arrester with the strain relief LIPS is  
 manufactured by JFD. A patent is its proof!  
 The twin-lead will bend only at a point separate from your contact—  
 therefore, your twin-lead cannot break away.



Only the exclusive JFD strain relief lip prevents the  
 contact washers used in all arresters from ripping your lead-in  
 apart, strand by strand until the wire is torn through and  
 the picture on your screen obliterated. Write for Form 84.

**FOR RIBBON TWIN-LEAD**

- No. AT105 ("Little Giant" with hardware for wall  
 or window sill mounting) List \$1.25
- No. AT105S ("Little Giant" with UL approved stainless  
 steel strap for pipe mounting) List \$1.50
- No. AT102 ("Jumbo" with UL approved stainless steel  
 strap for Universal Mounting) List \$2.25

**FOR TUBULAR TWIN-LEAD**

- No. AT103 ("Jumbo" with UL approved stainless steel  
 strap for Universal Mounting) List \$2.25

Available with four color, sales producing counter display, on request

**JFD MFG. CO.**

BROOKLYN 4, N.Y.  
 BENSONDUNST 6-3100

World's Largest Manufacturer  
 of T. Antennas and Accessories

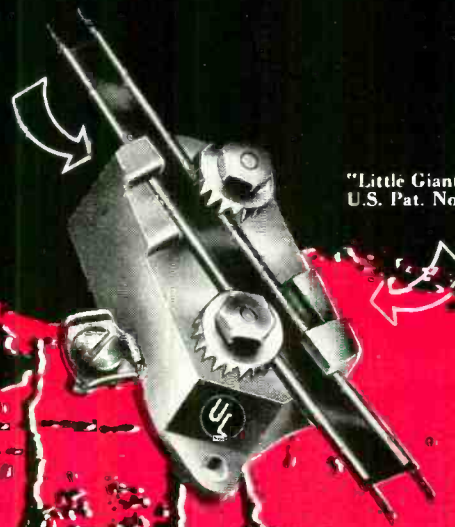

"Little Giant" Lightning Arrester  
 U.S. Pat. No. D-4664





**NEW!** **2 GREAT BOOKS**  
By Milton S. Kiver  
**IF YOU SERVICE TV  
—YOU NEED THEM!**

**"TV Servicing Short-Cuts  
Based on Actual Case Histories"**



shows you how to solve commonly recurring troubles

the book that really teaches fast, expert service techniques

This book describes a series of actual TV service case histories, each presenting a specific problem about a specific receiver.

The symptoms of the trouble are described and then followed by a step-by-step explanation of how the service technician localized and tracked down the defect. Finally, there is a detailed discussion of how this particular trouble can be tracked down and solved in any TV set. The discussions which follow each case history are invaluable—they explain how to apply the proper time-saving servicing techniques to any TV receiver. Here, in one volume, is the successful experience of experts—to make your service work easier, quicker, more profitable. Over 100 pages, 5½ x 8½, illustrated. Pays for itself on a single service job.

ORDER TK-1. Only ..... \$1.50

**"HOW TO UNDERSTAND AND USE  
TV TEST INSTRUMENTS"**



shows you how to get the most from your test instruments

Provides basic explanations of how each test instrument operates; describes functions of each control and shows their proper adjustment to place the instrument

in operation. Covers: Vacuum Tube Voltmeters, AM Signal Generators, Sweep Signal Generators, Oscilloscopes, Video Signal Generators, Field Intensity Meters, Voltage Calibrators. Describes each in detail; explains functions; tells proper use in actual servicing; shows how to avoid improper indications. Because this book gives you a clear, complete understanding of your test instruments, you get more out of them, save time, and add to your earning power. Over 175 pages, 8½ x 11, illustrated.

ORDER TN-1. Only ..... \$3.00

**HOWARD W. SAMS & CO., INC.**

Order from your Parts Jobber today, or write direct to Howard W. Sams & Co., Inc. 2205 East 46th Street, Indianapolis 5, Ind.

My (check) (money order) for \$..... enclosed. Send the following books:

TK-1 (\$1.50)       TN-1 (\$3.00)

Name.....

Address.....

City..... Zone..... State.....

tors with proper conditions for demonstrating the Permoflux CH-8M corner horn speaker enclosure to full advantage. The display unit is available to distributors at cost with the purchase of at least three baffles.

General Cement Mfg. Co., Rockford, Ill., is now packaging 240 different hardware items in hinged plastic boxes

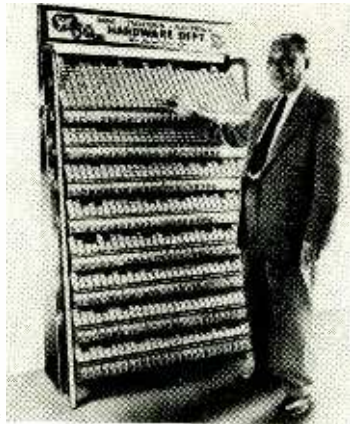

on quickly accessible self-service racks. The new merchandising arrangement is called the "G-C 50 (Hinged Cover) Line."

Littelfuse, Inc., Des Plaines, Ill., lists car radio fuses for all cars made from 1940 through 1952 in its new "Auto-



motive Fuse Guide". The company's TV Fuse Guide is also available, printed on durable enamel stock suitable for wall mounting.

The General Electric Tube Department conducted a series of electronic tube application clinics in five California cities. The program was aimed at bringing detailed information on new tube developments and applications to the engineering staffs of electronics equipment manufacturers and other users.

JFD Manufacturing Co., Brooklyn, N. Y., in an effort to promote the sale of its lightning arresters, has begun a drive to alert TV set owners to the dangers of lightning striking TV antennas.

**1953 Show Notes**

The 1953 Electronic Parts Show will be held at the Conrad Hilton Hotel in Chicago, May 18-21, according to Samuel L. Baraf, newly-elected president of the Show Corp. The Show will run

from Monday through Thursday, from 10 am to 6 pm, with a supplementary seminar program. A new section will be added to the exhibition hall to accommodate about 40 more booths.

In addition to Baraf, other newly-elected officers of the Show Corp. include:—Arthur Stallman, vice-president; Matthew Little, secretary; and Jack A. Berman, treasurer.

President Baraf appointed the following as Committee chairmen:—Jack A. Berman, Budget and Educational; W. D. Jenkins, Entertainment; Arthur Stallman, Credentials; Vin Ulrich, Housing; and Harry Stark, Publicity.

**Production**

The RTMA reported that 2,517,157 TV sets had been produced during the first seven months of 1952. The Association also reported that 5,280,079 radio sets had been produced of which 2,034,745 were home sets; 1,639,097 auto radios; 838,799 clock radios; and 776,438 portables.

**New Plants and Expansions**

Raytheon Manufacturing Co., Waltham, Mass., opened a new office building in Cleveland. The company also announced that it is completing negotiations for a lease of a plant in South Lowell, Mass. It plans to use the South Lowell building for engineering and production work of an undisclosed nature for the U.S. Government.

Sylvania Electric Products, Inc., has begun construction of a 40,000-sq.-ft. plant near Mountain View, Cal. which will house a new group of product development laboratories of the company's Electronics Division.

Standard Coil Products Co., Inc., purchased about four acres of plant development space in the Melrose Park district of Chicago adjacent to its present plant facilities. The company plans a 70,000-foot addition to its present Melrose Park building.

Westinghouse Electric Corp. completed all building construction on its new electronic tube plant and division headquarters at Elmira, N. Y. The new plant will manufacture TV tubes for home and government use, and transmitting, industrial, and special-purpose tubes for commercial and military applications.

Standard Transformer Corp. is nearing completion on two new wings of its Chicago plant at Addison, Elston, and Kedzie Avenues.

Jersey Specialty Co., Inc., built a new plant in Mountain View, N. J. The company makes TV lead-in wire and lamp cord and engages in wire spooling operations.

International Resistance Co., Philadelphia, added 450 employees to its manufacturing staff.

Electro-Voice, Inc., Buchanan, Mich., built a new balcony in its plant which provides over 4,000 sq. ft. of additional floor space to house its expanded laboratory.

Hallcrafters, Inc., entered the Canadian TV field with the establishment of (Please turn to page 22)



J. E. SMITH  
President  
National Radio  
Institute  
Washington, D. C.

# I Will Train You at Home

## For Good Pay Jobs, Success in

# RADIO-TELEVISION



### YOU LEARN SERVICING

by practicing with equipment I furnish

You build valuable Multitester (at left) as part of my Servicing Course. You use it to make many tests, get practical experience, make EXTRA money fixing neighbors' radios in spare time. Many of my students earn \$5, \$10 a week extra while learning. I send you many other kits too. You build a modern Radio. You build many circuits common to Radio and Television. All equipment is yours to keep. Read about and see other equipment in my free book. Mail card below.



### YOU LEARN COMMUNICATIONS

by practicing with equipment I furnish

As part of my Communications Course I send you kits of parts to build the low power broadcasting transmitter shown at right and many other circuits common to Radio and Television. You use this equipment to get practical experience putting a station "on the air," performing procedures demanded of Broadcast Station operators. I train you for FCC Commercial Operator's License. Mail Card for Sample Lesson and 64-Page Book. FREE!



**There are Good Jobs, Good Pay, Success in Radio-TV! SEE OTHER SIDE**



### TELEVISION is Today's Good Job Maker

In 1951 over 15,000,000 homes had Television sets, more are being sold every day. 108 TV stations are already operating, over 1800 are now authorized and many hundreds are expected to be on the air in 1953. This means new jobs, more jobs and better pay for trained men. The time to act is NOW! Start learning Radio-Television servicing or communications. Want to get ahead? America's fast growing industry offers good pay, a bright future and security. Cut out and mail card now. J. E. Smith, President, National Radio Institute, Washington, D.C.

**CUT OUT AND MAIL THIS CARD NOW**

## Sample Lesson & 64-Page Book

# Both FREE

This card entitles you to Actual Lesson on Servicing, shows how you learn Radio-Television at home. You'll also receive my 64-Page Book, "How to Be a Success in Radio-Television." Mail card now!

**NO STAMP NEEDED! WE PAY POSTAGE**

Mr. J. E. SMITH, President,  
National Radio Institute, Washington 9, D.C.

Mail me Lesson and Book, "How to Be a Success in Radio-Television." (No Salesman will call. Please write plainly.)

NAME ..... AGE.....

ADDRESS.....

CITY..... ZONE..... STATE.....

A B C D E F

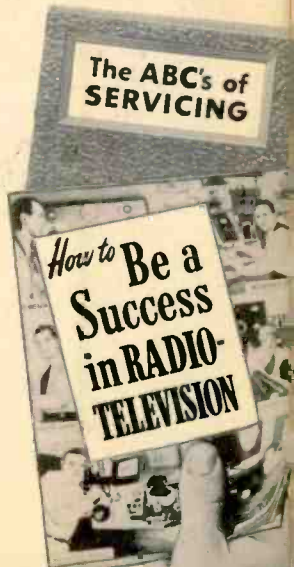



# Train at Home to Jump Your Pay as a RADIO-TV Technician



J. E. Smith, President  
National Radio Institute

The men whose letters are published below were not born successful. At one time they were doing exactly as you are doing now... reading my ad! But they acted. They decided they would know more... so they could earn more! They acted! Mail the card now for my 2 books FREE.

## There's a Bright Future for You in America's Fast Growing Industry

Do you want good pay, a job with a bright future, security? Would you like to have a profitable business of your own? If so, find out how you can realize your ambition in the fast growing RADIO-TELEVISION industry. Even without Television, the industry is bigger than ever before. 105 million home and auto radios, 2900 Radio Broadcasting Stations, 108 TV Stations with 1800 more now authorized. Expanding use of Aviation and Police Radio, Micro-Wave Relay, Two-Way

Radio for buses, taxis, etc., are making opportunities for Servicing and Communications Technicians and FCC Licensed Operators.

### You Learn by Practicing with Kits I Furnish

With both my Servicing Course and my NEW Communications Course I send you many Valuable Kits of Parts. They "bring to life" theory you learn in my illustrated texts. Mail card for my big 64-page book. It shows photos of equipment you build from kits I send.

### My Training Includes Television

Both my Servicing and Communications Courses include lessons on TV principles. You get practical experience by working on circuits common to both Radio and Television. My graduates are filling jobs, making good money in both Radio and Television. Remember, the way to a successful career in Television is through experience in Radio.

### Send NOW for 2 Books FREE

### Mail the Postage-Free Card NOW!

What will YOU be doing one year from today... will you be on your way toward a good job of your own in a Radio and Television service shop or business? Decide now that you are going to know more and earn more! ACT NOW! Take the important first step to a career and security. Send the postage-free card now for my FREE DOUBLE OFFER. You get Actual Servicing Lesson. Also my 64-page book, "How to Be a Success in Radio-Television." Read what my graduates are doing, earning; see equipment you practice with at home. Mail card now. J. E. SMITH, President, National Radio Institute, Washington 9, D.C. Our 39th year.

## I TRAINED THESE MEN



### Handicapped but Successful

"I am now Chief Engineer at WHAW. My left hand is off at the wrist. A man can do if he wants to." R. J. Bailey, Weston, W. Va.



### \$10 a Week In Spare Time

"Before finishing, I earned as much as \$10 a week in Radio servicing, in my spare time. I recommend NRI." S. J. Petrucci, Miami, Fla.



### Control Operator, Station WEAN

"I received my license and worked on ships. Now with WEAN as control operator, NRI course is complete." R. Arnold, Rumford, R. I.



### Trained Men Make Money In TV

"I am now servicing Television. Your course enabled me to repair TV receivers without any trouble." R. Currier, Fair Haven, Vt.



### Has Growing Business

"Am becoming expert Teletrician as well as Radiotrician. Without your course this would be impossible." P. Brogan, Louisville, Ky.



### Got First Job Thru NRI

"My first job was with KDLR. Now Chief Engr. of Radio Equipment for Police and Fire Dept." T. Norton, Hamilton, Ohio.

### NRI Training Can Lead to Jobs Like These in RADIO-TELEVISION

**BROADCASTING**  
Chief Technician  
Chief Operator  
Power Monitor  
Recording Operator  
Remote Control Operator

**SERVICING**  
Home and Auto Radios  
P.A. Systems  
Television Receivers  
Electronic Controls  
FM Radios

**IN RADIO PLANTS**  
Design Assistant  
Transmitter Design Technician  
Service Manager  
Tester  
Serviceman  
Research Assistant

**SHIP AND HARBOR RADIO**  
Chief Operator  
Assistant Operator  
Radiotelephone Operator

**GOVERNMENT RADIO**  
Operator in Army, Navy, Marine Corps, Coast Guard  
Forestry Service  
Dispatcher  
Airways Radio Operator

**AVIATION RADIO**  
Plane Radio Operator  
Transmitter Technician  
Receiver Technician  
Airport Transmitter Operator

**TELEVISION**  
Pick-up Operator  
Voice Transmitter Operator  
Television Technician  
Remote Control Operator  
Service and Maintenance Technician

**POLICE RADIO**  
Transmitter Operator  
Receiver Serviceman

FIRST CLASS  
Permit No. 20-R  
(Sec. 34.9, P.L. & R.)  
Washington, D.C.

## BUSINESS REPLY CARD

No Postage Stamp Necessary If Mailed In The United States

4c POSTAGE WILL BE PAID BY

NATIONAL RADIO INSTITUTE

16th and U Sts., N.W.

Washington 9, D. C.

## Find Out What RADIO-TV Offers You

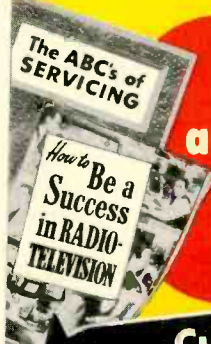

**SAMPLE LESSON and 64-PAGE BOOK Both FREE**

Cut out and mail postage-free card today!

## Make Extra Money While Learning

Keep your job while training. Many NRI students make \$5, \$10 and more a week extra fixing neighbors' Radios in spare time while learning. I start sending you special booklets that show you how to service sets the day you enroll. Multi-tester you build with parts I furnish helps discover and correct Radio troubles.



## Want Your Own Business?

Many N.R.I. trained men start their own business with capital earned in spare time. Let me show you how you can be your own boss... Robert Dohmen, New Prague, Minn., (whose store is shown at right) says, "Am now tied in with two television outfits and do warranty work for dealers. Often fall back to N.R.I. textbooks for information on installing Television sets."





Model  
1203D

# HIGH-FIDELITY REPRODUCTION AT ONE-TENTH THE COST!

Model  
1201D

**IMPORTANT BULLETIN**—Your local distributor has just received details on a new, radically different G-E Speaker policy. Call him today!

**Compared with speakers ten times more expensive—many listeners actually prefer G-E Model 1201D**

**I**N recent tests, many un-biased listeners actually preferred the G-E 1201D for its exceptionally fine reproduction! Side by side comparisons at a given volume level were made to try and determine the difference between these G-E speakers and others costing ten times as much.

These General Electric speakers are designed to meet and surpass the exacting standards of performance so essential to high fidelity. Their wide acceptance spells out the answer—for dependability, durability, and all-round superb performance.

Remember, there's a General Electric speaker for every application—27 speaker models in 8 different sizes!

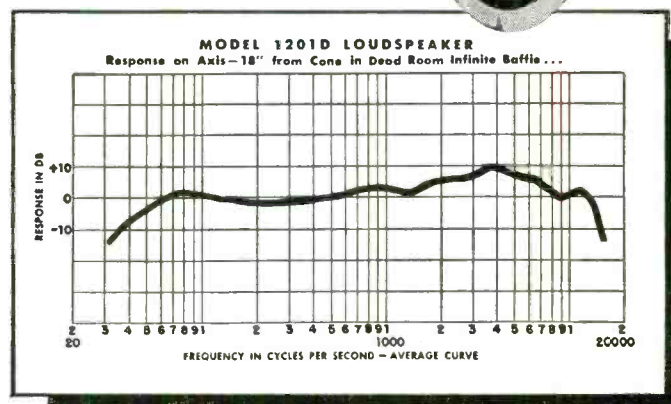

## OUTSTANDING FEATURES:

- **ECONOMY**—Compare their cost, and you'll find it lower by far than any speaker of comparable quality on the market.
- **EXCEPTIONALLY WIDE FREQUENCY RANGE**—50 to 13,000 cycles.
- **FAMOUS G-E ALUMINUM BASE VOICE COIL**—Unaffected by moisture and temperature variations.
- **G-E ALNICO 5 MAGNET**—for both maximum efficiency and sensitivity.

# GENERAL ELECTRIC

**GET THIS  
CATALOG  
FREE!**



General Electric Company, Section 45112  
Electronics Park, Syracuse, New York

Please send me your G-E Loudspeaker Catalog.

NAME \_\_\_\_\_

ADDRESS \_\_\_\_\_

CITY \_\_\_\_\_ STATE \_\_\_\_\_

For Clearest Viewing  
at Greatest Distance . . .

THE  
**SCANAFAR**  
TV BOOSTER



### NEW ASTATIC MODEL CT-1

*If* you have not tried  
the new Scanafar

Astatic Model CT-1 TV Booster,

you simply have yet to learn how vast an amount of improvement in TV reception a booster can really provide. And there is no secret about why the Scanafar provides such superior performance. It's a new and vastly improved booster design, abreast of modern, major improvements in TV receivers (check the accompanying list of features). The result is, whether used with new or older model receivers, you get a new experience in sharp, contrasty, snow-free pictures and crisp, clear sound. There is no loss of picture definition nor suppression of sound. Truly, the Scanafar ends the search for a DEFINITELY better TV Booster.

**List Price . . . . \$ 32.50**

### Features

The Scanafar employs a balanced, cascaded circuit, with a neutralized 6J6 tube driving a 6BQ7. Both tubes are used over the entire TV frequency range. Band width is over seven megacycles on all channels. Provision is made for either 72 ohm or 300 ohm impedance input and output. For other descriptive and technical information, write for illustrated literature.

#### EXPORT DEPARTMENT

401 Broadway,  
New York 13, N. Y.  
Cable Address:  
Astatic, New York.



offices in Toronto under the name of Hallicrafters Canada, Ltd.

Cenco Corp., Chicago, is constructing a new research and development laboratory which will permit the company to extend its activities into the fields of chemistry and electronics. The company previously conducted development and engineering work in the field of physics.

Transducer Corp., Boston, merged with its parent concern, the American Machine & Foundry Co. The former subsidiary is now the Electronic Division.

The Laboratory for Electronics, Inc. located its new headquarters at 75 Pitts St., Boston.

Magnecord, Inc., manufacturer of magnetic recording equipment, moved its sales and advertising offices to 225 West Ohio St., Chicago. The Engineering Department remains at 233 West Erie St.

Wyco Metal Products, North Hollywood, Cal., manufacturer of relay cabinet racks, is constructing an additional 6,000 feet of manufacturing space.

#### Business Briefs

. . . Philco Corp. established a separate Radio Division in recognition of the size and importance of its radio business. William H. Chaffee, formerly vice-president and director of purchases, was appointed vice-president of the new division. The Television Division, which has received separate divisional status, continues under the direction of Frederick D. Ogilby.

. . . Capitol Radio Engineering Institute, Washington, D. C., inaugurated a non-technical, non-mathematical home study course, "Television Studio Operations."

. . . CBS-Hytron sales, purchasing, and executive offices are now fully set up in the company's new plant in Danvers, Mass. The company's mailing address is now officially 100 Endicott St., Danvers, Mass.

. . . International Correspondence Schools of Scranton, Pa., announced a new television course designed to acquaint manufacturing and sales engineers, broadcast engineers, students, and technical workers with all components of transmitting and receiving equipment, both monochrome and color.

. . . LaPointe-Plascomold Corp., Rockville, Conn., manufacturer of "Vee-D-X" TV antenna systems, successfully completed its recently initiated financing program. Over 40% of the 92,194 shares of common stock offered were subscribed to by stockholders. The balance was sold to financial houses and others.

. . . Magnavox Co., Fort Wayne, Ind., has discontinued the manufacture of 17-inch TV sets. Frank Freimann, president of the company, predicted that the 17-inch set would eventually be relegated to the position of the 12-inch set.

. . . The RTMA announced that member companies received orders for radio communications and other equipment from the U.S. Government for the first half of 1952 totaling \$538,794,477 compared with orders of \$508,709,882 for the first half of 1951. END



# THE WORLD'S FIRST BROAD BAND YAGI!

**CHANNEL MASTER'S**  
*new* **f.u.t.u.r.a.m.i.c**



The first antenna ever built that combines . . .

- Broad band coverage *with the*
- High gain and directivity of the Yagi

*Designed for service TODAY and TOMORROW -- in these 3 booming VHF markets:*

Horizontal Polar Pattern

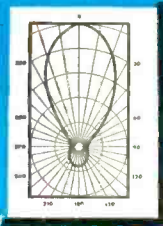

**BOOM BRACED**

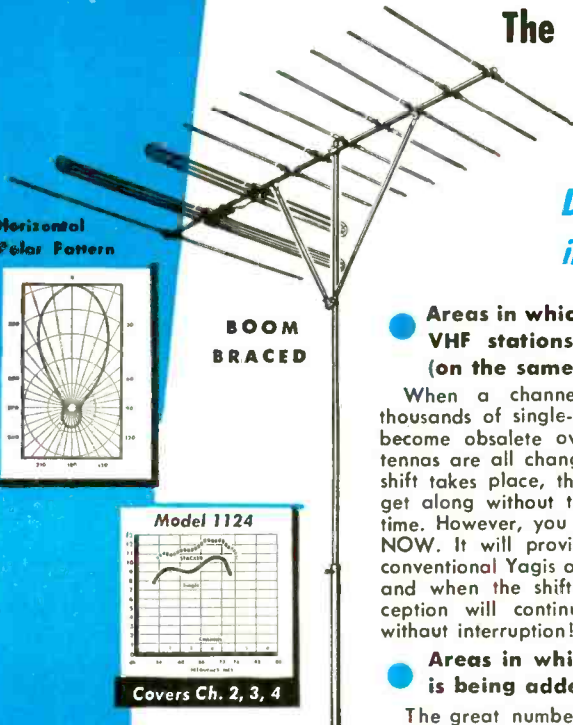

- Areas in which the FCC has ordered VHF stations to change channels (on the same band).

When a channel-shift takes place, the thousands of single-channel Yagis in use will become obsolete overnight. Unless such antennas are all changed on the same day the shift takes place, the set owner will have to get along without television for a period of time. However, you can install the Futuramic NOW. It will provide better reception than conventional Yagis on the present channels — and when the shift occurs, this superior reception will continue on the new channel without interruption!

- Areas in which a new VHF station is being added to the present one.

The great number of single-channel Yagis

now in use will not bring in the new channel. If an additional Yagi is installed, it will have to be tied into the present installation with separate leads and a switching system. However, ONE Futuramic will do the job of BOTH antennas — at lower cost — with better results on both channels.

- Areas served at present by two or more VHF stations (on the same band).

In such areas, the installation man has had to compromise between conventional broad band antennas, and separate Yagis for each channel. Only the Futuramic will give you the full advantages of both. It combines highest gain and sharpest directivity with simple, economical installation.

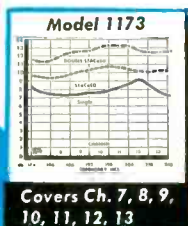
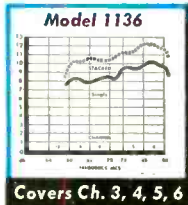
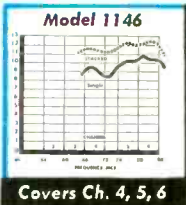
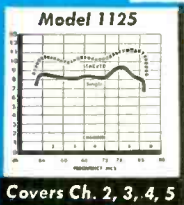
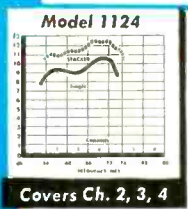

Model No.	Channels Covered	List Price
1173	7, 8, 9, 10, 11, 12, and 13	\$20.83
1124	2, 3, and 4	\$40.97
1125	2, 3, 4, and 5	
1136	3, 4, 5, and 6	
1146	4, 5, and 6	

**SHATTERS all performance records!**

- Channel for channel, the Broad Band Futuramic will outperform any conventional SINGLE-CHANNEL Yagi.
- On each of its specified channels, one single Low Band Futuramic will outperform any 4-bay conical or fan array.
- A single High Band Futuramic will outperform any 2-bay conical or fan array on every channel from 7 to 13.
- A high-low Futuramic combination is the most sensitive array ever devised for all-channel VHF reception.
- And the Futuramic uses Channel Master's famous Z-Match system for maximum stacking gain.

Write for complete technical literature.

**CHANNEL MASTER CORP.**  
ELLENVILLE, N. Y.

## THIS ELECTRONIC NOSE SNIFFS OUT LEAKS

Starting electronic nose on its way. It is pulled from pole to pole by line extending toward the ground. Previously workmen had to paint the cable with soap solution, so bubbles would disclose leaks.

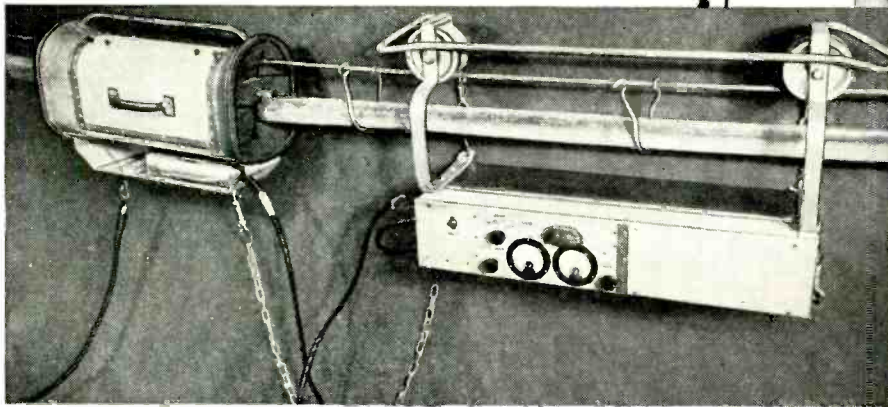

For test, the cable is cleared of protective nitrogen or air, and filled with Freon gas. Case at left collects escaping gas which operates Freon-sensitive detector underneath. At points where Freon escapes through sheath cracks, the box at right—a combined control unit and power supply—rings a bell. Workmen mark the point of leak for later repair.

AFTER years of buffeting by the wind, even tough telephone cable sometimes shows its age. Here and there the lead sheath may crack from fatigue or wear through at support points. Before moisture can enter to damage vital insulation, leaks must be located and sealed.

To speed detection, Bell Laboratories scientists constructed an electronic nose which *sniffs* out the leaks. Using an electrically operated element developed by the

General Electric Company, the device detects leaks of as little as 1/100 cubic foot per day. Sheath inspection can be stepped up to 120 feet per minute.

Thus Bell scientists add findings in other fields to their own original research in ways to make your telephone system serve you better. On the other hand their discoveries are often used by other industries. Sharing of scientific information adds greatly to the over-all scientific and technological strength of America.



# BELL TELEPHONE LABORATORIES

Improving telephone service for America provides careers for creative men in scientific and technical fields

RADIO-ELECTRONICS





Leonard C. Lane,  
B.S., M.A.  
President of Radio-Television  
Training Association,  
Exec. Dir. of Pierce School  
of Radio and Television

# AMAZING NEW TRAINING PLAN

# THOUSANDS OF BETTER PAY JOBS IN TELEVISION

I PREPARE YOU AT HOME WITHIN MONTHS!

**AT NO EXTRA COST!  
YOU GET A ROUND TRIP TO  
NEW YORK CITY**

FROM ANYWHERE IN THE U.S. OR CANADA—I pay your way to New York and return. PLUS 2 FREE weeks. 50 hours of advanced instruction and shop training at the **PIERCE SCHOOL OF RADIO & TELEVISION**. You use modern electronics equipment, including student-operated TV and Radio stations. You go behind the scenes of New York's big Radio-TV centers, to study first hand. And I give you all this **AT NO EXTRA COST!** (Applies to complete Radio-TV course only.)

Only RTTA makes this amazing offer.

**EXTRA FEATURES THAT MEAN MORE MONEY FOR YOU!**

Thousands of new job opportunities will be available for you right in your own state, now that the government has lifted restrictions on new TV stations. My simple, successful methods can PREPARE YOU NOW to take your place in America's booming TELEVISION and Electronics industries... help you get the success and happiness that you always wanted out of life. You learn the practical, easy way by using actual parts and equipment in the 15 big Radio-TV kits I send you, including a COMPLETE TV RECEIVER... yours to build and keep.

**My Advanced Training Prepares You For Better Jobs**

Then, after you finish your training for a position as a full-fledged TV Technician—where you can write your own ticket and choose from dozens of fascinating careers—I don't stop there! I continue to train you—**AT NO EXTRA COST!**—to qualify for even better pay in the BETTER JOBS that demand FCC licenses, with my...

**FREE FCC COACHING COURSE**  
PREPARES YOU AT HOME FOR YOUR  
FCC LICENSE  
THE BEST JOBS IN TV AND RADIO  
REQUIRE AN FCC LICENSE

Given to every student at **NO EXTRA COST** after TV Theory and Practice is completed.

**Earn Extra Money in Spare Time**

Make as much as \$25.00 a week in your spare time while learning—repairing Radio-TV sets. Many of my students pay for their entire training from spare time earnings almost from the very beginning... start their own service business.

**FREE EMPLOYMENT ASSISTANCE.** My vocational adviser will show you how you can have a good-paying career in the locality of your choice.

**I GET MY GRADUATES GOOD PAYING JOBS**

**"As Merchant Ship Radio Officer, I receive \$867 for 40-day trip. Your training helped me get this fine position."**  
—Stanley Nawrocki

**"I now hold a fine air-line position at La Guardia Field, New York City, thanks to your excellent training."**  
—Joseph Rosenberg

**"Your excellent instruction helped me get my present job as an airport radio mechanic for American Airlines."**  
—Eugene E. Basko

**"Thanks to your training, I qualified for a good job as a Receiver Fester at Federal Telephone and Radio."**  
—Paul Frank Seier

Many others working at NBC, RCA, CBS, Dumont, Philco, Emerson, Admiral and other leading firms.

**RADIO-TELEVISION TRAINING ASSOCIATION**  
1629 Broadway, Radio City Station, New York City 19, N. Y.  
Approved as a Correspondence School under the laws of the State of New York

**SET-UP YOUR OWN HOME LABORATORY WITH THE 15 BIG TELEVISION-RADIO KITS WE SEND YOU (At No Extra Cost)**

**YOU BUILD AND KEEP ALL THESE UNITS**

- INCLUDING BIG SCREEN TV RECEIVER,
- plus Super-Hot Radio Receiver,
- R.F. Signal Generator, Combination
- Voltmeter-Ammeter-Ohmmeter,
- C-W Telephone
- Receiver, AC-DC
- Power Supply.
- Everything
- Furnished
- Including
- All Tubes, and
- Big TV Tube



**NOW!** Advanced FM-TV Training For Men Who Know Radio  
Prepares You For Higher Pay Jobs In A Few Months  
COMPLETE theory and practical training course... complete with kits including large screen TV receiver.  
FCC License Coaching Course Included FREE.

## VETERANS!

**MAIL COUPON TODAY**

MY SIMPLE METHODS MAKE SUCCESS EASY!

**IF ELIGIBLE UNDER NEW G. I. BILL (discharged after June 27, 1950)—CHECK COUPON BELOW!**



**NO SALESMAN WILL CALL!**

Mr. Leonard C. Lane, President  
RADIO-TELEVISION TRAINING ASSN.  
1629 Broadway, Radio City Station  
New York 19, N. Y.

Dept. R-11

Dear Mr. Lane:

Mail me your **NEW FREE BOOK** and **SAMPLE LESSON** that will show me how I can make **BIG MONEY** in TELEVISION. I understand I am under no obligation and no salesman will call.

Name \_\_\_\_\_ Age \_\_\_\_\_

Address \_\_\_\_\_

City \_\_\_\_\_ Zone \_\_\_\_\_ State \_\_\_\_\_

I am interested in:  Radio-TV  Advanced FM-TV  
**VETERANS:** If qualified under new G.I. Bill, check here



**BOTH FREE**  
New  
Illustrated  
Book plus  
Sample  
Lesson



# SYLVANIA PICTURE TUBES

## Out-perform, out-last all others tested!

Fifty minutes *on* . . . ten minutes *off* . . . hour after hour for 500 consecutive hours, Sylvania Picture Tubes were tested side by side with the tubes of other leading manufacturers.

These intensive tests, made under punishing, accelerated voltages were conducted under supervision of an outside, independent laboratory. Checks were also taken over a 3-month period for emission, leakage, color, light out-put, grid control, and other characteristics.



impartial testing company  
proves **SYLVANIA**  
picture tubes  
are Finest!

**SEND FOR THE  
COMPLETE  
REPORT!**



**Read the remarkable record.**

The chart at right tells the story. Note that *only* Sylvania Picture Tubes showed no failures. And, in over-all point quality, *Sylvania won over all other brands by a wide margin.*

These important conclusions definitely place Sylvania Picture Tubes in the highest rank. They also mean the highest in trouble-free operation . . . better business . . . more satisfied customers for every dealer who orders Sylvania Picture Tubes. For full details about these important tests write today to: Sylvania Electric Products Inc., Dept. R-2711, 1740 Broadway, New York 19, New York.

# SYLVANIA



RADIO TUBES; TELEVISION PICTURE TUBES; ELECTRONIC PRODUCTS; ELECTRONIC TEST EQUIPMENT; FLUORESCENT TUBES, FIXTURES, SIGN TUBING, WIRING DEVICES; LIGHT BULBS; PHOTOLAMPS; TELEVISION SETS

United States Testing Co. 1415 Park Ave., Hoboken, N. J.			Test No. E-5095 August 8, 1952
Manufacturer	Number of Tubes Tested	Number of Failures	Overall Point Quality
A	8	1	81
B	8	1	78
C	8	6	62
D	8	1	83
E	8	4	67
F	8	5	42
G	8	4	52
H	8	5	30
<b>SYLVANIA</b>	<b>8</b>	<b>NONE</b>	<b>92</b>

# Here's your Opportunity

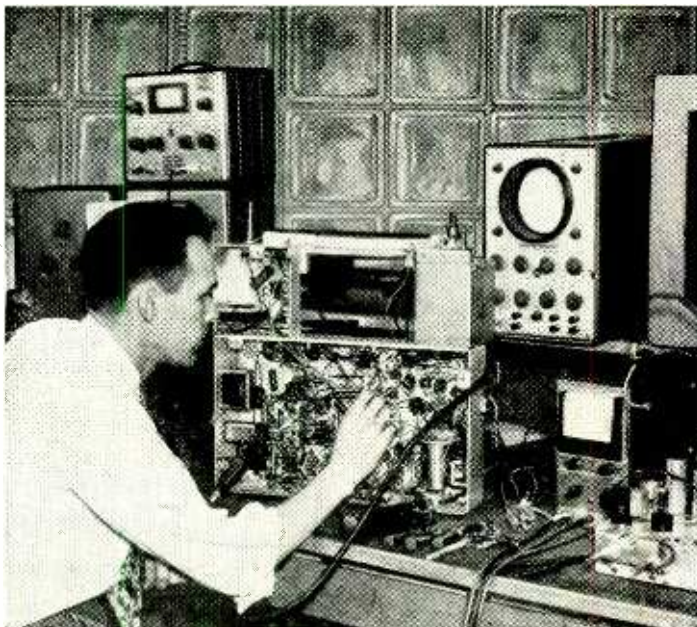

## to prepare for a good job or a business of your own in TV SERVICING

**There are today more good jobs** open in TV Servicing than there are trained and experienced men to fill them. Yes, thousands of opportunities exist now for good-pay jobs offering employment security for years and years to come. Thousands of TV Servicing jobs are going begging. Do you want one of them?

Experts agree, that because of the critical shortage of trained and experienced TV Servicemen, and the tremendous future growth of the industry, no vocational field today offers more opportunities than TV Servicing.

### The Big New Industry with a Great Future

Television is just in the beginning stages of its big industrial boom. Look at these amazing facts:

- Within a few years over 1000 TV stations will be telecasting compared with 108 TV stations now on the air.
- Nearly one-half of all families living within the present TV areas do not yet own TV receivers.
- The new trans-continental video network plus better and more interesting programs plus larger viewing screens and color TV will increase the installation of new receivers, will induce present owners of 12-inch and smaller size viewing screens to buy newer model receivers.
- The power increases of many existing stations and improved reception range of current receivers will result in receivers being installed and serviced in the fringe areas of present stations.
- Under the FCC proposal, over 70 per cent of all communities will be served by UHF channels exclusively. This means TV servicemen must know UHF receivers before the new UHF stations in their area are opened.
- No one yet knows how great the industrial TV market will be.

### RCA Institutes Home Study Course prepares you for a Career in TV Servicing

The addition of the RCA Institutes TV Service Training to your present radio-electronics experience will qualify you to step out and grasp the golden opportunities that now exist in television—America's fastest growing industry.

Learn at home—in your spare time—while you study the practical *how-to-do-it* techniques with *how-it-works* information. Easy-to-read and easy-to-understand lessons under the supervision of RCA engineers and experienced instructors quickly train you to qualify for the many good jobs now waiting for trained TV servicemen. Don't pass up this lifetime opportunity for financial security and a bright future in TV. Learn TV Servicing from RCA—pioneers and leaders in radio, television and electronic developments.

RCA Institutes conducts a resident school in New York City offering day and evening courses in Radio and TV Servicing, Radio Code and Radio Operating, Radio Broadcasting, Advanced Technology. Write for free catalog on resident courses.

## Send for FREE BOOKLET

Mail the coupon—today. Get complete information on the RCA INSTITUTES Home Study Course in Television Servicing. Booklet gives you a general outline of the course by units. See how this practical home study course trains you quickly, easily. Mail coupon in envelope or paste on postal card.



### MAIL COUPON NOW!

RCA INSTITUTES, INC., Home Study Department RE-1152  
350 West Fourth Street, New York 14, N. Y.

Without obligation on my part, please send me copy of booklet "RCA INSTITUTES Home Study Course in TELEVISION SERVICING." (No salesman will call.)

Name \_\_\_\_\_ (please print)

Address \_\_\_\_\_

City \_\_\_\_\_ Zone \_\_\_\_\_ State \_\_\_\_\_



**RCA INSTITUTES, INC.**  
A SERVICE OF RADIO CORPORATION OF AMERICA  
350 WEST FOURTH STREET, NEW YORK 14, N. Y.



**EICO**  
TEST INSTRUMENTS

*Guard*

*CBS-Columbia Inc.*

HIGH STANDARDS OF  
TELEVISION PRODUCTION QUALITY

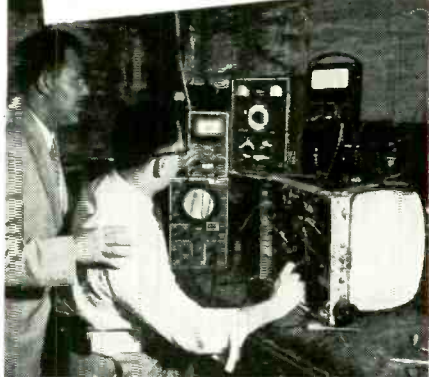

In the CBS-Columbia design laboratories, Al Goldberg takes some important readings with the EICO Model 221 Vacuum Tube Voltmeter and Model 355 Multimeter, as Harry R. Ashley looks on.



Mr. Al Goldberg, Assistant Chief Engineer of CBS-Columbia and Harry R. Ashley, President of EICO, inspecting the use of the EICO Model 221 Vacuum Tube Voltmeter and Model HVP-1 High Voltage Probe at the Sweep Frequency Troubleshooting Position on the CBS-Columbia Television production lines.



221K VTVM KIT \$25.95  
WIRED \$49.55



HIGH VOLTAGE  
PROBE \$6.95

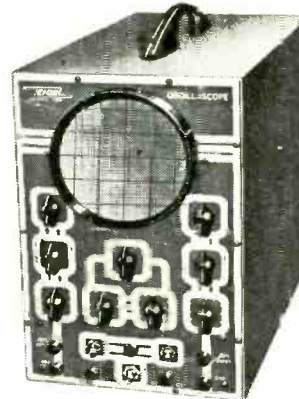

425E 5" PJSH-PL-L  
SCOPE KIT \$44.95. WIRED \$79.95

**KITS**  
WIRED INSTRUMENTS

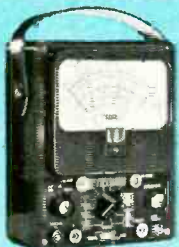

NEW 563K MULTIMETER  
KIT \$24.95 WIRED \$29.95.  
20,000 ohms/volt



320K SIG. GEN. KIT \$19.95. WIRED \$29.25  
322K SIG. GEN. KIT \$23.95. WIRED \$34.95

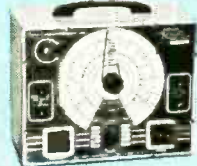

952K R-C BRIDGE &  
R-C COMP KIT \$19.95  
WIRED \$29.95



1040K BATTERY ELIM.  
KIT \$25.95. WIRED \$34.55



NEW 377K Sine & Square Wave  
AUDIO GE-1. KIT \$31.95 WIRED \$49.95

NEW 24K  
VTVM KIT \$34.95  
WIRED \$54.95  
7 1/2" METER



NEW 536K MULTI-  
METER KIT \$12.90  
WIRED \$1...90  
100C ohms/volt

1171K RES.  
DECADE BOX KIT  
\$19.95  
WIRED \$24.95

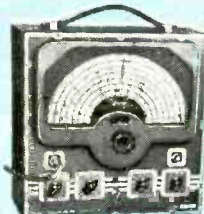

315K DELUXE SIG.  
GEN. KIT \$39.95  
WIRED \$59.95



145K SIG.  
TRACER KIT  
\$19.95  
WIRED  
\$28.95



625K  
TUBE TESTER KIT \$34.95  
WIRED \$49.95

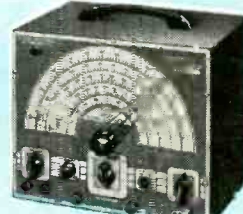

360K SWEEP GEN. KIT \$34.95  
WIRED \$49.95



NEW CRA PIX TUBE  
ADAPTOR for above \$4.50

*For Laboratory Precision at Lowest Cost—  
the Leaders Look to EICO!*

**WHY** does CBS-Columbia, Inc., one of America's great headline-makers in Television set production, use EICO Test Instruments on both its new Television production lines and in its design laboratories?

**BECAUSE** — like Emerson, Tele-King, Teletone, Majestic, and many another famous TV manufacturer coast to coast, CBS-Columbia knows that . . .

*Only EICO Test Equipment delivers  
All 10 EICO nomical Features!*

1. Laboratory Precision
2. Lowest Cost
3. Lifetime Dependability
4. Speedy Operation
5. Rugged Construction
6. Quality Components
7. Latest Engineering
8. Super-Simplified Assembly and Use Instructions
9. Laboratory-Styled Appearance
10. Exclusive EICO Make-Good Guarantee

Before You buy any higher-priced equipment, look at the EICO line—in *Wired and Kit form!* Each EICO product is jam-packed with unbelievable value. Compare, see EICO instruments today—in stock at your local jobber—and SAVE! Write NOW for FREE newest Catalog 11-C.

**FOLLOW THE LEADERS  
... INSIST ON EICO!**

**EICO**  
Reg. U. S. Pat. Off.

ELECTRONIC INSTRUMENT CO., Inc.  
84 WITHERS STREET, BROOKLYN 11, NEW YORK

©1958 Electronic Instrument Co., Inc. Prices 3% higher on West Coast. Due to unstable conditions, prices and specifications are subject to change without notice.

# MAGNETIC TAPE TV RECORDING

. . . *A major TV improvement is now in the making* . . .

By HUGO GERNSBACK

**U**P TO VERY recently, television programs could be recorded only on standard optical motion picture film. Recording of television programs is important to television stations who require a record of their emissions, not only in audio, but of video as well. More important today is the growing trend to film drama and studio programs in advance and broadcast them via film at a subsequent date. Frequently a television station must play back a program for many reasons, such as business, program improvement, verification of script, and for a number of other purposes. Private individuals also often wish to record live television shows, particularly important ones of historical interest, and various other types. Many TV network programs nowadays are recorded and shipped to the subscribing stations on optical film (kinescope recordings).

Television stations in the past have been handicapped a great deal in recording their programs, mainly on account of the great expense of optical film and the necessary time loss. The optical film must first be developed, the same as an ordinary photograph negative; it must then be dried. This is time-consuming, and is also very expensive, particularly when tens of thousands of feet of photographic film must be handled. In addition the picture quality is poor, as all who have seen kinescope recording can testify.

The industry has been experimenting for years to do away with optical film and substitute something better and cheaper, if possible.

It appears that this hope is about to be realized in the very near future. Within one, or at the most two years, magnetic tape recording may take over completely with a huge saving in money as well as in time all around. The theoretical end has long been realized, at least on paper. Recent practical results have encouraged a number of research institutions, as well as private research experimenters, to such an extent that the goal seems now to be in sight.

The device works somewhat along these lines (for patent reasons, some of the essential technical details cannot be revealed at present):

The tape recorder is attached to the output of the video amplifier and now records the video impulses on a standard magnetic tape. No excessive speed is necessary to run the tape recorder, as might be thought. There is, of course, no developing with the magnetic

tape, and it can be played back immediately after the recording, the same as with standard magnetic tape now. While it has always been a comparatively simple matter to record audio signals on tape and play them back, with video impulses the situation is quite different. Video impulses have *much* higher frequencies as compared to audio impulses. While an excellent audio amplifier covers the band from 20 to 20,000 cycles (and the range of a phonograph record is not that great) the video tape must record all signals from zero frequency to at least 4,000,000 cycles! This extremely wide frequency range posed a number of serious engineering problems in designing effective recording and playback mechanisms.

When the magnetic tape is played back, the video and synchronizing impulses are fed through another video amplifier and on to the transmitter for broadcasting, just as though they originated in a studio camera. Or, if the tape recorder is being used with a TV receiver, the amplified video and sync pulses are fed to the cathode-ray tube and the sweep circuits of the receiver in the usual manner.

It now appears that the technical bugs are rapidly being solved, and the results achieved so far give a tolerably clear picture for most purposes. The improvement is such that within the very near future it will be a certainty that all television broadcasters will be able to use the new magnetic tape recorder.

Not only will the magnetic tape recorder find an important use in the television industry, but the motion picture industry is even more interested.

We recently had a talk with Loren L. Ryder, A.S.C., Chief of Sound, Paramount Pictures Corporation, of Hollywood, California, who has also been prominent in developing magnetic tape for television recording. He informed us that when magnetic tape recording is perfected, the big motion picture companies will save several million dollars a year in discarding the present optical film. It was also pointed out to us that certain optical film recordings often become obsolete and must be discarded. This is not true of magnetic tape, which can be used over and over again hundreds of times simply by demagnetizing the former recording, when, of course, the magnetic tape becomes usable again.

This does not exhaust all the uses of magnetic tape for optical purposes. It is only a beginning.



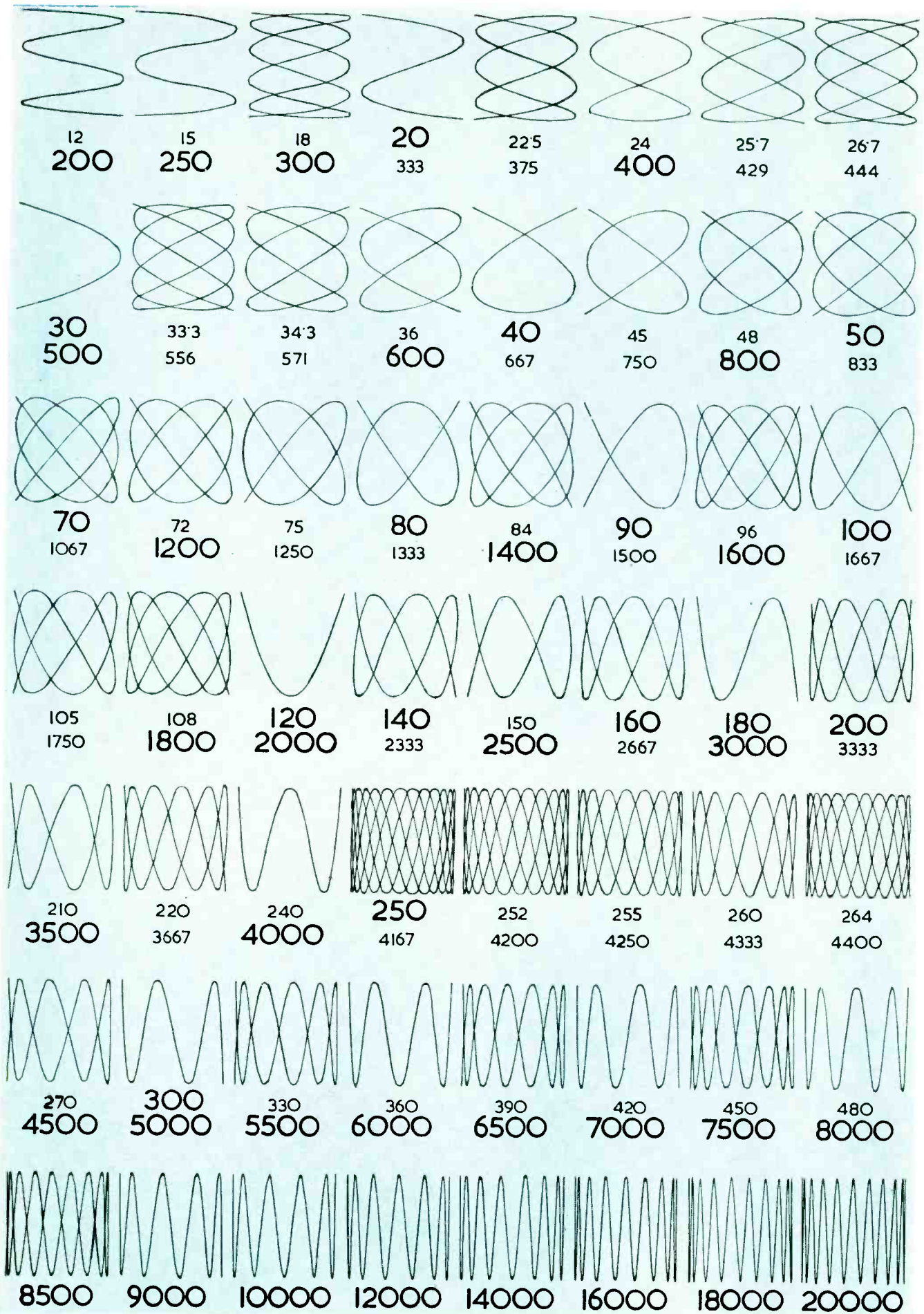

The recognition patterns are calibrated against 60 cycles for upper-line frequencies; against 1,000 cycles for lower line.

# CALIBRATING AUDIO OSCILLATORS

A scope and a very simple breadboard oscillator are all you need to get these highly accurate frequency patterns

By N. H. CROWHURST

**B**UILDING a good audio oscillator is neither difficult nor particularly expensive, nowadays. There are plenty of good designs to choose from. The Wien bridge feedback circuit described in the November, 1951, *RADIO-ELECTRONICS* is an excellent example of high quality at reasonable cost. But the difficult job, for most of us, is providing the frequency calibration.

The simplest method by far is to use Lissajous patterns; but most books on the subject give a few samples, state the frequency ratios they represent, and then tell us "... With a little practice, more complicated patterns can easily be recognized." This is where many of us come unstuck. If you're mathematically inclined you can sit down and figure out various ratios for the frequencies you want, and then work out some idea of what the patterns will look like: then just twiddle the controls until the desired patterns appear. Of course, if you have already located a few frequencies accurately with the aid of the simpler patterns it is easier to find the right spots for the more complicated ones by *interpolation*. But many don't get even that far—they're lost in a maze of patterns at the beginning, and don't know where to start.

I have calibrated a great many oscillators with Lissajous patterns (mostly on a 50-cycle line standard), and can appreciate the truth of the book statement, "With practice . . ."! The dif-

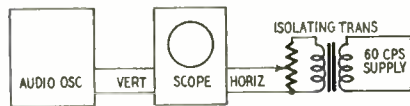
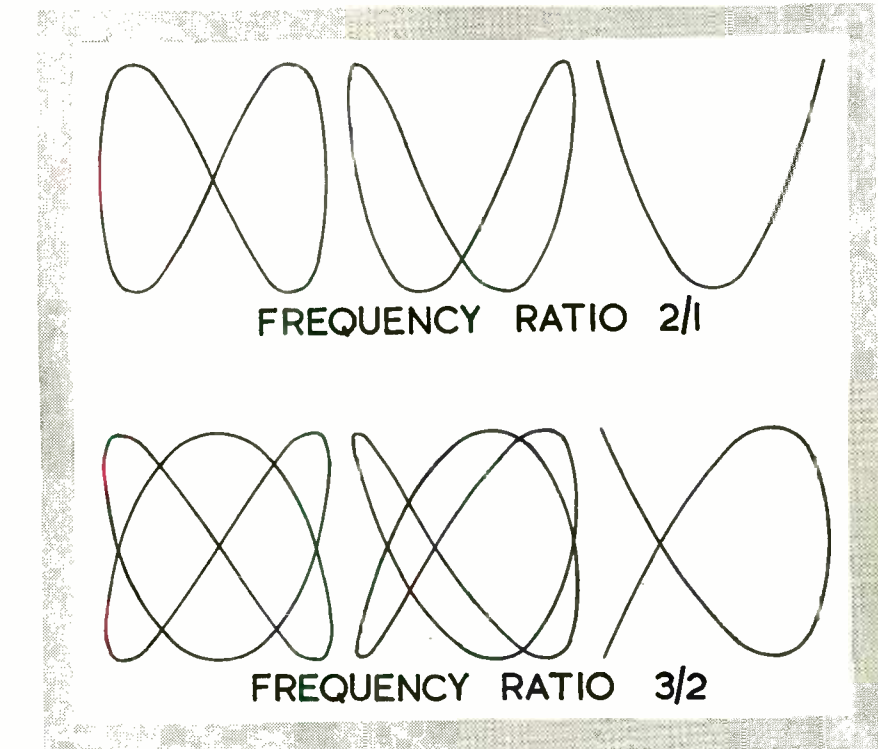

Fig. 1 (above)—Lissajous patterns for 120 and 90 cycles in three possible positions on the oscilloscope screen.

Fig. 2, left—Equipment setup for calibrating frequencies up to 480 cycles with the help of the 60-cycle power line.

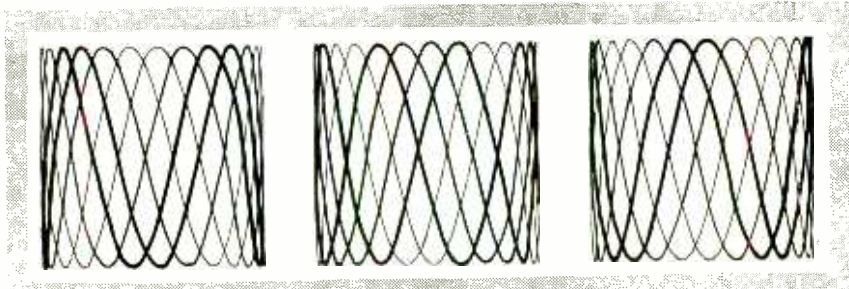

Fig. 3—The scope patterns for 250 cycles in three possible locked positions.

ficulty at the beginning is knowing what you are looking for. The patterns are not quite as simple with 60 cycles as with 50, but the job is still fairly easy *when you know what to look for*.

## Basic rules

The calibration depends on the stability of the line frequency. If the line frequency is actually 59.5 or 60.5 instead of 60 cycles, the calibration accuracy can still be held within 1%, which is good enough for most purposes. But if the frequency swings between these two extremes while you

are calibrating, the results can be very confusing. It is best to do the job at a time when the line frequency is reasonably stable. Try to avoid transit rush hours, mealtimes (when electric stoves and other appliances are being switched on and off), or dusk, when industrial loads are changing and lighting loads are coming on. Normal daytime working hours, or mid-evening, usually give the best results. If the supply frequency fluctuates it is difficult keeping the patterns steady enough to recognize them.

The calibration *must* be based on



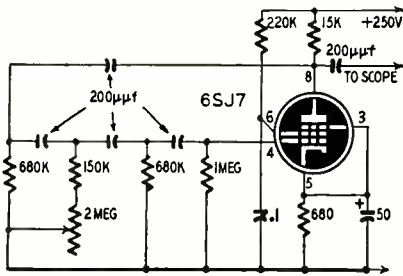

Fig. 4—Circuit of simple 1-kc standard.

stationary patterns, because then the frequency is as accurate as the reference standard—in this case the line frequency. The pattern should be moved into the best position for positive identification by first detuning the oscillator slightly so the pattern drifts slowly; then coming into accurate tune when the pattern is in the right position.

Fig. 1 shows three possible positions for two patterns, one representing a frequency ratio of 2/1 and the other 3/2. Using a 60-cycle reference, these patterns represent 120 and 90 cycles respectively. In both cases the right-hand pattern is the easiest to recognize: the trace folds back on itself, leaving two open ends.

Complicated patterns appear much simpler, because half the lines on the screen are superimposed on the other half. (This method also provides a valuable check on oscillator waveform. If the waves are not pure sinusoids, the two halves of the pattern will not match perfectly, and it will be impossible to lock them in. All the patterns shown in the recognition chart are in the locked position.)

### Calibration procedure

Fig. 2 shows the setup for calibrating the lower frequencies (up to 480 cycles) directly from the 60-cycle reference source. The *upper figure* under each pattern in the chart on page 30 is the frequency it represents *during this stage of the procedure*. Mark the simplest patterns (20, 30, 40, 60, 90, 120, and 180 cycles) first. This makes it easy to identify patterns for the principal intermediate frequencies (24, 36, 45, 48, 50, 75, 80, 100, and 150 cycles), and the higher harmonics of 60 cycles (420, 300, 360, 420, and 480). Then go on to the more complicated patterns.

The pattern for 250 cycles is probably the hardest to recognize. It will

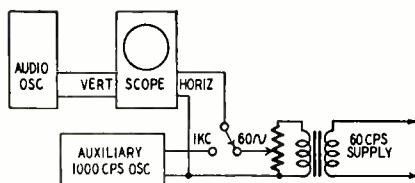

Fig. 5—High-frequency calibration setup.

have considerable flicker, due to the fact that it takes 1/10 second for the oscilloscope spot to trace out the figure. (This is also true of the 50- and 70-cycle patterns, but they are much less complex.) An accurate guide to iden-

tifying the right pattern is to count the number of crossover points on any part-cycle between the top and bottom of the trace. The 250-cycle pattern has five crossovers; 252 and 264 cycles each have 4; 255 cycles has 3; and 260 cycles has only two.

Fig. 3 is an enlarged view of the 250-cycle pattern in three possible positions on a medium-persistence scope.

### Calibrating higher frequencies

Maintaining the same calibration accuracy for frequencies above 480 cycles requires a second reference oscillator. Since only one frequency (1,000 cycles) is required, a breadboard setup will serve the purpose. Fig. 4 is the circuit of a simple phase-shift oscillator tunable from about 700 cycles to 1,400 cycles. Fig. 5 is the setup for adjusting this oscillator to exactly 1 kc, and using it to calibrate the main oscillator at the higher frequencies.

Note that 200, 250, and 300 cycles appear in both sets of figures on the reference chart. These three pairs of patterns are used to find 1 kc in the following manner:

With the switch in the 60-cycle position adjust the *main oscillator* for the original 200-cycle pattern (upper number 200). Now switch to the 1-kc position and adjust the *phase-shift oscillator* for the other 200-cycle pattern (lower figure 200). This should set the phase-shift oscillator to exactly 1 kc. Double-check by repeating these steps with the 250- and 300-cycle patterns. The temporary oscillator can now be used as a reference standard for calibrating the main oscillator to 20 kc, using the patterns for the lower sets of figures. (1 kc on the main oscillator should produce a straight diagonal line, ellipse, or circle, just as in the original 60-cycle calibration against the line frequency. Check back frequently against 200, 250, or 300 cycles to see that the phase-shift standard stays on 1 kc.

You may have a little difficulty at first in recognizing the patterns for the highest frequencies, owing to the large number of waves presented, and the convergence at the edges of the pattern, which makes them difficult to count. Notice the patterns for 6, 7, 8, 9 and 10 kc; the *even* ones have both ends either at the top or the bottom; the *odd* ones have one end at the top and one at the bottom. Above 10 kc, only the even-frequency patterns are used, to give 12, 14, 16, 18 and 20 kc.

There will be an odd pattern (not shown) between each pair. The difference between the two types can best be determined by examining both ends of the trace. The even patterns will be symmetrical top and bottom, but not the odd ones.

The great value of the chart is that any pattern obtained can be recognized quickly, and its position on the frequency scale known immediately and accurately. This gives a clear indication of *which way and how far* to turn the oscillator dial to find the pattern for the next frequency to be calibrated. END

# LOUDSPEAKER

By JACK D. GALLAGHER

**A** FEW articles which have given the reader an idea of how to make his own crossover network have been written. However, such articles usually specify the coils in millihenries, and information about how many turns of wire to wind on a form of given dimensions to obtain a required value of inductance may be hard to find.

Fortunately, there are approximate formulas which can be used in designing network inductors. The results obtained will be close enough for practical purposes if care is used in their application.

Many variables are involved in winding inductors of any sort. For instance, the number of turns that any multilayer form will hold depends not only upon the diameter and insulation of the wire used, but also upon the method by which the wire is applied to the winding space provided. Obviously, if the wire is crooked or wound loosely about the form, valuable winding space will be lost. Each turn must lie on top of the preceding turn if the maximum number of turns is to be wound in the space provided.

One good method of winding wire on the form is to clamp a hand drill in a vise, then place a bolt or machine screw through the core of the form and fasten it securely with a lockwasher and a nut. For large or rectangular cores, use a wooden form cut to fit the core and drilled for the bolt. The length of the bolt should be such that when the bolt is clamped in the drill chuck, the form will be as close to the chuck as possible. Such an arrangement leaves one hand free to keep the wire taut while the other is occupied turning the drill crank.

Two circuits are shown in Fig. 1-a, and two in Fig. 1-b. Those in 1-a use the conventional m-derived network; those in 1-b have the constant-resistance type of network. The necessary formulas for calculating values of inductance and capacitance in either case are given.

Since the purpose of this article is to supply adequate information for winding the inductors to be used in the networks of Fig. 1, we will leave it up to the reader to determine the value of capacitance required by simply using the formulas shown. And we'll ignore the inductance formulas, using the tables instead.

### A typical example

Suppose the type of network chosen is the constant-resistance series circuit of Fig. 1-b. The forms on which the inductances are to be made have a meas-

# NETWORK INDUCTORS

Simplified winding data for these all-important filter elements in multi-speaker installations.

ured diameter of 1 3/8 inches, and a winding length L of 1 inch is available. The winding depth, C, is equal to half the diameter, D, as shown in Fig. 2-a.

The value of N for a diameter, D, of 1 inch is given in Table I. All values of N in Table I are based on a diameter, D, of 1 inch, a winding depth, C, equal to half the diameter of the form, a winding length of 1 inch, and a voice-coil, R<sub>v</sub>, impedance of 4 ohms. If the desired crossover frequency is to be 800 cycles, the value of N (in Table I) is equal to 151 turns. This value, however, is for a D of 1 inch, and for other diam-

eters a correction factor must be applied to this value of N. These factors are given in Table III. The factor for 1 3/8-inch-diameter form is 0.79. Hence, all values of N (Table I) should be multiplied by 0.79 if a 1 3/8-inch form is used to wind the coils.

In the example:

$$151 \times 0.79 = 119 \text{ turns.}$$

If the voice-coil impedance of the woofer is 8 ohms instead of 4 ohms, the value of N (119) must be multiplied by  $\sqrt{2}$  or

$$119 \times \sqrt{2} = 169 \text{ turns.}$$

This value of N is the number of

turns needed on the form for a crossover frequency of 800 cycles and an impedance, R<sub>v</sub>, of 8 ohms for the loudspeaker voice coil.

The next step is to determine the size and type of wire to use in winding the inductances. The available winding space is equal to the winding length, L, times one-half the diameter of the form:

$$L \times 0.5 \times 1.375 = 0.688 \text{ sq. in.}$$

A size of wire which will wind 169 turns in 0.688 sq. in. or 246 turns per square inch must be used. The number of turns per square inch for various sizes and types of wire is given in Table IV. From this table, No. 16 d.c.c. will wind 271 turns per square inch. However, in the winding space of 0.688 square inch,

$$271 \times 0.688 = 187 \text{ turns}$$

of No. 16 d.c.c. can be wound. This is 18 turns more than the required number and will cause the crossover frequency to be about 140 cycles lower than 800 cycles. Adding one-half of the difference between 169 turns and 187 turns to the required number of turns (169) will raise the crossover frequency to approximately 800 cycles. The foregoing statement will not be true in all cases, but can be used as a means of minimizing the changes in the coils at the final testing of the network.

If the winding area is to be kept square in cross section, the values of N for various crossover frequencies are as listed in Table II. Correction factors for various diameters to be used with Table II can be found in Table III, and in all cases these factors should be multiplied by the values of N listed in Table I and Table II.

The values of N in Tables I and II were obtained by using Wheeler's and Bunet's formulas for multilayer inductances as given on page 148 of the *Radiotron Designer's Handbook* (third edition). END

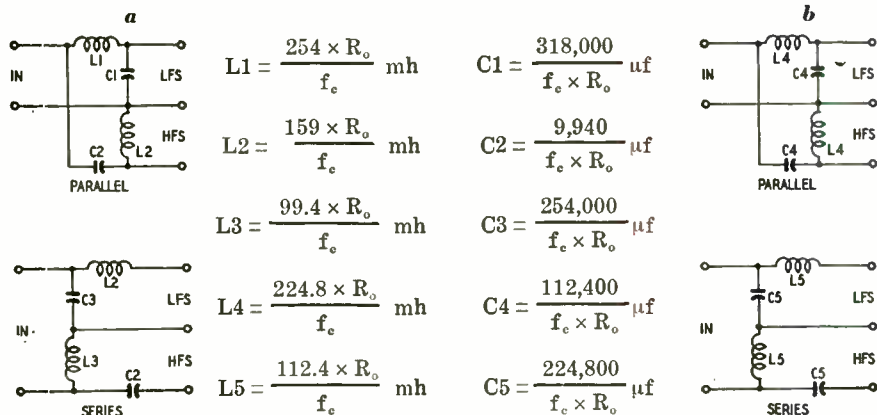

Fig. 1—Four types of dividing networks and formulas for computing their values.

TABLE I

Values of N for D = 1", C = D/2, l = 1", R <sub>v</sub> = 4 ohms								
Circuits	Type	f <sub>c</sub> = 400	500	600	700	800	900	1000
Constant Z	Par. (L4)	303	270	247	229	214	202	192
	Series (L5)	214	191	175	162	151	143	136
Conventional m-derived	Par. (L1)	323	289	264	244	228	215	205
	Par. (L2)	255	228	208	193	181	171	162
	Series (L3)	202	181	165	153	143	135	128

For R<sub>v</sub> = 8 ohms, multiply all values by  $\sqrt{2}$ .  
For R<sub>v</sub> = 16 ohms, multiply all values by 2.

TABLE II

Values of N for a square winding area—D = 1", C = 1 = D/2, R <sub>v</sub> = 4 ohms								
Circuits	Type	f <sub>c</sub> = 400	500	600	700	800	900	1000
Constant Z	Par. (L4)	267	239	225	202	190	178	170
	Series (L5)	189	169	159	143	134	126	120
Conventional m-derived	Par. (L1)	284	254	239	214	201	189	180
	Par. (L2)	225	201	184	170	159	150	143
	Series (L3)	178	159	145	135	126	119	113

For R<sub>v</sub> = 8 ohms, multiply all values by  $\sqrt{2}$ .  
For R<sub>v</sub> = 16 ohms, multiply all values by 2.

TABLE III

Correction factors for various values of D							
Diameter =	1/4	1 3/8	1/2	1 5/8	1 3/4	1 7/8	2.0
Table I	0.85	0.79	0.74	0.70	0.67	0.63	0.60
Table II	0.90	0.85	0.82	0.79	0.76	0.73	0.71

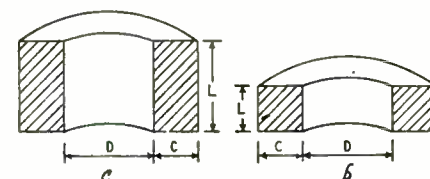

Fig. 2-a—Coils used in Table I. 2-b—Square cross-section coils of Table II.

TABLE IV

Turns per square inch for various sizes and types of wire			
Wire Size	D.C.C.	S.C.C.	Enameled
16	271	321	348
17	329	397	437
18	399	493	548





# "Short" Circuits

By ROBERT F. SCOTT

Technical Editor

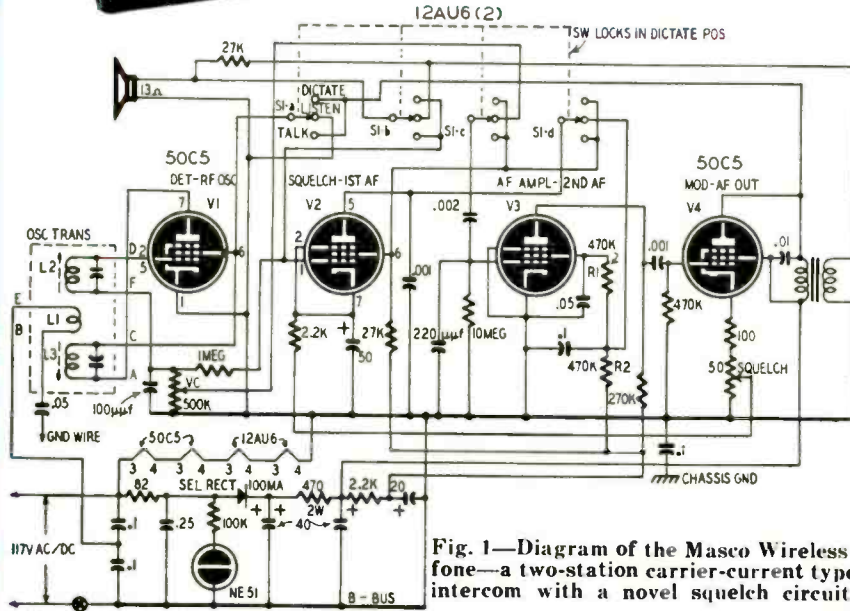

Fig. 1—Diagram of the Masco Wirelessfone—a two-station carrier-current type intercom with a novel squelch circuit.

HOME and office types of carrier-current or wired-wireless intercommunication systems are making a rapid comeback after about 15 years of relative oblivion. In this type of intercom, each unit or station is a radio transmitter and receiver combination. The desired information is carried from one station to the other over the power lines. No additional wiring is needed. For this reason, wired-wireless intercoms are widely used where it is desired to communicate between any two points on a common power distribution system. They are applicable to homes, small offices, material storage yards, industrial plants, and other places where it may be impractical to string connecting wires between the two points, or where it may be handy to move one or more of the stations to different places.

## The Masco Wirelessfone

The Masco model WF-1 *Wirelessfone* shown in Fig. 1 is typical of the two-station systems now widely used by parents as electronic baby sitters. Two identical units are used in the system. Unlike some systems which use one or both sides of the power line to carry the information, this system uses the metallic sheath of conduit as the active conductor whenever possible. Masco engineers claim that this increases the range of the units by making it possible to send and receive around distribution transformers, circuit breakers, and meters, which normally cut off or greatly attenuate the signal.

When switch S1 is in the LISTEN position, the incoming r.f. signal developed across coupling coil L1 is coupled into the receiver antenna coil L2 and its tuning capacitor. Section S1-a of the function switch grounds the plate and screen of V1 so its control grid and cathode function as a diode detector. The incoming signal developed across L2 is applied between grid and cathode of V1, and a rectified voltage appears across the 500,000-ohm volume control. Adequate r.f. selectivity and rejection of the 60-cycle line frequency is provided by L2 and its tuning capacitor, which are resonated at approximately 175 kc.

The full a.f. signal developed across the volume control is fed to the grid of V2 through a 1-megohm isolating resistor. A portion of the a.f. signal is tapped off by the arm of the control and fed through S1-c to the grid of V3, and the set operates as a conventional amplifier from here on.

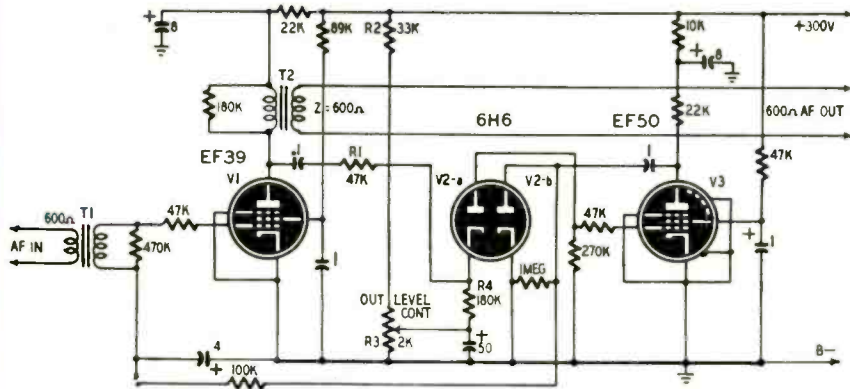

Fig. 2—Automatic volume control for audio amplifiers and PA systems.

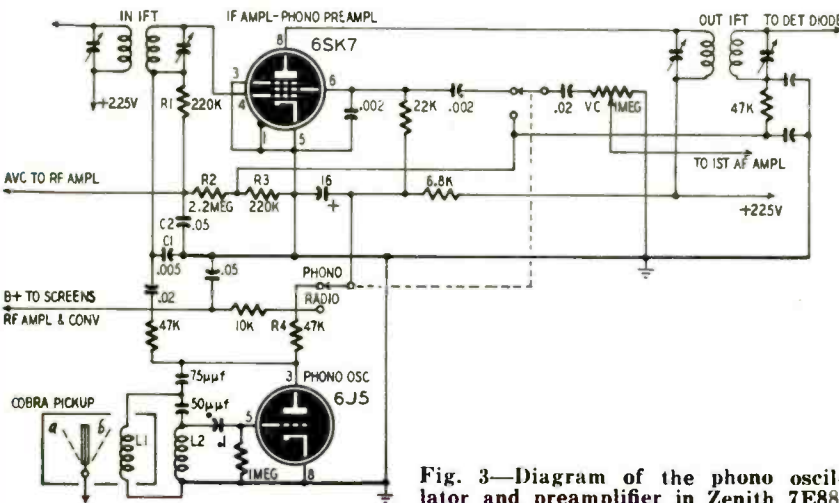

Fig. 3—Diagram of the phono oscillator and preamplifier in Zenith 7E88.



V2 is an automatic squelch tube which silences the receiver when no r.f. signal is being picked up. The plate voltage for this stage is tapped off at the midpoint of the 940,000-ohm screen resistor network (R1 and R2) for V3. The heavy plate current develops a large voltage drop across R2 and reduces the screen voltage of V3 to the point where this stage is virtually cut off.

When a r.f. carrier is received, the negative voltage developed across the volume control biases V2 to cutoff. The screen of V3 rises to the normal value and that tube develops full gain. The signal fed to the grid of V3 through the arm of the volume control is amplified normally, then passed on to the input circuit of the a.f. output stage (V4).

The 50-ohm squelch control in the cathode circuit of V4 determines the sensitivity of the squelch tube. Advancing the control so there is more resistance in the circuit places a small amount of positive bias on the cathode of V2, permitting weaker r.f. signals to operate the squelch circuit.

When S1 is thrown to TALK or DICTATE, V1 become the r.f. oscillator, operating at about 175 kc. V2 is the first a.f. amplifier, V3 is the second a.f. amplifier, and V4 is a class A Heising modulator. S1-a ungrounds the plate and screen of V1 and connects them to the plate of V4 through L3 of the oscillator transformer. L2 and L3 are grid and plate coils of a tuned-grid, tuned-plate oscillator. The modulated r.f. energy is coupled into the power line through L1.

The speaker is used as the microphone when transmitting. Its ungrounded side is connected to the grid of V2 through S1-b. S1-d disconnects the plate of V2 from the junction of R1 and R2 and connects it to its own screen, so this stage operates as a triode voltage amplifier coupled by S1-c to the grid of V3 through a .002- $\mu$ f coupling capacitor.

### A.v.c. for audio circuits

A device which automatically varies the gain of an audio amplifier system to hold its output constant as the input signal varies over wide levels is often needed in PA systems, radio-telephone modulators, conference-type intercommunicators, and teletype receivers. A circuit of this type is described by A. B. Shore<sup>1</sup> of the Engineering Division of <sup>1</sup>*Electronic Engineering*, Aug. 1952, page 374-376.

the BBC. Fig. 2 is the diagram of the a.v.c. amplifier which holds the audio output level constant to approximately  $\pm 0.2$  db as the input signal varies over a range of 40 db.

The unit operates at low signal levels. Its input and output are through transformers working from and into 600-ohm lines. With this setup, the a.v.c. amplifier can be constructed as a separate unit and inserted in the line between a mike and amplifier or between a preamplifier and main amplifier. However, there is no obvious reason why the circuit cannot be modified to operate with high-impedance input and output circuits. In this case, the circuit could be incorporated into a microphone preamplifier or amplifier control unit.

EF39, a European remote-cutoff pentode similar to the 7B7 and 6S7, is the variable-gain amplifier. The signal is fed into its control grid from the secondary of T1. After amplification, the signal is fed to the main amplifier through T2. The signal at the plate of the EF39 is also applied to a voltage divider consisting of R1 and R4. A portion of this voltage is tapped off and fed to diode V2-a connected in a high-impedance circuit to minimize loading on V1. The cathode of V2-a is biased positive by a voltage taken from R3, the output level control.

V2-a conducts only when the peak a.c. signal exceeds the bias on its cathode. When V2-a is conducting, the d.c. voltage developed across the 270,000-ohm diode load resistor is the difference between the peak a.c. voltage and the d.c. bias. The difference voltage is applied to the control grid of the EF50 bias amplifier. (This tube is available as war surplus but a 6AK5, 6SJ7, or a pair of triode stages may be substituted as long as they provide an equivalent amount of gain.) After amplification, the signal is rectified by V2-b and the resulting d.c. voltage is used to bias the control grid of V1. The voltage developed by V2-b is approximately equal to the product of the d.c. voltage produced by V2-a and the gain of V3.

### How it operates

Mr. Shore demonstrates the operation of this circuit with the following example:

The gain of V1 varies from 100 with minus 5 volts of bias to 1 when the bias is increased to minus 40 volts. V3 is operated with a constant gain of 100. V1 is initially operating with 5 volts of bias. The output level control (R3) is set so the cathode of V2-a is 10 volts positive.

When a 0.1005-volt (r.m.s.) signal is applied to the input, a 10.05-volt (r.m.s.) signal appears across the primary of T2 and 10.05 volts (*peak*) on the cathode of V2-a. The 0.05 volt difference between the d.c. bias and the peak voltage is rectified and fed to the grid of V3. This signal is amplified 100 times in the EF50, and then rectified by V2-b to produce 5 volts of bias for

the control grid of V1. Thus, we see how a 0.1005-volt signal is needed at the input terminals to maintain 5 volts of bias for V1.

Now, if the signal increases so the bias of V1 increases to 40 volts, the gain drops to unity. Working backward, the 40 volts of bias requires a signal of approximately 0.4 volt peak on the grid of V3. Since this is the difference between the peak output of V1 and the d.c. bias (10 volts) on the cathode of V2-a, V1 must develop a 10.4-volt signal. Since its gain is unity with 40 volts of bias, the input signal must be 10.4 volts.

From these examples, we see that the output changes only 0.35 volt—less than 0.3 db—as the input voltage changes from .1005 to 10.4—a change of slightly more than 40 db.

### Zenith's Cobra pickup circuits

Dynamic and crystal pickups are voltage generators, but the Cobra pickup controls the voltage developed by an r.f. oscillator and detector combination. Fig. 3 shows the circuit used for the pickup in the Zenith 7E88 chassis. The oscillator grid coil L2 and the other components of the 2.5-mc r.f. oscillator are mounted on the receiver chassis, while plate coil L1 is in the cartridge assembly. L1 consists of approximately 40 turns of No. 40 wire fixed in position in the cartridge. The needle or stylus is fastened rigidly to a stainless-steel vane pivoted so movement of the needle causes it to move closer to or farther away from L1.

The needle follows the grooves in the record and the vane swings between *a* and *b*. This changes the Q of L1 and varies the voltage across it.

Since L1 and L2 are parts of the oscillatory circuit, any change in the r.f. voltage in L1 will vary the grid-leak bias and cause a change in plate current. The plate current, which varies with audio modulation on the record, causes a corresponding a.f. voltage to develop across the oscillator load resistor R4.

### The preamplifier

This audio signal voltage is fed to a voltage amplifier stage. The voltage amplifier varies from one set to another. In the 7E22 chassis, the i.f. amplifier is used as the phonograph preamplifier. The signal voltage is taken off the oscillator plate through a 47,000-ohm resistor and a .02- $\mu$ f capacitor and is fed to the grid of the 6SK7 i.f. amplifier. C1 filters out any 2.5-mc r.f. voltage that may be present.

The secondary of the i.f. transformer does not affect the operation of the circuit because it appears as a short-circuit at frequencies far removed from resonance (455 kc). The control grid of the 6SK7 is returned to ground through R1, R2, and R3.

The audio voltage is amplified between the control and screen grids and then fed to the volume control in the grid circuit of the 6SQ7 detector and first a.f. amplifier. END



Harmonic-rich sawtooth waves . . .  
easy and inexpensive to produce  
. . . can help the technician

## Check Audio Response with a NEON GLOW TUBE

By JAMES G. ARNOLD

THE neon-lamp oscillator is highly popular as a modulator in low-cost signal generators and related equipment. It can also be used effectively in many other applications. The output of a neon-lamp oscillator is a sawtooth wave. If the proper precautions are taken, this device can be used to test audio-amplifier response in the same way as a square-wave generator. The test procedure is as simple as the square-wave method and the cost of the equipment is negligible. This method of testing amplifier response, of course, can be used with any type of sawtooth generator. The neon-lamp oscillator is stressed because the components are widely available and very inexpensive.

### Waveform analysis

Let's analyze a sawtooth wave and compare it with a square wave. Any waveform can be broken down into a number of component sine waves: These are a fundamental and its harmonics of various amplitudes. Figs. 1 and 2 show the harmonic content of a symmetrical square wave and a linear sawtooth wave. The sawtooth wave has about half the odd-harmonic content of the square wave. For example, the 7th harmonic in the square wave is twice the amplitude of the 7th harmonic in the sawtooth. We might conclude that testing an amplifier over a given range with a sawtooth wave would require about twice as many points as with a square wave. This is generally true.

Suppose we are testing an amplifier with flat response to 5,000 cycles, but falling off rapidly at higher frequencies. If a 3,000-cycle sawtooth wave is applied to the input, the 3,000-cycle fundamental component will get the full gain of the amplifier but its harmonics will not. This will result in a distorted

sawtooth wave at the amplifier output. In a similar manner, if the amplifier has poor low-frequency response and a 50-cycle sawtooth is applied to the input, the high-frequency harmonics will be amplified more than the 50-cycle fundamental. The output wave will be distorted in a different manner. The effects of poor high- and low-frequency response on square waves and sawtooth waves are illustrated in Fig. 3. In both cases poor low-frequency response distorts the portions of the waves that have the slowest rate of change. The circuit time-constants are too short to maintain a relatively long transient potential. Poor high-frequency response rounds off the sharp corners through the inability of the circuit to accept rapid rates of change in voltage. With the proper interpretation amplifier response can be checked with a sawtooth wave as well as with a square wave.

### The oscillator circuit

Fig. 4 is the basic circuit of a neon-lamp oscillator. When d.c. is applied the capacitor starts to charge up to the applied voltage, but the charging current is limited by R. The capacitor voltage rises according to the exponential formula  $E_c = E_n(1 - e^{-t/RC})$ . This charging cycle is illustrated in Fig. 5. For all practical purposes the capacitor will reach the applied voltage after about 4 time constants (4RC).

When the rising voltage across the capacitor reaches a critical value called the "ignition point" the neon lamp ionizes and conducts. Its internal resistance when ionized is low enough to act as a virtual short circuit. The capacitor discharges almost instantly through the lamp until the voltage drops to a second critical value called the "extinction point." At this point the neon lamp de-

ionizes and removes the short across the capacitor. The charging cycle immediately begins again and the process repeats itself indefinitely, generating the voltage waveform shown in Fig. 6-a.

(Ignition and extinction voltages differ widely with various types of neon lamps. In general, lamps made for 117-volt service ignite at about 70 volts and extinguish at about 55 to 60 volts. The sawtooth waves shown in Fig. 6-a would thus have a peak-to-peak amplitude of 10-15 volts.)

The waveform shown in Fig. 6-a is not linear enough for our purpose. For maximum linearity we use only a small portion of the charging cycle. We cannot change the extinction or ignition voltages of the neon lamp but we can accomplish the same thing by increasing the applied voltage ( $E_n$ ). This gives us the steeper charging curve shown in Fig. 6-b.

The high-frequency limit for this type of relaxation oscillator is approximately 10 kc. Above this frequency the deionization time of the lamp becomes an appreciable part of the cycle. The bulb will not be able to extinguish itself fast enough to start the next cycle immediately.

The oscillator frequency can be determined mathematically from the time required for the charge to rise from  $E_c$  to  $E_i$ . This turns out to be:

$$t = RC \times \log \left( \frac{E_n - E_i}{E_n - E_c} \right)$$

where;

t = time (seconds)

RC = microfarads times megohms

$E_i$  = ignition voltage

$E_c$  = extinction voltage

$E_n$  = supply voltage

The frequency is 1/t. While this formula enables one to calibrate the oscillator

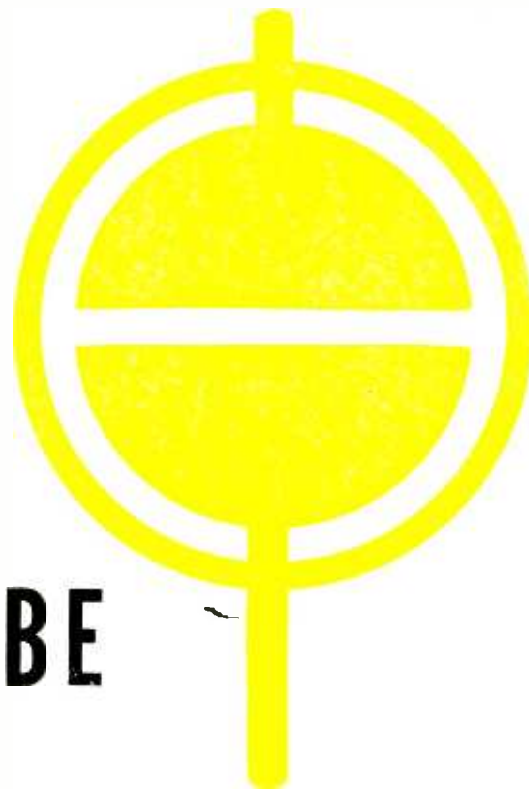

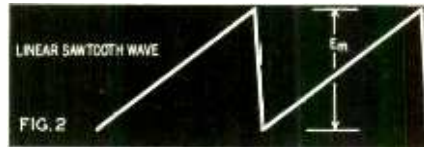

SQUARE WAVE

SAWTOOTH

1(F)	2	3	4	5	6	7	8	9	10	No. of harmonic	1(F)	2	3	4	5	6	7	8	9	10
100	0	33	0	20	0	14	0	11	0	% of fundamental	100	50	33	25	20	17	14	12	11	10
127	0	41	0	25	0	18	0	14	0	% of E <sub>m</sub>	63	32	21	16	13	10	9	8	7	6

Figs. 1 and 2—Main harmonics of square and sawtooth waves.

Fig. 3—Distorted waveforms show amplifier deficiencies.

Fig. 4—Neon-lamp oscillator.

Fig. 5—Capacitor charges exponentially through resistor.

Fig. 6—(a) Neon-oscillator waveform. (b) Raising supply voltage improves linearity.

Fig. 7—Complete oscillator-buffer-amplifier schematic.

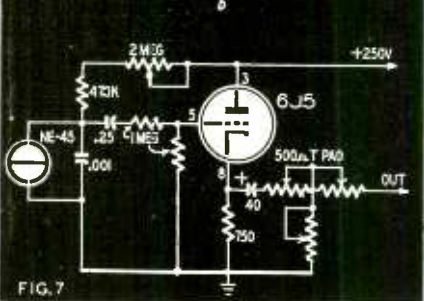
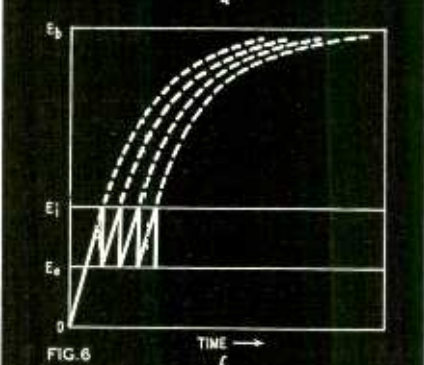
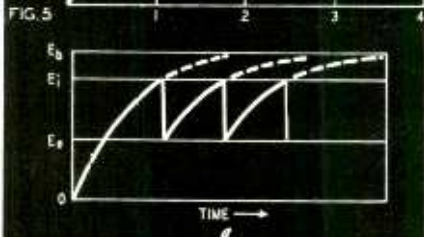
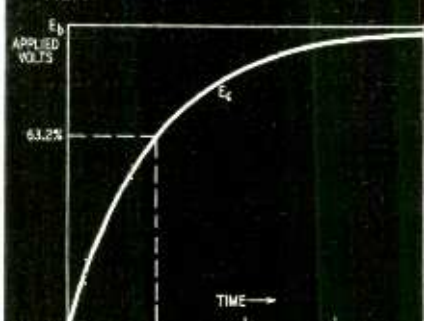
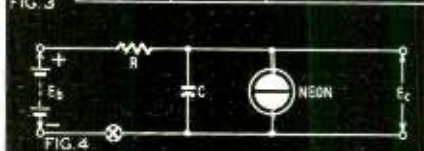
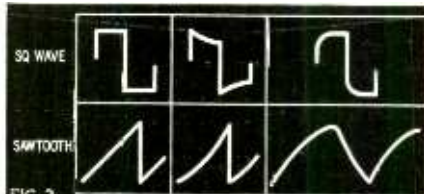

on paper, it is much less trouble to calibrate the oscillator with a good signal generator and an oscilloscope.

**Additional circuit requirements**

While a sawtooth output of 10 to 15 volts is adequate for most amplifier tests, the neon-lamp generator is inherently a high-impedance device. Its frequency and waveform will be seriously affected if the oscillator is heavily loaded. The solution is to use a buffer amplifier between the oscillator and the equipment under test.

Since no voltage amplification is needed a cathode follower is the ideal buffer for this purpose. (See "Cathode Follower Applications," by I. Queen, in last month's RADIO-ELECTRONICS.) Its input impedance is very high, and the output impedance may be practically any value desired.

Care should be taken not to overload the buffer. If the cathode follower is not capable of handling the 15-volt input a voltage divider should be used in the grid circuit, as shown in Fig. 7. The buffer grid receives only 7½ volts and its output is approximately 5 volts. A 500-ohm T-pad attenuator is used to maintain constant output impedance. If higher output voltage is required change the buffer-output coupling capacitor to 0.5 µf and feed the signal to the grid of a low-distortion voltage amplifier. This amplifier should have a grid resistor of at least 100,000 ohms.

This basic circuit can easily be adapted to the individual requirements of the experimenter. Where frequency stability is important use a well-regulated voltage supply for the oscillator. This can be done with gaseous regulator tubes. The variations are unlimited and the basic circuit should prove valuable to any experimenter. END

**PHONO OSCILLATOR FOR FM AND SPLIT-SOUND TV SETS**

By ELLIOT A. McCREADY

The FM phono oscillator shown in the diagram was built for use with my Du Mont FM-TV receiver. The unit can be constructed on an extremely small chassis. The combined frequency characteristics of the FM or TV receiver and the average recording and crystal pickup give reproduction that will satisfy the average listener.

The circuit is a conventional reactance-modulated oscillator using a 12AT7 dual triode operating on any convenient portion of the TV or FM band. With this coil (5 turns No. 16 tinned copper spaced to ½ inch on a ¾-inch slug-tuned form) the operating

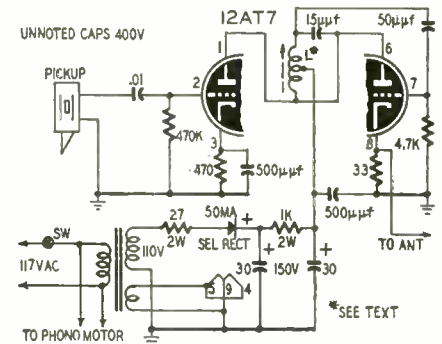

Circuit of the FM phono oscillator.

frequency is variable enough to cover the lower TV band but a slight reduction in the number of turns will raise

**Materials for phono oscillator**

- Resistors: 1—470,000, 1—4,700, 1—470, 1—33 ohms, ½ watt or larger; 1—1,000, 1—27 ohms, 2 watts.
- Capacitors: (Mica or ceramic) 2—500, 1—51, 1—15 µf 400 volts. (Electrolytic) 2—30 µf, 150 volts.
- Miscellaneous: 1—half-wave power transformer with heater winding, 1—s.p.s.t. toggle switch, 1—50-ma selenium rectifier, 1—12AT7, 1—9-pin miniature socket, 1—slug-tuned ¾-inch form, hookup wire, hardware.

the frequency if desired. Oscillator drift might prove annoying on the higher frequencies, so a low operating frequency is recommended. None of the components is critical; however a high-output crystal pickup should be used to fully modulate the FM oscillator.

Heat causes frequency drift, so mount all heat-producing components in a well-ventilated spot. Use high-frequency wiring technique—keep leads short. The antenna is an 8-inch length of hookup wire. Use as short an antenna as practical to minimize radiation.

The constructor must remember that this unit will not operate with a TV set using an intercarrier sound circuit. Intercarrier receivers require a fixed-frequency picture carrier to beat against the sound carrier and produce a new sound i.f. of 4.5 mc which deviates up to ± 25 kc with the FM modulation. END



# TAPE RECORDING

By I. QUEEN

Editorial Associate

## PART IV—Professional-type units and special equipment for dubbing to film or disc

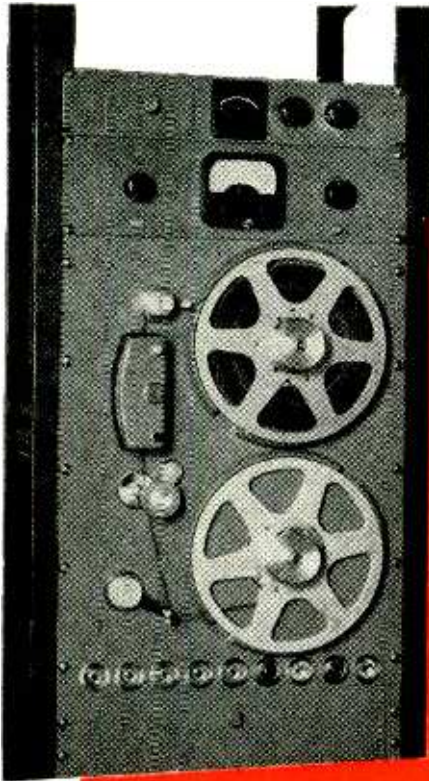

(Above) RCA PT-11A broadcast-quality tape installation. Below) Magnecordette portable record-playback unit.

**M**OST professional recorders operate at 15 i.p.s. and maintain good response to 15 kc. Almost identical equalization is used in the different makes so that tape recorded on one machine can be played back without distortion on another. Treble is boosted during recording (pre-equalization). Bass is boosted during playback (post-equalization).

Heavy-duty professional equipment is often designed to mount either vertically in a rack or horizontally in a console. (Vertical mounting saves considerable space in multiple installations, and provides complete accessibility and visibility for checking operation.) Two or more large motors are generally used to drive the transport. These can start and stop the mechanism almost instantly, and they practically eliminate wow. Most models have separate amplifier channels for recording and playback. Signal-to-noise ratio is maintained at 55 db or better. Push-button control is often included. The buttons energize solenoids so that the machine can be adapted easily to remote control. A VU meter (instead of a neon lamp or electron-ray tube) indicates signal level.

Semiprofessional models may include some of the features mentioned above, but are designed for lighter duty. They may be installed in a cabinet for home or office use, or in one or two carrying cases. Prices in this group range from about \$285 to \$600.

### Concertone

Concertone model 1401 has many desirable professional features. It is a basic unit which may be installed in a console or carrying case. The carrying case includes an 8-inch high-fidelity speaker and a monitoring amplifier.

The transport uses three balanced motors and runs at either 7.5 or 15 i.p.s. At fast speed, response is flat (2 db) from 50–15,000 cycles. Wow is 0.1% and signal-to-noise ratio is better than 50 db. Rewind speed is over 2,500 feet

per minute. A 10½-inch tape reel can be accommodate, for one-half hour, single-track recordings at 15-i.p.s.

The Concertone is supplied with either single (full-tape-width) heads or dual-track heads. Three separate heads (erase, record, playback) are prealigned on a "quick-change" base. Thus monitoring may be done directly from the tape. Immediately after being magnetized at the recording head, the tape passes the playback head for monitoring.

Fig. 1 is the amplifier circuit. Recording and playback channels are separate.

The recording amplifier is the lower section. The first two stages (V104 and V105) have flat response and high gain. The next stage (V107) provides treble boost. (This minimizes the effects of hiss, thermal noise, and other h.f. background sounds that may be introduced during or after recording, and compensates for h.f. loss in the playback system.) Its 15,000-ohm cathode resistor is shunted by a series-resonant network. With the speed switch closed (7.5 i.p.s.) the resonant frequency of the network is about 8 kc. When the switch is open, resonance is at 15 kc. At frequencies far below resonance, the network has such high impedance that it has negligible shunting effect on the cathode resistor. Degeneration in the large cathode resistor gives the stage low gain. As the frequency rises the network impedance decreases and reduces the negative feedback by shunting the cathode resistor to a greater degree. The gain increases uniformly up to the network resonant frequency.

V106 works as a diode. Its plate load is a 10-megohm resistor and a .02-μf capacitor. The capacitor charges rapidly when the diode conducts on negative half-cycles of the audio signal. Then it discharges slowly through the 10-megohm resistor. The charge follows the average audio variations so it can be used to indicate modulation level on the 6E5 electron-ray tube.

The h.f. erase-oscillator (Fig. 2) is designed for minimum hiss and noise.



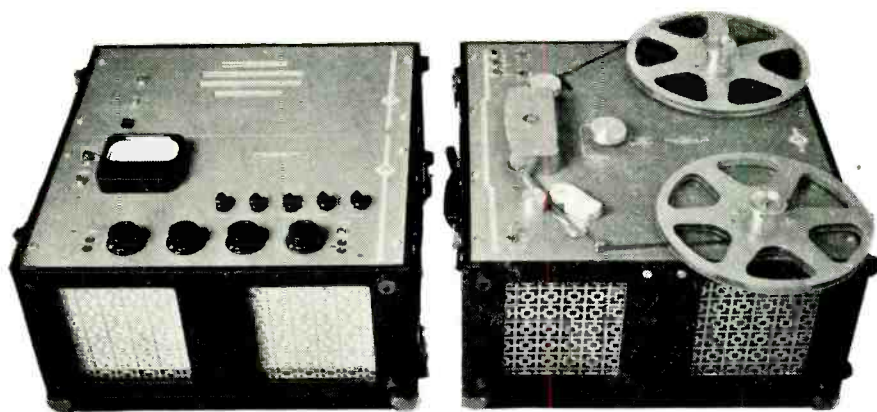

Stancil-Hoffman model R4 wide-range portable recorder-playback.

Two 6AQ5 tubes are used in push-pull at a frequency of about 60 kc. The circuit is adjusted first for minimum oscillator hiss with the 500-ohm balance potentiometer. The *noise adjust* control reduces residual tape noise by injecting a small amount of d.c. bias into the recording head. When correctly set, tape hiss is practically zero. Note that the erase head itself forms the plate tank of the oscillator.

The playback channel is at the top of Fig. 1. The first stage (V101) has high gain and is not equalized. The R-C networks between the next two stages

boost bass considerably. The .003- $\mu$ f capacitor and 5,600-ohm resistor shunt the input to V103. At high frequencies the capacitor is a virtual short, and bypasses most of the signal to ground through the 5,600-ohm resistor. At low frequencies the capacitor is practically an open circuit, and there is no shunting effect. (There is no actual *bass boost*; the lows are made to seem stronger by reducing the highs. This is one of the reasons for the h.f. pre-emphasis in the recording amplifier.) The small variable capacitor across the 2.2-megohm resistor allows the

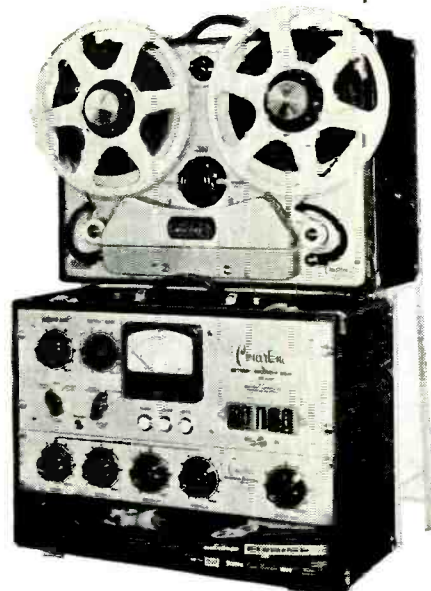

Concertone NWA-1 portable network recorder with 4-channel signal mixer.

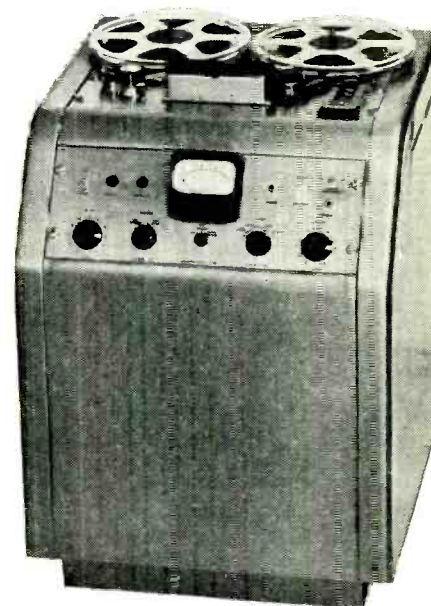

Ampex model 402 console recorder with combined control-playback amplifier unit.

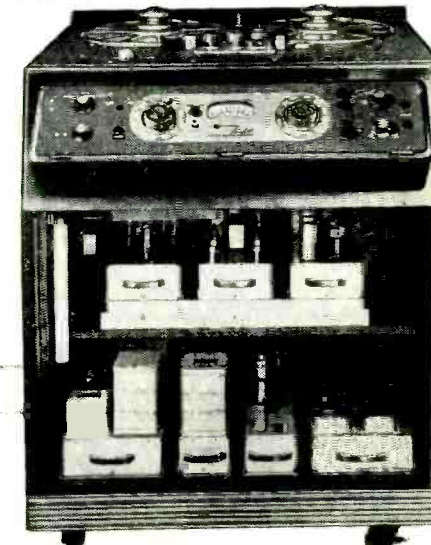

Fairchild 126 master unit for recording, playback, and dubbing to or from other recording media (film, disc, or wire).

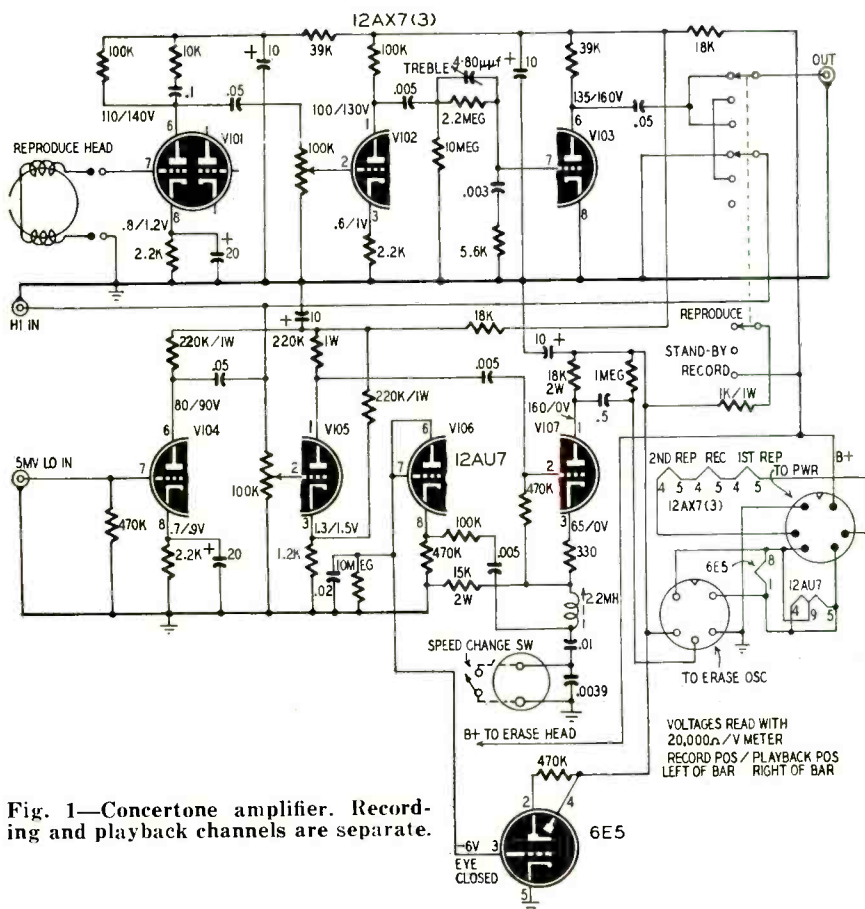

Fig. 1—Concertone amplifier. Recording and playback channels are separate.



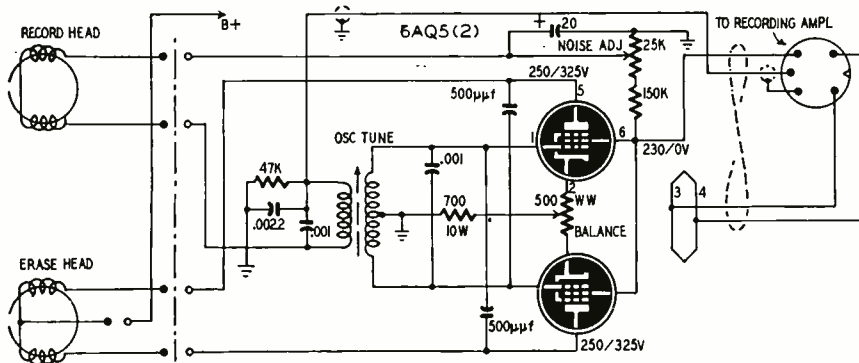

Fig. 2—Concertone recorder h.f. bias and erase oscillator.

treble response to be adjusted over a narrow range to compensate for wear in the heads. (See Part II of this series, in the September RADIO-ELECTRONICS.)

The heaters of the three 12AX7 tubes (V101 to V105) are connected in series and supplied with d.c. for low hum and noise. The output of the playback channel (about 1 volt r.m.s.) feeds into the monitoring amplifier shown in Fig. 3.

The playback amplifier may also be used for PA work. The *low input* terminal is used for weak signals (down to 5 mv). Signals of about 1 volt or more are fed directly to the monitoring amplifier when the recorder switch is set to *standby*.

Fig. 4 is the schematic of the power supply.

The Concertone rack-mounted network model NWR-1 has advanced professional features. Its response is 40–15,000 cycles, and signal-to-noise ratio is 55 db. The tape attains full speed in less than 0.1 second, and can be stopped almost instantly. A VU meter measures input and output levels, and bias current. This model may be operated by remote control.

**Magnecord**

Model PT6-A is a basic portable recorder mechanism, and requires an external amplifier. Transport speeds are 7.5 or 15 i.p.s. Speed is changed by removing one capstan and substituting another of different diameter. Separate heads provide erase and record-playback functions. At 15 i.p.s. response is 50–15,000 cycles (2 db). At 7.5 i.p.s. it is flat to 7,000 cycles. Normally a 7-inch reel is maximum. With an adapter, the

transport takes a 10½-inch reel. The PT6-J matching portable record-playback amplifier has a single channel equalized for one speed (7.5 or 15 as specified).

Model PT7-A is a more advanced portable unit with push-button control, electrical speed changing, high forward speed, and three separate heads. Single- or three-channel matching amplifiers with VU meters and equalization control are available.

The recently announced *Magnecordette* uses a PT6-A mechanism with a built-in recording amplifier. Both are mounted in a cabinet suitable for home or office. Features include: fast forward shuttle, two inputs (mike and radio-phon), and equalization for each speed (7.5 or 15 i.p.s.). Audio-tube heaters are fed with d.c. For playback the recording amplifier acts as a pre-amplifier which may be connected to any radio or phono power amplifier. Its output impedance is 100,000 ohms.

**Stancil-Hoffman**

Model R4 has a response flat within 1 db from 50–15,000 cycles at 15 i.p.s. At 7.5 i.p.s. it is flat to 7,500 cycles (1 db). Wow is less than 0.1%. Rewinding is at 2,000 feet per minute, and a 5,000-foot roll of tape can be accommodated. An illuminated 4½-inch VU meter indicates input and output levels, bias, and erase currents. Forward, rewind, and stop are controlled by push-buttons.

R4-30 is an even higher-fidelity recorder with a tape speed of 30 i.p.s. Its output is flat from 40 to 40,000 cycles within 2 db. Wow is less than .09% and harmonic distortion less than 1%.

Both models can operate either horizontally or vertically and take reels up to 13¾ inches in diameter. No rubber idlers or linkages are used in the drive systems. Speed is variable in either direction. Motor torque is controlled automatically for different reel diameters and as the takeup reel winds up more tape and becomes heavier.

**Ampex**

Models 400A and 401A have many features of console recorders, but are available in portable cases. The first uses half-track heads, the other full-track heads. Otherwise they are similar. These recorders are push-button operated. Relays and solenoids control

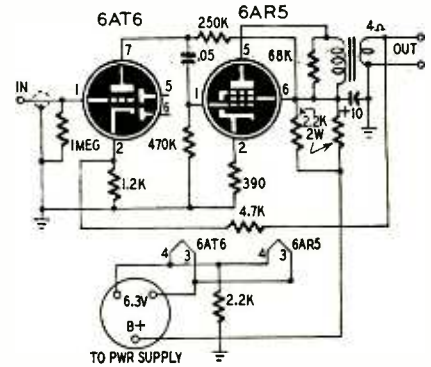

Fig. 3—The schematic diagram of the Concertone tape-monitoring amplifier.

mechanical functions so that remote control may be used if desired. Speeds are 7.5 and 15 i.p.s. in both models. Special head design and equalization networks give flat response to 15 kc even at the slower speed! A 4-inch VU meter reads input and output levels, and may be used to measure bias and erase currents while recording. The input can be used with high-impedance radio tuners or low-impedance broadcast mikes. A built-in mike preamp is included. The erase, record, and play heads are in a single plug-in housing for quick removal or replacement.

The machine reaches full speed in 0.1 second and can be stopped in the time it takes the tape to move 2 inches. Wow is 0.2%. Special shielding on the heads and d.c. operation of the first amplifier-tube heater give a signal-to-noise ratio better than 55 db.

Model 300 is a heavy-duty console recorder. Wow is 0.1%. Response is 30–15,000 cycles at either 7.5 or 15 i.p.s. Rewinding is done at 2,400 feet per min.

**Amplifier Corp. of America**

This manufacturer introduced the idea of using twin tracks on standard tape, and now makes "Twin-Trax" models 810 and 710. These are single-speed machines. In each case, the code letter "B" is added to indicate the 7.5-i.p.s. speed, and "C" denotes 15 i.p.s. The 810-series recorders are complete in themselves. The 710 series are composed of two separate units, the transport (plus speaker), and the amplifier, each in a rugged, luggage type case.

These machines feature automatic reversal. A piece of aluminum foil is attached at the desired point along the recording tape. When the foil contacts a switch, it energizes a solenoid which reverses the mechanism. Complete reversal is effected in 0.2 seconds. Each "Twin-Trax" has a signal-to-noise ratio of 45 db or more. At the faster speed, response is flat (2 db) from 30–13,000 cycles. Wow is less than 0.2%.

Fig. 5 shows the recording amplifier. The first two stages raise the signal to about 1 volt.

The first section of the 6SN7-GT is a booster stage to compensate for the voltage loss in the following equalizer. The second section is fed from a voltage divider made up of the 270,000-ohm, 10,000-ohm, and 100,000-ohm resistors. The 500-µF capacitor bypasses the

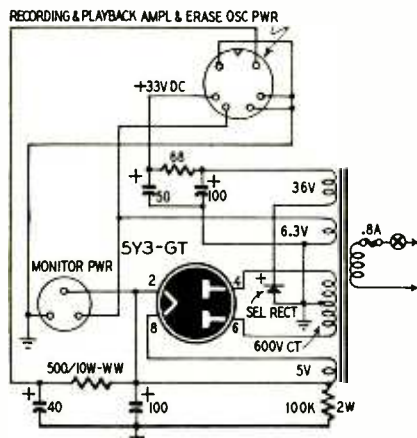

Fig. 4—Power supply for above units.





# TV SERVICE CLINIC

Conducted By  
**MATTHEW MANDL\***

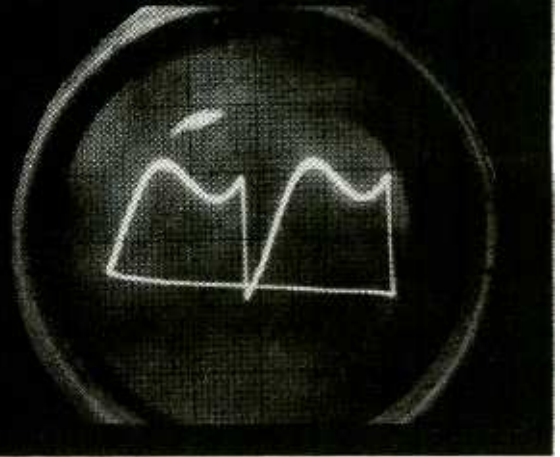

Fig. 1—Waveform at "C" in Synchronguide circuit. (Scope sweep 7,875 cycles.)

ONE of the disadvantages of the Synchronguide horizontal-a.f.c. lock system is the complex adjustment procedure necessary when the circuit gets out of alignment. This involves critical settings of frequency and waveform controls, horizontal locking-range trimmer, hold control, and drive, to get the waveform shown in Fig. 1 (The scope is connected between point "C" and ground.) If the broad and narrow peaks are not of equal height, pull-in and noise-immunity will be affected. (See RADIO-ELECTRONICS for January, 1952, page 50). These tedious adjustments are a nuisance to the busy service technician, and the unpopularity of the Synchronguide circuit (Fig. 2) is attested by the number of letters received by the Clinic on the subject.

A preview of some 1953 receivers brings the welcome news that a number of manufacturers are abandoning the Synchronguide in favor of the older *phase-detector* or Synchronlock circuits. As these systems involve several tubes compared with a single 6SN7-GT for the Synchronguide, the change is apparently aimed at simplifying service for the benefit of the technician. The fewer adjustments required with the older circuits mean that the horizontal sweep can be brought to peak performance without having to remove the chassis for the scope routine.

Despite the widespread use of the Synchronguide circuit during the past few years, several companies have always been "hold-outs"—among them Westinghouse, Capehart, Zenith, and General Electric. These manufacturers continue to use the older lock systems in their latest receivers. For example, in the new Capehart CX-36 receiver, chassis CT-52 and CT-57, a 6AL5 tube is used as a phase discriminator, one-half of a 12AT7 is used for a reactance control, while a 12AU7 is used for an oscillator and discharge tube. The circuit is similar to the one used in the original RCA 630 receiver.

In the 1953 Zenith receivers (chassis 19K20, 19K22, 19K23, and 21K20 series) one-half of a 6AQ7-GT tube is

used as a horizontal phase detector, and the other section of the tube is used for the oscillator control. A 6SN7-GT is used for the horizontal blocking oscillator and discharge tube. In both the Synchronlock and phase-detector systems, the discharge tube is necessary to develop sufficient grid drive for the horizontal output tube. Adding the discharge tube for sawtooth formation also gives better control of horizontal linearity.

Philco, one of the first to use the Synchronguide, has abandoned it in its new TV-90 receivers in favor of a 6AL5 phase discriminator and a 12AU7 cathode-coupled multivibrator horizontal oscillator.

### Other changes

Capehart, Zenith, Admiral, Emerson, and a number of others are now using the cascode-tuner principle for greater signal-to-noise ratio and for higher gain. RCA and Philco, who have been using cascode tuners for about two years, have added some refinements for better a.g.c. action and improved performance. The 6BZ7 is replacing the former 6BQ7 for the r.f. stage because of its higher transconductance (6,800  $\mu$ hos, against 6,000 for the 6BQ7).

Besides the foregoing, many new receivers have swung to the type of vertical sweep circuit in which two tubes (or a single twin-triode) form a combination multivibrator and output amplifier. This system has an elaborate

R-C network to cut down noise susceptibility and increase vertical sync stability.

Familiarization with these circuits is a must for the progressive technician. He will encounter them more frequently in all late models. (For more complete descriptions of the cascode and vertical-sweep circuits, refer to the April, 1952, issue of RADIO-ELECTRONICS, page 46.)

### Inability to center picture

I have converted an Admiral 30A1 receiver to a larger tube. I used a Merit HVO-7 flyback transformer and an MDF-70 cosine yoke. I am using a Quam QF2 focalizer but left the old focus coil in the circuit temporarily so as not to disturb voltages and currents in the circuit. I intend to replace it later with a resistor of suitable value. I am unable to center the picture properly and cannot get rid of neck shadow at the right side of the screen. This shadow seems to be affected by the ion-trap position—that is, moving the ion trap back and forth will increase and decrease the shadow. The position of the focalizer also affects the shadow to some extent. However, even by positioning these units to the best of my ability, I still get the neck shadow and cannot position the picture to fill the mask. The ion trap must be placed near the base of the tube. D. C. G., Bloomfield, Conn.

When the focalizer and centering adjustments cannot correct the conditions

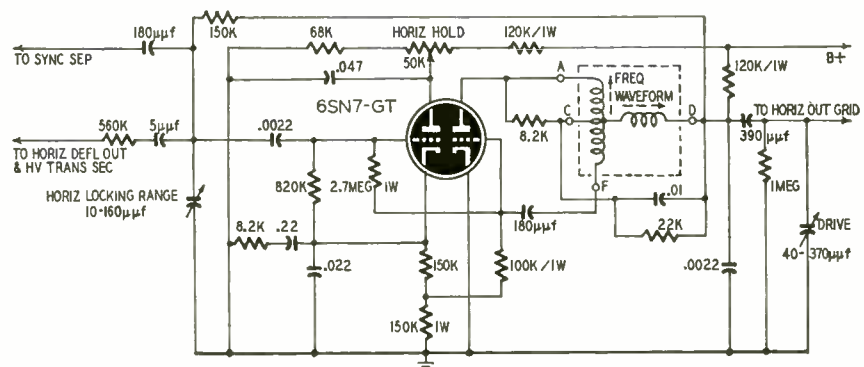

Fig. 2—Synchronguide horizontal oscillator and automatic frequency control.

RADIO-ELECTRONICS

\*Author of Mandl's Television Servicing

you detail, the fault may be either improper idling voltage to the yoke or improper alignment of the yoke with respect to the focalizer. See that the yoke fits snugly against the flare of the picture tube. The yoke bracket may have to be bent so the yoke will line up properly with the focalizer. Remove the picture tube and see that the hole in the focus unit is aligned with the neck aperture of the yoke.

The fact that the ion-trap magnet must be placed against the base to reduce neck shadow may indicate either the wrong type (single-magnet vs. double), the wrong strength (gauss), or a correct magnet that has weakened with use. Use a single-magnet ion trap with bent-gun picture tubes. (You did not mention the type of tube in use at present.) This condition may be corrected when you cure the troubles with the focalizer and yoke positioning. The focalizer adjustments should take care of corner shadow, and the ion trap should be adjusted for *maximum brightness only*.

**Picture quality**

*In a Tech-Master model 1930 receiver, the definition is poor. The trouble seems to be poor interlace, and it seems that when a program is being received the picture is out of focus, yet the individual horizontal line traces are sharp and clear. The receiver has been aligned but this apparently had no effect. E. G., Bedford, Ohio.*

From your description of the symptoms, it is obvious that the poor definition is caused by defects in the video-amplifier circuits, misalignment, or overloading on exceptionally strong signals. The fact that line structure is sharp and clear but picture detail is blurred indicates that the focus circuit is normal. (This would not be caused by poor interlace. Loss of interlace would coarsen line structure but the picture would still appear fairly sharp and clear.)

First try disconnecting one of the antenna leads. Then check both video-amplifier stages for defective tubes, resistors, capacitors, and peaking coils, or open connections.

If the video-amplifier stages are all right, the trouble is probably improper tuner tracking or picture-i.f. alignment. Despite the fact that you had the receiver realigned, it is advisable to re-

check i.f. alignment with the procedure given in the RCA 630 service notes. Make all trap adjustments first to prevent them from interfering with the bandpass response curve. Use an accurate marker, sweep generator and scope. The tuner in the Tech-Master model 1930 differs from that used in the RCA 630, and the specific service notes for the particular tuner used would have to be followed. Some Tech-Master receivers used the 206E1 tuner, and others the TV-201 Standard Coil tuner.

**Buzz in Sentinel**

*In a Sentinel model 413 a pronounced buzz has developed in the audio. The intensity of the buzz varies with the picture modulation, and with the setting of the contrast control, but cannot be eliminated by turning down the contrast. In this receiver there is also insufficient width. What remedies do you suggest? J. L. D., Milford, Mass.*

From your description you are getting "intercarrier buzz". This is a condition encountered frequently in intercarrier receivers. Try adjusting the slug trimmer in the 4.5-mc coil feeding the 6AU6 first-sound-i.f. amplifier. If this does not reduce the buzz, adjust both the primary and secondary of the discriminator transformer feeding the 6T8 sound detector. Do not turn the trimmers very much either way because these settings are critical and you may throw the discriminator completely out of alignment. If these procedures do not help, look for defective tubes and parts, and check the alignment of the i.f. and 4.5-mc sound stages.

For decreased width, check for an open 500- $\mu$ f capacitor between the 6W4 damper plate and the horizontal size trimmer. Also try a new 6BG6-G and a new 1X2. A short or a leak in the .05- $\mu$ f and 0.1- $\mu$ f capacitors connected to the horizontal linearity coil could also cause this trouble. Also check the 250- $\mu$ f sawtooth-forming capacitor in the horizontal oscillator output circuit.

**TV audio to hi-fi amplifier**

*I would like to feed the audio output from an Admiral 30A14N television receiver to a Heathkit Williamson pre-amplifier. Can this be done by tapping the audio from the voice coil? The TV speaker has a 750-ohm field coil and a 3.6-ohm voice coil. What is the best procedure for doing this? C. B. H., Memphis 12, Tenn.*

In order to feed the audio from an Admiral 30A14N receiver to your Heathkit Williamson preamplifier, you should take the output from the volume control as shown in Fig. 3. This will give better tone quality than if you attempted to use the output of the receiver's whole audio system. Disconnect the audio plug (M201) from the lower chassis and feed it into your amplifier by attaching a suitable plug. Do not disturb the 6SJ7 or 6Y6-G tubes in the receiver. There is no harm in their not getting a signal input, and their normal current drain will maintain the

proper load on the TV power supply. (If there is any hum or howl from the TV speaker, short out the audio input connector M202.) Leave the speaker undisturbed to maintain the field coil circuit for the power supply. Use the crystal or tuner input to the Williamson or bypass the preamp entirely. The volume control in the TV receiver can be used to set the output desired.

**Arcs and shorts in h.v. system**

*In a Stromberg-Carlson TC-19 receiver I am experiencing considerable difficulty with arcing and shorts in the high-voltage system. The condition is more pronounced during damp weather. I have tried to find the arc a number of times but have not been able to locate the exact place of breakdown. I have cleaned all the dust from the high voltage section without avail. What suggestions do you have? W. E. R., Chicago 17, Ill.*

Arcing and shorts in the high-voltage system of this receiver are often caused by poor contact at the junction of the plug-receptacle high-voltage connectors. Press them firmly together for good contact. The connector lead should be dressed away from any tubes—especially the 12AU7's—to prevent heat deterioration of insulation which could short the high voltage. (This multilead cable is the one that plugs into the top of the main chassis.)

Early production runs of this model were subject to failure of the 500- $\mu$ f, 15,000-volt capacitors (part 110595) in the high-voltage supply. The deflection-coil assembly (part 114672) also developed internal shorts through heat breaking down the insulation between windings. Replace the capacitors with 500- $\mu$ f, 20,000-volt types (part 110680). The new replacement yokes have improved insulation to minimize breakdown, though they have retained the same part number as the original.

**Fuse and screen-resistor failure**

*In a Philco 50T1403 receiver the fuse has blown and the horizontal output screen resistor has burned out. Could you list the common causes for these conditions? Also, how can the width coil be checked? I get no resistance reading across it. Any information would be greatly appreciated. R. H., Wood Ridge, New Jersey.*

The blown fuse as well as the burned-out screen resistor could be caused by a shorted screen-bypass capacitor or one which shorts intermittently. Other causes include a gassy or defective 6BG6-G horizontal output tube or improper grid drive to this tube. Improper drive will increase current consumption and shorten the life of the tube as well as overheat parts.

The width coil can be checked by disconnecting it from the secondary of the flyback transformer. This coil has very low resistance (a fraction of an ohm) and an ordinary ohm-meter is only useful for checking whether or not the winding is open. END

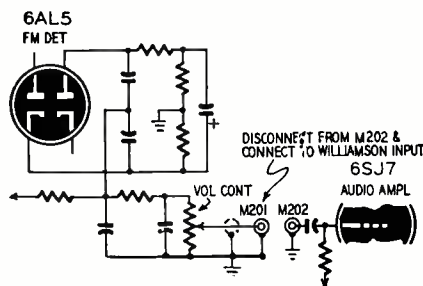

Fig. 3—Connections between TV chassis and audio amplifier in Admiral 30A1. NOVEMBER, 1952





# SIGNAL TRACES

By JOHN D. BURKE

Why not a sectionalized TV set  
for finding troubles in others?

I HAVE used tuned signal tracing on thousands of *radio* chassis—and urged others to use the same methods (my book *Rapid Radio Repair*, and articles in RADIO-ELECTRONICS). So naturally I gave some thought to how to improve on the signal tracing procedures now used in *television* repair.

(A number of people have remarked that I should figure out an instrument as useful in television as the tuned signal tracer I use on radio.)

We do use signal tracing in TV now—in many ways. We use oscilloscopes, we trace signal voltages, we inject signals. Some of us use bar generators, even pattern generators. There are also the cruder forms of signal tracing. We pull out tubes and note the effect; we make finger tests, click tests, use capacitors on test leads to apply a.c. from the heater line to various grids (as Mr. Kiver says). And many more.

However, my idea was, and is, quite different. So far, to my knowledge, no one has published anything like it. In its simplest form, the idea is to use *one* television set to find out what is wrong with *another* television set.

My first approach, about five years ago, was to consider what might be done with the oscilloscope itself. Why does not the oscilloscope reproduce a picture, if we apply the video signal to its kinescope? (Some scopes do!—*Editor*.) For the simple reason that the average scope does not have a vertical sweep oscillator. Horizontal, yes. Vertical, no.

Also—it has no means for external control of the scanning spot's intensity.

So—since my own scope is a redesigned Army surplus radar unit anyway, I added a few parts and a tube, and thereby had a 60-cycle vertical sweep oscillator—plus means for external sync on both sweeps—and external control of the spot intensity. Now I had a raster—if I wanted it.

By taking sync from points in the set under test, and video from another point, my scope reproduced station programs.

One may say, "What's so smart about that? You merely made your scope into

a television 'slave' unit!"

The point is, and was, that my converted "slave" was a *test instrument*. I was *not* interested in watching programs on its 5-inch screen: I was interested in finding out why a certain TV set (it happened to be my own) gave everybody rubber legs!

Using this homemade "slave," I figured out the cause of the difficulty. Thereafter I did not get around to hooking up the same arrangement again. Still, there were times when I wished it were not so patched-up a job.

Last week, however, the ideal test occurred. A young friend had been sweating for days over a 630 type chassis (with a.g.c.) which had several types of sync troubles all at once. He asked for help.

Conventional methods, laboriously applied, located several leaky coupling capacitors, an i.f. tube with a high-resistance grid-to-cathode leakage, and a horizontal sync circuit slightly out of adjustment.

Still there remained an erratic bending—occurring several minutes after the set warmed up.

You may laugh at the solution. (Aren't most troubles simple when we find them?) But this problem did have him, and me, stumped for hours! One half of a 6AL5—the half used for d.c. restorer—had no emission. As a result, picture information was getting into the sync circuits, even though that set has plenty of limiting action in the regular sync tubes. Very little effect was noticeable in the picture brightness or contrast. Not while we sought the trouble; later it did look much better after replacing the 6AL5.

The point of the story is that *after* I used another 630 chassis to signal-trace in the first set—in just a few minutes we *knew* that the trouble was in the vicinity of the 2nd video output tube.

The known-to-be-good chassis was connected to an antenna—the antenna was left off the misbehaving set. The two chassis were joined with a test lead. Another test lead, with a .005- $\mu$ f ca-

pacitor in series, was connected first from the grid of the 2nd video tube of the good set to the same point on the other. (That spot was chosen to start since it represented a halfway point in the travels of sync pulses through the set.)

On the set being tested a weak picture appeared (as well as on the known-to-be-good set) and synced well vertically. However, the same horizontal bend appeared. The fault was between the 2nd video and the kinescope.

We moved along to the d.c. restorer. Same points on the two sets joined together through the capacitor test lead. Now again a weak picture *but no bend!*

To recapitulate: If the signal was bridged across from the good set to the 2nd video grid of our set-in-trouble, it acquired a bend. If bridged at the d.c. restorer, it did not get twisted. Therefore the trouble had to be between those two points!

We concentrated on that part of the set, and located the defective 6AL5. (Not too quickly, I admit. He had tested the tube; perhaps it was intermittent.) But I was sure that we were working on a hot scent—the trouble had to be there!

What possibilities flow from the above?

Certainly any technician can jumper over from one chassis to another, in many different ways; and furthermore, allow *either* the set under test, *or* the one being used as a test instrument—to be the initial receptor of the television signals.

For that matter, it would be possible to detour the signal *back and forth* several times, till it emerged on one or the other picture tubes, or both—and through one loudspeaker or the other, or both!

If such use of television chassis on the test bench becomes popular, and I may have had any part in its adoption—swell.

But I really have even bigger fish to fry.

There is need for a highly flexible test instrument, the characteristics of which I wish to suggest. Here are some



of the problems which designers will have to solve:

The basic character of the signal is always determined by the television transmitting station. But when it starts through any television set, all sorts of things happen to it. The worst problem for us, so far as signal tracing is concerned, happens at the mixer. For, by my count, it may be converted to any one of *dozens* of video i.f.'s the manufacturers have used, and are using. Right there we get into trouble.

Our test instrument should be able to tune to any of those frequencies, so that, at the very least, we can pick off the picture from any point in the i.f. of *any* TV set we work on. That means an i.f. range from 21 mc to 46 mc (and probably more).

In radio work the tuned signal tracers are tunable in all the intermediate frequencies used in AM receivers. An ideal signal tracer for television should do as well.

Furthermore, the instrument itself ought to have its own front end—it should be a complete television set—and thus not only should give us an i.f. amplifier which is tunable to any frequency used in TV sets in general . . . but also should have an arrangement whereby its local oscillator's frequency shall be variable within such a range that the test instrument's front end can produce a signal at any intermediate frequency we want to work with! Do I make myself understood?

Let us say that what I am proposing—in this latter respect—is an instrument to provide us with a TV test oscillator which converts TV programs to whatever intermediate frequency we desire.

Technically, or rather mechanically, the instrument would need, first:

1. An r.f. and mixer tuned step-by-step to all the channels.
2. An oscillator tuned step by step, *plus* being continuously variable within a wide range to supply an i.f. output from the mixer anywhere from 21 to 46 mc.
3. An i.f. strip variably tuned—ganged—so that it can operate any-

where from 21 to 46 mc.

There are further complications to be worked out. Read on.

1. The problem of conventional sound; and intercarrier, and its variations.
2. The question—is the video signal positive or negative at the picture tube? (Is cathode or grid control used in the set we wish to test?)
3. Is chassis "hot" or "cold"? (Important factor.)
4. Sync take off point. And how many times inverted?
5. Method of contrast control, relating to technician's problems in using the instrument.
7. Provision for either taking off or injecting signal at many different points: video, audio, sync, sweeps—all significant points.
8. Test leads and other test accessories, including:  
Plug-and-socket combinations such as are used for connecting TV slave units to master sets.  
Dummy shields to slip over tubes—inject or take off signal.  
Plug-and-socket interconnections with all pin connections made accessible to above-chassis tests.  
Plug-and-socket arrangements for different types of deflection yokes and focus coils, to facilitate substituting or interchanging these components in either set.
9. Access to audio amplifier, of course, and to loudspeaker for test purposes.

It would be advantageous to include a meter. When connected to a.g.c. of our *test-TV-set-instrument* it would serve as a field-strength meter. It also could be used for many other purposes, including measurement and comparison of B-supply currents in various circuit branches of both receivers.

The whole thing should be portable of course; sensitive—by all means! Able to act as a receiver on a small antenna; able to pick up weak i.f. signals out of the set under test; and it should be as rugged as possible.

When such an instrument is available, TV repairing will be a much pleasanter occupation. END

## \$100 PRIZE CONTEST— WHAT IS ELECTRONICS?

The technical public is having more and more trouble with the term "electronics" as every day goes past. Once it was a simple term indeed, which was applied only to that branch of electricity which uses vacuum tubes. We are a long way from that simple stage today. Electronics—or radio-electronics—has developed with such rapidity, branched out so much and so far, that even technicians are hard put to keep up with its progress.

Even years ago the phototube was considered an electronic device, though its function was far different from that of electronic tubes as previously known. Now the transistor is unhesitatingly classed as an electronic device, and—under its wing—crystal diodes are included in electronic apparatus. Yet we are still trying to struggle along with ideas and terms fitted to the vacuum-tube era. For instance, Webster says: "*Electronics*: That branch of physics that treats of the emission, behavior, and effects of electrons especially in vacuum tubes, photoelectric cells and the like." (Italics ours.)

Clearly, a new definition is needed. Dr. W. L. Everitt, past president of the I.R.E. and present Dean of the College of Engineering of the University of Illinois, has offered one of the best ones so far. Dr. Everitt says:

"*Electronics is the science and technology which deals primarily with the supplementing of man's senses and his brain power by devices which collect and process information, transmit it to the point needed, and there either control machines or present the processed information to human beings for their direct use.*"

This definition is too vague. While former definitions did not cover the whole field of electronics, one could conceive of a mechanical or electrical system which would meet the above specifications.

The technical public needs a definition which is clear and all-embracing. It should cover not only all types of electron tubes, including phototubes and cathode-ray tubes, and their functions, but also the new transistor, the crystal diode, and other devices which depend on the action of electrons in semiconductors. It should take into account electron emission from radioactive bodies, and even the radiant energy in interplanetary and interstellar space.

RADIO-ELECTRONICS therefore asks its readers to contribute new definitions. There will be one prize of \$100 for the best definition of 30 words or less, and three others:

Second Prize .....	\$50
Third Prize .....	\$25
Fourth Prize .....	\$10

The following rules *must* be observed:

1. A contestant may submit one or more definitions of 30 words or less.
2. If two or more entries are judged to be equally good, identical prize awards will be made for both.
3. All entries will be judged by the Board of Editors of RADIO-ELECTRONICS, whose decisions will be final.
4. Employees of RADIO-ELECTRONICS and their relatives are excluded.
5. Closing date of the contest is December 31, 1952. Entries must be postmarked not later than midnight of that date.
6. Results of the contest and names of the prize winners will be published in the March, 1953, issue of RADIO-ELECTRONICS. Prizes will be paid on or before the publication date of that issue. END



# TV SERVICE NOTES

JOHN B. LEDBETTER\*

**M**OST TV receivers eventually develop certain troubles which are more or less peculiar to a particular make or model. After servicing a number of receivers of the same make, you learn to anticipate certain troubles simply because they are more likely to show up in that particular set. On the other hand, if the receiver you are checking is unfamiliar, you may spend valuable time looking for a defect which might become perfectly obvious after several such models have been checked.

The following service notes are based on such recurrent troubles and are presented in the hope of helping you cut a few corners in your servicing time.

## Head-end and video section

*Oscillator shifts frequency or stops oscillating entirely (Philco, Admiral, Crosley and other receivers using turret-type tuners.)*

Often caused by cold-soldered or rosin connections on the tuner terminals or switch contacts. Resolder each connection with a hot iron and fresh solder. In several cases sweating these connections has saved replacement of the entire tuner. Other common causes of trouble: the oscillator, oscillator control, and low-voltage rectifier tubes, and the small ceramic capacitors in the oscillator grid and coupling circuits.

*Shift in oscillator frequency, accompanied by severe fading or complete loss of picture (some General Electric models).*

Often due to a defective 12- $\mu$ f capacitor between oscillator grid and B-minus. When replacing this capacitor, also replace the 10,000-ohm resistor across it. If care is used this can be done without removing the tuner assembly.

*Drifting Sound (DuMont RA-109A, 112A, 113, 116, 117, 119).*

Usually an open fixed tuning capacitor in one of the sound i.f. transformers. There are two of these in each sound i.f. can; humidity or vibration often causes a terminal to separate from the capacitor plate and open the connection. This may show up during alignment as low gain or inability of the transformer to peak properly.

*Flashing on the screen (all DuMont Telesets).*

Intermittent contact between the deflection yoke cover and the focus coil

\* Engineer, WKRC-TV.

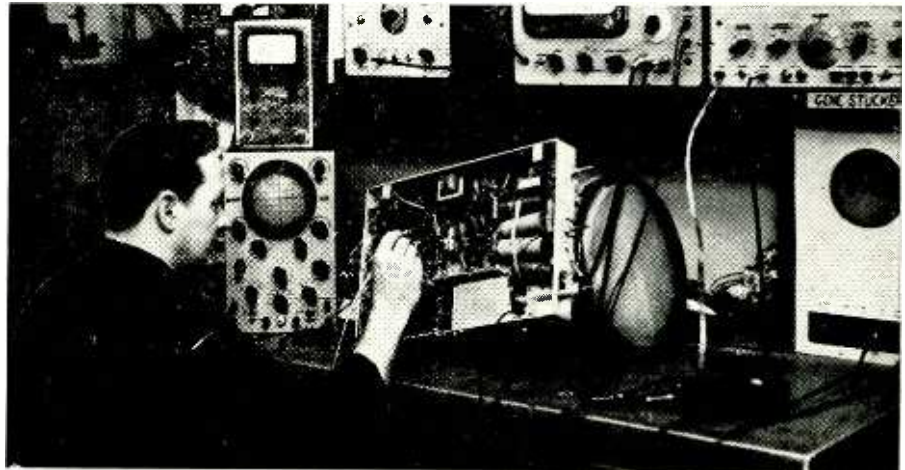

Photo courtesy Mirus Television Service, Cincinnati, Ohio.

case. Both are grounded but there is still a large potential difference between them. Redress the yoke cable away from the focus coil. (Note: Similar flashing can be caused by dirty or defective contacts in the Inductuner.)

*Snow in picture (General Electric models with series-wired filaments).*

Check for a burned-out 6AB4 r.f. amplifier. A 43-ohm resistor in parallel with this filament keeps the other tubes lighted and may throw suspicion elsewhere unless the 6AB4 is tested.

*Snow in picture (all DuMont Telesets with 6J6 r.f. amplifier).*

If reception on low channels is good at first but becomes snowy after several hours of operation, check the 10,000-ohm resistor in the 6J6 r.f. amplifier plate circuit. This resistor often increases to 30,000 ohms or more.

*Snow in picture (all current DuMont Telesets).*

If this trouble shows up after the set has been operating several minutes, check the a.g.c. voltages with a v.t.v.m. If the i.f. a.g.c. voltage decreases and the tuner a.g.c. increases when the snow appears, one of the video i.f. tubes probably has a grid-cathode leak. Locate the defective i.f. tube by substitution.

*Snow on weak signals (DuMont RA-109A).*

Check for insufficient a.g.c. delay voltage. Increase by replacing the 10-megohm a.g.c. resistor (R355) with an 8.2-megohm resistor. (Fig. 1). This raises the signal at the input of the video i.f. strip and helps to override tube noise in these stages.

*Intermittent fading of picture (All makes).*

Cold-solder connections at the base of the picture tube. Check by resoldering each pin with a hot iron, applying new solder to give a clean, firm connection.

*Contrast control critical in adjust-*

*ment (DuMont RA-112A, 113).*

Open compensating coil in grid of the 6AH6 video amplifier. (L 202 in Fig. 2).

*Interaction between contrast and brightness controls (DuMont 117A).*

If brightness increases when the contrast is advanced, check for an open peaking coil (L202 in Fig. 3) in the plate circuit of the 6AH6 video amplifier.

*Tunable hum only with selector in "TELE" position and with tone control on maximum. (DuMont RA-109A).*

This indicates 60-cycle ripple on the a.g.c. line; the a.g.c. control is not properly adjusted. Readjust carefully.

*Hum bars in picture; present only when channel is tuned in (all makes).*

Heater-cathode short in the oscillator tube. (This is fairly common in types like the 6C4, 6J6, and 12AT7). This defect can also cause spurious oscillation, with resultant interference to other TV receivers. Substitute a new oscillator tube.

*Picture overloads on strong signals; very unstable; a.g.c. control has little effect (DuMont RA-112A, 113, 117A, 120A).*

Leaky .05- $\mu$ f capacitor in the a.g.c. voltage-divider circuit (C226 in Fig. 4).

*Several fine, bright, evenly spaced horizontal lines from top to bottom on raster; may be accompanied by poor d.c. restoration (DuMont RA-112A, 113).*

Probably due to an open .05- $\mu$ f cathode capacitor from pin 5 of the 6AL5 d.c. restorer stage to ground. (Fig. 2).

## Vertical synchronizing section

*Occasional loss of vertical sync; usually only one or two frames (all makes using a germanium diode video detector).*

If the vertical oscillator or clipper circuits check normal and the video i.f.

response curve is normal, try a new germanium diode. The low-frequency response of this unit sometimes drops off and causes partial loss of the vertical sync pulses.

No vertical hold; horizontal hold critical; low plate voltage on sync clipper (DuMont RA-103D, 104A, 110A).

Leaky 0.1- $\mu$ f coupling capacitor to the grid of the 6SN7-GT vertical buffer stage (Fig. 5).

Poor interlace (Stromberg-Carlson model 17 series).

Interlace troubles in some of these models can be corrected by removing or shorting out the 10,000-ohm resistor in the vertical sweep circuit (R48 in Fig. 6).

Audible 60-cycle hum (DuMont RA-109A).

Sometimes caused by mechanical vibration of the power transformer core. This vibration is amplified by the chassis and cabinet; sometimes by the room itself. Shock-mount the transformer on sponge-rubber or rubber grommets. (Later-production models provide shock-mounting; a kit is avail-

able from the manufacturer for earlier models).

Audio buzz on high channels (earlier General Electric models).

Usually caused by overloading the converter grid. Try connecting the converter grid resistor to ground (this resistor normally goes to the a.g.c. voltage bus).

Hum; 60-cycle buzz (Air King 700-93 and similar makes using a glass 6SQ7-GT).

The 6SQ7-GT often picks up 60-cycle radiation from the vertical sweep circuits. Replace with a metal 6SQ7, or install a tube shield.

Strong 60-cycle hum (Admiral 24D1, 24E1, 24F1, 24G1, 24H1).

If no apparent circuit defects are found (i.e., open filter capacitors, cathode-heater short in one of the audio or sound i.f. amplifier tubes), try: (1) reversing the coupling capacitor from volume control to the 1st audio grid, (2) dressing the a.c. leads to the power switch away from the 1st audio grid, and (3) checking the cold-side connection of the volume control. If this goes

to the grounded heater terminal on the 1st audio amplifier tube socket, remove and reconnect to the grounded cathode terminal on the same socket.

Hum; 60-cycle buzz (DuMont RA-109A; also other makes).

Defective 30- $\mu$ f 450-v filter capacitor in the low-voltage power supply. In several other makes, check for poor contact between the picture-tube Aquadag coating and the grounding strips.

Audio Hum (DuMont RA-109A).

Inadequate lead dress of audio wiring. To correct: (1) Shorten the wire going from ground end of volume control by 2 1/4 inches; (2) shorten the lead going from the tone control to the .005- $\mu$ f (in series with tone control and ground) by 1 inch; and (3) dress the .02- $\mu$ f coupling capacitor from 1st sound amplifier plate (pin 1 to pin 7 on 12AU7) so that its flat side is away from the chassis.

Alternate black and white bars, approximately 1/4-inch wide (DuMont RA-119A).

Check for a microphonic 6AU5 vertical output tube. (TO BE CONTINUED)

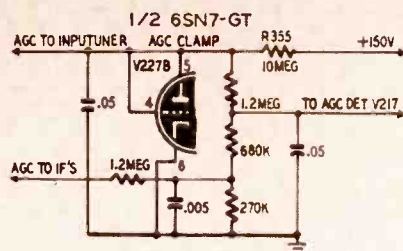

Fig. 1—Schematic of the a.g.c. clamp diode and a.g.c. distribution network in the DuMont model RA-109A Teleset.

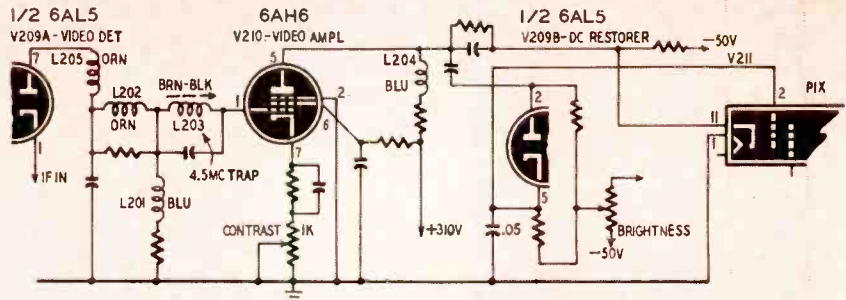

Fig. 2—Video detector, video amplifier, d.c. restorer, and picture-tube input circuits in DuMont Telesets RA-112A and 113. Troubles caused by an open peaking coil (L202) in the detector output, and an open .05- $\mu$ f capacitor between the d.c.-restorer cathode and ground are discussed on the preceding page.

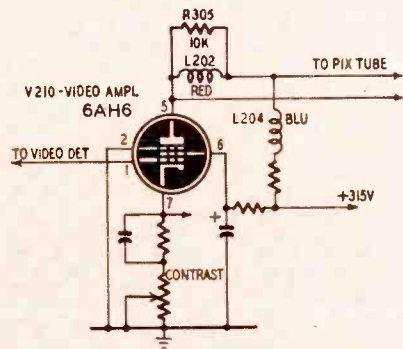

Fig. 3—DuMont 117A video amplifier.

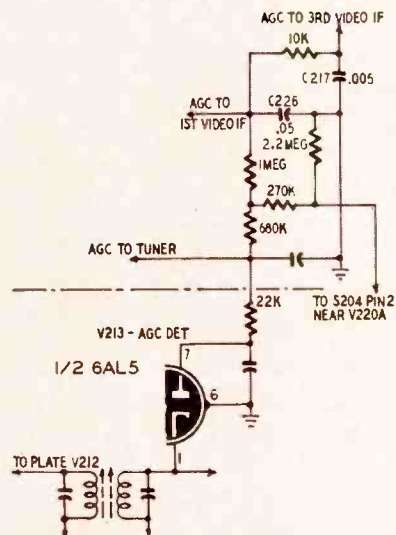

Fig. 4—A.g.c.-detector circuit in DuMont RA-112A, 113, 117A, and 120A.

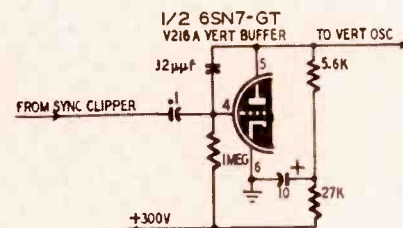

Fig. 5—Buffer between sync and vertical sweep in DuMont 103D, 104A, and 110A.

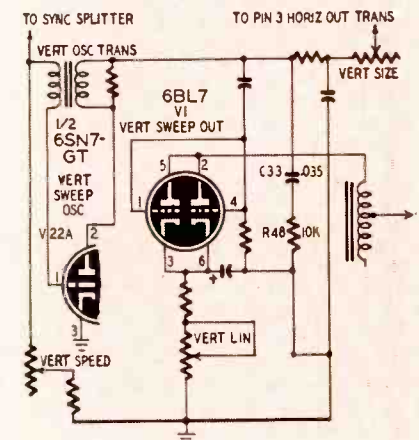
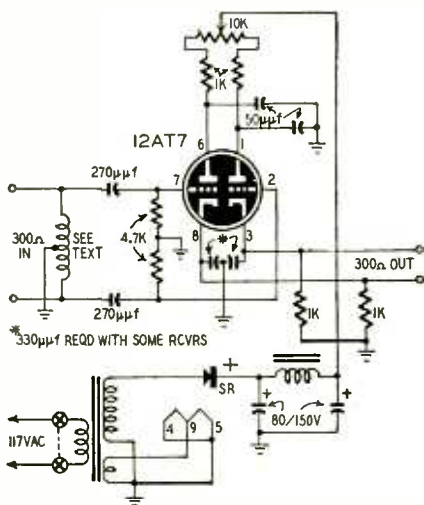

Fig. 6—Stromberg-Carlson vertical sweep.



# ANTENNA BALANCING UNIT

By WALTER S. MILLER



**T**HIS unit was designed as the result of a number of complaints of interference, tunable ghosts, snow, slight leading ghosts, and other telltale effects of impedance mismatch. The whole unit, including the power supply, is enclosed in a 4 x 4 x 4-inch aluminum box, which is easily installed in the customer's receiver. While the idea is not new—a simple unit that required no tubes or elaborate controls was described in RADIO-ELECTRONICS some time ago—this is a decided refinement which makes it possible to vary the input to the set as much as 50%.

Technically the unit is a class A amplifier conducting in phase or out of phase in accordance with the voltage applied to each triode section. The control is so placed across the source of supply that the voltage on one of the triode plates increases as that on the other decreases. The gain and output of the two sections are affected by this variation of voltage.

The unit is very simple to operate. There is only one control. Set it at the point of maximum performance and check the picture or test pattern for the telltale effects of impedance mismatch: slight leading ghost, some snow, tunable ghost, poor picture in fringe areas, acceptance of some interference. Then set the phasing control of the unit to a

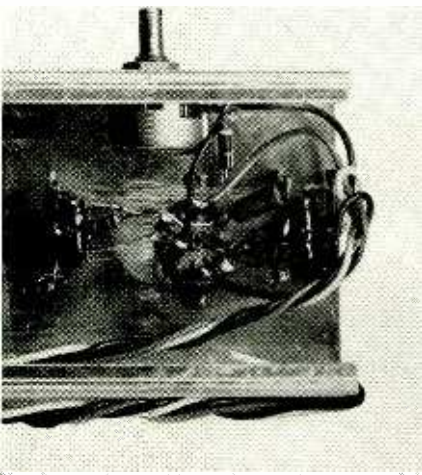
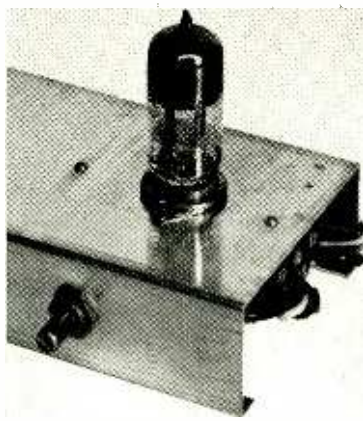

Photos of a later model without power supply but same underchassis layout.

point of maximum picture acceptance and a slight gain in over-all picture level, and leave it.

There are few construction problems. The unit is built on a 3 x 3 x 1-inch aluminum chassis. An isolation transformer—made by Merit—with a 1-1 primary-secondary ratio was used. It also has a filament winding rated at 6.3 volts and about 1 ampere. The input coil is the only specially constructed item, and it consists simply of 16 turns of No. 28 enameled wire wound on a 2.2-megohm resistor and center-tapped.

#### Parts list for antenna balancer:

**Resistors:** 2—1,000, 2—4,700 ohms, 1—2.2 megohm, 1/2 watt; 2—1,000 ohms, 1 watt; 1—10,000-ohm, 2-watt potentiometer.

**Capacitors:** 2—50  $\mu$ f, 2—270  $\mu$ f, ceramic; 2—80- $\mu$ f, 150-volt, electrolytic.

**Miscellaneous:** 1 12AT7 tube and socket for same; 1 isolation transformer, as per text; 1 selenium rectifier, 50 ma; 1 a.c.-d.c. choke; 1 d.p.d.f. toggle switch; chassis, cabinet, pilot lamp, wire, and hardware.

Layout is simple. The tube is mounted near the left side of the chassis—as viewed from the front—and the transformer as far as possible to the right. The electrolytics (in a single can) and a.c.-d.c. choke are mounted one ahead of the other close beside the transformer. Then the tube is mounted in the clear space, halfway between the choke and capacitor and the side of the chassis and a little to the rear. The potentiometer is mounted ahead of the tube, with a pilot light to its right. The leads come in from the left side of the chassis, and go out directly behind the tube. END

## TV DX REPORTS

If there is a TV dx enthusiast left, after the slim pickings of September and October, he can look for a few dx chances in November. There will not be much, but observations made in past years show a small but well-defined rise during November, compared to the two previous months. Stations in Cuba and Mexico will be good bets, and in this country those south of the Mason-Dixon Line will be seen more often than those farther north.

Tropospheric bending, on the other hand, will start its drop toward the winter minimum in November. Here again, the northerner is at a disadvantage, for the weather in the southern states will still be warm enough to produce appreciable inversions fairly frequently. Even the most northern areas will have good reception at times, but more often it will be on the poor side and getting worse as the month wears on.

Viewers who have to rely on stations 50 miles or more away for their entertainment will find their picture quality deteriorating gradually during November, and many of the uninitiated will be after their technicians to fix up their sets so that they will "work like they did last summer." It may take some patience to convince them that everything is in good order, but it can also mean an opportunity for the sale of a booster, or the erection of a better antenna system. "It's an ill wind—!" END

## NON-OWNERS LOVE TV, TOO!

Meck Television, Inc., querying 340 residents of Washington, D. C. on their TV habits, found that non-owners average 12 hours a week watching TV at the homes of friends and neighbors, exclusive of time spent watching in public places.

53% of those queried did not own TV sets. When asked what they rated as the most desirable feature of a TV receiver, the majority said "Clear picture." Large screens, cabinet styling, low cost, and good audio quality followed in order of preference.

Viewing time for non-owners ranged from three to 35 hours per week, with comedy programs the favorites. END

## INSTRUCTORS NEEDED

Civilian instructors are urgently needed at the Signal Corps Training Center, Camp Gordon (near Augusta), Georgia, at salaries ranging from \$3,795 to \$5,060 per year.

Persons trained in telephone central-office maintenance, telephone installation and repair, pole-line construction, communications equipment storage, communications-center operations, power-equipment maintenance, teletypewriter-equipment maintenance, or cryptography should contact the U. S. Civil Service Commission, Board of Examiners, Camp Gordon, Georgia. END

# RELAXACISOR

A new job for the familiar blocking oscillator—generating safe pulse currents for muscular stimulation



"Relaxacisor" electronic stimulator.

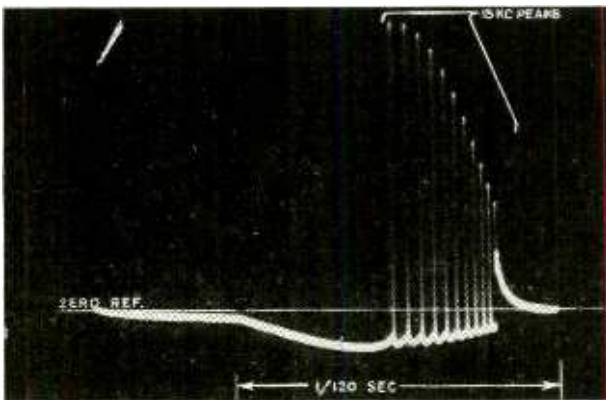
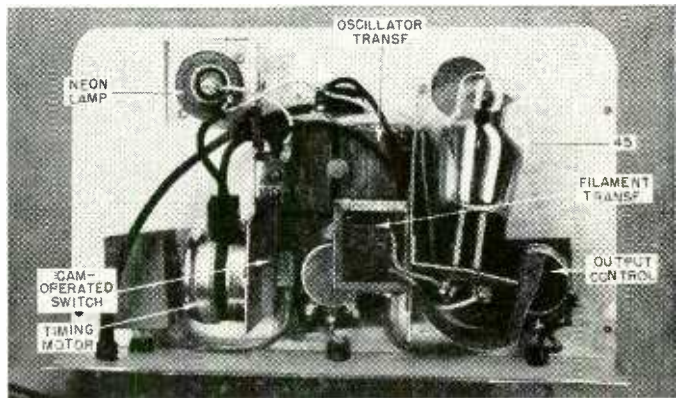

Fig. 2—Pulses appear only during part of each line cycle.



Internal assembly of the "Relaxacisor".

ONE of the first effects discovered by primitive experimenters in applied electricity was its contracting effect on the muscles. What was originally a scientific novelty and even a form of amusement for practical jokers then went through a period (about 75 to 100 years ago) when all sorts of miraculous physiological effects were claimed for "Galvanic Generators" which were nothing more than shocking devices.

Nowadays the application of controlled electrical currents to the human body has a more exact scientific basis. Shock treatments are used successfully

in treating certain mental disorders, and (with somewhat different results) in the administration of criminal law.

In some fields of medicine, muscular stimulation by electrical means has proved beneficial where the patient is unable to take normal exercise, or where only local areas are to be treated.

While devices for this purpose have limited application, some of them use electronic methods of generating and controlling the muscle currents.

One of these is known commercially as the "Relaxacisor." This unit delivers physiologically safe pulsating currents to three output circuits, which may be applied singly or in combination to various areas of the body. Contact is made through moistened cloth-covered electrodes. The device is almost completely foolproof, and is well enough protected against shock or other accidents to receive the approval of Underwriters' Laboratories, Inc.

We are in no way qualified to pass on the therapeutic qualities of the instrument, but believe its features will be interesting to electronic technicians, especially any who may be called on to service one of these devices.

Fig. 1 is the Relaxacisor circuit. A 45 triode operates as a Hartley-type blocking oscillator. The tank inductance is tuned to about 15 kc by stray capacitance. A high degree of damping is provided by a shorted turn loosely coupled to the tank. Blocking time

varies with the loading across each of the three output-secondary windings.

Raw a.c. from the power line is applied to the cathode end of the oscillator circuit through a cam-operated switch. The cam is driven at 20 r.p.m. by a synchronous clock motor and turns the oscillator alternately on and off for equal periods of 1½ seconds.

Since the tube conducts only when its plate is positive, the oscillator circuit is energized only on alternate half-cycles. Even then, oscillations do not start until after the line voltage has reached its maximum value.

An operating cycle is shown in Fig. 2. The oscillator circuit is turned on for 1½ seconds, but damped oscillations take place only during the last half of each positive half-cycle. Then the cam opens the circuit for 1½ seconds.

The maximum amount of energy delivered to the patient is kept well within safe limits. Tests have shown that where the patient can control the output of a shocking device, a feeling of discomfort is reached long before the current is strong enough to contract the muscles and prevent him from turning down the output\*. As an added safety feature, output connections to the Relaxacisor are made through banana plugs, so that even a slight pull disconnects the leads. END

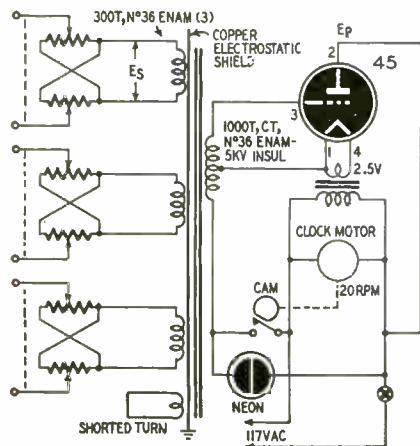

Fig. 1—Circuit of the "Relaxacisor".  
NOVEMBER, 1952

\*Underwriters' Laboratories, Inc., Report "Electrical. No. 21032."





# TRANSISTOR SAWTOOTH OSCILLATOR

functions as  
signal source for  
testing others

By H. G. RUDENBERG

**B**EFORE starting on the development of advanced circuits and new applications for transistors, it is desirable to observe their operation in some of the simpler circuits in which they have been used successfully. This article illustrates waveforms observed with a Raytheon CK716 transistor used as a sawtooth relaxation oscillator.

A straightforward test circuit for observing the static characteristics of point-contact transistors on a cathode-ray oscilloscope is also described. As part of a program of familiarization with transistors and transistor circuits, the characteristics of a number of transistors of Raytheon manufacture, as well as those made by other companies, were examined and compared with these two circuits.

Both point-contact and junction transistors have been discussed in many articles in the technical press. The point-contact transistor consists of two pointed wires in contact with a specially prepared surface of germanium of great purity. These wire points are spaced only a few thousandths of an inch apart. Each wire alone would act as a point-contact rectifier against the germanium block. In operation, the collector wire is biased in the reverse direction so that, in spite of moderate biasing voltage, the current drawn is normally very low. The emitter contact is biased in the forward direction with

respect to the *base* represented by the germanium block. Current carriers are injected by the emitter wire into the germanium. These drift toward the collector, thereby increasing the current flow in the collector circuit. If the points are properly formed by chemical and electrical treatment and are spaced close enough to each other, the increase in collector current is greater than that accounted for by the number of emitted carriers drifting toward the collector region. It is the interaction of the current carriers from the two points close together on the germanium surface which provides the transistor action.

The fact that the current gain, referred to as "alpha," is greater than 1 is quite apparent from the static characteristics of an individual Raytheon transistor type CK716, shown in Fig. 1. Naturally the average characteristic curves would vary from the one shown by the small statistical spread encountered between different units of the same type. When biased so that the operating point of the transistor swings through the region of high current gain, such a unit would be suitable for use as a relaxation oscillator or in a trigger circuit.

It has been found that high-gain transistors—and this includes the type CK716—operated with a large external base resistance, can have positive feedback even at low frequencies or even for direct currents. This is a great advan-

tage when performance as a negative-resistance oscillator is required.

## Sawtooth oscillator

The sawtooth oscillator circuit of Fig. 2 uses a high resistance in the base lead of the transistor to obtain the positive feedback required for a relaxation oscillator. This useful property of point-contact transistors—namely, the positive feedback obtainable with high base resistance, is the very one which could cause difficulty and instability when these units are used as high-gain amplifiers. At the same time, an additional base resistance such as the 10,000-ohm resistor in the circuit of Fig. 2 will provide sufficiently strong feedback to obtain dependable triggering and stable oscillations.

To consider that in more detail, let us follow the effect of a small increase in emitter current. If the current gain of the unit is greater than 1, this increase causes a larger change in the negative collector current. Finally, since the sum of emitter, collector, and base currents must be zero, this also produces a reduction of the base current entering the transistor. Thus, a rising emitter-to-base voltage causes a rising emitter current and a lowering of the base current. A lowering of the base voltage with respect to ground results, since the base current flowing through the base resistance has decreased. This drop of base potential is equivalent to a still

RADIO-ELECTRONICS

greater emitter-to-base voltage, so that this process may increase cumulatively if the base resistance is big enough.

Referring to the circuit of Fig. 2, this cumulative increase of emitter current and drop of base-to-ground voltage continues until capacitor C is fully charged negatively. Then the emitter current stops just as suddenly, the base current drops, and the base voltage becomes positive again. A slow discharge of the negative charge on capacitor C through resistor R now follows. When enough charge has leaked off to permit the emitter to conduct current again, the cycle is repeated.

The values for this sawtooth oscillator circuit are not critical, except that some limiting resistors have been included to avoid overloading the transistors. The main requirements are a transistor with a current gain of the order of 1.5 and frequency response better than 100 kc to provide rapid switching from one state to another. The frequency obtained with the values shown in the circuit diagram is near 10 kc but could be lowered by increasing capacitor C.

On the practical side, it will be noted from the cover photograph that a miniature plug is used as an intermediate adapter to allow the rapid interchange of various transistors in the same circuit. This also made the transistor more manageable for multiple tests, as the present sockets have not been designed for a large amount of plugging in and plugging out. An on-off switch is also provided, which in the off position shorts both emitter and collector leads of the transistor to the base connection. This is particularly important in a new circuit whose characteristics may not be fully known at the start, as it helps prevent the possible overload of a transistor when adjustments in the circuit are being made.

**Characteristics**

Fig. 1 shows the static characteristic of a particular CK716 point-contact transistor. This type has now been manufactured for some time. (Junction transistors are now also under active development at Raytheon.) Used in the sawtooth oscillator circuit of Fig. 2, the CK716 quickly produces stable oscillations. Owing to the rapid change in transistor characteristics with temperature (about 5% for each degree Fahrenheit), a small drift in warmup is naturally to be expected. This occurs immediately after turning on the unit at the currents encountered here. After the first 10 seconds, the circuit drifted in frequency by only 1% over the next hour. This type oscillator has been used considerably as a test source for providing an audio voltage for the static characteristic measuring circuit of Fig. 3. The sawtooth waveforms were obtained from terminals A in Fig. 2. No use has as yet been made of the waveforms obtainable at B and C, but applications will suggest themselves.

The static characteristic measuring

circuit shown in Fig. 3 may be connected manually to trace any two of the four variables (emitter voltage, emitter current, collector voltage, and collector current) against each other on a cathode-ray oscilloscope. Connections are changed by plugging the different measuring leads to the horizontal and vertical amplifiers of a d.c. oscilloscope and by connecting the sweeping and fixed current sources to the appropriate plugs on the chassis. In most cases, it is sufficient to display the so-called collector characteristic family on the screen. This

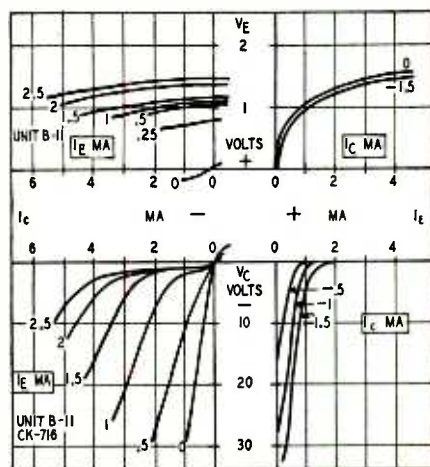

Fig. 1—Curves of the four sets of characteristics of a type CK716 transistor.

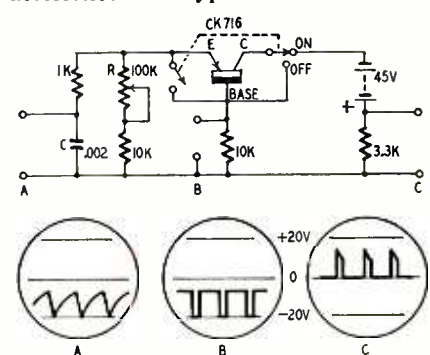

Fig. 2—The transistor sawtooth oscillator and waveforms at its terminals.

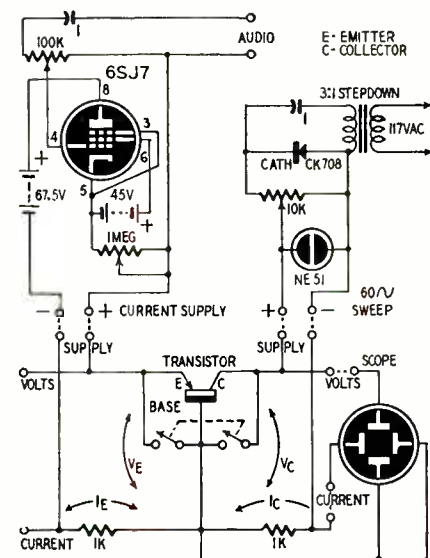

Fig. 3—The test setup for measuring the static characteristics of transistors.

collector family of an individual Raytheon CK716 transistor is illustrated in Fig. 1. Here the collector is fed from a high-resistance, 60-cycle source so that the collector voltage vs collector current characteristic of the CK716 is visible on the oscilloscope. The emitter current in this case is held constant by a pentode constant-current supply which can be adjusted to furnish any reasonable emitter current. To prevent any major overvoltage of the collector circuit which might cause burnout of a transistor, it is advisable to connect a small neon bulb across the collector input leads. This will prevent any rise of voltage above 50 or 60, and reduces the possibility of overloading the collector.

The transistor currents are displayed on the oscilloscope by virtue of the voltage drops across 1,000-ohm resistors. To preserve the zero points and base lines when moving from one characteristic to the next, it has been found useful to use a direct-coupled oscilloscope. The voltage regulators in this should be well adjusted so as to avoid an otherwise annoying slow drift of the base lines.

After calibration of the oscilloscope screen, the desired characteristics are traced on graph paper with the help of a camera lucida. This consists of a semi-reflecting mirror which aids in accurate tracing. It also permits later comparison of an oscilloscope trace with a sample characteristic obtained at some other time. This simple technique allows the determination of drift and of variations between units more quickly than if the characteristics were photographed. In particular, it is possible at a later date to superimpose on an earlier tracing some other pertinent data. Thus one can check the effects of overload or aging of the transistors.

**Transistor tests transistors**

To obtain a more rapid dynamic indication of the current gain (alpha), the grid of the pentode constant current supply may be connected to a small audio voltage, such as may be obtained from terminals A of the sawtooth oscillator of Fig. 2. This, essentially, displays at the peaks of the audio waveform two characteristics of the transistor simultaneously. From the distance apart of these curves and the oscilloscope calibration, the current gain is readily determined. From such curves the various transistor parameters, operating voltages, currents, and resistances can be obtained by a graphical analysis. This is similar to the methods used with vacuum-tube characteristic curves, familiar to all engineers.

This circuit and other similar ones can be adapted from published diagrams by anyone interested in the use of transistors. They have considerable value because of their simplicity and the ease with which the various characteristics of the transistor can be observed. Thus, they have proven their value in providing a quick estimate of transistor characteristics to personnel who are beginning to work in this field. END



# TELEPOCKET

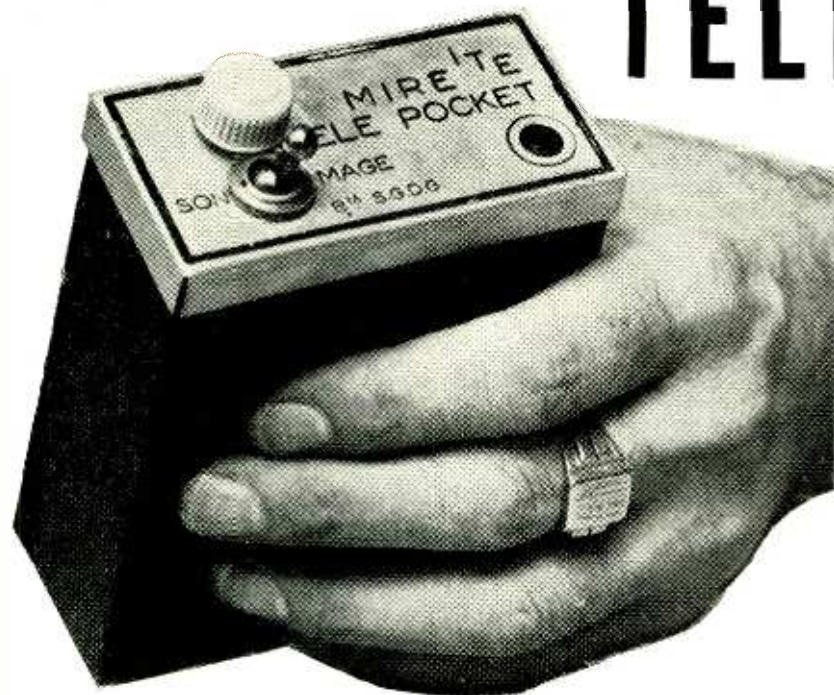

This cross-hatch generator can be carried in the technician's pocket

By A. V. J. MARTIN\*

THE Telepocket is a midget cross-hatch pattern generator with outside dimensions of only  $4\frac{1}{2} \times 3\frac{1}{4} \times 1\frac{3}{4}$  inches. In its original form, it was produced commercially by the Industrial Television and Electronic Co., of Paris (ITE) and was described in *Television* in November, 1950. The present instrument is a simplification of that one, using the same components more efficiently, and abandoning the selenium rectifier which was necessary in the older model.

The instrument was designed to work on one TV channel, but could readily be adapted to operate on two or more—or to tune continuously over either the high or low band—by adding more positions to the sound-video switch or replacing it with a small variable capacitor. The signal put out at either the sound or picture carrier of the desired channel is modulated by:

1. Vertical sync and blanking pulses, whose duration can be varied by the operator.

2. Horizontal bars, number of which may also be adjusted.

3. Vertical bars. Eight of these appear on the screen in Fig. 1. This number can be increased or decreased, if desired.

The Telepocket uses a double-triode tube. One half of it is the modulated oscillator; the other is the rectifier. (See Fig. 2.) The tube used is an ECC40, but any double triode will work satisfactorily if the heater-to-cathode insulation is good enough to permit using one section of the tube as a recti-

\*Editor, *Television* (Paris, France)

fier. A small selenium rectifier and a single triode also might be used. The American 12AT7 would probably be a better tube on the high band than the original, a rimlock type which reaches its limit somewhere near 200 mc.

The rectifier output is filtered by a 10,000-ohm resistor and 50- $\mu$ f electrolytic capacitor.

The other section of the tube is the r.f. oscillator. Two tuned circuits are inserted between its plate and grid, and it is modulated from two external sources. The pulse at power-line frequency which appears across the 470-ohm resistor each time the rectifier conducts is differentiated by the R-C circuit composed of the 15- $\mu$ f capacitor and the 100,000-ohm grid resistor, and is applied to the oscillator, blanking it out during the vertical retrace. The form of the pip approximates closely that of the usual sync and blanking portion of the composite video signal.

A small neon bulb, N, mounted through a hole in the lid, does double duty as a pilot light and a relaxation oscillator, operating at a multiple of the line frequency. Its frequency, and hence the number of horizontal bars, is adjusted by the 500,000-ohm potentiometer P. It is held in sync by pulses at the power-line frequency through the two .01- $\mu$ f capacitors.

There are two tuned circuits in series with each other in the tube's plate-grid circuit. L1 is tuned to the desired TV station frequency. In this instrument, designed for the French low-frequency transmitter, the sound carrier is at 42 mc, with video at 46 mc. It was wound

with 6 turns of No. 16 wire spaced its own width, on a  $\frac{1}{2}$ -inch form, with a plate winding of 2 turns. Small trimmers permit tuning exactly to the correct frequencies.

This coil arrangement would be suitable for the lower part of the v.h.f. band, or a slug-tuned coil like the Cambridge Thermionic LS-3 type 30-mc coil could be used for the tuned winding. The plate coil will be 2 to 3 turns of No. 16 wire. Coupling between grid and plate coils is varied for smooth oscillation, then left fixed.

The other circuit, L2, is tuned to nine times the horizontal sweep frequency and produces eight bars, one being lost during retrace. A small 3:1 universal-wound transformer which resonated to the desired frequency with a .001- $\mu$ f capacitor across it was used. A 175-kc i.f. transformer may be used here, removing primary turns till about one-third are left, for the plate coil. The secondary may be tuned to the desired harmonic (approximately 142 kc for eight

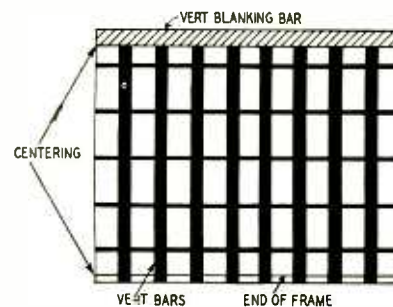
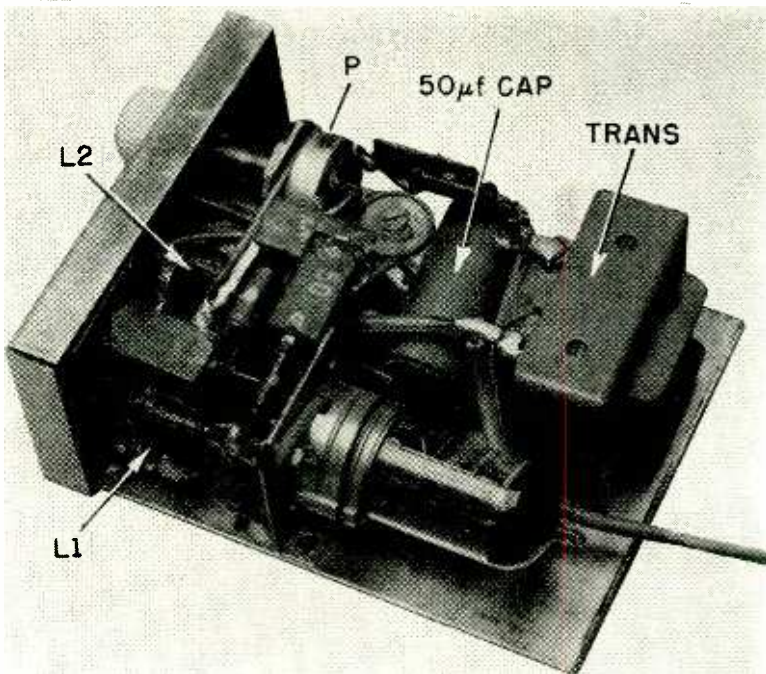

Fig. 1—Pattern supplied by Telepocket.



Interior view of Telepocket bar generator shows layout of parts.

visible bars) by replacing the .001- $\mu$ f capacitor with a variable padder. It is not necessary, of course, that eight bars be used, and with a variable padder it will be possible to vary the number. The secondary (grid coil) is damped by a 10,000-ohm resistor, and the coupling is adjusted till oscillation is violent, giving a deep black level.

There is no output terminal. The generator radiates direct to the TV receiver. Coupling may be varied by moving the Telepocket away from the receiver. Unwanted coupling can be further reduced by plugging it into an outlet different from that used for the TV set under test.

The crosshatch pattern gives a quick check of the over-all performance of a receiver and can be used to adjust horizontal and vertical linearity and to produce a pattern useful for making focus, ion-trap, and other adjustments. The vertical blanking (the grayish part of the pattern) allows one to adjust the

vertical centering controls. With a little experience, the sharpness of the black-to-white transitions of the vertical bars gives a good idea of the pass-band and shows up any overshoot or ringing.

**Materials for Telepocket**

**Resistors:** 1—470, 2—10,000, 1—3,300, 2—100,000, 1—470,000 ohms, 1/2 watt; 1—500,000-ohm potentiometer.

**Capacitors:** (Ceramic or mica) 1—15, 1—50, 1—100  $\mu$ f; (paper) 2—.001, 4—.01  $\mu$ f; (electrolytic) 1—50  $\mu$ f, 150 volts; (variable trimmers) 1—15, 1—30  $\mu$ f.

**Miscellaneous:** 1 tube, double triode (see text); 1 filament transformer, 6.3 or 12.6-volt, as required; 1 neon tube; 1 s.p.d.t. switch, sockets, case, hardware, wire.

The instrument uses a small filament transformer. This is the most efficient way of obtaining filament voltage—a resistor would dissipate too much heat for such a small device. No line switch has been provided. The case was already well filled, and there is a very simple and absolutely certain way of cutting off the power—just pull the plug! END

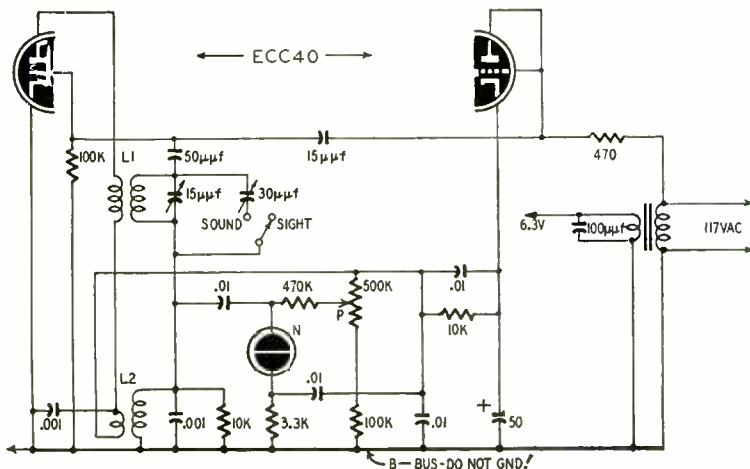

Fig. 2—Diagram of the instrument. A 12AT7 would be used for American jobs.

**ANTENNA LESSON**

By C. TIERNEY

THE chimney was the best place for the TV antenna, so the boss decided to put it there. The kid helper pointed to the weak mortar. "But will that brickwork hold the antenna?"

The boss smiled. "I've tied masts to chimneys worse than this and they held. It would be a nuisance to have the owner repair his chimney every time we wanted to put up an antenna."

"But it doesn't look safe."

The boss laughed. "The straps might even hold the bricks together," he said.

"If the antenna falls it might hit those power lines." The kid pointed to some lines that ran close to the house.

The boss rubbed his chin for a moment, eyed the power lines, mentally judged the distance between them and the Yagi. It could fall close, he thought. But he was a busy man and there were a lot of sets waiting for him on the bench. He turned back to the chimney. "Come on, kid," he said. "If we worried about all the things that could happen we'd never get any work done."

After the installation, the boss and his helper hurried back to the shop to beat the storm that had suddenly blackened the sky. An hour later the boss braved the heavy wind and rain for a cup of coffee.

On the street he met Jake, the druggist. Jake was stretching his neck, trying to see up the street. "Fire down there," he said. "Hooper's place."

"I just left Hooper's place. Put up an antenna . . ." The boss suddenly had a funny feeling in his stomach. He ran back to the shop for his truck.

Driving back through the storm he was plain scared. Had the storm toppled the antenna into the power lines? He knew such a mistake as he had made could easily cost the Hoopers their home. It could bring injury to them—even death. And, even at best—if nothing happened but a few scorched boards—the results of that one mistake would cost him his business. He would be sued for the damage. The cause of the fire would be in the newspapers for everyone to read. People would be frightened to buy TV sets from him, feeling that he might make a bad mistake in installation again.

When he got there the house was lit up—but only with electric lights. Not a sign of fire! Dropping into the corner candy store, he asked, "Was there a fire at Hooper's house tonight?"

"Yes," came the reply. "Someone dropped a cigarette on the chesterfield."

Back in the shop, the boss looked at his helper. "We got to go out to the Hooper place tomorrow and fix that antenna right," he said. "With those power lines so close, it could be dangerous." From that one bad experience the boss had learned his lesson. He realized that an antenna installation job puts the safety of a house and family right into his hands—and that there is no satisfactory halfway measure for safety! END



A number of advantages  
will be found in this

# NOVEL BEAT

By ALFRED HAAS

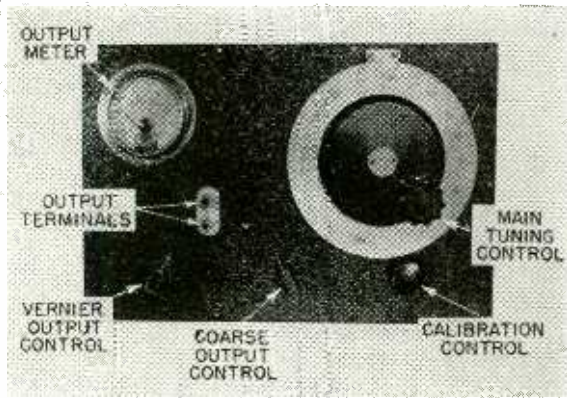

Front view of the signal generator. The large vernier dial simplifies the frequency calibration and tuning.

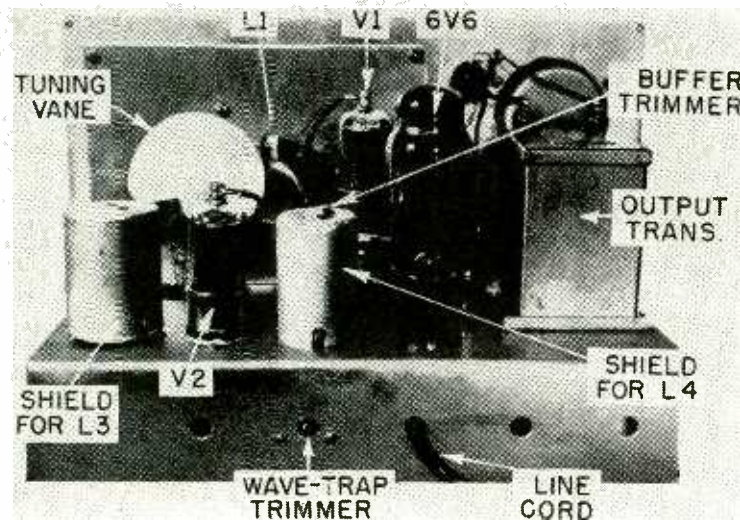

Rear view of instrument shows parts layout for optimum performance.

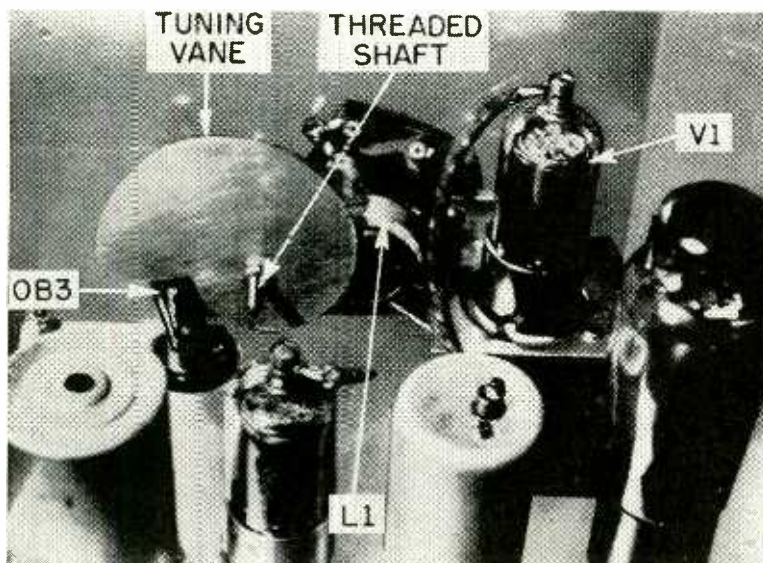

Close-up of the tuner. Oscillator frequency changes with the area of tuning vane in field of L1. Vane shape determines the tuning dial spread.

CONSTRUCTORS of home-built bridge-tuned audio signal generators sometimes run into a number of difficulties during construction and often find that the finished instrument has a number of disadvantages. To mention a few:

1. Resistance-tuned circuits should have matched variable resistors with low tolerances. These are hard to get.

2. Capacitance-tuned circuits usually require large tuning capacitors which must be carefully isolated and shielded to prevent hum. Since the shielding increases the size of the already bulky component, the complete instrument is usually disproportionately large.

3. To avoid cramped graduations at the low-frequency end of the scale, the tuning capacitor should have specially shaped plates of a type unavailable to the home constructor.

4. Setting of the feedback control is likely to be critical. Improper setting or drift results in distorted output.

5. With the average components, the tuning ratio is limited to about 1 to 10. Thus at least three ranges are needed to cover the audio spectrum.

The inductance-tuned beat-frequency type audio oscillator described here features low distortion, high stability, and a wide tuning range without any of the disadvantages listed above.

In a beat-frequency oscillator (b.f.o.), the outputs of two r.f. oscillators, one fixed and the other variable, are fed into a nonlinear mixer circuit so that they combine to generate a number of additional frequencies. A block diagram of an audio beat-frequency oscillator is shown in Fig. 1. One frequency, equal to the difference between the fixed frequency ( $F_f$ ) and the variable frequency ( $F_v$ ), will fall in the audio spectrum if  $F_f$  and  $F_v$  are sufficiently close. Other frequencies in the output of the mixer include  $F_v$ ,  $F_f$ ,  $F_v + F_f$ , their harmonics, and beats equal to the sum and the difference between each harmonic and all the others. A low-pass filter removes  $F_v$ ,  $F_f$ , their harmonics, and other spurious signals, leaving only the desired audio signal  $F_n$ .

If you have an audio v.t.v.m., you can omit the output meter. But, you should substitute an electron-ray tube or similar device as a null indicator for zero beating the two r.f. oscillators.

# FREQUENCY OSCILLATOR

## Stabilizing the b.f.o.

The a.f. signal is the difference between two higher frequencies so we must design the high-frequency oscillators so their total drift will be low. We do this by making them as nearly alike physically and electronically as possible. The rate and direction of the drifts will then be nearly equal and their effect on  $F_s$  will be negligible. Tapping the tube connections down on the tuned coil minimizes frequency shift due to changes in interelectrode capacitance and Miller effect. Operating both oscillators from a common voltage-regulated source stabilizes them against line-voltage fluctuations.

Stability improves as the oscillator frequency is lowered. However, if we make the frequencies too low, unwanted beats are likely to ride through the low-pass filter and cause distortion. As a compromise, the two oscillators operate in the vicinity of 100 kc.

When two closely coupled oscillators are tuned to the same frequency, they tend to lock in. That is, the stronger takes hold and synchronizes the weaker one with it. When this happens, there is no audio output below 100 cycles or so and dial calibration and stability will be affected above the lock-in point. Pulling and lock-in can be minimized by shielding and isolating the two oscillators. Converter-type tubes can be used to reduce coupling through the electronic circuits.

## Reducing distortion

The signal at the plate of the mixer tube contains a large number of spurious frequencies. These must be entirely eliminated for minimum distortion. The relative amplitudes of  $F_r$  and  $F_v$ , at the input of the mixer also affect the distortion in the output signal. The optimum ratio is about 1 to 10.

## The inductance-tuned b.f.o.

The inductance-tuned b.f.o. type audio signal generator shown in Fig. 2 and in the photographs tunes from 0 to 12,000 cycles in one band with good waveform and stability. It features variable-inductance tuning which makes it possible to get almost any desirable spread on the dial which may cover 300 degrees or more.

A pair of 6K8 triode-hexode converter tubes replace the two oscillators, two buffers, and the mixer in Fig. 1. The triode section of V1 is the variable-frequency oscillator which tunes from 120 to 132 kc. Its hexode section is the mixer. The triode section of V2 is the 120-kc fixed oscillator and the hexode section is a 120-kc tuned buffer amplifier. The signal from the 120-kc oscillator is fed into the buffer amplifier through the common control grid. The hexode, with its signal grid (grid 3) grounded, has its plate circuit tuned to 120 kc. This tuned circuit eliminates harmonics of the fixed oscillator and prevents them from entering the mixer.

The oscillators develop 8-volt r.f. signals (measured with a v.t.v.m. and r.f. probe) on their grids. To provide an amplitude ratio of 10 to 1, a 20-turn secondary was added to L4 to feed a 0.8-volt r.f. signal to the signal grid of V1.

The r.f. signals at the plate of the mixer are filtered out by the 200- $\mu$ f capacitor, 2.5-mh r.f. choke, and a 125-kc series-tuned trap. The audio signal appears across the 47,000-ohm load resistor. The 10,000-ohm resistor and 0.5- $\mu$ f capacitor provide additional fil-

tering to eliminate hum in the mixer plate circuit.

The vernier output control is in the grid-circuit of the 6V6 a.f. amplifier. This tube operates over the straight part of its characteristic curve to prevent the generation of harmonics which we have eliminated in preceding circuits. A small amount of negative feedback, introduced by the unbypassed cathode, improves the output waveform. However, if the output falls off at higher frequencies, shunt a .01- $\mu$ f capacitor across the cathode biasing resistor to restore the level. The output transformer should be a high-quality unit with a 5,000-ohm primary and 500-ohm secondary. The 15-volt maximum output can be reduced to 1.5 or 0.15 volts.

The output meter consists of a 200- $\mu$ a meter, a copper-oxide bridge meter rectifier, and a series resistor of about 6,800 ohms—the exact value depends on the make of rectifier you use. This resistor is shunted by a 100- $\mu$ f capacitor to compensate for the reduced efficiency of the rectifier at higher audio frequencies. When the series resistor and capacitor are carefully matched to the meter and rectifier, calibration is true throughout the audio range.

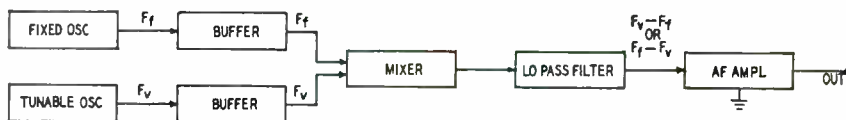

Fig. 1—A block diagram of a basic b.f.o. type audio-frequency signal generator.

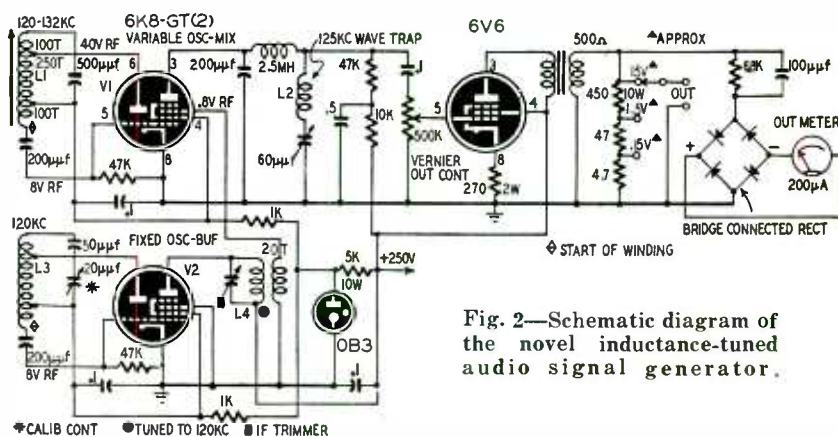

Fig. 2—Schematic diagram of the novel inductance-tuned audio signal generator.



I have a good general-purpose power supply that I decided to use instead of

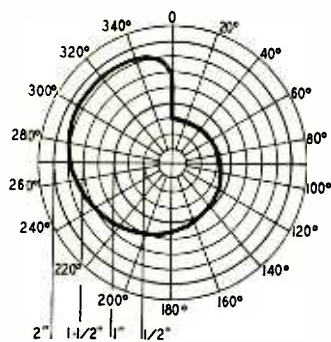

Fig. 3—Polar diagram of the tuner vane.

building one into the instrument. Of course, the power supply can be built-in, if you wish. It should deliver 250 volts well filtered at 80 ma and 6.3 volts a.c. at 1.05 amp or more. A 0B3 regulates the voltage at 90 for the triode plates and screens of the 6K8's.

### The tuning mechanism

Most variable-inductance tuning systems have coils wound on forms which have metallic cores. A non-magnetic core reduces the inductance and a magnetic core increases it. Moving the core into or out of the coil's field changes the apparent inductance. Plunger-type cores were rejected as a tuning method because it would be necessary to construct a foolproof system for converting rotary motion of the tuning dial into longitudinal motion inside the coil

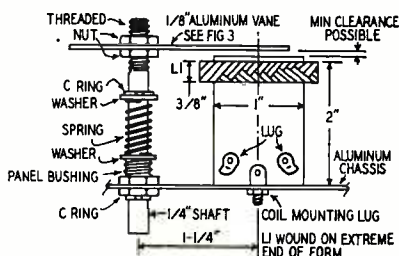

Fig. 4—Physical arrangement of tuner.

form. Instead, a cam-shaped sheet of aluminum is rotated in the field of the coil. The construction of the sheet or vane is shown in Fig. 3. The vane is positioned so it covers the entire end of the coil in the high-frequency position and is entirely clear of the coil in the low-frequency position. Swinging the vane through its range shifts the frequency of the variable oscillator from 120 to 132 kc.

Fig. 4 shows the mechanical details of the tuner. The panel bushing and "C" rings were taken from a discarded potentiometer. The vane is fastened tightly between two nuts on the threaded end of a 1/4-inch shaft supported by and rotating in the panel bushing. The arrangement of the coil spring and washers eliminates backlash and lateral motion which would disturb the calibration. The coil (L1) must be wound on the extreme end of its form so the vane can be positioned as close as possible to it without touching.

Oscillator coils L1 and L3 should be exact duplicates. Use 1-inch diameter forms and wind the 450-turn coils in three sections with No. 34 d.s.c. wire. The first section has 100 turns, the second 250, and the third 100. Leads are brought out from the ends of the coil as well as from the junctions of the sections. The starting ends of the first 100-turn sections connect to the grids of the 6K8's. The finished coils are 3/8 inch wide. If you do not have access to a coil winder, cement two stiff paper flanges 3/8 inch apart on each of the forms and wind the coils on the spools thus prepared. Impregnate the finished coils with coil dope and let them dry.

L2 and L4 are primary and secondary windings from an i.f. transformer which tunes to about 130 kc. Separate the coils by cutting the form midway between them. Use the top one for the primary of L4. Wind a secondary consisting of 20 turns of No. 34 d.s.c. wire 1/8 inch below the primary, then put this coil back into the shield can. The remaining i.f. coil (L2) is a wave trap tuned to 125 kc with a 60- $\mu$ f padder.

### Final adjustments

Connect a speaker or phones across the output terminals, set the vernier and coarse output controls for maximum output. Rotate the tuning vane and vary the setting of the CALIBRATION CONTROL trimmer for an audible beat. If you don't hear one, connect a small trimmer across L1 or L3 and try again. If you still cannot get a beat, switch the trimmer over to the other coil and try again. When you get a beat, set the tuning vane so it is farthest from the coil. Set the CALIBRATION CONTROL to about half capacitance, then tune the oscillators to zero beat with a small trimmer across one of the coils.

### Materials for audio b.f.o.

**Resistors:** 1—4.7, 1—47, 1—10,000, 1—33,000, 2—47,000, 2—100,000 ohms, 1/2 watt; 1—270 ohms, 2 watts; 1—450, 1—5,000 ohms, 10 watts; 1—500,000 ohms potentiometer; 1—6,500 ohms approximate (see text).  
**Capacitors:** (Paper) 4—0.1, 1—0.5  $\mu$ f, 600 volts, (Ceramic or mica) 1—50, 1—100, 3—200, 2—500  $\mu$ f. (Air or ceramic trimmers) 1—20, 1—60  $\mu$ f.  
**Tubes:** 2—6K8 or 6K8-GT, 1—6V6 or 6V6-GT, 1—0B3 /VR-90.  
**Miscellaneous:** 1—5-watt output transformer, 5,000 ohms primary and 500-ohm secondary; 4—octal sockets; 1—single-pole, 3-position rotary switch; 1—2.5-mh r.f. choke; 1—200  $\mu$ a d.c. meter; 1—full-wave bridge instrument rectifier; 1—roll of No. 34 d.s.c. wire; 1—132-kc i.f. transformer. Dial, chassis, knobs, output terminal posts, hardware.

Adjust the main tuning control (the tuning vane) for a comfortable note, then set the trimmer on L4 for maximum output. Try a larger or smaller trimmer if the circuit won't peak.

A scope is used for tuning the wave trap and for calibrating the instrument. Connect the scope across the vernier output control. Any r.f. voltage which comes through from the oscillators will be superimposed on the audio signal and produce a broad trace on the screen. Adjust the capacitor in series with L2 for the finest possible line. You can calibrate the instrument by using Lissajous figures. (See the article by N. H. Crowhurst on page 30 of this issue.—*Editor*)

## DIRECT-READING COUNTER

By NATHANIEL RHITA

THIS novel counter circuit is the heart of the direct-reading carrier frequency meter in the Hewlett-Packard FM and TV monitors. It permits the engineer to read the carrier frequency directly from the meter instead of heterodyning it against a standard and interpolating the frequency from dial readings.

The carrier signal is heterodyned against a precision crystal to produce a 30-kc i.f. This i.f. signal is fed to a three-stage limiter-amplifier which produces square waves which are fed to the pulse-counting discriminator in the diagram. The counter tubes V1 and V2 are excited in push-pull. V3 is a constant-current pentode which assures uniform plate currents for V1 and V2.

The counter tubes are alternately and periodically driven to full conduction by one half-cycle of the square wave and then blocked on the other. When V1 is unblocked by a positive half-cycle, the voltage across R1 rises abruptly. As C1 charges it passes a current which decays exponentially as shown at *a*. At the same instant V2 is blocked by a negative half-cycle. The voltage drop across R2 disappears quickly, and C2 discharges exponentially as shown by "*b*." Pulses *a* and *b* have a cumulative effect through the rectifier unit. A half-cycle later the capacitor pulses reverse their direction as shown by *c* and *d*.

The full-wave rectifier sends currents through M1 in the same direction. The time constants of R1, C1 and R2, C2 are so small the capacitor pulses die down to zero before the next ones appear. Therefore the meter current is propor-

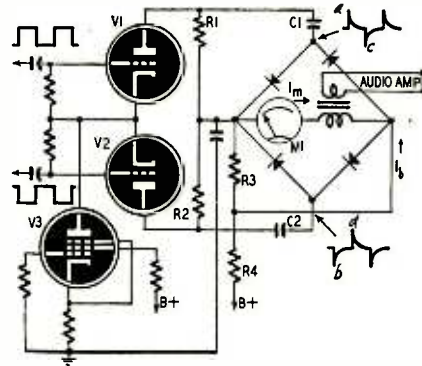

tional to frequency. For convenience in monitoring carrier deviation, the capacitor currents  $I_m$  are balanced by a reverse current  $I_b$ . This is supplied by the divider R3, R4 which is adjusted to obtain a deflection to zero-center when the i.f. is exactly 30 mc. This corresponds to zero deviation of the carrier.

The meter—calibrated in kilocycles—deflects above or below zero-center when the carrier deviates in a positive or negative direction. Its accuracy can be made better than 0.005% from 30 to 50 mc and .0002% above 50mc.

A transformer in series with M1 picks off the modulation. This is amplified to control peak modulation and modulation deviation indicators. END

# HOW TO LICK A SERIOUS PROBLEM

By JIM KIRK

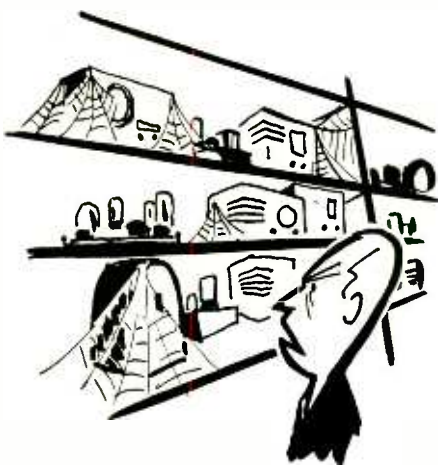

**A**NTIQUE radio sets left by customers for months, or often, *forever*, can break a man. They have taken up time and money and continue to take up needed shelf space. Other service businesses such as shoe repair and dry cleaning have the problem of articles left behind, but the radio service technician is especially harried because of his large investment in repairs and the storage space involved.

This problem came to me as a direct result of a policy I decided to pursue years ago. In my early days in the game, I had allowed customers to take sets without full payment . . .

"I only have a couple of dollars until pay day. I'll give you the balance, Saturday."

Saturday never came. I fell for other excuses enabling guys to take sets without paying the entire amount. I soon found this equivalent to price cutting since I seemed *never* to collect the remainder. So, I put it down in my book that from then on I'd be smart—no one would get his set for less than full price.

Then customers began leaving their sets. You have had this problem, too! You worry about the cost of the parts you have installed. Your time doesn't worry you as much, but it should. I started writing monthly letters to customers, with small success. Then one day I got desperate. There had been a new-looking set left on my hands for six months. I wrote the owner that if he didn't call for it within a week, I would sell it. That brought results. The belligerent owner appeared and said, sneering:

"My lawyer says you can't sell that radio. My bill of sale shows I own that set. You have no such evidence. You'd be selling stolen property—and I could sue you for everything you've got!"

Where the law is concerned, lambs and new-born babes have nothing on me for innocence. I consulted a lawyer friend of my own. He said, in part,

"The customer is right. He could sue you. However, it seldom works that

way in practice. He would have the double expense of hiring a lawyer and paying court costs."

"How about those shoe repair places that have signs, 'Goods left over 30 days will be sold for costs?'" I asked the lawyer.

"Those signs are illegal—they're just to frighten customers. The law says you must keep such property a year and then advertise it for sale."

I asked around the neighborhood to learn what others were doing.

A bicycle repair man confided that he had the problem of "kids leaving their bikes." He had tried to solve it in a way I imitated, for a time. His solution helped somewhat. Every two weeks, he sent a post card to the customer. The second post card bore the notice, "Second Warning," the third, "Third Warning," and so on.

A tailor told me his system and I tried that, too. I sent letters to customers who left goods a month and told them there would be a storage charge of 25 cents a week if the radios were not called for in a week. That moved some of my customers but not once did I get the 25 cents a week. (If I could really get 25 cents a week for every set left here, I would not mind so much having the junk around.)

The real solution to this problem works like magic. And the customer walks away with the set when it's ready! Where the set is a relic and the repairs will be costly, and the customer says, "Go ahead and fix it," I tell him, in a friendly way, that I will have to make quite an investment in parts. I would like a down payment. I give him the impression that I am not worried about my labor, that my only concern is for the money I will have to lay out for parts. I have been amazed by the readiness of the customer to shell out a down payment. Surprisingly, most set-owners, on their own initiative, pay all, or almost all of the total cost! This works so unexpectedly well that it leaves me dizzy! A customer may leave his property—but leave his property *and* a deposit—*never!* END

## UNEXPECTED SOLUTION TO SERVICE PUZZLER

By E. W. SCOTT

**W**HEN my Stromberg-Carlson TV-125 (chassis TV-12) is operating normally with a good antenna in a strong-signal area, channels 2, 4, and 5 provide the best pictures with the contrast control backed down almost to the left-hand stop. A few weeks ago I noticed that we could not receive channel 13 sound or picture and it was necessary to advance the contrast control about halfway for a good picture. A few days later the condition got worse. Pictures were weak and snowy on all channels, and advancing the contrast control caused tearing and loss of sync. The sound was excellent.

The next Sunday morning we set to work. The antenna and lead-in were in good shape. Voltages were a little low on all B plus lines. We did not have spare 5U4's on hand, so we plugged in a pair of 5R4-GY's. Voltages returned to normal and we could get good pictures without loss of sync or tearing. However, we still had to operate with the contrast wide open. We decided to check the tubes by substituting a few good ones which we had on hand. Tubes in the tuner, sync, sound i.f., and video circuits checked O.K.

We didn't have spare 6AG5's for the video i.f. strip, so we checked heater continuity without paying attention to the resistance values. The ohmmeter needle kicked wildly, so we decided that the heaters were good. Voltages on the plate and screen were within normal 10% tolerance. Interchanging the three 6AG5's had no effect on the performance.

Finally, after rechecking voltages and substituting tubes, I noticed that the 6AG5's in the first and second video i.f. stages were stone cold while the other tubes were too hot to touch. A second continuity check on the cold tubes showed one heater to have a resistance of well over 100 ohms while the other was about 68 ohms.

I replaced these tubes and watched them closely as the set was turned on. The heaters glowed dimly for a few seconds then went out. A quick check showed that the heaters opened up as soon as they were heated. The set operated normally when these tubes were replaced with 6AK5's. (These are still in use and are excellent substitutes.)

Still puzzled by the acceptable performance of the set with two burned-out video i.f. tubes, I clipped the heater pins off the bad 6AG5's and reinserted them in their sockets. We could still get all channels except 13 simply by setting the contrast control wide open. This test proved that strong signals could feed from the output of the tuner through wiring and interelectrode capacitance of the defective 6AG5's to the sound take-off and the video or video i.f. circuits which were functioning normally. END



**F**LIP-FLOPS are circuits which have as their most distinctive characteristic two equilibrium states of current flow. They are used extensively for counting in digital computers. Both ordinary vacuum tubes and thyatrons are commonly used for the flip-flop; this article will introduce the reader to circuits which use *cold-cathode*, gas-triode tubes.

The basic circuit is given in Fig. 1. It consists of two type 0A4-G tubes which require positive triggering potential on the starting anode for a current discharge to occur from anode to cathode (or the other way around, if you like). After initiating a discharge, the starter electrode loses control and the flow continues till the anode potential is lowered to below the ionization voltage for the tube. Consider first both gas-triodes of Fig. 1 in the nonconducting state with a d.c. source of 135 volts connected. To start conduction, a pulse of plus 90 volts is applied at the input terminals. One tube will begin to conduct first because of the slight variation of characteristics between the two tubes. The voltage across the conducting tube will drop from 135 volts to 70 volts. With this abrupt change of conditions, the capacitor will momentarily act as a short-circuit to hold both tubes at the lowered potential. As the capacitor charges to 65 volts, the nonconducting tube voltage will be restored to 135. The pulse is made short so that danger of both tubes starting to conduct is at a minimum. The starter-anode electrode (SA) of the conducting tube will assume a positive potential because of the ionized gas around it, but this is insufficient to trigger the other tube. If a second pulse is now applied, the starter electrode of the nonconducting tube initiates a glow discharge and starts conduction. This drops the anode voltage from 135 volts to 70 volts. This drop plus the negative charge on the capacitor force the first-conducting tube voltage down to plus 5 volts, which is too low to sustain ionization, so conduction stops. The voltage returns to the nonconducting value of 135 volts as the capacitor charges. As each subsequent pulse is injected into the circuit, the conducting tube will stop and the nonconducting tube will start. As viewed at one anode of the circuit, the two equilibrium states of current flow are "none" and "some"; the two equilibrium states of voltage are 135 volts and 70 volts.

In certain applications, such as locking circuits, it may be advantageous to have separate input connections to each starting anode. A signal applied to one starting electrode could be used to trigger the circuit and a signal applied to the other could be used to "reset" or stop the condition started. One example of input signals for this connection would be two phototubes operating from different sources of light; another would be two resonant circuits attached to the power line to receive triggering signal pulses on different carrier frequencies.

It is easy to provide a power source

# FLIP-FLOP COUNTER

uses  
cold-cathode  
tubes

By BOB WHITE

for this circuit. A selenium rectifier and filter are all that is needed for a.c.-d.c. line operation, or three 45-volt batteries connected in series fill the bill for portable operation. The current drain of each pair of cold-cathode tubes in this connection is only about 11 ma; this is enough to operate sensitive relays for controlling external circuits. Since conduction in these tubes is characterized by a purplish glow, the active tube is readily identified. Externally connected glow lamps can be used as indicators.

## A pulse counter

Two or more of these circuits can be connected together to count pulses. Such a circuit is given in Fig. 2. Here the source of pulses is a push-button and a small capacitor. At the instant the button completes the circuit, a positive voltage of 135 volts is applied to the starting anodes of V1 and V2. The .006- $\mu$ f capacitor rapidly charges so that though the button remains pressed, the triggering voltage drops below the criti-

cal value rapidly. After the button is released, the shunting resistor discharges the capacitor so it will be uncharged when the next positive pulse comes. Each time V2 changes from the conducting state to the nonconducting state, a positive pulse is momentarily applied through the 0.1- $\mu$ f capacitor to the starting anodes of V3 and V4. Similarly, each time V4 changes from conduction to nonconduction, a pulse is sent to trigger a possible additional pair of tubes, and so forth. The table shows the sequence of events when a number of pulses are sent to four pairs of circuits. Triggering voltage on these tubes varies—put those which fire easiest in the V1, V3, etc., positions to insure correct sequence.

After studying the behavior of the system, tubes V1, V2, V4, V6, and V8 were labeled 1, 2, 2, 4, and 8 respectively. By adding the numbers assigned to those tubes which are in conduction after any given pulse, the number of the pulse will be found. Before begin-

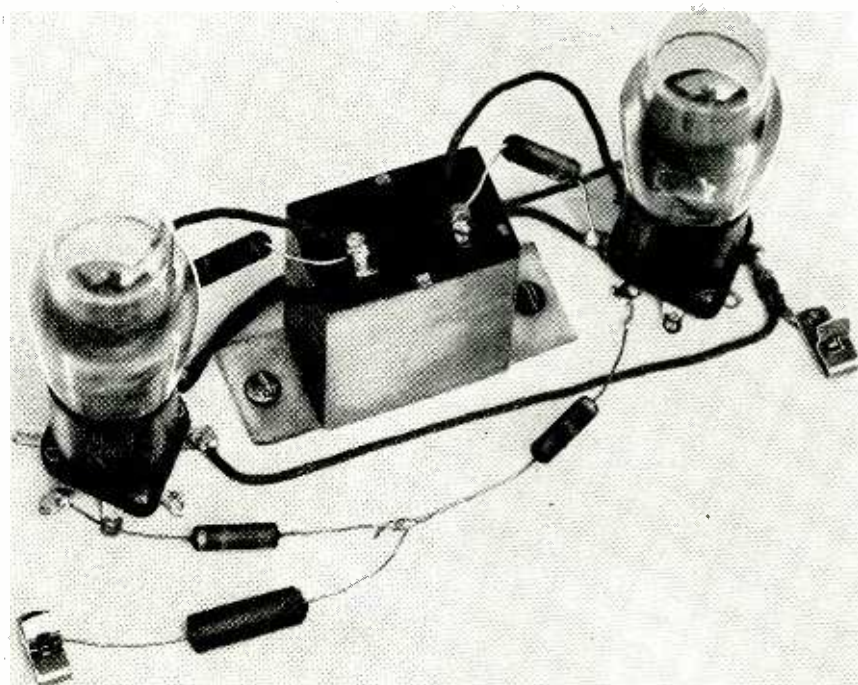

Experimental model of the circuit of Fig. 1. Large block in center is the capacitor.





**TRAIN FASTER—TRAIN BETTER—TRAIN EASIER  
IN 10 MONTHS—OR LESS—FOR  
**RADIO-TELEVISION****

Our 21st Year Training Men for Greater Incomes and Security in Radio-Television

**I SEND YOU  
18 BIG KITS**

of Radio Television parts and equipment. Much of your training will be actual construction and experimentation . . . the kind of truly PRACTICAL instruction that prepares you for your Radio-Television career.



Frank L. Sprayberry  
President  
Sprayberry Academy  
of Radio

**NEW! NO OBLIGATION PLAN**

**You Have No Monthly Payment Contract to Sign  
Pay For Your Training as You Earn and Learn**

You can get into Radio-Television, today's fastest growing big money opportunity field, in *months* instead of years! My completely new "package unit" training plan prepares you in as little as 10 months or even less! *No monthly payment contract to sign—thus NO RISK to you!* This is America's finest, most complete, practical training—gets you ready to handle any practical job in the booming Radio-Television industry. Start your own profitable Radio-Television shop . . . or accept a good paying job. I have trained hundreds of successful Radio-Television technicians during the past 21 years—and stand ready to train you, even if you have no previous experience! Mail coupon and get all the facts—FREE!



**Valuable Equipment Included  
With Training**

The new Sprayberry "package" plan includes many big kits of genuine, professional Radio-Television equipment. You perform over 300 demonstrations, experiments and construction projects. You build a powerful 6-tube 2-band radio set, multi-range test meter, signal generator, signal tracer, many other projects. All equipment and lessons are yours to keep . . . you have practically everything you need to set up your own profitable Radio-Television service shop.

**Earn Extra Money While You Learn!**

All your 10 months of training is IN YOUR HOME in spare hours. Keep on with your present job and income while learning. With each training "package" unit, you receive extra plans and "Business Builder" ideas for spare time Radio-Television jobs. New television stations everywhere, open vast new opportunities for trained Radio-Television Technicians—and those in training. If you expect to be in the armed forces later, there is no better preparation than practical Sprayberry Radio-Television training.

**YOU BUILD** the Television set and the powerful superhet radio receiver shown above. IN ADDITION to the other test units shown here (many are not shown because of lack of space). All equipment I send you is YOURS TO KEEP.

Approved for Veterans under the G. I. Bill

**SPRAYBERRY ACADEMY OF RADIO 111 NORTH CANAL ST. Dept. 20-P, Chicago 6, I. I.**

**MAIL COUPON  
TODAY!  
NO OBLIGATION**

I invite you to get all the facts—  
**FREE TO YOU 3 BIG  
RADIO-TELEVISION BOOKS**

I want you to have ALL the facts about my new 10-MONTH Radio-Television Training—without cost! Rush coupon for my three big Radio-Television books: "How to Make Money in Radio-Television." PLUS my new illustrated Television Bulletin PLUS an actual sample Sprayberry Lesson—ALL FREE. No obligation and no salesman will call. Mail coupon NOW!

**SPRAYBERRY ACADEMY OF RADIO, Dept. 20-P,  
111 North Canal St., Chicago 6, III.**

Please rush to me all information on your 10-MONTH Radio-Television Training Plan. I understand this does not obligate me and that no salesman will call upon me. Be sure to include 3 books FREE.

Name..... Age.....  
Address.....  
City..... Zone..... State.....





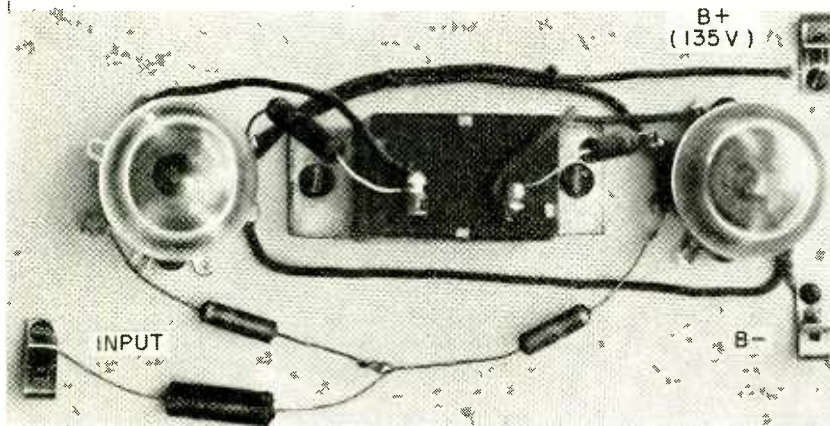

Semi-schematic view of basic circuit; a breadboard hookup minus breadboard.

ning a count, pulse the circuit till all even-numbered tubes are on and odd ones off (count of 16). As an example, consider the 6th pulse: V2 and V6 will be lit, which corresponds to 2 and 4, or a total of 6. It will be noted that with one pair of tubes, counting up to 2 without repeating is possible, with two pairs up to 4, with three pairs up to 8, with four pairs up to 16, etc.

Neon bulbs of the 2-watt size can be directly connected across the 2- $\mu$ f capacitors to indicate circuit conditions without disrupting circuit functions. The negative post of the neon bulb is the one to glow so that the negative lead from the capacitor can be noted and the change in polarity observed. The small T2 neon bulbs used with dropping resistors can give external indication when connected between anode and cathode; the connection should be made to the mate of the tube whose conduction is to be denoted. If only four tubes are to be used as in Fig. 2, it is possible to connect two T2 neon bulbs with their dropping resistors from V1 to V3 and

from V1 to V4. The four posts of the neon bulbs will light in sequence as the four pulses are applied. A slight flash in the nonconducting neon bulb occurs at the instant of polarity reversal, but this should be a small objection. The most important method of indication is the use of sensitive relays (11-ma requirement); these can be inserted in series with the 6,800-ohm resistors, which should be reduced to compensate for the added coil resistance.

The rate at which this circuit is capable of handling pulses is limited to a few pulses per second. An investigation into the circuit revealed the cause to be the 0.1- $\mu$ f coupling capacitor which does not discharge sufficiently at high pulse-repetition rates. The basic circuit in Fig. 1 was estimated to be capable of handling over 100 pulses per second.

Fig. 3 shows the adaptation of the fundamental circuit to a frequency divider which is in reality the pulse counter operating at a synchronous rate. The source of triggering pulses is the 60-cycle line itself. Each time the positive half of the cycle is impressed on the starter anodes, the pair of tubes exchange states so that we have one complete cycle in the output for each two line-frequency cycles; in other words, the output frequency of the first pair is 30 cycles per second. The same 0.1- $\mu$ f coupling capacitor is included in this circuit, but to speed the discharge process a 500,000-ohm shunting potentiometer has been added. This adjustable resistance allows setting the triggering

rate of the second pair at once every two cycles or every four cycles (with increased resistance settings). The output of the second pair of tubes may then be either one-fourth or one-eighth the input frequency. With only four cold-cathode tubes, an output of 15 or 7.5 cycles is obtained with a source of 60 cycles. Additional pairs of tubes can be added to divide the frequency output to any extent desired. The output waveform approaches that of a square wave.

The shunting resistance technique cannot be applied to extremely low frequency pulse rates. The resistance connection to the positive side of the power supply tends to produce an oscillatory condition with the result that free-running oscillations may occur or both tubes may conduct simultaneously. The solution to the problem of handling rates of pulses continuously from extremely slow rates to those in the region of 100 per second lies perhaps in the use of higher voltage sources so that smaller coupling capacitors will serve to trigger successive stages.

The cold-cathode tube does not seem to have been utilized to as great an extent as its unusual features would merit. The low power consumption, the instan-

SEQUENCE TABLE

	(1)	(2)	(2)	(4)	(8)			
PULSE	V1	V2	V3	V4	V5	V6	V7	V8
1	ON	OFF	ON	OFF	ON	OFF	ON	OFF
2	OFF	ON	ON	OFF	ON	OFF	ON	OFF
3	ON	OFF	OFF	ON	ON	OFF	ON	OFF
4	OFF	ON	ON	ON	ON	OFF	ON	OFF
5	ON	OFF	ON	OFF	OFF	ON	ON	OFF
6	OFF	ON	ON	OFF	OFF	ON	ON	OFF
7	ON	OFF	OFF	ON	OFF	ON	ON	OFF
8	OFF	ON	OFF	ON	OFF	ON	ON	OFF
9	ON	OFF	ON	OFF	ON	OFF	OFF	ON
10	OFF	ON	ON	ON	ON	OFF	OFF	ON
11	ON	OFF	OFF	ON	ON	OFF	OFF	ON
12	OFF	ON	OFF	ON	ON	OFF	OFF	ON
13	ON	OFF	ON	OFF	OFF	ON	OFF	ON
14	OFF	ON	ON	OFF	OFF	ON	OFF	ON
15	ON	OFF	OFF	ON	OFF	ON	OFF	ON
16	OFF	ON	OFF	ON	OFF	ON	OFF	ON

For additional circuits using cold-cathode tubes refer to the article "Photoelectric Relays Use Cold-Cathode Tubes" in the April, 1950, issue of RADIO-ELECTRONICS.

taneous warmup time, the greatly reduced heating, and the long life make this type tube unique in many applications. The miniature type cold-cathode triode which is available could replace the OA4-G used with the circuits presented if compactness is essential. END

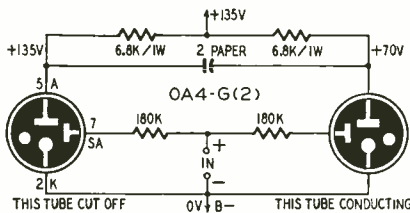

Fig. 1—Cold-cathode flip-flop circuit.

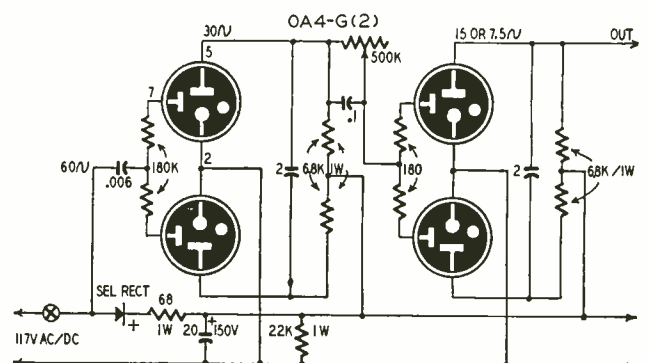
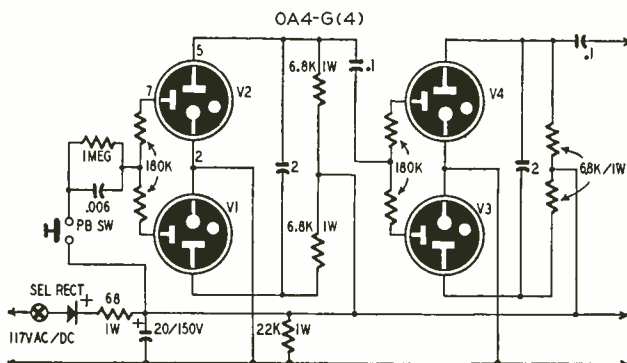
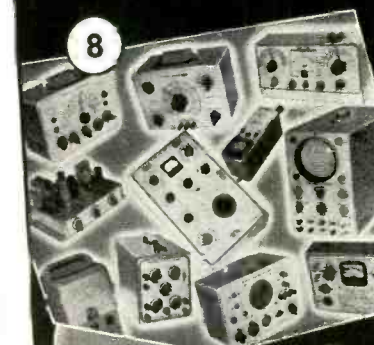
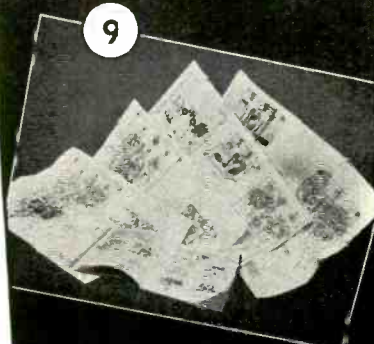
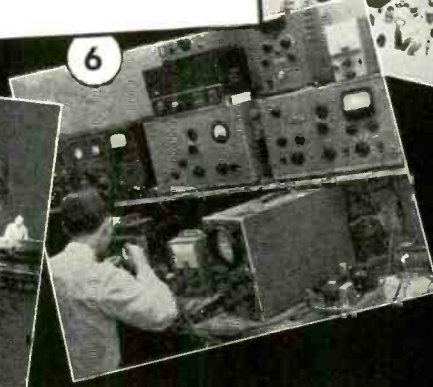
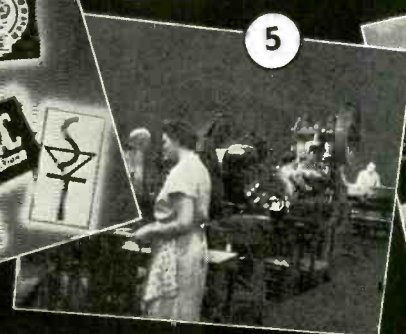
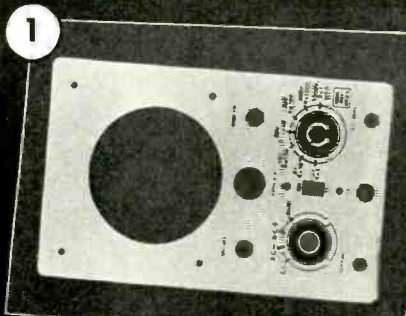

Fig. 2, left—A practical form of cold-cathode pulse counter. Fig. 3, right—A simple frequency dividing circuit.



# Check these ADVANTAGES FOUND Only in HEATHKITS



## 1. Baked Enamel Lifetime Finish Panels

— Oven baked finishes for maximum durability and freedom from marks, scratches and discoloration. Panels that can really take service shop and laboratory abuse.

## 2. Save Money

— You save all expensive factory wiring costs when you build your own. And, direct factory to customer sales eliminate all middle man profits. You can have a complete Heathkit laboratory or service shop for what one or two pieces of ready built equipment cost.

## 3. Modern Styling

— New "fitted panels" and formed cabinets with rounded corners present a smart, professional appearance. Dignified appearance for prestige.

## 4. Quality Components Used Throughout

— Heathkits use well known, time and quality tested components such as Simpson, Chicago Transformer, Wilkor, Allen-Bradley, Altec-Lansing, Centralab, Cinch, Oak, Grigsby-Allison, Mallory and many others.

## 5. Extensive Factory Facilities

— Shearing, punching, forming, spot welding, etc. is done right in our own plant—controlled production for highest quality and less cost to you.

## 6. Extensive and careful engineering

— A staff of engineers working in a modern, well equipped laboratory carefully develop Heathkits according to highest engineering practices. Your assurance of accurate, up to the minute instruments.

## 7. Complete Kits

— All the parts are right in the kit—you get all tubes, controls, transformers, meters—everything—no other components to buy. And no cutting, punching, or painting necessary—it's all done for you. Heathkits go together easily and smoothly.

## 8. Only Complete Line

— Over 30 kits available—Heathkits form the only complete line of kit-form test equipment on the market. Kits for hams, engineers, service men, schools and audio enthusiasts.

## 9. Detailed, Complete Instruction Manuals

— Comprehensive manuals tell you exactly how to build your Heathkit. Manuals contain easy-to-follow instructions, clear large pictorials, schematic, detail drawings, etc. They make construction easy, fun, and educational.

## Nine New Heathkits This Year!

EXPORT AGENT  
ROCKE INTERNATIONAL CORP.  
13 E. 40th ST.  
NEW YORK CITY (16)  
CABLE: ARKAR N.Y.

# The HEATH COMPANY

... BENTON HARBOR 20, MICHIGAN



# NEW Heathkit "Q" METER KIT

• A HIGH QUALITY Q METER AT LOW COST.

MODEL QM-1

SHIPPING  
WT. 12 LBS.

**\$39<sup>50</sup>**

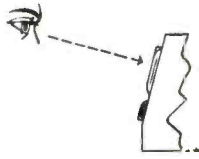
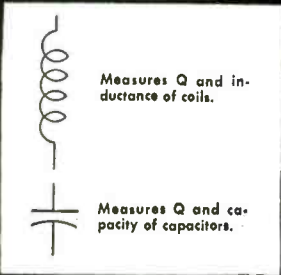

Slant face cabinet for ease in reading the meter.



• First Q METER within the price range of all.

• Read Q's of 0-500 directly on calibrated scale.

• Stable oscillator supplies R.F. frequencies of 150 kc to 18 megacycles.

• Calibrated capacitor with range of 40 mmf to 450 mmf with vernier of  $\pm 3$  mmf.

• Simple, easy operation.

• Can be used to measure small inductances or capacitors.

• Measures Q of condensers, RF resistance and distributed capacity of coils.

• Measures capacity by substitution, capacity by resonance, inductance by resonance.

• Slanted panel for convenient operation.

Another outstanding example of progressive HEATHKIT engineering. Now a highly desirable Q METER within the price range of all laboratories, schools and experimenters. No longer is it necessary to deny yourself the many measurement advantages offered by this instrument.

Use the new HEATHKIT Q METER for the following simple basic measurements: capacity by substitution, capacity by resonance, inductance by resonance and Q at the OPERATING frequency all can be read on the calibrated scales. The method used to obtain information regarding the Q of condensers, RF resistance, distributed capacity in coils, etc., is only slightly more involved. In the HEATHKIT Q METER, the generated RF signal is coupled through a cathode follower and injected across a low impedance condenser which is included in the resonant circuit under test. Large  $4\frac{1}{2}$ " 50 microampere Simpson meter reads Q directly. The resonating condenser and vernier condenser are calibrated in mmf for substitution method capacity tests. The resonating condenser is also calibrated in effective capacity for resonance tests. The inductance calibration serves for rapid determination of the approximate inductance of a coil. The HEATHKIT Q METER has a generator frequency range of 150 kc to 18 megacycles. Vernier capacity covers  $\pm 3$  mmf and the resonating condenser is calibrated from 40 mmf to 450 mmf actual capacity or 40 mmf to 350 mmf effective capacity. Meter reads Q directly up to 250. Higher and lower full scale readings can be obtained by varying the injection voltage levels.

The entire kit consists of 12AT7, 6AL5, 6C4, OD3 and 6X5 tubes, 50 microampere Simpson meter, power transformer, cabinet and all other parts necessary for construction as well as instructions for assembling, testing and operation of the completed instrument.

## Heathkit DECADE RESISTANCE KIT

The HEATHKIT DECADE RESISTANCE KIT is widely used by schools, experimenters and laboratories because of the extremely wide resistance range offered and the useful, dependable service provided. The DECADE consists of 5 rotary 2 deck ceramic wafer switches with silver plated contacts and twenty 1% precision resistors in a circuit which provides the resistance range of 1 ohm to 99,999 ohms in 1 ohm steps. The HEATHKIT DECADE RESISTANCE KIT is simple to construct and is housed in a beautiful polished birch cabinet with an attractive panel. The DECADE will furnish years of accurate trouble-free service.

Individual decade sections of above can be purchased separately for special applications.



MODEL DR-1  
SHIPPING  
WT. 4 LBS.

**\$19.50**

## NEW Heathkit DECADE CONDENSER KIT

Extremely useful in all experimental and design work such as determination of design work such as determination of condenser values for: compensating networks, filters, bridge impedances, tuned circuits, etc. Uses all precision silver mica condensers within  $\pm 1\%$  accuracy. Values run in three decades from 100 MMFD to 0.111 MFD in steps of 100 MMFD. Smooth acting, positive detent, highest quality ceramic wafer switches make all capacitor values easy to set up and keep losses to a minimum. Low loss dielectric terminal board mounts on outside of panel for easy cleaning. Heathkit binding posts accommodate a wide variety of test leads. Comes complete with all parts, including polished birch cabinet.

Individual decade sections of above can be purchased separately.

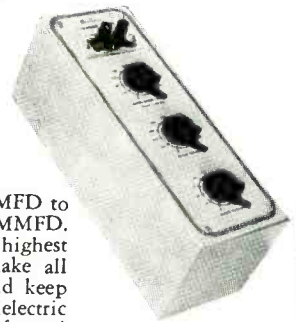

MODEL DC-1  
SHIPPING  
WT. 4 LBS.

**\$16<sup>50</sup>**

EXPORT AGENT  
ROCKE INTERNATIONAL CORP.  
13 E. 40th ST.  
NEW YORK CITY (16)  
CABLE: ARLAB-N.Y.

The **HEATH COMPANY**

... BENTON HARBOR 20, MICHIGAN

# NEW *Heathkit* OSCILLOSCOPE KIT

• NEW WIDE BAND VERTICAL AMPLIFIER  $\pm 2$  DB 10 CYCLES TO 1 MC.

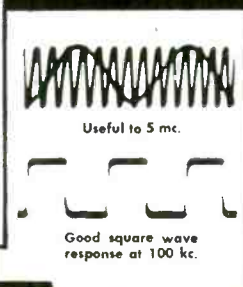
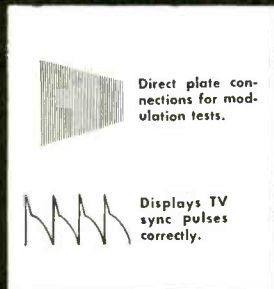

MODEL O-8

SHIPPING  
WT. 29 LBS.

**\$43.50**



- New wider band vertical amplifier  $\pm 2$  db from 10 cycles to 1 megacycle useful to over 5 megacycles.

- High sensitivity in vertical amplifier. .025 volts RMS per inch deflection.

- New 3 step input attenuator input ranges X1, X10, X100.

- New 5CP1 intensifier type tube for greater brilliance.

- Terminal board and rear cabinet opening provisions for direct connections to deflecting plates.

- Newly styled formed and ventilated aluminum cabinet.

- Wide band sweep generator, 15 cycles to over 100 kc. Will synchronize with 5 megacycle signal.

- 10 tube circuit featuring push pull operation of vertical and horizontal amplifiers.

- Internal synchronization on either positive or negative peaks.

- Reproduces faithfully the front and back porches of TV sync pulses. Excellent square wave reproduction to over 100 kc.

- Optional Intensifier kit available for 2200 volt operation.

Proudly announcing the new 1953 HEATHKIT Model O-8 OSCILLOSCOPE featuring the finest performance ever offered in this extremely popular kit instrument. Improved wider band vertical amplifier featuring a new 3-step input attenuator affording smooth control of the excellent .025 volts per inch vertical sensitivity. Possibility of overloading the vertical input circuit is minimized. Greater band width in the vertical channel is a decided advantage to TV service men. Permits clear observation of all TV sync pulse detail and excellent square wave reproduction over 100 kc. 5CP1 intensifier type CR tube provides a brilliant trace with normal accelerating voltages. A handsome, ventilated cabinet with smooth rounded corners and a snug fitting drawn panel adds to the smartly styled professional appearance. Longer life is assured through cooler instrument operation. Push pull output stages in both vertical and horizontal amplifiers for balanced deflection of the spot. All of the many fine features of the previous model have been retained. Rear cabinet access to terminal board for direct connection to CR plates. The entire kit of all 10 tubes, parts, cabinet and panel as well as detailed construction manual for assembly and operation of the instrument included.

**INTENSIFIER KIT:** For extreme trace brilliance in special applications such as photography, group demonstrations or operation in brightly lighted areas an optional Intensifier kit providing 2200 volt operation of the CR tube is available. Kit includes high voltage filter condenser, high voltage selenium rectifier, etc. \$7.50.



## *Heathkit* SCOPE DEMODULATOR PROBE KIT

Trouble shooting or aligning TV, RF, IF and video stages requires demodulation of high frequency signals before Oscilloscope observation. The HEATHKIT SCOPE DEMODULATOR PROBE KIT was specifically developed for this application. Kit consists of a probe housing, crystal diode detector circuit, shielded cable and spade lugs. Assembly is simple and the probe will quickly prove its usefulness as an Oscilloscope accessory.

No. 337  
SHIP. WT. 1 LB.  
**\$4.50**

## NEW *Heathkit* VOLTAGE CALIBRATOR KIT

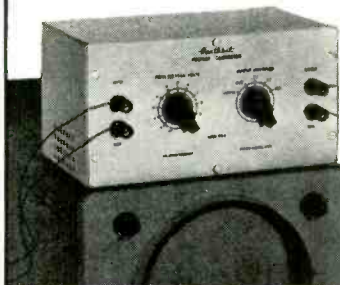

MODEL VC-1  
SHIPPING  
WT. 5 LBS.  
**\$9.50**

Use the Heathkit Voltage Calibrator with your oscilloscope to measure peak-to-peak TV complex waveshapes. TV manufacturer's specifications indicate correct peak-to-peak voltages and this kit will permit making these important measurements.

A big help to engineers in circuit work. Makes peak-to-peak voltage measurements of complex waveshapes of all kinds. Flat topped semi-square wave output of calibrator assures fast and easy measurement of any voltage between .01 and 100V peak-to-peak.

The Voltage Calibrator can remain connected to your oscilloscope at all times for instant use. "Signal" position connects signal under study directly through calibrator and into scope input circuit for direct observation. Eliminates transferring leads from calibrator. *A wonderful scope accessory.*

## *Heathkit* ELECTRONIC SWITCH KIT



MODEL S-2  
SHIPPING  
WT. 11 LBS.

**\$19.50**

A few dollars spent for this accessory will increase the usefulness of a scope immeasurably. An electronic switch will open up a whole new field of scope applications for you. The S-2 allows TWO SIGNALS to be observed at the SAME TIME — this important feature allows you to immediately spot phase shift, clipping, distortion, etc. The two signals under observation can be superimposed or separated for individual study. Each signal input has an individual gain control for properly adjusting scope trace patterns. Has both coarse and fine frequency controls for adjusting switching time. Multivibrator switching frequency is from less than 10 cps to over 2000 cps in three overlapping ranges. Kit comes complete including 5 tubes, power transformer, all controls, instruction manual, etc. *Every scope owner should have one!*

EXPORT AGENT  
ROCKE INTERNATIONAL CORP.  
13 E. 40th ST.  
NEW YORK CITY (16)  
CABLE AREA 8 N. Y.

*The* **HEATH COMPANY**

... BENTON HARBOR 20, MICHIGAN



# Heathkit VACUUM TUBE **VOLTMETER KIT**

• NEW 1½ VOLT RANGE ON 1953 VTVM.

**MODEL V-6**

SHIPPING  
WT., 7 LBS.

**\$24.50**

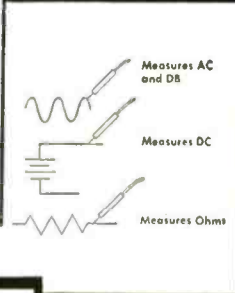
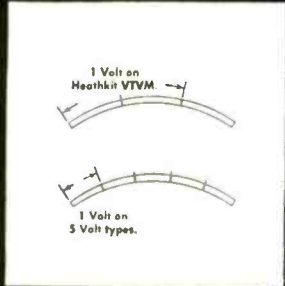
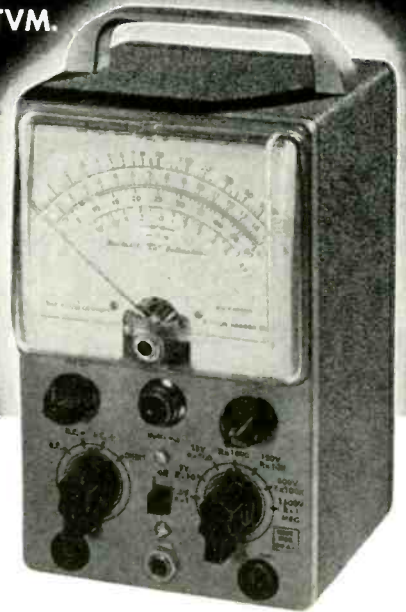

- New 1½ volt low range gives over 2" of scale per volt instead of less than ¾" found on 5 volt range type.
- Increased accuracy due to expanded scales.
- New 1500 volt DC high range gives 50% greater coverage.
- Seven ranges in all. 1½, 5, 15, 50, 150, 500 and 1500 volts DC (1000 volts maximum AC only).
- Provides proper service ranges 150 volts for AC DC work and 500 volts for AC type service.
- High input impedance, 11 megohms minimizes circuit loading.
- Variety of accessory probe kits available.
- 1% precision resistors in multiplier circuits.
- 200 microampere Simpson meter.
- Center scale zero adjust.
- Transformer operated.
- Test leads included.
- New cabinet styling.
- Large, clearly marked meter scales indicate ohms, AC volts, DC volts and DB.

The 1953 Heathkit V-6 VTVM has improved ranges! The lowest range has been moved way down to 1.5V full scale. This gives 3½" of actual scale length for the 1.5V covered—that's 2½ inches per volt!! Now, you can make your low level measurements faster and with greater accuracy.

And the upper range has been moved up. Readings up to 1500V DC can be readily made with new, improved VTVM—plus readings up to 1000V on AC. Higher ranges for extended use.

New vertical chassis mounting gives added chassis space for really easy wiring—no tight corners to worry about. Uses only highest quality components throughout. Simpson 200 microampere meter movement combined with 1% precision resistors in multiplier circuit insure highly accurate and dependable readings.

AC and DC voltage ranges are 0-1.5V-5V-15V-50V-150V-500V-1500V. (1000V max. reading on AC) — a total of seven ranges for convenient, accurate readings. Instrument also measures resistance from .1 ohm to over 1 billion ohms in seven handy ranges of RX1, X10, X100, X1000, X10K, X1 Meg., — all convenient multiples of 10 with no skips. Has Db scale in red for easy identification.

New panel has tough baked on enamel finish for freedom from scratches and maximum durability. Modern styled, formed, compact cabinet with rounded edges and crackle finish is truly handsome.

Comprehensive, detailed instruction manual with step-by-step instructions, figures, pictorials, etc. makes assembly a cinch.

Be sure and look over the special accessory VTVM probes below — for added usefulness.

<p><b>Heathkit R. F. PROBE KIT</b> SHIP. WT. 1 LBS. <b>\$5.50</b> No. 309 Extends RF range of HEATHKIT 11 megohm VTVM to 250 megacycles ± 10%.</p>	<p><b>Heathkit 30,000 V. D.C. PROBE KIT</b> SHIP. WT. 2 LBS. <b>\$5.50</b> No. 336 Provides DC multiplication factor of 100 for any 11 megohm VTVM.</p>	<p><b>Heathkit PEAK TO PEAK VOLTAGE PROBE KIT</b> SHIP. WT. 2 LBS. <b>\$6.50</b> No. 338 Reads on DC scale of any 11 megohm VTVM 5 kc to 5 megacycle range.</p>
--	---	---

## NEW Heathkit BATTERY TESTER KIT

The new Heathkit Battery Tester measures all types of dry batteries between 1½ volts and 150 volts under actual load conditions. Readings are made directly on a three-color GOOD-WEAK-REPLACE scale that your customers can readily understand. Operation is extremely simple and merely requires that the leads be connected to the battery under test. Only one control to adjust in addition to a panel switch for A or B battery types.

The Heathkit Battery Tester features compact assembly. An accurate meter movement and wire wound control mount in the portable, rugged plastic case.

Use the BT-1 to check portable radio batteries, hearing aid batteries, lantern batteries and photo flash gun batteries.

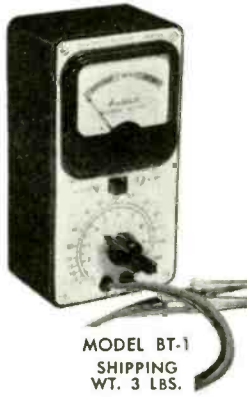

MODEL BT-1  
SHIPPING  
WT. 3 LBS.

**\$7.50**

## Heathkit AC VACUUM TUBE VOLTMETER KIT

A new AC VTVM that makes possible those sensitive AC measurements required by laboratories, audio enthusiasts and experimenters. Ten full scale ranges of .01, .03, .1, .3, 1, 3, 10, 30, 100 and 300 volts RMS. 10 DB ranges from -52 to +52 DB. Frequency response within 1 DB from 20 cycles to 50 kc. Simpson 200 microampere meter with large plainly marked meter scales. Precision multiplier resistors. Two amplifier stages using miniature tubes. A unique bridge rectifier meter circuit and a clean layout of parts. Order the AV-2 today and become acquainted with the interesting possibilities offered by this instrument.

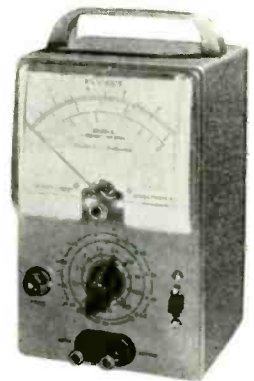

MODEL AV-2  
SHIPPING  
WT. 5 LBS.

**\$29.50**

EXPORT AGENT  
**ROCKE INTERNATIONAL CORP.**  
13 E. 40th ST.  
NEW YORK CITY (16)  
CALIF. AREA - N.Y.

*The* **HEATH COMPANY**

... BENTON HARBOR 20, MICHIGAN

# NEW *Heathkit* GRID DIP METER KIT

• CONVENIENT ONE HAND OPERATION.

Indicates frequency of energized circuits.

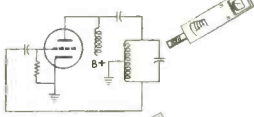

Indicates frequency of de-energized tuned circuits.

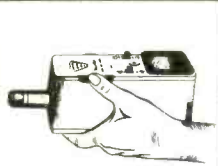
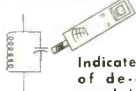

Complete unit easily held and operated with one hand.

MODEL GD-1

SHIPPING  
WT. 4 LBS.

**\$19<sup>50</sup>**



- New GRID DIP METER with assembled calibrated coils.
- Uses quality Simpson 500 microampere meter.
- One hand operation, extremely compact. Only 2½" wide by 3" high by 7" long.
- Variable meter sensitivity control.
- Uses newest type 6AF4 high frequency triode in a Colpitts oscillator circuit.
- Continuous coverage from 2 megacycles to over 250 megacycles in 6 ranges.
- Head phone monitoring jack.
- AC power transformer operated for maximum safety.

Here is the GRID DIP METER KIT you have been asking for. This new HEATHKIT instrument is compact, highly sensitive and easy to use. Housed in a handsome formed aluminum cabinet—rounded corners—durable oven baked finish on panel and cabinet. The entire instrument can be easily held and operated in one hand, tuning accomplished with the thumb wheel drive. This excellent design feature leaves the other hand entirely free for making circuit adjustments. The instrument with many applications — with oscillator energized, use it for finding the resonant frequency of tuned circuits, locating parasitics, determining characteristics of filter circuits, roughly tuning transmitter stages with power off, and neutralizing transmitters. Useful in TV and radio repair work for alignment of traps, filters, IF stages, peaking and compensation networks within the 2 to 250 megacycle range. With the oscillator not energized, the instrument acts as an absorption wave meter and indicates the frequency of radiating power sources. Locates spurious oscillations, as a relative indication of power in various transmitter stages, etc. Phone jack permits monitoring of AM transmitter for determination of radiated hum, audio quality, etc. (Head phones not included). Complete kit includes plug-in coils, tube, all necessary parts and detailed assembly and instruction manual.

## *Heathkit* IMPEDANCE BRIDGE KIT



MODEL IB-1B  
SHIPPING  
WT. 15 LBS.

**\$69<sup>50</sup>**

The HEATHKIT IMPEDANCE BRIDGE is especially useful in educational training programs, industrial laboratories and for experimental work. Use it for measuring AC and DC resistance value of resistors,

determination of condenser capacitance and dissipation factor, finding coil inductance and storage factor, electrical measurements work, etc. Quality components: GR 1000 cycle hummer, GR main control, Mallory ceramic wafer silver plated contact switches, ½% precision resistors, etc. The basic circuit is a self powered, 4 arm bridge. Choice of Wheatstone, Capacitance comparison, Maxwell or Hay bridge circuits. Resistance from 10 milliohm to 10 megohm. Capacitance 10 mmf to 100 mfd. Inductance 10 microhenry to 100 henries. Dissipation factor .002 to 1. Storage factor (Q) 1 to 1000. The IMPEDANCE BRIDGE has provisions for external generator use for measurement at other than the 1000 cycle level. Take the guess work out of electrical measurements. The HEATHKIT IMPEDANCE BRIDGE mounted in a beautiful polished birch cabinet with large easy reading panel calibrations will furnish years of accurate, trouble free measurement service.

## *Heathkit* HANDITESTER KIT

The HEATHKIT Model M-1 HANDITESTER fulfills requirements for a portable volt ohm milliammeter. This kit features precision 1% resistors, 3 deck switch for trouble free mounting of parts, specially designed battery bracket, smooth acting ohms adjust control, beautiful molded bakelite case and a 400 microampere meter movement. 5 convenient AC and DC voltage ranges as follows: 10 - 30 - 300 - 1000 - 5000 volts. Ohms ranges 0 - 3000 and 0 - 300,000. DC milliamperage ranges 0 - 10 milliamperes and 0 - 100 milliamperes. The instrument is easily assembled from complete instructions and pictorial diagrams. Test leads are included. Carry the HEATHKIT M-1 HANDITESTER in your tool box at all times for those simple jobs and eliminate that extra trip for additional testing equipment.

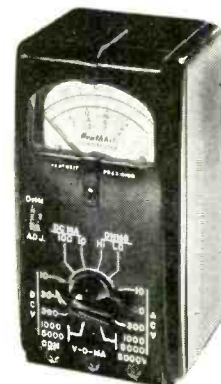

MODEL M-1  
SHIPPING  
WT. 3 LBS.

**\$13<sup>50</sup>**

EXPORT AGENT  
ROCKE INTERNATIONAL CORP.  
13 E. 40th ST.  
NEW YORK CITY (16)  
CABLE: ARLAB N.Y.

*The* **HEATH COMPANY**

... BENTON HARBOR 20, MICHIGAN



NEW  
*Heathkit*

# AUDIO GENERATOR KIT

• RANGE EXTENDED TO 1 MEGACYCLE.

MODEL AG-8

SHIPPING  
WT. 16 LBS.

**\$29.50**

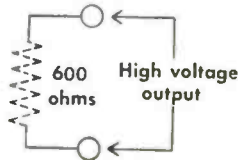

Low impedance output  
High voltage output



Sine wave output  
from 20 cycles to 1  
megacycle.

- Improved design — new low price.
- Frequency coverage in five ranges from 20 cycles per second to 1 megacycle.
- Response flat 1 DB from 20 cycles to 400 kilocycles. Down 3 DB at 600 kilocycles. Down only 8 DB at 1 megacycle.
- Five calibrated output voltage ranges, continuously variable 1 mv, 10 mv, 100 mv, 1 v, 10 v.
- Low impedance output circuit. 600 ohms.
- Distortion less than .4 of 1% from 100 cycles per second through the audible range.
- New HEATHKIT universal type binding posts.
- Durable infra-red baked enamel panel.
- Transformer operated for safe operation.
- Sturdy, ventilated steel cabinet.

A new Audio Generator with features heretofore found in only the most expensive generators. Such features as complete coverage from 20 cycles to 1 Mc — response flat  $\pm 1$  db from 20 cycles to 400 Kc, down 3 db at 600 Kc and down only 8 db at 1 Mc.

And it has calibrated output . . . Calibrated continuously variable and step attenuator output controls allow you to easily set calibrated output voltage. Moreover, distortion is less than .4 of 1% from 100 cps through the audible range.

Oscillator section consists of a two stage resistance coupled amplifier (6SJ7 and 6AK6) utilizing both positive and negative feedback for oscillator operation and reduction of distortion. Oscillator section drives a cathode follower output power amplifier (6AK6) which isolates the oscillator from variations in load and presents a low impedance output (600 Ohms). Power supply is transformer operated and utilizes 6X5 rectifier with 2 sections of RC filtering.

An unbeatable dollar value — for here is an audio generator with wide frequency coverage, excellent frequency response, stepped and continuously variable calibrated output, high signal level, low impedance output, and low inherent distortion.

## *Heathkit* AUDIO FREQUENCY METER KIT

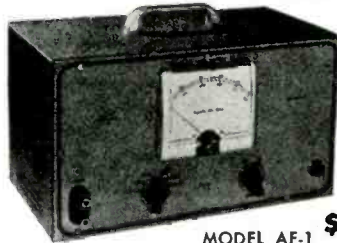

SHIPPING  
WT. 15 LBS.

MODEL AF-1 **\$34.50**

The HEATHKIT AUDIO FREQUENCY METER provides a simple and easy way to check unknown audio frequencies from 10 cycles to 100 kc between 3 and 300 volts RMS. The instrument features 7 ranges for accuracy and wide coverage. The meter itself has a quality 200 microampere Simpson movement and large clearly marked scales. The AUDIO FREQUENCY METER is transformer operated and features a voltage regulator tube to maintain constant plate voltage on the second stage. Kit supplied complete with all necessary construction material and a detailed construction manual.

## NEW *Heathkit* AUDIO OSCILLATOR KIT



MODEL AO-1  
SHIPPING  
WT. 14 LBS.

**\$24.50**

A new Audio Oscillator with both sine and square wave coverage from 20 to 20,000 cycles . . . An instrument designed to completely fulfill the needs of the audio engineer and enthusiast — Has numerous advantages such as high level output (up to 10V obtainable across the entire range), distortion less than .6%, and low impedance output.

Special design features include the use of a thermistor in the second amplifier stage for keeping the output essentially flat across the entire range.

A cathode coupled clipper circuit produces good, clean, square waves with rise time of only 2 microseconds. Oscillator section uses 1% precision resistors in range multiplier circuit for greatest accuracy.

You'll like the operation of this fine new kit.

## *Heathkit* SQUARE WAVE GENERATOR KIT

The HEATHKIT SQUARE WAVE GENERATOR is an excellent square wave frequency source with wide range coverage from 10 cycles to 100 kc continuously variable. This feature makes it useful for TV and wide band amplifier work as well as audio experimentation. The output voltage is continuously variable between 0 and 20 volts. The circuitry consists of a multivibrator stage, a clipping and squaring stage and a cathode follower low impedance output stage. The power supply is transformer operated and utilizes a full wave rectifier circuit with two sections of filtering. Another excellent HEATHKIT value at this remarkable low price. Kit includes all necessary construction material as well as complete instruction manual for assembly and operation.



MODEL SQ-1  
SHIPPING  
WT. 14 LBS.

**\$29.50**

EXPORT AGENT  
ROCKE INTERNATIONAL CORP.  
13 E. 40th ST.  
NEW YORK CITY (16)  
CABLE: AR148 N.Y.

*The* **HEATH COMPANY**

... BENTON HARBOR 20, MICHIGAN

# NEW *Heathkit* VISUAL-AURAL SIGNAL TRACER KIT

• NEW NOISE LOCATOR AND WATTMETER CIRCUITS.

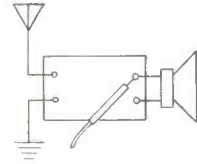
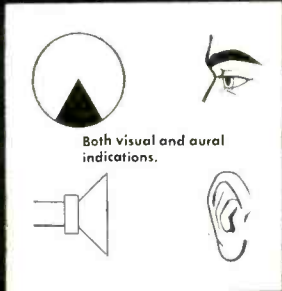

Traces signals from antenna clear through speaker.

MODEL T-3

SHIPPING  
WT. 8 LBS.

**\$22<sup>50</sup>**



- Permits visual signal observation as well as aural operation.
- Two separate input channels.
- Tremendous RF channel sensitivity. Adequate for actual signal detection at receiver input.
- Separate high gain RF and low gain audio channels.
- A unique and useful noise locator circuit.
- Built-in calibrated wattmeter.
- Two separate shielded probes for RF and audio application.
- Additional test leads supplied.
- Substitution test speaker and output transformer eliminates necessity for speaker removal in service work.
- Utility amplifier. Check record changers, tuners, microphones, instrument pickups, etc.
- VTVM and Scope panel terminals.
- 5 tube transformer operated circuit.

The new HEATHKIT VISUAL AURAL SIGNAL TRACER represents one of the most convenient and useful instruments the service man can use in AM, FM and TV service work. The electron ray beam indicator constantly monitors both input channels for visual observation of the signal. Now, see and hear the signal level for easier estimation of signal strength and gain per stage in a receiver circuit. Separate high gain channel and special shielded demodulator probe for RF circuit work. Low gain channel for audio circuit investigation and for use as a noise locator. In this feature, approximately 200 volts DC is applied to a suspected circuit component and the action of the voltage in the component can be seen and heard to determine satisfactory operation. This feature alone will prove tremendously helpful in locating the source of objectionable noises in coils, transformers, resistors, condensers, cold solder joints, controls, etc. A convenient wattmeter permits rapid preliminary check for voltage distribution circuit breakdown as well as transformer failures. Use the T-3 as a universal test speaker and substitution transformer and save service time by eliminating the necessity for speaker removal on every service call. Additional service uses are: as a utility amplifier for checking the output of record changers, tuners, microphones, instrument pickups, etc. Separate panel terminals permit utilization of other shop equipment such as your Oscilloscope or VTVM. Entire kit supplied complete with 5 tubes, all necessary construction material along with a detailed step by step instruction manual for the assembly and operation of the instrument.

## NEW *Heathkit* CONDENSER CHECKER KIT

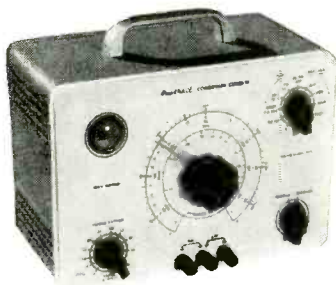

MODEL C-3  
SHIPPING  
WT. 7 LBS.

**\$19<sup>50</sup>**

Announcing the new improved Model C-3 HEATHKIT CONDENSER housed in a new smartly styled professional appearing cabinet featuring rounded corners and snug fitting drawn panel. Adequate provisions for ventilation insures longer instrument life through cooler operation. Use the C-3 to accurately measure those unknown condenser and resistor values. All readings of condensers and resistors are read directly on the calibrated scales. Range of condenser measurements is from .00001 mfd to 1000 mfd. Calibrated resistance measurements can be made from 100 ohms to 5 megohms. A leakage test with a choice of 5 DC polarizing voltages will quickly indicate condenser operating quality under actual voltage load conditions. The spring return leakage test switch automatically discharges the condenser under test and eliminates shock hazard. An electron ray beam indicator tube is used in a new leakage test circuit for added sensitivity. The instrument is transformer operated for safety and will prove an extremely welcome addition to your shop equipment. The kit is furnished complete with all necessary parts, test leads and includes a step by step detailed construction manual for assembly and operation.

insures longer instrument life through cooler operation. Use the C-3 to accurately measure those unknown condenser and resistor values. All readings of condensers and resistors are read directly on the calibrated scales. Range of condenser measurements is from .00001 mfd to 1000 mfd. Calibrated resistance measurements can be made from 100 ohms to 5 megohms. A leakage test with a choice of 5 DC polarizing voltages will quickly indicate condenser operating quality under actual voltage load conditions. The spring return leakage test switch automatically discharges the condenser under test and eliminates shock hazard. An electron ray beam indicator tube is used in a new leakage test circuit for added sensitivity. The instrument is transformer operated for safety and will prove an extremely welcome addition to your shop equipment. The kit is furnished complete with all necessary parts, test leads and includes a step by step detailed construction manual for assembly and operation.

## *Heathkit* TV ALIGNMENT GENERATOR KIT

MODEL TS-2  
SHIPPING  
WT. 20 LBS.

**\$39<sup>50</sup>**



Here is an excellent TV ALIGNMENT GENERATOR designed to do TV service work quickly, easily and properly. The Model TS-2 when used in conjunction with an Oscilloscope provides a means of correctly aligning TV receivers. The instrument furnishes a frequency modulated signal covering in 2 bands the range of 10 to 90 megacycles and 150 to 230 megacycles. An absorption type frequency marker covers from 20 to 75 megacycles in 2 ranges; therefore you have a simple, convenient means of checking 1F's independent of oscillator calibration. Sweep width is variable from 0 to 12 megacycles. Other excellent features are horizontal sweep voltage controlled with a phasing control — both step and continuously variable attenuation for setting the output signal to the desired level — a convenient stand by switch — and blanking for establishing a single trace with a base reference level. Make your work easier, save time and repair with confidence. Order your HEATHKIT TV ALIGNMENT GENERATOR now.

EXPORT AGENT  
ROCKE INTERNATIONAL CORP.  
13 E. 40th ST.  
NEW YORK CITY (16)  
CABLE: AREA-N.Y.

*The* **HEATH COMPANY**

... BENTON HARBOR 20, MICHIGAN



# Heathkit TUBE CHECKER KIT

MODEL TC-1

SHIPPING  
WT. 12 LBS.

## \$29.50

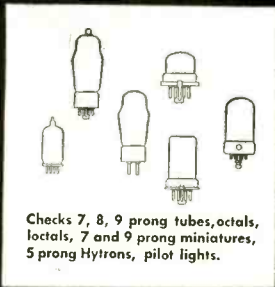

Checks 7, 8, 9 prong tubes, octals, localts, 7 and 9 prong miniatures, 5 prong Hytrons, pilot lights.

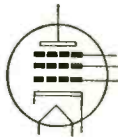

Checks for opens, shorts, emission, filament and filament tap continuity.

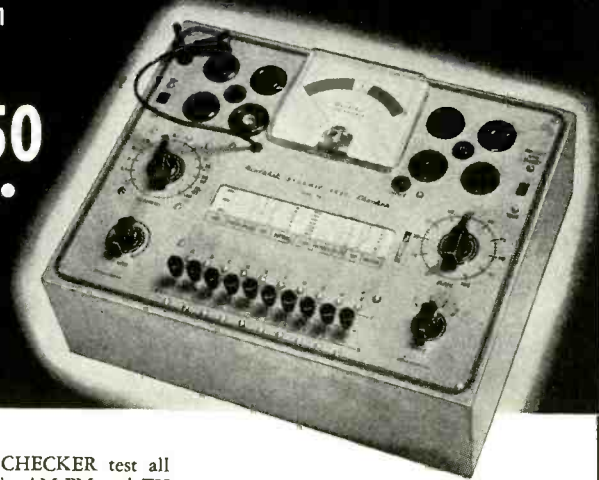

- Beautiful counter type birch cabinet.
- 4½" Simpson 3 color meter.
- Simplified setup procedure.
- Built-in gear driven roll chart.
- Checks emission, shorted elements, open elements and continuity.
- Complete protection against obsolescence.
- Sockets for every modern tube.
- Blank for new types.
- Individual element switches.
- Contact type pilot light test socket.
- Line adjust control.

### PORTABLE TUBE CHECKER KIT MODEL TC-1P

Same as TC-1 except supplied with polished birch cabinet (with removable lid) instead of counter type cabinet. Shipping weight 14 lbs. **\$34.50**

No. 365 Polished Birch Tube Checker Cabinet only. Shipping Weight 7 lbs. **\$7.50**

With the HEATHKIT TC-1 TUBE CHECKER test all types of tubes commonly encountered in AM-FM and TV receiver circuits. Test setup procedure is simplified, rapid and flexible. Tube quality is read directly on a beautiful 4½" Simpson three color BAD - ? - GOOD scale that your customers can readily understand. Panel sockets accommodate 4, 5, 6 and 7 prong tubes, octals, localts, 7 and 9 prong miniatures, 5 prong Hytrons, a blank socket for new tubes and a contact type socket for quick checking of pilot lights. Built-in gear driven roll chart for instant reference. Neon short indicator, individual three position lever switch for each tube element, spring return test switch, line set control to compensate for supply voltage variations. At this low price, no service man need be without the advantages offered by the HEATHKIT TUBE CHECKER.

### Heathkit TV PICTURE TUBE TEST ADAPTER

Use your HEATHKIT TUBE CHECKER with this new TV TEST ADAPTER to determine picture tube quality. Check for emission and shorts, independent of TV power supply. Consists of standard 12 pin TV tube socket, 4 feet of cable, octal socket connector and data sheet. Quickly prove TV picture tube condition to yourself and your customer.



No. 355  
Ship. Wt. **\$4.50**  
1 lb.

### Heathkit RESISTANCE SUBSTITUTION BOX KIT

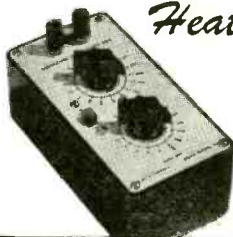
MODEL RS-1  
SHIPPING  
WT. 3 LBS.

## \$5.50

NEW HEATHKIT RESISTANCE SUBSTITUTION BOX KIT provides switch selection of any single one of 36 RTMA 1 watt 10% standard value resistors, ranging from 15 ohms to 10 megohms. This coverage available in 2 ranges in decades of 15, 22, 33, 47, 68 and 100. Housed in rugged plastic cabinet featuring new HEATHKIT universal type binding posts. The entire kit priced less than the retail value of the resistors alone.

### Heathkit BATTERY ELIMINATOR KIT

A clean 6 volt d-c supply source is definitely required for successful automobile radio servicing. Has a continuously variable d-c output from 0 to 8 volts. It can be safely operated at a steady 10 ampere level and will deliver up to 15 amperes for intermittent periods. The voltage output terminals are completely isolated from the chassis to accommodate additional service applications such as supplying bias voltages or d-c substitution voltages for battery operated tube filament circuits.

The output of the Battery Eliminator is constantly monitored by a d-c voltmeter and a d-c ammeter. The circuit features an automatic overload relay of self resetting type. For additional protection, a panel mounting fuse is provided. Build this kit in a few hours and pocket a substantial savings.

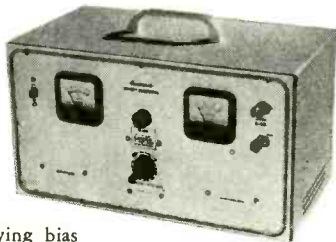
MODEL BE-3  
SHIPPING  
WT. 20 LBS.

## \$24.50

### Heathkit VIBRATOR TESTER KIT

Repair time is valuable, and the Heathkit Vibrator Tester will save you hours of work. Instantly tells the condition of the vibrator under test—and the check is thorough and complete. Checks vibrator for proper starting, and the easy-to-read meter indicates the quality of output on large BAD-GOOD scales. Tests both interrupter and selfrectifier types of vibrators. Five different sockets for checking hundreds of vibrators.

Operates from any battery eliminator capable of delivering continuously variable voltage from 4-6V at 4 amps. The Heathkit BE-3 Battery Eliminator is ideal for operating this kit.

Faulty vibrators can be spotted within seconds and you're free to go on to other service jobs.

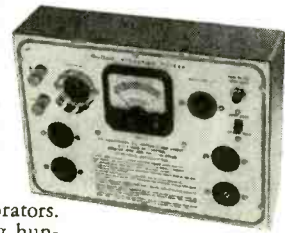
MODEL VT-1  
SHIPPING  
WT. 7 LBS.

## \$14.50

EXPORT AGENT  
ROCKE INTERNATIONAL CORP.  
13 E. 40th ST.  
NEW YORK CITY (10)  
CABLE: APLAS-N.Y.

# The HEATH COMPANY

... BENTON HARBOR 20, MICHIGAN

# Heathkit SIGNAL GENERATOR KIT

MODEL SG-7

SHIPPING  
WT. 7 LBS.

**\$19.50**

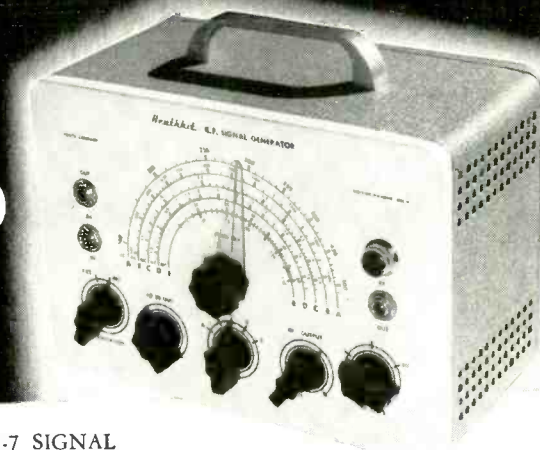

Modulated or unmodulated RF output.

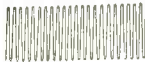

400 cycle sine wave output.

- Step attenuated RF output.
- 6 to 1 vernier dial ratio.
- Turret mounted coil sub-assembly.
- Pre-calibrated and adjusted coils.
- Hartley RF oscillator circuit.
- Colpitts oscillator 400 cycle sine wave output.
- Modulated or unmodulated RF output.
- Frequency coverage on fundamentals 160 kc to 50 megacycles in five ranges. 51 megacycles to 150 megacycles on calibrated harmonics.
- RF output in excess of 100,000 microvolts.
- Audio output 1 1/2 to 2 volts.
- AC transformer operated.
- Professionally styled cabinet.
- Infra red baked enamel panel.

The new HEATHKIT Model SG-7 SIGNAL GENERATOR easily fulfills requirements for a controllable, modulated or unmodulated source of variable frequency. A convenient 400 cycle sine wave output is available for audio work. All RF oscillator coils are precision wound and adjusted to calibration before shipment thereby assuring maximum accuracy. The coils, band switch and tuning condenser all mount as a turret assembly so as to offer the advantage of short wiring leads and easy mounting of parts. The RF output circuit is of the low impedance type obtained by the use of cathode coupling to the output jacks. The level of RF output is varied by means of the RF step and RF output control. Use the HEATHKIT SG-7 as an RF signal source modulated or unmodulated for radio repair, laboratory work, experimental testing, 400 cycle sine wave audio testing, checking RF stages, alignment of both AM and FM IF stages, marker generator for TV alignment, etc. The kit is transformer operated and utilizes miniature tubes for ease in handling high frequency. Panel jacks and a convenient switching system permit either external or internal modulation. The entire kit is supplied complete with tubes and all necessary material as well as a detailed step by step instruction manual for the assembly and operation of the instrument.

## Heathkit INTERMODULATION ANALYZER KIT



MODEL IM-1  
SHIPPING WT.  
18 LBS.

**\$39.50**

The HEATHKIT MODEL IM-1 is an extremely versatile instrument specifically designed for measuring the degree of interaction between two

signals caused by a specific piece of apparatus, or a chain of equipment. It is primarily intended for tests of audio equipment but may be used in other applications such as making tests of microphones, records, recording equipment, phonograph pickups and loud speakers. Use it for checking tape or disc recordings, as a sensitive AC voltmeter, as a high pass noise meter for adjusting tape bias, cutting needle pitch or other applications. High and low test frequency source, intermodulation section, power supply and AC voltmeter all in one complete unit. Percent intermodulation is directly read on three calibrated ranges, 30%, 10% and 3% full scale. Both 4 to 1 and 1 to 1 ratios of low to high frequencies easily set up. At this low kit price YOU can enjoy the benefits of Intermodulation analysis for accurate audio interpretations.

## Heathkit LABORATORY REGULATED POWER SUPPLY KIT



MODEL PS-2  
SHIPPING  
WT. 20 LBS.

**\$29.50**

New HEATHKIT LABORATORY POWER SUPPLY provides continuously variable regulated DC voltage output

from 160 volts to 400 volts depending on load. Panel terminals supply separate 6.3 V. AC supply at 4 amperes for filament circuits. A 3 1/2" plastic cased panel mounted meter provides accurate metered output for either voltage of current measurements. Exceptionally low ripple content of .012% admirably qualifies the HEATHKIT LABORATORY POWER SUPPLY for high gain audio applications. Ideal for laboratory work requiring a reference voltage for meter calibration or for plotting tube characteristics. In service work, it can be used as a separate variable voltage supply to determine the desirable operating voltage in a specific circuit. Use it as a DC substitution voltage in trouble shooting TV circuits exhibiting symptoms of extraneous undesirable components in plate supply circuits. Entire kit, including all 5 tubes now available at this low price.

EXPORT AGENTS  
ROCKE INTERNATIONAL  
13 E. 40th ST.  
NEW YORK CITY 16  
CABLE: ARLAB N Y

The **HEATH COMPANY**

... BENTON HARBOR 20, MICHIGAN



# Heathkit WILLIAMSON TYPE AMPLIFIER KIT

The new HEATHKIT WILLIAMSON TYPE AMPLIFIER incorporates the latest improvements described in Audio Engineering's "Gilding the Lily." 5881 output tubes and a new Peerless output transformer with additional primary taps afford peak power output of well over 20 watts. Frequency response  $\pm 1$  db from 10 cycles to 100 kc. allows reproduction of highs and lows with equal crispness and clarity. Harmonic and intermodulation distortion have been reduced to less than  $\frac{1}{2}$  of 1% at 5 watts. This eliminates the harsh unpleasant qualities which contribute to listening fatigue. Make this amplifier the heart of your radio system to achieve the fine reproduction that is the goal of all music lovers.

The HEATHKIT PREAMPLIFIER (available separately or in combination with the amplifier kit) features inputs for magnetic or low level cartridges, crystal pickups and tuners, turnover control for LP or 78 type records, individual bass and treble tone controls each providing up to 15 DB of boost or attenuation. Special notched shafts on preamplifier controls and switches adaptable to custom installation. The preamplifier can be mounted in any position and a liberal length of connecting cable is supplied. No radio experience is required to construct this amplifier. All punching, forming, or drilling has already been done. The complete kit includes all necessary parts as well as a detailed step by step construction manual with pictorial diagrams to greatly simplify the construction.

**ACROSOUND TRANSFORMER OPTION.** If desired, the output transformer with the kit will be the Acrosound output transformer, type TO-300. The use of this transformer permits ultra-linear operation as described in Audio Engineering's "Ultra-Linear Operation of the Williamson Amplifier."

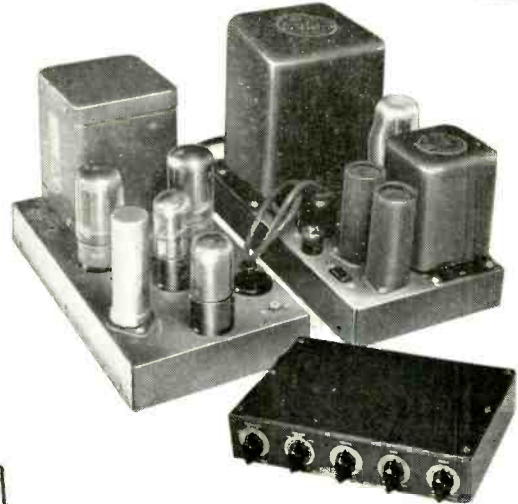

## Heathkit FM TUNER KIT

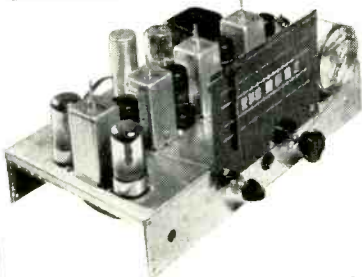

MODEL FM-2  
SHIPPING  
WT. 9 LBS.

**\$22.50**

The HEATHKIT MODEL FM-2 TUNER specifically designed for simplified kit construction features a preassembled and adjusted tuning unit. Three double tuned IF transformers and a discriminator transformer are used in an 8 tube circuit. Smooth tuning is obtained through a 9 to 1 ratio vernier drive using a calibrated six inch slide rule type dial. The usual frequency coverage of 88 to 108 megacycles is provided.

Experience the thrill of building your own FM tuner. Operate it through your amplifier or radio and enjoy all the advantages of true FM reception. Transformer operated power supply to simplify connections to all types of audio systems. The kit is supplied complete with all 8 tubes and a necessary material required for construction. A complete instruction manual simplifies assembly and operation.

### PRICES OF VARIOUS COMBINATIONS

- W-2 Amplifier Kit** (Incl. Main Amplifier with Peerless Output Transformer, Power Supply and WA-P1 Preamplifier Kit) Shipping Weight 39 lbs. **\$69.50**
- W-2M Amplifier Kit** (Incl. Main Amplifier with Peerless Output Transformer and Power Supply) Shipping Weight 29 lbs. Shipped express only **\$49.75**
- W-3 Amplifier Kit** (Incl. Main Amplifier with Acrosound Output Transformer, Power Supply and WA-P1 Preamplifier Kit) Shipping Weight 39 lbs. Shipped express only **\$69.50**
- W-3M Amplifier Kit** (Incl. Main Amplifier with Acrosound Output Transformer and Power Supply) Shipping Weight 29 lbs. Shipped express only **\$49.75**
- WA-P1 Preamplifier Kit only.** Shipping Weight 7 lbs. Shipped express or parcel post. **\$19.75**

## Heathkit ECONOMY 6 WATT AMPLIFIER KIT



MODEL A-7  
SHIPPING  
WT. 10 LBS.

**\$14.50**

The HEATHKIT Model A-7 amplifier features beam power, push pull output with frequency response flat  $\pm 1\frac{1}{2}$  DB from 20 to 20,000 cycles. Separate volume, bass and treble controls. Two input circuits, output impedances of 4, 8, and 15 ohms. Peak power output rated at full 6 watts. High quality components, simplified layout, attractive gray finished chassis, break off type adjustable length control shafts and attractive lettered control panel.

THE MODEL A7A amplifier incorporates a preamplifier stage with special compensated network to provide the necessary voltage gain for operation with variable reluctance or low output level phono cartridges. Excellent gain for microphone operation in a moderate powered sound system. **\$16.50**

## Heathkit HIGH FIDELITY 20 WATT AMPLIFIER KIT

The HEATHKIT MODEL A-8 amplifier kit was designed to deliver high fidelity performance with adequate power output at moderate cost. The frequency response is within  $\pm 1$  DB from 20 to 20,000 cycles. Distortion at 3 DB below maximum power output at 1000 cycles is only .8%. The amplifier features a Chicago power transformer in a drawn steel case and a Peerless output transformer with output impedances of 4, 8, and 16 ohms available. Separate bass and treble tone controls permit wide range of tonal adjustment to meet the requirements of the most discerning listener. The amplifier uses a 6SJ7 voltage amplifier, a 6SN7 amplifier and phase splitter and two 6L6's in push pull output and a 5U4G rectifier. Two input jacks for either crystal or tuner operation. The kit includes all necessary material as well as a detailed step by step construction manual.



MODEL A-8  
SHIPPING WT. 19 LBS.

**\$33.50**

MODEL A8-A features an added 6SJ7 stage (preamplifier) for operating from a variable reluctance cartridge or other low output level phono pickups. Can also be used with a microphone. A 3 position panel switch affords the desired input service. **\$35.50**

EXPORT AGENT  
**ROCKE INTERNATIONAL CORP.**  
15 E. 40th ST.  
NEW YORK CITY (16)  
CABLE: ARLAN-N.Y.

**The HEATH COMPANY**  
... BENTON HARBOR 20, MICHIGAN

RADIO-ELECTRONICS



# Heathkit SUPERHETERODYNE RECEIVER KITS

- High gain dual iron core tuned type IF transformers
- AC transformer operation for safety
- Continuously variable tone control
- Sturdy punched and plated steel chassis
- Ideal for custom installation
- Full AVC action
- Inverse feedback for improved frequency response
- Kit supplied with all necessary construction material except speaker and cabinet. (Available separately if desired).

6 tube all wave circuit.  
3 ranges, continuous coverage 550 kc to over 20 megacycles, shipping wt. 11 lbs.

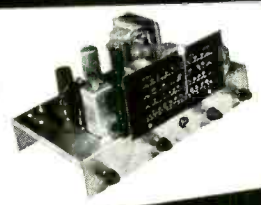

Model AR-1  
**\$23.50**

5 tube broadcast band 550 to 1600 kc coverage, shipping wt. 11 lbs.

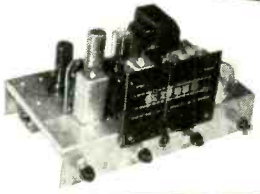

Model BR-1  
**\$19.50**

Two excellent radio receiver kits featuring clean design and open layout for simplified construction. Satisfy that urge to build your own radio receiver and select the model which meets your requirements. Both receivers feature continuously variable tone control, a radio phono switch and phono input and an AC receptacle for the phono motor. A six inch calibrated slide rule type dial with a 9 to 1 ratio vernier dial drive insures easy tuning.

## SHIPPING INFORMATION

ON PARCEL POST ORDERS include postage for weight shown and insurance. (We insure all shipments.) Don't worry about sending more than the correct amount — if you send us too much, every extra cent will be promptly returned.  
ON EXPRESS ORDERS do not include transportation charges. They will be collected by Express Agency on delivery.

ORDERS FROM CANADA must include full remittance for merchandise.  
Orders processed on the same day received. Customers notified of an unavoidable delay.  
U. S. postal or express money orders, bank drafts or checks are acceptable. Do not send loose coins or stamps.

ALL PRICES SUBJECT TO CHANGE WITHOUT NOTICE

REPORT AGENT  
ROCKE INTERNATIONAL CORP.  
13 E. 40th ST.  
NEW YORK CITY (16)  
CABLE: ARAB-N.Y.

# The HEATH COMPANY

... BENTON HARBOR 20, MICHIGAN

## ORDER BLANK

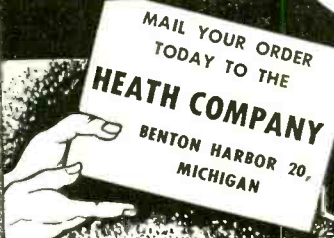

From \_\_\_\_\_

- SHIP VIA
- Parcel Post
  - Express
  - Freight
  - Best Way

(PLEASE PRINT)

QUANTITY	ITEM	PRICE	QUANTITY	ITEM	PRICE
	Heathkit Oscilloscope Kit—Model O-8 (29 lbs.)	\$43.50		Heathkit Square Wave Gen. Kit—Model SQ-1 (14 lbs.)	\$29.50
	Heathkit Intensifier Kit (O-8 only) No. 339 (1 lb.)	7.50		Heathkit AC VTVM Kit—Model AV-2 (5 lbs.)	29.50
	Heathkit Voltage Calibrator Kit—Model VC-1 (5 lbs.)	9.50		Heathkit Intermodulation Analyzer Kit—Model IM-1 (18 lbs.)	39.50
	Heathkit Electronic Switch Kit—Model S-2 (11 lbs.)	19.50		Heathkit Regulated Power Supply Kit—Model PS-2 (20 lbs.)	29.50
	Heathkit Scope Demodulator Probe Kit No. 337 (1 lb.)	4.50		Heathkit Handitester Kit—Model M-1 (3 lbs.)	13.50
	Heathkit T.V. Alignment Generator Kit—Model TS-2 (20 lbs.)	39.50		Heathkit Decade Resistance Kit—Model DR-1 (4 lbs.)	19.50
	Heathkit Q Meter Kit—Model QM-1 (12 lbs.)	39.50		Heathkit Decade Condenser Kit—Model DC-1 (4 lbs.)	16.50
	Heathkit Grid Dip Meter Kit—Model GD-1 (4 lbs.)	19.50		Heathkit Impedance Bridge Kit—Model IB-1B (15 lbs.)	69.50
	Heathkit VTVM Kit—Model V-6 (7 lbs.)	24.50		Heathkit Battery Tester Kit—Model BT-1 (3 lbs.)	7.50
	Heathkit RF Probe Kit No. 309 (1 lb.)	5.50		Heathkit Resistance Substitution Box Kit—Model RS-1 (3 lbs.)	5.50
	Heathkit HV Probe Kit No. 336 (2 lbs.)	5.50		Heathkit F.M. Tuner Kit—Model FM-2 (9 lbs.)	22.50
	Heathkit Peak-to-Peak Volt. Probe Kit No. 338 (2 lbs.)	6.50		Heathkit Broadcast Receiver Kit—Model BR-1 (11 lbs.)	19.50
	Heathkit Visual-Aural Signal Tracer Kit—Model T-3 (8 lbs.)	22.50		Heathkit Three Band Receiver Kit—Model AR-1 (11 lbs.)	23.50
	Heathkit Condenser Checker Kit—Model C-3 (7 lbs.)	19.50		Heathkit Amplifier Kit—Model A-7 (10 lbs.)	14.50
	Heathkit RF Signal Generator Kit—Model SG-7 (7 lbs.)	19.50		Heathkit Amplifier Kit—Model A-7A (10 lbs.)	16.50
	Heathkit Tube Checker Kit—Model TC-1 (12 lbs.)	29.50		Heathkit Amplifier Kit—Model A-8 (19 lbs.)	33.50
	Heathkit T.V. Tube Adapter No. 355 (1 lb.)	4.50		Heathkit Amplifier Kit—Model A-8A (19 lbs.)	35.50
	Heathkit Battery Eliminator Kit—Model BE-3 (20 lbs.)	24.50		Williamson Type Amplifier Kit (Type: )	
	Heathkit Vibrator Tester Kit—Model VT-1 (7 lbs.)	14.50		Shipped express only	
	Heathkit Audio Generator Kit—Model AG-8 (16 lbs.)	29.50		WA-P1 Preamplifier Kit (7 lbs.) (Shipped exp. or p.p.)	19.75
	Heathkit Audio Oscillator Kit—Model AO-1 (14 lbs.)	24.50			
	Heathkit Audio Frequency Meter Kit—Model AF-1 (15 lbs.)	34.50			

\*Please ship C.O.D.  Postage enclosed \_\_\_\_\_ lbs. Enclosed find  Check  Money Order for \_\_\_\_\_



# YOU CAN UNDERSTAND REACTANCE!

By T. W. DRESSER

**E**VER stop to think why 8- $\mu$ f capacitors are all right to smooth a full-wave rectifying circuit yet it takes from 16 to 60  $\mu$ f to do the same job in a half-wave arrangement? Or why a sharply tuned circuit steps up the voltage so terrifically at resonance? It doesn't concern you? Believe me, it does. If you want to know

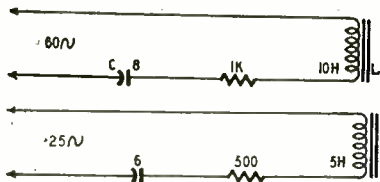

Figs. 1 and 2—These typical circuits are employed in the calculations below.

why, try plugging a sixty cycle a.c. radio into a 25-cycle supply. Then figure out why the filter capacitors blew! You'll be lost if you don't know something of reactance.

Many technicians are scared of problems in this field by such things as

$$Z = \sqrt{R^2 + (2\pi fL - \frac{1}{2\pi fC})^2}$$

In actual fact it is not necessary to have any knowledge of higher mathematics to work out the answer. If you can divide, multiply, add and subtract you have just about all that is required, and if you can handle Ohm's Law for d.c. while you are shaving, as most of us technicians can, there is no need to shy like a startled colt when a few a.c. items are dragged into that same Law.

There are three potent things in an a.c. circuit, resistance, inductive reactance and capacitive reactance. If you know the inductance and capacitance, it is easy to get at their reactances, and by combining them and the resistance to sort out the precise working conditions of the circuit. It takes no more than minutes and may save hours and dollars.

All circuit schematics indicate the values of R wherever it is used. They do not show either inductive or capacitive reactance values. The simple reason is that both are dependent upon frequency, and you know how many frequencies are kicking about in, say, the grid circuit of a detector at any particular moment. An inductive component in that circuit will show a different reactance to each frequency; a multiplicity of reactances overall, in fact. Nevertheless if there is an r.f. choke or a feed capacitor in the circuit it has to have a label of some sort, so it's indicated as 8 microhenries or 100  $\mu$ f. These indications, in themselves, don't mean much, any more than the label on a can of pork-and-beans indicates a

specific amount of pork. Usually the values are marked on schematics but their real importance lies in their ability to be, at the same time, as an inductance or capacitance, a low resistance to some frequencies and a very high one to others. An instance is the parallel-connected i.f. wave trap, an inductance tuned by a small capacitance, which is a low resistance to intermediate frequencies and a high resistance to wanted signals at the same time.

Given the inductance or capacitance value on the schematic and the frequency, the rest is simple. The formula

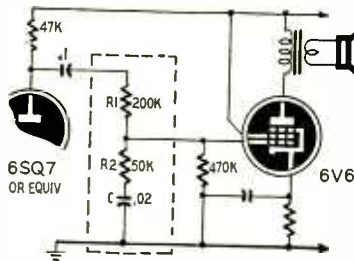

Fig. 3—A reactance bass-boost circuit.

for inductance states:

$$X_L = 2\pi fL$$

$X_L$  being inductive reactance,  $f$  the frequency and  $L$  the inductance.  $\pi$  is 3.1416—a constant everybody knows—so twice that is 6.283. Let's forget about the decimal and call  $2\pi$  simply 6. The Hebrews and Babylonians never knew different and got away with it for centuries!

The formula for capacitance is:

$$X_C = \frac{1}{2\pi fC}$$

$f$  = frequency again,  $C$  capacitance and  $2\pi$  still stays at 6.

If the answer in either case is to be OHMS then  $L$  and  $C$  must be in HENRYS and FARADS. With henrys it is easy; a smoothing choke of 10 henrys in a 60-cycle circuit will have a reactance of  $6 \times 10 \times 10$ , or 3600 ohms. R.f. coil reactances are just as straightforward if you remember that where the inductance is in microhenrys the frequency must be in megacycles or if in millihenrys frequency in kilocycles. A 1- $\mu$ h (microhenry) short wave coil at 7.5 mc (40 meters), will have a reactance of  $6 \times 7.5 \times 10 = 450$  ohms, while a coil of 2.5 millihenrys at 200 kc has a reactance of  $6 \times 200 \times 2.5$ , or 3,000 ohms. Nothing much to it, is there?

Hunks of capacitance like FARADS are never used in practical work, so the formula for capacitive reactance needs to be modified to bring it into line with microfarads and micromicrofarads.

Rewriting it as:

$$X_C = \frac{1,000,000}{2\pi fC}$$

where  $C$  is in micromicrofarads and  $f$  in megacycles, does just that. If  $C$  is in microfarads then  $f$  must be in cycles. As an example, an 8- $\mu$ f smoothing capacitor at 120 cycles (ripple frequency of a full-wave rectifier) has a reactance of

$$\frac{1,000,000}{6 \times 120 \times 8} = 173 \text{ ohms.}$$

Let us apply this information practically to an a.c. circuit with resistance,  $C$  reactance and  $L$  reactance as shown in Fig. 1, and connected to a 117-volt

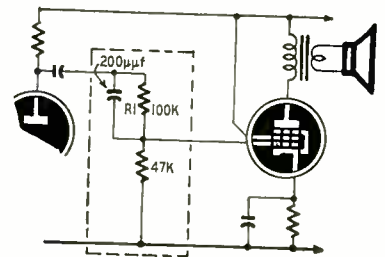

Fig. 4—Using reactance to boost highs.

60-cycle supply. Mentally calculating the reactances from the formulas and the figures shown in Fig. 1

CHECK:

$$X_L = 2\pi fL = 6 \times 60 \times 10 = 3,600 \text{ ohms.}$$

$$X_C = \frac{1,000,000}{6 \times 60 \times 8} = -347 \text{ ohms.}$$

Now  $X_C$  and  $X_L$  always work opposite to each other in a circuit. The mathematical approach is to consider  $X_C$  negative and deduct its value from  $X_L$ ;  $3,600 - 347 = 3,253$  ohms, which (being positive) is inductive. Now going back to

$$Z = \sqrt{R^2 + (2\pi fL - \frac{1}{2\pi fC})^2}$$

We've already cleared  $2\pi fL - \frac{1}{2\pi fC}$

and got 3,253 as the answer. So we can re-dish the  $Z = \dots$  etc. as  $Z = \sqrt{R^2 + X^2}$  or  $\sqrt{1,000^2 + 3,253^2}$  which comes out to 3403 ohms. (Use a slide rule for the square roots.)

Check:

$$3,253 \times 3,253 = 10,582,009.$$

$$1,000 \times 1,000 = 1,000,000.$$

$$10,582,009 + 1,000,000 = 11,582,009.$$

$$\sqrt{11,582,009} = 3,403 \text{ ohms}$$

Now you can get back to old man Ohm and his Law. The voltage is 117,  $Z$  is 3,403 ohms, so the current in the circuit will be

$$\frac{117}{3,403} = .034 \text{ amps or } 34 \text{ ma approximately.}$$

Suppose now you want to find the voltage across each component in the

# The Winning *COMBINATION* for a perfect *TV* picture!

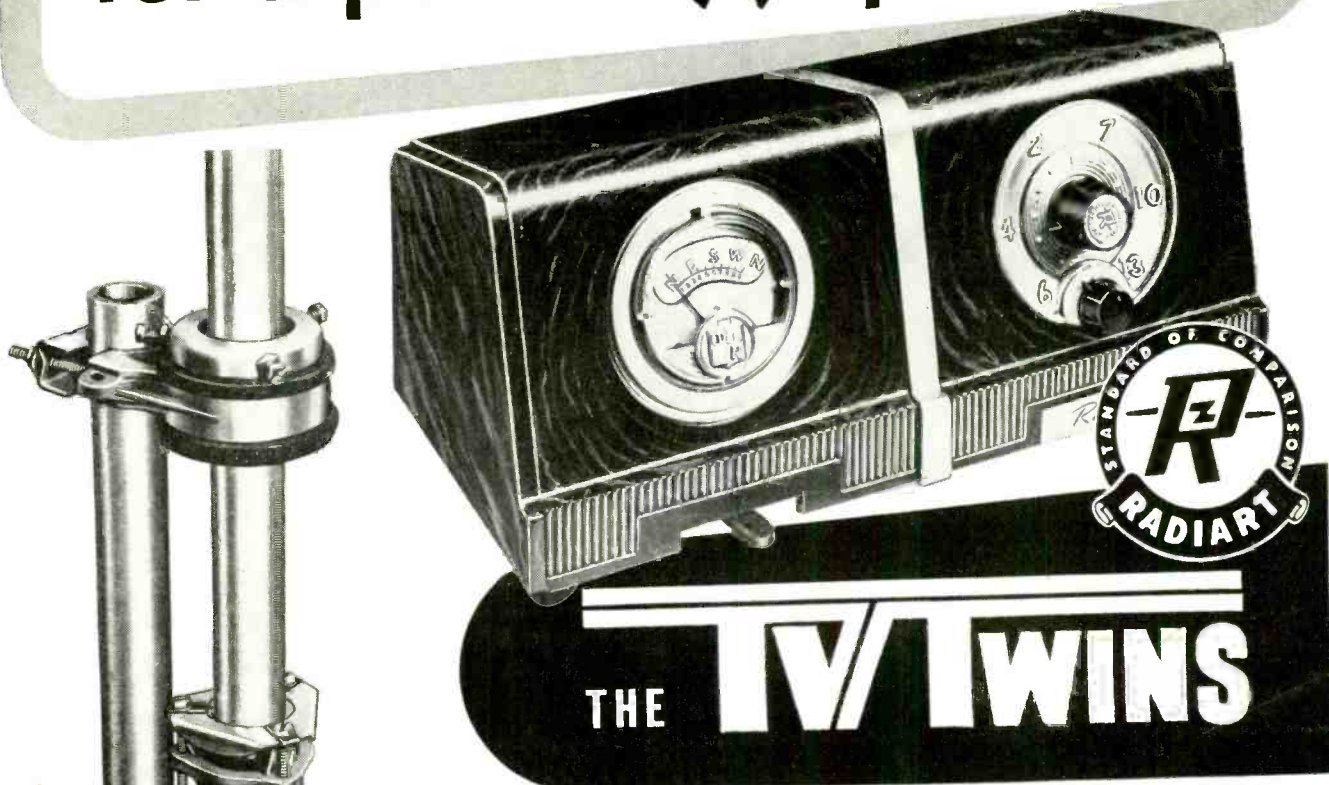

Here's What You Get — ALL YOU NEED  
TO GET THE MOST OUT OF ANY TV SET!

- ★ CDR Rotor, Model TR-11 . . . . . \$44.95
- ★ Thrust Bearing, Model TA-6 . . . . . 4.95
- ★ Radiart Booster, Model TVB-1 . . . . . 29.95
- ★ Connecting Kit, Model TA-7 . . . . . 1.00

If Bought Separately . . . \$80.85

**SPECIAL RETAIL  
COMBINATION PRICE...** \$ **74<sup>95</sup>**

Model RAC-4497 . . .

Regular Trade  
Discount Applies

Here's a rare opportunity to really get the most out of any TV set—putting it to work at peak possible performance... and at a real savings! We have combined these 4 Radiart units into one package and at real savings! The quality can't be beat... and the two cabinets form a handsome piece of furniture for any home. Will handle any antenna array... meter dial on remote control cabinet... and the booster improves picture quality beyond compare! **ACT NOW!**



SUBSIDIARY OF



**THE RADIART CORPORATION CLEVELAND 13, OHIO**

VIBRATORS • AUTO AERIALS • TV ANTENNAS • ROTORS • POWER SUPPLIES





# NOW-

## Centralab's new miniature a lot more switch

New Miniature Size

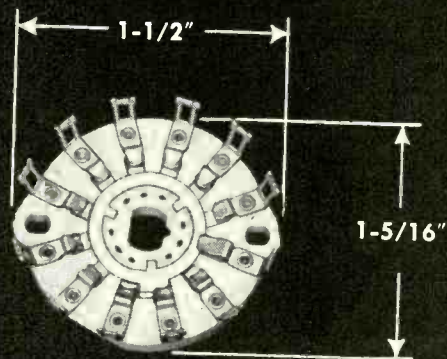

Standard Size

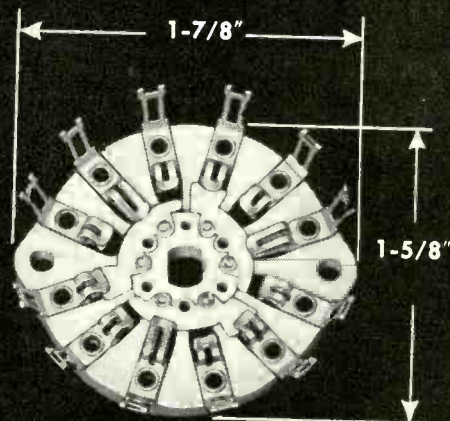

### COMPARE the size of the new Centralab miniature switch with conventional standard size models

The new, miniature switch is a full  $\frac{3}{8}$ " smaller in diameter than standard switches! More important, they allow more positions per pole, even with miniaturization. For example:

- 1 pole — 12 active positions per section  
(former 1-pole switch had only 11 positions).
- 2 poles — 6 active positions per section  
(former 2-pole switch had only 5 positions).

RADIO-ELECTRONICS

# -in stock!

## switch line offers you in a lot smaller package

THESE new series PA-2000 miniature switches give you more flexibility. And expert designing retains maximum protection.

Centralab miniature switches feature one-piece shaft construction, permitting more accurate indexing. They are available with one to six sections per shaft, one to 18 poles per switch. Sections are Steatite and can be had in shorting and non-shorting arrangements. Adjustable stop allows selection of positions or continuous rotation. *More, these switches are guaranteed to withstand a minimum of 50 hours of salt-spray tests.* No other units on the market as stock

items will do as well. Separate Steatite sections, index assemblies, hardware and accessories also available.

These features make it possible for you to use these Centralab switches for AM, FM or TV repair, intercom installations, mobile equipment, public address systems or any medium power application.

You save time and money when you insist on Centralab switches. That's because the complete Centralab line offers you the exact switch you want, when you need it, always available from one source. *And they're offered at attractive low prices!*

### CHECK THESE NEW SMALLER DIMENSIONS!

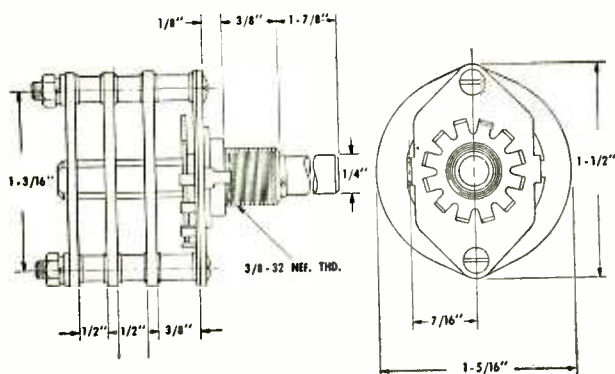

Total Number Poles	Total Positions	Number Sections	Poles Per Section	Cat. No. Shorting	Cat. No. Non-Shorting
1	2-12	1	1	PA-2000	PA-2001
2	2-6	1	2	PA-2002	PA-2003
2	2-12	2	1	PA-2004	PA-2005
3	2-5	1	3	PA-2006	PA-2007
3	2-12	3	1	PA-2008	PA-2009
4	2-6	2	2	PA-2010	PA-2011
4	2-12	4	1	PA-2012	PA-2013
5	2-3	1	5	PA-2014	PA-2015
5	2-12	5	1	PA-2016	PA-2017
6	2	1	6	PA-2018	PA-2019
6	2-5	2	3	PA-2020	PA-2021
6	2-6	3	2	PA-2022	PA-2023
6	2-12	6	1	PA-2024	PA-2025
8	2-6	4	2	PA-2026	PA-2027
9	2-5	3	3	PA-2028	PA-2029
10	2-3	2	5	PA-2030	PA-2031
10	2-6	5	2	PA-2032	PA-2033
12	2	2	6	PA-2034	PA-2035
12	2-6	6	2	PA-2036	PA-2037
15	2-3	3	5	PA-2038	PA-2039
18	2	3	6	PA-2040	PA-2041

#### SPECIAL

1	2-10	1	1	PA-2042	
---	------	---	---	---------	--

#### MINIATURE SWITCHES WITH 60° INDEXING

1	2-6	1	1		PA-2043
2	2-6	2	1		PA-2045

(1½" spacing between sections)



The Centralab miniature switch line is only one of the more than 470 new items listed in Centralab's new Catalog 28. Get your copy of this 32-page index to the latest developments in the fast-changing electronics field. See your distributor or write direct.

# Centralab

A Division of GLOBE-UNION INC.

922 E. Keefe Avenue • Milwaukee 1, Wisconsin

In Canada, 635 Queen Street East, Toronto, Ontario





circuit. Ohm says multiply  $R \times I$  so the voltage across the capacitor is  $347 \times .034 = 11.8$  volts; across the choke  $3,600 \times .034 = 122.4$  volts; across the resistance  $1,000 \times .034 = 34$  volts. Coming back to the first paragraph and the a.c. radio plugged into a 25-cycle supply, suppose the input circuit is as in Fig. 2.  $X_L$  now becomes  $6 \times 25 \times 5 = 750$  ohms.  $X_C$  becomes  $\frac{1,000,000}{6 \times 25 \times 6} = 1,111$  ohms approximately.

Back to  $Z$  again.  $X$  is now  $750 - 1,111$  or  $-361$  ohms, so  $\sqrt{R^2 + X^2}$  becomes  $380,321$  and its square root becomes about 616 ohms. The current in the circuit, assuming the transformer output is 250 volts  $B$ , then becomes 406 ma and the voltage across each component: ca-

pacitor 451; choke 305, and resistor 203! Now you will see why that capacitor packed in: 451 volts doesn't do a 250-volt working electrolytic much good!

When the two reactances cancel out, as they do in resonant circuits, leaving practically the resistance alone, the current rises to very large values provided the resistance is small. The voltage across the choke and capacitor can then rise to some thousands. It is precisely this principle of cancellation of reactances which accounts for the steep increase in voltage in resonant r.f. circuits, and it is also reactance which determines grid leak and capacitor values and many other things. Knowing the workings of reactance you can calculate the values of choke inductance and elec-

trolytic capacitance for any smoothing circuit, and work out your own.

As an instance a choke of 10 henrys and capacitor of  $8 \mu\text{f}$ , common in a.c. circuits, have reactances of 7,200 and 173 ohms at the ripple frequency while on d.c. the choke reactance is zero and that of the capacitor approaches infinity.

Another place where reactance is important is in tone control circuits. The majority of these are fairly simple. A common one is that in Fig. 3. It is a sort of voltage divider, in which part of the output voltage of the first tube is tapped off for the grid of the second. At high frequencies, the capacitor in series with  $R_2$  has negligible reactance, so that the second grid is tapped in only about one-fifth of the way up the divider. The reactance of the capacitor rises at low frequencies (a  $.01\text{-}\mu\text{f}$  capacitor at 80 cycles has a reactance of about 200,000 ohms) so the impedance of the lower part of the network rises and more of the output voltage gets to the next grid. This is a bass-boosting circuit.

We begin to get an important amount of boost when the reactance of  $C$  equals the resistance of  $R_2$ . Therefore, if you want to start boost at 150 cycles, the capacitor may be calculated by:

$$C = \frac{1,000,000}{6 \times 150 \times R_2}$$

If  $R_2$  is 50,000 ohms  $C$  should be approximately  $.02 \mu\text{f}$ .

With the other values given in Fig. 3 the boost is about 12 db. Such a circuit can be conveniently inserted between the second detector and output stage of any normal radio, and will give the required boost. But don't forget that there will be some loss at all except the bass frequencies.

Capacitive reactance may also be employed to give a rising high-frequency characteristic where it is required, for instance in audio circuits to compensate for poor high note response in speakers or to balance sideband cutting in i.f. amplifiers. The circuit is given in Fig. 4.

As with the previous circuit the frequency at which the boost begins is that frequency at which the reactance of the capacitor is equal to the resistor across which it is paralleled. The value of the capacitor can be computed as before

$$\text{from } C = \frac{1}{2\pi f R_1}. \text{ Taking the starting boost frequency as 7 kc we get roughly:}$$

$$C = \frac{1,000,000}{6 \times 7,000 \times 100,000} = .00024 \mu\text{f}$$

But this is not an article about tone controls, and the above examples will suffice. If you want more circuits—treble cut, bass cut, combination bass and treble boost—see the *Radiotron Designer's Handbook*. You will find them there, as well as Figs. 3 and 4 above.

Reactance enters into many other circuits: the calculation of grid capacitor and leak values for good quality, cathode and plate decoupling circuits and others. Knowing reactance will help you sort out all this, and in so doing will increase your professional status. That, in down to earth language, means dollars!

END

RADIO-ELECTRONICS

# AIM

MODEL No. RIM-70

## FOR THE FINEST TELEVISION PICTURES

### AIM - AUTOMATICALLY MATCHES IMPEDENCE BETWEEN ANTENNA and RECEIVER

There is always sure to be a difference (great or small) in impedance between the various types of antenna installations and the leadlines which carry picture impulses to the television receiver. To insure the closest possible reproduction as sent out from the studios, it is ABSOLUTELY NECESSARY that there be an EXACT impedance match between antenna, leadline and set.

**AIM** is the only known answer. **AIM DOES ITS JOB AUTOMATICALLY.** It's the "brain"—it does its own thinking. There is nothing to set at any time—no dials to turn—it's ready—just as you get it... "JUST INSTALL—THAT'S ALL."

**AIM WORKS ON ALL CHANNELS:** for V.H.F.—2 through 13, and U.H.F.—14 through 83.

**AIM HAS ALL THESE ADVANTAGES And FEATURES:**

**AIM:** Added signal strength helps to eliminate "snow." Provides clear, sharp pictures.

**AIM:** To get 3 to 7 additional decibels gain—on all channels.

**AIM:** To prevent standing waves on the leadline.

**AIM:** At the antenna—easily installed.

**AIM:** Compact—with Junction Box measuring only  $2\frac{5}{8}'' \times 1\frac{3}{8}'' \times 1''$  depth. Weighs only 8 ounces complete with U-Clamp and approximately 47' of AIM Wire.

**AIM:** Individually packed in attractive plastic box. 12 boxes to Counter Display Carton.

**AIM:** FOR EVERY INSTALLATION—PAST & FUTURE. **AIM:** To make more TV friends and a steady profitable sale—ON EVERY INSTALLATION. You're RIGHT—when you AIM RIGHT.

**AIM** was developed by one of the country's largest aircraft manufacturers and is FULLY COVERED BY PATENTS.

**SOLD ONLY THROUGH DISTRIBUTORS. LIST PRICE: \$4.95**



**ELECTRONICS MFG. CO.**

9820 IRWIN AVENUE

INGLEWOOD 1, CALIFORNIA

ALSO MANUFACTURERS: V.H.F. And U.H.F. ANTENNAS—HANDY PAD TUBES COVERS—ANTENNA CONNECTORS—TUBE REACTIVATORS—AUTO SPEAKER GRILLE KITS—VENT PIPE CLAMPS



# BUY TEST EQUIPMENT ON THIS RADICALLY NEW TIME PAYMENT PLAN

**NO INTEREST!! - NO CARRYING CHARGES!!**

USE CONVENIENT TIME PAYMENT ORDER BLANK BELOW

## Superior's New JUNIOR SUPER-METER

**MOST COMPLETE AND COMPACT MULTI-SERVICE INSTRUMENT EVER DESIGNED**



**Measures:**  
\* Voltage \* Current \* Resistance  
\* Capacity \* Reactance \* Inductance  
\* Decibels

**Specifications:** D.C. Volts: 0-7.5/75/150/750/1500 Volts. A.C. Volts: 0-15/150/300/1500/3000 Volts. Resistance: 0-10,000/100,000 ohms. 0-10 Megohms. D.C. Current: 0-7.5/75 Ma. 0-7.5 amps. Capacity: .001 Mfd.—2 Mfd. .1 Mfd.—20 Mfd. Electrolytic Leakage: Reads quality of electrolytics at 150 Volt test potential. Decibels: -10 Db to +18 Db. +10 Db to +38 Db. +38 Db. to +58 Db. Reactance: 15 ohms—25 K ohms 15 K ohms—2.5 Megohms. Inductance: .5 Henry—50 Henries 30 Henries—10 K Henries. Plus Good-Bad scale for checking the quality of electrolytic condensers.

Handsome round cornered molded bakelite case 3 1/8" x 5 7/8" x 2 1/4" complete with all test leads and instructions

**\$21.40**  
NET

## Superior's New TUBE TESTER Model TV-11



• Uses the new self-cleaning Lever Action Switches for individual element testing. Because all elements are numbered according to pin number in the RMA base numbering system, the user can instantly identify which element is under test. Tubes having tapped filaments and tubes with filaments terminating in more than one pin are truly tested with the Model TV-11 as any of the pins may be placed in the neutral position when necessary. • Uses no combination type sockets. Instead individual sockets are used for each type of tube. Thus it is impossible to damage a tube by inserting it in the wrong socket. • Free-moving built-in roll chart provides complete data for all tubes. • Phono jack on front panel for plugging in either phones or external amplifier detects microphonic tubes or noise due to faulty elements and loose external connections.

Operates on 105-130 Volt 60 Cycles A.C. Hand-rubbed oak cabinet complete with portable cover

**\$47.50**  
NET

## Superior's New Model 670-A SUPER-METER



**A combination volt-ohm milliammeter plus capacity reactance inductance and decibel measurements**

**SPECIFICATIONS:**  
D.C. VOLTS: 0 to 7.5/15/75/150/750/1,500/7,500 Volts  
A.C. VOLTS: 0 to 15/30/150/300/1,500/3,000 Volts  
OUTPUT VOLTS: 0 to 15/30/150/300/1,500/3,000 Volts  
D.C. CURRENT: 0 to 1.5/15/150 Ma. 0 to 1.5/15 Amperes  
RESISTANCE: 0 to 1,000/100,000 Ohms 0 to 10 Megohms  
CAPACITY: .001 to 1 Mfd. 1 to 50 Mfd. (Quality test for electrolytics)  
REACTANCE: 50 to 2,500 Ohms 2,500 Ohms to 2.5 Megohms  
INDUCTANCE: .15 to 7 Henries 7 to 7,000 Henries  
DECIBELS: -6 to +18 +14 to +38 +34 to +58

Comes housed in rugged, crackle-finished steel cabinet complete with test leads and operating instructions. Size 6 1/4" x 9 1/2" x 4 1/2"

**\$28.40**  
NET

**ADDED FEATURE**  
The Model 670-A includes a special GOOD-BAD scale for checking the quality of electrolytic condensers at a test potential of 150 Volts.

## Superior's New TV BAR GENERATOR



**THROWS AN ACTUAL BAR PATTERN ON ANY TV RECEIVER SCREEN!!**

Two Simple Steps

1. Connect Bar Generator to Antenna Post of any TV Receiver.
2. Plug Line Card into A. C. Outlet and Throw Switch.

**RESULT:** A stable never-shifting vertical or horizontal pattern projected on the screen of the TV receiver under test.

Power Supply: 105-125 Volt 60 Cycles. Power Consumption: 20 Watts. Channels: 2-5 on panel, 7-13 by harmonics. Horizontal lines: 4 to 12 (Variable). Vertical lines: 12 (Fixed). Vertical sweep output: 60 Cycles. Horizontal sweep output: 15,750 Cycles.

TV Bar Generator comes complete with shielded leads and detailed operating instructions. Only

**\$39.95**  
NET

## New Model 200-AM and FM SIGNAL GENERATOR

Provides complete coverage for A.M.-F.M. and TV alignment



\*R.F. Frequency Ranges: 100 Kilocycles to 150 Megacycles.  
\*Modulating Frequency: 400 Cycles. May be used for modulating the R.F. signal. Also available separately. \*Attenuation: The constant impedance attenuator is isolated from the oscillating circuit by the buffer tube. Output impedance of this model is only 100 ohms. This low impedance reduces losses in the output cable. \*Oscillatory circuit: Hartley oscillator with cathode follower buffer tube. Frequency stability is assured by modulating the buffer tube. \*Accuracy: Use of high-Q permeability tuned coils adjusted against 1/10th of 1% standards assures an accuracy of 1% on all ranges from 100 Kilocycles to 10 Megacycles and an accuracy of 2% on the higher frequencies.

\* Tubes used: One 954 as oscillator; one 954 as modulated buffer amplifier; T-2 as modulator; 7193 as rectifier. The Model 200 comes complete with output cable and operating instructions

**\$21.85**  
NET

## NEW TIME PAYMENT PLAN ORDER BLANK

MOSS ELECTRONIC DISTRIBUTING CO., INC.  
Dept. B-38, 38 Murray Street, New York 7, N. Y.

Please send me the units checked below. I am enclosing the down payment with order and agree to pay the monthly balance as shown. It is understood there will be no carrying, interest or any other charges, provided I send my monthly payments when due. It is further understood that should I fail to make payment when due, the full unpaid balance shall become immediately due and payable.

- JUNIOR SUPER METER..... Total Price \$21.40  
\$5.40 down payment. Balance \$4.00 monthly for 4 months.
- MODEL TV-11..... Total Price \$47.50  
\$11.50 down payment. Balance \$6.00 monthly for 6 months.
- MODEL 670-A..... Total Price \$28.40  
\$7.40 down payment. Balance \$3.50 monthly for 6 months.
- TELEVISION BAR GENERATOR..... Total Price \$39.95  
\$9.95 down payment. Balance \$5.00 monthly for 6 months.
- MODEL 200..... Total Price \$21.85  
\$5.85 down payment. Balance \$4.00 monthly for 4 months.
- I enclose \$\_\_\_\_\_ as down payment.
- Ship C.O.D. for the down payment.

Signature \_\_\_\_\_

Name \_\_\_\_\_

Address \_\_\_\_\_

City \_\_\_\_\_ Zone \_\_\_\_\_ State \_\_\_\_\_



# BRIDGES in speech circuits

Ordinary resistance networks can combine or isolate several signal inputs in the simplest "inter-com" or the most complex broadcasting hookup

By HILTON REMLEY

THE COMMON Wheatstone bridge has a number of interesting and valuable possibilities in audio and broadcast work. Fig. 1 is the fundamental Wheatstone circuit used to measure an unknown resistance by comparing it with a known resistance.  $R_1$  is made equal to  $R_2$ . Then, when

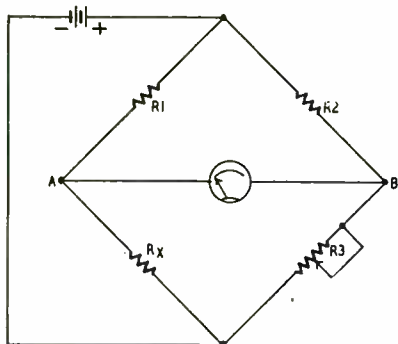

Fig. 1—A basic Wheatstone bridge.

calibrated arm  $R_3$  is adjusted to equal the unknown resistor  $R_x$ , the voltages at A and B must be equal. With both ends of the meter at the same voltage there will be no deflection. The result will be the same if the battery is replaced by an a.c. voltage. As long as we use only pure resistance in all four arms of the bridge, there will be no

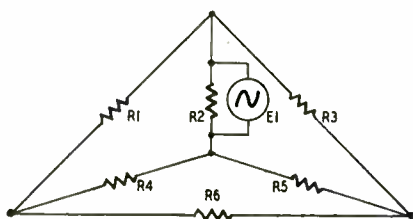

Fig. 2-a—"Delta-Star" bridge.  $E_1$  appears across all branches except  $R_6$ .

voltage difference between A and B when the bridge is perfectly balanced.

This basic bridge is ideal for canceling out all or part of a signal across two terminals of a multiterminal network. Skeptics will remark that a voltage-divider type volume control does the same thing with fewer complications.

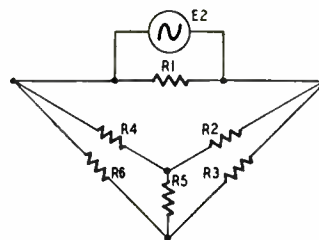
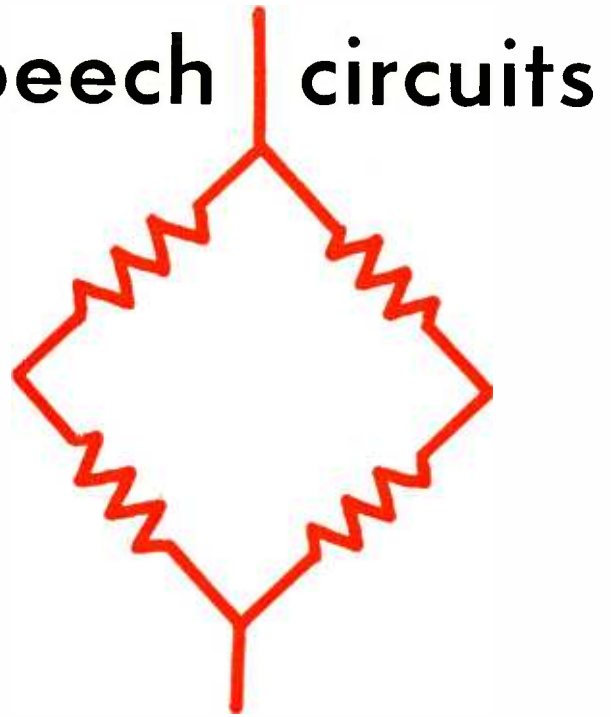

Fig. 2-b—Another "Delta-Star."  $E_2$  appears across every resistor except  $R_5$ .

However, modifications of the simple bridge allow us to apply several signals simultaneously to a common circuit and to control each one independently of the others.

### Delta-star bridge

Fig. 2-a is a simple double-bridge circuit formed by combining the delta ( $\Delta$ ) and star (Y) connections used in polyphase a.c. power circuits. As long as the three outside arms are equal, and the three inside arms are equal (regardless of the actual resistance values) any signal  $E_1$  applied across  $R_2$  will not appear across  $R_6$ . The signal does appear, reduced in amplitude, across each of the remaining resistors. By the same reasoning, a signal  $E_2$  applied across  $R_1$  will cancel out across  $R_5$  but not across the other arms (Fig. 2-b).



A signal across any resistor in the outside (delta) network will not appear across the resistor diagonally opposite in the inside (star) network. Likewise, a signal across any inside resistor will cancel out in the outside resistor diagonally opposite.

Let's put this little trick to use. Sup-

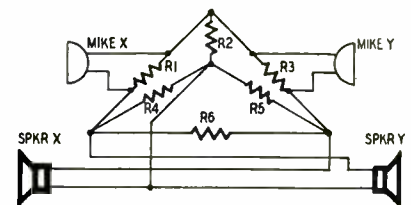

Fig. 3—Switchless 2-way communication circuit using "Delta-Star" bridge. Each speaker hears only other mike.

pose we have two people X and Y, in separate rooms with microphones and loudspeakers connected as shown in Fig. 3. If X speaks, he cannot hear in his loudspeaker what he says in the X microphone. Y's loudspeaker receives X with no difficulty. If Y speaks, X hears him clearly, but Y cannot hear himself in his own speaker. (This is called an *anti-sidetone* circuit by telephone engineers. In simplified form it prevents you from hearing your own voice in a telephone receiver.)

This is an ideal arrangement where a "full talk" circuit is needed for continuous operation without SEND and RECEIVE switching. It lends itself very well to broadcast work where a program originates in two different studios. The delta-connected resistors of the previous circuits are simply replaced by "H" pads. (Fig. 4). Each

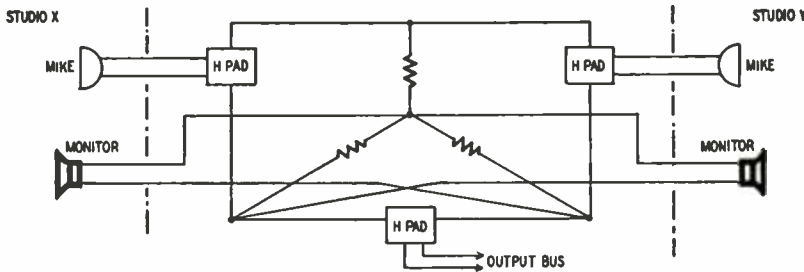

Fig. 4—Typical studio setup. H-pads replace resistors in outside arms of bridge.

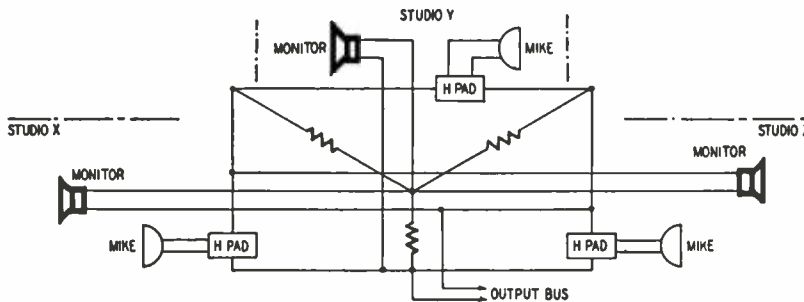

Fig. 5—A three-way hookup is possible, but the branches are difficult to balance.

studio can hear everything that goes on in the other. Such a case might call for a soloist in one studio with the announcer in another, or two portions of a single program succeeding one another from different studios, with everyone in each studio fully aware of proceedings in the other. Everything taking place in both studios may be heard across any "H" pad, and the output to a transmitter, network, recording channel, or audition bus is taken from the bottom pad in Fig. 4. (If this feed is not required the output "H" pad can be replaced by a single resistor equal to the impedance of the pad itself.

**Three-way bridge**

We may carry our system one step further, and feed the outputs of *three studios* into such a bridge. This allows each studio to hear anything taking place in the other two without hearing its own program material in the monitor. This arrangement is shown in Fig. 5. The feed for the main program bus must be taken from one of the stu-

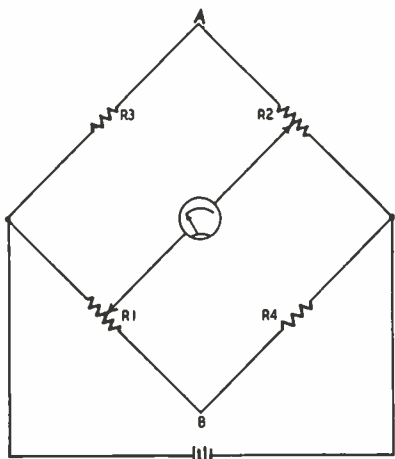

Fig. 6—Modified basic bridge circuit.

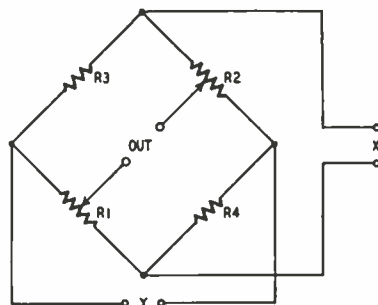

Fig. 7—Two-way mixing with modified bridge controls signal ratio. If one signal is raised the other must be reduced.

dio outputs. This creates two problems. First, the bridge becomes very difficult to balance; second, the output level of the studio feeding the program bus will be higher than either of the other two studios, unless all three outputs are adjusted to overcome these differences. These adjustments are very critical, and for that reason this last system is seldom used.

In any of these systems the signal levels fed to monitor loudspeakers must be under control at all times, to prevent setting up acoustic feedback through the entire system. Operation below the feed-back point still provides a wider operating range than most

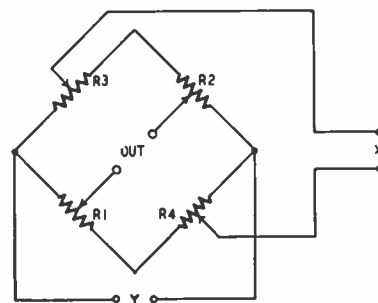

Fig. 8—This form of mixing bridge allows unlimited control of either signal.

other monitor systems. With headphone monitoring there is no feedback problem.

**Mixing bridge**

Further examination of the bridge circuit discloses another interesting angle. Suppose we make up our bridge circuit as shown in Fig. 6, with all resistors equal, but two of them equipped with sliders. By moving the sliders we can obtain any voltage up to the maximum input on the meter. When the opposite sliders are at A and B the bridge is balanced and the meter reads zero.

The results are the same if we apply a.c. instead of d.c. Suppose we feed in two signals at the same time, as shown in Fig. 7. This time signal Y will not be present across X, nor will

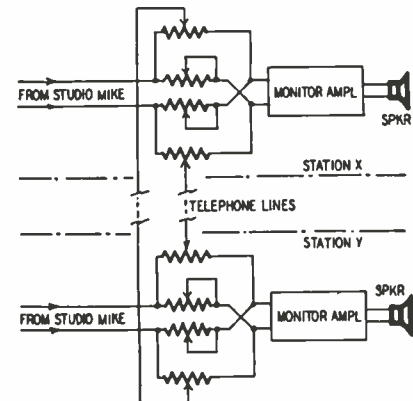

Fig. 9—Broadcast hookup using single pair with dual mixing and monitoring.

signal X appear across Y. Suppose next we want to combine these two signals, in equal or unequal amplitudes. This can be done by taking the combined signal from any single resistor. Their relative strengths in the output circuit depend on the positions of the sliders. If we increase one signal, we must decrease the other.

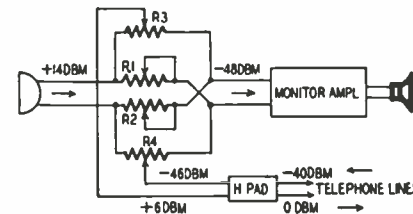

Fig. 10—One end of the two-way circuit.

The next step, then, is to modify the bridge to make at least one of these signals independent of the other. Looking at Fig. 8, we see that if signal X is applied to sliders on R3 and R4 the amount of signal X in the output may be adjusted from maximum to minimum without affecting the strength of signal Y. Two uses for such an arrangement prompted the author to investigate this circuit.

**Broadcast applications**

The first problem was to set up a two-way, continuous-talk circuit over a considerable length of leased telephone line. The fact that the line input level (Please turn to p. 82)



# TRIO ANNOUNCES SENSATIONAL NEW **ZIG-ZAG** ANTENNA

Patent Pending

- ★ **Higher Gain than any Yagi!**
- Plus**
- ★ **All-Channel VHF Performance!**

Here's the greatest advance in TV antennas since TRIO'S introduction of the dual channel yagil! The sensational new TRIO ZIG-ZAG antenna is basically a multiple element yagi type antenna on each channel, yet one 2-bay antenna — and in some models a single bay antenna — covers all VHF channels!

This sensational antenna has sharper directivity and higher front-to-back ratio. It provides snow-free pictures, and fade-free sound even in the most remote fringe areas.

Tremendous forward gain is accomplished without long, bulky, arrays that operate on only one channel. With the new fringe area model ZIG-ZAG antenna, one bay provides tremendous gain on all low channels, 2 thru 6, and the other bay provides similar high gain on channels 7 thru 13.

### HOW THIS AMAZING ANTENNA WORKS

Trio ZIG-ZAG antennas utilize a new principle whereby an array is composed of a series of elements, one or more of which is resonant on any one channel while the remaining elements, which are non-resonant on that channel, provide parasitic voltages having the proper phase relative to the direct voltage. These act as very efficient directors and reflectors. All elements are directly connected to the feed-line.

The various models, listed below, are designed to provide a simple installation for all areas, from metropolitan to extreme fringe. Two bay models, like the single bay models, are operated with a single 300 ohm lead-in to the set, with less than a 3:1 standing wave ratio.

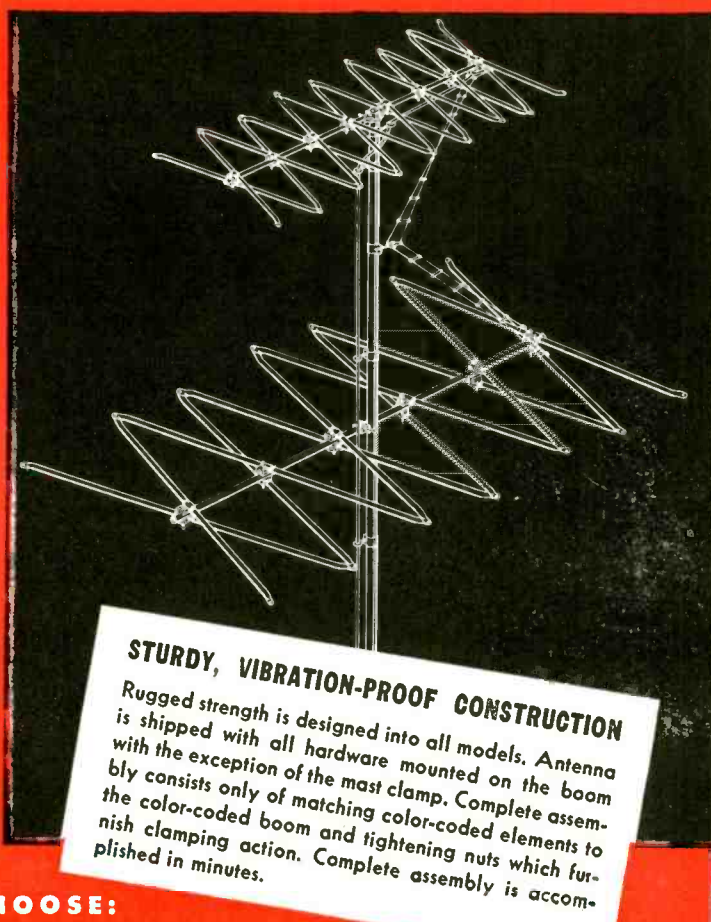

### 8 MODELS FROM WHICH TO CHOOSE:



ZZ12L

ZZ16H

**FOR EXTREME FRINGE RECEPTION** — ZZ16H provides over 14 DB voltage gain as compared with a resonant reference dipole on Channels 7 thru 13; and ZZ12L provides gain of 12 to 14 DB on Channels 2 thru 6. Gain of the ZZ12L is 12 DB on Channels 2 and 3 and is 14 on Channels 4, 5 and 6. These models have narrowest forward lobe and highest front-to-back ratio and should be used in areas where co-channel interference is a problem.



ZZ8L

ZZ8H

**FOR NORMAL FRINGE RECEPTION** — Where maximum gain is not necessary, these models are ideal. The ZZ8H for Channels 7 thru 13 and the ZZ8L for Channels 2 thru 6. Voltage gain is 9 DB on Channels 2 and 3 and 11 DB on Channels 4 thru 13. These models have patterns comparable to a well designed multi-element single channel yagi.



WRITE FOR CATALOG

ZZ6L

ZZ6H

**FOR NEAR FRINGE RECEPTION** — These models provide a voltage gain of 8 to 9 DB on Channels 2 thru 13. These models have pattern and gain comparable to a cut-to-channel yagi. ZZ6L covers Channels 2 thru 6. ZZ6H covers Channels 7 thru 13.

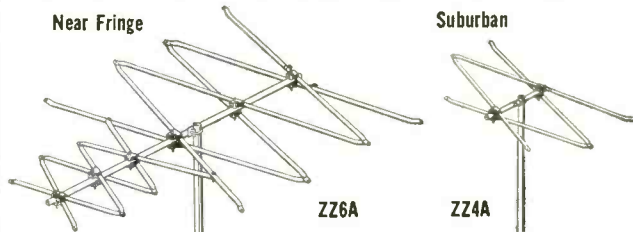

Near Fringe

Suburban

ZZ6A

ZZ4A

**SINGLE BAY ALL-CHANNEL RECEPTION** — Model ZZ4A is a single bay antenna providing adequate gain and directivity on all channels, 2 thru 13, in suburban areas. Model ZZ6A is also an all-channel single bay antenna providing greater gain for near fringe use.



**TRIO MANUFACTURING COMPANY • GRIGGSVILLE, ILLINOIS**

# The TRIRO ROTATOR

## Strongest Ever Built

The TRIRO ROTATOR passes strength and endurance tests that impose weight loads 5 times greater than a Channel 4 yagi installation—endures without failure operation equalling 15 years normal use.

## Backed by \$50,000 of Research

To produce the best rotator made, TRIRO spent \$50,000 in exhaustive testing, research and engineering. Exhaustive tests on all makes of rotators were independently conducted by one of the nation's largest manufacturers of TV sets. The TRIRO ROTATOR was the only one that passed these grueling tests!

- ✓ Two powerful 24 volt motors used — one for each direction of rotation. Each motor under load only fraction of time — will not burn out!
- ✓ Corrosion resisting, weatherproof housing of die-cast aluminum for greater strength, lighter weight, perfect alignment of parts!
- ✓ Positive electrical stops at ends of 360° rotation prevent damaging or twisting of leads!
- ✓ Will support heavy TV arrays — even in 80 MPH winds!
- ✓ Permanently lubricated with special grease that functions perfectly in high and low temperature extremes!
- ✓ Ball-bearing end thrusts on all shafts, including motor! Main shaft vertical load carried on large oversized "Oilite" self-lubricating bearing!
- ✓ All motors, shafts and gears mounted on a rugged, one-piece casting for true alignment and longer life!
- ✓ 1 1/16" diameter tool steel main shaft and mast holder will withstand 4500 inch pounds bending moment!
- ✓ Rotator and mast holder fits any pipe size up to 2" OD!
- ✓ Precision built to extremely close tolerances!



## Smartly Styled

### DIRECTION INDICATOR

The handsome TRIRO ROTATOR is easy to operate. There's no need to hold control for continuous operation! A light touch of the "finger tip" control starts rotation in either direction. Another touch stops antenna at desired position! Gracefully styled, the smart TRIRO ROTATOR is a handsome accessory —not just another "box."



**FULLY TESTED—  
FULLY GUARANTEED**

Every TRIRO ROTATOR and DIRECTION INDICATOR is guaranteed against defective parts and workmanship for two years. Each TRIRO ROTATOR is thoroughly factory tested to the equivalent of 3 months of constant operation. This, plus an additional torque test, guarantees each unit to be perfect in every detail of assembly!

  
**TRIRO** Manufacturing Company  
 GRIGGSVILLE, ILLINOIS



# TRAIN FOR TELEVISION

in 3 easy steps!



**ONLY \$1550**  
for the complete training (all 3 books)

**5 Months to Pay!**  
...pay while you learn

These three really great books make it easy for you to train for television—at absolute minimum cost. No lessons to wait for! No wasted time!

Read singly, each book is an authentic, easy-to-understand guide to an essential phase of modern TV. Add all three together and you have a specialized training that can help you win better pay, a bigger job or even a business of your own in the fastest-growing industry of all!



The famous

**RINEHART TV LIBRARY**

## 1—FREQUENCY MODULATION

This great, 448-page book with over 300 illustrations provides up-to-the-minute training in the circuit system by which TV sound is transmitted. You learn all about FM theory, circuits, transmitters, receivers, mobile units, tuning indicators, antennas, test equipment, alignment, service, etc. Price \$5.00 separately.

## 2—TELEVISION SERVICING

After studying this great book, you'll find even the most puzzling TV service problems greatly simplified. You'll work better, faster—more profitably! Actual service case histories make things amazingly clear. Illustrations explain details step by step. Subjects range from testing, repair and component replacements, antennas, testing, improving picture linearity to fringe area reception, vital service data, and many others. Price \$4.00 when purchased separately.

## 3—TELEVISION ENGINEERING

This 700-page book can help guide you to good pay in manufacturing, lab or broadcast studio work and other advanced phases of TV. Includes transmission fundamentals, a full explanation of the cathode ray tube, TV camera chains, telecasting techniques, lenses, oscilloscopes, synchronizing generators, video amplifiers, power supplies and many more. Contains 385 helpful illustrations. Price \$7.50 separately.

### YOU CAN'T LOSE on this offer!

Read this famous RINEHART TV LIBRARY for 10 full days before you decide! Bought singly, these 3 fact-packed books cost \$16.50. Under this offer you save \$1 and have the privilege of paying in easy monthly installments while you use the books. Use coupon!

### 10-DAY FREE EXAMINATION

Dept. RE-112, RINEHART BOOKS, INC.,  
Technical Division,  
232 Madison Ave., New York 16, N. Y.

Send me the famous RINEHART TV LIBRARY (3 books) for 10-DAY FREE EXAMINATION. If the books are not what I want, I will return them postpaid in good condition at the end of 10 days without any further obligation on my part. If I decide to keep them, I will then enclose \$3.50 as my first payment and will send you \$3 a month for 4 months until the total special price of \$15.50 is paid.

NOTE: Any of these books may be bought separately at prices indicated for each.

Name .....

Address .....

City, Zone, State .....

Your employer .....

was limited to 6 milliwatts or less made it necessary to install amplifiers at both ends of the line to bring the signals up to loudspeaker level. Since only one pair of wires was available, there would normally be a considerable difference in level between incoming and outgoing signals at each end of the line. The use of balanced, 6-winding hybrid coils at once suggested itself, but time, and the coils, were not available and some other device had to be

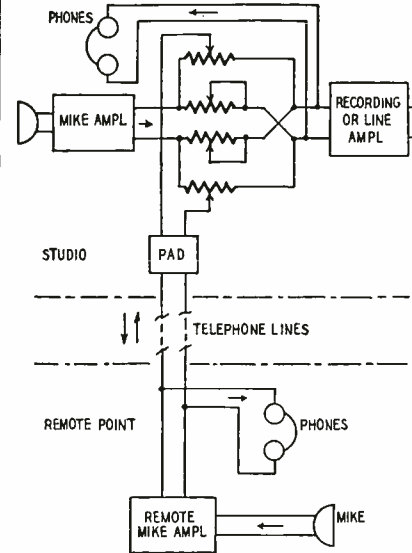

Fig. 11—Studio-remote two-way hook-up over single pair, with combined signal output to program bus or recorder.

used. Fig. 9 shows how it was done.

This arrangement allows at least a 40-db difference in level between the incoming and outgoing signals on the program line, yet each signal is present in the loudspeakers with equal level. All four resistors in the bridge circuit at either end of the line are of equal value. In this instance all were 500-ohm potentiometers.

Let's look at the circuit a little more closely. Fig. 10 shows just one end of the line, with typical signal levels as they might appear at various points. If all four arms are equal, then the signal from the microphone will balance out at the input to the monitor.

The two sides of the microphone circuit go through equal resistors, after which the two sides are interchanged, thus presenting equal but opposite voltages to the speaker input. At the same time, however, the incoming line signal will not be balanced out completely, since there will be two unequal resistors in series on each side of that line. Adjustments of  $R_1$  and  $R_2$  should be the only adjustment necessary. All resistors are made variable to allow very precise adjustment of the bridge.  $R_1$  and  $R_2$  should each have a total resistance equal to or slightly greater than the combined resistance of  $R_3$  and  $R_4$ .

This bridge scheme was also employed to advantage in a series of interview programs conducted over a local broadcast station.

The idea may be of interest to other engineers faced with similar special events programs. It was necessary that the announcer conduct his interview

# TRY WELLS



## FOR ELECTRONIC COMPONENTS

We offer immediate delivery from our vast stock of more than 25,000 items—all standard make, carefully inspected and fully guaranteed. Our prices are below market.

### Always Check Wells' Stock First!

Quotations and quantities available will be given immediately upon request.

- ADEL CLAMPS
- ANTENNAS
- Insulators, Mast Sections
- BINDING POSTS
- BLOWERS
- CABLE ASSEMBLIES
- CHOKES
- COILS
- CONDENSERS
- Oil Filled; Bathtub, Hearing Aid, Transmitting
- Micas, Silver Micas, Ceramic, Variable, Trimmer
- CRYSTALS
- DYNAMOTORS & BRUSHES
- FILTERS
- FUSES & MOUNTINGS
- GENERATORS
- GROUND RODS
- HEADSETS
- IF COILS
- JACKS
- JACK BOXES
- KEYS, Telegraph
- KNOBS
- LAMPS
- LORD MOUNTS
- LUGS
- MOTORS & BRUSHES
- PLUGS
- RECTIFIERS
- Selenium, Copper Oxide, Meter, Diode
- RESISTORS—All Types
- SELSYNS
- SOCKETS
- SWITCHES
- Aircraft, Micro, Switchettes, Toggle
- TIMERS
- TUBING—Flexible
- TUNING SHAFTS
- TRANSFORMERS—All Types
- VIBRATORS
- WALKIE TALKIES

### Available Now!

A complete signal corps stock number listing of items in our stock. Write for listing No. SG-200. (For government agencies and contractors only.)

Manufacturers and distributors—write for Radio-Electronics Catalog No. H 501.

Write, Wire, Phone Your Requirements

all phones: **SEeley 8-4143**



833 W. CHICAGO AVE., DEPT. Y, CHICAGO 22, ILL.

RADIO-ELECTRONICS

**it's NEW!**

# Pioneer television VHF-UHF Signal-Range CALCULATOR

**HANDY...**

*Simple to Use*

**FAST...**

## MOST PRACTICAL LOW COST TV INSTALLATION AID BUILT

This new Signal-Range Calculator quickly shows the approximate Grade "A", Grade "B", and Principal City coverage for all VHF and UHF television channels. Expected field strength in microvolts-per-meter is also given for distances up to 100 miles from the TV transmitter.

Coverage radius is read directly from the rule for stations operating with effective radiated powers from 10 to 1000 kilowatts, and for antenna heights up to 3000 feet.

## Easy to Use...

All you need to know is TV station's published power and antenna height. Helps you determine antenna type and accessories needed for adequate TV microvolt signal at fringe installations up to 100 miles.

## Quickly Shows...

- TV station coverage contours.
- Signal strength for any distance from 5 to 100 miles.
- Signal strength of different stations for every location.
- Increased station coverage when antenna height and operating power is increased.
- Expected coverage of new UHF stations soon to be in operation.
- Teaches you the facts which influence transmitter coverage.
- Lists FCC required field signal-strength.

## Practical... Handy...

Designed to FCC rules and regulations governing TV stations. Accuracy in nearly all cases is within 5% of the FCC charts.

... This calculator will help you determine antenna type and accessories needed for adequate TV microvolt signal at fringe insulations up to 100 miles.

Attractive, durable leather case included.

**FITS  
YOUR  
POCKET**

## You need it now...

With this Signal-Range Calculator you can figure and compare expected signal strengths from stations operating with different powers and an different channels. For example, if Station "A" by observation or measurement has an inferior signal to Station "B" you can determine if difference in strength can be explained by transmitting conditions, or whether difficulty is at the receiver. Helps you determine effect new channel changes will have, as well as answer questions about expected coverage of UHF stations soon to begin operation.

This fine new calculator will help you determine in advance the antenna type and accessories necessary for adequate TV microvolt signal at fringe installations up to 100 miles. Copyrighted and designed exclusively for Pioneer Electronic Supply Co. by nationally known communication engineer J. B. Epperson, Associate Member of Federal Communications Consulting Engineers.

Attractive leather case and instructions included.

**Price \$5.45  
NET**

PIONEER ELECTRONIC SUPPLY CO.  
2117 Prospect Ave.  
Cleveland 15, Ohio

Gentlemen: Kindly send me one of your new Signal-Range Calculators complete with instructions and attractive leather case. I understand that I need send no money—just pay postman \$5.45 net plus a few cents postage on arrival.

Name \_\_\_\_\_

Street \_\_\_\_\_

City \_\_\_\_\_ Zone \_\_\_\_\_ State \_\_\_\_\_

**Pioneer** ELECTRONIC SUPPLY CO.  
2117 Prospect Avenue • Cleveland 15, Ohio  
EVERYTHING IN ELECTRONICS FOR INDUSTRY

Copyright 1952



**now...**

**a rear seat speaker for every model automobile**



**4"x6" speaker \$9.95 list**

**6"x9" speaker \$13.95 list**

**includes:**

- ★ unique Aero-Tone design
- ★ 5 adaptor plugs — for every radio hook-up
- ★ plug adaptor at no extra cost
- ★ exclusive chrome-finished grilles
- ★ many other outstanding features

**featuring the OXFORD WEATHERPROOF SPEAKERS**

manufactured by **Aero Tone**

**ORDER from your JOBBER TODAY!**

**Manufacturing Co., Inc.**  
4836 Joy Road — Detroit 4, Michigan

from the studio, making it appear that he was at the remote point. Two systems suggested themselves at once. Use of an order-wire cue circuit, or a receiver at the nemo point, with earphones for the persons being interviewed. The order wire was overruled because of expense and length of line. The receiver scheme worked well for a time, until the program was ordered transcribed for delayed broadcast. Then the bridge circuit was set up as shown in Fig. 11.

The inputs from the remote point and the studio are mixed in the bridge to provide equal levels to the recording (or program) bus, while the signal from the studio is fed back over the line with sufficient level to permit the person being interviewed to hear the studio easily. Two signals of greatly different levels are present on a single line, yet do not interfere.

We have presented only a few useful bridge circuits. Other uses for such circuits suggest themselves from time to time. For example, the monitor circuit of a remotely located radio transmitter might be fed back to the control point over the same program line that feeds the transmitter, allowing the control operator to monitor the actual output signal. This might be used to advantage by the professional or the amateur on phone or c.w. Bridges of this type can be easily incorporated in either a.c. or d.c. remote circuits, over a single-pair line, to provide a number of control functions. One need use only a little thought, and some patience, to develop a number of circuits of this type. END



*Suggested by Frank Kulak, Carnegie, Pa.*

**SAVE UP TO 50% CABINART FOLDED HORN ENCLOSURE KITS**

**MODEL 61**  
For 12" Speakers:  
32" H, 32" W, 16" D.  
Wt. 26 lbs.  
**\$19.95**  
NET



**MODEL 63**  
For 15" Speakers:  
32" H, 36" W, 17 1/2" D.  
Wt. 28 lbs.  
**\$23.95**  
NET

You high fidelity fans can assemble your own acoustically engineered folded horn corner speaker enclosure from a fine Cabinart kit. Save up to 50% and more on the usual complete models by less than two hours of simple assembly. Enjoy a full extra octave of full clean bass never reproduced by the ordinary cabinet.

Kit includes everything you need — 5/8" pre-cut select white gum plywood — pre-cut speaker opening, grille cloth, kimsul acoustic insulation, hardware. Assembly and finishing instructions.

Make Arrow's great, new Audio Center your home base for everything in high fidelity and sound equipment. Audio Center is America's only 5-story building devoted exclusively to Audio — Biggest Stocks, Best Prices, Fastest Service. Check us on your needs — convince yourself.

ARROW ELECTRONICS

*Audio Center*

BEAUTY IN SOUND

65 CORTLAND ST., NEW YORK 7, N. Y., DEPT. RE-11



Now on your Jobber's counter

**Take One!**

**Ersin Multicore**

**World's Finest 3-Core Solder in one-pound "Handi-feed" cartons! at your Jobbers.**

Multicore Sales Corp.,  
164 Duane St., N. Y. Dept. RE-11



# What Rauland means by "Perfection Through Research"

Rauland is one of the few companies devoting so much top engineering talent full time to picture tube improvement and perfection.

The result of this painstaking research has been to give you many more picture tube advancements since the war than has any other manufacturer . . .

more dependability and faster installation in the field for service dealers and service men . . . and greater assurance of customer satisfaction when you install Rauland replacement tubes.

That's why more and more jobbers, dealers and service men are standardizing on Rauland replacement tubes.

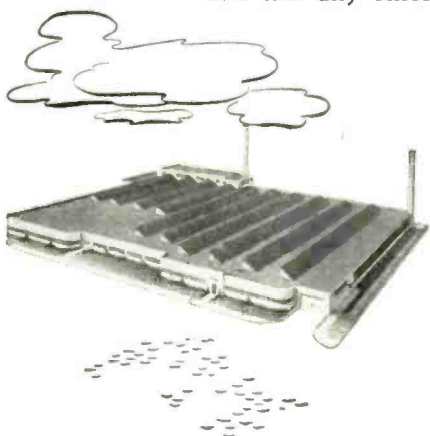

Rubber model for studying electron optical designing—basis for Rauland's exclusive Indicator Ion Trap.

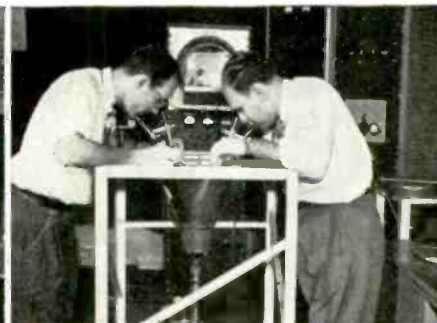

Alignment of the screen and parallax mask of tri-color tube containing approximately a million fluorescent dots.



All-electronic tri-color tube in electronic receiver system (left) in comparison with mechanical system (right).



Inspection and checking of perforations .0075" in diameter in masks of tri-color picture tubes.



Rauland large-screen projectors using three different optical systems, all of which give theater-size pictures.



Careful study of the formation of thin metallic films in a vacuum . . . basis for the aluminizing of tubes.



Examination with polarimeter permits careful control of strains for superior glass-to-metal sealing.



A physicist using a Rauland-developed radiation meter in checking X-ray radiations from cathode ray apparatus.

## THE RAULAND CORPORATION



*Perfection Through Research*

2425 N. KNOX AVENUE • CHICAGO 41, ILLINOIS





**FOR THE FIRST TIME Anywhere!**

**A BROAD BAND, 3 TUBE, 3 STAGE, FULLY AUTOMATIC BOOSTER WITH ALL-CHANNEL GAIN IN EXCESS OF 18 db.**

and only **\$39.50** LIST

**THE NEW B-T BOOSTER**  
 MODEL HA-3 Fully Automatic  
 DESIGNED FOR BETTER TELEVISION

What John wanted most and found hard to get, Was a booster what boosted, with no knobs to set.

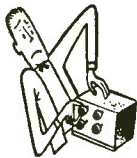

"Knobs," he complained, "makes tuning more tough," And, "Lord knows", he cried, "My set has enough."

"And who needs more boxes to clutter the house? There's enough work around for me and my spouse."



"You'd laugh if I cranked my car like we useter, So why have old-fashioned knobs on a booster?"

But, John had a Tech-man who knew his TV Who showed John the booster made by B-T.



At last, John is happy, and more so to learn That the booster is hidden and no knobs to turn.

- NO knobs to set.
- NO channel tuning.
- NO band-switching.

Lower noise factor. Attractive hammertone steel cabinet.



**BLONDER-TONGUE LABORATORIES, INC.**  
 WESTFIELD, NEW JERSEY

## SIMPLIFIED REMOTE CONTROL FOR TRANSMITTERS

By LYMAN E. GRAY

One of the problems involved in planning a new base station for communicating with mobile units is whether or not to install the transmitter at the point of operation. Naturally, the cost of a remote-control unit bears heavily on the final decision. Most factory-built remotes include an audio amplifier and power supply, and require 80-100 volts for relay operation. They are fairly expensive, and if frequencies are changed or a different type of transmitter added, the special remote control unit may be useless, and has practically no resale value.

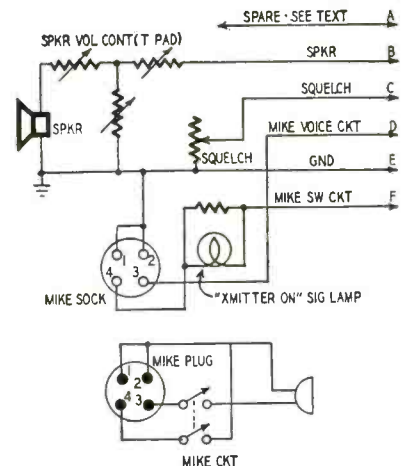

Fig. 1—Wiring diagram of operator's remote-control unit. Mike switch permits control from more than one point.

If the transmitter and operating point are in the same building, or not more than half a mile apart, this remote-control unit will serve dependably, and can be built for very little money. It has no tubes or power supply, and carries only a very small voltage at any time.

The unit requires three pairs of No. 14 wire (6 wires) between the operating point and the transmitter. Use plastic-insulated wire if the lines are to be run in conduit.

The operator's control unit (Fig. 1) contains a speaker volume control, squelch control, pilot lamp (required by the FCC to show when transmitter is on), and a four-contact microphone receptacle. (The resistor across the lamp allows transmitter to operate if pilot lamp fails. Value of resistor is not critical because lamp need not glow at full brilliance.) The d.p.s.t. "push-to-talk" switch in the mike circuit allows several of these units to control the same transmitter. (If an s.p.s.t. mike switch were used all the microphones would be in parallel.) The squelch controls will be in parallel when more than one control unit is on, but by careful selection of the values for these controls, two or





Now Available!

# TELL-A-FAULT

## The Troubleshooter's Troubleshooting Service

The first issue of TELL-A-FAULT, Rider's completely new troubleshooting service, has been sent to all subscribers. There's still time for you to receive the big first issue of troubleshooting information — but you must hurry as the supply is limited.

Nothing like TELL-A-FAULT has ever before been attempted in the servicing industry. It is practical information for the practical man. No theory!

Specifically, TELL-A-FAULT deals with the troubleshooting (symptoms and cures) of all types of television receivers — also radio receivers, record changers, and recorders. Special emphasis, however, is given to television.

This quadruple-threat service consists of:

- (1) time-saving pictorial, symptom and cure sheets
- (2) circuit guides
- (3) servicing-technique short cuts
- (4) the usage of all sorts of test equipment

You profit by the experience of experts who are working daily in the Rider service laboratory. They analyze receiver symptoms and determine the faults and cures. TELL-A-FAULT saves you many hours of profit-consuming diagnosis time.

During the course of a year you receive between 768 and 1,152 symptom pictures (between 64 and 96 pictures each month) plus circuit guides, servicing short cuts, and information on how to use test equipment.

TELL-A-FAULT will save you hours of time! As few as one or two symptom sheets can save you enough time to pay for the entire year's cost of the service.

The entire service costs you less than twenty cents a week! You receive a full 12 month's TELL-A-FAULT for only \$10.00.

Become a charter subscriber to the TELL-A-FAULT service. Start with the very first issue!

Write today for complete information on the most unique SERVICE ever made available to TV-radio service technicians.

### TELL-A-FAULT

does your troubleshooting for you!



**JOHN F. RIDER**

PUBLISHER, INC.  
480 Canal St., N. Y. 13, N. Y.

more units can be operated simultaneously without difficulty. (If the line voltage is stable and local noise is low, the squelch control can usually be eliminated.)

The transmitter junction box (Fig. 2) is merely a multi-contact switch for changing over from local to remote operation. The schematic is self-explanatory except for Line A. This line is not needed where the transmitter is on the air at all times, but should be installed

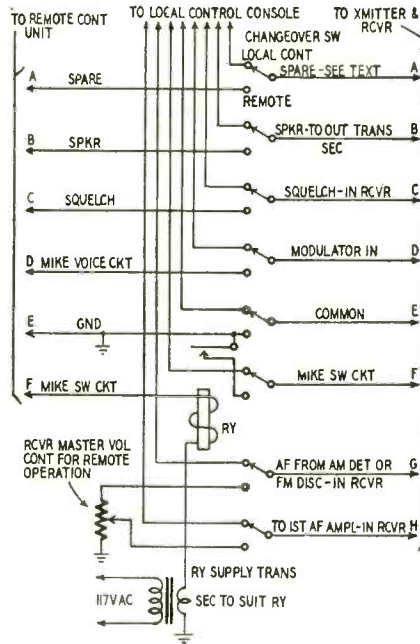

Fig. 2—Transmitter-room junction box.

as a spare. (It can be used to operate a "standby" pilot light.) If the transmitter is to be turned on and off from the operating point a relay similar to the one in the microphone circuit can be connected to line A. The relay contacts would connect to the power-control relay in the transmitter.

The transformer should supply the operating voltage required by whatever relays you have on hand, or decide to use. (The replacement problem is simplified if these are the same type as those used in the transmitter.) A volume control is included in the junction box to limit the audio feed to the monitor. It should have the same value as the input control in the monitor amplifier. END

### M.D.'s ASSAIL HORROR SHOWS

Doctors say many TV and radio programs menace children's health. An editorial in the *Journal* of the American Medical Association cited a survey of 153 children to show the effects of crime and horror films and radio programs. 76% became highly nervous, 85% suffered sleep disturbances, and fears were multiplied 500% in almost every child. The editorial warned the television industry to forestall possible government censorship by eliminating from its programs anything even potentially dangerous to the health of the nation's children.

## November Special! SNYDER TV ANTENNAS Your Choice!

**3.95 each**  
2.95 in lots of 6

Reg. \$4.95  
**CONICAL ARRAY**

8 hi-tensile 3/16" aluminum alloy elements. Heavy duty molded bakelite insulators. Heavy steel cadmium plated hardware. All channels. Snyder model XA-44 less masts.

Reg. \$4.95  
**DOUBLE V TV ARRAY**

Reg. \$4.39  
**Hi-Lo Array**

Hi-gain for fringe areas. 4 hi-tensile 3/16" aluminum alloy elements. 2 aluminum alloy 1/2" crossarms. Completely pre-assembled. Model AR-55 less mast. 2 folded dipoles (hi & lo) with reflectors. The best all channel folded dipole anywhere near this exceptionally low price. AR-21 less mast.

Address Orders To Dept. RE-11  
Write For Free F.Y.I. Flyer

# WHOLESALE RADIO PARTS CO., Inc.

311 W. Baltimore St.  
**BALTIMORE 1, MD.**

## GREYLOCK 1953 CATALOG

AN ESSENTIAL BUYING GUIDE for every RADIO & TV SERVICEMAN!

- featuring:
- GREYLOCK TUBES, at new low prices!
  - STANDARD BRAND TUBES, tremendous values!
  - COMPLETE STOCKS OF STANDARD BRAND LINES

including:

<b>INSTRUMENTS</b> EICO Jackson EMC Oak Ridge	<b>BOOKS</b> Howard Sams Rider Coyne Editors & Engineers	<b>OTHER TOP BRANDS</b> C.D. Vibrators, Converters, Antenna Rotators Merit Transformers Sprague Condensers Stanwyck Coils GE Lamps Reconal Needles Shure Microphones RMS Antennas, Accessories Electrovoice Burgess Batteries Quam-Nichols Speakers Regency Boosters
<b>HARDWARE, TOOLS</b> ICA Walsco Jackson Irons Phillips Guns X-celite Eby Mueller	<b>RADIOS, SOUND EQUIPMENT</b> Pentron Bogen Challenger Atlas Sound Steelman Phones Gen'l Industries Esquire Clock Radios	

**GREYLOCK** ELECTRONICS SUPPLY CO.  
115 Liberty St., N. Y. 6  
Phone BE. 3-0224

GREYLOCK ELECTRONICS, Dept. C-11  
115 Liberty St., N. Y. 6

Send FREE Catalog #200 at once to

Name .....

Address .....

City..... State .....



## Sangamo's dry tubular electrolytic capacitor *that fits anywhere*

Type MT and MTD electrolytic capacitors, "Chieftains" of the Sangamo line, are built to provide longer life, greater dependability, and better electrical characteristics in television and other electronic applications. Their small physical size makes them a "natural" for application in tight spots beneath a chassis, and the bare tinned-copper wire leads make them easy to mount.

Sangamo "Chieftains" are contained in hermetically-sealed round aluminum cans and are tightly encased in heavy cardboard sleeves on which polarity is clearly indicated. Double, pure paper spacers assure adequate breakdown characteristics

and all sections are tightly held in place within the container. Multiple staking connects the terminal tabs to the electrodes, providing permanent low resistance contact throughout the life of the capacitor. The low voltage units are supplied with etched cathodes to maintain uniform capacity when the capacitor is subjected to heat and high ripple currents.

"Chieftains" are manufactured under controlled conditions of almost surgical cleanliness, utilizing the very finest materials and production procedures available in the industry, for your assurance of quality in every respect.

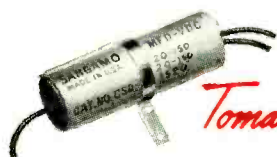

*Tomahawk*



*Warrior*



*Mohican*

Your own trial-use will convince you that new standards of dependability and longevity have been built into Sangamo Electrolytics. Order from the new Sangamo Capacitor Catalog No. 800A which is yours for the asking, and without obligation.

*Those who know*

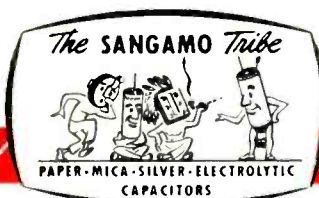

*...choose Sangamo*

# SANGAMO ELECTRIC COMPANY

MARION, ILLINOIS



For accurate  
flexible and  
quick tube  
testing at  
low cost...  
model 3413-A

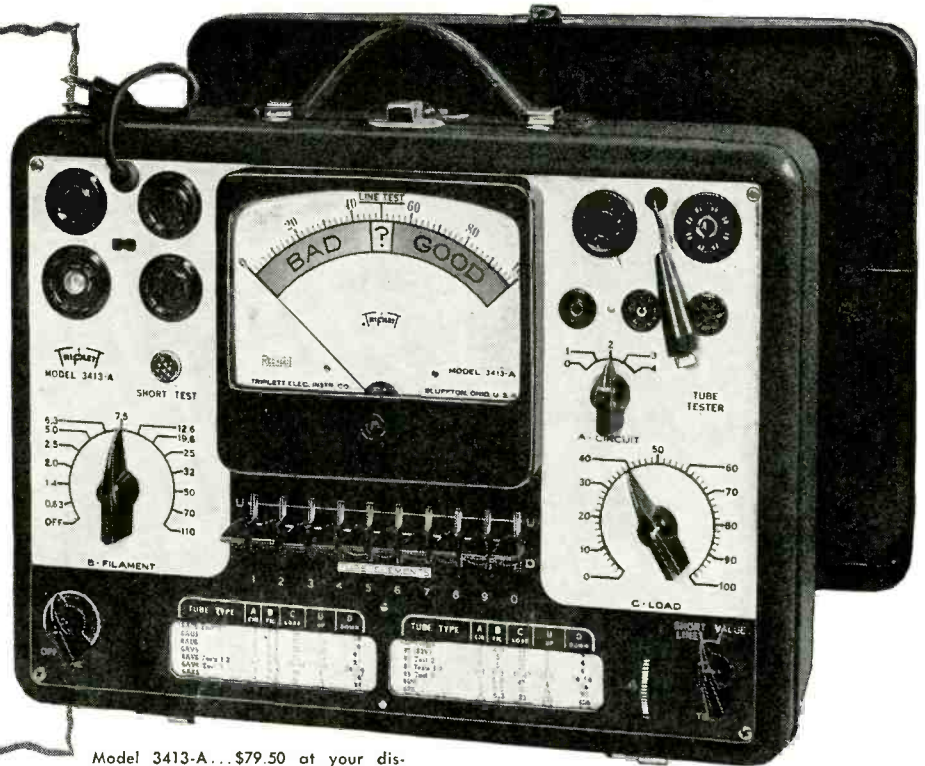

Model 3413-A... \$79.50 at your distributor. (Price subject to change.) BV Adapter, \$7.90 Add'l.

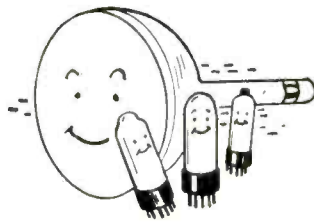

1. YOU CAN TEST MORE TYPES of tubes, also appliances for shorts and open circuits.

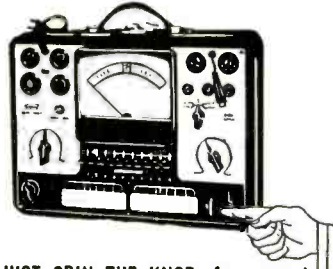

2. JUST SPIN THE KNOB—for correct, last-minute data, on the speed roll chart. Lists 700 tubes.

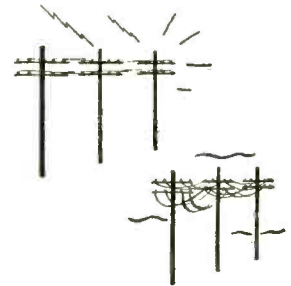

3. YOU CAN COMPENSATE for line voltage—just throw snap-action switch.

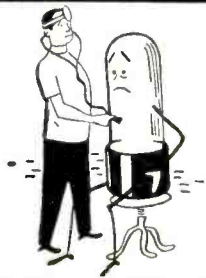

4. YOU CAN TEST EACH ELEMENT in each tube—by a simple flip of the switch.



5. YOU CAN TEST THE NEW TUBES—including those with low cathode current.



6. YOU GET NEW TUBE DATA—immediately, while it is still news. No waiting.

Nearly Half a Century of Service to the Service Man

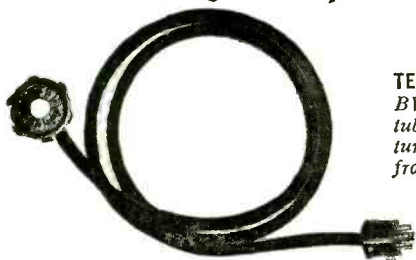

TESTS PICTURE TUBES, TOO! With this BV Adapter, Model 3413-A tests every tube in a TV receiver, including the Picture Tube—without even removing tube from receiver or carton! Saves time!

FOR THE MAN WHO TAKES PRIDE IN HIS WORK

# Triplet

TRIPLET ELECTRICAL INSTRUMENT CO. BLUFFTON, OHIO, U.S.A.

# BUILD 15 RADIOS WITH THE PROGRESSIVE RADIO "EDU-KIT"

This is a practical home radio course! No radio experience is needed. You start learning a simple radio circuit and advance as quickly as you wish. You build RECEIVERS, TRANSMITTERS, AMPLIFIERS, CODE OSCILLATOR, SIGNAL TRACER. All parts and instructions are included and clearly explained.

### ALL PARTS ARE INCLUDED!

The Progressive Radio "Edu-Kit" contains all parts necessary to build 15 different radios including tubes, paper condensers, mica condensers, electrolytic condensers, variable condensers, selenium rectifiers, chassis, hardware, tie strips, tube sockets, solder, wire, soldering iron, tubing, coils, instruction book, radio tester, etc.; in brief, everything you need in a practical radio course. The Progressive Radio "Edu-Kit" requires no instructor. All instructions are included. All parts are individually boxed and identified by name,

photograph and diagram. Every step involved in building these sets is carefully explained. You cannot make a mistake.

Nothing extra to buy . . . nothing to return . . . you keep everything! You can quickly pay for kit by repairing radios. Think of it — the signal tracer alone is worth more than the small cost of this kit!

### WHAT "EDU-KIT" BUYERS SAY!

"I can assure you that it is a wonderful kit and good value" C. J. Benadie, Newton Road, Beaconfield, Kimberley, South Africa: "I am very satisfied with the "Edu-Kit" Dominic Stracuzza, 111 Clarence St., London, Ont. Canada: "I received my Progressive "Edu-Kit" and I want to let you know that I am very pleased with it" F. B. Hartman, 290 Westminster St., Providence, R. I.: "This morning I was showing my Progressive Radio "Edu-Kit" to one of our representatives from our office in Richmond, and, already he wants me to purchase some for his hospital's" Veterans Administration, Physical Medicine Rehabilitation Service, Washington, D. C.: "I received one of your Radio "Edu-Kits" and I am happy to report that my ten-year-old boy, with very little supervision, built a complete three-tube receiver - one that works - in less than three hours" Bill Leonard, C.B.S. Radio, New York, N. Y.

**FREE RADIO TESTER . T. V. BOOK  
QUIZES . SOLDERING IRON  
MEMBERSHIP IN RADIO AND T. V. CLUB**

FREE Radio and T.V. Trouble-shooting Guide sent when you ask for complete information OR rush us your order and you get FREE valuable Surprise Gift Package in addition to Radio and T.V. Trouble-shooting Guide. Write today!

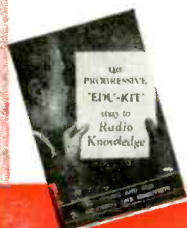

POSTAGE PREPAID ON CASH ORDERS  
-C.O.D. ORDERS ACCEPTED IN U.S.A.

*Now anyone can*

# LEARN RADIO

*at Home*



**NO PREVIOUS  
TRAINING**

**NEEDED... EXCELLENT  
BACKGROUND FOR T. V.**

Specifically prepared for any person with the desire to learn radio, it has been successfully used by young and old. It is unnecessary to have even the slightest background in science or radio. The Progressive Radio "Edu-Kit" is used by many Radio Schools & Clubs in this country and abroad. It is used by the Veterans Administration for Vocational Guidance and Training.

*You risk nothing -*  
**10 DAY MONEY-BACK GUARANTEE**

**BUILD 15 RADIOS**  
*Only*  
**\$ 19.95**  
**COMPLETE**

**PROGRESSIVE ELECTRONICS CO.**  
497 UNION AVE. RE-65 BROOKLYN 11, NEW YORK



# CONCORD *Presents* RCP

## RADIO CITY PRODUCTS

'FIRST WITH THE FINEST' IN

# TEST EQUIPMENT



### At Last! A Complete "Do-All" TV Generator

**MODEL 740.** One compact, efficient instrument giving the performance of several high-priced TV service instruments.

**IT'S A SIGNAL GENERATOR**

Modulated or unmodulated carrier signal covering every VHF TV channel. Add every FM band—ALL ON FUNDAMENTALS.

**A MARKER GENERATOR**

1/10th of 1% on 0-11 Mc. Better than 1/2 of 1% overall. Perfect for alignment.

**AN AUDIO GENERATOR**

Supplies 540 cps signal at the audio output.

**A PATTERN GENERATOR**

Horizontal or vertical bars or cross-hatch.

**RANGE:** 0-220 MC with skips, all on fundamentals.  
**MODULATION:** Both 540 cps and 220.5 Kc provided.  
**TUNING:** Dial continuously calibrated thru 340 Mc. Each TV channel precisely spotted on dial.

Handsome metal cabinet with new rugged construction. Size 10x6x8". Weight 8 lbs. . . . Net

**\$69.50**

### TV - RADIO - CRT TUBE TESTER & VTVM

ALL IN ONE UNIT:

- A Tube Tester
- A CRT Reactivator
- A VTVM (AC & DC)
- AN Ohmmeter

**THE TUBE TESTER:** All of the features of the famous 323 Dynoptimum free point tube tester. Tests all modern tubes.

**THE CRT TESTER:** Will check all magnetic deflection type Television Picture tubes.

**THE REACTIVATOR:** Revives and reactivates many otherwise Dim or Bad Television CRTS.

**THE VTVM:**—17 range balanced bridge type VTVM. Input imp. 25 Megohms. Zero center scale for (discriminator alignment). AC, DC volts 0-1000 on 5 scales. Oh. — 20 to + 62 on 5 scales.

**THE OHMMETER:** 2 ohms to 1000 Megs on 5 Ranges. Ideal for checking condenser leakage or shorts.

Hand-rubbed oak carrying case with leads, probe, batteries, etc.—12 1/2 x 12 3/4 x 4 1/2" — wt. 12 1/2 lbs.

**MODEL 808**—Complete . . . . . Net \$99.95

High Voltage probe for above. Extends range to 30,000 V on VTVM. Net \$8.95

**MODEL MVPM-1**



**\$99.95**



### "Mighty Midget" MIDGETSCOPE MODEL 533M

A truly miniaturized professional oscilloscope for maximum operational convenience.

**FEATURING:** High sensitivity; wide-band response; light in weight and small in size; all controls on front panel below the screen; operates in horizontal or vertical position; CRT tilted for best angle viewing; shielded CRT with protective bezel and graph screen.

**Specifications:**  
 Sensitivity—Vertical: .02 Volts per 1" rms. Horizontal: .06 Volts per 11" rms.

Frequency Response—2 db. from 20 cps. to 150 Kc. Excellent Transient Response.

Push-Pull Deflection—For undistorted response.

Input Impedance—Vertical: 5 Megohms shunted by 50 MMF. Horizontal: 1 Megohm shunted by 70 MMF.

Tubes—12AT7, 12AU7, 6J6, 117Z6, 3MP1 CRT.

**\$99.50**

In metal case with etched panel. Fuse protected. 105-125V AC—1 1/2" x 7 1/4" x 5 1/2". Wt. 9 lbs. Model 533M—Complete, ready to operate. . . . Net \$99.50

**VALUES GALORE!**

- RADIO
- TELEVISION
- ELECTRONIC BUYER'S GUIDE

**CONCORD RADIO**

Send TODAY for your

**FREE COPY**

of our latest Buyer's Guide.

**CONCORD RADIO**

55 VESEY ST. - NEW YORK 7, N.Y.

Phone DLgby 9-1132

### RCP's SERVISHOP

Equal to a Complete Service Shop



- Tube Tester
- Condenser Tester
- Set Tester
- AM Generator
- FM Generator
- AF Generator

**MODEL 8773**— Complete with tubes, batteries and test leads, output leads, etc.—housed in beautiful natural finish oak case. Weight 18 lbs. Overall size 16 1/2 x 12 3/4 x 5 1/2". An outstanding value at

**\$99.95** Net

**At last!** An up-to-date tube tester for testing modern, miniature, novel base and sub-miniature tubes with the new, speedy Rollindex Roll Chart—combined with a complete multimeter measuring AC and DC volts—DC milliamperes and amperes—ohms and megohms, decibels and output volts and also a condenser tester, AM signal generator, FM signal generator and audio oscillator.

**CONCORD RADIO Dept. C-11**  
 55 Vesey Street, New York 7

- Please send at once:
- FREE COPY of your latest BUYER'S GUIDE.
  - Model 740 RCP TV Generator. . . . . \$69.50
  - Model 808 RCP CRT Tester & VTVM . . . . . \$99.95
  - Model 533M RCP Midgetscope. . . . . \$99.50
  - Model 8773 RCP Servishop. . . . . \$99.95
- Check in full, or 20% deposit enclosed.

NAME .....

ADDRESS .....

CITY ..... STATE .....

### SCREEN-METAL CHASSIS FOR FAST TEST SETUPS

By R. F. SCHWARTZ

Punched steel screening makes ideal breadboards for experimental work. The type used by the writer is 1/16 inch thick with 1/8 by 1-inch slots. This material is inexpensive and has the great advantage that almost any parts can be mounted quickly without additional drilling. This makes it easy to change parts whenever you wish, and the same chassis can be used over and over. These 1/8-inch slots will clear No. 4 machine screws. (They can be enlarged, of course, with a file or a tapered reamer to take larger sizes.) No. 6 sheet-metal screws (Parker-Kalon type Z or equivalent) fit the slots without enlargement, eliminate the need for nuts and lock-washers, and will hold almost anything well enough for experimental purposes. Holes for potentiometers and for socket-punch pilots can be reamed or drilled. Hand-drilling is difficult, but a drill press or electric hand drill can be used if the piece is clamped firmly.

Two of these chassis are shown in the photo. The one on the left is a video pre-amplifier; the other is a laboratory breadboard fitted with five tube sockets and potentiometers. The tapered reamer in the foreground is used for enlarging holes when necessary. Both pieces were finished by painting. Cadmium- or zinc-plated screening can be used where soldering to the chassis is required.

At higher frequencies the slots may create long inductive paths for ground currents. A copper ground strip or bus should be used in such cases.

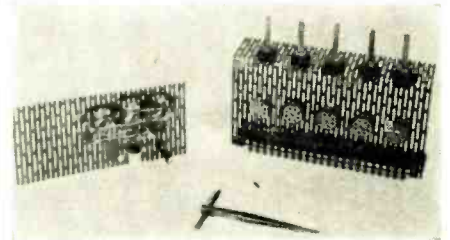

On the basis of \$30.40 for a sheet of screening 36 x 96 inches, a 10 x 5 x 2-inch chassis costs about 85 cents. This screening is also very useful in experimental work on large equipment. Whenever additional parts or meters are needed in some circuit you can make mounting brackets or subchassis in very little time with simple tools. Three-eighth-inch strips of the screening, sheared in the direction of the slots, make fine capacitor clamps.

(At least one manufacturer has brought out this type of chassis in commercial form. *Electro Manufacturer's Corp.*, 2105 Ludlow St., Philadelphia 3, Pa., makes a 13 x 8 1/2 x 3-inch perforated steel chassis base, and a variety of matching aluminum brackets prepunched for standard tube sockets, potentiometers, toggle switches, fuse posts, and meters.—Editor) END

RADIO-ELECTRONICS



A Guiding Beacon For  
Quality Electronic Parts



Your Local  
**RADIART**  
Distributor



**RADIART Sales Offices Across The Nation**



**These Are The Cities With RADIART Distributors  
In CANADA**

**Ontario**

- BELLEVILLE
- GUELPH
- HAMILTON
- KITCHENER
- LONDON
- NIAGARA FALLS
- NORTH BAY
- OTTAWA
- ST. CATHERINE'S
- TORONTO
- WINDSOR

**Quebec**

- MONTREAL
- QUEBEC
- SHERBROOKE

**Nova Scotia**

- HALIFAX
- KENTVILLE

**Newfoundland**

- ST. JOHN'S

**Saskatchewan**

- REGINA

**New Brunswick**

- ST. JOHN
- WOODSTOCK

**Alberta**

- CALGARY

**Manitoba**

- WINNIPEG

**BUY OF THE MONTH**



The CDR ROTOR... model TR-12 offers all you could ask for in an antenna turning device! It will support and turn with ease any TV antenna array...and has a handsome modern design plastic cabinet with meter control dial and finger-tip lever. Other features include speedy installation with no loose parts to assemble... 4 wire cable installation... quick mounting antenna mast collet and is dependable and trouble free in operation. See them at your jobber or write for literature.

**FOR NAME OF YOUR NEAREST RADIART DISTRIBUTOR**

USE COUPON BELOW

**RADIART SALES CO., 1926 Gerrard Street, East Toronto, Canada**

..... Please send names of the Radiart Distributors in my area stocking the following Radiart products in which I am interested:  C-D-R Rotors,  Vibrators,  TV and FM Antennas,  "Spee-Dee" Chimney Mounts,  Lightning Arresters,  Auto Aerials,  Power Supplies

..... Please have a Radiart Distributor call on me.

Name .....

Address .....

City..... State.....



**THE RADIART CORPORATION CLEVELAND 2, OHIO**

VIBRATORS • AUTO AERIALS • TV ANTENNAS • ROTORS • POWER SUPPLIES



# Your most valuable business asset is a SATISFIED CUSTOMER!

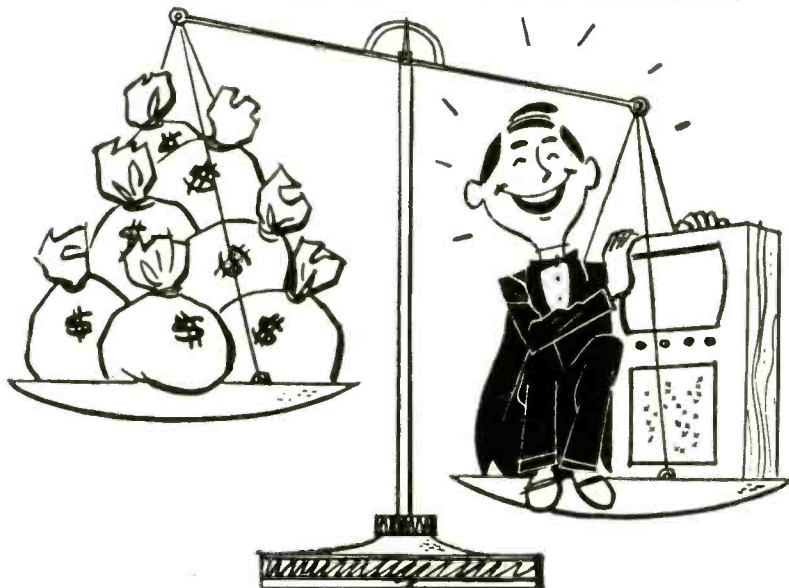

## insure customer good will with DEPENDABLE OHMITE RESISTANCE UNITS

Don't endanger your business reputation by using "just-as-good" replacement parts. Protect customer good will with OHMITE resistance units—known the world over for dependability.

Servicemen, amateurs, and engineers everywhere agree that these quality components provide extra reliability and long life. Insist on OHMITE resistance units... it's good business!

**OHMITE MANUFACTURING COMPANY, 4895 Flournoy St., Chicago 44, Ill.**

Send for stock catalog

Be Right with... **OHMITE**®

RHEOSTATS • RESISTORS • TAP SWITCHES

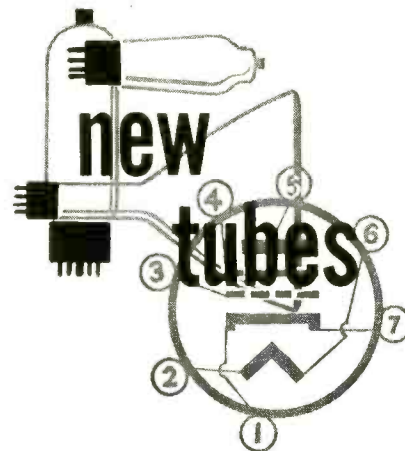

RCA has announced the 6AX4-GT, a half-wave, high-vacuum, heater-cathode rectifier for use as a damper tube in TV receivers. The 6AX4-GT has improved insulation to withstand negative peak pulses of as much as 4,000 volts between heater and cathode, with a d.c. component up to 900 volts. Basing is shown in the diagram below.

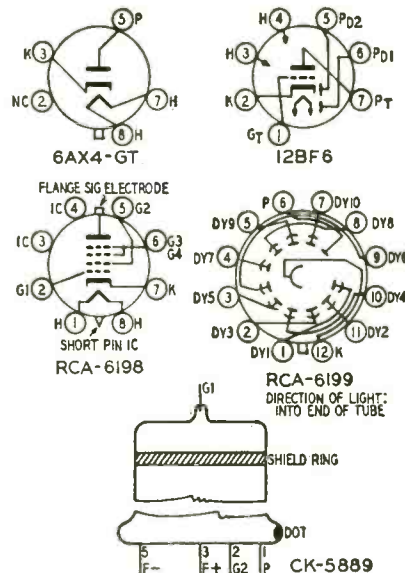

Type 12BF6 was also announced by RCA. This is a miniature duo-diode-medium-mu-triode designed for automotive equipment operating from 12.6-volt batteries. Except for its heater rating of 12.6 volts, 150 ma, the 12BF6 has the same characteristics and basing (shown above) as the older 6BF6.

The G-E 27EP4 is a magnetic-focus, magnetic-deflection, all-glass rectangular picture tube. An aluminized backing

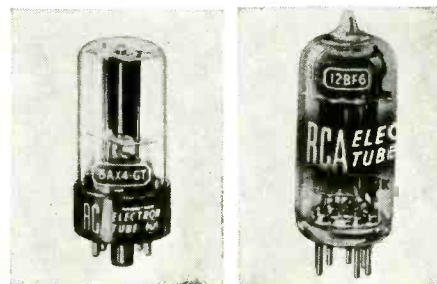

# Now... at Your PHILCO Distributor



## The New TV Test Equipment You Need!



Yes, at low cost, your Philco distributor offers a full selection of up-to-the-minute test equipment designed for TV service and installation. Stop in and see it. Ask for a demonstration. No obligation at all.

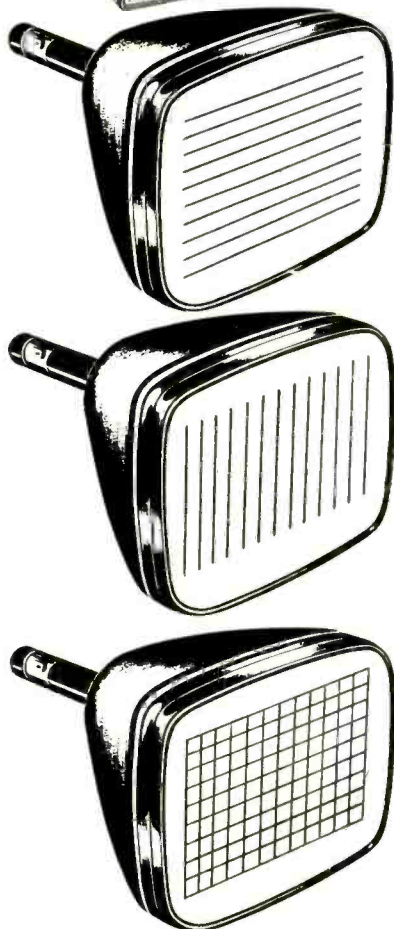

### TV Linearity Pattern Generator

No need to wait for a station test pattern. With this equipment you generate your own pattern on the screen... horizontal, vertical or crosshatch... and thus make all routine adjustments. Uses 105-125 volt, 60 cycle power supply. Crystal control line frequency oscillator. 100-6,000 MV output voltage. 50 ohm output impedance. Matches 72 or 300 ohm inputs.

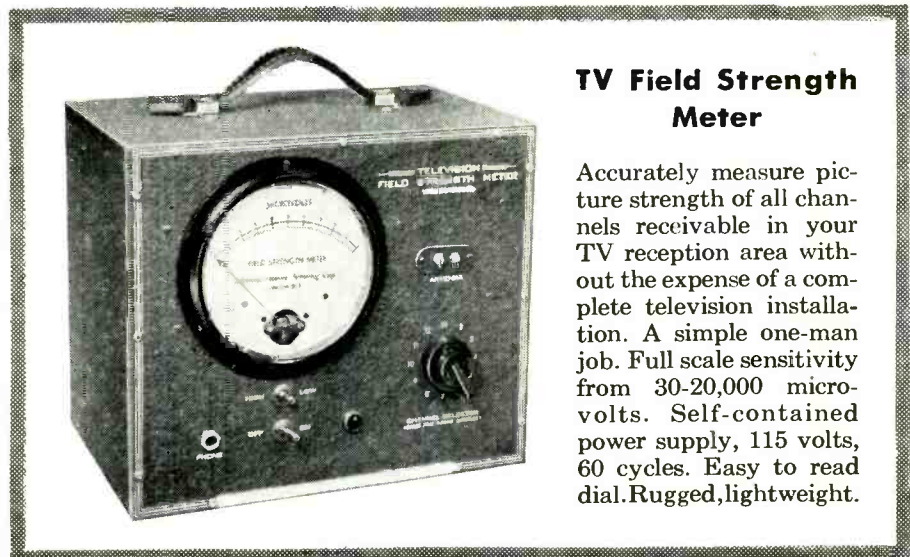

### TV Field Strength Meter

Accurately measure picture strength of all channels receivable in your TV reception area without the expense of a complete television installation. A simple one-man job. Full scale sensitivity from 30-20,000 microvolts. Self-contained power supply, 115 volts, 60 cycles. Easy to read dial. Rugged, lightweight.



# NOW YOU'LL Really Know How to Use 'Scopes!



Don't let the oscilloscope "stump" you! Learn to use it fully on all sorts of jobs—and watch your efficiency soar!

## MODERN OSCILLOSCOPES AND THEIR USES

BY JACOB H. RUITER, Jr.  
of Allen B. DuMont Laboratories, Inc.  
326 pages, 370 illustrations, \$6.00

Here at last is a book that makes it easy for you to become expert in the many uses of the greatest, most versatile service instrument of all—the oscilloscope! It contains no involved mathematics. First, the author explains oscilloscopes fully—then gets right down to earth in telling exactly how to use them on AM, FM and TV service work . . . from locating receiver troubles to aligning and adjusting the most complicated circuits.

### HOW THEY WORK

Expert knowledge of oscilloscopes helps you work faster, far more accurately and more profitably on all sorts of service and laboratory jobs. Basic subjects covered include:  
1—Introduction to Oscilloscopes; 2—History of the Oscillograph; 3—Development of the Cathode Ray Tube; 4—Principles of Cathode Ray Tube Operation; 5—Details of the Modern Cathode Ray Tube; 6—The General-Purpose Oscilloscope; 7—Power-Supply Circuits; 8—Amplifiers, Attenuators and Positioning Circuits; 9—Time-Base Circuits.

### HOW TO USE OSCILLOSCOPES ON ALL TYPES OF JOBS

Each operation is carefully explained including the making of connections, adjustment of circuit components, setting the oscilloscope controls and analyzing patterns. About 400 illustrations including dozens of pattern photos make things doubly clear. Here are the specific how-to-do-it subjects covered: 10—Operation; 11—Interpretation of Basic Patterns; 12—Auxiliary Equipment; 13—Typical Applications in Electronics; 14—Servicing A-M Receivers; 15—Servicing F-M Receivers; 16—Television Receiver Servicing; 17—Use of the Radio Transmitter; 18—Using the Oscilloscope in Teaching; 19—Additional Industrial Uses; 20—Photographing Cathode Ray Tube Patterns; (a) Glossary. **Send coupon today!**

### READ IT 10 DAYS . . . at our risk!

Dept. RE-1125, RINEHART BOOKS, Inc.  
Technical Division,  
232 Madison Avenue, New York 16, N. Y.

Send MODERN OSCILLOSCOPES AND THEIR USES for 10-DAY FREE EXAMINATION. If book is satisfactory, I will then send you \$6.00 promptly in full payment. If not, I will return book postpaid in good condition and owe you nothing.

Name.....

Address.....

City, Zone, State.....

Employers' Name and Address.....

Price outside U.S.A. \$6.50, cash only.  
Money back if you return book within 10 days.

reflects light emitted from the inner surface of the screen, providing a picture up to 100% brighter than a non-aluminized 27-inch tube operated at the same voltage, and increasing the contrast range.

The 27EP4 provides a 24 x 18½-inch picture. Overall length is less than 23 inches, about one inch shorter than the



G-E 24AP4 introduced in 1950. The space saving is made possible by use of a 90-degree diagonal deflecting angle.

Recommended operating conditions for the 27EP4: Ultor, 16,000 volts; grid No. 2, 300 volts; grid No. 1, -33 to -77 volts; ion-trap field intensity, 38 gausses. The 27EP4 has a standard 5-pin duodecal base.

### Transmitting types

The RCA Tube Department has announced the 6198 Vidicon, a small TV camera tube for industrial television applications.

Utilizing a photoconductive layer as its light-sensitive element, this new camera tube has a sensitivity which permits televising scenes with 100 to 200 foot-candles of incident illumination. The photoconductive layer has a spectral response similar to the human eye.

The 6198 provides 400-line resolution, uses magnetic focus and deflection, and operates at relatively low d.c. voltages.

Only about 1 inch in diameter and 6¼ inches in length, the 6198 lends itself to use in light-weight, compact television cameras, and simplifies the design of associated equipment. The size and location of the photoconductive layer permit a wide choice of commercially available lenses.

A special deflecting yoke, focusing coil, alignment coil, horizontal-deflection output transformer, and vertical-deflection output transformer for the 6198 will be available from the RCA Tube Department.

The new Vidicon has a special 8-pin ditetrap base. Connections are shown in the accompanying diagram.

The General Electric GL-6017 is a

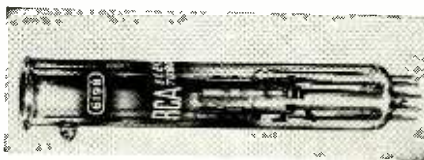

# 10-DAY TRIAL

OF THE BEST-PERFORMING LOW-PRICED, ALL CHANNEL ANTENNA ON THE MARKET!

THE FRINGE AREA

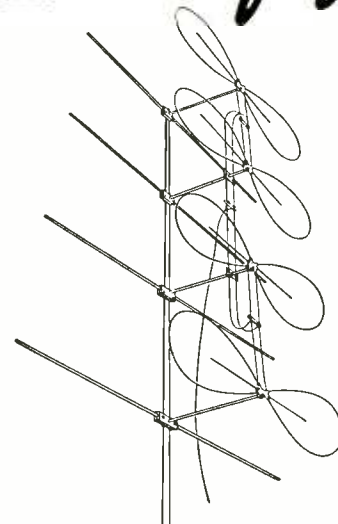

You can enjoy perfect long-range television reception for 10 days with a Fringe Area Butterfly — and it won't cost you a cent for its use.

To acquaint you with this outstanding new all-channel antenna, Tel-a-Ray will send you a Fringe Area Butterfly you can use for 10 days.

If you want to keep the Butterfly after 10 days, you may do so at a price of only \$29.95 (list price) for the four-bay array shown above. If not, send it right back.

Your only cost for using this matchless, long-range, all-channel antenna for 10 days is the shipping charge.

Give your family or customer TV reception at its best. Try a Butterfly! It's a Tel-a-Ray exclusive.

**TEL-A-RAY**  
ENTERPRISES, INC.  
HENDERSON, KY.  
RADIO-ELECTRONICS



## Your best picture tube and set tester ... an RCA VoltOhmyst\*

Save time and money—be sure—by pre-checking TV chassis and picture tubes in the home with an RCA "VoltOhmyst". Here's how . . .

Bringing your RCA "VoltOhmyst" into the customer's home on every service call is more than good psychology—it's good business—because the features of an RCA "VoltOhmyst" permit you to make a rapid and systematic check of the chassis as well as the picture tube—right in front of the customer.

Here's how you go about it (no picture or a dim picture, but sound okay):

1. Turn on set and visually check that picture-tube heater is lighted. Check adjustment of ion-trap and focusing magnets.
2. If picture-tube heater is not lighted, remove the socket from the tube and check heater continuity with "VoltOhmyst". Also check heater-to-cathode leakage.
3. Measure socket-terminal voltages to ground with "VoltOhmyst." Note action of Brightness Control on grid or cathode voltage.
4. Check for video voltage at grid or cathode ter-

\*Reg. U.S. Pat. Off.

minal of picture-tube socket with "VoltOhmyst" AC Probe.

5. Replace picture-tube socket and measure high voltage with WG-289 High-Voltage Probe. Note effect of Brightness Control on high voltage.
6. If high voltage is lower than normal, measure "B plus" and "boosted B plus" voltages with "VoltOhmyst" DC Probe. If B-plus voltage is normal and boosted B-plus voltage is low, try a new damper tube.
7. If "B plus" and "boosted B plus" voltages are both normal, try new tubes in the horizontal output, horizontal oscillator, and HV rectifier.
8. If none of these tests indicate the trouble, then it may be concluded that the picture tube is at fault.

These simple tests permit you to give the customer an immediate and positive diagnosis of the trouble . . . and in many cases, permit you to correct the fault on the spot. Most important—you know immediately whether a new picture tube is needed, or whether it will be necessary to take the chassis to the shop.



WG-289 High-Voltage Probe with WG-206 Multiplier resistor, \$9.95 Suggested User Price.

WV-77A Junior "VoltOhmyst," only \$47.50 Suggested User Price.

Only RCA makes the "VoltOhmyst"

RCA "VoltOhmysts" measure DC voltages in high-impedance circuits, *even with rf present*, without the ill effects of heavy circuit loading, regeneration, or frequency shift. They also measure AC over a wide frequency range, *even in the presence of DC* . . . and detect leakage resistances as high as 1000 megohms.

See the WV-77A and the WG-289 as well as the WV-87A and WV-97A "VoltOhmysts" at your local RCA Distributor, or write for bulletins to Commercial Engineering, Section Harrison, N. J.



**RADIO CORPORATION of AMERICA**  
TEST EQUIPMENT  
HARRISON, N. J.



*to the* **E. E. or PHYSICS GRADUATE**  
*with experience in*

**RADAR OR ELECTRONICS**

*Hughes Research and Development Laboratories,  
 one of the nation's large electronics organizations, is now  
 creating a number of new openings  
 in an important phase of its operation.*



*Here is what one of these positions offers you:*

**1. THE COMPANY**

Hughes Research and Development Laboratories is located in Southern California. We are presently engaged in the development of advanced radar devices, electronic computers and guided missiles.

**2. THE NEW OPENINGS**

The positions are for men who will serve as technical advisors to the companies and government agencies purchasing Hughes equipment. Your specific job would be to help insure the successful operation of our equipment in the field.

**3. THE TRAINING**

Upon joining our organization,

you will work in our Laboratories for several months until you are thoroughly familiar with the equipment you will later help the Services to understand and properly employ.

**4. WHERE YOU WORK**

After your period of training (at full pay), you may (1) remain with the company Laboratories in Southern California in an instruction or administrative capacity, (2) become the Hughes representative at a company where our equipment is being installed, or (3) be the Hughes representative at a military base in this country—

or overseas (single men only). Compensation is made for traveling and for moving household effects, and married men keep their families with them at all times.

**5. YOUR FUTURE**

You will gain all-around experience that will increase your value to the company as it further expands in the field of electronics. The next few years are certain to see a large-scale commercial employment of electronic systems—and your training in the most advanced electronic techniques now will qualify you for even more important positions then.

**HOW TO APPLY**

If you are under thirty-five years of age, and if you have an E. E. or Physics degree, with some experience in radar or electronics,

write to:

**HUGHES**

**RESEARCH AND DEVELOPMENT LABORATORIES**  
 Engineering Personnel Department  
 CULVER CITY, LOS ANGELES COUNTY, CALIFORNIA

*Assurance is required  
 that relocation of the applicant will not cause  
 disruption of an urgent military project.*

## New Design

forced-air cooled triode designed particularly for grounded-grid operation as a radio-frequency amplifier or oscillator.

The new tube is rated at 660 watts power output as a class-B amplifier in television transmitters and 1,100 watts output in class-C telegraphy service.



In television applications, it is particularly useful for operation on channels 7 to 13 (174-216 megacycles) but is rated for full output to 400 megacycles.

Maximum ratings for the tube as a radio-frequency power amplifier in class-B television service: d.c. plate current, 0.7 amp; plate input, 2,000 watts; plate dissipation, 1,000 watts.

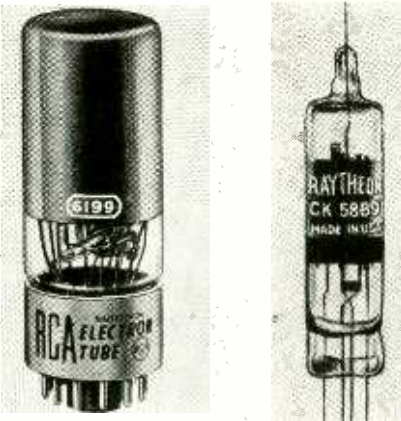

### Special types

The Raytheon type CK5889 is a sub-miniature pentode electrometer tube with a control-grid current rating of  $3 \times 10^{-15}$  amperes maximum. Minimum power is required by the 1.25-volt, 0.0075 amp filament. A permanently bonded conducting ring around the bulb may be grounded through a connecting clip to provide complete isolation of the grid lead, which is at the top of the tube.

Typical operating characteristics of the CK5889 are: Plate voltage, 12; screen voltage, 4; grid voltage, -2; amplification factor, 250; transconductance, 10  $\mu$ mhos; plate current, 4  $\mu$ amp; screen current, 4  $\mu$ amp; grid current,  $3 \times 10^{-15}$  amp maximum. The CK5889 may be operated as a triode (screen connected to plate). Flexible-lead connections are given in the basing diagram on the preceding page.

NOVEMBER, 1952

# THE SIMPSON MODEL 260 VOLT-OHM-MILLIAMMETER

*outsells all others combined  
because . . .*

- A** covers all ranges necessary for Radio and TV set testing
- B** includes the Simpson 50 Microampere Meter Movement known the world over for its ruggedness
- C** no bulky harness wiring, thus eliminating all intercircuit leakage at this high sensitivity
- D** molded recesses for resistors, batteries, etc.
- E** easy battery replacement
- all components — including case and panels — are specially designed and completely tooled for maximum utility . . . not merely assembled from stock parts

**ranges** 20,000 Ohms per Volt DC,  
1,000 Ohms per Volt AC  
Volts, AC and DC: 2.5, 10, 50,  
250, 1000, 5000  
Output: 2.5, 10, 50, 250, 1000  
Milliamperes, DC: 10, 100, 500  
Microamperes, DC: 100  
Amperes, DC: 10  
Decibels (5 ranges):  
-12 to +55 DB  
Ohms: 0-2000 (12 ohms  
center), 0-200,000 (1200 ohms  
center), 0-20 megohms  
(120,000 ohms center)

SIMPSON ELECTRIC COMPANY

5200 W. Kinzie St., Chicago 44 Phone COLumbus 1-1221

In Canada: Bach-Simpson, Ltd., London, Ont.

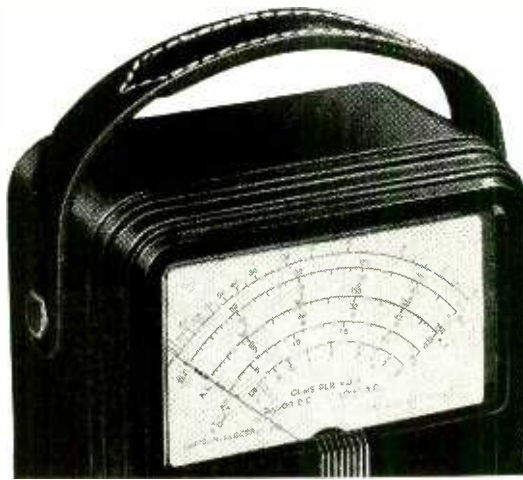

BURTON BROWNE ADVERTISING

### prices

Model 260 \$38.95;  
With Roll Top \$46.90.  
Complete with test  
leads and operator's  
manual. 25,000 volt  
DC Probe for use with  
Model 260, \$9.95.



## COLOR TONE TELEVISION!

ON YOUR TV

Simply attach TELECOLOR FILTER to front of set and enjoy programs in glorious color tones instead of dull black and white. GUARANTEED to give genuine color tone. Can also be used with any other filter. Once tried, you will never go back to old black and white. Write for FREE information. ORDER BY MAIL. NEW REDUCED PRICES!

Send check, M.O., cash, COD to Dept. RE 11

10 in. .... \$1	16, 17 in. .... \$3
12, 14 in. \$2	19, 21 in. .... \$5

**HARVARD LAB.** 459 FULTON ST. BROOKLYN 1, N.Y.

## 500 FORMULAS TO SUCCESS

MANY million dollar firms started with a single formula, for which they paid a big price. Here you have 500—no less—tried and tested formulas, recipes and processes for making things . . . all at the ridiculously low price of 25c. Here is your opportunity to start a business with but a few dollars' capital and with undreamed-of profits in prospect. You can also use these formulas in your own home to cut household expenses to the bone. Or you can put them to use in your workshop to cut costs as much as 100%. Quit paying out many dollars in profits to manufacturers, wholesalers, and dealers, when you can make the same thing yourself for a few cents. It's so easy when you follow our simple instructions.

66 PAGES, 47,000 WORDS IN TEXT  
Send for "500 FORMULAS AND RECIPES" today. Enclose 25c, that's all! You won't be asked for another cent now or later. Sold on a money-back guarantee.

**NATIONAL PLANS COMPANY**  
1966 Broadway, New York 23, N. Y.





# MONEY-SAVING OFFER

**ON THE TWO LATEST AND GREATEST  
GHIRARDI RADIO-TV SERVICE TRAINING BOOKS**

**... only \$12 for the 2-book set  
... 4 months to pay  
... 10-day examination privilege**

**THE  
BASIC  
"KNOW-HOW"  
OF MODERN  
CIRCUITS**



**COMPLETE  
TRAINING IN  
PROFESSIONAL  
SERVICE  
METHODS**

## RADIO AND TELEVISION RECEIVER CIRCUITRY AND OPERATION

Learn circuits fully—and watch service "headaches" disappear!

IT'S lots easier to repair any radio or TV set when you know all about its circuits and their peculiarities! You locate troubles faster. You work more efficiently. What's more, the basic knowledge contained in Ghirardi's *Radio & TV Receiver Circuitry and Operation* is ideal to help fit you for dozens of other radio-TV-electronic jobs.

Actually, there are only a few basic circuits—but each of these has many variations. You learn to recognize each of them instantly. You learn how to locate troubles in far less time and with a lot less testing.

### SPEEDS UP YOUR WORK ON TOUGH JOBS!

Here's what this great new book covers:—1-Amplitude Modulation; 2-Frequency Modulation; 3-RF Amplifiers and TRF Receivers; 4-AM Superhets; 5-AM Detectors and AVC Systems; 6-Push-Button Tuning and AFC Systems; 7-AF Amplifiers; 8-Loudspeakers; 9-Radio Power Supplies; 10-Television Receivers; 11-Phono Pickups and Record Players; 12-Automatic Record Changers; 13-Mechanical Construction of Receivers, etc.

Contains 688 pages, jam-packed with helpful servicing data. 417 illustrations help make circuits easy to learn. Price separately \$6.00.

See for yourself how much this book can help you! Use coupon for 10-day examination!



When you buy . . .

a Ghirardi technical training book, you KNOW you're getting the best—at the lowest possible cost. For over 20 years, Ghirardi books have been more widely used in schools, colleges, for military and naval radio training and for more home study than any other books of their kind!

## RADIO AND TELEVISION RECEIVER TROUBLESHOOTING AND REPAIR

The book that paves your way to better-paying service jobs!

FOR beginners, Ghirardi's *NEW Radio & TV Receiver TROUBLESHOOTING AND REPAIR* makes every phase of the work easy to understand. For experienced servicemen, it is a splendid way to "brush up" on specific types of work; to develop better troubleshooting techniques; or to find fast answers to problems.

Of particular importance, you learn all about modern test methods. Starting with quick analysis of common troubles, you then progress rapidly to "static" tests and "dynamic" signal tracing and signal injection techniques. Special problems in hard-to-fix sets are clearly explained. Step by step charts demonstrate professional servicing procedures almost at a glance.

### THE HOW-TO-DO-IT GUIDE TO MODERN SERVICING

Receiver alignment is made easier than you might have thought possible. Tuning problems, speaker troubles, components and their repair or replacement and dozens of other subjects are covered fully.

You learn to analyze TV patterns accurately; how to handle TV fading and propagation troubles; what to do about intermittent troubles—in short, everything the modern serviceman needs to know. Contains 820 pages, 419 illus.

Start training NOW for greater service efficiency, better jobs and higher profits!

Use coupon. Read this big book for 10 days before you decide whether or not to buy!

The RCA-6199 is a small, 10-stage multiplier phototube for scintillation counters and other applications involving low-level, large-area light sources. It is highly sensitive to the blue-rich light emitted by excited organic phosphors such as anthracene, and inorganic materials such as thallium-activated sodium iodide.

The 6199 has a semi-transparent cathode with a diameter of 1¼ inches on the inner surface of the face end of the bulb, a flat face 1 inch in diameter for mounting flat phosphor crystals in direct contact with the surface; and 10 electrostatically focused multiplying stages.

Because of the relatively large cathode area and excellent optical coupling between phosphor and cathode, the scintillation pulses are larger in amplitude than the majority of the dark-current pulses. END

### NOVEL CIRCUIT COOLER

Built-in refrigeration for high-temperature electronic equipment without moving parts is provided by the *Condor cooler*, a product of Condor Radio Mfg. Co. of Prescott, Ariz. A hermetically-sealed metal tube containing liquid refrigerant is mounted vertically with its base clamped, welded, or soldered to the component to be cooled. The refrigerant absorbs heat from the circuit, vaporizes, and condenses at the rela-



tively cool top of the tube. It returns as a liquid to the bottom, maintaining continuous cooling action. Ten times the heat conductivity of solid copper is claimed.

The cooler is available in stock lengths of 6, 9, and 12 inches, having equivalent heat dissipations of 10, 20, and 50 watts respectively. Special types can be furnished for incorporation in tube structures, power resistors, or potted circuit units. END



Suggested by  
Mill's Winebrenner  
Hollywood, Calif.

RADIO-ELECTRONICS

## 10-DAY EXAMINATION OFFER!

Dept. RE-112, Rinehart Books, Inc., Technical Division,  
232 Madison Ave., New York 16, New York

Send books checked below for 10-day examination. In 10 days, I will either remit price indicated in full or return books in good condition.

- Radio & TV Receiver Circuitry & Operation Price \$6.00
- Radio & TV Receiver Troubleshooting & Repair Price \$6.75
- COMBINATION OFFER—both books only \$12 (Regular price \$12.75—you save 75¢)

(Payable at the rate of \$3 after 10 days if you decide to keep books, and \$3 a month thereafter until total of \$12 is paid.)

Name .....

Address .....

City..... Zone..... State.....

Employer .....

OUTSIDE U.S.A.—\$7.25 for TROUBLESHOOTING & REPAIR; \$6.50 for CIRCUITRY & OPERATION; \$13.00 for BOTH books. Cash Only. Money refunded if you return books in 10 days.

# BIGGEST TV VALUES IN THE COUNTRY!

## #630 STANDARD TV KIT

THIS OFFER MAKES TV HISTORY... never ever so low a price, never ever such high quality... Quality and improvements in components that will enable the finished chassis to operate 10, 12 1/2 and certain 16" picture tubes... This STANDARD KIT consists of a complete set of parts, similar to those used in the famous RCA #630 29-tube chassis, including all tubes, speaker, resistors in correct 5%, 10%, 20% tolerances, the new Cascode Tuner and the Brooks LIFE-SIZE Instructions (less CRT & wire)

only... **\$93.78**

### SUPER DELUXE

## #630 TV BASIC PARTS KIT

- PUNCHED & DRILLED CHASSIS PAN
- BRACKET & SHIELD KIT (18 items)
- VIDEO & I.F. KIT (19 items)
- POWER TRANSFORMER #201T6
- VERTICAL OUTPUT TRANSFORMER
- VERTICAL BLOCKING TRANSFORMER
- FLYBACK TRANS #211T5
- FOCUS COIL, #202D2
- COSINE DEFL. YOKE 70°

**\$39.39**

Including LIFE-SIZE TV builder's instructions

## #630 TELEVISION PARTS

- RCA FRONT END TUNER, compl. w/tubes... \$22.49
- STANDARD CASCODE, compl. w/tubes... 22.49
- ESCUTCHEON PLATE, for either tuner... .69
- COMPLETE SET OF KNOBS, incl. decals... 1.34
- COMPLETE SET OF KNOBS, gold incl. decals... 2.49
- POWER TRANSFORMER, 295ma... 201T6... 9.97
- VERTICAL OUTPUT TRANS. 204T2... 2.69
- VERTICAL BLOCKING TRANS. 208T2... 1.32
- HORIZONTAL OUTPUT TRANS. 211T3... 2.98
- HORIZONTAL OUTPUT TRANS. 211T5... 3.98
- FOCUS COIL, 247 ohms, 202D1... 2.29
- FOCUS COIL, 470 ohms, 202D2... 3.42
- DEFLECTION YOKE, 60° 201D1... 2.97
- COSINE DEFLECTION YOKE, 70° 206D1... 3.98
- HORIZONTAL DISCRIM. TRANS. 208T8... 1.49
- FILTER CHOKE, 62 ohms... 1.47
- WIDTH CONTROL COIL, keyed AGC... .79
- ION TRAP BEAM BENDER, (single) 203D1... .79
- ION TRAP BEAM BENDER, (double) 203D3... .98
- AUDIO OUTPUT TRANSFORMER (6K6)... .69
- HV RECTIFIER, SOCKET ASSEMBLY, double... 1.37
- PUNCHED CHASSIS PAN, cadmium plated... 4.87



### INDOOR TV ANTENNA

- Newest, panorama high-gain type
- Brass 3-section chrome plated dipoles
- Absolutely tilt and tip-proof

list price \$5.95 special at **\$1.99**

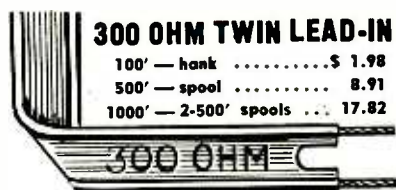

### 300 OHM TWIN LEAD-IN

- 100'—hank .....\$ 1.98
- 500'—spool ..... 8.91
- 1000'—2-500' spools... 17.82



### 72 OHM COAXIAL CABLE

- 100'—hank .....\$ 4.84
- 500'—spool ..... 22.99
- 1000'—2-500' spools... 43.86

## Brooks LIFE-SIZE Edition

#630 TV KIT BUILDER—SET OF INSTRUCTIONS BUILDING YOUR OWN #630 TV CHASSIS is now simplified with this COMPLETE SET OF BUILDING & WIRING INSTRUCTIONS. Covers all #630's, from the RCA 10" SET to the latest SUPER DELUXE 31-tube 16" to 24" RECEIVER.

EVERYTHING AT A GLANCE LAYOUT CHARTS show chassis and components in actual LIFE-SIZE with instructions alongside the illustrations.

GUESSWORK IS ELIMINATED by specially prepared SCHEMATIC DIAGRAMS, LOCATION GUIDANCE, CODE CHARTS, ALIGNMENT PROCEDURE and TOP AND BOTTOM PHOTOGRAPHS OF A COMPLETED CHASSIS (assembled from these instructions) clearly showing placement of each component.

Popular priced at only **\$2.49** Postpaid

## #630 PARTS • IN SETS

- VIDEO AND I.F. KIT, 19 items... \$7.84
- AGC KIT, complete with instructions... 4.59
- VARIABLE CONTROL KIT, 9 controls... 5.83
- CARBON RESISTOR KIT, 107 resistors... 6.98
- WIREWOUND RESISTOR KIT, 4 resistors... 2.31
- BRACKET AND SHIELD KIT, 18 items... 8.63
- ELECTROLYTIC CONDENSER KIT, 6 cond... 7.37
- TUBULAR CONDENSER KIT, 38 condensers... 4.28
- CERAMIC CONDENSER KIT, 28 condensers... 3.37
- MICA CONDENSER KIT, 11 condensers... 1.38
- COMPLETE SOCKET KIT, 25 sockets... 1.57
- TV WIRE & SOLDER KIT, for any Set... 1.49

## Modernize a #630 or Any TV Set With a New STANDARD CASCODE TUNER

For better all around performance

Complete with tubes, and step by step instructions **\$22.49**

## PULSE KEYED AGC KIT

Finest, most accurate and the easiest Kit to install in a #630 or in any other make TV receiver. Improves performance, eliminates airplane flutter and picture jumping and insures a steady picture on all channels.

COMPLETE SET OF PARTS **\$4.59** Including 6AU6 tube & Instructions

## FAMOUS REGENCY BOOSTER

Largest Selling Booster AT ANY PRICE!



### NEW MODEL

- Greater Pickup
- Greater Stability
- One Knob Control
- Easy To Install

Underwriters' Approved

Complete w/Instructions **\$19.11** list price \$32.50 special at

## SPECIAL #630 TV PACKAGE

Hints for Better Pictures on Your #630 TV 630 TV Diagram with Modifications All for only **\$1.00** Illustrated TV Conversion Manual Pulse Keyed AGC Circuit Diagram RMA Resistor & Mica Code Charts **1.00** post-paid

You will also receive our latest catalog and flyers with special offers in TV, Chassis, Cabinets, Picture Tubes, Parts, Radios, Portables, Auto Radios, Radio Tubes, Test Equipment, Accessories, etc., at WHOLE-SALE PRICES.

## #630 SUPER DELUXE KIT

For the 31-tube CHASSIS that operates all 16" to 24" picture tubes... Tops for fringe areas... Peak performance for clarity, brilliance, stability and definition... This SUPER DELUXE TV KIT consists of a complete set of parts, including the basic components of the STANDARD KIT plus added features, more tubes, doubler components, AGC components, Cascode tuner, Cosine 70° deflection yoke, 12" speaker, etc., and the Brooks LIFE-SIZE Instructions. (less CRT & wire)

only... **\$119.44**

## STANDARD PICTURE TUBES

DuMont or Sheldon With a Full Year Guarantee! BRAND NEW—IN FACTORY SEALED CARTONS

- 10" —#10BP4A (Round, Black) ..... \$18.36
- 12 1/2" — 12LP4A (Round, Black) ..... 24.72
- 14" — 14CP4A (Rectangular, Black) ..... 26.48
- 16" — 16AP4A (Round, Metal, Black) ..... 28.97
- 16" — 16DP4A (Round, Black) ..... 28.97
- 16" — 16GP4A (Round, Metal, Black) ..... 28.97
- 16" — 16TP4 (Rectangular, Black) ..... 28.97
- 17" — 17BP4A (Rectangular, Black) ..... 29.63
- 19" — 19AP4A (Round, Metal, Black) ..... 34.82
- 20" — 20CP4A (Rectangular, Black) ..... 39.74
- 21" — 21EP4A (Rectangular, Black) ..... 44.68
- 24" — 24AP4 (Round, Metal, Black) ..... 69.49

## UNIVERSAL Picture Tube MOUNTING BRACKETS

Fits All 12 1/2" to 21" Picture Tubes Complete—Including band that holds picture tube.

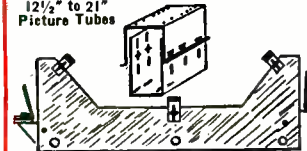

**\$6.97**

Also available for the 24" picture tube \$7.97

## A PLAN TO SAVE YOU MONEY

PACKAGE DEALS—Each containing an assortment of the most desirable types and sizes, at a cost of only 1/3 than if bought separately!

Resistor & cond. code charts FREE with each order!

100 ASSORTED TUBULAR CONDENSERS **\$4.69**

100 ASSORTED 1/2 WATT RESISTORS **3.97**

15 Ass. Radio Electrolytic CONDENSERS **4.74**

15 Assorted TV Electrolytic CONDENSERS **6.88**

100 ASSORTED MICA CONDENSERS **4.99**

100 ASSORTED CERAMIC CONDENSERS **4.99**

100 ASSORTED 1 WATT RESISTORS **5.89**

100 ASST. PILOT LIGHTS #44, 46, 47 & 51 **4.83**

100 ASSORTED SOCKETS Octal, Localt & Miniature **3.92**

100 ASSORTED KNOBS SCREW & PUSH-ON **3.97**

10 VOLUME CONTROLS ASSORTED, WITH SWITCH **2.94**

10 VOLUME CONTROLS ASSORTED, LESS SWITCH **1.94**

**BROOKS RADIO & TV CORP., 84 Vesey St., Dept. A, New York 7, N.Y. TELEPHONE COrtland 7-2359**



# JACKSON INTRODUCES

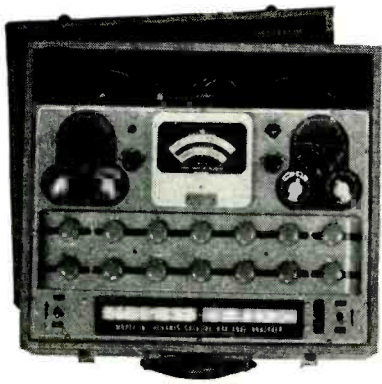

## MODEL 707 DYNAMIC® CATHODE RAY TUBE ANALYZER

FOR INDUSTRIAL,  
MILITARY,  
AND TV SERVICE

### BEAM CURRENT TEST • GRID CONTROL TEST GAS CONTENT TEST • LEAKAGE TEST

This instrument is unlimited in application, as it provides an analysis of *all* CR tubes including multi-gun types, either in the carton or in the chassis. Both high and low voltage power supplies are incorporated to obtain the voltage necessary for the various test requirements.

**BEAM CURRENT TEST.** This is made to the *final* anode—not to the grid or any other element, as in common emission testers. The beam current scale of the meter is designed not only to indicate sufficient or insufficient beam current, but also to give you an accurate forecast of the end of tube life.

**GRID CONTROL TEST.** The beam current (picture brightness) may be up to par; but, if the grid does not have the ability to cut off and control the beam current, the tube is absolutely useless. Therefore, a grid control test must be associated with any beam current test for true evaluation.

**GAS CONTENT TEST.** This test is quite often considered relatively unimportant, but the facts are that approximately 35% of all CR

tubes are rendered unsatisfactory as a result of abnormal gas content. The gas test circuit checks the currents set up by gas ionization and measures them in the millimicroampere range. This test is based on JAN specifications. It is of particular importance when field testing CR tubes in critical applications such as military equipment.

**LEAKAGE TEST.** The flexible switching arrangement of the Dynamic Analyzer isolates each element for individual leakage tests by a highly sensitive current. Indications are observed on a neon lamp.

**TEST VOLTAGES.** Both high and low voltage power supplies, with multiple filtering, are incorporated to insure maximum efficiency for each test procedure.

See your distributor or write

# JACKSON ELECTRICAL INSTRUMENT CO.

"Service Engineered"  
Test Equipment

DAYTON 2, OHIO

In Canada:  
The Canadian Marconi Co.

## THE TECHNICAL APPROACH

Radio and television service technicians justly resent the recent unfavorable publicity which castigates a hard-working, essentially honest profession. Among other groups, the Associated Radio and Television Service Technicians of New York City are banded together to fight such attacks, and at times to launch counter-offensives of their own.

The ARTSNY meets monthly to debate such issues as TV service exposés, the proposed New York State licensing bill to cover television servicing, and other matters of importance to the working service technician.

Professional standards—long recognized as a primary requirement of the industry—are sought, so that the properly trained electronic technician may hold his own with fellow craftsmen—diagnosticians and engineers of service in other fields.

A strong educational campaign to inform the public of the service engineer's true status is necessary. But it is even more important that the TV repairman be a genuine, competent technician—a true engineer of service—before he attempts to present any plans to the public. Therefore, ARTSNY—as a regular feature of its meetings—invites a factory representative of a standard radio-electronic product, or other authority on some phase of TV or radio, to lecture on the use of instruments, electronic practice, and service techniques. These speakers are encouraged to demonstrate at these meetings the principles they describe.

Both service instruments and service applications are shown on the spot and the men get the feel of actually using the techniques as they are described.

At a recent meeting, Dave Gnessin of Transvision, Inc., is shown discussing the theoretical considerations of picture tube breakdowns, and demonstrating practical methods of re-activating picture tubes with field instruments.



Great emphasis was placed on knowing exactly what is going on, so that the householder may have confidence in the man who represents the service industry in her home. Safety techniques were gone over in careful detail, since practical operating voltages in television sets invariably exceed 10,000 volts for picture-tube application.

Some of the new techniques for field application discussed were picture-tube testing in the carton, in the set in the customer's home, and on the service bench; cause for loss of picture bright-

RADIO-ELECTRONICS

# SAVE \$50. on this Brand New 1953 SUPER-POWER TV CHASSIS

FOR CUSTOM INSTALLATION IN YOUR OWN BOOKCASE, WALL OR CABINET. RMA Guaranteed—Factory Wired

Directly adaptable for color and UHF

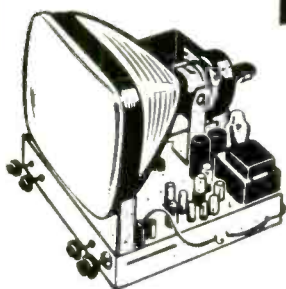

The first time! 1953 New design Super-Cascade TV Chassis model 620. The ideal companion model for the famous 630 DX-Chassis.

FREE! New TV trouble shooting book with each chassis.

This new chassis incorporates all the new advances in TV that have been developed in the largest research laboratories and in various test homes.

**NEW!**  
**NEW!**  
**NEW!**  
**NEW!**

- Super-Cascade standard coil tuner for longer range and greater sensitivity; doubly shielded to prevent interference and radiation.
- Auto-Stable synchronized circuits to give a perfectly stable picture even in fringe areas and under all conditions.
- Low-Noise bi-filter IF system to widen the band width and produce the ultimate in picture quality.
- Local-fringe switch to increase sensitivity for ideal fringe area reception.

Now! **\$123.50** Complete (less CRT)

**COMPARE THESE INVALUABLE FEATURES!**

- Super-cascade turret tuner; 12 channels; may be converted to UHF in 10 seconds.
- Fast action automatic gain control to eliminate outside interference & simplify tuning.
- Hi-voltage section protected by fuse.
- Cosine yoke for edge to edge focus with perfect linearity.
- Increased hi-voltage for better daylight viewing.
- Increased sensitivity in fringe areas by using special new local-fringe switch.
- Large, heavy magnet Alnico V PM speaker.
- Front & rear mounting brackets for all tubes.
- Finest quality, standard components used throughout.
- Chassis comes complete with plugs & sockets for yoke, focus coil & speaker... ready to play. Connect antenna—turn it on!

**EXTRA SAVINGS! Complete Combinations!**

- #620 Chassis plus 17" picture tube ..... **\$144.50**
- #620 Chassis & 17" tube & table model cabinet, a complete TV set ..... **154.50**
- #620 Chassis & 17" tube & console cabinet, a complete TV set ..... **169.50**
- #620 Chassis plus 20" picture tube ..... **154.50**
- #620 Chassis & 20" tube & table model cabinet, a complete TV set ..... **179.50**
- #620 Chassis & 20" tube & console cabinet, a complete TV set ..... **194.50**
- #620 Chassis plus 21" picture tube ..... **159.50**
- #620 Chassis & 21" tube & full size decorator cabinet with 3/4 doors, a complete TV set ..... **229.50**

Above combinations include mahogany cabinets and are completely assembled—ready to give you endless hours of pleasure and entertainment!

**Save up to \$50 on these Decorator TV Cabinets**



For 17", 19", 20" & 21" Picture Tubes—630 or other Chassis. Every beautiful cabinet is richly finished of hand rubbed mahogany and made by our own cabinetmakers. They are custom styled, guaranteed new & perfect. Includes: safety glass, mask & mounting brackets. Cabinets are also available with blank control panel to fit any chassis.

Model 100: Original list, \$79.95. Now only **\$38.50**

Model 200: Original list, \$99.95. Reduced to **\$45.50**

Blonde finish, add \$10.



**630-DX Chassis**

With new Cascade tuner, 30-tubes, for 16" to 24" picture tube. Adaptable for color and UHF.

RMA Guaranteed. Factory wired, tested and ready to play. Includes 12" speaker, hardware and knobs.

FREE! New trouble shooting book with every chassis!

Universal Mounting Brackets ..... **\$5.95**

For extra long range and finest reception up to 200 miles without a booster! Can't be beat for price or quality.

**\$144.50**

(Incl. Fed Tax, less CRT)



**SPEAKERS**  
New Low Prices!  
All Alnico V

- 4" PM ..... **\$1.29**
- 5" PM ..... **1.39**
- 6" PM ..... **1.69**
- 4" x 6" PM ..... **1.69**
- 8" PM ..... **3.95**
- 12" PM ..... **5.95**
- 6" 62 ohm double duty with output trans. .... **2.75**
- 4" x 6" 1500 ohm with output trans. .... **2.75**
- 12" 2,500 ohm ..... **3.95**

Added Dividends!

DEDUCT 10¢ from the price of any speaker in lots of 10 or more—may be assorted.

SAVE PLENTY—ORDER MANY!

**CONVERT YOUR OLD TV SET TO 17", 20", 21" or 24" PICTURE TUBE.**

Complete conversion kit to match your set! Wonderful new kit comes complete with all parts and diagrams necessary to easily convert any set to larger tube size. Kit includes:

- 70° Cosine yoke
- Matched hi-voltage transformer
- Width coil
- 20,000 V. condenser
- Kit of resistors
- Diagram of instructions

Dealer **\$9.95**

Net: Complete Kit. Be sure to send us make & model of your set for matching conversion kit.

**Great Savings on Nationally Known**

**PHONOGRAPHS**

Guaranteed, Brand New, Sealed Cartons

2-Watt powerful amplifier. 115 V. AC, Alnico V PM Speaker, volume control & switch; heavy duty constant speed motor, shock-proof, covered in beautiful simulated leather.

- Single speed: Lots of 3: **\$12.95**
- \$13.95** ea.
- 3-Speed: Lots of 3: **\$16.95**
- \$17.95** ea.

3-Speed with VM Automatic Changer, plays all size records: Lots of 3: **\$42.50**  
**\$46.95** ea.



Radio-Phono Combination with 3-speed automatic record changer and 5-tube radio. **\$55.50** ea.

**Rose Co.'s ANTENNA KIT**  
Saves you many dollars!

New antenna kits contain everything needed for a complete, satisfactory installation. NOW is the time to replace those old rusty worn out antennas with these brand new aluminum jobs. Be ready for the millions of dollars of TV entertainment scheduled for the fall. Don't miss a single show because of poor reception!

No. K-21 KIT includes:

- 1-8 element conical antenna
- 75 ft. highest quality 300 ohm wire
- 2-5 ft. 1/4" steel mast sections
- 2 mast stand-off insulators
- 4 screw-eye standoffs
- 1 all-angle base mount
- 1 UL approved lightning arrester

Save! Dealer **\$6.99** Net:

No. K-22 KIT includes:

- Same as above except that it includes 2-8 element conical antennas and 1 set of stacking bars.

Terrific Buy! Dealer **\$9.99** Net:

No. K-31 KIT includes:

- Same as K-21 (above) except that it includes a new single pre-assembled super-fan conical antenna. Finest conical ever made.

Great Value! Dealer **\$10.99** Net:

No. K-32 KIT includes:

- Same as K-31 except that it includes 2 super-fan conical antennas and one set of stacking bars.

Best Buy! Dealer **\$14.99** Net:

**TV PICTURE TUBES**

Full Year Guarantee—Non-glare—Black Face—Brand New—Standard Brands—Sealed Cartons

- 10BP4 Round Glass **\$19.95**
- 12LP4 Round Glass **22.95**
- 14BP4 Rect Glass **22.95**
- 16AP4 Round Metal **26.95**
- 16GP4 Round Metal **28.95**
- 16MP4 Round Glass **32.95**
- 14KP4 Rect Glass **24.95**
- 17BP4 Rect Glass **23.95**
- 19AP4 Round Metal **33.95**
- 20CP4 Rect Glass **34.95**
- 21EP4 Rect Cyl face **36.95**
- 24AP4 Round Metal **43.95**

Never before have we been able to sell these tubes at such low prices—order now!

**Genuine MOLDED CONDENSERS**

Fresh Stock! All mineral oil filled—Fully molded—100 Centigrade—Meets Jan. C91 tests—GUARANTEED All 600 Volts

Cap.	per 10	per 100	Cap.	per 10	per 100
.001	\$.79	\$6.90	.01	\$.89	\$7.90
.002	.79	6.90	.02	.89	7.90
.005	.79	6.90	.05	1.09	9.90
	.79	6.90	.1	1.25	11.30

May be assorted in 100 lots

**5-TUBE, AC/DC RADIO SUPERHET**

Table model radio of famous make with illuminated dial, glistening plastic cabinet, automatic volume control. Licensed by RCA. 5-Tubes, incl. rect. AC/DC superhet. circuit Alnico V speaker 540 to 1650 KC (560 to 182 meters)

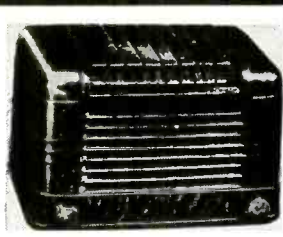

6 tuned circuits Built-in loop antenna Dealer Net: lots of 4: **\$14.95** ea. **\$15.95** ea.

**D.P.D.T. SWITCH**

For Hi-La frequency antennas. Special close-out price: **39¢** ea.

box of 10 **29¢** ea.

MIN. ORDER: \$5.00. 25% with order, balance COD. Include postage with order. All merchandise subject to prior sale. Prices subject to change without notice. FOB New York City.

**ELECTROLYTIC CONDENSERS**  
LOWEST PRICE WE KNOW

Mfd.	ea.	Lots of 10	Lots of 100
20/20—150 V.	39¢	\$3.50	\$33.95
40/40—150 V.	45¢	3.95	37.95
50/30—150 V.	45¢	3.95	37.95
50/50—150 V.	49¢	4.39	39.95
40/40/20—150 V.	69¢	6.49	57.95
50/30/20—150 V.	69¢	6.49	57.95
50/50 x 200			
150 V.—25 V.	79¢	7.49	67.95
25—25 V.	19¢	1.50	13.50
25—50 V.	19¢	1.50	13.50
20—150 V.	29¢	2.39	23.95
40—150 V.	29¢	2.39	23.95
8—450 V.	39¢	3.19	29.95
10—450 V.	39¢	3.19	29.95
14—450 V.	39¢	4.95	47.95
30—450 V.	59¢	4.95	47.95

**Tubes**

**Terrific Buys!**  
BRAND NEW, STANDARD BRANDS, FULLY GUARANTEED, INDIVIDUALLY BOXED

- 0Z4 ... **\$5.55**
- 1B3 ... **.89**
- 1X2A ... **.89**
- 5U4 ... **.65**
- 6AG5 ... **.80**
- 6AL5 ... **.60**
- 6AQ5 ... **.65**
- 6AU6 ... **.60**
- 6BC5 ... **.75**
- 6BG6 ... **1.79**
- 6BL7 ... **1.10**
- 6BN6 ... **.99**
- 6BQ6 ... **.99**
- 6CB6 ... **.75**
- 6F8 ... **.99**
- 6L6GA ... **1.35**
- 6L6 ... **.85**
- 6SA7 ... **.60**
- 6SN7 ... **.82**
- 6T8 ... **.79**
- 6V6 ... **.65**
- 6W4 ... **.44**
- 35Z5 ... **.47**
- 39/44 ... **.49**
- 50L6 ... **.63**
- 12A6 ... **.59**
- 12AU7 ... **.89**
- 12AT7 ... **.99**
- 12BH7 ... **1.10**
- 25BQ6 ... **.99**
- 25L6 ... **.60**
- 35L6 ... **.63**
- 35W4 ... **.44**
- 50L6 ... **.63**

All other Tubes in Stock

100 Park Place—Dept. E-11—New York 7, N. Y. C. Ortlandt 7-6195.

**THE ROSE COMPANY**



for Intercom

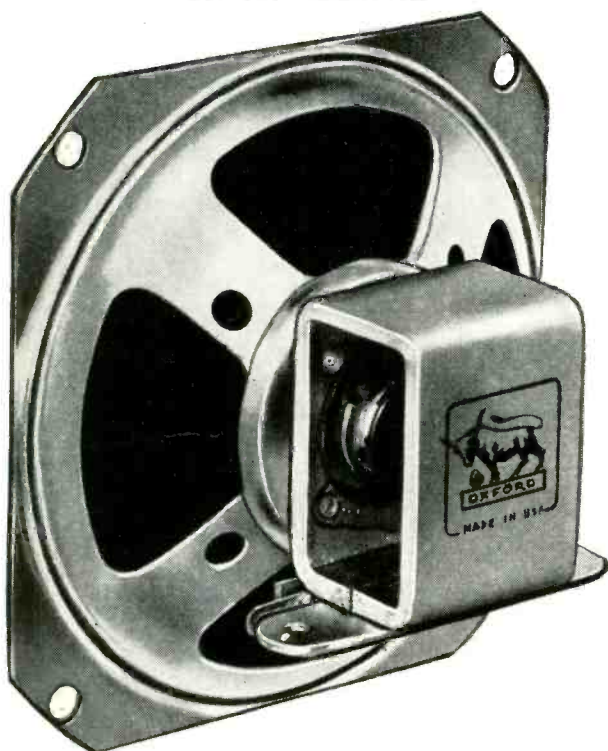

it's  
**OXFORD**  
Speakers

Preferred for original equipment  
... Proven for replacement!

Available at leading jobbers!

**OXFORD**  
ELECTRIC CORPORATION

3911 S. Michigan Ave. • Chicago 15, Ill.  
EXPORT ROBUEN AGENCIES, NEW YORK CITY

Other OXFORD Speakers for:

- Radio and Television
- Outdoor and Weather-proof Applications
- Portable Sets
- Auto Radios
- P.A. Systems
- High Fidelity

A copy of our latest catalog will be sent upon request.



ness and means of diagnosing these causes with instruments; detecting the presence of gas in tubes; use of high-frequency sparker to burn out tube shorts; practical application of a reactivation schedule with laboratory-quality instruments as compared to crude techniques for renewing picture-tube brightness.

Besides the technical discussion, the same meeting considered plans for improved advertising and consumer education. The goal is public recognition of the electronic service industry as a full-fledged profession rendering distinguished public service.

#### DEMAND STATE LICENSING

"Most important business" of the Empire State Federation of Electronic Technicians Associations September meeting was the passing of a resolution declaring that: "ESFETA, Incorporated is in favor of State licensing of radio and TV electronic technicians, such license to be so designed that standards of competency and ethics will be stabilized for the protection of the public."

The meeting of delegates from New York State service associations took place at Endicott, N. Y., September 14. Other business discussed included organizational problems and the possibility of union with other electronic service federations.

#### TV SERVICE STORY TOLD IN G-E ADVERTISEMENTS

Advertisements designed to acquaint the television set owner with the triumphs and tribulations of his television service technician have been placed in leading consumer magazines by the General Electric Co. The ads, which began in *Life* and *Collier's* in September, are headed "America's Newest Profession Keeps 18 Million Sets Healthy." They tell of the growth of television from 2,000 to 18,000,000 sets in five years, and of the service technician's successful struggle to gain the technical knowledge and skill to meet the flood of unfamiliar work. Also, that the modern TV technician, in addition to having to undergo lengthy and expensive training, must have as much as \$3,000 worth of equipment to carry on his work.

#### CAPITAL TO GET LICENSES?

The draft of a proposal for licensing TV and radio service personnel has been completed and is under consideration by District of Columbia authorities, according to the chairman of the District's licensing board.

It was stated that the proposed regulations had been the subject of study for about a year, but the exact text of the proposals was not revealed.

#### TCA ACTIVITIES VARIED

The Television Contractors' Association, Philadelphia, has launched a membership drive among local service organizations. As a special inducement, membership dues have been reduced to \$10 per month, with a \$50 initiation fee.

RADIO-ELECTRONICS

## With the Technician

TCA has been active in the fight on unsavory business practices and has cooperated with the District Attorney's office and the Better Business Bureau in several investigations which are expected to result in indictments for the racketeering firms, it is reported.

The *TV Tuner*, monthly magazine of the TCA, has been discontinued in favor of a plan to sponsor a series of articles in neighborhood papers, with the idea of bringing home to the consuming public the complexities of television service and the problems of the TV service technician.

### CALIFORNIA GROUP FAVORS LICENSES FOR TECHNICIANS

Harry Ward, Public Relations Officer of the Long Beach Radio Technicians Association, largest of the Southern California groups, put his association emphatically on record in favor of technician licensing in a letter to a local trade paper recently. Mr. Ward said in part:

"Our crying need at present is for more and better technicians, the elimination of the unfit and irresponsible 'screw-driver repairman,' and the restoration of public confidence in the trained, experienced technician. LBRTA believes that a State-wide system of examination and licensing would be more practical and more effective than city or county regulation under police supervision."

### TWO PENNSYLVANIA GROUPS HAVE FILED FOR CHARTERS

The Federation of Radio Servicemen's Associations of Pennsylvania (FRSAP) which has operated for a number of years as an informally organized group, has filed for a charter as a non-profit organization in the State of Pennsylvania.

The Mid-State Radio Servicemen's Association, local group of the Harrisburg area and member of the FRSAP, filed for incorporation at the same time.

### COLUMBUS HONORS EDITOR

The Associated Radio & Television Service Dealers of Columbus, Ohio (ARTSD), voted at their August 6th meeting to present the Editor of the *ARTSD News* "with a tangible token of the Association's appreciation." Reason for the timing was that John Graham, who has edited the local mimeographed paper for eight years, was absent on vacation, making it "the only meeting of the year we can do anything behind John's back."

Editor Graham is not the only member of the Columbus organization who has a near-perfect attendance record. The Association encourages regularity by putting a number after each meeting notice to indicate to the member how many meetings he has missed. A (3) after the notice warns the member to attend, or else, and a (4) indicates that he is no longer in good standing.

The August 6th meeting, which began with a dinner, ended with a conducted tour through the local television station, WBNS-TV. END

NOVEMBER, 1952

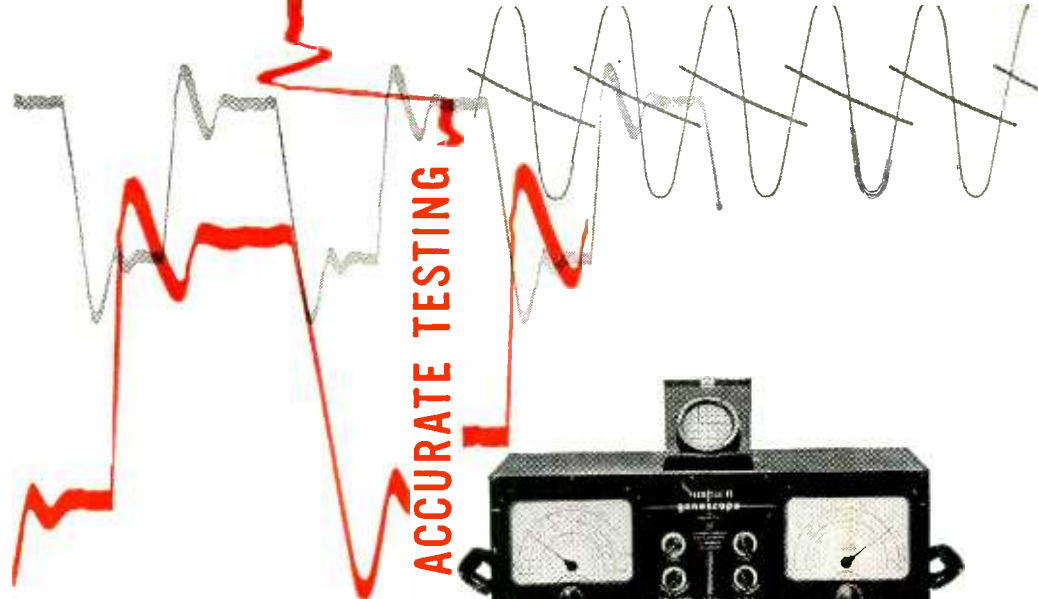

approved by  
service managers of:

admiral  
zenith  
motorola  
emerson  
hoffman  
hallicrafters

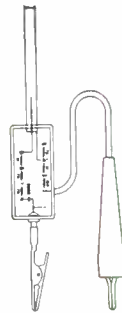

SIMPSON MODEL 480 GENESCOPE FOR ACCURATE TESTING



- All the necessary signal sources for alignment of FM and TV receivers • Includes the Simpson High Sensitivity Oscilloscope and high frequency crystal probe for signal tracing • Independent, continuously variable attenuators and step attenuators for both AM and FM units offer complete control of output at all times • 0-15 megacycle sweep is provided by a noiseless specially designed sweep motor based on D'Arsonval meter movement principles • The exclusive Simpson output cable (illustrated) includes a variable termination network, quickly adapted to provide open, 75 or 300 ohm terminations — the addition of a pad provides attenuation and isolation Use of appropriate resistors across certain terminals will provide any other termination required. A .002 MFD blocking condenser can be added on any termination for use on circuits containing a DC component • The FM generator output voltage is constant within .2 DB per MC of sweep.

dealer's net \$395.00

SIMPSON ELECTRIC COMPANY

5200 W. Kinzie St., Chicago 44, Illinois • Phone: COlumbus 1-1221 • In Canada: Bach-Simpson, Ltd., London, Ont.

BURTON BROWNE ADVERTISING

## NEW! MOSLEY WALL-THRU



Cat. No. 625  
List Price \$1.95

Cat. No. 625-PK WALL-THRU, complete with MOSLEY Universal TV Lead-In Socket and Plug.  
List Price \$3.00

For TV, FM and Amateur Transmission Line

- Fits Any Wall Up To 13" Thick!
- Completely Weather-Proof!
- For Standard Flat 300 Ohm Line or RG-59/U Co-ax Cable!
- MOSLEY Lead-In Socket Can Be Mounted Direct To Inside Plate!
- Precision Molded Polystyrene End Plates!
- Easily, Quickly Installed!

**MOSLEY ELECTRONICS**

2125 Lackland Road

Overland, Missouri



## New Devices

### NOVICE KIT

Thordarson-Meissner, Mount Carmel, Ill., has designed a 20-watt transmitter kit for the novice. Tube complement consists of a 5U4 rectifier and 6L6 crystal oscillator. The chassis is already



drilled, and instructions are furnished for assembly. The unit will not become obsolete when the novice advances to higher grade license because it can be used to furnish excitation for a high-power rig.

### NEW CAPACITORS

Sprague Products Co., 81 Marshall St., North Adams, Mass., have added two capacitors to their line. Type 48P18 is rated at 0.5  $\mu$ f, 50 volts d.c. working, and 40 amperes through current. It filters voltage regulator noise in mobile radio installations when installed in series with the battery and generator armature leads to the voltage regulator.

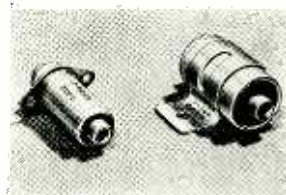

Capacitor 80P3 filters and bypasses harmonics and spurious r.f. currents in transmitters, radio, and TV receivers. A bulkhead mounting bracket permits through-chassis mounting for complete circuit shielding and isolation. It is rated at 0.1  $\mu$ f, 600 volts d.c. working, 20 amperes through current, and may be used at potentials up to 250 volts, 60 cycles a.c.

### ZIG-ZAG ANTENNAS

Trio Manufacturing Co., Griggsville, Ill., has announced a new series of Zig-Zag antennas. Construction is such that on any one channel there are resonant elements and the remaining



elements act as directors and reflectors. All elements are end-connected in one continuous series. Eight models cover all requirements for reception in ultra-fringe, near-fringe, suburban, and metropolitan areas.

### DUAL-CHANNEL YAGIS

Technical Appliance Corp., Sherburne, N. Y., has announced a new line of Yagi antennas making possible the reception of two channels with a single antenna. The Taco Dual-Channel Yagis have high gain and sharp directivity, with excellent front-to-back ratio.

Although designed primarily for fringe areas where two channels are operating and are received from the same direction, it is possible to use

them on two channels in different directions by using a rotator.

The new antenna is a 5-element design with three directors, antenna element, and one reflector. A folded

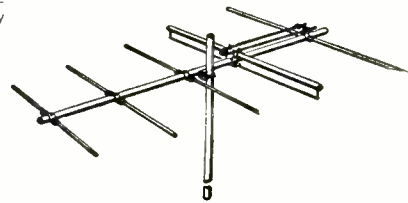

dipole tuning element is connected across the terminals of the antenna element, as a bazooka, and factory-tuned to the desired two channels. Combinations 3-6, 4-5, are now available, and other combinations can be supplied on special order.

### REVERSIBLE MOTOR

General Industries Co., Elyria, Ohio is producing a reversible 2-pole, four-coil motor for remote-control TV tuners and rotating antenna applications.

Called Model O, this motor can be furnished either as split-phase capacitor or split-phase resistance type, de-

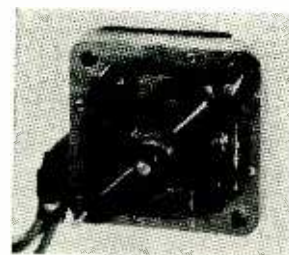

pending upon application requirements. It is designed for 24, 12 or 6 volts a.c., 60 cycles, and may be used horizontally or vertically without affecting performance characteristics.

### FREQUENCY METER

Lampkin Laboratories, Inc., Bradenton, Fla., have placed on the market the new type 105-B micrometer frequency meter. It measures center frequency deviation on FM or AM trans-



mitters through a continuous range of frequencies, 0.1 mc to 175 mc. It supercedes the old type 105-A.

A stage of audio amplification and a function selector switch accomplish greatly increased sensitivity when measuring the frequency of v.h.f. transmitters; higher output for feeding into v.h.f. receivers for alignment purposes; and a strong headphone signal when calibrating against the internal crystal standard, permitting settings to better than 1 part per million.

### VARI-CHOKE

Grayburne Corp., 103 Lafayette St., New York 13, N. Y., have added a new Vari-Choke, Model V-60, to their line. The inductance range is variable from 30 to 130 mh. The coil section is  $\frac{3}{8}$ -inch diameter by  $\frac{1}{2}$ -inch long. Total overall length including snap-in mount is 2-inches. It is the unit at the left in the illustration.

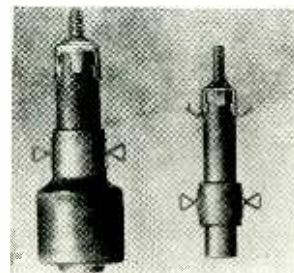

RADIO-ELECTRONICS

AMPHENOL  
-INLINE\*  
ANTENNA

Teamed together for  
BETTER TV PICTURE QUALITY

AMPHENOL  
TUBULAR  
TWIN-LEAD

AMPHENOL

The vast majority of TV technicians are agreed that the Amphenol Inline is the best choice in a broadbanded antenna. The Amphenol Inline has uniform gain over all the VHF channels with more signal strength than any other all-channel antenna on the market. In addition, the Inline is packaged for an easy, quick installation, including mast, twin-lead and insulators. And, the Amphenol Inline is strong too! The installer knows that he will not be called back in a few weeks or months to repair or replace broken, defective or unsatisfactory elements. The Inline is built to take all the punishment of severe weather conditions and will continue to provide a strong, steady signal to the TV set years after its installation.

Amphenol Tubular Twin-Lead is ideal for all TV installations and has proved to be the one economical answer for sea coast and other weather troubled areas. Because of its extremely low-loss and constant impedance, unaffected by weather conditions or age, Amphenol Tubular Twin-Lead is recommended by leading authorities for UHF TV reception. The low-loss characteristic makes this the ideal twin-lead for fringe areas and installations requiring long lengths of twin-lead.

See your Authorized Amphenol Distributor for your free copy of this 20-page booklet containing information on all the factors that influence Better TV Picture Quality.



AMERICAN PHENOLIC CORPORATION  
1830 SOUTH 54TH AVENUE • CHICAGO 50, ILLINOIS



The item at the right is one of a series of Ferrite-cored coil forms of high-dielectric Cosmolite, assembled for snap-in mount. The sizes are: C1, 1/4 inch x 1 1/8 inch; C2, 1/4 inch x 2 inches; C3, 3/8 inch x 1 1/8 inches; and C4, 3/8 inch by 2 inches.

**FM ANTENNA**

The Gonset Co., 801 S. Main St., Burbank, Cal., has announced an array for high-fidelity reception on FM receivers in areas where signal strength is low.

The FM Radarray shows a gain over the entire 88-108 mc band of approximately 10 db, a high front-to-back ratio, and a 50-degree forward pattern. This pattern is sharp enough to eliminate practically all cases of multi-path distortion, yet broad enough to insure that desired stations need not lie in exactly the same direction.

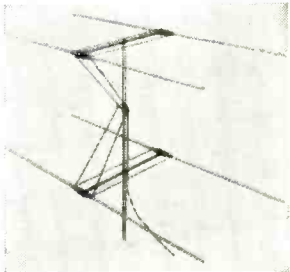

**NEW CONNECTOR**

RMS, 2016 Bronxdale Ave., New York 60, N. Y., has introduced a connector for splicing hi-gain open transmission line. The unit, model CON-450, is a clear lucite block into which the two wires from the lines to be connected are placed and held securely under screw pressure. The connectors are packaged 100 to a carton, and are available from RMS distributors.



**FOLD-OVER TOWER**

Rohn Manufacturing Co., 2108 Main St., Peoria, Ill., is manufacturing a Fold-Over Tower, using standard Rohn



Tower sections and a Fold-Over kit. The kit consists of a short base section, hinge section, boom and reel and cable mechanism.

The tower hinges near the midsection, and can be raised and lowered by turning the crank on the reel. When the tower is lowered antenna changing and servicing can be done on the ground.

**NEW ANTENNA**

Telrex, Inc., Asbury Park, N.J. has announced production of its new Meteor series of E-Z-Rig conical V-beams. The central feature of the antenna is the aluminum "outrigger" pivot plate and mating pressure plate which reduce set-up time without relying on springs, locks, molded plastics, etc. Tightening of a wing nut grips the dural element rods in a 3-inch aluminum clamp. It is insulated with Micarta. The Meteor is available in the basic single unit, Model ME-2X-TV, in two-bay array,

**A HOT Little BOOSTER for HOT Front Ends**



**\$24.95 LIST**

**VIDEON JR.** won't oscillate with the hot front ends of new sets!

**PERFORMANCEWISE**—It's tops

**PRICEWISE**—It's right . . . and as for customer satisfaction, you cut costly call backs when you install a VIDEON JR.

Write For Descriptive Folder And Name Of Your Distributor



**ELECTRONIC CORPORATION**

222 East Ohio Street · Indianapolis, Indiana

NOVEMBER, 1952

**insuline**

*...world's largest producer of TEST LEADS and PROBES*

Multiple Probe

Laboratory Test Leads    Pencil Type Test Leads    Photo Needle Test Leads    Slim Handle Test Leads

Unbreakable Test Leads

INSULINE has been the leading maker of test leads and probes (standard and special types) for 32 years. Over 2000 items . . . including tools, hardware, components, metal goods, antennas, accessories . . . for every electronic requirement. INSULINE jacks, plugs and connectors are used by practically every major manufacturer as standard equipment.

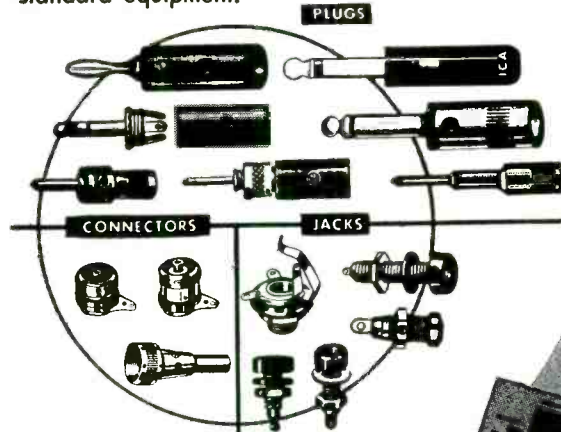

Write Dept. RE-11 for latest catalog illustrating and describing complete line.



**insuline**

**CORPORATION OF AMERICA**

INSULINE BUILDING • 34-02 35th Ave. • Long Island City, N. Y.

West Coast Branch and Warehouse:  
1333 South Flower Street, Los Angeles, Calif.  
Exclusive Canadian Sales Agents:  
CANADIAN MARCONI COMPANY, Toronto



Because product leadership depends on component quality

Tektronix, Inc. relies on...



SELENIUM RECTIFIERS

The Tektronix Cathode-Ray Oscilloscope, recognized leader in its field, is a high precision instrument and light in weight because of essential mobility. Since it is urgent that sweep rates and deflection sensitivities remain constant in spite of line voltage variations, all critical voltages are electronically controlled.

Specified for the power supply, of course, are SELETRON Selenium Rectifiers to help maintain Tektronix standards. In the type 517 Oscilloscope, SELETRON 5Q1 rectifiers are combined to furnish 750 milliamps at 150 volts and 500 milliamps at 225 volts. Their ruggedness and dependability aid materially in maintaining the stability of this wide band high voltage instrument.

Versatile SELETRON Selenium Rectifiers are available in a complete range of sizes for every electronic circuit—from a few mils up to thousands of amps. Whatever your problem in rectification—whether in radio, communications or for heavy industrial use, count on our engineers to be of real assistance. Your correspondence is invited. Remember, product quality depends on component quality!

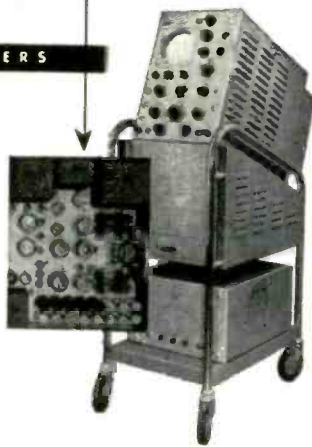
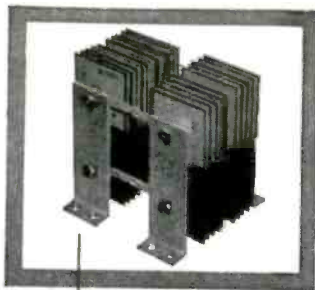

Selenium and Germanium Division

RADIO RECEPTOR COMPANY, INC.

Since 1922 in Radio and Electronics  
Sales Dept. 251 W 19th St., New York 11, N. Y. - Factory 84 W. 9th St., Brooklyn 11, N. Y.

RADIO-ELECTRONICS is paying good rates on acceptance for original and unusual articles on phonograph, television, FM and AM servicing, as well as articles on industrial electronic equipment and applications. Good constructional stories on receivers or other pieces of electronic equipment can also be used. Send for a copy of our Authors' Guide. Address:

THE EDITOR  
RADIO-ELECTRONICS  
25 West Broadway, New York 7, N. Y.

Model ME-4X-TV and in a four-bay unit, Model ME-8X-TV.

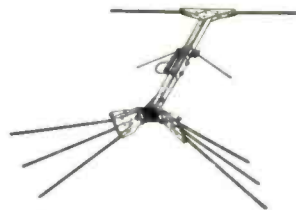

METAL MIRROR

General Cement Manufacturing Co., 919 Taylor Ave., Rockford, Ill., has brought out an adjustable metal mirror for TV set servicing. Measuring 12 x 10 inches, of heavy chrome plated metal to prevent distortion of image, it is large enough to give the service technician a good look at the set's picture while adjusting rear controls. It is listed as catalog number 8198.

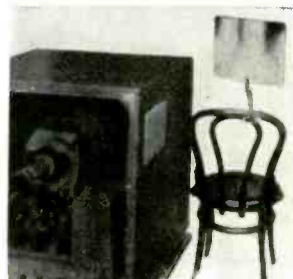

B-T BOOSTER

Blonder-Tongue Laboratories, Inc., Westfield, N.J., announces an automatic 3-stage booster, Model HA-3, which delivers gain in excess of 18 db over all channels. Providing reception for fringe and weak signal areas, it is also recommended for installations where only an indoor antenna is permitted.



The three dual triodes operate continuously on both high and low bands. Additional features include automatic on-off operation with TV set, a switch for attenuating strong signals, and u.h.f. adaptability.

VOLTAGE BOOSTER

I.D.E.A., Inc., 7900 Pendleton Pike, Indianapolis 26, Ind., has designed a voltage booster which maintains a 117-volt output regardless of line voltage variations from 90 to 130 volts. Called the Regency VB-1, the booster can be used with any electrical device drawing 350 watts or less. An automatic transformer with tapped primary, it can be used with equal efficiency in high-voltage areas to decrease line voltage.



SPEAKER HOUSING

RCA Victor, Camden, N.J., has developed a new explosion-proof speaker housing, in which a tortuous sound path between the speaker diaphragm and the horn serves to extinguish any flame generated within the mechanism before it reaches the horn or the outside atmosphere. The new housing, which bears the approval and seal of the Underwriters Laboratories, is designed to fit all RCA horns and several diaphragm-type speaker mechanisms.

END



Regency



Largest Selling Booster

AT ANY PRICE!



**HI-GAIN TUNER-BOOSTER**

LESS TUBES WITH DIAL

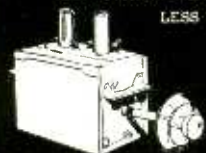

**\$4.75**

COMPLETE WITH TUBES

**\$6.00**

SOLVE POOR T. V. RECEPTION WITH A HI-GAIN BOOSTER. BANISH WEAK FRINGE AREAS, REDUCE SNOW. THIS UNIT COMES TO YOU AS A HIGHLY SERVICEABLE HIGH-GAIN TUNER. USES 6J6 TUBES IN VERY EFFICIENT HI-Q CIRCUIT. HAS 8 TUNED CIRCUITS USING PURE SILVER INDUCTANCES AND INDIVIDUAL COMPENSATION PROVIDING HIGH GAIN ON CHANNELS 7 TO 13. BUILT IN 5:1 VERNIER DRIVE. THIS IS A COMPLETE DEPARTURE FROM ORDINARY TUNERS.

ALL NECESSARY PARTS AND INSTRUCTIONS ARE INCLUDED TO CONVERT THIS UNIT IN A FEW MINUTES TO ONE OF THE HIGHEST GAIN BOOSTERS ON THE MARKET.

SEND FOR OUR NEW BULLETIN LISTING PICTURE AND RECEIVING TUBES, SPEAKERS AND MANY OTHER T. V. COMPONENTS AT TERRIFIC PRICE REDUCTIONS.

SHIPMENTS SENT POSTPAID WHEN FULL PAYMENT IS ENCLOSED WITH ORDER 25% DEPOSIT ON C. O. D. SHIPMENTS OPEN ACCOUNT PRIVILEGES TO RATED FIRMS.

Dept No. RE 11

**FRANK W. DE GRAY**  
AND ASSOCIATES  
11842 W. JEFFERSON BOULEVARD  
CULVER CITY, CALIFORNIA

Be sure and reserve your copy of the big December issue of RADIO-ELECTRONICS. On sale at your newsstand November 26.

**TUBES** Today's Best Buys

Top Quality at Terrific Savings  
**RTMA Guaranteed**

1A7GT	\$.79	6B4	1.50	7F7	.95
1B3	1.05	6BA6	.55	7G7	1.30
1L4	.60	6BC5	.56	7H7	.70
1L6	.60	6BE6	.49	7N7	.90
1L9	.95	6BF5	.95	7Q7	.89
1N23B	3.50	6BF6	.70	7V7	.95
1N34	.89	6BG6G	1.98	7W7	1.25
1R5	.60	6BH6	.75	12A6	.49
1S4	.65	6BJ6	.65	12AT6	.40
1S5	.65	6BQ6	1.27	12AT7	.80
1T4	.65	6C4	.60	12AU6	.49
1U4	.60	6CB6	.65	12AU7	.50
1U5	.50	6CD6G	1.93	12AV7	.95
1X2A	.85	6E5	1.05	12AX7	.75
2A3	1.45	6H6M	.59	12BA6	.48
2D21	1.40	6J5M	.65	12BA7	.80
2X2	.60	6I6	.73	12BE6	.55
3A4	.65	6K6	.65	12BG6	.50
3Q4	.55	6K7	.70	12K8	.49
3V4	.62	6L6G	1.05	12SA7GT	.70
3S4	.80	6N7G/M	.95	12SF5M	.65
5U4G	.55	6S4	.71	12SH7	.79
5V4	.95	6S7M	.85	12SJ7	.60
5Y3GT	.39	6SA7GT	.70	12SK7	.65
5Z3	.85	6SC7	1.10	12SQ7	.70
6A7	1.00	6SG7	.75	12SN7GT	.75
6AB4	.65	6SH7	.65	12SR7	.65
6AB5/6N5	1.25	6SJ7	.70	14B6	.95
6AC7	.95	6SK7GT	.53	19BG6G	1.98
6AG5	.80	6SL7GT	.65	19T8	.86
6AG7	1.40	6SN7GT	.65	25A V5	.95
6AH6	1.40	6SQ7GT	.65	25L6GT	.60
6AJ5	1.45	6T8	.86	25W4	.80
6AK5	.95	6V6GT	.60	35L6GT	.53
6AK6	1.20	6W4GT	.49	35W4	.47
6AL5	.84	6X4	.39	35Z5GT	.49
6AQ5	.65	6X5	.39	50B5	.53
6AS5	.65	6Y6	.85	50C5	.53
6AT6	.45	7AD7	1.25	50L6GT	.53
6AU6	.65	7C5	.70	59	1.50
6AV6	.50	7C7	.85	75	.85
6AX5GT	.85	7E7	1.30	89Y	.75

Minimum Order \$15.00

**IMMEDIATE DELIVERY!**

Write for quotations, many other types available. 20% Deposit with order, balance C.O.D. All tubes subject to prior sale. Prices subject to change without notice.

**WRITE, WIRE, CALL—TODAY!**

We Buy Anything in Electronics—large or small Quantities!

**Nat Adelman**

168 Washington St. New York 6, N. Y. CO. 7-6091

**WOW MEASUREMENT**

Patent No. 2,602,837

Harry R. Foster, E. Orange, and Elma E. Crump, W. Caldwell, N. J.

(Assigned to Omega Labs., Pine Brook, N. J.)

This instrument can measure the slightest change in speed of a rotating wheel or disc. It indicates wow to better than .01%. It can check the performance of recorders and playbacks, gear trains, electric timing motors, and other rotating machinery.

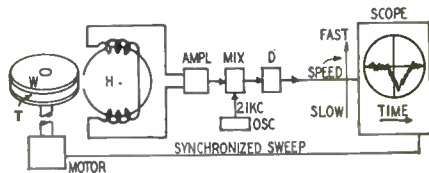

A rotating wheel W is shown under measurement. Around its rim is a magnetic tape T which carries a recording of 20 kc. The tape frequency will be correct only when W rotates at normal speed. If the speed is greater than normal, the frequency will be higher than 20 kc. If the speed is slower, the frequency will be less than 20 kc. A magnetic head H picks up the tape signal, which is then amplified and heterodyned against a 21-kc signal provided by a highly stable oscillator. The beat is fed to a discriminator or FM detector D.

D is adjusted for zero output when the beat is exactly 1 kc, that is, when W rotates at normal speed. The output of D is positive when W rotates faster than normal. Output is negative when the speed is slower than normal.

A scope is used for measurement. Its horizontal sweep is synchronized with the rotation of W. If the screen shows a momentary deflection upwards, it means that the speed of W increased for an instant. A downward deflection means a decreased speed. The figure shows a typical pattern.

**THERMOCOUPLE BRIDGE**

Patent No. 2,591,358

Donald T. Imler, Gettysburg, Pa.

(Assigned to Glenn L. Martin Co., Middle River, Md.)

This invention is applicable in measuring a weak d.c. signal from a thermocouple or similar device. Thermocouple TC is connected in one arm of a bridge constructed as shown. R is adjusted for balance at room temperature. Thus no a.c. signal appears across the primary P of the output transformer.

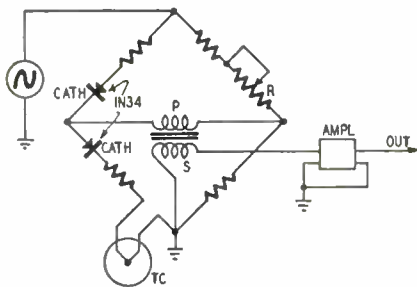

When the temperature rises or falls, TC output will also vary. This voltage change is small, but it varies the bias on both rectifiers. Since one of the 1N34's is in the same arm of the bridge as the thermocouple element, its effective resistance is increased (or decreased) more by the voltage generated by the thermocouple than that of the other 1N34. As a result the bridge is unbalanced and a.c. passes through P. The voltage thus produced is stepped up in the secondary S and is amplified and made to produce an audible signal, a record on a graph, or other indication.

A pulsed voltage of about 3 kc is preferred as excitation for the bridge, but you can use any convenient source of a.c. of about the same frequency. The amplifier in the output circuit may be designed for high gain and low noise, since it need not respond to signals other than those of the excitation frequency.

Often copied  
**NEVER  
EQUALLED**



**Super Power**

SINGLE CHANNEL ANTENNAS

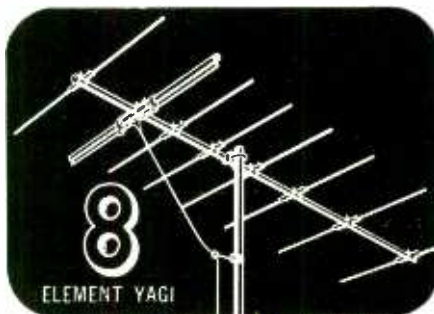

**LONG JOHN** — America's first and finest 8-element Single Channel Performer. 40% more gain than the best 5-element Yagi — and equal gain to a double stacked 5-element Yagi array... at lower cost! Model LJ... \$12.50 list, less most for Channels 7-13.



**LONG LONG JOHN** — guaranteed to outperform all others! Super high gain 12-element Yagi provides grand slam power for fringe areas. New rigidized boom, pre-assembled construction, for fast, easy installation. Model LLJ, Channel 7-13... \$18.50 list less mast.

**VEE-D-X**

THE LAPOINTE PLASCOMOLD CORP.  
Rockville, Connecticut

Gentlemen:

Please send me literature and prices on both Long Johns.

Company Name .....

Address .....

City..... Zone..... State.....

Your Name .....

Name of Jobber .....



# AMPLITEL

Exclusive Franchises Available

## MASTER AMPLIFIED TV ANTENNA SYSTEMS



Designed in the laboratories of **TRANSVISION, INC.**—exclusively for **AMPLITEL**

**GIVES PERFECT RECEPTION ON ALL CHANNELS (TV, FM, and AM)**

- Easy to install
- Economical in cost
- Easy to maintain

**NOW—AMPLITEL** equipment and "know-how" are available to Service Organizations, P.A. Men, and Dealers. The flexibility of **AMPLITEL** makes it adaptable to any installation requirement—including color and U.H.F. The superb performance record of **AMPLITEL** rates it tops in the field. That is why it is the choice of over **250 outstanding Apartments, Hotels, Hospitals, Schools and communities** in greater New York alone.

You are in a key position to become the leader in your community in this fast-growing and profitable industry.

Write for full details now, attention of Mr. H. Morris

# AMPLITEL INC.

362 West 57th Street, New York 19, N. Y. JUDSON 6-1444

### VERSATILE TRIGGER

Patent No. 2,604,589

Meryl C. Burns, Richmond, Calif.  
(Assigned to Marchant Calculating Machine Co.)

This efficient circuit needs only a couple of neon lamps, a few resistors and capacitors, and a d.c. source. It is useful as a trigger to shift conductivity from one tube to the other; a low-frequency oscillator; or a univibrator (single shot multivibrator). Stability is very good.

The neon tubes are connected across a battery (or d.c. power supply) and a source of positive tripping pulses. The battery voltage is too low to fire the tubes, but ionization can occur when positive pulses are superimposed. The first pulse ionizes the tube that has the lower breakdown potential (for example A1). Current flows through this tube and resistor R1. The sudden voltage drop across the resistor is fed as a negative pulse to A2 through capacitor C. It blocks A2.

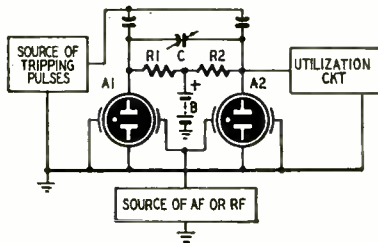

The second pulse raises the potential across A2 and fires it. Again a negative voltage drop (this time across R2) is generated, passed through C, and fed to A1. This tube is extinguished. Successive pulses continue to fire the neon tubes alternately. For binary counting, additional triggers are added.

To increase stability, an r.f. or a.f. generator is connected to external electrodes placed near each tube. The neon gas is kept partially ionized by the alternating field.

This circuit becomes an oscillator when the voltage of B is higher than the breakdown voltage of the tubes. Under this condition, one of the tubes (say A1) tends to fire first. When it does, its companion receives a negative charge (from R1) which blocks it. When the charge leaks off, A2 is ionized, causing A1 to block. This multivibrator action continues automatically. Frequency is controlled by C, R1 and R2. These components can vary the recovery period required for the negative charge to leak off.

If a univibrator is needed, the battery voltage is made higher than the breakdown value of one tube, but lower than that of the other tube. This is done by tapping the d.c. supply and feeding different voltages to the tubes. Normally, one tube (for example A1) conducts, while the other is blocked. A positive pulse triggers A2 to conduction, so A1 is extinguished. The negative charge (from R2) leaks off, permitting A1 to ionize again. Therefore A2 is extinguished and the circuit returns to its original condition. Successive pulses cause a repetition of the cycle.

### ATMOSPHERIC INVESTIGATION

Patent No. 2,606,443

George W. Gilman, Summit, N.J.  
(Assigned to Bell Telephone Labs., Inc.)

This patent describes a type of sound-ranging system for determining the height and density of layers or strata in the earth's atmosphere. The apparatus consists of a transmitter which sends out short pulses of sound at regular intervals and a receiver for picking up echoes or reflections. A sharp beam of sound is transmitted upward. When it strikes a layer where atmospheric conditions are markedly different from those below, some of the sound is reflected back to earth where it is picked up and timed. At the instant that the sound leaves the transmitter, a pip appears on the baseline of a scope. The returning sound or echo produces a second pip. The height of the layer is determined by the distance between pips.

A thin stratum may be transparent to low-frequency signals so no echoes are produced. At a higher frequency, strong reflections may result. The thickness of the layer is determined by measuring the wavelengths of sounds at which

# LEARN CODE AND THEORY AS LOW AS \$6.95

ECONOMICAL HOME STUDY COURSES FREE FOR YOU



PASS AMATEUR AND COMMERCIAL CODE EXAMS AND AMATEUR THEORY EXAMS THE EASY FAST WAY. BEAT THE ADVANCED CLASS DEADLINE (closes Dec. 31)

### 3 "AMECO" COURSES AVAILABLE:

#1—NOVICE CODE COURSE. You get and keep 10 recordings (alphabet through 8 W.P.M.). Includes typical F. C. C. type code exams. Free instruction book on learning how to send and receive code the simplest, fastest way, plus an album; plus charts to check your receiving accuracy. **\$7.95** all for the low price of only

#2—SENIOR CODE COURSE. You get and keep everything given in the Novice Course except that you get 22 recordings (alphabet through 18 W.P.M.) plus typical F. C. C. type code exams for General class and 2nd class commercial telegraph licenses. All this for **\$12.95** only

#3—COMPLETE RADIO THEORY COURSE. A complete, simplified home study theory course in radio, covering the Novice Technician, conditional, general, and advanced classes—all under one cover—with hundreds of typical F. C. C. type questions to prepare you for license exams. No technical background required. You also get, FREE, one year of consultation and a guide to setting up your ham station. All for the amazingly low **\$6.95** low price of

All Courses Have Money-Back Guarantee Offer Today or Write for Free Information  
**AMERICAN Electronics Co., Dept. RE11**  
1431 Wilkins Ave., N.Y. 59  
Tel. No. DAYTON 9-4815

### \$3.00 FOR CARTOON IDEAS

RADIO-ELECTRONICS prints several radio cartoons every month. Readers are invited to contribute humorous radio ideas which can be used in cartoon form. It is not necessary that you draw a sketch, unless you wish.

Address

**RADIO-CARTOONS, RADIO-ELECTRONICS**  
25 West Broadway,  
New York 7, N. Y.



# EVERY RADIOMAN

Can Use These SERVICE HINTS!

Valuable Manual Yours—FREE!

Every page of "How to Simplify Radio Repairs" is packed with on-the-bench, practical ideas. Contains photos, charts, diagrams—no fluff—no vague theory. In plain every-day language it gives you priceless suggestions—new servicing ideas. You'll use and benefit from the experience of experts. Partial list of contents: How to Localize Trouble; How to Service Amplifiers; How to Test for Distortion; How to Test Audio Circuits; How to Test Speakers; How to Find Faults in Oscillators; How to Test Radio Parts—and it's all yours—FREE! No obligation.



SEND COUPON OR GOVERNMENT POSTCARD FOR YOUR FREE COPY TODAY!

FEILER ENGINEERING CO., Dept. 12RCS  
8026 N. Monticello Ave.,  
Skokie, Ill. (Suburb of Chicago)  
Please RUSH my FREE copy of "How to Simplify Radio Repairs."  
Name.....  
Address.....  
City.....Zone.....State.....

# PHOTOFACT USERS TELL THE EXPERT WAY TO TACKLE ANY TV-RADIO SERVICE JOB

here's what you do:

**1**

Determine the make and model number of the set on your bench. Use your PF INDEX to find the applicable PHOTOFACT Folder—takes just 60 seconds.



**2**

Reach into your PHOTOFACT library for the proper Folder. You're ready for time-saving, work-saving, expert service action.

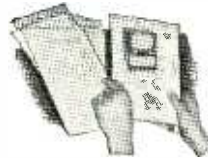

**3**

**YOU HAVE YOUR HANDS ON THE ONE TOOL YOU'LL USE ON EVERY JOB**

Here's what you find in PHOTOFACT Folders: A uniform, consistent presentation of *complete* service data, accurate because it's based on actual analysis of the production receiver. And here are the exclusive features—Standard Notation Schematics with voltages and wave forms right on the diagrams; chassis view photos, top and bottom, with all parts and relationships shown, all alignment points given, all parts identified; tube placement diagrams, top and bottom, all tubes and functions indicated, even socket pin locations shown, including fuse location guide and rating; tube check chart showing common troubles and tubes responsible; complete alignment instructions, including oscilloscope patterns; resistance measurements taken at every tube socket; separate photos of TV tuner, showing all parts locations and alignment points; photos of cabinet showing service controls; complete disassembly instructions; complete parts lists, each part identified by circuit symbol and keyed to schematics and photos—showing ratings, manufacturer's original part number and proper replacements available from 29 leading components manufacturers—plus—dial cord stringing instructions; special service instructions (such as horizontal sweep circuit adjustments, etc.)—everything you have a right to expect in the world's finest TV-Radio service data . . .

**4**

**NOW HERE'S HOW YOU SAVE TIME AND EARN MORE**

You're ready to tackle the job—any job—because you have *all* the answers *instantly* at your finger tips in PHOTOFACT. Here are the *practical* ways it works for you: Suspect a tube? Diagnose and replace the defective tube in seconds—the tube location chart shows you which one and where. Operating voltages correct? The exact answers are right on the schematic—available at a glance. Need fuse replacement? The answer's right on the tube location guide. Defective component? There's the *right* replacement in the parts list. For these and a hundred other problems, PHOTOFACT provides the *instant, correct* solution. That's why the experts use PHOTOFACT—the practical way to *save time and earn more*.

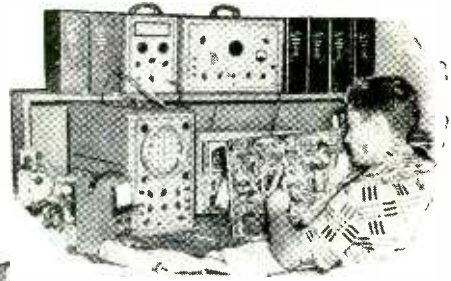
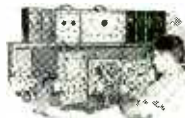

if you're not using the Expert Way—we'll prove you'll save time and earn more with PHOTOFACT service data

**FREE**

**SERVICE TECHNICIANS HERE'S OUR OFFER:**

We'll send you any Photofact Folder listed in the "PF INDEX and Technical Digest." If you haven't an Index, get a Free copy from your local Photofact distributor or write us for it today. To obtain Free Folder, be sure to state Photofact Set and Folder Number exactly as shown in the Index.

NOW—learn for yourself how PHOTOFACT makes your TV and Radio repair work *quicker, easier, more profitable*. We want you to get and use an actual PHOTOFACT Folder. We want you to know why over 35,000 expert service technicians count on this invaluable data daily—count on it for *successful, profitable* business. Get your FREE Folder now. Examine, compare. Then try the Expert Way on your very next job. You'll discover why you can't afford to be without PHOTOFACT!

**NOTE:** Our FREE Folder offer is limited to Service Technicians only. Attach coupon to your letterhead or business card, and mention your jobber's name. Experimenters and others may obtain the Photofact Folder by remitting amount shown below.

**HOWARD W. SAMS & CO., INC.**

HOWARD W. SAMS & CO., INC.  
2205 E. 46th St., Indianapolis 5, Ind.

I am a Service Technician. Send me Free Folder No. . . . . which appears in Photofact Set No. . . . . (as listed in the PF Index).

I am an Experimenter. Enclosed \$ . . . . . Send Folder No. . . . . which appears in Photofact Set No. . . . . (TV—\$1.00, AM/FM—50c. Record Changer or Communications Receiver—75c).

Name . . . . .

Address . . . . .

City . . . . . Zone . . . . . State . . . . .

**EASY PAY PLAN!**

**PAY AS YOU EARN!** Ask your distributor about this desirable plan. Only \$18.39 puts the entire profit-boosting Photofact library in your shop now!

**Yes, your PHOTOFACT Service Data is the ONE TOOL YOU'LL USE ON EVERY SERVICE JOB**

**STOP!**  
**TV INTERFERENCE**

Eliminates interference caused by Short Wave... F.M. Hams... Diathermy... Atmospheric disturbances, etc.

With a **TELEMATIC Full Range FILTER KIT**

**SIMPLE — SPEEDY — EFFICIENT**

- Eliminates antenna-fed interference!
- Covers full-range both I.F. and R.F. Sharper, steadier picture!
- Fewer service recalls!
- Any filter in kit replaceable separately!

**FILTER KIT** contains 2 Hi-Pass Filters, 4 WAVE TRAPS covering full range of interference signals.

Send for FREE Booklet on TV-INTERFERENCE

**TELEMATIC**  
ONE JOHLEMON ST. BROOKLYN 2, N. Y.

A Full Size  
**LIGHTNING ARRESTER**  
at the Price of a Midget

**LIGHTNING ARRESTER**

**MODEL TA5** Real protection against lightning and static charges—the RADIART Lightning Arrester has all the features! Fits anywhere... inside or out... handles standard or jumbo leads... no wire stripping necessary... does not unbalance the line... low internal capacity... no loss of signal... internal resistance "leaks off" static discharges!  
UNDERWRITERS LABORATORIES APPROVED.

**THE RADIART CORPORATION**  
CLEVELAND 13, OHIO

NOVEMBER, 1952





**FOR FINEST TV RECEPTION**

**FOR USE WHEREVER TOUGH WEATHER CONDITIONS PREVAIL  
TESTED AND RECOMMENDED FOR FINEST UHF - VHF RECEPTION**

**GOODLINE SHEATH-LEED**—a NEW DON GOOD PRODUCT—is our fine Standard \*GOODLINE AIRLEAD encased in a tubing of pure polyethylene of finest quality to protect it under all-weather and all-climatic conditions. It is especially recommended for use in coastal areas where salt spray encrusts the regular leadline, in hot humid areas, where much alternate rainfall and strong sunlight prevails and where leadlines are subjected to frost, snow and icy conditions.



Exhaustive tests made after two years have shown that the average flat or round 300 ohm leadline installed within two blocks from the ocean will give but 2 to 4 weeks of satisfactory operation due to salt spray deposits encrusting the leadline. With GOODLINE SHEATH-LEED protection, the product gives highly satisfactory service for a year and more.

For finest trouble-free reception—even in areas where more favorable weather Prevails—INSIST UPON HAVING GOODLINE SHEATH-LEED INSTALLED FOR YOUR LEADLINE.

**NO. 803-GS SHEATH-LEED:** STANDARD BROWN GOODLINE AIRLEAD. Sheathed in pure Polyethylene Standard Brown LEED-SHEATH (another new Don Good product). For 300 ohm use. 1,000 foot reels—standard length... Shorter lengths available.

**NO. 823-GS SHEATH-LEED:** Color—Golden-Clear Goodline Air Lead. Sheathed in Silver-Gray Pure Polyethylene LEED-SHEATH (another new Don Good Product). GOLDEN-CLEAR GOODLINE AIRLEAD is electronic polyethylene in its purest form, and when shielded from ultra-violet light with Silver-Gray LEED-SHEATH, the installation will give years of trouble-free service. For 300 ohm use. 1,000 foot reels—standard length... Shorter lengths available.

**NO. 733-GA: \*GOODLINE AIRLEAD. THE BASIS OF FINEST TV RECEPTION.**  
FEATURES: 1—Sharp, clean, "snow-free" pictures—with 80% of loss producing dielectric web removed. 2—Correct impedance for "ghost-free" reception. Nominal 300 ohms. 3—Lower in cost than other leadlines purported to accomplish same results. 4—Correct spacing for minimum radiation loss. Less than 1% of operating wave length. 5—Fully insulated—approved by safety experts. 6—Pure, electronic polyethylene insulation—specially treated by our chemists for extreme weather. 7—Highly efficient conductors: Flexible, stranded—to insure long life. 8—Easily installed with standard insulators. 9—Packaged: 100'—250'—500'—1,000'—2,500'. Colors: Standard Brown, Golden-Clear and Silver-Gray.

IF YOUR JOBBER or TV DEALER CANNOT SUPPLY, WRITE FOR SAMPLES AND NEW LITERATURE

\*Patent Pending. \*Trade Mark. U.S. and Foreign Patents Pending

**EXCLUSIVE LICENSEE AND SOLE MANUFACTURER**

*Don Good, INC.*

1014 FAIR OAKS AVENUE  
SOUTH PASADENA, CALIFORNIA

**OUTSTANDING GOODLINE PRODUCTS:**

DON GOOD, INC. Manufacturers: Sheath-Leed & Leed-Sheath Protection. Goodline Airlead.



Try YOUR Voice! Talk! Sing! Play! Over 100 Practical Uses!

**Broadcast Thru Any Radio**

Test & improve your voice, playing, thrill & fool friends. Do acts, surprise programs. Imitate Crosby or Hope, announce games & events, be disc jockey, etc. Practise broadcasting, be popular. Educational, over 100 practical uses.

- How do YOU Sound? —Jokes, Party Fun, Home Entertainment
  - Public Address Amplifier —Secret Detectaphone, Overhear Others
  - Intercommunication System —Announce People & Events
- Use with 1, 2 or more radios for powerful public address system, music amplifier, etc. Use to overhear private conversations, hobby or burglar alarm. Used by show barkers. Talk as you walk! Improve personality! Speak better! Sing & Play better! Learn techniques worth many dollars. Do "fake" broadcasts. "Call all cars!" Used in home, school, clubs, shop.

**New Micro-Vox Wireless Microphone**

**Broadcast to Car & Portable Radios Too!**

No Wiring! No Connections! Do Not Touch Radio—Works Normally  
NEW SELF-CONTAINED PORTABLE TRANSMITTER, broadcasts over ANY radio within 75 feet. Even talk from one car to another! No adapters; no experience needed. High fidelity, professional tone, adjustable volume. Adjustable frequency tuning dial. READY FOR IMMEDIATE USE. Electronic 1-tube unit, complete with long-life batteries. Walnut plastic housing. 6-in. high. Operates indoors or outdoors. Uses new war-surplus parts; amazingly low priced; limited quantity. \$8.98

Guaranteed. ORDER NOW. (2 for \$17.50 postpaid). Price (add 25¢ post.) EACH  
JOHNSON SMITH & CO. Dept. 622 Detroit 7, Michigan

echoes appear and disappear. (This can be done with a sweep-type sound generator.)

The illustration shows a height-temperature graph of the atmosphere. Temperature is maximum at the earth's surface and drops steadily as altitude increases up to point P1 which is the lower level of a layer where atmospheric condi-

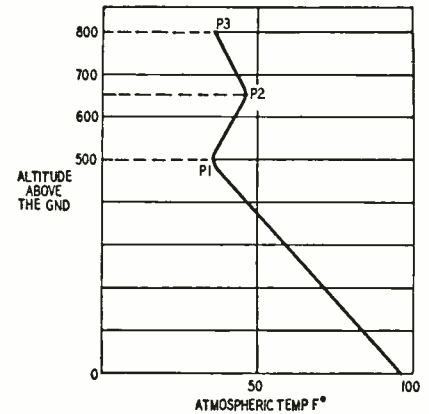

tions are different. Between P1 and P2, the temperature rises with altitude. Above P2, the temperature drops with altitude until another layer is reached. The propagation characteristics of P1-P2 are such that reflections are produced.

**PULSE DELAY**

Patent No. 2,600,185

Lyttleton W. Ballard, Ilchester, Md.

(Assigned to Westinghouse Electric Corp.)

Radar and other circuits often need timing pulses which occur in pairs. For example, the first of the pair can initiate a sweep in a scope. The second pulse terminates the sweep. If the interval between the two pulses is known, the sweep becomes a calibrated time base.

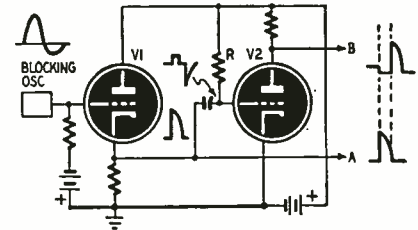

In this circuit, a blocking oscillator generates a sine-like wave (as shown). This is fed to a cathode follower, V1. Negative output is lost because the follower works past cutoff. The positive wave shown at A becomes the reference pulse, that is, the first of the pair. This pulse is also differentiated by the grid capacitor and grid-cathode resistance of V2, giving a wave with positive and negative peaks. The grid of V2 is held positive by R so that grid current damps out the positive peak. The negative pip is amplified and fed to B. It appears as a positive pulse.

Note that the leading edge of B coincides with the trailing edge of A. The time delay depends upon the blocking oscillator frequency.

**HARMONIC GENERATOR**

Patent No. 2,600,560

William T. McMahon, Madison, N. J.

(Assigned to Bell Telephone Laboratories, Inc.)

This invention is useful in telephone circuits, but is suitable for other applications as well. It generates high-order odd harmonics. There are few components and no moving parts. As an example, it can multiply a 20-cycle ringing signal to a 420-cycle ringback tone. This is the 21st harmonic! The 20-cycle fundamental energizes a

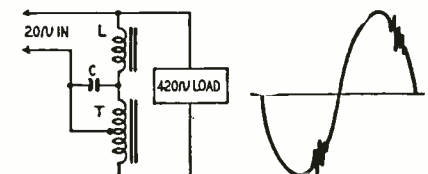

RADIO-ELECTRONICS

telephone ringer. The harmonic is transmitted back to the calling party to let him know when ringing takes place.

The circuit includes a coil L and an autotransformer T. L is worked below saturation but T is saturated by the ringing tone. Due to its non-linearity, T generates a large number of odd harmonics. C tunes L to accentuate the desired harmonic. The inductance of L provides a fixed minimum reactance in the circuit, even when T is saturated.

The harmonic modulates the fundamental, as shown in the insert. The percentage of modulation is governed by the position of the tap on T.

**SINE COMPUTER**

Patent No. 2,598,312

Charles C. Shumard, Hopewell, N. J.  
(Assigned to Radia Corp. of America)

Here is a simple, accurate network for finding the sines of angles. Except where the utmost precision is needed, this circuit can replace the specially-wound potentiometers and complicated mechanical devices now used. The new network (a) uses only 5 fixed resistors and a ganged pair of linear potentiometers.

Full rotation of the ganged potentiometers represents 90°. When their full resistance is in the circuit, the output voltage will be some value E. If the pots are rotated half-way the equivalent angle will be 45°, and the output is .707E. (The sine of 45° is .707.) The output voltage is always proportional to the sine of the angle of rotation. The error at any angle is shown at b. Maximum error is only about .36%.

The network gives only sines, but cosines are

easily determined. The sine of any angle is the same as the cosine of its complementary angle.

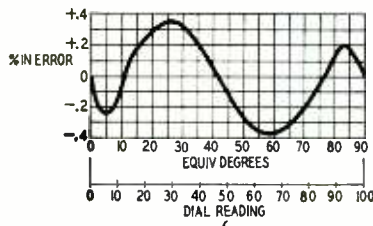
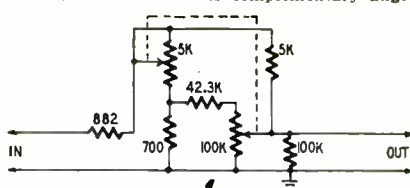

**D.C. TO A.C. CONVERSION**

Patent No. 2,600,172

Ercell E. St. John, Oak Ridge, Tenn.  
(Assigned to United States of America as represented by the U. S. Atomic Energy Commission)

This is an ingenious system for converting weak d.c. signals to a.c. (The a.c. can be amplified more efficiently than d.c.) This circuit has high conversion efficiency, linearity and signal-handling ability. It uses no vibrators or other moving parts.

A 400-cycle square wave from generator B feeds through an R-C network to oppositely poled diodes. (These diodes, D1, D2, may be in a single envelope, as in a 6AL5.) The cathode of D2 is biased positively by a signal A.

The negative half of B is completely shorted out by D1. D2 does the same to the positive half, only when its bias is zero. If a signal A does exist, there will be bias on D2 and part of the positive square wave remains. We will give an example. Assume that B has a peak of 5 volts, and that A is 1 volt. D2 conducts only when its plate is more positive than its cathode. Therefore it conducts and shorts out any part of the positive wave of B that exceeds 1 volt. The amplitude can go no lower because the plate of D2 would be less positive than the cathode.

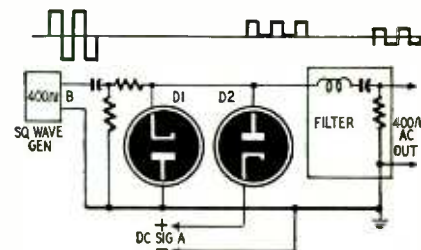

In every case, therefore, the filter input is a positive pulsating-d.c. square wave with a peak value equal to A. The filter extracts the fundamental frequency (400 cycles) only. Thus its output is a pure a.c. voltage which is proportional to A.

**TeleSound CUSTOM-BUILT TV CABINETS**

DIRECT FROM MANUFACTURER TO YOU—COMPARE PRICE and QUALITY!

Be price conscious! TELESOUND Wholesale Prices enable you to sell more, make a BETTER PROFIT for yourself!



H:25", D:21 1/2", W:25" Wgt: 50 lbs.  
TABLE MODEL 500 ..... \$42.00

As above, for 24" Picture Tube  
H:31", D:24", W:27" Wgt: 60 lbs. .... \$55.80



H:40 1/2", D:22 1/2", W:25 1/4"  
CONSOLE MODEL 200 ..... \$45.50

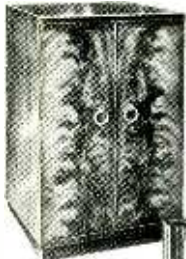

H:40 1/2", D:24", W:25"  
CONSOLE MODEL 800 ..... \$82.50

ALL PRICES TAX INCLUDED

**TV PICTURE TUBES**

**SHELDON BLUE LABEL**  
One Year Guarantee  
Dumont—1 Year Guarantee  
Fidelity—1 Year Guarantee  
**DON'T BE MISLED—**  
Demand Guaranteed STANDARD BRANDS!

12 1/2" Black or White	\$20.50
14" Glass Rect. (Blk)	\$20.50
16" Glass Round (Blk)	\$30.50
16" Glass Rect. (Blk)	\$30.50
17" Rectangular (Blk)	\$29.50
19" Round (Blk)	\$33.50
20" Rectangular (Blk)	\$35.50
21" Rectangular (Blk)	\$39.50
24" Metal	\$69.50
27" Rectangular	Wholesale Price on Request

**Famous SUPER DeLUXE 630 CHASSIS**

—YOUR CHOICE—  
**REGAL**  
or  
**VIDEO** Model 630K3C



SMASHINGLY LOW PRICED!

**\$142.50**

- 30 tubes—for 16" to 24" Picture Tubes
- High Efficiency High Voltage Circuit
- Keyed AGC

- Automatic brightness control
- Special extra high gain Cascade Stand-ard Coil Tuner

- Directly adaptable for UHF.
- 12" Quality Speaker
- Factory wired, aligned, tested.

- Complete, ready to play, including tubes, knobs and hardware
- Less CRT

Video 630DX DeLuxe Chassis for extreme fringe areas. Complete, \$149.50  
Techmaster C-30 Chassis, Complete with Tubes & Speaker, Less CRT, \$149.50  
DeLuxe Techmaster 2431P Chassis. Complete less CRT ..... \$189.50  
FREE OFFER! Schematic Diagram and complete 24 page service manual FREE with any of these chassis!

**Here's the "PACKAGE DEAL" You've Waited for!**

SAVE MONEY! Order the cabinet of your choice from the TeleSound models illustrated, in combination with the famous 630 TV Chassis, (Regal or Video), 12" speaker, and your choice of picture tube. If Techmaster C-30 chassis desired, add \$10.00 to combination price. (For deluxe Techmaster 2431P chassis, add \$50. For Video 630DX DeLuxe chassis add \$10. Check these sensationally low prices:

CABINET STYLE	COMBINED WITH Super 630 chassis, 12" speaker, and			
	17" CRT	20" CRT	21" CRT	24" CRT
500	\$205.75	\$211.60	\$215.50	\$258.20
200	209.15	215.00	218.90	.....
800	245.10	251.05	254.95	.....
1200*	291.50	297.35	301.25	.....

\*Record Changer not included.

**TERRIFIC TELESOUND OFFER**

Any above combination, consisting of your choice of TV chassis, 12" P.M. Speaker and Picture Tube. **FACTORY-INSTALLED** in the cabinet of your choice, tested, and ready to play ..... for only **\$15.00** Additional

Please include 25% deposit with orders, balance C.O.D. All shipments F.O.B., NYC "Designers & Manufacturers of Custom TV and Radio Furniture"

**TeleSound CORPORATION**

421 West 28th Street  
New York 1, N.Y.  
Phone: WI 7-0719



# one model for all tv sets



Pat. App. For

Order the Engineered Product — installs permanently inside cabinet in minutes (no wiring or soldering) — fully automatic — 3 boost positions to select desired tube brilliance.



- ★ For either Series — or Parallel-wired filaments.
- ★ Increases electron emission, makes dim tubes **BRITE**
- ★ Isolates filament, relieves cathode-filament shorts.



- ★ Line power supply, does not disturb any TV Set circuits.
- ★ Made to sell, packaged to sell:

Write for complete, illustrated literature.  
SOLD through recognized wholesalers ONLY. ORDER TODAY!

**Perma-Power COMPANY**  
4721 N. Damen Ave., Chicago 25, Ill.

"Manufacturers of electronic equipment since 1928"

## RECURRENT PULSE GENERATOR

This timing circuit delivers periodic current pulses to the coil of a ratchet relay in the telemetering system of an experimental radiosonde. The diagram is one of several interesting ones discussed by Verner E. Suomi and Earl W. Barrett in *The Review of Scientific Instruments*.

The 0B2 voltage-regulator tube is used as a relaxation oscillator. For best results, connect the 0B2 with polarity opposite that used for voltage-regulator service. Initial application of battery

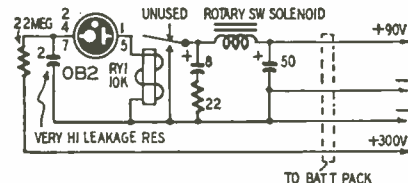

voltage causes the 2-μf capacitor to start charging through the 22-megohm resistor from the 300-volt supply. When the charge reaches about 130 volts the 0B2 conducts and the capacitor begins discharging through the coil of relay RY-1. When the voltage drops slightly below 105, the tube cuts off and the capacitor again begins charging toward 300 volts. Upon reaching 130 volts, the tube conducts and the cycle begins anew.

Each time the 2-μf capacitor discharges through the coil of RY-1, the contacts close momentarily. This causes approximately 4 amperes to flow from the 90-volt battery and the 50-μf capacitor through the solenoid and contacts of RY-1 to ground. The surge of current through the solenoid operates the ratchet relay. If the 50-μf capacitor is omitted, the current from the battery alone is not sufficient to operate the solenoid relay because the internal resistance of the batteries limits the discharge current.

The 8-μf capacitor and 22-ohm resistor absorb the arc which would occur across the close-spaced contacts of RY-1 at the instant that it opens. RY-1 is a plate-circuit relay (Sigma 10-MZ) having a 10,000-ohm coil. Its contacts should not remain closed for more than 80 milliseconds. With the values shown, the pulses recur at intervals of about 7 seconds. The 2-μf timing capacitor should be carefully selected for a very high resistance. Use an oil-impregnated paper capacitor with the highest possible voltage rating for best results.

## ECONOMICAL BIAS SUPPLY

If you need a low-current bias supply delivering up to 150 volts for biasing a transmitter or amplifier, you can't beat the circuit shown. This circuit, which uses a full-wave rectifier to simplify filtering, delivers 150 volts pure d.c. with zero load.

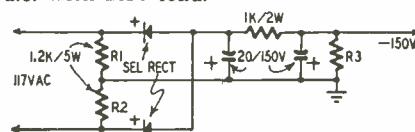

Our January number will again be a  
**SPECIAL TELEVISION ISSUE!**

All the receiver and antenna directories, C-R tube and components replacement lists and the other features which made this number a must in past years will again be present in expanded form, together with new material on u.h.f. prospects, equipment and techniques.

Watch for the  
**1953 SPECIAL TV ISSUE!**

# TELEVISION

*Big demand for graduates*

**B.S. DEGREE IN 27 MONTHS** in radio including TV engineering—VHF, UHF, AM and FM. Students use over \$100,000 worth of equipment including 2 large commercial type transmitters in new TV lab. Intense specialized course includes strong basis in mathematics, science and advanced design in radio and TV.

Hundreds of young men each year are earning engineering degrees in this recognized institution. Start any quarter. Many earn a major part of expenses in this industrial center. Low tuition. Competent instruction. Thorough, intense, practical program.

Also **B.S. DEGREE IN 27 MO.** in Aeronautical, Chemical, Civil, Electrical and Mechanical Engineering. G.I. Gov't approved. Enter Dec., March, June, Sept. Free catalog. **ENROLL NOW**

**INDIANA TECHNICAL COLLEGE**  
17112 E. Washington Blvd., Fort Wayne 2, Indiana

PLEASE MENTION  
**RADIO-ELECTRONICS**

when answering advertisements



# MUSIC LOVERS

Full Range Tone is possible on your phonograph.

A General Electric Reluctance Pickup in place of your present crystal will make all the difference in the world.

**WE DO THE WORK . . .  
YOU ENJOY IT**

Disconnect your tone arm and mail it to us. We will install the GE Cartridge for you and furnish you with an easy plug in preamplifier requiring no tools. WE pay postage.

TOTAL Cost to you only **\$14.50**

Please tell us types of tubes when ordering.

**JAN ELECTRONIC DIST. CO.**  
222 Fulton St., N. Y. 7 Worth 4-0632

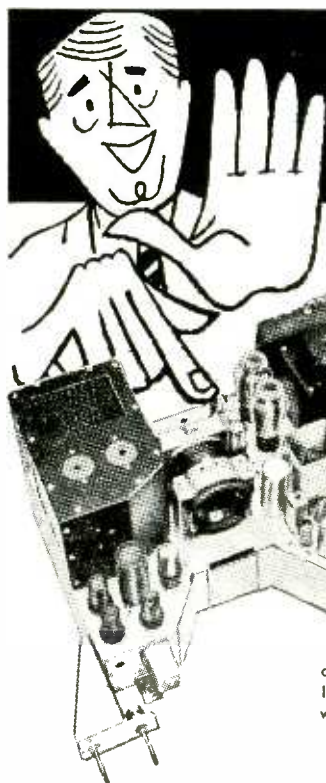

# DON'T BUY BEFORE CHECKING STEVE-EL'S PRICES!

The new and improved Super Famous "630" T.V. Chassis, is a 30 tube high quality television receiver (including 3 rectifiers). Manufacturer licensed under Radio Corporation of America patents. This chassis is the standard by which all other T.V. chassis are measured. Standard R.M.A. Guarantee! FREE replacement on defective tubes and parts.

**FEATURES:** • Full channel coverage. • Discriminator-type FM sound system. • Improved picture brilliance. • AFC horizontal hold. • Keyed AGC. • Stabilized vertical hold. • 3 stage sync. separator and clipper. • Automatic brightness control. • 4 Mc band width. • Highest quality parts used. All standard tubes. • For all Cathode Ray tube sizes and types. 16", 17", 19", 20" and 24" Tubes. Perfect for Fringe Area Reception.—Will work where most sets fail to operate.

**NEW 1953 "630" TV CHASSIS**  
*World's Finest!*  
**Only \$138<sup>50</sup>**

**With HiGain Cascade Tuner**

R.C.A. Hi-Fi 12" Speaker complete with knobs and hardware. Complete with Fed. Taxes Paid. Less Cathode Ray Tube **\$138.50**

**630D F. Chassis**—Extra power for fringe areas. Can be operated without booster or complicated antenna. Complete with Fed. Taxes Paid. Less Cathode Ray Tube **\$151.50**

**Universal Cathode Ray Chassis Mounting Brackets** Used to mount CRT on 630 Chassis. Fits all tubes. Complete—includes band to hold picture tube. CAT. No. X-404 **\$5.55**

If brackets are ordered with 630 chassis..... **\$4.95**

## CASCADE TUNER

Now get pictures never before obtainable. Convert your old tuner to the amazing new STANDARD COIL CAS-CODE. **\$19<sup>95</sup>**

**LUCITE** 17" ... \$5.95 21" ... \$ 7.95

**MASKS** 20" ... 6.95 24" ... 13.95

## WEN SOLDERING GUN

Heats in 3 to 5 seconds. Perfectly balanced. Built-in spotlight. Handle and case are heat and shock resistant.

250 Watts, 120 Volts A.C. only.

**\$9<sup>71</sup>**

List \$12.50

For Limited Time Only . . . . .

## TV PICTURE TUBES

**All Brand New STANDARD BRANDS —NO REBUILTS**

**GUARANTEED FOR ONE FULL YEAR**

14BP4	.....	\$19.95
16GP4	.....	26.00
16KP4	.....	23.40
17BP4	.....	23.40
19AP4	.....	23.95
20CP4	.....	32.00
21EP4	.....	34.40
24AP4	.....	59.60

## FREE

Write Dept. RE-11 for latest catalog and complete list of tubes on sale.

## STANDARD BRAND TUBES

Individually boxed and fully guaranteed (Manufacturers of tubes refuse permission to mention name because tubes are FAR BELOW FAIR TRADE PRICES).

1A7	... .89	6AG5	... .79	6CB6	... .71	6X5	... .62	12SQ7	... .68
1B3	... .89	6AH6	... 1.29	6CD6	... 2.39	7C5	... .74	14A7	... .84
1H5	... .71	6AK5	... 1.29	6J5	... .54	7F7	... .74	14B6	... .94
1N5	... .74	6AL5	... .68	6J6	... .94	7K7	... 1.09	25BQ6	... 1.29
1R5	... .79	6AQ5	... .59	6K6	... .66	7N7	... .84	25L6	... .64
1S5	... .79	6AT6	... .68	6K7	... .74	12AT6	... .65	25W4	... .78
1T4	... .79	6AU6	... .69	6SA7	... .64	12A7	... .99	25Z6	... .62
1U5	... .78	6BA6	... .69	6SH7	... .64	12A7	... .86	35L6	... .86
1X2A	... .94	6BC5	... .74	6SJ7	... .74	12A7	... 1.19	35W4	... .52
3Q4	... .89	6BE6	... .79	6SK7	... .72	12AX7	... .99	35Z5	... .51
3Q5	... .89	6BC6	... 1.76	6SL7	... .74	12BA6	... .69	50A5	... .96
3V4	... .73	6BH6	... .86	6SN7	... .74	12BE6	... .69	50B5	... .74
5U4	... .63	6BK7	... 1.15	6SQ7	... .64	12BH7	... .99	50C5	... .66
5V4	... .97	6BQ6	... 1.24	6T8	... .99	12SA7	... .77	50L6	... .64
5Y3	... .47	6BR7	... 1.15	6V6GT	... .64	12SK7	... .77	11Z3	... .64
6AC7	... .94	6C4	... .54	6W4	... .64	12SN7	... .84		

Also partial listing only. Send for complete list.

# STEVE-EL ELECTRONICS CORP.

61 READE STREET • NEW YORK 7, N. Y.

Phone COrtlandt 7-0086



# TV DIRECT FROM THIS GREAT FACTORY TO YOU

BRINGS YOU  
**Finest Quality at Lowest Prices**

## TRANSVISION

**TV KITS, WIRED CHASSIS, and SETS**  
CABINETS, COMPONENTS, INSTRUMENTS, and ACCESSORIES  
**MAKE MONEY**  
on Top Quality TV Picture Tubes:

- **TRADE-IN ALLOWANCE**  
Make from \$2.00 to \$5.00 glass allowance on each "dud."
- **FULL 2 YR. GUARANTEE:**  
Only Transvision gives you a Guarantee for 24 months.

**FREE BOOKLET:** "INSIDE CRT, or What You Should Know About Picture Tubes." Written by CRT experts, illustrated. It will **MAKE MONEY FOR YOU.** WRITE FOR IT NOW.

**FREE CHART:** Write for Picture Tube Interchangeability Chart.

**COMPARE:** Get the full details on the Transvision tube deal today.

New... TRANSVISION Picture Tube PRICES

Tube Type	Cost, WITH GLASS allowance	Cost, WITHOUT GLASS allowance
10BP4	\$11.80	\$13.80
12Y4" Glass (any type)	13.45	15.75
12Y4" Metal (any type)	13.95	16.25
14RP4	16.50	18.25
16" Metal (any type)	19.90	23.20
16" Round or Rect. (any type)	18.90	22.25
17BP4	18.90	22.25
19" Metal or Glass (any type)	23.95	28.95
20CP4	26.95	31.95

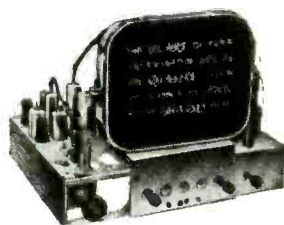

**Sensational Offer:**  
**TV \$39**  
**KITS**  
DOWN\*

Build World's Finest Chassis—the A4

\***BUILD THE FINEST CHASSIS MONEY CAN BUY** with the famous A4 Kit by Transvision. **PAY AS YOU WIRE—only \$39 for the starting package.** Easy to assemble, enjoyable, educational—gets you the most superb TV set imaginable. Easiest to service, too. Don't put it off. With these easy terms you can get started now. Also **WIRED CHASSIS at LOW COST.** The A4 in completely wired chassis form gives you the world's finest TV set, with latest circuits and extra sensitivity for fringe areas. Gives clearer, brighter picture. Easy to service and keep up to date; built to last for years. Write for amazing low prices.

**SIZES:** The A4 Kit and Wired Chassis are available in 17" and 20" sizes. Also with **REMOTE CONTROL.**

**BEAUTIFUL TV CONSOLES**

Ideal for Custom-Building or Conversion. Factory prices start from \$49. Send for Cabinet Catalog now.



**MULTI-SET CONNECTORS**

feed up to 5 TV Sets from 1 Antenna  
Prices: Multi-Set Conn. for 2 sets... \$4.95 list\*  
For 3 or 4 sets... 7.95 list\*

\*Dealers, write for discounts

**U. H. F. ADAPTERS**

will be available for all Transvision Sets and Kits.

Write for Transvision's Factory Agent Plan and complete literature

**FREE:** EXTRA INCOME EVERY MONTH from hints in "TV and Electronics Notes." Request addressograph plate and mailing for FREE. Or send 50c to cover cost of sample copy. Monthly issues are gold mines of Products, Sales, Service, Conversion, etc. **WRITE DEPT. RE-11 TODAY!**

**TRANSVISION, INC. NEW ROCHELLE, N. Y.**

If the load impedance R3 is 10,000 ohms or more and the external load does not draw current, only about 2.5 watts is dissipated in R1 and R2. If R3 is much less than 10,000 ohms and includes the total impedance across the output of the supply, increase the wattage rating or the resistance of R1 and R2. If their resistance is increased and the supply delivers power to the external load, the output voltage will decrease considerably. If you require a small positive-voltage supply, reverse the connections to the selenium rectifiers and the polarity of the filter capacitors.—Lt. Frank R. Williams

**NEW RADIATION METER**

Radioactivity radiation meters are widely used in health monitoring, contamination surveys, in the manufacture of radiochemicals, and in specialized industrial applications such as measuring the thickness of certain materials. The range of radiation intensities that can be handled by many such instruments is limited if the indicating meter has a linear scale.

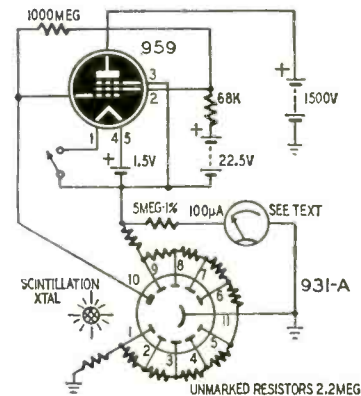

The novel portable radiation meter shown in the diagram is one of several similar models developed by the Chalk River Laboratories of the National Research Council of Canada, and described in *The Review of Scientific Instruments*, by R. E. Bell and R. L. Graham. It has a logarithmic meter which permits measurements of a wide range of intensities. The detector element consists of a scintillation crystal and a 931-A, 1P21, 5819, or similar photomultiplier tube. The 959 acorn-type tube is used as a constant-current tube. Its purpose is to raise or lower the voltage applied to the anode of the photomultiplier to keep the current through the circuit constant under varying levels of radiation intensity.

The voltage for the photomultiplier electrodes is taken from across the 5-megohm cathode resistor for the 959. A voltage divider consisting of ten 2.2-megohm resistors distributes the voltage to the electrodes. The meter reads the cathode voltage of the 959 and indicates approximately the logarithm of the intensity of radiation. It is mounted in an inverted position. The scale, calibrated from 1 to 10,000 mR units per hour, extends from 1,150 volts on the left to 300 volts on the right. The needle is backed off mechanically so the normal zero point corresponds to 300 volts.

**FIELD-STRENGTH METER**

Field-strength meters are widely used in adjusting antennas and for checking the fundamental and harmonic output of transmitters. A meter of this type which covers from 140 kc to 33 mc in five bands is described in *L'Antenna* (Milan, Italy). The circuit of the instrument is shown in the diagram. The tuning capacitor is a 500- $\mu$ f unit. A single 365- $\mu$ f unit or two such units connected in parallel can be used. In either case the tuning ranges will be slightly different from those listed in Table I.

**Table I**

Band & range	No. of turns	Tap
(1) 140-420 kc	See text	
(2) 415-1,250 kc	110 turns No. 36 jumble-wound	20 turns
(3) 1.1-3.0 mc	45 turns No. 32 close-wound	10 turns
(4) 2.8-8.3 mc	13 turns No. 28 close-wound	4 turns
(5) 8.0-33 mc	5 1/2 turns No. 20 spaced diameter	2.5 turns

Note: All coils wound on 1/2-inch forms.

Details of the 140-420-kc coil are not listed in the table. It consists of four bank-wound pies of No. 36 cotton-covered enameled wire. The pies have 40, 155, 155, and 70 turns respectively. The antenna is connected across the 70-

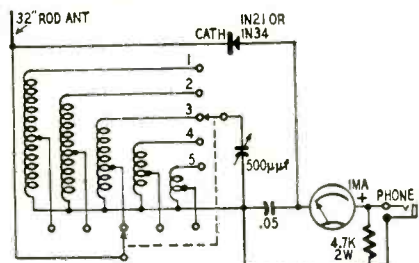

turn pie. As a substitute, use a long-wave (aircraft) antenna coil or a 4-pie, 5-mh r.f. choke with the tap between the first and second pies.

**Table II**

Meter reading (ma)	Decibels
0.015	0
0.10	4.5
0.20	8.5
0.30	11.0
0.40	13.0
0.50	14.5
0.60	16.0
0.70	17.0
0.80	18.0
0.90	19.0
1.00	20.0

The diode and meter circuits are tapped down on the tuned coil to minimize loading and to sharpen tuning. Meter readings can be converted to decibels by using Table II. END

NOVEMBER, 1952

# Servicemen - BOOST YOUR INCOME - SAVE HUNDREDS of DOLLARS

—these TRANSVISION Instruments are *real necessities*—a "must" for your shop if you are not to throw good money away.

**Here's why: —**

1. **TESTING**—you can accurately test Cathode Ray Tubes.
2. **REACTIVATING**—you can save many dim or worn out tubes by reactivation.
3. **SPARKING OUT ELECTRICAL LEAKAGE** — many Cathode Ray Tubes develop electrical leakage. This can now be repaired.

## CRT TESTER-REACTIVATOR-SPARKER

**3 Instruments in 1, making a complete CRT testing and repair unit. Compact, dependable, profitable.**

It's a combination of the Transvision **TESTER-REACTIVATOR** and **TESTER SPARKER** in one handy instrument. It **TESTS PICTURE TUBES**—measures Cathode emission, locates shorts between elements, locates high resistance shorts or leakage as high as 3 megohms. **REACTIVATES DIM TUBES. SPARKS OUT ELECTRICAL LEAKAGE** in picture tubes.

Fully Guaranteed. ....

**\$34<sup>95</sup>** net

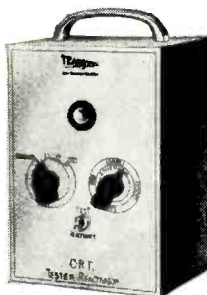

## CRT TESTER-REACTIVATOR

**2 Instruments in 1.** As a **REACTIVATOR** it renews brightness, sharpness, and detail of old dim CR Tubes, without removal of tube. It's also an accurate **TESTER: Measures Cathode emission, locates shorts between elements, locates high resistance shorts or leakage as high as 3 megohms.** 110V-60 cycles; wt. 3 lbs. Fully Guaranteed. ....

**\$19<sup>95</sup>** net

## CRT TESTER-SPARKER

**2 Instruments in 1.** As a **PICTURE TUBE SPARKER**, it sparks out electrical leakage between elements. *Saves many picture tubes and small tubes* which would usually be discarded. Cathode-grid leakage is an especially common occurrence. The *Sparker* also gives a rapid check of gas condition of the tube.

As a **TESTER** it provides a variable 8,000-14,000 D.C. supply—useful for analyzing hard-to-solve deflection problems. Fully Guaranteed. ....

**\$19<sup>95</sup>** net

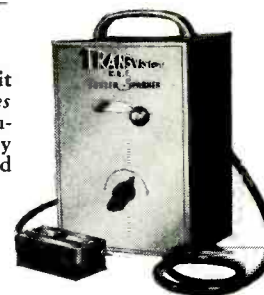

## FIELD STRENGTH METER

for better TV installations. Make more efficient, more profitable TV installations, and save half the work, with the Transvision Field Strength Meter. *Especially good for fringe areas*—measures field strength as low as 10 microvolts. A great buy at this low price. **\$59** net

Order direct from **TRANSVISION, INC., New Rochelle, N. Y.**

-----RUSH THIS COUPON-----

**TRANSVISION, INC., Dept. RE-115 NEW ROCHELLE, N. Y.**

Please send

\$.....deposit enclosed; send C.O.D. .... in full enclosed; send prepaid.

Name ..... Address .....



## RECEPTION TROUBLES

# LICKED!

Salt air?  
Hot damp climate?  
Strong winds?  
Poor "fringe" reception?

### NEW SYNKOTE *All-weather* TWIN-LEAD gives clearer, steadier pictures all year 'round

This new SYNKOTE 300  $\Omega$  *all-weather* twin-lead is absolutely the finest ever made — stronger, thicker, and with a lower signal loss than even the popular 100 mil twin-lead introduced by Plastoid early this year. Each lead contains #18 stranded wire imbedded in a heavy (185 mil) brown or translucent white polyethylene web. Ideal for fringe areas, long drops and windy climates, this new twin-lead strongly resists sunlight, salt air, heat, snow, ice and abrasion.

Ask your jobber today to show you this ultra-rugged SYNKOTE lead-in. The catalog number is #PP 3444.

# Synkote®

## DEPENDABLE

HOOK-UP WIRE • COAXIAL CABLE • TV LEAD-IN WIRE

### PLASTOID

Corporation Long Island City 1, N. Y.

"Manufactured by the mile . . . tested by the inch"

### OPPORTUNITY AD-LETS

Rates—35¢ per word (including name, address and initials). Minimum ad 10 words. Cash must accompany all ads except those placed by accredited agencies. Discount for 6 issues, 10%, for 12 issues, 20%. Misleading or objectionable ads not accepted. Copy for January issue must reach us before November 21, 1952.

Radio-Electronics, 25 W. Broadway, New York 7, N. Y.

SPEAKERS REPAIRED at wholesale prices. Guaranteed workmanship. Fast service. Amprite Speakers Service, 70 Vesey St., New York 7, N. Y.

Brand New! AUTOMATIC DEFROSTER UNIT for old refrigerator sells like wildfire at \$7.95. Sweeps costly competition into discard. You make up to \$1.00 on every sale. Rush name for free offer. DEFROSTER SALES CO., 415 N. LaSalle, Dept. HC-173-T, Chicago 10.

TUBES AND EQUIPMENT BOUGHT, SOLD AND EXCHANGED. For a fair deal send details to B. N. Gensler, W2LNI, 136 Liberty, N. Y. 6, N. Y.

WE REPAIR, CONVERT, SELL, ALL TYPES OF electrical instruments, tube checkers and analyzers. Hazleton Instrument Co. (Electric Meter Laboratory), 128 Liberty Street, New York, N. Y. Telephone—BARclay 7-4239.

WANTED—TOP PRICES PAID—Navy Selsyns 1DG, 1F, 1CT, 5CT, 5D, 5DG, 5G, 6G, 7G, etc. and BC-348, BC-221, AN/ART-13, AN/ARC-1, AN/ARC-3, RTA-1B, AN/APR-4. Lectronic Research, 719 Arch St., Philadelphia, Pa.

WANTED: AN/APR-4, other "APR-", "TS-", "IE-", ARC-1, ARC-3, ART-13, BC-348, etc. Microwave Equipment, everything Surplus, Special tubes, Tec Manuals, Lab Quality Equipment, Meters, Fast Action, Fair Treatment, Top Dollar! Littell, Parhills Box 26, Dayton 9, Ohio.

BUY WHOLESALE—25,000 ITEMS—CATALOG 25¢. Matthews, 1472-P2 Broadway, N. Y. C. 36.

ELECTRONIC CIRCUIT DESIGN RADIO ENGINEERING problems. Willard R. Moody, Consulting Electronics Engineer, 5705 Carters Lane, Riverdale, Maryland.

ALL TYPES OF ANTENNAS FOR AMATEUR AND TV. Aluminum Tubing, Willard Radcliff, Postoria, Ohio.

TV AND FM ANTENNAS, YAGI, CONICAL, BOW-TIE Mounts, accessories. Lowest Prices. Wholesale Supply Co., Lunenburg 2, Mass.

ENJOY 3 COLOR TELEVISION SCREEN, SEND \$1. State Screen Size. Zingo Products, Dept. K, Johnstown, New York.

## Try This One

### CABINET SCRATCHES

Often service technicians have difficulty in concealing cabinet scratches where the finish is not broken down to the wood. A simple trick helps to hide the blemish—use a needle to puncture the scratch in a few places so that the stain can penetrate and soak into the wood.—*B. W. Welz*

### NOVEL CRYSTAL SET

This crystal receiver uses a pair of 1N34 germanium diodes in a modified bridge rectifier circuit which approximately doubles the signal level obtained from a half-wave detector using the same tuned circuit and antenna. The coil consists of 200 turns of No. 26

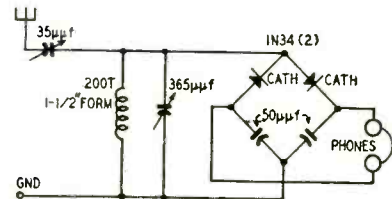

enameled wire on a 1½-inch form. I used 50-µmf capacitors in the detector circuit but you should experiment with smaller and larger values to obtain optimum results. I get good results with a 45-foot antenna only 15 feet off ground. No doubt a longer, higher antenna will provide a stronger signal.—*Richard Wurtzinger*

### SAVING TEST LEADS

Frequently phone cords and test leads fray, short-circuit, or open up at or near the point where the lead enters the tip. The life of these leads can be greatly prolonged by covering the upper part of the metal tip and the adjoining section of the lead with rubber cement. I use FoMoCo rubber cement sold by Ford auto accessory dealers. It dries to a semiflexible state and transfers the strain from the wire insulation to the tip. This minimizes wire breakage.

This cement has literally hundreds of uses in a radio service shop. It will hold rubber, cloth, wood, etc., to metal. It can be used, for example, to cement speaker cones in place, to attach grill cloth to metal or plastic cabinets, or to hold down patches of covering material which have become detached from a cabinet or container.—*R. Albert Greninger*.

### LOOSE TUBE BASES

Tubes in which the glass envelopes have come loose from their bases should not be kept in service. The envelope is likely to twist and cause the leads to short and damage other components in the equipment. Instead of replacing such tubes, repair them by applying a heavy layer of Miracle cement around the area where the envelope joins the base. Let it dry for about 24 hours and the tube will be as good as new.—*Alan M. Parker*

RADIO-ELECTRONICS

the only personal part of any communication system!

more LISTENING COMFORT with . . .

TELEX lightweight headsets!

Modern, lightweight, durable . . . Easily adjustable and built for hard usage, TELEX Headsets give top quality reception without the punishment of extra weight and pressure.

Office Transcribing Machines • Radio Monitoring • Telecasting • Amateur Radio • Record Stores • Theaters • Phone-Order Boards • Wired Music Installations • Commercial Communications • Electronic Laboratories.

Telex produces headsets to manufacturers' specifications



For complete information on any of the above headsets, write

TELEX ELECTRO-ACOUSTIC DIV., Department 4-C St. Paul 1, Minnesota

In Canada: ATLAS RADIO CORP., Toronto

Trade Mark Standard of the World for Quality Headsets

**TELEX**  
HEARING AT ITS BEST

the only personal part of any communication system!

**\*MONOSET**

The modern styling and the dependability and superior performance of the TELEX Monoset have made old fashioned headphones obsolete. Magnetic.

**\*DYNASET**

New dynamic under-chin TELEX Dynaset, with more highs and lows of both music and speech, is the delight of radio and TV monitors. Weighs only 1.25 oz.

**\*TWINSET**

This lightweight 1.6 oz. TELEX Twinset pipes signal directly into the ear, blocking out ground noises and banishing listening fatigue. Magnetic.

**\*EARSET**

Sensitive TELEX Earset slips onto ear and is preferred by all who use single-phone headsets. Weighs only 1/2 oz. and leaves other ear free for phone calls or conversation.

**THIRD HAND FOR SOLDERING**

Although many gadgets have been devised to substitute for an extra hand while soldering loose radio components, I find that you can still do a good job with your fingers. Furthermore, you won't misplace them just when you need them most.

Wind some solder around the index finger, letting the end protrude about 2 inches. Grasp the component to be soldered or tinned between the thumb and middle finger, manipulating the solder with the index finger, and, with the soldering iron in the other hand, you're in business.

Incidentally, if you don't have the time or patience to coat the tip of your soldering iron with silver solder, the iron will tin easier and hold it longer if you use a very coarse file rather than a fine one for dressing the bit.—Don Freitag

**TV ANTENNA TRICK**

Weak or burned out tubes in the front end or i.f. stages of a TV set often cause troubles which have the same effect on performance as a defective lead-in system. Since checking the antenna is usually the first step in a service call of this nature, we have lost a lot of valuable time in the past, climbing up on the roof or tower to check the antenna and lead-in, when the real trouble was in the set.

To minimize these useless trips, we now connect a 4,700-ohm, 1/2-watt resistor across the lead-in terminals at the antenna whenever we install vees, conicals, and all other antennas that do not have folded-dipole radiators. Now, if we suspect antenna lead-in trouble, we can check it quickly by connecting an ohmmeter across the lead-in at the set. (The lead-in should be disconnected from the receiver antenna terminals if the set does not have blocking capacitors in the input circuit.) This is not necessary with a folded-dipole antenna because the antenna itself is a short across the lead-in. In either case, a break in the lead-in is indicated by a very high or infinite resistance.—Alvin B. Kaufman

**CHASSIS PUNCHING**

You can save a lot of energy and time if you use this method the next time you use a Greenlee or Pioneer type socket punch. After drilling the pilot hole, assemble the punch in the usual manner, but make sure that the cap-screw head is on the outside of the chassis. Fasten the screw head in a vise and tighten the punch with your fingers. Now, all you have to do is turn the chassis clockwise until the hole is punched. After the hole has been punched, the chassis can be lifted off so the socket punch can be disassembled while still in the vise.

This procedure is particularly useful when a number of identical holes must be punched. You don't have to remove the screw or the die from the vise until you have completed the job.—James L. Somerville

**Compare!**

PROVE EMC SUPERIORITY!



**MODEL 106**  
**Vacuum Tube Voltmeter**  
**✓CHECK THESE FEATURES**

Specially designed for field alignment of television and radio sets. Uses dual triode balanced bridge circuit. All functions and ranges completely electronic—meter cannot burn out. Zero center position for FM discriminator alignment. Uses 1% precision resistors for voltage multipliers. 5 DB ranges. Full scale deflection of 1 1/2 volts for both AC-DC volts. Measures resistance in 5 ranges from .2 ohm to 1000 megohms. 1 Meg isolating resistor in probe.

**SPECIFICATIONS**

**DC VOLTAGE:** Input resistance 16.5 megohms or 1 1/4 megohms per volt. Ranges: 0 to 1.5, 10, 100, 300, 1000 up to 30,000 volts (with accessory probe.)

**AC VOLTAGE:** Input resistance 2 megohms. Ranges 0 to 1.5, 10, 100, 300, 1000. Frequency response flat from: 25-100,000 cycles.

**OHMS:** 1000—10,000—100,000—10 megohms, 1000 megohms.

Compact, portable bakelite case measures 4 1/4" x 5 1/4" x 2 7/8".

**MODEL 106 . . . . . \$35.90**  
**In Kit form . . . . . \$23.90**  
**MODEL HVP 30,000 Volt Probe for Model 106 . . . \$8.75**

Write Dept RE11 for latest FREE Catalog  
SEE COMPLETE LINE AT YOUR JOBBERS.

**EMC** Electronic Measurements Corp.  
280 Lafayette St., New York 12, N. Y.  
Export Dept. 303 W. 42nd St., N. Y. C.

**SERVICE TECHNICIANS**

What was your most unusual service case? Not necessarily the most difficult one, but the one you will remember longest, either because of the problem itself or because of other conditions surrounding the job. If the experience was interesting to you, it probably will be to other readers of RADIO-ELECTRONICS. We will pay \$10 for each "My Most Unusual Service Job" item we consider outstanding enough to publish in this magazine. If the item is striking enough or carries sufficient technical information to be worth more than \$10 in our opinion, it will be paid for at our regular space rates. Address your stories to Unusual Service Job RADIO-ELECTRONICS 25 West Broadway New York 7, N. Y.

**In An Early Issue!**

These important articles by authors well known to the RADIO-ELECTRONICS readership are now being prepared for publication. Most of them will appear next month.

More U.H.F. Converters . . . . . Fred King  
Push-Pull Drivers . . . . . George Fletcher Cooper  
Compact Low-Power

Transmitter . . . . . J. D. Gallagher  
Amplifier Equalizer Design

TV Diagnostician's  
Case Book . . . . . David T. Armstrong  
Ultrasonic Therapy Unit . . . . . S. M. Milanowski







**BRIGHTEN YOUR SALES PICTURE** With the New **KINE-LITE** Pat. Pending

Picture Tube Brightener & Regenerator

VIDAIRE'S Kine-Lite operates on ANY cathode ray picture tube of 10" and larger, including electrostatic focus.



VIDAIRE's Kine-Lite brings new brightness to TV picture tubes having low emission—permanent installation—can be re-used—simple instructions with each unit.

- ★ Renews brilliance and contrast of picture
- ★ Prolongs life of old picture tubes
- ★ Easy to install ★ No soldering necessary
- ★ For all standard tubes using dual-decal bases
- ★ No limit to tube size—10" to 30"
- ★ Standard Warranty ★ Two connecting plugs
- ★ Compact, attractive package
- ★ QUICK SELLER — EXCEPTIONAL PROFITS

Sold only through VIDAIRE distributors Write for Catalog A

**Vidaire Electronics Mfg. Co.**



Mfrs. of TV color equipment, phono & TV amplifiers  
6 E. 39th St., N. Y. 16, N. Y.  
LExington 2-7372

**Superior's new TELEVISION BAR GENERATOR**



**THROWS AN ACTUAL BAR PATTERN ON ANY TV RECEIVER SCREEN!!**

- TWO SIMPLE STEPS**
1. Connect Bar Generator to Antenna Post of Any TV Receiver.
  2. Plug Line Cord into A.C. Outlet and Throw Switch.

**RESULTS**—A stable never-shifting vertical or horizontal pattern projected on the screen of the TV receiver under test.

**AT YOUR RADIO PARTS JOBBER**

DEALERS NET PRICE only **39<sup>95</sup>**



Manufactured and Guaranteed by **SUPERIOR INSTRUMENTS CO.**  
227 Fulton Street • New York 7, N. Y.

Write Dept. RC-11 for catalog of complete line.

**TELEVISION-RADIO Electricity REFRIGERATION-ELECTRONICS**  
IN THE GREAT SHOPS OF **COYNE**

**TRAIN QUICKLY! OLDEST, BEST EQUIPPED SCHOOL of ITS KIND in U.S.**  
*Draft Age and Older Men..*

Come to the Great Shops of Coyne in Chicago. Get practical training in TELEVISION-RADIO or ELECTRICITY—vital in Defense Program. Prepare now for a better job or better service rating.

Approved for veterans—finance plan for non-vets. Non-vets enroll now, pay most of tuition after graduation. If you need part-time work to help out with living expenses while at Coyne, we'll help you get it. Special plan for men of Draft Age.

**FREE BOOK** Clip coupon for Big Free Illustrated Book. Indicate below course that interests you. No salesman will call. Act NOW.

**COYNE SCHOOL** A TECHNICAL TRADE INSTITUTE CHARTERED NOT FOR PROFIT Established 1899 500 S. Paulina, Chicago

**ELECTRICITY ★ TELEVISION RADIO ★ REFRIGERATION ★ ELECTRONICS**

**B. W. COOKE, Pres. COYNE School**  
500 S. Paulina St., Chicago 12, Ill. Dept. 82-81H

Send FREE BOOK and full details on:

TELEVISION-RADIO     ELECTRICITY

NAME.....  
ADDRESS.....  
CITY..... STATE.....

NOVEMBER, 1952

**AMERICA'S FASTEST GROWING TV ANTENNA MANUFACTURER**  
**DAVIS ELECTRONICS**

**THERE MUST BE A REASON**

**THE REASON IS:** The DAVIS SUPER-VISION is the finest antenna built for V.H.F. ALL CHANNEL and for FRINGE AREA and DX RECEPTION... A steady flow of enthusiastic letters from users all over the U.S. attests to this fact—and is outstanding proof of its UNIVERSAL ACCEPTABILITY.

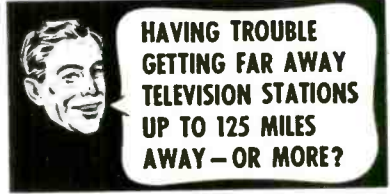

1. EXCELLENT FOR FRINGE AREA and DX RECEIVING—and broad band receiving with high gain on all channels—2 through 13.
2. CLEARER PICTURES UP TO 125 MILES OR MORE—from the station.
3. GHOST PROBLEMS REDUCED or eliminated due to excellent pattern.
4. PROVIDES 10 DB OR MORE GAIN ON HIGH CHANNELS where gain is needed most.
5. EXCELLENT FRONT TO BACK RATIO on all channels. No co-channel interference.
6. MINIMIZES INTERFERENCE: Airplane Flutter—Diathermy and Ignition—F.M.—Neon Signs—X-Ray—Industrial—Etc.
7. ELIMINATES DOUBLE STACKED ARRAYS, and out-performs 2 bay yagis on low band and 4 bay yagis on high channels.

**DAVIS ELECTRONICS**  
4313 WEST MAGNOLIA BLVD.  
BURBANK, CALIFORNIA  
Manufacturers of V.H.F. and U.H.F. Antennas  
Backed by Over a Quarter Century of Electronic Experience

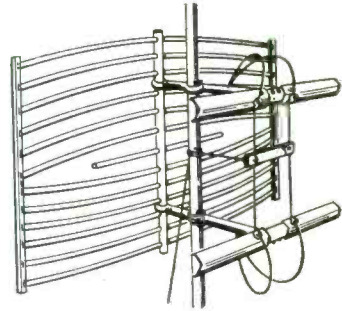

**DAVIS SUPER-VISION**  
"THE ORIGINAL ANTENNA SOLD WITH A MONEY-BACK GUARANTEE"

- ADVANTAGES OF THE DAVIS SUPER-VISION WITH ELECTRONIC DIPOLE SEPARATORS:**
8. ONLY ONE TRANSMISSION LINE NECESSARY.
  9. NO WORRY OVER POSSIBLE CHANNEL CHANGES on either high or low channels.
  10. CAN BE TIPPED WITHOUT TILTING MAST to take advantage of horizontal wave lengths.
  11. Can be used with ANTENNA ROTOR

AT YOUR JOBBERS, OR WRITE TO:

**DAVIS ELECTRONICS** 1-20  
4313 West Magnolia Blvd., Burbank, California

**SIRS: RUSH INFORMATION TO ME AS CHECKED BELOW:**

Send Free Technical Data on new SUPER-VISION ANTENNA.

Send Name and Address of NEAREST JOBBER.

Name.....  
Street.....  
City..... State.....





*This Month's Special*

- SUPERSONIC CRYSTALS, Rochelle salt, ea. . . \$5.00
- TV LEAD-IN WIRE, 300 ohms, HI-Q. Roll  
Lo-Loss \$17.50/M FT
- BC 306 ANTENNA TUNING UNIT, NEW . . . 6.95
- R9/APN-4, New, With Tubes . . . 75.00
- ID6/APN-4, New, With Tubes and Crystal . . . 75.00
- A-62 Phantom Antenna . . . 8.50
- 2 Meter Choke, 1000 MA, 20-144 . . . 1.00
- Supersonic Crystal Head, M-1, 22-27KC HI-2 . . . 27.45
- Underwater Microphone, Model JR, 2-50m . . . 24.50
- Dynamic Mike & Headset Combo, B-19, New . . . 3.75
- HS-30 Inserts, M-300 . . . per M 3.50
- AN/ARC-4 VHF Trans-Rev . . . 75.00
- PE 36 Test Set, New . . . 37.50
- SCR 274 Test Set, 1-104 . . . 12.25
- DM 34 Driver Trans, 616 to P-P 811's . . . 1.29
- DM 34 Dynamotor, 14V In, 220 V, 80 MA out  
Sens. Relay: 3.5MA, 13K ohms, 2PST, 2A . . . 1.29
- Klixon Breaker: Thermal, 35A . . . .69
- T-30 Carbon Mikes, New . . . .89
- Tel. Tape, 3/8"x8 1/2" Rolls . . . 23¢ ea. 5/ 1.00
- Tel. Tape, 4" Rolls . . . 12¢ ea. 10/ 1.00

**24 VOLT TRANSFORMER**

For operating surplus gear, toy trains, gadgets, etc. Operates from 115V, 60 cy., supplies 24 V.A.C. at 1.2 amp., herm. sealed and cased—a great buy at only **\$1.49**

**OSCILLOSCOPE SUPPLY KIT**

Ideal for 3" Scope or Panadapter. Delivers 850V negative, 300VDC @ 65MA, 6.3V @ 4A, 6.3V @ 6A, 2.5V @ 1.75A. You get 1—Herm. Sealed Transformer 1-25H Choke, 1-2X2 Tube, 1-6x5 Rect. 3—Filter Cond. 1—Filter Resistor, 1—Transformer Bleeder for only **\$12.95**

**UNIVERSAL SUPPLY KIT**

Delivers 230V @ 40MA DC From 110/220VAC, 60 Cy. Kit Consists of i-1TX Transformer, 1-5 Hy @ 40MA Choke, 2-8MFD @ 450V Filter, 1-6x5 Rect. Cond. 1-6x5 Tube. A great buy at only **\$3.95**

**INTERPHONE TRANSFORMER SET**  
Rig your own interphone. Kit consist of 1-Input Transformer (Matches 4 or 6 OHM SPKR to Gird) and 1-Output Transformer (Matches 50L6, 35L6, 25L6, etc. to 4 or 6 OHM Speaker Set) **\$1.00**  
of 2 XFMRs. ONLY



**BC 605 INTERCOM**

Easily converted to an Ideal Inter-Communications set for office, home or factory. Original, New w/conversion Diagram **\$4.75**

#606 Control Boxes.

Send M.O. or Check. Shipping Chgs. C.O.D.

**COMMUNICATIONS EQUIPMENT CO.**

131 Liberty St. Dept. C-11, New York City 7, N. Y.

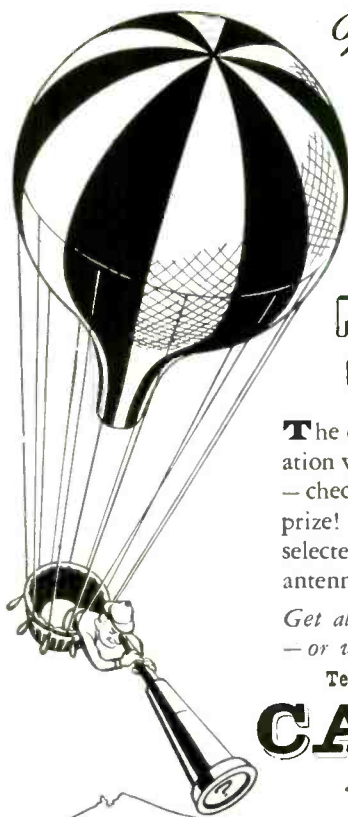

*We're Looking For*

**The Oldest TACO TV ANTENNA**

The oldest operating Taco TV Antenna still in operation will win a cash prize for you! Check your records — check the installations you service — win that cash prize! At the same time, the owner of the installation selected as the oldest will receive a brand new Taco antenna installation absolutely FREE!

Get all the details from your Taco distributor today — or write: **ANTENNA CONTEST**

Technical Appliance Corporation, Sherburne, N. Y.

**CASH PRIZE!**

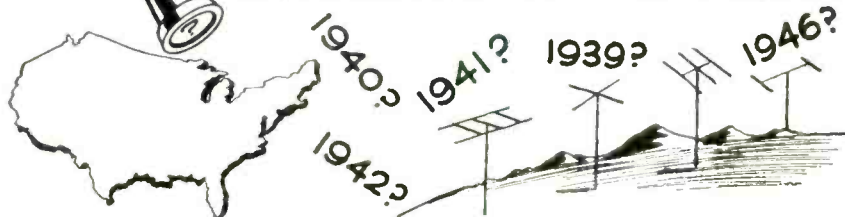

**FIX ANY RADIO**

**Amazing New Invention**

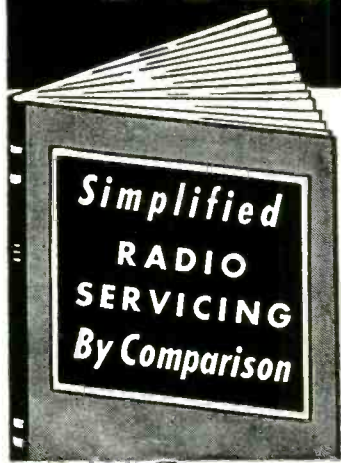

Find radio faults with a new simplified method. Repair all radios in minutes instead of hours. Revolutionary, different Comparison technique permits you to do expert work almost immediately. Most repairs can be made without any test equipment. Simplified point-to-point, cross-reference, circuit suggestions locate faults quickly and easily.



**NO TESTERS NEEDED**

This newly developed method tells you how to locate the source of trouble in any radio set without equipment. Make needed tests, measure voltage, trace the signal, by using only a 5¢ resistor, small condenser, and a crystal detector. Inject signals without any signal generator. Test parts by the new Comparison method. Test tubes without equipment. Repair any radio expertly following simplified picture plans. Improve your radio servicing ability. Data on all sets, portables, FM, AC-DC, P.A., inter-coms, clock radios. Send coupon.

**CHARTS, BLUE-PRINTS, TESTS**

Learn time-saving trouble-shooting short-cuts; find any radio fault with ease. Follow the tests shown on 24 large circuit blueprints. Gives over 1,000 practical repair hints. For all types of radios. Hundreds of simplified tests using only a 5¢ resistor and any filter condenser. Introductory material to help beginners. Several chapters on test equipment. Complete plan in manual form, 61 job-sheets, data on all tubes, 92 large pages, 8 1/2 x 11 inches. Schematics, pictures, charts. Sold on no-risk trial. Price, only \$1.50. Use coupon below.

**Supreme Radio & TV Manuals**

Your complete source of all needed RADIO and TV diagrams and service data. Most amazing values. Still sold at pre-Korean prices. Only \$2 for most volumes. Every Radio manual contains large schematics, all needed alignment facts, parts lists, voltage values, trimmers, dial stringing, and service hints. Each TV manual is a practical treatise on servicing the year's sets, with giant blueprints, patterns, waveforms, charts, suggested changes. See coupon at right for a complete list of these low-priced manuals.



**Supreme Publications**  
Sold by All Leading Radio Jobbers

**NO-RISK TRIAL ORDER COUPON**

**SUPREME PUBLICATIONS, 3727 W. 13th St., Chicago 23, ILL.**

- Radio Diagram Manuals
- New 1952 Manual, \$2.50
  - 1951 Radio } EACH
  - 1950 Manual } **\$2.50**
  - 1949 Radio }
- RADIO MANUALS
- 1948
  - 1947
  - 1946
  - 1942
  - 1941
  - 1940
  - 1939
  - 1926-1938 Manual, \$2.50
- PRICED AT ONLY \$2 EACH**

Send Radio and TV manuals checked  at left and below. Satisfaction guaranteed or money back.

- Simplified Radio Servicing (Fix Any Radio) **\$1.50**
- 1952 Television Manual, \$3.      1951 TV, \$3.
- 1950 Television Manual, \$3.      1949 TV, \$3.
- 1948 TV, \$3.      1947 TV & FM, only \$2.

- I am enclosing \$ . . . . . Send postpaid.
- Send C.O.D. I am enclosing \$ . . . . . deposit.

Name: .....

Address: .....





## Don't spoil the reflection

Your reputation as a skilled Service Man depends a great deal on your choice of replacement parts. The performance of replacement speakers reflects upon your ability and knowledge. Be sure the reflection is favorable. Specify Utah\* speakers—and your customers will say "That Service Man Knows His Business!"

\*All Utah speakers have exclusive Utah Universal Angle Mounting.

FREE . . . WRITE TODAY FOR THE NEW UTAH  
REPLACEMENT SPEAKER CATALOG S201

Export Dept. Rocke International Corporation, N. Y. C.

**utah**

**RADIO PRODUCTS CO., INC.**  
HUNTINGTON, INDIANA

A WHOLLY OWNED SUBSIDIARY OF NEWPORT STEEL CORPORATION

**OVER 50,000  
TECHNICIANS  
HAVE LEARNED**

**HOW TO GET  
THE MOST OUT  
OF BASIC TEST  
EQUIPMENT**

for A.M. - F.M. - TV

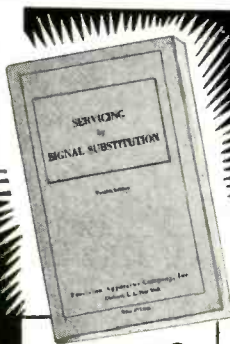

**ONLY 40¢**  
103 pages. Invaluable information that will help you re-double the value of your basic test equipment.

**'SERVICING BY  
SIGNAL SUBSTITUTION'**  
A BEST SELLER FOR OVER 12 YEARS!  
(NEW, UP-TO-DATE, 12th EDITION)

The Modern, Simplified, Dynamic Approach to Receiver Adjustment & Alignment Problems.

- ★ Nothing complicated to learn
- ★ No extra equipment to purchase
- ★ Universal . . . non-obsolete
- ★ Employs only Basic Test Instruments

Ask for "S.S.S." at your local Radio Parts Jobber or remit 40¢ in small stamps or coin directly to factory.

**PRECISION APPARATUS COMPANY, INC.**  
92-27 HORACE HARDING BLVD., ELMHURST 4, N. Y.

The mixer coil, L3, is adjusted by spacing its turns for maximum signal at 142 mc or on the net frequency.

Open the cathode circuit (pin 8) of the mixer and adjust the coupling between L3 and L4 and the tuning of L4 so the cathode current is approximately 2.5 ma. The current should drop to about 1.4 ma when the crystal is removed from its socket.

The mixer output circuit is a variation of the Collins coupler. The input side is tuned by the capacitance of the 3-inch shielded lead from the mixer plate to L5 and the output capacitance of the mixer section. The output side of the coupler is tuned by the capacitance of 3 feet of 80-ohm coax. The mixer output tunes broadly but it should be peaked at the center of the i.f. range.

The coils are wound as follows:

L1—4 turns No. 22 cambric-covered hook-up wire interwound with the ground end of L2.

L2—5 turns of No. 14 tinned copper wire  $\frac{7}{16}$  inch inside diameter, spaced to  $\frac{3}{4}$  inch. Tapped  $1\frac{1}{2}$  turns from the ground end.

L3—4 turns of No. 14 tinned copper wire  $\frac{3}{8}$  inch inside diameter, spaced to  $\frac{5}{8}$  inch.

L4—3 turns No. 14 tinned copper wire  $\frac{3}{8}$  inch inside diameter, spaced to  $\frac{1}{4}$  inch. Placed  $\frac{1}{8}$  inch from L3.

L5—40 turns of No. 36 enamel wire scramble-wound on  $\frac{1}{4}$ -inch slug-tuned form.

L6—17 turns of No. 26 d.c.c. wire close-wound on  $\frac{1}{4}$ -inch slug-tuned form. Tap at  $4\frac{1}{2}$  turns.

RFC1, RFC2, and RFC3—21 turns of No. 26 d.c.c. wound on  $\frac{1}{4}$ -inch slug-tuned form.

### ANTENNA STACKING PROBLEM

? I am using a 2-bay all-channel conical antenna and would like to convert it to a 4-bay job, stacked 2 high and 2 wide. What spacing should I use and how should I match the elements to a 300-ohm transmission line? How much gain can I expect? Will I get better results by stacking the antennas horizontally or vertically instead of in combination?—C. W. Appleton, Wis.

A. There are almost as many versions of the basic conical antenna as there are antenna manufacturers. Some have their elements proportioned so they are approximately one-half wavelength long for channel 2 and several wavelengths long at channel 13. Others have rods of different lengths in the radiator. In either case, it is impossible to guess at the resonant frequency of the antenna. Since stacking distances and the length of the phasing harness are based on the resonant frequency, information on spacing should be supplied by the antenna manufacturer. If the data is not available, you can probably hit the correct spacing close enough if you consider the longest element as being one-half wavelength (from tip to tip) at the resonant frequency. The vertical spacing will be one-half wavelength and

RADIO-ELECTRONICS

the horizontal spacing will be one wavelength from one vertical mast to the other or one-half wavelength between adjacent tips. Use three-quarter wavelength sections of 425-ohm transmission line to connect each 2-bay stack to the 300-ohm lead-in.

Yagis and other types designed for one or possibly two adjacent channels should be one-half wavelength apart vertically and one wavelength horizontally. One wavelength in inches equals 11,800 divided by the frequency in megacycles.

The gain of an antenna system increases 3 db each time you double the number of elements (radiators). Thus a 2-element antenna has a gain of 3 db over a single antenna of the same dimensions. A 4-bay stack has a gain of 3 db over a 2-bay model and a gain of 6 db when compared to a single element. These gain figures are theoretical. Actual values depend on the closeness of matching to the transmission line and element length and spacing.

The gain of an array is constant regardless of the method of stacking. You can stack horizontally, vertically, or in a combination of the two methods. Stacking increases the sharpness of the radiation pattern in the plane in which the antennas are stacked. Vertically stacked antennas are easier to erect and maintain. The horizontal pattern is the same as for a single bay, and the sharp vertical pattern thus produced often reduces interference pickup from sources below and above the plane of the antenna. When a number of elements are stacked vertically, it is wise to experiment with the height of the array and to tip the mast forward or backward for maximum signal pickup.

With horizontal stacking, the vertical pattern remains unchanged while the horizontal pattern is sharpened. Too much sharpening of the horizontal pattern makes it difficult to orient the antenna for a distant TV station. The mast and antenna supports must also be unusually sturdy to hold the antenna in place after alignment. **END**

**TUNABLE HUM**

? In an Admiral 25A16 chassis 21A1, I get an intermittent hum which is tunable. I have tracked the tuner and realigned both the video and sound sections. I've also replaced both the vertical and horizontal oscillator tubes and checked capacitors which might be causing the trouble, all to no avail.—M. H., Brooklyn, N. Y.

A. This is not an intercarrier receiver and therefore the hum would not be the buzz often encountered in such receivers. The manufacturer suggests the following remedy for eliminating hum in these models: Connect a 2,200-ohm, ½-watt resistor and a 0.1-µf, 400-volt capacitor in series from the 6AU6 a.g.c. tube plate (pin 5 of V305) to ground. Also connect 25 inches of ½-inch bonding braid under the bracket holding the webbing for the picture tube on the side nearest the audio lead. Connect the other end of the braid under the power supply chassis, at the mounting screw nearest the audio lead. **END**

NOVEMBER, 1952

# 2 NEW SERVICE AIDS

RADIO-TV ALL PURPOSE

## TOOL KIT \$9.95

SERVICEMAN'S NET

COMPLETE 17-PIECE TOOL KIT

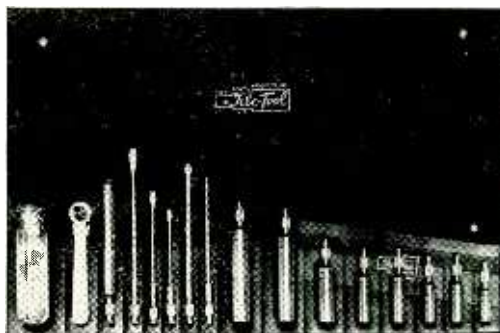

- 8 deep wall socket wrenches—1/4" to 9/16"
- 1 ratchet handle—forward or reverse
- 3 screw driver blades—small, medium, large
- 2 recessed head screw drivers—medium, large
- 1 five-inch tool extension
- 1 amber handle—4" x 1 1/8"
- 1 heavy duty roll-up container

Designed to reach every part of chassis. Instantaneous tool changing. High quality, case hardened polished steel. Positive grip wrenches.

# CHASSIS HOLDER

## \$1.00 PAIR

SERVICEMAN'S NET

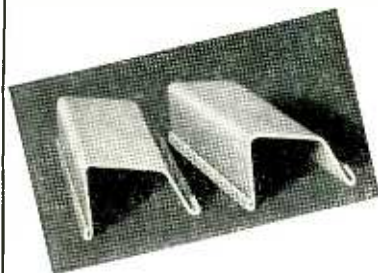

- SAFE—EASY—FIRM CHASSIS HANDLING  
6" smooth, round finger rail permits proper balance in carrying chassis. No more cut fingers or aching backs.
- IDEAL FOR SHOP OR FACTORY

AVAILABLE AT YOUR JOBBER—OR WRITE FOR CATALOGS

MANUFACTURED BY **TELE-SCOPIC PRODUCTS, Inc.**

111 W. 42nd St., New York 36, N. Y.

**TRAIN AT HOME FOR UHF-TV AND**



Learn practical, professional type TV Servicing without leaving your present job. Included are money-making extras such as set conversion, master antenna installation, UHF-TV, field servicing short cuts. You can start earning Television money after first few lessons. You learn to test, trouble shoot and repair all types of TV sets.

**HERE'S HOW YOU GET EXPERIENCE!**

You train on a large screen, modern TV receiver, furnished with the course and yours to keep! As an optional feature you can get two weeks actual experience with Chicago's largest independent servicing organization. You learn by doing! Age is no barrier. Many students are over 40! ACT NOW! Send for FREE Catalog and SAMPLE LESSON today!

**TELEVISION COMMUNICATIONS INSTITUTE**  
205 W. Wacker Dr., Dept. RE-12, Chicago 6, Ill.



**MAIL NOW FOR FREE BOOKLET**

MILTON S. KIVER, President  
TELEVISION COMMUNICATIONS INST.  
205 W. Wacker Dr., Dept. RE-12, Chicago 6, Ill.  
Rush FREE Catalog and Sample Lesson. I am not obligated. Salesman will not call.

Name.....Age.....

Address.....

City.....Zone.....State.....

BEGINNERS check here for Pre-TV Radio Course.



**NO!** the most expensive sets don't  
always work better in the fringe areas,

**BUT...**

ANY television receiver equipped with a

**TARZIAN TUNER**

will do the best job of pulling in distant stations

It's no wonder that manufacturers of many of the better known TV sets on the market today depend upon the trouble-free TARZIAN TUNER for the excellent performance of their sets.

No other commercial tuning unit possesses so many of the desirable features found only in the TARZIAN TUNER. For unexcelled selectivity . . . stability . . . and reception—especially in fringe areas—there is no better tuner than the **TARZIAN TUNER**

The sensible Tarzian approach to UHF—a full band, all station tuner—is a typical engineering example of keeping up with—or rather—one step ahead of—developments in the ever changing industry.



**SARKES TARZIAN, Inc., Tuner Division, Bloomington, Indiana**

**TARZIAN MADE PRODUCTS**

Tuners      Air Trimmers      Selenium Rectifiers      Cathode-Ray and Receiving Tubes

STATIONS WTTT (5000 WATTS) AND WTTV (CHANNEL 10)  
OWNED AND OPERATED BY SARKES TARZIAN IN BLOOMINGTON

**PRES-PROBE CONDENSER TESTER**



**Finds Intermittent  
Condensers Instantly**

Pres-probe's sliding tip with variable resistance prevents condenser heating. Tests with power on. Requires no adjustment. Stops guesswork. Saves time. Convenient probe size (7/8" long). Satisfaction guaranteed.

See Your Dist. or Order Direct

**PRES-PROBE CO.**  
4034 N. Sixth St., Milwaukee 12, Wisc.

**NET**  
**795**  
Postpaid  
U. S. A.

**BUSINESS FORMS for RADIO-TV SERVICE**

Job Tickets, Sales Books, Work Sheets, Service Contracts, Service Charts, Call Routing System, Master Service Card System, Pricing System. All Designed for Radio and TV Service to help service dealers and technicians in dealing with their customers. See them at your Radio and TV Parts Distributor.

**CATALOG FREE—Write Now**

**OELRICH PUBLICATIONS**  
4135 N. Lawler Ave., Chicago 41, Ill.

Send Free Catalog       Enclosed is 25¢ for Catalog and Kit of Sample Sheets

Name \_\_\_\_\_

Address \_\_\_\_\_

City \_\_\_\_\_

**ADMIRAL 21 SERIES CHASSIS**

The sensitivity of 21B1, 21C1, 21D1, 21E1, 21H1, and 21J1 chassis can be increased by as much as 100% for better performance in weak-signal areas by connecting a 470,000-ohm resistor (part No. 60B8-474) between test point T and ground. This can be done without removing the chassis. Simply solder a banana plug to one end of the resistor and solder the other end to the chassis. Insert the banana plug into test point T.

Do not make this change in an area where strong signals can be received, as this will cause jitter and poor quality pictures. A switch can be installed to disconnect the resistor from ground when a strong station is being received.

Test point T is located on a 4-hole socket in the center of the left side of the chassis as viewed from the rear. It is the socket hole nearest the front of the chassis.—*Admiral Radio & TV Service Bulletin*

**DU MONT RA-111**

If the cause of high-voltage failure cannot be located by checking the usual components in the horizontal output and high-voltage rectifier circuits, make the following test:

Disconnect the lead going to pin 1 of the horizontal output transformer. Turn on the set and check for B plus voltage on pin 1. If voltage is present, replace the transformer, because this indicates a short circuit between primary and secondary.—*James T. Smith*

(It is advisable to remove the 6BQ6-GT from its socket before turning on the set for this test. The screen input rating may be exceeded and the tube ruined by operating it with full screen voltage and no plate voltage.—*Editor*)

**TUNING TROUBLES**

Sometimes, when aligning a set, tuning does not follow the dial calibration, or sensitivity is not satisfactory over the entire band. In such cases, inspect the sections of the tuning capacitor.

Turn the gang to full mesh and inspect the spacing between stator and rotor plates of each section, viewing the plates from both sides of the gang. Slowly turn the gang through its range. In some cases, improper spacing will be noted.

If all sections show a similar displacement of plates, the trouble is most likely caused by end play or shifting of the capacitor shaft. The remedy is to adjust (if possible) the bearings at the end of the gang.

If all sections are not displaced, the sections which are displaced must be adjusted. This is not difficult if the stator sections are held in place by machine screws. If they are mounted with rivets through the bakelite or fiber at the ends of the plates, it is sometimes possible to drill out the rivets and replace them with No. 4 or No. 6 machine screws and nuts. It is then a simple matter to adjust the spacing. If it is impossible to make mechanical adjustments, the capacitor should be replaced. It is not practical to attempt to overcome a general stator or rotor

RADIO-ELECTRONICS

Save \$\$\$ On These TV BUYS OF THE YEAR

Rocket MOTORLESS TV DIRECTIONAL ANTENNA

- 360° Electronically Switched Beam
- No Motors
- No Roof Orientation
- No Electric Power
- No Ghosts



AX-599 Direc-tronic As shown \$16.95

**Flick of Switch Clears Picture Instantly**  
Provides same clear pictures as rotating aerials costing 4 times as much. Electronically beams in all directions with full 360° rotation. You select direction with Directronic Beam Selector located at set. Model AX-599 stacked array includes 18 hi-tensile aluminum elements, 1 set connecting struts, Universal U-Clamps for mast, Directronic Beam Switch, and 75-feet of TH-X lead in. Model AX-59 Directronic 9-element Single \$10.35

**ROCKET 5 ELEMENT YAGI**  
EXCELLENT PICTURES IN FRINGE AREAS

Designed for high gain with minimum interference from ghosts and noise due to directive pattern. Produces clear sharp pictures. 5 heavy aluminum elements include one folded dipole, one reflector, three directors. Strong molded insulator. Non-slip mast clamp. Completely pre-assembled. Less mask.

Channels 2 or 3 ..... \$7.95 ea. 4, 5, or 6 ..... \$6.95  
Channels 7 to 13 ..... \$3.95



When ordering specify exact channel number desired.

**ROCKET SUPER-GAIN YAGI**  
8 ELEMENT TV ANTENNA

Designed for finest pictures in ultra-fringe weak signal areas. Array consists of one folded dipole, one reflector and six directors. Less mast.

Channels 7-13 \$7.95 Channels 4, 5, or 6 \$13.95  
Channels 2 or 3 ..... \$16.95

Perfect Pictures In Fringe Areas

**Rocket SUPER-FRINGE ANTENNA**  
—FOR ALL CHANNELS

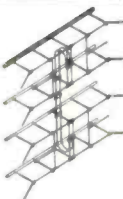

This truly sensational TV antenna is THE ANSWER to super-fringe area reception. Twenty-four driven elements provide a balanced all-channel db gain that produces astounding results at 125 or more miles from transmitter. For the ultra-fringe location, we strongly recommend this powerful antenna as the "Finest All-Channel TV Antenna On The Market Today". Model 400-E. \$27.95

- 29 Anodized Aluminum Elements (guaranteed against staining or tarnishing)
- Solid Cast-Aluminum Back-up Blocks
- Plexi-class III-dielectric Insulators
- Aluminum Washers and Stand-offs
- Cadmium-plated Nuts & Bolts
- 3/16" Dowel Pins
- Light Weight—no thrust bearing required on Rotor for average installation
- Size: 92" wide—80" high

**Look At These Amazing Features!**

- Clears pictures up to 125 miles and more from station
- 12 driven elements on low band!
- 12 driven elements on high band!
- One transmission line!
- Total weight only 8 lbs.!
- High gain—low noise ratio!

Consists—5 element array	\$3.95
Stacked 2 Bay array with tie rods	8.65

<b>LOWEST PRICES ON ANTENNA ACCESSORIES</b>	
Mast Steel (Dualcoated 5' crimped) 1 1/4" O.D.	\$1.05
Mast Steel (Dualcoated 10') 1 1/4" O.D.	1.95
Mast Connectors for 1 1/4" O.D. mast	.59
Chimney Mount Complete with Straps	1.19
Peak Roof Saddle (will take up to 1 1/2" O.D.)	1.59
Lightning Arrestor-TV	.69
Galvanized Steel Guy Wire—8/20	3/4c ft.
Galvanized Steel Guy Wire—11/20	1 1/2c ft.
Rocket TV-In-Lead—7/28 stranded	2c ft.
#100 Mil Lo-Loss 10 strand TV-In Lead	4c ft.
Rocket Open Line Twin-Lead (500' reel)	20.95
Mast Stand-off Insulators—3"	.10
Stand-off Screw Insulators—2"	.03
Wall Bracket—6" clearance	1.49
Wall Bracket—12" clearance	2.49

ALL PRICES F.O.B. CLEVELAND, OHIO  
Do not remit more than complete purchase price. Pay shipping charges on receipt of goods. 25% deposit on C.O.D. orders, please. Money-back guarantee.

**National Electronics**  
OF CLEVELAND  
**THE HOUSE OF TV VALUES**  
211 Delco Building, Cleveland 3, Ohio

displacement by bending individual plates. This is satisfactory when only two or three plates have been accidentally damaged.—Philco Service and Accessory Merchandiser

**WESTINGHOUSE H-210 AND H-211**

Cabinet-buzz in these models may be caused by warpage of the plastic due to temperature changes, etc. To correct this, loosen the two chassis-mounting screws, squeeze the cabinet sides until they are parallel, and then tighten the screws. This will hold the back cover more firmly against the sides and will stop the vibration.—Westinghouse Service Hints

**TELE-TONE TV-149**

Horizontal shrinkage in this set is usually caused by a change in the values of the two 47,000-ohm plate load resistors for the horizontal sweep amplifier. Prolonged overheating will cause these units to change their values. If their values are other than 47,000 ohms, replace them with 2-watt units.—Leon Medler

**SAVING 1.4-VOLT TUBES**

In cases where tubes are blown in a 3-way receiver, it is advisable to check the voltage and current on the filament string with the tubes removed from their sockets. First add the filament voltages of all tubes in the series-connected string, then divide the total by the filament current in amperes. The resultant gives the equivalent resistance of the filament circuit.

Obtain a resistor having the same value as the equivalent resistance. Plug its leads into the filament connectors of one of the sockets in the string. Plug short lengths of hookup wire into the filament connectors on the remaining sockets in the string. Now, with the set adjusted for a.c.-d.c. operation, you can check the voltage and current in the filament string without running the risk of blowing out a set of 1.4-volt tubes.—Daniel J. Driscoll

**MOTOROLA TS-67 TV CHASSIS**

Overheating of the horizontal output transformer in these chassis has been traced to a resonant condition caused by improper setting of the horizontal linearity coil. For proper adjustment, proceed as follows:

1. Replace the fuse temporarily with a 150-ma meter.
2. Adjust the linearity control slug throughout its range. It will peak to a meter reading of 125-130 ma at both ends of its range.
3. Find the point between these two peaks where the meter drops to about 90 ma with good horizontal linearity. This is the proper setting of the core. If the dip does not occur, this indicates a defect in the linearity coil or capacitors C-119 (.03 μf) or C-120 (.04 μf) in the horizontal linearity circuit.
4. Remove the milliammeter and replace the fuse after making the adjustment.—Motorola Service and Installation Bulletin

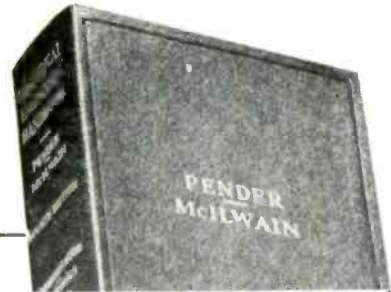

Use the book 148 experts wrote!

Study the whole field of **COMMUNICATION** and **ELECTRONICS** for Only \$8.50

This volume of Pender's *Electrical Engineers' Handbook* is much more than a standard, widely used reference. Actually, this great 1618-page, encyclopedic book is a practical course which puts at your fingertips all of the information needed for any phase of radio, TV, and electronics work—from basic math and equipment to advanced research and development! Learn from the book the experts use!

It sets out all the necessary tables, charts, diagrams, drawings and other illustrations—1479 in all—to make every point crystal-clear. Its 23 fact-packed chapters answer thousands of questions which arise constantly and give you hundreds of pages of additional up-to-date data on subjects such as: Circuit Stability, FM Systems, Symmetrical Components, Electronic Rectifiers, Aircraft Equipment, Servomechanisms, Microwave Plumbing, TV Broadcasting, Pulse Techniques, Dielectric Heating, Plastic Insulating Materials, Permanent Magnets, and many, many others.

A specially-prepared Index makes it easy to locate any information desired, on any subject, in a matter of seconds. And think of it! You get all this—a complete course in Communication-Electronics and a handsome, impressive reference for your work-desk or library—at a cost of only half a cent per page! Read and examine this great work for 10 days, entirely ON APPROVAL. See for yourself how valuable it can be to you.

... and a companion course in

**ELECTRIC POWER**

By Harold Pender and Wm. A. Del Mar

This volume of Pender's *Electrical Engineers' Handbook* is the perfect manual for the radio technician or serviceman who wants to extend his earning power beyond the field of communication, into power generation and power equipment.

It provides a wealth of practical data, charts, tables and illustrations—and covers, with up-to-date treatments, all important subjects with up-to-date treatments, all important power subjects. 1716 pages; 977 illustrations. \$8.50

—TRY THEM FOR 10 DAYS FREE—

JOHN WILEY & SONS, INC.  
440 Fourth Ave., New York 16, N. Y.

Please send books checked below for me to read and examine for ten days ON APPROVAL. If I keep them I'll send price plus postage. Otherwise I'll return books in good condition.

- Communication-Electronics  Electric Power (Pender-McIlwain) \$8.50 (Pender-Del Mar) \$8.50

Name.....  
Address.....  
City..... State.....  
Employed by.....  
(RE 112)  
We pay postage if you send payment with coupon.



The Sensational New

# RCP

## 'DO-ALL' 3

COMPLETELY SERVICES TELEVISION

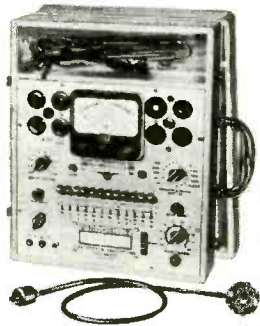
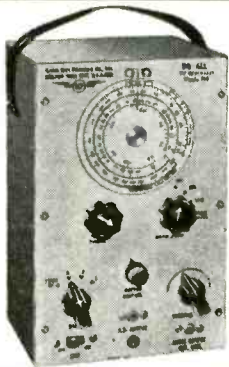

**TV Do-All GENERATOR**  
MODEL 740

- IT'S A
- SIGNAL GENERATOR
  - AUDIO GENERATOR
  - PATTERN GENERATOR
  - MARKER GENERATOR

MODEL 740-Complete, **\$6950**  
Ready to operate . . . NET

**TV Set & Tube Tester**  
MODEL 808

- ★ A TUBE TESTER
- ★ A CATHODE RAY TUBE TESTER
- ★ A CATHODE RAY TUBE REACTIVATOR
- ★ A VACUUM TUBE VOLTMETER (AC-DC)
- ★ AN OHMMETER

MODEL 808-Complete, **\$9995**  
Ready to operate . . . NET

**MIDGETSCOPE**  
MODEL 533M

*weighs only 9 lbs.*  
Size: 11<sup>3</sup>/<sub>4</sub>" x 7<sup>3</sup>/<sub>4</sub>" x 5<sup>1</sup>/<sub>2</sub>"  
SENSITIVITY:—Vertical—20 millivolts (.020 volts for 1" rms deflection on CRT face.)  
Horizontal—.6 volts.

MODEL 533M-Complete, **\$9950**  
Ready to operate . . . NET

Write for the latest RCP Catalog to Dept. RE-11

**RADIO CITY PRODUCTS CO., INC.**  
152 WEST 25th ST • NEW YORK 1, N. Y.

**New Proximity Probe**

**TESTS ALL TV HI VOLTAGE SUPPLY SYSTEMS**

INSTANTLY checks hi-voltage transformer action—horizontal oscillator—sweep output—damper—hi-voltage rectifier, etc. Used under actual operating conditions. Determines exact procedure to trouble shoot no raster problems and intermittents. No connections—no shocks—saves time—clips in pocket. Used by professional TV servicemen for home calls and bench work.

Complete instructions enclosed.  
Send check or **\$3.95** Fully Guaranteed  
M.O. Postpaid U.S.A. Net

Box 215 **SERVICE PRODUCTS CO.**  
Lawrence, Mass.

**6/20 GALVANIZED STEEL WIRE STRAND**

delivery from stock—low prices  
**SPENCER WIRE CO., INC.**  
West Brookfield, Mass.

**PLEASE MENTION RADIO-ELECTRONICS when answering advertisements**

Dr. Oliver E. Buckley, Chairman of the Board of BELL TELEPHONE LABORATORIES, INC., retired after 38 years of service in the Bell System. Prior to being chairman of the Board, Dr.



Dr. O. E. Buckley

Buckley served as president of Bell Telephone Labs from 1940 until 1951. He has had an extremely active and productive career in science and engineering.

Edward M. Cappucci was promoted to general manager of RMS, New York City. Cappucci joined RMS as plant superintendent of the Antenna Division several years ago, and was later shifted to purchasing. In addition to his new duties, he continues as executive in charge of purchasing.



E. M. Cappucci

Dr. Carl F. Moen joined ELECTRO-VOICE, Buchanan, Mich., as senior engineer. He was formerly professor of physics at Pennsylvania State College.



Dr. C. F. Moen

Other engineering appointments at Electro-Voice include Norman Friedman, Lynn Talbott, James Wendt, and Frank James as junior engineers, and John English as mechanical designer.

E. B. Harrison was appointed general sales manager of the Peerless Electrical Products Division of ALTEC LANSING CORP., Beverly Hills, Cal. Other promotions at the Peerless plant include A. A. Emlen to plant manager, E. E. Goldsmith to assistant plant manager, and V. W. Staads to supervisor of production planning, shipping and stores. H. S. Morris of the New York office continues as the division's eastern sales manager.

Joseph Schlig was appointed advertising and sales promotion manager for the Electronic Tube Division of WESTINGHOUSE ELECTRIC CORP., Elmira, N. Y. Schlig has served in various Westinghouse sales and advertising positions since his graduation from Stevens Institute of Technology in 1949.



Joseph Schlig

George W. Hartner was promoted to advertising and publicity director of NATIONAL ELECTRIC PRODUCTS CORP., Pittsburgh. He had been advertising and sales promotion manager since 1946. He will direct advertising for both

RADIO-ELECTRONICS



the electrical roughing-in lines and the television department. The company also announced the appointment of Luther D. Shank, retiring director of the Electrical Division of the NPA, as assistant to R. C. Bennett, Jr., the vice-president and general sales manager.

... J. R. (Jack) Poppele resigned as vice-president in charge of engineering for the MUTUAL BROADCASTING SYSTEM and as director of engineering for WOR, New York City. He had been with WOR since 1922. Poppele will set up his own consultant firm.

**Obituaries**

William J. Larkin, vice-president in charge of engineering and production of the NATIONAL CO., INC., Malden, Mass.

Brigadier General Grant B. Layng, former radio sales executive, drowned at Bridgehampton, N. Y.

**Personnel Notes**

... A. D. Plamondon, Jr., president of INDIANA STEEL PRODUCTS, was elected president of the RTMA, succeeding Glen McDaniel who resigned. Plamondon continues as Chairman of the Board of Directors.

... W. E. Boss was appointed manager of the Television Market Development Section of the RCA VICTOR Home Instrument Department. He was formerly assistant to J. B. Elliott, the company's vice-president in charge of consumer products.

... Rear-Admiral Stanley F. Patten, USN (retired), vice-president of ALLEN B. DU MONT LABORATORIES, INC., Clifton, N. J., was elected to the Board of Directors.

... A. D. Plamondon, Jr., RTMA President, announced the following Committee chairman appointments: W. M. Adams, Sprague Electric Co., Export Committee; Dr. W. R. G. Baker, General Electric Co., reappointed chairman of the Television Committee; and John W. Craig, Crosley Division, Avco Manufacturing Corp., reappointed chairman of the FM Policy Committee.

... Raymond A. Mastrobuoni joined JFD MANUFACTURING Co., INC., Brooklyn, N. Y., as director of traffic. Mastrobuoni has had over 18 years of experience in the traffic management field.

... Robert Webb, formerly of American Television, joined the Sales Department of SIMPSON ELECTRIC Co., Chicago, as government contract coordinator.

... Francis F. Florsheim, COLUMBIA WIRE & SUPPLY Co., Chicago, was named chairman of the Association of Electronic Parts & Equipment Manufacturers at the group's annual meeting in Chicago. Karl W. Jensen, Jensen Industries, Inc., Chicago, was named vice chairman, and Helen Staniland Quam, Quam-Nichols Co., Chicago, was re-elected to her 15th term as treasurer. Kenneth C. Prince was reappointed executive secretary.

... Tom Murphy was promoted to chief engineer of CONDENSER PRODUCTS Co., Chicago.

—end—

**"CONICAL-V-BEAMS"**  
REGISTERED TRADE MARK

**SOLVE BOTH of your antenna problems**

with *telrex*  
**-FOR TV, FM AND UHF!**

**1. PERFORMANCE AT EXTREME RANGE**  
Only Telrex offers the long distance, all-station champion. The Telrex 8X-TV, illustrated, will outperform any antenna or combination of cut-to-frequency antennas. It is unequalled for long distance reception up to 200 miles. If the 8X-TV does not provide a useable signal, TV reception is impossible or impractical.

**2. WEATHER-DURABLE CONSTRUCTION**  
Install the all-weather, ruggedized antennas that withstand extremes of climate. Telrex production engineers have combined sterling-quality lightweight materials, superb engineering and metal working craftsmanship to produce antennas that you can install and forget! Factory ratings on all models are conservative.

THERE'S A **TELREX** FOR EVERY PURPOSE AND EVERY TYPE RECEPTION AREA —WRITE TODAY FOR NEW LITERATURE

ALSO! EXCLUSIVE MANUFACTURERS OF THE "FISHBONE" SERIES SINGLE CHANNEL 10 ELEMENT ARRAYS

Be sure it's a "CONICAL-V-BEAM" — look for the *telrex* TRADEMARK

*telrex* INC.  
CONICAL-V-BEAMS  
AMERICA'S OUTSTANDING TELEVISION BEAM  
ASBURY PARK 9, N. J.

**K I T S** **RADIOS** **K I T S**  
7 & 3 band Electric and/or battery  
**TELEVISION**  
AC/DC Operation  
**TEST INSTRUMENTS**  
Write for FREE Catalog  
**ARKAY—Radio Kits, Inc.**  
120 Cedar St., New York 6, N. Y.

**ARE YOU MOVING?**  
—Don't forget to send us the address label from your last copy of RADIO-ELECTRONICS ... plus your new address.  
—If we receive these before the 10th of the month, you will continue getting the magazine without interruption.

**WANTED**  
**WE NEED YOUR SURPLUS ELECTRONIC EQUIPMENT**  
**WE PAY TOP \$\$\$ FOR:**

★ RADIO RECEIVERS	★ PLUGS
★ TRANSMITTERS	★ CORDS
★ ARC-1	★ RELAYS
★ ARC-3	★ TELEPHONE MATERIALS
★ ART-13	★ AN CONNECTORS
★ CONTROL BOXES	★ WE BUY ANYTHING!
★ INDICATORS	
★ CLAMPS	

Write, Wire today! Tell us what you have.  
**TALLEN CO., Inc., Dept. RE**  
159 Carlton Ave., Brooklyn 5, N. Y.





# American Beauty

## Electric Soldering Irons are Service Proven...

Since 1894

These features make American Beauty the Standard-of-Perfection on the world's production lines . . . where dependability, long life and efficiency are demanded.



TEMPERATURE REGULATING STAND

Thermostatically controlled to maintain heat of Iron at any desired temperature while at rest.

- Nickel-coated, corrosion-resistant tips, easily and quickly replaced
- Super-flexible cord, American Beauty made, resists wear due to flexing
- Heating element of chrome-nickel ribbon resistance wire
- Insulated with pure mica
- Built-in adapter for ground wire

WRITE FOR FREE LITERATURE

**AMERICAN ELECTRICAL HEATER COMPANY**  
DETROIT 2, MICHIGAN



We, connected with the Help-Freddie-Walk Fund, organized by RADIO-ELECTRONICS sometime ago in an effort to aid little Freddie Thomason, four-year old son of Herschel Thomason, radio technician of Magnolia, Arkansas, were particularly pleased to receive the following letter from Christine Holmberg, of Detroit, Michigan:

"Here is my \$2.00 that I earned by selling my comic books, popcorn, and cool-ade. I am 10½, blonde hair, and blue eyes. I only hope this will help you to walk. Good-by, good luck, and much happiness."

As most of our readers know, Freddie was born without arms or legs, and will always be dependent upon mechanical appliances to help him live a fairly normal and useful life. He has already been fitted with artificial legs, and his father reports that he "is an extremely happy and healthy boy. He uses his legs a lot and we are looking forward to the day when they start to work on his arms."

You can see that our work is not done! As Freddie continues to grow, he will need new appliances, and these, of course, will cost thousands of dollars. The "Freddie Fund" has just topped its first \$10,000, but this is only the beginning. And to keep pace with Freddie, we need the help of each and every reader.

Won't you send in your contributions, large or small, whenever and as often as you can? No amount is too small to receive our acknowledgment and sincere thanks for the part you are playing in this worthy cause. *Make all checks, money orders, etc., payable to Herschel Thomason.* Address all letters to:

HELP-FREDDIE-WALK FUND  
c/o RADIO-ELECTRONICS Magazine  
25 West Broadway  
New York 7, New York

**FAMILY CIRCLE CONTRIBUTIONS**  
Balance as of August 21, 1952...\$ 561.50  
FAMILY CIRCLE Contributions as of September 19, 1952..... 561.50

**RADIO-ELECTRONICS CONTRIBUTIONS**  
Balance as of August 21, 1952.....\$ 9,394.26  
Anonymous, Scituate, Mass. .... 15.00  
Anonymous, White Plains, N. Y. ... 2.00  
Gordon Bucknam, Rochester, N. Y. ... 5.00  
Detect-O-Ray Co., Chicago, Ill. ... 10.00  
Christine Holmberg, Detroit, Mich. ... 2.00  
C. J. Meyer, St. Albans, N. Y. .... 5.00  
Harold J. Oswald, Aerophysics and Electro-Mechanical Training School, Downey, Calif. .... 3.00  
Domenic Toretti, Duquesne, Pa. ... 5.00  
Ernest L. Petit, Los Angeles, Calif. ... 2.00

RADIO-ELECTRONICS Contributions as of September 19, 1952...\$ 9,443.26  
FAMILY CIRCLE Contributions ... 561.50  
TOTAL Contributions as of September 19, 1952 .....\$10,004.76

RADIO-ELECTRONICS



**N. Y. AUDIO FAIR OCT. 29**

The Audio Engineering Society is holding its fourth annual convention October 29 through November 1, at the Hotel New Yorker in New York City. Twenty-four papers by outstanding authorities in the fields of audio component and circuit design have been scheduled for the seven technical sessions.

The annual banquet is being held on Thursday evening, October 30, and features a special binaural sound broadcast over WQXR AM-FM, between 9:05 and 9:30 PM, Eastern Standard Time.

**TV KEEPS FOLKS HOME**

Average televiewers in the American home spend 3 hours and 24 minutes in front of the video set each day, according to a New York advertising agency. Radio listening drops from 87% in non-TV homes to 67% in TV homes. Weekly magazine reading drops only from 69% to 60%, but movie going drops one-third when TV comes into the home. These figures are the result of a study made by Batten, Barton, Durstine & Osborn, Inc., who surveyed 5,657 homes (in communities having populations of 2,500 and upwards) in the 48 states.

The study was made to determine the effects of television on the leisure-time recreational activities of the American public.

**WINDOW ANTENNA ILLEGAL**

No window antennas without landlord's permission is latest N. Y. Supreme Court ruling. In West Holding Corp. v. Cordero, reported in the *New York Law Journal*, the judge, while expressing sympathy with the tenant, nevertheless upheld the landlord's claim of trespass and ordered the antenna removed.

**Radio Thirty-Five Years Ago**  
In Cernsback Publications

**HUGO CERNSBACK**  
Founder

Modern Electrics	1908
Wireless Association of America	1908
Electrical Experimenter	1913
Radio News	1914
Science & Invention	1920
Television	1927
Radio-Craft	1929
Short-Wave Craft	1930
Television News	1931

Some of the larger libraries still have copies of ELECTRICAL EXPERIMENTER on file for interested readers.

**NOVEMBER, 1918**

**ELECTRICAL EXPERIMENTER**

The Phenomena of Electrical Conduction in Gases, by Rogers D. Rusk, M.A.

A Sensitive Wireless Recorder, by Arno A. Kluge

The How and Why of Radio Apparatus, by H. Winfield Secor

The Oscillograph—How It Works, by Professor Lindley Pyle, Professor of Physics, Washington University

Experimental Arc Lamp from Spark Gap, by N. Kenneth Mehaffie

NOVEMBER, 1952

**Get the NEW 1953 HUDSON CATALOG**



**FREE!**

**Keep Up-to-Date with the Latest in Radio, TV, and Industrial Electronics**

Solve time and money with this complete, new buying guide! Over 196 pages of Radio, TV, Tubes, Test Instruments . . . for Industry, Amateur, Service Technicians. World's finest High Fidelity and Audio Equipment, plus the latest JAN Cross-Reference GUIDE and all types of fully approved JAN Components.

**ALL Standard Makes in Stock for Prompt Delivery—AT LOWEST POSSIBLE PRICES.**

*Send for your FREE Copy Today!*

**HUDSON**

**RADIO & TELEVISION CORP.**

**48 WEST 48th ST. • 212 FULTON ST.**  
New York 36, N. Y.      New York 7, N. Y.

Circle 6-4060

**NEW! WO-88A 5" OSCILLOSCOPE**

HIGH GAIN • WIDE BAND • DIRECT COUPLED

Response flat from dc to 100 Kc; within—3db at 500 Kc; within -10 db at 1 Mc. Excellent square wave response with negligible tilt and over-shoot. Vertical deflection sensitivity 25 rms millivolts per inch. Direct-coupled push-pull, two stage vertical amplifier. Frequency compensated, voltage-calibrated attenuators. 5" CR tube with graph screen scaled directly in peak-to-peak voltage. Overall input resistance 10 megohms shunted by 9.5 uuf with WG-216B Low Capacitance Probe. "Plus" and "minus" sync. 1-volt peak-to-peak calibrating voltage.

Price  
**\$159.50**

Complete with Matched Probes and Cables



For fast service on RCA TUBES, TEST INSTRUMENTS, BATTERIES, PARTS . . . Call Hudson your complete, dependable source!

Mail this handy coupon

Hudson Radio & TV Corp. (Dept. R-11)  
48 West 48th St., New York 36, N. Y.

Please send FREE copy of 1953 Hudson Catalog

Enclosed is  check  M.O. \$.....

Ship the following: .....

Name.....

Address.....

City.....Zone.....State.....

**The finest all-channel antenna ever made!**



Patented

HIGH BAND PATTERN

LOW BAND PATTERN

Request further information from your local dealer

the SKYLINE

- ★ 28 fewer element connections
- ★ ..... 3 integral elements VS. 40
- ★ Pre-assembled ★ Quick rigtime
- ★ ..... Extra heavy—all aluminum
- ★ Amazing reception up to 150 mi.

The Skyline foldable colinear antenna possesses higher gain with respect to signal strength because the **elements are integral!**

No loss of signal strength through a multiplicity of mechanical connections.

Only the Skyline continues to maintain high gain with respect to signal strength over an **indefinite period of time.**

The Skyline colinear antenna, with its new engineering developments, is fast replacing **all other types** in fringe areas.

**SKYLINE MFG. CO. 1458C3 E. 17 St., Cleveland 14, Ohio**

You can't keep up with u.h.f. TV without reading the articles in future issues of  
**RADIO-ELECTRONICS**



# standard brands TUBES \$AVE!

individually boxed

024 ... \$ .49	6AB4 ... .55	6BC5 ... .59	198G6G ... 1.59
1B3GT ... .79	6AC7 ... .89	6BE6 ... .52	19T8 ... .79
1L4 ... .59	6AG5 ... .59	6BF5 ... .63	25AV5GT ... .95
1R5 ... .59	6AG7 ... .95	6BG6G ... 1.59	25BQ6GT ... .98
1S4 ... .69	6AH6 ... .95	6BH6 ... .65	25L6GT ... .49
1S5 ... .59	6AK5 ... .85	6BJ6 ... .55	25Z6GT ... .45
1T4 ... .59	6AL5 ... .49	6BL7 ... .89	35B5 ... .55
1U4 ... .63	6AQ5 ... .49	6BN6 ... .85	35C5 ... .55
1U5 ... .55	6AO6 ... .45	6BQ6 ... .98	35L6GT ... .55
1X2A ... .72	6AR5 ... .49	6BQ7 ... .98	35W4 ... .37
3Q4 ... .68	6AS5 ... .56	6C4 ... .44	35Z5GT ... .35
3Q5GT ... .65	6AT6 ... .41	6C5 ... .51	50B5 ... .55
354 ... .59	6AU6 ... .49	6C86 ... .59	50C5 ... .55
3V4 ... .59	6AV5GT ... .99	6CD6G ... 1.65	50L6GT ... .54
5T4 ... 1.19	6AV6 ... .41	6E5 ... .69	117N7GT 1.35
5U4G ... .49	6B4G ... .89	6F6GT ... .49	117P7GT 1.35
5V4G ... .89	6BA6 ... .49	6H6 ... .51	117Z3 ... .49
5Y3G ... .35	6BA7 ... .69	6J5GT ... .49	

Many other types equally low priced—include all your tube needs with your order. Above prices effective Sept. 15, 1952. One of the largest stocks in the country! Min. Order \$25.00. Terms: 25% with order, balance C.O.D. All prices subject to change without notice. F.O.B. New York City. Mail order division.

## TeleVision Materials Corp.

120 LIBERTY ST., NEW YORK 6, N.Y. • COrtlandt 7-4307

**FREE**

Write today for "How to Service T.V. Receivers" with the HICKOK VIDEO GENERATOR.

**Hickok Electrical Instrument Co.**  
10814 Dupont Ave., Cleveland, Ohio

H. G. CISIN'S

### RAPID NEW TROUBLE SHOOTING & ALIGNMENT TV CONSULTANT

WITHOUT experience or knowledge, this fast, easy, new method of TV servicing enables the novice to diagnose TV troubles expertly.

**NO THEORY—NO MATH**—copyrighted method locates all faults in record-breaking time, regardless of make or model. Shows simple, quick step-by-step **ALIGNMENT** methods and explains by pictures, diagrams and in easily understood language **HOW, WHEN and WHERE** to use **TV TEST INSTRUMENTS**.

Most complete and practical book on **TV TROUBLE SHOOTING and ALIGNMENT** ever written! Contains over 300 picture, raster and sound troubles and more than 135 **RAPID CHECKS**, many requiring no instruments, instead using picture tube as guide.

**THIS AMAZING NEW TV BOOK YOURS TO TRY 5 DAYS FREE!**

This book has a complete section on installation and servicing of **UHF** units; addition of **UHF CONVERTERS** to **VHF** sets; servicing **UHF**; tracing faults in **UHF** sets and converters; test instruments for **UHF** servicing. Also contains over 125 illustrations including **TV** picture faults, station patterns, scope waveforms, diagrams—everything needed to take the mystery out of TV servicing.

**TV CONSULTANT** is the ideal reference book for the TV expert, the service bench, the TV tool kit and for schools.

**Price \$2 postpaid**  
**GUARANTEED, MONEY BACK IN 5 DAYS IF NOT SATISFIED. Mail this coupon with only \$2—send name and address today!**

**RUSH COUPON NOW!**

H. G. CISIN, Consulting Engineer Dept. E-16  
200 Clinton Street, Brooklyn 2, N.Y.

Please RUSH postpaid your new book on TV Trouble Shooting and Alignment—"TV CONSULTANT". Enclosed find \$2.

Name.....  
Address.....  
City..... Zone..... State.....

**SENDING CODE RECEIVING SPEED**

Be a "key" man. Learn how to send and receive messages in code by telegraph and radio. Commerce needs thousands of men for jobs. Good pay, adventure, interesting work. Learn at home quickly through famous **Candler System**. Qualify for Amateur or Commercial License. Write for **FREE BOOK**.

**CANDLER SYSTEM CO.**  
Dept. 3-M, Box 928, Denver 1, Colo., U.S.A.

**!! TUBE CLEARANCE SALE !! . 90 DAY GUARANTEE!** Standard brands, unsealed cartons

#24, 26, 27, 34, 39, 41, 42, 46, 55, 56, 85, 89 or 9K7	29¢
#1H4, 1H6, 1J6, 6B7, 6F5, 6G5, 6SD7, 6SH7, 6R7 or 7B	39¢
#35, 43, 71, 77, 114, 5Y3, 5Y4, 5U4, 6F6, 6J5, 6K8, 6SA7, 6SK7, 6C5, 6U7, 7A4, 7B6, or 7G7	59¢
#1A7, 1L6, 1LH4, 2A5, 2A6, 6A3, 6A6, 6B8, 6C7, 6SN7, 7A7, 7AG7, 7C6, 7C7, 7Y4, 12SN, 47, 50 or 57	69¢

**!! MOTOR SPECIALS !!**

6 Volt DC Motor . . . 1750 RPM, 1/4" shaft, O.D. 2 1/2"x3 3/4"	2.49
AC-DC Blower . . . 5100 RPM, 3" fan, 27V, 1.5A, O.D. 2 1/2"x5 1/2", Shpg. wt. 3 lbs.	3.95
1/17 H.P. Motor (G.E.) . . . 1725 RPM, .7 amp, Shunt wound, 3/8" shaft, 110V, DC, 4 3/8"x5 1/2", Fully cased with mtg. Shpg. wt. 13 lbs.	2.95
115V, AC Induction Motor . . . 1750 RPM, fract. H.P. 2 1/2"x3 1/4"x1 1/8" shaft	1.39

**LEOTONE**

**"JUMBO RADIO PARTS KIT"**, 17 full lbs of: Coils, Condensers, Switches, Controls, Wire, Hardware, Resistors, Sockets, plus **MUCH MORE!!** Ship. wt. 20 lbs. **\$3.95**

**"ALNICO MAGNETS"**—"U" Magnet, 1"x1/2"x3/8"

Round Bar, 2"x3/8" O.D.	ea 59¢	10/5.50
Block Magn, 1 1/2"x3/8"x3/8"	ea 25¢	12/50
Flat Bar, 1 1/2"x1"x5/16"	ea 79¢	6/3.95

Alnico Magnet Kit . . . powerful Bar, Block, "U" Ring, Rod types, Kit of 10 ass'd. . . 1.98

H5-33 Headset with 13" cord & PL-54 plug . . . 2.89

ANB-H-1 Phone Units . . . 300 ohm imped. . . . .98

Dynamic Headset & Hand Mike (M41), New . . . 3.49

Single Shielded Phono Wire . . . coils 20-75 ft. 3¢ ft.

Hearing Aid Amplifier (2 tube) . . . ready-wired, Make A Real Vest Pocket Radio adding simple tuner. 2"x5"x1 1/2". With Schematic For 2 or 3 Tube Set. Less tubes, case . . . . . 2.49

Cabinet Draw Slides . . . silent ball-bearing . . . 13" (9" ext.) . \$2.10 pr; 15" (11" ext.) . \$2.25 pr; 16 1/2" (12 1/2" ext.) . \$2.39; Hvy. duty all-Steel 15 1/2" 12 1/2" . . . . . \$3.25

Speaker Cones . . . 4" to 12", incl. free-edge. Less voice coils, 12 ass'd . . . . . 1.98

Speaker Repair Kit . . . Liberal assortment of: Spiders, Rings, V.C. Forms, Felt, Chamois Leather, Shim Kit, Cement & Instructions . . . 2.49

**!! SPECIAL !!** . . . Both Cone & Repair Kits for Only . . . . . 3.95

**"FACTORY SPEAKER REPAIRS SINCE 1927"**  
Min. order \$3.00. 20% deposit req. on all C.O.D.'s. Full remittance with foreign orders. Please add sufficient postage—excess refunded.

**LEOTONE RADIO CORP.**  
67 Day Street  
New York 7, N. Y.

**U.S.-AUSTRALIAN HOOKUP**

Dear Editor:

Here is a radio service bench from "down under," at Litchfield's Radio and Electrical Service, West Ryde, N.S.W., Australia.

From left to right the instruments along the top shelf are: tube-checker-circuit analyzer; signal tracer; volt-ohm-milliammeter; Hickok signal generator; RCA scope. Bottom shelf: universal speaker set to match any field or output transformer; output meter; d.c.



power supply for battery sets; wide-range volt-amp-ohmmeter; v.t.v.m.; output meter calibrated in db; and three a.c.-line voltmeters. The bench work surface swings up to cover the instrument panel when not in use.

L. LITCHFIELD

West Ryde, N.S.W.

(Mr. Litchfield has crammed a remarkable amount of equipment—all useful—into an old desk. The units along the bottom shelf are apparently homemade, but their uniform professional appearance speaks much for Mr. Litchfield's skill.—Editor)

**MAN BITES DOG**

Dear Editor:

There is a Philco 17-inch television set next door which radiates a very strong signal across the 80- and 75-meter amateur radio band. This radiation makes it very hard to copy a c.w. signal on 80 meters. I was wondering if you could tell me what can be done about this?

Also what should I do if the people are not co-operative about fixing this trouble? The reason I must have this trouble fixed is that I have just received my amateur radio license and I cannot get on the air while this trouble goes on.

I would appreciate hearing some suggestions from you.

HERB MESLER

San Carlos, Calif.

(This is reverse TVI with a vengeance! Unfortunately for our correspondent, most of the remedies for this condition have to be applied to the TV receiver. See "TV Interference to Broadcast Receivers," by Mandl, in the October, 1950, issue, for more information on this subject.)

Manufacturers of TV receivers are becoming very co-operative about such trouble elimination where their sets are to blame, and Mr. Mesler can possibly obtain information—and in some cases, components—which may clear up the trouble. If the owner remains non-co-operative, a letter to the local office of

the FCC, setting forth the exact details of the interference will probably be helpful.

Have any of our readers had experiences which might give Mr. Mesler a lead?—Editor)

**BOLLER'S BILL**

Dear Editor:

After reading Paul Boller's letter on page 127 of the September issue I don't see how he could stay in business with a profit of only \$2.24. I would like to know how much he would make out of the job after considering rent, repairs on test equipment, taxes, insurance, phone, bookkeeping, gas for transportation, and truck repairs, even though the customer brings the midget to the shop himself.

Mr. Boller's charge of \$5.77 would be all right if he is doing only part-time servicing from his home. I, too, do part time servicing, and my bill would be \$6.20:

1—1R5 Tube	\$2.00
1—67½-v B battery	2.45
2—1½-v A batteries	.25
Service charge	1.50
Total	\$6.20
My cost	- 3.40
Profit	2.80

This includes an alignment (if needed) and a tube check. Only first-class materials are used in making repairs, with a 90-day guarantee on parts.

My profit was only 56 cents more than Mr. Boller's. But a large shop with expensive overhead would have to charge more than either Mr. Boller or myself to do business honestly.

G. P. OBERTO

Richmond, Va.

**CORRECTIONS**

The operating frequencies mentioned in the article "Frequency Stabilized Diathermy" (page 58 of the September issue) are incorrect by current FCC standards. The regulation regarding diathermy equipment has been changed—shifting the center frequency from 27.32 mc to 27.12 mc. Thus, the correct crystal frequency is 6.780 mc rather than 6.830 mc. Likewise, the doubler frequency is lowered to 13.56 mc.

Our thanks to Mr. B. F. Borsody, of Washington, D. C. for calling our attention to this change in the FCC regulations.

There are two arithmetical misprints on page 47 of the October issue. In the second column the equation  $2 \times 0.250/g = 80$  ohms should be changed to  $2/g = 333$  ohms. Three lines later, the equation  $3^2 \times 80 = 56$  milliwatts should read  $3^2/2 \times 333 = 13.5$  milliwatts.

On page 88 of the September issue, the authors of the book *Electronics for Communication Engineers* are given as John McGraw and Vin Zeluff. Change this to read: John Markus and Vin Zeluff. We offer our apologies to Mr. Markus. END

NOVEMBER, 1952

IT'S NEW



**The MAGNEMITE\***

Designed by A. C. Shaney, internationally-known leader in tape recorder development, and built by Amplifier Corp. of America, leaders and pioneers in magnetic recorders since 1936 — the Magnemite\* is also a leader in its field — the first completely portable tape recorder, powered by self-contained dry batteries! Measuring only 11½ x 8½ x 5½ inches, and weighing only 9½ lbs., the Magnemite\* represents ease and convenience in remote recording.

4 models available, including a unit designed to NAB recording standards. Priced from \$225. Write today for descriptive literature.

**THE 10-POUND PORTABLE BATTERY-OPERATED MIDGET TAPE RECORDER**

**New DRY CELL BATTERIES**

The Magnemite\* uses inexpensive flashlight-type batteries that last 100 operating hours. No wet cells that require re-charging or special handling.

**New SPRING-WOUND MOTOR**

The triply-compensated flyball governor-controlled motor runs at constant speed for 15 minutes with each winding.

**New 2-HOUR RECORDING**

Two full hours of recording at 1-7/8 inches per sec., using 2 sound tracks, are accommodated on a standard 5-inch reel of tape.

**New GREATER SENSITIVITY**

Crystal-clear recordings of normal conversations can be made from any distance up to 100 feet away from the microphone.

\*Trademark Reg.

**AMPLIFIER CORP. of AMERICA • 398 Broadway • New York 13, N. Y.**

No Time to Lose . . . So Lose No Time to PLACE YOUR WIRE ORDER

**N-O-W!**



JSC is currently running 3 and 4 times above normal production with a steadily mounting backlog in 300-Ohm TV Transmission Wire.

Lifting of credit controls, new TV channel openings, overwhelming demands from Canadian and South American sources, Presidential contest interests and enlarged scope of video's top-drawer entertainers—these factors point to an even greater demand for TV wire. Remember, first come first served for world famous truly-dependable JSC Wire Products.

See your nearest JSC distributor who proudly displays the blue and orange disc of quality!

**ON-THE SPOT BATTERY RECORDER**  
**WALKIE-RECORDALL** 8 lb. miniature BATTERY RECORDER-PLAYBACK  
 Continuous, permanent, accurate, indexed recording at only 5¢ per hr. Instantaneous, permanent playback. Picks up sound up to 60 ft. Records conferences, lectures, dictation, 2-way phone & sales talks; while walking, riding or flying. Records in closed briefcase with "hidden mike"! Write for details.  
**MILES REPRODUCER CO., INC.**  
 812 BROADWAY Dept. RE-11 NEW YORK 3, N. Y.

**PEN-OSCIL-LITE**  
 Extremely convenient test oscillator for all radio servicing; alignment • Small as a pen • Self powered • Range from 700 cycles audio to over 600 megacycles u.n.f. • Output from zero to 125 v. • Low in cost • Used by Signal Corps  
 • Write for information.  
**GENERAL TEST EQUIPMENT**  
**38 Argyle Ave. Buffalo 9, N. Y.**

**WANTED**  
 BD110 Telephone Switchboards, BD100 Telegraph Switchboards, BD90 Power Boards, EE101 V-F Ringers, BE72 Cabinets, FM19 Frames, RA43, REC30, K55988, RA87, RA37, RA91 Rectifiers, BD101 Test Boards, 888 Switchboards, Type CF1A, CF3A, CF2B Carrier Equipments. Any condition and quantity.  
 Box 752-1 Radio Electronics  
**25 W. Broadway, New York 7, N. Y.**

**LOVE THAT QUICK-WEDGE!**  
*I use it instead of a conventional screwdriver!*

**Quick-Wedge SCREW-HOLDING SCREWDRIVER**  
 unconditionally guaranteed

**ASK FOR IT AT YOUR DEALER**  
 KEDMAN CO. • 233 S. 5th WEST • SALT LAKE CITY, UTAH



THE **B**s... BEETHOVEN, BRAHMS AND BACH

they're different  
they're improved  
they're better than ever!

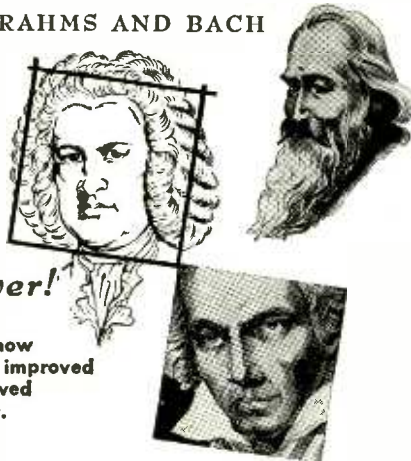

Yes, Bach, Beethoven and Brahms are now better than ever—we don't mean we've improved their music, but we do mean we've improved the reproduction of their recorded music.



It's the new, improved Pickering Cartridges that give credence to this claim. Yes, Pickering Cartridges are different. They're improved. They're better than ever. Pickering patented Cartridges with Dynamic Coupling\* are superior in every way, by providing: **HIGHER FREQUENCY RESPONSE • NEGLIGIBLE INTERMODULATION DISTORTION • BETTER TRACKING CHARACTERISTICS**

**\* DYNAMIC COUPLING ASSURES** constant stylus contact with the record grooves over the entire audio spectrum (20-20,000 cps) • full frequency response • full transient response • no resonances • no mistracking • no grinding of groove walls

**PICKERING and company, incorporated**



Pickering High Fidelity Components are available through leading Radio Parts distributors everywhere; detailed literature sent upon request. Address Department P-1

Oceanside, L. I., New York



**MONEY SAVER KITS from RADIO DEALERS SUPPLY CO.**

**5 TUBE AC-DC SUPERHET KIT**

Kit #1—Five Tube superheterodyne kit, A.C.-D.C. contains all components required to construct this latest design, highly sensitive superheterodyne broadcast receiver complete with black bakelite cabinet (excludes wire and solder) ..... Price **\$7.95**

Extra for a kit of 5 tubes (12AT6, 12BA6, 12BE6, 35WA, 50C5). Price \$3.25.

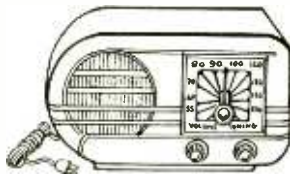

Kit #2—A low-priced **6 TUBE KIT** designed for high sensitivity, excellent selectivity and good tone quality. Uses 25L6, 25Z6, 6SQ7, 6SA7, 6SK7, 6SK7 in an easily constructed circuit. The 6 Tube Kit is shipped with all parts, including punched chassis, resistors, condensers, coil, sockets, PM Speaker, hardware, etc.

And at a closeout price of only **\$6.95** less tubes and cabinet

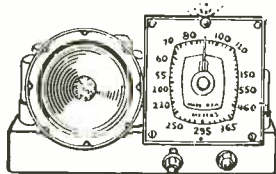

Extra for matched set of six tubes for kit **\$3.25**

Satisfaction guaranteed on all merchandise. All prices subject to change without notice.

Write for FREE Catalog.

**RADIO DEALERS SUPPLY CO., 154 GREENWICH ST., NEW YORK, N. Y.**

**Electronic Code Practice Oscillator & Blinker Kit**

AC/DC or Battery Operated!

Kit #3—One of the most practical Code Practice Oscillators ever designed, yet one of the simplest to build and operate. Can be used with any number of headphones. Adjustable Pitch Control—Any type of telephone can be used. No warmup time—ready to operate instantly. Simple and safe to operate. Operates anywhere—with AC or DC power, or from a 90 volt Miniature Battery. Learn Blinker Code with flashing light. Blinker can be used as signaling device. International Morse Code included.

Kit each **\$195** Assembled **\$295**

Kit #4—Basic 1 tube training kit. Simple to construct complete with all parts one tube and headset diagrams and instructions included. Use 1-354 tube and a 67½ volt Battery. Price \$3.95—less Battery.

Kit #5—2 tube Amplifier Kit complete with 50L6, 35Z5, and 4" PM to convert Kit No. 1 to a 3 tube set for loudspeaker operation. \$4.95

**THREE TUBE PHONO AMPLIFIER**

Not a Kit!

An assembled unit ready for installation using tone and volume control and six feet of rubber cord ..... **\$2.95**

(Not including Tubes)

With Complete Set of Tubes ..... \$3.95

**PHONO OSCILLATOR**

Not a Kit!

Wireless phono oscillator transmits recording for crystal pick-ups or voice from carbon mike through radio without wires. Can also be used as an intercomm by using P.M. speaker as mike. Price (excluding tubes) ..... **\$2.95**

With Complete Set of Tubes ..... \$3.95

**CAPACITOR GUIDE**

The Sprague Counter Catalog C-382 is a 12-page booklet listing electrolytics, molded tubulars, disc ceramics, high voltage ceramics, and the new "Universal Doorknob" ceramic.

Copies available to distributors from Sprague Products Co., North Adams, Mass.

**AUDIO CATALOG**

Harvey's new high-fidelity audio catalog is slanted to the music lover approaching hi-fi for the first time. Data permitting technical comparison of amplifiers, speakers, and tuners is also listed for sound engineers and seasoned high-fidelity enthusiasts.

Available free from Harvey Radio Co., Inc., 103 West 43rd St., New York 18, N. Y.

**TRANSFORMER CATALOG**

SIE has issued a six-page catalog listing input transformers, interstage transformers, output transformers, and reactors.

For free copy write to Southwestern Industrial Electronics Co., 2831 Post Oak Road, P.O. Box 13058, Houston 19, Tex.

**RADIO EDU-KIT**

Progressive Electronics has issued a booklet describing their Radio Edu-Kit, and containing servicing information. Accompanying this booklet is another on TV servicing.

For free copies write to Progressive Electronics Co., 497 Union Ave., Dept. RC, Brooklyn 11, N. Y.

**CAMERA CHAIN**

Du Mont's new 20-page booklet on the universal image orthicon television camera chain Model TA-124-E explains how a single triple-duty chain can be used in studios, in the field, and for film pickup, and stresses the advantages of one camera chain doing the work of three.

Available to station personnel, prospective broadcasters, and other interested members of the industry from the Television Transmitter Division, Allen B. Du Mont Laboratories, Inc., 1500 Main Ave., Clifton, N. J.

**WIREWOUND RESISTORS**

Shallcross Mfg. Co.'s Engineering Bulletin L-27 is a guide to precision wirewound resistors designed for military specifications. It summarizes the important differences between the new MIL-R-93A and old JAN-R-93 specifications and has a cross-reference table listing MIL and JAN type designations and the Shallcross resistors designed in accordance with these specifications.

For free copy write to Shallcross Mfg. Co., Collingdale, Pa.

**HOME AMPLIFIERS**

Modern Classics in Sound is the new 8-page booklet issued by Newcomb Audio Products Co. to describe their remote-control home amplifiers. Full specifications are given for each model.

Available direct from Newcomb Audio Products Co., 6824 Lexington Ave., Hollywood 38, Cal.

# STAN-BURN E-P-A-R-K-E

## ★ ANTENNAE SPECIALS ★

★ DOUBLE V 3/4" .....	1-11	12 or more
★ DOUBLE V 3/8" Dowel .....	\$2.98	\$2.20
★ DOUBLE V 1/2" Dowel .....	3.48	2.48
★ 10 Element Conical 3/4" .....	3.98	2.98
★ 10 Element Conical 1/2" .....	3.58	2.58
★ Folded HI Straight Low Quick		
Rig 1/2" elements .....	4.25	3.25
★ WINDOW CONICALS .....	4.95	3.75
MASTS		
★ 5 FOOT SWEGGED .....	.79	.69
★ 10 FOOT PLAIN .....	1.39	1.29
TV WIRE		
★ 55 Mil. 300 OHM .....	\$14.95 M Ft.	
★ 72 OHM COAXIAL .....	48.00 M Ft.	

## ★ CATHODE RAY TUBE SPECIALS ★

STANDARD BRANDS—UNCONDITIONALLY			
★ 10BP4A	Sheldon	\$13.95	17BP4A Federal 23.00
★ 10BP4A	N.U.	18.95	19AP4A Sheldon 29.95
★ 12LP4A	Sheldon	15.95	19AP4A GE 38.00
★ 12LP4A	Thomas	13.95	19BP4A Thomas 39.95
★ 16AP4A	Sheldon	24.00	19DP4A Sheldon 29.95
★ 16AP4A	GE	34.20	20CP4A Dumont 37.00
★ 16DP4A	Thomas	24.30	20CP4A Sheldon 31.00
★ 1F-D-HP4A	Sheldon	24.00	21EP4A Federal 29.00
★ 16GP4A	Sheldon	24.00	21EP4A Dumont 39.00
★ 16GP4A	Rutland	30.25	21EP4A Sheldon 33.00
★ 16JP4A	Sheldon	24.00	24AP4A GE 68.40
★ 16RP4A	GE & HU	23.40	Single Ion traps .39
★ 16KP4A	Sheldon	22.00	Double Ion traps .39
★ CLASSIC 100 REGAL with basic tuner \$139.50			
★ T. F. V. BALL (Similar to RCA) 2.98			
★ OPEN FACE CABINET 19.00			

## ★ TRANSFORMERS ★

★ RCA type for 16" to 24" K032 .....	\$3.85
★ G.E. Type for 16" to 24" K045 .....	3.85

## ★ DEFLECTION YOKES ★

★ Cosine Ferrite Todd Yoke 70" .....	\$4.20
--------------------------------------	--------

## ★ SPECIALS ★

★ 4 Prong Vibrators, each .....	\$1.29
★ Lots of 12 or more GUARANTEED .....	1.19
★ Standard TV Tuner .....	10.95
★ 12" Heavy Slug Speaker .....	Special 4.98

## ★ AUDIO DEVICES, DISCS, and Scotch Tape in Stock ★

★ Audio Plastic Red Oxide Plastic tape—	
Half hour spool .....	\$2.30
One hour spool .....	3.30

## ★ WIRE RECORDERS IN STOCK ★

★ WILCOX GAY—Model 2A10 .....	\$89.97
★ PENTRON—Model 973C—2 apd. Tape Rdr net	134.50
★ RADIO (Model RC2-HIF) Amplifier .....	22.88
★ CRAFTS (Model RC10—AM-FM Tuner) net	130.84
★ MEN (Model CR—Williamson Amplifier) net	99.43

## ★ AUTHORIZED DISTRIBUTORS for: ★

General Electric, Kenrad, Tung-Sol, National Union, Jewel, De Wald, Regal, Automatic and Setchel Carlson.

Write for our latest price list to Dept. RE-11

**STAN-BURN RADIO and ELECTRONICS CO.**  
(C.R.S. THEATRE BLDG.)  
1697 BROADWAY • NEW YORK 19, N.Y.

**Every RADIOMAN can use these SERVICE HINTS!**

Valuable Manual Yours—FREE  
Write today—no obligation

FEILER ENGINEERING CO. Dept. 11RC2-1  
8026 N. Monticello Ave., Skokie, Ill. (Suburb of Chicago)

**STANDARD BRAND TUBES**  
Individually boxed, fully guaranteed

6AC7 .....	75¢	6AV6 .....	39¢
6AL5 .....	39¢	12SJ7 .....	45¢
6X4 .....	35¢	25L6 .....	45¢
6BG6 .....	\$1.75	5U4 .....	49¢

Other Tubes at above Low Prices! Ramit in full or 25% deposit required on each C.O.D. order F.O.B. N.Y.C. Minimum order \$5.00.

**ALLIED ELECTRONIC SALES**  
74 Cortlandt St., N. Y. BA 7-5839

**AC-DC MUSIC AMPLIFIER**

Volume and tone control.  
1.5 w. output.  
See your jobber.

**MICHAEL MFG. CO.**  
227 N Water St.  
Milwaukee 2, Wis.

### TINY TRANSFORMERS

A new catalog has just been issued, describing the Crest line of miniature, subminiature, and microminiature transformers for hearing aids, portable amplifiers, light-weight transmitters, airborne equipment, and transistor circuits.

Available free of charge from Crest Laboratories, Inc., Whitehall Bldg., Far Rockaway, N. Y.

### FRETCO ANTENNA BOOKLETS

Fretco Antenna Facts and Fretline Handbook are the titles of two 7-page booklets of interest to TV antenna technicians, dealers, and set owners. The first describes and illustrates the basic types of antennas and gives pertinent information on spacing and element lengths for beams and Yagis, and on the use and construction of quarter-wavelength matching stubs. The handbook is devoted to transmission lines. It contains charts and graphs showing conductor spacing and diameter for open-wire lines ranging from about 150 to 800 ohms impedance, losses due to mismatch on line, and transmission-line velocity constants and attenuation factors.

Copies of both booklets can be obtained free of charge by writing to Fretco Inc., 1041 Forbes St., Pittsburgh 19, Pa.

### FOR WOULD-BE HAMS

You Can Be There is the American Radio Relay League's new pamphlet designed to interest the reader in obtaining a novice class amateur radio operator's license. Its purpose is not only personal enjoyment, but to encourage professional electronics careers in industry or military service.

Copies will be distributed through youth organizations, educational and civic groups, and electronics manufacturers and distributors.

### ELECTRONIC SHORTCUTS

A booklet written for the hobbyist, experimenter, or modelmaker in which 24 applications of germanium crystal diodes are described. Among the more interesting circuits are an interval timer, spark quencher, door opener, photoelectric relay, and radio control circuits.

Available from Advertising Department, Sylvania Electric Products Inc., Buffalo, N. Y. Price 25¢.

### ELECTRONIC TRANSFORMERS

Catalog TR-52, released by Triad Transformer Mfg. Co., lists more than 450 items with specifications and prices. Featured are hermetically-sealed transformers designed to MIL-T-27 specifications, high-quality audio transformers, 400-cycle power transformers, "Trijet" miniature transformers, toroids, general purpose transformers for radio and TV replacement, geophysical transformers, and amplifier kits.

Copies may be had by writing Triad Transformer Manufacturing Co., P.O. Box 17813, Los Angeles 34, Calif. END

**EASY LOW-COST WAY to own a PROFESSIONAL QUALITY tapeMaster TAPE RECORDER**



**DUAL SPEED HIGH FIDELITY**

**PORTABLE MODEL PT-125**

Use with Your Own Audio Amplifier, Radio or Radio-Phono Combination, or with new tapeMaster Model SA-13 Power Amplifier and Speaker.

For the first time, a completely flexible professional quality tape recorder like this—at such economical cost! Advanced engineering and customized design make tapeMaster a natural choice of recording enthusiasts everywhere.

Built to RTMA Standards • Dual Track Dual Speed—7.5" and 3.75" sec. • Fast Forward and Rewind • Direct Threading of Tape • Push-Pull Supersonic Bias-Erase Response 50-8000 cps ± 3 db at 7.5 and 50-5000 cps at 3.75 • Inputs for Radio, Phono and Mike • Full Monitoring • Neon Record Level Indicator • For 105-125 V 60 cycle AC (Also available for 110-220 V 50 cycle AC)

Complete with 5" spool of plastic tape and 7" empty take-up spool, in sturdy carrying case covered with waterproof leatherette, less audio amplifier and microphone. Size: 12 1/2" x 12" x 9 1/2" high. **\$99.50**

Net Price.....

(Slightly Higher West and South)

Tape Transport Mechanism and Matching Pre-Amplifier with Push-Pull Supersonic Bias-Erase Oscillator also available individually for custom installations.

**MODEL SA-13 POWER AMPLIFIER AND SPEAKER**

Portable companion to the PT-125 tape recorder. Combines a special type speaker, new amplifier design, and effective principle of baffling. Amplifier response ± 1 db 30-15,000 cps. Peak output 8 watts. Has separate bass and treble control. 12" x 9 1/2" x 18 1/2" high. **\$79.50**

Net Price.....

Send for FREE Bulletin 102-A

**tapeMaster inc.**  
13 W. HUBBARD ST. • CHICAGO 10, ILL.

Export: Scheel International, Inc.  
Chicago 18, U.S.A. • Cable: Marschel



**HERE ARE ONLY A FEW OF THE BIG VALUES IN THE LATEST 148 PAGE 1953 B-A CATALOG!**

**FREE!** Write us if you have not received it

**BURSTEIN-APPLEBEE CO.**  
1012-14 McGee St., Kansas City 6, Mo.

Send Free B-A Catalog No. 531.  
 My order is attached for items from below.

\$ \_\_\_\_\_ enclosed.

Name \_\_\_\_\_  
Address \_\_\_\_\_  
City \_\_\_\_\_ State \_\_\_\_\_

**POWER SUPPLY KIT**  
**110 VOLT FILTERED DC at 40MA**

ALL FOR **\$1.79**

Here at a Big Saving you get Top Quality basic components for a Power Supply with many applications for Mike or Phono Pre-Amp, Midget Radios or Audio Amplifiers, Photo Cell equip., Garage Door Openers, Code Practice Oscillators, TV Boosters, Test Equipment, etc.

Kit consists of a compact, fully enclosed Power Transformer, pri: 117 V. 60 cycle AC 110 V @ 40 MA. H.V. Sec., and 6.3 V @ 1 amp. for filament. A 35 MA-130 V. Selenium Rectifier, and a 16 Mid-150 V. DC wkg-225 V. peak electrolytic Filter Condenser . . . both very compact and easy to mount with the tinned wire leads. Wt. 1 1/2 lbs. You Get All Above No. 14B993. PER KIT..... **\$1.79**

**COMPACT CABINET & CHASSIS**

CABINET AND CHASSIS **\$1.29**

**Cabinet** is blank (no holes) except for ventilating slots. Modern design brown bakelite, size 8" W. X 4 1/2" H. X 4 1/2" D. Open side can be used as bottom or back. Adaptable for a wide variety of uses.

**Chassis**—Sturdy construction 7 1/2" W. X 3" D X 1 1/2" flange. Has hole for miniature socket, and drill holes for mtg. of other components. Can be easily altered for more socket holes and to specific needs. Exactly fits above cabinet and fastens to studs in cabinet by means of spring wires (included). Wt. 2 lbs.

No. 32A189. Cabinet & Chassis Both For... **\$1.29**

**POWER SUPPLY KIT, CABINET & CHASSIS**  
No. 31B85. ALL FOR..... **\$2.98**

**75 AND 80 METER CRYSTALS**

**IN REGULAR FT243 HOLDERS**

**79c**

First quality guaranteed active oscillators made to Signal Corps specs. . . every one brand new and tested! Better get plenty while available . . . we doubt this lucky buy can be repeated.

Available in following frequencies:

3525 KC No. 15A1173	<b>CHOICE EACH 79c</b>
3655 KC No. 15A1174	
3665 KC No. 15A1175	
3700 KC No. 15A1176	
3735 KC No. 15A1177	
3980 KC No. 15A1178	

You can easily change frequency if necessary by following crystal grinding instructions in any handbook.

Assortment of 4 Crystals—Our choice from above.  
No. 17B818. Per Assst..... **\$2.45**

INCLUDE ALLOWANCE FOR POSTAGE—ALL OVER-PAYMENTS REFUNDED.

**BURSTEIN-APPLEBEE CO.**  
1012-14 MCGEE ST. KANSAS CITY, MO.

**HIGH-FREQUENCY TRANSMISSION LINES**, by J. DeFrance. Published by Bayside Publishers, 36-35 206 St., Bay-side, L. I., N. Y. Flexible paper covers. 7x10 inches, 40 pages. Price 90 cents.

Here is practical treatment for a difficult but important subject. In easy steps, the author develops clear concepts of reflection, impedance, standing waves, etc. Higher math is avoided. Simple algebra, trigonometry, and vectors do appear.

The booklet is especially interesting to the beginner in h.f., because it tries for simplicity, rather than completeness. For example, a transmission line diagram of fields is given without comment. Simplification is sometimes carried to a point that would infuriate a mathematician. In an explanation of characteristic impedance, we find the relation between impedance, inductance, and capacitance stated—as  $Z_0=L/C$  (rather than  $\sqrt{L/C}$ ). Evidently this is a simplification to show that  $Z_0$  depends on  $L/C$ , which is true.

There are three chapters: fundamentals, reflections, and applications. The last shows how to use theory in designing antennas, stubs, and guides.—IQ

**ANTENNAS: THEORY AND PRACTICE**, by Sergei A. Schelkunoff and Harald T. Friis. Published by John Wiley & Sons, Inc., New York, N. Y. 6 x 9 inches, 639 pages. Price \$10.00.

This comprehensive book describes basic antenna types over a wide frequency range. It deals more with fundamental theory than with detailed study of any specialized types. It is written for radio engineers, physicists and others who can understand calculus and vector notation. Vector analysis is not undertaken.

Physical and mathematical foundations for the subject are provided in the first two chapters: radiation principles and Maxwell's equations. These are followed by descriptions of various waves, impedance, directive radiation and other topics. Next are chapters on the dipole, rhombic, linear systems, etc. The last few chapters cover microwave antennas: horns, slot antennas, reflectors and lenses. Throughout the book the authors stress physical concepts as well as mathematical analysis.

Many illustrations and numerical tables are supplied. All except the last few chapters are followed by problems relating to antenna design and practice. Most problems are accompanied by answers.—IQ

**THE ELECTROMAGNETIC FIELD**, by Max Mason and Warren Weaver. Published by Dover Publications, Inc., 1780 Broadway, New York 19, N. Y. 5 1/2 x 8 inches, 390 pages. Price, cloth bound \$3.95; paper bound \$1.85.

This work, originally published in 1929, covers theory and principles equally important today. Using calculus and vector methods, it analyzes clearly and progresses rapidly. This is a text for (Please turn to p. 139)

**ENGINEERS**

Make this your home for important work under ideal conditions

- TV Receiver Design Eng.
- Test & Inspection Eng.
- Electronics Eng.
- Field Engineers
- Lab Technicians

**TO WORK ON:**

Radar, G. C. A., Mobile Radio, Auto Radio, Airborne Communication & Navigation Equipment, Television, Antennas, Microwave Equipment, Servo Mechanisms, Guided Missiles and Test Equipment.

**YOU BENEFIT**

from high wages, a modern, air-conditioned plant, paid vacations and holidays, group insurance and a good chance for advancement. Housing immediately available in the beautiful suburban and country areas that surround the Bendix plant.

Write Wire, Phone Mr. E. O. Cole, Dept. 5

**Bendix Radio**

DIVISION OF BENDIX AVIATION CORP.  
BALTIMORE-4, MD. Phone: TOWSON 2200

**EASY TO LEARN CODE**

It is easy to learn or increase speed with an Instructograph Code Teacher. Affords the quickest and most practical method yet developed. For beginners or advanced students. Available tapes for beginner's alphabet to typical messages on all subjects. Speed range 5 to 40 WPM. Always ready—no QRM.

**ENDORSED BY THOUSANDS!**

The Instructograph Code Teacher literally takes the place of an operator-instructor and enables anyone to learn and master code without further assistance. Thousands of successful operators have "acquired the code" with the Instructograph System. Write today for convenient rental and purchase plans.

**INSTRUCTOGRAPH COMPANY**

4701 Sheridan Rd., Dept. RC, Chicago 40, Ill.  
RADIO-ELECTRONICS



# TV SERVICING E-X-C-L-U-S-I-V-E-L-Y

For nearly a decade, hundreds of students have turned to WesternTV for practical shop training. They wanted the advantages of specialized training . . . they wanted to learn HOW to repair radio and television receivers—NOT design them—NOT build them. They wanted to become TV specialists—NOT "general practitioners."

**WE GAVE THEM WHAT THEY WANTED**  
 . . . no complicated mathematical design . . . no engineering theory . . . no slide-rule operations . . . no other non-essential, time-consuming subjects of no practical value to the TV specialist. WesternTV students obtain valuable "field experience" in our full-equipped shops . . . actually work on some 20 brands of TV sets . . . learn to use over 15 types of professional test & measuring instruments . . . learn to service all types of home television receivers.

**OUR GRADUATES HOLD TOP-PAYING JOBS.**  
 . . . the constant demand for WesternTV shop-trained technicians speaks for itself . . . calls come in from such distant cities as Washington, D. C. I WesternTV graduates are gainfully employed as TV Service Managers, TV "bench" Technicians, and in other supervisory positions; many successfully operate their own TV service business.

See why—send for Booklet E-11.

APPROVED FOR VETERANS

## WESTERN TELEVISION INSTITUTE

341 West 18th St., Los Angeles 15, Calif.

# BE A RADIO ENGINEER!

You can enter this uncrowded, inter-calling field. Defense expansion, new developments in electronics demand trained technicians. Study all phases radio & electronics theory and practice: TV; FM; broadcasting; servicing; aviation, marine, police radio. 18-month course equal in radio content to 4 yrs. college. H.S. or equivalent required. Begin Jan., March, June, Sept. Campus life. Write for catalog.



**VALPARAISO TECHNICAL INSTITUTE**  
 Dept. C Valparaiso, Ind.

# LEARN TELEVISION

**ELECTRONICS and RADIO**

Engineering Laboratory and Classroom Training, Day and Evening Classes.

Write for Illustrated Catalog

**ELECTRONICS INSTITUTE, Inc.**  
 21 HENRY, DETROIT 1, MICH.

# RADIO COURSES

- RADIO OPERATING • CODE
- RADIO SERVICING • ELECTRONICS
- F. M. TELEVISION

Preparation for Civilian, Maritime, Army and Navy license requirements.

Write for Catalog TE

**Y.M.C.A. TRADE & TECH. SCHOOL**

15 W. 63 St., N. Y. 23  
 INdicott 2-8117

# RADIO and TELEVISION ELECTRONICS

in all Technical Phases  
 New Classes (Day & Evening)  
 Start 1st of Dec., Mar., June, Sept.  
**FREE PLACEMENT SERVICE**  
 for GRADUATES

For Free Catalog write Dept. RC-52

**RCA INSTITUTES, INC.**

A Service of Radio Corporation of America  
 350 West 4th St., New York 14, N. Y.

# RADIO ENGINEERING DEGREE IN 27 MONTHS

Intensive, specialized course including strong basis in mathematics and electrical engineering, advanced radio theory and design, television. Modern lab. Low tuition. Self-help opportunities. Also U.S. degree in 27 months in Aeronautical, Chemical, Civil, Electrical, and Mechanical Engineering G.I. Gov't approved. Enter December, March, June, September. Catalog.

**INDIANA TECHNICAL COLLEGE**

1511 E. Washington Blvd., Fort Wayne 2, Indiana

# RADIO SCHOOL DIRECTORY

## Unlimited Opportunities in RADIO ENGINEERING

**DEGREE IN 27 MONTHS**

Complete Radio engineering course including telev. U. H. F. and F. M. Bachelor of Science Degree also in Mech., Civil, Elect., Chem., and Aero. Eng.; Bus. Adm., Acct. Extensive campus, modern buildings, well equipped labs. Low cost. Prep courses. Personalized, practical instruction. Founded 1884. Placement service. Growing shortage of engineers. Prepare now for unlimited opportunities ahead. Enter January, March, June, September. Write for catalog.



**TRI-STATE COLLEGE**

24112 College Ave. ANGOLA, IND.

### FOR THE FIRST TIME!

For several years you've read about the Don Martin School now—for the first time—we are prepared to offer a course by mail. You can obtain your first class radio telephone operator's license from this special course. Operators are desperately needed now by radio and TV stations as well as the aircraft industry. Secure your future.

Be certain that your training is of the best, enjoy the school recognized by the profession. Write today for full information.

**THE DON MARTIN SCHOOL OF RADIO AND TELEVISION ARTS AND SCIENCES**

Correspondence Section

1655 No. Cherokee, Hollywood 28, Calif. HU. 2-3281.

# COLOR TELEVISION



Color TV is just one of 30 modern subjects included in new I. C. S. course in *FM and Television Servicing*, other up-to-date, low-cost courses—391 in all. Engineering, Business. Special technical training. High School. Study in your spare time. Set your own pace. Individual instruction from experts. Diploma awarded. I. C. S. is oldest and largest. Known and respected the world over.

**FREE "SUCCESS" BOOK!** 36 pages packed with worthwhile tips on "How to Succeed." Gives you step-by-step plan of action. Pocket-size edition. Man or woman—young or old—if you make \$2000 or \$20,000 a year, this book can help you. Send for it *plus* free catalogs on career that interests you.

**International Correspondence Schools, Box 2869-H**  
 Scranton, Pa.

Please send "How to Succeed" book and catalog on course

In.....  
 Name..... Age.....  
 Address.....

## TELEVISION-RADIO ELECTRONICS

Training in all branches television, radio and electronics. FCC exam. preparation. Write for free catalog.

**COMMERCIAL RADIO INSTITUTE**

(Founded 1920)

38 W. Biddle St., Baltimore 1, Md.

Approved by Maryland State Board of Education

# Become an ELECTRICAL ENGINEER in 36 MONTHS

## Bachelor of Science Degree — Major in Electronics or Power

It is estimated by 1955 there will be at least two positions for every engineering and technician graduate. This college offers a tested plan that permits you to enter these vast employment opportunities at an early date. Save a valuable year through optional year-round study. Receive advanced credit for prior training gained in the armed forces, other schools or field experience.

**ENTER BOTH RADIO AND TELEVISION** 12 months or one-third of the B. S. degree course (Electronics major)—also brings you the **Radio Technician's** certificate. An added 6-month course qualifies you for the **Radio-TV Technician's** certificate. Recent developments open unlimited opportunities for TV technicians and engineers.

**THE PROVEN "UNIT CHASSIS SYSTEM"** of teaching was developed here. It "breaks down" the TV set by stages. You learn every component of all types and makes — and are prepared for future design changes, including the advent of color.

**12-MONTH TELEVISION SERVICE COURSE** . . . trains for good servicing jobs and shop ownership in the shortest practical time under expert instructors.

**Terms open January, April, July, October.** Over 48,000 former students from all states and 23 overseas countries. Faculty of trained specialists. Modern laboratories and equipment.

Write for free 110-page catalog, 48-page pictorial booklet "Your Career" and "Occupational Guidance Bulletins."

# MILWAUKEE SCHOOL OF ENGINEERING

NONPROFIT • FOUNDED IN 1903



Milwaukee School of Engineering  
 Dept. RE-1152, 1025 North Milwaukee  
 Milwaukee 1, Wisconsin

Without obligation send Catalog for Electrical Engineering, B. S. Degree, major in  Electronics;  Power;  "Your Career";  Occupational Guidance Bulletin on:  Radio-TV;  Electrical Power;  Welding;  Heating, Refrigeration, Air conditioning;  Mechanical Engineering, B. S. Degree;  Preparatory;  Television Service.

Name..... Age.....  
 Address.....  
 City..... Zone..... State.....

If veteran, indicate date of discharge.....



# MATTISON

**SILVER ROCKET  
630 CHASSIS with  
TUNEABLE**

**BUILT-IN BOOSTER  
for Better DX Reception**

Featuring NEW CASCODE TUNER  
made for UHF interchangeable  
tuning strips and 70° COSINE YOKE

Tube  
Complement:  
28 tubes  
3 rectifiers  
1 CRT

32



### All Channel Booster

- Broad band single knob control pre-amplifier built in to eliminate long leads which may cause regeneration and attenuation of signal.
- ONLY THE MATTISON 630 CHASSIS HAS AN ALL CHANNEL TUNEABLE BUILT-IN BOOSTER THAT INCREASES SIGNAL STRENGTH UP TO 10 TIMES. THE SILVER ROCKET WILL OUT-PERFORM ANY CHASSIS MADE AND IS PRICED RIGHT TO SELL FAST WITH AN EXTRAORDINARY MARGIN OF PROFIT FOR YOU. WRITE FOR CONFIDENTIAL PRICE SCHEDULE.

• Mattison features a complete line of cabinets MADE IN MATTISON'S OWN CABINET FACTORY. 36 breathtaking designs that blend perfectly in any setting, traditional or modern.

ALL  
CABINETS  
MADE IN  
MATTISON'S  
OWN  
CABINET  
FACTORY!



### The HERITAGE 21"

Genuine Mahogany. Deeply paneled 1 1/2" thick doors. Crotch Mahogany design and Hi-light shading throughout. Illuminated channel selector. Chassis is side mounted. Dimensions: height 40", width 32 1/2", depth 23 1/2".

**DEALERS! SERVICE DEALERS!** Here is your opportunity to become the "important" TV Dealer in your area for THE FINEST CUSTOM-BUILT LINE OF TV RECEIVERS. FREE! Write for Mattison's merchandising portfolio, explaining the "UNASSEMBLED PLAN" and "\$1,000,000 FLOOR PLAN."



Manufactured with integrity

**Mattison Television & Radio Corp.**  
893 Broadway, Dept. RE, N. Y. 3, N. Y.

## ADVERTISING INDEX

Adelman, Nat	121
Aero-Tone Mfg. Co., Inc.	84
Allied Electric Sales	13
Allied Radio Corporation	130
American Electrical Heater Co.	106
American Electronics Company	106
American Phenolic Corp.	133
Amplifier Corporation of America	110
Amptel, Inc.	84
Arkay Radio Kits, Inc.	129
Arrow Electronics	84
Astastic Corporation	133
Atlas Sound Corp.	138
Barry Electronics Corp.	24
Bell Telephone Labs	136
Bendix Radio	86
Blonder-Tongue Labs	101
Brooks Radio & TV Corp.	132
Burstein-Appiebee Co.	74, 75
Candler System Co.	132
Capitol Radio Engineering Institute	139
Centralab—Div. of Globe Union	132
Channel Master Corp.	23
Cisair, H. G.	132
Cleveland Institute of Radio Electronics	123
Communications Equipment Co.	92
Concord Radio	139
Coyne Electrical & TV Radio School	16
Crest Laboratories, Inc.	121
Davis Electronics	109
DeForest's Training, Inc.	87
De Gray and Assoc.	109
Delco Radio	87
DuWors Labs, Inc. Allen B.	Inside Front Cover
Editors & Engineers	28
Electronic Instrument Co., Inc.	119
Electronic Measurements Corp.	110, 135
Feiler Engineering Co.	21
General Electric Co.	133
General Test Equipment	132
Good, Inc. Don	133
Grayburne Corporation	122
Greylock Electronic Supply Co.	88
Halldorson Transformer Co., The	99
Harvard Labs	61-71 inclusive
Heath Co.	131
Hickok Electrical Instrument Co.	98
Hudson Radio & TV Corp.	115
Hughes Aircraft Corp.	136
Hytron Radio & Electronics Corp.	17
Indiana Technical College	102
Instructograph Co.	133
Insuline Corporation of America	112
JFD Mfg. Co., Inc.	133
Jackson Electrical Instrument Co.	133
Jan Electronic Distributing Co.	112
Jersey Specialty Co.	133
Johnson Smith & Co.	133
Kedman Company	109
Krylon, Inc.	132
LaPointe-Plascomold Corp.	132
Leotone Radio Corp.	138
Mallory & Co., Inc. P. R.	Inside Back Cover
Mattison Television & Radio Corp.	138
McGraw-Hill Book Co.	139
Merit Coil & Transformer Co.	135
Michael Manufacturing Co.	133
Wiles Co., Inc.	105
Mosley Electronics	77
Moss Electronic Distributing Co., Inc.	84
National Sales Corp.	127
National Electronics of Cleveland	99
National Plans Co.	19, 20
National Radio Institute	2
National Schools	126
Neirich Publications	118
Omrite Mfg. Co.	104
Opportunity Adlets	114
Oxford Electric Corporation	134
Perma-Power, Inc.	138
Philco Corporation	118
Pickering & Co.	134
Pioneer Electronic Supply Co.	118
Plastoid Corporation	124
Precision Apparatus Co., Inc.	126
Pre-Probe Co.	51
Progressive Electronics Co.	27
RCA Institutes, Inc.	97, Back Cover
RCA Victor Division	73, 93
Radiart Corp.	128
Radio City Products	134
Radio Dealers Supply	108
Radio Receptor Co., Inc.	108

## RADIO SCHOOL DIRECTORY PAGE 137

Commercial Radio Institute	
Electronics Institute	
Indiana Technical College	
International Correspondence Schools	
Martin School	
Milwaukee School of Engineering	
RCA Institutes, Inc.	
Tri-State College	
Valparaiso Technical Institute	
Western Radio Television Institute	
YMCA Trade & Technical School	

Radio-Television Training, Assn.	25
Rauland Corp., The	85
Raytheon Manufacturing Co.	86
Recechy Div. (I.D.E.A., Inc.)	108
Rider, Inc., Publisher, John F.	103
Rinehart Books, Inc.	82, 96, 100
Rose Company	76
Rytel Electronics Mfg. Co.	18, 111
Sams & Co., Inc., Howard W.	89
Sangamo Electric Co.	128
Service Products Co.	99, 105
Service Electric Co.	131
Skyline Manufacturing Co.	139
Soundronics Labs., Inc.	128
Spencer Wire Co., Inc.	59
Spraybury Academy of Radio	115
Stan-Burn Radio & Electronics Co.	121
Steve-El Electronics Corp.	26
Superior Instruments Co.	140
Supreme Publications	129
Sylvania Electric Products	129
Tallen Co., Inc.	129
Tape Master, Inc.	126
Tarzan, Inc., Sarkes	123
Technical Appliance Co.	96
Tel-A-Ray Enterprises, Inc.	111
Telematic Industries, Inc.	125
Telescopac Products, Inc.	132
Telesound Corp.	129
Television Communications Institute	125
Television Materials, Inc.	132
Telex, Inc.	129
Telrex, Inc.	116, 117
Transmission, Inc.	80, 81
Trio Mfg. Co.	90
Triplett Electrical Instrument Co.	12
Tung-Sol Electric Co.	124
Utah Radio Products Co.	109
Vee-D-K	121
Vidairre Television Co.	107
Videon Electronic Corp.	82
Wells Sales	10, 11
Westhouse Electric Corp.	88
Wholesale Radio Parts Co., Inc.	127
John Wiley & Sons, Inc.	120
Winchager Corporation	120

Radio-Electronics does not assume responsibility for any errors appearing in above index.

## New Listing Every Month TUBES

Standard R.M.A. Warranty. We endeavor to give you low, low prices, consistent with quality merchandise and service.

Here is only a partial listing of our large stocks. You may order popular types not listed at approx. same savings. Not Specials in Light-face Type.

OA2	5.98	6AH6	1.00	12BA7	90
OB2	1.10	6AJ5	1.75	12BD6	1.25
OC3/VR105	6AK5	.75	12BE6	.45	
	1.19	6AK6	.85	12C8	.79
OD3/VR150	6AL5	.59	12H6	.75	
	.95	6AN5	2.25	12SA7	.75
OZ4	59	6AT6	.68	12SF5	.67
1A7GT	.89	6AU6	.65	12SG7	.95
1AE4	.90	6AV6	.55	12SH7	.69
1B3GT	.83	6BB8	.65	12SJ7	.75
1H5GT	.69	6BC5	.65	12SK7	.84
1N5GT	.74	6BD6	.86	12SL7	.75
1L4	.60	6BE6	.45	12SN7GT	.84
1LA6	.90	6BG6-G	1.60	12SR7-M	.75
1N21-B	3.45	6BY5-G	1.10	14F7	.80
1N23-A	2.45	6C4	.49	25AV5	1.25
1N23-B	3.70	6CB6	.49	25B06-GT	.79
1N34	.64	6F6-M	.89	25L6GT	.64
1N38-A	.75	6F8-G	.89	25Z6	.67
1N44	1.21	6G6-G	.95	35B5	.40
1N45	.84	6J5GT	.49	45C5	.69
1N51	.51	6J7	.59	35Z5GT	.49
1N52	1.71	6K6-GT	.59	42	.65
1N54	.84	6K7-M	.70	50C5	.50
1N63	3.81	6L6-GT	.49	50L6-GT	.55
1N64	.72	6L5G	.49	117Z6	1.00
1N65	.84	6L6-G	1.19	304-TH	7.50
1N69	1.23	6L7	.98	304-TL	8.00
1N70	3.15	6N7-M	.95	717-A	.98
1N72	1.20	6Q7-GT	.80	805	2.50
1N73	28.53	6S7-M	.98	807	1.59
1N74	21.90	6SD7	.79	811-A	3.95
1N75	3.33	6SG7	.88	829	9.95
1N81	2.58	6SH7	.64	832	7.25
1U3	.49	6SJ7-GT	.69	832-A	8.50
2B7	.75	6S7-M	.70	837	1.45
GL2C43	15.95	6SK7-GT	.60	866-A	1.55
2D21	1.35	6SL7-GT	.60	G872-A	3.25
2E24	2.75	6SN7-GT	.70	12B0	.80
2E30	2.19	6T8	.75	1613	.75
3A4	.59	6U4-GT	.65	1614	2.25
3D6/1299	.50	6V6-GT	.60	1616	.74
3N4	.49	6X5-GT	.52	1619	.30
3055GT/G	.99	6Y6-G	.95	1622(6L6)	1.95
3S4	.80	7A6	.65	1625	.40
5FP7	1.95	7A8	.75	1629	.30
5R4GY	1.29	7C7	.80	1631	1.50
5U4G	.59	7F7	.74	1632	.70
5Y4G	1.15	7H7	.80	2050	1.48
5X4G	.85	12A6	.65	5516	5.95
5Y3GT	.45	12AT7	.75	5654	2.00
6BA4	.75	12AU7	.69	5910	.75
6AB7	.98	12AV6	.55	9001	1.35
6AC7	.94	12AX7	.99	9003	1.10
6AG5	.65	12BA6	.69	9004	.39

Five hundred other types stocked at similar savings

## SELENIUM RECTIFIERS

Current (Continuous)	Full-Wave 18/14 Volts	Bridge 36/28 Volts	Types 54/42 Volts	130/100 Volts
1 Amp.	\$1.25	\$2.10	\$3.60	\$7.50
2 Amps.	2.20	3.60	6.50	10.50
2 1/2 Amps.				13.00
4 Amps.	3.75	6.75	8.75	
5 Amps.	4.95	7.95	12.95	27.00
6 Amps.	5.50	9.00	14.00	33.00
10 Amps.	6.75	12.00	20.00	40.00
12 Amps.	8.50	16.00	25.50	50.00
20 Amps.	13.25	24.00	36.00	90.00
24 Amps.	16.00	31.00	39.50	98.00
30 Amps.	18.50	36.00		
36 Amps.	25.50	45.00		

New Selenium Rectifier Transformers  
PRI: 115 V. 60 cycles in } 4 Amps \$ 8.75  
SEC: 9, 12, 18, 24, and 36 } 12 Amps 16.75  
Volts } 24 Amps 35.75

- Made to our specs for continuous heavy-duty use
- 115V. PRI—18V. @ 2 amps. XFMR \$2.75
  - 115V. PRI—33V. @ 55 amps. sec. XFMR. \$39.00
  - 115V. PRI—5V. @ 190 Amp. SEC. \$59.95
  - 115/230 V. 60 cy. PRI. SEC: 1.5, 30.5, 33.5, and 36.5V @ 4 AMPS. Herm. Sealed @ \$6.50

New Selenium Rectifier Chokes  
4 Amps.—.07 ohm—6 ohm \$7.95  
12 Amps.—.01 ohm—1 ohm \$14.90  
24 Amps.—.004 hv.—.025 ohm \$29.95

We can manufacture other Selenium Rectifiers, Selenium Rectifier Supplies, XFMRs., & Chokes. Write.  
• Biley-type SMC-100—Crystal Standards. 100 KC and 1,000 KC Bar New \$8.50

• A-R-11—Complete Station for 20, 40, or 80 meters. Superhet Rev.—50 Watts CW w/ built in AC Pwr Supply. New—in compact suitcase (orig. cost over \$500) An excellent buy for only \$99.50  
• Weston Meters. 0-100 micro amps. 2 1/2" Diam (Blank Scale) New Boxed. VERY Special \$5.95

Carter, 6 V. Dynamotors, in original cartons.  
—590 VDC @ 150 ma. Only 7" x 4" x 3"  
Special \$28.00. (Regular net over \$50.00)

**BARRY ELECTRONICS CORP.**  
136 Liberty Street, N.Y. 6, N.Y. REctor 2-2562  
Terms: 25% with order, balance C.O.D.—Send a few cents for postage—All merchandise guaranteed, F.O.B. N.Y.C. \*Please, minimum order \$2\*



for dependable sound,  
**INDUSTRY** relies on  
**ATLAS**



DR Double-Reentrant Projectors

**DEPENDABLE QUALITY:**

The latest electro-acoustic research and engineering—and over 20 years of manufacturing know-how—are behind every ATLAS product.

**DEPENDABLE SERVICE:**

Coast-to-coast and around the world today—in every Industrial, Marine, Railroad, Military, Educational, Civic, U.S. and Foreign Government application—under every kind of climate and noise condition—ATLAS sound equipment is famous for highest efficiency and durability. That's the proof of ATLAS performance dependability.

**DEPENDABLE DELIVERY:**

Yes, ATLAS gives our Government highest priority. And yes, we too feel the pinch of material shortages. But our customers will continue to get our usual dependable delivery—because we believe in equitable and dependable distribution to all ATLAS users.

**DEPENDABLE PROFITS:**

Completeness of line, excellence of product, dependable delivery, right prices—that's the ATLAS combination that means high, steady Industrial Sound profits for You!

JUDGE for yourself, COMPARE ATLAS at your local Jobber today. See why ATLAS is the preferred line for utmost dependability. Write NOW for FREE latest Catalog 551.



Paging & Talk-Back Speakers



ALNICO-V-PLUS Driver Units



Dual Speakers



FULL-GRIP, VELVET-ACTION Mike Stands

**ATLAS SOUND CORP.**  
1443-39th Street, Brooklyn 18, N. Y.  
In Canada: Atlas Radio Corp., Ltd., Toronto, Ont.

**SOUNDTRONICS SPECIALS**

3 SECTION SPIRAL INDUCTIVE TUNER Range 55 to 218 MC 3 SECTION . . . . . 3.95

TOP BRAND 557 CERAMIC TRIMMERS 15-65 mmfd or 1.5 to 7 mmfd. . . . . 15c ea. CENT. STYLE 823 AN TRIMMERS—20-125 mmfd. . . . . 34c

TUBULAR TYPE TRIMMERS—5.5 mmfd. . . . . 9c

TOP BRAND BUTTON MICA Type CB 500 mmfd. . . . . 9c type FA 2000 mmfd. 14c

MUTER CERAMIC CONDENSERS—5c ea. 15, 22, 33, 56, 75, 82, 180, 220 mmfd. . . \$4.50 per C.

NEW STANDARD BRAND RESISTORS 1/2 W 2.5c 1 W 3.9c 2 W 4.9c NO Min. Order Req. Quantity Discounts

TOP BRAND 1/2 W 1000 W V. D. C.—6c ea. 5 to 25c

HAIR FELT FOR SOUND WORK—12" x 24" 1/2—12c ea.

50 new pop. type 1/2, 1 & 2W coded resistors  
50 small pop. type ceramic conds. Your Choice All voltages and cap. \$1.49 ea. 50 postage stamp mica conds.

ARC-5 RECEIVER IF strip—8.5 meg IF. Contains the following circuits: mixer, 1st IF amp, 2nd IF amp, det. AVC, squeelch neut. 1st AF & Squeelch amp. 2nd A.P. complete wired IF strip, balance & output trans. 2.49

Terms—25% w/ order, balance C.O.D.

**SOUNDTRONICS LABS.** 632 Arch St., Phila. 6, Pa. MA-7-2775

the serious scientific student who can use mathematics and needs a sound knowledge of electromagnetic fields.

There are 4 chapters. The first starts with Coulomb's Law and applications. Chapter II analyzes Electrostatics for Conductors and Dielectrics. The next, Magnetostatics, includes magnetism and steady electric currents. The last chapter introduces the reader to Maxwell's Equations and various fields.

Each part of each chapter begins with an introduction and helpful remarks. Each part ends with problems based on the text. Each chapter ends with a brief resume. A large mathematical appendix appears at the end of the book. A formula index lists the more important equations, with the page number where each was derived in the text.—IQ

**ELECTRICAL ENGINEERING**, by William H. Erickson and Nelson H. Bryant. Published by John Wiley & Sons, Inc., 440 Fourth Ave., New York 16, N. Y. 6x9 inches, 523 pages. Price \$6.00.

The material in this book has been used successfully for several years by engineering classes. It is excellent for several reasons. It is clearly written and easy to follow. It emphasizes circuits, machines, electronics—the three important branches of electrical engineering—equally. Practical problems with answers accompany each chapter. Physical as well as mathematical analyses are presented.

The authors have struck a good balance between topics in this wide field. The first nine chapters describe d.c., a.c., and magnetic circuits. They are followed by ten chapters on instruments, motors, synchros, and other machines. Theory, construction, and applications are included. The last nine chapters are devoted to electronics circuits and components.

There are several appendices. These list wire tables, show how to use complex (vector) notation, and discuss the cathode-ray oscilloscope.—IQ

**EXTENSION AND DISSEMINATION OF THE ELECTRICAL AND MAGNETIC UNITS BY THE NATIONAL BUREAU OF STANDARDS.** Circular 531 of the National Bureau of Standards. 8 x 10 1/4 inches, 33 pages. Price 25¢. For sale by Supt. of Documents, U. S. Govt. Printing Office, Washington 25, D. C.

The National Bureau of Standards establishes, maintains and disseminates units of measurement. This circular shows how various electrical and magnetic units are derived from those of voltage and resistance. These two are considered basic because standard cells and resistors are readily duplicated and transported.

Chapter headings include: magnetic units, d.c. to a.c. transfer, peak voltage measurement, extension of range, scale of voltage and current, and others. Calibration and comparison methods are described. An extensive bibliography lists NBS and other papers on this subject.—IQ

**NOW! BECOME EXPERT AT**  
**RADIO-TELEVISION**  
**IN 4 EASY STEPS!**

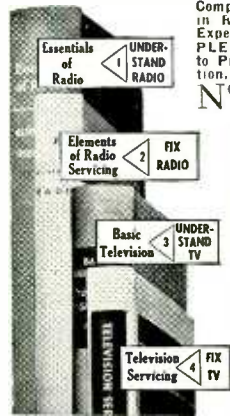

Complete Self-Training Library in RADIO and TV by Famous Experts—Takes You BY SIMPLE STEPS From Basic Theory to Problems of Repair, Installation, Color TV, etc.

NOW you can do ANY Radio-TV installation, service, or repair job like an expert; operate field-testing equipment; understand problems of TV, FM-AM transmission, etc. Step into a good-paying job—or start your own service business. Train yourself AT HOME . . . IN SPARE TIME . . . with the McGraw-Hill Radio and Television Servicing Library.

2296 Pages—1611 Illustrations

The men who wrote this complete 4-volume Library are among the outstanding radio and TV instructors in America today. Every detail is clearly explained in over TWO THOUSAND PAGES of step-by-step instruction and over SIXTEEN HUNDRED "how-to-do-it" illustrations, cross-section diagrams, etc. The review questions and answers "nail down" everything you learn. At a glance "trouble-shooting" charts show how to diagnose instantly any radio or TV breakdown . . . and how to repair it expertly and quickly.

The Library will pay for itself many times over. It gives all you need to know for FM and TV in the FCC's 1st-class license exam; gives an experienced technician more confidence and skill.

**SEND NO MONEY**

Mail coupon below to examine complete four-volume Library FREE for 10 days. No obligation. Or you may examine individual books FREE for 10 days by checking the proper boxes in coupon.

**PARTIAL CONTENTS**

**ESSENTIALS OF RADIO.** 300 pages, 433 illus. Circuit Analysis • Vacuum Tubes • Circuits: Detector • Amplifier • Tube Oscillator • Power Supply • Transmitting, Receiving • Etc.

**ELEMENTS OF RADIO SERVICING.** 475 pages, 375 illus. Multimeters • AC Power Supply • Speakers • Antennas • Auto Radios • Push-Pull Output Stage

**BASIC TELEVISION.** 592 pages, 415 illus. Scanning • Synchronizing • Video Signal • Brightness Control • DC Insertion • Picture • FM Alignment • Picture Tubes • VHF and UHF transmission • Reception

**TELEVISION SERVICING.** 429 pages, 388 illus. Antennas • Transmission Lines • Test-pattern and Picture Analysis • Localizing Reception Troubles • Interference Remedies • Deflection Circuits . . . AND MUCH MORE!

**FREE 10-DAY TRIAL COUPON**

**McGraw-Hill Book Co., Inc., Dept. RE-11-52**  
327 West 41st St., New York 18, N. Y.

Send me for 10 day free examination the Radio and TV Servicing Library, 4 Vols. (Regular retail price is \$26.00; Special Course Price only \$21.95 in easy installments.) If not satisfied with Course, I will return it, pay nothing. Otherwise, I'll send \$1.95 plus delivery then and only \$4.00 monthly for 5 months.

If you wish to examine any of these books individually, check below the ones you wish us to send you for 10 Days' FREE EXAMINATION:

- Essentials of Radio.  Elements of Radio Servicing, \$5.25  
 Basic Television.  Television Servicing, \$7.50  
 For any book I keep, I'll send \$2.00 plus delivery in 10 days, balance in easy monthly installments.

Name.....  
Address.....  
City..... Zone..... State.....

Position.....  
Company..... RE-11-52

WE PAY FOR DELIVERY if you send first payment of \$1.95 when ordering Library or full price when ordering individual books (prices above). Same return privilege.







# What's your unlucky day?

Bad luck—in the form of dissatisfied customers—can come your way any day in the month if you buy capacitors by rating only rather than by rating *and* brand. But . . . you can make every day a lucky day if you . . .



## Make Sure! Make it Mallory!

Repair work that insures satisfied customers is yours every time if you always specify Mallory capacitors, because outstanding performance is built into *all* Mallory capacitors.



Mallory FP's are the only fabricated plate capacitors available to the replacement trade. And they are accepted as *the* top-notch capacitors by the makers of TV and radio sets. Mallory FP's give long-lasting service even at 185° F. (85° C.).



Mallory Plascaps\* are the first completely engineered plastic tubular capacitors. Always use them and avoid leakage . . . premature shorting . . . unsoldered leads . . . off-center cartridges. Count on Mallory Plascap as you do on Mallory FP's.

In the past 25 years, Mallory research and engineering work has resulted in a series of developments that give you capacitors which are smaller . . . more uniform . . . longer-lasting . . . more resistant to heat. Look to Mallory for future capacitor improvements. Order Mallory capacitors today and be sure.

*Depend on your Mallory Distributor for quality products at competitive prices.*

P. R. MALLORY & CO. Inc.  
**MALLORY**

CAPACITORS • CONTROLS • VIBRATORS • SWITCHES • RESISTORS  
• RECTIFIERS • VIBRAPACK\* POWER SUPPLIES • FILTERS

\*Reg. U.S. Pat. Off.

**APPROVED PRECISION PRODUCTS**

**P. R. MALLORY & CO., Inc., INDIANAPOLIS 6, INDIANA**



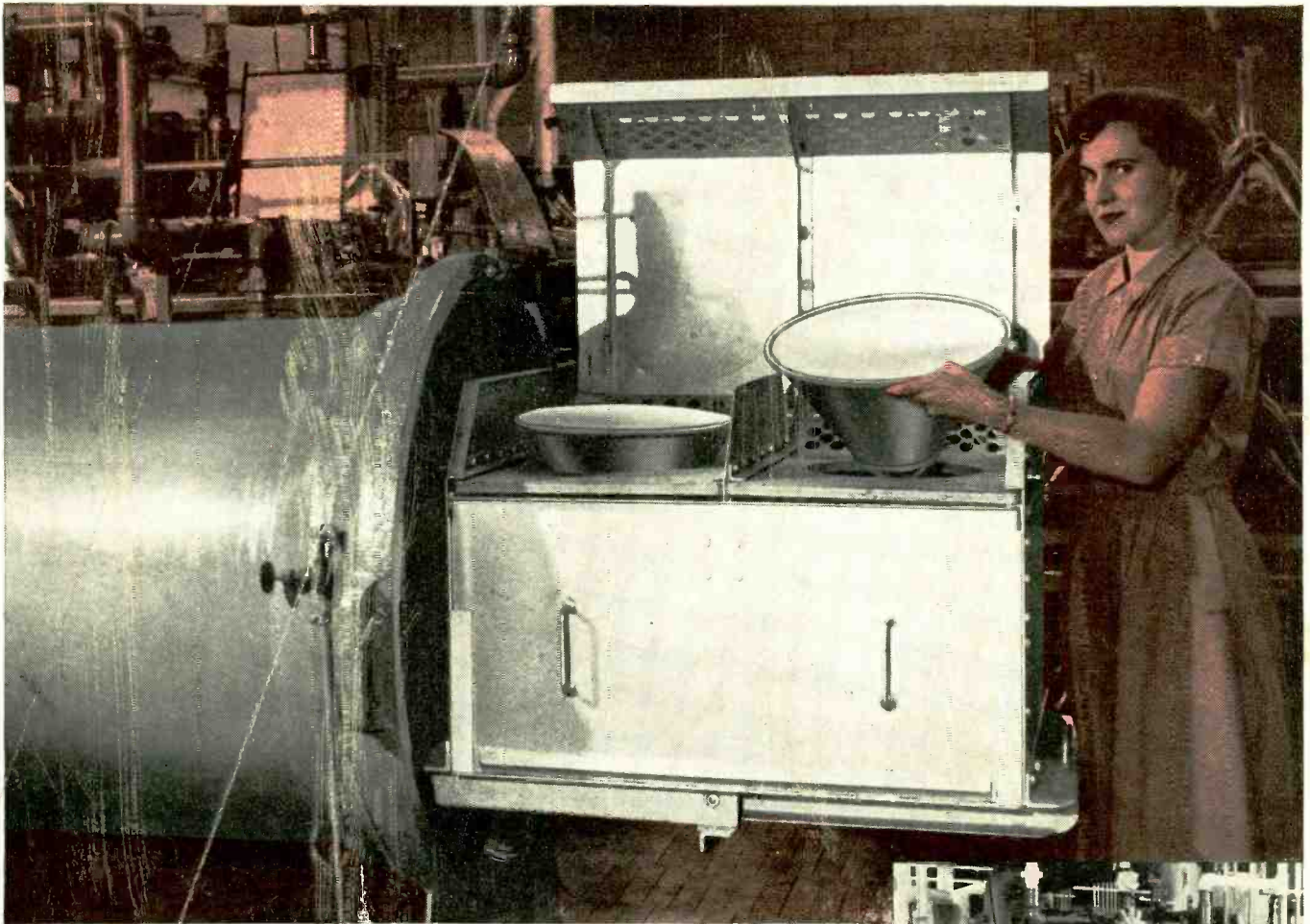

Top: Picture tubes being placed into carriage before being rolled into chamber. Right: Operator admitting compressed air into chamber.

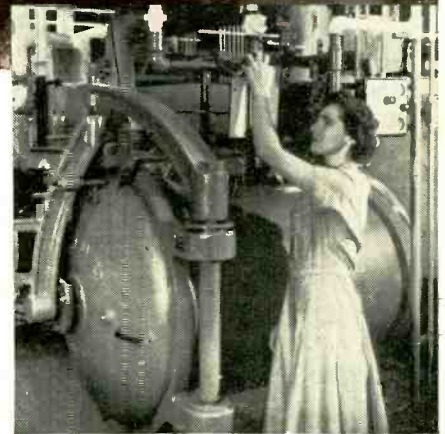

## The Torture Chamber that tests the strength of RCA Picture Tubes

How *strong* is a picture tube? Well, certainly no stronger than its envelope. And that means that poor sealing of glass-to-glass or glass-to-metal, improper annealing of the glass—and even thermal or physical shock during manufacture—can contribute to structural weakness.

How *strong* should a picture tube be? Obviously, it must at least have adequate strength to be handled, transported, and installed safely. To insure safety, RCA has established a rigid standard of strength based on

air-pressure tests evolved through unequaled years of experience.

Throughout the day, glass and metal picture tubes of each size are picked at random from the production lines, and placed in an air-compression chamber where they are subjected to "torturing" pressure for several minutes. Any tubes failing this test are examined by RCA production inspectors who can trace the fault and correct it on the production line almost as soon as it appears. Result . . . *structurally weak tubes never reach your shop.*

RCA's constant vigilance at *all* stages of manufacture is your assurance that only top-quality RCA picture tubes leave the factory. In this way, RCA closely guards its own reputation . . . *and yours as well.*

With RCA Receiving Tubes, as well as RCA Kinescopes, **TOP-QUALITY CONTROL** makes the difference.



**RADIO CORPORATION of AMERICA**  
ELECTRON TUBES  
HARRISON, N. J.

TMK. ®