

LATEST IN TELEVISION · SERVICING · AUDIO

RADIO — ELECTRONICS

K

HUGO GERNSBACK, Editor

NEW TV TUBES HAVE
ELECTROSTATIC FOCUS

5-TUBE POCKET SUPER

DESIGN TECHNIQUES
FOR V.H.F. AND U.H.F.



MAY
1951

30¢

U. S. and
CANADA

CONVERTING TO BIGGER TV TUBES — SEE TELEVISION SECTION

www.americanradiohistory.com

215

SQUARE INCHES OF FINEST
PICTORIAL REPRODUCTION...

Yours with the

*new Bent-Gun for
edge-to-edge sharpness,
gray filter face plate,
"Standard" neck length of 7 $\frac{3}{16}$ "*



*Our commercial
engineering department
invites all design inquiries*

ALLEN B. DUMONT LABORATORIES INC., TUBE DIVISION, CLIFTON, N. J.

NEW



I'LL TRAIN YOU FOR YOUR FCC LICENSE

A Federal Communications Commission Commercial Operator's License puts you in line for a good job in Radio or Television Broadcasting, Police, Marine, Aviation, Two-way, Mobile or Micro-wave Relay Radio. Mail coupon below for 64-page book FREE. It will give you complete facts about my NEW Communications course.



YOU BUILD THIS TRANSMITTER

with parts I send. With this Transmitter you practice how to put a station "on the air." You perform procedures demanded of Broadcast Station Operators, conduct many experiments, make many practical tests.

LEARN COMMUNICATIONS by PRACTICING at Home in Spare Time

with MANY KITS of RADIO EQUIPMENT I SEND



MY COURSE INCLUDES TELEVISION

Course Is New! Different!

Mail coupon now for facts about my NEW, intensely practical course in Radio-Television Communications. Let me send you FREE book. Read outlines of 78 lesson texts written by leaders in Communications and edited for you by my practical staff. See the nine big Kits of Parts I send that "bring to life" theory you learn. Read about the Transmitter you build and operate, about the Electronic Multitester you get. All equipment yours to keep. My NEW course covers Theory thoroughly and you get Practical Experience building units like those shown at the left. It's backed by N. R. I.—the world's oldest and largest home study Radio-Television school.

Mail Coupon For Book FREE

Send today! See what my NEW course is like. Find out how I get you ready for a brighter future, better earnings, more security in Radio-Television. Send coupon now in envelope or paste on a postal. **NO OBLIGATION. NO SALESMAN WILL CALL!** My book, sent to you FREE, tells the full story. J. E. SMITH, President, Dept. 1EF, National Radio Institute, Washington 9, D. C.

Ever think HOW FAST Radio-Television Communications is changing, developing, growing? Have you considered what this amazing progress can mean to you?

Look at these facts. In 1946 only 6,000 Television sets were sold. In 1950, over 5,000,000. By 1954, 25,000,000 Television sets will be in use, according to estimates. 100 Television Stations are operating in 35 states. Authorities predict there will be over 1,000 Television Stations. This rapid growth means new jobs, more jobs, good pay for qualified men all over the U. S. and Canada. Then add development of FM, Two-way Radio, Police, Marine, Aviation and Micro-wave Relay Radio! Think what all this means! New jobs, more jobs for beginners! Better jobs, better pay for experienced men!

Are you a beginner who wants steady work in this growing field? My NEW course can help you get an FCC License and prepare for the job you want. Are you a man with some training in Radio or Radar, or a Licensed Operator? My NEW course modernizes, increases the value of your knowledge and experience!

Servicing Training Also Offered by N. R. I.

If you prefer a good-pay job in Radio-Television Servicing or your own money-making Radio-Television Sales and Service Shop, I'll train you at home. My famous Servicing Course also includes many Kits of Radio Parts. You use them to get PRACTICAL EXPERIENCE with circuits common to Radio and Television. I also show you how to make \$5, \$10 a week or more EXTRA MONEY fixing neighbors' Radios while training. Full information in my 64-page book. Mail coupon.

YOU BUILD this Transmitter Power Supply used in the basic experiments in RF and AF amplifiers, frequency multipliers, buffers, etc.

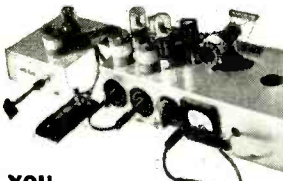

YOU PRACTICE setting up code, amplitude and frequency modulation circuits (put voice, music, etc., on "carrier signals" you produce). You learn how to get best performance.



YOU MEASURE current, voltage (AC, DC and RF), resistance and impedance in circuits with Electronic Multitester you build. Shows how basic transmitter circuits behave; needed to maintain station operation.



YOU BUILD this Wavemeter and use it to determine frequency of operation, make other tests on transmitter currents.

VETERANS Get this training under G. I. Bill MAIL COUPON!

I TRAINED THESE MEN



"N.R.I. has been my stepping stone from a few hundred to over \$4,000 a year as a Radio Engineer."—ALTON B. MICHAELS, Trenton, Georgia.



"I am employed by WKBO as transmitter operator. Have more than doubled salary since starting in Radio full time!"—A. HERR, New Cumberland, Penna.



"Am Broadcast Engineer at WLPM. Your NEW Communications course shows the kind of equipment we use."—J. BANGLEY, JR., Suffolk, Virginia.



"4 years ago, I was a book-keeper with hand-to-mouth salary. Am now Radio Engineer with ABC network."—N. H. WARD, Ridgefield Park, N. J.

MAIL NOW-BOOK FREE

MR. J. E. SMITH, President, Dept. 1EF National Radio Institute, Washington 9, D. C. Mail me your 64-page Book about Radio and Television Communications opportunities and training. (No salesman will call. Please write plainly.)

Name..... Age.....
 Address.....
 City..... Zone..... State.....
 Check if Veteran Approved Under G. I. Bill

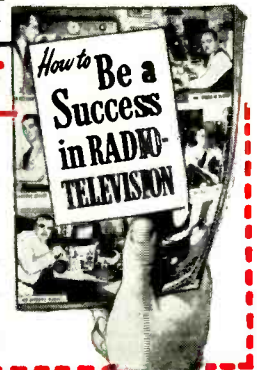

RADIO — ELECTRONICS

Incorporating
SHORT WAVE CRAFT® TELEVISION NEWS®
RADIO & TELEVISION
*Trademark registered U. S. Patent Office

formerly RADIO-CRAFT

MEMBER
AUDIT BUREAU OF CIRCULATIONS

Hugo Gernsback, Editor-in-Chief

M. Harvey Gernsback, Editorial Director

Fred Shunaman, Managing Editor
Robert F. Scott, W2PWG, Technical Editor
Manfred Wentzel, Associate Editor

I. Queen, Editorial Associate
Angie Pascale, Production Manager
Wm. Lyon McLaughlin, Tech. Illustration Director

Lee Robinson, General Manager
John J. Lamson, Sales Manager

G. Aliquo, Circulation Manager
Robert Fallath, Promotion Manager

CONTENTS

MAY, 1951

Editorial (Page 23)			
Needed Electronic Inventions.....	by Hugo Gernsback	23	
Television (Pages 24-33)			
Converting to Bigger TV Tubes (Cover Feature)			
by Larry Oebbecke		24	
Electrostatic Focus Kine Uses Simple H.V. Supplies	by Robert B. Gary	27	
What's the Mystery Behind Television DX	by E. P. Tilton, W1HDQ	28	
TV Trouble Lexicon	by John B. Ledbetter	31	
Television Service Clinic.....	by Walter H. Buchsbaum	33	
Servicing—Test Instruments (Pages 34-43)			
Useful 2-in-1 Meter.....	by H. L. Bumbaugh	34	
TV Tube Substitutions.....	by I. Queen	37	
Picture-Tube Replacements		38	
Speed Means More Money	by W. G. Eslick	39	
Video Bar Generator Speeds Set Alignment...by Richard Henry		40	
Variable Power Supply for Shop or Laboratory.....	by Allen W. Smith	43	
Audio (Pages 44-50)			
Speaker Impedance?.....	by J. W. Straede	44	
Audio Feedback Design, Part VII...by George Fletcher Cooper		46	
Electronics and Music, Part XI.....	by Richard H. Dorf	48	
Non-Eavesdropping Intercom.....	by George W. Buntan	50	
Construction (Pages 52-62)			
Calibrated Attenuators for Audio Generators..by B. Cederqvist		52	
Automatic Electronic Timer varies Both On and Off Periods.....	by William H. Minor	56	
Electronics (Pages 64-72)			
How an Electronic Brain Works, Part VIII..by Edmund C. Berkeley		64	
Two-Tone Source Aids Insomniacs.....	by Chas. Beazley	71	
FM (Pages 76-80)			
FM Set Uses New Type Detector.....	by J. J. J. Fakkeldy	76	
New Design (Pages 82-83)			
Cathode-Ray Monofomer		82	
Theory and Engineering (Page 90-98)			
Design Technique for V.H.F. and U.H.F.....	by B. E. Parker	91	
Departments			
The Radio Month..	12	Try This One	110
Radio Business.....	15	Technotes	113
New Devices	84	Miscellany	116
New Patents.....	100	Association News..	118
Radio-Electronic		People	121
Circuits	102	Communications ..	125
Question Box.....	106	Book Reviews.....	126

ON THE COVER: In this very typical scene in Dave Krantz' Philadelphia Television Service Corporation Frank Krantz is aligning a completed job and Pete Maugeri is touching up an installed combination unit which has just been converted. *Kodachrome by Avery Slack*

DESIGNED FOR TV SERVICING



The best way to avoid costly service callbacks on TV electrolytic capacitor replacement jobs is to use Sprague 'lytics.

Actual service records prove they are tops for keeping you out of trouble with service customers—by keeping their TV sets working right!

And Sprague has the most complete listing of every type of television electrolytic.

Write for your catalog today!

SPRAGUE
PRODUCTS COMPANY
DISTRIBUTORS' DIVISION OF THE SPRAGUE ELECTRIC COMPANY
81 MARSHALL ST., NORTH ADAMS, MASS.

RADIO-ELECTRONICS, May 1951, Volume XXII, No. 8. Published monthly. Publications Office: Erie Ave., F to G Streets, Philadelphia 32, Pa. Entered as second class matter September 27, 1948, at the post office at Philadelphia, Pa., under the Act of March 3, 1879. SUBSCRIPTION RATES: In U. S. and Canada, in U. S. possessions, Mexico, South and Central American countries, \$3.50; \$6.00 for two years; \$8.00 for three years; single copies 30c. All other foreign countries \$4.50 a year, \$8.00 for two years, \$11.00 for three years. Allow one month for change of address. When ordering a change please furnish an address stencil impression from a recent wrapper. RADCRAFT PUBLICATIONS, INC. Hugo Gernsback, Pres.; M. Harvey Gernsback, Vice-Pres.; G. Aliquo, Sec'y; Contents copyright, 1951, by Radracraft Publications, Inc. Text and illustrations must not be reproduced without permission of copyright owners.

EDITORIAL and ADVERTISING OFFICES, 25 West Broadway, New York 7, N. Y. Tel. Rector 2-8630
BRANCH ADVERTISING OFFICES: Chicago: 520 N. Michigan Ave. Telephone SUperior 7-1796. Los Angeles: Ralph W. Harker, 1127 Wilshire Blvd., Tel. MA 6-1271. San Francisco: Ralph W. Harker, 582 Market St., Tel. GARfield 1-2481. FOREIGN AGENTS: Great Britain: Atlas Publishing and Distributing Co., Ltd., London E.C.4. Australia: McGill's Agency, Melbourne. France: Brentano's, Paris 2e. Holland: Trilectron, Heemstede. Greece: International Book & News Agency, Athens. So. Africa: Central News Agency, Ltd., Johannesburg; Capetown: Durhan, Natal. Universal Book Agency, Johannesburg. Middle East: Steimatzy Middle East Agency, Jerusalem, India: Broadway News Centre, Dadar, Bombay #14. K. L. Kannappa Mudaliar, Madras 2. Pakistan: Paradise Book Stall, Karachi 3. POSTMASTER: If undeliverable send form 3578 to: RADIO-ELECTRONICS, 25 West Broadway, New York 7, N. Y.

GET INTO RADIO-TELEVISION ELECTRONICS By Shop-Method Home Training

GOOD JOBS AWAIT THE TRAINED RADIO-TV TECHNICIAN

There is a place for *you* in the great Radio-Television-Electronics industry when you are trained as National Schools will train you at home!

Trained technicians are in growing demand at good pay—in manufacturing, broadcasting, television, communications, radar, research laboratories, home Radio-TV service, and other branches of the field. National Schools Master Shop-Method Home Training, with newly added lessons and equipment, trains you in your spare time, right in your own home, for these fascinating opportunities. **OUR METHOD IS PROVED BY THE SUCCESS OF NATIONAL SCHOOLS TRAINED MEN, ALL OVER THE WORLD, SINCE 1905.**

EARN WHILE YOU LEARN

Many National students pay for all or part of their training with spare time earnings. We'll show you how you can do the same! Early in your training, you receive "Spare-time Work" Lessons which will enable you to earn extra money servicing neighbors' and friends' Radio and Television receivers, appliances, etc.

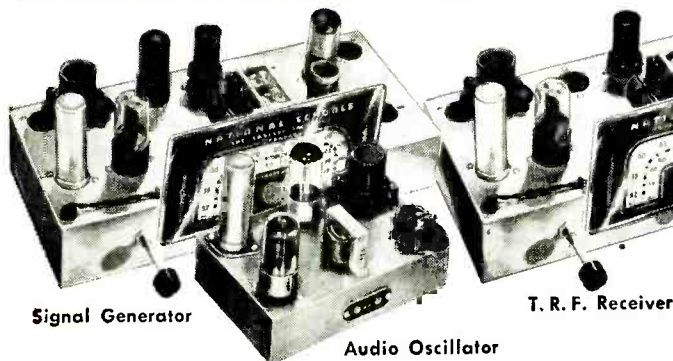

Signal Generator

Audio Oscillator

T. R. F. Receiver

National Schools Training Is All-Embracing

National Schools prepares you for your choice of many job opportunities. Thousands of home, portable, and auto radios are being sold daily—more than ever before. Television is sweeping the country, too. Co-axial cables now under construction will soon bring Television to every city, town, and farm! National Schools' complete training program qualifies you in all fields. Read this partial list of opportunities for trained technicians:

- Business of Your Own • Broadcasting
- Radio Manufacturing, Sales, Service • Telecasting
- Television Manufacturing, Sales, Service
- Laboratories: Installation, Maintenance of Electronic Equipment
- Electrolysis, Call Systems
- Garages: Auto Radio Sales, Service
- Sound Systems and Telephone Companies, Engineering Firms
- Theatre Sound Systems, Police Radio
- And scores of other good jobs in many related fields.

TELEVISION TRAINING

A complete series of 16 - 10 - the - minute Television lessons is an important part of your course. They cover all phases of Television repairing, servicing and construction. The same lesson texts used by resident students in our own modern and complete Television broadcast studios, laboratories and classrooms!



MASTER ALL PHASES!

Get Master Shop-Method Home Training from an Established Practical Resident School with its own Training Shops, Laboratories, and Studios—and almost 50 Years of Successful Experience in Training Ambitious Men.



We Bring National Schools To You

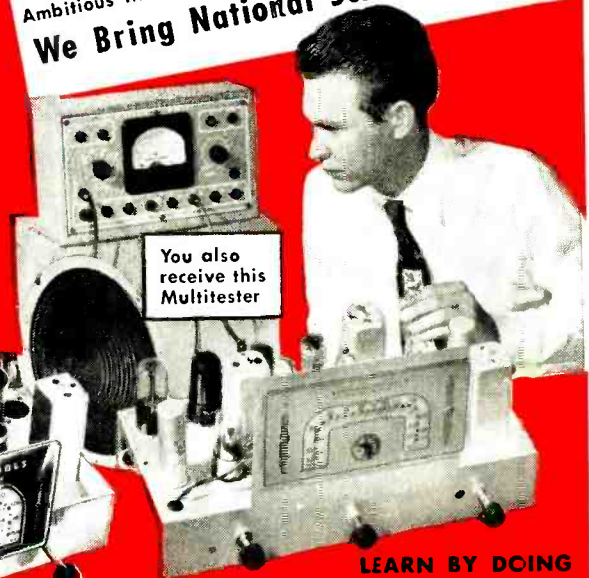

You also receive this Multitester

LEARN BY DOING

You receive and keep all the modern equipment shown above, including tubes and valuable, professional quality Multitester. No extra charges. You build the fine Superheterodyne Receiver with parts we send you.

FREE! These 2 Free Books give you all the facts. Send today for National Schools' new, illustrated Book of Opportunity in Radio-Television-Electronics, and an actual Sample Lesson. No cost—no obligation. Use the coupon now—we'll answer by return airmail.

APPROVED FOR VETERANS AND NON-VETERANS
Check coupon below

Both Resident & Home Study Courses offered

NATIONAL SCHOOLS

LOS ANGELES 37, CALIF. • EST. 1905

FIND OUT NOW... MAIL COUPON TODAY

National Schools, Dept. 5-RE
4000 South Figueroa Street
Los Angeles 37, California

Mail in envelope or paste on penny postal.

Send me your FREE book "Your Future in Radio" and the sample lesson of your course. I understand no salesman will call on me.

NAME _____ AGE _____

ADDRESS _____

CITY _____ ZONE _____ STATE _____

Check here if Veteran of World War II

"OUR CALL-BACK EXPENSE SCARED US!"



"Customers' sets kept giving us trouble. That was before we standardized on quality tubes . . . G-E tubes!"

Says

**MIKE FILDERMAN, Vice-President
Phillips Radio Company
2012 Shannon Place, S. E.
Washington, D. C.**

"Today we don't worry, as we did once, about call-back expense endangering profits. Quality tubes, which we use 100 percent, have done away with our most common cause of receiver trouble—tube failures. When our men finish one service job, they can go on to another knowing it's unlikely the first customer will ask for a return visit. Believe me, that saves plenty when you're servicing TV sets on yearly contract—and Phillips has about 15,000 contracts in the Washington, D. C., area . . . Quality and G-E mean the same thing to us! We feature G-E tubes; we find they keep our call-backs down, our men productive, our profits up."

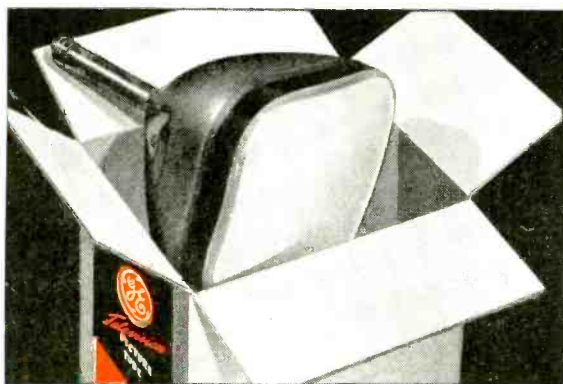

It's a habit with customers, to ask to see the G-E label on tube cartons . . . so Phillips Radio and other service dealers have discovered. No name excels General Electric in public acceptance—means more quality-wise, builds greater user confidence.

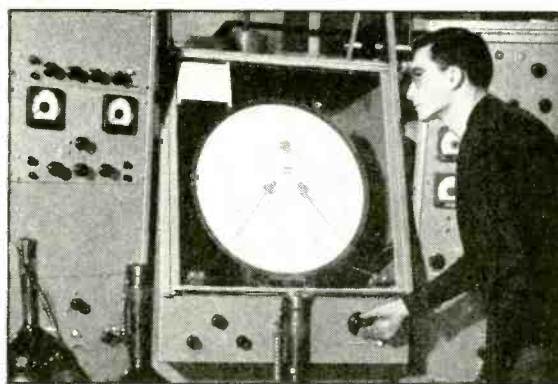

Every G-E picture tube is carefully tested for electrical and screen characteristics. Here brightness is being measured, and the screen area inspected for any blemishes. Many other tests follow. G-E tubes are pre-checked for superior performance!

FOR QUALITY TUBES TO CUT DOWN YOUR CALL-BACKS, SEE YOUR G-E TUBE DISTRIBUTOR!

GENERAL  ELECTRIC

1B1-KAB

RADIO-ELECTRONICS for

TV Exec Cites Need for More Skill in TV Servicemen

Military Needs Also Growing . . . Service Manager for Chicago Firm Warns "Old-Timers" that Youngsters are Better Prepared

AT a meeting of the Philadelphia Radio Servicemen's Association, Tim Alexander, service manager of Motorola, Inc., Chicago, and chairman of the Radio Manufacturer's Association Service Committee, as quoted in *Radio & Television Weekly*, warned the old-timers among the radio servicemen that the "youngsters" coming into the business, fresh out of colleges and technical schools, would be taking their jobs away from them unless they take the necessary steps to make themselves as "competent as their new competition."

He pointed out that the "screw-driver and plier" serviceman has no permanent place in television, and that adequate test equipment and knowledge of its use are as important to the television technician as the X-ray machine is to the surgeon.

Mr. Alexander said, "If you are a mediocre television man who can repair a set only by slow, plodding, tenacious work—watch out. Pretty soon one of those 'youngsters' will open a store across the street from you. By virtue of his better training and greater skill, he will be able to do the job in one-quarter of the time. He will be paid twice as much per hour as you get, but the customer will still get off at half-price." He advised the men to go to school again for latest methods and servicing information.

* * *

CREI offers just the specialized home study training you need. It's a streamlined course—fast, accurate, and complete—for men in the top third of the field. It gives practical answers to the technical problems you run into while servicing today's intricate TV and FM equipment. It is kept up-to-date through constant checking with CREI's affiliate, one of Washington's largest retailers of TV sets and home appliances. Maintenance problems encountered by this retailer's TV technicians are used as a practical lab to test the precision of CREI training.

MAY, 1951



Adequate test equipment and knowledge of its use are as important to TV technicians as X-ray machines are to surgeons.

CREI, an accredited technical institute founded in 1927, invites your investigation. CREI graduates today fill important radio-TV posts throughout the industry. During World War II CREI trained thousands of technicians for the Army, Navy and Coast Guard. Special CREI technical texts were used in the Navy's own training program. Leading industrial firms—RCA Victor, United Air Lines, TWA, Pan American Airways—to name only a few—use CREI's group training programs.

As one well-informed industry spokesman puts it, "Technicians are becoming as scarce as certain tubes." Growing military needs are cutting into the available supply of skilled personnel. The electronics industry, already a giant with normal civilian demands, is expanding rapidly to take care of military orders. Opportunity exists for qualified men—in essential industry as well as TV servicing.

Are you qualified? Start preparing now—while there is time to cash in on a well-paid technical job. Write today for complete FREE information. The cost of this famous home-study training is nominal, the terms easy.

The Three Basic CREI Courses:

Television and FM Servicing (streamlined course for men in "top third" of field); Practical Radio Engineering (fundamental course in all phases of radio-electronics); Practical Television Engineering (specialized training for professional radiomen).

Also available as Residence School Courses.

NOTE TO MEN WHO EXPECT TO BE IN UNIFORM SOON:

If you expect to enter the armed services, why not prepare now to qualify for a top job at good pay. TV-electronics training is excellent background for vitally important radar, communications, and navigation work.

CAPITOL RADIO ENGINEERING INSTITUTE
 Dept. 145C, 16th & Park Rd., N. W., Washington 10, D. C.

Gentlemen: Send me complete details of the TV and FM Servicing home study course. Also send brochure that explains the CREI self-improvement program and gives complete details and outline of course. I am attaching a brief resume of my experience, education and present position.

Check the Field of Greatest Interest:

<input type="checkbox"/> TV, FM & Advanced AM Servicing	<input type="checkbox"/> Aeronautical Radio Engineering
<input type="checkbox"/> Practical Television Engineering	<input type="checkbox"/> Broadcast Radio Engineering (AM, FM, TV)
<input type="checkbox"/> Practical Radio Engineering	<input type="checkbox"/> Radio-Electronics in Industry

NAME _____ AGE _____

ADDRESS _____

CITY _____ ZONE _____ STATE _____

IF RESIDENCE SCHOOL IN WASHINGTON, D.C., IS PREFERRED, CHECK HERE

"This Seal means a 'Good Deal' to me!"

"My Television and Radio sets are pretty big investments to me. That's why I insist that they be serviced by a Raytheon Bonded Electronic Technician — a technician whose work is backed by a cash bond — whose skill and integrity are above reproach."

The RAYTHEON Bonded Electronic Technician Program means a *good deal* to you, too. If you can qualify for this important honor, your 90-day guarantee on TV and Radio repairs is cash-protected up to \$400.00 by a *bond*. You receive a Registered Certificate, Identification Cards, Creed Displays and Decals and a host of other sales helps and shop aids — all designed to tell the world you're a completely capable, thoroughly reliable service dealer—a dealer with whom customers can deal with complete confidence. And yet, this great sales stimulator *costs you nothing* — it's Raytheon's investment in your future.

If you're interested in getting head and shoulders above your competitors, better ask your Raytheon Tube Distributor if you can qualify for this exclusive sales asset.



RIGHT... for SOUND and SIGHT

RAYTHEON MANUFACTURING COMPANY

Receiving Tube Division

Newton, Massachusetts, Chicago, Illinois, Atlanta, Ga., Los Angeles, Calif.

RADIO AND TELEVISION RECEIVING TUBES, CATHODE RAY TUBES, SPECIAL PURPOSE TUBES, SUBMINIATURE TUBES, MICROWAVE TUBES



Excellence in Electronics

COPYRIGHT 1962

RADIO-ELECTRONICS for

GET IT! READ IT YOURSELF!
FREE Opportunity News Bulletin
 shows you **89 WAYS** to earn money in
TELEVISION

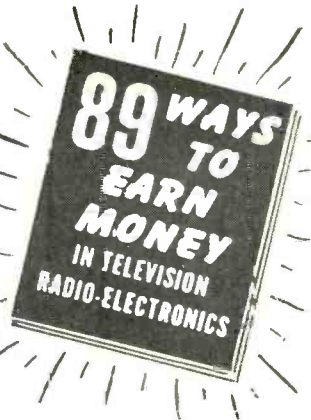

RADIO, ELECTRONICS



OPTIONAL FEATURE
 ABOVE: Build and keep a real 16 INCH commercial TV receiver — a wonderful instructional project. Optional at slight additional cost after completing regular training.

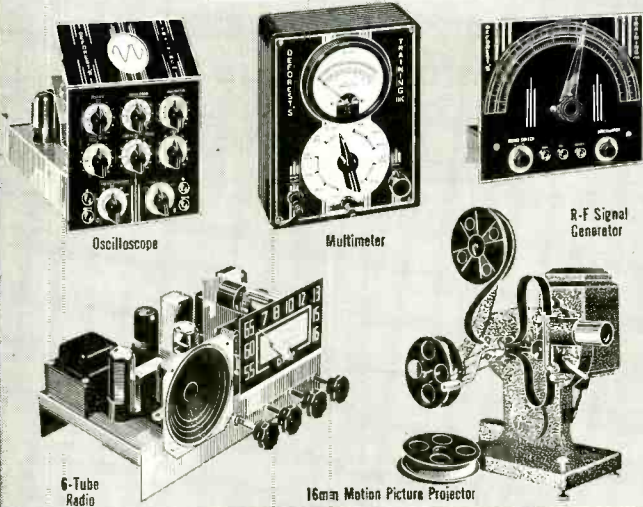

Oscilloscope

Multimeter

R-F Signal Generator

6-Tube Radio

16mm Motion Picture Projector

Let us show you how readily you may prepare to enter this highly profitable field.

Mail coupon today for YOUR FREE COPY of one of the most interesting, opportunity-packed News Bulletins we have seen. It shows you SCORES OF WAYS to make money in today's amazing, billion dollar field of Television, Radio, Electronics.

NOW—GET THE ANSWERS!

See HOW you can get the start you need toward a real job or your own profitable business . . . HOW you may get into work that pays real money, that's so interesting . . . HOW to build toward a grand future in one of America's most rapidly growing, promising, newer fields of opportunity.

NO PREVIOUS EXPERIENCE OR KNOWLEDGE NEEDED: You'll see WHY DeForest's Training, Inc. offers one of the most complete combinations of practical home training advantages available today . . . HOW you can get and keep the same type of basic electronic equipment used in our Chicago training laboratories, one of the nation's finest . . . HOW you set up your own HOME LABORATORY and work over 300 experiments — including building and keeping the commercial-type test equipment shown at lower left.

HOME MOVIES: You'll even see HOW you can get the wonderful advantages of "learn-by-seeing" movies on the wall of your own room. See hidden actions that can help you tremendously to understand and remember certain points.

EMPLOYMENT SERVICE: And by all means, see HOW you can get training that also combines an Employment Service for that all-important starting help after you complete the program.

MILITARY SERVICE!

If subject to military service, the information we have for you should prove doubly interesting. Mail coupon today.

MODERN LABORATORIES: If preferred, you can get all your preparation in our new Chicago training laboratories—one of the finest of its kind.

Here is YOUR big chance!

MAIL COUPON TODAY!

DeFOREST'S TRAINING, INC.
 CHICAGO 14, ILLINOIS
 A De VRY INSTITUTION

DeFOREST'S TRAINING, INC., Dept. RE-5-H
 2533 N. Ashland Ave., Chicago 14, Ill.

Without obligation, I would like that new Opportunity News Bulletin showing 89 ways to earn money in Television-Radio-Electronics . . . and how I may prepare to get started in this thrilling field.

Name..... Age.....
 Street..... Apt.....
 City..... Zone..... State.....

Proven Performance around the world!

89 countries, 33 governments use Hallicrafters

equipment. These precision instruments are prized by experts, remembered by veterans, and preferred throughout the world by short-wave listeners who want a radio that is all radio.



Model SX-62

Model SX-62—World's finest receiver for the all-wave listener. Outperforms any broadcast receiver on any frequency—continuous coverage from 540 kc to 109 Mc in six bands. Crystal calibration oscillator built in. Six position selectivity with crystal filter. Two stages r-f, three stages i-f amplification. 10-watt push-pull high fidelity output. Phonograph jack, 14 tubes plus regulator and rectifier. \$289.50



Model SX-71

Model SX-71—Value-packed with features specifically asked for by the Hams. Extra sensitivity, selectivity, and stability; double super-heterodyne, plus built-in, Narrow Band FM. One r-f, two conversion, and three i-f stages. Range 538 kc to 35 Mc, 46-55 Mc. Extra wide dials for Main and Bandsread Tuning. Sensitivity, Volume, BFO Pitch, Selectivity, and Crystal Phasing controls. AVC, BFO, Rec./Standby, ANL Tone, and Phono-Rec. switches. Phonograph input jack. 500, 3.2-ohm output. . \$199.50



Model S-76

Model S-76—The only double superhet with 50 kc second i-f and the only set now known with a giant sized 4-inch "S" meter. Another new Hallicrafters engineering triumph. One r-f, two conversion, and two i-f stages; temperature compensated, voltage regulated. Range 540-1580 kc, 1.72-32 Mc in four bands. Separate electrical bandsread, with calibrated dial. Sensitivity, Volume, BFO Pitch, Selectivity and Tone Controls: AVC, Rec./Standby, BFO, ANL switches. Phonograph input jack. 3.2 or 500 ohm outputs 9 tubes plus voltage regulator and rectifier \$169.50



Model S-40B

Model S-40B—New version of an old favorite. Temperature compensated oscillator; tuned r-f stage, two i-f stages for better selectivity. Covers 540 kc to 43 Mc in four bands. Sensitivity, volume, three-position Tone, BFO Pitch, controls; AVC, BFO, Rec./Standby, and Noise Limiter Switches. Built-in PM speaker. External power, remote control connections. 7 tubes plus rectifier. \$99.95



Model S-72

Model SR-75—A small transceiver for the novice class or beginning amateur; can also be used later as exciter unit. Receives on 540 kc through 32 Mc, transmits on 10, 11, 20, 40, or 80 meter bands. 10 watts input to final amp. Receiving section is substantially same as our S-38B Bandsread tuning, Speaker/phones switch, BFO switch. Rec./Standby switch; four tubes plus rectifier. Transmitting section uses electron coupled Xtal oscillator plus output tube of receiver. Voltage doubler rectifier to increase plate voltage. 5 tubes plus rectifier. \$89.95

SR-75 for 115 volts, 50/60 cycle AC. Shipped with coils, less crystals. . . \$89.95

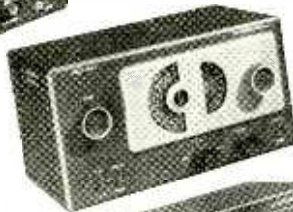

Model SR-75

Model S-38B—Pulls in broadcast stations in weak signal areas where ordinary sets fail. Also offers world-wide reception for the short-wave listener and the new amateur. Covers Broadcast Band and three short-wave bands. 540 kc to 32 Mc. Separate Fine Tuning control, BFO, Rec./Standby. Speaker/Phones switches. Built-in PM speaker. Four tubes plus rectifier. For 115 V. AC or DC. \$49.50

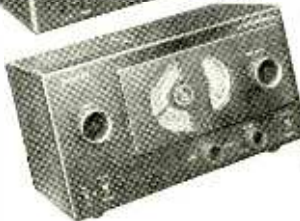

Model S-38B

S-72—One stage r-f, two stages i-f amplification. Built-in loop antenna for broadcast, plus 61" collapsible whip for short-wave. Band-spread tuning knob for separation of short-wave stations. Sensitivity control combined with code (BFO) switch. Jack for headphones. Brown leatherette cabinet, space inside for power cord and headphones. 8 tubes plus rectifier. Less batteries. For 115 V. AC or DC or batt. Regular Model S-72. Broadcast Band 540-1600 kc, plus three short-wave bands. 1.5-30.5 Mc. \$109.95



World's Leading Manufacturers of Precision Radio & Television, Chicago 24, Illinois

Visit Booth #576, Radio Parts Show, Stevens Hotel, Chicago, Illinois

PERFORMANCE IS WHAT COUNTS!

ANCHOR'S

superiority of performance
remains unchallenged!

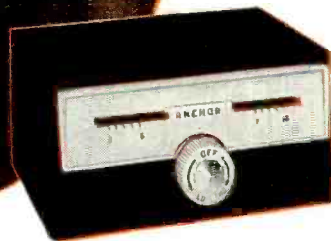
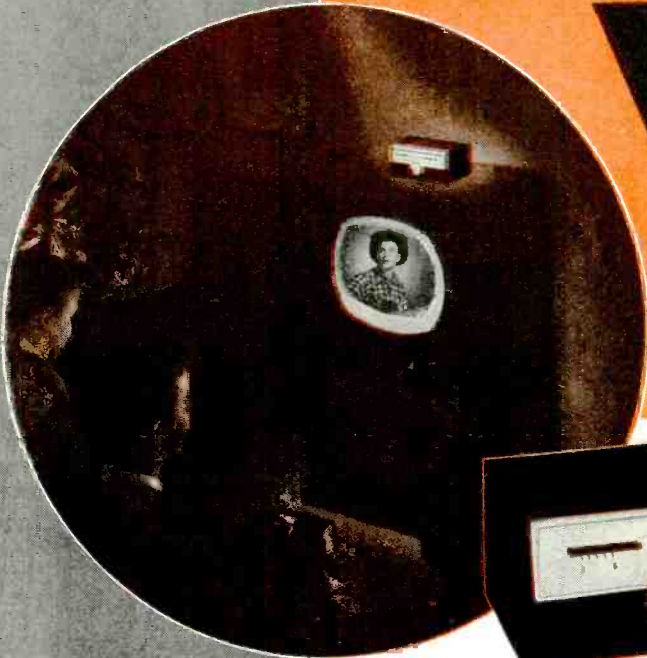

THE ANCHOR *Suburbanite*

Single-Stage Booster—for low signal areas in or near cities. Assures consistently good reception up to 75 miles.

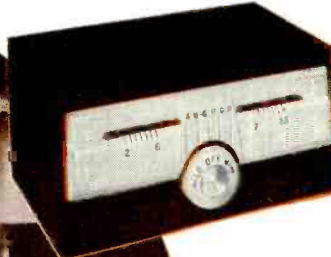
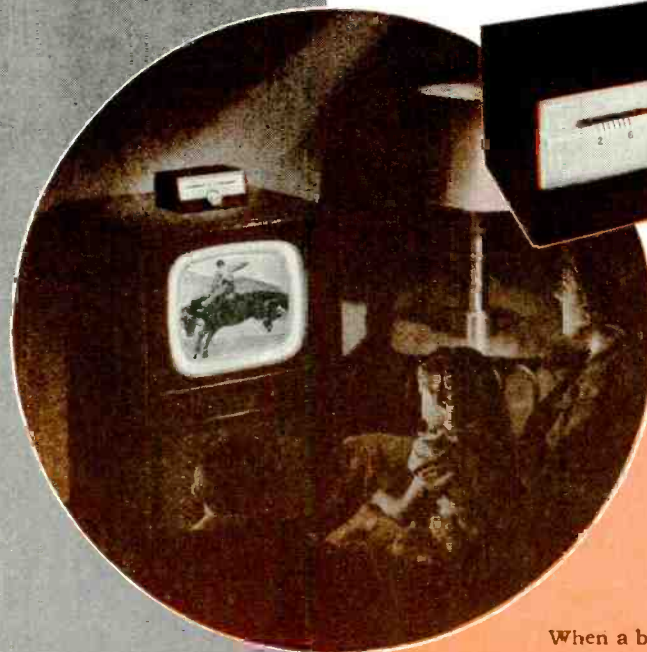

THE ANCHOR *Granger*

Two-Stage Booster—recommended for distant rural areas. Assures consistently good reception for over 100 miles.



Despite critical material shortages, Anchor not only is offering the same high quality standards so widely hailed by the TV set industry, itself, but it is still making as many boosters as a year ago. To meet the current unprecedented demand, however, Anchor would have to expand, which is naturally not possible now! Therefore they have had to institute a very strict allocating system. No preference on deliveries to anyone has been or ever will be practiced.

When a booster is needed to complete a perfect installation, Anchor's outstanding performance under all conditions has made it the first choice of those who buy and sell. So always buy the *best*—first!



ANCHOR ENGINEERING ALWAYS A YEAR AHEAD!

ANCHOR RADIO CORP.

2215 SOUTH ST. LOUIS AVENUE • CHICAGO 23, ILLINOIS

See us at Booth 131 at the Radio Parts Show

USE PHOTOFAC

the world's best Radio-TV service data—it pays for itself every working day

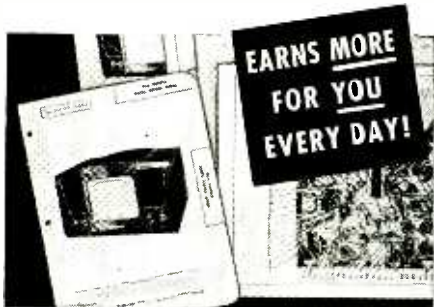

Try PHOTOFACT!

FREE We'll send you any Photofact Folder listed in the Photofact Cumulative Index

WE'LL PROVE YOU'LL SAVE TIME and EARN MORE WITH PHOTOFACT

NOW—learn for yourself—at our expense—how PHOTOFACT makes your Radio and TV work *quicker, easier, more profitable!* Examine an actual PHOTOFACT Folder. Use it. You'll learn first-hand why over 35,000 successful service technicians use PHOTOFACT daily. You'll learn that no other service gives you PHOTOFACT'S *completeness, accuracy, uniformity, and lowest cost.* PHOTOFACT is the *only* radio and TV service data prepared from laboratory analysis of the actual equipment. Know the facts—get your **FREE** Folder now. Examine, use, compare—learn why no modern service shop can afford to be without PHOTOFACT!

WRITE FOR FREE INDEX

PAY AS YOU EARN! Ask your distributor about this amazing plan. Only \$18.39 puts the entire profit-boosting Photofact library in your shop now!

NOTE: Our **FREE** Folder offer is limited to Service Technicians only. Attach coupon below to your letterhead and mention your jobber's name. If you have no letterhead, send coupon to your jobber. Experimenters and others may obtain the Photofact Folder by remitting amount shown below.

HOWARD W. SAMS & CO., INC.
2201 E. 46th St., Indianapolis 5, Ind.

- Send **FREE** Photofact Cumulative Index
 Send Full Easy-Pay Details

I am a Service Technician:

- Send **FREE** Folder for set model.....

I am an Experimenter: Enclosed \$.....

- Send Folder for set model.....
TV-\$1.00. Record Changer or Comm. Receiver-.75c. AM/FM-50c

Name.....

Address.....

City.....Zone...State.....

A NEW WALKIE-TALKIE about half the size and weight of its World War II counterpart and with about twice the range is now being delivered to the U.S. Army Signal Corps by RCA. Using the latest in subminiaturization techniques, the set has complete subassemblies such as the FM discriminator scaled down to fit in metal cylinders no larger than a miniature tube. It also boasts the smallest tuning coil of its type ever manufactured. The coil is smaller than a dime in diameter and about ½-inch thick, but has a Q of over 100.

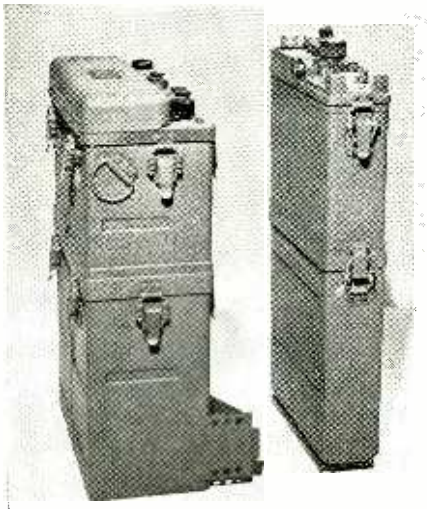

Old walkie-talkie, left, and new model.

The transmitter-receiver section of the walkie-talkie is only 3 inches deep, 9½ inches high, and 10½ inches wide, and it weighs only 9 pounds. The battery power supply is about the same size, and the complete equipment, including carrying harness, antennas, spare parts, and handset, weighs about 25 pounds. The set has 16 tubes and provides two-way voice communication over a range of about 5 miles on frequencies in the v.h.f. band. Provision is made for remote operation and unattended relay operation, using two sets, to facilitate communication over hills or other obstacles.

TWO NEW LABORATORIES, one for applied research in electronics and the other for student electrical engineering activities, will be built at Stanford University in California, according to an announcement by President Wallace Sterling. The new facilities will represent an outlay of \$250,000, and the student laboratories will be in the form of a wing adjoining the applied research center.

The student laboratory is made possible by a gift from the Hewlett-Packard Company, electronics equipment manufacturing firm headed by two Stanford graduates, William Hewlett and David Packard. The company's gift was made in appreciation of the training these men received while attending Stanford and for the opportunity they had to carry on their own experiments in the old radio laboratory. Mr. Hewlett's thesis was the oscillator which later became the basis of the Hewlett-Packard business.

RADAR SCREEN to guard the continental United States against a sneak air attack will be completed within the year, according to a statement by Air Force Secretary Thomas K. Finletter. An additional network to guard Alaska will be completed within another year. The protective system will include all-weather interceptor aircraft to go after attackers which the radar picks up, and the radar itself will be augmented by thousands of civilian volunteer observers.

TUBES FOR COLOR TV have been in production at the rate of 100 per month at the RCA's Tube Division, it was reported in March. The production had been going on for three or four months, and the tubes were being shipped to set manufacturers for experimental use. RCA sources said that the tubes are hand made and could not be mass-produced at the present time. The company also made known that the April production schedule for the new chassis using the electrostatically focused black-and-white tubes would be postponed a few months.

THE UPPER ATMOSPHERE, already the subject of much prodding and probing, will undergo more probing by National Bureau of Standards scientists whose object is to improve long-range radio communications. They will use a mobile sending and receiving station, located directly under the predicted point where a radio beam between Sterling, Virginia, and St. Louis, Missouri, is bent back toward the earth.

By very careful study of this and other bending points, the scientists hope to get an accurate map of the path of radio waves through the ionosphere.

ELECTRONIC PARTS manufacturers will be allowed to make more parts for television and radio sets than are now being produced. The Office of Civilian Requirements in the National Production Authority approved the principle of making certain that parts enough are turned out to keep existing equipment operating.

Distributors had requested that scarce metals be allotted to parts manufacturers in sufficient quantity to allow them to operate at 50% above present levels. OCR approved of the basic policy, but said that actual percentages would have to be worked out in line with the requirements of essential industries. Steps are also being taken to recover scarce metals from scrap and from low-grade ores.

LATEST ELECTROSTATIC focus picture tube operates with a focusing voltage from 350 down to 150 volts or less, working off the receiver's regular low-voltage supply. Engineers of the Rauland Corp. used an entirely new approach to design the electron gun. Provisional number for the 17-inch rectangular tube is 17HP4. Fourteen- and 20-inch rectangular models will also be made.

RADIO-ELECTRONICS for

FREE

TELLS HOW—

**WE GUARANTEE
TO TRAIN AND COACH YOU AT HOME
IN SPARE TIME UNTIL YOU GET
YOUR FCC LICENSE**

If you have had any practical experience — Amateur, Army, Navy, radio repair, or experimenting.

TELLS HOW—

OUR AMAZINGLY EFFECTIVE JOB-FINDING SERVICE HELPS GIVE STUDENTS GET BETTER JOBS. HERE ARE JUST A FEW RECENT EXAMPLES OF JOB-FINDING RESULTS:

GETS FIVE JOB-OFFERS FROM BROADCAST STATIONS

"Your 'Chief Engineer's Bulletin' is a grand way of obtaining employment for your graduates who have obtained their 1st class license. Since my name has been on the list I have received calls or letters from five stations in the southern states, and am now employed as Transmitter Engineer at WMMT."

Elmer Powell, Box 274, Sparta, Tenn.

GETS CIVIL SERVICE JOB

"I have obtained a position at Wright-Patterson Air Force Base, Dayton, Ohio, as Junior Electronic Equipment Repairman. The Employment Application you prepared for me had a lot to do with me landing this desirable position."

Charles E. Loomis, 4516 Genesee Ave., Dayton 6, Ohio

GETS JOB WITH CAA

"I have had half a dozen or so offers since I mailed some fifty of the two hundred employment applications your school forwarded me. I accepted a position with the Civil Aeronautics Administration as Maintenance Technician. Thank you very much for the fine cooperation and help your organization has given me in finding a job in the radio field."

Dole E. Young, 122 Robbins St., Owosso, Mich.

HERE'S PROOF FCC LICENSES ARE OFTEN SECURED IN A FEW HOURS OF STUDY WITH OUR COACHING AT HOME IN SPARE TIME:

Name and Address	License	Lessons
Lee Worthy, 2210 1/2 Wilshire St., Bakersfield, Cal.	2nd Phone	16
Clifford E. Vogt, Box 1016, Dania, Fla.	1st Phone	20
Francis X. Foerch, 38 Beucler Pl., Bergenfield, N. J.	1st Phone	38
S/Sgt. Ben H. Davis, 317 North Roosevelt, Lebanon, Ill.	1st Phone	28
Albert Schoell, 110 West 11th St., Escondido, Cal.	2nd Phone	23

CLEVELAND INSTITUTE OF RADIO ELECTRONICS
Desk RE-29, 4900 Euclid Bldg., Cleveland 3, Ohio
[Approved for Veteran Training Under "GI Bill of Rights"]

TELLS HOW—

EMPLOYERS MAKE JOB OFFERS LIKE THESE TO OUR GRADUATES EVERY MONTH!

Telegram, August 9, 1950, from Chief Engineer, Broadcast Station, Pennsylvania. "Have job opening for one transmitter operator to start immediately, contact me at once."
Letter, August 12, 1950, from Dir. Radio Div. State Highway Patrol. "We have two vacancies in our radio Communication division. Starting pay \$200; \$250 after six months' satisfactory service. Will you recommend graduates of your school?"
Letter, August 24, 1950, from radio-television sales and service company, Ohio. "We are in need of a good television man. The pay will be good, also good surroundings to work in. Please let us hear from you."

These are just a few of the examples of the job offers that come to our office periodically. Some licensed radio-man filled each of these jobs; it might have been you!

Ours is the only home study course which supplies FCC-type examinations with all lessons and final tests.



ACT NOW!
Get All 3 FREE

Your FCC ticket is Always Recognized in All Radio Fields as proof of Your Technical Ability.

MAIL COUPON NOW

Cleveland Institute of Radio Electronics
Desk RE-29—4900 Euclid Bldg.,
Cleveland 3, Ohio
(Address to Desk No. 1 avoid delay.)

I want to know how I can get my FCC Ticket in a minimum of time. Send me your FREE booklet, "How to Pass FCC License Examinations" (does not cover exams for Amateur License), as well as a sample FCC-type exam and the amazing new booklet, "Money-Making FCC License information."

Name.....
Address.....
City..... Zone..... State.....
Paste on penny postcard or send air mail.

Watch
MERIT
for TV in '51

Merit is meeting the rapidly rising demand for TV replacements with a TV line as complete as current and advance information will permit

TRY MERIT FIRST FOR TV CONVERSION OR REPLACEMENT!



HV06—Universal Ferrite core "FLYBACK" permits widest coverage.



MDF70—70° high efficiency Ferrite yoke for tubes up to 19"



MWC-I—Width linearity control with AGC winding (Automatic Gain Control).

FOCUS COILS



Free!

Write today for:

- MERIT TV REPL GUIDE AND CATALOG—Dec. 1950 issue. Up-to-date listing of all replacements.
- MERIT 1951 CATALOG No. 5111 Show specs. on complete line of TV, Radio, Amateur and Industrial Transformers.

See Us at the RADIO PARTS SHOW, booth 689

TAPE-MARKED TO HELP YOU!
Handy tape marking on every Merit Transformer shows permanent hook-up data for quick reference. ORIGINAL BY MERIT.

MERIT
SINCE 1918
FINE RADIO PARTS
MERIT
TRANSFORMER CORP.

4443 NORTH CLARK ST., CHICAGO 40, ILL.



New high-speed facsimile equipment. The transmitter is at right, receiver at left.

HIGH-SPEED FACSIMILE equipment just perfected by the Western Union Telegraph Company will process message material ten times as fast as present apparatus.

The scanning rate is about 127 square inches per minute, or the equivalent of some 3,000 words of newspaper text.

Material to be transmitted is put into a transparent cylinder. When the end gate of the cylinder is closed, the machine starts automatically, the centrifugal force keeping the copy against the spinning cylinder wall. The drum speed is 1,800 r.p.m. as against 180 revolutions in older equipment. A pin point of light is focused along a track paralleling the spinning cylinder, and a photocell reacts to the light and dark portions of the page. The scanning is 120 lines to the inch.

At the receiver, the signals are fed through a moving stylus to an electro-sensitive recording paper (*Teledeltos*) developed especially for this machine. Instantly a permanent reproduction of the material transmitted appears ready for use. The paper feeds automatically from a 9¼-inch wide roll, and signal from the transmitter causes a knife to cut the facsimile copy from the roll at the end of the message. No processing of any kind, either before or after transmission is needed.

The equipment uses a bandwidth of 31 kc and a carrier of 25 kc. The carrier is modulated up to 15.5 kc by the scanner and both sidebands are used, so that the full spectrum is 9.5 to 40.5 kc.

ELECTRIC RAZORS, garage-door openers, diathermy machines, and other such devices should be controlled or shut down, if necessary, to keep them from aiding enemy bombers in finding their target. This point was brought out by the Defense Department in asking Congress to give the President

greater control over the air waves. Present law gives the President authority over broadcasting, but the Defense Department is seeking to make the laws more specific, especially those concerning periods of emergency.

ADVERTISING BY RADIO in street-cars and buses was banned some weeks ago by the City of Minneapolis. A temporary injunction to stop the ban was sought by Broadcast Services, Inc., but the city filed a demurrer claiming that there was no cause for legal action because it had a right to stop the music and advertising. A county court judge overruled the demurrer and the city must now prove that the ban was not unreasonable.

FCC PROPOSALS for vast expansion of television service through opening channels for 2,000 additional television stations were announced March 22. Three-quarters of the new stations would be in the u.h.f. region, though 500 v.h.f. stations were planned as well. These would be allocated on 12 v.h.f. and 65 or 70 u.h.f. channels. Increased power for existing stations, especially in the v.h.f., was proposed.

Co-channel v.h.f. stations will have minimum separation of 180 miles (about the same as at present) by requiring use of offset carrier operation.

The FCC stated that it intended to consider lifting the freeze immediately on new v.h.f. station construction in Alaska, Hawaii, Puerto Rico and the Virgin Islands, where operation cannot cause interference to existing services.

Roughly 10% of the allocations are reserved for educational television.

Broadcast networks and television manufacturers joined in hailing the announcement as a preliminary to an early end of the television freeze.

—end—

Merchandising and Promotion

Littelfuse, Inc. has developed a new compact transparent plastic package for holding its TV "Snap-On" fuse holders.



The box, which holds 10 fuses, has many other uses once the fuses have been sold.

General Electric has issued a new TV Replacement Parts Catalog to distributors, which lists the parts for G-E sets produced from 1945 to December 1, 1950. The 144-page, loose-leaf catalog includes a cross reference which makes it possible to determine all the information about any part.

Electro-Voice, Inc., Buchanan, Mich. launched a promotional campaign on its phono-cartridge, using advertisements and selling aids. The company has also



issued a complete replacement chart which gives comprehensive data on phono-cartridge replacements, including the products of other manufacturers. The chart is available free from Electro-Voice distributors, or directly from the company.

Philco Corp. has issued a new phono-graph needle display merchandiser to help service technicians and dealers sell its needles. It is available from the company's distributors.

Simpson Electric Co. released its new 16-page bulletin illustrating all the Simpson test instruments. This bulletin, No. 51, includes a complete listing of the company's test equipment.

Servicing Business

Sylvania Electric Products, Inc. is sponsoring a number of meetings for radio and TV service technicians, in cooperation with authorized distributors. The first meeting was held in Baltimore where more than 300 attended a two-hour talk by Clarence L. Simpson, service engineer for Sylvania's Radio Tube and Picture Divisions.

RCA Service Co. was commended by Albert M. Haas, president of the Philadelphia Contractors Association, for its efforts in making available to TV service technicians, up-to-date information on changes and improvements in receiver engineering. Mr. Haas spoke at the conclusion of the RCA Service Co. training course, sponsored by the Raymond Rosen Co., RCA Victor's Philadelphia distributor.

E. C. Cahill, president of the RCA Service Co., said that the TV servicing industry could see its way through the problems facing it today by pooling its ingenuity. As his company's contribution to such a pool, Mr. Cahill made available to the industry a comprehensive conservation program.

The American Distributing Co., Baltimore subsidiary of the American Television Co., has inaugurated a promotion plan to sell TV conversions on a wide scale. The initial meeting was attended by 95% of all TV service dealers in Baltimore.

Production and Sales

Philco Corp. has announced a new nation-wide program of factory-supervised service assuring Philco customers of good service. The plan keeps the responsibility for service with the dealers and service technicians. More field service engineers have been added to assure closer supervision of each area. Additional servicing technical data is also being supplied.

The RTMA reported that 18% of all home radios and 10% of all TV sets produced in 1950 contained FM reception facilities. An estimated 1,471,900 radios with FM circuits were made during 1950, as compared with 1,000,000 in 1949.

Parts Situation

The National Better Business Bureau reported that its 13-city survey among dealers, distributors and service technicians indicated that the scarcity of parts had increased considerably during the past six months. Estimates range from 0 to over 200%. A joint committee of the Better Business Bureau and RTMA is working on a series of recommendations to alleviate this condition.

The Association of Electronic Parts & Equipment Manufacturers hailed the announcement that the NPA had established a priority system for critical materials for maintenance and repair parts as a "tremendous help" for radio-TV industry. The order, in general, followed the suggestions presented by the mobilization committee of EP&EM and a committee of the Sales Managers Club, Eastern Group.

The RTMA urged the heads of all member-companies to cooperate in an industry-wide program to conserve materials. Dr. W. R. G. Baker, director of the RTMA Engineering Department held a meeting of the engineers to implement the conservation program.

The International Resistance Company announced a plan to support distributors who go into manufacturing or assembling of equipment for defense order production contracts. IRC will offer them manufacturer's prices and engineering assistance on all its products whenever needed.

Jensen Mfg. Co. is under way on a drive to salvage Alnico V, the permanent magnet material from discarded loudspeakers, in an effort to maintain a supply of speakers for the replacement industry. Service technicians and dealers are urged to turn discards over to co-operating distributors. A special allocation for such distributors will be made, determined by the jobber's scrap contribution. Display and mailing pieces are being used to back up the campaign.

New Plants and Expansions

Sylvania Electric Products has purchased a new factory at Woburn, Mass., which will be used for the production of electronic tubes and equipment for national defense. Construction on the million-dollar 100,000 square-foot factory will be started this spring.

The Centralab division of Globe-Union has established an additional manufacturing plant in a six-story building in Milwaukee, Wis. The 65,000 square feet of additional space will be used by Centralab to make a new line of electronic devices which have both defense and peacetime applications.

Jensen Industries, Inc. recently acquired an interest in Orradio Industries, Opelika, Ala. The move was made to permit Jensen to broaden its line of phono-products.

Hallicrafters Co. has purchased for \$225,000 a building in Chicago which it had been occupying on lease since January 1, 1950.

Insuline Corp. of America has acquired a third factory in Long Island City, N. Y. It provides 50,000 square feet of floor space and will be equipped with \$100,000 worth of new machines.

Annual Financial Reports

	1950	1949
Allied Electric Products, Inc.		
(Parent Company Sheldon Electric, 6 mos. to 12/31/50)		
Earnings	\$552,634	\$34,490
Sales	\$6,502,451	\$1,571,140
Clarostat Mfg. Co.		
Earnings	\$407,908	\$102,113 (loss)
Sales	\$5,985,240	\$2,331,970
Cornell-Dubilier		
(December, 1950, Quarter)		
Earnings	\$333,709	not given
Sales	\$8,049,393	not given
Gabriel Co.		
(Parent Company Ward Products)		
Earnings	\$824,271	\$325,674

Sales	\$12,670,250	\$9,751,412
General Electric		
Earnings	\$173,424,000	\$125,639,000
Sales	\$1,960,429,000	\$1,613,564,000
Radio Corp. of America		
Earnings	\$46,249,865	\$25,144,279
Sales	\$586,393,450	\$397,259,020
Tung-Sol Lamp Works, Inc.		
Earnings	\$3,058,151	\$867,469
Sales	\$29,425,022	\$15,530,969
Dividends		
General Electric voted a 75¢ dividend, an increase over the previous 60¢ quarterly dividend.		
Allied Electric Products (parent company Sheldon Electric) declared a quarterly dividend of 20¢ on common stock		

and 11¼¢ on preferred stock. RCA has announced an 87½¢ dividend on preferred stock. Sprague Electric Co. has declared a quarterly dividend of 50¢ a share on common stock.

Business Briefs

... RCA released the details of the development of its three-color TV picture tube to manufacturers to further experimental work in color TV.

... Zetka Television, Inc., Clifton, N. J., has acquired the right to purchase an interest in Sightmaster's patents on cathode-ray tubes for color.

... Howard J. Rowland, chief electrical engineer of Workshop Associates was granted a patent for developments incorporated in the company's "Dubl-Vee" TV antenna.

... Boland & Boyce and Norman J. Trought, industrial designer, joined under the name of Trought, Boland & Boyce, Newark, N. J.

... Clarostat Manufacturing Co. announced that jobber sales had doubled during 1950.

... RCA announced that it is proceeding with full-scale production of its instantaneous theater TV system.

... Central Transformer Co. was recently formed in Chicago under the direction of Morton R. Whitman, president, and Lloyd G. Shore, secretary-treasurer.

... RCA Institutes announced a Home Study TV Course for working technicians in a move to combat the increasing shortage of trained TV service technicians.

... The Workshop Associates announced a 60% increase in sales for 1950 as compared to the previous year.

... The RTMA FM Policy Committee met in Washington, D. C., with the FM Committee of the National Association of Broadcasters to discuss problems facing FM manufacturers and broadcasters.

... Burgess Battery Co. received a certificate of merit for 1950 from the New York Hall of Science, for its pioneering of artificial electrolytic manganese dioxides and its founding of the industry of reserve type cells.

Show Section

The 1951 Parts Distributors Conference and Show will be held at the Hotel Stevens in Chicago May 21 to 23. Distributor registrations have already set an all-time record. About 175 manufacturers have either reserved booths in the Exhibition Hall or display rooms in the hotel. As innovated last year, attendance in the Exhibition Hall and display room area will be restricted to distributors and manufacturers' representatives.

The educational program of the 1951 show will include a complete clinic on selling. It will feature an hour-long demonstration of visual selling by the "three flying horsemen of sales"—Jim Dornoff, Les Falk, and Al Herr, Milwaukee sales executives.

Helen Staniland Quam, of Quam-

RADIO-ELECTRONICS for



Model 60X Crystal
\$10.85 List

A new Turner unit for hand, desk or stand use. Designed especially to meet all competition where good quality speech reproduction is required and low cost is important. A natural for hams, economical public address and sound systems . . . an ideal microphone for home recorders. Attractive case finished in baked on beige wrinkle enamel. Compare the Turner "COMPETITOR" with any microphone in its class and you'll agree that dollar for dollar it's a terrific microphone value.

Model 60X Crystal. Response: 70 to 7000 c.p.s. Level: 52 db below 1 volt/dyne/sq. cm. Moisture sealed crystal. Complete with 6 ft. cable and stand adaptor \$10.85 List
Model S60X Crystal. With on-off slide switch \$12.85 List
Write for Complete Details.

THE TURNER COMPANY

933 17th Street N. E. Cedar Rapids, Iowa.

In Canada:

Canadian Marconi Company, Toronto, Ontario and Branches

Export:

Ad. Auriema, Inc., 89 Broad Street, New York 4, N. Y.

Visit TURNER at The
Parts Show, Stevens Hotel
May 21, 22, 23, Booth 577
and rooms 519A - 520A



Microphones BY TURNER

Crystals licensed under patents of the Brush Development Company

NEW ELECTROSTATIC RECTANGULAR 20FP4

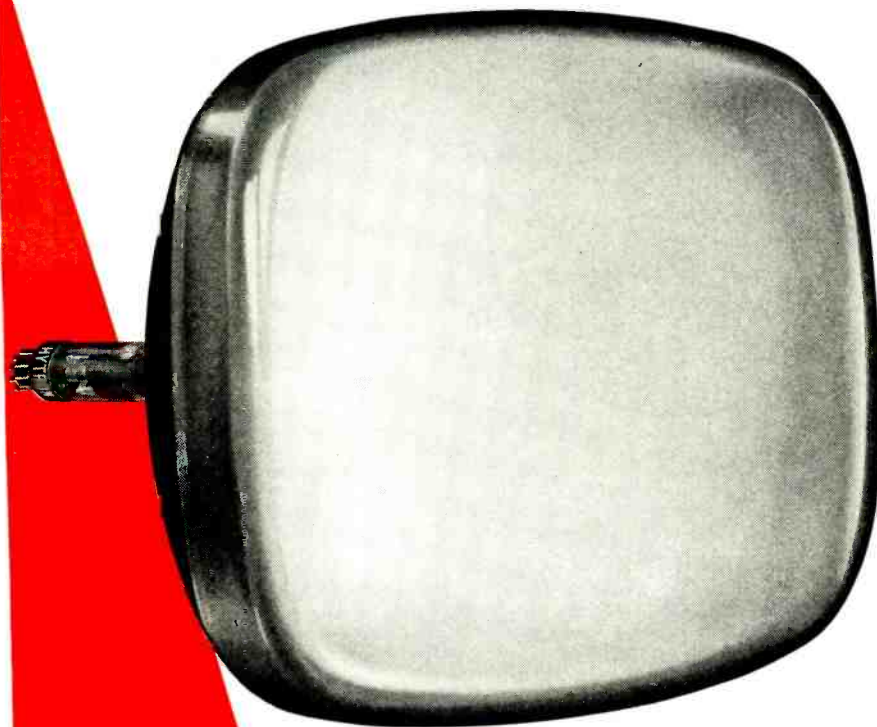

ANOTHER
HYTRON FIRST
FOR YOU

To its logically designed original *studio-matched* rectangular, Hytron now adds new advantages: the cobalt-and-copper savings of electrostatic focus.

The original Hytron electrostatic type 20FP4 eliminates the magnetic focus unit. Uses a single-field ion-trap magnet. Yet the 20FP4 gives you unsurpassed, clear, sharp pictures . . . despite economies in associated components enforced by defense needs.

Seeing is believing. Watch for this newest Hytron first from the world's most modern picture-tube plant. You'll be seeing it, buying it soon. You'll marvel at its sharp pictures, even at lower line voltages.

Again you'll say it pays to stay out front in picture tubes. It pays to insist on Hytron's original *studio-matched* rectangulars . . . choice of 9 out of 10 leading TV set makers.



MAIN OFFICE: SALEM, MASSACHUSETTS

HAVE YOU
GOT YOUR COPY?

The new 5th edition of the Hytron Reference Guide for Miniature Electron Tubes is out. See your Hytron jobber. Get your free copy of this old friend brought up to date today.

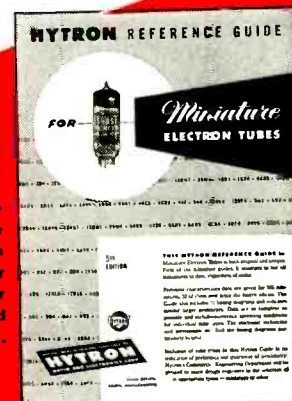

NEW ASTATIC CARTRIDGE REPLACES ADMIRAL 78 RPM SNAP-IN CARTRIDGE

(Admiral Part No. AI372)



ACTUAL SIZE



Special Astatic Model 402-M Ceramic Cartridge is Designed for Simple Plug-in Installation

INSTALLING Astatic's special new 402-M Ceramic Cartridge in the Admiral Arms for which it was designed is a simple matter of inserting the three-prong terminals in the three snap-in receptacles found in these arms. Snap-in action holds the 402-M securely in place and nothing else need be done. Top-notch performance is assured. Output of the 402-M has been increased above that of similar cartridges. Light weight and minimum needle pressure are additional advantages. Astatic type "G" replaceable needle with 3-mil precious metal tip is employed.

SPECIFICATIONS

Model No.	List Price	Minimum Needle Pressure	Output Voltage 1000 c.p.s. 0.5 Meg Load	Frequency Range c.p.s	Needle Type	Approx. Net Wt. in Grams	Code
402-M	\$6.90	12 gr.	0.7*	50 to 10,000	G-78 (osmium tip)	8	ASWZN



Write for new Astatic Form No. 51, Complete Reference Chart on Astatic Cartridges which are Replacements for various Admiral Phonographs and Phonograph Combinations.

Nichols, chairman of the Trade Names Display Committee, announced that this year's "Aisle of Trade Names" will be nearly double the size of last year's display. Nearly 200 names, a virtual Who's Who of the replacement parts industry, will be exhibited.

List of Exhibitors in THE 1951 PARTS DISTRIBUTORS CONFERENCE & SHOW

COMPANY	EXHIBITION HALL BOOTH NUMBER ASSIGNED	DISPLAY ROOM NUMBER
Aerovox Corporation	411	
Alliance Manufacturing Co.	322	
Alpha Wire Corporation	420	
Altec Lansing Corp.	302	607
American Microphone Co.	671	
American Phenolic Corp.	207	550A-551A
American Radio Hardware Co.	125	
American TV & Radio Co.	419	
Amperite Co.	311	
Anchor Radio Corp.	131	
Approved Electronic Instrument Co.	107	
Astatic Corp.	216	542A-544A
Atlas Sound Corp.	213	553
Audak Company		523
Audio Devices	315	602A
Barker & Williamson, Inc.	321	
Belden Manufacturing Co.	405	
Bell Sound Systems	223	613A-615A
David Bogen Co., Inc.		610-611
British Industries Corp.	301	
Brush Development Co.	678	
Burgess Battery Co.	587	
Bussman Manufacturing Co.	113	
Camburn, Inc.	119	
Centralab Division	573	
Channel Master Corp.		547
Chicago Transformer Division	676	535A-536A
Clarostat Mfg. Company	580	
Clear Beam Antennas	24	
Columbia Wire & Supply Co.	204	
Consolidated Wire & Assoc. Companies	117	
Copperweld Steel Co.	108	
Cornish Wire	683	
Crest Transformer Corp.	205	
Drake Electric Works	222	
Allen B. Du Mont Laboratories		521-522
Duotone Company	210	
Eicor, Inc.		700-701A
Electronic Instrument Co.	202	
Electronic Measurements Corp.	6	
Electro Products Laboratories	418	
Electronic Publishing Co.	609	
Electro-Voice, Inc.	320	658A-659A
Electrovox Co., Inc.	120	
Erie Resistor Corp.	318	512-513
Espey Manufacturing Co.	579	
Federal Tel. & Radio		620-621
Freed Transformer Co.	305	
Gee-Lar Manufacturing Co.	102	
General Cement Manufacturing Co.	416	507
General Electric Co.	590	521A
General Industries	219	619A-620A
Graybill	309	
Guardian Electric Co.	414	
Haldorson Company	114	
Hallcrafters Co.	576	605A-607A
Hammarlund Mfg. Co.	417	
Hickock Electrical Instr. Co.		515A-517A
Hi-Lo TV Antenna Corp.	112	
Hytron Radio & Electronics Corp.	408	
Illinois Condenser Co.	130	
Illinois Transformer Co.	122	639-640
Indiana Steel Products Co.	412	509A
Insuline Corp. of America	406	556
International Resistance Co.	677	
Industrial Precision Prods.		658
Jackson Electrical Instrument Co.	421	
James Vibrapowr Co.	208	
J-B-T Instruments	410	657
Jensen Industries	316	616
Jensen Manufacturing Co.	402	504-505
Jersey Specialty Co.	25	
J. F. D. Manufacturing Co.	313	534
E. F. Johnson Co.	133	

RADIO-ELECTRONICS for

Kester Solder Co.	220	
LaPointe-Plascomold Corp.	691	660
Lenz Electric Mfg. Co.	212	659
Littelfuse, Inc.	214	553A
Lowell Metal Products Corp.	121	
P. R. Mallory & Co.	586	
Markel Electric Products	571	638A
Merit Transformer Corp.	689	
James Millen Mfg. Co.	217	
M. A. Miller Mfg. Co.	105	
Modern-Aire Mfg. Co.		661A
National Company	575	
National Union Radio Corp.	103	
Newcomb Audio Products Co.	415	604-605
Oak Ridge Products	10	
Ohmite Manufacturing Co.	306	
Oxford Electric Corp.	312	529
Park Metalware Co.	319	
Par-Metal Products Co.	422	
Peerless Products Industries	126	
Penn Boiler & Burner Mfg. Corp.	682	661
Pentron Corp.	124	502
Permoflux Corp.	684	521A-526A
Permo, Inc.	413	
Philmore Mfg. Company	585	513A
Phoenix Electronics	110	604A
Pickering & Company		520
Precision Apparatus Co.	304	501
Premax Products Division	135	
Presto Recording Corp.		507A
Pyramid Electric Co.	572	
Quam-Nichols Company	578	560
Racon Electric Co.	118	533A
Radeleco Mfg. Company	23	
Radiart Corp.	409	528A-530A
Radio Apparatus Corp.		612A
Radio Corporation of America	209	504A-505A
Radio Craftsmen, Inc.	403	
RADIO-ELECTRONICS		603
Radio Merchandise Sales	3	
Radio Receptor Co.	203	
Rauland-Borg Corp.	314	622A-623A
The Rauland Corp.	310	
Raytheon Mfg. Co.	591	
Recoton Corp.	215	
Reeves Soundcraft Corp.	111	537
Regency Division	27	
Rek-O-Kut Company		557A
John F. Rider Publisher, Inc.	303	
Howard W. Sams & Co.	407	
Sangamo Electric Co.	221	556A
Walter L. Schott Co.	109	
Shedon Electric Co.	201	630A-631A
Shure Brothers, Inc.	588	557
Simpson Electric Co.	581	537A
Mark Simpson Mfg. Co.	679	600-603A
Herman H. Smith, Inc.	308	
Snyder Manufacturing Co.	681	
Sola Electric Co.	582	
Sonic Industries		536
Spraling Products Co.	225	512A
Sprague Products Co.	583	
Square Root Manufacturing Co.	211	654A-655A
Standard Coil Products	680	
Standard Transformer Corp.	401	500-501A
Switchcraft, Inc.	115	
Sylvania Electric Products	574	560A-561A
Talk-A-Phone Co.	218	610A-611A
Tech-Master Products Co.		549
Technical Appliance Corp.	21	
Tele-Matic Industries	106	
Tel-O-Tube Sales Corp.		632
Telrex, Inc.	687	
Thordarson-Meissner Division	22	
Triad Transformer Mfg. Co.	404	601-602
Tricraft Products	206	
Trimm, Inc.	129	
Triplett Electrical Instr. Co.	675	532A
Tung-Sol Lamp Works, Inc.	104	516
Turner Company	577	519A-520A
United Catalog Publishers		628-629
United Transformer Co.	584	
University Loudspeakers	127	539A
Vaco Products Co.	307	
Veri-Best Electronics, Inc.	101	
V-M Corporation	673	561
Waldom Electronics, Inc.	589	
Ward Leonard Electric Co.	123	
Ward Products Corp.	685	
Webster Chicago Corp.	317	
Weller Electric Corp.	592	
Weston Electrical Instr. Co.		613-614
Workshop Associates, Inc.	128	509

—end—



We CHALLENGE the performance of any 12" speaker with a

Permoflux ROYAL EIGHT"

SAYS PERMOFLUX'S MR. HY-FY

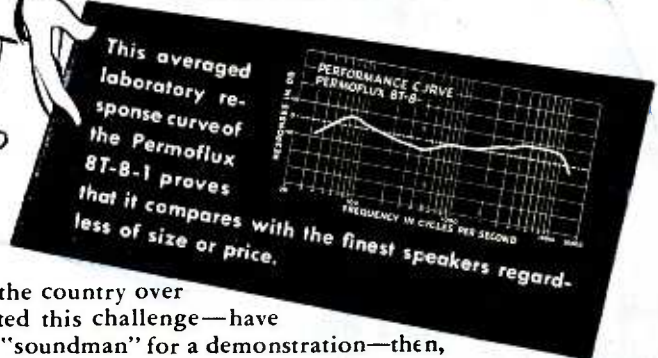

Hi-Fi Fans the country over have accepted this challenge—have asked their "soundman" for a demonstration—then, have installed a Permoflux Royal Eight" in their own audio equipment. Now they possess a magnificent speaker at a reasonable price which reproduces sound with superior sensitivity and fidelity as well as tonal qualities which YOU too will want to add to perfect the excellence of your own equipment.

Send for beautifully illustrated catalog No. J201 to address listed below for further information including a full page devoted to correct baffling of Royal Eight" and other size speakers.



Servicemen!



PERMOFLUX ROYAL EIGHT" WITH THE FAMOUS BLUE CONE
DEALER'S PRICE \$13.50

Check These Exclusive Features

- Permoflux's exclusive slotted, treated cone gives the following results which makes their speaker comparable to any 12" speaker:
- Soft-suspended cone and extra-large spider provide extended low frequency response.
- Deeper, curvilinear cone greatly extends high-frequency response.
- High permeance yoke increases output.
- 8 ohm—10 watt voice coil.
- Big speaker performance in a small frame allows smaller more economical baffle.

Here's BIG SPEAKER performance—clean, brilliant, musical reproduction but at a sensible price level. Your customers will approve and buy. Order one for test today—your money refunded if you do not agree that it is truly outstanding in performance.

Inquire about Permoflux's Complete Royal Blue Line 6" to 15" Speakers
See us at Booth 684 at the RADIO PARTS SHOW

10-DAY TRIAL—MONEY BACK GUARANTEE

PERMOFLUX CORPORATION
4910 W. Grand Ave., Chicago 39, Ill.

Please send _____ Permoflux Royal Eight" (8T-8-1)
 Check Money order enclosed

Name of Favorite Distributor _____
Your Name _____
Address _____
City _____ Zone _____ State _____





This "gun" shoots wire around corners



Bell Telephone Company craftsman wraps a wire to complete a connection. Wire is inserted into the nozzle and a rotating spindle whips it around terminals.

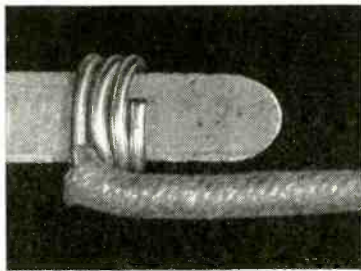

Close-up of connection made with new tool—neat, tight windings.

IT DOESN'T take long to wrap a wire around a terminal and snip off the end. But *hundreds of millions* of such connections are being made each year to keep up with America's growing demand for telephone service.

Now this job is done much more efficiently with a new wire wrapping tool invented at Bell Telephone Laboratories. This "gun" whirls wire tightly around terminals before solder is applied. The connection is better and there is no excess wire to be clipped off—perhaps to drop among a maze of connections and cause trouble later.

The new tool is being developed in different forms for specialized uses. The hand-operated wrapper in the illustration is for the telephone man's tool kit. Power-driven wrappers developed by Western Electric, manufacturing unit of the Bell System, are speeding the production of telephone equipment. The gun's small nozzle reaches where fingers couldn't—a big advantage these days when efforts are being made to produce telephone system parts smaller as well as better.

Bell Telephone Laboratories scientists devise many special tools that help your telephone system to keep pace with service demands economically—keeping your telephone service one of today's best bargains.

BELL TELEPHONE LABORATORIES

WORKING CONTINUALLY TO KEEP YOUR TELEPHONE SERVICE BIG IN VALUE AND LOW IN COST



RADIO-ELECTRONICS for



DON'T LET HIM "PITCH" YOU

**BLACK
IS
WHITE...**

INSIST ON

Sheldon "Telegenic" Picture Tubes

where **BLACK IS BLACK-**

WHITE IS WHITE- *and between*

ALL THE NATURAL

INTERMEDIATE SHADING!

This FULL RANGE of picture tones seen only on Sheldon "Telegenic" Picture Tubes, makes possible MAXIMUM CONTRAST with CLARITY . . . with NO EYE STRAIN and NO GLARE . . . whether on a Velour Black or clear face screen . . . whether viewed in daylight or under artificial light.

Superior picture quality is the reason why Sheldon Picture Tube production has been stepped up to 5,000 daily! This production increase is made possible by another recent installation of the most modern in-line exhaust unit in the industry.

SHELDON ELECTRIC CO.

A Division of ALLIED ELECTRIC PRODUCTS INC.
68-98 Coit Street, Irvington 11, N. J.

Branch Offices & Warehouses:

CHICAGO 7, ILL., 426 S. Clinton St. • LOS ANGELES 26, CAL., 1755 Glendale Blvd

Sheldon
NATURAL IMAGE

SOFT GLOW
Picture Tube

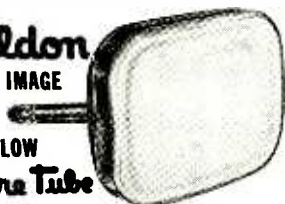

Manufacturers of

SHELDON TELEVISION PICTURE TUBES
CATHODE RAY TUBES • FLUORESCENT
LAMP STARTERS AND LAMP HOLDERS
SHELDON REFLECTOR & INFRA-RED
LAMPS • PHOTOFLOOD & PHOTOSPOT
LAMPS • TAPMASTER EXTENSION CORD
SETS & CUBE TAPS • SPRING-ACTION
PLUGS • RECTIFIER BULBS

**WRITE FOR VISUAL PROOF
OF SHELDON'S SUPERIOR PICTURE QUALITY!**

MAIL COUPON TODAY

Sheldon Electric Co., 68 Coit St., Irvington 11, N. J. B

- Send Proof of Picture Quality
 "Characteristics and Dimensions" Wall Chart
 "Television Mis-Information"
 "Ion Burns—How to Prevent Them" Brochure
(They're free — but PLEASE PRINT)

Name _____ Title _____

Company _____

Street _____

City _____ Zone _____ State _____

VISIT BOOTH NO. 201, PARTS DISTRIBUTOR SHOW, STEVENS HOTEL, CHICAGO, MAY 21-23.

© 1951—ALLIED ELECTRIC PRODUCTS INC.

EICO KITS
and INSTRUMENTS

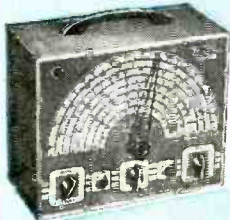

320K SIG. GEN. KIT \$19.95
Wired \$29.95

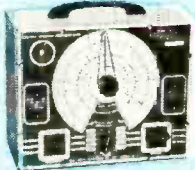

New 950K COND.-RES. COMP.
BRIDGE KIT \$19.95 Wired \$29.95

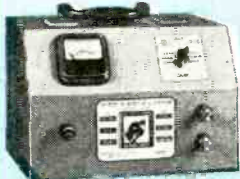

New 1040K BATTERY FLIM.
KIT \$25.95 Wired \$34.95



511K VOM KIT \$14.95
Wired \$17.95



145K SIG. TRAKER KIT \$19.95
Wired \$28.95



HV PROBE
(Wired only) \$6.95

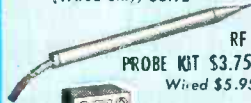

RF
PROBE KIT \$3.75
Wired \$5.95



C-5 5MC
CRYSTAL
\$3.95

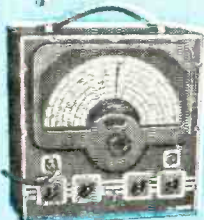

New 315K DELUXE SIG. GEN.
KIT \$39.95 Wired \$59.95

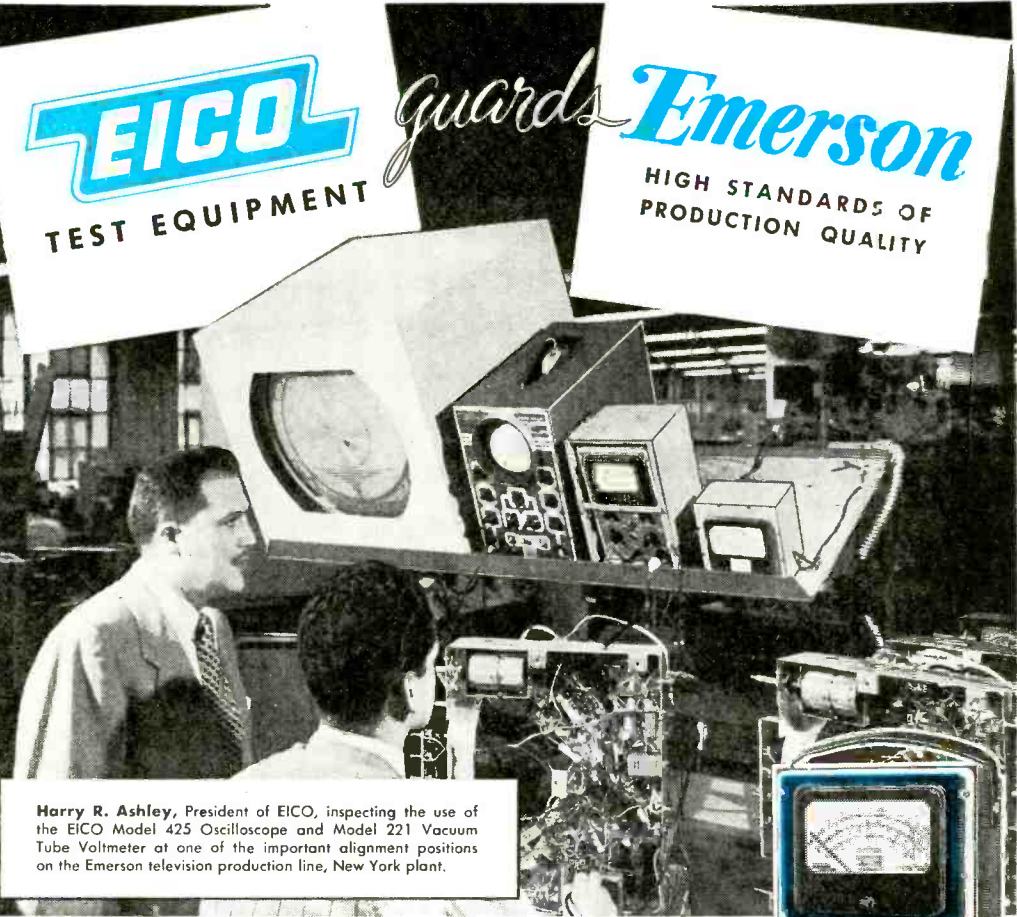

EICO
TEST EQUIPMENT

guards **Emerson**

HIGH STANDARDS OF
PRODUCTION QUALITY

Harry R. Ashley, President of EICO, inspecting the use of the EICO Model 425 Oscilloscope and Model 221 Vacuum Tube Voltmeter at one of the important alignment positions on the Emerson television production line, New York plant.

For Laboratory Precision at Lowest Cost—the Leaders Look to EICO!

FOR electronics test equipment, there's no tougher proving ground than the factories where TV sets are made. There's where the pace is fastest, precision requirements the highest, costs the tightest—and day-after-day dependability an absolute *must*.

In both the giant New York and New Jersey television plants of the Emerson Radio & Phonograph Corporation — at the many critical constant-duty testing positions along the production line—EICO instruments stand guard. For Emerson has found that for speed, accuracy and trustworthiness, at lowest cost, EICO instruments always deliver the fullest measure of value.

From coast to coast, in one leading TV factory after another, this is the experience—*this is the proof of EICO superiority*—that is repeated again and again. The top-flight TV set makers have discovered—and over 50,000 servicemen have learned—that *for the industry's greatest instrument values, at the industry's lowest costs—it's EICO!*

Be sure you look at the *EICO* line *before you buy any higher-priced equipment!* Each *EICO* product is jam-packed with unbelievable value. *YOU* be the judge—compare *EICO* at your local jobber today—and *SAVE!* Write *NOW* for free newest Catalog 5-C.

FOLLOW THE LEADERS . . .

INSIST ON EICO!



New 221K VTVM KIT \$25.95
Wired \$49.95



New 425K 5" SCOPE KIT \$44.95
Wired \$79.95



New 625K
TUBE TESTER KIT \$34.95
Wired \$49.95



360K SWEEP GEN. KIT \$34.95
Wired \$49.95



ELECTRONIC INSTRUMENT CO., Inc.
276 NEWPORT STREET, BROOKLYN 12, NEW YORK

© 1950, Electronic Instrument Co., Inc.

Prices: 5% higher on West Coast. Due to unsettled conditions, prices and specifications are subject to change without notice.

Needed Electronic Inventions

... Much remains to be invented in electronics ...

By HUGO GERNSBACH

ELECTRONICS is still comparatively young. We stand at the mere beginning of the art and our so-called vast accomplishments of the past will be trifling compared to what we will achieve during the next few decades. There will never be an end to invention and progress, as long as our present civilization continues. What seems fantastic in one age becomes commonplace to the next.

At present there are many gaps to be bridged by new developments and there is hardly any field of endeavor in which electronics cannot improve existing deficiencies. Here are a few random thoughts among the thousands of possibilities for needed improvements:

Double-Check Circuits. Early last March a Constellation plane with 22 passengers and crewmen enroute from Venezuela circled New York's Idlewild Airport for 38 minutes before making a safe landing. During this time of extreme tension for all on board, the crew tried to determine whether the big ship's nose wheel had locked into place. The plane's indicator lights showed that the wheel gear was down but not locked. A crash landing was prepared for, but the landing proved uneventful because the wheel gear *was* locked. Here again is the old story of something gone wrong either with the circuit or with a mechanical part of it.

When life and property are dependent upon circuits, as they often are, circuits ought to be completely trustworthy. For this reason, on important circuits of this type, the operator should never have to depend on a single circuit. For want of a better name, we should have double-checked circuits or duplicated circuits, or some type of electronic safety circuits, duplicated or even triplicated so that misfunctions of this type could not occur as they now often do. This is especially important where the operator cannot see what is happening with vital parts.

Multiple-View Aircraft Television. Here, the thought of a modified television arrangement comes to mind, so that the airplane's pilot can make sure by looking that everything is in order before going ahead with the next step, such as, in the above case, landing.

In airplanes where weight is a very important consideration it will be difficult to use television in its present state. When television has been simplified, such a scheme will be feasible, though this may be many years in the future.

Remotely controlled instruments in atomic plants today are monitored by television because weight of equipment and cost is of no great importance when so many lives are at stake.

The problem applying to aircraft is eventually soluble by electronics alone, at not too great a cost and embodying reasonable weights.

Airplane Collisions. The more planes we operate, the more the chances of mid-air collisions increase. Aerial

collisions are by no means a rarity nowadays. They happen right along at great cost of life and property.

It is physically impossible for a pilot to see simultaneously in six directions: up, down, east, west, north, and south. The busy pilot has all he can do to look in one direction, perhaps two at times, but that is all.

In the not too distant future all planes will be equipped with television cameras in such a manner that screen images from a number of directions will be in front of the pilot at all times. Only the great weight and cost of the equipment make this idea unworkable at present.

It should be possible in the meanwhile, however, to use a six-way modified—or sweep—radar installation, which need not weigh too much if miniature tubes and other miniature components are used. In this case, too, there would be several miniature screens which a pilot or copilot could watch and see if another plane was approaching from any direction. When finally engineered such a device will prevent many collisions. Such radar installations will be particularly advantageous during night flying and while flying in overcast weather when the visibility is extremely poor or nil.

Blackened Bulbs. Ever since the advent of incandescent lights electrical bulbs have blackened on the inside with use. While this condition was much worse when we had carbon filaments, even the present metallic ones still give off a vast amount of particles which in time make a dense deposit inside the glass bulb, cutting off useful light. Incandescent lamp manufacturers have improved this condition through the years, but even the best bulbs today still blacken badly if used long enough. Often it is necessary to discard badly blackened bulbs that still light.

Here is an important electronic problem that is not impossible to solve. It is purely electronic in nature and sooner or later someone may make a fortune inventing a remedy.

Electronic Telautograph. The present-day telautograph is not sufficiently flexible for many uses, for instance, in signing a check by remote control. The reason is that the signature does not come out with sufficient fidelity. Electronic improvements might correct this.

In many large corporations, government agencies, etc., where thousands of checks or bonds must be hand-signed each day, mechanical gadgets are now used whereby a multiplicity of checks can be signed simultaneously. A mechanical device of this type, however, has limitations. Usually not more than 30 signatures can be made at the same time.

An electronic telautograph check signer could be devised whereby 100, 200 or more checks could be signed at the same time. This would only be one application of such a telautograph. There are hundreds of other uses, in business, in banking, in government, etc., where such a machine would be highly welcome. It should not be too difficult to devise.

Converting to Bigger TV Tubes



By LARRY OEBBECKE*

Plan with care,
and profit from
this added serv-
icing business

The author with a completely converted set. He holds the original front panel and a blank which is cut to fit the larger kinescope.

THE business of converting small-screen television receivers to use bigger tubes is a practical and profitable business which can be added to your present servicing organization without too great an investment. This additional business can be profitable if you know what you are doing. We have been in this phase of the business for about one year, and our shop at the present time is handling an average of 25 to 35 picture tube conversions a week.

The first models of any make require more than normal time to design and engineer a perfect conversion so that its looks are equal to that of a commercial product. The research and effort devoted to these first models will eventually pay off as a number of these particular sets enter the shop, but an intelligent survey beforehand can take most of the risk out of such work and make it profitable.

It is necessary to be practical and to turn down sets which cannot be converted with a reasonable amount of work. For example, we never attempt to convert electrostatically deflected receivers. Too many parts would have to be added and too much redesign done. This of course eliminates a large number of the 7-inch sets, most of which are electrostatic. The cost of converting

such a set would practically buy a new large-screen set.

Most 10-inch sets are convertible. An exception is one of the Belmont receivers, which uses the electrostatically deflected 10HP4. All receivers require roughly the same amount of work; some, like the RCA 7 and 8 series, are a little easier. Philco chassis possibly require a little more thought than others due to the mechanical mounting and electrical circuit changes. Admirals and Emersons are much like the RCA's as far as part changes are concerned. The Admirals do not present any more difficulty than RCA's or Philcos except that, because of cabinet limitations, we convert to 14-inch tubes only and do not go to 16 inches on this brand.

Typical shop procedure

The procedure on all sets coming into the shop is:

1. A complete check of the set's operation on all local receiving channels to determine if there are any defects in the set before it is converted. If such defects are found they must be corrected before the set is converted, to forestall any difficulty that may arise in the process of conversion.
2. Chassis are removed from cabinets for all electrical work.
3. To install a new C-R tube, mounting brackets must be made where it isn't

possible to remake the present brackets on the chassis. We find it practical to redesign most of the mountings. Advanced stocking of such mountings for each popular model has saved us a great deal of time and money, as all conversions in our shop are to rectangular tubes.

4. The cabinet work for each model requires a great deal of planning before any cutting can be done. We make it our business to know in advance the amount of cabinet work required on any particular model. A pattern is made of each cabinet front panel which permits us easier operation when converting other sets of the same model. Each model is converted in a standard fashion so we will know that what we put into the cabinet will fit. At no time in the process of converting do we permit the end of the cathode-ray tube to project through the back of the set. We do not approve of that type of work in our shop.

The tubes we use for 14-inch conversions are the standard 14BP4, 14CP4, and 14EP4. These are all short-neck, 70° deflection rectangular tubes. For 16-inch we use the 16RP4 and the 16KP4, and for larger sizes the 19EP4 and the 20CP4. These tubes are of standard makes.

In a typical conversion the deflection coil is removed and a new 70° yoke is

*Manager, Philadelphia Television Service Corp.

used in its place. The focus coil in most cases is not changed. Philco 12-inch models can be converted to 14-inch without changes in the power supply. In conversions where the high-voltage transformer is changed, the width coil and the horizontal linearity coil are also changed. Philco parts for these various changes are usually obtainable; also other available makes can be used. We have to a great extent standardized on RCA parts for all sets, simply because we found them most convenient from a viewpoint of quick availability. We use the RCA 206D1 or Merit MD70F deflection coil, the RCA horizontal linearity coil 209R1 and the width control 208R1. At least two high-voltage transformers can be used, the G-E 77J1 and the Merit HV06. Another approach is to use the RCA 218T1. Since it is used in a voltage-doubling circuit, it requires an extra 1B3-G and a few capacitors and resistors.

With the installation of the new components such as the yoke, linearity and width coils and transformer changes where necessary, we then proceed with the mounting of the C-R tube brackets. With the completion of these two steps, we are ready to turn on the set and start checking for any other changes to be made.

Philco conversions

Slightly different tactics are required on different Philco circuits, and the results obtained will also vary somewhat. For instance, the Philco 1001 can be converted to a 14-inch rectangular tube only. The cabinet is too small to house a 16-inch tube. The 10-inch models 1040 and 1076 can be converted to use either 14- or 16-inch tubes. The 12-inch Philco models 1240, 1278, and 1280 can be converted to use either 14- or 16-inch tubes.

Photos of the Philco 1076 indicate that the cabinet opening had to be enlarged to accommodate the larger tube. The same is true of the 1278, another simple conversion job. In the Philco 1280, we had to change the left-side pulley arrangement, since the chassis gives you no room to work with to the right.

A Philco 1050 was converted as an experiment. The job was satisfactory, but in general the conversion is too expensive to be worth while to the customer. The difficulty is in the cabinet. There are two side sections covered with grille cloth. It was necessary to build a new front panel right across the top of the cabinet to make this conversion.

RCA receiver conversions

Some of the easiest RCA sets to convert are the 730TV1 and 730TV2, the 8TV321 and 8TV323, and the 9TW333. Some differences in procedure in these sets are necessary since the tubes are cabinet-mounted. All RCA sets mounted their tubes through the front of the cabinet until very recently.

The above sets can be easily con-

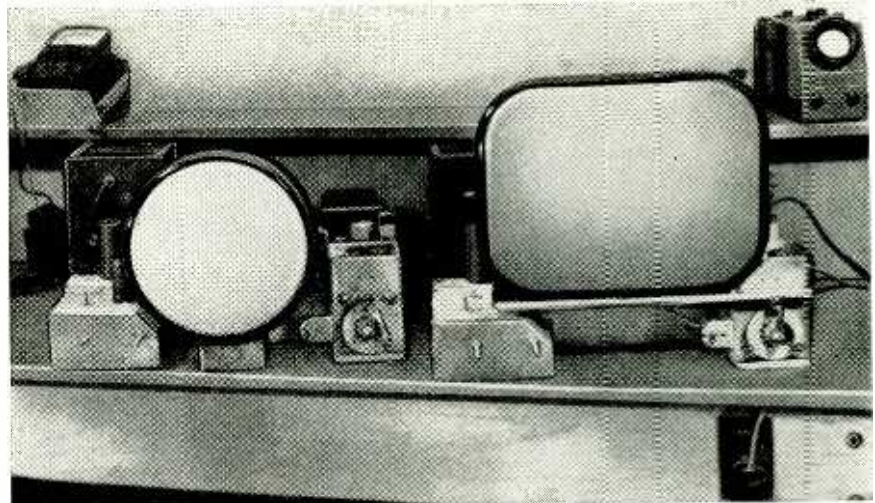

The set at left still has its original round tube, the one at right has been converted to take a large rectangular tube. Both sets have the same chassis.

verted to the 14-inch tube. Since the tube is supported by the deflection coils, etc., the bracket assembly which holds the yoke and focus coil must be lifted three-quarters of an inch to give the necessary additional height for the bigger tube.

Other work on these sets is to replace the deflection yoke and make a few minor changes in the horizontal output and high-voltage power supply. These changes consist mainly in changing values of capacitors and resistors—the values depending on what we find in the sets. There is quite a bit of variation and no rules can be laid down. All the above sets have the same transformer, which does not have to be changed. We get up to 10,500 volts, which is quite satisfactory on a 14-inch tube designed for 12,000.

The RCA 700 series (721TS and TCS) have electromagnetic ion traps. We discard them and replace with a 39-ohm high-wattage resistor. A PM ion trap is placed on the neck of the tube.

When converting the 8T241 from a 10- to a 14-inch tube, take off the set

section of the front panel. In every set we have seen, we have found underneath it a completely finished front. This simplifies the problem of enlarging the opening. Only slight retouching on the lower panel is required to make a professional looking job.

The 8T244 is covered with a grille cloth. The danger of fraying or tearing it is the difficulty here. If you wet the grille cloth and cut it with a razor blade along the line you are going to saw, it will not fray. Due to lack of space, the mask has to be notched at the bottom to clear the knobs.

The 8TV323 can be converted to 14 inches with no trouble. It can also be converted to 16 inches because of the long door which goes all the way down to the decorative part. The whole chassis is moved down two to three inches, and a new front panel installed, etc. In this model the customer pays for extra cabinet work. The similar 321 can be converted to 14 inches only. If the chassis were moved down on this model, the knobs would be below the door on the cabinet.

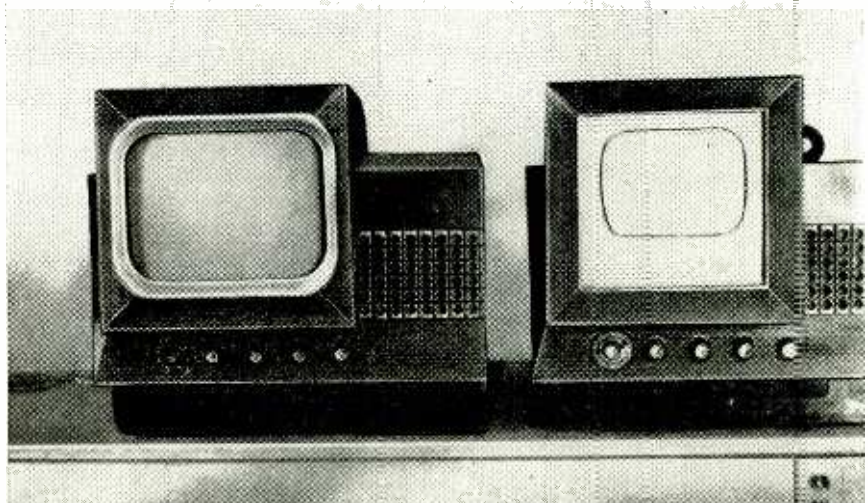

Another pair of sets. The one at left is converted, the one at right is not.

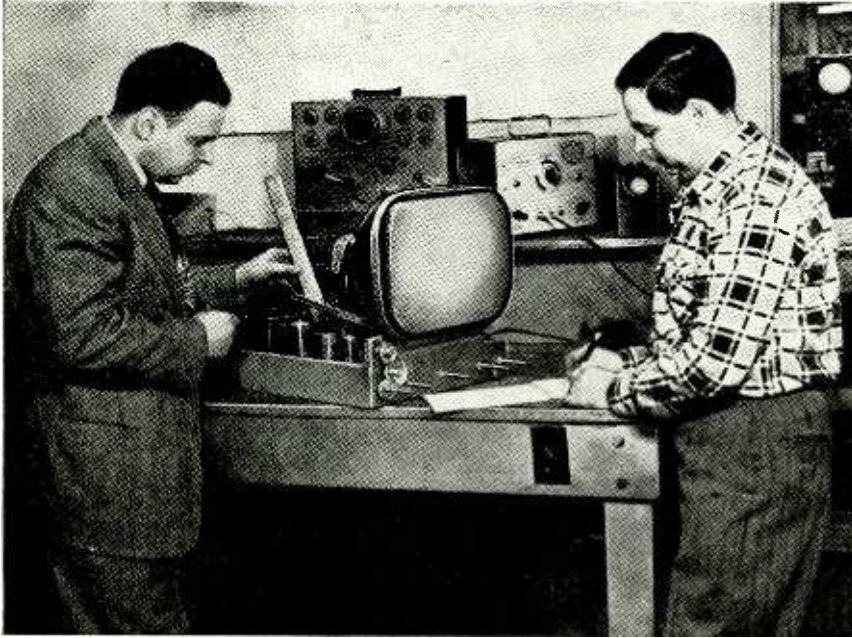

Carefully recording the problems encountered when converting the first of a given set model is effort well spent and will save much time in future jobs.

The 730TV1 and 730TV2 can also be converted to 16 inches. We have adequate cabinet room because of the shallowness of the chassis. We move the chassis back $3\frac{1}{2}$ inches, which makes room for the front of the tube. The problem is what to do with the controls which are in front. A subchassis is built and fastened to the front of the regular chassis. All the controls, with the exception of the channel selector and fine tuning control, are moved forward to it. We do not move the channel selector mechanism, so an extension shaft has to be built. This is a delicate piece of work, since it is a shaft within a shaft, but we have been successful. This shaft extension has been designed by our shop and is produced in quantities in advance to fit all RCA models requiring 16-inch conversions. For models 630, 830, and 641 a special wooden mask has been designed by our shop to convert these sets to 14-inch rectangular tubes. This mask replaces the mask which is standard equipment on these models. The fronts used by us are made of unfinished wood by a local cabinet maker and after being put in place and cut to receive the new tube are finished to match the set. The 630, 8TS30, and 641TV can be converted to 12-inch round tubes with this new front mask and without electrical changes. The new tube is a 52" type, and will operate satisfactorily on the old high-voltage supply. These sets can be converted to 14 inches by making the same electrical changes as in other sets, but require very careful measurements in the cabinet work, as space is limited. Larger tubes require a new cabinet.

Some other aspects

Time spent in making a conversion varies from six to ten hours (one man). This includes the bracket assembly. Notes and patterns are made on first

conversions and all difficulties and peculiarities carefully recorded. *This is one of the things that must be done to make conversion profitable.* When the same type set comes into the shop again, the technician only has to refer back to the notes. Also patterns should be made of all the plastic masks that are used in various cabinet models. Some may require rounding or shaping of the corners, the cutting of height and width on a mask, the reshaping of the top of the mask frame, or the notching to be placed over some of the knobs. To prepare such patterns will save you a lot of time and make all of one model look uniform.

All brackets, mountings, and subpanels or chassis are made of aluminum, which makes handling and drilling easier. All manufacturers' name plates are replaced on the panel, and when controls are moved they are relabeled for the customer's use. Keep an eye on the possibility of future service on these conversions whether you service them or someone else does. All mountings and changes should be made so that the next man can work easily with the chassis. This not only is for your advantage but it will help maintain quicker service for the customer.

We find it unnecessary to make a survey of each receiver before taking a conversion job. Quotations are given over the phone, if the set and model number is known. However, the man who picks up the set makes a careful check of the TV-Radio-and-Phono receiving conditions, and any faults found are noted right on the back of the customer's receipt.

If any repairs are required in any of the above units, the customer is advised that there will be an additional charge for this service.

If there are any peculiarities in the receiving conditions, such as ghosts,

FM interference, ignition noises, or interference, they are called to the customer's attention and he is told that any defects that are there now will be blown up and made more conspicuous along with the rest of the picture. A larger tube cannot cure reception troubles.

All sets before delivery to the customer's home are set up and adjusted on a pattern generator, assuring perfect linearity. If the instrument isn't available it is then advisable to check each set out on a test pattern. This will save many recalls.

Our warranty covers our work for a period of 90 days. The picture tube is guaranteed for a year. Guarantee does not cover those circuits in which we have done no work but only to the converted circuits.

—end—

ELIMINATE RETRACE LINES

Vertical retrace lines may not prove objectionable to TV viewers in areas of moderate signal strength when contrast and brightness levels can be properly adjusted. However, in fringe areas the vertical retrace lines become visible with low contrast and high brightness control settings. This difficulty may be more noticeable in some of the cheaper receivers where economy is the ruling factor in construction.

It is not too much trouble or expense to remedy this difficulty in your present receiver. The circuit shown within the dashed lines in the figure, may be similar to the vertical sweep circuit in your set. Although a blocking oscillator is shown for the example, this idea can be applied to a receiver with a multivibrator sweep oscillator also. The portion shown in dotted lines is an integrator whose purpose is to take some of the positive pulse voltage appearing in the vertical oscillator output and reshape it for application to the picture tube cathode which biases it to cutoff during the retrace time.—
Wilbur Hantz

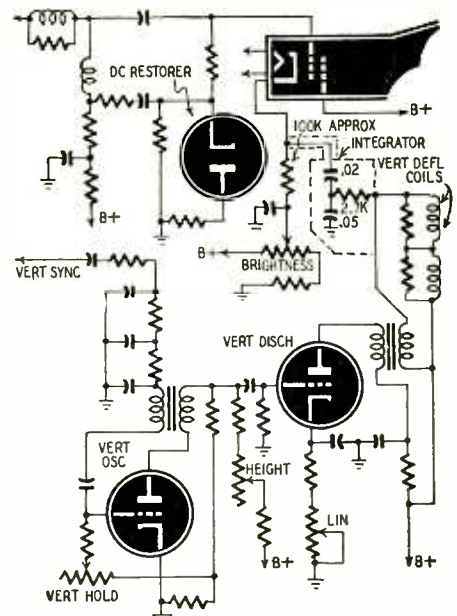

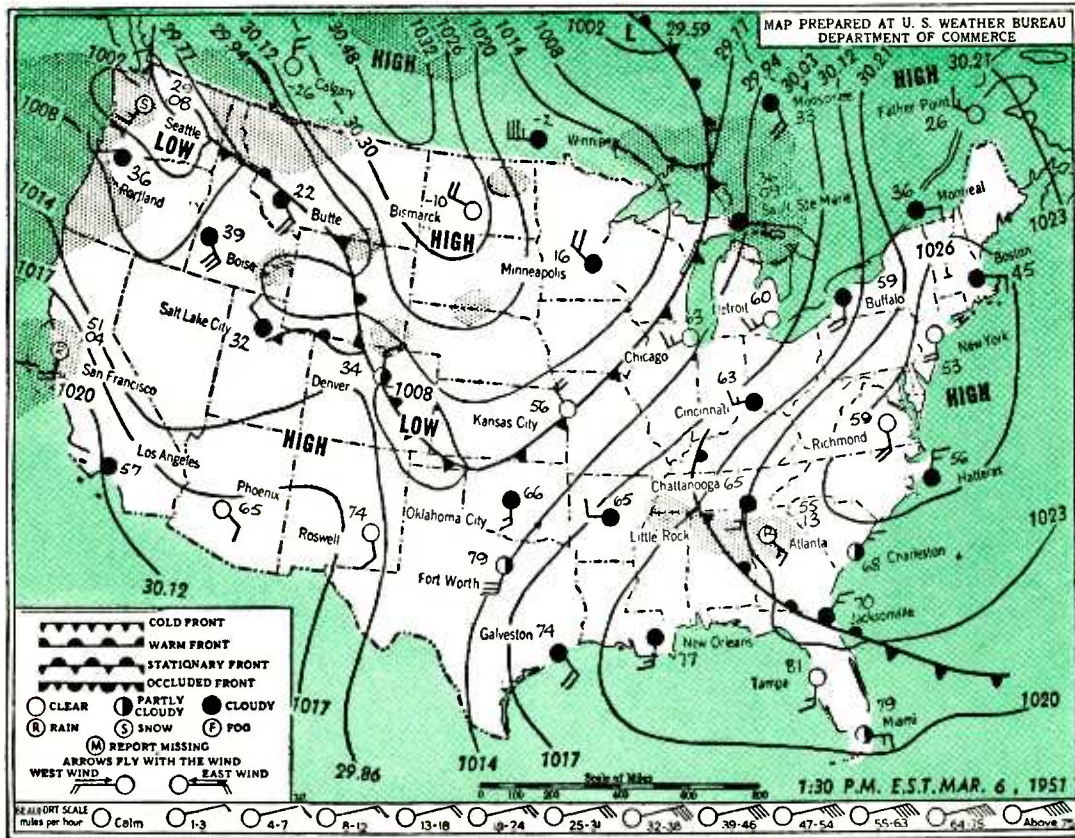

Large air masses, as those shown on this weather map, affect TV reception as they sweep the country.

WHAT'S THE MYSTERY BEHIND TELEVISION DX

By E. P. TILTON, W1HDQ*

THE TV viewer is often astounded and sometimes annoyed by pictures from distant stations on his TV screen. Sometimes they come in with such strength as to drown out local programs. Television viewers are divided into two camps—the dx hounds who are pleased and proud to receive programs from 1,000 miles or more away, and the local-station televiewers who object to the interference. The first group is much the larger, and many people are inquiring as to the whys and wherefores of long-distance television propagation.

As the first service to use the frequencies above 30 mc, the radio amateurs have contributed much to our knowledge of v.h.f. propagation. Amateur activity on 56-60 mc in the 10 years before the 1941 shutdown, and more recently in the new band at 50-54 mc, provided data on the lower TV channels. The high band is similar to the amateur 144-148 mc assignment, where

*V.h.f. Editor, QST Magazine

thousands of hams have been working since 1945.

Long-distance propagation is considered a nuisance by commercial services. The ham, on the contrary, jumps at every opportunity for work beyond his normal communicating range.

There are many ways by which a 50-mc or higher-frequency signal can reach points beyond the normal working radius. Only two are important in TV reception. One is closely allied with weather phenomena and can be predicted with considerable accuracy 24 to 48 hours in advance. The other is the result of spotty concentrations of high ionization density in the E-layer region of the ionosphere, some 50 miles above the earth's surface. Its causes are not well known and consequently it is predictable only in a general way.

These two phenomena, *tropospheric bending* and *sporadic-E skip*, account for all the TV dx reported in recent issues of this magazine.

Tropospheric Bending

V.h.f. waves leaving the transmitting antenna take off into space in straight lines, so a television station's service area is a somewhat irregular circle of a diameter of perhaps 80 miles, depending on antenna height, transmitter power, nature of the terrain, receiver sensitivity, and other variables, including the weather at the time. The weather exerts an influence because the speed of radio waves varies with the dielectric constant of the medium they travel through. The temperature and humidity of air affect its dielectric constant, so our v.h.f. wave is bent slightly when it passes through a boundary between air masses having different temperature and moisture content.

Large masses of air are constantly moving across our country from west to east in fairly well-defined and predictable patterns. Modern weather forecasting methods are largely based on plotting of this air-mass movement¹. Under stable weather conditions the boundary between two very different air masses may remain well defined for up to several days.

If this boundary lies along the path between a TV station and a distant receiver, a station may be received far outside its normal coverage. (Air-mass boundary bending can work the other way, too, reducing the coverage to below normal.)

The bending of radio waves by atmospheric stratification increases with frequency, but it is negligible below

about 25 mc. The amateur 50-mc band is noticeably more responsive to tropospheric effects than is the 28-mc band, and the 144-mc band often shows strong signals from points several hundred miles distant, while 50 mc is only slightly affected. The distance over which refracted signals may be heard increases with frequency, *other things being equal*. 50-mc signals are seldom heard beyond 300 miles by tropospheric means (troposphere: the atmosphere between the stratosphere and earth, in which our weather occurs), but the 144-mc band often supports communication over distances up to 500 miles in the warmer months, and 700 to 800 miles is not uncommon. The current record for two-way amateur communication on 144 mc is nearly 1,200 miles.

From this we can see that the high-band TV channels, 7 to 13, should provide more tropospheric dx than the lower ones, channels 2 to 6. Why this is not borne out in current TV experience is easily understood when we consider the difference in performance of most receivers between the high and low channels. Most antenna installations favor the low band, and there is a preponderance of low-band stations. Channel 4 alone has almost as many stations on the air as all seven channels of the high band combined. (But we don't get as much dx on all seven channels combined as on channel 4. Perhaps there are a few propagation factors affecting 200-mc signals that are still not understood?—*Editor*)

Tropospheric bending occurs in all seasons, but is most pronounced in warm or mild weather, reaching its peak in most sections of the country during the fair calm weather of September and October. Large-scale air-mass movement is only one cause. Another is atmospheric convection that develops any warm sunny day along our coastlines, causing seaside locations to head the list of desirable homesites for the v.h.f. enthusiast, whether he be a communicating amateur or a TV set owner. The favorable season is longer in the more southern regions. The Gulf Coast, the Lower Mississippi Valley and the California coastal areas enjoy a considerable advantage in this respect. At the peak of the season, however, the broad reaches of the nearly flat Middle West states are favored with tropospheric bending hardly equalled elsewhere.

In addition to variations induced by weather changes, tropospheric bending follows a regular daily cycle. Early morning, when the sun heats the air aloft before the earth's surface temperature is affected, may be the best part of the day for v.h.f. propagation. (This knowledge is of little use to the TV enthusiast, transmitting schedules being what they are.) Of more practical value is the repetition of the temperature inversion in the period around sundown, when the earth cools more quickly than the layer of air immediately above it.

This daily cycle may be observed the year around, but when it is combined

with other factors already enumerated we may have a truly phenomenal degree of bending on the frequencies above about 100 mc or so. This happens frequently along our coasts in May and June and September and October, and somewhat less often over inland areas. The turbulent weather of midsummer tends to dispel the air-mass boundary conditions most favorable to long-distance propagation, and cold weather discourages the coastal convection and diurnal factors. Tropospheric bending over distances beyond 300 miles is rare in winter.

The reports of observer Glaub of East Moline, Ill., of reception of WHIO-TV, Dayton, Ohio, channel 13, and WKRC-TV, Cincinnati, channel 11, on September 5, are typical examples of tropospheric bending on the high channels. Observer Swanson, Rockford, Ill., saw WSPD, Toledo, channel 13, on September 6 and 7² by the same air-mass condition. This period of three nights is of particular interest, as it was the occasion of the 144-mc work over nearly 1,200 miles mentioned earlier. Beginning just before midnight on the 6th an amateur in eastern New York worked several stations in Iowa, Missouri, and Kansas, and was heard in Oklahoma, more than 1,400 miles away!

Reception on October 30 of WJAR-TV, Providence, R. I., channel 11, by observer Canning³ of Halifax, Nova Scotia, is an example of the coastal type of opening. This sort of thing could be done much more often than is generally appreciated if the 144-mc experience of Halifax and Yarmouth amateurs is any indication. A Yarmouth man has found it possible to work as far south as Norfolk, Va., fairly often, and his best dx, Fayetteville, North Carolina, about 900 miles, was worked with signals of tremendous strength.

Even though the power level of amateur stations is far below that of the most modest high-band TV station, signals over such distances are often well above that required to provide a good TV picture on a reasonably sensitive receiver. There is little doubt that high-band TV dx could be logged much more often if viewers knew when to be on the lookout for it.

The practical receiving range for low-band stations can be extended appreciably by the use of properly designed r.f. amplifiers and antenna systems, as demonstrated by observer Dubreuil⁴ of Lavaltrie, Quebec, who has succeeded in receiving WRGB-TV, Schenectady, and WSYR-TV, Syracuse (channels 4 and 5) consistently, over a 260-mile path.

Sporadic-E Skip

Practically all low-band TV dx beyond 400 miles is the result of reflections in the E-layer region of the ionosphere. As such it is markedly different from tropospheric bending. The experienced observer should have no trouble in distinguishing between the two phenomena. Because the reflection takes place many miles above the earth there is a *skip zone* of several hundred miles in which the signal is not ordinarily heard. Sporadic-E skip reception is most common over distances of 600 to 1,300 miles, though exceptionally intense ionization may bring the minimum skip down to as low as 300 miles, and multiple-hop effects can extend the coverage to 2,500 miles or more.

At times there appears to be a tie-in with observable weather effects, but the correlation is not well established, nor is the exact cause of the phenomenon completely known. After years of observation by amateurs and scientists, prediction of sporadic-E is still only

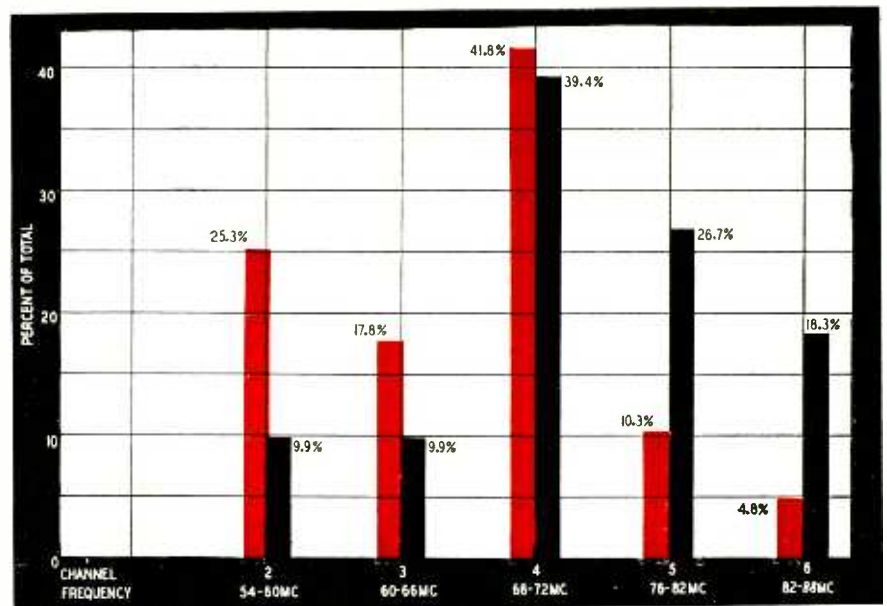

Fig. 1—This tabulation, compiled from 146 dx reports in RADIO-ELECTRONICS, illustrates the effect of increasing frequency on the occurrence of sporadic-E layer skip. The red columns show the percent of total reports, the black show the percentage of the total number of stations on each TV channel in the U.S.

partially successful. We do know quite a bit about it in a general way, however. We know that it can develop at any hour, in any season, but that it is most common in the mid-day and early-evening hours of the six-week period either side of the longest day of the year, or from early May to the middle of August. There is a minor period from early December to the middle of January.

Ionization sufficiently dense to reflect signals on frequencies up to 60 mc or more is very frequent in the May-to-August period, and the signal strengths encountered at times are nothing short of astounding. This explains the occasional dx reception reports from viewers having small receivers and indoor antennas. As an example, an observer in New England, in the fringe area of WCBS-TV, New York, may find his channel 2 reception taken over by WSB-TV, Atlanta, WJBK-TV, Detroit, WFMY-TV, Greensboro, North Carolina, or even KPRC-TV, Houston, Texas, instead of his customary New York program. Or the interference may be only strong enough to cause the uninformed viewer to call his repairman.

Examination of 146 low-band dx reports in recent issues of RADIO-ELECTRONICS shows them to be of sporadic-E origin. The times of reception, where given, agree closely with amateur 50-mc observations for the same period, and every date listed is one on which amateurs were making sporadic-E contacts over roughly the same paths.

From amateur experience on 28, 50, 56, 112, and 144 mc, and from observation of skip effects in the FM band, 88 to 108 mc, we know that sporadic-E drops off sharply with frequency, being relatively rare above about 100 mc. The top frequency is not precisely known, but it seems unlikely that high-band TV channels are ever affected.

This drop in sporadic-E with frequency is apparent in Fig. 1, even though the chart was compiled from a relatively small mass of data. From it we see that channel 2, with less than 10% of the country's stations, accounted for more than one-fourth of the reports. Channel 3, with the same number of stations, netted only 17.8% of the reports. Nearly 42% of the reports were for channel 4 stations. This slightly inconsistent figure (channel 4 having 39.4% of the stations) is easily explained. The presence of many more stations, with better distribution over the country, makes for more monitoring of that channel, and more antenna installations favoring it. Reports for channels 5 and 6 are greatly in the minority, though 45% of the country's stations are operating there.

Other causes of v.h.f. dx

Though tropospheric bending and sporadic-E skip account for nearly all the TV dx thus far observed, other factors can enter the picture. There is a very slight possibility of reflection from the ionospheric F2 layer. The reception of BBC television by Henry

Rieder, of Capetown, South Africa, in 1947 and 1948 was in this category. This is a daytime phenomenon exclusively, and it is possible only near the peak of the 11-year sunspot cycle. Even then (the peak was in February, 1948) it is doubtful whether the upper frequency limit of F2-layer propagation is high enough to affect American TV stations. Note that the BBC video is on 45 mc, the sound on 41.5 mc. The writer received both frequencies often in October and November, 1946-48, but the video has been heard infrequently since. The sound was heard well a few times in 1949, but not at all in 1950. There is practically no possibility of transatlantic TV reception again before 1957 or 1958, at the present state of the art.

V.h.f. waves can be bounced back by the aurora borealis. Swing your TV array around to the north the next time an aurora lights the skies. Because of the scattered nature of the reflected signals there may be severe multipath distortion of the reception, and signals so reflected are generally rather weak. Try all the channels, however—you may be in for some surprises!

Anticipating favorable conditions

Armed with the above facts we can examine the TV dx reports so far published in this magazine and say, with some assurance, just how each of them happened. Better, we can look ahead and see when such things are likely to happen again.

Because tropospheric openings are closely related to weather conditions, we can spot them several days away if we study the weather across the country in detail. This can be done fairly well by watching the weather maps that are published in many newspapers. The type showing pressure distribution is best for our purposes. If a large high-pressure area is shown moving slowly across the country we can be almost certain that improved propagation will accompany its passing our locality. The best tropospheric bending is almost always closely associated with the middle or the trailing edge of a large high-pressure movement.

It is not the barometric pressure gradient that causes the bending, but rather the atmospheric stratification that accompanies it. The pressure lines on the weather map, called isobars (or lines of equal barometric pressure) are merely a convenient indicator as to when and where favorable conditions may exist.

We can do fairly well at short-term prediction of tropospheric openings if we do no more than watch the local weather. Temperature and barometric pressure changes, the wind direction, visibility, changing cloud forms—these are weather signs by which man has predicted the weather for generations, long before the advent of weather maps or television. They are still good for local forecasting, and for guessing when better TV reception is in prospect.

Some favorable signs: High barometer, after a slow rise. Thin high cloud-

iness, and little or no wind. Ground fog in the early morning, or late at night. Cumulus clouds forming around mid-day, but not mushrooming into thunderheads. A weather forecast for rain after a protracted fair spell in summer, or snow turning to rain in winter.

Prediction of sporadic-E skip is something else again, for the best minds in the business have not yet been able to do it with any reliability. We know when it is most likely to happen, and we can recognize it when it breaks, but it still pulls some surprises on us that don't fit in with previously observed patterns.

A classic example is the case of January 4, 1951. Beginning about 7:15 pm EST, sporadic-E skip began to break out over most of eastern United States and Canada. The area affected ranged from Nova Scotia to Florida, and from the Atlantic to well past the Mississippi. An amateur friend of the writer, in Yarmouth, N. S., taking time out from his rapid succession of dx contacts on 50 mc, found signals jamming his TV set on all channels from 2 to 6. The jumble was such that it was difficult to identify any one station. This was 300 miles from the nearest TV transmitter—and in midwinter!

Catching a major portion of the sporadic-E openings the year around takes frequent observation and not a little luck, but the ionosphere does drop a few clues. Begin checking in earnest in late April, particularly around 7 to 9 pm. If you have a receiver covering the amateur bands at 28 or 50 mc watch out for signs of "short skip" communication. If 28-mc stations are heard working distances of 300 to 1,200 miles there's a good chance that at least channel 2 may be open over the same paths. If 50-mc stations are heard similarly, several channels are probably open.

Make a note of any open dates. As sporadic-E is related to solar conditions in a general way, there is likely to be a recurrence of any pronounced opening in about 27 days, the time Old Sol takes to make one complete turn on his axis. There are usually two major openings each month, about two weeks apart, and once those periods are established there is a good chance that repeat performances can be caught the following months on similar days, four weeks later. The average solar disturbance will remain active for at least three solar rotations.

Probably the most important adjuncts to improved dx reception are a sensitive receiver and a high-gain antenna system. The best openings can be caught on any kind of gear, but a low-noise front end of adequate gain, and a properly designed antenna system equipped with a rotator will bring in dx signals many times when the average installation shows no sign of life whatever.

REFERENCES

- 1 Modern aerological techniques have been the subject of many popular texts in recent years. One recommended by the author is *Weather and the Ocean of Air*, Wenstrom, Houghton Mifflin Company.
- 2 *Radio-Electronics*, December, 1950, page 27.
- 3, 4 *Radio-Electronics*, January, 1951, page 69.

—end—

TV Trouble Lexicon Lists Common Faults

Beginning a series of technotes arranged for quick reference

By JOHN B. LEDBETTER*



OVER a period of time, different makes or models of television receivers are likely to develop traits or operating irregularities peculiar only to that particular model. In many cases, familiarity with these peculiarities or symptoms of trouble will save a great deal of time which otherwise might be spent in routine trouble-shooting. For example, a receiver brought in with the complaint "no high voltage, sound O.K." would warrant an immediate check of the high-voltage filter capacitor if this particular model were known for its tendency to blow out filters. Similarly, a model which invariably overloads or cross-modulates on strong local signals would suggest the proper procedure.

Although some of the troubles listed in the following paragraphs apply specifically to the receivers named, there are many cases in which similar troubles will appear in other makes and models. For this reason, diagrams of the affected stage or circuit are included so that comparisons can be made in similar complaints. Code numbers on the diagrams are those of the manufacturer and may not agree with numbers on diagrams printed by other publishers of service information.

It is recommended that all available service notes be entered in alphabetical order in a loose-leaf notebook or similar file system for easy reference. Very little time is required to keep this system up to date, and it is surprising how useful it can prove.

Admiral

T-10. Dark horizontal strip (4 inches wide) across top of picture; bottom of picture light. If dark strip moves down slowly, check for cathode-heater short in one of the video amplifier or video i.f. stages. If dark strip is stationary, check filter capacitors.

19A11. Picture off center to right, horizontal centering control has no effect. Defective centering control. Defective 5V4-G. Open or shorted capacitor in horizontal deflection circuit.

20A1, 20B1. Horizontal jitter on one channel only (usually channel 4). Caused by overloading of 6AU6 sync separator. Remedy: Remove the 47,000-ohm resistor (screen grid to ground) in this stage. Disconnect one end of the 82,000-ohm screen grid resistor from B-plus and reconnect to arm of contrast control. (This change has been made in later models.)

24D1. Arcing in vertical output stage. In earlier models, the 6S4 vertical output plate terminal often arced to ground. Remedy: Replace tube socket with high-quality type. Also replace 2,200-ohm resistor R417 even though it checks good. (Later models use low-loss socket.)

26X36N (chassis 24D1). Horizontal pulling toward left (top of picture only). Improper adjustment of horizontal hold control. Defective horizontal output tube (earlier models use a 6BG6-G, later models a 6CD6-G).

30A1. Microphonics. Microphonic 6J6. Loose tube socket of shield base. (Spot-solder these to tuner chassis. This applies also to models using a 6C4 oscillator.) Loose or dirty fine tuning control. Improper lead dress in sound i.f. stages. Binding of control shafts or knobs to receiver cabinet. In stubborn cases, shock-mount the speaker and chassis.

30A1. Pulling to right (top of picture only). In earlier models, remove the two 470,000-ohm plate resistors R413 and R414 in the horizontal sync discriminator stage and replace with two 180,000-ohm resistors. Readjust horizontal oscillator if necessary.

Capehart-Farnsworth

CX-31. Horizontal sweep will not lock in. Defective 6SN7-GT horizontal oscillator-a.f.c. tube.

501P, 502P, 504P, 461P. No high voltage, no horizontal deflection. Open h.v. winding on horizontal output transformer (terminals 2 and 3). Defective 1B3-GT (check by substitution; tube

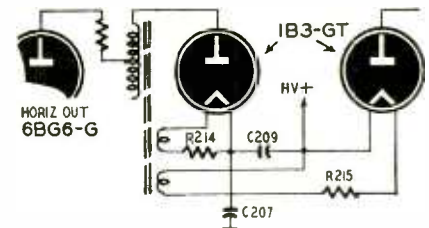

Fig. 1—Part of the high-voltage circuit used in Capehart-Farnsworth sets.

may check good, yet be gassy). Open 1B3-GT filament circuit. Shorted capacitors C209 or C207. Open resistors R214 or R215. (See Fig. 1.)

Vertical jitter. Excessive contrast setting. Noise in vertical sync circuit. Cold-soldered connections in vertical oscillator circuit.

Picture smear. Insufficient bias on video amplifiers, resulting in grid current on

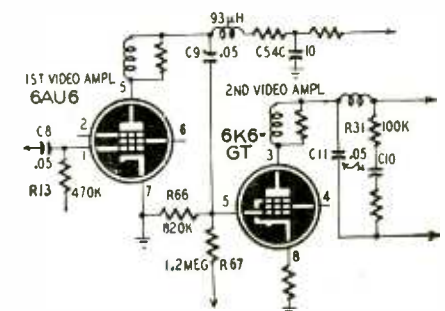

Fig. 2—Picture smear may be caused by incorrect bias on the video amplifier.

*Engineer, WKRC-TV

video signal. Defective coupling or grid-load resistor. Check R13, R67, R66, R31; C8, C9, C10, C11, C54C. (See Fig. 2.)

Vertical nonlinearity. Incorrect adjustment of vertical linearity control. Defective 6K6-GT vertical output. Defec-

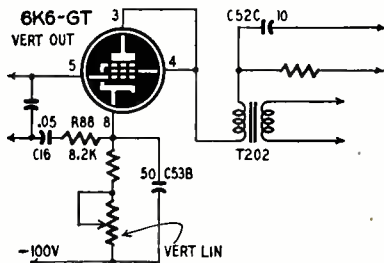

Fig. 3—Vertical output stage has the linearity control in the cathode circuit.

tive vertical output transformer. Defective resistor R88; capacitors C16, C53B, or C52C. (see Fig. 3.)

Horizontal nonlinearity. Incorrect adjustment of horizontal linearity control. Defective 6BG6-G horizontal output, 5V4-G damper, or 6AS7-G reaction scanner. Defective horizontal output transformer. Defective resistor R201, R219, R220, R223, or R224; capacitors C201, C211, or C212.

Picture out of phase horizontally. Incorrect adjustment of horizontal sync

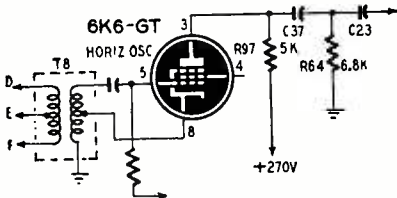

Fig. 4—Horizontal oscillator circuit.

discriminator phase control. Reversal of leads D and F on sync discriminator transformer. Defective resistor R97 or R64. (see Fig. 4.)

Raster nonsymmetrical. Improper adjustment of focus coil. Defective deflection coils.

610P, 651P, 661P. Horizontal nonlinearity. Change in resistance, capacitance, or inductance values in grid circuit of beam relaxer; check values against schematic. Shorted turns in horizontal deflection coils or transformer.

Stretching at top of picture (wide spacing of several lines). Open .05- μ f coupling capacitor or open 5,600-ohm resistor in vertical oscillator. Open cathode bypass capacitor in vertical amplifier. Defective vertical output transformer.

Black bars on left side of picture. Defective 6L6 horizontal oscillator, causing spurious oscillation.

Poor horizontal sync (lines similar to auto ignition interference). High-voltage corona affecting sync. Check spacing of 1B3-G tube socket lugs. Re-dress

wiring away from h.v. bleeder circuit.

Horizontal sync drifts. Defective 6SN7-GT or 6K6 on sync chassis. Defect in horizontal a.f.c. circuit.

Picture size changes when vertical centering control is adjusted (jumpy movement of center of picture only). Defective centering capacitor across vertical centering potentiometer.

White bar at bottom of picture. Overloading of vertical amplifier. Defective vertical amplifier tube.

Portions of picture tear out. Excessive contrast setting. Excessive signal at antenna. Strong outside interference. Defective 6L6 horizontal oscillator. Audio leaking through to picture-tube grid (check i.f. sound trap).

No focus (picture size changes when focus control is adjusted). Open focus coil. Poor solder joint or connection at coil or plug socket.

No picture, focus and width controls run hot. Breakdown of filter capacitor or other h.v. components (or wiring), causing B-plus short to ground. Arc-over in 6L6 socket. Use ceramic socket for replacement. Re-dress wiring around socket.

No picture or sound, oscillation in system. Poor or improper grounding in shields and r.f. subassembly, or in under-chassis i.f. shields. These shields must be well grounded with every nut screwed down tight *at only* the points provided. Touching the shield to another ground point can cause oscillation.

651P. Microphonic howl. Defective 6J6 mixer, 6J6 oscillator, 6J6 r.f., or one of the 6AC7 i.f. amplifiers. If a 6AC7 is causing trouble, try a lead damping weight on top of tube. This applies to receivers using tubes such as 12AT7, etc.

Crosley

9-408. No raster. Defective 1B3-G or 6BG6-G. Shorted filter capacitor. Check .005- μ f, 10,000-volt filter for open or high-leakage.

307-TA. No raster. Defective 6SN7-GT horizontal discharge. Check by substitution only.

Du Mont

RA-101. Sync instability (horizontal breakup after hour or so operation). Defective 6H6 or 6AC7 in a.f.c. circuit. Defective .01- μ f capacitor C10, .05- μ f C9, or .01- μ f C3. *Note:* Lock-in range of secondary tuning slug should be at least 1 full turn. Stabilization can be improved by mounting sync chassis on spacers or otherwise increasing ventilation.

RA-102. AM tuner birdies (heterodyne), evenly spaced carriers every 17 kc across broadcast band. (H.v. r.f.

oscillator or horizontal sweep generator is in free-running condition). Defective cathode resistor, grid resistor in h.v. oscillator. Dirty contacts of beam cut-off relay. Improper adjustment of armature return spring tension.

No high voltage. Defective 1B3-G or 807 in power supply. Defective h.v. transformer.

Horizontal "wobble" in picture. Defective 6AC7 video amplifier. Defective 807 horizontal output. Defective 6SN7-GT first sync amplifier.

Arc between 807 plate cap and power cable wiring. (This cable tends to work its way close to the plate of the 807 sweep amplifier.) See that cable runs directly to chassis plug and is clear of all tubes on receiver chassis.

Abnormal noise flashes on screen (in high-humidity and salt-water areas). Corona discharge in h.v. r.f. power supply. Remedy: dress leads to lengthen discharge path, paint exposed h.v. points with insulating compound, install insulating sleeving on leads.

Low picture i.f. sensitivity (picture level drops when sound carrier is properly tuned in). Weak i.f. tubes. Defective 1N34 video rectifier. Defective tube in Inputuner.

Notches in picture or raster (moving up and down). Defective 6AS7.

Poor definition. Defective 1N34 crystal video detector.

Excessive variation in picture size (during evening's operation). Improperly adjusted high voltage.

RA-102, -103D, -104D, -110A. Vertical jitter (bounce) in strong signal areas. Modification of vertical oscillator circuit helpful; contact nearest Du Mont distributor or service organization for details.

RA-103. Flicker in picture. Faulty installation. Defective 6AG5 in video i.f. strip. Fluctuating line voltage. *Note:* In latter case, connect a 0.5- μ f capacitor from the picture-tube cathode (arm of potentiometer R227) to junction of resistors R222 and R223 and capacitor C216B.

RA-103, -105. No picture or sound, or very weak picture and sound (early models only). Breakdown of 125- μ f capacitor C113 in Inductuner. (Breakdown due to defect in particular manufacturer's item, replaced by different manufacturer's capacitor in later sets.

Flicker (jumping or pumping); lack of sharpness or definition. Fluctuating or low line voltage. Install Sola constant-voltage transformer. (RA-108A models have self-regulating power transformers and are not affected by line-voltage fluctuations.

—end—

Television Service Clinic

Conducted by **WALTER BUCHSBAUM***

MANY of our readers have submitted problems involving foldover either on new TV sets or on those which have been converted to a larger picture tube. This foldover appears on the left side of the picture and can be shifted slightly by adjusting the horizontal hold control or the phasing slug on some types of horizontal oscillator transformers. The origin of this defect lies usually in the inherent time constant of either the flyback transformer, the deflection yoke, or both. For the present TV scanning rate the horizontal retrace time is approximately 9 microseconds and most of the high-efficiency transformers have a time constant of 11 to 18 microseconds. Thus the entire picture information is not contained in a single line, but continues for a short portion of the otherwise invisible retrace, giving the appearance of a transparent folding-over of the picture on the left edge.

In some instances this foldover can be reduced or eliminated by proper alignment of the horizontal oscillator transformer, or by using a properly matched flyback and yoke combination. Since very few high-efficiency flyback transformers have the required short time constant, the next best approach is to eliminate not the foldover, but its annoying appearance.

The flyback pulse voltage present at the "hot" side of the horizontal yoke is a strong positive pulse which occurs at exactly the same time and for the same duration as the horizontal retrace. This pulse can be used to eliminate the foldover effect. One simple scheme is to connect a portion of this pulse to the first anode of the picture tube, an element which is usually connected to a 350- to 400-volt B-plus point. A voltage divider is made as shown in Fig. 1 and the values of R1 and R2 are adjusted

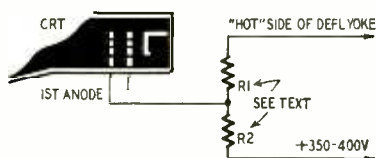

Fig. 1—A circuit to reduce foldover.

to blank out the foldover without affecting the rest of the picture. If too strong a pulse is used the left side of the picture will appear darkened. If the pulse is too weak, the foldover will remain visible. A good starting value for R1 is 100,000 ohms and for R2 between 330,000 and 470,000 ohms. Both resistors

should be 1-watt types to avoid deterioration under the high pulse voltages. If too much pulse results, increase the value of R1; if too little is present, reduce R1. The lead to the first anode of the picture tube is usually a bright red lead going directly from the socket to a B-plus point.

It can be argued that by the above method a portion of the picture is lost. This is true, but the portion is only a very thin strip, normally at the extreme right of the picture, and we doubt that any viewer would ever miss this tiny edge. In any event, the elimination of the foldover is usually such a great improvement that it far outweighs the loss of a small edge which is often blanked out by the mask anyway.

Remote picture tube

I want to add a remote 17-inch tube to an RCA T-100 to be located 10 feet from the receiver. What kind of cables should I use and how should I obtain the picture signal from the present set? How

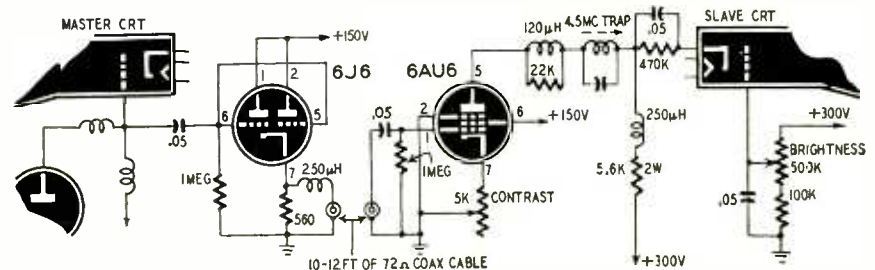

Fig. 2—Cathode follower and picture amplifier hookup for remote picture tube.

can I connect a cathode follower? What circuit should I use for an additional picture amplifier?—F. R. Carr, San Mateo, Cal.

Fig. 2 shows suitable connections for a cathode follower and the extra picture amplifier. Different values may be required for the video peaking coils, depending on the wiring and layout, but with the coils shown you should get a fairly good frequency response from the circuit.

The 6J6 cathode follower is connected to use both sections in parallel and this tube should be mounted near the video amplifier of the original receiver. The 6AU6 auxiliary amplifier should be located at the remote viewing unit. It may be possible to bring the filament and B-plus leads over from the main chassis, but if the sweep sections for both picture tubes are in use, a separate power supply and sweep circuits will be required for the slave unit.

No gain from booster

We have an Astatic AT-1 TV booster that gives no gain at all. The set works

better without it, although we have followed manufacturer's specifications to the letter.—H. Masterson Radio, Grand Rapids, Mich.

Apparently one of the tubes is not working properly or else a coil or other defective part may be the reason for this failure. I would suggest that you replace all tubes in the booster, measure the plate, screen, and B-plus voltages, and check all coils and connections with an ohmmeter. As a last resort, replace each coupling capacitor in turn and try tuning each circuit slightly.

Distorted scanning lines

The scanning lines in a Zenith model 23H52R are distorted on the left side for about 4 inches horizontally and extending from top to bottom. How can this be cured?—S. Barton, Pittsburgh, Pa.

This condition is known as "damping bars" or "ringing." To remove it, replace the 56- μ f capacitor in the deflection yoke by one of at least 68 μ f. Re-

place the damping tube and the 6BG6-G and readjust the horizontal drive control. As a last resort, shunt the grid resistor of the 6BG6-G with a 1-meg-ohm resistor.

6CB6 in weak-signal area

Is it possible to use 6CB6's in place of 6AG5's in a 630 TS type set for better weak-signal area reception?—L. H. Paejke, Arp, Tex.

The new 6CB6 can be used in place of either a 6AG5 or a 6BC5. However, the 6CB6 has no internal connection from suppressor (pin 7) to cathode (pin 2) so that some rewiring is necessary. In the tuner, connect pin 7 to pin 2; in the i.f. circuit connect pin 7 to ground and connect the cathode resistor (39 ohms) from pin 2 to ground. Realignment of tuner and the i.f.'s is necessary.

Should oscillation occur with the new tubes, dress all leads carefully to prevent grid-to-plate coupling. Change the cathode resistors to 56 ohms in those stages showing the greatest tendency to oscillate.

—end—

*Author of *Television Servicing*, Prentice-Hall, 1950.

Useful 2-in-1 Meter

0 30 60
 A grid dipper plus an absorption meter, both in one case, give versatility to this unit

By

L. L. BUMBAUGH

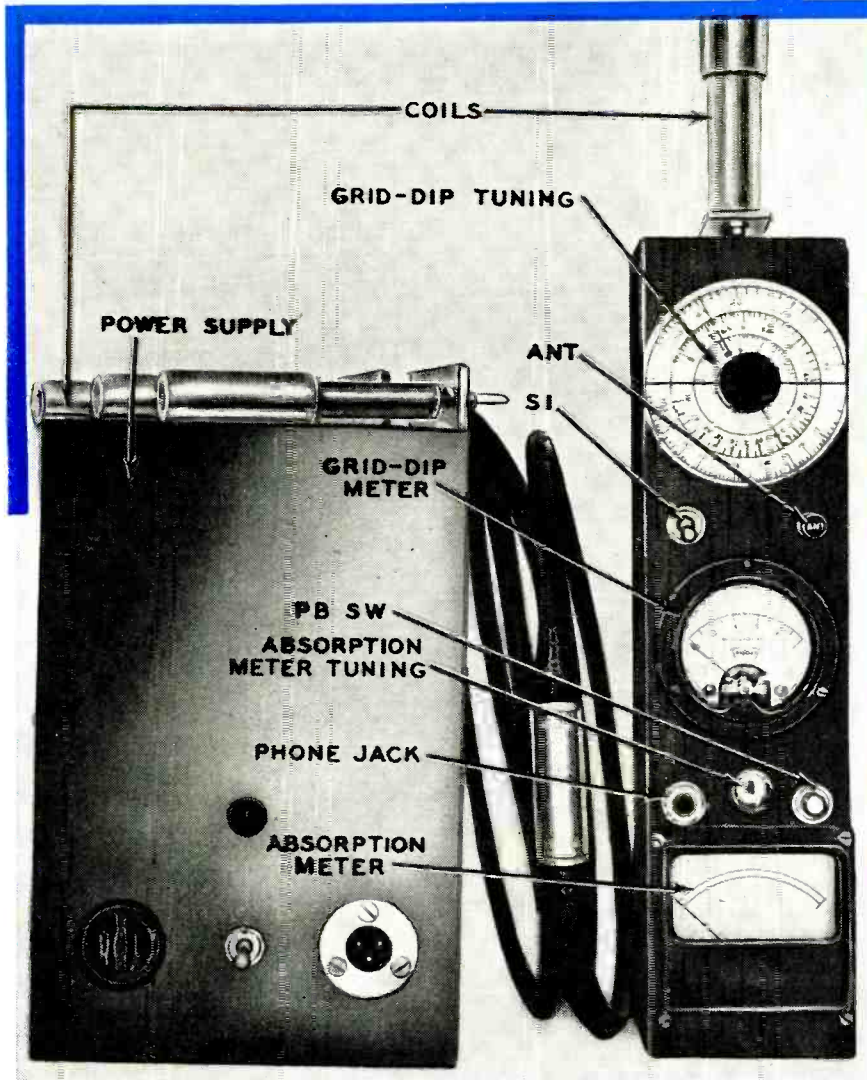
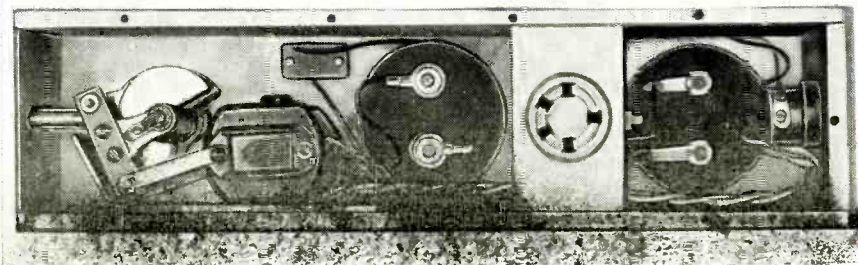

Photo of the grid dip and absorption meter together with the power supply. The absorption meter uses no power, is entirely independent of the dip meter.



Rear view of the meter. The 5-pin coil socket is mounted between the meters on a metal strip fitted across the back. The left end of the case is of lucite.

ANY radio technicians and amateurs do not have access to such laboratory instruments as inductance and capacitance bridges, and must first energize circuits to check their operating frequency and characteristics, instead of being able to assemble combinations of capacitors and inductors and predetermine their behavior when they are placed in circuit. Amateurs also frequently cannot determine the actual power output of their transmitters by the only reliable measurement—that of field strength at a distance.

This meter is an r.f. oscillator with a milliammeter in the grid circuit. Plug-in coils are used to vary the inductance, and a calibrated variable capacitor extends the frequency range for any one coil. The milliammeter reads rectified grid current, and this current is a measure of the energy in the oscillatory circuit—the greater the energy the greater the current.

This type of meter is called a grid dip meter and its operation is based on the interaction of coupled circuits. An example will best explain its operation.

Assume we have a coil and fixed capacitor hooked up in parallel and we wish to find the resonant frequency and Q of this circuit. The L-C combination will absorb energy from an external or exciting source when its resonant frequency is the same as that of the source. Since our L-C combination is fixed, we must vary the frequency of the source to the correct resonant frequency. In this case the source will be a grid dip oscillator, or, as we prefer to call it, a grid dip meter.

We first select a coil for the meter whose range is likely to include the resonant frequency of our L-C combination. Then we place the meter coil alongside the coil of the L-C circuit and tune the meter through its range and watch the milliammeter for any change in reading. Initially the meter will read well up on the scale, but as we turn the capacitor dial it will make a sudden dip and then return to its high reading. We tune the meter for its greatest dip and refer to the tuning capacitor dial which is calibrated in frequency for each inductance coil. This frequency is the resonant frequency of our L-C combination, and the sharpness of tuning and depth of the dip give us a good idea of its Q.

When the energized circuit of the grid dip meter has the same frequency as the resonant frequency of our L-C

RADIO-ELECTRONICS for

Uses for the meter

The grid dip meter can be used as an absorption type frequency meter by removing the plate voltage from the 955 tube with switch S1. In this case, resonance is indicated by upward readings on the milliammeter.

Range (mc)	Secondary		Tuned primary		
	Turns	Wire Size	Turns	Wire Size	Winding Length (in)
1.75-6	11	30	38	24	1 5/8
4.5-16.3	6	30	18	20	1 1/2
10.4-28	4	30	9	16	1 1/4
25.3-80	2	30	3	16	1

Secondary turns all close-wound, 1/2-inch diameter, spaced 1/4-inch from primary. Use enameled wire for all windings.

Inductance can be measured with the meter by hooking it up in parallel with a known value of capacitance and finding the resonant frequency of this combination. The value of the inductance is then given by:

$$L = \frac{1,000,000}{4\pi^2 f^2 C}$$

where L is in henrys, f in cycles, and C in microfarads.

In the same way a capacitor can be measured with a known value of inductance. In this case the value is given by:

$$C = \frac{1,000,000}{4\pi^2 f^2 L}$$

and the answer comes out in microfarads.

Being an r.f. oscillator, the grid dip meter naturally will serve as a signal generator. It can be used for receiver alignment, as well as to measure the Q of a tuned circuit. To find Q, connect a v.t.v.m. across the tuned circuit and measure the voltage as the grid dip oscillator is tuned to the resonant frequency of the tuned circuit. Then back the meter off resonance (both above and below) to the point where the v.t.v.m. reads 70.7% of the voltage at resonance. The Q is then found by applying the formula:

$$Q = \frac{f}{f1 - f2}$$

In this case f is the resonant frequency, and f1 and f2 are the off-resonance frequencies at the 70.7% points.

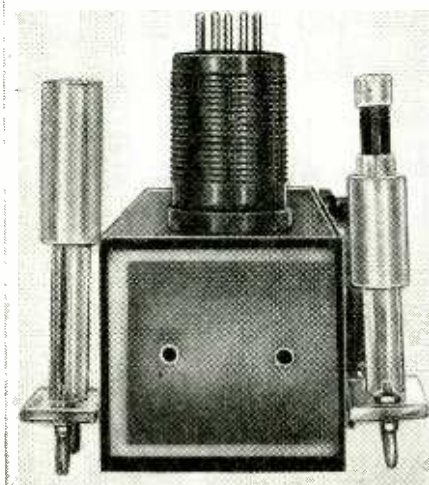

An end view of the meter showing the lucite end piece and some of the coils.

Coil No.	Range (mc)	A (in)	B (in)	Wire Size	Turns
1	2.9-5.4	3/4	1 1/8	30	100
2	4.5-8.3	1/2	1 1/4	30	108
3	6.5-11.9	1/2	3/4	30	57
4	10.2-18	1/2	1-3/16	24	45
5	17.5-31	1/2	1 1/8	20	24

Coil No. 5 spaced over 1 inch, all others close-wound. Use enameled wire for all windings.

Antennas also can be checked with the meter. In this case it is necessary to get near a point of high current in the antenna because coupling to the meter coil is inductive. If such a point cannot be reached, turn the meter pickup coil so its axis is parallel with the antenna wire to get capacitive pickup. Normally this pickup is rather weak. Another way to get pickup is to wrap a turn or so of the antenna or several turns of the lead in around the pickup coil.

Standing waves on a transmission line can be detected by energizing the line and sliding the meter pickup coil along the line while watching for a reading. For this check, use the meter as an absorption meter and watch the milliammeter for a reading. Neutralization can be checked in the same way.

Parasitics are located by plugging headphones into the jack provided for them on the front panel and using the instrument as a grid dip meter. Be careful not to come in contact with the power circuits of the transmitter. Using the meter as a grid dip meter, tune it through its range until you find the

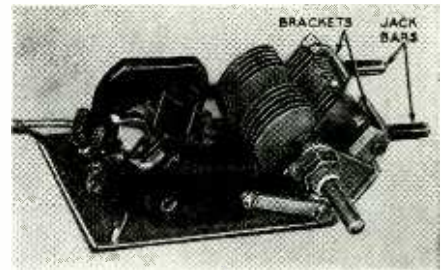

The oscillator circuit is built on a separate subassembly. This view shows the two jack bars mounted on the capacitor.

parasitic beat note. Leave the meter setting unchanged and explore the transmitter until the dip of the milliammeter indicates that the offending resonant circuit is nearby.

Materials for Grid Dip Meter

Resistors: 1—220, 1—10,000, 1—22,000-ohm, 1/2-watt. Capacitors: 4—200-μf, mica; 1—50-μf, 2-gang, variable.

Miscellaneous: 1—type 955 tube and ceramic socket; 1—0-1-ma meter; 1—closed circuit phone jack; jack bars, coil forms and coils (see text); 1—s.p.s.t. switch; hookup wire and assorted hardware.

Materials for Absorption Meter

Capacitors: 1—002-μf, mica, 1—140-μf variable. Miscellaneous: 1—0-400-μa meter; 1—150-ma lamp; 1—push-button switch; 1—1N34 crystal; 5-pin, 1 1/2-inch diameter coil forms and sockets; hookup wire, and assorted hardware.

Materials for Power Supply

Resistors: 2—2,500-ohm, 10-watt. Capacitors: 1—12-μf, 450-volt, electrolytic. Miscellaneous: 1—350-0-350-volt a.c. power transformer with 6.3 and 5-volt windings; 1—5Y3-GT, 1—0D3, tubes and sockets; 1—pilot lamp; 3-wire shielded cable; hookup wire and assorted hardware.

—end—

A Voltage-Regulated Power Pack

Voltage-regulated and variable-voltage power supplies are described from time to time but supplies having variable output which is stable over a range of load conditions are hard to find. Capable of delivering 110 ma at 175 volts d.c. and 60 ma at 300 volts, this electronically regulated variable-voltage supply is recommended by Cornell-Dubilier Electric Corp. for experimental and laboratory service.

The power transformer is rated at 120 ma. If more current is required, the power transformer and rectifier can be replaced with units having higher current ratings.

The 6B4 serves as a variable resistor in series with the load. The internal resistance of the tube is controlled by the bias applied to its grid by the

6SJ7 d.c. amplifier. A drop in output voltage lowers the bias on the 6B4 so its internal resistance drops and restores the output voltage to its preset level. The 15,000-ohm potentiometer controls the output voltage by varying the grid bias on the 6SJ7. This tube is stabilized by passing its cathode current through the 0C3 voltage-regulator tube.

A 150-ma meter measures the current drawn by the load and a 500-volt d.c. meter measures the output voltage. A standard 1-ma d.c. meter having a resistance of 105 ohms can be converted to a 150-ma meter by shunting it with a 0.7-ohm resistor. Likewise, a 1-ma meter can be converted to read 500 volts by connecting a 500,000-ohm resistor in series with it.

—end—

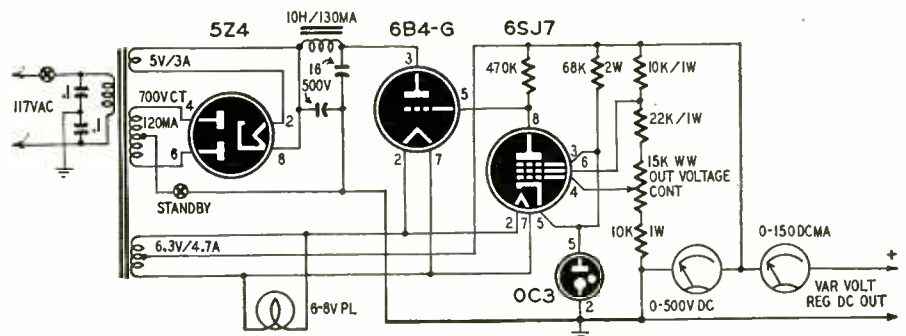

TV Tube Substitutions

By I. QUEEN

THE present tube shortage affects many types. In many areas, however, the demand is especially frantic for types widely used in TV service. The replacement problem is more serious for TV owners because their sets require about three times as many tubes as radios do. Besides, there are factors which increase the mortality rate of TV tubes.

For one thing, the eye is more critical than the ear. Distortion or low gain in picture circuits become apparent when tubes become weak. Many listeners remain unaware of audio defects long after their tubes are definitely bad. Another factor is the TV service which is commonly sold on a contract basis. A radio owner may be reluctant to call his service technician until his set suffers a major breakdown. On the other hand, with service guaranteed, the TV owner may expect almost perfect reception. The service technician may want to replace doubtful tubes himself to avoid unnecessary calls. All this helps to increase the replacement rate of TV tubes.

Technically, TV tube replacements are far more critical than substitutions in AM radios, where tolerances are often very broad. During the last war, more than one large service department worked on the basis that if a substituted tube did not burn out immediately, and if the set continued to play, the substitution was satisfactory!

Television is not as simple as that. In the v.h.f. front ends, a tube whose

characteristics are almost exactly similar to those of the one replaced may refuse to work at all. According to several recent Technotes, tubes of the same type number but made by different companies may vary enough to prevent full interchangeability in certain circuits (RADIO-ELECTRONICS, April, 1951, page 98). This may be the case in video i.f. and detector circuits—and possibly others—as well as in the front ends.

Differences in sets and circuits are also important. The technician will find that a tube substitution which is satisfactory on one model may not work at all on another by the same maker.

As compared to anything we have experienced before, television tube substitution is going to be a matter of cut-and-try, and will depend far more on the technician's individual ingenuity and intelligence than on any help he may get from substitution charts.











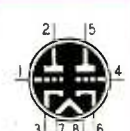





The accompanying chart is therefore intended to serve merely as a rough guide and possible time-saver. It lists five categories of tubes used in many TV sets. Each group includes tubes closely related. In some cases only slight changes are required to substitute one type for another. In others the difference in characteristics is rather wide. This is because of the wider variation in TV circuit characteristics than in

AM radios. In almost any a.c. receiver, the voltage applied to a given element of a given tube may be predicted within 10%. The range is much wider in television. As a result it may be found that a replacement tube which varies from the original may still be suited to the conditions of a given circuit. When substituting one h.f. type for another, realignment is nearly always necessary. In the rectifier and power tube columns, peak voltage and maximum current ratings should be noted. Remember that a tube with a higher voltage rating than the one replaced often may be used.

Any of the tubes listed as damper-rectifiers will operate as straight rectifiers. The inverse peak plate voltage is considerably lower for rectifier than for damper use. The 5V4-GT operates as rectifier with a 1400 IPV rating, and the 6W4-GT with 1250. Ratings for the tubes marked (R) are rectifier ratings. Their high voltage drop makes them unlikely damper substitutes, as the internal resistance of a damper should be as low as possible.

Sometimes a substitution is advantageous as well as necessary. This is true because many of the newer type tubes are more efficient than those formerly used. For example, the original 630 TS RCA chassis used several 6AG5 tubes in the i.f. channel. The latest models use 6AU6 and 6CB6 tubes. Not only do these perform better but they are cheaper as well.

—end—

RF-IF VOLTAGE AMPL.	DUD-TRIODE MEDIUM MU	HIGH VOLTAGE RECTIFIER	DAMPER-RECTIFIER	BEAM POWER HORIZ. REFLECTION
6AG5 6AK5 6BC5  RATINGS AT Ep 180V 6AG5 Ip 7.0 Rk 350 gm 5700 P-G .025 6AK5 Ip 7.7 Rk 200 gm 5100 P-G .02 6BC5 Ip 8 -Eg 4.9 gm 6000 P-G .03	6SN7-GT  FIL 6.3V/4.6A Ep 250V Ip9 -Eg 8.0V	1B3-GT  CAP FIL-1.25V/2A Ip 2 IPV 40KV	5V4-GT  FIL-5V/2A Ip 175 IPV 2KV	6BG6-G  CAP FIL-6.3V/9A PL. SURGE 6KV DISS 20W
6CB6 12AW6  12AW6 FIL 12.6V/15A 6CB6 Ep 200V/9.5MA gm 6200 P-G .02 12AW6 SAME AS 6AG5	7N7 LOCTAL  SAME RATINGS AS ABOVE	1X2  CAP FIL-1.25V/2A Ip 1 IPV 15KV 2.5,8 1,4,6,9	5U4-GT  FIL-5V/3A Ip 225 IPV 1.55KV (R)	807 5 PIN SOCKET  CAP RATINGS SAME AS ABOVE
6AU6 12AU6  12AU6 FIL 12.6V/15A Ep 250V/10.8MA -Eg 1.0 gm 5200 P-G .0035 12AU6 SAME EXCEPT 12.6V/15A FIL	6F8-G  CAP SAME RATINGS AS ABOVE	1V2  FIL-.625V/3A Ip .5 IPV 7.5KV	5Y3-GT  FIL-5V/2A Ip 125 IPV 1.4KV (R)	6BQ6-GT  CAP FIL-6.3V/1.2A PL. SURGE 5KV DISS 10W
	12AU7 12BH7  12AU7 FIL 12.6V/15A; 6.3V/3A 12BH7 FIL 12.6V/3A; 6.3V/6A 12AU7 -Eg 8.5V Ep 250V Ip 10.5 12BH7 -Eg 10.5V Ep 250V Ip 11.5	FILS 6.3V/3A UNLESS NOTED P-G=UNSHIELDED PLATE TO GRID CAPACITANCE IN $\mu\mu\text{F}$ DISS=MAXIMUM PLATE DISSIPATION Ip=RATINGS IN MA UNLESS NOTED OTHERWISE ALL TUBES FIT OCTAL SOCKETS UNLESS NOTED OTHERWISE IPV=PEAK INVERSE PLATE VOLTAGE	6W4-GT  FIL-6.3V/1.2A Ip 125 IPV 3.5KV	6BD5-GT  6.3V/9A 6AU5-GT 6.3V/1.25A 6AV5-GT 6.3V/1.2A SURGE DISS 6BD5-GT 4KV 10W 6AU5-GT 4.5KV 10W 6AV5-GT 5.5KV 11W

Picture-Tube Replacements

THE current tube shortage and the gradual change to larger screens are making some types of picture tubes difficult to replace. A replacement guide for picture tubes can become an almost endless cross-index of tube types unless we assume that physical and electrical alterations are to be held to a bare minimum which requires hardly more work than replacing a tube with another of the same type. *Interchanging metal and glass, round and rectangular, or electrostatic and magnetically-focused tubes are conversion jobs rather than simple tube replacement.*

The over-all dimensions of tubes become the most important factor in substituting tubes of the same general size and type, so this replacement guide lists tubes in *descending order of size*. Thus, if tube lengths vary from 18¾ to 17½ inches (as they do in 12½-inch round types) you can feel sure that you are not likely to have as much trouble replacing with one listed above it as you would when using the top tube in the list to replace the one on the bottom. Tubes with the same dimensions and electrical characteristics and differing only in the type of face plate are considered as being completely interchangeable

without modifying the circuit or cabinet in any manner. For example: the 16GP4, 16GP4-A, -B, and -C are identical except for the face plate. There are no types which approximate the 8AP4 (metal round) and 17CP4 (metal rectangular) tubes.

Deflection angles can be divided roughly into two classes. The first covers from 50 to 60 degrees and the second covers wide-angle tubes of the 70-degree variety. A new deflection yoke is necessary when a 50-60-degree tube is replaced by a wide-angle type. When replacing a 16AP4 (53 degrees) with a 16EP4 (60 degrees), the necessity for replacing the deflection yoke will depend on the particular set. Some may use a yoke like the RCA 20D1 or 20D12 which provides for deflections up to 53 degrees, while other sets may use a type 205D1 or equivalent which can be used with tubes up to 60 degrees. The need for replacing the yoke is best determined by experiment.

Face-plate curvature may be a factor in selecting a substitute tube. If you substitute a tube having a smaller radius of curvature, the center of the face is likely to strike the safety-glass when the tube is properly seated in its cradle. Likewise, if a tube having a larger radius of curvature (flatter face) is used as a replacement for one having a smaller radius, the mask may not fit.

Anode connectors for glass tubes are of two general types. Some are recessed balls and the others are cavities. The location of the connectors with respect to the base pins and the position on the cone varies from one type of tube to another. This may make it necessary to use a longer high-voltage lead. It is better to replace the entire lead rather than to splice it. A faulty splice is likely to cause arcing and the wrapping over the splice is likely to be a point for voltage breakdown and corona.



Fig. 1

Fig. 2

Fig. 3

Socket wiring diagrams are the same for most type of tubes, but the size and type of base may make it necessary to change the socket. In most instances, this is a small job which can be done in a few minutes.

This chart is not foolproof and we don't believe that you will ever find one that is foolproof as long as each manufacturer continues to produce sets in many different types and models. If you give some thought to the possible substitutions before installing a new tube you will find that a large number of common tubes can be replaced with a minimum of time and effort.

Special notes:

a—This tube has no exterior conductive
(Continued at bottom of facing page)

Tube type	Bulb diameter or diagonal (inches)	Overall length (inches)	Ion trap type	Base diagram Fig. No.	Anode connector	Misc. notes
10-inch glass round, 50 degrees						
10BP4	10 1/2	17 5/8	Double	1	Cavity	
10EP4	10 1/2	17 5/8	Double	1	Ball	
10FP4	10 1/2	17 5/8	None	1	Cavity	
10MP4	10 1/2	17	Single	2	Cavity	
10CP4	10 1/2	16 5/8	None	1	Ball	
12½-inch glass round, 50 degrees						
12LP4	12 7/16	18 3/4	Double	1	Cavity	a, b, c
12TP4	12 7/16	18 3/4	Double	1	Cavity	
12CP4	12 1/16	18 5/8	None	3	Cavity	a
12VP4	12 7/16	18	Single	2	Cavity	b
12XP4	12 7/16	17 5/8	None	1	Cavity	
12QP4	12 7/16	17 1/2	Single	1	Ball	a
12JP4	12	17 1/2	None	1	Ball	a, d
12RP4	12	17 1/2	Single	1	Ball	a, d
14-inch glass rectangular, 70 degrees						
14EP4	13 11/16	16 13/16	Double	1	Cavity	
14CP4	13 11/16	16 3/4	Single	1	Cavity	e
14DP4	13 11/16	16 3/4	Double	1	Cavity	a
16-inch glass rectangular, 70 degrees						
16QP4	16 1/8	19 1/8	Double	1	Cavity	a
16KP4	16 1/8	18 3/4	Single	1	Cavity	e
16RP4	16 1/8	18 3/4	Single	1	Cavity	e
16XP4	16 1/8	18 3/4	Double	1	Cavity	a, e
16TP4	16 1/8	18 1/8	Single	1	Cavity	e
16UP4	17 1/8	18 1/8	Single	1	Cavity	e
16-inch glass round, 50—60 degrees						
16LP4	15 7/8	22 1/4	Double	1	Cavity	f, g
16MP4	16 1/8	21 3/4	Double	1	Cavity	
16FP4	16 1/8	21 1/4	Single	1	Ball	a
16CP4	15 7/8	21 1/2	Double	1	Cavity	a, f, g
16HP4	15 7/8	21 1/4	Double	1	Cavity	f
16JP4	16 1/8	20 3/4	Double	1	Cavity	
16DP4	15 7/8	20 3/4	Double	1	Cavity	a
16-inch glass round, 70 degrees						
16ZP4	15 7/8	22 1/4	Double	1	Cavity	
16WP4	15 7/8	17 3/4	Double	1	Cavity	a
16SP4	15 7/8	17 5/16	Single	1	Cavity	
16YP4	15 7/8	17 5/16	Single	1	Cavity	
16VP4	15 7/8	17 3/16	Single	1	Cavity	a
16-inch metal round						
16AP4	15 7/8	22 5/16	Double	1	Cone	h
16EP4	15 7/8	19 5/8	Double	1	Cone	i
16GP4	15 7/8	17 11/17	Single	1	Cone	i, k
17-inch glass rectangular						
17BP4	16 5/8	19 5/8	Single	1	Cavity	
17AP4	16 5/8	18 5/8	Single	1	Cavity	
19-inch glass round						
19FP4	18 7/8	22	Double	1	Cavity	a, e
19DP4	18 7/8	21 1/2	Double	1	Cavity	
19GP4	18 7/8	21 1/4	Single	1	Cavity	a, e
20-inch glass rectangular, 70 degrees						
20DP4	20 3/32	21 7/8	Single	1	Cavity	l
20CP4	20 3/32	21 7/16	Single	1	Cavity	

Speed Means More Money

TIME is the all-important factor if one is to make a living out of radio. Watch your time and your reputation, and make an honest charge large enough to pay for your time and investment, and you *can* eat.

In any radio with distorted tone, look immediately for leaky coupling capacitors. A 1,000-ohm-per-volt meter is almost useless for this quick test, but a 20,000-ohms-per-volt or a v.t. voltmeter will do. Measure between grid and ground, usually on the lowest range. There will be a slight upward movement of the meter (if a leaky coupler is very bad, sometimes full-scale deflection). With the meter on a higher range (depending on ohms-per-volt of the meter and voltage of the particular circuit) shunt the grid resistor, the plate resistor, and the screen grid with meter probes. This will tell about the resistors (if tone clears up or volume comes up to natural strength).

Gassy tubes will sometimes cause a *plus* potential on the grid. In a Grunow 11G, the two coupling capacitors that feed the 6F6's were replaced and new metal tubes were installed. About 10 volts plus appeared on one grid and 2 on the other. First thought was that the

(Continued from facing page)

coating. It may be necessary to add approximately 500 μ f to the high-voltage filter when it replaces one with an exterior coating. In the reverse case, be sure to ground the exterior coating of the replacement tube.

- b—A triode-type tube. It has no No. 2 grid. For circuit modifications, compare circuits of sets having triode- and tetrode-type tubes.
- c—This tube has a 2.5-volt, 2.1-amp heater. All others have 6.3-volt, 600-ma heaters.
- d—Face plate has 20-inch radius of curvature. All others in this size group have 40-inch radius.
- e—Requires RMA 109 focus coil. Others in this group require RMA type 106.
- f—Face-plate curvature has 56-inch radius. Others in this group have 27-inch radius.
- g—Deflection angle is 50 degrees. Others in this group have 60-degree angles.
- h—50-degree deflection angle.
- i—60-degree deflection angle.
- j—70-degree deflection angle.
- k—Face plate curvature has 40-inch radius. Others in this group have 27-inch radius.
- l—Some have outside conductive coatings, others have not. (See note a.)

—end—

By W. G. ESLICK

new capacitors were at fault but it chanced that the 6F6's didn't have the No. 6 pin and by looking through one could see a purple glow in the one that had a 10-volt reading. It was due to gassiness of the tube, fresh off the shelf.

Revealing voltage checks

On portable radios be sure to check the filament voltage. Comebacks are frequent otherwise, for the oscillator won't "fire" if either weak filters, weak rectifiers, or a changed filament-dropping resistor be at fault. If replacements are not handy, a resistor bridged across the filament resistor will raise the voltage (start at 10,000 ohms and work down till filament voltage is correct). This is a temporary repair, so a tag ought to be put on the set.

On any set, after checking the tubes measure the B-plus at the rectifier and screen, plate, and cathode of the power tube (if self bias is used). That will indicate if the power circuit is O.K.

"Circuit-disturbance" is quick

Assuming the set is dead, a "noise check" is the fastest way to locate trouble. Start at the grid of the power tube, then to the plate of the first audio for hum or a loud click, and then to the grid of the a.f. tube, to diode plates of the second det. and back through the i.f. system grid by grid and plate by plate to the mixer and r.f. (if any). If a hum or click is heard back to the diode plates and a click is heard on the i.f. plate but not on the grid, for example, the trouble is in that stage.

By using the meter as a test resistor as practiced by older radiomen for years trouble-shooting can be narrowed down in seconds to one certain point. Use a little common sense on what range to use. With a 20,000-ohms-per-volt meter, 200 volts would be the equal of a 2-meg resistor (with some capacitance and inductance of course). Then use the voltage check and hum-click test.

Many of the midget portables of several different brands—even some in dealer warranty—are low in volume and mushy. Either making a voltage check or using the meter as a resistor will find a bad screen resistor in the first audio in 90% of the cases.

Using a low-range voltage scale to check for positive voltages on grids will also work in the r.f. section, as a lot of r.f.'s are resistance-coupled to the mixer (and a few sets use the same in the i.f.'s also).

If noise can be obtained through the set at the grid of the mixer and r.f. when the grid is touched, it's a good bet

that the oscillator is the guilty stage.

Many noisy volume controls (if not worn out, of course) can be cleaned with carbon tet. Using an eye dropper and squirting some in at the solder lugs and where the shaft enters the control will clear up noise. Also use carbon tet for tuning noise at capacitor end and at bearings, at all pulleys, and at shaft.

Know your tubes!

Memorize the popular tube base connections so you know which point is which and what normal voltage to expect at each plate and screen, of course depending on their use in the set and whether it is a.c., a.c.-d.c., or battery. Voltages vary a lot, it's true, but one can know if the voltage is low or high by knowing tubes and circuits. If an r.f.-i.f. or mixer plate voltage is around 250, the screen should be around 80 to 125 volts (with exceptions, of course). In a.c.-d.c. sets the screens are usually the same as the plates but never below 60 volts if the set is to have any power. Audio screens may run as low as 15 to 20 volts, depending on other circuit values. Example: on a 6V6 power tube one would find around 250 volts on pin 3 (plate) and on pin 4 (screen) and either zero or 12-18 volts on the cathode (self bias or fixed bias). If zero, check to see for sure if there is fixed bias and measure it between ground and the cold side of the grid resistor (if a divider network isn't used).

Automobile radios

Some auto radios using 6V6's (7C5's) have around 160 and upward of plate voltage and some have as much as straight a.c. sets. This will have to be learned by testing, then remembering it on the next one of the same type.

If an auto radio has a high current drain and buzzing vibrator, check the buffer first, and then after a new one is installed, see if the vibrator is O.K.

Outside of the power pack and hash filter system, the auto radio is the same as any other radio, except antenna input circuit to match the small auto antenna.

A handy tool for catching those intermittent filaments that come and go in an a.c.-d.c. set is a little neon lamp to bridge across each filament and find the intermittent. A v.t.v.m. or at least a meter of 20,000 ohms per volt sensitivity is almost a must in radio.

Another speedy tool is a signal tracer, a simple audio amplifier with one tube preferably in a probe with an .01 and an .0001 capacitor between probe and grid, one for a.f. and one for r.f. One can find *where* volume is lost, *where* the tone mashes up and a score of other things. It is worth its weight in gold.

—end—

Video Bar Generator Speeds Set Alignment

This compact instrument provides a pattern for precise adjustment of television sweep circuits

By RICHARD HENRY

SERVICE technicians have come a long way indeed from the days when a voltohmmeter, tube tester, and signal generator could do just about any testing job that came up in ordinary service work. The outstanding cause of the additional headaches is television.

Most technicians have found that existing test instruments satisfy their needs except in one department: there is still no cheap and easy way to put an actual picture on the receiver screen to simulate exact operating conditions. Perhaps some day someone will make a monoscope camera chain cheaply enough so that every service shop can put the RMA test pattern on every receiver before it leaves the bench. Meantime, some cheaper and handier way to

check linearity and operation of the sync circuits and the signal channels is very useful.

One good answer is a bar generator such as the one pictured and described on these pages. As the diagram shows at a glance, the circuit is easily constructed by an experienced experimenter with the time to spend, or the instrument may be purchased ready made.¹ As photo A indicates, it is small enough to be carried around for use in adjusting receivers after they are installed, and it takes up little space on the service bench when it is used for checking the sweeps and as a handy signal generator.

The bar generator is most often used

¹Superior Instruments Company, New York, N. Y.

to adjust horizontal and vertical linearity of receivers. It contains a v.h.f. oscillator, tunable continuously over channels 2 through 6. The v.h.f. oscillator is grid-modulated by a second tube which may be either an oscillator or an amplifier.

Vertical linearity

When vertical linearity is to be adjusted, the v.h.f. oscillator is tuned to some channel between 2 and 6 and the receiver tunes in the signal. (Since all the tests can be made on these lower-frequency channels where the receiver is most stable, it is not necessary to use channels 7-13. However, if there is some necessity for testing on the upper channels, the v.h.f. oscillator generates plenty of harmonics which can be used.) The oscillator which furnishes the modulation is tuned to a frequency which is an integral multiple of the receiver's vertical-sweep frequency. Assuming that the vertical hold control is set correctly with a tuned-in station to begin with, the vertical-sweep frequency is 60 cycles.

If the frequency reaching the C-R tube grid from the bar generator (the demodulated signal) is 120 cycles, and the waveform is sine, two light and two dark bars, all equal in height, will appear horizontally across the screen. The reasoning is quite simple. It takes the cathode-ray spot 1/60 second to go from top to bottom of the raster. It takes the modulation signal only 1/120 second to go through a cycle from zero to maximum positive, to maximum negative, and back to zero. Therefore there are two modulation cycles for every field scanned by the spot. Each time the modulation goes positive the screen darkens; each time it goes negative the screen is brighter. The brightening and darkening takes place twice per field and the result is two horizontal light bars which appear against a dark background.

The same kind of reasoning applies when we modulate the generator's v.h.f. oscillator with, say, a 600-cycle signal, which is easier to work with, for it produces 10 light bars. And if we use a highly pulsed waveform (with pulses negative), like the oscillogram of Photo B, the light areas of the picture are very narrow and the pattern looks like that in Photo C.

Now we have a very useful pattern on the screen. If the receiver's vertical-sweep oscillator's waveform is a perfect sawtooth with linear rise, the bars are equally spaced. If it is nonlinear, the bars will be unequally spaced as in Photo D. The bar pattern is even more useful than the usual station test pattern (which is now almost unobtainable on the air), for it shows exactly where the nonlinearity is on the screen (at the top in the case in Photo D). It is a simple matter to readjust the vertical linearity and height controls on the receiver to eliminate the nonlinearity. Though the results are easy to judge by eye, finicky purists can even take a ruler and measure the distances be-

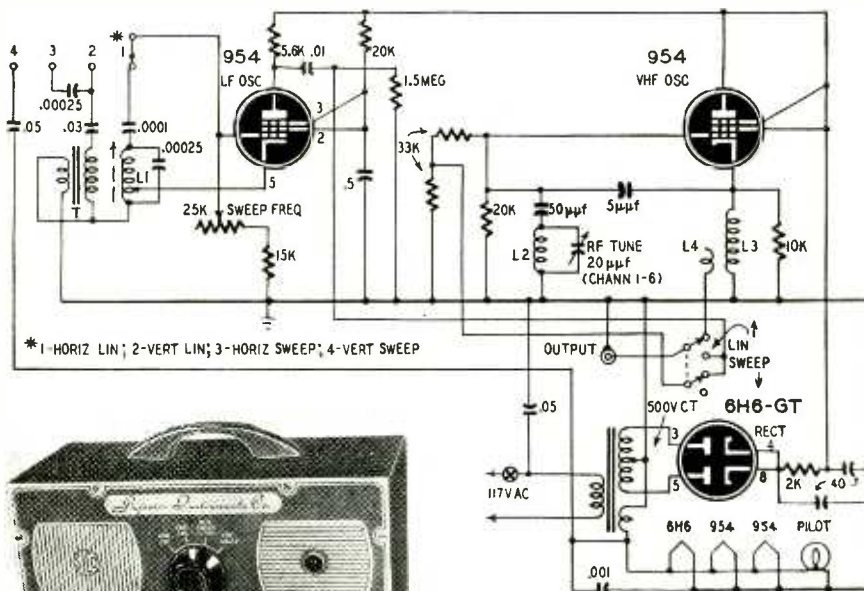

Complete schematic diagram of the Superior bar generator. Data on the coils is given in the text. Other v.h.f. tubes may be substituted for the 954's shown.

Photo A—The Superior bar generator is housed in this 5 x 10 x 7-inch case.



tween adjacent lines until linearity is correct to the narrow side of a gnat's whisker.

Horizontal linearity

The same idea is used to create vertical bars for judging horizontal linearity. The modulation oscillator this time must operate at a multiple of the 15,750-cycle line-scan frequency. To produce 23 bars, for instance, it operates at 362.25 kc, which is 23 times 15,750 cycles. Each time the light spot travels from left to right once, it is darkened and brightened 23 times. When the 23-times ratio is exactly right the bright spots are lined up vertically and we have vertical bars. If the ratio is slightly off, the bars become diagonal. However, as with the horizontal bars, the vertical-bar signal itself tends to lock the horizontal oscillator in sync with itself, so the bars can be made to stay put.

Judging horizontal linearity is simply a matter of observing the spacing between the bars. In Photo E, for instance, the bars are fairly equally spaced except at the very edges, where better linearity probably would not be possible anyway.

The bar method of checking horizontal linearity proved particularly useful in the writer's Admiral 30A1 which has three controls for adjusting horizontal scanning. The two most often used are the horizontal drive potentiometer and the width slug. There is, however, an additional slug adjustment (on the chassis deck) whose principal effect is only in the center of the screen. Using a station test pattern, an egg-shaped circle would normally be corrected with the first two controls. However, if, the inner slug needs adjustment, there is no way of knowing it; rounding the pattern circle with the outer controls would cause nonlinearity at the edges and that would not be easy to put a finger on. Using the bars, the conditions at each area on the screen show up independently of other areas and the technician can see exactly what is needed.

Checking sweep circuits

There are two more uses for the bar generator which are possible with only a very slight addition to the equipment necessary for linearity checking. These

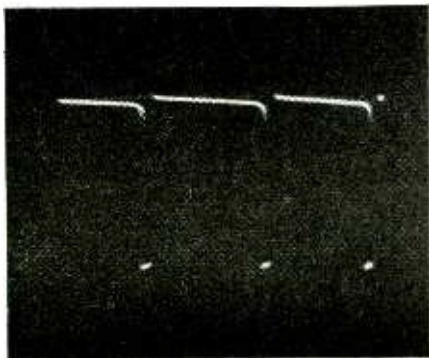

Photo B—Pulsed waveform for vertical linearity testing gives narrow light bars.

are checking the horizontal and vertical sweep oscillators.

If the modulation oscillator is used by itself as a 15,750-cycle pulse generator, it is an excellent tool for checking sets in which the high voltage is dead. A common cause of this is failure of the horizontal sweep oscillator, whose pulses are used to create the high voltage necessary for the second anode of the cathode-ray tube. There are other causes, however.

The 15,750-cycle pulse generator is simply connected to the point where the sweep pulses should normally appear. If high voltage returns, the sweep oscillator itself was the cause of the trouble. If not, the sweep oscillator is probably working and the following circuit should be checked for bad components or open connections. In contrast to the usual way of diagnosing high-voltage failure—laboriously checking all the components—this system of simply replacing the sweep oscillator is a big time-saver.

The vertical sweep also can be checked. In this case it is only necessary to use the modulator tube as an amplifier. A 60-cycle signal from the bar generator's filament supply is fed to the grid, and the plate output is connected to the receiver in place of the vertical-sweep oscillator. The amplifier distorts the waveshape so as to approximate a sawtooth, as illustrated by the oscillogram of Photo F.

In both cases the amplitude of the signals is not usually as great as would be obtained from the set's own oscillators. The result is that the sweep is not as great as normal and the width and height of the raster are smaller than usual. For testing purposes those deficiencies are of no importance as their mere presence indicates that oscillator was faulty.

The circuit

The schematic diagram shows how simple the bar generator is. The 954 tubes are still plentiful on the surplus market at low prices and they perform excellently at all television frequencies. Their only drawback is that they require the special acorn sockets. Other high-frequency miniatures would undoubtedly be adequate and a little experimenting might be worthwhile.

The v.h.f. oscillator is an adaptation of the grounded-plate Colpitts. L3 is an r.f. choke consisting of 80 turns of No. 34 enameled wire close-wound on a 5/16-inch form. L2 is 2 turns of No. 20 enameled wire on a 3/16-inch form. The circuit is unconventional but it oscillates at the drop of a hat without the touchiness of some v.h.f. oscillator circuits.

The low-frequency modulating oscillator has a 4-position switch. In position 1 it is a grounded-plate Hartley, oscillating in the 300-kc region. The tuning slug can be set for about 362.25 kc. to obtain 23 vertical bars. Fewer bars can be had if additional capacitance is added to the .00025 µf across the coil. A lower harmonic of the line frequency

syncs more easily, though the higher frequency places more bars on the screen for easier visual interpretation of linearity. The coil L1 can be wound by experiment, or a standard 12SA7 oscillator coil for the broadcast band can be used with about .001 µf connected across it.

In positions 2 and 3 the oscillator

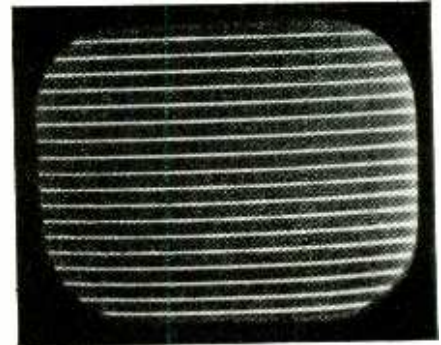

Photo C—Horizontal bars on receiver screen for testing of vertical linearity.

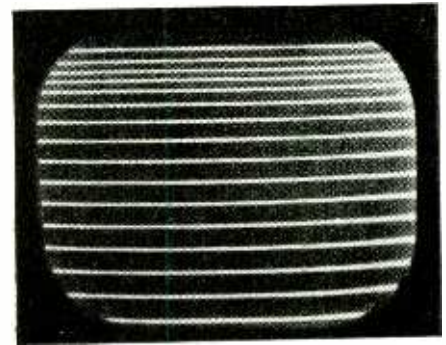

Photo D—Set with nonlinear vertical sweep shows bunching of bars at top.



Photo E—Pattern of 23 vertical bars on the receiver screen for horizontal check.

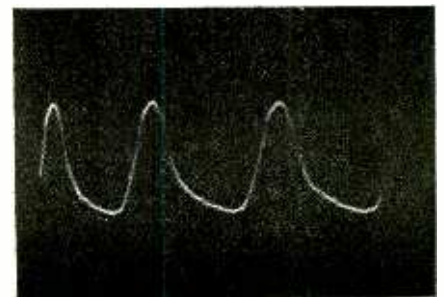

Photo F—The modulator distorts the 60-cycle vertical sweep signal from the line.

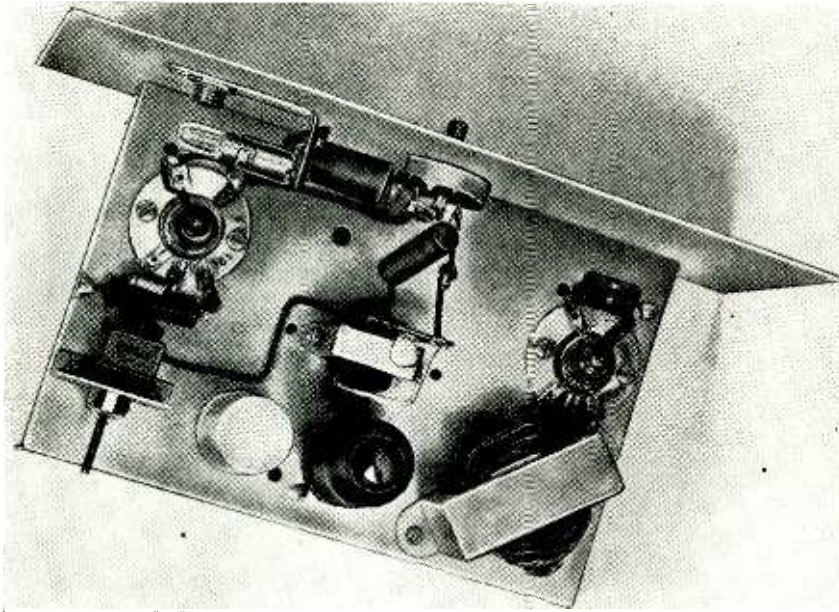

Photo G—Chassis top of the unit. V.h.f. oscillator is at right, i.f. at left.

grid is connected to a blocking-oscillator transformer T. In the commercial instrument these are special units, but a transformer designed to couple a single low- μ triode to a 500-ohm line will work practically as well. The 500-ohm winding should be the one that is grounded.

In position 4, the grid is connected to a 60-cycle signal from the filament supply, and the tube is used as a distorting amplifier and modulator.

The grid leak is variable, the simplest method of fine-tuning the oscillator. It provides a rather wide range for vertical linearity checking—anything from

3 to 12 or more horizontal bars. Its effect is not great for producing vertical bars because of the much higher oscillator frequency, but it is useful for getting the frequency exact once the slug of L1 has been adjusted approximately.

The output of the generator is available through a standard phono jack connected to a switch. In the LINEARITY position, the jack is connected to a small coupling coil L4 consisting of 10 turns of No. 26 enameled wire wound around the ground end of L3. The coupling is capacitive, not inductive. At the same time the switch connects the output of

the modulator tube to the grid of the v.h.f. oscillator to provide grid modulation.

In the SWEEP position the output switch connects the jack directly to the modulator. Though, as we have described, positions 3 and 4 of the selector switch are used for sweep-circuit substitution, the bar generator is also useful as a source of audio voltage for rough checking of sound circuits. With the selector in position 2 and the output switch on the sweep position, an audio signal of 180 to 600 cycles or more is available. It is pulsed, of course (see Photo B), and cannot be used for any exact measurement, but it is a handy source of audio for signal tracing the a.f. circuits.

Construction and operation

Simple as the bar generator is in principle, it still includes a v.h.f. oscillator which must be reasonably stable, and a modulation oscillator which must remain on frequency for reasonable periods. The commercial instrument is built on a copper-clad chassis (see Photos G and H) to avoid ground loops as far as possible, and is entirely cased in a metal box to avoid interference to other receivers on the bench or nearby. Use short leads and take care to avoid cold solder joints. The slug of L1 is reachable through a small hole in the rear of the case so that the operator can set up the number of vertical bars he wishes on a particular set. Larger screens require more bars for the average person because when there are few and they are widely separated they are harder to judge quickly by eye with any accuracy.

Operation for linearity checking is very easy. The shielded connector cable is plugged into the jack on the front panel and the alligator clips on the other end are fastened to the receiver's antenna terminals. The receiver's station selector is set at some channel between 2 and 6 and the bar generator's r.f. tuning knob is rotated until the screen brightens. It is satisfactory to have the brightness and contrast controls of the receiver set as for an average picture. The selector-switch knob is set to vertical or horizontal linearity and the SWEEP FREQ control is adjusted until the bars appear and stand still on the screen.

When the unit is used as a substitute sweep source, the receiver chassis of course must be pulled out of the cabinet. Reference to the receiver diagram will quickly indicate where to connect the generator output to substitute for the suspected sawtooth generators of the faulty set.

Materials for Generator

Resistors: 1—2,000, 1—5,600, 1—10,000, 1—15,000, 2—20,000, 2—33,000 ohms; 1—1.5 megohms; 1—25,000 ohms, potentiometer.
Capacitors: 1—5, 1—50, 2—250 μ f, ceramic; 2—0.01, 1—0.1, 1—0.3, 2—0.5, 1—0.5 μ f, 400 volts, paper; 2—40 μ f, 450 volts, electrolytic; 1—30 μ f, variable.
Miscellaneous: 2—954, 1—6H6-CT, tubes and sockets; 1—500-volt c.t. transformer with 6.3-volt winding; 1—s.p.s.t., 1—d.p.d.t., 1—single pole, 4-position, switches; 1—pilot lamp and assembly; coil forms, chassis, hookup wire, assorted hardware.

—end—

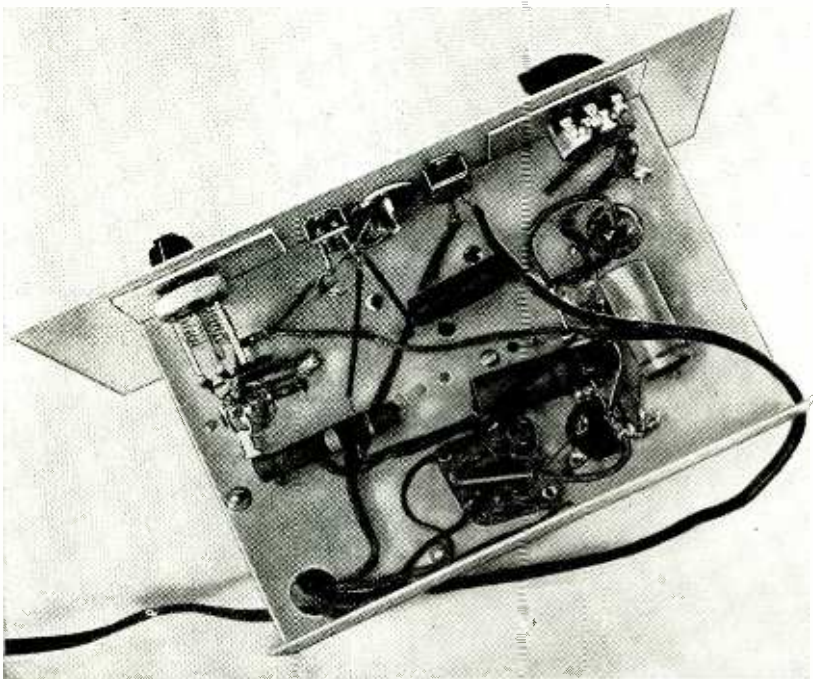
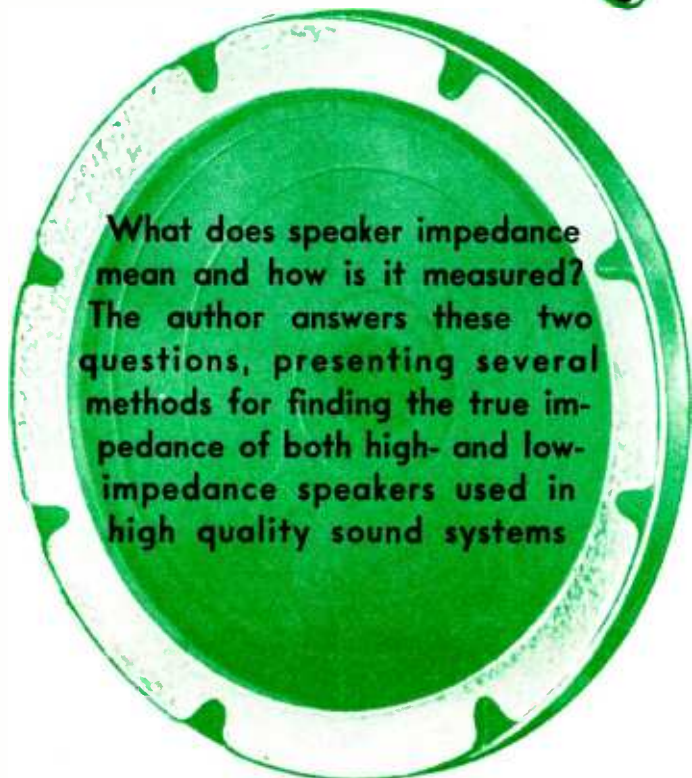

Photo H—Underchassis view. The r.f. tuning coil is at the end of the tuning capacitor at photo left. Below it is the cathode coil combination L3-L4 in the diagram.

Speaker Impedance?

By JOHN W. STRAEDE*



THE radio service technician often comes across speakers with unknown voice-coil impedances. Furthermore, in designing a good sound system it is necessary to know the *true* voice-coil impedance with the actual load. The nominal impedance (usually that at 400 or 1,000 cycles) is insufficient. The true impedance at some resonant frequency may be as much as ten times the nominal value stated by the manufacturer. If both the impedance of the voice coil and the input to the speaker transformer can be measured over the entire frequency range, the latter can be checked for spurious resonances.

The method described in this article can also be adapted to measure other impedances, as those of recording cutters and magnetic recorders.

Variation of voice-coil impedance with frequency, together with the d.c. resistance, gives a good indication of the efficiency of the speaker. A good speaker (including its baffle or flare) has an almost constant impedance. A cheap speaker has pronounced peaks—the impedance at the bass peak may be many times that at mid-frequencies.

Knowing the correct impedance of a speaker is especially important if the speaker is used in combination with one

or more other speakers. Several speakers in parallel might be used to supply sound to various locations; or several might be used at one location, each covering a different frequency range. In either case correct impedance matching is essential for best results.

What does impedance mean? It is defined as the ratio of the voltage across the speaker to the current flowing through it (both measured in r.m.s. or both in peak values):

$$Z = \frac{E}{I}$$

What makes up impedance?

As shown in Fig. 1, the voice-coil impedance is made up of the ohmic or d.c. resistance of the wire, radiation

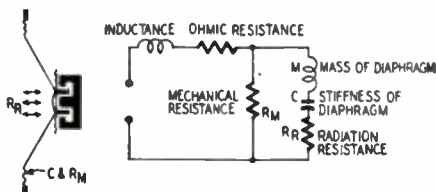

Fig. 1—Equivalent circuit of a loudspeaker showing the various components that make up the voice-coil impedance.

resistance due to the dissipation of energy in the form of sound, mechanical resistance because the spider and cone rim are not perfectly flexible, and

a number of reactances (which change with frequency). The inductive reactances—those which increase with frequency—include that due to the number of turns in the coil and the mass of the diaphragm. The capacitive reactances (inversely proportional to frequency) include those due to the stiffnesses of spider and cone rim.

There is also a reactance due to the elasticity of the air directly in front of the diaphragm.

Methods of measuring

Just as there are two main methods for measuring resistance—the Ohm's law method and the Wheatstone bridge

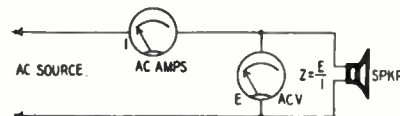

Fig. 2—Hookup for the voltmeter-ammeter method of impedance checking.

—so there are two main methods for measuring impedance! Using the formula $Z = E/I$, where

Z = impedance in ohms,

E = potential difference in volts, and I = current flowing in amperes, all we need to do is pass an alternating current of suitable frequency through the voice coil and make two measurements (see Fig. 2). In fact if we have an a.c. supply of constant voltage, we could calibrate an a.c. ammeter to read impedance directly in ohms, just as the simple d.c. multimeters use a 1½-volt battery and are calibrated to read directly.

It is the Ohm's law method we use here, but with certain modifications.

For very precise impedance measurement there is nothing to beat an a.c. bridge—balance being necessary for both the resistive and reactive components (Fig. 3). While the bridge methods will yield accurate results they are rather tedious, and a faster method is better for the service technician and amplifier designer.

If the same current flows through two components in series, the voltage across those components will be proportional to their impedances. If $Z = E/I$, then Z is proportional to E if I is constant.

This method, derived from Ohm's law, consists of connecting a resistance of known value in series with the voice coil and connecting the pair across the output of an audio-frequency oscillator. An a.c. voltmeter (preferably of

*B. Sc. (Melb. Univ.) M.I.E.S., A.M.I.R.E. (Aust.), Melbourne, Australia

high impedance) is used to measure the voltage E_z across the voice coil and E_r across the resistor (of resistance R ohms). Then

$$Z = R \times E_z/E_r.$$

The circuit is shown in Fig. 4 and is quite practical. The value of R should be of the same order as that of Z , say 5 ohms for voice-coil measurement and

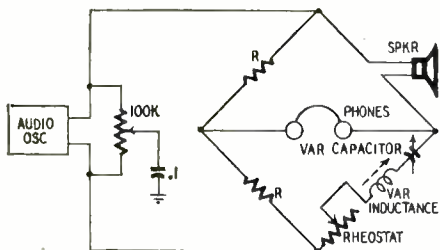

Fig. 3—Circuit of an a. c. bridge for measuring speakers of high impedance.

5,000 ohms for the reflected impedance at the primary of a speaker transformer. For accuracy a fairly high current is necessary.

Using an oscilloscope

A more interesting method uses an oscilloscope as a voltmeter and has the advantage that both voltages are indicated simultaneously on the screen. As

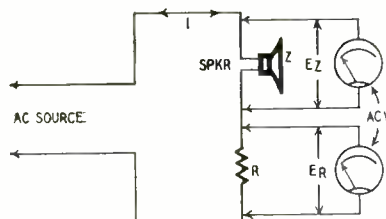

Fig. 4—A simple but effective hookup for measuring speaker impedance with a voltmeter, resistor, and oscillator.

shown in Fig. 5, both the voice coil and a calibrated variable resistor are connected in series and the voltages are applied (via the amplifiers of the scope) to the vertical and horizontal plates.

Here is the procedure: First replace the voice coil by a known resistance (say 5 ohms), and adjust the variable resistor to the same value. Now adjust the sensitivity controls of the amplifiers to give a trace consisting of a line at a 45° slope on the screen. This adjustment is important. The horizontal width of the trace must be exactly equal to the vertical height. After this adjustment, which equalizes the amplifier sensitivities, the controls must not be moved. The 5-ohm fixed resistor is replaced by the voice coil; and from here on there are two ways to proceed.

Method A: Without touching any oscilloscope control and leaving the variable resistance set at 5 ohms, measure carefully the horizontal width w and the vertical height h of the trace. Both measurements should be in the same units.

Now the impedance is calculated from the formula

$$Z = 5h/w \text{ ohms.}$$

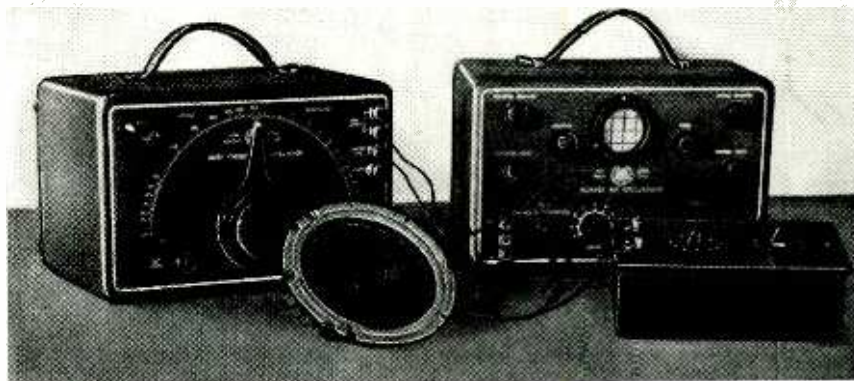

This photo shows the setup for using a scope to measure the speaker impedance.

This method is handy if a large number of measurements are to be made, and should be used if the trace is *very* different from a straight line. (It will probably be a narrow ellipse.)

Method B: Leave the oscilloscope controls alone and readjust the variable resistor until the trace is symmetrical about a 45° line (so that the width and height of trace are equal). The voice-coil impedance is then equal to the value of the variable resistor. This method is useful if the trace is very nearly a straight line—the trace *will* be a straight line at one or more frequencies when the voice coil acts as a pure resistance. One of those frequencies is very close to the bass resonant frequency. This method is also better for small oscilloscopes using tubes 2 inches or less in diameter.

Whichever method is used, it is interesting to study the variation in impedance with type of baffle. Even if a hand is placed in front of the speaker, a distinct change will occur in the

oscilloscope trace as impedance varies.

In all this work a source of audio-frequency voltage is required. Such an oscillator should have an output of at least 5 volts across a load of 10 ohms for low-impedance work. For high-impedance measurements an output of 20 volts across 10,000 ohms is required. These outputs are low and easily satisfied by commercial oscillators.

—end—

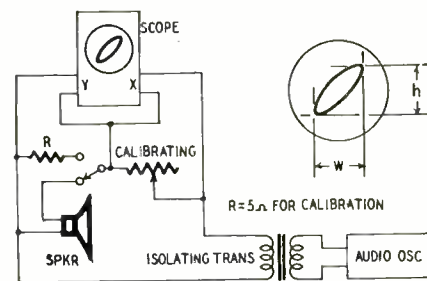

Fig. 5—How to use an oscilloscope to compare voltages and impedances.

3-Way Speaker Net Uses Low Cost Parts

This high-fidelity, 3-way loudspeaker system, demonstrated at the 1950 Audio Fair in New York City, can be constructed from relatively inexpensive components. It handles 30 watts of power and its frequency response is from 30 to 15,000 cycles. Variable attenuators are used to adjust the output level of each speaker.

Speaker No. 1 is a University tweeter model 4408, No. 2 is a Cobra 12, and No. 3 is a 12-inch speaker model 6200. L1 is a 0.5-mh coil which may be made by winding 175 turns of No. 16 d.c.c. wire on a bobbin 1 inch in diameter and 1 inch long fitted with flanges 2 1/4 inches in diameter. L2 is approximately 5 mh and may consist of 550 turns of No. 16 d.c.c. on a 1-inch bobbin 2 inches long with flanges 4 inches in diameter.

The variable attenuators are 50-ohm, wire-wound potentiometers rated at 5 watts or more. C1, C2, and C3 are paper capacitors. Their working voltages need not be more than 100 volts. If low-voltage papers are not available, you can use low-voltage electrolytics

connected back-to-back (with the negative or positive terminals tied together). Remember that the electrolytics are in series, so it takes two 30- μ f units to replace the 30- μ f paper unit. The same applies to the 15- μ f capacitor.

The cabinet, 30 x 40 x 16 inches, was constructed of 3/4-inch plywood with a 4 x 20-inch port cut in the top of the rear cover.

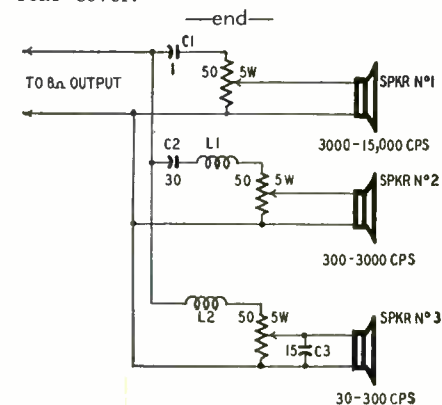

—end—

Audio Feedback Design

Part VII—How to use positive feedback to cut down distortion

By GEORGE FLETCHER COOPER

THE earlier articles of this series have discussed the method of designing a conventional negative feedback amplifier for audio frequency use. The control of output impedance has not yet been discussed, but this will be considered in a later article. In this article we shall discuss one of the refinements of design which can give a considerable improvement in performance at very low material cost. Low material cost we consider a factor because the use of positive feedback can involve quite a lot of time and trouble.

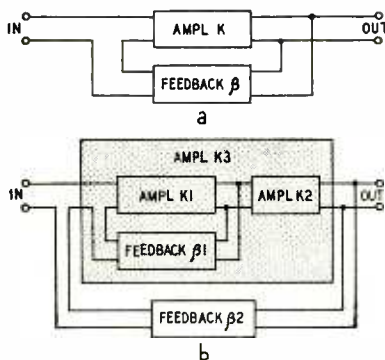

Fig. 1—The basic feedback circuit is at *a*, while *b* shows a second feedback loop within the over all feedback loop.

By using negative feedback we can flatten the frequency response, and we can reduce the harmonic and intermodulation distortion. That is what we said in the first article of this series. Is there any reason why we should not apply common-sense arguments and say that by using positive feedback we shall make the frequency response less flat and shall increase the harmonic and intermodulation distortion?

There are two separate reasons for using positive feedback. One is to help control the impedance of an amplifier, and this we shall leave until we come to discuss the effects of feedback, positive and negative, on the impedance. The other reason is that we can improve the performance by the use of positive feedback, if— And that *if* is the subject of this article.

Mathematical equations you either understand or you don't. Words, as all politicians know, can mean just what

you want them to. First let us look again at Fig. 1-a, the basic circuit we had in the first article. In this, as you will remember, K is the amplifier itself, and β is the feedback network. Instead of taking a simple amplifier in the box K , we can split this amplifier into two parts, K_1 and K_2 , with feedback β_1 around K_1 and β_2 around both K_1 and K_2 . (Fig. 1-b.) Thus β_2 is the negative feedback around K which we have in Fig. 1-a. Now the combination of K_1 and β_1 is a normal amplifier with feedback, having a gain of

$$K' = \frac{K_1}{1 + \beta_1 K_1}$$

This is in tandem with K_2 , giving a gain, without allowing for β_2 , of

$$K_3 = K' \times K_2$$

We can write this in full as

$$K_3 = \frac{K_1 K_2}{1 + \beta_1 K_1}$$

When we apply the extra feedback β_2 , the over-all gain becomes

$$K'' = \frac{K_3}{1 + \beta_2 K_3} = \frac{K_1 K_2}{1 + \beta_1 K_1} \times \frac{1}{1 + \frac{\beta_2 K_1 K_2}{1 + \beta_1 K_1}} = \frac{K_1 K_2}{1 + \beta_1 K_1 + \beta_2 K_1 K_2}$$

If we have a fair amount of gain and feedback, we can simplify this to

$$K'' = \frac{K_1 K_2}{\beta_1 K_1 + \beta_2 K_1 K_2} = \frac{K_2}{\beta_1 + \beta_2 K_2}$$

in the limit, to $1/\beta_2$. This, of course, is the standard feedback formula. But let us look at this basic two-path feedback equation more closely. We have

$$K'' = \frac{K_1 K_2}{1 + \beta_1 K_1 + \beta_2 K_1 K_2}$$

When β is *negative* feedback, βK is a positive quantity, so that $1 + \beta K > 1$. Therefore, if the network β_1 provides *positive* feedback, $\beta_1 K_1$ will be a negative quantity. Let us take $1 + \beta_1 K_1 = 0$, which means that the loss in β_1 equals the gain in K_1 , and the feedback is connected as positive feedback. This, by the way, is the amount of feedback which connected as negative feedback would reduce the gain by 6 db. With $1 + \beta_1 K_1 = 0$ we obviously have

$$K'' = \frac{K_1 K_2}{\beta_2 K_1 K_2} = \frac{1}{\beta_2}$$

Notice that now there is no approximation: we haven't left out any small quantities. We actually have an over-all gain which is settled only by the feedback network. Since the feedback

network is assumed to be made up only of resistors it must be absolutely linear, and the distortion will be zero.

Limitations of this result

It is obvious that the mathematics has not told us the whole story. We must examine the results more closely: let us look again at our first equation

$$K' = \frac{K_1}{1 + \beta_1 K_1}$$

We took $1 + \beta_1 K_1 = 0$ to achieve our final distortion free amplifier. This means that $K' = K_1/0 = \infty$. That's fine, we have infinite gain, so that any input at all will overload the first amplifier unit. Anyway, K_1 is not exactly constant, because if it were, we should have no distortion, so why worry about using any feedback. Obviously we are pushing things too hard if we take $1 + \beta_1 K_1 = 0$: let us try something a little milder. Assume that $K_1 = 100$ (40 db) at maximum tube transconductance, and 50 (34 db) with low-limit tubes. A twin triode would give about this much gain. Take $\beta_1 = -1/200$, so that $K_1 \beta_1 = 1/2$ to $1/4$. Then $K' = 2K_1$ in the maximum transconductance case, which gives $K' = 200$. Thus there is an increase in the forward gain of 6 db, and if the positive feedback has not introduced any extra distortion the over-all distortion, with K_2 and β_2 in circuit, will be reduced to one-half.

Even now, of course, the reader may be suspicious, because if negative feed-

back reduces distortion, positive feedback must increase it. Let us assume that K_1 consists of two single-ended stages, while K_2 is a push-pull stage. The second single-ended stage will produce some second harmonic, say 3%, while the push-pull stage produces mainly third harmonic, say 8%. The total

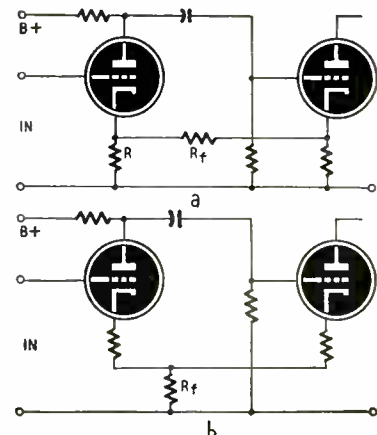

Fig. 2—Two simple circuits for applying positive feedback to an amplifier.

distortion in the two circuits will be $\sqrt{(3^2 + 8^2)}\% = 8.54\%$. If β_2 produces 20 db feedback the over-all distortion will be 0.854%. Now we add the positive feedback to the first two stages: we get 6 db more gain, but we get $2 \times 3\% = 6\%$ distortion here. The total distortion is now $\sqrt{(6^2 + 8^2)}\% = 10\%$. As we have the same β_2 with 6 db extra gain in the forward direction, the over-all distortion is reduced to 0.5%.

Maybe that improvement doesn't seem worthwhile. We can look at some other numbers. The first stage, K_1 , might be kept to 1% distortion by careful design and, if you don't mind trimming it when the tubes are replaced, it would be possible to add 20 db of positive feedback. Without positive feedback, but with 20 db negative feedback, the over-all distortion would be 1.01%. With positive feedback this is brought down to 0.2%. An improvement of five times is really something, because it would cost 14 db gain to get this improvement using negative feedback only.

Here, then, is the background of the positive feedback story. The questions that remain are how to produce the feedback, what it costs in components, and what it costs in design effort. First of all, how should we produce the positive feedback? It is possible to show, though I do not propose to do it here, that we should always put negative feedback around as long a chain as possible, while we should put positive feedback around the shortest possible loop. The simplest possible circuit is that shown in Fig. 2-a, a circuit which is equivalent to Fig. 2-b. If we replace R_f in Fig. 2-a, by a capacitor, we have a fairly familiar circuit, the cathode-coupled multivibrator. This multivibrator circuit corresponds to much more positive feedback than we need.

Looking at Fig. 2, we see that we have gotten rid of two cathode by-pass capacitors and substituted one resistor. That doesn't seem too expensive, especially when you remember that the performance is improved. In Fig. 2-a the extra resistor will be a fairly large one; we shall see the sort of value needed later. In the circuit of Fig. 2-b the common resistor is a small one; a few tens of ohms. As the two cathodes in Fig. 2-a will usually be at about the same potential, there will not be much d.c. in the feedback resistor R_f , so that it will only be a minimum wattage component. Also, the value does not have much effect on the bias.

We can calculate the size of R_f approximately by the following method. Assume that the two tubes are the two halves of a 12AT7 double triode. With 1 mv applied to the input, the cathode-ground voltage for the first tube, without positive feedback, will be about $\frac{1}{2}$ mv, and the plate-ground voltage about 20 mv. This is the grid-ground voltage for the second tube, and will produce a cathode-ground voltage of about 10 mv. By producing a cathode-ground voltage of 1 mv at the first tube we could keep this condition steady even without an input, so that we need $R_f = 9R$. For a 12AT7 R will be about 200 ohms, and

we get a value of $R_f = 1,800$ ohms for infinite gain. For 6 db feedback the value will be about 4,000 ohms. This calculation is only a very rough one, to find out what size of resistor to try in the circuit, because the exact expression is rather long and the proof would occupy half my space here. It is always much easier to connect in a variable resistor and to adjust it.

There are two ways of approaching the design aspects of positive feedback. We can calculate the phase and amplitude response of K_1 , and then calculate what happens with positive feedback. When I get around to describing the " $\mu\beta$ calculator" in a later article you will see an easy way of carrying out the calculation. The alternative is to make K_2 responsible for controlling the phase and amplitude out in the critical regions where the negative feedback can cause instability. We do this at low frequencies very often by keeping the output transformer inductance as the limiting factor. At high frequencies a small capacitor, or a pair for push-pull, can be used to have the same effect.

There is possible a modification of this second approach. If you look back to the December issue, which I have by me as I write, you will see the responses calculated for Mr. Williamson's amplifier. At $\omega = 64$ (about 10 c.p.s.) and $\omega = 0.5 \times 10^6$ (about 90 kc) the phase shift is only 75 to 80°. So long as the positive feedback is out of action outside the frequency band 10 to 90,000 cycles, which isn't a bad working band, the over-all stability should not be affected. Fig. 3 shows how the basic circuit of Fig. 2-a can be modified to make this happen. The shunt capacitor C_1 short-circuits R at high frequencies, and we must have $\omega C_1 R \gg 1$ at the upper end, which we saw might be as high as 90 kc. The other capacitor, C_2 , open-circuits the feedback path through R_f at low frequencies, so that $\omega C_2 R \ll 1$ at the lower end, which might be at 10 cycles. Thus typical values could be $R = 200$ ohms, $C_1 = 0.01 \mu\text{f}$, $C_2 = 1 \mu\text{f}$. With these values we would have positive feedback over the range from 100 cycles to 10 kc, which is the most important region unless you are a super-extra-ultra-high-fidelity fan. Most orchestral power comes up in the middle of the band, and that is where we need low distortion most of the time.

There is a rather interesting modification of this circuit which has been published. This is shown in Fig. 4. V_1 has a high value of cathode resistor, about 5K, which will produce a lot of local negative feedback. With the gain control potentiometer at maximum the positive feedback resistor is adjusted to compensate for this negative feedback. When the gain control is turned down to deal with a strong signal the value of K_1 is reduced, so that $K_1 \beta_1$ gets less, the positive feedback has less effect, and V_1 is linearized by the local negative feedback.

I have discussed only the cathode-cathode feedback circuit, because I haven't found any use for any other possible positive feedback circuit. As

soon as you get away from this relatively low-impedance feedback path, stray capacitances start to be important, and these bring phase problems in their train.

Some time ago Peter Sulzer described another application of positive feedback which is useful if you can make it work. This is in pentode circuits. The screen of a pentode can be regarded as either a grid, controlling the plate current, or a plate, having a current controlled by the first grid. Usually the input is zero, and the plate load also is zero, because of the decoupling capacitor. Suppose, however, that we leave out the decoupling capacitor, as we do in the tri-tet circuit. Then we have a signal at the screen. By feeding back this signal to the screen of the preceding stage, where the screen now acts as a control grid, we can introduce enough

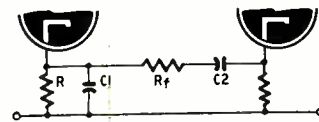

Fig. 3—A modified version of Fig. 2-a that will provide positive feedback only in the middle of the audio range.

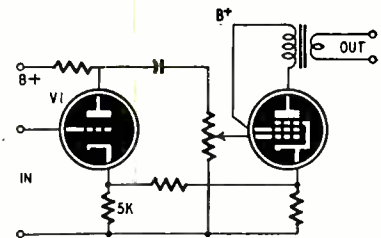

Fig. 4—Feedback circuit for a broadcast receiver to get high gain on weak signals, low gain with strong signals.

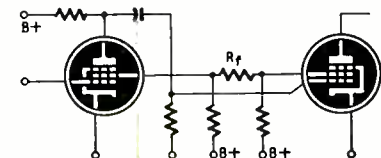

Fig. 5—Feedback from screen to screen will eliminate the decoupling capacitor.

positive feedback. Fig. 5 shows the sort of circuit we finish up with, and again we have saved the price of two capacitors by the use of only one resistor. The important thing in using this circuit is to avoid too much gain to the screen in the second stage, and although I have drawn only a dropping resistor I think it is essential to feed the second screen from a relatively low-resistance voltage divider.

When I started this series I said I wasn't writing an amplifier cook book. To take positive feedback out of the jam-making class—you know that tedious business of seeing if the jelly sets—you must have the means for calculating the phase and amplitude characteristics. The " $\mu\beta$ calculator" is a sort of slide rule for this job, and designing amplifiers with multiple feedback loops without it is like cooking without measures: ask the dairyman for five tablespoons of milk! But it is so easy to vary the feedback that I have no apologies.

(continued next month)

Electronics and Music

Part XI—Photoelectric methods for generating tones and for producing harmonics to get a desired quality

By

RICHARD H. DORF

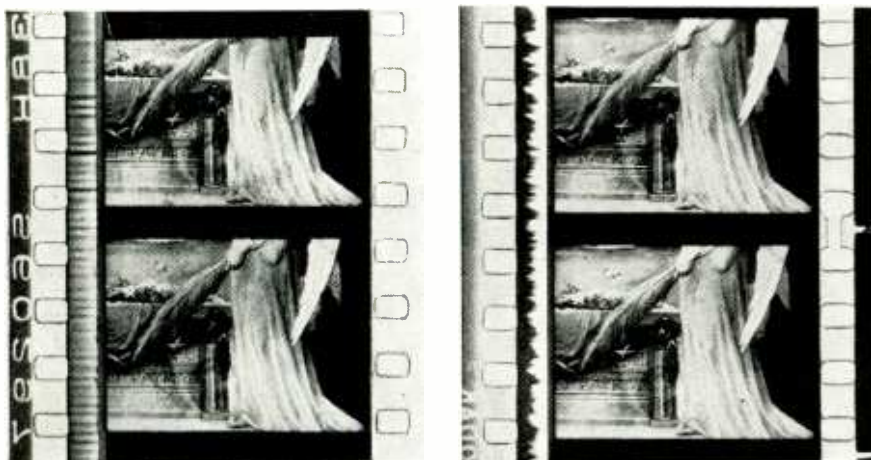

Fig. 1-a, left—A section of film with a sound track using variable density
Fig. 1-b, right—A film using the variable area method for generating sound.

BEFORE describing the Thyratone in the last two issues of RADIO-ELECTRONICS, we had concluded our discussion of electronic tone generators. The circuits shown did not, by far, exhaust the total that have been used in one way or another, but to describe them all would require several volumes. Additional generators and dividers will be shown, however, as time goes on and we go into the details of the important commercially built instruments available today.

Because this series of articles deals with *electronic* musical instruments, we shall make only passing mention of the several other methods of creating music electrically. These methods fall into two classes: electromechanical generators, and amplified acoustic generators. In the first class we find photoelectric, electrostatic, and electromagnetic generators, and instruments which employ the principle of playing back pre-recorded notes. In the second appear electric pianos, amplified reed organs, amplified guitars, most electronic chime and carillon systems, and the like. In most instruments which use acoustic generators, the design problems are largely limited to picking up and amplifying the tones. That kind of problem is very nearly standard in electronics (though, of course, special methods are sometimes necessary) and our treat-

ment will be limited to a later description of the Wurlitzer organ, which generates its tones with banks of air-driven reeds.

Photoelectric generators

So far as the writer knows, only two photoelectric organs have been built for the commercial market, the German Welte organ and, very recently, one by an American manufacturer, not yet on the market. Although the principles of photoelectric tone production are not complex, the practical problems of construction and production are.

In principle, photoelectric systems are similar to sound-on-film, in which a narrow strip at the edge of the film contains a continuously varying pattern of either variable density or variable area. Fig. 1 illustrates this. In Fig. 1-a the strip at the right edge of the film varies in density as the film travels along. A steady light source in the projector shines a beam through this strip onto the cathode of a photoelectric tube. As the density or blackness of the strip varies so does the amount of light reaching the phototube. The tube's output varies accordingly. Fed into an amplifier, the output variations, which are at an audio rate, cause sound to be heard in the loudspeaker.

Fig. 1-b shows the variable-area method. In this case, the film is opaqued or blacked to a certain degree at each

point along the film strip. The amount of clear film (white in the illustration) which remains at each point determines the amount of light allowed to pass to the phototube. Since this is constantly changing at an audio rate, the phototube output, fed to an amplifier, again causes the speaker to "speak."

In electronic music, however, we are concerned not with a constantly changing recording but with a steady repetition of single tones. It is standard practice, therefore, to make "re-entrant" light recordings such as the one illustrated in Fig. 2.

Fig. 2 shows a segment of a disc made of glass. The entire disc is clear except for the black waveform pictures in 18 concentric bands. If a spot of light is focused on one of these bands as the disc revolves and a photoelectric tube is placed on the other side of the disc so that whatever light passes through the disc hits it, the amount of light reaching the tube varies in accordance with the area of clear glass between the two. The tube output current varies in exact accord with the shape of the black waveform picture. If the disc is turned fast enough so that the variations are at an audio rate, the sound from the speaker will correspond to the waveform pictured and will have a frequency or pitch determined by the number of waveforms scanned each second.

This scheme is the electronic musical equivalent of variable-area film recording. A variable-density system may be used instead, by having each band consist of a strip of constant width but of varying degrees of opacity. Or, instead of a transparency on glass, the disc may be of metal, with holes in it. This is a chopper, which alternately interrupts and passes the light.

Obtaining correct pitches

The most obvious (and the most accurate) way of providing disc scanning patterns which give the correct musical pitches for an entire instrument is to have a separate disc for each of the 12 fundamental notes of the chromatic scale, and to drive each at the right speed.

For example, the C disc must generate a tone of 65.41 cycles for the lowest C of the organ manual. If it has a

RADIO-ELECTRONICS for

single pattern on the circular strip which is to generate this note, it must revolve 65.41 times per second or 3924.6 r.p.m. The speed necessary can be reduced by any desired factor, however, if the number of patterns around the strip for that note is multiplied by the same factor. If, for instance, there are 10 patterns, the speed can be reduced to 392.46 r.p.m. and the pitch will still be 65.41 cycles.

The next band on the same disc would probably be designed to produce the next octave pitch, 130.8 cycles, which means it must have twice as many patterns for the same speed. The octave above must have twice as many patterns as that, and so on, until the outer band has enough patterns to produce the highest pitch wanted. Obviously, 12 such discs, each revolving at a different speed, are necessary. The complexity of a gearing system needed to drive 12 discs at different, yet exact, speeds is a deterrent to such designs, but the problem can be simplified to some extent by keeping in mind that pitch errors of about 0.25% or less can be neglected. This is equivalent to 1 part in 400, which means that a nominal 440-cycle note could be 441 or 439 cycles without too bad an effect. Even this error, however, can be detected by people with acute ears, and for the sake of safety the error should be limited to 0.1% or 1 part in 1,000. That means that actual frequency should correspond to nominal frequency to four significant figures, as given in the frequency chart on page 42 of the August, 1950, issue of RADIO-ELECTRONICS. To be specific, F_m , for instance, listed as 87.31 cycles, may vary only .01 cycle, or from 87.30 to 87.32; C_m , listed as 2093, may vary 1 cycle either way, from 2092 to 2094.

Mathematically, of course, there is no reason why a single speed would not be adequate for all the notes. The maximum permissible speed would be that which, in cycles per second, is a sub-multiple of all the desired audio frequencies. Other speeds are possible, too, if some of the discs contain a single pattern for the lowest note and others have more than one.

In a practical commercially designed organ, that speed has worked out to approximately 1 revolution every 2 seconds; the revolving element is a drum rather than a series of discs. The extremely slow speed, however, poses other problems, such as regulation, for the slower the speed, the harder it is to keep it constant.

Keying and tone shaping

Photoelectric organs can be keyed electrically by simply closing switches in series with separate lamps which provide light sources for the pattern bands. A more common method, however, though more complex for the individual constructor, is mechanical—the keys operate shutters which cover the patterns when they are not desired.

Tone coloration may be dependent on the patterns themselves, as in Fig. 2,

which is the scheme of a European organ. A separate disc is provided for each note; the 18 bands on the disc shape the waveform of the light reaching the phototube to produce 18 different tone colors, corresponding to the same number of organ stops. A system of shutters, operated magnetically by the playing keys and stop switches, allows light to pass through an appropriate part of the disc. The discs are glass, with photographic emulsion, and the patterns are printed photographically from a master negative.

In any photoelectric organ, it is important that the patterns on the discs or drum be re-entrant. That is, it is not sufficient merely to have the right number of patterns or holes in a given circular band; they must be evenly spaced. To illustrate, Fig. 3-a shows a disc with 8 holes in the first band, 16 holes in the second. If the disc is rotated at 367.5 r.p.m., the inner band will produce G_{11} at 49 cycles and the outer G_{23} at 98 cycles.

Fig. 3-b shows a similar disc with the same numbers of holes, but with the outer ring unevenly spaced. When the light is passing through the 16 holes in turn, a higher frequency than 98 cycles will be produced because the close spacing makes the cycles occur too quickly. When the one wide-spaced pair of holes comes around, there will be a sudden low-frequency element.

This illustrates, among other things, the fact that the number of holes in each circle must be a whole number. If the designer starts with a certain speed in mind, then figures the number of holes to be placed in each band, he will probably come out with a fractional number—say, 4.5 holes. It is impossible, naturally, to make half a hole, and the only other alternative is to space the holes as if it were possible—to lay out the design by dividing 360 degrees by the number of holes, 4.5, then drill what holes are possible and leave an uneven space in one spot.

The correct procedure is to figure on a certain number of holes, then calculate the necessary speed. A formula can easily be worked out: Frequency divided by the number of holes or patterns gives the speed in revolutions per second. This is multiplied by 60 for r.p.m. Thus:

$$\text{r.p.m.} = \frac{60f}{n}$$

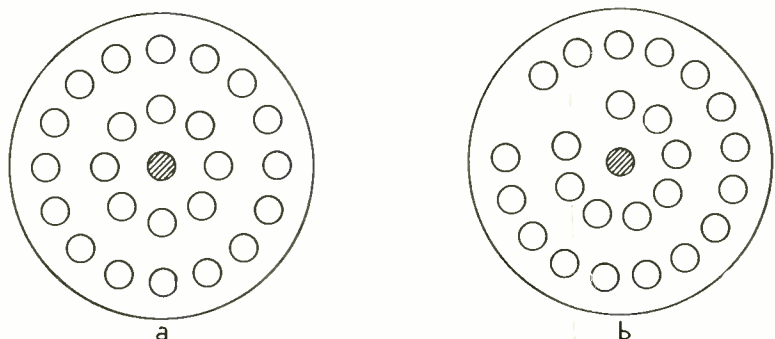

Fig. 3—A drawing showing why the pattern on a tone disc must be re-entrant.

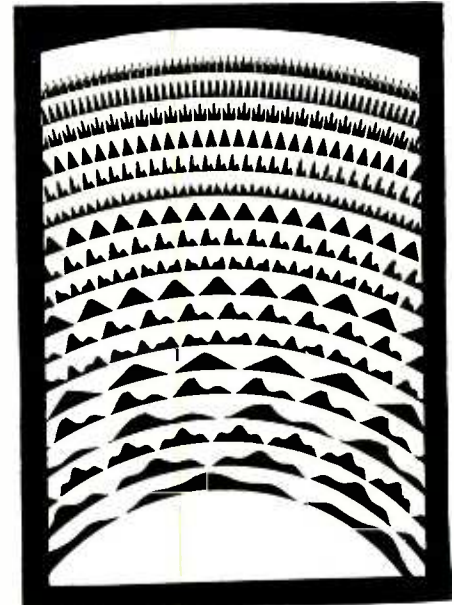

Fig. 2—Segment of tone pattern disc.

where f is the audio frequency desired and n is the number of holes or patterns. Note that the spacing of the holes from the center of the disc makes no difference in the pitch.

Another method of tone coloring is disclosed by Alexander Roth in Patent No. 2,513,109. His instrument uses a rotating-disc system to produce sine waves, one for each note. Each note is keyed by lighting a lamp, which shines through a band of slits in a disc. With switches, the player can make more than one lamp light when a key is pressed—he can light lamps of the notes corresponding to harmonics of the key he presses. Potentiometers regulate the current through the individual lamps; the amount of light determines the loudness of each harmonic, and the player can thus make up from its harmonics whatever tone color he wishes. The system is fundamentally equivalent to the Hammond Organ's harmonic synthesis system, which will be described in some detail in a soon forthcoming article.

Photoelectric organs are very difficult to build and operate satisfactorily. It can be done, however, by constructors with sufficient mechanical skill. The writer would be most interested in hearing from readers who have done so.

(continued next month)

Non-Eavesdropping Intercom

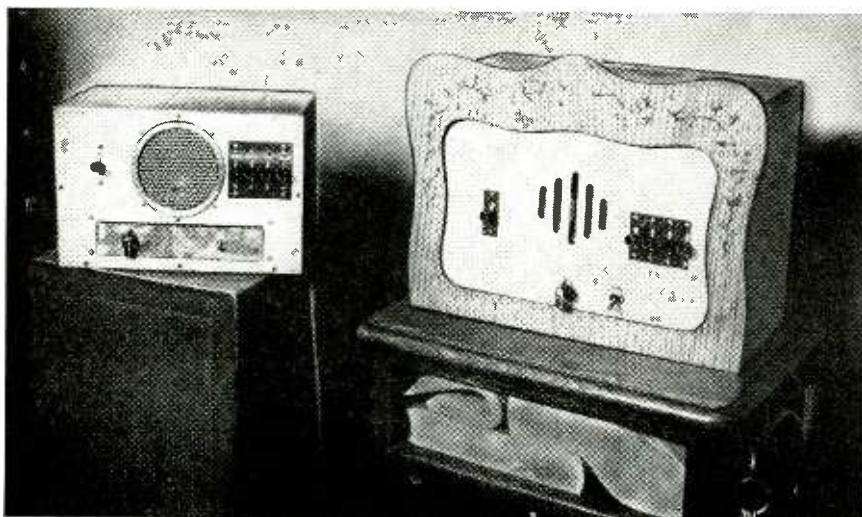

Photo A—One master is for the receptionist, the other is for the switchboard.

RECENTLY an intercommunication system was installed at the Griffith Observatory in Los Angeles to connect several points in the building which did not have local telephone stations. These points are now within call of the secretary's desk. The first station was installed at the rear service entrance of the building with a signal button so delivery men might call the office. This was made a slave station with the talk-listen control on the master station in the office. Three substations in parallel were installed in the shops at convenient points so that no one need walk more than a few steps to answer a call. Other substations were installed in the darkroom and telescope dome. These could not be straight slave stations with listen control at the master station because the secretary might tune in at a time when

shop slang might be flying. This type of language is not for the ears of a young lady, so a system we call "non-eavesdropping" was worked out. The difference between this type and the straight slave station is that the remote station has its own talk-listen switch.

Fig. 1 shows how the substations are connected. Two conductors are run to each station. One is the talk wire and the other is the listen wire. The return for each of them is made to ground. An s.p.d.t. push-button switch is used at the substation for talk-listen control. A d.p.s.t. selector switch at the master station connects the substation to the amplifier. The talk-listen switch at the master station is a d.p.d.t. unit. The master station cannot hear the substation unless the substation operator presses his talk button. The station at the rear door has no talk-listen button. One wire is used for the voice circuit and the other wire of the pair for the signal buzzer. The selector switch for the rear door is a d.p.d.t. unit which disconnects all the other selector switches when it is connected to the rear door. This is necessary to avoid eavesdropping at the other stations. Two or more stations (excluding the rear door) may be called simultaneously by throwing their selector switches.

It was later found that a second master station was needed for use in the evenings when the building was open to the public. This was installed at the information desk and connected in parallel with the master station in the office. This works out very well, as the two master stations are never used during the same part of the day. The circuit used in the master stations is shown in Fig. 2. One cabinet was made to be a piece of furniture and the other,

Separate talk-listen switches at each station insure privacy

By GEORGE W. BUNTON

a wrinkle-finished metal job, has a more business-like appearance. The two master stations for the system are shown in Photo A.

There is nothing unusual about the amplifier except possibly the unby-passed cathode resistors. Bypass capacitors were omitted to reduce the gain of the amplifier and to improve the quality by inverse feedback. With some of the stations over 200 feet from the master, the volume is good when speaking in a normal conversational voice as much as 10 feet from the speaker.

Certain precautions were observed in placing parts. The input and output transformers were placed as far apart as possible. One is above and the other below the steel chassis, which helps to isolate them. The input grid lead from the secondary of the transformer is short to avoid hum pickup, and the input lead to the primary is shielded and dressed to avoid feedback.

The power supply (not shown) uses a 650-volt center-tapped transformer

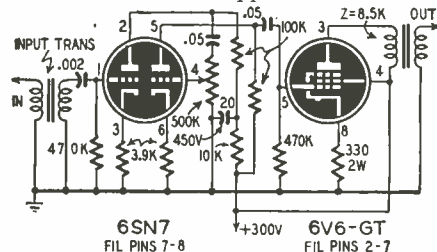

Fig. 2—Schematic of the intercom amplifier. The power supply is not shown, and a 5Y3-GT rectifier in a conventional circuit.

No cross-talk has been noticed, although the leads to the remote stations are cabled together for approximately 50 feet. None of them are shielded.

Materials for Intercom

Resistors: 1—330-ohm, 2-watt; 2—3,900-, 1—10,000-, 2—100,000-, 2—470,000-ohm, 1/2-watt; 1—500,000-ohm potentiometer.

Capacitors: 1—.002-, .05- μ f, 400-volt, paper; 1—20- μ f, 450-volt, electrolytic.

Miscellaneous: 1—intercom input transformer, 1—output transformer, 8,500-ohm primary, secondary to match speaker voice coil; 5—switches, s.p.d.t., push-button; 4—switches, 2-pole, 3-position, nonshorting, positive-index; 1—switch, 2-pole, 3-position, nonshorting, spring-return; chassis, speakers, terminal strips, sockets, tubes, etc.

—end—

RADIO-ELECTRONICS for

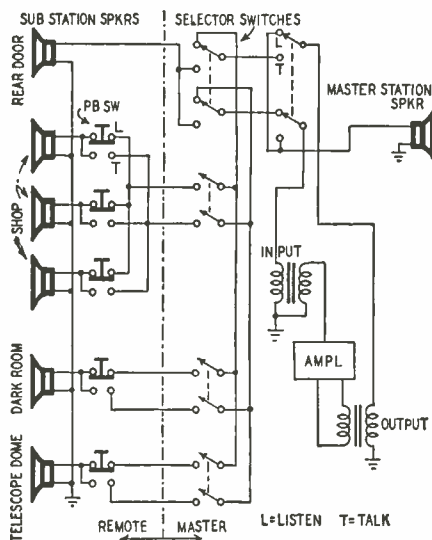

Fig. 1—Wiring diagram of the master station and the four remote stations.

GET IT!

1951 ALLIED catalog

free!

the only complete
up-to-date catalog for
Everything in Radio, Television
and Industrial Electronics

212 value-packed pages



Send for it today!

Here's the only *complete, up-to-date* Buying Guide to TV, Radio and Industrial Electronics—packed with the world's largest selections of quality equipment at lowest, money-saving prices. See the latest in TV, AM and FM receivers; radio-phonos; new Sound Systems and P.A. equipment; High-Fidelity Custom Sound components; recorders and accessories; full selections of newest Amateur receivers and station gear; test instruments; builders' kits; huge listings of parts, tubes, tools, books—the world's *most complete stocks* of quality equipment.

ALLIED gives you *every* buying advantage; speedy delivery, expert personal help, lowest prices, assured satisfaction, liberal time payment terms. Get the latest 1951 ALLIED Catalog. Keep it handy—it will save you time and money. Send for your FREE copy!



THE WORLD'S LARGEST STOCKS

- Radio Parts Unlimited
- Test Instruments
- Television & Home Radios
- P.A. and Hi-Fi Equipment
- Amateur Station Gear
- Supplies for Industry

QUICK, EXPERT SERVICE

SEND TODAY FOR RADIO'S LEADING BUYING GUIDE

ALLIED IS YOUR TELEVISION HEADQUARTERS



To keep up with TV, depend on ALLIED! Count on us for the latest releases and largest stocks of picture tubes, component parts, antennas and accessories—plus the latest in TV tuners and kits. If it's anything in TV—depend on ALLIED!

ALLIED RADIO

the World's Largest Radio Supply House

EVERYTHING IN ELECTRONICS

free

ALLIED RADIO CORP.
833 W. Jackson Blvd., Dept. 2-E-1
Chicago 7, Illinois

Send FREE 212-page 1951 ALLIED Catalog No. 126

Name _____

Address _____

City _____ Zone _____ State _____

Calibrated Attenuator For Audio Generators

By B. J. CEDERQVIST*

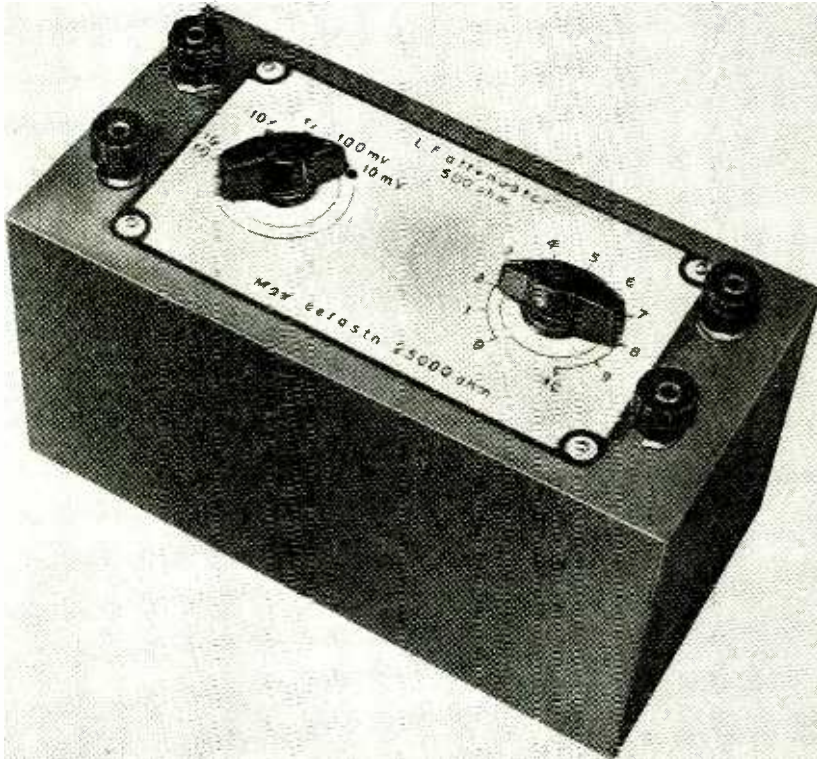

The attenuator. Range switch is at left; calibrated output potentiometer at right.

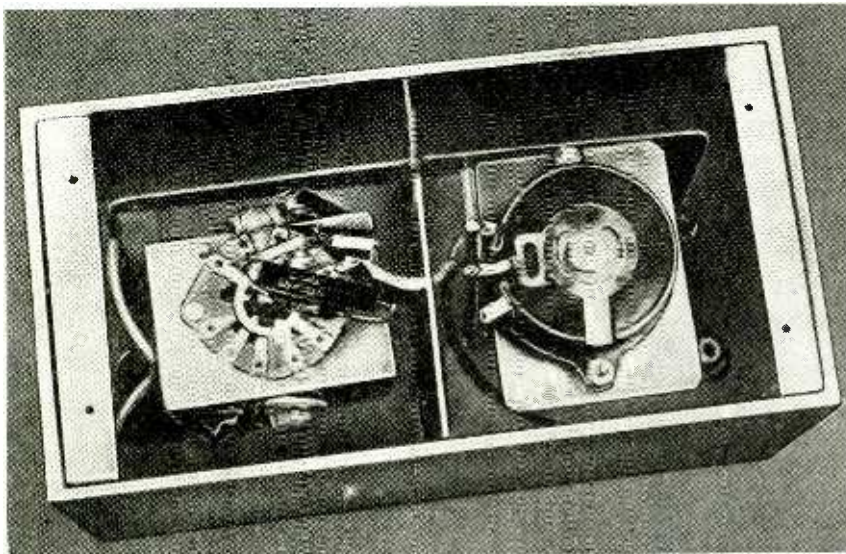

This inside view of the attenuator gives an excellent idea of the shielding.

VERY few of the factory-made audio generators provide for setting the output level at a desired value. Some of them have just a fixed low- and high-impedance output. Others have a potentiometer connected across the output so the voltage can be varied from 0 to possibly 20 volts. But you can't set the generator to, say, exactly 1 microvolt, suitable to feed into a highly sensitive amplifier.

You can't measure 1 μ v with the regular tube voltmeters nowadays available in the market, but 10 volts can easily be measured with every v.t.v.m. A test on my audio generator showed that I got—across a 500-ohm resistor connected to the output—more than 10 volts on all frequencies from 30 cycles to 20 kc, which showed that if an attenuator with an input and output impedance of 500 ohms could be connected to the generator, the input voltage to this attenuator could be held at 10 volts over the above frequency range.

The attenuator theory

Fig. 1 is the basic circuit diagram of the attenuator. The different values for R1 and R2 are easily calculated when the impedance and the input-output voltage ratio $\frac{V1}{V2}$ is known.

$$R1 = Z \left[\frac{\frac{V1}{V2} - 1}{\frac{V1}{V2} + 1} \right] \text{ ohms}$$

$$R2 = Z \left[\frac{2 \frac{V1}{V2}}{\left(\frac{V1}{V2}\right)^2 - 1} \right] \text{ ohms}$$

In the above equations, Z represents the attenuator impedance (500 ohms in this case). V1 is the input voltage and V2 the output voltage.

Let us first assume that we should like to have, as in the unit pictured, a constant input voltage V1 of 10 volts and an output voltage V2 of 10, 1, 0.1, and .01 volts and an impedance of 500 ohms. The calculated values of R1 and R2 will then be (with sufficient accuracy):

Output (V2)	$\frac{V1}{V2}$	R1	R2	Sw. Pos.
10	1	0	∞	1
1	10	409	101	2
0.1	100	490	10	3
.01	1,000	500	1	4

If we now connect two 500-ohm linear wire-wound potentiometers to V2 as shown in Fig. 1, the different output voltages from V2 can be varied down to 0. Since R4 increases as R3 decreases, the output impedance remains constant at 500 ohms and independent

* Finnish Cable Works Ltd., Helsinki, Finland

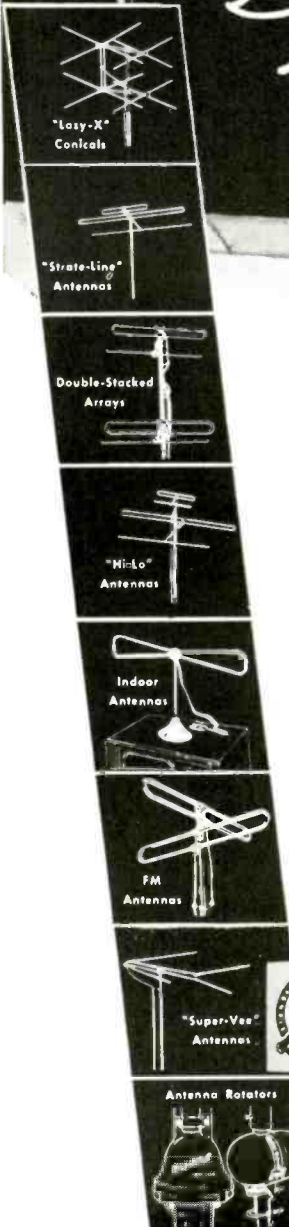
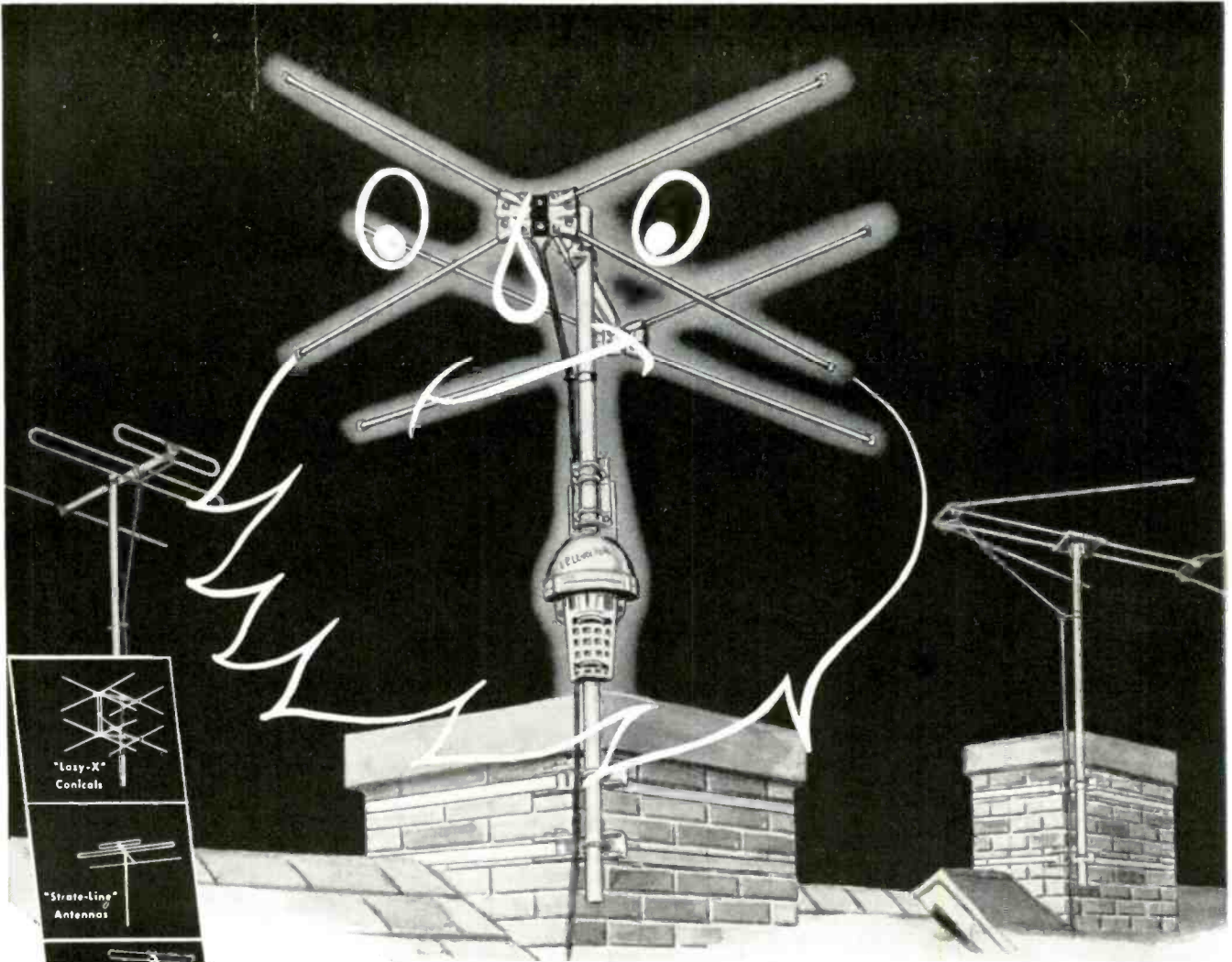

When It's Needed the Most . . .

RADIART Quality Meets the Challenge

IF it were possible for antennas, like men, to grow beards, **RADIART ANTENNAS** would have them. Because they're designed to last and last, in fact, to grow "old enough to shave". This length of service is one of the invisible features of **RADIART** design and construction that have helped establish leadership in the antenna field. When an installation of a **RADIART** antenna is completed, the serviceman and his customer KNOW that that antenna is up to stay and will perform in the manner of a true champion. No shorting out . . . no bending or twisting in wind, rain or snow . . . no rusting away of the elements — they're built to last. When it comes to durability, too . . . again, **RADIART** quality meets the challenge.



SUBSIDIARY OF



THE RADIART CORPORATION CLEVELAND 2, OHIO

VIBRATORS • AUTO AERIALS • TV ANTENNAS • ROTATORS • POWER SUPPLIES

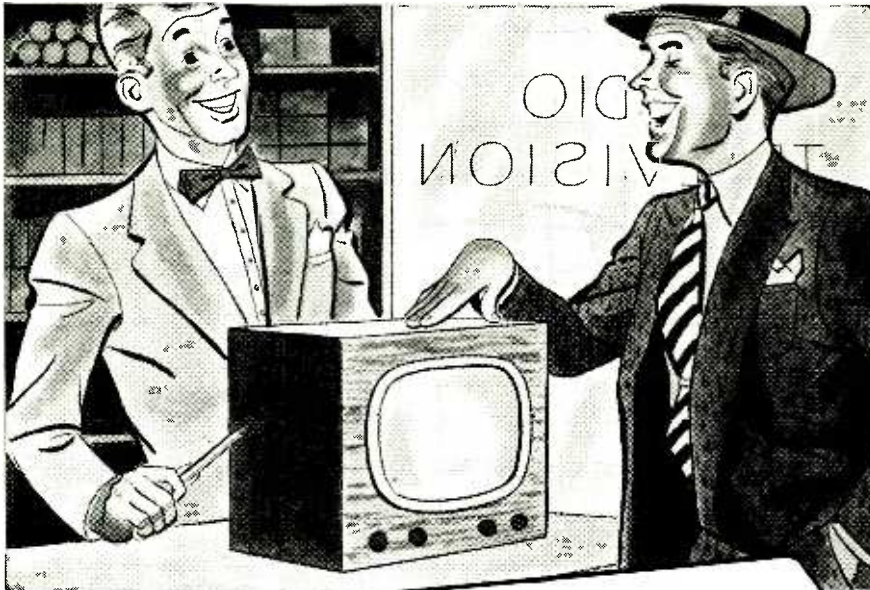

This man is your MOST VALUABLE BUSINESS ASSET!

A satisfied customer—the keystone of any successful business! You endanger customer good will when you use “just-as-good” replacement parts on your repair jobs. Use quality OHMITE components—known the world over for dependability among servicemen, amateurs, and design engineers—and you can be sure of customer satisfaction every time. It’s just good business!

OHMITE MANUFACTURING COMPANY
4894 Flournoy St., Chicago 44, Ill.

Be Right with OHMITE®
RHEOSTATS • RESISTORS • TAP SWITCHES



Write FOR STOCK CATALOG

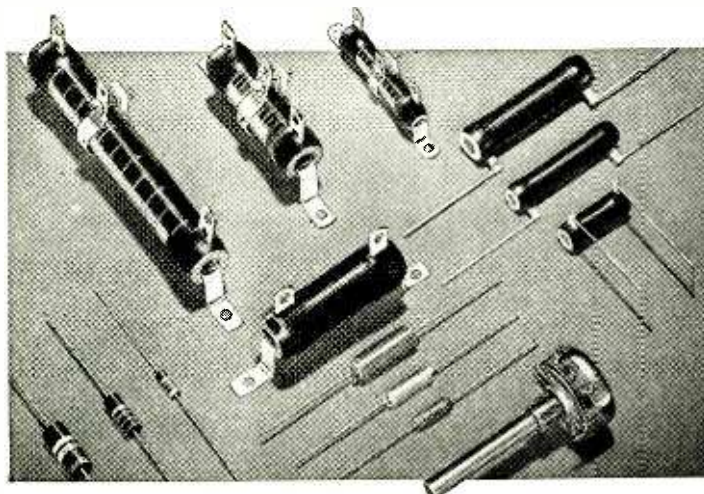

of the output voltage. Fig. 2 shows the complete circuit diagram.

The physical details

My attenuator is mounted in a small aluminum box 8 x 4 x 4 inches. It is important that the attenuator be well screened. The resistors R1 and R2 are assembled on a 4-pole 4-position switch so that the resistors R1 and R2 are on the front wafer and the resistors R1' on the rear wafer. From this rear wafer a wire runs through the partition to the potentiometer R3, which is at the rear. Metal screens are also mounted between the two wafers of the switch

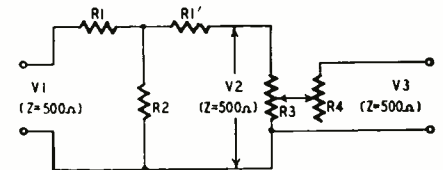

Fig. 1—The basic attenuator circuit.

and between the potentiometers, as shown in the inside view photo. The exact values of the resistors are obtained by connecting different resistors in parallel. For the lower values resistance wire can be bifilar-wound on a high-ohm resistor.

The instrument is finished with a panel carrying a range scale for the switch and a linear scale calibrated

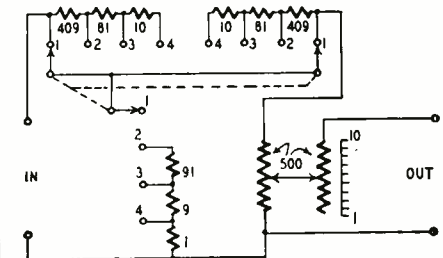

Fig. 2—The complete circuit diagram. Odd-sized resistors can be made up by paralleling two or more. The scale by the output potentiometer represents that for the right knob on the panel.

from 1 to 10 for the potentiometers, as shown in the photo. From the screening point of view, flush-mounted pin jacks and plugs might have been better than the pin jack binding posts used.

The attenuator is, of course, simply inserted between the audio generator and the load and the output adjusted to 10 volts in Position 1. Then the switch can be moved to the position giving the desired attenuation.

On this attenuator the maximum load is 25,000 ohms. This causes a very slight drop in voltage. It is very seldom an amplifier has so low an input impedance. For lighter loads (higher impedances) the voltage drop is negligible. The attenuator can also be calibrated in db if one would prefer using decibels instead of volts. With the equations above it is also easy to calculate the design of attenuators for different ranges or different impedances.

—end—

LEARN RADIO



INSIDE OUT!

THAT's the way to become an expert radio service man. Study the theory and principles first. These are vitally important. Then roll up your sleeves and actually work with radios — assembling, experimenting, trouble-shooting, repairing. That way you learn radio *from the inside out.*

Which explains why I.C.S., in its new Radio Course, concentrates on *equipment*. You get the best. Matched parts for an excellent 5-tube superheterodyne receiver. Your own professional-quality multitester. A complete signal generator

kit. High-grade servicemen's tools. "Rider's Perpetual Trouble-Shooter's Manual." Plus lesson material and instruction service second to none. Also included is Principles of Television, which is a steppingstone to TV installation and service.

Learn by doing! That's the world-famous I.C.S. method. Thoroughly practical. Completely modern. *Success proved.* The coupon below brings you full details—on radio servicing or on any of the more than 400 I.C.S. Courses. Mark and mail it *today!*

INTERNATIONAL CORRESPONDENCE SCHOOLS

BOX 2882-G, SCRANTON 9, PENNA.

APPROVED
under the
G. I. BILL

Without cost or obligation, please send me full particulars about the course *before* which I have marked X:

- | | | | | |
|---|---|---|--|---|
| <p>Air Conditioning and Plumbing Courses</p> <p><input type="checkbox"/> Air Conditioning
<input type="checkbox"/> Heating <input type="checkbox"/> Plumbing
<input type="checkbox"/> Refrigeration
<input type="checkbox"/> Steam Fitting</p> <p>Chemical Courses</p> <p><input type="checkbox"/> Chemical Engineering
<input type="checkbox"/> Chemistry, Analytical
<input type="checkbox"/> Chemistry, Industrial
<input type="checkbox"/> Chemistry, Mfg. Iron and Steel</p> <p><input type="checkbox"/> Petroleum Refining
<input type="checkbox"/> Plastics
<input type="checkbox"/> Pulp and Paper Making</p> <p>Civil Engineering, Architectural and Mining Courses</p> <p><input type="checkbox"/> Architectural Drafting
<input type="checkbox"/> Architecture
<input type="checkbox"/> Building Estimating
<input type="checkbox"/> Civil Engineering
<input type="checkbox"/> Coal Mining</p> | <p><input type="checkbox"/> Contracting and Building
<input type="checkbox"/> Highway Engineering
<input type="checkbox"/> Lumber Dealer
<input type="checkbox"/> Reading Structural Blueprints
<input type="checkbox"/> Sanitary Engineering
<input type="checkbox"/> Structural Drafting
<input type="checkbox"/> Structural Engineering
<input type="checkbox"/> Surveying and Mapping</p> <p>Communications Courses</p> <p><input type="checkbox"/> Electronics <input type="checkbox"/> Television
<input type="checkbox"/> Practical Telephony
<input type="checkbox"/> Radio, General
<input type="checkbox"/> Radio Operating
<input type="checkbox"/> Radio Servicing
<input type="checkbox"/> Telegraph Engineering</p> <p>Electrical Courses</p> <p><input type="checkbox"/> Electrical Drafting
<input type="checkbox"/> Electrical Engineering
<input type="checkbox"/> Electric Light and Power
<input type="checkbox"/> Lighting Technician
<input type="checkbox"/> Power House Electric
<input type="checkbox"/> Practical Electrician
<input type="checkbox"/> Ship Electrician</p> | <p>Internal Combustion Engines Courses</p> <p><input type="checkbox"/> Auto Technician
<input type="checkbox"/> Aviation
<input type="checkbox"/> Diesel-Electric
<input type="checkbox"/> Diesel Engines
<input type="checkbox"/> Gas Engines</p> <p>Mechanical Courses</p> <p><input type="checkbox"/> Aeronautical Eng'r's, Jr.
<input type="checkbox"/> Aircraft Drafting
<input type="checkbox"/> Flight Engineer
<input type="checkbox"/> Forging <input type="checkbox"/> Foundry Work
<input type="checkbox"/> Heat Treatment of Metals
<input type="checkbox"/> Industrial Engineering
<input type="checkbox"/> Industrial Instrumentation
<input type="checkbox"/> Industrial Metallurgy
<input type="checkbox"/> Machine Shop
<input type="checkbox"/> Machine Shop Insp.
<input type="checkbox"/> Mechanical Engineering
<input type="checkbox"/> Mold-Loft Work
<input type="checkbox"/> Patternmaking—Wood, Metal
<input type="checkbox"/> Reading Shop Blueprints
<input type="checkbox"/> Sheet-Metal Drafting
<input type="checkbox"/> Sheet-Metal Worker
<input type="checkbox"/> Ship Drafting
<input type="checkbox"/> Ship Fitting</p> | <p><input type="checkbox"/> Tool Designing
<input type="checkbox"/> Toolmaking
<input type="checkbox"/> Welding—Gas and Elec.</p> <p>Railroad Courses</p> <p><input type="checkbox"/> Air Brake
<input type="checkbox"/> Car Inspector
<input type="checkbox"/> Diesel Locomotive
<input type="checkbox"/> Locomotive Engineer
<input type="checkbox"/> Locomotive Fireman
<input type="checkbox"/> Locomotive Machinist
<input type="checkbox"/> Railroad Section Foreman
<input type="checkbox"/> Steam-Diesel Loco. Eng.</p> <p>Stationary Engineering Courses</p> <p><input type="checkbox"/> Boilermaking
<input type="checkbox"/> Combustion Engineering
<input type="checkbox"/> Engine Running
<input type="checkbox"/> Marine Engineering
<input type="checkbox"/> Power Plant Engr.
<input type="checkbox"/> Steam Engineering</p> <p>Textile Courses</p> <p><input type="checkbox"/> Cotton Manufacturing
<input type="checkbox"/> Fancy Cotton Weaving
<input type="checkbox"/> Loom Fixing
<input type="checkbox"/> Rayon Weaving
<input type="checkbox"/> Textile Designing
<input type="checkbox"/> Woolen Manufacturing</p> | <p>Business and Academic Courses</p> <p><input type="checkbox"/> Accounting <input type="checkbox"/> Advertising
<input type="checkbox"/> Bookkeeping
<input type="checkbox"/> Business Administration
<input type="checkbox"/> Business Correspondence
<input type="checkbox"/> Business Law
<input type="checkbox"/> Cert. Pub. Accounting
<input type="checkbox"/> Commercial
<input type="checkbox"/> Commercial Art
<input type="checkbox"/> Cost Accounting
<input type="checkbox"/> Federal Tax
<input type="checkbox"/> First Year College
<input type="checkbox"/> Foremanship <input type="checkbox"/> French
<input type="checkbox"/> Good English
<input type="checkbox"/> High School
<input type="checkbox"/> Higher Mathematics
<input type="checkbox"/> Illustration
<input type="checkbox"/> Industrial Supervision
<input type="checkbox"/> Motor Traffic
<input type="checkbox"/> Postal Civil Service
<input type="checkbox"/> Retailing
<input type="checkbox"/> Retail Bus. Mgmt.
<input type="checkbox"/> Salesmanship
<input type="checkbox"/> Secretarial
<input type="checkbox"/> Sign Lettering
<input type="checkbox"/> Spanish <input type="checkbox"/> Stenography
<input type="checkbox"/> Traffic Management
<input type="checkbox"/> Typing</p> |
|---|---|---|--|---|

Name _____ Home Address _____ City _____ State _____
 Age _____ Present Position _____ Employed by _____ Working Hours _____ A.M. to _____ P.M.
 Length of Service in World War II _____

Enrollment under G. I. Bill approved for World War II Veterans. Special tuition rates to members of the Armed Forces. Canadian residents send coupon to International Correspondence Schools Canadian, Ltd., Montreal, Canada.

Specially Designed

for
TV
Technicians

New **OVER/UNDER**
WELLER
SOLDERING GUN

For ticklish TV soldering, there's no tool like the new 135-watt Weller Gun. Dual spotlights eliminate shadows. Precision balance assures accurate soldering. Long length reaches deep into chassis. 5-second heating saves time and current. Your Weller Gun pays for itself in a few months.



Check This Exclusive Combination of Features

- **5-SECOND HEATING**—No waiting. Saves power.
- **OVER/UNDER DESIGN**—Tube construction gives bracing action to tip, and improves visibility.
- **DUAL SOLDERLITE**—Prefocused spotlights completely eliminate shadows—let you see clearly.
- **LONGER REACH**—Slides easily into the most complicated set-up. Reaches tight corners.
- **COMPACT DESIGN**—Streamlined and precision balanced for delicate "pin-point" soldering.
- **TRIGGER-SWITCH CONTROL**—Adjusts heat to the job. No need to unplug gun between jobs.
- **DUAL HEAT**—Single heat 100 watts; dual heat 100/135 watts; 120 volts, 60 cycles. Handles all light-duty soldering.

See new Model WD-135 at your distributor, or write for bulletin direct.

• **SOLDERING GUIDE.** Get your new copy of "Soldering Tips"—revised, up-to-date and fully illustrated 20-page booklet of practical soldering suggestions. Price 10c of your distributor, or order direct.

WELLER
ELECTRIC CORP.
828 Packer Street, Easton, Pa.

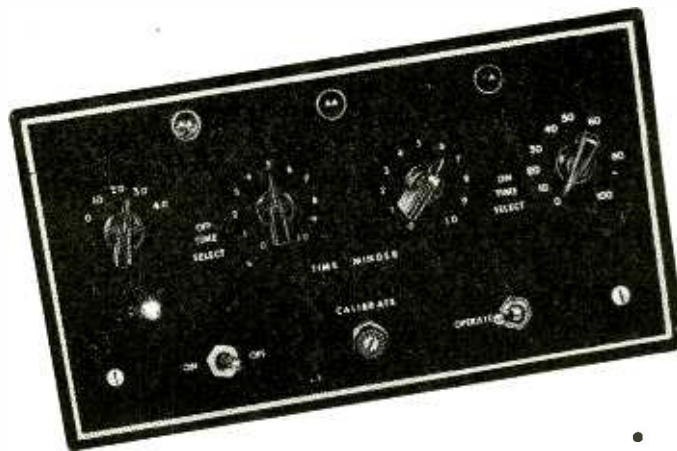

Front panel of the "Time Minder." The selector switches show total time.

Automatic Electronic Timer Varies On and Off Periods

By WILLIAM H. MINOR

A FULLY automatic electronic timer has a number of practical uses. Unlike the semiautomatic timers that have appeared in various radio magazines, this one times both the on and the off periods, each independent of the other, in 1-second steps. The maximum ON period is 50 seconds, while the OFF period varies from a short pulse to 120 seconds. The circuit appears in Fig. 1.

The instrument, now called the "time minder," has a timing error of considerably less than the 10% which was

originally allowed in the design. This was done by carefully selecting resistors having the least variation from the nominal value. Even at that, the error can be disregarded for many applications as long as the error itself is constant, as it is with this timer.

The timer is most useful for the photographer who makes a great number of prints from the same negative or from negatives requiring equal exposure times. In such work it saves much time and eliminates many unnecessary motions. The operator has

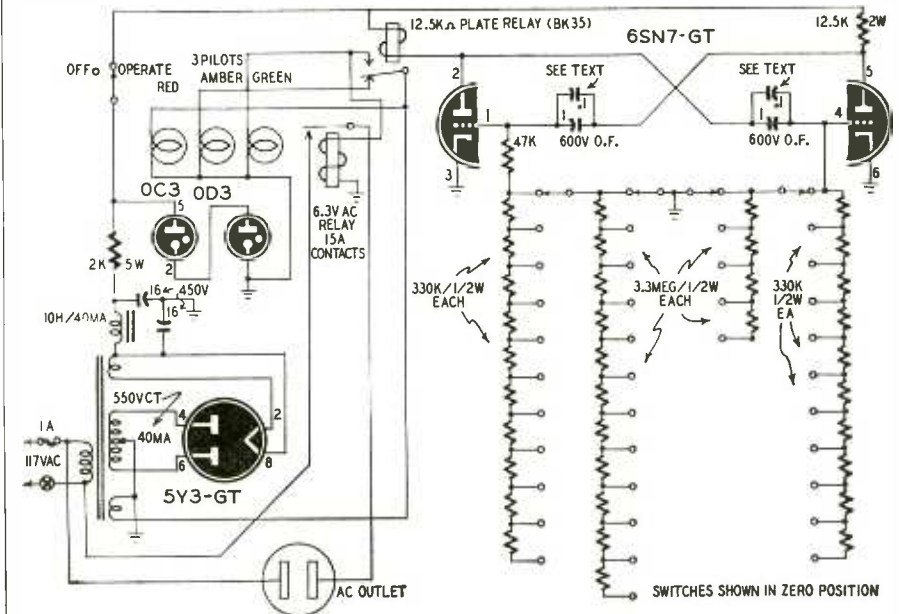

Fig. 1—The timer circuit. Accuracy is good if resistors are carefully picked.

NEW INDICATOR ION TRAP

*A
Rauland
"Exclusive"*



Speeds Service—Builds Profits

Rauland's new Indicator Ion Trap is winning the cheers of more service men and dealers every day—because of the time and trouble it saves in Ion Trap Magnet adjustment, and because it eliminates mirrors and guesswork.

Now it's a matter of seconds to adjust the ion trap magnet with absolute precision. The service man simply moves the magnet until the signal glow is reduced to minimum.

This important new Rauland development is incorporated in all Rauland tubes produced today—as a feature of Rauland's new Tilted Offset Gun. This gun offers the additional advantages of giving only a single Ion Trap Magnet and of maximum sharpness of focus.

Only Rauland offers this advanced feature—one of half a dozen post-war developments from Rauland.

For further information, write to...

THE RAULAND CORPORATION



Perfection Through Research

4245 N. KNOX AVENUE • CHICAGO 41, ILLINOIS



RAULAND

The first to introduce commercially these popular features:

Tilted Offset Gun

Indicator Ion Trap

Luxide (Black) Screen

Reflection-Proof Screen

Aluminized Tube



AT HOME



Above is a small portion of the Jackson test equipment used in the Electronic Laboratories at Temple University, Philadelphia. There hundreds of technicians and engineers are graduated yearly. Jackson is proud to have played such an important role in the careers of these people.

AND ABROAD



Jackson equipment displayed by LARI R at the 1950 International Television Show in Milan, Italy. In Europe, as in the United States, Jackson instruments are selected for television servicing.

JACKSON Instruments are a world-wide standard for the Radio and Television Industry.

WRITE for new '51 catalog

JACKSON ELECTRICAL INSTRUMENT COMPANY
Dayton 1, Ohio

only to pretime himself on the time he needs to remove and insert a new sheet of paper in the printing position and set the OFF period (with a slight margin of safety) to that time. The ON period is set to the time required to produce the proper contrast when the paper is correctly developed. After that the operator does no more than remove and insert paper while the instrument does the rest of the exposing process.

If the operator makes a mistake, he immediately opens the OPERATE switch and the enlarger lamp is extinguished. A word of caution: After resetting the switch to OPERATE position, the multivibrator should be allowed at least one full cycle to re-establish its sequence before proceeding with the process.

About the circuit

A type 6SN7-GT dual triode is used in a conventional multivibrator with the load resistor in one section replaced with a sensitive relay (12,500 ohms). In this circuit the BK-35 relay, from a surplus marker beacon receiver BC-1033 was used since it was readily available. The resistor in the other plate should match the relay resistance. The grid circuit of either stage is coupled to the opposing plate through a parallel combination of a 1- μ f and a .1- μ f capacitor. The grid resistor is variable by switching to choose the series total of the 330,000-ohm and 3.3-megohm resistors. Each 330,000-ohm resistor times 1 second while the 3.3-megohm resistor, being 10 times the value, offers 10-second steps. The calibrator that shows in the front panel photo is not used.

The ON period has a minimum pulse time of about 0.1 second and when the switch is set to the zero position a 47,000-ohm resistor is in the grid-to-ground circuit. This resistor is never removed from the circuit and its time adds to the selected times.

When the triode containing the load relay conducts, the relay closes and operates a 6.3-volt a.c. relay. This latter relay has contacts which will handle 15 amperes in series with the 110-volt outlet plug from which the appliance is operated. The load at 15 amperes should be noninductive. This particular arrangement was chosen so the plate relay could be made to operate the indicating pilot lamps.

To insure against frequency changes due to varying plate potentials, the tube is supplied by two voltage regulator tubes giving 255 volts d.c. The effect of regulator failure is instantly obvious if one tube is removed from its socket. Timing, though not necessarily erratic, changes from the desired value.

The circuit was completed with the exception of the .1- μ f capacitor paralleling the 1- μ f coupler. With the periods set to 10 seconds, timing was checked with a stop watch while different values of shunt capacitance were added. The .1- μ f capacitor set the time to within $\frac{1}{10}$ second for the 10-second period. No further calibration is necessary.

Commercially available cabinets are suitable for construction of the time



Play This
Winning Combination
OF

TV PROFIT MAKERS

50-STATIONS-50



MODEL HIR TENNA-ROTOR is the only fully automatic rotator. Just set it and forget it. Your antenna turns to the proper position and stops. North—East—South—West—direction indicator dial shows exact antenna position at all times. Extremely accurate!

THIS NEW TV BOOSTER features one simple control. Automatic on-off switch gives maximum, uniform high gain on all channels—quick to install. An excellent companion item to the Tenna-Rotor. The New Alliance Tenna-Scope!

NATION-WIDE TV ADVERTISING PRE-SELLS! Tenna-Rotor is the only TV accessory backed by a powerful, sustained television campaign—national in scope. Alliance Tenna-Rotor offers faster installation with 4-conductor "Zip" cable. Works in any weather. 1-year guarantee. U. L. approved.

ALLIANCE MANUFACTURING COMPANY • Alliance, Ohio

GET AHEAD FASTER IN RADIO-TELEVISION ELECTRONICS

Use the HANDBOOKS
the EXPERTS USE

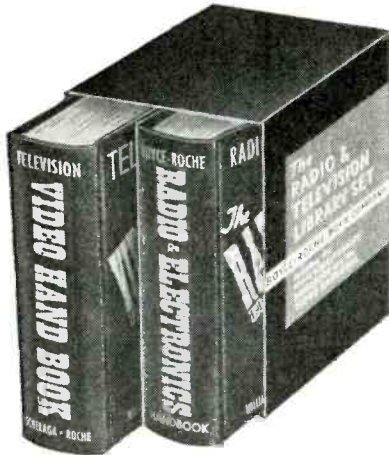

The library set assists you in every operation in radio, television and electronics. Gives you the fundamentals, complete ground work understanding of all types of radio, television, electronic gear and their circuits, including theory of operation.

Shows you expert methods of planning, building, installing, operating, testing, adjusting, and servicing. The know-how of radio, television and electronics presented in plain language and simple terms with easy to understand pictures and working diagrams.

Complete Data Section containing hundreds of pages over all. Color codes, cable charts, wire tables, screw sizes, mounting dimensions, symbols, abbreviations, charts, graphs, tables, formulas, standards, and vacuum tubes including cathode ray tubes.

You get 1800 pages of basic knowledge, methods and data of radio, television, electronics completely illustrated with over 2000 pictures, drawings, codes, charts and graphs.

Written by the Boyce-Roche experts who make electronic manuals for the U. S. Signal Corps.

RADIO & ELECTRONICS HANDBOOK provides instruction and reference on fundamentals, parts, tubes, circuit elements, receivers, transmitters, amplifier systems, power supplies, antennas, meters, test equipment, and accessories, with complete Data Section.

VIDEO HANDBOOK teaches television and provides complete handbook reference on all phases with full sections on principles of television, receivers, antennas, test equipment, servicing, pattern interpretation, transmitters, show production and more.

**SEND NO MONEY
10 DAY FREE EXAMINATION**

SPECIAL OFFER—Save one dollar. Get both books described above in handsome slip case as shown for only\$10.90
(only while special Library Set offer lasts)

BOYCE ROCHE BOOK CO.
Caldwell 45, New Jersey

Send Library Set @ \$10.90
 Radio & Electronics Handbook @ \$5.95
 Video Handbook @ \$5.95

In ten days I will send you price plus postage or I will return book(s) postpaid. (Offer good only in U. S.)

Name

Address

City, Zone, State

Employed By

Save Postage. We pay postage if you enclose full price now. Money back on same return privilege.

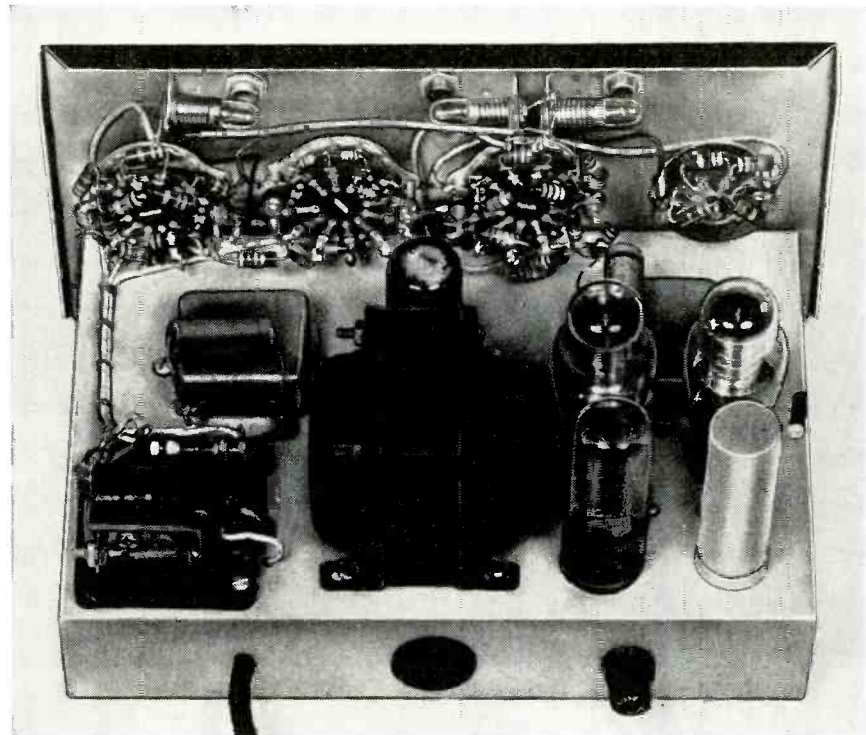

Rear view of the timer. All the timing resistors are mounted on the switches.

minder. The one pictured was folded in the shop from ½ hard aluminum from the junkyard war surplus. The finish is several coats of synthetic aircraft lacquer, and commercial decals added the final touch.

The resistors of the timing circuit are soldered directly to the switches before the switches are mounted on the panel. Any and all wires in the circuit may be cabled for a neat appearance. The timing is the arithmetic sum of the values appearing on the decals.

The timing design

In the original design a choice of R and C had to be made to produce at

least a rough approximation of the desired 1-second period. The tube current was assumed to be the 10 milliamperes and it was assumed that conduction would start in either tube when its grid reached the value of -4 volts.

A current flow of 10 ma creates a drop of 125 volts in the load resistor and the grid of the opposite tube would then be driven to a -125 volts, at which time the capacitor would charge toward 0 potential. Charging follows the curve:

$$e = Ee^{-\frac{t}{RC}}$$

Sufficient information is then given to solve the equation for the required R-C combination.

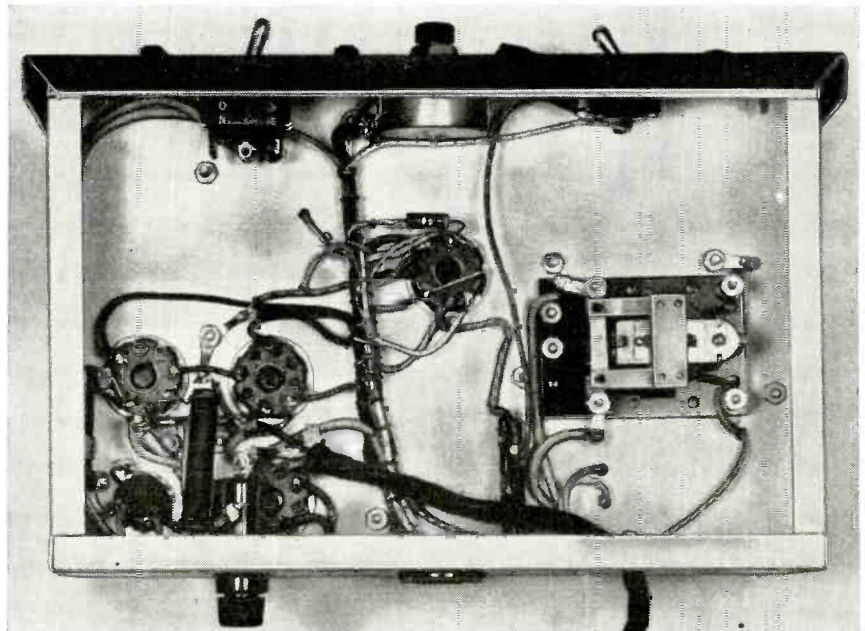

The underside of the timer's chassis. The wiring is all cabled for neatness.

MOST POWERFUL

ANTENNA COMBINATION IN TV HISTORY

**SINGLE
CHANNEL**

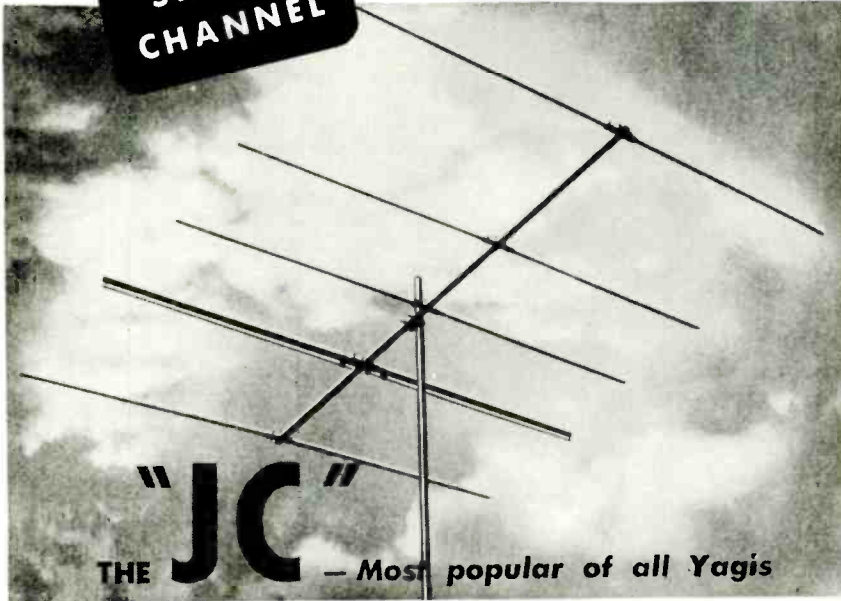

"JC"
THE **JC** — Most popular of all Yagis

NEW Stacked Arrays

PRODUCE SHARP, CLEAR PICTURES AT AMAZING DISTANCES

Vee-D-X — largest producer of Yagis — brings you new stacked arrays that provide still higher gain and further reduce noise interference. Perfected by Vee-D-X engineers in collaboration with a foremost authority on wave propagation, these stacked arrays make a world of difference in picture quality. In addition to the already popular double stacked array ("A" below) with half-wave spacing, you can employ double stacked arrays with full-wave spacing ("B" below) and half-wave four stacked, either vertical or side-by-side. Choice of array depends on area terrain and reception conditions.

POWERFUL STACKED ARRAYS FOR ALL SINGLE CHANNEL REQUIREMENTS

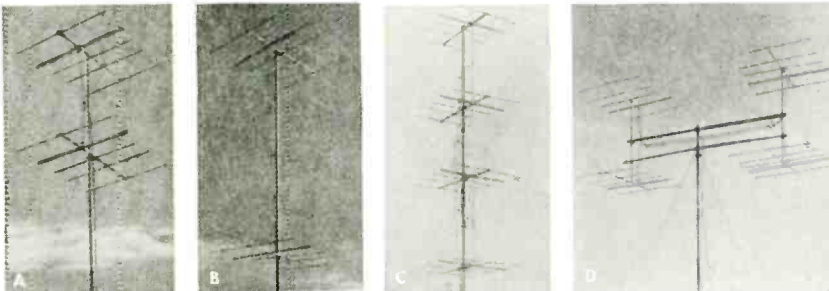

(A) Double Stacked JC Array with half-wave spacing. Provides additional gain and improved signal-to-noise ratio.

(B) Double Stacked JC Array with full-wave spacing. Provides highest possible gain in low noise areas.

(C) Four Stacked Vertical JC Array provides extremely high gain and excellent improvement of signal-to-noise ratio. Ideal for long distance reception areas with relatively flat terrain.

(D) Four Stacked Side-by-side JC Array — a radically new type of array developed for highest gain in hilly and mountainous terrain. Provides powerful long distance reception.

**ALL
CHANNEL**

COLINEAR ARRAY

*The New Favorite
in Areas Where Both High and Low
Channel Reception is Required*

This exclusive Vee-D-X antenna was developed to fill the need for more powerful all-channel reception in primary as well as fringe areas. Besides producing higher gain throughout the TV spectrum, the Colinear may be cut to any single high channel for sharp directivity, yet will resonate on low channels regardless of high channel selected. Like the Vee-D-X JC Yagi, the Colinear is completely pre-assembled. It is also the lowest priced four-bay array ever manufactured.

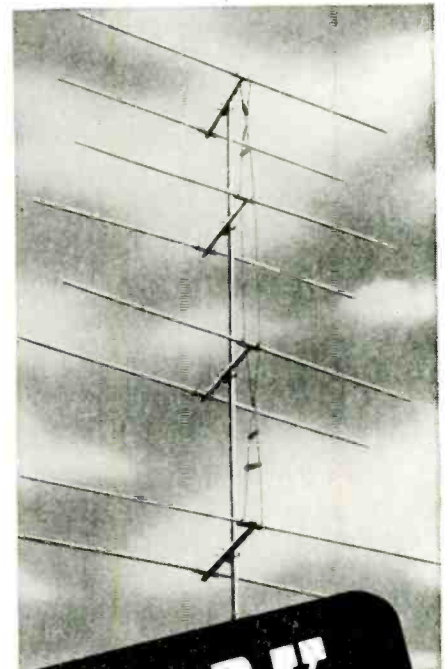

VEE-D-X
THE WORLD'S
MOST POWERFUL ANTENNAS

THE LAPOINTE - PLASCOMOLD CORPORATION, WINDSOR LOCKS, CONNECTICUT
MAY, 1951

"When did you last change your Phono-Cartridge?"



That's your \$70 (Million) question, Mr. Service-Dealer!

Right now . . . 10,000,000 old style, heavy, stiff-acting phono-cartridges in existing record players are *obsolete*. They limit reproduction. They rapidly wear out valuable records. They should be replaced immediately with *modern, lightweight, compliant* cartridges that guarantee greater record enjoyment, longer record and needle life. Current cartridges that operate inefficiently should be replaced, too.

So check the cartridge on every job . . . ask every record player owner this simple question: "When did you last change your phono-cartridge?" You'll render a service your customers will appreciate—you'll sell replacements like never before—you'll make more money!

Now for better playing, record saving performance . . . REPLACE . . . MODERNIZE with easy-to-install E-V Cartridges. Exclusive features of E-V Torque Drive make it ideal for fast and slow speed records. Has extra-high voltage-compliance ratio. No bearings or bushings to deteriorate. Simplified design permits maximum replacements with fewer models. Single and dual needle types. Used today in original equipment of many leading manufacturers.

Make the Finger-Tip Compliance Test



Modern, compliant needle system

Old style, stiff-acting needle system

Electro-Voice

421 CARROLL STREET • BUCHANAN, MICHIGAN
Export: 13 East 40th St., New York 16, N.Y., U.S.A. Cables: Arlab



FREE!

REPLACEMENT CHART

Large, Complete Replacement Chart. Gives handy cross-reference and valuable data. Tells when to replace a phono-cartridge. Ask your E-V Distributor or send for it now.

Electro-Voice, Inc.
421 Carroll St., Buchanan, Michigan
Send FREE Cartridge Replacement Chart

Name.....
Address.....
City.....Zone.....State.....

The capacitor which took the grid to -125 volts must charge 95% of its excursion to 0, which upon solution of the equation proves to be

$$t = RC \left(R \text{ in ohms } C \text{ in farads} \right)$$

or $RC = 0.33$ when t equals 1 second since $0.33 \times 10^{-6} \times 1 \times 10^{-6} = 0.33$

R was taken as 330,000 ohms and C as 1 μf .

Actually the design and end results were close enough together that the timing did fall within the allowed 10% error. The addition of the .1- μf capacitor merely corrected existing errors to a closer approximation.

The timing resistors used in this instrument were selected to provide the most convenient timing intervals to suit the uses for which the timer was designed. Other constructors may find different values more useful for their particular needs. These can be calculated by using the steps given above.

More positions can be included in the OFF TIME SELECT switch. In this instrument it provides only 40 seconds total time, which was adequate for the timer's original purpose. As many as 10 positions will work satisfactorily in this circuit.

Materials for Timer

Resistors: 1—47,000, 20—330,000 ohms, 16—3.3 meg-ohms, 1/2 watt; 1—2,000 ohms, 1/2 watt; 1—12,500 ohms, 2 watts (selected from 12,000-ohm standard value to match relay resistance).

Capacitors: 2—0.1 μf , 600 volts, paper; 2—1 μf , 600 volts, oil filled; 2—16 μf , 450 volts, electrolytic.

Miscellaneous: 1—550-volt at 40 ma center-tapped transformer with 5-volt and 6.3-volt windings; 1—10-henry, 40-ma choke; 1—12,500-ohm relay (BK35); 1—6.3-volt relay with 14-amp contacts; 1—6SN7-GT, 1—5Y3-GT, 1—0C3, 1—0D3, tubes and sockets; 3—single-pole, 11 position, 1—single pole, 6 position, 2—s.p.s.t., switches; 3—pilot lamps and assembly; 1—female a.c. outlet; 1—1 amp fuse and holder; chassis, hookup wire, and assorted hardware.

—end—

SIMPLE STROBOSCOPE

A stroboscope for studying rotary or reciprocating motion can be made from a few inexpensive parts which can probably be found on the average experimenter's workbench. It draws negligible power and can be operated from dry batteries or any supply delivering 120 to 250 volts d.c.

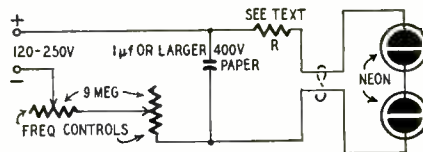

The circuit is basically a variable-frequency relaxation oscillator using neon tubes. These are mounted on the end of a length of 2-conductor cable so their light can be concentrated on the object in motion. A high resistance is required for a wide range, so we used two 9-megohm variable resistors in series. Two controls in series provide a sort of vernier action which makes it easier to adjust the strobo to the desired frequency. Two 10-megohm units will work just as well and will probably be easier to acquire. Resistor R protects the neon lamps. Refer to manufacturer's data for its resistance.—
O. C. Vidden



Frank J. Moch says—
 "there is no other **OSCILLOSCOPE**
 like the **NEW Simpson MODEL 476**
MIRROSCOPE"

FRANK J. MOCH,
 president of the
 National Alliance of Television and
 Electronics Service Associations.

Simpson's new and completely advanced type of oscilloscope—Model 476 **MIRROSCOPE**—is designed to eliminate certain inherent disadvantages found in the conventional type of oscilloscope by use of the "Mirroscope principle." In this kind of construction the 5-inch cathode ray tube is mounted in a vertical position, thus reducing bench space requirements to an area of only 9" x 8" thereby permitting better concentration of associated equipment for any type of test procedure. The cathode ray image is reflected from an optical type front surfaced mirror mounted in the adjustable cover at the top of the cabinet bringing the viewing surface of instrument near eye level when instrument is used on benches of normal height. The mirror angle is quickly and easily adjusted to any position of the operator. The cover with integral side wings forms an effective shield against external light sources or may be closed down for protection of the tube and mirror when the instrument is not in use. The upright construction permits location of controls and connections for maximum convenience and allows for internal cathode ray tube connections at the front of the panel instead of the rear.

SENSITIVITY:

Vertical direct.12 volts rms per in.
 Vertical amplifier.20 millivolts rms per in.
 Horizontal direct. . . .14 volts rms per in.
 Horizontal amplifier. . . .38 millivolts rms per in.

INPUT IMPEDANCE:

Vertical direct. . . .10 megohms, 15 mmf.
 Horizontal direct. . .10 megohms, 15 mmf.
 Vertical amplifier.300,000 ohms, 30 mmf.
 Horizontal amplifier. . . .500,000 ohms, 15 mmf.

Horizontal trace expansion is over 4 times tube diameter. This makes it possible to examine minute portions of a response pattern for finer detail.

Linear Sweep frequency is continuously adjustable in five overlapping ranges from 15 cycles to 60,000 cycles. Internal, external or line frequency synchronization with variable amplitude is available.

Means for intensity or "Z axis" modulation is provided. Approximately 14 volts peak will blank a trace of normal intensity.

The vertical amplifier frequency response is within 3 DB from 20 cycles to over 300,000 cycles and is usable to well over three megacycles. Square wave slant and over-shoot is held to less than 5 per cent of amplitude. This response will be found adequate for all phases of television receiver service including observation and diagnosis of Sync. signals.

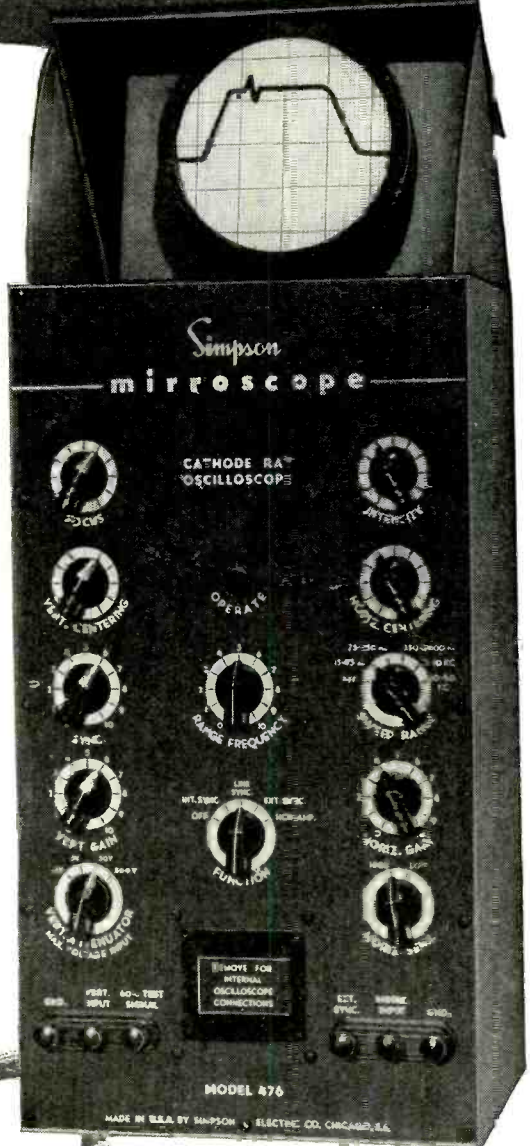

TUBE COMPLEMENT:

- 5UP4 Cathode Ray Tube.
- 4-6J6 Horizontal and Vertical Amplifiers.
- 1-12AU7 Vertical pre-amplifier.
- 1-6J6 Linear Sweep oscillator and Sync. injector.
- 2-6X4 High voltage rectifiers.

LINE VOLTAGE: 105-125 volts, 50-60 cycles.
 SIZE: Height 16 1/4"; Width 9 1/8"; Depth 8" over all
 WEIGHT: 25 lbs.; Shipping weight 30 lbs.
 High Frequency Crystal Probe...\$7.50
 DEALERS NET PRICE including operators manual \$179.50



SIMPSON ELECTRIC COMPANY
 5200 W. Kinzie St., Chicago 44, Ill.
 Phone: Columbus 1-1221
 In Canada:
 Bach-Simpson Ltd., London, Ontario

BURTON BROWNE ADVERTISING

How an Electronic Brain Works

Part VIII—The flip-flop circuit and other methods used to store information in electronic computers

By EDMUND C. BERKELEY and ROBERT A. JENSEN

IN THE previous articles of this series, we have described a simple example of an electric brain made up of relays.

We have shown that we can have a complete, and rather interesting, miniature electric brain made up essentially of the following: 16 registers, each consisting of two relays, which may store

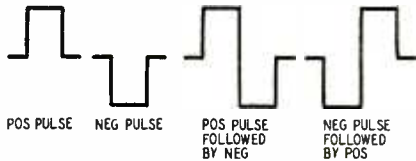

Fig. 1—Pulses like these carry information in electronic computer circuits.

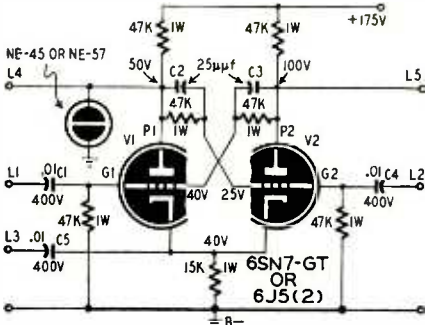

Fig. 2—A flip-flop circuit. V1 is conducting when the voltages are as shown. numbers 0, 1, 2, 3, (in binary, 00, 01, 10, 11), or operations "addition," "negation," "greater-than," "selection" (codes 00, 01, 10, 11); and 1 register, consisting of 5 relays, which stores instructions (codes 00000, 00001, 11111).

There are many problems which require such vast amounts of computation that they have never been attacked by human mathematicians. Relay brains have been able to handle some of these problems. But even a relay brain is too slow for the biggest problems, such as computing the aiming direction of a missile that will intercept another one (like a buzz-bomb) in time to shoot it down. The fastest that an ordinary relay can operate is about 5 or 10 milliseconds. However the fastest that an electronic tube can operate is better than a microsecond.

So, with our background of understanding how a relay automatic computer operates, we can now set out to see how an electronic brain can operate that would compute a thousand times faster than a relay brain. We must translate the ideas we have been dealing with out of the language of relays into the language of electronic tubes.

It must be remembered that no one has yet constructed a complete operating miniature electronic brain. Consequently most of the information here given is derived from work that has been done with the giant electronic automatic computers.

Information

How shall we make electronic equipment express information? In electronic computers, just as in relay computers, the basic piece of information is a binary digit, a yes or a no, a 1 or a 0, a tube conducting or not conducting, the presence or absence of a certain change of voltage, etc. It is much easier

and more direct to construct an electronic computer that operates in the pure binary system than it is to construct one that operates in the decimal system.

There are several main systems for representing information. The first system is that 1 is represented by a pulse of voltage (either positive or negative) at a certain time, and 0 is represented by the absence of a pulse at such time. A second system is that 1 is represented by a positive pulse of voltage, and 0 is represented by a negative pulse of voltage. Here, the absence of a pulse at a time when a pulse is expected becomes a useful indication that something has gone wrong. A third system makes use of a pair of pulses: a positive followed by a negative denotes a 1, and a negative followed by a positive denotes a 0. The second and third systems are more reliable, and for that reason are used in some automatic computers; but the first system is simpler and has the advantage that the presence of information is indicated by a pulse that may be either positive or negative. Fig. 1 shows the pulse arrangements. The minimum duration of a pulse depends on the time of operation of electronic tubes, which range in the neighborhood of 1 microsecond to 1/20 of a microsecond in most computer circuits.

Because of the speed of operation of an electron tube, many automatic electronic computers operate serially—that is with a bus consisting of just one line along which all pulses travel. One of those finished recently (the Bureau of Standards Eastern Automatic Com-

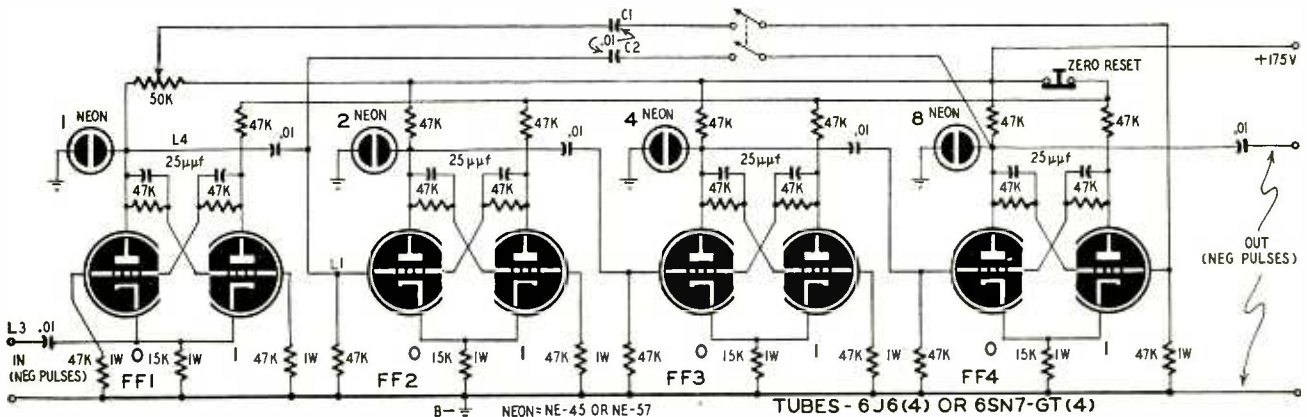

Fig. 3—A binary decade counter. This string of flip-flops is used to count up to and store any number from 0 to 9. Then it resets, passing an impulse to a similar unit, which acts as the "tens" bank, and so to any desired number of decades.



*We're Doing Our Best
to Keep Up With the Demand*



AND THE DEMAND IS PHENOMENAL — far beyond our material limitations . . . but be patient and your order will be delivered. We are distributing TELE-ROTORS uniformly throughout all TV areas . . . so wait . . . don't compromise with quality. **YOU CAN'T BEAT A TELE-ROTOR!**

TELE-ROTOR

This heavy-duty TELE-ROTOR has no match! It's more powerful . . . will turn any TV antenna array under any weather conditions. Easily installed . . . it is trouble-free in performance. Easiest of all to operate!

MODEL TR-2 rotator with "compass control" cabinet having illuminated "perfect pattern" dial . . . (uses 8 wire cable) . . . **\$49.95**

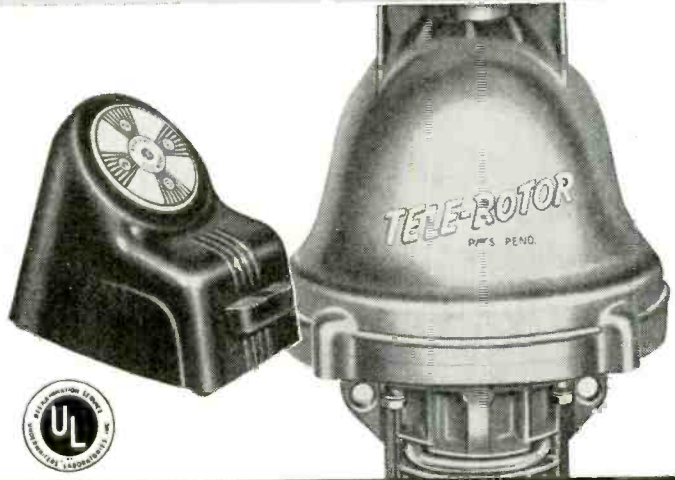

TELE-ROTOR CUB



The new TELE-ROTOR "CUB" is ideal for average installations. The same husky motor as the Heavy-Duty model . . . the "CUB" is the fastest and easiest of all rotators to install. All-In-Line design . . . with true in-line thrust between antenna and mast. The 3/4" STEEL shaft rotates on a case hardened steel ball . . . with inline reamed oilless bearings.

MODEL 502A rotator with plastic control cabinet having indicating meter for "hairline" tuning. (Uses 5 wire cable) **\$44.95**

MODEL 501A rotator with control cabinet having end-of-rotation signal. Light flashes every 7.2° showing antenna is turning. (Uses 5 wire cable) **\$34.95**



CORNELL-DUBILIER SOUTH PLAINFIELD, N. J.

THE RADIART CORPORATION CLEVELAND 2, OHIO

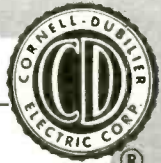

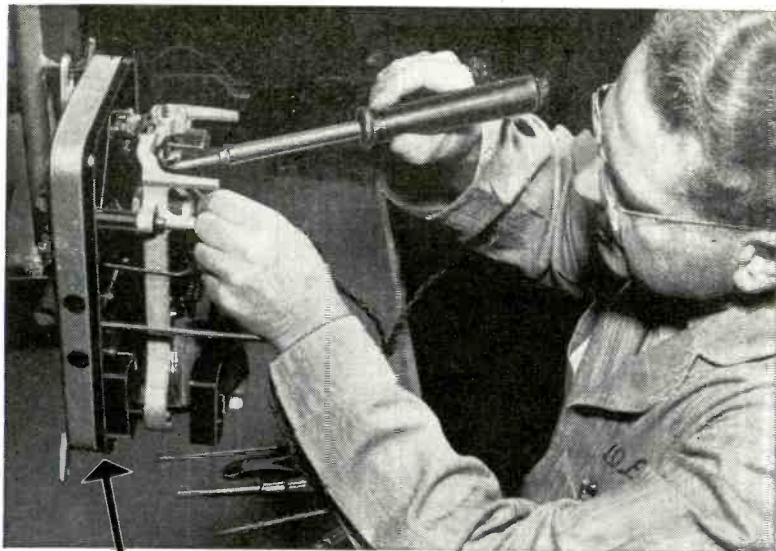

from
INSTRUMENTS
to
ARMATURES

American Beauty

SOLDERING IRONS
for **PRODUCTION JOBS**
LARGE or SMALL!

For descriptive catalog pages write Dept. S-2



DEPENDABLE • DURABLE • EFFICIENT • SINCE 1894

AMERICAN ELECTRICAL HEATER CO.
DETROIT 2, MICH.

puter, in Washington, D. C.) is of this kind, and has a one-line bus along which all pulses travel in a series. It works with numbers of 45 binary digits, and its speed of operation is 1,100 additions or subtractions per second, or 330 multiplications or divisions per second.

But there is one electronic computer (Whirlwind I, built by the Servomechanism Laboratory at Massachusetts Institute of Technology) which uses a 16-line bus along which pulses travel in parallel. It works with numbers of 15 binary digits and an algebraic sign, plus or minus. Because of the parallel bus, this machine is able to reach the speed of 30,000 multiplications per second.

Flip-flop

As we have already seen, the first thing we have to do with a pulse of information is to store it—hold it in such a way that we can use it later. For example, in Simon, we would feed a number into a set of relays and hold it there till we had fed another number into another set. Then we could add the two numbers together, or compare their size, or do something else with them. Without this *memory*—this ability to store a number until it is needed—a computer would be so limited that it would be almost useless.

Large computers may use relays to store information till needed, or they may use electron tubes. One type of computer (such as the International Business Machines Electronic Selective Sequence Calculator, located at 57th Street and Madison Avenue, New York City), uses tubes for very short storage periods and relays for information that has to be stored for longer periods. Information that must be remembered indefinitely is placed on long punched rolls of paper.

If we can make the counter count up to 1,001 (9 in the decimal system) and then reset when the next pulse is received, we have a *decade* counter, or one that counts in tens. (The pulse that resets the first decade is fed to a second as an integer, so that two decades can count to 99.)

One of the standard ways of storing a pulse of information electronically is the *flip-flop* circuit (see Fig. 2). It consists of two triodes (in one envelope, a 6SN7-GT, for example; or in two envelopes, two 6J5's for example), and it has two stable states: (1) triode V1 conducting and triode V2 not conducting; (2) triode V1 not conducting and triode V2 conducting.

Now let us take a look at the operation of the flip-flop. Suppose we put a negative pulse (or voltage drop) on the input lead L1. Capacitor C1 transmits this pulse, and it goes to grid G1. The negative pulse reduces the current through triode V1, and so produces a rise in the plate voltage on plate P1. This positive pulse is at once transmitted through capacitor C2 to grid G2, and starts triode V2 conducting. As it starts to conduct, the current flow lowers the plate voltage on plate P2. This voltage drop is at once transmitted as a

RADIO-ELECTRONICS for

negative pulse through capacitor C3 to grid G1, and makes grid G1 even more negative, tending to cut off triode V1. This process continues and rushes to conclusion in less than a few microseconds. Triode V2 is then conducting (at saturation) and triode V1 is cut off. As long as the power supply is on, the flip-flop records and stores the fact that a negative pulse came along on lead L1. The neon lamp lights when triode V2 is conducting, and indicates a "1" stored in the flip-flop. The lamp is off when a "0" is stored.

Another consecutive negative pulse on L1 will now have no effect, but a positive pulse on lead L1 or a negative pulse on lead L2 will cause the flip-flop to change back to its original state. In regard to lead L2, we can see that a similar description applies symmetrically.

Now let us consider lead L3, which runs through capacitor C5 to the cathodes of both triodes. A negative pulse on this lead will cause a change of state in the flip-flop, no matter which of the two triodes is conducting. So the flip-flop will actually count, 0, 1, 0, 1, 0, 1, 0, 1, 0, depending on the number of negative pulses that come in on this lead. A positive pulse will have no

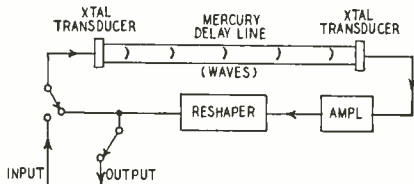

Fig. 4—Storage circuit with a mercury delay line and two crystal transducers.

effect. However, the shaping of these pulses may require additional components, while the shapes of the pulses used on leads L1 and L2 are not too critical.

This flip-flop is very similar to one actually used in the ENIAC, the first big automatic electronic computer. ENIAC was finished in 1946 at the Moore School of Electrical Engineering, and is now operating at the Ballistic Research Laboratories, Aberdeen, Maryland. (The ENIAC flip-flop is described further in a paper "High-Speed N-Scale Counters," by T. K. Sharpless, in *Electronics*, March 1948.)

Now suppose we hitch three more flip-flops in succession to this first flip-flop (see Fig. 3). We impulse FF1 by lead L3, so that (1) it changes state on every pulse, and (2) it puts out on output lead L4 alternately a positive pulse and a negative pulse. We connect lead L4 on flip-flop 1 to lead L1 on FF2; then only negative pulses on L4 cause flip-flop 2 to change state. We make similar connections between FF2 and FF3, and between FF3 and FF4. Then we have a binary counter that will count 0000, 0001, 0010, 0011, 0100, etc., up to 1111. Capacitors C1 and C2 are used to trip the counter back to 0000 after holding 1001. This is the principle used in the 4-tube counter decade described by John T. Potter in *Electronics* of June, 1944.

For storing one binary digit of information, a 1 or a 0, a flip-flop is decidedly expensive. Consequently it is used only in those parts of an automatic computer where a great deal of traffic with information requires the convenience and justifies the expense.

Delay line

Another scheme for storing information in an electronic computer is the *sonic delay line* (see Fig. 4). A sonic delay line consists of material which will transmit pulses as a series of molecular vibrations, more slowly than the usual wire conductor. It may be made of a solid, or of liquid in a tube, or air, in the case of an echo.

For example, think of a long rope, one end in your hand, the other end tied, and the whole rope pulled fairly taut. You shake your hand quickly, and a wave (or pulse) will travel down the rope. As soon as one wave (or pulse) has been started down the rope (or delay line), another can be started almost immediately after it, and the second will follow the first one without interfering with it. Thus what is basically needed for a sonic delay line is any medium down which a pulse may travel. As long as the medium is built suitably, the pulse will not die out until it is needed.

Now in the case of the rope, when the wave or pulse reaches the end of the rope that is tied, the pulse is reflected, and a wave of reversed phase travels back. Of course, reflected waves are not wanted, and a sonic delay line, contrary to the rope, is designed so that reflections are eliminated or rendered unimportant.

We therefore can see that information is stored in a sonic delay line as a series of pulses and absences of pulses, a pattern of 1's (the presence of pulses) and 0's (the absence of pulses).

The pattern is retained by sending it around and around a loop. How do we "write" information in a sonic delay line? We feed a series of pulses and absences of pulses into it. How do we "read" information from the line? We send it along two channels, one the channel back to the front end of the delay line, so that the information will circulate and be remembered, and the other the channel into the part of the computer where we want to use the information, say, into a bank of flip-flops. How do we "erase" information in the delay line? We interrupt the circulating loop long enough so that all the pulses are eliminated.

A type of sonic delay line that has been used quite widely in electronic computers is the *mercury delay line* or *mercury tank* (see Fig. 4). At each end of a long tube filled with mercury is a quartz crystal in contact with the mercury. When a voltage pulse is applied to the quartz, its shape changes (piezoelectric effect). The quartz agitates the mercury, and sends a ripple down the tank. The ripple is picked up at the far end by another quartz crystal and there converted back into an electric pulse. It is somewhat smeared, and so

SURE CURE FOR BATTERY HEADACHES

NO FUSS, NO MUSS WITH
Electro
ELECTRONIC EQUIPMENT
BATTERY ELIMINATORS

SAVE TIME, MONEY...

Servicing DC Equipment From AC Lines!



Model "B"
POWER SUPPLY
with Conduction Cooling

DEMONSTRATE and TEST CAR, AIR, MARINE RADIOS
... also relays, phone circuits, instruments, other low voltage devices. End costly storage battery failures with Electro's dependable power supply. Lower-priced; new exclusive conduction cooling assures lowest cost per ampere output and silent long-life operation. 6 volts, 20 amps.
New Low Cost "BJ" JUNIOR DC POWER SUPPLY, 5 volts, 12.5 amps.

OVER 2 MILLION Battery Radios Offer Huge PROFIT Market!



New Model "5"
BATTERY ELIMINATOR
with Selenium Rectifier

CONVERT BATTERY RADIOS to AC ALL-ELECTRIC
Now is the time your customers want dependable all-electric hum-free performance... tap this big timely market now! Operates any 1.4 volt 4 to 6 tube battery radio from 115 volt 50/60 cycle source. Fits most radios. Guaranteed 3 years.

SEND COUPON NOW!

ELECTRO PRODUCTS LABORATORIES
4507-BS Ravenswood Ave., Chicago 40, Ill.
Send literature and name of nearest source
Name.....
Address.....
City.....Zone...State.....
In Canada: Atlas Radio Corp. Limited, Toronto

RG CABLES

by Amphenol—

AMPHENOL Coax and Twinax Cables are produced to standards surpassing military specifications for electrical performance and mechanical design.

The majority of AMPHENOL'S RG Cables utilize polyethylene which possesses exceptional dielectric properties—low loss, flexibility, mechanical stability. Teflon dielectric is used in others designed to operate efficiently under extremely high temperature conditions.

AMPHENOL RG Cable standards require closer centering of conductors than "AN" specifications—20% closer for Coax and 50% closer for Twinax. Perfection of design, quality of materials and precision of manufacture are basic factors behind the superior performance of AMPHENOL Cables. Specify AMPHENOL, the quality name in electronics.

AMPHENOL

AMPHENOL

AMERICAN PHENOLIC CORPORATION

1830 So. 54th Avenue
Chicago 50, Illinois

is amplified and reshaped, in the loop shown. A mercury tank several feet long will store a pattern of about a thousand pulses about a microsecond apart. So it is equivalent to a thousand flip-flops.

Shorter delay lines are useful for remembering numbers in a computation. Very short delay lines—such as a "one-pulse delay line"—are not of the sonic type but of the electrical type, and consist of a network of capacitors and inductors and are an essential element of the computing circuits of some of the electronic brains. The delays obtainable with a small electrical delay line are from a fraction of a microsecond to a few microseconds.

Mercury delay lines for use in giant automatic electronic computers are being manufactured by the Eckert-Mauchly Computer Corp., Philadelphia, Raytheon Manufacturing Co., Waltham, Mass., and other organizations. The details of their operation in many cases involve trade secrets, although in the literature there is some information about operating details.

It is apparent that if the power goes off, or even flickers, the computer's memory of the pattern of the pulses may be erased in whole or in part. For this reason some of the builders of electronic computers do not like to rely on delay line storage.

Magnetic drum and tape

A compact and efficient device for storing pulses—and storing them even if the power goes off—is the *magnetic drum*. This is a rotating cylinder which may be of different sizes, but one size that has been used is about 12 inches long and 6 or 8 inches in diameter. It usually rotates at 1,800, or 3,600, or 7,200 r.p.m. The drum may be of brass or aluminum, and is coated with a compound containing magnetic particles. The compound is put on like paint, with a brush or spray gun.

Mounted almost touching the drum are small electromagnets or *magnetic heads*, very similar to magnetic tape-recorder heads. The separation between the two sides of the pole piece may be about 3/1000 of an inch, and the distance of the magnetic head from the drum may be perhaps 2/1000 of an inch. A pulse of current passed through the magnetic head causes the recording of a magnetized spot on the rapidly rotating surface of the drum. A positive pulse will cause, say, a north-south magnetization, and a negative pulse vice versa.

The number of magnetized spots in an inch along the perimeter around the drum may be 20 to 60, and the number of channels side by side along the length of the drum may be 8 or 10 to the inch. So if we can get 400 magnetized spots to the square inch, and put them on 250 square inches of drum surface, the magnetic drum will be the equivalent of 100,000 flip-flops. Magnetic drum storage is being used in automatic electronic computers that have been made by the Harvard Computation Laboratory, Cambridge, Mass.,

Engineering Research Associates, St. Paul, Minn., Northrup Aircraft Co., Hawthorne, Calif., and other organizations. Here again very little if any information has been published revealing the exact know-how for reading, writing, and erasing pulses on drums, and the normal procedure has apparently been for each laboratory to work out its own technique.

In general, what is needed, of course, is something that will act like the holes in Simon's program tape to connect the pulses that the pickup head senses, into effective use in the computer at the exact instant the head passes over the point which holds the desired pattern of information.

To accomplish this, the information that is on a channel of the drum is always being "read" by the pickup head whose duty is reading; but the pulses are allowed into the computer only when the computer calls for admission, and an electronic switch allows them to come in. The timing is naturally very important, and is based on a series of permanently-recorded equally-spaced pulses on the drum, called the master clock channel.

Magnetic tape wound on a reel, such as is used in magnetic sound recording, has proved to be an important, useful, and reliable means for "slow storage". By this we mean storage of large quantities of information where a relatively long time (seconds) for access to the information is permissible. Six channels across a quarter-inch width of tape, and 100 magnetized spots to an inch of length seems to be a realizable objective.

Magnetic tape is well accepted as about the best device for input, output, and slow storage in an automatic electronic computer. Raytheon Manufacturing Co. is offering for sale multi-channel magnetic heads for reading (sensing), writing (recording), and

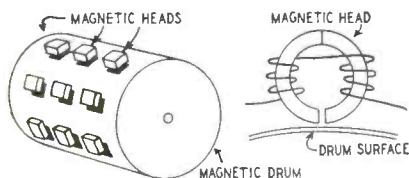

Fig. 5—Magnetic drums make one of the most efficient ways of storing information in smaller electronic computers.

erasing (eliminating) pulses on magnetic tape, and so undoubtedly would furnish details and know-how for using their heads.

Both the delay line and the magnetic drum have the disadvantages that the computer has to wait for the information to become available. If a delay line or a channel on a drum is storing 20 numbers, and the one you want has just gone by, you have to wait for the other 19 numbers to go by before you can pick up the number you want. In the case of a magnetic drum, you could of course put on additional reading heads and read out from that part of the periphery of the drum which is nearest to the location of the number

Reach out **FARTHER...**
and bring 'em in **STRONGER!**



"Long Ranger"

YAGI TV ANTENNA ARRAYS

with High Impedance Driven Element for Direct Match to 300 Ohm Lead-in.

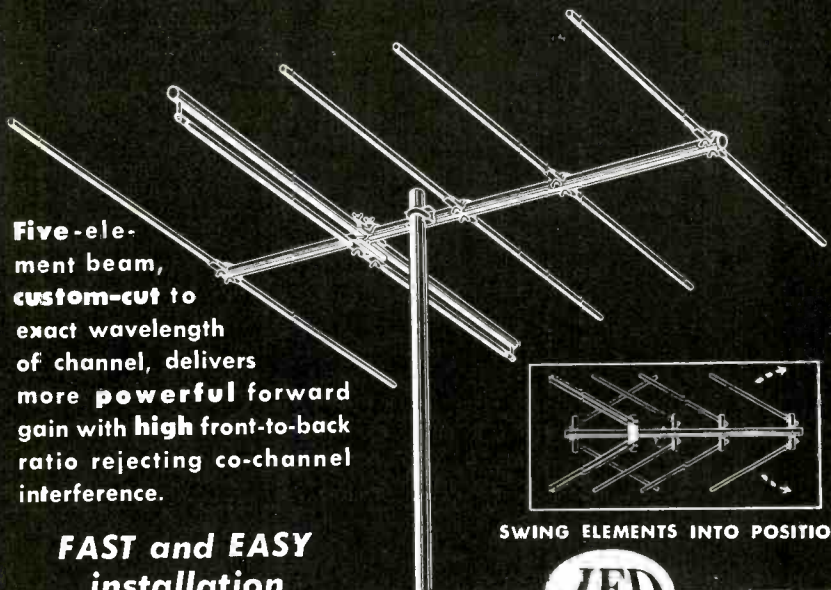

Five-element beam, custom-cut to exact wavelength of channel, delivers more powerful forward gain with high front-to-back ratio rejecting co-channel interference.

FAST and EASY installation

JFD YAGI antennas are completely pre-assembled at the factory. Just swing the "Quik-Rig" elements into position and tighten the wing nuts.

These all-aluminum JFD "Long Ranger" YAGI antennas are something to shout about... because even the really remote stations are now being pulled in with satisfactory viewing results. And JFD advanced design plus sturdy construction assure durability and long-lasting, trouble-free performance. Let these superior JFD installations help you e-x-p-a-n-d your television market.

Write for FREE Technical Data Sheet No. 59

SWING ELEMENTS INTO POSITION



5-ELEMENT YAGIS

LOW BAND

- No. 5Y2 (Channel 2)
- No. 5Y3 (Channel 3)
- No. 5Y4 (Channel 4)
- No. 5Y5 (Channel 5)
- No. 5Y6 (Channel 6)

HIGH BAND

- No. 5Y7 (Channel 7)
- No. 5Y8 (Channel 8)
- No. 5Y9 (Channel 9)
- No. 5Y10 (Channel 10)
- No. 5Y11 (Channel 11)
- No. 5Y12 (Channel 12)
- No. 5Y13 (Channel 13)

"Long Ranger" YAGI antennas for all of the high band channels are also available in stacked array. Jumper bars for stacking of low band "YAGIS" are also available.



MANUFACTURING CO., Inc.

6101 E 16th AVE., BROOKLYN 4, N. Y.
FIRST In Television Antennas and Accessories



SW-54 \$49.95

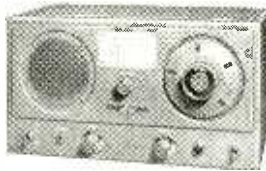

HFS \$142
(less power supply)

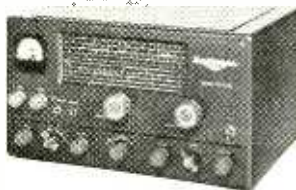

NC-125 \$149.50
(less speaker)

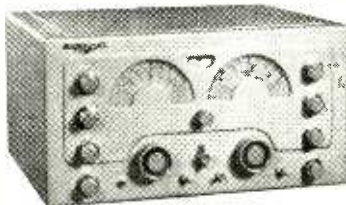

NC-183 \$279
(less speaker)



HRO-50TI
price to be announced

*Whatever the purpose
whatever the price...*



builds it better!

you are interested in. But that can be troublesome. Why not have all the numbers in storage accessible practically at once?

Electrostatic storage

In one form, the method of electrostatic storage uses a dielectric screen in a cathode-ray tube. The beam that scans the screen divides it into a pattern of, say, 32 by 32, or 1,024 separated spots. Information is stored on these spots as the presence or absence of certain electric charges. The spots are written on or read out or erased by one beam of electrons. The electric charges that have been recorded on the screen are held in their places and prevented from leaking away by another beam of electrons, a so-called "holding beam."

Electrostatic storage has proved to be rather a ticklish technique to master. F. C. Williams at the University of Manchester in England has succeeded in using electrostatic storage in the automatic electronic computer built there. Also, the Servomechanisms Laboratory at Massachusetts Institute of Technology is installing some electrostatic storage memory in Whirlwind I, which will still further raise its speed of 30,000 multiplications a second. Certainly, no miniature automatic electronic computer would be expected to make use of electrostatic storage, whereas a small magnetic drum would be a logical choice for its memory.

(continued next month)

LISTENERS BUY FM PROGRAM

To prevent their favorite program from being interrupted by commercials, listeners to an FM music series donated practically as much as the station would have received had the series been handled on the regular commercial basis.

The station with the music-loving audience was WABF (FM) of New York City, and the program the New Friends of Music concert series. The audience was informed that "it would be inconsistent with the tone and mood of the concerts" to have them sponsored by advertisers. Instead the listeners were asked to subscribe to the series by sending the station any sums they wished. During the first weeks of the program it was announced that more than 2,000 listeners had responded, sending WABF more than 90% of the amount which would have been realized had the program been sold in the regular manner to a commercial sponsor.

ELECTRONIC MONEY COUNTER

Eight tons of old currency—mostly one dollar bills—removed from circulation daily by the Department of Treasury is now being counted by an automatic electronic machine. Developing the counter was a difficult job as the old money is badly wrinkled and dog-eared.

NOW!



**STORES
TO
SERVE
YOU**

- PHILADELPHIA
509 Arch Street
- WEST PHILA.
6205 Market St.
- CAMDEN, N. J.
1133-35-37
Haddon Ave.
- WILMINGTON,
DEL.
6th & Orange Sts.
- ATLANTIC CITY
N. J.
4401 Ventnor Ave.

Almo RADIO CO.
EXECUTIVE OFFICES & WAREHOUSE
412-16 North Sixth St.
Philadelphia 23, Pa.

CRYSTALS Low Freq.

FT-241. A holder 1/2" pin spacing, for ham and general use. Xtal controlled. Signal Generators, Q-5 RS S.S.B. Exciters (Nov. QST) marked in army Mc harmonic frequencies—Directions for deriving fundamental frequencies enclosed. Listed below by fundamental frequency, fractions omitted.

370	419	444	485	512	391	447
372	420	445	486	513	392	448
374	422	446	487	514	393	450
375	423	458	488	515	394	451
376	424	459	490	516	395	453
377	425	461	491	518	396	454
379	455	462	492	519	397	455
390	427	468	493	520	398	456
381	429	469	494	522	400	457
383	430	470	495	523	401	463
384	431	472	496	525	402	465
385	433	473	497	526	403	498
386	434	474	502	527	404	500
387	435	475	503	529	405	501
388	436	476	504	530	406	538
412	437	477	505	531	407	540
413	438	479	506	533	408	each
414	440	480	507	534	409	\$1.94
415	441	481	508	536	411	each
416	442	483	509	537	each	
418	443	484	511	390	69c	

1% PRECISION RESISTORS

.6	468	33.000
1.01	800	40.000
5	920	53.000
5.05	1100	57.000
10.1	4300	75.000
18	5000	84.000
43.5	7500	30c ea.
50	8500	10 For \$2.50
75	10,000	100.000
82	10,000	120.000
120	10,000	120.000
125	12,000	120.000
128	12,000	150.000
150	17,000	220K
128	17,300	250K
250	20,000	40c ea.
300	25,000	10 For \$3.50
430	30,000	\$3.50
		1 Meg. 75c ea.

Attention CAP MEN!!!



Attention Men!!!
BC 429 Receiver, 3-gang TRF non-radiating receiver, designed for air-craft use, complete with tubes and C-339 tuning unit covering 200-400 kc and 2500-4700 kc. less p.w.r. sup.\$3.95

T.U. for BCAR 230 or 430

3.2-4MC
5-6.2MC
1.2-1.5MC
1-1.2 MC
Price 95c ea.
4-5MC w/
4495KC
XTAL \$2.79 ea.

GIBSON GIRL



The Emergency Radio Transmitter. Send S O S signals automatically on 500KC. 150-mile range. No batteries required. Has hand-driven generator tubes, wire. New. 11's only\$3.40

RC-605 INTERPHONE AMPLIFIER

Easily converted to an ideal intercommunications set for office-home or factory. Original. New w/conversion diagram. \$4.49

Rated Concerns Send P.O. Minimum Order \$3.00
Send M.O. or CHK. Mdse. Guardt. Shpg. Charges
Sent C.O.D. Price F.O.B. N.Y.C. Phone Di. 9-4124

COMMUNICATIONS EQUIPMENT CO.

131 Liberty St. Dept. C-5 New York City 7, N. Y.

TWO-TONE SOURCE AIDS INSOMNIACS

Readers who laughed at Mohamed U. Fip's *Hypnotron* in the April issue are invited to look at this dead-serious article on a real tone generator that puts you to sleep with a series of sound pulses.

By CHAS. BEAZLEY

The Slumberbug* is a sound-producing device designed to aid insomnia sufferers. It uses no electron tubes and the sound is produced by the normal voltage variations of alternating current fed, unamplified, through an output transformer into a loudspeaker.

The Slumberbug produces a steady background hum of 60 cycles which is overridden at intervals of about 3 seconds by another slightly louder hum. The louder hum maintains itself for about 3 seconds and then cuts off, reverting to the background hum again. This cycle, loud-soft, repeats itself as long as the device is in operation. The background hum, although apparently continuous, is actually cut off when the louder hum appears. The effect is that of a background hum with a slightly louder modulating hum riding in over it. There is also an apparent change in the quality of the tone between the two hums.

When the set is working, current flows through the resistor and the entire circuit, producing a soft hum from the loudspeaker. The synchronous motor also starts to rotate. When the cam mounted on its shaft reaches the normally open switch contacts it closes them, thus shorting out the resistance. This allows more current to flow in the output transformer primary and the tone is louder at the speaker.

The shape of the cam on the motor is governed by the speed of the motor and the length of sounds desired. I use a 4-r.p.m. motor carrying a 2-lobe bakelite cam which produces a complete cycle of 7.5 seconds, or 3.75 seconds loud and the same soft. This timing is generally satisfactory although others may prefer different timing.

The indicator light is a 3-watt, 117-volt candelabra base lamp which varies brilliance with the changes in volume. It is primarily an on-off indicator, as the Slumberbug is generally operated at very low over-all volume and could easily be left turned on all day.

The iron core choke can be an a.c.-d.c. radio filter choke or something heavier, depending how much contact click appears at the loudspeaker. Do not try a capacitor across the points to eliminate click, as in this circuit it makes matters worse and shortens the contact life of the switch.

* Patent pending. Registered Trade Mark applied for.



WINDOW

Bazuka

A BROAD BAND ANTENNA for all channels . . .

The Window Bazuka is of simple compact design . . . for use where roof installations are not practical. Our "quick rig" method makes it easy to install . . . eliminates vibrations and swaying . . . perched securely on the ledge to prevent sagging—strut on the side prevents vibration. The antenna is adjustable to all stock size windows and can be oriented 360 degrees.

VERI-BEST ELECTRONICS COMPANY
233 spring street,
new york 13, new york

The King of all Antennas



BUY DIRECT From Factory

SAVE!! \$169.95
Fed. Tax Incl. (Less CRT)

New Improved 32 tube—630TS type chassis

Complete with

- New Electro-Scope Magic Eye Tuning Indicator
- Completely wired and aligned by expert technicians.
- Newly developed keyed automatic gain control.
- Latest type Standard Coil tuner.

TUBES FOR ABOVE

16" (Round)	\$35.50
16" (Rectangular)	39.50
17" (Rectangular)	43.50
19" (Round, metal)	59.00
20" (Rectangular)	64.95

All tubes Black Face standard brands.
6 mos. RTMA guarantee on tubes
3 mos. parts guarantee on chassis
Beautiful cabinets for above—available

Terms: \$25.00 deposit on all orders—Balance C.O.D.
F.O.B.—N. Y. Factory
Prices subject to change without notice

IMMEDIATE DELIVERY Visit our showrooms

AD - RITZ 158 Grand Street
M F G . C O R P . New York, N. Y.
Phone WO 4-6763

MIDWEST Mammoth 19 1/2 inch PICTURE TUBE

Presents its **NEW 1951** Line of **TELEVISION** and **RADIOS**

30 DAYS TRIAL
Don't buy any radio or television receiver until you've seen the new 1951 Midwest Line — it's the finest in 31 years.

FACTORY-TO-YOU **EASY TERMS**

MIDWEST RADIO & TELEVISION CORP.
Dept. 33-M, 909 Broadway, Cincinnati 2, Ohio

SEND THIS COUPON ON 1c POST CARD FOR NEW 1951 FREE 4 COLOR MIDWEST CATALOG

NAME _____
ADDRESS _____
CITY _____ ZONE _____ STATE _____

BELIEVE IT OR NOT!

630 TS

TYPE CHASSIS
MFG. LICENSED UNDER
R.C.A. PATENTS

31 TUBE CHASSIS

- 1 Best for Fringe Areas
- 2 Improved Keyed A.G.C.
- 3 Full 4 Megacycle Band Width
- 4 16 KV Output
- 5 A.F.C. Sync. Separator Syncrok
- 6 Latest 1951 Features
- 7 Focus Coil-Yoke Removable Plugs
- 8 Standard Tuner
- 9 Improved Down to 45 Microvolts
- 10 Set equipped with Phono Jack
- 11 Set uses 70° Deflection Coil
- 12 Complete Chassis with Tubes Aligned. Not a Kit
- 13 Large 12" Speaker
- 14 All Knobs—Channel Selector
- 15 Universal Mounting Brackets. Tube on Chassis
- 16 Free Plastic Mask with Every Set
- 17 Free Schematic with Every Set
- 18 Free R.M.A. Guarantee on Chassis-Tube
- 19 Free—No Extras—Tax Included
- 20 Free Delivery on Paid Order 6 or More
- 21 Dumont Tuner F.M. Radio \$10 Extra
- 22 Cabinets—Console 16" 17" 20" \$59
- 23 Cabinets—Half Doors 17" 20" \$69
- 24 Cabinets—Full Doors 17" 20" \$79
- 25 In Mahogany or Blonde. Same price.

COMPLETE CHASSIS
INCLUDING BLACK
RECTANGULAR PIC-
TURE TUBE

16" \$189

17" \$199

20" \$219

24" \$299

25% WITH ORDER
BALANCE C.O.D.

Dealers, Dist., Mfg.
SPECIAL PRICES
LOTS 12 OR MORE

UPSTATE, 107 DUANE, SCHENECTADY, N.Y. TEL. 4-3008

A 0.1- μ f capacitor will give an apparently higher pitched but rougher tone than the one shown while a 1- μ f capacitor will give a smooth, bass, foghorn effect. The amount of capacitance used is limited by the output transformer used. If a better impedance match is used the loss in volume with a 1.0- μ f capacitor will not make any difference and the output tone will be free of ripple. We used an output transformer for the 50L6 tube because it is generally on hand and is satisfactory. A 3-position switch can serve as a tone control by selecting capacitors.

How it works

The Slumberbug was designed to help my wife sleep and is based on the double-toned sound of a foghorn of the type used in lighthouses and lightships. I have spent a good many years at sea as a radio operator and have always felt that a foghorn in the distance had a sleep-inducing sound. I had noticed that it interrupted any attempt at continued consecutive thought by its timed recurrences. During the few

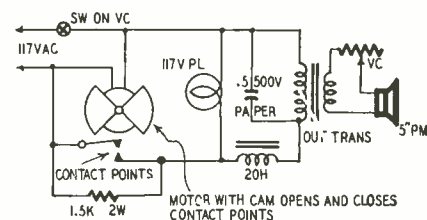

Circuit of the double tone generator.

nights in my life that I have had trouble in getting to sleep my brain seemed to be spinning along at high speed with none of that drowsy, slow-down effect always experienced by the good sleeper when he rolls into bed. He *knows* he can go to sleep—and as a result he *does*.

I believe that the brain generates energy which it supplies to the body and which the body in turn retransmits to the brain. When this energy level is lowered by slowing down of the brain action, a point is reached which I call the "sleep-level." Once the brain-energy drops below this sleep-level we automatically click over into sleep.

The Slumberbug was designed to interrupt and to retard any attempt at continuous thought. I recommend that users of the device give it at least a portion of their attention when they are in bed; that they count to themselves the length of the louder and of the softer tones. They will find that, if they count up to say 15 when they first lie down, after a few minutes they no longer will reach 15 in their count. *Their brain action is slowing down.* I also advise users to set the over-all volume at whatever level seems most pleasant but *not* to reduce it so the background hum becomes inaudible.

Materials for Slumberbug

1—1,500-ohm, 2-watt resistor; 1—100-ohm, wire-wound potentiometer; 1—0.5- or 1- μ f capacitor; 1—20-henry choke; 1—output transformer for 50L6; 1—5-inch PM speaker; 1—synchronous clock motor (about 4 r.p.m.) with cam; 1—117-volt pilot lamp; 1—s.p.s.t. switch mounted on potentiometer; contact points; chassis; hookup wire, assorted hardware.

—end—

BUILD PRESTIGE and PROFITS



No installation is better than its component parts. In loudspeakers, there's no wiser choice than UNIVERSITY—the time tested leader that provides *performance plus!* UNIVERSITY "progressive engineering" constantly explores new materials, new production methods, new ideas to further improve the performance, construction, and dependability of its products. These are your guarantee of satisfied customers every time.

WITH
University
LOUDSPEAKERS

PAGING SPEAKERS

MODEL
COBRA-12



MODEL
2W-25



Here are two UNIVERSITY paging and talk-back speakers that answer even the toughest installation problems. For wide angle coverage and also maximum use of corner locations COBRA-12 is a natural, with 120° horizontal dispersion and optimum 60° in vertical plane. Model 2W-25 is ideal for bi-directional requirements. In addition, sound can be directed either downward or outward by use of exclusive ruggedly constructed, triple-protected against the elements, these speakers may be used indoors or out. Economical, too—reduce number of speakers normally required.



UNIVERSITY
LOUDSPEAKERS • INC

80 SO. KENSICO AVE., WHITE PLAINS, N. Y.



TECHNILOG

IT'S HELPFUL . . .

IT'S PRACTICAL . . .

Aids to better sound-casting. A technical catalog written by experts for engineers, designers, installation and service men. Write for free copy to Desk 40.

**you can have
perfect
reception
when you
know your
TV A-B-C's**

Here's the System that makes perfect TV reception available in every fringe area — and it's as simple and inexpensive as A-B-C. Your first step — A — is the famous Tel-a-Ray Model T antenna — the durable, non-corrosive antenna that consistently receives fine reception from stations as much as 200 miles away.

Second in the simple Tel-a-Ray A-B-C System is the Tel-a-Ray Pre-Amplifier. This ingenious, powerful pre-amplifier — the only one of its kind in the low price range — mounts right to your Model T antenna to bring in sharper, stronger, clearer images without increasing the line noise or other distracting sounds.

The "C" of the A-B-C System is your receiver. That's all you need to give you exciting after evening of wonderful, clear television. The Tel-a-Ray A-B-C System is working for fringe area TV's throughout the country. It will work for you! Write today for complete information.

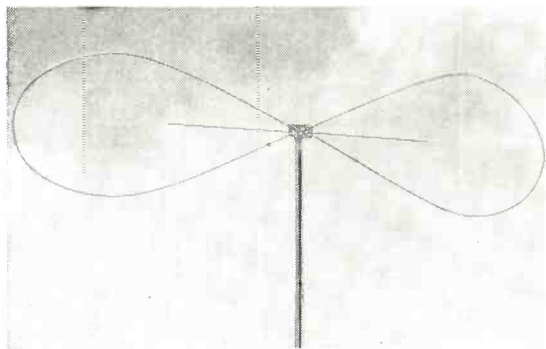

Your best bet for good primary area reception is the Tel-a-Ray Butterfly antenna. The Butterfly receives 13 channels and FM radio — is completely guaranteed against wind and weather damage. It sells for just \$2.95 (suggested list).

Tel-a-Ray

ENTERPRISES, INCORPORATED



TRADE MARK

BOX 332E
HENDERSON, KENTUCKY

The Most Adaptable Small Control You Ever Saw...

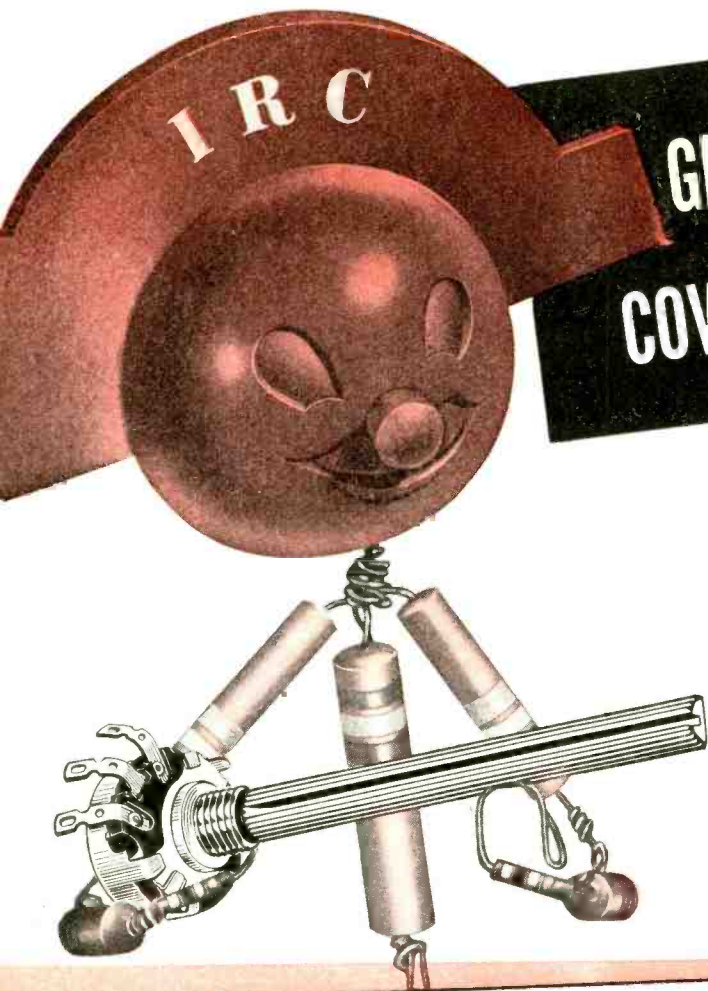

**GIVES YOU WIDEST REPLACEMENT
COVERAGE WITH FAR LESS STOCK!**

60 IRC Q CONTROLS WITH
ADAPTABLE FIXED SHAFTS cover *all*
important values—give you *complete* replacement
coverage with minimum stock—and
slash your inventory investment to the bone.

No other control line so closely meets
your servicing needs. No other gives
you so much for your money. Here's why...

**EXCLUSIVE
KNOB MASTER
SHAFT**

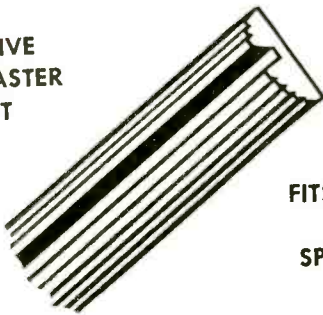

**FITS KNURLED
AND
SPRING-TYPE
KNOB**

Here's the shaft you've dreamed of for years—a shaft that will fit virtually all your standard knob requirements without inserts or modification—a shaft you can just cut to length and use.

IRC's Knob Master Shaft is shown in exploded view above. Note these points of construction:

1. Substantial portion of shaft is knurled. It readily fits most knurled knobs without slotting of shaft. Either tight or loose knobs may be fitted by slotting shaft for $\frac{3}{8}$ " and adjusting ends by spreading or compressing.
2. Flat of shaft accommodates all spring-type push-on knobs requiring normal $\frac{3}{32}$ " deep flat.
3. Groove simulates narrow flat for spring-type knobs requiring $\frac{1}{32}$ " deep flat. Also provides guide for slotting where needed.

Knob Master Shaft is standard with *all* Type Q Replacement Controls. Eliminates need for stocking several different controls of the same value because of shaft differences. Far more expensive to make than ordinary replacement shafts, Knob Master is exclusive with IRC.

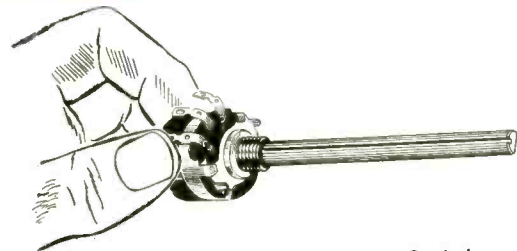

TYPE Q FEATURES $\frac{1}{4}$ " LONG BUSHING. Independent survey, plus IRC engineering study, prove that a $\frac{1}{4}$ " long bushing will permit more replacements than will the conventional $\frac{3}{8}$ " long bushing. Only IRC provides you with a complete standard line of controls of the small $\frac{15}{16}$ " size with the shorter bushing necessary for maximum replacement use.

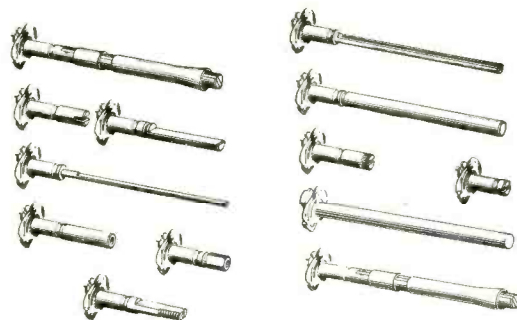

INTERCHANGEABLE FIXED SHAFTS give you widest coverage of control replacements with a far smaller stock of controls. Resilient Retainer Ring lets you remove Knob Master Fixed Shaft and replace with any of 13 special fixed shafts. Interchange takes less than a minute, using only a pocket-knife or screwdriver. You meet almost any special requirement without expanding control stocks.

ASSEMBLE YOUR OWN STANDARD AND CONCENTRIC DUALS, TOO!

Two sensational IRC developments answer the great majority of your dual replacement problems—and eliminate long searches and waits for exact duplicates.

With IRC's amazing new CONCENTRIKIT of specially designed, universal parts, you can quickly assemble over 90% of all concentric dual types—in home and auto sets as well as in TV.

For standard duals, exclusive IRC MULTISECTIONS can be added to Q Controls just like switches—in just a few seconds - convert standard controls to duals, triples or even quadruples.

NOTHING COULD BE SIMPLER, EASIER, MORE PRACTICAL!

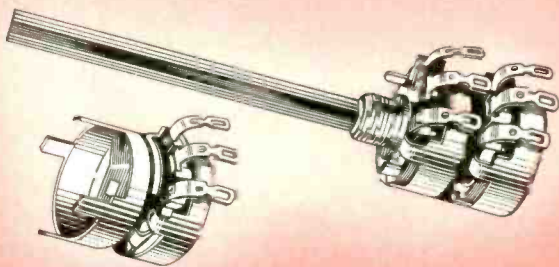

STANDARD GANGED CONTROLS ARE EASY TOO. For standard duals, triples, quadruples, add IRC MULTISECTIONS just as you would switches. 20 of these units provide over 11,000,000 variations—give you coverage from 500 ohms to 10 megohms. No need to stock or search for standard duals. Flexible, easy-to-use MULTISECTIONS are the answer to ganged-control problems.



INTERNATIONAL RESISTANCE COMPANY

401 N. Broad Street, Philadelphia 8, Pa

Wherever the Circuit Says 

In Canada: International Resistance Co., Ltd., Toronto, Licensee

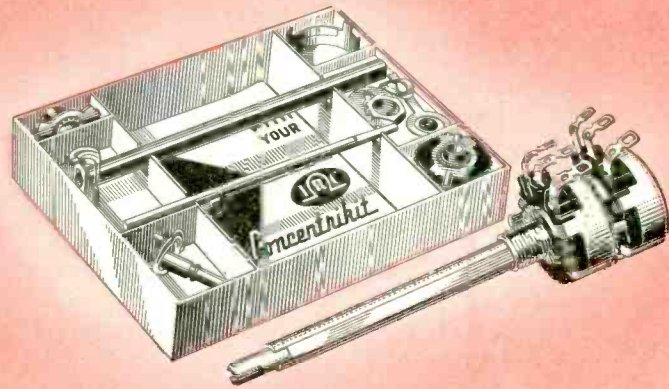

NO MORE WORRYING ABOUT EXACT DUPLICATES. In a matter of minutes you can assemble your own concentric duals—with IRC's original CONCENTRIKIT. Each CONCENTRIKIT contains 11 universal parts which you combine with separate shaft ends and base elements. Step-by-step instructions, included in each kit, make CONCENTRIKIT fool-proof. It's the practical answer to television's ever-increasing need for concentric duals.

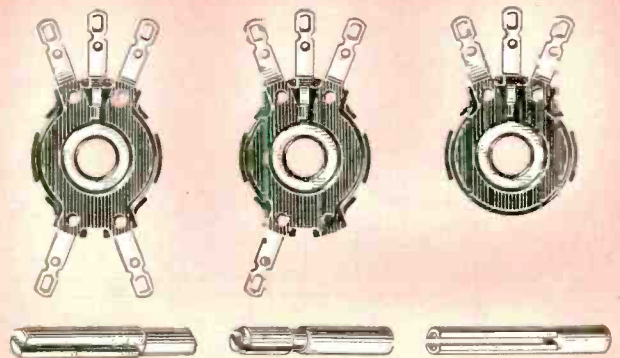

LIMITLESS OPPORTUNITIES for adapting controls to specific requirements—that's what you get with these interchangeable Base Elements and shaft ends. Each unit contains molded base, element, terminals and collector ring—no loose parts. Designed for use with CONCENTRIKIT, these base elements are available in a wide assortment of resistance values and a variety of taps. They may also be interchanged in any standard Q Control.



New Type 76 Switches are quickly and easily attached to any IRC Q Control. In addition to Type 76-1 Single Pole, IRC now provides a double pole unit as well—Type 76-2. IRC Q Controls are so designed that switch throw takes place after contactor reaches terminal adjacent to switch toggle. This makes electrical rotation of control the same with or without switch.



INTERNATIONAL RESISTANCE COMPANY
417 N. BROAD ST., PHILA. 8, PA.

Please send me additional IRC Q Control information in latest issue of Catalog Bulletin DC-1.

NAME

COMPANY

ADDRESS

J. P. ARNDT & CO., ADV. AGENCY

IMMEDIATE DELIVERY OF

Top Quality

MINIATURE SWITCHES

This list of brand new standard brand miniature switches represents only a few of many types in stock at Wells. Large quantities of most types are on hand for your immediate requirements. Write or wire for quotations on switches not listed.

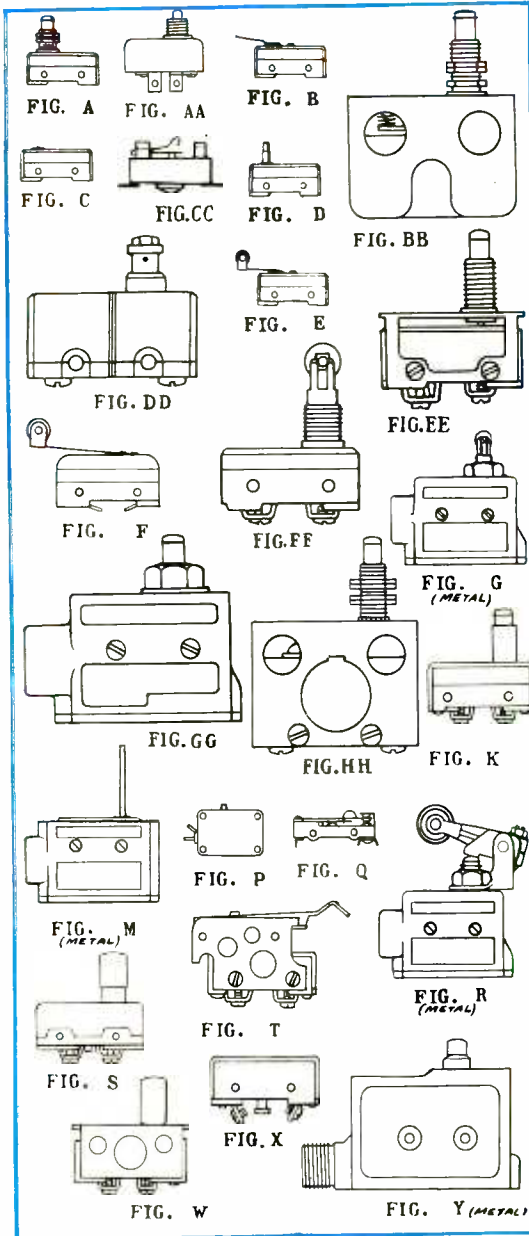

Stock #	Mfr.	Type #	Contact	Fig.	Price	Stock #	Mfr.	Type #	Contact	Fig.	Price
41MC2	ACRO	2M03.1A	NO	P	.50	41MD53	MICRO	WP5M5	NC	AA	.50
41MM2	MU	AC2101BB	SPDT	W	.85	41MC27	MICRD	WZ2RST	NC	D	.55
41MC6	MU	APB236	SPDT	A	1.15	41MD48	MICRO	WZ2RT	NC	C	.65
41MC26	MU	APG210	NO	A	.80	41MD33	MICRO	WZ3PW2	NC	F	.80
41MC17	MICRO	B-1	NC	Y	1.45	41MD16	MICRO	WZ7R	NC	C	.55
41MC16	MICRO	B-1T	NC	DD	.90	41MD43	MICRO	WZ7RQ1T	NC	A	.70
41MC7	MICRO	B-14	NO	HH	1.70	41MC15	MICRO	WZ7RQ2T	NC	A	.70
41MD62	MICRO	B-R	SPDT	C	.70	41MD36	MICRO	WZ7RST	NC	D	.55
41MD46	MICRO	B-RL18	SPDT	B	.95	41MC24	MICRO	WZ7RQTN	NC	Y	1.45
41MD63	MICRO	B-RS36	SPDT	D	.80	41MC23	MICRO	WZ7RQTN	NC	R	3.75
41MD23	MICRO	BD-RL32	SPDT	B	.95	41MD54	MICRO	WZ8RX	NC	X	.80
41MLH	MICRO	BZRQ41	SPDT	W	.85	41MC9	MICRO	WZR31	NC	C	.65
41MD51	MICRO	BZ-R37	SPDT	C	.70	41MD57	MICRO	WZR31	NC	T	.70
41MD2	MICRO	BZE7RQ2	SPDT	GG	1.70	41MD31	MICRO	WZR0	NC	C	.55
41MD21	MICRO	BZ-7RST	SPDT	D	.80	41MD19	MICRO	WZRL8	NC	B	.70
41MD38	MICRO	BZE2RQ9TN1	SPDT	G	2.65	41ML3	MICRO	WZRQ41	NC	W	.65
41MO6	MU	CUM 24155	NO	E	.80	41ML2	MICRO	WZV7RQ9T1	NC	G	2.25
41ML1	MU	O	NO	BB	1.50	41ML21	MICRO	X757	NC	C	.55
41MC12	MICRO	D in case	NC	Y	1.45	41MO37	ACRO	XC1A	NC	C	.55
41MD34	KLIXON	ES692070	NC	CC	.50	41MC5	ACRO	XO45L	SPDT	B	.95
41MO65	MICRO	G-R26	NO	C	.60	41MD4	MICRO	YZ	NO	C	.75
41MO60	MICRO	G-RL	NO	B	.80	41MO40	MICRO	YA2RLE4D13	NO	B	.70
41MC11	MICRO	G-RL 5	NO	B	.80	41MD24	MICRO	YZ2YLTC1	SPDT	B	.95
41MD61	MICRO	G-RL35	NO	B	.80	41MC1	MICRO	YZ2YST	SPDT	D	.60
41MD41	MICRO	G-RL43	NO	B	.80	41MD13	MICRO	YZ3R3	NO	C	.60
41MD64	MICRO	G-RS	NO	D	.55	41MD56	MICRO	YZ3RLTC2	NO	B	.80
41MD66	MICRO	G-RS36	NO	D	.60	41MC14	MICRO	YZ3RW2T	NO	F	.90
41MC32	ACRO	HRO 7.1P2TSP1	NO	K	.65	41MD49	MICRO	YZ7RQ9T6	NO	FF	.85
41MC19	ACRO	HRO 7.4P2T	NO	S	.60	41M032	MICRO	YZ7RST	NO	D	.60
41MO8	ACRO	HRRC 7.1A	NC	C	.55	41MC13	MICRO	YZ7RA6	NO	EE	1.00
41MD27	ACRO	HRR0 7.1A	NO	C	.60	41MD25	MICRO	YZRQ1	NO	A	.80
41MC31	MICRO	LN-11 HO3	SPDT	M	1.70	41MC20	MICRO	YZRQ4	NO	S	.60
41MC18	MU	MLB 321	SPDT	B	.95	41MD59	MICRO	YZRQ41	NO	W	.75
41MD1	MU	MLR 643	NC	B	.70	41MD20	MICRO	YZ7RQT	NO	K	.65
41MD55	PHAO.	PS 2000	SPDT	C	.85	41MD42	MICRO	YZRTX1	NO	X	.95
41MC28	ACRO	RC71P2T	NC	A	.70	41MC27	MU	Z	NC	Y	1.45
41MD45	ACRO	RO1P2T	ND	A	.80	41MD44	ACRO	Blue Stripe	SPDT	C	.70
41MD22	ACRO	RO2M	NO	E	.80	41MD52	MU	Blue Dot	SPDT	E	.90
41MD28	ACRO	RO2M12T	NO	E	.80	41MC8	MU	Red Dot	NC	C	.65
41MC25	MICRO	R-RS	NC	D	.50	41MD18	MICRO	Open Type	SPDT	Q	.50
41MD47	MICRO	R-RS13	NC	D	.50	41MD39	MU	Green Dot	NO	B	.80
41MD9	MICRO	SW-186	NC	D	.50	41MC29	MU	Green Dot	NO	D	.55
41MC10	MICRO	WP3M5	NC	AA	.50	41MD26	MAXSON	Precision	SPDT	B	.95
41MC4	MICRO	WP5M3	NC	AA	.50						

Order Direct or Through Your Local Parts Distributor

PARTS SHOW VISITORS:
Be sure to visit our new Chicago Ave. display. Plenty of free parking.

SEeley 8-4143

WIDE SELECTION OF ELECTRONIC COMPONENTS AT WELLS

- Tubes • Resistors • Condensers • Wire and Cable
- Volume Controls • Co-ax Connectors • Relays • Rectifiers
- Transformers • Chokes • Micro Switches, Toggles • Antennas
- Accessories • Electronic Assemblies • Dial Light Assemblies



833 W. CHICAGO AVE., DEPT. Y, CHICAGO 22, ILL.

INDISPENSABLE! PHOTOFACT BOOKS



Photofact Television Course. Covers TV principles, operation and practice. 216 pages; profusely illustrated; 8 1/2 x 11". Order TV-1 Only \$3.00

Television Antennas. New 2nd edition. Describes all TV antenna types; tells how to select, install, solve troubles. Saves time; helps you earn more. 200 pages; illustrated. Order TAG-1 Only \$2.00

Television Tube Location Guide. Accurate diagrams show position and function of all tubes in hundreds of TV sets; helps you diagnose trouble without removing chassis. 200 pages; pocket-size. Order TGL-1 Only \$1.50

1949-1950 Record Changer Manual. Vol. 3. Covers 44 models made in 1949, including multi-speed changers and wire and tape recorders. Original data based on actual analysis of equipment. 286 pages; 8 1/2 x 11"; paper-bound. Order CM-3 Only \$3.00

1948-1949 Changer Manual. Vol. 2. Covers 45 models made in 1948-49. Paper bound. Order CM-2 Only \$4.95

1947-1948 Changer Manual. Vol. 1. Covers 40 post-war models up to 1948. Order CM-1 Only \$4.95

Recording & Reproduction of Sound. A complete authoritative treatment of all phases of recording and amplification. 6 x 9". Order RR-1 Only \$5.00



Post-War Audio Amplifiers. Vol. 2. A complete analysis of 104 well-known audio amplifiers and 12 well-known tuners made in 1949-50. 368 pages, 8 1/2 x 11". Order AA-2 Only \$3.95

Post-War Audio Amplifiers. Vol. 1. Covers 102 amplifiers and FM tuners made through 1948. 352 pages. Order AA-1 Only \$3.95

Auto Radio Manual. Complete service data on more than 100 post-war auto radio models. Covers over 24 mfrs. 350 pages, 8 1/2 x 11". Order AR-1 Only \$4.95

Communications Receiver Manual. Complete analysis of 50 popular communications models. 246 pages, 8 1/2 x 11". Order CR-1 Only \$3.00

Radio Receiver Tube Placement Guide. Accurate diagrams show where to replace each tube in 5500 radio models, covering 1938-1947 receivers. 192 pages, pocket-size. Order TP-1 Only \$1.25

Dial Cord Stringing Guide. Vol. 2. Covers receivers made from 1947 through 1949. Shows you the one right way to string a dial cord in thousands of models. Pocket-size. Order DC-2 Only \$1.00

Dial Cord Guide. Vol. 1. Covers sets produced 1938 through 1946. Order DC-1 Only \$1.00

Radio-TV Industry Red Book. 2nd Edition. Complete data on replacement parts for 22,000 sets made 1938-1950, including valuable TV information. Covers all major replacements. Over 600 pages. Only \$3.95



Making Money in TV Servicing. Tested, proved methods of operating a profitable TV service business. Written by Eugene Ecklund, B. E. E., former manager of the National Service Department, Allen B. DuMont Laboratories, Inc. Covers planning, financing, work control, purchasing, service charges, advertising—plus much more. Own this practical guide to success now. Over 130 pages. Order MM-1 Only \$1.25

Order from your Parts Jobber or write direct to
HOWARD W. SAMS & CO., INC., 2201 E. 46th St., Indianapolis 5, Indiana

The limiting action of the induction detector is rather good, although it may be that the gated-beam tube is still better in this respect. Nevertheless, a separate limiter stage is an unnecessary luxury if sufficient signal strength is available to cause plate current variation of 0.2 ma or more. The audio output is sufficient to drive the output stage directly, and if a high-transconductance tube is used, there is enough output to spare for application of frequency-corrected negative feedback.

Types of tubes to use

As to suitable tube types, the Philips AK2 is best. In American types, the 6K8 is just about as good, but requires slightly higher screen voltage. The 6A7 works nicely, but its output is lower. This is no disadvantage if the receiver is to be used with an existing amplifier. Several other tube types with the required succession of grids probably will also do the job, but it is essential that the capacitance between the control grids be as low as possible.

Although a t.r.f. circuit could be used with the induction detector, a superheterodyne circuit is more efficient because of the high frequencies used for FM broadcast. On the other hand, the detector works best at a rather high frequency. At 20 to 25 mc, single-tuned

tube handles FM signals well in the given circuit. As this receiver was designed in Europe, where most areas are served by only one FM station, ganged tuning is not used. Rough tuning is done by the air trimmer C2. The actual tuning is obtained by rotating a shorted turn in the field of the oscillator coil L3. The shorted turn is mounted on the tuning shaft at 45° and inside the oscillator coil, which is fixed to the chassis but also at 45° to the tuning shaft as shown in Fig. 2. L3 itself is 4 turns of No. 15 wire spaced over 3/8 inch and 3/8 inch in diameter. The antenna is pretuned to the signal by C1 and needs no retuning unless the antenna is



Fig. 2—Detail drawing of the coil L3.

changed. L2 is 3 turns of No. 18 wire, 1/2 inch in diameter and spaced over 3/8 inch. L1 is 2 turns inside L2.

The i.f. circuits can be tuned either

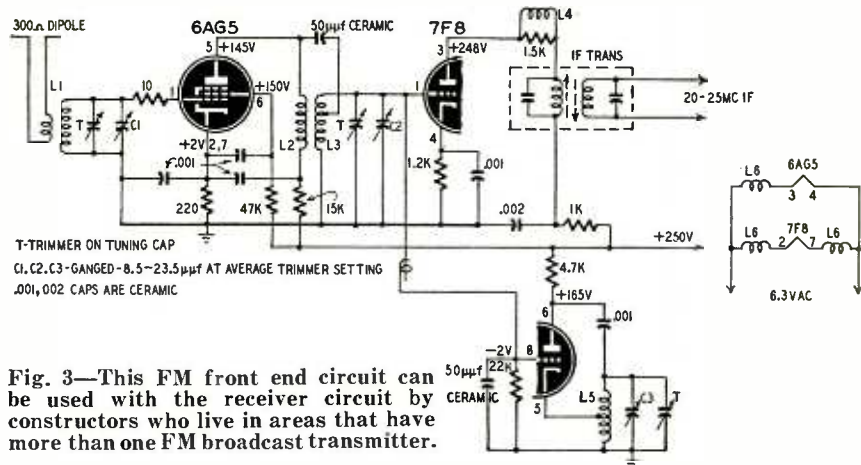

Fig. 3—This FM front end circuit can be used with the receiver circuit by constructors who live in areas that have more than one FM broadcast transmitter.

i.f. circuits of practical Q are wide enough to pass the FM signal without undue sideband cutoff. This i.f. falls within the range of ordinary test generators, and the required inductance values are about the size of those used for the short wavebands. High-transconductance tubes are preferable for the i.f. stage, although a small cathode resistor may be needed for stability.

Noise problems do not arise in this receiver, and almost any modern mixer

with slugs, with fixed capacitors matching the input and output capacitances of the tubes, or with trimmers. The required inductance is about 1.5 μh.

(This receiver is designed to pick up only one station at a frequency of about 100 mc. Constructors in areas having more than one FM broadcast station may wish to use the front-end circuit shown in Fig. 3, which is from "Simplified FM Receiver Uses Crystal Detector," RADIO-CRAFT for June, 1948. Coil

Table I—Coil data for circuit of Fig. 3

Coil	Turns	Tap (from hot end)	Wire	Form
L1*	2 1/2		No. 14 finned	3/8-in. inside dia.
L2	50		No. 30 enam.	5/32-in. dia., 100,000-ohm resistor
L3	2 1/2	1/2	No. 14 finned	3/8-in. inside dia.
L4	15		No. 22 enam.	3/16-in. dia., 1,500-ohm resistor
L5	1 1/2	1/2	No. 14 finned	3/8-in. inside dia.
L6	25		No. 26 enam.	68,000-ohm, 1/2-watt resistor

* Primary is 1 1/2 turns hookup wire inside of L1. L1, L3, L5 are self-supporting.



Model 666-R

NOTE the wide ranges of this compact pocket-size instrument. Note controls—flush with panel. Then study the inside view. Nowhere will you find, in design and manufacturing quality, the equal of 666-R.



A BASIC TOOL

**POCKET-SIZE: VOLT-OHM-MIL-AMMETER
WITH SELF-CONTAINED RESISTANCE RANGES TO 3 MEGOHMS**

1. Resistance Ranges from 0-3000 Ohms (.5 Ohm low reading) to 3 Megohms, self-contained. Also A.C.-D.C. Volts to 5000, 10 ranges; and 3 Direct Current ranges.

2. Enclosed Selector Switch, molded construction. Keeps dirt out, and retains contact alignment permanently.

3. Unit Construction—Resistors, shunts, rectifier, batteries, are housed in a molded base integral with the switch. Direct connections without cabling. No chance for shorts.

4. Resistors are precision film or wire-wound types, each in its own compartment.

ONLY \$26.50—at your Distributor

In Canada: Triplet Instruments of Canada, Georgetown, Ontario.

FOR THE MAN WHO TAKES PRIDE IN HIS WORK

Triplet

TRIPLET ELECTRICAL INSTRUMENT CO., BLUFFTON, OHIO, U. S. A.

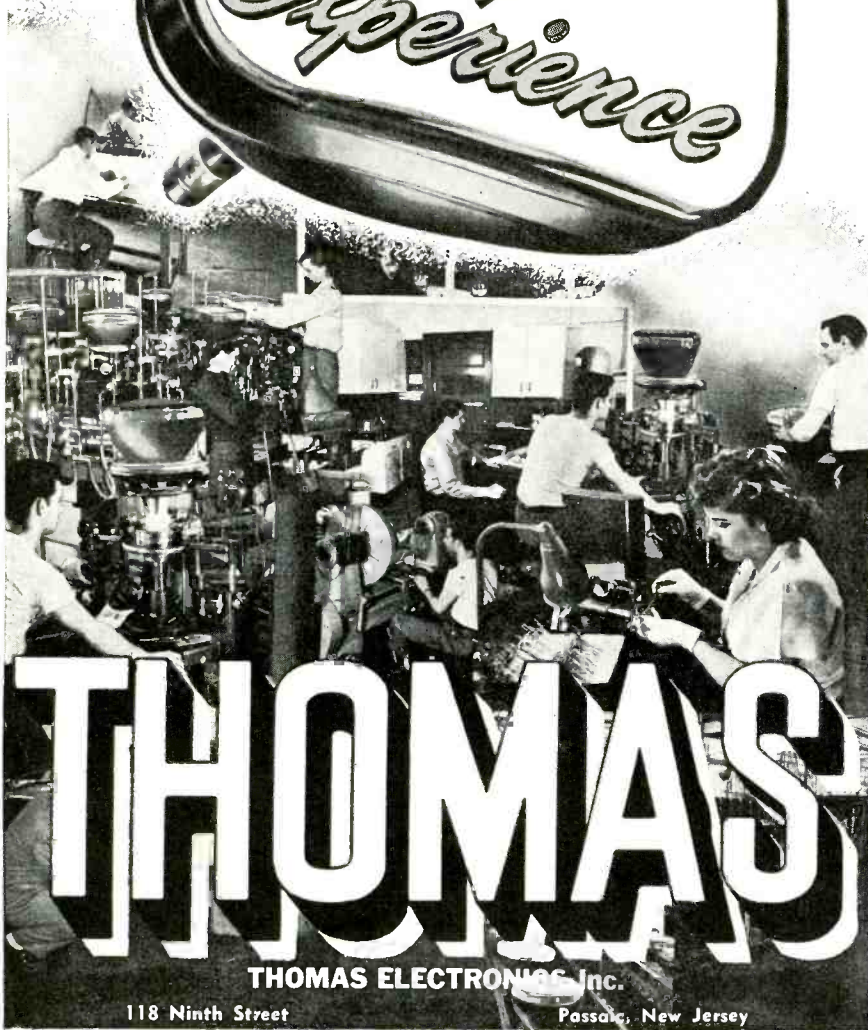

THOMAS

THOMAS ELECTRONICS, Inc.

118 Ninth Street

Passaic, New Jersey

VERSATILE!

KLIPZON*

CRYSTAL PROBES

KLIPZON
self-holding
points **FREE**
BOTH HANDS

NO HAND
CAPACITY



Klipzon
HIGH FREQUENCY Crystal Probes

bring added versatility to your VTVM or VOM.

With a KLIPZON Type V or C Crystal Probe handy . . . your VTVM or VOM becomes a VHF instrument

Type V provides accurate means of measuring voltages up to 200 Mc with your VTVM . . . Input resistance .25 megohms @ 500 Kc . . . 150,000 OHMS @ 10 Mc . . . 25,000 OHMS @ 100 Mc.

Write for folder E-1 describing many Radio and TV uses. *TM

Type C adapts VOM for indication and comparison of VHF voltages . . . for peaking IF's . . . checking GAIN . . . C.R. Oscilloscope wave analysis . . . for maximum signal, minimum ghosts.

FOR EASY ONE MAN TV
ANTENNA directional
ADJUSTMENTS



At Your Local Parts Distributor

UNITED TECHNICAL LABORATORIES

MORRISTOWN,
New Jersey

data is given in Table I. Another excellent tuner is described in "Low-Noise Front End," in the June, 1950, issue of RADIO-ELECTRONICS. Television sound i.f. transformers, which usually tune either to 21.25 or 21.75 mc, would work well in this circuit. The oscillator, of course, must tune higher than the incoming signal by an amount equal to the i.f. In most front-end circuits, the oscillator adjustment will have sufficient range to do this so that altering the coils is not necessary.—Editor)

The induction detector is sensitive to stray hum fields, so that the power transformer must be carefully placed. Grounding the transformer primaries through capacitors will remove some of the hum. Mounting a small horseshoe magnet near the detector will help to remove the final traces of hum. A tuning indicator is essential with this receiver, and a meter is best. Normal current runs between 0.5 and 1 ma in this circuit.

Tuning and alignment

To align the set, apply a modulated signal between 20 and 25 mc. Tune the grid and plate circuits of the i.f. tube until they peak and the signal is heard. The meter reading will also vary. When both circuits are brought to resonance, tune the auxiliary circuit. The meter will jump suddenly when the i.f. is passed. For the present, tune to the lowest meter reading with the anode feedback trimmer set at minimum capacitance.

Now try to find the FM signal. Tune the antenna circuit and adjust the antenna position and coupling so that the meter reads at least 0.1 ma below the no-signal level. By small variations in the tuning of both tuned circuits of the detector, the deflections above and below the no-signal value should be made the same number of scale divisions on the meter when the receiver is tuned through the FM signal. With too small a signal, the up-scale deflection is greater. Even then, good reception is possible, but not entirely free from noise and interference as an FM signal should be.

Once the set is aligned, the tuning is easy. The correct tuning point is midway between the lowest and the highest meter reading. At the two peaks the sound is distorted and weak. During the first quarter of an hour or so, the oscillator may drift somewhat. After that, no retuning of the receiver is necessary.

Materials for Receiver

Resistors: 1—15, 1—100, 2—150, 1—270, 1—470, 2—1,000, 1—4,700, 1—6,800, 1—10,000, 2—22,000, 1—47,000, 2—100,000, 1—220,000 ohms, 1/2 watt; 1—1, 1—2.2 megohms, 1/2 watt; 1—3,300, 1—22,000, 1—33,000, 1—220,000 ohms, 1 watt; 1—150 ohms, 1 watt, 5%; 1—500,000 ohms, 1—1 megohm, potentiometers.

Capacitors: 1—56 μ fd, ceramic; 2—47, 1—100, 1—290, 1—500, 7—2,000 μ fd, mica or ceramic; 2—500 μ fd, mica; 1—.002, 1—.05 μ f, 400 volts, paper; 1—.01 μ f, 2,000 volts, paper; 3—16 μ f, 450 volts, 1—50 μ f, 15 volts, electrolytic; 3—3-30 μ fd, trimmers.

Miscellaneous: 1—6A7, 1—6F6-G, 1—6BA6, 1—6V6-G, 1—5Y3-G, tubes and sockets; 1—560-volt c.t., 60-ma power transformer with 5- and 6.3-volt windings; 1—10-henry, 60-ma choke; 1-output transformer, 6V6-G plate-to-voice coil; chassis, hookup wire, assorted hardware.

—end—

RADIO-ELECTRONICS for



Music's immortals play again, sing again, in RCA Victor's "Treasury of Immortal Performances"

A treasury of Music's Immortals

Now artists whose names are musical legend live again for the modern listener. You can hear them, at their finest, in RCA Victor's "Treasury of Immortal Performances."

In recreating these performances on both 33 and 45 rpm, acoustical engineers drew on a vault of master records guarded for posterity by RCA Victor. But new electronic techniques, developed through RCA research, give the new records a quality far surpassing that of the originals.

Because RCA Victor could draw on so vast a storehouse of the past, there is something in the "Treasury of Immortal Performances" for listeners of every age and taste. Caruso sings light and serious music—as do Schumann-Heink, Mary Garden, and others . . . Paderewski is here . . . and, if your taste is for popular music, such greats as Berigan, Armstrong, Waller, in rare early records.

* * *

See the latest wonders of radio, television, and electronics at RCA Exhibition Hall, 36 West 49th St., N. Y. Admission is free. Radio Corporation of America, RCA Building, Radio City, N. Y. 20, N. Y.



The magic of RCA Victor's "45" system—as an independent unit, or combined with radio or television receivers—has already led 55 record-makers to adopt it.



RADIO CORPORATION of AMERICA

World Leader in Radio — First in Television

to Radio-TV
FREE Service Technicians



the new fact-packed
PF INDEX!
(PHOTOFACT INDEX AND TECHNICAL DIGEST)

- ★ Each issue packed with authoritative articles on TV, Radio, latest servicing techniques
- ★ Latest complete Index to PHOTOFACT, world's finest service data

Don't miss a single issue! Be sure to get your PF INDEX—the valuable new publication you'll read from cover to cover—and use at your bench every working day.

PF INDEX brings you complete, fully illustrated discussions of latest developments in Radio and TV. Keeps you up-to-date on new circuit designs, latest testing methods, time-saving repair techniques, good shop practices—helps you operate a better, more profitable business.

Have all this practical, authoritative information plus the complete Index to PHOTOFACT Folders—the quick reference guide to the world's finest service data, PF INDEX is worth dollars to you—and costs you nothing. Get your FREE copy today!

Ask Your Jobber for It!

HOWARD W. SAMS & CO., INC.

Get the current PF Index from your Parts Jobber, or write us direct on your letterhead (or enclose business card). Address: Howard W. Sams & Co., Inc., 2201 E. 46th St., Indianapolis 5, Ind.

FREE

Send FREE copy of the current PF Index

Name.....

Address.....

City..... State.....

CATHODE-RAY MONOFORMER GENERATES ANY WAVEFORM

The monoformer is a basically new type of cathode-ray tube. Its output varies in any desired manner when a linear input is applied. For example, the output may be controlled to vary as the logarithm, cosine, square root, or any other function of the input that may be desired.

The basic principle of the monoformer, shown in the diagram, is described in Patent No. 2,528,020 issued to D. E. Sunstein and assigned to the Philco Corporation.

A sawtooth wave is applied the horizontal deflectors of the cathode-ray tube. A mask bounded by the desired curve is placed between the tube and a photocell. A lens focuses the flying spot onto the cell. Amplified output is fed back to the vertical deflectors of the tube. The amplifier (not part of the monoformer) should have high sensitivity. Its d.c. output polarity depends upon input-signal strength. When input is zero, A is positive and B is negative. The vertical plates are biased so the spot is at the top of the screen with no input. With maximum input A is negative and B positive. The amplifier has no output when the input is midway between these extremes.

The beam is deflected horizontally by the input voltage. If the spot is above the mask boundary at any instant, maximum light strikes the cell. The amplifier drives the upper vertical deflection plate negative, and the spot is driven downward.

If the spot is below the boundary no light hits the photocell. The polarity of the amplifier output (and vertical deflectors) is reversed. Now the force on the spot is upward. Between these two conditions is a position of equilibrium, with the spot centered on the edge of the mask. Because the electron beam has practically no inertia, it will follow the shape of the mask as it is swept across the screen.

The amplifier output is also the output of the system. It is always proportional to the vertical deflection of the spot (voltage across the vertical deflecting plates). If the mask has the shape of some mathematical curve, for example a logarithmic curve or a sine, the monoformer output will be a logarithmic or sine voltage, if the horizontal sweep is linear.

An external mask is convenient because it can be changed or replaced at will. If it is to remain fixed at all times it is better to position it within the tube. This simplifies the equipment and eliminates the need for a photocell. In the practical form of Philco monoformer (quantizing tube) the curve is photographically printed on a metal target within the tube. This target emits secondary electrons freely. Below the curve the target is treated with a carbon compound to reduce emission. The target is connected to the amplifier which feeds the vertical deflectors of the cathode-ray tube.

The Philco monoformer has a maxi-

QUAM
Adjust-A-Cone
SPEAKERS



with the
**ADJUSTABLE
VOICE
COIL**

NO RUBBING VOICE COILS
There is nothing more annoying than a squawking speaker with a rubbing voice coil! It can easily happen to any conventionally built speaker where the spider is cemented in place with no means of adjustment.
But not on a Quam Adjust-A-Cone Speaker. Just before it is packed for shipment, the Quam Adjustable Voice Coil is carefully and exactly centered. Rubbing Voice Coils are unheard of on Quam Speakers, and dissatisfied customers will be equally rare when you "REPLACE WITH QUAM"

WRITE FOR COMPLETE QUAM CATALOG
VISIT BOOTH 578
CHICAGO PARTS SHOW

Also Makers of Quam Focalizer Units and Ion Traps

QUAM-NICHOLS COMPANY

521 E. 33rd Place Chicago 16, Illinois

MAKERS OF QUALITY SPEAKERS FOR 27 YEARS, UNDER THE SAME MANAGEMENT

Immediate Delivery • Critical Radio & TV

TUBES
25% to 50% OFF LIST

ADMIRABLE TELEVISION SUPPLY CORP.
334 Furman St., Bklyn. 2, N. Y. • TRiangle 5-7096

ON-THE SPOT BATTERY RECORDER

WALKIE-RECORJALL 8 lb. miniature BATTERY RECORDER-PLAYBACK
Continuous, permanent, accurate, indexed recording at only 5¢ per hr. Instantaneous, permanent playback. Picks up sound up to 60 ft. Records conferences, lectures, dictation, 2-way phone & sales talks; while walking, riding or flying. Records in closed briefcase with "hidden mike"! Write for details.

MILES REPRODUCER CO., INC.
812 BROADWAY Dep't RE5 NEW YORK 3, N. Y.

mum output error of about 2%. Maximum input signal is 50 volts. A maximum output of about 250 volts can be obtained.

The monoformer has many practical applications. Among them are:

1. **Wave analyzer.** The mask can be cut to follow the curve to be analyzed. As the beam follows its path it generates an output proportional to the wave amplitude. This electrical output may be analyzed by any electronic analyzer to determine the component frequencies of the curve.

2. **Calculator.** The curve may be drawn to provide an output of any function. For example, it may be the logarithm, cosine, square root, or any other complex function of the input. Two or more monoformers may be connected to add or subtract outputs. Because adding logarithms is equivalent to multiplying numbers, monoformers can be used to multiply, square and do other calculations.

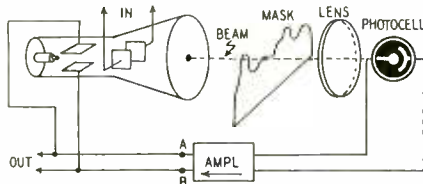

A diagram to illustrate the monoformer.

3. **Speech scrambler.** A mask of any complex or usual shape may be used for this purpose. An input speech wave becomes garbled at the output. Unless the mask shape is known, there is little likelihood of unscrambling the speech even with another monoformer.

4. **Compensator.** A known nonlinearity may be corrected or compensated for by introducing the opposite type of error. The required mask may be designed by cut-and-try or calculation to make this correction.

5. **Tone generator.** Tone or timbre depends upon the number and amplitude of harmonics present. By using the proper shape of mask an input frequency remains unchanged, but any number of harmonics may be added as desired.



Suggested by Arthur Henrikson, Chicago, Ill.

Valuable guides for television technicians

Just published!

MOVIES FOR TV



A practical how-to-do-it guide for technician and program director alike.

This complete, practical book gives you all the information you need to choose the best equipment, operate it most efficiently, and make the most effective use of movies on TV programs. It explains the operation of all leading makes of cameras, projectors, sound and kinescope recording equipment, different types of lenses, etc., giving the advantages, disadvantages, and relative costs of each. It shows what may go wrong and how to avoid trouble, what type of picture is good on television and what is not, how to light movies for best TV reception, how to insure good shots on location, combine live scenes with movies, produce special effects, titles, newsreels, different types of commercials, and much else that will be of utmost practical aid to station personnel and program planners. *By J. H. Battison.*

CHECK THE ONES THAT CAN HELP YOU MOST AND SEE THEM ON APPROVAL

TELEVISION & FM ANTENNA GUIDE



How to get the most out of the antenna system at any location.

This excellent handbook will save you much testing and readjusting and insure the best reception from any antenna system. It gives you the characteristics, dimensions, advantages and disadvantages of all VHF and UHF antennas and allied equipment, including heretofore unpublished information on new types recently tested by the authors. It tells how to determine the right type of antenna for a specific location, locate space loops, determine signal strength, etc.; how to mount various types of antennas on different kinds of roofs or window sills; how to minimize noise and avoid standing waves in transmission lines, and all other installation procedures. Handy tables give comparative data, and there is full, clear instruction in all fundamental antenna principles. *By Noll & Mandl.*

Outstandingly helpful references

TELEVISION FOR RADIOMEN



The outstanding book on television for servicemen. Explains in clear, non-mathematical terms the operating principles and function of every part and circuit in today's TV receivers, and the chief principles of transmission. Complete, practical instruction in installation and alignment procedures, testing equipment and how to use it, adjustment, and trouble-shooting. *By E. M. Noll.*

RADIO & TELEVISION MATHEMATICS



This unique handbook of 721 problems and solutions shows you what formulas to use, what numerical values to substitute, and each step in solving any problem you are likely to encounter in radio, television, or industrial electronics. Conveniently arranged and fully indexed for quick reference. *By Bernhard Fischer.*

USE THIS COUPON

to get FREE examination copies. If you're not fully satisfied, you may return them without further charge.

The Macmillan Company, 60 Fifth Avenue, New York 11

- Movies for TV \$4.65
- Television & FM Antenna Guide. \$5.50
- Television for Radiomen \$7.50
- Radio & Television Mathematics \$6.00

Please send me the books checked. I will either remit in full or return the books in 10 days.

Signed

Address

TWO SETS IN EVERY HOME Made Easy with New Coupler

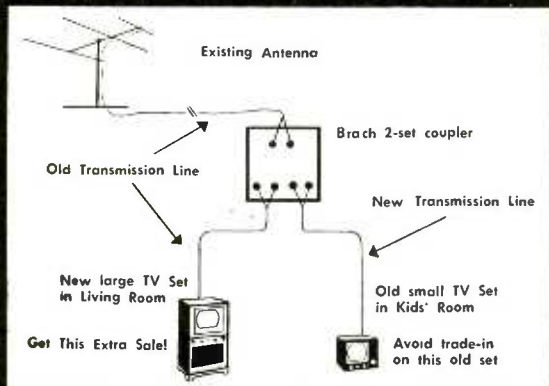

The Brach 2-Set Coupler

- Eliminates interference
- Matches 300 & 75 ohm lines
- Installs with hand tools
- Low in cost
- Avoids trade-in sales

ONLY
\$1495
LIST

BRACH MANUFACTURING CORP. (Div. of General Bronze Corp.)
200 Central Ave. Newark 4, N. J.

SAVE

THAT GOOD LOOKING OLD CONSOLE—
REPLACE THE OBSOLETE RADIO

with a modern, easily installed

ESPEY AM/FM CHASSIS

and your favorite console is "right-up-to-date"

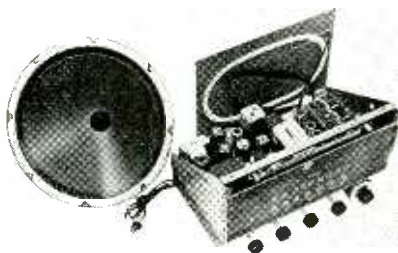

Rated an excellent instrument by America's foremost electronic engineers. Fully licensed under RCA and Hazeltine patents. The photo shows the Espey Model 511-B, supplied ready to play. Equipped with tubes, antenna, speaker and all necessary hardware for mounting.

NEW FEATURES—Improved frequency modulation circuit, drift compensated • 12 tubes plus rectifier, electronic tuning eye and pre-amplifier pick-up tubes • 4 dual purpose tubes • High quality AM-FM reception • Push-pull beam power audio output 10 watts • Switch for easy changing to crystal or variable reluctance pick-ups • Multitap audio output transformer supplying 4—8—500 ohms.

Makers of fine radios since 1928.

Write for literature RC-5 for complete specifications on Model 511-B and others.

ESPEY
MANUFACTURING COMPANY, INC.
528 EAST 72nd STREET, NEW YORK 21, N. Y.

NEW OSCILLOSCOPE Hickock Electrical Instrument Co. Cleveland, Ohio

Intended for general purpose industrial and electronic laboratory use, the model 640 5-inch oscilloscope features high stability and sensitivity. Its wide-band amplifier has a response from d.c. to 4.5 mc (3 db down) and a sensitivity of 10 mv per inch. Maximum input potential is 1,000 volts peak, and input

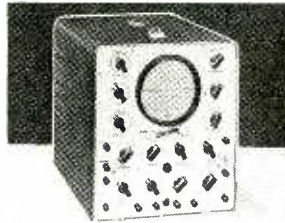

impedance is 2 megohms, 50 μ mf. Recurrent and driven sweeps range from 2 cycles to 30,000 cycles, and provision is made for supplying external sweeps of 10 seconds or slower. Sweeps of 30 and 7,875 cycles are provided for observing television patterns.

The instrument is fully shielded, shock-mounted, and has built-in calibrating voltages. An expandable sweep (6 times expansion) is an additional feature.

TV RECEIVER KIT

Tech-Master Products Co.
New York, N. Y.

Improvements in the 630 type circuit used in these kits bring them up to date as the latest in TV engineering. The major features of the circuit are quick action keyed a.g.c., "hi-sweep" voltage-multiplier system, 12-channel turret tuner, and full 4-mc bandwidth.

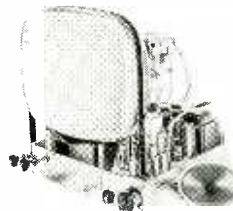

Carefully planned schematic and pictorial diagrams, as well as simple-to-follow instructions, are included. Top quality, circuit aligned components minimize the amount of final adjustments necessary. This kit comes in two models: the de luxe kit, model 630D19, has the principal components mounted in place, while the standard kit, model 630S19, comes unassembled. Both kits are supplied with all components, picture-tube mounting brackets, speaker, and all tubes (less kinescope, wire, and solder.) The chassis measures 21 $\frac{3}{4}$ -inches wide by 15 $\frac{3}{4}$ -inches deep.

DUAL POTENTIOMETERS

P. R. Mallory & Co.
Indianapolis, Ind.

To attain maximum coverage of a great variety of television and auto radio receivers, these dual controls are being sold in subassembly form. The service technician can complete the assembly in less than five minutes, combining control sections of specified ratings for his particular application. The control sections are supplied in factory-assembled form, making possible complete factory inspection and testing. A new a.c. switch makes



attachment simple and sure by positive indexing and design that permits secure locking in position without removing the control housing.

It has also been announced that the single-section Mallory Midgetrol is now supplied with a permanently fixed, tubular brass shaft that can be adapted in a few sections for split-knurled or

flatted type knobs by inserting one of two steel shaft ends contained in every package. The purpose of the new design is to make installation by the serviceman as fast and simple as possible, without sacrificing the stability of a permanently secured shaft.

SPACE-SAVING SCOPE

Simpson Electric Co.
Chicago, Ill.

The Model 476 Mirroscope is designed to save space on the testing bench. The 5-inch cathode-ray tube is mounted in a vertical position. This construction reduces bench requirements to an area of only 9 x 8-inches. The cathode-ray image is reflected from a high-grade mirror mounted in the adjustable cover at the top of the cabinet; thus the viewing surface is brought near the eye level when the instrument is used on benches of normal height. Mirror and wing sides at top—for deflecting light—fold into the cabinet when it is not in use. Height is 16 $\frac{1}{4}$ inches and width 9 $\frac{1}{8}$ inches.

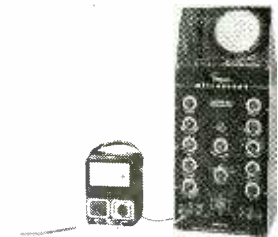

COBRA-TYPE HORN

Racon Electric Co.
New York, N. Y.

The COB-11 is a cobra-type horn for public address systems requiring a maximum concentration of sound in a horizontal plane. It provides a uniform sound field over a horizontal angle of 120° and a vertical angle of 40°. It is exponentially flared for maximum transfer of energy and has a low-frequency cutoff design point of 250 cycles.

The horn consists of heavy two-piece non-vibratory aluminum casting, designed to withstand severe use both indoors and outdoors. It has a rib reinforced two-section serrated mounting bracket (not illustrated) for coupling to a standard 1 $\frac{1}{4}$ -inch mounting flange. The horn has a standard thread size to permit attachment of any standard 25-35-watt driver unit.

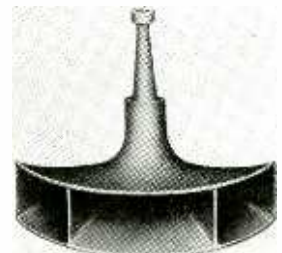

The COB-11 may also be used as a middle register or high-frequency horn in high-quality audio systems using two or three loudspeakers. The combination of high efficiency, wide angular coverage and low cutoff make it well suited for this purpose.

POLYPHASE REPRODUCER

Audak Co.
New York, N. Y.

The L-6 G single magnetic unit will play any and all lateral recordings at



speeds of 33-1/3, 45 or 78 r.p.m. A special connector is available which permits the unit to be plugged into the Garrard changer arm. Once the unit has been plugged in, it becomes a permanent part of the arm, thus eliminating repeated adjustments on the arm.

The point pressure is 8 grams for all discs. The output is approximately 20 mv. Response is from 20 to over 10,000 c.p.s. The sapphire or diamond stylus is easily replaceable.

INDOOR TV ANTENNA

JFD Manufacturing Co.
Brooklyn, N. Y.

A uniquely designed base, perfectly balanced and weighted, prevents the JFD "Tip-Proof" indoor antenna from tipping or rocking despite full extension of dipoles. Made of engraved satin-finish mahogany plastic, it harmonizes perfectly with any room in the

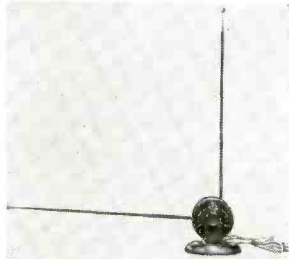

home. Three-section, triple-chrome-plated telescopic dipoles can be adjusted from 15 to 41 inches for quick and easy orientation. A tension design holds dipoles at any position—collapsed or extended. A felt pad cushions the base of the antenna and protects the finest furniture surfaces.

WINDOW ANTENNA

Veri-Best Television Products, Inc.
New York, N. Y.

The Bazuka is a high Q single-element coaxial type antenna that works

into a 300-ohm input, or into a 72-ohm input with a matching transformer. The bandwidth is broad enough to cover the entire TV band. It has a rising characteristic in the 88- to 108-mc FM band. The distributed capacitance between the inner rod and the outer section tends to lower the effective resonance frequency of the system, similar to end-loading of an antenna by the use of L and C. The efficiency tends to fall slowly around 80 mc on the single Bazuka model W836. It is recommended for locations up to 10 miles from station location.

OUTPUT TRANSFORMER

Partridge Transformers, Ltd.
Surrey, England

The CFB series of audio transformers use the latest grain-orientated strip-wound C cores and are built to the highest standards for equipment reproducing the full audio bandwidth with very low distortion. They will satisfy all the requirements of the Williamson circuit, and the 15-octave bandwidth ensures a greater margin of stability, or alternatively, allows a greater degree of feedback.

Power rating is 60 watts from 30 to 30,000 cycles with less than 1% distortion with no negative feedback. The 10,000-ohm primary has a d.c. resistance of 88 ohms in each half and will carry 180 ma continuously. The transformer is hermetically sealed, weighs 10 pounds, and is finished with a durable stove-enamel bronze. Many of the larger American distributors now carry Partridge audio transformers in stock.

U.H.F. ANTENNA

Workshop Associates, Inc.
Needham Heights, Mass.

The model 6HW is a high-gain beacon antenna for 450 to 470 mc. Over-all gain is nearly 8 db, the vertical radiation pattern is narrowed to concentrate energy on the horizon, and horizontal radiation is nondirectional. Impedance is 50 ohms with a voltage standing-wave ratio of less than 2 to 1. The antenna is designed especially for u.h.f. mobile service where higher-gain antennas are required.

**ABSOLUTELY NO KNOWLEDGE OF RADIO NECESSARY
FREE TOOLS WITH KIT • NO ADDITIONAL PARTS NEEDED**

- EXCELLENT BACKGROUND FOR TELEVISION
- 10 DAY MONEY-BACK GUARANTEE

WHAT THE PROGRESSIVE RADIO "EDU-KIT" OFFERS YOU

The Progressive Radio "Edu-Kit" offers you a home study course at a rock bottom price. Our kit is designed to train Radio Technicians, with the basic facts of Radio Theory and Construction Practice expressed simply and clearly. You will gain a knowledge of basic Radio Principles involved in Radio Reception, Radio Transmission and Audio Amplification.

You will learn how to identify Radio Symbols and Diagrams; how to build radios, using regular radio circuit schematics; how to mount various radio parts; how to wire and solder in a professional manner. You will learn how to operate Receivers, Transmitters, and Audio Amplifiers. You will learn how to service and trouble-shoot radios. In brief, you will receive a basic education in Radio exactly like the kind you would expect to receive in a Radio Course costing several hundreds of dollars.

THE KIT FOR EVERYONE

The Progressive Radio "Edu-Kit" was specifically prepared for any person who has a desire to learn Radio. The Kit has been used successfully by young and old in all parts of the world. It is not necessary that you have even the slightest background in science or radio.

The Progressive Radio "Edu-Kit" is used by many Radio Schools and Clubs in this country and abroad. It is used by the Veterans Administration for Vocational Guidance and Training.

The Progressive Radio "Edu-Kit" requires no instructor. All instructions are included. All parts are individually boxed, and identified by name, photograph and diagram. Every step involved in building these sets is carefully explained. You cannot make a mistake.

PROGRESSIVE TEACHING METHOD

The Progressive Radio "Edu-Kit" comes complete with instructions. These instructions are arranged in a clear, simple and progressive manner. The theory of Radio Transmission, Radio Reception and Audio Amplification is clearly explained. Every part is identified by photograph and diagram; you will learn the function and theory of every part used.

The Progressive Radio "Edu-Kit" uses the principle of "Learn By Doing". Therefore you will build radios to illustrate the principles which you learn. These radios are designed in a modern manner, according to the best principles of present-day educational practice. You begin by building a simple radio. The next set that you build is slightly more advanced. Gradually, in a progressive manner, you will find yourself constructing still more advanced radio sets, and doing work like a professional Radio Technician. Altogether you will build fifteen radios, including Receivers, Amplifiers and Transmitters.

The Progressive Radio "EDU-KIT" Is Complete

You will receive every part necessary to build 15 different radio sets. This includes tubes, tube sockets, variable condensers, electrolytic condensers, mica condensers, paper condensers, resistors, tie strips, coils, tubing, hardware, etc. Every part that you need is included. In addition these parts are individually packaged, so that you can easily identify every item.

TROUBLE-SHOOTING LESSONS

Trouble-shooting and servicing lessons are included. You will be taught to recognize and repair troubles. While you are learning in this practical way, you will be able to do many a repair job for your neighbors and friends, and charge fees which will far exceed the cost of the Kit. Here is an opportunity for you to learn radio and have others pay for it.

FREE EXTRAS IN 1951

- ELECTRICAL AND RADIO TESTER
- ELECTRIC SOLDERING IRON
- BOOK ON TELEVISION
- RADIO TROUBLE-SHOOTING GUIDE
- MEMBERSHIP IN RADIO-TELEVISION CLUB
- CONSULTATION SERVICE • QUIZZES

The Progressive Radio "Edu-Kit" is sold with a 10-day money-back guarantee. Order your Progressive Radio "EDU-KIT" Today, or send for further information.

Postage prepaid on cash orders—C.O.D. orders accepted in U. S. A.

PROGRESSIVE ELECTRONICS CO.

497 UNION AVE., Dept. RE-47 Brooklyn 11, N. Y.
(See advertising index for other advertisement of Progressive Electronics Co.)

JOE B. HIGGINBOTHAM, JR.

Nuberg, Ga.

**THANKS,
Mr. Higginbotham!**

Radio Receptor Co., Inc.
West 19th Street
New York 11, N.Y.

Gentlemen:

Please send me your pamphlet on the design, application and servicing of selenium rectifiers.

Although I have serviced many receivers which have selenium rectifiers I have very little information on them and believe your pamphlet would be a valuable asset to my shop.

I use your rectifiers, supplied by Southeastern Radio Parts Co. and Specialty Distributing Co. of Atlanta, Ga., and like them very much. Also I appreciate your consideration of the radio repairman in that you supply a data sheet with each rectifier and the trouble taken to print the servicing information.

Yours Truly

Joe B. Higginbotham Jr.
Joe B. Higginbotham Jr.



SELETRON RECTIFIERS

... And our thanks go as well to the other thousands of servicemen and hams who insist upon top performing SELETRON Selenium Rectifiers in electronic circuits and as replacements in Radio and TV sets.

You can depend on SELETRON all ways ... Full technical information is always available without obligation. Look for Howard W. Sam's Red Book Supplement listing SELETRON replacements, and write us for Bulletin RS-32.



SELETRON DIVISION
RADIO RECEPTOR COMPANY, INC.
Since 1922 in Radio and Electronics
Factory: 84 North 9th St., Brooklyn 11, N. Y. • Sales Department: 251 West 19th St., New York 11, N. Y.

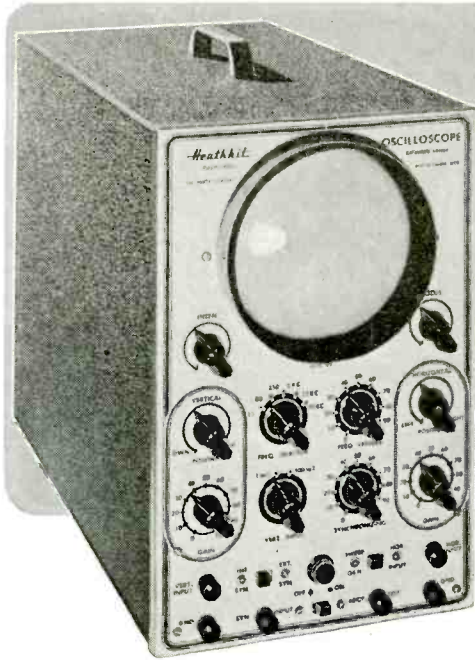

Heathkit MODEL 0-6 . . . PUSH-PULL . . . 5" OSCILLOSCOPE KIT

The new Heathkit 5" Push-Pull Oscilloscope Kit is again the best buy. No other kit offers half the features — check them.

Measure either AC or DC on this new scope — the first oscilloscope under \$100.00 with a DC amplifier.

The vertical amplifier has frequency compensated step attenuator input into a cathode follower stage. The gain control is of the non frequency discriminating type — accurate response at any setting. A push-pull pentode stage feeds the CR tube. New type positioning control has wide range for observing any portion of the trace.

The horizontal amplifiers are direct coupled to the CR tube and may be used as either AC or DC amplifiers. Separate binding posts are provided for AC or DC.

The multivibrator type sweep generator has new frequency compensation for the wide range it covers; 15 cycles to over 100,000 cycles.

The new model 0-6 scope uses 10 tubes in all, including 5" CR tube. Has improved amplifiers for better response useful to 2 megacycles. Tremendous sensitivity .04V RMS per inch horizontal — .09V RMS per inch vertical. Only Heathkit Scopes have all the features.

New husky heavy duty power transformer has 50% more laminations. It runs cool and has the lowest possible magnetic field. A complete electrostatic shield covers primary and other necessary windings and has lead brought out for proper grounding.

The new filter condenser has separate sections for the vertical and horizontal screen grids and prevents interaction between them. An improved intensity circuit provides almost double previous brilliance and better intensity modulation.

A new synchronization circuit allows the trace to be synchronized with either the positive or negative pulse, an important feature in observing the complex pulses encountered in television servicing.

The magnetic alloy shield supplied for the CR tube is of new design and uses a special metal developed by Allegheny Ludlum for such applications.

Model 0-6 . . . Shipping Wt. 24 lbs.

\$3950

The kit is complete, all tubes, cabinet, transformer, controls, grid screen, tube shield, etc. The instruction manual has complete step-by-step assembly and pictorials of every section. Compare it with all others and you will buy a Heathkit.

NEW INEXPENSIVE Heathkit ELECTRONIC SWITCH KIT

The companion piece to a scope — Feed two different signals into the switch, connect its output to a scope, and you can observe both signals — each as an individual trace. Gain of each input is easily set (gain A and gain B controls), the switching frequency is simple to adjust (coarse and fine frequency controls) and the traces can be superimposed for comparison or separated for individual study (position control).

Use the switch to see distortion, phase shift, clipping due to improper bias, both the input and output traces of an amplifier, — as a square wave generator over limited range.

The kit is complete; all tubes, switches, cabinet, power transformer and all other parts, plus a clear detailed construction manual.



Model 5-2
Shipping Wt. 11 lbs.

\$1950

New MODEL V-4 A

Heathkit VTVM KIT

The new Heathkit Model V-4A VTVM Kit measures up to 30,000 Volts DC and 250 megacycles when used with accessory probes — think of it, all in one electronic instrument more useful than ever before. The AC Voltmeter is so flat and extended in its response (± 1 db from 20 cycles to 2 megacycles) that it eliminates the need for separate expensive AC VTVM's.

The new 200 microampere, $4\frac{1}{2}$ " streamline meter with quality Simpson movement (five times as sensitive as the commonly used 1 MA meter) has a shatter proof plastic meter face for maximum protection. Meter has all the desirable scales and indicates AC volts, DC volts, ohms, db (direct reading), and even has a special zero center marking for quick FM alignment.

There are six complete ranges for each function. Four functions give total of 24 ranges. The 3 volt range allows $33\frac{1}{3}\%$ of the scale for reading 1 volt, as against only 20% of the scale on the 5 volt types.

New $\frac{1}{2}\%$ ceramic precision resistors are the most accurate commercial type available — you find the same make and quality in the finest laboratory equipment selling for thousands of dollars. The entire voltage divider decade uses these $\frac{1}{2}\%$ resistors.

Both AC and DC voltmeter measurements use a push-pull electronic voltmeter circuit, and the meter circuit makes the meter burn-out proof. Electronic ohmmeter circuit measures resistance over the amazing range of $1/10$ ohm to one billion ohms, all with internal 3 volt battery. Ohmmeter batteries mount on the chassis in snap-in mounting for easy replacement.

Voltage ranges are full scale — 3 Volts, 10 Volts, 30 Volts, 100 Volts, 300 Volts, 1000 Volts. Complete decoding coverage without gaps.

The DC probe is isolated for dynamic measurements. Negligible circuit loading. Gets the accurate reading without disturbing the operation of the equipment under test. Kit comes complete: cabinet, transformer, Simpson meter, test leads, complete assembly and instruction manual.

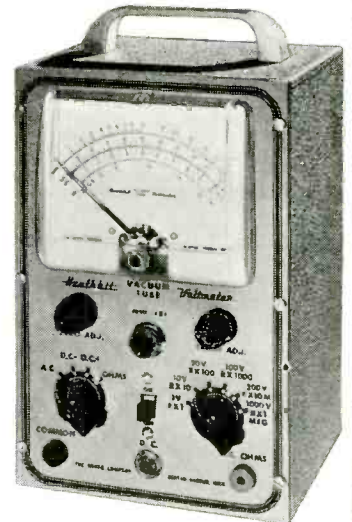

Model V-4A . . . Shipping Wt. 8 lbs.

Note New Low Price

\$2350

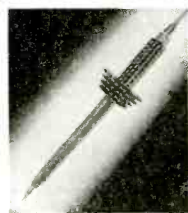

Heathkit 30,000V DC PROBE KIT

A new 30,000 V DC Probe Kit to handle high voltages with safety. For TV service work and all other high voltage applications. Sleek looking — Two color molded plastic — Red body and guard — jet black handle. Comes with connector, cable, and PL55 type plug. Plugs into Heathkit VTVM so that 300V scale is conveniently multiplied by 100. Can be used with any standard 11 megohm VTVM.

\$550

No. 336 High Voltage Probe Kit . . . Shipping Wt. 2 lbs.

Heathkit RF PROBE KIT

This RF Probe Kit comes complete with probe housing, crystal diode detector, connector, lead and plug and all other parts plus clear assembly instructions. Extends range of Heathkit VTVM to 250 Mc. $\pm 10\%$. Works on any 11 megohm input VTVM. Specify No. 309 RF Probe Kit.



Shipping Wt. 1 lb.

\$550

EXPORT AGENT
ROCKE INTERNATIONAL CORP.
1315 40th ST.
NEW YORK CITY (16)
CABLE: ARIAS, N.Y.

The HEATH COMPANY

. . . BENTON HARBOR 20, MICHIGAN

NEW Heathkit TV ALIGNMENT GENERATOR KIT

Here is an excellent TV Alignment Generator designed to do TV service work quickly, easily, and properly. The model TS-2 when used in conjunction with an oscilloscope provides a means of correctly aligning television receivers.

The instrument provides a frequency modulated signal covering, in two bands, the range of 10 to 90 Mc. and 150 to 230 Mc. — thus, ALL ALLOCATED TV CHANNELS AS WELL AS IF FREQUENCIES ARE COVERED.

An absorption type frequency marker covers from 20 to 75 Mc. in two ranges — therefore, you have a simple, convenient means of frequency checking of IF's, independent of oscillator calibration.

Sweep width is controlled from the front panel and covers a sweep deviation of 0-12 Mc. — all the sweep you could possibly need or want.

And still other excellent features are: Horizontal sweep voltage available at the front panel (and controlled with a phasing control) — both step and continuously variable attenuation for setting the output signal to the desired level — a convenient instrument stand-by position — vernier drive of both oscillator and marker tuning condensers — and blanking for establishing a single trace with base reference level. Make your work easier, save time, and repair with confidence — order your Heathkit TV Alignment Generator now!



\$3950

Model TS-2
Shipping Wt. 20 lbs.

Heathkit SIGNAL GENERATOR KIT

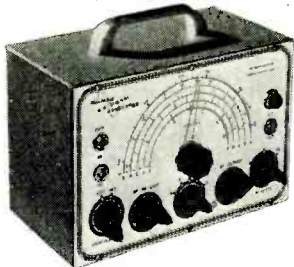

Model SG-6
Shipping Wt.
7 lbs.

\$1950

The new Heathkit Signal Generator Kit has dozens of improvements. Covers the extended range of 160 Kc to 50 megacycles on fundamentals and up to 150 megacycles on useful calibrated harmonics; makes this Heathkit ideal as a marker oscillator for TV. Output level can be conveniently set by means of both step attenuator and continuously variable output controls. Instrument has new miniature HF tubes to easily handle the high frequencies covered.

Uses 6C4 master oscillator and 6C4 sine wave audio oscillator. The kit is transformer operated and a husky selenium rectifier is used in the power supply. All coils are precision wound and checked for calibration making only one adjustment necessary for all bands.

New sine wave audio oscillator provides internal modulation and is also available for external audio testing. Switch provided allows the oscillator to be modulated by an external audio oscillator for fidelity testing of receivers. Comes complete, all tubes, cabinet, test leads, every part. The instruction manual has step-by-step instructions and pictorials. It's easy and fun to build a Heathkit Model SG-6 Signal Generator.

Heathkit SIGNAL TRACER

and UNIVERSAL TEST SPEAKER KIT

The popular Heathkit Signal Tracer has now been combined with a universal test speaker at no increase in price. The same high quality tracer follows signal from antenna to speaker — locates intermittents — finds defective parts quicker — saves valuable service time — gives greater income per service hour. Works equally well on broadcast, FM, or TV receivers. The test speaker has an assortment of switching ranges to match either push-pull or single output impedances. Also tests microphones, pickups and PA systems. Comes complete: cabinet, 110V 60 cycle power transformer, tubes, test probe, all necessary parts, and detailed instructions for assembly and use.



Model T-2
Shipping Wt. 7 lbs.

\$1950

Heathkit TUBE CHECKER KIT

Test your tubes the modern way — dynamically — the simplest, yet fastest and surest method — your Heathkit has a switch for each tube element and measures that element — no chance for open or shorted elements slipping by. All the advantages of the mutual conductance type without the slow cumbersome time consuming setups. Checks for opens, shorts, each element individually, filament and filament tap continuity, and emission.

This Tube Checker has all the features — beautiful 3 color BAD-?-GOOD meter — complete selection of voltages — roller chart listing hundreds of tubes including the new 9 pin miniatures — finest quality Centralab lever switches — high grade birch, counter-type cabinet — continuously variable line adjust control — every feature you need to sell tubes properly. The most modern type tube checker with complete protection against obsolescence. Uses only the best of parts — rugged oversize 110V 60 cycle power transformer, finest of Mallory and Centralab switches and controls, complete set of sockets for all type tubes with blank spare for future types. Fast action, gear driven roller chart quickly locates the setting for any type tube. Simplified switching cuts necessary testing time to a minimum and saves valuable service time. Simple method allows instant setup of new tube types without waiting for factory data. No matter what the arrangement of tube elements is, the Heathkit flexible switching method easily handles it. Order your Heathkit Tube Checker Kit today and see for yourself that Heath again saves you two-thirds and yet retains all the quality. Complete with instructions, all parts, and cabinet.

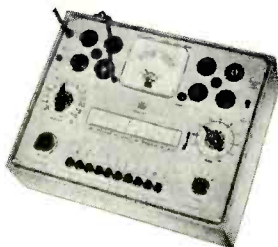

Model TC-1
Shipping Wt.
12 lbs.

\$2950

Heathkit CONDENSER CHECKER KIT



\$1950

Checks all types of condensers — paper, mica, ceramic, electrolytic. All condenser scales are direct reading and require no charts or multipliers. Covers range of .00001 MFD to 1000 MFD. A Condenser Checker that anyone can read. A leakage test and polarizing voltage for 20 to 500 V provided. Measures power factor of electrolytics between 0% and 50% and reads resistance from 100 ohms to 5 megohms. The magic eye indicator makes testing easy.

The kit is 110V 60 cycle transformer operated and comes complete with rectifier tube, magic eye tube, cabinet, calibrated panel and all other parts. Has clear detailed instructions for assembly and use.

Model C-2 Shipping Wt. 6 lbs.

NEW Heathkit

HANDITESTER KIT

A precision portable volt-ohm-milliammeter. Uses only high quality parts — All precision 1/2% resistors, three deck switch for trouble-free mounting of parts, specially designed battery mounting bracket, smooth acting ohm adjust control, beautiful molded bakelite case, 400 microamp meter movement, etc.

DC and AC voltage ranges 10-30-300-1000-5000V. Ohms range 0-3000 and 0-300,000 Range Milliampers 0-10 Ma, 0-100 Ma. Easily assembled from complete instructions and pictorial diagrams.



\$1350

Model M-1 Shipping Wt. 3 lbs.

EXPORT AGENT
ROCKE INTERNATIONAL CORP.
13 E. 40th ST.
NEW YORK CITY (16)
CABLE: ARIAS-N.Y.

The HEATH COMPANY

... BENTON HARBOR 20, MICHIGAN

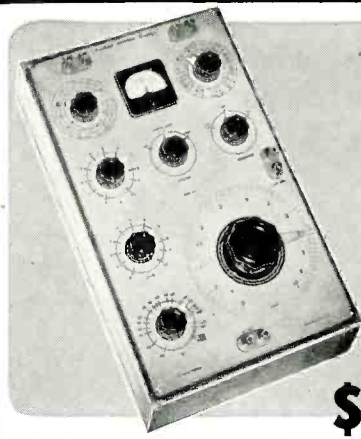

Model IB-1B...Shipping Wt. 15 lbs.

NEW *Heathkit* IMPEDANCE BRIDGE KIT

This Impedance Bridge Kit is really a favorite with schools, industrial laboratories, and serious experimenters. An invaluable instrument for those doing electrical measurements work. Reads resistance from .01 Ohms to 10 megohms, capacitance from .00001 MFD to 100 MFD, inductance from 10 microhenries to 100 henries, dissipation factor from .002 to 1, and storage factor from 1 to 1000. And you don't have to worry about selecting the proper bridge circuit for the various measurements—the instrument automatically makes the correct circuit when you set up for taking the measurement you want. Bridge utilizes Wheatstone, Hay, Maxwell, and capacitance comparison circuits for the wide range and types of measurements possible. And it's self powered—has internal battery and General Radio 1000 cycle hummer. No external generator required—has provisions for external generator if measurements at other than 1000 cycles are desired.

Kit utilizes only highest quality parts. General Radio main calibrated control, General Radio hummer, Mallory ceramic switches, excellent 200 microamp zero center galvanometer, laboratory type binding posts with standard 3/4 inch centers, 1/2% precision ceramic-body type multiplier resistors, beautiful birch cabinet and ready calibrated panel. (Headphones not included.)

Take the guesswork out of electrical measurements—order your Heathkit Impedance Bridge Kit today—you'll like it.

\$6950

Heathkit LABORATORY RESISTANCE DECADE KIT



Model RD-1
Ship. Wt. 4 lbs.

\$1950

An indispensable piece of laboratory equipment—the Heathkit Resistance Decade Kit gives you resistance settings from 1 to 99,999 ohms IN ONE OHM STEPS. For greatest accuracy, 1/2% precision ceramic-body type resistors and highest quality ceramic wafer switches are used.

Designed to match the impedance bridge above, the Resistance Decade Kit has a beautiful birch cabinet and attractive panel. It's easy to build, and comes complete with all parts and construction manual.

Heathkit LABORATORY POWER SUPPLY KIT



Model PS-1
Ship. Wt. 20 lbs.

\$2950

Every experimenter needs a good power supply for electronic setups of all kinds. This unit has been expressly designed to act as a HV supply and a 6.3 V filament voltage source.

Voltage control allows selection of HV output desired (continuously variable within limits outlined), and a Volts—Ma switch provides choice of output metering. A large, plainly marked, and direct reading meter scale indicates either DC voltage output in volts or DC current output in Ma. (Range of meter 0-500V DC, 0-200 Ma DC). Instrument has convenient stand-by position and pilot light.

Comes with power transformer, filament transformer, meter, 5Y3 rectifier, two 1619 control tubes, completely punched and formed chassis, panel, cabinet, detailed construction manual, and all other parts to make the kit complete.

LIMITS:

No load.....	Variable	150-400V DC
25 Ma.....	Variable	30-310V DC
50 Ma.....	Variable	25-250V DC
Higher loads.....	Voltage drops off proportionally	

Heathkit BATTERY ELIMINATOR KIT



Model BE-2
Ship. Wt. 19 lbs.

\$2250

A few auto radio repair jobs will pay for the Heathkit Battery Eliminator Kit. It's fast for service. The voltage can be lowered to find sticky vibrators or raised to ferret out intermittents. Provides variable DC voltage 5 to 7 1/2 Volts at 10 Amps, continuous or 15 Amps, intermittent.

Also serves as storage battery charger. A well filtered, rugged power supply uses heavy duty selenium rectifier, a husky choke, and a 4000 MFD electrolytic condenser for clean DC. 0-15V voltmeter indicates output which is variable in eight steps. Better be equipped for all types of service—it means more income.

NEW *Heathkit* SINE and SQUARE WAVE AUDIO GENERATOR KIT

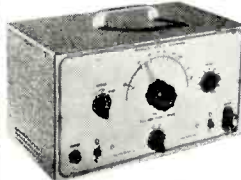

Model AG-7
Ship. Wt. 15 lbs.

\$3450

We proudly present the NEW MODEL Sine and Square Wave Audio Generator Kit. Designed with versatility, usefulness, and dependability in mind, the AG-7 gives you the two most needed waveshapes right at your fingertips—the sine wave and the square wave.

The range switch and plainly calibrated frequency scale give rapid and easy frequency selection, and the output control permits setting the output to any desired level.

A high-low impedance switch sets the instrument for either high or low impedance output—on high to connect to high impedance load, and on low to work into a low impedance transformer with negligible DC resistance.

Coverage is from 20 to 20,000 cycles, and distortion is at a minimum—you can readily trust the output waveshape.

6 tubes, quality 4 gang tuning condenser, power transformer, metal cased filter condenser, 1/2% precision resistors in the frequency determining circuit, and all other parts come with the kit—plus, a complete construction manual. A tremendous kit, and the price is truly low.

TWO HIGH QUALITY *Heathkit* SUPERHETERODYNE RECEIVER KITS



Model BR-1 Broadcast Model Kit covers 550 to 1600 Kc. Shipping Wt. 10 lbs.

\$1950



Model AR-1 3 Band Receiver Kit covers 55 Kc. to over 20 Mc. continuous. Extremely high sensitivity. Shipping Wt. 10 lbs.

\$2350

Two new Heathkits. Ideal for schools, replacement of worn out receivers, amateurs and custom installations.

Both are transformer operated quality units. The best of materials used throughout—six inch calibrated slide rule dial—quality power output transformers—dual iron core shielded I.F. coils—metal cased filter condenser. The chassis has phono input jack, 110 Volt output for phono motor, and there is a phono-radio switch on panel. A large metal panel simplifying installation in used console cabinets is included. Comes complete with tubes and instruction manual incorporating pictorials and step-by-step instructions (less speaker and cabinet). The three band model has simple coil turret which is assembled separately for ease of construction.

Heathkit FM TUNER KIT

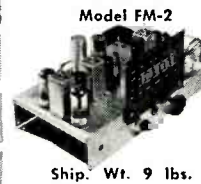

Model FM-2
Ship. Wt. 9 lbs.

\$2250

The Heathkit FM Tuner Model FM-2 was designed for best tonal reproduction. The circuit incorporates the most desirable FM features—true FM.

Utilizes 8 tubes: 7E5 Oscillator, 6SH7 mixer, two 6SH7 IF amplifiers, 6SH7 limiter, two 7C4 diodes as discriminator, and 6X5 rectifier.

The instrument is transformer operated making it safe for connection to any type receiver or amplifier. Has ready wound and adjusted RF coils, and 2 stages of 10.7 Mc IF (including limiter). A calibrated six inch slide rule dial has vernier drive for easy tuning. All parts and complete construction manual furnished.

EXPORT AGENT
ROCKE INTERNATIONAL CORP.
13 E. 40th ST.
NEW YORK CITY (16)
CABLE: ARLAB-N.Y.

The **HEATH COMPANY**

... BENTON HARBOR 20, MICHIGAN

Heathkit ECONOMY . . . 6 WATT AMPLIFIER KIT

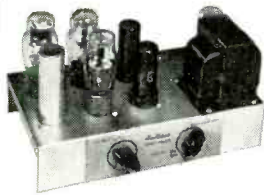

\$12.50

Model A-4. Ship. Wt. 8 lbs.

This new Heathkit Amplifier was designed to give quality reproduction and yet remain low in price. Has two preamp stages, phase inverter stage, and push-pull beam power output. Comes complete with six tubes, quality output transformer (to 3-4 ohm voice coil), husky cased power transformer and all other parts. Has tone and volume controls. Instruction manual has pictorial for easy assembly. Six watts output with response flat $\pm 1\frac{1}{2}$ db from 50 to 15,000 cycles. A quality amplifier kit at a new low price. Better build one.

No. 304. 12 inch Speaker..... \$6.95

Heathkit HIGH FIDELITY . . . 20 WATT AMPLIFIER KIT

Our latest and finest amplifier — the Model A-6 (or A-6A) is capable of a full 20 Watts of high fidelity output — good faithful reproduction made possible through careful circuit design and the use of only highest quality components. Frequency response within ± 1 db from 20-20,000 cycles. Distortion at 3 db below maximum power output (at 1000 cycles) is only .8%.

The power transformer is rugged and conservatively rated and will deliver full plate and filament supply with ease. The output transformer was selected because of its exceptionally good frequency response and wide range of output impedances (4-8-16-150-600 ohms). Both are Chicago-Transformers in drawn steel case for shielding and maximum protection to windings.

The unit has dual tone controls to set the output for the tonal quality desired — treble control attenuates up to 15 db at 10,000 cycles — bass control gives bass boost up to 10 db at 50 cycles.

Tube complement consists of 5U4G rectifier, 6SJ7 voltage amplifier, 6SN7 amplifier and phase splitter, and two 6L6's in push-pull output. Comes complete with all parts and detailed construction manual. (Speaker not included)

MODEL A-6: For tuner and crystal phono inputs. Has two position selector switch for convenient switching to type of input desired. **Shipping Wt. 18 lbs. \$33.50**

MODEL A-6A: Features an added 6SJ7 stage (preamplifier) for operating from variable reluctance cartridge phono pickup, mike input, and either tuner or standard crystal phono pickup. A three position selector switch provides flexible switching. **Shipping Wt. 18 lbs. \$35.50**



\$33.50

Heathkit RECEIVER AND TUNER CABINETS



\$4.95

Blonde birch veneer cabinet for either of the receivers or tuner. The modern styling is an asset to any room. 5" speaker fits in end of cabinet when used with receivers. (Speaker not included.) Size 7 x 13 $\frac{1}{2}$ x 18 $\frac{1}{4}$ inches. Order No. 345 for either receiver model. Specify No. 350 for the FM Tuner

Shipping Wt. 5 lbs.

Metal professional type communications receiver cabinet. Finished in deep grey and fits the panel supplied with Heathkit BR-1 and AR-1 Receivers. 5" speaker mounts in end of cabinet. (Speaker and panel shown not included with cabinet.) Gives professional appearance to Heathkit receivers. Size 7 x 14 x 7 $\frac{3}{4}$ inches.

Specify No. 335. Shipping Wt. 6 lbs.



\$4.50



MAIL TO THE
HEATH COMPANY
BENTON HARBOR 20,
MICHIGAN

ORDER BLANK

From _____

SHIP VIA

- Parcel Post
- Express
- Freight
- Best Way

Quantity	Item	Price	Quantity	Item	Price
	Heathkit Oscilloscope Kit — Model O-6			Heathkit R.F. Probe Kit — No. 309	
	Heathkit VTVM Kit — Model V-4A			Heathkit H.V. Probe Kit — No. 336	
	Heathkit FM Tuner Kit — FM-2			Heathkit R.F. Signal Gen. Kit — Model SG-6	
	Heathkit Broadcast Receiver Kit — Model BR-1			Heathkit Condenser Checker Kit — Model C-2	
	Heathkit Three Band Receiver Kit — Model AR-1			Heathkit Handitester Kit — Model M-1	
	Heathkit Amplifier Kit — Model A-4			Heathkit Power Supply Kit — Model PS-1	
	Heathkit Amplifier Kit — Model A-6 (or A-6A)			Heathkit Resistance Decade Kit — Model RD-1	
	Heathkit Tube Checker Kit — Model TC-1			Heathkit Impedance Bridge Kit — Model IB-1B	
	Heathkit Audio Generator Kit — Model AG-7				
	Heathkit Battery Eliminator Kit — Model BE-2				
	Heathkit Electronic Switch Kit — Model S-2				
	Heathkit T.V. Alignment Gen. Kit — TS-2				
	Heathkit Signal Tracer Kit — Model T-2				

On Parcel Post Orders, include postage for weight shown and insurance. (We insure all shipments.)

On Express Orders, do not include transportation charges — they will be collected by the Express Agency at time of delivery.

Enclosed find Check Money Order for _____

Please ship C.O.D. Postage enclosed for _____ lbs.

ALL PRICES SUBJECT TO CHANGE WITHOUT NOTICE

EXPORT AGENT
ROCKE INTERNATIONAL CORP.
13 E. 40th ST.
NEW YORK CITY (16)
CABLE: ARLAB-N.Y.

The HEATH COMPANY

. . . BENTON HARBOR 20, MICHIGAN

Beat the Tube Shortage!

This invaluable book shows you how to keep radio and TV sets working . . . even though exact replacements are unavailable.

RECEIVING TUBE SUBSTITUTION GUIDE BOOK



For TV-AM-FM Receivers and Allied Equipment
by H. A. Middleton

2500 Radio and TV tube substitutions listed: TV receiver filament wiring; heater substitution wiring instructions; tube types classified by functions. Other priceless data you must have in order to keep your shop as well as receivers going. Get this book without further delay.

215 pages, 8½ x 11, durable paper cover.
Only \$2.40

All About Antennas

No other book so thoroughly and clearly explains theory and practical aspects of TV antennas . . . a money-maker for you.

TV and OTHER RECEIVING ANTENNAS (Theory and Practice)



by Arnold B. Bailey

A "must" reference book on all types of receiving antennas. If you have any questions, you'll find all the answers in this volume. It incorporates 50 data pages, never before published, on approximately 50 different basic types of antennas. Shows which type is best . . . what it can do . . . and how to use it. Technician, teacher, student, engineer — all can use this book. And it's readable because mathematics has been translated into charts and graphs.

595 pages, 310 illustrations. . . . Only \$6.00

About Master Antennas

Master Antenna Systems are a big business. Make sure you get your share by making sure you know all about installations.



TV MASTER ANTENNA SYSTEMS

by Ira Kamen and Richard H. Dorf

More than 50 million dollars will be spent in 1951 for TV Master Antenna Systems installed in apartment buildings, hotels, hospitals, institutions, etc. . . . in both new and old buildings. This book provides a practical working manual that deals with installation, usage, maintenance, etc. It shows how the Master Antenna System is installed, how it works, and how you can capitalize on this fast-growing field.

356 pages. 234 illustrations. Cloth bound.
Only \$5.00

Time-Saving! Money-Making!

Stop wasting time, effort and money in trying to "dope out" difficult TV installations . . . order this book today.



TV INSTALLATION TECHNIQUES

by Samuel L. Marshall

The only book of its kind. Gives ALL the facts about such things as ice loading, wind surface, mounting requirements, etc. Accurate data on receiver adjustment in the home.

Municipal regulations in all the major TV areas in U.S.A. Complete information on all mechanical and electrical considerations. Sure to be a great help to you.

330 pages, 5½ x 8½. 270 illustrations. Cloth bound. . . . Only \$3.60

At Your Jobber's or ORDER DIRECT on a 10-DAY MONEY-BACK GUARANTEE.

JOHN F. RIDER PUBLISHER, Inc.
480 Canal Street • New York 13, N. Y.

VARIABLE GROOVE SPACING

To get full dynamic range of music in disc recording, ample space must be left between adjacent grooves for the greater lateral cutting during the loudest passages. However, in most music, the loudest passages occur only occasionally, so that most of this space between adjacent grooves is wasted.

The German physicist Eduard Rhein has developed an electronic brain which computes the groove spacing and controls the cutter so that the spacing is continuously variable and is correct for the actual requirements of the music at any instant. (Another device for variable pitch recording was described in "Unusual Techniques in Sound Recording" in RADIO-ELECTRONICS for May, 1950.)

The problem with such a device is that the electronic brain must compute its instructions a fraction of a second in advance so that it can warn the cutter to keep clear of the preceding groove as a loud passage is about to occur, or so that it can allow the cutter to approach the preceding groove without risk. This particular system operates by having volume level of the music previously recorded. This recording controls the computing device which in turn controls the cutter.

With the Rhein system, the playing time of the average dance record is increased appreciably, a 10-inch record becoming about equivalent to a 12-inch record of standard type. In symphonic music, the dynamic range can be increased to the point where it is equivalent to that of the live music.

14-TUBE TELEVISER

A new television receiver design using only 14 tubes and having a 17-inch rectangular picture tube was announced recently by the Air Marshal Corporation of Brooklyn, N. Y. The result of considerable engineering work, the new set is said to have ample sweep and brightness for a 20-inch tube. It will be available in both console and table models.

One feature of the Air Marshal is what is called a "universal service plan." Dealers or distributors will have spare chassis available. Should trouble develop, the repairman need only remove four screws, slip out the chassis and replace it with a spare. This permits all repair work to be done at a central shop where complete equipment and specialized technicians will be available. Distributor plans for the new receiver are not yet complete, but several have already been appointed.

PLASTIC PROJECTION LENS

A plastic lens, 22½ inches in diameter, has been designed by the Polaroid Company to project a 15 x 20-foot TV picture on a screen. Said to be the largest ever manufactured commercially for the Schmidt optical system, the lens has already been installed in about a dozen theater systems. The cost of such a plastic lens is only a fraction of the cost of a similar glass unit.

You need it! Get it...Now!

New Rider TV Manual . . . VOLUME 6



at your nearby Jobbers' today! Hurry in for your copy before the present supply is exhausted!

EXCLUSIVE FEATURES

- All TV Production Runs and Changes from August, 1950 Through January, 1951
- Circuit Function Descriptions.
- Unpacking and Installation Data.
- Signal Waveforms for Trouble Shooting.
- COMPLETE Alignment Data.
- COMPLETE Parts List.
- Circuit Changes.

RIDER TV MANUAL...Vol. 6

ACCURATE . . . AUTHENTIC . . . FACTORY-AUTHORIZED TV servicing information direct from 66 manufacturers. BIG 12"x 15" page size, and all pages filed in proper place. Large, easy-to-read diagrams. Equivalent of 2320 pages, (8½" x 11") plus Cumulative Index Volumes 1 through 6 . . . \$24.00

With all 6 RIDER TV MANUALS on your shelves you will have the world's greatest compilation of TV servicing information — right at your fingertips. This information will save you time, save you trouble, help you do a better servicing job, and help increase your profits. SEE YOUR JOBBER TODAY!

Now Available!

RIDER Manual . . . Vol. XXI



Here's another RIDER volume that you must have on your shelves...another time-saver . . . another money-maker for you! Factory-authorized servicing information from 61 manufacturers . . . AM-FM,

Auto Radios, Record Changers, Disc Recorders, Tape Recorders. Coverage from December, 1949 through October, 1950. 1648 pages plus Cumulative Index Volumes XVI through XXI . . . \$21.00

Every Day, More and More Servicemen Buy RIDER MANUALS For PLUS Profits!

JOHN F. RIDER PUBLISHER, Inc.
480 Canal Street • New York 13, N. Y.

DESIGN TECHNIQUES FOR V.H.F. AND U.H.F.

By B. E. PARKER*

V.H.F. and u.h.f. design, construction, and service use techniques which are completely ignored at shortwave and broadcast frequencies. These techniques are not complicated, though at times it may appear that those "in the know" are trying to make them so.

Actually it is a matter of adjusting our thinking to include such things as distributed capacitance, inductance, etc., in the v.h.f. design or service problem. We can still make capacitors behave as capacitors instead of inductors, and r.f. chokes still appear as inductances instead of capacitors, if we select the proper types.

Distributed capacitance, distributed inductance, etc., sound like formidable engineering terms, but we need not use the engineering approach if we accept the fact that every piece of wire regardless of how short or long, has distributed capacitance and distributed inductance. The best example is the familiar hairpin coil used on television tuners and by hams in their v.h.f. transmitters.



Fig. 1—A 2-inch lead has significant self inductance at v.h.f. and u.h.f.

Fig. 1 illustrates schematically, the inductance of a piece of wire 2 inches long. The inductance is small; in fact, so small that it can be ignored completely in the broadcast band. Take that same inductance of this piece of wire and insert it in the screen bypass circuit of a v.h.f. or u.h.f. tube as shown in Fig. 2. This is exactly the same as inserting an r.f. choke in series with the bypass capacitor which destroys all r.f. bypassing action of the capacitor, and causes oscillations or instability. From this, we readily deduce that capacitors with inch-long leads have no place in v.h.f. circuits.

V.h.f. and u.h.f. capacitors

We have reached the conclusion that v.h.f. and u.h.f. capacitors should not have long leads because of the effective series inductance. Commercially available capacitors may have even more effective series inductance due to their construction. Paper capacitors are perhaps the worst offenders of built-in inductance because they are wound. This increases the inductance in the same way as winding a straight piece of wire into several turns.

Paper capacitors are not usable above 30 mc because of this inherent inductance. They also have another disad-

*Engineering Head, V.H.F. Dept., Gates Radio Co., Quincy, Ill.

EVERYONE WANTS AN "ORIGINAL"



A copy is never as good as the original. That's why TRIO TV Antennas are "wanted" antennas. TRIO has consistently led the industry in developing better, more efficient antennas. Never "just like" another, every new TRIO model is original and represents an improvement over any existing TV antenna.

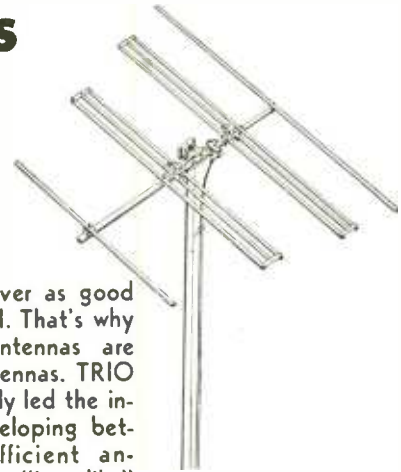

* MODEL 445, the famous Single-bay TRIO Yagi for TV channels 4 & 5. Supplied less mast and transmission line.

* Patent Pending — No licensing arrangements granted for duplicating principle of this antenna.

TRIO YAGI SETS THE PACE

An example of TRIO's original design is the amazing dual channel TRIO Yagi — a single-bay 4 element yagi that provides full 10 DB gain on two channels! Available for channels 4-5 and 7-9, this revolutionary antenna makes bulky stacked arrays obsolete by providing excellent fringe area TV reception where other antennas fail!

HOW IT WORKS

Antenna consists of 4 elements whose function is different on the two channels. For example: in Model 445, the elements, on channel 4, act as reflector, dipole, director, director, in that order; while on channel 5, the same elements act as reflector, reflector, dipole and director. Careful design insures proper impedance match with standard 300 ohm lead.

COMPARE THESE ADVANTAGES

- Provides gain on both channels 4 and 5 (or 7 and 9) Equal to Any Two conventional 4-element yagis!
- One bay replaces bulky stacked array!
- One lead replaces old-style 2-lead systems!
- Less weight-per-gain than any other TV antenna!
- Greatly reduced installation costs for complete TV coverage!
- Can be stacked for additional gain.

Model 445. Single or stacked Yagi for Channels 4 & 5.

Model 479. Single or stacked Yagi for Channels 7 & 9.

Model 645. "Controlled Pattern" System consisting of 2 bays offset stacked and "Phasitron." Eliminates co-channel interference. For Channels 4 & 5.

Model 579. "Controlled Pattern" System for Channels 7 & 9.

Model 304. Single Channel Yagi with Double Dipole for Channels 2 to 13.

Model 604. Same as Model 645 except for single channel operation.



Over 43,000 Technicians Have Learned

HOW TO GET THE MOST OUT OF BASIC TEST EQUIPMENT

Why Not You, Too?

SERVICING by SIGNAL SUBSTITUTION

A BEST SELLER FOR OVER 9 YEARS! (NEW, UP-TO-DATE, 11TH EDITION)

The Simple, Modern, Dynamic Speed Approach To Receiver Adjustment and Alignment Problems, AM-FM-TV.

- Nothing complex to learn
- Universal — non-obsolete
- No extra equipment to purchase
- Employs Only Basic Test Equipment

Ask for "S.S.S." at your local Radio Parts Jobber or order direct from factory.

only 40¢

100 pages. Invaluable information that will help you re-double the value of your basic test equipment.

PRECISION APPARATUS COMPANY, INC. • 92-27 Horace Harding Blvd., Elmhurst 4, N. Y.

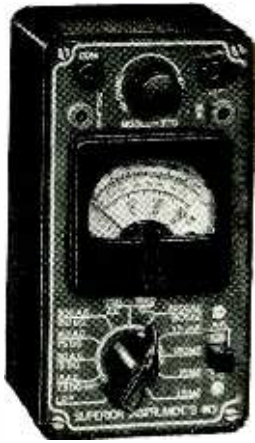

Superior's New Model 770

AN ACCURATE POCKET-SIZE VOLT-OHM MILLIAMMETER

(SENSITIVITY—1000 OHMS PER VOLT)

FEATURES: Compact—measures 3 1/4" x 5 7/8" x 2 1/4". Uses latest design 2% accurate 1 Mil. D'Arsonval type meter. Some zero adjustment holds for both resistance ranges. It is not necessary to readjust when switching from one resistance range to another. This is an important time-saving feature never before included in a V.O.M. in this price range. Housed in round-cornered, molded case. Beautiful black etched panel. Depressed letters filled with permanent white, insures long-life even with constant use. **SPECIFICATIONS:** 6 A.C. VOLTAGE RANGES: 0—15/30/150/300/1500/3000 VOLTS. 6 D.C. VOLTAGE RANGES: 0—7.5/15/75/150/750/1500 VOLTS. 4 D.C. CURRENT RANGES: 0—1.5/15/150 MA. 0—1.5 AMPS. 2 RESISTANCE RANGES: 0—500 OHMS 0—1 MEGOHM.

The Model 770 comes complete with self-contained batteries, test leads and all operating instructions.

\$14⁹⁰
NET



Superior's New Model 670

SUPER-METER

A COMBINATION VOLT-OHM MILLIAMMETER PLUS CAPACITY REACTANCE INDUCTANCE AND DECIBEL MEASUREMENTS

SPECIFICATIONS:

D.C. VOLTS: 0 to 7.5/15/75/150/750/1,500/7,500 Volts
 A.C. VOLTS: 0 to 15/30/150/300/1,500/3,000 Volts
 OUTPUT VOLTS: 0 to 15/30/150/300/1,500/3,000 Volts
 D.C. CURRENT: 0 to 1.5/15/150 Ma. 0 to 1.5 Amperes
 RESISTANCE: 0 to 500/100,000 Ohms 0 to 10 Megohms
 CAPACITY: .001 to .2 Mfd. .1 to 4 Mfd. (Quality test for electrolytics)
 REACTANCE: 700 to 27,000 Ohms 13,000 Ohms to 3 Megohms
 INDUCTANCE: 1.75 to 70 Henries 35 to 8,000 Henries
 DECIBELS: — 10 to + 18 + 10 to + 38 + 30 to + 58

ADDED FEATURE:

The Model 670 includes a special GOOD-BAD scale for checking the quality of electrolytic condensers at a test potential of 150 Volts.

The Model 670 comes housed in a rugged, crackle-finished steel cabinet complete with test leads and operating instructions. Size 5 1/2" x 7 1/2" x 3".

\$28⁴⁰
NET

Superior's New Model TV-11

TUBE TESTER



- Specifications:**
- Tests all tubes including 4, 5, 6, 7, Octal, Lock-in, Peanut, Bantam, Hearing-aid, Thyatron, Miniatures, Sub-Miniatures, Novals, Sub-Minars, Proximity Fuse Types, etc.
 - Tests for "shorts" and "leakages" up to 5 Megohms.
 - Uses the new self-cleaning Lever Action Switches for individual element testing. Because all elements are numbered according to pin-number in the RMA base numbering system, the user can instantly identify which element is under test. Tubes having tapped filaments and tubes with filaments terminating in more than one pin are truly tested with the Model TV-11 as any of the pins may be placed in the neutral position when necessary.
 - The Model TV-11 does not use any combination type sockets. Instead individual sockets are used for each type of tube. Thus it is impossible to damage a tube by inserting it in the wrong socket.
 - Free-moving built-in roll chart provides complete data for all tubes.
 - Newly designed Line Voltage Control compensates for variation of any line voltage between 105 Volts and 130 Volts.

EXTRA SERVICE

The Model TV-11 may be used as an extremely sensitive Condenser Leakage Checker. A relaxation type oscillator incorporated in this model will detect leakage even when the frequency is one per minute.

***NOISE TEST**
Phono Jack on front panel for plugging in either phones or external amplifier will detect microphonic tubes or noise due to faulty elements and loose external connections.

The Model TV-11 operates on 105-130 Volt 60 Cycles A.C. Comes housed in a beautiful hand-rubbed oak cabinet complete with portable cover. Size 11 1/2" x 13" x 6". Shipping Weight 15 lbs.

\$47⁵⁰
NET

USE CONVENIENT RUSH ORDER FORM ON OPPOSITE PAGE

GENERAL ELECTRONIC DISTRIBUTING CO. DEPT. RC-5, 98 PARK PLACE
NEW YORK 7, N. Y.

RADIO-ELECTRONICS for

Superior's New Model TV-20



Ultra H. F. Voltmeter Probe converts Model TV-20 into Negative Peak-Reading H. F. Voltmeter.

20,000 OHMS PER VOLT MULTI-METER and TELEVISION KILOVOLT METER

The Model TV-20 was designed to provide all the multi-meter measurement requirements of A. M., F. M. and Television. Unlike other recent models, which are actually standard V.O.M.'s converted to test the new Television Voltages, the Model TV-20 is a completely new unit. It provides the sensitivity, ranges and accessories which are needed to service F. M. and Television in addition to A. M. Radio. The High Voltage Probe for example, with a range of 50,000 volts and designed to withstand 100,000 volts, is an integral part of the instrument with a special compartment for housing it when not in use.

SPECIFICATIONS

- 9 D. C. VOLTAGE RANGES: (At 20,000 ohms per Volt) 0-2.5/10/50/100/250/500/1,000/5,000/50,000 Volts
- 8 A. C. VOLTAGE RANGES: (At 1,000 ohms per Volt) 0-2.5/10/50/100/250/500/1,000/5,000 Volts
- 5 D. C. CURRENT RANGES: 0-50 Microamperes, 0-5/50/500 Milliampere, 0-5 Amperes
- 4 RESISTANCE RANGES: 0-2,000/20,000 ohms, 0-2/20 Megohms,
- 7 D. B. RANGES: (All D. B. ranges based on ODb = 1 Mv. into a 600 ohm line)
 - 4 to +10 db + 8 to +22 db + 28 to +42 db + 42 to +56 db
 - + 22 to +36 db + 36 to +50 db + 48 to +62 db
- 7 OUTPUT VOLTAGE RANGES: 0 to 2.5/10/50/100/250/500/1,000 Volts

The Model TV-20 operates on self-contained batteries. Comes housed in beautiful hand-rubbed oak cabinet complete with portable cover. Built-in High Voltage Probe. H. F. Probe, Test Leads and all operating instructions. Measures 4 1/2" x 10 1/4" x 11 1/2". Shipping Weight 10 lbs.

\$39.95 NET

The New Model 200

AM and FM SIGNAL GENERATOR

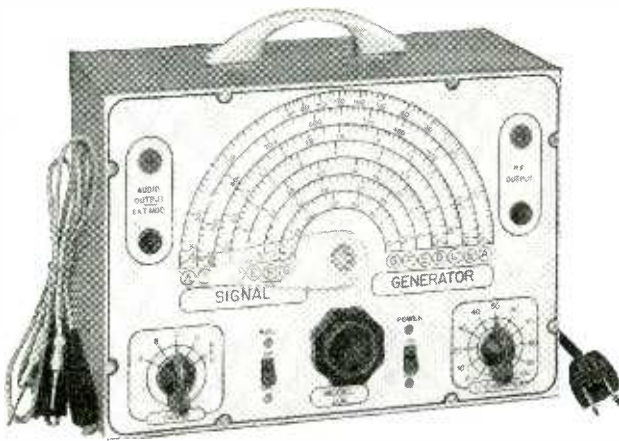

- ★ **R.F. FREQUENCY RANGES:** 100 Kilocycles to 150 Megacycles.
- ★ **MODULATING FREQUENCY:** 400 Cycles. May be used for modulating the R.F. signal. Also available separately.
- ★ **ATTENUATION:** The constant impedance attenuator is isolated from the oscillating circuit by the buffer tube. Output impedance of this model is only 100 ohms. This low impedance reduces losses in the output cable.
- ★ **OSCILLATORY CIRCUIT:** Hartley oscillator with cathode follower buffer tube. Frequency stability is assured by modulating the buffer tube.
- ★ **ACCURACY:** Use of high-Q permeability tuned coils adjusted against 1/10th of 1% standards assures an accuracy of 1% on all ranges from 100 Kilocycles to 10 Megacycles and an accuracy of 2% on the higher frequencies.
- ★ **TUBES USED:** 12AU7—One section is used as oscillator and the second is modulated cathode follower. T-2 is used as modulator. 6C4 is used as rectifier.

The Model 200 operates on 110 Volts A.C. Comes complete with output cable and operating instructions.

\$21.85 NET

Superior's New Model TV-30

TELEVISION SIGNAL GENERATOR

ENABLES ALIGNMENT OF TELEVISION I. F. AND FRONT ENDS WITHOUT THE USE OF AN OSCILLOSCOPE!

FEATURES Built-in modulator may be used to modulate the R. F. Frequency, also to localize the cause of trouble in the audio circuits of T. V. Receivers.

Double shielding of oscillatory circuit assures stability and reduces radiation to absolute minimum. All I. F. frequencies and 2 to 13 channel frequencies are calibrated direct in Megacycles on the Vernier dial. Markers for the Video and Audio carriers within their respective channels are also calibrated on the dial.

Stability assured by cathode follower buffer tube and double shielding of component parts.

SPECIFICATIONS Frequency Range: 4 Bands—No switching; 18-32 Mc., 35-65 Mc., 54-98 Mc., 150-250 Mc.
Audio Modulating Frequency: 400 cycles (Sine Wave). Attenuator: 4 position, ladder type with constant impedance control for fine adjustment.
Model TV-30 comes complete with shielded co-axial lead and all operating instructions. Measure 6" x 7" x 9".

\$33.95 NET



MONEY BACK GUARANTEE!!

GENERAL ELECTRONIC DISTRIBUTING CO.

GENTLEMEN: PLEASE RUSH THE MATERIAL LISTED BELOW:

DEPT. RC-5 98 PARK PLACE, NEW YORK 7, N. Y.

Phone REctor 2-1677

QUANTITY	MODEL	PRICE	TOTAL

Name _____
 Address _____
 City _____ Zone _____ State _____
 \$ _____ (Deposit Enclosed—
 (Payment in Full Enclosed) Ship Balance C.O.D.)

the MOST COMPLETE TV CONTROL REPLACEMENT MANUAL

- ★ Almost 3000 control listings of 350 different TV set models and chassis, produced by 75 different manufacturers.
- ★ Alphabetically and numerically listed.
- ★ Replaced by 327 different controls — 222 RTV or Exact-Duplicate and 105 Standard numbers.

Clarostat's done it again! Here's the outstanding compilation of TV control replacements. In a jiffy, you can spot the *right replacement* for any wornout or defective TV control. Simple as ABC — like this:

1. Look up particular TV set manufacturer listed alphabetically.
2. Find given TV set model or chassis, arranged in numerical order.
3. Identify defective or wornout control and/or description or function.
4. Note Clarostat Standard or RTV (Exact-Duplicate) replacement avail-



able. As a double check, listing includes manufacturer's stock and parts numbers.

5. Order Clarostat replacement from nearest or favorite Clarostat distributor.

GET YOUR COPY!

Send us a dollar bill and start saving time, trouble, money, in TV servicing. Or get your copy from your Clarostat distributor.



Controls and Resistors

CLAROSTAT MFG. CO., INC. • DOVER, NEW HAMPSHIRE
IN CANADA: CANADIAN MARCONI CO. LTD., MONTREAL, P. Q., AND BRANCHES

ATLAS Built to take it!



ATLAS DR PROJECTORS, non resonant, uniform response, sturdy, storm proof, compact, demountable.

Regardless of the application Atlas Sound speakers are built to "take it." In the Armed Forces . . . Industrial plants . . . public gatherings . . . under any climatical conditions, Atlas Sound speakers stand up.

Over twenty years' experience in the manufacture of sound equipment goes into every Atlas product.

Years of diligent research in Electro Acoustics and constant experimentation in mechanical developments guarantees quality, complete and lasting satisfaction.

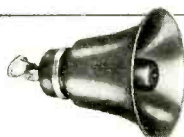

ATLAS PAGING AND TALK BACK SPEAKERS with ATLAS "Alnico-V-Plus" driver unit. A medium size speaker ruggedly constructed 12 watt input power.



Dual speaker excellent for industrial and talk back applications, simplifies installation in long corridors, hallways, etc.

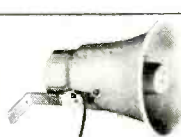

A super efficient sub miniature speaker produces clear intelligible speech at a minimum input power.



ATLAS De-Luxe "Alnico-V-Plus" Driver Units with built in "uni-match" transformers. 30 watt input.



ATLAS "FULL GRIP VELVET ACTION" MICROPHONE STANDS. No slipping—No noise—No rattle—No scratching—No wear.

Write for new No. 551 catalog

ATLAS SOUND CORP.

1453 — 39th STREET, BROOKLYN 18, N. Y.
in Canada, Atlas Radio Corp., Ltd., Toronto, Ont.



vantage which is apparent at high frequencies. Their insulation is less effective and the power factor increases. From an r.f. viewpoint, the poor power factor might make the capacitor appear as in Fig. 3-a, 3-b or even 3-c. Obviously, a bypass capacitor which has a series resistor has little value as an r.f. bypass.

Molded mica capacitors have less built-in inductance but they must be used cautiously in v.h.f. bypass circuits. A typical molded mica capacitor of .002 μf with leads less than $\frac{1}{4}$ inch long has a resonant circuit *within itself* at approximately 40 mc. This resonance is due to the short leads and the small amount of inductance inherent in its construction. At all frequencies above 40 mc, this capacitor behaves toward r.f. as if it were a small coil or inductance.

Molded mica capacitors have somewhat better power factor than paper units. The actual power factor depends on the material used for molding the case. Cases of low-loss v.h.f. material, of course, have much better power factors.

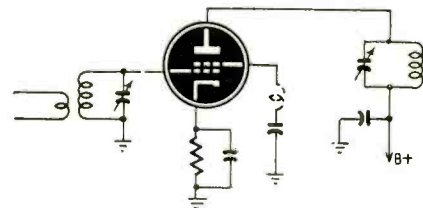

Fig. 2—Schematic showing the effect of lead length in a screen bypass circuit.

Ceramic capacitors find wide use in v.h.f. and u.h.f. circuits since they can be built economically to have very low inductance and good power factor. In fact, a typical ceramic bypass capacitor of 100 μf with $\frac{1}{4}$ -inch leads may have a self-resonant frequency as high as 400 or 500 mc. Ceramic capacitors have another desirable characteristic: they take up very little space on the chassis. New v.h.f. and u.h.f. designs use ceramic capacitors in both front end and i.f. stages.

In tuned circuits, ceramic capacitors are useful as drift-compensating elements as they can be built to have almost any drift characteristic. With proper selection of the ceramic mixture the capacitance can be increased in direct relation to an increase or decrease in temperature. For the most part, ceramic capacitors of the large-value bypass type have a negative temperature coefficient. Their capacitance decreases as the temperature increases. In service and maintenance this factor must be considered if the capacitor is used in a tuned circuit; otherwise, drift and detuning will result.

Resistors for v.h.f.

Resistors in tuned circuits or r.f. circuits at v.h.f. are no longer purely resistive elements. A typical carbon resistor schematically appears as in Fig. 4. The shunt capacitance is due

New SUPREME 1951 TV Manual

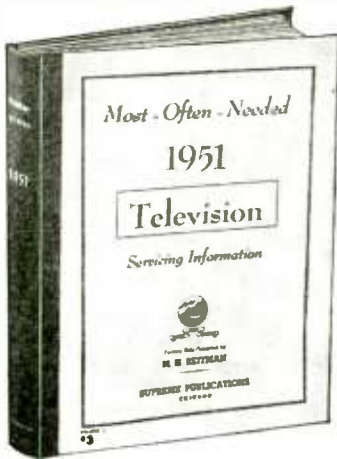

New 1951 Television Manual

This newest giant volume of the series covers 1951 factory data on all popular television sets of all makes. There are circuit explanations, 192 pages of alignment procedure, test patterns, response curves, pages of waveforms, voltage charts, service hints, and dozens of large double-page circuit diagrams. Manual style binding. At your parts jobber or by mail, only..... **\$3**

1950 T-V Manual. Includes service material on all popular TV sets of all makes from Admiral to Zenith. Large size: 8 1/2"x11", plus ten mammoth 11x15" blueprints. Only..... **\$3**

1949 T-V Manual. Similar to the volume listed above. Has 192 extra-large pages, plus 9 double-spread giant blueprints. To order see coupon below, only..... **\$3**

1948 T-V Manual. Earlier volume has material on all popular T-V sets of this period. Large size: 8 1/2"x11". Remarkable value. Including 8 fold-out blueprints, only.... **\$3**

1947 FM and T-V Manual. Covers all needed FM and television sets including popular R.C.A. 630TS. Size: 8 1/2"x11". Data on 192 pages, Only..... **\$2**

INCLUDES ALL POPULAR SETS

The new 1951 TV manual has complete service material on every popular television set of every important manufacturer. Here is helpful, practical, factory-prepared data that will make servicing and adjustment easy for you. This new giant manual, as well as the previous volumes listed at left, has complete circuits, alignment facts, test patterns, response curves, service hints, voltage charts, waveforms, recommended changes for improvement, and many double-spread diagram blueprints. Here is your TV service material to help you become an expert, and at only \$3 and \$2 per manual.

FIND—FIX ALL T-V FAULTS

Use the new 1951 TV manual and the earlier volumes (see listing at left) to help you with all TV repairs. Cuts hour-wasting jobs to pleasant moments. Use test patterns for quick adjustment, or look up probable cause of trouble in the pages of hints after simply observing fault in video picture. No equipment needed with these tests. Or use your voltmeter and compare values with many voltage charts included. With an oscilloscope you can get waveforms similar to hundreds illustrated using test points suggested and in a flash locate what used-to-be a hard-to-find fault. Order at our risk for a 10-day trial. Use coupon at bottom of page.



All Supreme Publications Radio and TV manuals are compiled by M. N. Beltman, radio engineer, teacher, author, and serviceman.

AMAZING BARGAIN OFFER

The new 1951 TV manual is the most remarkable value offered by Supreme Publications in their 17 years of business. This giant-size television servicing manual at only \$3, or the TV manuals for previous years for only \$3 and \$2 each, are amazing bargains and defy competition. There is nothing else like them. Each manual is a virtual treatise on practical television repairs. By normal standards, each such large manual packed as it is with practical facts, hundreds of illustrations, diagrams, charts, photographs, and expensive extra-large blueprints, should sell for \$10—but as SUPREME special values they are priced at \$3 and \$2 each. Only a publisher who sold over one million TV and radio manuals can offer such bargains based on tremendous volume-sales.

YOURS TO USE ON TRIAL

Be ready to repair any TV set by having in your shop all five Television Manuals described at left. Or try the new 1951 TV manual to see what an amazing bargain you get for only \$3. Order on no-risk trial by using coupon at bottom of page.

SUPREME RADIO MANUALS

New 1950 Radio Diagrams

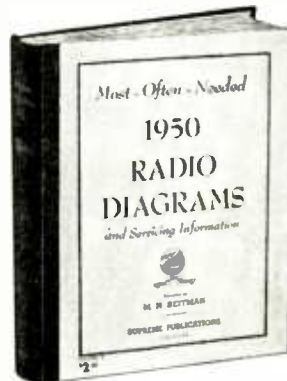

Now you can benefit and save money with Supreme amazing manual scoop. This one giant volume has all the service data you need on all recent radio sets. Here you have clearly-printed large schematics, needed alignment data, parts lists, voltage values, and information on stage gain, location of trimmers, and dial stringing illustrations. This is the help you need to find tough faults in a jiffy. The new 1950 radio manual is a worthy companion to the 9 previous volumes used to an advantage by over 128,000 shrewd radio men.

BIGGEST BARGAIN IN SERVICE DATA

Wise servicemen know that Supreme Publications manuals have all the material needed at the lowest prices. For the remarkable bargain price (only \$2 for most volumes) you are assured of having on hand needed diagrams and all other essential repair facts on almost all sets you will ever service. Every popular radio of all makes, from old-timers to new 1950 sets is covered. Select manuals wanted, see list below.

SUPREME RADIO MANUALS for PREVIOUS YEARS



1949 1948 1947 1946 1942 1941 1940 1939
SUPREME Most-Often-Needed RADIO DIAGRAMS
 Each Manual only \$2. (1949 is \$2.50); 192 pages of diagrams, alignment data, voltage values, parts lists, and service hints; large size, 8 1/2" x 11". To order, see coupon below. **RADIO Diagrams 240 Pages Price \$2.50**

RADIO-ELECTRONICS HOME-STUDY COURSE

ONLY \$3.95 COMPLETE 3 VOLUMES 53 Lessons

NEW AMAZING OFFER

Here is the most amazing bargain in radio training. The price scoop of the year. For only \$3.95 (full price) you receive a complete radio-electronics course of 53 large, fact-packed lessons. Covers every topic of radio fundamentals, practical servicing, TV, FM, audio, and industrial electronics. Published in three giant books, bound in one super-mammoth volume. Printed in 1951. Compares lesson by lesson with the best \$200 home-study correspondence courses; but here you get all lessons at one time at the unheard-of bargain price of only \$3.95; nothing further to pay or buy.

THREE COURSES IN ONE

The complete training of these 53 large lessons is really THREE distinct courses (1) Practical Radio, (2) Applied Electronics, and (3) Radio Servicing. The lessons are clear, practical, easy to master and use. Early lessons will make fundamentals clear even to a beginner, while other lessons will give you the practical "know-how" of an expert. Notice in the illustration of the manuals, at top, that the wide column on each page has the text, while the narrow column contains pertinent explanations usually supplied by a teacher. These teacher comments guide you over the hard parts, stress points of importance, tell you how to perform practical experiments, using any home radio. There are hundreds of review self-testing questions, 427 drawings, pictures, diagrams, and over a thousand service hints.

YOURS TO TRY FOR 10 DAYS

Just send no-risk coupon, at right, and receive the 3-volume COURSE for a free examination. Use all this material a full 10 days in your own home. Read a few lessons, examine the hundreds of illustrations, apply some of the hints to fix a couple of radios. Only then, if you are pleased, the complete course of 53 lessons, in three volumes, is yours to keep for only \$3.95, full price; otherwise, it costs you nothing for the use and examination. Fair enough? Please rush coupon or ask your jobber while your special price is still only..... **\$3.95**

Supreme Publications
 Sold by All Leading Radio Jobbers

NO-RISK TRIAL ORDER COUPON

SUPREME PUBLICATIONS, 3727 W. 13 St., Chicago 23, ILL.

Send on trial the manuals checked below and at right. You guarantee complete satisfaction.

- New 1951 Television Service Manual..... **\$3.**
- 1950 Television Manual, \$3. 1949 TV, \$3.
- 1948 TV, \$3. 1947 TV & FM, only **\$2.**
- Radio & Electronics Course, 53 lessons. **\$3.95**

- I am enclosing \$..... Send postpaid.
- Send C.O.D. I am enclosing \$... deposit.

Name:
 Address:

- Most-Often-Needed Radio Diagram Manuals
- New 1950 Manual. \$2.50
 - 1949 Radio Manual. \$2.50
 - 1948
 - 1947
 - 1946
 - 1942
 - 1941
 - 1940
 - 1939
 - 1926-1938 Manual, \$2.50
- PRICED AT ONLY \$2 EACH**

TRANSFORMERS WITH RESERVE CAPACITY

*For Better Reception... More Customer Satisfaction
... Increased Profits*

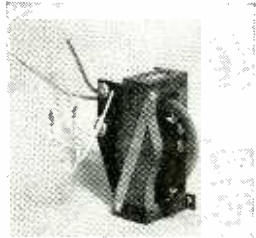

TV-10 (Flyback) for RCA 211T1 Type Sets.

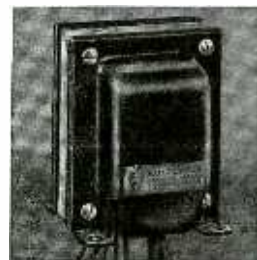

S-77—Power, 400 V. 200 M.A., 5V. 4A., 6.3 V. 5.5A.C.T.



N-97—Auto Vibrator, 270 V. 60 M.A. See Vibrator Guide.

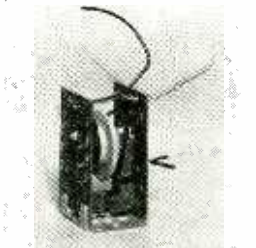

TV-14 (Flyback) for GE77J1 Type Sets.

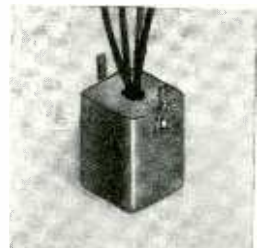

N-613—TV Vertical Blocking Oscillator Transformer.



Y-20—High Fidelity Output, ± 2 DB from 20-20000 Cycles.

● Service engineers who know Halldorson know that Halldorson transformers are among the best in the field...with the widest selection: special outputs, semi-universal and universal outputs, impedance matching units, powers, vibrators, filaments and chokes. Every unit is guaranteed. *Get ahead with Halldorson.* See your parts-jobber, or write.

WRITE FOR CATALOG
... listing over 330 standard types for virtually every TV and Radio service need.



The Halldorson Company
4500 N. Ravenswood Ave.
Chicago 40, Illinois



POLIC FM ALARM
RADIO APPARATUS CORPORATION
DEPT. RE-5 310 FOUNTAIN SQUARE THEATRE BLDG., INDIANAPOLIS 3, INDIANA

Get EMERGENCY BAND CALLS At Home!

● Many fans spend hundreds of happy hours listening to city and state police calls on their Police-Alarm radios. . . . Police-Alarm Model PR-31 is a quality radio which will give years of trouble-free service on the 30-50 mc. band. Can be used on either AC or DC current of 115 volts. Besides police calls, the 30-50 mc. band also is used by fire departments, ambulances, border patrol, forestry, maritime, railroads, bus lines, and other services. Enjoy the thrill of listening to these vital messages at home. Model PR-31 (illustrated) **\$44.95**
Police-Alarm Model PR-8 is available for 152-162 mc. band reception. **\$44.95**
Price, complete

largely to the capacitance between the carbon granules and the end terminations.

In a typical 1-watt, 100,000-ohm resistor the effective resistance or impedance may fall as low as 40,000 ohms at 150 mc. The higher the resistance value, the greater the deviation from the actual value as the frequency is increased. A typical 50-ohm resistor may not decrease below 30 or 40 ohms at 150 mc, while a 500,000-ohm unit of the same type would decrease to 200,000 or 300,000 ohms—a much greater percentage.

Generally a ½-watt resistor suffers less from this than does its larger 1-watt brother of the same brand. This sensitivity to frequency varies from brand to brand, and even somewhat from batch to batch of the same brand.

Because of frequency sensitivity of

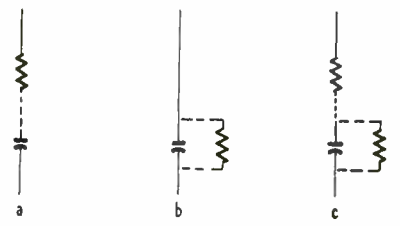

Fig. 3—Capacitor losses and power factor due to the material and construction

resistors, the exact replacement, both brand and wattage, should be used in v.h.f. equipment if the resistor carries r.f. or is closely related with an r.f. circuit.

R.f. chokes

In v.h.f. design and servicing, r.f. chokes are selected according to frequency. A good r.f. choke at 60 mc may



Fig. 4—At v.h.f., a carbon resistor has in effect a capacitor in parallel.

be worthless at 150 mc. In fact, it probably will be capacitive. It is becoming practice to rate r.f. chokes according to their effective frequency range. Fig. 5 illustrates the frequency ratings of a typical line of r.f. chokes.

The reason for rating r.f. chokes is apparent if we examine them closely. Between each adjacent turn of wire and all other turns is a certain amount of capacitance. Fig. 6-a illustrates this effect. Collectively, these capacitances might be represented as one value as in Fig. 6-b. The frequency at which this distributed capacitance and the normal inductance of the choke form a parallel resonant circuit is the frequency where the choke is most effective. It offers the highest impedance to this frequency. Below this frequency, the choke acts as an inductance but at higher frequencies it acts like a capacitor. Obviously we must choose r.f. chokes to avoid this capacitive effect. This is the reason for rating r.f. chokes according to frequency range in addition to the usual inductance value.

Insulation material

Bakelite, which is a good insulator in the broadcast and shortwave bands, is a rather poor insulator for v.h.f. and u.h.f. For this reason, other materials must be used for sockets, coil forms, variable capacitor support, etc. Mica-filled bakelite, while not the best, performs well at v.h.f. Sockets made from this material have relatively low loss and still have the mechanical strength and convenience of the Bakelite socket. Ceramic properly glazed is a good v.h.f. insulator and is used rather extensively for sockets and insulation.

Polystyrene is an excellent insulator easily molded into sockets and insulators. For sockets it has the handicap that heat developed in soldering to the socket terminals may melt the polystyrene. Soldering must be done very carefully. This is not too much of a handicap for the service technician or ham, but it does hamper fast production and assembly line techniques.

Glass-bonded mica, marketed under the trade names of Mycalex and Mykroy, is another good v.h.f. and u.h.f. insulator. It is easily molded, yet is resistant to heat under 800 to 1,000°.

Chassis material

Chassis material is very important at v.h.f. and u.h.f. because of skin effect. At high frequencies current tends to travel on the surface or skin instead of throughout the entire material thickness as it does at low frequencies. Therefore we must use high-conductivity chassis material if we use the chassis as a return circuit.

Silver is the best material but is too costly for most uses. Silver plating, however, is used extensively. It is usually as good as solid silver since the v.h.f. and u.h.f. currents do travel on the surface. Coils and capacitors in high-performance commercial equipment are often plated.

Since plating is hardly feasible for the average experimenter or service technician, the next best is copper with a mirror-smooth surface. To preserve this surface and prevent oxidation, a coat of clear lacquer is used. Clear fingernail polish or linoleum lacquer is satisfactory.

Aluminum is the next best material for chassis. Relatively inexpensive, it can be worked with simple hand tools. A polished aluminum surface is an excellent v.h.f. and u.h.f. conductor as well as one of the best v.h.f. shielding materials. Modern TV transmitters use much aluminum for shielding.

Lead lengths

One point often overlooked by both the experimenter and service technician in v.h.f. equipment is short lead lengths. This cannot be overemphasized. A long lead, of say 3 inches, in the grid of an r.f. stage operating on TV channel 13 would have appreciable inductance. This appears as a coil inserted between the tube grid and the tuned circuit as shown in Fig. 7. This length of wire may have an inductance as high as 0.5 microhenry—a sizeable impedance on channel 13. To get the most gain from the r.f. stage we cannot afford such an impedance in the grid circuit.

Suppose we have a long lead in the screen grid bypass circuit. This lead length shows up as an inductance in series with the bypass capacitor and

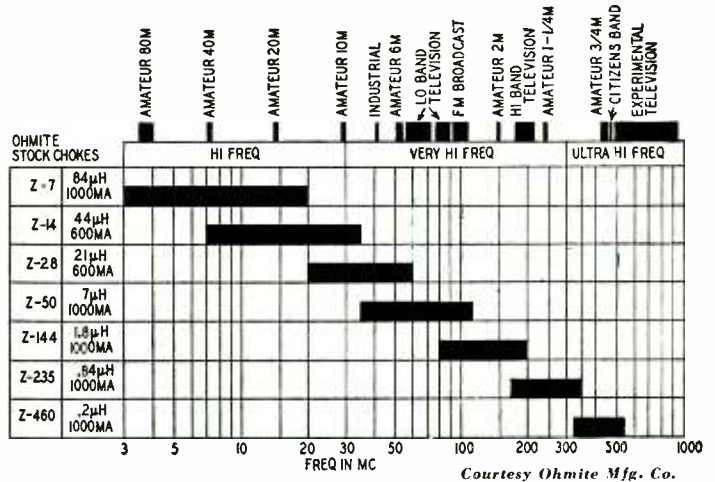

Fig. 5—Chart of frequency ranges of stock Ohmite chokes.

insuline *Auto Radio* ANTENNAS and ACCESSORIES

sturdy
hi-quality
"jiffy-installed"

FENDER and COWL "Solo-mount"
Patent Applied For

The auto radio antenna "one man" can install in three simple steps!

... that is all there is to it!

ALL THE DESIRABLE FEATURES

- Noise-free reception.
- Heavy chrome-plated Admiralty brass.
- Guaranteed rust-proof and rattle-proof.
- Equipped with Delco and Motorola fittings.
- 36" weather-proof, shielded loom cable.
- Three sections — extends to 60 inches.
- Fits all makes of cars, including latest models.

DISAPPEARING ANTENNAS

Closes to 6½" and extends to 56". Swivel base for any angle adjustment.

SIDE COWL ANTENNAS

Varied styles and extension lengths. Complete, ready to install.

Fast Seller!

ANTENNA BOOSTERS

Quickly attached to present aerial. Clever designs.

ILLUMINATED AUTO ANTENNA

Lights up 24" shaft and discs on top. Fast Seller!

Do you have our latest catalog?

If not, write Dept. RE-5 at once! Hundreds of items pertaining to auto antennas are fully described and illustrated.

On special request: Catalog of TV antennas and accessories. Catalog of general electronic parts and equipment.

insuline CORPORATION OF AMERICA

INSULINE BUILDING • 36-02 35th AVENUE • LONG ISLAND CITY, N. Y.
West Coast Branch and Warehouse: 1335 South Flower Street, Los Angeles, Calif.
Exclusive Canadian Sales Agents: CANADIAN MARCONI COMPANY, Toronto

Good

THE PERFORMANCE — PROVED LINE

Don Good Products are acknowledged performance products — precisely engineered for their job—with a wealth of experience behind their building. They do what they're "planned" to do. That's why you'll be pleased with them.

NEW, GOOD HI-PASS TELEVISION FILTER*



ELIMINATES or GREATLY REDUCES INTERFERENCE which may be picked up by I.F. Amplifier or TV Receiver. Effectively eliminates interference arising from strong, local low-frequency fields: Amateur Radio Stations, Diathermy Equipment, X-Ray, Industrial Induction Heaters, Household Appliances, Neon Lights, etc. . . . Pretuned at factory. No adjustments required. Easily installed at antenna terminals. In low-loss Polystyrene case. . . . TWO MODELS: No. 300 for 300 Ohm line. . . . No. 72 for 72 Ohm line.

CORRECTLY PRICED at \$3.95 List

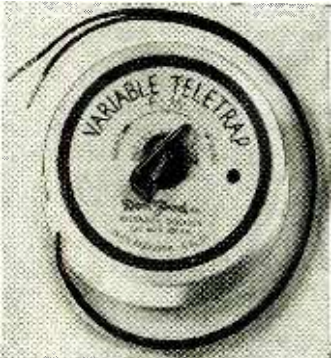

NEW, GOOD VARIABLE TELETRAPS NO. R-301 FM—88 MC to 110 MC. Without an equal for effectively eliminating interference from FM Stations within its tuning range. NO. R-302 DA.—26 MC to 32 MC. Wonderfully effective for eliminating interference from DIATHERMY and AMATEUR signals within its tuning range.

CORRECTLY PRICED at \$3.95 LIST

INVESTIGATE GOODLINE AIRLEAD*

ELIMINATES 80% of FEEDLINE DIELECTRIC LOSSES. It's the "AIRLEAD OF THE FUTURE." . . . Standard close wire spacing and standard nominal impedance eliminates losses through re-radiation. Also effectively eliminates WET WEATHER LOSSES. FIND OUT ABOUT THIS MOST EFFECTIVE OF ALL LEADLINES.

WRITE FOR SPECIAL LITERATURE giving full information: Features, Specifications, Wire Lengths, etc.

*Patent Pending. *Trade Mark. U. S. & Foreign Patents Pending.



EXCLUSIVE LICENSEE & SOLE MANUFACTURER
1014 FAIR OAKS AVE.
SOUTH PASADENA, CALIFORNIA

lessens or, in some cases, destroys all bypass action. Most of us have experienced oscillations when a screen grid bypass capacitor opened. Screen bypass leads must be kept as short as possible to minimize series inductance.

One good approach has been ceramic bypass capacitors built right into the socket proper. The tube pin makes direct contact with the inside of the tubular ceramic capacitor while the outside of the capacitor is connected directly to the socket mounting ring.

The cardinal rule is simple. *Keep all lead lengths to an absolute minimum.* In servicing, note the lead length used by the manufacturer before cutting a defective component from the circuit. In making the replacement use the same lead length as the original and put the new part in the same space occupied by the original.

The larger the wire size, the smaller the distributed inductance. Flat, wide straps have less inductance than wire, but this may be offset in grid and plate circuits due to the increased capacitance of the strap to ground.

We can summarize h.f. techniques with:

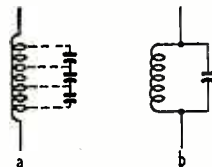

Fig. 6—Capacitance between the turns of an r.f. choke is important at v.h.f.

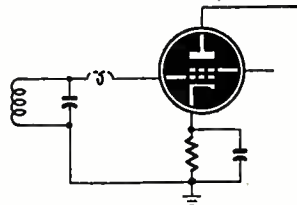

Fig. 7—Long grid leads may introduce too much inductance in an r.f. circuit.

1. Select v.h.f. and u.h.f. components specifically built for these frequencies.
2. Use insulating materials having low loss factor.
3. Keep lead lengths as short as possible. If we keep these rules in mind, the same general concepts apply at v.h.f. as at broadcast frequencies.

By following these simple rules we can make high-frequency circuits behave just as easily as lower frequency circuits. Most important, we keep at a minimum those many unpredictables that are due to faulty wiring and inadequate components.

—end—

IMPORTANT TO VETERANS

Veterans who plan to enter school or enroll for correspondence school training must act quickly. The great majority of World War II veterans must start their training—actually be enrolled in the school of their choice—by July 25, 1951, or they will lose their educational benefits. Veterans discharged after July 25, 1947, have four years from discharge date to start their training.

BUFFALO RADIO SUPPLY

219-221 Genesee St., Dept. RE-5
Buffalo 3, N. Y.

35 MM Slide Projector & Enlarger

Most terrific photographic bargain of the 20th century. A fine precision instrument with many features!!

- Takes roll film or 2x2 slides.
- Automatic slide changer furnished.
- No more waiting for enlargements to enjoy your candid shots. All you need is a flat surface to project on.
- Has 300 W 110V Bulb, but 6V, 12V, 220V or 220V available.
- 8 precision ground, optical glass elements in optical system. (No other projector on the market has more.)
- Automatic rewind of film.
- Heat absorbing filter.
- Use as an enlarger for making your own prints of any desired size.
- Plano-Convex Meniscus Condenser.
- 5" focus Brown-Violet coated, double anastigmat F3.5 lens.
- Swivel projector head.
- Projector tilts to any angle on base.

Brands New Society for Visual Education Model AAA Projector. Super Special \$40.00. (Less than half price.)

QUANTITY LIMITED

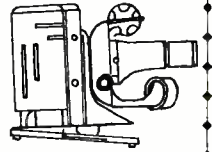

60 cycle		5 V. TRANSFORMERS	
Size of set	Secondary		Price
4-5 Tubes	*650V.-40Ma.-5V. & 2.5 or 6.3V.		1.75
5-8 "	*650V.-45Ma.-5V. & 2.5 or 6.3V.		1.90
6-7 "	*675V.-30Ma.-5V. & 2.5 or 6.3V.		2.35
7-8 "	*700V.-70Ma.-5V. & 6.3 or two 2.5V.		3.00
7-8 "	*700V.-70Ma.-5V. & 6.3 (25 Cv.)		4.50
8-9 "	*700V.-90Ma.-5V.-3A. 2.5V-3.5A. 2.5V.-10.5A.		3.50
9-11 "	*700V.-5V. & 6.3 at 4A.		3.50
10-15 "	*600V.-150Ma.-5V. & 6.3V.		4.00
File XFMR	12V.-40VA.		1.35
" "	5-4 Amp. 10,000 V. insulation		1.95
" "	6.3V.-1.5 Amp.		1.15
" "	6.3V.-15A., 6.3V.-15A.		3.95
Isolation	115 V. to 115 V. 3 A. Can be used as auto transformer to double or halve voltage.		2.95
" "	6.3 V. to 6.3 V.-5A. double or halve 10,000 V. insulation.		1.25

*Specify whether 6.3 or 2.5 V. Filament is desired.

CRYSTAL DIODE

No adjustment required. Use in field strength meters, noise limiters, signal tracer probes, wavemeters, or as 1st or 2nd detector. The world's finest detector for crystal sets. Higher efficiency and much greater volume. 75c or 3 for \$1.95

New 18-Watt Utility Amplifier Kit

Kit Model SA, high quality wide range 18-watt public address amplifier. Matched component parts. 3-stage, high-gain circuit with push-pull 7C5 output tubes. Dual inputs for mike, phono or radio tuner. Fully shielded. Universal output to match any speakers used. Fully variable tone control on output. Complete with all parts and tubes. Super Special. \$16.95.



SUPER HEAVY DUTY HIGH FIDELITY UNIVERSAL OUTPUT TRANSFORMER

by famous manufacturer
Flat within 1 D.B. to 20,000 cycles. Handles up to 125 watts without distortion. Hermetically sealed with 2500 volt insulation and porcelain standoff terminals. 6 3/4" high and 14 lbs. net weight. 18 impedance impedances available, plus 500 ohm line. \$80.00 value for only \$20.00.



A BETTER RAT TRAP

(Or From Blind Mice to Electric Eyes)
We offer a limited quantity of sensitive photo cell amplifiers complete with tubes, including the photocell. These were part of an ingenious rat trap manufactured by the Kryptar Optical Company of Rochester, N. Y. for use in flour and feed mills, etc., all over the world, in killing rats. This was done when the rodents interrupted a light beam, setting off a mechanism which electrocuted them. These amplifiers are useful for traffic counting, checking units in a production line, for opening garage doors, for burglar alarms, for smoke detectors on chimneys or fire alarms, for turning on street lights at dusk; and many other applications.
Super Special, completely wired—\$12.50.
Kit Form—\$8.50.



PUSH SWITCH
9 Section. Make-Break & SPDT ea. Pressing one releases all others.
98c

PHONO SCRATCH ELIMINATOR
Consists of 2 condensers and iron core choke connected in filter network. Same as used in most jukeboxes. Connects instantly between pick-up and amplifier. \$2.00.

STORAGE BATTERIES
Large Navy Type Storage Batteries 6V-225 Ampere hours. Shipped Dry, shipping weight 100 lbs. Special \$25.00.

FIRST CLASS
PERMIT NO. 3062
SEC. 510, P. L. & R.
NEW YORK, N. Y.

BUSINESS REPLY CARD
NO POSTAGE NECESSARY IF MAILED IN U. S. A.

2c Postage will be paid by

RADIO-ELECTRONICS
25 West Broadway
New York 7, N. Y.

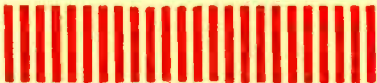



NEW

SUBSCRIPTION ORDER

**PLEASE ENTER MY SUBSCRIPTION
AS INDICATED BELOW**

THREE YEARS \$8.00

TWO YEARS \$6.00

ONE YEAR \$3.50

Remittance Enclosed

I'll Pay When Billed

NAME.....
(Please print)

STREET.....

CITY.....**ZONE**.....

STATE.....

*Canada, Mexico, South and Central
America same as U.S.A. All other foreign
\$1.00 extra for each year.*

IMPORTANT NOTICE TO READERS!

Today's ever-shifting defense and civilian demands are bringing rapid-fire changes in radio, television and audio. A subscription to RADIO-ELECTRONICS now, is your insurance of getting important topical information on servicing, construction, theory and new developments every month, at the lowest cost, no matter what the future brings in the way of prices, paper shortages or defense demands.

SUBSCRIBE TODAY**3 Years \$8.00****2 Years \$6.00****1 Year \$3.50**

**Watch for RADIO-ELECTRONICS'
trim new cover next month!**



Learn Circuits from A to Z... and Watch Service Troubles Disappear!



Read This NEW GHIRARDI BOOK FOR 10 DAYS at our risk!



A. A. GHIRARDI

Here—just out—is the latest and greatest of the famous A. A. Ghirardi books, "RADIO AND TELEVISION RECEIVER CIRCUITRY AND OPERATION"! Actually, despite the many circuit variations, there are only a few really basic circuits in modern radio, FM and television receivers. Let this big, illustrated book teach you all about these—and you'll be able to handle all types of service faster, better and more profitably.

HANDLE TOUGH JOBS IN 1/2 THE USUAL TIME!

Starting with a clear explanation of AM and FM, RADIO AND TELEVISION RECEIVER CIRCUITRY AND OPERATION then progresses to a complete understanding of ALL basic circuits. You learn how each circuit operates—what it consists of—how to recognize it quickly—how to trace troubles with a minimum of laborious testing—how to make repairs promptly. By making it easy for you to understand each circuit and its relation to other circuits, this great book helps you go right to the seat of the trouble with far less time and effort. It speeds up your work. It makes it easy to understand new receivers—to know just how they function and how to service them quickly and accurately.

NO OTHER BOOK LIKE IT!

Prepare yourself for bigger jobs, better pay! Send coupon today. Read this great book for 10 full days under our MONEY-BACK GUARANTEE offer.

10 DAY MONEY-BACK GUARANTEE

Dept. RE-51, Rinehart Books, Inc., Technical Division, 232 Madison Ave., New York 16, N. Y.
 Enclosed find \$6 for A. A. Ghirardi's new RADIO AND TELEVISION RECEIVER CIRCUITRY AND OPERATION book; or send C.O.D. and I will pay postman this amount plus postage. If book is not satisfactory, I will return it after 10 days and you guarantee to refund my \$6. (Price \$6.50 cash only outside U.S.A.—same return privilege)

Name _____
 Address _____
 City, Zone, State _____

ELECTRONIC SWITCH HANDLES MANY SIGNALS

Patent No. 2,521,952
 Richard G. Stephenson, Santa Fe, N.M.
 (Assigned to the United States of America as represented by the Sec'y of the Navy)

This circuit can switch as many signals as desired transferring one signal at a time to a common output. As an example, it can be used to display several signals, one at a time, on an oscilloscope. With sufficiently rapid switching all signals become visible at once and are easily compared.

An a.f. oscillator is coupled to a lowpass filter through a transformer. There are as many filter sections as signals to be switched, 5 in this figure. Within the passband (from d.c. to cut-off) there is no attenuation but phase is shifted by each filter section. Each section is designed for a shift of $360/N$, where N is the number of filter sections. Therefore the figure shows a shift of $1/5$ of a.f. cycle or 72° .

E1, E2, etc. are the signals to be switched to the output. Each signal is connected to the grid

of a separate cathode follower, V1, V2, etc. Only one triode conducts at a time. Conduction can occur only while the positive crest of each a.f. cycle exceeds the negative bias at the transformer secondary. The bias is adjusted for a conduction interval of $1/N$ of each a.f. cycle.

During the $1/5$ cycle that A goes positive, V1 conducts. If R1 is large enough the output is nearly equal to E1. During this time all other tubes are blocked. Since the phase at B lags A by $1/5$ cycle, B goes positive as soon as A becomes negative again. For the next $1/5$ cycle V2 conducts and the output is nearly equal to E2.

The positive crest of the a.f. wave thus travels down the filter making the successive points A, B, C, etc., positive. Each tube conducts for $1/5$ cycle and transfers its input signal to the output during that interval.

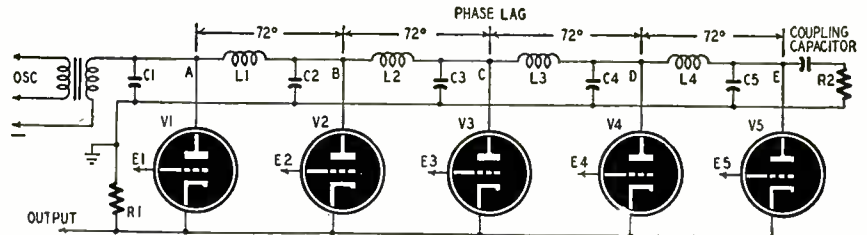

U.H.F. OSCILLATOR TUBE USES NO TUNED CIRCUITS

Patent No. 2,520,383
 Palmer H. Craig, Gainesville, Fla.
 (Assigned to Invex, Inc.)

Oscillation at a frequency determined by the speed with which electrons move through the tube instead of L or C values, is the feature of this invention.

Electrons from a cathode move toward G, the grid. A square-wave generator switches the electron stream on and off so that electrons move to the right in groups or bunches. They are speeded up by the voltage E1 on the first anode P1. Later they come under the field due to E2 on the accelerator P2.

After passing through the aperture in the center of P1, the electron bunches move through a

series of magnetic rings, R. Each ring is made of permalloy or other high-permeability metal and has a coil L wound over it. As the electrons approach and pass each ring they generate a magnetic field in it. This varying field induces a voltage in the coil. The voltage of each coil feeds the output load.

The frequency of the induced voltage is determined by the speed with which electrons move. If desired, C may be added to resonate with coils L. The phase shifter is adjusted to time the electron bunches for maximum output across the oscillator load.

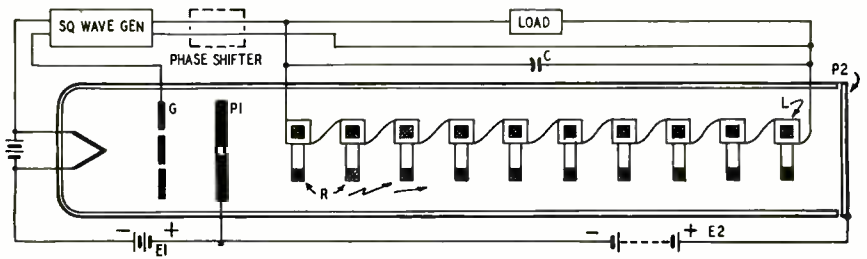

AUTOMATIC I.F. CONTROL FOR RADAR

Patent No. 2,519,369
 William W. Hansen and John R. Wooyard,
 Garden City, L. I.
 (Assigned to Sperry Corp.)

At the very high frequencies used in radar, even very slight instability or drift in the carrier frequency produces relatively large shifts in the i.f. at the receiver. For this reason, the receivers must use a wide-band i.f. strip.

This invention uses a signal from the transmitter to control the receiver i.f. so that a sharply-tuned i.f. strip can be used, giving the advantages of low noise, high gain, and peak efficiency. The figure shows a simplified version. The modulator mixes the second harmonic of the 15-mc oscillator with the carrier frequency F. The sum frequency passes a filter and is fed to the receiver. The carrier is transmitted to the target through antenna T.

At the receiver, R intercepts the echo signal and feeds it to a mixer. Here the sum frequency (F + 30) mixes with the carrier to produce the

desired beat, which is 30 mc regardless of moderate variations in the carrier frequency.

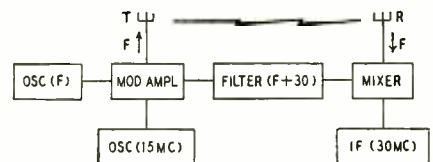

This system is particularly adaptable to radar systems where the receiver and transmitter are usually at the same location. It could be used just as well with any similarly situated equipment operating in the v.h.f. and u.h.f. regions where i.f. stability is an important factor.

EXPANDED SCALE METER

Patent No. 2,526,329

Harvey H. Chamberlain, Marblehead, Mass.
(Assigned to General Electric Co.)

This d.c. meter has an expanded scale to provide more accurate readings.

A zero-center instrument is used with its coil across a bridge circuit. One arm is an OC3 tube. R is a dropping resistor. The other two arms are chosen to balance the bridge when the input is 200 volts.

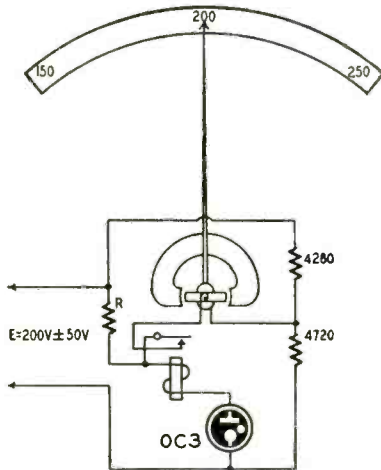

With an input less or greater than 200 volts, the pointer deflects in one direction or the other due to bridge unbalance. The milliammeter shown has an internal resistance of 3,000 ohms and a full-scale current of 5 ma. With the circuit values shown the meter current may be calculated from:

$$I_m = \frac{4720 E - (105)(4280 + 4720)}{(4280 + 4720) R_m + (4280)(4720)}$$

where R_m is the meter resistance.

When the input drops to less than about 200 volts, the regulator tube is extinguished. Then excessive current may flow through the meter and damage the pointer. To prevent this, a relay opens the circuit, and the VR tube stops conducting.

IMPROVED OSCILLATOR

Patent No. 2,510,868

James R. Day, Peconic, N. Y.

(Assigned to Press Wireless, Inc.)

This oscillator has unusual stability. Frequency is determined almost solely by the crystal itself since changes in the circuit have negligible effect. V1, a cathode-follower, has low impedance output and cannot be affected by variations in the following stage. V2 is a cathode-fed amplifier (with respect to the signal). Its stability is high because of the shielding effect of its grid.

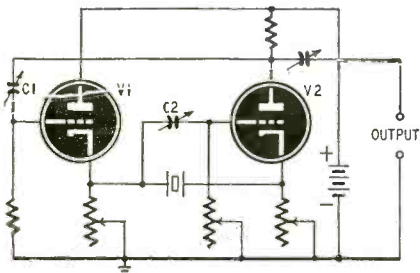

The crystal itself is series resonant at some frequency. Because of the low impedance near this frequency, practically the entire voltage output of V1 is transferred to V2. At frequencies removed from series resonance the impedance rises sharply and only a fraction of the signal is applied to V2. The output of V2 is in phase with the input to V1, and the feedback through C1 causes oscillation.

Because of the capacitance of the crystal holder there is also a parallel-resonant frequency of the crystal. This frequency is rejected while the series-resonant frequency is accepted. The phasing capacitor C2 neutralizes the capacitance of the crystal holder. This is done by passing r.f. through C2 to the grid of V2 while the holder capacitance permits r.f. to flow to its cathode.

—end—

RCP TELEVISION AND RADIO

Complete Service Equipment for

Model TV-80 SWEEP GENERATOR & MARKER

A high quality Sweep Generator combined with a TV marker. Sharp, clean-cut patterns with stability and sharp legible marking.

Comprehensive range—continuously variable 5—240 megacycles.

Sweep width—variable 400 KC to 10 MC.
Linearity—as required for band pass checking with an oscilloscope.

High "Q" absorption marker 17 to 48 MC.
Future IF's of higher frequencies provided by direct calibration of marker dial.

Marker calibration—accurate to within 1 per cent.
Planetary Drive.

Provision for use of external marker.

Special design permits retrace to be blanked out independently, regardless of type of oscilloscope used.

Controls for regulating sweep width—sweep amplitude—phasing—marker tuning—Pilot Light—Power Switch.

TEE VEE 90 OSCILLOSCOPE

Combines two essential instruments needed in TV testing alignment—service. A complete oscilloscope and a complete sweep generator that can be used independently. Oscilloscope also has its own variable linear sweep. Sinusoidal sweep with phasing control for use with internal RF sweep generator when testing band pass characteristics. Synchronization provision for either internal positive, external or line frequency.

External jack provided for trace blanking. Requires 10 volts of negative pulse to blank a normal intensity level trace.

Independent sweep generator has a center frequency range of 1.5 to 45 megacycles giving a choice of any IF frequency desired. The band width can be varied continuously from 0.5 KC to 7 MC.

Traveling detector probe is included for observing signal at any point of the RF circuit under test.
Supplied with tubes, probe, coaxial output cable.

NEW MODEL 654 V.T. VOLTMETER

Electronic balanced bridge type push pull circuit V.T. voltmeter for A.C. measurements, as well as D.C.

A discriminator alignment scale with zero center permits operation in both directions.

Ohmmeter measurements—0.2 ohm to 1000 megohms in 5 range.

DC Volts: 0-5-25-100-250-1000.
AC Volts: 0-5-25-100-250-1000.

DB: —20 to 16, —6 to 30. 6 to 42, 14 to 50, 26 to 62.

Complete with isolation probe and leads.

Net Price \$57.50

NEW DYNOPTIMUM FREE POINT TUBE TESTER

MODEL 323 P.C.

The only tube tester that protects against obsolescence by having 2 extra circuit and tube element switches that are spares and are not used with 2 extra socket caps for possible new tube bases—more pins and elements.

Besides it is a free point tube tester designed to test the very latest tubes such as the new 8-prong sub-miniatures, etc. Unusually speedy to operate, simple and accurate. New design roll chart gives approximately 1,000 tube listings. All short-leakage and quality tests included.



RADIO-CITY PRODUCTS CO., INC.
152 West 25th St. New York 1, N. Y.

Buy from your Jobber. Insist on R.C.P. instruments. Write For Catalog RE5.

Communication Problems Solved WITH ARMY FIELD TELEPHONE WIRE

All-purpose—all-weather
This is genuine W110R Army Field Wire on original steel reels. Insulated, 2-conductor, copper-steel strands. Excellent for all types of communication. Used extensively by telephone companies, industry, engineering projects, ranches, public address systems, etc.
GRADE I—New, unused, excellent condition.
Mile reels (wt. 160 lbs.) \$19.50
Half-mile reels (wt. 80 lbs.) 10.00
GRADE II—New, unused, good condition.
Mile reels \$15.50 Half-mile reels \$8.00

ACT NOW! LIMITED SUPPLY!

All prices FOB Sacramento. No COD. (Calif. residents add 3% for sales tax.) Small orders sent postage collect, heavy orders freight.
Write for FREE FOLDER, Telephone Specialties. Send check or money order
LORIS SALES
P.O. Box 1896-RE-5, Sacramento, California



DISTRIBUTORS OF Automatic Custom AUTO RADIOS

Net...\$45⁰²

1949-1950-1951 Ford, Chevrolet, Plymouth, Dodge, Hudson; 1950-1951 Studebaker; 1951 Henry J.

EVERY SET A CUSTOM 5 TUBE 3 GANG HIGH-POWERED SUPERHETERODYNE
Mail Orders Filled Promptly. Specify Car and Year. Postage Prepaid on Cash Orders; COD's accepted in U.S.A.
PROGRESSIVE ELECTRONICS CO.
497 Union Ave., Dept. RE 47, Brooklyn 11, N.Y.
(See advertising index for other advertisement of Progressive Electronics Co.)

TRANSVISION

ANNOUNCES

NEW LOW PRICES

on 17"-20" TV KITS,
CHASSIS and CABINETS

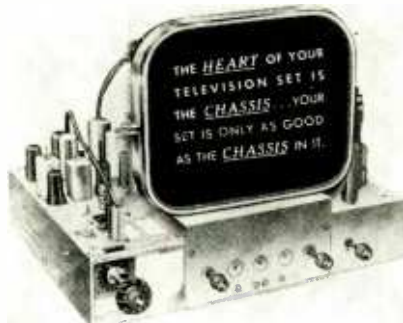

SAVE UP TO 50%!

Transvision makes the finest TV KITS and WIRED CHASSIS that money can buy. PRICED AMAZINGLY LOW. Kits are easy to assemble. Give top quality picture and sound. Ideal for both hobbyists and dealers.

BEAUTIFUL NEW CABINETS

Write for Catalog RE

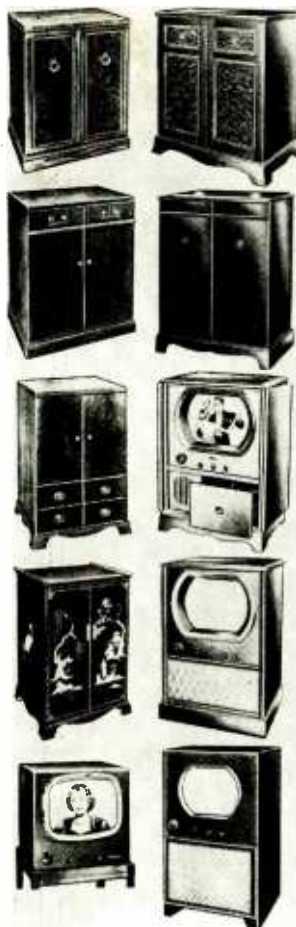

Write for Prices and Details Today!

TRANSVISION, INC.

Dept. RE

NEW ROCHELLE, N. Y.

HIGH-FREQUENCY CUTOFF CONTROL

Sometimes annoying buzzes and rattles are noticed when playing records on wide-range reproducing systems. This effect—most often noticed immediately following a sharp transient—can be traced to poor tracking, worn records and needles, and in some instances, to defects in the record. Fortunately these noise frequencies are concentrated in the upper end of the audio spectrum where they can be considerably attenuated or entirely eliminated with a low-pass filter.

In the equalizer for the original Williamson amplifier, a parallel-T network in the feedback loop of a triode-connected 6F5 amplifier provided high-frequency cutoff at 5,000, 7,000, 10,000, and 13,000 cycles. Writing in *TSF Pour Tous* (Paris, France) Jacques Lignon shows how he modified the circuit to use a 6F5 tube and to

provide an additional position for cutoff at 2,500 cycles for records which are extremely bad.

The modified diagram and the high-frequency response for various settings of the switch are shown. This circuit can be inserted after a triode stage in a preamplifier or in the main amplifier. It is not worth while to construct this circuit if you do not have facilities for running response curves. Many components are so critical that normal tolerances, erroneous markings, and changes in value because of overheating or physical damage can seriously affect the performance of the circuit. Silvered mica capacitors are recommended for the switched circuits. Those in the parallel-T should be carefully matched or have 1% tolerances, as should the two 100,000-ohm resistors. The 50,000-ohm resistor has a tolerance of 1%.

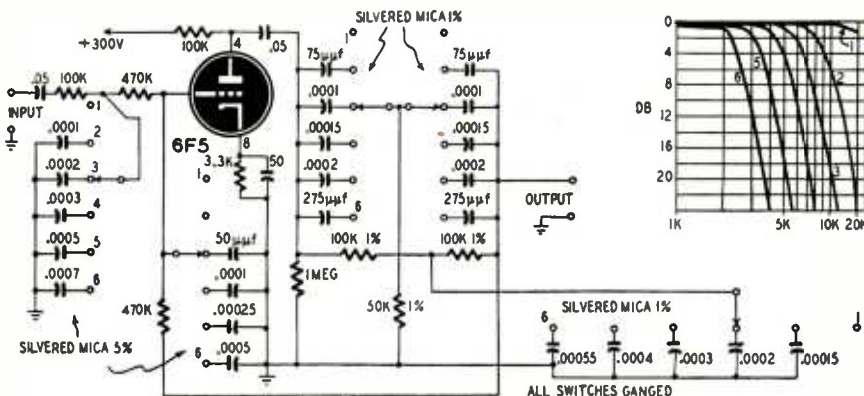

VARIABLE-VOLTAGE REGULATED SUPPLY

Most laboratory and experimental power supplies are designed to deliver variable voltages which must be manually adjusted for different loads or to deliver one or more fixed voltages which are regulated over a comparatively narrow current range. This circuit, reprinted from catalog TR-51 issued by Triad Transformer Mfg. Co., delivers from 0 to 300 volts which is regulated

within 1/2% from 20 to 300 volts with loads varying from 0 to 150 ma and line voltages ranging from 105 to 125. It also delivers continuously variable bias of 0 to 150 volts at currents up to 5 ma.

The circuit is easy to build and operate. High-quality components should be used throughout. R1 and R2 have 2% tolerances and should be either wire-

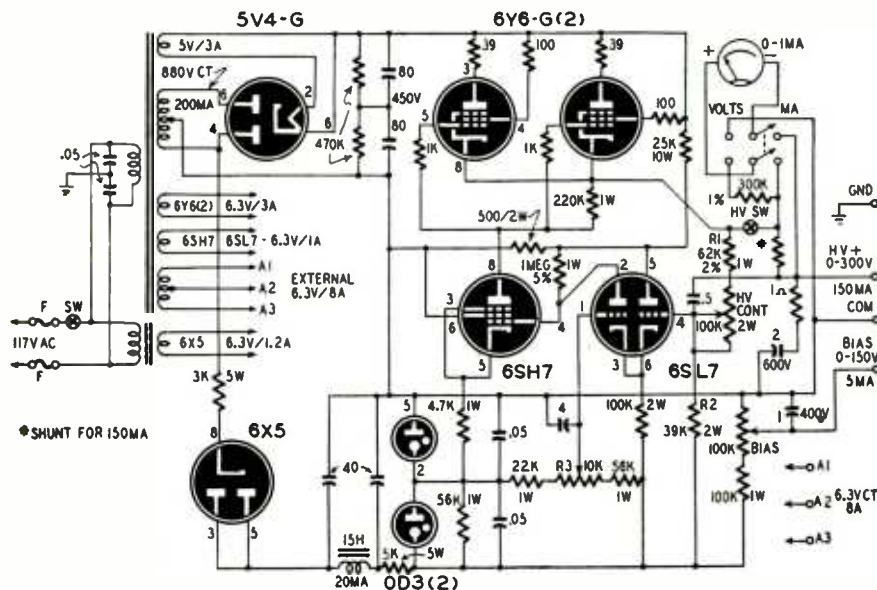

wound or spiral-cut carbon types. The 100,000-ohm high-voltage and bias controls should be linear units rated at 2 watts or more.

Set the high-voltage control to maximum, then adjust R3 so the output is exactly 300 volts. The high-voltage control will then cover from 0 to 300 volts.

WATTMETER SUBSTITUTE

Useful and easy to build, this wattmeter will check the power consumed by radios, TV sets, and various a.c. appliances. Short circuits and overloads can be detected by comparing the meter reading with the manufacturer's rating on the device. Most service technicians do not have an a.c. ammeter but they do have a reliable a.c. volt meter which can be used.

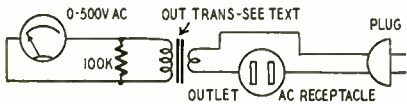

Select a husky output transformer which has a secondary consisting of few turns of heavy wire or use one having a tapped secondary. Connect an a.c. receptacle and line cord in series with the secondary and shunt the primary with a 100,000-ohm resistor and a 500- or 1,000-volt a.c. meter. The resistor is to prevent arcing across the primary.

When a set or other appliance is plugged into the outlet, the meter will show a voltage which can be converted to watts. Plug different size lamps into the receptacle and record the voltage and wattage ratings. Use the tap on the transformer which makes the meter read nearest 100 volts with a 100-watt lamp. When a number of checks have been made, record the data on a chart or graph.

To check a radio or TV set, plug it into the wattmeter and let its tubes come to operating temperature. Convert the meter reading to watts and compare this figure with the manufacturer's wattage rating. Shorted filter or bypass capacitors in a receiver or amplifier will cause a noticeable increase in wattage. Open transformers, resistors, etc., will cause the wattage to be low. Excessive current in a motor will probably be caused by shorted turns in a winding or by an excessive load.—G. L. Garvin

HOME BROADCASTER

It is easy to convert a standard superhet receiver into a home broadcaster. Disconnect the primary of the output transformer from the output tube. Ground one end and connect the other to the arm of the volume control or to the grid of the first a.f. amplifier. Connect the secondary of an ordinary

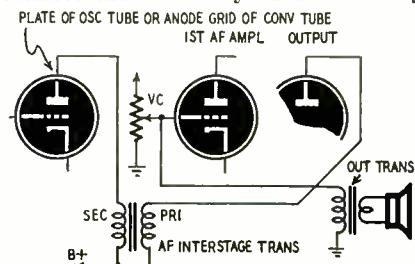

By Popular Demand
OAK RIDGE presents FOR THE FIRST TIME



SMALLEST PRECISION-BUILT MULTITESTER in the Industry!
20,000 OHMS PER VOLT
MODEL 105

Sensational new miniature test instrument (3 7/8" x 3 1/2" x 3") fully equal to any popular multitester in performance and operating characteristics—yet less than HALF THE SIZE

- DC and AC Volts: 0-2.5-10-50-250-1000-5000
- Output: 0-2.5-10-50-250-1000
- DC Millamps: 10-100-500
- DC Microamps: 100
- Decibels: -12 to +55 in 7 ranges
- Ohms: 0-2000 0-200,000, 0-20 Meg.

Hi-Volt probe to 25,000 volts available. Ideal for servicing ON-THE-SPOT! A real time and money saver. MODEL 105.

These OAK RIDGE Precision Portable TV TEST INSTRUMENTS

... Solve 95% of TV Servicing Problems **RIGHT ON THE JOB!**

MODEL 101 SUBSTITUTION TESTER



Has Test Speaker with voice coil and transformer connections, range of resistors, paper, ceramic, electrolytic condensers, variable pot; and simple sig. tracer—can be used as audio signal tracer for Radio & TV.

MODEL 103 SIGNAL GENERATOR



Combines small size, sturdiness, ACCURACY and dependability. Locates trouble fast, from antenna to CRT or speaker. Packed with features to make TV servicing easier, faster, more profitable!

MODEL 104 "SYN-CHRO-SWEEP"



Pat. App. For

New invention for TV testing, widely endorsed by experts. Supplies own synch. and sweep pulses for signal tracing synch. and sweep circuits with or without test pattern, scope, or bench equipment!

COMPLETE PORTABLE TV TESTING LABORATORIES



Four individually removable instruments in carrying case. Model A-100, includes models 101, 102, 103, 104 described above. Model B-100 includes models 101, 103, 104, 105 described above.

MODEL 102 HIGH VOLTAGE TESTER



Perfect midget instrument for portability and accuracy. PRECISION MOVEMENT has 3 ranges: 0-500V, 0-150KV, 0-30KV and 10,000 ohm-per-volt sensitivity. Ideal for hi-voltage testing of TV sets right in the home!

OAK RIDGE PRODUCTS

Mfg. Div. of Video Television, Inc.
37-01-C Vernon Blvd.,
Long Island City 1, N. Y.

HAVE YOU A JOB FOR A TRAINED TECHNICIAN?

We have a number of alert young men who have completed intensive training in Radio and Television Repairing. They learned their trades thoroughly by working on actual equipment under personal, expert supervision. If you need a trained man, we invite you to write for an outline of our course, and for a prospectus of the graduate. No fees, of course. Address:

Placement Manager, Dept. P108-5
COMMERCIAL TRADES INSTITUTE
 1400 Greenleaf Chicago 26

EASY TO LEARN CODE

It is easy to learn or increase speed with an Instructograph Code Teacher. Affords the quickest and most practical method yet developed. For beginners or advanced students. Available tapes from beginner's alphabet to typical messages on all subjects. Speed range 5 to 40 WPM. Always ready—no QRM.

ENDORSED BY THOUSANDS!

The Instructograph Code Teacher literally takes the place of an operator-instructor and enables anyone to learn and master code without further assistance. Thousands of successful operators have "acquired the code" with the Instructograph System. Write today for convenient rental and purchase plans.



INSTRUCTOGRAPH COMPANY

4701 Sheridan Rd., Dept. RC, Chicago 40, Ill.

FOR TOP QUALITY PICTURES



—USE

PERFECTION ION TRAPS

- Simplest to Install
- Stay Put—No Wobble
- Standard on All Leading TV Sets Including

ADMIRAL CORP. PHILCO
 AIR KING RCA VICTOR
 AMERICAN REGAL
 TELEVISION ELECTRONICS
 BENDIX SENTINEL
 DEWALD STEWART
 DU MONT WARNER
 EMERSON STROMBERG-
 GAROD CARLSON
 GENERAL ELECTRIC
 HALLICRAFTERS TELEPHONE
 HOFFMAN TELEQUIP
 JACKSON TRAD
 INDUSTRIES WARWICK
 MECK WELLS-GARDNER
 MOTOROLA WESTINGHOUSE
 MUNTZ WILCOX-GAY
 OLYMPIC ZENITH

Order today from your supplier!

PERFECTION ELECTRIC COMPANY
 2645 South Wabash Ave., Chicago 16, Ill.

Makers of Perfection Speakers and Beamajuster TV Centering Controls

TV PICTURE TUBES

G. E. and HYTRON in stock for immediate delivery

7JP4	\$18.37	16KP4A	\$43.12
10 FP4A	28.91	17BP4A	38.56
12LP4A	25.63	19AP4A	61.20
16KP4	38.56	20CP4	65.02

All prices net. (In California add 3% Sales Tax)
 Full Factory Guarantee.

FREE with each purchase:
 G.E. Picture Tube Replacement Guide.
 G.E. Sweep Circuit Book.

Terms: 25% with order. Balance C.O.D. Send remittance in full and save C.O.D. charges.

COAST ELECTRONIC SUPPLY COMPANY
 527 W. Main Street
 Alhambra, California Phone: ATlantic 9-4361

interstage audio transformer in series with the oscillator plate or the anode grid of the converter tube. Insert the primary of the transformer between B-plus and the plate of the power amplifier stage.

With this setup, the speaker becomes a microphone. Set the dial of the broadcaster approximately 456 kc (assuming a 456-kc i.f.) below the frequency of the receiver used with it.—Ambrose Fisher

CAPACITOR CHECKER

This circuit can be used to check the quality and approximate capacitance of the most common values of electrolytic and paper capacitors. The circuit consists of a relaxation-type oscillator transformer-coupled to an audio amplifier and speaker or a pair of headphones.

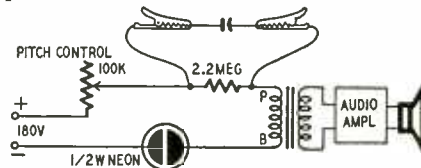

With the values shown, the neon tube oscillates readily with good capacitors having values as low as approximately .005 µf. Capacitor values are determined by comparing the tone produced by the unit under test with that of a standard capacitor. If the capacitor is open, the lamp will not oscillate and no sound will be heard. A shorted capacitor causes the lamp to glow continuously.

The capacitors are connected to the unit by flexible leads fitted with alligator clips.—H. Desforges

GARAGE-DOOR OPENER

This radio-control transmitter and receiver is designed for controlling garage doors from an automobile, but it can be used for almost any other operations which require that an external circuit be opened or closed. Most circuits of this type operate in the v.h.f. band where they sometimes cause interference to TV and other services. The possibility of interference is practically nonexistent in this transmitter because it operates at approximately 420 kc with negligible power input.

The transmitter shown in Fig. 1 gets its operating voltages from the auto-

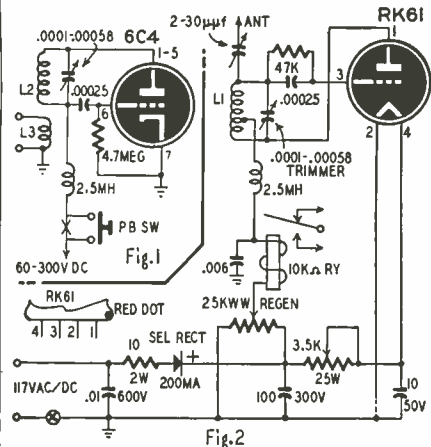

VEE-D-X for the finest LIGHTNING ARRESTERS at the Lowest Prices



New!
2-WIRE RW-200
 only **125** LIST

4-WIRE RW-204
 only **150** LIST

The first and only arrester that will accommodate 4-wire rotator line as well as regular 2-wire transmission line.

The new VEE-D-X Model RW-200 is the popular low-priced arrester. Similar in design and construction to the RW-204. Two saw tooth contact points assure positive protection for any 2-wire installation.



The Original 2-Wire RW-300

For use with 2-wire standard transmission line. An air gap plus resistor provide double protection. RW-300 is manufactured of moisture resistant Mica-fill Bakelite. RW-300A — highest quality thermo-setting plastic.



only **200** LIST

LA PAINTE-PLASCOMOL CORP., WINDSOR LOCKS, CONN.

"TAB" That's A Buy! END EQUIPMENT BUYS!

BC645 (USN Model CG 43AAG) Ideal Citz'ns Band Conversion, New, Less Tubes, Connectors & Dyn.	\$12.95
RADIO COMP RCVR Less Tubes, As Is.	5.98
TG5 Keyer, As Is.	5.98
EE5 Portable Ass'y, w/handset, Compled, As Is, No Returns.	5.98
R9/APN4 Revr, Less Tubes, As Is.	14.98
TG10 Code Unit, Less Tubes, As Is.	19.95
B19-M4 Varometer Unit, As Is.	1.98
RM29 Control Unit, BRAND NEW.	11.98
RT34/APS12 30 Mc IF, Less Tubes, As Is.	7.98
R74/APS3 Good, As Is, Less Tubes.	29.98
R59/TPS3 Good, As Is, Less Tubes.	24.98
EE65 Telephone Test Set, Fine Cond.	3.98
BE65 Time Interval Signal, Used.	2.49
R74/CRW Revr, Less Tubes, As Is.	19.98
R89/ARNSA, Less Tubes, CAA Appvd.	19.98
PE97 Plate Supply Unit, Less Tubes, Good.	9.98
I-108 Range Calibrator, Metal Case Good.	29.98
PE120 Pwr Supply, Less Tubes, Used.	9.98
Mackay 168B Radio Xmitter, w/Metal Case, Less Vibrapack & Tubes, As Is.	2.98
I-198 Sig. Gen, Good Cond, Less Tubes.	14.95
BC212 Amp, Exc Cond, Less Tubes.	1.49
M299 Mike Adaptor, Good Cond.	2.95
BC453 RCVR (190-550Kc) New, w/tubes.	24.49
BC454 Revr (3-6Mc) New, w/tubes.	10.49
BC455 Range Calibrator, IT, * Dyn, As Is.	4.95
BC456 Mod, Less Tubes, * Dyn, As Is.	1.98
BC457 Xmr (4-5-3Mc), LT, * As Is.	3.49
BC458 Xmr (5-3-7Mc), LT, * As Is.	3.98
SCR595 IFF, Less Tubes, As Is.	3.98
BC602 Cont Box for 322, As Is.	1.29
BC605 Amp, Less Tubes, As Is.	3.98
SCR695 IFF, Less Tubes, As Is.	4.98
BC906 Freq. Mtr, Exc Cond, Less Tubes.	29.95

Sell Your SURPLUS TUBES & Gear To "TAB"—Send List & Best Prices

TUBES

New—Guaranteed Specials This Month to Readers of Radio-Electronics

1A7	\$1.32	6AC7	\$1.74	12SF5GT	\$0.79
1B3GT	1.59	6AG5	1.59	12SF7GT	.79
1H5G	1.05	6AK5	2.34	12SG7	.89
1N5GT	1.05	6AL5	1.32	12SH7	1.10
1R5	1.06	6AU6	1.36	12S4GT	.89
1T4	1.05	6B4G	1.98	12SR7	.98
1T4/5910	1.05	6B6GT	2.25	21J6GT	.87
1U5	.95	6H6	1.15	25Y6/25Z5	.90
1X2A	1.59	6J6	2.75	35Z4GT	.75
2A9	1.05	6SN7G	1.32	35Z5GT	4.90
3Q5GT	1.25	6U4/6W4	.95	50A5	1.35
3R4	1.05	6V6GT	1.20	50C5	1.03
3Y4	.89	6X4	.89	50L6GT	.99
5U4G	.99	7C5	1.08	Tubes Gld. Via	
5Y3GT	1.25	12AU7	1.92	R. Exp. Only.	
6A5G	3.10	12SA7GT	1.05	Others—Write.	

IN34 XTALS, 79c; 10 for \$7.50
 Write for Your Free "TABOGRAM". Money Back Guarantee (Cost of Mde. Only). \$5. Min. Order F.O.B. NYC. Add Shpg. Charges & 25% Deposit. Prices subject to change without notice.

"TAB" That's A Buy!
 Dept. 5RE, 6 Church Street
 New York 6, N. Y., U. S. A.
 Cor. Church & Liberty Sts.
 Room 200, Phone Worth 2-7230

mobile radio and is small enough to be mounted inside some sets. It also can be constructed as a separate unit and installed under the dashboard. A push-button switch in series with the B-plus lead turns the control on and off. A toggle switch may be inserted in the heater lead to reduce the battery drain by 150 ma when the transmitter is not in use.

The receiver is a superregenerative detector using an RK61 gas triode. The resting plate current of approximately 1.5 ma drops to 0.5 ma when a signal is received. This drop in current is sufficient to release the relay in the plate circuit. The relay is a sensitive unit having s.p.d.t. contacts and a coil of approximately 10,000 ohms. We use the contacts to control two electric motors which open and close the garage doors.

L1 and L2 are each 70 turns of No. 22 d.c.c. wire close-wound on 1 1/4-inch forms. L1 is tapped at 7 turns from the plate end. L3 is a 10-turn winding over L2.

The transmitter may be coupled to a whip-type automobile antenna. The receiving antenna should be the shortest one that permits reliable control operation at a distance of 50 feet. A short piece of wire will usually do.

The receiver operates from a transformerless type supply. Make sure that the 3,500-ohm resistor is set for maximum resistance when the unit is turned on for the first time. With a d.c. voltmeter across the RK61 filament, gradually reduce the resistance until the meter reads 1.5 volts. Adjust the 25,000-ohm regeneration control for maximum sensitivity.—Edwin Kucharski
—end—

AID FOR TV STUDENTS

To keep up with fast-changing television circuits, students at the Milwaukee School of Engineering begin their TV studies with a complete set that is built on 11 different chassis, each containing one of the major sections of the receiver. Thus the beginning student can study each block by itself without being confused by the maze of tubes and wiring of a complete 25- or 30-tube set. He then can correlate the various units and study their interaction. Many of the units are interchangeable with others that perform the same function but use different circuits, and each unit is easily modernized as TV circuits are improved.
—end—

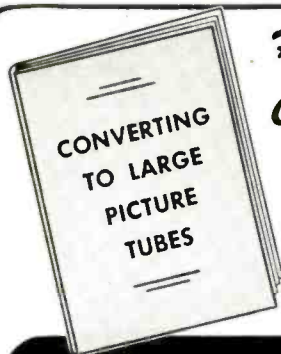
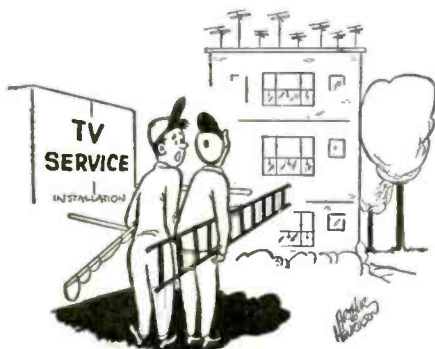

Here it is! First Complete Conversion Book in America!

Just off the press! The first complete book published in all America that gives you all the facts . . . all the photos . . . all the diagrams you need to convert 10" or 12" television sets (RCA, Philco, GE, Admiral, Crosley and many others!) to big 14", 16" and even 20" picture tubes! Simple and easy to follow!
A VITAL "MUST" FOR EVERY TV SERVICE MAN!

"CONVERTING to LARGE PICTURE TUBES"

ONLY
\$1.50
POSTAGE PAID

There's big money for you when you learn to convert TV sets to big screen this easy way. This new book tells all you need to know . . . solves problems quickly . . . expertly. Get your copy now!

SOLVES EVERY PROBLEM OF TV CONVERSION!

- Focus
- Linearity
- Width
- Cabinet Modification
- Height
- Centering
- Blanking

Order Your Copy, Today!

AMERICAN DISTRIBUTING CO., DEPT. RE-5
1810 WINCHESTER ST., BALTIMORE 17, MARYLAND
I am enclosing check or money order for \$ _____
Rush _____ copies of "Converting to Large Picture Tubes" at once. (\$1.50 per copy. No C.O.D.'s.)
NAME _____
ADDRESS _____
CITY _____ STATE _____

Let MILTON S. KIVER Help You Prepare For COLOR TV And...

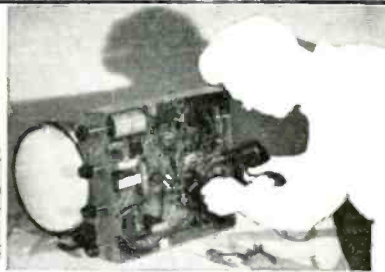

Easy to TRAIN AT HOME This Practical Way!

Men with the right training in Television Servicing are in big demand . . . pull down big pay. T.C.I. TRAINS YOU RIGHT with easy-to-follow technical training designed by servicemen, for servicemen! You learn practical, professional type Television Servicing without leaving your present job. Included are money-making extras such as set conversion, master antenna installation, COLOR TV and field servicing short cuts. You can start earning Television money after the first few lessons. You learn to test, trouble shoot and repair all types of TV sets. You learn **COLOR CONVERSION** too!

HERE'S HOW YOU GET EXPERIENCE!

You train on your own large screen modern television receiver, furnished as part of your course. This set is yours to keep! As an optional feature you can get two weeks of actual field experience out on service jobs and on the repair bench for Chicago's largest independent servicing organization. You learn Television Servicing by actually doing Television Servicing . . . you get the practical know-how you need to qualify for **BIG MONEY** in this fast-growing field. Age is no barrier. Many TCI students are over 40!

ACT NOW! Fill out and mail coupon for **FREE** Catalog and **SAMPLE LESSON**. Write **TODAY!**

YOU GET and keep modern large screen Television receiver.
YOU DO actual testing, servicing, trouble shooting and repairing

FOR THE BEGINNER
TCI offers a low-cost Pre-Television Course in Radio, especially designed to prepare you for television in just 5 to 7 weeks. Everything you need from basic radio through servicing . . . to Television.

MAIL NOW FOR FREE BOOKLET

MILTON S. KIVER, President
TELEVISION COMMUNICATIONS INSTITUTE
205 W. Wacker Dr., Dept. RE-3 Chicago 6, Ill.
O. K. Mr. Kiver! Rush **FREE** Catalog on your practical home study course in Television Servicing, including **COLOR TV**. Include **FREE** Sample Lesson. I am not obligated. Salesman will not call.

Name _____ Age _____
Address _____
City _____ Zone _____ State _____
() **BEGINNERS** check here for information on Pre-Tel Radio Course.

TELEVISION COMMUNICATIONS INSTITUTE
205 W. Wacker Dr., Dept. RE-3, Chicago 6, Ill.

***VOLOMETERS**

*Reg. Trade Mark for Volt-Ohm-Milliammeter

from the New

EMC ECONOMY LINE



MODEL 104
(20,000 ohms per volt meter)
• 4 1/2" SQUARE METER (50 micro-amperes—Alnico magnet)
• Includes carrying strap
5 DC Voltage Ranges at 20,000 ohms/volt to 3,000 V.; 5 AC Voltage Ranges to 3,000 V. 3 Resistance Ranges to 20 megs. Also 3 AC & DC Current Ranges at 5 DB Ranges. **\$26.95**

MODEL 102

(1000 ohms per volt meter)

• 3" SQUARE METER
• 3 AC CURRENT RANGES (0-30/150/600 ma.)
• Same zero adjustment for both resistance ranges (0-1000 ohms, 0-1 megohms)
5 DC & 5 AC Voltage Ranges to 3,000 Volts Also 4 DC Current Ranges. **\$14.90**



MODEL 103
(1000 ohms per volt meter)
• 4 1/2" SQUARE METER
• 3 AC CURRENT RANGES (0-30/150/600 ma.)
• Same zero adjustment for both resistance ranges (0-1000 ohms, 0-1 megohms)
Same Ranges as Model 102. Also 5 DB **\$18.75**
Model 103-S with plastic carrying strap **\$19.25**



All of the above have round cornered, bakelite, molded cases.

Export Dept., 103 W. 42nd St., N.Y.C.
Write Dep't RE-5 for Free Catalog

Gives More Measurement Value Per Dollar

ELECTRONIC MEASUREMENTS CORPORATION
280 Lafayette St., New York 12, N.Y.

NEW CONDENSER TESTER



Finds Intermittent Condensers Instantly

Pres-probe's sliding tip with variable resistance prevents condenser heating. Tests with power on. Requires no adjustment. Stops guesswork. Saves time. Convenient probe size (7 1/8" long). Satisfaction guaranteed

795
Postpaid U.S.A.

See Your Dist. or Order Direct
PRES-PROBE CO.

4034 N. SIXTH ST., MILWAUKEE 12, WIS.

REWINDING A RELAY

? I want to replace the coil in the flash-tuning relay in a Silvertone model 4587 receiver. Can you tell me the length and size of the wire to use? I am also interested in knowing the voltage, current, and resistance of the coil so I can get the correct replacement.—F. C. B., Detroit, Mich.

A. We do not have any technical data on the relay used in this set. Servicing data which we have indicates that the drain on the B-supply is approximately 100 ma and the drop across the relay coil and the 150-ohm resistor shunting it is approximately 5.5 volts. Manufacturer's instructions state that the relay should pull in at 60 ma.

The size of the magnet core or the force needed to pull in the armature are not known, so we cannot provide data on wire size. If the core is intact and the winding is damaged, remove the old wire. Count the number of turns in at least one layer and count the number of layers. Use the same size wire to rewind the coil. Try to put on as many turns as were on the original winding. Check the coil by putting it in series with a 6-volt battery and a 100-ohm wire-wound potentiometer. Adjust the pot and the spring tension so the relay pulls in at 60 ma.

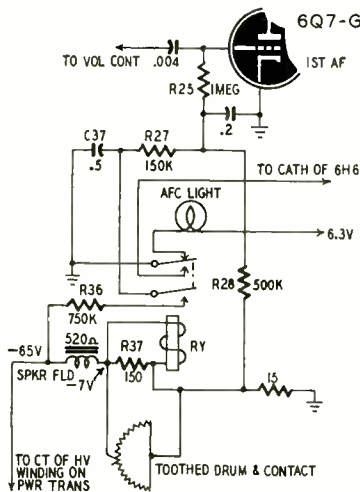

If the relay is missing from the circuit, try to find a 6-volt d.c. relay which has double-pole, double-throw contacts and a coil of 55 ohms or more. The diagram shows the basic circuit, including the relay. If the relay coil is approximately 55 ohms, shunt resistor R37 should be omitted. For other values, select a value for R37 which will produce a drop of 5.5-6 volts across the coil and resistor combination so the relay will operate properly.

S-METER FOR BC-454

? I would like to add an S-meter to my BC-454 receiver. Please print a diagram showing how I may do this.—J. W. S., Utica, N. Y.

A. An S-meter is not practical unless the receiver has a.v.c. The unused diode in the 12SR7 (pin 5) may be used as the a.v.c. rectifier. The diagram shows the alterations which must be made. This diode develops the a.v.c. voltage which is applied to the control

grids of the r.f. and i.f. stages. The 12AT6, the S-meter tube, is a simple v.t.v.m. which measures the a.v.c. voltage.

The 100,000-ohm variable resistor sets the meter to zero (full scale) for

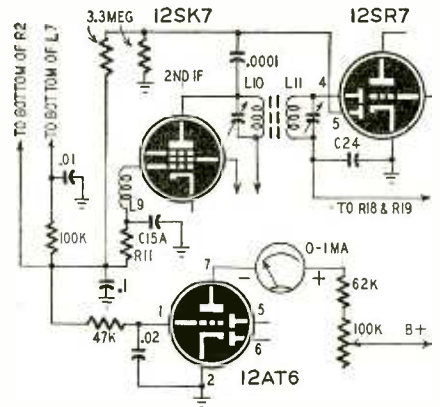

no signal input. Vary the B-plus voltage on the 12AT6 and the value of the 62,000-ohm resistor so the needle is against the left-hand pin on a powerful local station.

AMPLIFIER FOR VT-52'S

? I would like to have the diagram of a transformer-coupled phono amplifier using VT-52's in push-pull. Can you supply me with such a circuit?—J. G. H., Saginaw, Mich.

A. According to the information we have, a VT-52 is the same as a standard 45 with the exception of the heater rating which is 7 volts at 1.18 amp. A diagram of an amplifier designed for these tubes is shown. If expense is a factor in the selection of tubes, you may find that the cost of a power transformer having a 7-volt winding or a separate 7-volt filament transformer will amount to considerably more than the money you save by using surplus VT-52's instead of standard 45's, 2A3's, 6B4's, or similar tubes. This circuit will work for any of these tubes when used with the correct filament voltage.

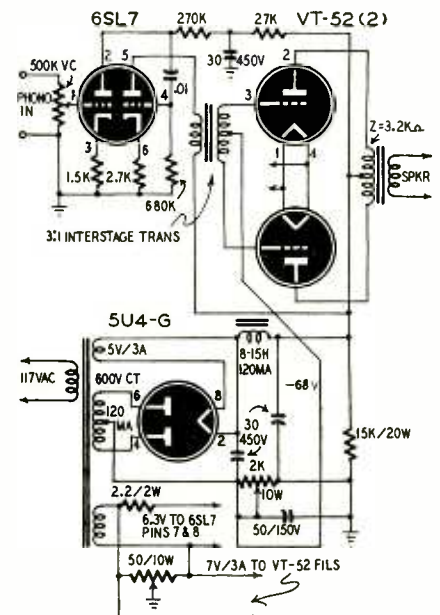

CONTROL TRANSMITTER

? I have a BC-1023-A receiver which I want to use for remote-control purposes. I want a diagram of a simple tone-modulated transmitter which I can use in my automobile to transmit a signal to control my garage doors. Can you help me?—R. C. T., Bay City, Mich.

A. The diagram shows a 75-mc transmitter which may be installed in your automobile. A simple push-button switch applies plate voltage to the r.f. and a.f. sections of the tube and puts the signal on the air to operate the control receiver.

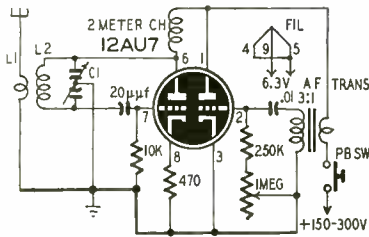

One triode of the 12AU7 is a 75-mc oscillator. C1 is a 15-µf split-stator tuning capacitor, L2 has 7 or 8 turns of No. 18 wire on a 3/4-inch form. The spacing between turns should be adjusted so the desired range can be covered with the tuning capacitor. L1 consists of 1 to 3 turns of wire around the center of L2.

It is advisable to adjust the frequency of the transmitter and receiver to avoid the possibility of interfering with aircraft marker beacons. Keep the transmitting antenna as short as possible to restrict radiation to the immediate area.

RECORDING FROM RADIO

? I have a disc recording unit which has a crystal cutter. Please show how this can be connected to my SX-42 receiver so I can make recordings off the air.—C. B. C., Toronto, Ont.

A. The circuit shows how the crystal cutter can be connected to the output of the SX-42 or to any receiver or amplifier having a push-pull output stage. The blocking capacitors prevent d.c. from damaging the crystal.

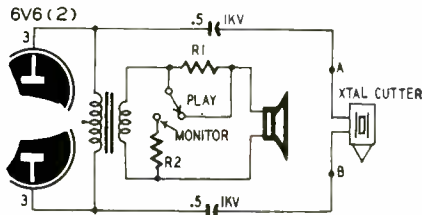

An attenuator pad comprising R1 and R2 may be switched into the speaker circuit to reduce the speaker level to approximately 11 db below that of the cutter. R1 is 10, 15, or 20 ohms and R2 is 4.5, 8, or 11 ohms when the speaker impedance is 3.2, 6, or 8 ohms, respectively.

To prevent overcutting, a volume-level indicator should be connected across points A and B. This may be a 150-volt a.c. meter having a resistance of 1,000 ohms per volt or more for satisfactory results.

Practical, Popular-priced Books on
RADIO-AUDIO-SERVICING
TWO NEW \$1.00 BOOKS



No. 43—MODEL CONTROL BY RADIO. By Edward L. Safford, Jr., 112 pages. An authority in the field of radio control gives you the first complete book on the subject. For beginner and expert. Tells you what radio control is, how it works and how to construct not only component parts but a complete system as well. Illustrations explain each step.

No. 42—HIGH-FIDELITY TECHNIQUES. By James R. Langham, 112 pages. You've never seen a technical book like it! Just as he'd talk to you across the work bench, RADIO-ELECTRONICS' popular audio writer tells you how to design your own equipment and how to get top performance from it. Takes the double talk out of high-fidelity work.

THREE IMPORTANT 75¢ BOOKS

No. 41—PUBLIC-ADDRESS GUIDE. 80 pages. This handy book shows the service technician the way to extra income in big-paying PA work. Covers installation, maintenance and construction.

No. 40—THE CATHODE-RAY OSCILLOSCOPE. 112 pages. A "must" for servicing TV, FM and AM receivers and in amateur operation! Tells in simple, but technically sound language, how the 'scope works and how to use it.

No. 39—PRACTICAL DISC RECORDING. 90 pages. Tells you how to make good disc recordings. Covers every phase, theory as well as technique. A full chapter is devoted to each component.



10 POPULAR 64-PAGE BOOKS — 50¢ EACH



No. 29—HANDY KINKS AND SHORT CUTS. A treasury of time savers! Antennas, power supplies, test equipment, phonographs, amplifiers. Easy reference. Illustrated.

No. 30—UNUSUAL PATENTED CIRCUITS. A gold mine of important hook-ups. Control circuits, detectors, amplifiers, power supplies, foreign circuits.

No. 31—RADIO QUESTIONS & ANSWERS. Answers the tough ones on circuit diagrams, amplifiers, receivers, transmitters, meters and test equipment.

No. 32—ADVANCED SERVICE TECHNIQUE. A "must" for the advanced service man! Covers specialized problems of servicing not usually found in ordinary textbooks.

No. 33—AMPLIFIER BUILDER'S GUIDE. For the designer and builder of audio equipment. Covers a variety of amplifiers with power outputs from 8 to 30 watts.

No. 34—RADIO-ELECTRONIC CIRCUITS. For the experimenter—circuit diagrams of intercom systems, power supplies, voltmeters, electronic relays, receivers, etc.

No. 35—AMATEUR RADIO BUILDER'S GUIDE. For the "ham" who builds his own. Receivers, transmitters, antennas, converters, etc. Practical construction data.

No. 36—RADIO TEST INSTRUMENTS. Practical construction data on signal tracers, capacity meters, portable and bench multi-checkers, voltmeters, etc.

No. 37—ELEMENTARY RADIO SERVICING. How to get started and keep going! Planning the shop, circuit checks, signal tracing—other fundamental servicing problems.

No. 38—HOW TO BUILD RADIO RECEIVERS. Describes 18 modern sets including short wave, broadcast, vhf, portable, ac-operated, ac-dc, miniatures—types for every fan.

RADCRAFT PUBLICATIONS, INC.

SEE YOUR DISTRIBUTOR OR MAIL THIS COUPON TODAY

RADCRAFT PUBLICATIONS, INC.
25 West Broadway, New York 7, N. Y.

Enclosed is \$..... for which please send me postpaid, the books checked below.

- 29
- 30
- 31
- 32
- 33
- 34
- 35
- 36
- 37
- 38
- 39
- 40
- 41
- 42
- 43

Name.....

Street.....

City..... Zone..... State.....

51

TECH-MASTER

TELEVISION

New **TECH-MASTER** *developments!*

LO-PRICED
Universal KIT



FOR TUBES UP TO 14" RECT.

First LOW-COST TV Receiver Kit completely engineered by TECH-MASTER. Features 2-knob control and small, lightweight chassis.

Model 5116 ... \$89.50

Set of circuit-matched TUBES tested with each individual kit... \$16.25

Advanced
630 Type KIT



FOR ALL TUBES 12" Rd. to 20" Rect.

The greatest advance in TV Kits developed by TECH-MASTER!

Model 630D19 (De-Luxe) Principal components assembled.

Resale Price \$159.50

Model 630S19 (Standard) Unassembled.

Resale Price \$154.50

Above Kits supplied with tubes, parts, speaker and pix tube mounting brackets (less Kine, wire and solder). **CONTACT YOUR JOBBER** or write Dept. RC-5 for literature.

TECH-MASTER PRODUCTS CO.

443-445 Broadway, New York 13, N. Y.

More leading engineers and technicians have built Tech-Master for their own use than any other Television Kit.



INTERFERENCE STUBS

? A friend says that a shorted quarter-wave or open half-wave stub will prevent FM interference from affecting the picture on a TV set. I bet him that he is wrong. I say that an open quarter-wave or shorted half-wave stub should be used. Who wins?—A. V. B., Los Angeles, Cal.

A. Better call it a draw if neither of you specified how the trap should be connected. A shorted end quarter-wave stub or trap offers a very high impedance, and a similar stub open at the end will appear as a short circuit at its resonant frequency. The opposite is

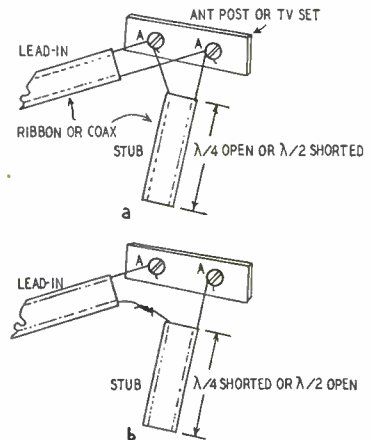

true of half-wave stubs. If the stub is connected across the lead-in as at a, it should appear as a short circuit at the interference frequency. Therefore you should use an open quarter-wave or a shorted half-wave stub.

When in series with one side of the line as at b, the trap should present a high impedance to the interference, therefore a shorted quarter-wave or open half-wave stub is required.

The actual length of a quarter-wave stub (open or shorted) may be found from: $L = 2952 \times V.P./f$, and a half-wave stub from $L = 5904 \times V.P./f$, where L is in inches, f is frequency in mc. V.P. (velocity of propagation) may be taken as 82% for 300- and 77% for 150-ohm ribbon lines; and 65.9% for all coaxial cables except RG-21/U.

Cut the stub a little long and experiment to get the correct length. For shorted stubs, use a razor blade or sharp needle to short the conductors at different spots to locate the point of minimum interference. Short the line permanently at this point. Merely snip off small pieces on open stubs.

TRANSFORMER SPECIFICATIONS

? Please give specifications on the output transformer used in the sound alarm described on page 31 of the October, 1950, issue.—E. H., Columbus, Ohio.

A. Any plate-to-voice coil output transformer will do the job. However, it is advisable to use one having a primary impedance of 20,000 ohms or more. Your best bet will be to use a standard intercom input transformer which may have a secondary impedance of 38,400 ohms or higher.

—end—

RADIO-ELECTRONICS for

STRETCH

THAT TV AREA!

TWIN-DRIVEN YAGI

- This entirely new antenna now makes possible TV sales in weak signal areas. Stretch your TV sales area.
- The first Yagi type antenna matched to 300 ohms. Exclusively Taco! Outperforms stacked arrays costing many times more.
- Jiffy-Rig assembly speeds installation.

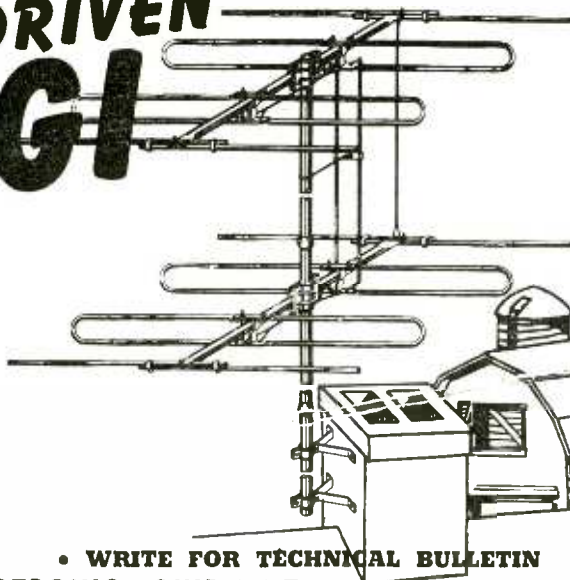

• WRITE FOR TECHNICAL BULLETIN

RADIO AND ELECTRONIC EQUIPMENT

TECHNICAL APPLIANCE CORP.

SHERBURNE, N. Y.

In Canada: Stromberg-Carlson Co. Ltd., Toronto 4, Ont.



**"HURRY, HURRY, HURRY!
DON'T MISS THIS NEW,
SIMPLIFIED SERVICING BOOK!"**

FREE!

**only until May 31st ...
with the purchase of one
Sylvania Picture Tube!**

Don't let this offer expire without your getting a copy of this splendid, fact-packed servicing manual. Filled with time-saving shortcuts and valuable servicing hints.

Now it's yours absolutely FREE from your Sylvania Distributor with the purchase of just one Sylvania Picture Tube, of any type. But the offer expires May 31st. So, act NOW! Write or call your distributor TODAY!

**SAVES TIME! SAVES MONEY! SOLVES
SCORES OF SERVICING PROBLEMS!**

This book contains 48 pages of pictures, diagrams, and easy-to-follow instructions covering:

Radio Servicing . . . Signal Tracing, Alignment, AVC and AFC Checking, Measurement of Voltages, Signal Levels, Power Output, Band Width and much more.

TV Servicing . . . Signal Tracing, Bandwidth Measurements, Wavetrap Checking, Sound Channel Tests and Alignment, Low and High Voltage Checks, Signal and Deflection Voltage Measurements, and numerous other subjects.

Audio Amplifier Servicing . . . DC, AC, and Signal Level Measurements; Tone Control, Fidelity, Gain Tests, Distortion, Power Output, and Noise Level Measurements; Signal Tracing, and Speaker Matching.

Miscellaneous Applications . . . 19 different applications of VTVM including Detecting Gassy Tubes, Checking Capacitors, Q Measurement, Turns Ratio Measurement, Impedance Checking.

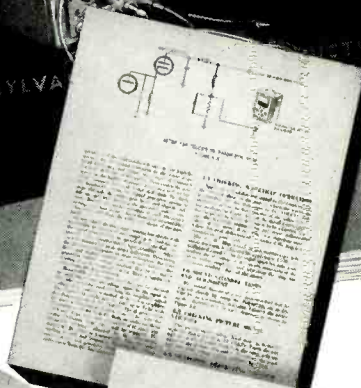
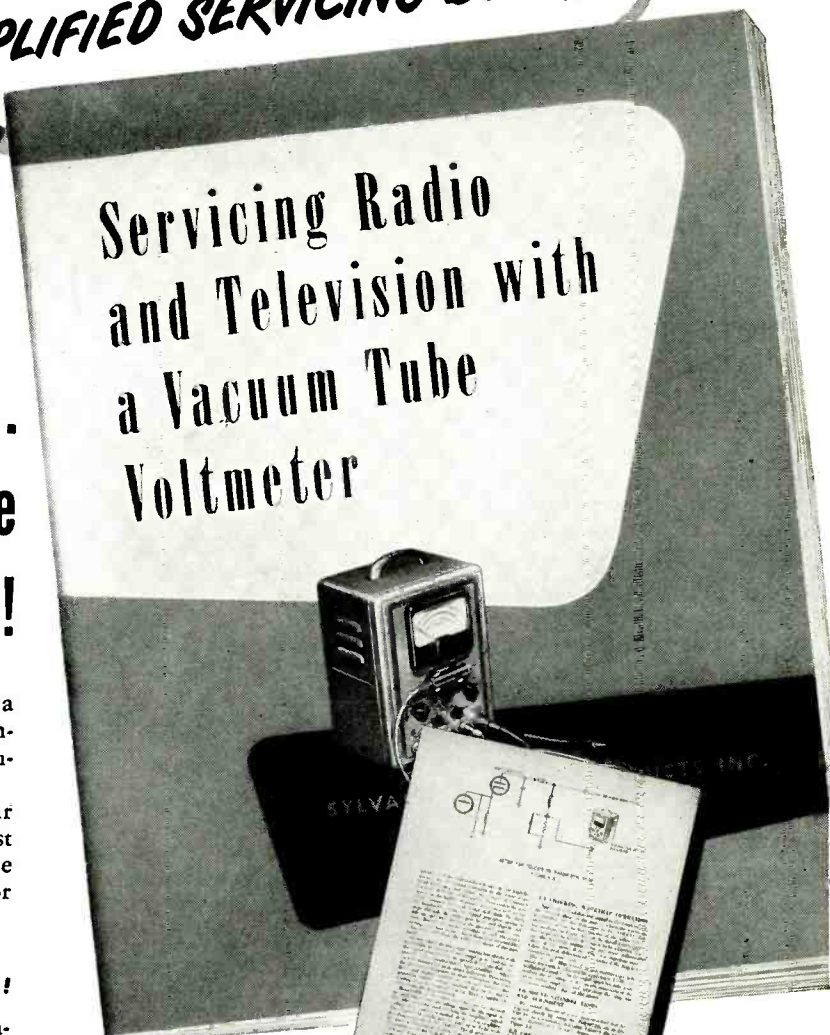

**"DON'T DELAY,
CALL YOUR
SYLVANIA DISTRIBUTOR
NOW!"**



Sample pages showing detailed, easy-to-read diagrams.



SYLVANIA ELECTRIC

RAID TUBES; TELEVISION PICTURE TUBES; ELECTRONIC PRODUCTS; ELECTRONIC TEST EQUIPMENT; FLUORESCENT TUBES, FIXTURES, SIGN TUBING, WIRING DEVICES; LIGHT BULBS; PHOTOLAMPS; TELEVISION SETS

MAY, 1951

**Collins Presents—
LABORATORY MASTERPIECES
FOR THE EXPERIENCED FEW
WITH KNOWLEDGE TO SELECT
AND ENJOY THE BEST.**

**THE 45-S CUSTOM SPECIAL
FM/AM TUNER**



- Bass and treble tone controls • Meter plus tuning eyes • Squelch
- High and low impedance output • Equalizer tube for magnetic phono cartridges • Voltage regulator tube
- Minimizes amplifier problem.

and
**THE HP-14 PROFESSIONAL
FM TUNER**

- 14 tubes • Permeability tuning
- Meter for precise tuning • Squelch
- Voltage regulator tube • Newly designed front panel assembly • Greater facility in cabinet mounting
- Low impedance output to match any amplifier input • High sensitivity • Can be used for accurate field strength measurements.

Both tuners meticulously fashioned for the finest custom radio installations.

Write for catalogue on our complete line of AM, FM, FM/AM tuners and amplifiers and preamplifiers.

**COLLINS AUDIO
PRODUCTS CO., INC.**

P. O. Box 368 Westfield, N. J.
Phone: We2-4390

**WANTED
TO BUY**

Large and small quantities of new or used electronic government or manufacturers' surplus tubes and equipment. Highest prices paid. State quantity, condition and best price in first letter.

Box No. F-2 c/o Radio-Electronics
25 West Broadway
New York 7, N. Y.

SAVE OLD RECTIFIERS

Don't discard defective selenium rectifiers after removing them from a circuit. Lay them aside until you have time to dismantle them. One brand of rectifier contains nine metal washers, two fiber washers, two grounding straps or lugs, one $\frac{3}{16}$ x 1-inch eyelet, and one $\frac{1}{4}$ x 1-inch paper coil form. Keep these parts in your spare-parts box. They will come in handy sooner than you think.—*Edward Tanrath*

HANDY TV SERVICING TOOL

A $\frac{1}{4}$ -inch nut driver or Spintite wrench is required to remove the cover of the high-voltage cage in most TV sets. Why not convert yours for use as a high-voltage indicator as well? Take a $\frac{1}{4}$ -inch hex nut driver and soften its plastic handle in hot water so the bit can be pulled out. Solder one terminal of a small neon lamp (NE-2 or similar) to the handle end of the bit. Drill the hole in the handle deep enough to accommodate the lamp on the end of the bit. Reheat the handle and insert the bit back in place.

The next time you suspect trouble in a high-voltage supply, use the wrench to remove the cover, then touch the bit to the plate of the high-voltage oscillator or cathode of the rectifier tube. Presence of high voltage is indicated by a glow in the neon lamp.—*O. G. Brickey*

REPAIRING VOLUME CONTROLS

On page 78 of the December, 1950 issue, a contributor described a tool for removing retaining rings used on switches, volume controls, etc. This system works O.K. but I'll still stick with my method.

I take two beer-can openers and grind the points down so they are very thin. Insert the points of the openers into the gap in the C-ring. Apply slight pressure on the handles and the washer slips off.

These tools are very handy to have around the workbench. When you are not using them to repair controls, you can always use them for their original purpose.—*Eugene Brunaccioni*

HOLDERS FOR TEST LEADS

My workbench looks much neater since I made clips to hold my various test leads when I'm not using them. Large holders for cartridge-type fuses supplied the necessary clips. I simply removed them from their base and screwed them to the wall over the bench.—*O. C. Vidden*

BUYING EXPERIMENTAL PARTS

Be sure to select units having terminal lugs rather than flexible leads when purchasing audio or power transformers, filter chokes, electrolytic capacitors, radio- and intermediate-frequency coils, and other parts commonly used in radio and electronic circuits. Leads are almost invariably cut to the correct length for the first project and are usually too short for the next one. Components with terminal lugs are harder to mount because mounting hole spacing is critical but you will find that they last longer in experimental service.—*Charles Erwin Cohn* —end—

Technical Bulletins

EACH \$1.00 Postpaid Foreign \$1.25

Simplified technical information on many subjects of everyday usefulness, written in simple, easy-to-understand language. They contain no complicated mathematics, chemical and electrical theories, and are not based on the assumption that the reader has had a technical training.

(102) Cleaning Products for Many Purposes—Over 35 effective chemical cleaners that you can make and sell.

(110) Electroplating Non-Metallic Objects—Includes wood, leather, plaster, glass, flowers, insects, fabrics. Complete directions.

(114) Thermostats Easily Made—Designing and making automatic control units of many types for maintaining uniform temperatures, automatic furnace regulation, safety controls to prevent overheating, etc.

(115) Glue Molds for Casting Novelties—Making flexible glue molds for casting small objects, using plastics, magnesite.

(119) Electroplating with Alloys—Bronze, brass and cadmium-silver. Improves finish and provides durable coating.

(123) Mirror Silvering—Make money re-silvering old mirrors and making new ones. Colored, front-surface, transparent and photo mirrors.

(124) Soldering All Metals—Includes aluminum and die-cast alloys. Secrets of using the right flux and correct technique.

(125) Buffing & Polishing—All details on correct polishing. How to select the right abrasive for different kinds of metal. Gives wheel speeds, types and sizes of motors for best results.

(129) Coloring Metals Chemically—Tested formulas and directions to produce durable finishes in many colors on brass, copper, iron, aluminum and their alloys by chemical processes.

(130) Glass-Working Technique—How to cut, drill, grind and mount glass correctly; includes cutting of circles and internal openings.

(132) Working with Plastics—Covers all details of cutting, tooling, bending, cementing and polishing. Enumerates various kinds. Shows how to design articles. Includes using liquid plastics.

(139) Rubber Molds for Casting Novelties—Used for same purpose as glue molds but where greater elasticity is required.

(141) Recording Thermometer—How to make device to record room temperatures over 12-hour periods on a disk. Has alarm-clock mechanism.

(146) Simplified Casting Methods—Making small castings of soft metals without use of sand molds. For novelties, toys, etc.

(147) Drills and How to Use Them—How to use drills in different metals, plastics and other materials. How to sharpen correctly. Includes charts giving speeds and rate of drilling.

(149) Electroplating with Copper, Nickel, Chromium, Zinc, Lead and Cadmium—Enables anyone to do this fascinating work on a small scale.

(156) Home-Maintenance Formulas & Repairs—Includes a large number of simple, effective solutions for everyday household problems.

TECHNIFAX, 520 N. Michigan Ave. Chicago 11, Ill.

Enclosed find \$..... for which send the following Technical Bulletin at \$1.00 each (Foreign \$1.25) as indicated by numbers:

Name _____

Address _____

City & State _____

RE-5-51

RADIO-ELECTRONICS for

INDUSTRIAL! EXPERIMENTERS! Look at these terrific buys.

ARMY AIRCRAFT RECEIVER— BC-946-B

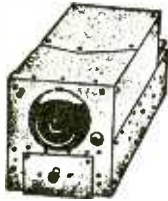

Covers 520 Kc to 1500 Kc Broadcast Band. 6 Tubes: 3—12SK7, 1—12SR7, 1—12A6, 1—12K8. Designed for dynamotor operation; can be easily converted to 110 volt or 32 volt use. Two IF Stages. Three-rang tuning con. BRAND NEW, in sealed carton, with tubes and instruction manual, less dynamotor **\$35.00**
Dynamotor DM-32A 3.95

SMASH VALUES IN RADIO RECEIVERS

BC 453 Rcvr.	Used \$17.95	New \$35.00
BC 454 Rcvr.	Used 9.95	New 16.50
BC 455 Rcvr.	Used 8.95	New 11.95
BC 456 Mod.	Used 3.95	New 6.95
BC 457 Xmtr.	Used 7.95	New 12.95
BC 458 Xmtr.	Used 8.95	New 13.95
BC 459 Xmtr.	Used 16.95	New 29.50
BC 696 Xmtr.	Used 16.95	New 24.95

BC-645 XMTR RECEIVER 15 Tubes 435 To 500 MC



The electronic equipment that saved many lives in the war. Set can be modified to use for 2-way communication, voice or code, on following bands: ham band 420-450 mc, citizens radio 460-470 mc, fixed and mobile 450-460 mc, television experimental 470-500 mc. 15 tubes (tubes alone worth more than sale price!): 4—7F7, 4—7H7, 2—7E6, 2—6F6, 2—955 and 1—WE316A. Now covers 460 to 490 mc. Brand new BC-645 with tubes, less power supply in factory carton. Shipping weight 25 lbs.

BRAND NEW \$18.95 each
PE-101C DYNAMOTOR for above BC-645 \$3.95
UHF ANTENNA ASSY, for above BC-645 \$2.45

BC148 RECEIVER-TRANSMITTER



Built for Sig. Corps by Farnsworth. Range 3960 to 4360 Kc. Complete two-way communications. Operates on batteries or hand generator. CW operation, handkey on base. Entire unit in two hinged parts. (Xmtr & Rcvr, and Battery compartment) closes down to 15 1/2" x 14 1/2" x 8 1/2" overall. Less tubes and batteries. Operating instructions included. Used, clean. **\$5.95 Each**

SETCHEL-CARLSON Beacon Radio Receiver BC-1206-C



Receives A-N beam signals, operates on 24-28 V DC. 5 Tubes: 3—14H7, 14R7, 28D7. Tunes 195 to 420 Kc. Size 4"x4"x6 1/2" wide. 4 lbs. In original carton. **New \$9.95**
Used \$7.95

TRANSMITTER BC-223-AX



Ideal for 80-meter band! 801 osc., 801 P.A., 2—46 modulators, 1—46 speech amp., 4 xtal freq. and master osc., on selector switch. 10 to 30-watt output, tone, voice or C.W. Black wrinkle case, complete with freq. chart and tubes in original cases, less xtals, BRAND NEW, sensationallly low price, shpg. wt. **\$29.50**
80 lbs.



JK-26 and PL-354—JACK & PLUG combination, for headset extension, etc. **35c Pair**

- PL-55—Standard 2-circ. phone plug, fits all phone jacks. **29c Each**
- PL-68—Standard 3-circ. mike plug, fits all 3-way mike jacks. **22c Each**

GE THYRATRON FG-105



Brand New MERCURY RECTIFIER
Individually boxed in factory sealed cartons. List Price \$30. Your cost **\$18.95**
While They Last!
For continuous rectifier and welder control service. Tetraole type, indirectly heated cathode; 10000 V peak, 10000 V peak inverse, Av. Max. current 6.4 amms continuous, 2 1/4 to 1 amps welder control service.

SAVE ON THESE STANDARD TUBES

1M5GT 1.12	6L6G 1.65	12S17 .95
1L4A 2.65	6Q7 .75	12SK7 1.35
1L4B 1.45	6SA7 1.25	12SL7 1.10
1L4C 1.45	6SC7 1.20	12SN7 1.75
1L4D 1.45	6SF5GT 1.10	12SQ7 1.25
1L4E 1.45	6SF7 .97	12SR7 .90
1L4F 1.65	6SG7 .95	12Z3 .85
1L4G 1.55	6S17 1.20	14A7 1.05
1L4H 1.45	6S27 1.20	14J7 1.35
1L4I 1.35	6S7GT 1.35	14F8 1.35
1M5GT 1.20	6SN7GT 1.65	14F7 1.20
1Q5GT 1.45	6SQ7 1.20	14G7 1.35
1R5 1.20	6S7 .95	14H7 1.10
1S4 1.20	6T8 2.20	14N7 1.35
1S5 1.00	6V6GT 1.20	14P7 1.25
1T4 1.10	6X5GT 1.30	19 .49
1T5GT 1.25	6V6G 1.25	24A .85
1U4 1.10	7A4 XXL	25L6 .90
1V .90	7A5 1.20	25Z5 1.25
2A3 1.45	7A6 1.20	25Z6GT 1.25
2A5 1.15	7A7 1.20	26 .59
2A6 .95	7B6 1.20	27 .65
2A7 .95	7B7 1.20	28 .55
2B7 .95	7B8 1.20	30 .75
2X2A .88	7C5 1.20	31 .55
2Y4G 1.10	7C6 1.20	32 .85
354 1.05	7C7 1.20	35 .51
3V4 1.05	7D6 1.20	33 .59
3T4 1.75	7E6 1.10	34 1.20
5U4G 1.20	7F5 1.25	35A5 1.25
5V4G 1.85	7C5 1.25	35B5 1.25
5W4 .95	7C7 1.25	35C5 1.25
5X4G 1.10	7E6 1.10	35L6GT 1.25
5Y3GT 1.00	7E7 1.10	35W4 1.05
5Y4G 1.85	7F7 1.00	35Z4 .95
5Z3 .95	7H7 2.15	35Z3 .88
5Z4 1.20	7H8 1.75	35Z4 .75
6A3 1.35	7I7 1.10	35Z5 1.20
6A6 1.25	7L7 1.30	36 .65
6A7 1.15	7N7 1.65	37 .65
6A8 1.10	7O7 1.10	38 .65
6AC7 1.30	7Y7 1.30	38/44 .75
6AG5 1.90	7Y4 .90	41 .75
6AG6 2.50	117L7 M7	42 .75
6AJ5 1.65	117N7 1.70	45 .75
6AK5 2.60	117P7 1.70	46 .85
6AL5 1.90	117Z3 .95	47 .95
6AL6 1.65	117Z6 1.40	48 2.75
6AL7 1.95	12A .85	49 .85
6AQ5 1.25	12AG .95	50A5 1.25
6AT6 1.30	12ABGT .95	50B5 1.40
6AU6 1.70	12ACGT .95	50C5 1.35
6AV6 .30	12AHGT .95	50L6GT 1.25
6BA6 1.50	12AT6 1.30	50Y6 1.05
6BE6 1.50	12AT7 2.25	53 1.25
6BG6 2.20	12AUG .95	54 .70
6BH6 1.75	12AU7 1.95	57 .85
6CA7 1.10	12AV6 1.30	58 .85
6CC .85	12AW6 1.90	59 1.25
6DD .85	12BA6 1.45	70L7 1.65
6ES 1.00	12BE6 1.55	71A .90
6F6 .80	12C7 .95	71 .75
6FB 1.20	12K7 1.05	76 .75
6FGT 1.05	12K8 1.60	77 .75
6J6 1.85	12Q7 .85	80 1.05
6J7GT 1.25	12SA7 1.10	82 1.35
6KG6T 1.15	12SC7 1.60	83 1.25
6K7 .85	12SF7 1.00	83V 1.35
6K8 1.15	12T7 .90	84/624 1.90
6L5 1.95	12SH7 .95	85 1.05

DC AMMETER 0-15 Amps



A terrific buy! 3 1/2" easy reading scale, 75 divisions. Black plastic case 4 1/2"x5 1/2"x2 3/4". Rubber covered test clip leads plus black metal carrying case with hinged cover. Brand new. Wonderful for automotive, battery charging, general test work. Value \$25. All yours for **\$5.25**

SELSYN 2J1G1

Operates from 57 1/2 V 400 cycles. Suggested wiring for 110 V 60 cycle included. Used, tested.

Price per pair **\$4.50**

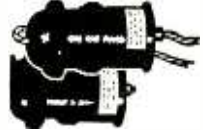

BC 605 INTERPHONE AMPLIFIER

Easily converted to an ideal intercommunications set for office—home—or factory. Complete w/conversion diagram for 110V operation.

BRAND NEW \$4.95

Please include 25% Deposit with order—Balance C.O.D. MINIMUM ORDER \$3.00. All Shipments F.O.B. Our Warehouse N.Y.C.

G & G SERVICE MAJESTIC RADIO PARTS SERVICE
53 VESEY STREET - NEW YORK 7, N.Y.

TERRIFIC VALUE 24-VOLT STORAGE BATTERY, BRAND NEW 17 AMP. HRS.



Made by Delco. 12 cells, heavy duty, very rugged. Shipped dry, uses standard sulphuric acid electrolyte. **VERY SPECIAL \$17.95**



6-VOLT STORAGE BATTERY
Navy Standard BRAND NEW. 15 ampere-hour rating **\$7.95**

ASTATIC R-3 CRYSTAL HANDMIKE
with 6-ft. R. C. Mike Cable **\$5.95**



ONE-QUART BOTTLE BATTERY ELECTROLYTE
Made by Willard, for above storage batteries. 1 quart sufficient for two 2-volt cells. Hermetically sealed. **\$1.45 per qt. bottle**

7-PRONG 2-VOLT RADIO VIBRATOR
for Portable and Farm Sets Replacement for GE LB 530 **\$1.95**



WILLARD 2-VOLT STORAGE BATTERY
20 Ampere-Hours
Exact replacement for GE portables for LB-500—BRAND NEW. Each **\$2.69**

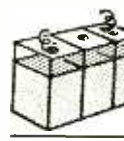

WILLARD MIDGET 6-V STORAGE BATTERY
3 amp hour rating. Transparent plastic case. Brand new. 3 1/2" x 1 3/4" x 2 3/4" high. Uses standard electrolyte. Each **\$2.65**

HEADPHONES—All Brand New!
Individually packed, complete with phone plug. HS-33 600 ohms, in lots of 3 **3.95 each**
HS-23 2000 ohms, in lots of 3 **3.25 each**
HS-30 With earplugs, LOTS OF 12 **1.65 each**

J. S. Army Field Phone Set EE-8



Leather case, with handset, generator, ringer, etc. Requires 2 flashlight cells. Wonderful value! Good **\$14.95**
Used, ea.



W.E. BREAST MIKE
Single button carbon mike, with breastplate. Very sensitive, complete with 6-ft. cord and W.E. plug. **SPECIAL. New \$1.29**



HANSET
Cradle-type handset with butterfly switch, unbreakable black plastic, 4-ft 3 wire cable. BRAND NEW, individually packed, each **\$7.50**

McElroy Automatic KEYS

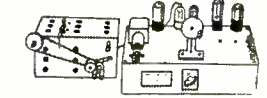

Suitable for keying transmitter, or for code practice. Has photocell and sensitive relay. Variable speed motor. 10V AC or DC. Complete with 2-117Z6 and 1-117L6 tubes, **\$21.00**
your cost

We Have Available CODE PRACTICE TAPE \$12.75
which was used for code practice work by the Signal Corps—from slow to fast practice. 15 rolls on 16MM metal reels in heavy wooden slotted case, to be used with McElroy TG10 Keyers, Tone Keyers or any code practice.

CONCORD SCOOP!

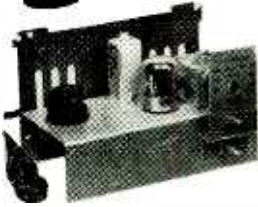

SAVE 50%
ON THIS
FM
TUNER
995
Your Net

Enjoy clear, static-free reception of your favorite music and sports events--convert to FM for less than \$10.00 with this Exclusive Concord FM tuner. Easily converts any AM receiver, phono amplifier or PA system for FM. Covers the entire 88-108 FM band. Tuning and on-off controls on front panel with terminals for connection of 300 ohm twin lead antenna on back. Extremely easy to install... Uses a 7F8 in a fremodyne circuit, plus a 6H6 rectifier. Size of chassis: 6-3/4 x 4 x 4-1/8". Complete with tubes. For 110-120 volts, AC-DC. 99-9502J--Shpg. Wt. 2 lbs. Net. 9.95

DUAL VIBRATOR POWER PACK 995

Your Net



Another Special Concord Exclusive!... Selling at a fraction of its original cost. Brand new vibrator power supply... ideal for mobile amateur rigs (transmitter & receiver) or mobile Public Address systems. Compactly designed cabinet can be easily mounted under auto dashboards. Two vibrators supply dual output: 400 volts at 150 ma; 225 volts at 60 ma with slight modification. Enclosed terminal board provides lugs for connecting handset, microphone, and speaker. Unit also has provisions for mounting speaker inside. Controls on front panel include: channel selector, on-off switch, squelch control (cuts out all noise when no signal is being received), and volume control. Supplied with instructions for modification but less vibrators. Size: 6-5/8 x 6 x 5-1/8". 99-9627J--Shpg. Wt. 9 lbs. Net. 9.95

Kit of 2 vibrators and vibrator socket for modification of above unit. 99-3957J--Shpg. Wt. 1 lb. Net. 5.79

THOUSANDS OF SIMILAR BARGAINS ARE YOURS AT

CONCORD RADIO

SEND FOR LATEST BUYER'S GUIDE

FILL IN AND MAIL TODAY

CONCORD RADIO CORP. Dept. JE-51
901 West Jackson Blvd., Chicago 7, Illinois

Enclosed \$..... (include shipping charge. Any excess will be refunded.) Rush me the following equipment.

- 99-9502J FM Converter \$9.95
- 99-9627J Vibrator Power Pack \$9.95
- 99-3957J Vibrator Kit \$5.79
- Send FREE latest Buyer's Guide

Name.....

Address.....

City..... Zone..... State.....

CALIBRATING OSCILLATORS

By using a simple experimental setup described in most elementary physics textbooks, you can accurately calibrate audio oscillators without oscilloscopes or other complex measuring equipment. The calibrating equipment consists of an audio amplifier and speaker having fairly good frequency response and an open-ended glass tube 1 to 1½ inch in diameter, calibrated in fractions of an inch, and somewhat longer than one-quarter wavelength at the lowest frequency to be checked.

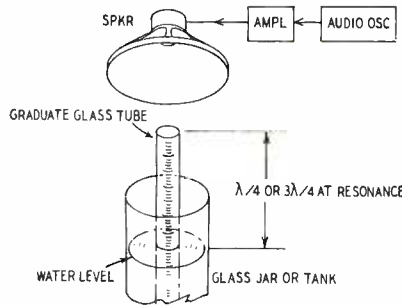

This calibration method is based on the fact that the sound level increases when a musical note produced by a tuning fork or similar instrument is closely coupled to a column of air one-quarter or three-quarters wavelength long at the same frequency. The frequency of the note is equal to the velocity of sound (in air) in feet per second divided by its wavelength in feet.

One-quarter wavelength is found by lowering a calibrated glass tube in water as shown in the setup until the sound level reaches a peak.

The velocity of sound is 1,090 feet per second at 0° C and increases 2 feet per second for each degree of increase in temperature. To find the velocity of sound in air (V) at any temperature T above 0° C, use the formula: $V = 1,090 + (2 \times T)$.

With the oscillator and amplifier operating and the speaker close to the top of the tube, slide the tube in and out of the water until resonance is indicated by a sharp increase in sound level. Read the tube length in inches, multiply by 4 to find wavelength in inches, then divide by 12 to convert to wavelength (L) in feet.

Frequency in c.p.s. equals V/L , where V is velocity at room temperature and L is wavelength in feet. For example: If the room temperature is 20° C and there is 6 inches between the water level and the top of the tube at resonance, the corrected velocity is $1,090 + (2 \times 20)$ or 1,130 ft./sec., L is $6 \times 4/12$ or 2 feet, and F is $1,130/2$ or 565 c.p.s.—Dominic Angelo, W9KGC

SOLDERING KINK

Replacing resistors, capacitors, and other components in electronic devices is often made difficult by excess solder on the terminals of sockets, switches, and mounting lugs. To remove excess solder, try holding a piece of heavy bus bar on the terminal and flowing the solder onto it.—O. C. Vidden

—end—

American



FULL VISION MODEL D-33 MICROPHONE

- ★ FULL VISION for both artist and audience
- ★ Attractive rich gold and black finish
- ★ For Broadcast, TV, AM, FM
- ★ Omnidirectional pick-up. No pre-amplifier required



- ★ Quickly and easily detached for hand use
- ★ Convenient, light-weight (weighs only 7 ounces)



- ★ Mounted on model desk-stand MODEL 4ND
- ★ Adjusts to any angle

CHICAGO SHOW
MAY 21-23
BOOTH 671

MODEL HB 3
FLOOR STAND

Write for free catalog and descriptive literature

AMERICAN MICROPHONE CO.
370 S. Fair Oaks Ave., Pasadena 1, Cal.

MOTOROLA TS-101 AND TS-119

Some complaints of sound interference in the picture are caused by pick-up from the discriminator circuit. If careful lead dress does not cure the condition, check capacitor C44 across the secondary of the transformer. This unit, a 150- μ mf, 500-volt ceramic tubular capacitor, should be connected so the outside plate goes to the low side of the coil. In strong signal areas, the simplest cure is to slightly detune the primary of the discriminator transformer. Do not do this in fringe areas because the gain is reduced.

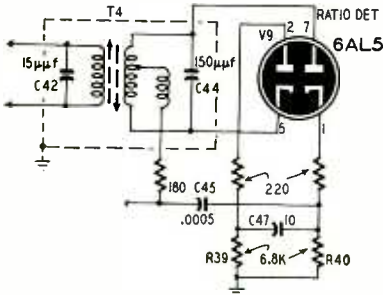

In fringe-area installations, the condition should be remedied by inserting suppressor resistors in series with each diode of the 6AL5 ratio detector. The circuit changes are shown in the diagram. Remove all wiring from pins 1 and 2 of the 6AL5 (V9). Connect a 220-ohm resistor to each of these pins. The leads which were disconnected from pins 1 and 2 are then connected to the other ends of the resistors.—*Motorola TV Service Notes*

NEW AUTO RADIOS

If new auto radios come in with sticking vibrators, check or replace the buffer capacitor and have the voltage regulator checked by a competent ignition mechanic before putting the set back in service.—*Brian Bailey*

ADMIRAL 30A1 CHASSIS

Complaints of no raster when the sound section of the set is O.K. are often caused by failure of the horizontal-discharge section of the 6SN7-GT V403-B. If this tube is bad, check the 6BG6-G output tube. The latter may have been ruined by excessive plate dissipation due to lack of drive when the 6SN7-GT failed.—*Wilbur J. Hantz*

SENTINEL TV SETS

Distorted or weak sound which shows up a week or 10 days after the set is placed in operation is caused by drift in the discriminator transformer in early production runs of models 419, 420, 423, 424, 425, and 428.

This is easily corrected by adjusting the secondary tuning slug located on top of the discriminator transformer shield can. Make this adjustment for minimum buzz and clearest sound. The correct position is between the two maximum-buzz peaks which will be noticed when the adjustment is turned right or left from minimum-buzz.

Discriminator transformers used in later models will be given an additional impregnation and baking process which will eliminate drift in this circuit.—*Sentinel Service Bulletin*

BARGAIN PAGE TUBES STANDARD BRANDS ONLY -FULLY GUARANTEED

0Z4A ... 1.09	3Q497	6BD6 ... 1.90	6R797	7C6 ... 1.59	12SF577
1A3 ... 1.05	3Q5GT ... 1.13	6BE6 ... 1.65	6S4 ... 1.15	7C793	12SF5GT79
1A6 ... 1.69	3S498	6BG6G ... 2.23	6S8GT ... 2.00	7E5 ... 1.25	12SF7 ... 1.01
1A7GT ... 1.04	3V498	6BH6 ... 1.90	6SA7 ... 1.40	7E6 ... 1.09	12SH7 ... 1.09
1B3GT ... 1.77	5R4GY ... 1.49	6BJ6 ... 1.90	6SA7GT ... 1.40	7E7 ... 1.09	12SJ7 ... 1.09
1B595	5T4 ... 1.70	6BQ6GT ... 2.95	6SB7Y ... 1.20	7F7 ... 1.04	12SJ7GT91
1C685	5U4G ... 1.25	6C4 ... 1.10	6SC7 ... 1.40	7F8 ... 2.35	12SK7 ... 1.65
1C7G95	5V4G ... 2.10	6C581	6SD7GT ... 1.27	7G7 ... 1.29	12SL7GT ... 1.05
1D7G95	5W481	6CB6 ... 1.60	6SF591	7H7 ... 1.89	12SN7GT ... 2.00
1F475	5X4G89	6CD6G ... 3.75	6SF797	7J7 ... 1.31	12Z397
1F5G95	5Y3GT ... 1.17	6C687	6SG7 ... 1.80	7K7 ... 1.31	14A7 ... 1.05
1G4GT97	5Z397	6C8G97	6SH7 ... 1.24	7L7 ... 2.20	14B6 ... 1.05
1G6GT ... 1.17	5Z4 ... 1.17	6D687	6SH7GT ... 1.29	7N7 ... 2.20	14Q7 ... 1.05
1J6G95	6A3 ... 1.37	6D7G87	6SJ7 ... 1.59	7Q794	14R7 ... 1.27
1L495	6A4 ... 1.59	6E5 ... 1.09	6SJ7GT ... 1.59	7R7 ... 1.13	25L6GT ... 1.00
1LA6 ... 1.30	6A6 ... 1.31	6F581	6SK7 ... 1.19	7S7 ... 1.31	25Z6GT ... 1.25
1LC5 ... 1.30	6A7 ... 1.04	6G6 ... 1.03	6SK7GT ... 1.19	7T7 ... 1.31	30Y488
1LC6 ... 1.30	6A8GT ... 1.04	6F6G ... 1.03	6SL7GT ... 1.19	7V7 ... 1.31	32L7GT ... 1.67
1LD5 ... 1.30	6A87 ... 1.39	6F7 ... 1.37	6SN7GT ... 1.75	7W7 ... 2.40	35Y489
1LN5 ... 1.30	6AC7 ... 1.70	6F8G ... 1.47	6SQ7GT ... 1.25	7Y489	35Z5GT ... 1.45
1N5GT97	6AF6G ... 1.31	6G6G97	6SR7 ... 1.50	7Z493	50A5 ... 1.33
1P5GT97	6AG5 ... 1.90	6H6 ... 1.13	6SS789	7A6 ... 1.26	50B5 ... 1.60
1Q5GT97	6AG7 ... 2.87	6J579	6T8 ... 2.70	7A8GT99	50C5 ... 1.02
1R5 ... 1.05	6AH6 ... 3.45	6J5GT80	6U5 ... 1.10	7A9 ... 1.40	50L6GT ... 1.60
1S4 ... 1.19	6AK5 ... 2.75	6J6 ... 2.90	6U7G89	7A9GT ... 1.40	5683
1S597	6AL5 ... 1.50	6J7 ... 1.70	6V6GT ... 1.19	7AT7 ... 2.65	7783
1T4 ... 1.04	6AQ5 ... 1.45	6J7GT ... 1.70	6W4GT ... 1.40	7AU6 ... 1.85	205189
1T5GT ... 1.30	6AR5 ... 1.40	6J8G ... 1.39	6W6GT ... 1.60	7AU7 ... 2.20	28D7 ... 1.33
1U497	6AS5 ... 1.85	6K6GT80	6X5GT ... 1.00	7AV6 ... 1.35	VR105 ... 1.49
1U594	6AS7G ... 6.50	6K775	6Y6G ... 1.19	7AV7 ... 3.00	VR150 ... 1.65
1V97	6AT6 ... 1.30	6K7GT79	7A497	7AX7 ... 2.40	30ATL ... 22.50
1X2, 1X2A ... 1.77	6AU5GT ... 1.75	6K8 ... 1.04	7A5 ... 1.09	7BA6 ... 1.45	30TA ... 9.95
2A3 ... 1.27	6AU6 ... 1.60	6K8GT ... 1.04	7A689	7BA7 ... 2.00	703A ... 3.95
2A588	6AV5GT ... 1.85	6L5G97	7A7 ... 1.59	7BE6 ... 1.55	705A ... 2.55
2A688	6AX5GT ... 1.45	6L6 ... 2.25	7A889	7BM7 ... 2.00	707B ... 14.95
2A788	6B4G ... 1.89	6L6G ... 1.97	7B4 ... 1.39	7C8 ... 1.34	803 ... 5.95
2C44 ... 1.49	6B7 ... 1.35	6L7G97	7B6 ... 1.49	7F589	805 ... 4.95
2E22 ... 1.37	6B8G ... 1.37	6N7 ... 1.40	7B789	7H6 ... 1.65	807 ... 1.85
2X2, 879 ... 1.31	6PA6 ... 1.60	6N7GT ... 1.25	7B889	12J7GT99	813 ... 8.95
3A5 ... 1.25	6BA7 ... 1.20	6P5GT ... 1.23	7C489	12Q7GT89	900455
3D6/129968	6BC5 ... 1.90	6Q787	7C588	12SA7 ... 1.03	900655

WIRE WOUND RESISTORS 5 WATT

Resistance	Price each	10 or more each	100 or more each
75 Ohms	\$0.21	\$0.19	\$0.15
100 Ohms	.21	.19	.15
200 Ohms	.21	.19	.15
5,000 Ohms	.22	.20	.16
6,000 Ohms	.22	.20	.16
10,000 Ohms	.22	.20	.16

10 WATT

Resistance	Price each	10 or more each	100 or more each
1.5 Ohms	.21	.19	.15
18 Ohms	.21	.19	.15
23 Ohms	.21	.19	.15
100 Ohms	.22	.20	.16
300 Ohms	.23	.21	.17
450 Ohms	.23	.21	.17
10,000 Ohms	.24	.22	.18
20,000 Ohms	.24	.22	.18

ELECTROLYTIC SPECIALS

40-10-150 V	} \$0.43
100-10 V	
40-20-150 V	

TOGGLE SWITCHES

DPST-AHH	\$0.49
SPST-AHH	0.43
DPST with leads	0.45

EXTRA SPECIAL ALL AMERICAN TUBE KIT

12SA7, 12SK7, 12SQ7, 50L6GT, 35Z5GT \$4.95

RESISTOR KIT

100 popular values \$3.49

VIBRATORS

Standard 4-prong non-synchronous. For 90% of auto radio replacements. \$1.19



PM SPEAKERS ALNICO No. 5

Very Best Quality. NATIONAL BRANDS. Individually packed.



Size	Price each	10 or more each
4"	\$1.75	\$1.69
5"	1.89	1.79
8"	3.59	3.25
10"	5.49	5.25
12"	6.89	6.49

SOCKETS

Socket Type	Each	Per 100
Molded Octal	\$0.12	\$9.95
Molded Loctal	.10	8.95
Octal Wafer	.04	3.95

CONTROLS

1 Meg with DPST Switch, 1" Split Knurled Shaft	\$0.49
100 K with SPST Switch, 3/8" Shaft	.35
1/2 Meg with Switch, Long Shaft	.54

CERAMIC CONDENSER KIT

100 most popular, assorted sizes \$6.95
12 most popular, assorted sizes 1.00

TV HV "Cartwheel" CONDENSERS

500 mmfd. 10 KV	\$0.49
500 mmfd. 15 KV	.59
500 mmfd. 20 KV	.69

EXTRA SPECIAL 8" DYNAMIC SPEAKER



Output for 50L6, 450ohm field... \$2.29

MICA CONDENSER KIT

100 most popular values... \$7.35
30 assorted values... 2.50

OUTPUT TRANSFORMERS

Standard Replacements for 50L6, 6V6, 25L6, 3Q3, 3Q4, 6K6, ea. \$0.49



Minimum order \$3.00. 25% deposit on C.O.D. orders. Prices subject to change without notice. Availability of merchandise subject to prior sale.

STEVE-EL ELECTRONICS CORP.

Dept. E-5 65 READE STREET NEW YORK 7, N. Y. COrtlandt 7-0086

TRIPLEX WAVE MASTER

TRIPLE DIRECTORS ¼ Wavelength Stacked

TWO BAY STACKED CONICAL

NO BOOSTER REQUIRED

MATCHES ANY OHM WIRE
75-150-300

Conical with 3-Element Dipole

SINGLE CONICAL
YOUR COST \$3.90

Third Dipole Element provides exceptional broad band response across both bands.

GHOST FREE RECEPTION ALL CHANNELS

INSTANT ASSEMBLY

EASY INSTALLATION
APPROX. WT. 7 POUNDS

YOUR COST \$7.70

IMMEDIATE DELIVERY

SENSATIONAL NEW TRIPLEX TV ANTENNA KIT

Includes: Two bay stacked conical triplex antenna, 10-ft mast, 100-ft. guy wire, 60-ft. 300 ohm lead, guy ring, mast insulators, house insulators, peak mounting base, guy hooks.
Nothing else to buy!

All For **\$12.95**

SINGLE CONICAL KIT SAME AS SHOWN ONLY ONE STACK CONICAL \$9.15

20% Deposit on all C.O.D. Orders

SOLD DIRECT—WRITE—WIRE—CALL—FAIRFAX 9171

RAY CO. 441 SUMMIT ST. TOLEDO, OHIO

CROSLY TV TUNERS

An orange dot next to the oscillator-mixer tube socket indicates that the tuner was aligned at the factory for a 12AV7 tube in place of a 12AT7. When it is necessary to replace the oscillator-mixer tube in tuners marked with the orange dot, always use a 12AV7 tube, otherwise realignment is necessary.—*Crosley Service Dept.*

GENERAL ELECTRIC TV SETS

Lack of high and low voltage in the G-E 10C101, 10C102, 10T1, 10T4, 10T5, 10T6, 12C101, 12C102, 12C105, and 12T1 as indicated by lack of sound and raster is probably caused by an open circuit in the 4.6-ohm current limiting resistor in series with the selenium rectifiers in the low-voltage supply. Use a factory replacement (catalog number RRW-048).—*James Moudry*

ZENITH 10S669 AND 10S690

These sets come in with extremely low volume. All components and tubes check O.K. Replace the 7G7/1232 r.f. amplifier tube before going further. Some of these tubes will check good even when they are too weak for these circuits.—*Lawrence Roeshot*

HUM IN TV SETS

Intermittent hum and noise in TV receivers can often be traced to an intermittent short between heater and cathode in the local oscillator tube. Since this short does not always show up on a tube tester, the most reliable test is to substitute a new tube. Because noise and hum of this type seldom appear in the picture, the technician can waste lots of time looking in the a.f. circuits.—*Don Ebert*

WESTINGHOUSE H-185

A severe a.c. hum which cannot be traced to bad filter capacitors in this three-way portable may be caused by the a.c. field around the selenium rectifier. The hum is picked up by the first audio grid.

Remove the red lead which runs between the B-plus terminal on the rectifier and the 180-ohm filter resistor and replace it with a shielded lead. Shield the rectifier with insulated tin foil.—*Vincent Petroccione*

MORE GAIN IN RCA TV SETS

Additional sound and picture gain for weak-signal areas is made possible by minor changes in the circuits of the following models: 6T54, -64, -65, -71, -74, -75, -76, -84, -86, -87, and 9T57, -77, -79, -89.

Change the first and second picture i.f. cathode resistors (R104 and R108 in 12½-inch models or R103 and R107 in 16- and 19-inch models) from 120 to 82 ohms. This provides additional gain through these stages.

Move the point of sound take-off (connection C) on trap T103 up two turns on the coil. This provides more 21-mc signal for the sound i.f. amplifier.

Carefully realign the sound and picture i.f. stages after making the above changes.—*RCA Service Tips*

AUTOMATIC M-90 AUTO RADIO



- Six Tube Superheterodyne • Three Gang Condenser • Powerful, Long-Distance Reception • Fits All Cars, Easy Installation
 - Mounting Brackets Included
 - 6 Tube model M90.....*\$33.87
- *Above price includes Federal, Excise Tax
- Approx. shipping weight (11) eleven pounds.

MAIL US YOUR ORDERS
All orders filled within 24 hours.
Standard Brand tubes 50% off list

Bill Sutton's Wholesale Electronics
Fifth at Commerce Fort Worth, Texas

SHOOT TV TROUBLE FAST!

With H. G. CISIN'S RAPID "TV TROUBLE SHOOTING METHOD"

EARN more money! Locate television troubles by this quick, entirely new method. Rapid checks enable you to locate all faults in record breaking time regardless of make or model! 160 Picture, Raster, Sound trouble symptoms. Over 100 Rapid Checks including over-all alignment checks, 26 illustrations; simplified step-by-step directions!

INCREASE your earning power with the most valuable aid to TV servicing ever written! **SEND YOUR NAME AND ADDRESS TODAY WITH ONLY \$1.00**

↓ RUSH COUPON NOW! ↓

H. G. CISIN, CONSULTING ENGINEER, Dept. E-3
200 Clinton Street, Brooklyn 2, N. Y.

Name

Address

City Zone State

Every RADIOMAN can use these SERVICE HINTS!

Valuable Manual Yours—FREE
Write today—no obligation.

FEILER ENGINEERING CO. Dept. 5RC1-1
8026 N. Monticello Ave., Skokie, Ill. (Suburb of Chicago)

Every page of "How to Simplify Radio Repairs" is packed with on-the-bench, practical ideas.

WANTED

- PE-237 POWER SUPPLY
 - GN-58 GENERATOR
 - 1306 TRANSMITTER RECEIVER
- BEST PRICES—NO QUANTITY TOO BIG, NONE TOO SMALL.**

WRITE TODAY GIVING DETAILS TO —

Box P-51-5, c/o Radio-Electronics, 25 W. Broadway, N. Y. C.

CARBON RESISTORS

½ watt and 1 watt non insulated. 100 assorted resistors \$5.00 postpaid.

Inquiries from large users solicited. We are manufacturers of resistors.

BUCK MFG. CO.

North Aurora, Ill. Phone Aurora 7993

PEN-OSCIL-LITE

Extremely convenient test oscillator for all radio servicing; alignment • Small as a pen • Self powered • Range from 700 cycles audio to over 600 megacycles u.h.f. • Output from zero to 125 v. • Low in cost • Used by Signal Corps • Write for information.

GENERAL TEST EQUIPMENT
38 Argyle Ave. Buffalo 9, N. Y.

HELP THE DEFENSE EFFORT

by turning over old copies of RADIO-ELECTRONICS and all other waste paper to paper collecting agencies in your community.

RCA 8BX5, 8BX54, 8BX55

The position of the battery pack affects the loop inductance. The inductance increases and the sensitivity of the set decreases because of poor tracking when the battery is removed.

When a battery is temporarily unavailable, place a sheet of aluminum, 8½ inches long, 3½ inches wide, and .02 to .05 inch thick in the bottom of the cabinet. This will approximate the effect of the battery so proper performance is restored. Brass may be used as a substitute for the aluminum sheet. Do not use iron or steel because the performance of the set will be adversely affected. The sheet can be waxed to the inside of the case to hold it in place. Do not place wax, cement, or other material on loop windings.

Be sure that the battery—or sheet—and chassis are in the correct position before aligning the oscillator and oscillator circuits. Follow manufacturer's instructions when aligning the i.f.'s. Conventional stage-by-stage alignment procedure cannot be used because of neutralization in the first i.f. stage.—RCA Service Data

AIR KING THREE-WAY PORTABLES

Distortion may be noticeable in the models 4012, 4016, 3912, and 3916 when operated on power lines, but not when in use on batteries. This may be caused by a weak 1A5-G output tube. Changing this tube will remedy the condition.—Air King Engineering Dept.

—end—

AEROVOX "Space Miser" CAPACITORS

P85

P83Z

P89ZXY

• Where space is mighty limited, you can count on Aerovox miniaturized capacitors to squeeze through. For examples:

Type SRE or Bantam electrolytics, aluminum tube, hermetically-sealed, insulating jacket. Type 89ZXY metallized-paper, hermetically-sealed. Type P85 paper tubulars with Duranite

end-fills. Type P83Z or Micro-miniatures, metallized-paper tubulars in molded thermo-plastic case. Adequate voltage and capacitance ratings in each type.

••••• Ask your Aerovox jobber about these miniaturized capacitors. Try them!



CAPACITORS • VIBRATORS • TEST INSTRUMENTS

For Radio-Electronic and Industrial Applications
AEROVOX CORPORATION, NEW BEDFORD, MASS., U. S. A. • Sales Offices In All Principal Cities
Export: 41 E. 42nd St., New York 17, N.Y. • Cable: AERDCAP, N.Y. • In Canada: AEROVOX CANADA LTD., Hamilton, Ont.

HOT VALUES, SCARCE ITEMS PLENTIFUL at ROSE Co.!

SPEAKERS
All Alnico V
Compare Quality—
Price!
4" P.M. ... \$1.59
5" P.M. ... 1.69
6" P.M. ... 1.98
12" P.M. ... 6.69
12" 2500 ohms ... 3.75
5% DISCOUNT 5%
SPECIAL: Deduct 5% from any assortment of 10 or more.
COBALT FREEZE WILL ADVANCE PRICES—ORDER NOW!

SELECTOR SWITCHES
Ceramic Selector: 1 gang, 3 pole, 3 position, Non Shorting. 39c ea. Save! 10 for \$2.90
Wafer Transfer: 3 pole switch, 1 pole, 2 position; 1 pole make & break. 25c ea. Save! 10 for \$1.90

OUTPUT TRANSFORMERS
1 S4 PP, 43 PP, 6V6 PP 60c ea.
45 PP, 3Q5, 6K6 PP 10 for \$2.90
3S4 PP, 25A6 PP 10 for \$2.90
3V4 PP, 6E6 PP \$6.59
50L6 49c ea.—10 for \$4.59
6V6 59c ea.—10 for \$5.59
25L6 PP 10 for \$5.59
50L6 PP 10 for \$5.59
35L6 PP 10 for \$5.59

SAVE ON THESE TV SPECIALS!
Famous #630 Super TV Chassis... Voltage Doubler... AGC... Standard Tuner... operates with all picture tubes. Licensed by RCA factory wired... complete, ready to play. Includes all hardware, (less CRT) \$151.89

CONDENSERS
ea. per 10
20 x 20—150V. 35c \$3.30
40 x 40—150V. 45c 4.30
50 x 30—150V. 45c 4.30
8 —450V. 39c 3.69
16 —450V. 39c 3.69
25 —25V. 19c 1.69

TV CONDENSERS
per 10
.0005 6000 V. 69c
.001 6000 V. 69c
.002 6000 V. 69c
.003 6000 V. 69c
.005 6000 V. 69c
per 10
.0002 1600 V. 15c
.001 1600 V. 15c
.002 1600 V. 15c
.003 1600 V. 15c
.004 1600 V. 15c
per 10
.001 1000 V. 11c
.002 1000 V. 11c
.003 1000 V. 11c
.004 1000 V. 11c
.005 1000 V. 11c
per 10
.001 1700 V. 15c
.002 1700 V. 15c
.003 1700 V. 15c
.004 1700 V. 15c
.005 1700 V. 15c

3-TUBE PHONO AMPLIFIER
For all type records, 2 1/2 Watt output. Completely wired with full range tone & volume controls plus switch. Less tubes: ONLY \$2.95 ea. Order 6 Save: \$2.79 ea.

STANDARD BRAND TV TUBES
16" Round \$34.50
16" Rect. 34.50
17" Rect. 38.50
19" Round 49.50
20" Rect. 49.50

TUBES RADIO & TV
RMA Guarantee—Boxed—All Critical Numbers in Stock!

024	\$.83	6L7	..69	12K8	..49
1A7	1.19	6Q7	..98	12Q7	..49
1C5	1.49	6R7	..59	12SA7	1.10
1R5	1.95	6S7	..90	12SF5	..69
1D5GP	..39	6SA7	..98	12SF7	..69
1H5	..98	6SC7	..98	12SH7	1.10
1L4	1.59	6SF5	..89	12SJ7	1.10
1L8A	1.33	6SF7	..89	12SM7	1.10
1L8S	1.09	6SH7	..89	12SL7	1.20
1N5	..98	6SK7	..98	12SN7	1.39
1N6	..29	6SL7	..98	12SQ7	..98
1Q5	..69	6SN7	1.59	12SR7	1.79
1R5	1.29	6S07	..98	12SA7	1.10
1S4	1.10	6S57	..89	14B6	1.10
1S5	1.10	6S77	..59	14H7	1.10
1T4	..98	6T8	1.79	14Q7	1.10
1U4	..90	6U4	1.49	19BG6G	3.5
1U5	..98	6U5	..98	19T8	1.95
1V4	..89	6U7	..89	32L7	1.98
1V2	1.49	6V6	..89	25BQ6	1.39
1X2A	1.49	6W4	..98	25L6	..90
1Y4	1.29	7A8	..98	28W4	1.20
3Q4	1.08	6X4	..89	25Z5	..95
3Q5	1.38	6X5	..75	25Z6	..98
3V4	1.08	6Z5	1.29	25Z7	1.98
3V4	1.19	7A4	..98	27	1.08
3A3	1.89	7A8	..98	32L7	1.98
5Y3	..69	7A6	..98	34	1.08
5Y4	..89	7A7	..98	35/51	1.08
6A3	1.08	7B8	..98	35A5	..98
6A7	1.09	7B4	..90	35/5	..98
6A8	..98	7B5	..90	35L6	1.10
6A8A	1.19	7B6	..90	35W4	1.00
6AC5	..59	7B7	1.08	35Z4	..98
6AC7	1.98	7C5	..90	35Z3	1.19
6AD7	..59	7C6	1.08	35Z4	..95
6AG5	1.89	7C7	..98	35Z5	..95
6AH6	2.59	7E5	..98	36	1.08
6AK5	1.08	7E6	..98	37	1.08
6AL5	1.89	7E7	1.32	38	..98
6ALS	1.10	7F7	..98	39/44	..29
6AR5	1.39	7R5	1.98	50	1.10
6AQ6	1.20	7C7	1.32	43	..98
6AR5	1.08	7H7	..98	45	..98
6AT6	1.28	7J6	1.39	45Z3	..98
6AU6	1.20	7R7	..98	45Z5	..98
6AV6	1.20	7V7	..98	46	1.39
6AG6	1.35	7W7	..98	49	1.39
6BC5	1.40	7X7	..98	50A5	1.19
6BB6	1.35	7Y4	..98	50B5	1.25
6BE6	1.19	7A6	..98	50C5	1.19
6BQ6	2.69	12A6	..49	50L6	1.19
6BH6	1.25	12A7	..39	50X6	1.10
6B16	1.25	12A8	1.20	50Y6	1.08
6BN6	1.75	12A15	1.28	56	..89
6BQ6	2.25	12A16	1.08	57	..79
6C4	1.08	12AV6	..98	75	1.19
6C86	1.10	12AU6	..98	70L7	1.08
6CD6G	3.98	12AU7	1.89	71A	1.19
6D5	1.08	12AV6	1.20	81	1.19
6F5	..98	12AV7	1.89	77	..49
6G6	..59	12AX7	1.89	80	..68
6H6	..90	12B6	1.20	81	2.39
6J5	..85	12BA7	1.20	84/6Z4	..98
6J6	1.98	12BE6	..98	117L7	1.95
6K5	..89	12BH7	1.89	17Z3	1.80
6K6	1.19	12F5	..49	117Z6	1.20
6K7	..69	12H6	..29		
6L6	1.79	12J5	..49		

PHONO PARTS
Pickup Arm with long leads, less crystal ea. 19c
78 RPM Motor...ea. \$2.89
3-Speed Motor...ea. 4.95
8-Speed Pickup...ea. 5.25
Regular Pickup...ea. 1.89
Webster N-10 Crystal ea. 1.00

PHONO CONTROLS
1/2 meg. or 1 meg., with switch 42c ea. 10 or more 35c ea.
1/2 meg. or 1 meg., less switch 23c ea. 10 or more 19c ea.
Kit, 12 Asst. VC all sizes & shaft lengths. \$1.29 comp. kit.

ROSE TV ACCESSORIES SPECIALS!
Wall Mounts: 4" Clearance...Dr. 75c
Wall Mounts: 15" Dr. \$1.35
6" Clearance...Dr. \$1.35
Chimney Mount: Only 1.35
Woodscrow Standoff: 3 1/2"ea. 5c
Hot Nail:ea. 5c
Wall Insulators ea. 5c
Mast Standoff:ea. 7c
For 1 1/2" Mast ea. 7c

300 OHM WIRE
100 ft. Coil\$ 3.95
1,000 ft. Spool 29.50

CONICAL ANTENNA
High Gain, Broad Band! Weather resistant, covers all TV & FM channels. Heavy aluminum. #65 Complete: \$3.89 Lots of 10—\$3.59 ea.

THE ROSE COMPANY
98 PARK PLACE DEPT. E5 NEW YORK 7, N. Y. COrtland 7-6195
Minimum Order: \$5.00, 25% deposit with order, balance C.O.D. Include postage with order. All merchandise subject to prior sale, F.C.B. New York City.

RTMA OPPOSES LICENSING

Licensing or public regulation of any form of radio and television service technicians met with strong opposition by the Radio-Television Manufacturers Association. That group voted overwhelmingly in favor of taking action to provide an effective answer to the demand for regulation, particularly in the New York City area.

Definite plans have not yet been drawn up to eliminate the criticism of present servicing facilities, but the RTMA indicated that manufacturers, distributors, and technicians will be called upon to cooperate in a program to eliminate unethical service operators. A code of advertising and selling ethics was drawn up by the RTMA and is being submitted to the entire membership for comment.

PICTURE TUBE FAILURE

Many set owners worry about their picture tube going bad and about the cost of replacement. This is particularly true of those who have not invested in a second year's service contract.

Yet picture tube failure is one of the least frequent causes for TV set repairs. One New Jersey service technician said that in over 400 sets serviced in the past few years, only about 15 required new picture tubes, and none of these were in sets he had sold in his own shop.

One prewar set was still using the same C-R tube.



THE FUND GOES OVER \$7,500.00

HELP-FREDDIE-WALK FUND

Last month we had a visit from Herschel Thomason, Arkansas radio technician, whose three-year-old son Freddie Thomason was born both armless and legless.

Freddie's father reported that the boy is getting along splendidly and has taken on quite a bit of weight and enjoys his leg braces immensely, although he cannot as yet walk. He has only learned to balance himself and the only way he will ever be able to walk will be by twisting his body from side to side, which will give him a sort of walk—none too good—but sufficient to be able to get around by himself.

Every few months his parents have to come up north to the institution which is fitting these appliances onto Freddie and gives him walking lessons. It will take a long time before he will finally be enabled to even have a semblance of walking.

This month we are happy to report the following generous contributions: \$3.50 tendered by Miss Cecilia J. Goldpaugh for the Pupils of a One-Room School in Sawkill, N. Y.

\$135.00 contributed by the Staff and Students of the Radio Electronic Television Schools, Detroit, Michigan through Eugene H. Wolfe.

Please do not stop with your efforts as all of us wish to help make Freddie a radioman when he finally grows up.

Please send your contributions from time to time—even the smallest donation will be greatly welcome.

Make all checks, money orders, etc., payable to Herschel Thomason. Please address all letters to:

Help-Freddie-Walk Fund
c/o RADIO-ELECTRONICS
25 West Broadway
New York 7, N. Y.

- Balance as of February 20, 1951... \$7,253.71
- Anonymous—Glendale, Calif. \$ 1.00
 - Anonymous—Los Angeles, Calif. 1.00
 - Anonymous—Ridgefield Park, N.J. 3.00
 - Anonymous—Troy, N.Y. 1.00
 - Anonymous—Bedford, Ohio 2.00
 - Katie Baier—Baltimore, Md. 1.00
 - J. H. Barksdale—Charlottesville, Va. 5.00
 - Bertha Bishop—Baltimore, Md. 1.00
 - H. L. Bumbaugh—Los Angeles, Calif. 5.00
 - Patricia Casto—Scotia, N.Y. 1.00
 - Erna Cermak—Baltimore, Md. 1.00
 - James J. Cermak—Baltimore, Md. 1.00
 - James O. Cermak—Baltimore, Md. 1.00
 - William E. Cermak—Baltimore, Md. 1.00
 - J. T. Cookson—Puxico, Mo. 1.00
 - Margie Cruttenden—Baltimore, Md. 1.00
 - Hazel Davis—Baltimore, Md.25
 - Mrs. V. E. Davison—Huron, S. Dak. 5.00
 - Mrs. C. P. Donnelly—New York, N.Y. 2.00
 - Eliot Brothers—El Paso, Tex. 5.00
 - Paul Evans—Dayton, Ohio 2.50
 - Karl Fleck—Baltimore, Md. 1.00

NIAGARA - One of AMERICA'S GREAT ELECTRONICS STORES presents...

NEW SHIPMENT!

ARC-5/R-28

2-Meter Receiver

Here is the 2-meter superhet you have been looking for! Absolutely one of the BEST available today! Tunes from 110 to 156 Mcs. in four crystal channels. (Easily converted to continuous tuning.) Tube lineup is as follows: 717A-R.F., 717A-Mixer, 2-12SH7-1st and 2nd I.F. (6.9 Mc.) 12SL7-Det-AVC-Squelch, 12SL7-1st audio-squelch amplifier, 12AG-2nd audio, 12NH7-R.F. Osc.—4th Harmonic Gen., 717A-Trip, 12th Harmonic Gen., 717A-Dial, 12th Harmonic Gen. A highly desirable superhet, made of rigidly inspected parts and contained in a hinged aluminum cabinet measuring 7 5/32" x 4 7/8" x 1 1/4". Complete with all tubes in original sealed cartone. **\$29.95**

FOR A LIMITED TIME ONLY!

With each order for ARC-5/R-28 Receivers, one copy of Vol. 2 "Surplus Radio Conversion Manual" (Regular price \$2.50) will be shipped at no additional cost! This volume contains circuit diagram and full description of above receiver, plus a wealth of conversion data on many other popular items of surplus equipment. Act Now, for Your **\$2.50 Bonus!**

TRANSFORMER BARGAINS (ALL WITH 110V—60CY PRI)

PLATE

- 511-T1-330-0-330 600MA. \$5.75
- D-161912-2500V. @ 4MA. (TV or Seco) 3.95
- S-13336-2500V. @ 4MA. 6.3V. @ .8A. 2.5V. @ 1.75A. 9.95
- D12-2736-1500V. @ 4MA. Electrostatic Shield. Herm. Seal. 4.95

FILAMENT

- T-2-2.5V. @ 10A. 3.95
- 528049-5VCT @ 3A. 5VCT @ 10.5A. 6.3VCT @ 3.5A. 4.50
- 475-T201-5VCT @ 15A. 5.95
- 58-6-63-2 x 5V. @ .085KVA (7.5KV. Insul.) 12.95
- K-3531-6.3 & 2.5V. @ .0107KVA (12.5KV. Insul.) 14.95
- D-161917-6.3V. @ 3A. 2.5V. @ 2A. 2.85
- P-4091-7.5V. @ 5A. 2.49

POWER

- P-6001-325-0-325 @ 40MA. 5VCT @ 2A. 2.5VCT @ 4A. 2.25
- P-6009-275-0-275 @ 70MA. 5V. @ 5A. 2.5V. @ 10.5A. 135-0-135 @ 90MA. 5V. @ 3A. 5V. @ 3A. 3.00
- C-12A1160-350-0-350 @ 70MA. 6.3V. @ 1.2A. 2.95
- T-4001-300-0-300 @ 125MA. 250-0-250 @ 75MA. 12.6V. @ 6A. 5V. @ 3.5A. 5V. @ 3A. 9.95
- BS-77-1-145-0-145 @ 55MA. 120V. @ 35MA. 5V. @ 3A. 5V. @ 2A. 3.49

MODULATION

- ARC-3-807RF to PP6LS (ABI) 2.49
- A-3866-200, 500 Ohms to 5, 6, 7, 8, 9, 10K Ohm.-150MA. 4.49
- ARP-13-P.P. 811 Modulations to Single 813 (Some insulators damaged, but guaranteed to work) 9.50

DRIVER

- A-4205-10,000 Ohm Plate to Single Grid.79

OUTPUT

- SP-12-P.P. 5V6 to 8 Ohm Voice Coil.79
- T-4625S-P.P. PAR. GNT. "B" to 8,000 Ohms. 1.75
- 511-T1-6V6 to 8 or 600 Ohms.85
- F-2003-1-P.P. or Single 6V6 to Univ. Line or V.C. 1.29

INPUT

- T-47368-600 Ohm C.T. to 300 Ohm Mike. 2.49

MIKE TO LINE

- A-4350-PRI & SEC 50, 200, 300, 500 Ohms. 2.49
- T-47309-30 Ohm Mike to 600 Ohm C.T. SEC. 1.65

CHOKES

- 7470633 1.48 HY 1.5 AMPS 6.50
- L-143 1.72 4 AMPS 9.95
- C-2303 2.5 100 MA.98
- 475-CH301 3.8 75 MA. 1.25
- 32564 8 200 MA. 2.35
- 13406 12 225 MA. 2.95
- 510X2 15 300 MA. 2.65
- 31-C-13 50 MA.95
- L-218 45 90 MA. 2.75

A NIAGARA SPECIAL A STANDARD TYPE TV TUNER

Exceptional value in a 12 channel turret tuner or front end. This high gain, low noise tuner is designed for receivers with 21.25 or 21.9 MC I.F. Drum type turret has replaceable channel coil and contact strips. Fine tuning is provided with stop at each extreme. Guaranteed to last for years and years. Will replace any tuner. **DOUBLE YOUR MONEY BACK** if replacement detent is ever required.

Tuner uses 1-6AK6 Mixer and 1-6AG Osc. WHILE THEY LAST Less Tubes with Tubes \$14.95

\$12.95

LIMITED QUANTITY

NIAGARA IS C.A.P. H.Q. GET A LYSCO C.A.P. TRANSMITTER

2374 KC, 25 Watt peak output transmitter in a rounded drawn black wrinkle finish case. Silk screened, white lettered panel. Features light weight (3 lbs.), antenna changeover relay, 50 Ohm coax output. Requires 500 V.D.C. @ 125 MA. 6.3V. AC/DC @ 1.35 Amps Fil. for models A140 & B140. C140 requires same 500V. plus 12.6V. AC/DC @ .45 Amps Fil.

Panel controls include Fil. Sw., Osc. tuning, P.A. tuning, meter and mike jacks and xtal socket. Modulated by new clamp type amplitude system. Measures 4" wide, 4 1/2" high, 6" deep.

Model A140 Less Tubes (1-6AQ5) **\$29.95**
Model B140 Less Tubes (3-6V6GT) **9.95**
Model C140 Less Tubes (3-12AG1) **9.95**
6AQ5-\$12.20 Ea., 6V6T-\$12.20 Ea., 12A6-\$11.74 Ea.

*** IMPORTANT CORRECTION ***
Ferries 18c Sig. Gen. L.N. incorrectly priced at \$99.95 in April issue. Should have read \$499.95—a terrific bargain.

Guarantee
Niagara's Guarantee of Satisfaction:
All items must meet with full approval or money refunded.

Dept. C-51

Niagara Radio Supply Corp.

Phone Dlgby 9-1132-34

NOTICE
Minimum order \$5. 20% deposit with orders un-limited. F.O.B. N.Y.C. Prices subject to change without notice.

160 Greenwich Street, New York 6, N. Y.

From a Dorchester Freddie to Freddie —Dorchester, Mass.	2.00
Don Goetcheus, W2QH —Binghamton, N.Y.	2.00
Paul Guertin—Quebec, Canada	3.00
R. F. Harvey—San Diego, Calif.	2.50
Hassett's—Franklin, Va.	2.00
Madge Higdon—Baltimore, Md.	1.00
Frank Hollingshead—Garnett, Kansas	5.00
Miss Jeanne Jones—Indianapolis, Ind.	2.00
O. G. Keylor—Lancaster, Pa.	3.00
Sfc. Eugene E. Kodadek Washington, D.C.	5.00
Mr. and Mrs. Gene Lemons & Sons Cambria, Ill.	2.00
Edward Lewand—Chicago, Ill.	2.00
H. Owen—Santa Marta, Col., S. A.	2.00
J. Owen—Santa Marta, Col., S. A.	2.00
Mrs. Isabel Owen—Santa Marta, Col., So. Amer.	1.05
Miss Isabel Owen—Santa Marta, Col., So. Amer.	1.00
Marie Peek—Baltimore, Md.	1.00
Walter Prybysz—Lockport, Ill.	2.00
Pupils of a One-Room School —Sawkill, N.Y.	3.50
Iva Rapp—Baltimore, Md.	1.75
Carrie Rellinghaus—Baltimore, Md.	1.00
O. E. Schellhose—Baltimore, Md.	5.00
Lawrence Sigmant—Weirton, W.Va.	2.00
Sgt. Paul H. Smith —c/o P.M., New York City	10.00
Staff and Students of the Radio Electronic Television Schools —Detroit, Mich.	135.00
Sunridge Radio T.V.—Brooklyn, N.Y.	1.00
Gray Trembly—Somerville, Mass.	5.00
T/Sgt. James E. Welch c/o P.M., New York, N.Y.	1.00
Mildred Wilson—Baltimore, Md.	1.00
George Wirsching—Baltimore, Md.	1.00
Wilbur Wright—Hamilton, Ohio	2.00
Total received to March 19, 1951.	\$7,505.26

Radio Thirty-Five Years Ago
In Gernsback Publications

HUGO GERNSBACK Founder	
Modern Electrics	1908
Electric Experimenter	1913
Radio News	1919
Science & Invention	1920
Television	1927
Radio-Craft	1929
Short-Wave Craft	1930
Television News	1931
Wireless Association of America	1908

Some of the larger libraries still have copies of **ELECTRICAL EXPERIMENTER** on file for interested readers.

**MAY, 1917
ELECTRICAL EXPERIMENTER**

- War and the Radio Amateur, by Hugo Gernsback
- Wireless Telegraphy, by E. B. Pillsbury
- San Diego—Largest Radio Station in U. S., by J. Bassett
- An Exceptional Amateur Radio Station
- Van Wireless Traces Messages
- How the Audion Repeater Repeats
- The Ionic Radio System and Theory of Ionic Tuning, by Otto E. Curtis
- Receiving Marconi 300 K. W. Spark Stations with Oscillating Audion, by Samuel Curtis, Jr.
- Distributed Capacity and its Effect, by Samuel Cohen
- A Study of the Law of Response of the Silicon Detector
- Auxiliary Relay Break for Coharers
- Using "Auto" Spark Coil for Radio, by George F. Harrington
- A Drum Type Antenna Switch, by Harold Davie

**THE WORLD'S LEADING
TWIN LEAD TELEVISION
LIGHTNING
ARRESTER**

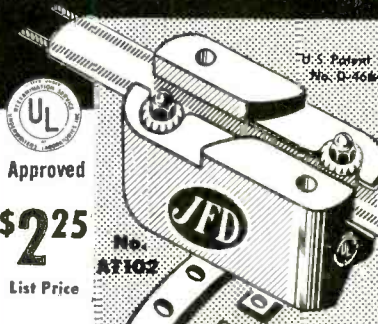

completely waterproof



SAFE TV GUARD

Protects television sets against lightning and static charges. Simple to install everywhere and anywhere... no stripping, cutting or spreading of wires. More than 500,000 in use today!

See your jobber or write to —



MANUFACTURING CO., INC.
E101-E 10th Ave., Brooklyn 4, New York
FIRST in Television Antennas and Accessories

**FREE! BOOK OF
TV PICTURE PATTERNS
& WAVE FORMS**

**Quick Reference TV Servicing Book Yours Free
Just For Examining Coyne's New 5-Volume Set
APPLIED PRACTICAL RADIO-TELEVISION**



If you want to "go places" in Television and Radio Servicing today, COYNE'S NEW 5-volume set **APPLIED PRACTICAL RADIO-TELEVISION** can help you. It is the most complete, up-to-date set of reference books in America, giving you the practical working knowledge that brings big money. 1500 jam-packed pages full of latest facts on television and radio—5000 subjects, 1000 illustrations and diagrams. COMPLETE SECTIONS ON COLOR TV WITH 1951 data on color TV adapters and converters—also new UHF channels. Shows how to install, service, shoot trouble, align all types of radio and television sets. "Break-down" photos help you understand quicker. Use this set free for 7 days—get FREE book of Television Picture Patterns for examining set. See sensational offer below.

FREE BOOK OF TV PICTURE PATTERNS if You Act At Once

Here's a sensational "get acquainted" offer. IF YOU ACT AT ONCE, a brand new TV servicing book, "TV SERVICING WITH PICTURE TUBE PATTERNS," is YOURS FREE. Shows dozens of actual TV picture tube photos and wave forms with clear explanations of what they mean and how to analyze and service the trouble faster. NOW YOU CAN GET A COPY ABSOLUTELY FREE just for asking to examine COYNE'S great 5-volume set **APPLIED PRACTICAL RADIO-TELEVISION** for 7 days. This offer is limited—mail coupon NOW.

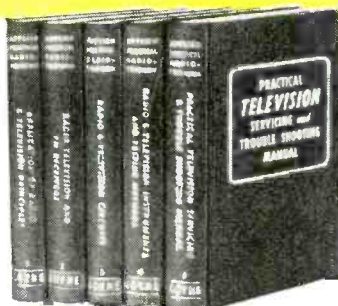

OFFER LIMITED—SEND COUPON TODAY!

Mail coupon for 7 days' FREE TRIAL OF COYNE'S 5-volume set. I'll include the book of TELEVISION PICTURE PATTERNS. If you keep the set you pay \$3.00 after 7 days' trial and \$3.00 a month until \$16.50 plus postage is paid (Cash price \$15.00). If not 100% satisfied with the set send it back and you owe NOTHING. EITHER WAY, HOWEVER, THE BOOK OF TELEVISION PICTURE PATTERNS IS YOURS FREE TO KEEP. Coupon is just a request to see the set and get the FREE book of picture patterns. This sensational offer is limited—SEND THE COUPON NOW.

SEND NO MONEY • MAIL COUPON NOW!

**COYNE ELECTRICAL & TELEVISION-RADIO SCHOOL, Dept. 51-T1
500 S. Paulina St., Chicago 12, Ill.**
O.K.! Rush "APPLIED PRACTICAL RADIO-TELEVISION" for 7 days' FREE TRIAL as per offer above. INCLUDE COPY OF TELEVISION PICTURE PATTERN BOOK AS MY FREE GIFT FOR EXAMINING THE SET.

NAME AGE

ADDRESS

CITY ZONE STATE

WHERE EMPLOYED

Check here if you want set sent COD. You pay postman \$15.00 on delivery. Same money-back guarantee of satisfaction.

COYNE ELECTRICAL AND TELEVISION-RADIO SCHOOL
An Institution Organized Not for Profit
500 SO. PAULINA ST. • DEPT. 51-T1 • CHICAGO 12, ILL.

Service Contract Exposed

The television service contract is just beginning to be dragged out into the light for remedy as the villain responsible for much of owners' difficulties and for most of the bad feeling between the set owner and the service technician. The surprising thing is that this has not been done before. Exposés and licensing bills both have gravely recited abuses due to the service contract, then gone on to recommend control, regulation, or greater attention to every other factor in servicing.

It began with the Associated Radio-Television Servicemen of New York City, who early this spring put on record a resolution which stated that since most of the customers' troubles were due to the contract method of servicing, pay-by-the-call servicing was to be recommended as a more reliable and less expensive method. The resolution was published in the daily press (and in RADIO-ELECTRONICS, April, page 94).

Next step was made by New York City Councilman Keegan, who has for nearly two years been attempting to put a licensing bill through the New York City Council. Faced at a public hearing with the fact that his proposed bill overlooked completely the dealer who writes service contracts but himself does no servicing, Keegan promised to amend the proposed bill to include all organizations writing service contracts. Keegan stressed that the great bulk of television service complaints originated with customers who had paid for a year's service in advance and had received inadequate or no service.

Now the New York Senate has swung into action, with the O'Connor Bill, No. 344, especially directed at service organizations who receive money under contract for television servicing. The full text of the proposed act follows:

Section 1. The legislature hereby declares that it is a matter of grave concern, that a great number of the inhabitants of the state have been deprived of money paid to persons, firms or corporations for service contracts which have not been fulfilled. Greater number of such inhabitants are daily becoming the owners of television receivers, and as a result thereof a new business of servicing, maintaining and repairing said television receivers, including installation and servicing of antennae has come into being. Due to the method of operating said business numerous persons have paid in advance sums of money for service contracts and thereafter have failed to receive said service due to the financial failure of the service organizations resulting in great financial loss to said inhabitants of the state. The unscrupulous tactics of such service organization tends to harm ethical businessmen and organizations and to discredit the television industry generally, it is hereby declared a

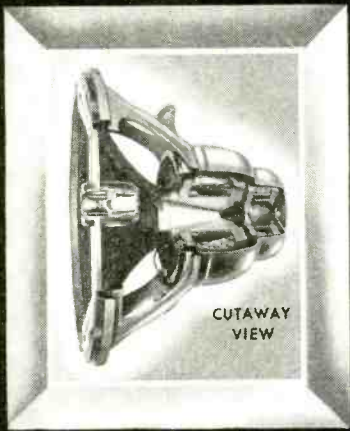

CUTAWAY VIEW

"no one has ever heard a G-610 who didn't want one!"

We believe this statement is literally true . . .

The Jensen G-610 Loudspeaker System brings you clear, clean, life-like reproduction with thrilling transport-to-the-original such as you have never heard before. Of course G-610's are in short supply, for the government has restricted cobalt for Alnico V magnets — and the G-610 has more magnetic energy than any speaker ever built. But when restrictions are relaxed and G-610's are again plentiful, then be sure you get a G-610 . . . NO ONE has ever heard one who didn't want one!

Furnished complete with Crossover and Control Network illustrated below.

Jensen
MANUFACTURING COMPANY
Division of The Muter Company

6601 So. Laramie Ave. • Chicago 38, Illinois

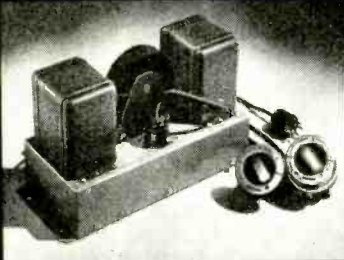

7 HARD TO GET ITEMS AT BIG SAVINGS TO YOU

AMAZING BLACK LIGHT



250-watt ultra-violet light source. Makes fluorescent articles glow in the dark. Fits any lamp socket. For experimenting, entertaining, unusual lighting effects. Ship. wt. 2 lbs. ITEM NO. 87 A SAVING AT **\$2.45**

LITTLE GIANT MAGNET



Lightweight 4 oz. ALNICO permanent magnet. 1 3/4" x 1 1/2". Lifts more than 20 TIMES ITS OWN WEIGHT! Ideal for hobbyists, experimenters. Shipping weight 3/4 lbs. ITEM NO. 159 BIG VALUE AT **\$2.45**

POWERFUL ALL PURPOSE MOTOR

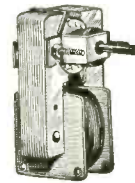

Sturdy shaded pole A.C. induction motor. 15 watts, 3000 rpm. 3"x2"x1 1/4"; 4 mounting studs; 7/8" shaft, 3/16" diameter; 110-120 volts. 50-60 cycles. A.C. only. When geared down, this unit can operate an 18" turntable with a 200 lb. dead weight. Use it for fans, displays, timers and many other practical purposes. Ship. wt. 2 lbs. ITEM NO. 147 UNUSUAL BUY **\$2.45**

WATTHOUR METER



Leading makes — completely overhauled, ready for service. 100-110 volts, 60 cycles, 2-wire A.C. 5 amp. Heavy metal case 8 1/2" x 6 1/4" x 5". Easy to install. Shipping weight 14 lbs. ITEM NO. 33 NOW ONLY **\$4.50**

WESTERN ELECTRIC BREAST MIKE



Lightweight 1 lb. carbon microphone. Aircraft type. Breastplate mounting, adjustable 2-way swivel. Easily fastened straps. For home broadcasts, communications etc. Complete with 6 foot cord, hard rubber plug. Sherardized plate, non-rusting finish. Ship. wt. 2 lbs. ITEM NO. 152 NEW LOW PRICE **\$1.50**

TELEPHONE TRANSMITTERS



Genuine transmitters made by Kellogg, Western Electric, Stromberg Carlson. Work on two dry cells. For P.A. systems, intercoms, other practical uses. Shipping weight 1 lb. ITEM 160 REAL VALUE **\$2.45**

250 POWER TELESCOPE LENS KIT

Make your own high powered 6 ft. telescope! Kit contains 3" diam., 75" focal length, ground and polished objective lens and necessary eye pieces. Magnifies 50x to 250x. Full instructions. Ship. wt. 1 lb. ITEM NO. 123 YOU SAVE AT **\$2.95**

HUDSON SPECIALTIES CO.
40 West Broadway, Dept. RE 5-51
New York 7, N. Y.

I am enclosing full remittance for items circled below. Shipping charges included.

OR, my deposit of \$..... Ship balance C.O.D.
MINIMUM C.O.D. ORDER \$5.00.

C.O.D. ORDERS ACCEPTED ONLY WITH 20% DEPOSIT
INCLUDE SHIPPING CHARGES.

Circle items wanted

87 159 147 33 152 160 123

Name..... Please Print Clearly

Address.....

City..... Zone..... State.....

matter of legislative determination that remedial measures are necessary.

§ 2. The penal law is hereby amended by inserting therein a new section, to be section thirteen hundred two-c, to read as follows:

§ 1302-c. Payments of money under contracts for servicing television receivers, apparatus and antennae. All payments of money received by any person, firm or corporation under contracts hereafter made by such person, firm or corporation as a consideration for the promise or agreement of such person, firm or corporation to install or service television receivers or any apparatus or equipment incidental thereto or connected therewith shall receive such money as a trust fund which must be deposited in a special account subject to withdrawal by such person, firm or corporation to the extent the withdrawal in any one month shall be equivalent of the proportion one month bears to the time of the entire contract. Payments made under any renewal of such contracts shall likewise be subject to the provisions of this section. Such person, firm or corporation may issue in place thereof a contract stating that a contract bond issued by an insurance company authorized to do business in this state and naming such company has been issued which guarantees the performance of such agreement.

§ 3. This act shall take effect immediately.

(We quote the bill verbatim: its language is not due to typographical errors on our part.—Editor)

This does not indicate that the television contract is on the way out. Many television set owners who have had the good luck (and good sense) to tie up with a reliable service firm find it a comfortable blend of service and insurance and prefer it to pay-by-the-call servicing. Put on a reputable basis, and stripped of the "unlimited calls" feature which is now disappearing from most service contracts, it may become a stable and permanent factor of television servicing.

New Slant on License

New slant on the television service licensing controversy was offered by the Associated Radio-Television Servicemen of New York City recently, in a proposal to license technicians rather than firms.

Introducing the proposal, ARTSNY president Max Leibowitz, pointed out that bills proposed up to the present provided for only one qualified technician to a service organization. This, he said, would not improve television servicing, but would have the opposite effect. A license that would attest that the man actually working on his receiver had passed a technical test and subscribed to a code of ethics would, however, assure the customer of qualified service, and would also partially protect the service industry from the

#630 Super Deluxe 30-tube TV CHASSIS

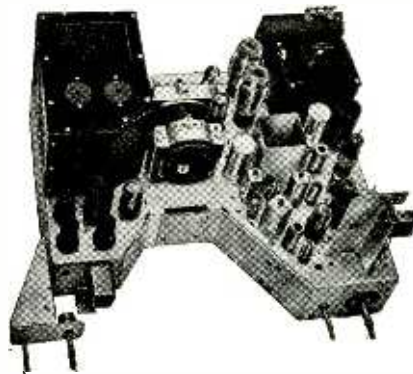

Manufactured in exacting standards with the authentic RCA #630. All chassis are Nickel Plated with molded paper condensers and molded sockets used throughout. AGC . . . STANDARD TUNER . . . LARGER POWER TRANSFORMER.

OPERATES ALL 15", 16", 17", 19", 20" PICTURE TUBES

\$164⁷⁵ COMPLETE ready to PLUG IN AND PLAY

Price includes 12" RCA Speaker, Knobs and Hardware (less CRT)

Leading National Brand PICTURE TUBES

- 16"—16GP4A \$35.25
- 16"—16RP4A \$39.25
- 17"—17BP4A \$45.25
- 19"—19AP4A or B . . . \$61.25
- 20"—20CP4 \$72.49

Nationally Known Manufacturer • • • Licensed by RCA

#630 PARTS TOP QUALITY LOW PRICES

SPECIAL: Dumont Tuner with FM for #630. 27.75

Standard Turret Tuner complete with tubes	22.49	Brightness & Hold Control Bracket	.59
Escutcheon Plate For Above	.65	Width Control Bracket	.15
Complete Set of Knobs	1.29	Tuner Shaft Bracket	.17
Power Transformer	10.98	Corona Ring	.09
Vertical Output Transformer	2.69	Corona Terminals (Set of 2)	.07
Sound Discriminator Transformer	1.11	Molded Miniature Sockets	.11
1st PIX IF Transformer	1.07	Molded Octal Sockets	.12
2nd PIX IF Transformer	1.07	Cathode Ray Tube Socket & Leads	.39
1st & 2nd Sound IF Transformer	1.01	TV Line Cord With Both Plugs	.29
Synchrolock Transformer	1.49	RCA 12" PM Speaker ALNICO #5	6.89
Filter Choke	1.49	Speaker Connecting Plugs Set of 2	.18
Cathode Trap Coil	1.07	500 MMF 20KV Condenser	.77
Width Control Coil Keyed AGC	.79	.033 MFD 1000V Molded Paper Condenser	.31
3rd & 4th Pix Coils	.39	.047 MFD 1000V Molded Paper Condenser	.31
Filament Chokes	.09	.01 MFD 600V Molded Paper Condenser	.16
Peaking Coil 203L1	.18	.25 MFD 600V Molded Paper Condenser	.39
Peaking Coil 203L2	.18	.0047 MFD 600V Molded Paper Condenser	.15
Peaking Coil 203L3	.18	.047 MFD 600V Molded Paper Condenser	.21
Peaking Coil 203L4	.18	.0022 MFD 600V Molded Paper Condenser	.15
Ion Trap Single	.79	.015 MFD 600V Molded Paper Condenser	.18
Ion Trap Double	.98	.0039 MFD 600V Molded Paper Condenser	.15
Audio Output Transformer (6K6)	.75	.1 MFD 600V Molded Paper Condenser	.25
HV Kinescope Lead (Large Button)	.39	Any 1/2 Watt 10% Carbon Insulated Resistor	.10
Picture & Sound Control	1.14	5000 Ohm 10 Watt WW Resistor	.33
Vertical & Horizontal Control	1.04	1000 Ohm 10 Watt WW Resistor	.31
Brightness Control	.49	40-10 MFD at 450V, 10 MFD-350V Electrolytic Can Condenser	1.49
Horizontal Centering Control	.57	40-40-10 MFD at 450V Electrolytic Can Condenser	1.49
Height Control	.48	20 MFD-450V, 80 MFD-350V Electrolytic Can Condenser	1.29
Vertical Linearity Control	.44	80 MFD-450V, 50 MFD-50V Electrolytic Can Condenser	1.24
Vertical Centering Control	.69	250 MFD-10V, 1000 MFD-6V Electrolytic Can Condenser	1.19
Focus Control	.98	40-10 MFD-450V, 80 MFD-150V Electrolytic Can Condenser	1.29
Flyback Transformer Super Hot	6.98	Bleeder, 50W, 1590 Ohms Tapped at 1360 and 230 Ohms	1.24
Focus Coil 470 ohm	3.69	Bleeder, 50W, 6855 Ohms Tapped at 6750, 93 and 12 Ohms	.87
Deflection Yoke 70"	3.98	Erie Disc Ceramicon .0015 MFD	.13
Chassis, Nickel Plated, Riveted Molded Sockets and Terminals	8.99	Erie Disc Ceramicon Dual .0015 MFD	.19
High Voltage Cage Assembly & Line Cord	4.39		
Voltage Divider Shield & Cover	1.79		
Electrolytic Condenser sub-Chassis	.93		
Sound Discriminator Shield	.18		
Yoke Bracket	.28		
Yoke Mtg. Hood	.57		
Cathode Trap Coil Shield	.39		
Chassis Mtg. Brackets (4)	.43		

All standard tubes available plus other parts. Write for prices.

Minimum Order \$5. Prices subject to change without notice.

TERMS: 25% deposit, balance C.O.D., F.O.B. New York.

TECHNICAL RADIO PARTS CO.

103 Avenue C

Brooklyn 18, N. Y.

TV CONVERSION PARTS ROUND-UP!

16" to 20" TV CONVERSION KIT

Illustrated Conversion Manual with Easy Step By Step Instructions Supplied With Each Kit

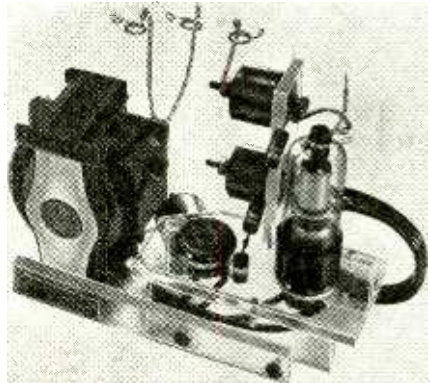

ASSEMBLED KIT FOR THE 630 CHASSIS

- Sub-Assembly (illustrated)
- Flyback Transformer #211T5
- Rectifier Tube #1B3
- Resistors & Condensers
- Set of 16" CRT Mounting Brackets

\$15.98

UNASSEMBLED KIT FOR ANY TV CHASSIS

(SAME SET OF COMPONENTS AS LISTED ABOVE)
Electrically the circuit remains the same. Unassembled form allows for modifications in mounting and wiring.

\$13.98

STANDARD GUARANTEED C-R TUBES

- 20"—RECTANGULAR (BLACK) \$64.89
- 19"—ROUND, METAL (BLACK) 54.74
- 17"—RECTANGULAR (BLACK) 39.63
- 16"—RECTANGULAR (BLACK) 36.97
- 16"—ROUND (BLACK) 36.97

**THE STREAMLINER.
MOST POPULAR
TV CABINET**

For all 16" to 20" CRT's
Center Drop Panel
Conceals Tuning Knobs.
In genuine
MAHOGANY or WALNUT
READY CUT FOR 630 TV
or
BLANK FOR ANY TV



\$74.98

H-42", W-26", D-25" Complete w/safety glass

UNIVERSAL CRT MOUNTING BRACKETS

Fits All
Picture
Tubes

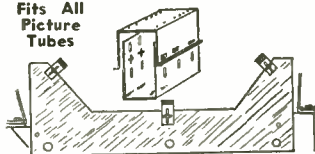

Complete—
incl. band
that holds
picture tube

\$6.97

Complete

CRYSTAL-CLEAR LUCITE MASKS

- 16"—ROUND — 13 1/2" x 17" \$5.97
- 16"—RECTANGULAR — 12 1/2" x 15 3/4" 5.84
- 17"—RECTANGULAR — 13 1/2" x 17" 5.97
- 19"—ROUND — 15 3/4" x 20" 7.69
- 20"—RECTANGULAR — 16 1/4" x 20 1/2" 7.98

ADDITIONAL TV CONVERSION PARTS

- DEFLECTION YOKE, 70° 206D1 \$3.98
- FOCUS COIL, 470 ohms, 202D2 3.42
- ION TRAP BEAM BENDER, (single) 203D179
- PLASTIC SLEEVE, for insulating 16AP4 1.88
- PLASTIC SLEEVE, for insulating 16GP4 1.88
- PLASTIC RING, for insulating rim 16" CRT 1.97
- PLASTIC SLEEVE, for insulating 19" CRT 1.96
- PLASTIC RING, for insulating rim 19" CRT 2.08

BROOKS RADIO & TV CORP.
84 Vesey St. Dept. A, New York 7, N. Y.

bad reputation caused by the work of half-trained "technicians."

ARTSNY also proposed that a group of radio technicians be chosen to act as a consultative body to any licensing authority set up by the council.

NEW SLATE FOR TEXAS GROUP

New 1951 officers of the Texas Electronic Technicians Association (TET) of Houston, Texas, are:

President—Frank J. Humpola (re-elected)

Vice-President—G. A. Brown

Secretary—Al Gaske

Treasurer—F. H. Lillard (re-elected)

The Houston association meets twice monthly, and since its beginning just a little over 18 months ago has increased its membership from the original 12 to a current 100.

SERVICING RESPONSIBILITY

"Divided responsibility" is the cause of much television service trouble, according to Victor H. Nyborg, president of the Association of Better Business Bureaus. In an article in the *American Magazine* entitled "Quacks of the Electronic Age," Mr. Nyborg states that the division of responsibility among the dealer, the repairman, and the manufacturer for the performance of a piece of equipment exists in this field as the first instance of such in business history. And it has led in some instances to what is known as the "three-cornered brush-off" familiar to set owners and service technicians alike, in which neither the service technician, the dealer, nor the manufacturer assume responsibility sufficient to satisfy the owner of the inoperative receiver. When the problem is not one of an inoperative receiver, but of dealer's representations as to performance, the situation becomes even more complex, as the repairman knows and the article proves.

Mr. Nyborg rejects licensing as a complete solution of the problem, by pointing out that it has not kept out the unscrupulous minority in such an old profession as medicine. He suggests that the remedy may be self-government by means of repairmen's organizations with defined codes of ethics and procedures strong enough so that the crooked service technician would flout them only at his peril. The Pittsburgh Radio Repair Men's Association is cited as an example, as well as combined groups in New York City, where dealers, the local service technicians' association, and the Better Business Bureau have co-operated to produce a fair practices code which is being used as a model in other cities.

OHIO CONFERENCE

Subjects to be presented at the National Conference on Airborne Electronics will range from Antennas and Components to Radar and Airborne Television. This conference will be held on May 23, 24, and 25 at the Biltmore Hotel in Dayton, Ohio.

—end—

AMPERITE
Studio Microphones
at P.A. Prices

Ideal for
**BROADCASTING
RECORDING
PUBLIC ADDRESS**

"The ultimate in microphone quality," says Evan Rushing, sound engineer of the Hotel New Yorker.

- Shout right into the new Amperite Microphone—or stand 2 feet away—reproduction is always perfect.
- Not affected by any climatic conditions.
- Guaranteed to withstand severe "knocking around."

Models
RBLG—200 ohms
RBHG—Hi-imp.
List \$42.00

"Kontak" Mikes
Model SKH, list \$12.00
Model KKH, list \$18.00

Special Offer: Write for Special Introductory Offer, and 4-page illustrated folder.

AMPERITE Company, Inc.
561 BROADWAY • NEW YORK 12, N. Y.
Canada: Atlas Radio Corp., Ltd., 560 King St. W., Toronto

TUBES? We have 'em in stock now!
FULLY GUARANTEED

7JP4	\$18.50	6J5GT	.60
10BP4	24.00	6J6	2.25
12LP4A	25.00	6K6GT	1.10
14BP4A	26.25	6S4	1.40
16GP4	35.25	6SA7GT	1.25
16HP4A	33.00	6SG7	.95
16RP4A	33.00	6SK7GT	1.25
17BP4A	34.00	6SN7GT	1.25
19AP4	59.95	6SN7WGT	2.00
20CP4A	57.50	6SQ7GT	1.25
OZ4/OZ4G	.90	6T8	1.50
1B3GT	1.65	6V6GT	1.30
1R5	1.40	6W4GT	1.25
1U4	1.00	6X4	.90
1X2A	1.60	6Y6G	1.10
2B7	1.30	7C5	1.10
3Q4	1.10	7C7	1.10
354	1.10	7C7	1.10
5T4	1.95	12AT7	1.75
5U4G	1.00	12AU7	1.25
6AC7	1.60	12BA6	1.10
6AG5	1.70	12BE6	1.10
6AG7	1.95	12BH7	1.85
6AH6	2.15	12SK7	.99
6AK5	2.25	12SN7GT	1.50
6AL5	.90	19T8	2.25
6AQ5	1.10	25L5GT	.95
6AU5GT	1.75	35C5	1.10
6AU6	1.25	35L6GT	1.00
6AV6	1.05	35Z5GT	.90
6BA6	1.25	50A5	1.50
6BC5	1.40	50C5	1.50
6BE6	1.35	50L6GT	1.00
6BQ6GT	1.75	1280	1.10
6BY5G	2.00	807	1.65
6CB6	1.20	304TH	13.95
6CD6G	3.50		

Terms: 25% with order. Balance C.O.D. Send Remittance in full and save C.O.D. charges. M'DSE. FOB N.Y.C.
"Subject to Prior Sale and Price Variations."
Rector 2-2563
BARRY ELECTRONICS CORP.
136 Liberty Street New York 6, N. Y.

W. L. Rothenberger, formerly assistant general sales manager of the RCA Tube Department, was promoted to the post of manager of sales operations. He will co-ordinate the activities of the Renewal Sales and Equipment Sales Sections. M. J. Carroll and H. F. Bersche continue as respective managers of the Equipment and Renewal Sales Sections. L. J. Battaglia was appointed manager of the Renewal Sales Field Force, and L. F. Holleran manager of Sales Administration. G. C. Brewster and M. R. Stoecker, newly appointed managers of the Sales Planning Section and the Product Distribution Section, report to Mr. Holleran.



W. L. Rothenberger

Lawrence Le Kashman, former assistant to the advertising manager, was promoted to manager of the Advertising and Sales Promotion Section of the RCA Tube Department. He reports to Julius Haber, advertising and sales promotion director for all RCA Technical Products. Mr. Haber was also named



L. Le Kashman

acting manager of Advertising and Public Relations for the Tube Department.

Leonard F. Cramer, vice-president and director of ALLEN B. DU MONT LABORATORIES, was named to head the company's newly formed Government Liaison Department. The new department will be responsible for defense mobilization planning and will work on armed forces contract negotiations.



Leonard F. Cramer

Edwin B. Hinck, active with ALLEN B. DU MONT LABORATORIES since 1943, was promoted to the post of sales manager of the Electronic Part Division. He succeeds Major Harry Van Rensselaer, who was recalled to active duty with the Air Force. Mr. Hinck will be responsible for the sale of new products and components manufactured by the Electronic Parts Division.



Edwin B. Hinck

Robert C. Tait and Fred R. Lack were elected co-chairman of the Joint Electronics Industry Committee sponsored by the RTMA and the National Security Industrial Association. The committee was established to co-ordinate industry mobilization activities.

MAY, 1951

"NO BOOK

in two generations, no book since Jules Verne, has undertaken to do what Hugo Gernsback in the first decade of our century has here so outstandingly achieved."

LEE DE FOREST
Father of Radio

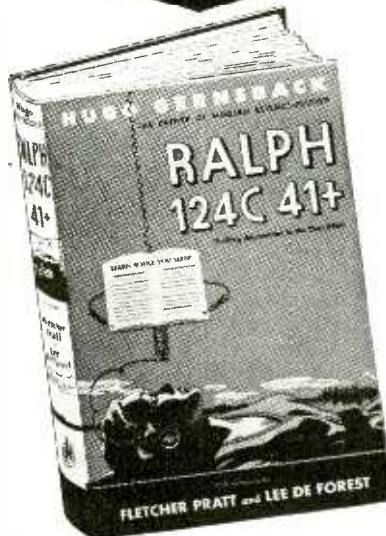

Forty years ago, Hugo Gernsback, Father of Modern Science Fiction, in this book, RALPH 124C 41+, predicted and described in startling detail, radar, the learn while you sleep method, television, televised operas, plastics, night baseball, blood transfusion, wire recording, micro film and a host of other scientific achievements—all undreamed of in 1911—but part of everyday life today.

All of these and scores more, not as yet realized, are found in his remarkable prophetic book. For Hugo Gernsback's prophecies are based not on fantasy but on the logical projections of established scientific facts.

RALPH 124C 41+ is the first and most remarkable true science fiction novel ever written! A whacking good adventure story that takes place in 2660 AD—but it is far more than fiction!

To technically minded people, RALPH 124C 41+ is the most complete and accurately documented catalog of scientific prophesy ever published. It was originally written in 1911 and published in book form in 1925. Now, because of its tremendous importance as a work of accurate, scientific prediction of the future, it has been reissued in a new, second edition.

Hugo Gernsback's writings were the spark that started many of today's top radio engineers and scientists on their way. Now again, this new edition of RALPH 124C 41+ may well be the inspiration for a new generation of pioneers of science.

RALPH 124C 41+ is the kind of book you should read. Order your copy now, only \$2.50 postpaid. The supply is limited.

RADIO PUBLICATIONS

25 West Broadway New York 7, N. Y.

MAIL THIS COUPON TODAY

RADIO PUBLICATIONS
25 West Broadway, New York 7, N. Y.

Gentlemen:

Send me a copy of RALPH 124C 41+ postpaid, at once. My remittance of \$2.50 is enclosed.

NAME.....
STREET.....
CITY.....ZONE.....STATE.....

**★ SERVICEMEN!
THERE'S BIG PROFIT IN
CONVERSION**

Wholesale Radio Has
Everything You Need

TO GET **20"** PICTURE
UP TO **AT LOW COST**

All The Width You'll Ever Need
With Plenty of Voltage To Spare

**SENSATIONAL NEW
H. V. TRANSFORMER**

Will furnish plenty of width and voltage for tubes up to 20". Will operate perfectly in nearly every make set. Will fit original flyback type transformer mounts. This high-efficiency-fer-rite-core transformer and a 20,000 v. 500 mm. condenser replacement will solve all your horizontal scan problems. No other power circuit replacements necessary. Order this sensational "8129" H.V. Transformer today. **\$6.60**

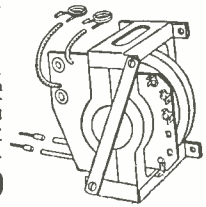

**G.E.—HYTRON—SHELDON
RECTANGULAR TUBES**

14BP4	26.25	17BP4A	39.35
14CP4	26.50	19EP4	61.75
16KP4	39.35	20CP4	66.35

70° DEFLECTION YOKES

Model		Stancor DY-7	\$6.45
DYB-130	\$4.50	Merit MD-70-F	6.60

FOCUS COILS

Model 202D2 or		Merit Focus Coil MF-2	\$6.60
----------------	--	-----------------------------	--------

**PLASTIC RECTANGULAR
MASKS**

14"	3.75	17"	5.65
16"	4.95	19"	7.20
		20"	7.50

**UNIVERSAL
BRACKET ASSEMBLY**

For RCA 630TS, 830TS and similar type chassis to mount all glass or metal, round or rectangular picture tubes from 12½" to 21".

Techmaster U-B Metal Brackets	\$4.65
Philmore Universal Bracket assm	8.25

FOR BEST TV RECEPTION

Rotate Antenna With

RADIART TELEROTOR



TR-2 with
direction
indicator
29.97

Durable, sturdy, weather-proofed. Reinforced die-cut housing. Precision gears. Positive stop at end of rotation. Reverses instantly. Mast, tower or platform mounting. Factory lubricated for life. Telerotor control gives immediate indication of antenna position.

8 Conductor Lead-In

Write for Free F. Y. I. Flyer
Address Orders to Dept. RE-5
or call Mulberry 2134

**WHOLESALE
RADIO PARTS CO., Inc.
311 W. Baltimore St.
BALTIMORE 1, MD.**

New York's Newest and Most Progressive Radio Supply House Invites You To Try Our...

- **GIANT RADIO SUPER-MARKET!**
Always Something New — An Entire Floor with Thousands of Standard and Surplus Radio Bargains. Help Yourself and Save!
- **LOWEST POSSIBLE PRICES!**
We will ship ANY Standard Item Shown in ANY Catalog At the Same Price or Lower, based on Current Costs.
- **ALL STANDARD MAKES!**
We Carry a Complete Stock of All Famous Makes of Radio, TV, Sound and Electronic Equipment.
- **COMPLETE SOUND STUDIO!**
All Famous Makes of High Fidelity Equipment are IN STOCK and ON DEMONSTRATION in our Elaborate Sound Studio.

FREE!

SEND for our New 1951 RADIO-TV-SOUND CATALOG The Most Complete, Informative Catalog-Manual Ever Published on High Fidelity Equipment!



HUDSON
RADIO & TELEVISION CORP.

212 FULTON ST • NEW YORK 7, N. Y.
Digby 9-1192 • OPEN THURSDAY EVENINGS UNTIL 9

LEARN

Television - Radio - OR Electricity
IN THE GREAT SHOPS OF **COYNE**

COYNE TRAIN QUICKLY!
OLDEST, BEST EQUIPPED SCHOOL of ITS KIND in U.S.
Young and Older Men

Come to the Great Shops of Coyne in Chicago. Get practical training in TELEVISION-RADIO or ELECTRICITY — vital in Defense Program. Prepare now for a better job or better service rating.

START NOW — PAY LATER

You can finance most of your tuition, pay for it later in easy monthly payments. Special plan for men of Draft Age. Part time employment service available.

GI APPROVED

FREE BOOK Clip coupon for Big Free Illustrated Book. Indicate below, course that interests you. No salesman will call. Act NOW.

An Institution not for Profit

B. W. COOKE, Pres.
COYNE Electrical & Television-Radio School,
500 S. Paulina St., Chicago 12, Ill. Dept. 51-81H

Send FREE BOOK and full details on:

TELEVISION-RADIO ELECTRICITY

NAME.....

ADDRESS.....

CITY..... STATE.....

James B. Lindsay was elected vice-president and director of THOMAS ELECTRONICS. He will direct the company's expanded production program in cathode-ray, miniature and subminiature television tubes. Mr. Lindsay has been active as a key electronic executive with several major companies.



James B. Lindsay

Louis Gerard Pacent, president of the PACENT ENGINEERING CORP., was awarded the Marconi Memorial Medal of Achievement by the Veteran Wireless Operators Association at its 26th Anniversary Dinner. Mr. Pacent received this award for his pioneer work in radio and communications. Captain George F. Shecklen, USNR, executive vice-president of the Radiomarine Corp. of America, also received the award.



Louis Gerard Pacent

R. M. Butler, distributor contact man in Philadelphia for the INTERNATIONAL RESISTANCE Co., was promoted to the position of assistant sales manager of the Merchandise Division servicing electronic distributors. J. F. Whitaker succeeded Mr. Butler in the Philadelphia area.



R. M. Butler

Arthur C. Stallman, Ithaca, N. Y.; Dahl W. Mack, Scranton, Pa.; W. D. Jenkins, Richmond, Va.; George Wedemeyer, Ann Arbor, Mich.; Hoyt C. Crabtree, Dallas, Tex.; and Lealis L. Hale, Monroe, La., were named by the Industry Advisory Committees of the National Production Authority to serve on the Electronic Parts and Components Distributors Industry Advisory Committee as members of the National Electronic Parts and Components Distributors Association.

Glen McDaniel, first full-time paid president of the RTMA, was named chairman of the association's Policy Committee. Other members include: Benjamin Abrams, EMERSON; Dr. W. R. G. Baker; GENERAL ELECTRIC; Paul Galvin, MOTOROLA; L. F. Hardy, PHILCO; Leslie F. Muter, MUTER CO.; A. D. Plamondon, Jr., INDIANA STEEL PRODUCTS; Robert C. Sprague, SPRAGUE ELECTRIC Co.; Robert C. Tait, STROMBERG-CARLSON; and R. G. Zender, LENZ ELECTRIC MFG. Co.

Personnel Notes

... Joseph T. Bozzelli, formerly with Brach Manufacturing Co., joined HAYDU BROTHERS, Plainfield, N. J., as general sales manager.

... R. O. Bullard was appointed manager of manufacturing of the GENERAL

TWIN-TRAX* TAPE RECORDERS



...give you more

MORE MODELS

the most complete variety of recorders for professional, semi-professional and experimenter use.

MORE FEATURES

for better quality, smoother performance and easier operation.

MORE VALUE

because our direct sales policy saves you dealer markups.

Send today for our catalog 5109 which lists complete technical specifications and performance ratings for all recorder models and accessories. *Trademark R

AMPLIFIER CORP. OF AMERICA

398 Broadway New York 13, N. Y.

BE YOUR OWN BOSS!

MAKE MORE MONEY



\$1.00 VALUE

25c

40,000 WORDS IN TEXT

NO ADS ALL "MEAT"!

In "CASH IN" you now get THE real money-makers — dozens of profitable tested mail order plans, confidential business secrets, dozens of practical tested formulas, successful tested schemes — actual experiences of men who have started on a shoestring — with less than \$10 capital. 25c a copy postpaid. Send U. S. stamps, money order, or coin.

Money Back Guarantee

NATIONAL PLANS COMPANY
1968 BROADWAY, NEW YORK 23, N. Y.



EVERY RADIOMAN

Can Use These SERVICE HINTS!

Valuable Manual Yours—FREE!

Every page of "How to Simplify Radio Repairs" is packed with on-the-bench, practical ideas. Contains photos, charts, diagrams—no fluff—no vague theory. In plain every-day language it gives you priceless suggestions—new servicing ideas. You'll use and benefit from the experience of experts. Partial list of contents: How to Localize Trouble; How to Service Amplifiers; How to Test for Distortions; How to Test Audio Circuits; How to Test Speakers; How to Find Faults in Oscillators; How to Test Radio Parts—and it's all yours—FREE! No obligation.



SEND COUPON OR PENNY POSTCARD FOR YOUR FREE COPY TODAY!

FEILER ENGINEERING CO., Dept. 5RC1
8026 N. Monticello Ave.,
Skokie, Ill. (Suburb of Chicago)

Please RUSH my FREE copy of "How to Simplify Radio Repairs."

Name.....

Address.....

City.....Zone.....State.....

RADIO-ELECTRONICS for

TESCO

SINGLE REFLECTOR CONICALS

- 1259—Single Bay 3/8" elements 3.90
- 1256—Single Bay 1/2" elements 4.69
- 1254—Double Bay 3/8" elements 8.15
- 1258—Double Bay 1/2" elements 9.65
- 1257—Four Bay 3/8" elements 18.15
- 1253—Four Bay 1/2" elements 20.99

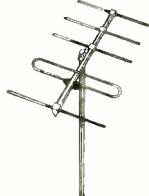

FIVE ELEMENT YAGI BEAMS

- 2002 to 2006—any lo channel.....10.62
- 2007 to 2013—any hi channel..... 3.93

- 1236—Single Bay Twin-V..... 4.58
- 1237—Double Bay Twin-V..... 9.15
- 1231—Four Bay Conical..... 20.85
- 1230—Double Bay Conical..... 9.56
- 1243—Swift Rig Folded Hi Straight Low..... 4.75
- 1240—Single section conical—lots of 6..... 2.05
- 1219—Swift Rig Folded Hi Straight Low..... 4.92
- 2113—Deluxe Indoor Antenna..... 2.48
- 1860—Chimney Mount..... Dozen Lots 1.54
- 1995—3 1/2" Mast Snap-On Standoff, per 100..... 4.00
- 1873—3 1/2" Mast Standoff Insulator, per 100..... 6.50
- 1872—4" Nail-In Insulator, Lots of 250..... .025
- 1870—3 1/2" Wood Screw-Eye Insulator, Lots of 250..... .025
- 1229—Single Bay Conical..... 4.58
- 1231—Four Bay Conical..... 20.85

Send for quantity prices and complete list

TELEVISION SUPPLY CO.

Box 213 Gracie Station New York, N.Y.



TV TOOL HOLSTERS

No. 24 TOOL HOLSTER Similar to electrician holster except side pockets not attached, making the overall dimensions 5 x 9 inches.

YOUR COST \$2.95

No. 25 ELECTRICIAN HOLSTER—5 Pockets. Stitched with seven cord top quality linen hat wax thread, and lock to solid harness leather back with steel rivets. Pockets made of pliable form fitting Russet leather. Special designed snap allows tool to be removed by use of one hand upward motion. Overall dimensions are: 8 x 9 inches.

YOUR COST \$3.95

10% CASH WITH ORDER

ALMO RADIO CO.
 1509 ARCH STREET • Philadelphia
 6205 MARKET STREET • West Phila.
 6th & ORANGE STS. • Wilmington
 4401 VENTNOR AVE. • Atlantic City

TELEVISION RECEIVER—\$1.00

Complete instructions for building your own television receiver. 16 pages—11"x17" of pictures, pictorial diagrams, clarified schematics. 17"x22" complete schematic diagram & chassis layout. Also booklet of alignment instructions, voltage & resistance tables and troubleshooting hints.—All for \$1.00. Write for free catalogue.

CERTIFIED TELEVISION LABORATORIES
 Dept. C, 5507-13th Ave., Brooklyn 19, N. Y.

ELECTRIC Tube Divisions. Formerly a staff assistant of the Tube Divisions, he has been with General Electric for 20 years.

... Harold J. Schulman, active in television servicing activities in the New York City area since 1946, joined ALLEN B. DU MONT LABORATORIES as service director of the Teleset Service Control Department.

... C. M. ("Buck") Lewis was named manager of the Broadcast and Communications Sales Section of the RCA Engineering Products Department. He was formerly manager of Broadcast Field Sales for the Engineering Products Department.

... Andrew F. Stanier was elected president of EUREKA TELEVISION AND TUBE CORP. He succeeds William R. Holt who resigned. Mr. Stanier will continue as chief engineer. Frank X. Wells, former chief maintenance supervisor, succeeds Mr. Holt as chief maintenance engineer. Mr. Holt will continue as chief engineering consultant as well as a member of the board of Eureka.

... D. E. H. Schulz, chairman of the Electrical Engineering Department at Armour Research Foundation of ILLINOIS INSTITUTE OF TECHNOLOGY, was elected president of the National Electronics Conference, Inc. Dr. W. G. Dow of the electrical engineering department at the UNIVERSITY OF MICHIGAN was made chairman of the board.

... Allen Henry, advertising manager of BELMONT RADIO CORPORATION, manufacturer of Raytheon television sets, was appointed contracts administrator for the company. He will retain supervision of television advertising. The company also appointed William Garstang, Midwest regional sales manager for Belmont, as contracts co-ordinator, technical products.

... Frank Freimann, president of MAGNAVOX Co., was elected a member of the RTMA Board of Directors by the Set Division Executive Committee to replace Richard A. O'Connor, chairman of the Board of MAGNAVOX, who resigned.

... Ray F. Crews was appointed vice-president in charge of sales for the FAIRCHILD RECORDING EQUIPMENT CORP.

... F. J. Cooke joined the REEVES SOUNDRAFT CORP. as general manager of the Colorcraft and Magnetic Tape Divisions. He was formerly an engineering executive with Remington Rand Electronic Tube Laboratory.

... L. W. Howard of TRIAD TRANSFORMER Co. was elected as the West Coast Electronic Manufacturers Association representative to the Radio Industry Co-ordinating Committee and the 1951 Parts Distributors Show.

... Jerome Tannenbaum and Bill Cameron joined the CONCORD RADIO CORP., Chicago, respectively as chief engineer of the Audio Division and store manager.

... Harry D. Hanafus was named purchasing agent for the newly formed Electronic Tube Division of the WESTINGHOUSE ELECTRIC CORP.

... W. E. Darden rejoined the HAMLUND MANUFACTURING Co. as gen-

PLATT SAVES YOU MORE



... so why not order by mail or visit PLATT'S BIG RETAIL STORE at 489 BROOME ST., NEW YORK CITY.

HEADSETS

- HS-33 low impedance with cord and plug, used, fine condition..... \$1.89
- HS-23 high impedance..... BRAND NEW with ear pads..... 3.25
- HS-33 low impedance..... BRAND NEW with ear pads, cord and PL54 plug..... 4.00
- TH-37A—1200 ohms with dual plugs..... 2.95
- HS-30 with ear plugs, low impedance, used, good condition..... .89

BEACON RECEIVER BC-438

Manufactured by Detroit

Frequency Range—200 KC to 400 KC, IF Frequency—142.5 KC Receiver Sensitivity—5 Microvolts for 10 Milliwatts output. Output Impedance—300 ohms and 4000 ohms to be selected internally. Power Output—150 Milliwatts. Volume control RF Gain Control, Power Supply—24-28 Volts Aeroplane Battery. Current—1.0 Amperes 6 tubes.



\$10.95
 BRAND NEW—ONLY



TS-268/U CRYSTAL RECTIFIER TEST SET

Brand New—complete with set of spare parts..... \$39.95



SCR-27N COMMAND and ARC-5 EQUIPMENT

- | RECEIVERS | | USED | NEW |
|-----------------------|--|------|---------|
| BC-453—190 to 550 KC | | | \$12.95 |
| BC-454—3 to 6 MC | | | 7.95 |
| BC-455—6 to 9 MC | | | \$11.95 |
| R-23—ARC 5—190-550 KC | | | 21.95 |

- | TRANSMITTERS | | | |
|------------------------|--|-------|-------|
| BC-457—4 to 5.3 MC | | 5.95 | |
| BC-458—5.3 to 7 MC | | 5.95 | 10.95 |
| BC-696—3 to 4 MC | | 14.95 | 24.95 |
| T-19—ARC 5—3 to 4 MC | | | 24.95 |
| BC-459—7 to 9.1 MC | | 12.95 | 24.95 |
| T-22—ARC 5—7 to 9.1 MC | | 12.95 | 24.95 |

- ### ADDITIONAL EQUIPMENT
- BC-456 Modulator..... 2.25 3.25
 - BC-450 Control Box (3 Receiver)..... .98 1.95
 - BC-451 Control Box (Transmitter)..... .88 1.49
 - BC-442 Relay Unit (ANT)..... 1.95 2.95
 - Plugs: PL-147, 148, 151, 152, 153, 154, 156—EACH..... .75
 - Flexible Shafting with gear to fit Receivers..... 2.25 1.69
 - 3 Receiver Rack.....
 - 2 Transmitter Rack..... 1.69



FIELD TELEPHONES

Army surplus, completely reconditioned and electrically tested, using 2 flashlight cells and a pair of interconnecting wires.

GUARANTEED—like new..... ONLY \$15.95



BC-223 TRANSMITTER

A 30 watt Transmitter ideal for ship-to-shore or Ham Rig. Crystal or MO control on four pre-selected channels. 2000 to 5250 KC. Use of 3 plug-in coils, five tubes:

- 2—801 and 3—46, and TU 17-18-25 tuning units.
- TRANSMITTER..... \$25.95
- TUBES..... 3.75
- TUNING UNITS..... 2.25 ea.
- PE-125 VIBRATOR POWER SUPPLY FOR BC-223..... \$18.95

WRITE FOR OUR FREE CIRCULAR!

MINIMUM ORDER \$2.00

Immediate Delivery—Send 25% deposit on C.O.D. order. All shipments F.O.B., N.Y.C. (N.Y.C. residents add sales tax to your remittance.)

PLATT ELECTRONICS CORP.
 Dept. B, 489 Broome St., N.Y. 13, N.Y.
 Phones: WO 4-0827 and WO 4-0828

MAKE ANTENNA MOUNTING EASIER with PENN TELEVISION PRODUCTS!

Manufacturers of Precision Engineered Mountings and Fittings for All TV Installations

UNIVERSAL PEAK ROOF MOUNT PRA-150

A heavy Cast Aluminum mount, especially designed to arch over the crown tile of peak roofs. Patented bearing permits locking in any position with turn of bolt. Swivels into position for quick use! Patented tongue gives firm support to mast from 3/4" to 2".

Write today to TV SALES DEPT. for descriptive literature and dealer prices on the complete PENN TV PRODUCTS LINE!

PENN TELEVISION PRODUCTS CO.
3336-38-40 Frankford Ave., Phila. 34, Pa.

LOVE THAT QUICK-WEDGE!

I use it instead of a conventional screwdriver!

Quick-Wedge SCREW-HOLDING SCREWDRIVER

unconditionally guaranteed

ASK FOR IT AT YOUR DEALER
KEDMAN CO. • 233 S. 5th WEST • SALT LAKE CITY, UTAH

Diamond Phono Needles

The one perfect phonograph needle is the Professional Diamond.

Professional, broadcast-station-quality Diamond Needle offers you: 1) elimination of record wear, 2) continuous high-fidelity reproduction, 3) savings up to several hundred dollars on sapphire or osmium needle replacements.

Purchase of a diamond needle can be the wisest investment you ever made... IF you get the best available needle!

IMPORTANT FACTS TO REMEMBER—Under a different trade name we manufacture the great bulk of the diamond styli used in broadcast station equipment. Every stylus we make, regardless of its ultimate destination—radio station or individual user—is of the same unexcelled, unconditionally guaranteed quality. Our styli should NOT be confused with five and ten dollar 'diamond needles'.

We can supply Professional Diamond Needles to replace practically any removable needle. (GE styli we re-tip). Tandem-tip needles can be tipped with LP diamond only, if desired. In all cases send used sample needle (s) with order. \$15.50 each, less 10% if both LP and 78 are ordered at same time. We can also supply cartridges with diamond styli, changers, etc. Let us know your needs. Prices and information furnished without obligation.

TELEVEX 484 West 238th St. New York 63, N. Y.

COLOR TONE ON YOUR TELEVISION!

Simply attach TELECOLOR FILTER to front of set and enjoy favorite programs in wonderful glorious color tones instead of dull black and white. TELECOLOR FILTER is one of the latest discoveries, its special formula coloring gives brilliant, pleasing, genuine color tone, life like color depth, reduced eyestrain and glare. See our January ad—page 114—Free information! Write Dept. RE-5

ORDER BY MAIL

10 inch	\$3.00
12, 14 inch..	4.00
16, 17 inch..	6.00
19, 21 inch..	10.00

HARVARD LABORATORY • 659 FULTON STREET • BROOKLYN 1, N. Y.

→ ARE TUBES YOUR PROBLEM? ~

TUBES

Draw from one of the largest inventories in the East

RADIO — TELEVISION — TRANSMITTING

Write or Phone → **Louis H. Grossberg**

SEND FOR pamphlet of 1,000,000 non-critical receiving tubes—excellent as substitutes—up to 90% off list.

SOLO ELECTRONIC SALES CORP.
190 Washington Street, New York 7, N. Y.

eral sales manager for the company. . . . H. Leslie Hoffman, president of the HOFFMAN RADIO CORP., was awarded a plaque by the San Francisco Academy of Television Arts and Sciences. The plaque was awarded for his company's contributions to the television industry and for his outstanding public service.

. . . W. G. (Bill) Many resigned as advertising and sales promotion manager of the CORNELL-DUBILIER CORP., to open his own public relations service.

. . . Russell G. Eggo, B. L. Bethel, Charles E. Palmer, Lewis G. Woycke, and Charles L. Hubbard were elected vice-presidents of JOHN MECK INDUSTRIES. John S. Meck was re-elected president and G. F. Meck treasurer.

. . . Arthur L. Reese, former West Coast regional manager of the Communications and Electronics Division of the Motorola Co., was named marketing manager of the Microwave and the Carrier and Control Sections of the company.

. . . George E. Smith was elected to the Board of Directors of the SIGHT-MASTER CORP.

. . . Henry Schneider, formerly with STEWART-WARNER, joined the PENTRON CORP. as special assistant to the director of purchasing.

. . . Robert Sebris, a Swiss instrument and meter engineer, joined OAK RIDGE PRODUCTS engineering staff.

. . . Henry Fogel was named executive vice president of the newly reorganized MCMURDO SILVER Co., New York City. He was previously with Tele-Tone Radio Corp.

. . . George A. Engelbert was promoted from assistant section chief to section chief, technical publications of Bendix Radio Division of BENDIX AVIATION.

. . . Joseph W. Fleming, manager of the Technical Information Center for PHILIPS LABORATORIES, was killed in an automobile accident in Edgewater, N. J.

—end—

PRE-1925 ELECTRIC LAMPS CAUSE TV INTERFERENCE

Ancient light bulbs can cause TVI, as mentioned in a Technote in the April RADIO-ELECTRONICS. Information from General Electric's Lamp Department reveals that bulbs of pre-1925 manufacture are the main offenders. These lamps have straight-wire filaments which radiate directly to the antenna circuit of the TV set. The interference appears as a horizontal pattern at one to three places on the screen.

Most of these lamps are probably located in hallways, attics, or basements, where they are used intermittently. Since frosted bulbs came into use about the same time as the coiled filament, usually the trouble is found to be caused by clear glass bulbs of older vintage.

One way of identifying this type of interference is by its intermittent character, as these lamps are turned on only occasionally.

RADIO-ELECTRONICS for

TV'S THE THING

Dear Editor:

I am a student at the Baltimore Technical Institute, which is the largest radio and television school in Maryland. I have completed radio and am now in TV. . . . In the last few months you have been printing a lot of valuable TV servicing information, such as the "Television Service Clinic" and a couple of others. The Service Clinic I think is very good and I hope you will continue it.

ALBERT BEHRENS

Dundalk, Md.

MORE ON TUBE CARDS

Dear Editor:

I would like to make a suggestion to Mr. J. R. Woollard of Nashville, Tennessee, regarding his idea of tube data on cards.

RCA has a Triple Pindex in which Mr. Woollard will find the tube diagrams large enough and there is enough room for any further reference data to be added.

I would like to add that I appreciate reading your magazine, especially the important contribution by Mr. Buchsbaum ("TV Service Clinic"), which is a great help to all service technicians.

F. G. WITNEY

Brooklyn, N. Y.

(This method might be satisfactory. We still feel, however, that some manufacturer is missing a bet in not putting out a card-index type of tube data book, possibly with the base diagrams on the back of the cards to permit a clearer drawing. It could be kept perpetually up to date with supplements as new tubes are produced.—Editor)

FM FOR AUTOS

Dear Editor:

Why doesn't the automobile industry manufacture and install frequency modulation radio receivers in their horseless chariots? Even when purchasing a Cadillac, one must buy an AM radio set.

CLYDE D. KIEBACH

Washington, D.C.



Suggested by N. Blev, Sarasota, Florida

My husband says he thinks it is a condenser . . ."



"It's Extra Dollars For Me.."

with **Jensen NEEDLES**

Increase your income 50% annually by selling a needle on every service call. It's easy to suggest a new needle when servicing a TV or radio set . . . the easiest dollars you ever made!

FREE!

Jensen's New 1951 Needle Wall Chart Tells You What To Use



JENSEN REPLACEMENT NEEDLE KIT

Contains the most popular sellers. Enables you to take care of 90% of all replacements. Get your kit and free wall chart from your jobber today.



Jensen INDUSTRIES, INC.

329 So. Wood St., Chicago 12, Ill.

WANTED
50 RADAR PARTS
Write or Call
World Wide Packing & Shipping Co.
350 Pearl St. Brooklyn, N. Y. MA 4-8371

RADIO TUBES
At bargain prices
Also complete stock of radio parts and electrical equipment at low prices.
Write for price list
OREGON BARGAIN SUPPLY
Box 31 La Grande, Oregon

IF YOU EXPECT TO BE IN UNIFORM OR IN ESSENTIAL INDUSTRY, TAKE THIS WISE STEP TO QUALIFY FOR A **Top Job & Good Pay**
IN RADIO—TELEVISION
ELECTRONICS

Whether you want a career in the electronics industry, or plan to enter military service, CREI Residence School training is your key to a better job at higher pay. Important firms like RCA-Victor, Bendix, and United Air Lines use CREI training for their technicians. During World War II CREI trained thousands for the Armed Services.
SEND FOR ILLUSTRATED FREE CATALOG. Get details of course and school, with survey of job opportunities. Classes start twice a month. Veterans! Training available under GI Bill. July 25, 1951 is deadline for most veterans. Don't delay! Write Dept. 305C now.
CAPITOL RADIO ENGINEERING INSTITUTE
An accredited Technical Institute Founded in 1927
Dept. 305C, 16th & Park Rd., N.W., Wash. 10, D. C.

NEW TELEVISION and RADIO TUBES IN STOCK

LARGE QUANTITIES—STANDARD BRANDS
—WRITE FOR DEALER'S DISCOUNTS

Very Low Prices for Quantity Orders				
1B3	6AQ5	6F7	6W4	12SH7 50A5
1T4	6AR6	6G6G	654	12SL7 50C5
2A5	6AT6	6H6	6X5	12SN7 50L6
3A4	6AU6	6J5	6Y6G	14E6 56
354	6AV6	6J6	7F8	25L6 59
3V4	6BB	6K6	12A6	25Z6 71A
5U4	6BA6	6L7	12A8	25Z6 85
5Y3	6BC5	6SH7	12AU7	33 95A
6A6	6BG6G	6SK7	12BA6	34 5687
6AC7	6BL7GT	6SL7	12J5GT	35Z5 VR90
6AG5	6BQ6	6SN7	12K8GT	36 VR105
6AK5	6C4	6T8	12Q7	37 VR150
6AL5	6C8	6V6	12SG7	38

YOUR MONEY RETURNED IN FULL—

If the **New Regency Television Booster** fails to improve your television enjoyment! Bring your picture out of the snow and reduce interference!
• Push-Pull Neutralized triode design assures high gain without adding snow.
• No external impedance matching devices required.
• Inductive tuning assures same high-gain wide-band operation on all channels.
• Single knob tuning control.
• Underwriters approved with 90 day RMA guarantee.
LOWEST Price—ONLY **\$19.11**

MODEL NFRD—RADIO NOISE FILTER

If it doesn't work, send it back!
We absolutely guarantee that our Model NFRD will eliminate all line noises when properly connected to radios, television sets, short wave sets, motors, electric shavers, refrigerators, vibrators, oil burners, transmitters, and all other sources of interference. This unit will carry up to 12 amperes or 1 1/4 KW of power and may be used right at the source of interference or at the radio.
Small size only 3"x1 1/2"x7 1/2". Very low price only
Each **\$1.95**

A SCIENTIFICALLY DESIGNED PHONO SCRATCH FILTER

Resonated at approximately 4500 cycles effectively reducing objectionable needle scratch without altering the brilliancy of reproduction.
Contains a HI-Q SERIES resonated circuit. Tested by means of an audio oscillator and an oscilloscope to give 22 db attenuation with very low signal loss.
EASY TO ATTACH
Just two wires to clip on. Compact
Price **\$1.98**

THREE TUBE PHONO AMPLIFIER

An assembled unit ready for installation using tone and volume control and six feet of rubber cord **\$2.95**
(Not including Tubes)
With Complete Set of Tubes **\$3.95**

PHONO OSCILLATOR

Wireless phono oscillator transmits recording for crystal pick-ups or voice from carbon mike through radio without wires. Can also be used as an intercomm by using P.M. speaker as mike. **\$2.95**
Price (excluding tubes) **\$2.95**
With Complete Set of Tubes **\$3.95**

NEW HIGH FIDELITY 12" COAXIAL SPEAKER

Because of the very low price, we cannot mention the well-known manufacturer's name. Has a built-in dividing network—an ideal Woofer-Tweeter combination. Rated at 12 watts, impedance 8 ohms.
Price **\$18.50**

Satisfaction guaranteed on all merchandise
All prices F.O.B. New York City
WRITE FOR FREE CATALOGUE T5

RADIO DEALERS SUPPLY CO.

154 Greenwich St. New York 6, N. Y.

MOST-OFTEN-NEEDED 1951 TELEVISION SERVICING INFORMATION, compiled by M. N. Beitman. Published by Supreme Publications, Chicago, Ill. 8 1/2 x 10 3/4 inches, 192 pages. Price \$3.00.

The latest edition to be added to the Most-Often-Needed series is, as its title implies, a compilation of service data on this year's crop of TV receivers. It contains schematic diagrams, alignment instructions, drawings showing placement of parts, and set manufacturer's latest production changes.

The material is arranged to serve as a quick and easy guide for the busy repairman who is not interested in wading through a lot of theory and explanation when he has a broken down set on his bench to repair.

Because the sets built in the period covered by this book were built during parts shortages, production changes were frequent. These are covered by the book wherever possible.

The value of this book of up-to-date servicing data need not be stressed to the working television service technician. The active TV experimenter and constructor will also find much of the data and circuitry contained in the book useful when modernizing or revamping an older set.—RFS

SUPER-REGENERATIVE RECEIVERS, by J. R. Whitehead. Published by Cambridge University Press, New York, N. Y. 5 1/2 x 8 1/2 inches, 169 pages. Price \$4.75.

Prior to the war little technical information was available on the design of superregenerative detectors. Judging from the published information, engineers knew comparatively little more than the rank amateur who was aware that they were tricky circuits which—with all their squeals and whistles—were, on occasion, capable of running rings around a superheterodyne designed to receive on the same frequencies.

The demand for simple, reliable v.h.f. radar receivers having high sensitivity and selectivity led to extended research on the superregenerative detector. As a result of this work, the author submits design data which makes possible the solution of such problems as: how signal-to-noise ratio compares with that of a superheterodyne, what is the optimum relationship between signal and quench frequencies for receiving different types of transmissions, how do various design factors affect gain and selectivity. The data which leads to the solution of these and other problems is substantiated by graphs, oscillographic patterns, and several practical diagrams.

The author uses higher mathematics to explain many of the phenomena and to develop design factors, but this does not make the book less useful from a practical standpoint. The author's clear, easy-to-read style and the many simplified design formulas make the work highly useful to students or engineers who may lack the background or inclination to wade through the more complex mathematical derivations and analyses.—RFS

—end—

OPPORTUNITY AD-LETS

Advertisements in this section cost 35c a word for each insertion. Name, address and initials must be included at the above-rate. Cash should accompany all classified advertisements unless placed by an accredited advertising agency. No advertisement for less than ten words accepted. Ten percent discount six issues, twenty percent for twelve issues. Objectionable or misleading advertisements not accepted. Advertisements for July issue must reach us not later than May 31, 1951.
Radio-Electronics, 25 W. Broadway, New York 7, N. Y.

SPEAKERS REPAIRED at wholesale prices. Guaranteed workmanship. Jobbers wanted. Amprite Speaker Service, 70 Vesey St., New York 7, N. Y.

JOBBS JOBS JOBS If you have had training or experience, or have a degree in either the electrical, aircraft, or petroleum field, and wish to obtain a job that you will be proud of, with the highest salary paid—according to your qualifications, then contact our office at once. The jobs are open, and we will place you immediately. No charge what-so-ever. Associated Research Services, 3126 Pawnee Road, Wichita, Kansas.

MAGAZINES (BACK DATED)—FOREIGN, DOMESTIC—Arts, Books, booklets, subscriptions, pin-ups, etc. Catalog 10c (refundable). Cicerone's, 86-22 Northern Blvd., Jackson Heights, N. Y.

USED CORRESPONDENCE COURSES and Educational Books Bought, Sold, Rented, Catalog Free. Educational Exchange, Summerville, Ga.

WE REPAIR, EXCHANGE, SELL, ALL TYPES OF electrical instruments, tube checkers and analyzers, Hazleton Instrument Co. (Electric Meter Laboratory), 140 Liberty Street, New York, N. Y. Telephone—BARclay 7-4239.

LANCASTER, ALLWINE & ROMMEL, 436 Rowen Building, Washington, D.C. Registered Patent Attorneys. Practice before United States Patent Office. Validity and Infringement, Investigations and Opinions. Booklet and form "Evidence of Conception" forwarded upon request.

WANTED: AN/APR-4, other "APR-", "ARR-", "TS-", "TE-", "ARC-1, ARC-3, ART-13, everything Surplus. Special tubes, Tech Manuals, Lab quality Test Equipment, etc. Describe, price in first letter. Littell, Farhills Box 26, Dayton 9, Ohio.

RADIO—TELEVISION—ELECTRONICS—TUTORING \$5 per lesson—Mo. Tech., 3907 North 25th Street, St. Louis 7, Missouri.

PHONOGRAPH RECORDS CHEAP. Catalogue, Paramount, PP-313 East Market, Wilkes-Barre, Penna.

SNIPERSCOPES & SNOOPERSCOPES WANTED. Any type, any condition. Needed immediately. Precise Company, 942 Kings Highway, Brooklyn 23, New York.

AMATEURS—RADIO AND ELECTRICAL RESEARCH Engineering, H7 Twillmann, R.R.#1, Chesterfield, Mo.

Consecrated to Quality Output
and Golden Rule Service

ASTRON
Fixed Capacitors and
RF Interference Filters

Write for
catalogue

ASTRON CORPORATION — 255 Grant Ave., East Newark, N. J.

COUPON-OF-THE-MONTH

- SAPPHIRE PHONO NEEDLES (LIST \$2.50) 2 for \$0.99
- A. C. CORD & PLUG SET 6FT. 5 for .99
- VOL. CONTROLS—STD. BR. 5 Meg. W, SW. 3 for .99
- CONDENSERS—40-20 MFD 150V (PP) 2 for .99
- CONDENSERS—20-20 Mfd. 150V. 3 for .99
- LOOP ANTENNA—HI GAIN (5"x8") 3 for .99
- OUTPUT TRANSFORMERS (FOR 50L6) 2 for .99
- OSC. COILS 455 KC (for 12SA7) 4 for .99
- BY PAS COND. KIT—18 Asstd.99
- DIAL CORD KIT—100 ft. Asstd. & 6 Springs.99
- GRILLE CLOTH—6 Asstd. 6"x6" & 10 Knobs.99
- COMBINATION KIT—All Above Items—Only. 10.00

WITH THIS COUPON—ORDER AT ONCE
Write for Monthly Coupons and Bulletin
RADIO DISTRIBUTING CO., Pasadena 18, Cal.

AUDIO ENGINEERING SCHOOL

Practical engineering training in Audio fundamentals, Disc, Film, Magnetic Recording, and Audio frequency measurements.
Studio training simulates Broadcast, Motion Picture, Television, and Commercial Recording work.
Approved for Veterans

HOLLYWOOD SOUND INSTITUTE, Inc.
1040-E North Kenmore, Hollywood 27, Calif.
Specify if Veteran or Non-Veteran

Prepare Now!
RADIO ENGINEERING

B. S. DEGREE IN 27 MONTHS

Complete Radio Engineering course incl. Telev., U.H.F. and F.M. BS Degree Courses also in Mech., Civil, Elect., Chem. and Aero Eng.; Bus. Adm., Acct. Extensive campus, modern buildings, well equipped labs. Low cost. Prep. courses. Personalized instruction. Heavy demand for graduates. Placement service. Founded in 1884. Prepare now for the civil and military opportunities ahead. **VETERANS:** You may still obtain training and a college degree at Tri-State College under present G.I. Bill. Last opportunity for new students to enroll is Summer Quarter, June 11, 1951. Hundreds of Tri-State veteran graduates are holding responsible positions with unlimited opportunities for future advancement. Enter March, June, Sept., Jan. Write for Catalog.

TRI-STATE COLLEGE
2451 COLLEGE AVE. ANGOLA, INDIANA

RADIO COURSES

- RADIO OPERATING • CODE
- RADIO SERVICING • ELECTRONICS
- F.M. TELEVISION

Preparation for Civilian, Maritime, Army and Navy license requirements.
Write for Catalog TE

TRADE & TECH. SCHOOL 229 W. 66 St., N. Y. 23
INDICOT 2-8117

TELEVISION

PREPARE FOR A GOOD JOB!
COMMERCIAL OPERATOR (CODE)
RADIO SERVICEMAN
TELEVISION SERVICING
BROADCAST ENGINEER

Approved for Veterans
SEND FOR FREE LITERATURE
BALTIMORE TECHNICAL INSTITUTE
1425 Eutaw Place, Dept. C, Baltimore 17, Md.

RADIO ENGINEERING DEGREE IN 27 MONTHS

Intensive, specialized course including strong basis in mathematics and electrical engineering, advanced radio theory and design, television. Modern lab. Low tuition. Self-help opportunities. Also 27-month courses in Aeronautical, Chemical, Civil, Electrical, and Mechanical Engineering. Approved for U.I.'s. Enter June, Sept., Dec., March. Catalogue
INDIANA TECHNICAL COLLEGE
165 E. Washington Blvd., Port Wayne 2, Indiana

TELEVISION
Laboratory and theoretical instruction covering all technical phases of Radio, P.M. Television. Leads to opportunities in Broadcasting, Industry or Own Business.
TOTAL TUITION \$450. NO EXTRAS.
Morn., Aft., or Eve. Small Weekly Payments.
Approved for Veterans. Enroll Now.
RADIO-TELEVISION INSTITUTE
Pioneers in Television Training Since 1938
480 Lexington Ave., N. Y. 17 (46th St.)
Plaza 9-5665 Licensed by N. Y. State

RCA RADIO and TELEVISION
Thorough Training For Men and Women in All Technical Phases
APPROVED FOR VETERANS
DAY-EVENINGS WEEKLY RATES
FREE PLACEMENT SERVICE FOR GRADUATES
For Free Catalog Write Dept. RC-51
RCA INSTITUTES, Inc.
A Service of Radio Corporation of America
350 WEST 4TH STREET NEW YORK 14, N. Y.

RADIO ENGINEERING
FM—Television—Broadcast

Police Radio, Marine Radio, Radio Servicing, Aviation Radio and Ultra High mobile applications. Thorough training in all branches of Radio and Electronics. Modern laboratories and equipment. Old established school. Ample housing facilities. 7 acre campus. Small classes. enrollments limited. Our graduates are in demand. Write for catalog.

Approved for Veterans
VALPARAISO TECHNICAL INSTITUTE
Dept. C VALPARAISO, INDIANA

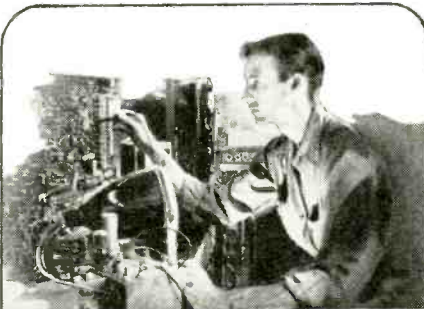

ENTER RADIO-TV ELECTRONICS

thru this Proven Plan

As a young man with a career to build, you may today be interested primarily in training for Radio — and perhaps for TV. But — *who knows* . . . you may some day have both the desire and opportunity to climb further and become an Electrical Engineer! Here, then, is a world-renowned educational plan that permits you to use your Radio training as a major stepping-stone to an even greater career.

IN 12 MONTHS BECOME A RADIO TECHNICIAN

Train here for radio shop operator or serviceman, mobile receivers and all types of transmitters, and for supervision of service personnel. You may then advance immediately, or at any future date, into courses described below.

IN 6 ADDITIONAL MONTHS you become a Radio-Television Technician

An additional 6-months course gives you intensive TV Technician's training — under the *personal guidance* so necessary in this expanding field.

ALSO...YOUR RADIO COURSE IS FULL CREDIT TOWARD THE B.S. DEGREE IN ELECTRICAL ENGINEERING

The Radio course, while complete in itself, is *one-third* of the college program (major in Electronics). Further — you are guided scientifically toward specialization beyond basic engineering training.



B.S. DEGREE IN 36 MOS.
Military, practical or prior academic training evaluated for advanced credit. Terms open July, October, January, April.

MILWAUKEE SCHOOL OF ENGINEERING

Technical Institute • College of Electrical Engineering

FREE—Write for "Occupational Guidance Manual" and 1951 Catalog.

MILWAUKEE SCHOOL OF ENGINEERING
Dept. RE-551, 1020 N. Broadway
Milwaukee, Wis.

Without obligation, mail Occupational Guidance Manual on:

Radio-TV Electrical Power Welding
 Heating, Refrigeration, Air Conditioning
Also send 1951 Catalog for Electrical Engineering, B.S. degree in Electric Power Electronics

Name..... Age.....
Address.....
City..... Zone... State.....
 Check if World War II Veteran

LEARN DAY and EVENING CLASSES TELEVISION

ELECTRONICS-RADIO
Modern Laboratory Instruction in

- SERVICING
- BROADCAST OPERATING
- ELECTRONIC and TV ENGINEERING

G.I. APPROVED

WRITE FOR ILLUSTRATED CATALOG
ELECTRONICS INSTITUTE, Inc.
21 HENRY, DETROIT 1, MICH.

RADIO COURSES

Preparatory Mathematics, Service, Broadcast, Television, Marine Operating, Aeronautical, Frequency Modulation, Radar.

Classes now forming for the Summer term beginning June 1st
Entrance exam, May 21st
Veterans. Literature.

COMMERCIAL RADIO INSTITUTE
(Founded 1920)
38 West Biddle Street, Baltimore 1, Md.

PRESENTING...

A NEW department of the DON MARTIN SCHOOL OF RADIO AND TELEVISION ARTS AND SCIENCES . . . for instruction and training in—
TELEVISION—Incorporating:

Production: Writing, Directing, Producing, Acting, Staging, Lighting.
Engineering: Transmission, Receiving, Camera and Studio, Operation, Theory of Video, Pickup and Reproduction.

Approved for veterans.

THE DON MARTIN SCHOOL OF RADIO AND TELEVISION ARTS AND SCIENCES
1655 No. Cherokee, Hollywood 28, Calif. HU. 23281.

CODE SENDING SPEED RECEIVING SPEED

Be a "key" man. Learn how to send and receive messages in code by telegraph and radio. Commerce needs thousands of men for jobs. Good pay, adventure, interesting work. Learn at home quickly through famous Candler System. Qualify for Amateur or Commercial License. Write for FREE BOOK
CANDLER SYSTEM CO.
Dept. 3-E, Box 928, Denver 1, Colo., U.S.A.

BECOME A RADIO AMATEUR

COMPLETE HOME-STUDY COURSE FOR PASSING FCC AMATEUR RADIO EXAMINATIONS.

LOW COST PERSONAL COACHING
Write for details
FEDERAL ELECTRONICS INSTITUTE
45 East Putnam Ave. (Dept. F) Greenwich, Conn.

AUDIO (SOUND) ENGINEERING HOME STUDY TRAINING

Practical, easy-to-understand lessons, written by competent Audio Engineers and Educators, prepare you for a better job and a good future in the Television, Radio, Motion Picture, and Recording Industries.

Write today for details—Learn while you earn!!

HOLLYWOOD TECHNICAL INSTITUTE
Div. RE
4925 Santa Monica Blvd., Hollywood 27, California

FREE TO TV SERVICEMEN THE LAST WORD IN TV TENNA INSTALLATIONS



BRAND NEW AUTHORITATIVE INFORMATIVE
Simplifies

TV-ANTENNA INSTALLATIONS

A fact-filled, pocket size reference manual edited by outstanding authorities. Packed with vital information on all types of antennas, Helpful Hints, Do's and Don'ts, Dimension Guide, Channel Frequencies, Proper Feed Methods and many other subjects.

LIMITED QUANTITY
PUBLICATION PRICE 50c. AVAILABLE WITHOUT OBLIGATION IF YOU WRITE IMMEDIATELY.

MAIL THIS COUPON TODAY

SNYDER MFG. CO., Dept. G
22nd & Ontario Sts., Phila. 40, Pa.

Please send free copy of TV TENNA TIPS

Name.....
Address.....
City.....Zone.....State.....

ADVERTISING INDEX

Admirable Television Company	82
Ad Ritz Manufacturing Company	71
Aerovox Corporation	119
Alliance Manufacturing Company	159
Allied Radio Corporation	51
Almo Radio Corporation	123
American Distributing Company	70
American Electrical Heater Company	66
American Microphone Company	112
American Phonoc Corporation	120
Amperite Company	122
Anchor Radio Corporation	98
Astac Corporation	18
Astron Corporation	126
Atlas Sound Corporation	94
Barry Electronics Corporation	120
Bell Telephone Laboratories	20
Boyce-Roche Book Company, Inc.	60
Brach Manufacturing Company	184
Brooks Radio Dist. Company	120
Buck Manufacturing Company	114
Buffalo Radio Supply	98
Capitol Radio Engineering Institute	7, 125
Certified Television Laboratories	123
Cisin, H. G.	114
Claroat Manufacturing Company	34
Cleveland Institute of Radio Electronics	13
Coast Electronic Supply Company	104
Collins Audio Products Company	111
Commercial Trades Institute	103
Communications Equipment Company	70
Concord Radio Corporation	98
Coyne Electrical School	117, 122
DeForest's Training, Incorporated	9
Du Mont, Allen B. Laboratories	Inside Front Cover
Electro-Products Laboratories	67
Electro-Voice Manufacturing Company	62
Electronic Instrument Company	22
Electronic Measurements Company	104
Espey Manufacturing Company, Inc.	84
Feiler Engineering Company	114, 122
G & G Radio Parts Service	111
General Electric Company	124
General Electronic Dist. Company	92, 93
General Test Equipment Company	114
Don Good, Incorporated	98
Greylock Electronic Supply Company	129
Halderson Company, (The)	96
Hallcrafters Co.	10
Harvard Laboratories	124
Heath Company	86, 87, 88, 89
Hudson Radio & TV Corporation	122
Hudson Specialties Corporation	118
Hytron Radio & Electronics Corporation	17
I.D.E.A. Inc. (Regency)	76
Instructograph Company	103
Insuline Corporation of America	97
International Correspondence Schools	74, 75
International Resistance Company	74, 75
JFD Manufacturing Company	69, 117, 128
Jackson Electrical Instrument Company	58
Jensen Industries, Inc.	125
Jensen Mfg. Co.	118
Kedman Company	124
La Pointe-Plascomold Company	61, 104
Leotone Radio Corporation	128
Litelfuso, Incorporated	130
Loris Sales Company	101
Macmillan Company (The)	83
Mallory & Company, Inc., P. R.	Inside Back Cover
Merit Transformer Corp.	71
Midwest Radio & TV Corporation	71
Miles Reproducer Co.	82
National Company	70
National Plans Company	122
National Radio Institute	3
National Schools	5
Niagara Radio Supply	116
Oak Ridge Products	103
Ohmite Manufacturing Company	54
Opportunity Adsets	118
Oregon Bargain Supply	125
Penn TV Products Company	124
Perfection Electric Company	19
Perrin Corporation	123
Platt Electronics	123
Precision Apparatus Company	106
Pre-Probe Company	106
Progressive Electronics	85, 101
Quam-Nichols Company	82
RCA Victor Division (Radio Corp. of America)	Back Cover
Radcraft Publications	53, 65
Radiart Corporation	95
Radio Apparatus Corporation	101
Radio City Products	124
Radio Corporation of America	81
Radio Dealers Supply	126
Radio Dist. Co.	26
Radio-Electronics	99
Radio Publications	121
Radio Receptor Company, Inc.	85

RADIO SCHOOL DIRECTORY (Page 127)

Baltimore Technical Institute	
Candler System Company	
Commercial Radio Institute	
Electronics Institute, Inc.	
Federal Electronics Institute	
Hollywood Sound Institute	
Hollywood Technical Institute	
Indiana Technical Institute	
Martin School, Inc.	
Milwaukee School of Engineering	
RCA Institutes	
Radio-Television Institute	
Tri-State College	
Valparaiso Technical Institute	
YMCA Trade & Technical Institute	
Rauland Corporation (The)	87
Ray Company	114
Raytheon Manufacturing Company	115
Rider, Incorporated, John F.	90
Rinehart Books, Incorporated	100
Rose Company (The)	115
Sams & Company, Inc., Howard W.	12, 78, 82
Sheldon Electric Company	21
Simpson Electric Company	108
Snyder Manufacturing Company	128
Solo Elec. Sales Corporation	124
Sprague Products Company	4
Steve-EI Electronics Corporation	113
Supreme Publications	95
Sutton's Wholesale Electronics, Bill	109
Sylvania Electric Products	104
Tab	104
Tech-Master Products Company	108
Technical Appliance Company	108
Technical Radio Parts Company	119
Technifax	110
Tele-Vox Enterprises, Incorporated	124
Television Communications Institute	105
Television Supply Company	123
Thomas Electronics	80
Transvision, Incorporated	102
Trio Manufacturing Company	79
Triplett Electric Instrument Company	16
Turner Company (The)	16
United Technical Laboratories	80
University Loudspeakers	72
Upstate Distributors	71
Veri-Best TV Products, Incorporated	71
Weller Electric Corporation	36
Wells Sales Company	121
Wholesale Radio Parts	121
World Wide Packing & Shipping Company	125

Radio-Electronics does not assume responsibility for any errors appearing in above index.

"Little Giant" TWIN LEAD LIGHTNING ARRESTER
Protects TV Sets Against Lightning and Static Charges

No. AT105
\$1.25 list

For Regular Twin Lead

SEEING IS BELIEVING!

ONLY JFD Lightning Arresters offer you these exclusive patented features...

1. Patented strain-relief Retaining Lip which prevents pulling or straining against contact points.
2. You actually see positive contact made with lead-in wire.
3. Lead-in contact remains fully visible at all times.
4. No wire stripping. No Arrester Cover to Hide Poor Contacts!

At Your Jobber or Write Direct

JFD MANUFACTURING CO., Inc.
6101E 16th AVENUE, BROOKLYN 4, N. Y.
FIRST in Television Antennas and Accessories

Leotone

LINE OF SIGHT AMPLIFIER (Bendix) PARTS GALORE!! New Metal case 7"x6"x4" . . . 1.95
VINYL SPAGHETTI . . . ass'd. sizes . . . 1.98

Leotone HIGH FIDELITY CRYSTAL MIKE Hi-imp'd., Rubber shock-mtd., 1 1/2" O. D., 1/2" Less housing. . . 1.29

ALUMINUM HOUSING for crystal mike . . . 15c
50W ADJUST. RESISTORS . . . 50W, 25 or 200 ohm . . . 39c
POWER RESISTORS . . . 50W, 15 ohms (IRC) . . . 1.29
50W-500 or 1250 ohms 59c 3/1.49
25W-250 ohm; center tap 59c 3/1.49
TUBE CLAMPS . . . I.D. 1-3/16" or 1-5/16" . . . 8c each 100 \$6.50

AUTOSVNS AV-38D; operates 24V. AC . . . 1.95
4 WIRE PLUG & JACK for cable ext. . . 49c 6/2.49
JK-26/PL-54 CONNECTORS . . . 1/2 wire br. 39c 6/1.98
MINI-CONNECTORS . . . PL-291/JK-48, 39c 6/1.98
MERCURY SWITCH . . . 1A/139c . . . 39c 3/1.00
DPDT TOGGLES . . . 6A/125V. split ball. . . 39c 3/1.00
3" BLOWER & HOUSING (LR #3) . . . less mtg. 1.95
BENCH LAMP . . . cove type. Gray enam. . . 1.95
4"x4 1/2"x3 1/2" . . . 59c 5/1.00
8 MPD-300V PAPER TUBULAR, metal . . . 23c 5/1.00
4 1750 RPM, 2 1/2" sq. x 1 1/2" . . . 12c 10/1.00
.05 MPD-600V OIL . . . upright, nut mtg. . . 59c
GRILLE CLOTH . . . Ivory, Tan or Brown. . . 9c
W-110B FIELD WIRE . . . coils . . . 100-400 . . . 19c 6/1.00
"POLYSTYRENE" . . . 12" lengths. Rod: 1/4" . . . 10c; 3/8" 20c; 1/2" 36c; 5/8" 59c; 3/4" 79c
Tubing (OD): 1/4" 16c; 1/2" 24c; 3/4" 34c

BROWN BAKELITE PANELS . . . 1/16" 7"x10" 39c
1 7"x14" 49c; 7"x18" 59c; 9"x15" 65c; 12"x12" 75c
6V. BUZZER & KEY(WE). 1/2" bakelite base. . . 1.49

RADIO HARDWARE TREASURE FULL of screws, nuts, washers, Lugs, Rivets, etc. 69c 3/1.98

SPDT SLIDE SWITCH . . . 3A/125V. 118" 19c 6/1.00

TELEPHONE WHIRL ANTENNAS . . . 99c 5/1.00

28V AC REVERSIBLE MOTOR . . . fract. H.P. . . 2.49

1 1/2" SQ. PANEL METERS . . . 0-9V.DC . . . 1.29

0-100AMPS. DC & shunt. 98c

Printed . . . 1 3/8" sq. . . 24c

G' BALL BEARINGS O.D. 5/8", I.D. 1/4" . . . 23c 5/1.00

1 3/4" I.D. 3/16" . . . 29c 4/1.00

CABINET DRAWER SLIDES . . . Ball bearing 1 1/2" (9" ext.) . . . 2.10
1 1/2" (9" ext.) . . . 1 1/2" (12 1/2" ext.) . . . 2.39
Heavy duty, all-steel 1 1/2"/12 1/2" . . . 3.25

CABINET LID SUPPORTS for CONSOLES, CHESTS, Spring action; self-holding to 70° . . . 49c

18 ft. WHIP ANTENNA . . . B screw sects. . . 2.49

MS-53 MAST SECTIONS . . . extend any lgth. . . 39c

POWERFUL "ALNICO MAGNETS" . . . overall: 2 1/2" 1 1/4"x7/8" SPECIAL!!! 98c 6/5.00

ALNICO MAGNET KIT . . . asstd. powerful Bar. Block 1/4" Ring. Kit of 10 only 1.98 (WRITE FOR "ALNICO MAGNET" SUPPLEMENT)

!!! BARGAIN KITS!!!—KNORS . . . 15. 25 asstd. 98c

MICA PADDERS-TRIMMERS . . . 15 asstd. 69c

ROTARY SELECTOR SWITCHES . . . 18 asstd. 1.75

DIAL WINDOWS . . . glass. 12 asstd. 1.39

VOLUME CONTROLS . . . less switch—6 asstd. 1.49

RESISTORS . . . Ferrule-end. 25 asstd. 79c

MICRO BAKELITE TRIMMERS (Micamold) 00001 to 2mtd. 200-600V. 50 asstd. . . 1.98

WIRE-WOUND RESISTORS . . . 5-20W 12 asstd. 98c

MFG. FACTORY REPAIRS SINCE 1927!! Min. Order \$3.00. 20% deposit on all COD's Please add sufficient postage—excess refunded Full remittance with foreign orders

LEOTONE RADIO CO.
67 Dey Street, New York 7, N. Y.

RADIO-ELECTRONICS for

www.americanradiohistory.com

GREYLOCK is still Delivering!

GREYLOCK TUBES

All Greylock tubes carry the standard RTMA guarantee. There is a 5% discount on any assortment of 100 tubes or more at the prices shown below. Tube orders shipped F.O.B. New York. On orders under \$3 there will be a \$1 handling charge. On all C.O.D. orders please enclose a 10% deposit. All prices are subject to change without notice.

Type	Each	Type	Each	Type	Each	Type	Each	Type	Each
01A	\$.69	5V4G	\$1.39	6F8G	\$.99	12A7G	\$.79	35Y4	\$.89
04A	1.49	5W4M	.79	6E6G	.49	12A77	1.69	35Z3	.99
0Y4	1.49	5W4GT	.79	6G7	.59	12A06	1.19	35Z4GT	.89
024M	.89	5X4G	.89	6H6GT	.89	12A07	1.49	35Z5GT	.89
1A3P	.69	5Y3GT	.69	6H6M	.89	12A07	1.69	36	.69
1A4P	.39	5Y4G	.79	6J5GT	.69	12AX7	1.39	37	.69
1A5GT	.79	5Z3	.89	6J6	1.99	12BA6	.99	38	.69
1A6	.99	5Z4	1.09	6J7GT	.99	12BA7	.99	39, 44	.69
1A7GT	1.09	6B4	1.09	6J8G	.89	12BD6	.99	41	.99
1B3 8016	1.49	6AC5GT	.99	6K5GT	.79	12BE6	.99	42	.99
		6AB5/6N5		6K6GT	.79	12BF6	.69	43	.99
1B4	.49	6AC7	1.29	6K7GT	.99	12BH7	1.39	45	.99
1B5 25S	.49	6AE5	.99	6K8GT	.79	12C8	.89	46, 55	.89
1B7	.59	6AE6	.79	6L5G	.49	12F5GT	.69	47, 56	.89
1C5GT	.99	6AF5	.89	6L6G	1.09	12H6	.79	46	.99
1C6	.39	6AG5	1.59	6L6GA	1.99	12J5GT	.69	47	.79
1C7G	.49	6AG7	1.89	6L7G	.49	12J7GT	.89	49	.79
1C8GP	.49	6AH5	1.49	6N9	1.49	12K7GT	1.09	30A5	1.19
1C7G	.49	6AR5	1.99	6N9	1.49	12K8	.79	30B5	1.19
1D4	.69	6A15	1.49	6P5GT	.79	12Q7GT	.79	30C5	1.09
1E5	.49	6AK5	1.99	6Q7GT	.79	12SA7GT	.99	5016GT	1.09
1E7	.49	6AK6	1.19	6Q7G	.79	12SC7	.89	50Y6GT	1.09
1F4	.39	6AL5	1.19	6R7G	.69	12SF5GT	.59	52	.79
1F3G	.49	6AQ5	1.19	6R7GT	.69	12SF7M	.69	55	.89
1F7	.49	6AR5	.89	6S4	.79	12SG7M	1.19	56	.89
1G4GT	.69	6AR6	.99	6S7G	.99	12SH7M	.99	57	.69
1G3	.49	6AS5	1.19	6S8GT	1.29	12SJ7GT	.89	58	.79
1G6G	.69	6AT6	.79	6SA7GT	.99	12SK7GT	.99	70A7	1.29
1H4G	.69	6AU5	1.59	6SC7M	1.19	12SL7GT	.99	70L7GT	1.69
1H3GT	.79	6AU6	1.19	6SD7GT	.79	12SN7GT	.79	71A	.99
1H6	.49	6AV5	1.49	6SE5GT	.59	12T8	1.09	75	.79
1H6	.49	6AV6	.79	6SF7M	.89	12SQ7GT	.89	76	.79
1L4	.89	6A3	.99	6SG7M	1.19	12SR7GT	.79	77	.79
1N5GT	.99	6A4	1.29	6SH7GT	1.19	12S8GT	.69	78	.99
1P5GT	.89	6A5	.99	6SJ7GT	.89	12Z3	.49	79	.79
1Q7GT	.89	6A6	.99	6SK7GT	.89	15	.89	80	.79
1R5	.99	6A7	1.29	6SL7GT	1.19	18	.89	81	.99
1S4	.39	6A8GT	.99	6SN7GT	1.29	19	.49	82	.99
1S5	.89	6A8M	.99	6SQ7GT	.79	19B6G	2.49	83	.99
1T4	.89	6B4G	1.59	6S7M	.99	19T8	1.49	83V	.99
1T5GT	.89	6B5	.99	6SS7GT	.89	22	.99	84/6Z4	.99
1U4	.89	6B6G	.89	6SS7M	.99	24A	.79	85	.79
1U5	.89	6B7	.79	6SU7GT	.89	24A6G	.89	86	.79
1V	.49	6B8G	.89	6T8	.89	25A7GT	.99	117L7/M7	2.29
1X2	1.49	6BA6	.99	6N7M	1.19	25BQ6	1.99	117L7/M7	2.29
2A3	.99	6BA7	1.19	6T7G	.79	25C6	.89	117N7GT	1.49
2A4	1.29	6BC5	1.19	6T8	1.69	25L6GT	.89	117P7GT	2.29
2A5	.59	6BE6	.99	6U4	1.19	25W4	.99	117P7GT	1.49
2A6	.49	6BF6	.79	6U5/6G5	1.19	25Y5	.89	117Z3	2.29
2A7	.49	6BG6	1.89	6V7G	.89	25Z5	.89	117Z3	2.29
2B7	.59	6BH6	1.19	6V6GT	1.19	25Z6GT	.89	117Z6GT	1.39
2C2	.79	6B16	1.19	6W4GT	.99	26	.59	182B	.99
2V1G	2.49	6RQ6GT	1.69	6K4	.69	27	.59	95A	.59
2X2A	1.49	6C4	.89	6X5GT	.89	30	.79	95	.59
2X2 879	.79	6C5GT	.79	6Y6G	1.19	31	.99	95B	.59
3A4	.49	6C6	.99	6Z7	.49	32L7GT	.99	10B1	1.49
3A5	.99	6C8G	.99	6Z5	.49	32	.59	9001	.79
3A3	1.99	6CB6	1.19	10Y	.49	33	.49	9002	.79
3J7 1291	.49	6CD6G	2.99	12A	.69	34	.49	9003	.79
3D1 1299	.49	6D6	.99	12A5	.49	34/51	.79	11A4	.99
3Q4	.89	6D7	.49	12A6	.49	35A5	.99	11A6	.99
3Q5GT	1.19	6D8G	.49	12A7	.99	35B5	.99	11B4	.99
3V4	.99	6E5	1.09	12A8GT	.79	35C5	.99	11C5	.99
5T4M	1.19	6F6GT	.99	12AL5	1.19	35L6GT	.99	11C6	.99
5U4G	.99	6F7	.99	12AH7	1.59	35W4	.79	11D5	.99

REGENCY TV SIGNAL BOOSTER Model DB 410

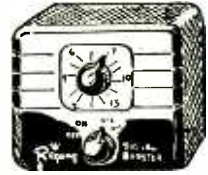

Installs simply . . . Single knob tuning control . . . Contra-Wound Bifilar Coils with push-pull triode . . . Electrical symmetry . . . No external impedance matching devices needed . . . Rich mahogany plastic cabinet with gilt dial panel. Underwriters' approved. YOUR NET COST \$49.11. LIST \$32.50.

All electromagnetic styles. Perfect condition. 30 day guarantee.

SPECIAL TV CATHODE RAY TUBES

SIZE	NET
10"	\$14.95
12"	18.95
14" (Rect.)	19.95
16" (Round)	24.95
16" (Rect.)	24.95
17" (Rect.)	24.95
20" (Rect.)	49.50



Complete parts for conversion from 10" or 12" to big 16" rect., 16" round, or 17" rect.

ANTENNAS "DOUBLE-V" TYPE

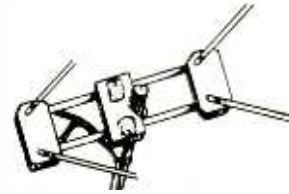

Highly directive, with extremely high gain in all areas that can be stacked for even greater gain. Quick-Rig design, no loose parts. Seamless aluminum tubing. Wood dowel reinforced. G2V \$4.95 G2VS (stacked) 10.45

CONICAL ANTENNAS

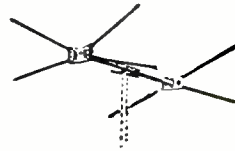

4-ELEMENT CONICAL ANTENNA. All channel, preassembled for fast installation. Made of lightweight, non-corrosive, seamless aluminum tubing. Excellent broadband and high gain response on all TV channels and FM bands. MODEL No. GC-430. \$6.19

4-ELEMENT CONICAL ANTENNA STACKED. Provides exceptionally high db gain on both bands. Especially good for "fringe" areas. Preassembled of non-corrosive seamless aluminum tubing. MODEL No. GC-431. \$12.19

4-ELEMENT "ECONOMY" CONICAL ANTENNA. Made of reinforced butt-seam aluminum elements and strong steel crossbars. Easily assembled. Single or stacked. MODEL No. GC-434 (single) . . . \$4.69 GC-435 (stacked) . . . \$9.45

EXTRA ELEMENTS FOR CONICALS TO MAKE FAN-FLECTOR STYLE: Low band elements . . . \$8.49 High band elements . . . \$3.35

"YAGI" TV BEAM ANTENNAS

A remarkable antenna built especially for "fringe areas" and where individual channel reception is poor. Each element is made to fit a specific channel and give you maximum reception. The "YAGI" has succeeded when others have failed. A bargain if ever there was one! Available in 4 and 5 Element Arrays.

CHANNEL #2-4-Element array . . . \$10.69	CHANNEL #7-4-Element array . . . \$6.25
5-Element array . . . 11.95	5-Element array . . . 7.29
CHANNEL #3-4-Element array . . . 9.85	CHANNEL #8-4-Element array . . . 5.95
5-Element array . . . 10.95	5-Element array . . . 6.50
CHANNEL #4-4-Element array . . . 8.95	CHANNEL #9-4-Element array . . . 4.95
5-Element array . . . 9.95	5-Element array . . . 6.38
CHANNEL #5-4-Element array . . . 8.45	CHANNEL #11-4-Element array . . . 4.95
5-Element array . . . 9.65	5-Element array . . . 6.26
CHANNEL #6-4-Element array . . . 8.25	CHANNEL #13-4-Element array . . . 4.95
5-Element array . . . 8.95	5-Element array . . . 6.00

SPEAKER SPECIALS



Less Transformer Except as Noted

	Net
3" ALNICO #5 Ea. \$1.29	1.25
4" IN CARTONS OF 30 "	1.59
4" 5" ALNICO #5	1.50
IN CARTONS OF 30 "	1.79
6" ALNICO #5	1.70
IN CARTONS OF 24 "	1.99
6" 2.13 OZ. ALNICO #5	1.90
IN CARTONS OF 24 "	1.99
6" PM WITH 8/6V6 OUTPUT	3.45
6" 8" 9" 3.16 OZ. ALNICO #5	3.95
8" 2.15 OZ. ALNICO #5	4.95
10" 6.8 OZ. ALNICO #5	6.95
12" 3 OHM VOICE COIL, 20 OZ. MAG. OR ALNICO EQUIVALENT	1.39
6"x4" 1000 OHM DYNAMIC, OVAL	1.39
6"x4" 1300 OHM DYNAMIC, OVAL	1.39
6"x4" 1500 OHM DYNAMIC, OVAL	1.39
3" 3000 OHM DYNAMIC49

AUTO SPEAKERS

7 1/4" 4 OHM DYNAMIC LESS OUTPUT	2.19
7 1/4" PM. LESS OUTPUT	4.95
6" 4 OHM DYNAMIC LESS OUTPUT	2.25
8" 4 OHM DYNAMIC LESS OUTPUT	2.25
8" PM LESS OUTPUT	3.95

INES CARRIED

American Cords	Krylon Sprays
Amperite	Littelfuse
Birnbach	Merit
Burgess	Mosley
Comet Irons	Oak Ridge
Crestal	Phillips
Cycle Master	Quam
Cyclo-Twist	Recoton
DuMont Tuners	Regency
Dutch Brand	R. M. S.
Easy Light Clock	John F. Ryder Publications
Eby	Howard Sams
Eico	Sprague
Excellite	Square Root
G. E. Lamps	Stanwyck
H. O. T.	Star Drills
I. C. A.	Trav-Electric
I. T. I. Boosters	Walsco
J. F. D.	

TERMS: Net C.O.D. F.O.B., N.Y.C. 10% Deposit required on all C.O.D. Orders Dept. C-5

"A Trusted Name in Radio!"
GREYLOCK ELECTRONICS SUPPLY CO.
 115 Liberty Street - New York 6, N.Y.

WRITE FOR SPRING SPECIAL DEPT. N-5



Be sure of your fuse!
 You know you are getting *original component quality*
 when your fuses come in the handy green dispenser box

Be sure of your fuse
 by the handy fuse size guide
 on every LITTELFUSE
 dispenser box

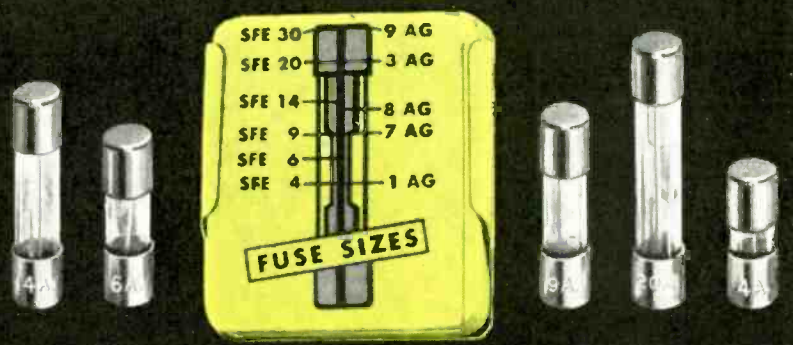

The only improvement in fuse packaging in 25 years.
 Another LITTELFUSE first. One at a time dispensing.
 No lost covers. LITTELFUSE INC., 4757 Ravenswood,
 Chicago 40. LONGbeach 1-4970

Because

**Break is Fast
and Clean...**

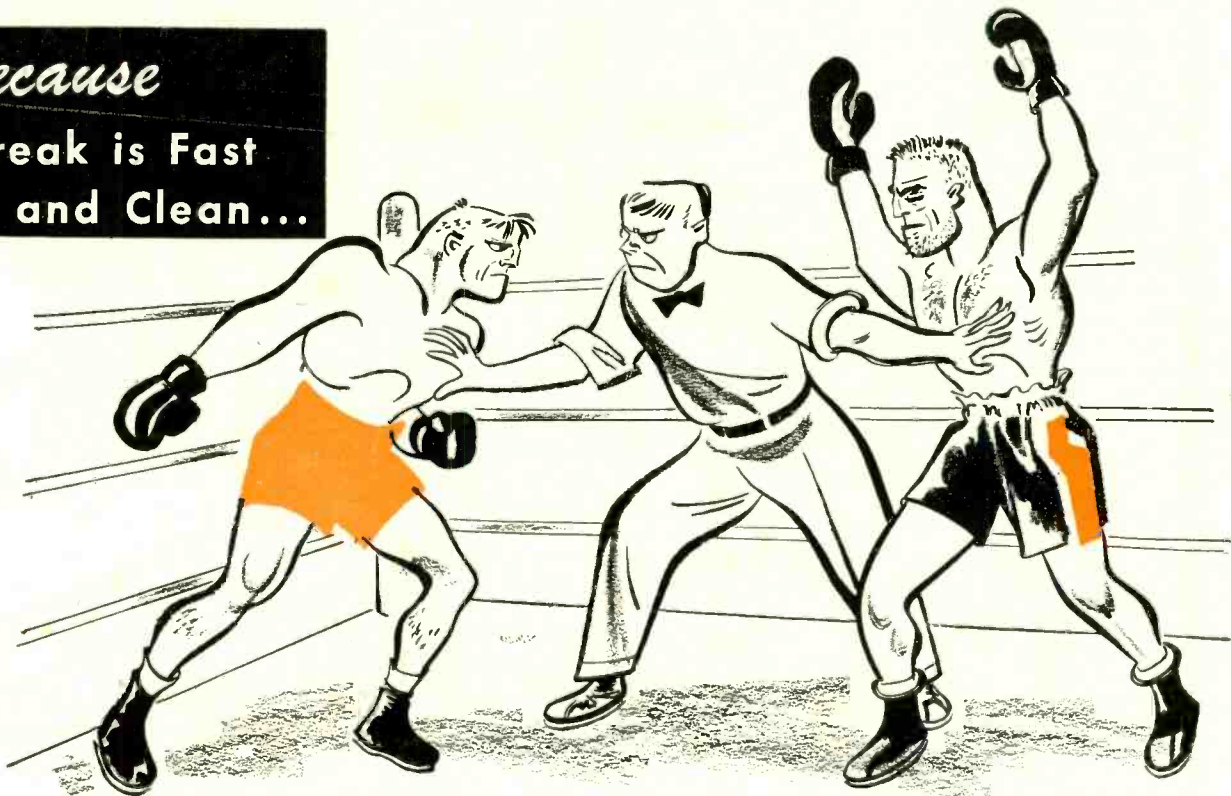

Mallory Vibrators Give Peak Performance!

Fast, clean break of contacts minimizes arcing and pitting. It teams up with gentle contact impact for less wear, and high contact pressure for low resistance—to produce a combination of features attainable only with the patented, tuned mechanism in Mallory Vibrators. That's the secret of their peak performance.

Mallory Vibrators are a result of Mallory's unique facilities in electronics, electro-chemistry and metallurgy. The perfect tuning is accomplished by an exclusive design and individual adjustment by skilled technicians. The contacts are made by Mallory's Contact Division, among the largest in the world. They possess an unusual "self-cleaning" action which prevents oxidation in service.

That's why more Mallory Vibrators are used in original equipment than all other makes combined. When you use Mallory Vibrators for replacement you can be sure of long life, dependable starting and high output efficiency. See your Mallory distributor now!

More Mallory Vibrators Are Used in Original Equipment Than All Other Makes Combined.



P. R. MALLORY & CO. Inc.
MALLORY

CAPACITORS • CONTROLS • VIBRATORS • SWITCHES • RESISTORS
• RECTIFIERS • VIBRAPACK* POWER SUPPLIES • FILTERS

*Reg. U.S. Pat. Off.

APPROVED PRECISION PRODUCTS

P. R. MALLORY & CO., Inc., INDIANAPOLIS 6, INDIANA

THE QUALITY OF RCA TUBES IS UNQUESTIONED



Profit Twice...

with RCA picture tubes



PROFIT ONCE—The largest and most profitable replacement business in television picture tubes comes from the types used in most television receivers . . . the fast-moving RCA types. That's true today . . . and it will be true tomorrow. Because they are high-volume types, RCA picture tubes simplify your inventory and stocking problems.

PROFIT TWICE—In addition, when you sell RCA picture tubes, you gain from customer confidence in the RCA brand . . . solidly established by the proved performance of RCA picture tubes in millions of television receivers. Their quality and dependability mean fewer service failures and fewer costly call-backs.

Keep informed...stay in touch with your RCA Tube Distributor



RADIO CORPORATION of AMERICA
ELECTRON TUBES

HARRISON, N. J.