

INCLUDING
*Communication
Engineering*
and
*TV & RADIO
ENGINEERING*

RADIO-ELECTRONIC *Engineering*

Reg. U. S. Pat. Off.

MARCH, 1955

JUNCTION TRANSISTOR TEST SET
7

ELECTRONIC TEMPERATURE CONTROLLER
10

COMPONENTS FOR
MECHANIZED PRODUCTION
12

U.H.F. BYPASS
CAPACITOR NOMOGRAPHS
14

CONTROLLED
BEAT-FREQUENCY OSCILLATOR
15

RECORDING DATA
ON MAGNETIC TAPE
18

DEPARTMENTS

NEW TUBES	22
NEWS BRIEFS	24
NEW PRODUCTS	26
COMMUNICATION REVIEW ..	28
TV-AM-FM PRODUCTION	28
CALENDAR	29
PERSONALS	30
NEW LITERATURE	32
TECHNICAL BOOKS	36

◀ This new horn-reflector type of microwave antenna, developed by *Bell Telephone Laboratories* engineers for use on radio relay routes, is capable of operating simultaneously in the 4000-, 6000-, and 11,000-mc. bands.

TELEVISION • ELECTRONICS • COMMUNICATIONS • AUDIO • MICROWAVES • RADAR • RESEARCH

LEADERS IN
MINIATURIZATION
FOR OVER
TWENTY YEARS...



MINIATURIZED TRANSFORMER COMPONENTS **FROM STOCK**

Items below and 650 others in our catalog A.

HERMETIC SUB-MINIATURE AUDIO UNITS

These are the smallest hermetic audios made.

Dimensions . . . 1/2 x 11/16 x 29/32 . . . Weight .8 oz.



TYPICAL ITEMS

Type No.	Application	MIL Type	Pri. Imp. Ohms	Sec. Imp. Ohms	DC in Pri MA	Response ± 2 db (Cyc.)	Max. level dbm
H-30	Input to grid	TF1A10YY	50*	62,500	0	150-10,000	+13
H-31	Single plate to single grid, 3:1	TF1A15YY	10,000	90,000	0	300-10,000	+13
H-32	Single plate to line	TF1A13YY	10,000*	200	3	300-10,000	+13
H-33	Single plate to low impedance	TF1A13YY	30,000	50	1	300-10,000	+15
H-34	Single plate to low impedance	TF1A13YY	100,000	60	.5	300-10,000	+6
H-35	Reactor	TF1A20YY	100 Henries-0 DC, 50 Henries-1 Ma. DC,	4,400 ohms.			
H-36	Transistor Interstage	TF1A15YY	25,000	1,000	.5	300-10,000	+10

*Can be used with higher source impedances, with corresponding reduction in frequency range and current

COMPACT HERMETIC AUDIO FILTERS



UTC standardized filters are for low pass, high pass, and band pass application in both inter-stage and line impedance designs. Thirty four stock values, others to order. Case 1-3/16 x 1-11/16 x 1-5/8 — 2-1/2 high . . . Weight 6-9 oz.

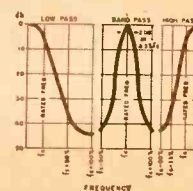

HERMETIC MINIATURE HI-Q TOROIDS

MQE units provide high Q, excellent stability and minimum hum pickup in a case only 1/2 x 1-1/16 x 17/32 . . . weight 1.5 oz.

TYPICAL ITEMS

Type No.	Inductance	DC Max.
MQE-1	7 mhy.	135
MQE-3	20 mhy.	80
MQE-5	50 mhy.	50
MQE-7	100 mhy.	35
MQE-10	.4 hy.	17
MQE-12	.9 hy.	12
MQE-15	2.8 hy.	7.2

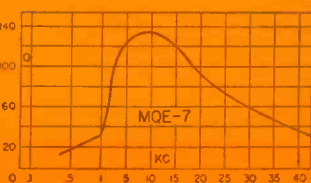

SUB-MINIATURE (WIDE RANGE) AUDIO UNITS

Standard for the industry for 15 yrs., these units provide 30-20,000 cycle response in a case 7/8 dia. x 1-3/16 high. Weight 1 oz.

TYPICAL ITEMS

Type No.	Application	Pri. Imp	Sec. Imp
0-1	Mike, pickup or line to 1 grid	50, 200/250, 500/600	50,000
0-4	Single plate to 1 grid	15,000	60,000
0-7	Single plate to 2 grids, D.C. in Pri.	15,000	95,000
0-9	Single plate to line, D.C. in Pri.	15,000	50, 200/250, 500/600
0-10	Push pull plates to line plate to plate	30,000 ohms plate to plate	50, 200/250, 500/600
0-12	Mixing and matching	50, 200/250	50, 200/250, 500/600
0-13	Reactor, 300 Hys.—no D.C.; 50 Hys.—3 MA. D.C., 6000 ohms		

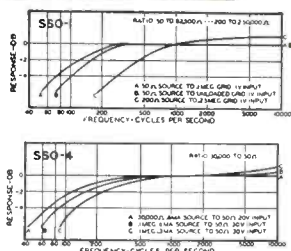

SUB-SUBOUNCER AUDIO UNITS

UTC Subouncer and sub-subouncer units provide exceptional efficiency and frequency range in miniature size. Constructional details assure maximum reliability. SSO units are 7/16 x 3/4 x 43/64 . . . Weight 1/50 lb.



Type	Application	Level	Pri. Imp.	MA D.C. in Pri.	Sec. Imp.	Pri. Res.	Sec. Res.
*SSO-1	Input	+ 4 V.U.	200 50	0	250,000 62,500	13.5	3700
SSO-2	Interstage /3:1	+ 4 V.U.	10,000	0.25	90,000	750	3250
*SSO-3	Plate to Line	+20 V.U.	10,000 25,000	3 1.5	200 500	2600	35
SSO-4	Output	+20 V.U.	30,000	1.0	50	2875	4.6
SSO-5	Reactor 50 HY at 1 mil. D.C. 4400 ohms D.C. Res.						
SSO-6	Output	+20 V.U.	100,000	.5	60	4700	3.3
*SSO-7	Transistor Interstage	+10 V.U.	20,000 30,000	.5 .5	800 1,200	850	125

* Impedance ratio is fixed, 1250:1 for SSO-1, 1:50 for SSO-3. Any impedance between the values shown may be employed.



HERMETIC VARIABLE INDUCTORS

These inductors provide high Q from 50-10,000 cycles with exceptional stability. Wide inductance range (10-1) in an extremely compact case 25/32 x 1-1/8 x 1-3/16 . . . Weight 2 oz.

TYPICAL ITEMS

TYPE No.	Min. Hys.	Mean Hys.	Max. Hys.	DC Ma
HVC-1	.002	.006	.02	100
HVC-3	.011	.040	.11	40
HVC-5	.07	.25	.7	20
HVC-6	.2	.6	2	15
HVC-10	7.0	25	70	3.5
HVC-12	50	150	500	1.5

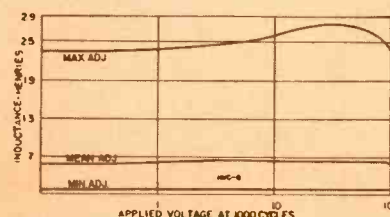
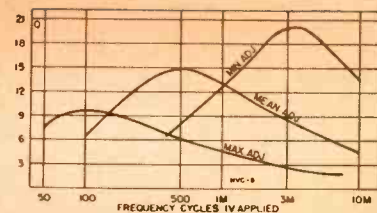

LET US MINIATURIZE YOUR GEAR.
SEND DETAILS OF YOUR NEEDS for SIZES and PRICES

UNITED TRANSFORMER CO.

150 Varick Street, New York 13, N. Y. • EXPORT DIVISION: 13 E. 40th St., New York 16, N. Y.

CABLES: "ARLAB"



POINT-TO-POINT F M

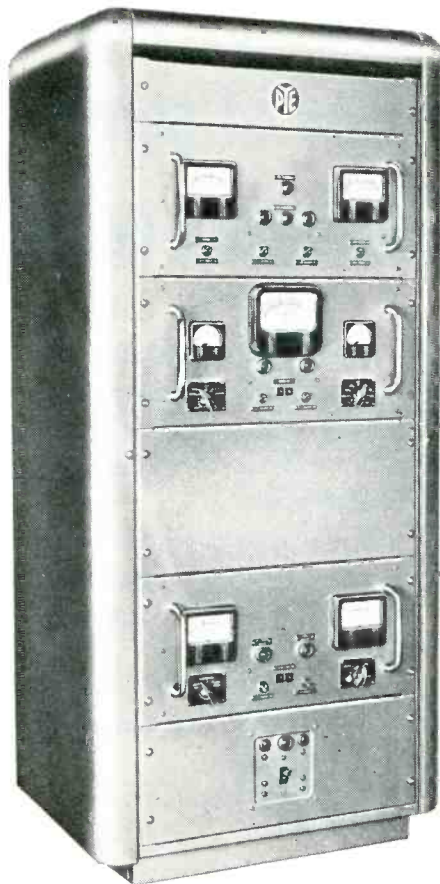
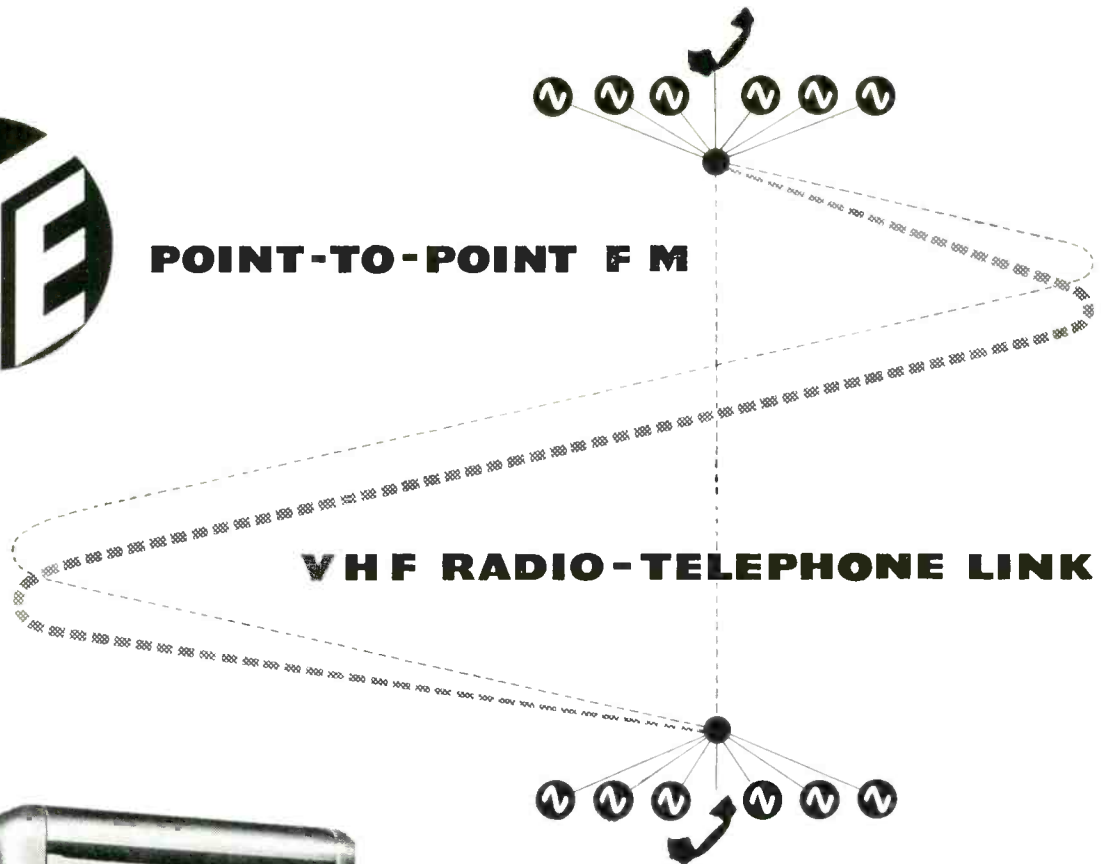

This Equipment will provide first-class single channel point-to-point facilities and, at the same time, possesses the necessary capacity for extension to six channels if required.

ABBREVIATED SPECIFICATION

- Frequency range: 60—216 mc/s
- Transmitter output Power: 10 watts or with Amplifier Unit — 50 watts
- Maximum Deviation: 50 kc's
- Receiver Bandwidth: 6 db down \pm 120 kc/s
- Overall Transmitter-Receiver Performance
- Frequency Response: 300 c/s—6 kc/s \pm 3 db; 6 kc/s—36 kc/s \pm 1 db
- Intermodulation Level: At least—55 dbm for 2 tones applied each at 0 dbm



Pye (New Zealand), Ltd.,
Auckland C.I., New Zealand.
Pye Radio & Television (Pty.) Ltd.,
Johannesburg,
South Africa.

Pye Canada, Ltd.,
Ajax, Canada.
Pye Limited,
Plaza de Necaxa 7,
Mexico 5.

Pye-Electronic Pty, Ltd.,
Melbourne, Australia.
Pye Limited,
Tucuman 829,
Buenos Aires.

Pye Ireland, Ltd.,
Dublin, Eire.
Pye Limited,
5th Ave. Building,
200 5th Ave., New York.

PYE LIMITED

CAMBRIDGE

ENGLAND

For more information, circle No. 2 on Reader Service Card

To the Engineer who is Very Particular



RCA expansion opens the kind of permanent opportunities you'll find most desirable

A whole new program of expansion at RCA—in Research, Systems, Design, Development and Manufacturing—opens a broad variety of permanent positions with all the features that appeal to the alert, creative engineer. These are opportunities with a future . . . available *today* for the man who wants to move ahead professionally with the world leader in electronics. They include work in fields of phenomenal growth. At the RCA engineering laboratories *listed in the chart on the right*, you'll find the kind of living and working conditions attractive to the professional man and his family.

Engineers and scientists find every important factor that stimulates creative

effort . . . including a quality and quantity of laboratory facilities unsurpassed in the electronics industry . . . and everyday association with men recognized at the top of their profession.

RCA's benefits add up to an impressive list of "extras." Among them: tuition for advanced study at recognized universities . . . a complete program of company-paid insurance for you and your family . . . a modern retirement program . . . relocation assistance available.

Your individual accomplishments and progress are recognized and rewarded through carefully planned advancement programs. Financially as well as professionally, you move ahead at RCA!

For more information, circle No. 3 on Reader Service Card

about His Future . . .

What can RCA offer you?

Check the chart below for your career opportunity in

COLOR TELEVISION
 AVIATION ELECTRONICS
 ELECTRON TUBES
 MISSILE GUIDANCE
 RADIO SYSTEMS

FIELDS OF ENGINEERING ACTIVITY	TYPE OF DEGREE AND YEARS OF EXPERIENCE PREFERRED											
	Electrical Engineers			Mechanical Engineers			Physical Science			Chemistry Ceramics Glass Technology Metallurgy		
	1-2	2-3	4+	1-2	2-3	4+	1-2	2-3	4+	1-2	2-3	4+
RESEARCH • SYSTEMS • DESIGN • DEVELOPMENT												
COLOR TV TUBES —Electron Optics—Instrumental Analysis—Solid States (Phosphors, High Temperature Phenomena, Photo Sensitive Materials and Glass to Metal Sealing)	L	L	L	L	L	L	L	L		L	L	L
RECEIVING TUBES —Circuitry—Life Test and Rating—Tube Testing—Thermionic Emission	H	H	H		H	H		H			H	H
MICROWAVE TUBES —Tube Development and Manufacture (Traveling Wave—Backward Wave)		H	H	H			H	H			H	H
GAS, POWER AND PHOTO TUBES —Photo Sensitive Devices—Glass to Metal Sealing	L	L	L	L	L		L	L		L	L	
AVIATION ELECTRONICS —Radar—Computers—Servo Mechanisms—Shock and Vibration—Circuitry—Remote Control—Heat Transfer—Sub-Miniaturization—Automatic Flight—Design for Automation—Transistorization			M			M				M		
RADAR —Circuitry—Antenna Design—Servo Systems—Gear Trains—Intricate Mechanisms—Fire Control			M			M				M		
COMPUTERS (ANALOG AND DIGITAL) —Systems—Advanced Development—Circuitry—Assembly Design—Mechanisms			M			M				M		
COMMUNICATIONS —Microwave—Aviation—Specialized Military Systems			M			M				M		
RADIO SYSTEMS —HF-VHF—Microwave—Propagation Analysis—Telephone, Telegraph Terminal Equipment		O	O		O	O		O	O			
MISSILE GUIDANCE —Systems Planning and Design—Radar—Fire Control—Shock Problems—Servo Mechanisms			M			M				M		
COMPONENTS —Transformers—Coils—TV Deflection Yokes (Color or Monochrome)—Resistors		C	C		C	C		C	C			
MANUFACTURING	L		L	L	L	L	L	L		L	L	
TV Color Tubes—Microwave Tubes	H			H								
MACHINE DESIGN		L	L		L	L						
Mechanical and Electrical—Automatic or Semi-Automatic Machines		H	H		H	H		H	H			

- C—Camden, N.J.—in greater Philadelphia near many suburban communities.
 H—Harrison, N.J.—just 18 minutes from downtown New York.
 L—Lancaster, Pa.—in beautiful Lancaster County, about an hour's drive west of Philadelphia.
 M—Moorestown, N.J.—quiet, attractive suburban community close to Philadelphia.
 O—Overseas—RCA International Division, several locations.

Location Code

Please send resume of education and experience, with location preferred, to:

Mr. John R. Weld,
 Employment Manager, Dept. C-4C
 Radio Corporation of America
 30 Rockefeller Plaza
 New York 20, N. Y.



RADIO CORPORATION OF AMERICA

Copyright 1954 Radio Corporation of America

For more information, circle No. 3 on Reader Service Card

CHICAGO

CONSERVATIVELY RATED INDUSTRIAL TRANSFORMERS

STANCOR®

Typical units from the industry's largest and most complete line of transformers for electrical and electronic applications.

ISOLATION TRANSFORMERS



"KA" TYPE
tap switch, line cord
and output receptacle

Primary 125/115/105 Volts. Secondary 115 Volts-50/60 cycles

PART NO.	RATING WATTS	MOUNTING TYPE
P-6160	100	KA
P-6161	250	KA
P-6298	500	KA
P-6125	1000	FK
P-6123	1500	FK

STEP-DOWN ISOLATION



"FK" TYPE
ceramic insulated input
terminals, two output
receptacles

Primary 250/230/210 Volts. Secondary 115 Volts-50/60 cycles

PART NO.	RATING WATTS	MOUNTING TYPE
P-6383	100	KA
P-6385	250	KA
P-6387	500	KA
P-6389	1000	FK
P-6390	1500	FK

STEP-DOWN AUTOTRANSFORMERS



"K" TYPE
line cord on input, out-
put receptacle



"SD" TYPE
"Sealed-in-Steel" con-
struction. Line cord and
output receptacle

Primary 230 Volts. Secondary 115 Volts-50/60 cycles

PART NO.	RATING WATTS	MOUNTING TYPE
SD-50	50	SD
P-5062	80	K
SD-100	100	SD
P-5063	100	K
SD-150	150	SD
P-5064	150	K
SD-250	250	SD
P-5065	300	K
SD-500	500	SD
P-6141	500	K
SD-1000	1000	SD
P-6124	1000	FK

LINE ADJUSTING TRANSFORMERS



"PV" TYPE

Input voltage 65/75/90/100/115/130/145, output voltage 115:
with selector switch and output voltmeter

PART NO.	RATING WATTS	MOUNTING TYPE
PV6441	150	PV
PV6442	350	PV
PV6443	500	PV
PV6444	750	PV

Full lines of Control and Power Circuit Trans-
formers are also available from Chicago Standard

CHICAGO STANDARD TRANSFORMER CORPORATION

ADDISON AND ELSTON
CHICAGO 18, ILLINOIS

FREE CATALOGS listing these units, and
over 1000 other CHICAGO-STANCOR
transformers are available from your
CHICAGO STANDARD distributor or by
writing Chicago Standard Transformer
Corporation.

Export Sales: Roburn Agencies, Inc., 431 Greenwich St., New York 13, N. Y.

For more information, circle No. 4 on Reader Service Card

RADIO-ELECTRONIC Engineering

Reg. U.S. Pat. Off.
INCLUDING

TV & RADIO & Communication
ENGINEERING & Engineering

Edited by H. S. RENNE
and the Radio & Television News Staff

VOLUME 24

NUMBER 3

MARCH, 1955

Editor and Asst. Publisher

OLIVER READ, D. Sc.

Managing Editor

WM. A. STOCKLIN, B. S.

Technical Editor

H. S. RENNE, M. S.

Assistant Editor

M. C. MAGNA

Art Editor

FRANK SAYLES

Draftsmen

ALBERT A. GANS
JOSEPH A. GOLANEK

Advertising Director

L. L. OSTEN

Advertising Manager

TED SUITO

Western Adv. Manager

JOHN E. PAYNE

ZIFF-DAVIS PUBLISHING COMPANY

WILLIAM B. ZIFF (1898-1953) FOUNDER

Editorial and Executive Offices

366 Madison Ave., New York 17, N. Y.

President

B. G. DAVIS

Vice-Presidents

H. J. MORGANROTH

M. H. FROELICH

Secretary-Treasurer

G. E. CARNEY

Circulation Manager

M. MICHAELSON

BRANCH OFFICES

CHICAGO (1): 64 E. Lake St.

LOS ANGELES (14): 900 Wilshire Blvd.

RADIO-ELECTRONIC ENGINEERING is published
each month as a separate publication and is avail-
able by subscription only when purchased with
a subscription to RADIO & TELEVISION NEWS.

(Average Paid Circulation Over 28,000)

Copyright 1955 by Ziff-Davis Publishing Company
(All Rights Reserved)

JUNCTION TRANSISTOR TEST SET

By
DWIGHT V. JONES
General Electric Company



Fig. 1. The test set and auxiliary equipment being used to measure the characteristics of junction transistors.

THE glamorous appeal of the visionary transistor is still prevalent, but now the transistor and its problems are here too. Thus, techniques and equipment for analyzing transistors are of great interest, as was quite evident at a recent Engineering Seminar on Transistors held for industry at Pennsylvania State University. The transistor test set to be described in this article was built in small quantity for use at Electronics Park in Syracuse, and one such set was on loan for use at the Seminar.

Mounted in a standard cabinet rack as shown in Fig. 6, the test set is designed to give complete low frequency analysis of a transistor in the laboratory. A vacuum tube voltmeter, an audio oscillator, and an oscilloscope are required as auxiliary equipment (Fig. 1). This equipment will measure or display the following essential characteristics of *p-n-p* and *n-p-n* junction transistors for both grounded base and grounded emitter connections:

1. All *h* parameters at 270 cycles
2. Output capacitance C_o
3. Collector cutoff current I_{co}
4. Collector curves V_c vs. I_c
5. Dynamic transfer curves

For grounded emitter connection only:

6. Maximum available power gain
7. Noise figure at 1000 cycles

Collector bias voltages of 0 to ± 5 volts, 0 to ± 25 volts, and 0 to ± 100 volts are available, and emitter bias currents of 0 to ± 1 ma., 0 to ± 10 ma., and 0 to ± 100 ma. can be obtained. Line regulators are provided which hold the line voltage constant to $\pm 1\%$ for both the test set itself and the auxiliary equipment.

All ranges of both the voltage and the

Equipment for analyzing the basic characteristics of either *n-p-n* or *p-n-p* junction transistors.

current supplies are metered and continuously variable. A low hum and noise output is one of the most important factors for bias supplies in transistor measuring equipment. The current supply must have a high a.c. and d.c. impedance and be capable of maintaining the current constant to $\pm 1\%$ with a variety of loads. It is desirable that the voltage supply have an impedance of less than 100 ohms.

Parameters Checked

The parameter checker measures the *h* parameters for both grounded base and grounded emitter connections, output capacitance C_o , and collector cutoff current I_{co} . Definitions for the *h* (hybrid) parameters are:

- h_{11} = input impedance (output short-circuited)
- h_{21} = current amplification (output short-circuited)
- h_{12} = voltage feedback ratio (input open-circuited)

h_{22} = output admittance (input open-circuited)

It is easy to approximate the terminations required for the *h* method in measuring the parameters for the grounded base connection of junction transistors. Approximating terminations for the grounded emitter connection is more difficult since the low frequency output impedance is less than that for grounded base and the input impedance is greater.

From the equivalent circuits in Fig. 2 and the above definitions, the following approximate relationships result:

$$\alpha \approx -h_{21} \quad r_b \approx \frac{h_{12}}{h_{22}}$$

$$r_c \approx \frac{1}{h_{22}} \quad r_o \approx \frac{h'_{12}}{h'_{22}}$$

where *h* is the grounded base parameter and *h'* is the grounded emitter. Thus, it is very easy to calculate the *T* network parameters from the *h* measurements.

Ranges of Measurement

The accuracy (excluding v.t.v.m. error) over the ranges shown in Table 1 varies from zero error to a maximum of 5%. Accuracy of the parameter measured depends on: (1) accuracy of the v.t.v.m.; (2) tolerance of the precision resistors (i.e., $R_1, R_2, R_3, R_4, R_5,$ and R_7 in the equivalent circuits, Fig. 4); and (3) degree to which the transistor terminations approach an open or short circuit as required.

Fig. 2. Low frequency equivalent circuits for grounded base junction transistors.

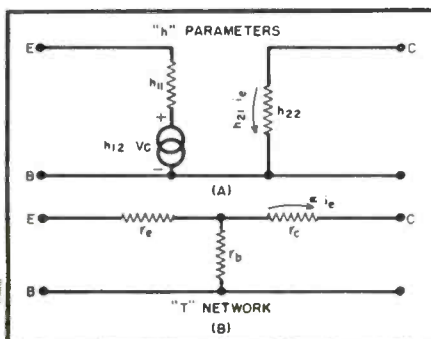

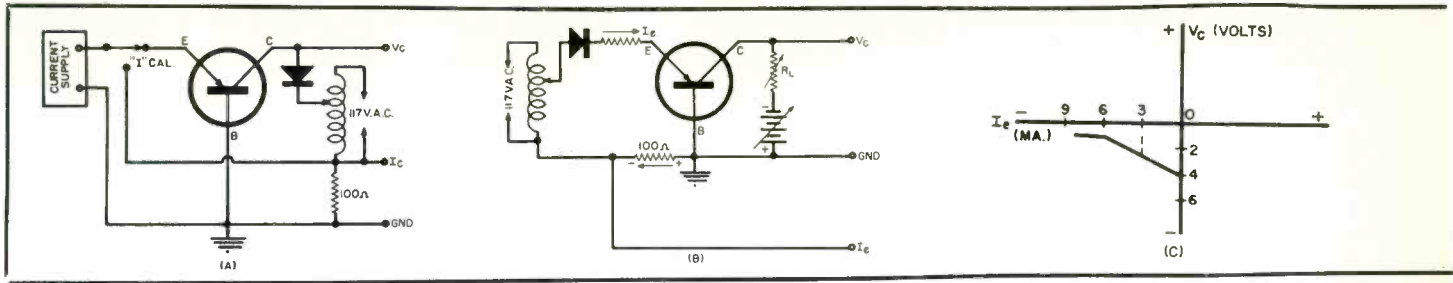

Fig. 3. (A) Circuit for V_c vs. I_c for grounded base p-n-p transistors. (B) Equivalent circuit of grounded base p-n-p dynamic transfer. (C) Grounded base dynamic transfer display for p-n-p transistors.

Specified ranges for the different h measurements may be extended if accuracy is not of prime importance. In Fig. 4, the symbol V indicates a v.t.v.m. A 270-cycle bandpass amplifier with a calibrated gain of 1000X is employed to increase the sensitivity of the v.t.v.m. By using a transformer to couple the 270-cycle signal into the measuring circuit, it is possible to ground both the oscillator and v.t.v.m. It is usually desirable to measure h_{21} (α) to a greater over-all accuracy than 5%. This greater accuracy can be obtained by measuring grounded emitter $h'_{21}[\alpha/(1-\alpha)]$ and then calculating α as follows:

$$\alpha = \frac{h'_{21}}{h'_{21} + 1} \quad (1)$$

A small signal current is used in making the h measurements so that such measurements will indicate precisely the linear, small-signal characteristics of the transistor.

The h_{22} grounded base circuit is used to obtain collector capacitance (C_c) in the range of 10 to 100 μfd . The signal generator is set to a low frequency, such as 100 cycles, where C_c is a negligible

Grounded Base	Grounded Emitter
$h_{11} \rightarrow 3\text{-}1000$ ohms	$h'_{11} \rightarrow 200\text{-}20,000$ ohms
$h_{21} \rightarrow .75$ to $.99$	$h'_{21} \rightarrow 10$ to 100
$h_{12} \rightarrow 3 \times 10^{-5}$ to 10^{-2}	$h'_{12} \rightarrow 10^{-4}$ to 10^{-1}
$h_{22} \rightarrow .1\text{-}10$ μmhos	$h'_{22} \rightarrow 10\text{-}1000$ μmhos

Table 1. Ranges covered by parameters.

part of h_{22} . Then the frequency of the signal generator is increased until the v.t.v.m. increases by 3 db. At the signal generator frequency, C_c and r_c have the same impedance, and thus the current (i_c of Fig. 4D) is twice its lower frequency value. Using the same frequency, C_c is calculated with an accuracy of approximately 10%.

$$C_c = \frac{h_{22} \times 10^6}{2 \pi f} \quad (2)$$

For this measurement, the 270-cycle filter must be switched out of the circuit.

I_{c0} is the collector current when the emitter current is zero; this is equivalent to the inverse current of a junction diode. I_{c0} ranges include: 0-25 μa ., 0-100 μa ., 0-500 μa ., and 0-2500 μa .. A phone plug is connected to the input of the

metering circuit, which makes it easy to plug in a more sensitive meter for transistors which have a very small I_{c0} .

Curves Displayed

The curve tracer displays one curve at a time of either collector or dynamic transfer characteristics. Collector characteristics for both grounded base and grounded emitter are obtained by sweeping the collector with a rectified 60-cycle sine wave of the correct polarity for p-n-p or n-p-n transistors; this sweeping collector voltage (V_c) is variable from 0 to 160 volts.

In the grounded base position, the curve is a display of collector voltage (V_c) vs. collector current (I_c) for a certain emitter bias. Thus, by varying the emitter bias from the constant current supply, any curve from the collector family can be displayed. In the grounded emitter position, the curve is a display of V_c vs. I_c for a certain base current which is measured with the meter on the parameter checker and may be adjusted for any curve from the grounded emitter collector family.

Built-in calibration on the oscillo-

Fig. 4. Equivalent circuits for h measurements for p-n-p transistors. The upper row shows the grounded base connection, while the lower row shows the corresponding grounded emitter connection.

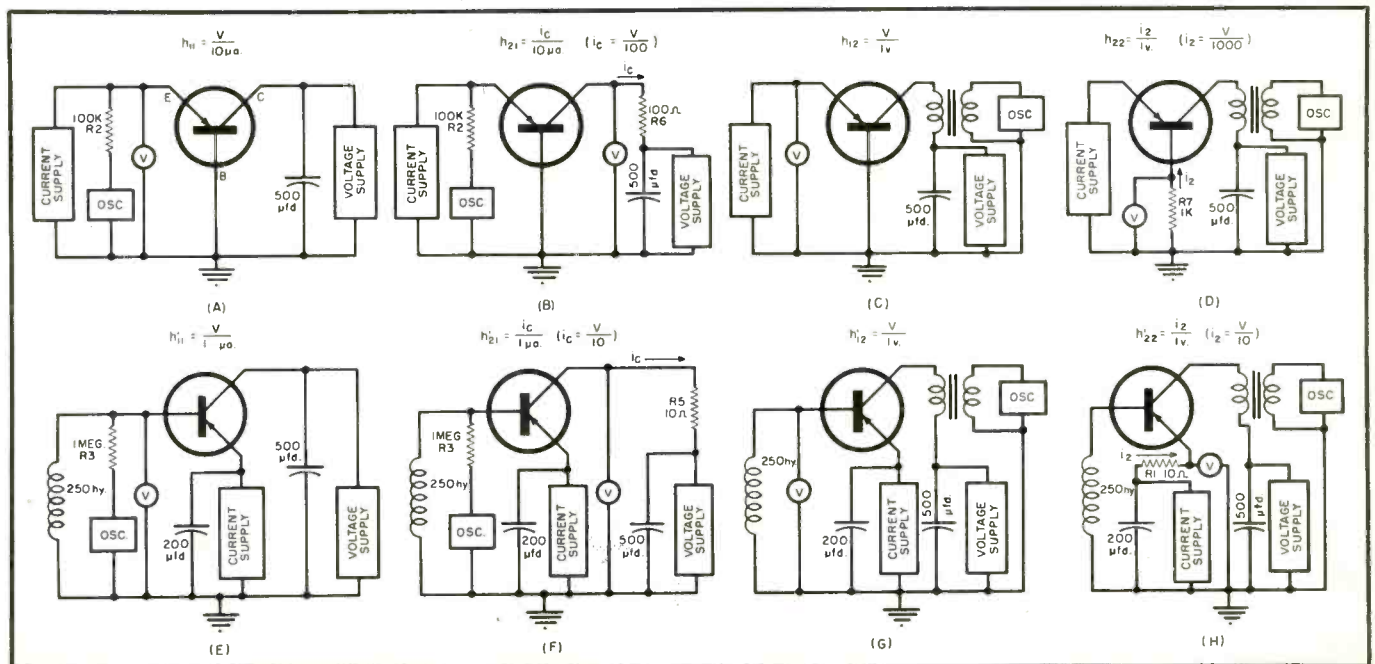

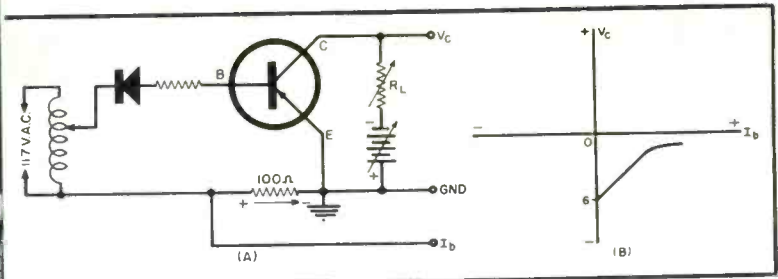
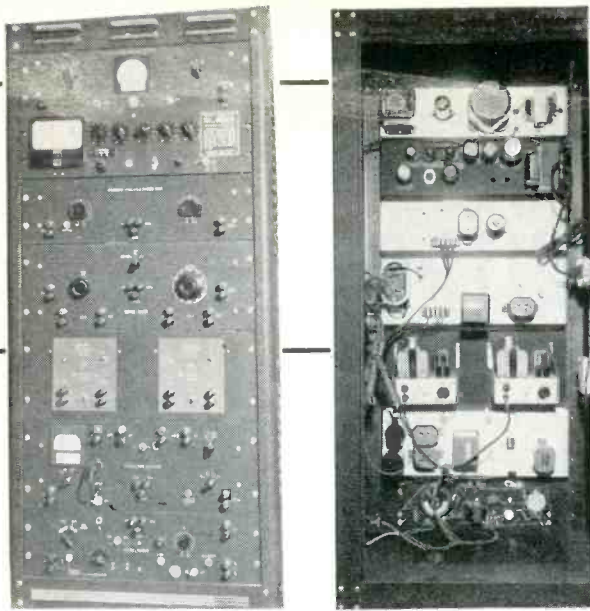

Fig. 5. (A) Equivalent circuit of grounded emitter p-n-p dynamic transfer, and (B) the dynamic transfer display.

scope is used to calibrate the voltage axis, and the current axis is calibrated with the "I cal" button which puts the metered constant current supply on the current axis. The collector display will show any irregularities and also the peak inverse voltage of the collector junction which appears in the display as an abrupt change in slope. Also, the slope for grounded emitter display can be compared with a calibrated potentiometer for an approximation of the value of $r_c(1-\alpha)$.

The dynamic transfer curves permit a display of both the linear and non-linear operating regions as a function of the collector voltage, input current swing, and output load that is connected to the "load" terminals. This will aid in selecting the proper current bias for large signal applications and assure linear operation. For instance, if the transistor circuit for the display in Fig. 3C were biased at 3 ma., then it would be capable of a maximum of 6-ma. peak-to-peak signal for linear operation.

Power Gain Measurements

Available power gain is defined as the ratio of the available power output from the amplifier to the available power output from the driving generator. If both input and output impedances are matched, maximum transfer of energy is obtained from generator to amplifier,

and maximum transfer of energy from amplifier to load. These are the conditions for which the maximum available power gain is defined¹.

The input impedance of a transistor will have an increasing reactive component as the frequency is increased. Exact input impedance match would require the conjugate complex impedance for the driving generator. For low frequency power gain measurements, the error is small if a resistance R_o equal to the absolute magnitude of input impedance is used for the driving generator impedance. The amount of available input power is $V_o^2/4R_o$ where V_o is the open circuit voltage of the driving generator in Fig. 7. The same principle is applied to the matched output.

Usually, the input impedance will vary for different transistors at a given frequency. Therefore, R_o should be variable as in Fig. 8, while the available input power should remain constant. This means that the generator must have a variable internal resistance but constant available power. A constant voltage generator can be converted into a constant power generator with the network that is between the constant voltage generator output and the transistor input of Fig. 8. $R_1 - R_5$ is a dual potentiometer made up of mechanically coupled wire-wound potentiometers and $R_7 - R_9$ is also a dual potentiometer.

R_3 has a much larger resistance than R_5 and R_6 , so the current in R_5 and R_6 from the driving generator will be constant for any variation of the dual potentiometer $R_4 - R_6$. Since R_5 has a linear taper, this assures a linear variation of V_o . R_7 has to vary as the square of the variation of V_o in order to keep the available power constant. For example, if V_o increases to twice the original value, the value of R_7 has to increase 2^2 or four times.

On the output, a v.t.v.m. is used in conjunction with a network similar to the one on the input so that the v.t.v.m. will give a power indication. The v.t.v.m. must give the same reading for the same amount of power dissipated in different values of R_L . Therefore, since R_L is a linear variation, r_2 (the resistance across which the v.t.v.m. is connected) must vary as the square root of the variation of R_L . For example, if R_L increases to four times the original value, r_2 must increase by $\sqrt{4}$ or two times. The voltmeter could be calibrated to read power gain directly in db, or a chart as in Fig. 9 will give the equivalent power gain in db.

The wire-wound potentiometers and the stray capacity across L_1 in Fig. 8 limit the frequency range. Power gain measurements are most accurate (± 1 db) in the frequency range from 100 to 1000 cycles. This range may be extended to 10 kc. except in the case of transistors with $r_c(1-\alpha)$ approaching 100K ohms. With the "set osc." button depressed, the oscillator should be adjusted for 3 volts on the v.t.v.m. R_o can be varied from 100 to 5000 ohms, and R_L from 1K to 100K (Fig. 11). R_L and

(Continued on page 33)

Fig. 7. Grounded emitter amplifier.

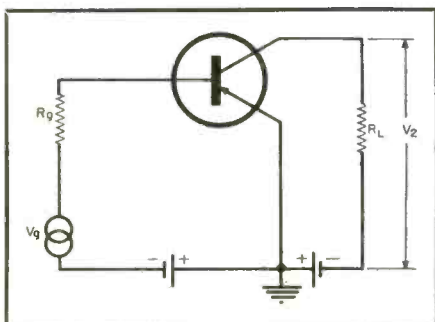
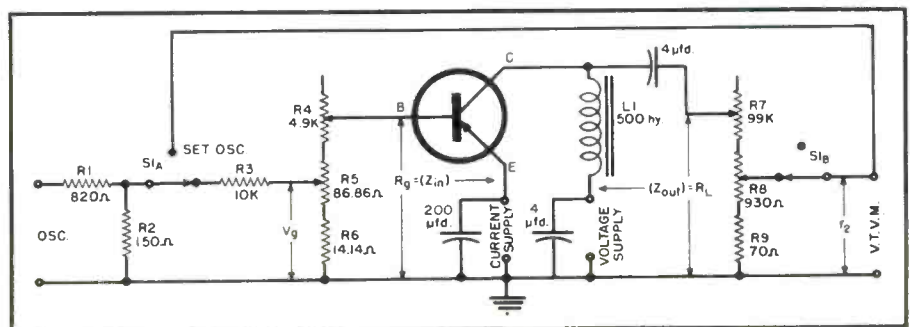

Fig. 8. Diagram of circuit for determining maximum available power gain.



ELECTRONIC

TEMPERATURE CONTROLLER

By

ALVIN B. KAUFMAN

Northrop Aircraft, Inc.

Special probe design and sensitive electronic circuit result in temperature cycling control within 0.25° F.

A TEMPERATURE controller capable of precise temperature setting and control of temperature cycling within 0.25° F will be presented in this article. Generally, a bandwidth control of this magnitude is not required for environmental testing. In the calibrating of precision resistance temperature probes, however, anything less results in unsatisfactory scatter and hysteresis of the resistance-vs.-temperature data calibration points. This type of inaccuracy cannot be tolerated when calibrations of 3% error or less are required.

Although many bimetallic switches are represented to control temperature within 0.2° F, in actual practice this can rarely be accomplished. The thermal inertia of such a switch plus the low thermal transfer coefficient of air at ambient pressures requires extremely long periods of time at slow heat cycling in order to approach the specified degree of control. Liquid immersion is usually required, with slow changes in ambient temperature. An example would be the temperature control of a small aquarium.

In the present application, a TC-2 *Statham* temperature test chamber had to be controlled over a range of -85° F to 350° F. It was apparent that adequate control of such a chamber could be obtained only with a temperature-sensitive element of small mass. This limited the temperature-sensing element to either a thermocouple or resistance element. As the use of a thermocouple would require a high gain amplifier, special circuits, and in general is involved and expensive, it was decided to center the design around a resistance probe control element capable of high output with low thermal inertia.

Temperature-Sensitive Element

In order to secure interchangeability of the temperature-sensitive element, a commercial part was selected. The requirement of low thermal inertia limited the probe to a low resistance unit of single layer construction of fine diameter alloy wire. The aircraft AN5525-2 temperature probe or its commercial equivalent met the requirement with a slight modification, as shown in Fig. 1.



Fig. 1. Modified aircraft temperature probe which is used to control chamber temperature.

To lower the probe's thermal lag time, which is a major factor with temperature control of low velocity air flow, the probe's regular AN 1/4" housing was removed and replaced with a larger tube profusely perforated with holes to allow direct air contact with the sensitive nickel alloy element. The silver spring leaves and mica insulators normally covering the element were removed. This tube is used only to provide protection for the element and is but a small part of the thermal system.

Failure to remove the probe housing results in a substantially higher thermal lag which causes a much wider bandwidth of control. Inherently, the accuracy of the control system is not worse; thermal lag simply prevents action by the controller at the right time because the probe cannot follow the temperature variations fast enough.

Most of the presently available AN5525 probes are not designed for disassembly. They may be used "as is" for the temperature control of liquids. As stated above, one make adaptable for this application is the AN5525-2 manufactured by *Edison-Splitdorf, Thomas A. Edison, Inc.* can supply these probes under special order. Control of liquid baths may also be made with a new fast response probe, *Thomas A. Edison, Inc.* part #221N90A.

Although no work has been done with *Baldwin-Lima-Hamilton* T-14 and TB-14 temperature gages, these gages might also be used for the control of air temperature. In appearance, they resemble strain gages and to some extent are strain-sensitive. However, use of such temperature-sensitive elements is subject to devising a satisfactory mounting to prevent thermal lag and strain error.

In contemplating various alternate temperature-resistance elements for use with a temperature controller, it must be noted that percentage change of resistance per °F determines the sensitivity of a probe, not its resistance change. Mass of the probe then indicates its usability for different environmental conditions.

Comparison of temperature coefficient of resistance alone does not indicate the most desirable probe element. Linearity, hysteresis, and repeatability are important factors. As an example, some of the new semiconductor elements have

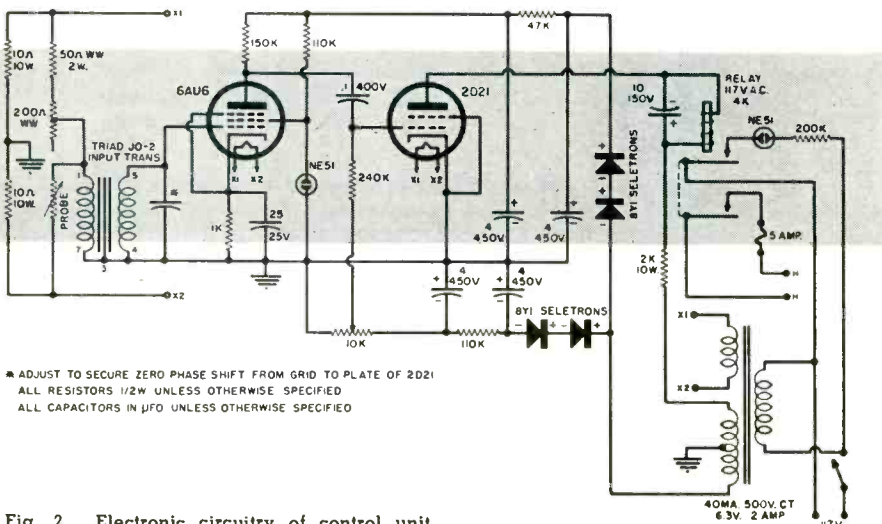
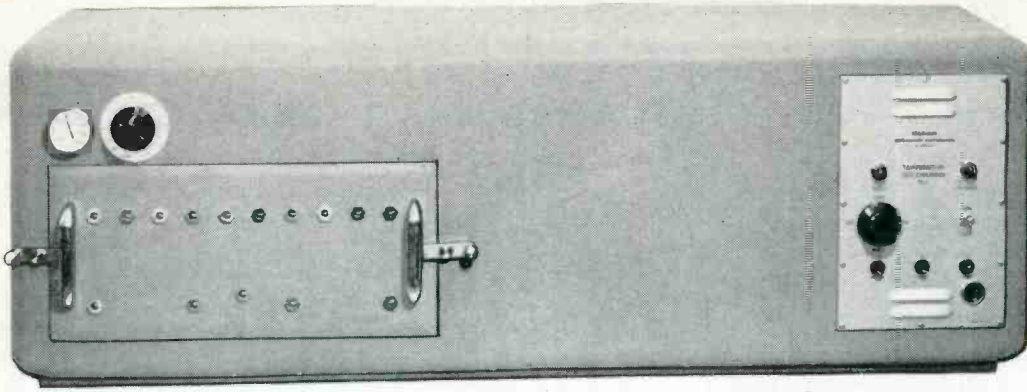

Fig. 2. Electronic circuitry of control unit.



The Statham TC-2 temperature test chamber, which is typical of chambers used by instrumentation engineers for calibration of probes, switches and other temperature-sensitive units.

a much higher dR/dT coefficient than the nickel alloy probe specified herein. These elements unfortunately have poor linearity, a wide hysteresis loop, and are not directly interchangeable.

Design Considerations

The bandwidth temperature control of a "sink" depends on many factors other than the sensitivity of the controller². Essential elements of a temperature control system include:

1. Heater-cooling element
2. Thermostat (control system)
3. Conducting medium (air, gas, liquid, etc.)
4. "Sink" (or load)

Three common mistakes made in designing a system are: (1) oversizing the heating unit, (2) undersizing the heating unit, and (3) demanding too wide a range of temperature control.

If the heating units are oversized, temperature recovery will be too rapid, and the temperature will overshoot. Furthermore, the thermal lag in electrical heaters, or the stored heat in metallic elements of gas burners, will result in undesirable temperature rise after the control has shut off the heating unit.

If the heating units are undersized, the build-up of the temperature will be too slow; and even after the proper temperature is reached, the heater capacity may not be sufficient to maintain temperature against variations of environmental changes or of heater supply fluctuations.

Too wide a range of expected temper-

An over-all view of a production model of the temperature controller, showing the Helipot ten-turn dial, pilot light, power switch, and the two fuses.

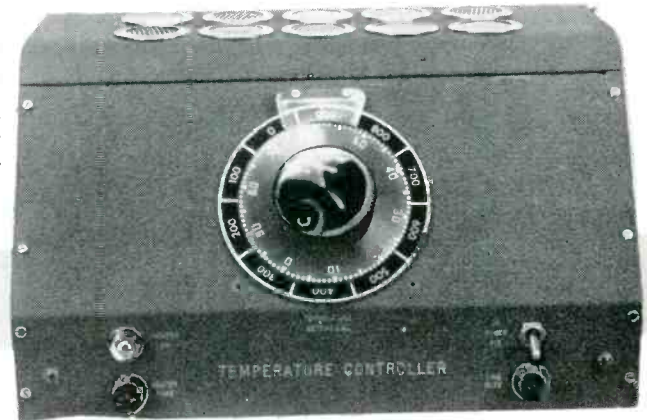

ature control may, in effect, result in an oversized heater for the lower temperatures and an undersized heater for the higher temperatures.

In the control of the Statham test chamber, the above problems are circumvented by the use of a three-position (high, medium, low) heater switch. This switch is set to give the narrowest bandwidth compatible with the magnitude of the test temperature and the dry ice loading of the chamber.

Before entering into a discussion of the electronic controller, there are two additional factors of importance. These are the optimum location of the thermal-resistive probe and the method of temperature control.

Effects of temperature gradients are often overlooked. Existence of temperature gradient can be used to great advantage especially with "on-off" type temperature controllers. Because the

load is located at some distance from the thermostat and heater, its temperature bandwidth may be small, even though the heater may go up to red heat seconds after the controller starts to operate. Heat flowing "down hill" from the heater to the test area gradually raises the test area temperature, and thus wider temperature fluctuation is permissible close to the heater.

This wider fluctuation may be employed to advantage in reducing the required sensitivity of the controller and in eliminating overshoot caused by heater thermal properties. Location of the probe too close to the heater, however, can result in excessive cycling of the controller. Optimum location of the control element then lies somewhere between the sink and heat source where control of the heater is employed. This method is utilized with the Statham

(Continued on page 30)

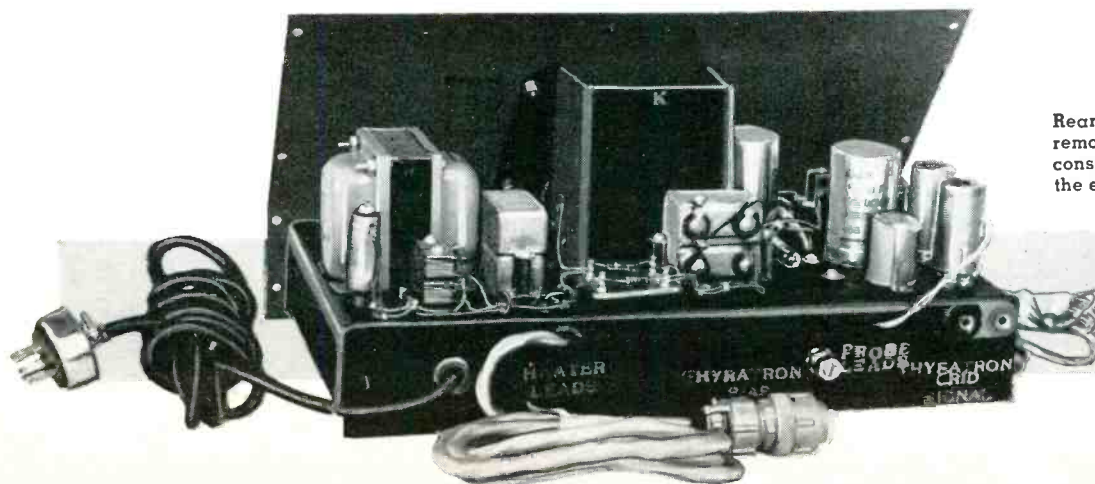

Rear view of temperature controller removed from its cabinet. Channel construction is utilized to minimize the effects of temperature variations.

COMPONENTS FOR MECHANIZED PRODUCTION

By **B. L. DAVIS**

National Bureau of Standards

An adhesive tape capacitor and a "chip" resistor have been developed, and a method of using the pyrolytic carbon resistor has been worked out.

SINCE the announcement of a new system for the mechanized production of electronics in 1953, the National Bureau of Standards has developed additional compatible components and techniques under the sponsorship of the Navy Bureau of Aeronautics. Recent advances in electronic process technology include an adhesive tape capacitor, a "chip" resistor, and a method of utilizing the pyrolytic carbon resistor. Evolved by the Bureau's process technology laboratory, they should do much to increase the versatility and applicability of electronic equipment manufactured by automatic production lines.

Development of systems for Modular Design of Electronics and Mechanized Production of Electronics (MDE-MPE), formerly code-named Project Tinkertoy, was begun by the Bureau with the cooperation of several industrial companies under the sponsorship of the Navy Bureau of Aeronautics as an industrial preparedness measure. The MDE-MPE system starts with raw or semi-pro-

cessed materials and automatically manufactures ceramic base wafers, dielectric elements for capacitors and adhesive tape resistors; prints conducting circuits and capacitors; and mounts resistors, capacitors and other component parts on standard, uniform steatite wafers. Wafers are stacked like building blocks to form modules that perform all the functions of one or more electronic stages. The pilot plant, operated by a commercial contractor, incorporates the principles of this system; it was designed to produce 1000 finished and inspected modules per hour.

Tape Capacitor

Designed specifically for application to the ceramic wafer by means of MDE-MPE machine techniques, the self-adhesive tape capacitor is manufactured in much the same manner as the NBS self-adhesive high-temperature tape resistor. A conducting tape, coated on one side with a dielectric, provides one element of the capacitor, while the other element is a silver pattern printed and

fired on the wafer. It is now possible to apply an adhesive tape resistor to one side of a wafer and an adhesive tape capacitor to the other side.

Materials required for the manufacture of the tape capacitor include: a heat-resisting asbestos paper tape, silver flake, silicone resin, butyl cellosolve, a powdered high-K titanate body, *N*-hexane, and epoxide resin. After the electrically conducting formulation (a mixture of the silver flake, silicone resin, and solvent) is ground in a ball mill, the mixture is sprayed on a loop of tape 1¼" wide, allowed to dry thoroughly, and then sprayed on the other side. When cured, the metallized tape is conductive along each side and from one side to the other. After being slit along the center to form two ¾" tapes, the material is ready for application of the dielectric film. A roll of tape 19' long will produce about 350 capacitors.

The dielectric formulation is composed of a high-K titanate body that has been pulverized in a ball mill with *N*-hexane until the particle size is about 1 to 2 microns, after which the slurry is allowed to evaporate under a hood. The ground titanate body is mixed with epoxide resin and further ball-milled. This tacky dielectric mixture is then sprayed on the metallized base tape in various thicknesses determined by the number of passes the tape makes in front of the spray gun.

By means of a screen press, the silver pattern that forms one electrode of the capacitor is applied to the steatite wafer. It is then dried and fired onto the ceramic. The adhesive dielectric-coated tape that forms the other electrode is cut into squares slightly larger than the silver contact and pressed down on it. A narrow conductive strip, similar to resistor tape but with a conductivity of approximately 0.02 ohm per half inch, is laid down between a contact on the edge of the wafer and the top side of the capacitor. The complete assembly is then cured by placing it in an oven at room temperature, raising the temperature to 225°C over a period of one-half hour, and holding it at 225°C for 45 minutes.

Capacitors of higher values can be manufactured by applying a number of layers of tape, one on top of another, with appropriate connections to the edge of the wafer. Smaller valued capacitors can be made by reducing the area of the silver pattern printed on the wafer, or by increasing the thickness of the dielectric layer.

Shelf life tests indicate that the capacitance changes no more than 1% during the first month after manufac-

One electrode of the capacitor is a printed silver pattern on an MDE-MPE wafer. Elements may be printed on either or both sides, depending on requirements. An adhesive tape resistor can be applied to the opposite side of the wafer.



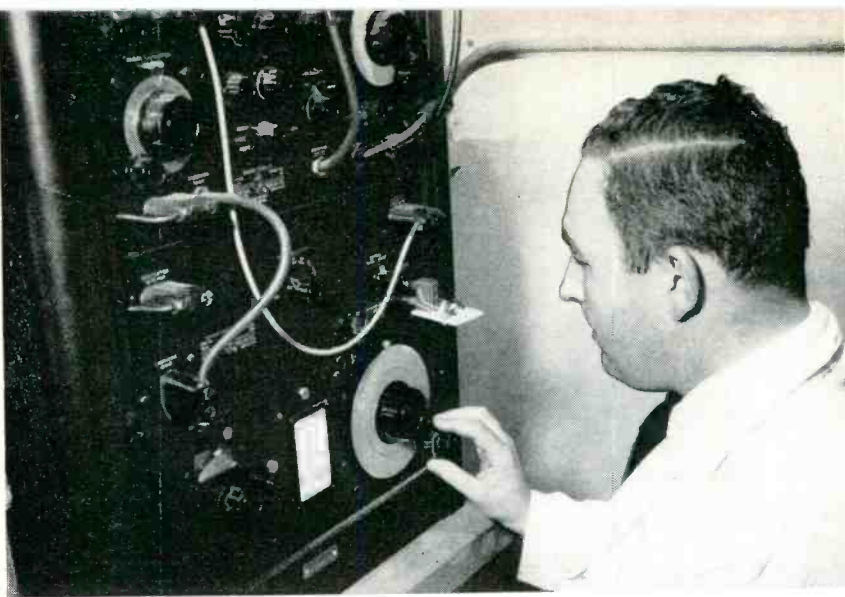

Tape capacitor being tested in an impedance bridge. Capacitance values ranging from 500 to 2000 μfd . have been made. Thickness of dielectric film and size of conducting wafer control the capacitance.

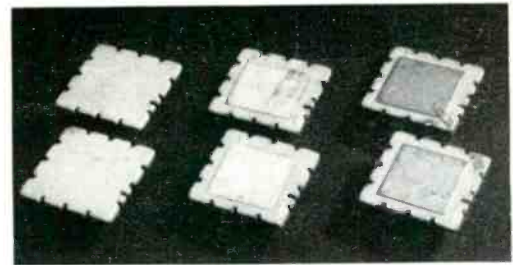

Tape capacitors in varying stages of production. At left are blank wafers; in the center, the silver pattern has been applied; right, dielectric-coated tape is pressed in place.

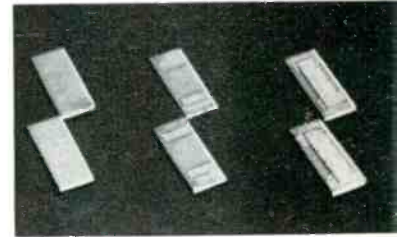

Chip resistors. Blank wafers are at left; in center, conducting tabs have been applied; at right, completed units.

ture, and that there is no change in the dissipation factor, which averages 0.7% at 1 kc. However, the capacitance does change somewhat with temperature, -3% from 25°C to 85°C, and -15% from 25°C to -55°C. In a load life test, a few capacitors shorted out, but otherwise only negligible changes occurred in capacitance and dissipation factor.

"Chip" Resistor

The "chip" resistor is made by applying self-adhesive resistor tape to a small chip of ceramic material. This resistor is not for use in the regular quantity production of modules, but aids the electronic design engineer in studying new modular circuits which are still in the "breadboard" stage or in producing prototype equipment for evaluation. The chip is inserted into a circuit simply by soldering it to the appropriate connections on a standard wafer.

Prepared resistor tape is manufactured automatically by means of the usual MDE-MPE techniques but is applied to a chip of cured steatite about 0.600" by 0.225" instead of the standard MDE-MPE wafer. A prototype machine developed by the NBS laboratories mounts the resistor on the chip. The chip, with its tinned and silvered connecting tabs already fired onto each end, is automatically oriented properly in a shallow die. A roll of tape of the desired resistance value is fed into the machine and is die-cut to a size of 0.5" x 0.125" to overlap the metallized tabs on each end. The machine then presses the cut tape, adhesive side down, onto the ceramic chip. When this operation is completed, the chip resistor is ejected from the machine into a hopper and is ready to be cured. The production model will be entirely automatic, will require no attention other than that necessary to supply it with steatite chips and resistor tape, and will be capable of man-

The pyrolytic carbon resistor, shown in several stages of manufacture, can be made either in flat or in round shapes.

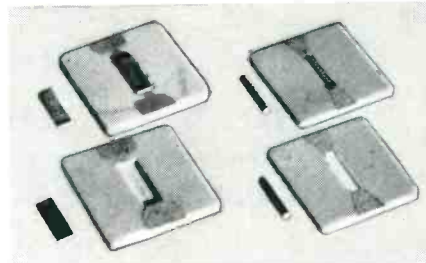

ufacturing 1000 chip resistors per hour.

Pyrolytic Carbon Resistor

Made by a process developed by the *Bell Telephone Laboratories*, the pyrolytic carbon resistor is a miniature component for use in communications equipment. Because this resistor may be manufactured in large quantities to close tolerances, the Bureau has adapted it to the MDE-MPE methods by inserting it in a specially designed wafer to produce a unit that is wholly compatible with other MDE-MPE units. The unit can be either flat or cylindrical and measures about $\frac{5}{8}$ " long by $\frac{1}{8}$ " wide or $\frac{1}{16}$ " in diameter.

Although not yet in regular production, the carbon-film resistor is being manufactured for small production runs under license from the *Western Electric Company*. It is made by cracking or decomposing methane gas in a high temperature chamber which also contains the miniature ceramic forms. Pure carbon is deposited on the ceramic in accurately controlled thicknesses. The coated form is then either grooved or spiraled mechanically to increase the electrical path length and to decrease the path cross section. Accurate control of resistance is achieved in this way, and the finished resistor is within 2% of its design value.

An MDE-MPE wafer having an appropriately shaped depression receives the carbon resistor. The depression has printed conducting paths on each end to provide connection from the resistor terminals to the riser wires of the completed module. After the resistor is in-

serted into the wafer, it is terminated with a silver thermosetting resin mixture and cured at 150°C for two hours or at 200°C for a half hour. It is then ready to be assembled, via the automatic production line, into a module with other electronic components.

BIBLIOGRAPHY:

(The following publications on Project Tinkertoy are available from the Office of Technical Services, U. S. Department of Commerce, Washington 25, D. C.)

- Vol. I—Summary MDE and MPE, PB111275.
- Vol. II—Conversion from Conventional Design to MDE, PB111276.
- Vol. III—Hand Fabrication Techniques, PB111277.
- Vol. IV—Mechanized Production of Electronics (MPE), PB111278.
- Vol. V—Manufacturing Cost Determination, PB111315.

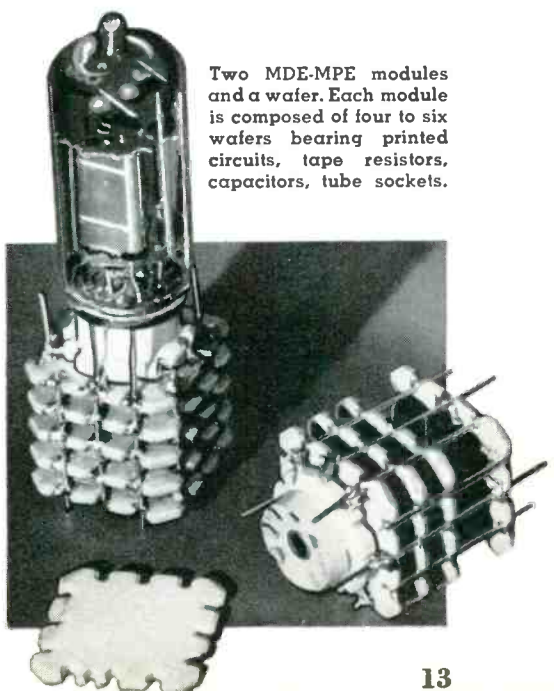

Two MDE-MPE modules and a wafer. Each module is composed of four to six wafers bearing printed circuits, tape resistors, capacitors, tube sockets.

U.H.F. BYPASS CAPACITOR NOMOGRAPHS

By
NORMAN B. RITCHEY
 Sylvania Electric Products Inc.

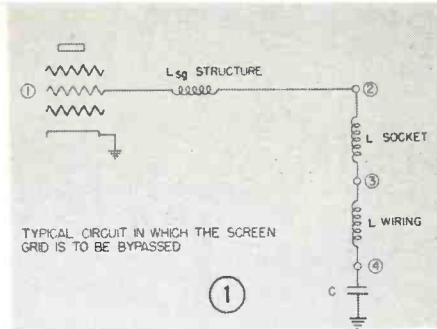

Series resonant bypassing is discussed, and nomographs of capacitor resonance presented.

THERE ARE few engineers who have not had the experience of putting together a high frequency amplifier or a TV or radar i.f. strip. Following the admonition to keep the leads short, tubes are always selected which are especially designed for this frequency range, and a chassis layout is then arranged which is nothing less than an artistic masterpiece. And the first time the unit is turned on . . . it oscillates. Upon trying all the timeworn remedies for oscillation, the net result may be a stable circuit that shows a decided tilt in the frequency response or, perhaps, an unwanted peak in the passband. After a siege of "piddling" in the laboratory, of course, the response can be cleaned up easily enough, but usually at the expense of the neat "artistic" layout; the messy-looking shields, chokes, bypass capacitors, etc., seem like the afterthoughts that they actually are. And in the process, it is hard sometimes not to lose faith in the "science" of electronics and to put u.h.f. amplifiers in the same class with voodoo.

Much of the trouble encountered in such chassis, however, can be traced to improper bypassing methods. It is the purpose of this article to explain a sound bypassing technique which can be used at u.h.f.

High Frequency Bypassing

The old rule-of-thumb of selecting a capacitor "over a specified minimum" is subject to considerable revision in the light of the information presented in this article. Effectiveness of high frequency bypassing can be shown to vary as a function of the capacitance, the wiring lengths, socket pin lengths, length of the tube structure, and any coupled paths that might reflect mutual inductance into the circuit. The circuit to be bypassed is usually somewhat similar to that shown in Fig. 1.

The desired effect is to have point 1, the screen, at ground potential. A heavy bypass will put point 4 at ground but will leave point 1 at an r.f. potential to contribute the feedback that becomes so troublesome in multistage units. By selecting C to resonate with the circuit

(Continued on page 36)

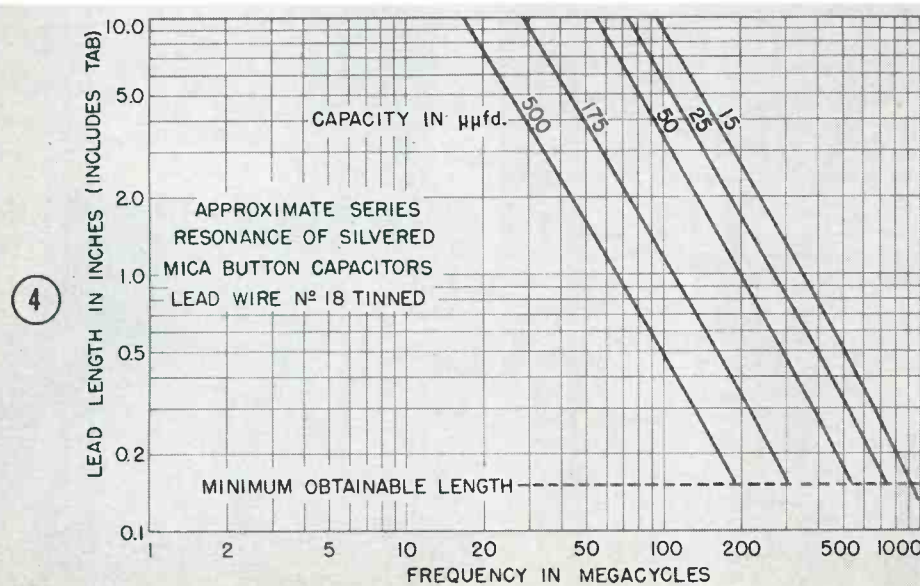
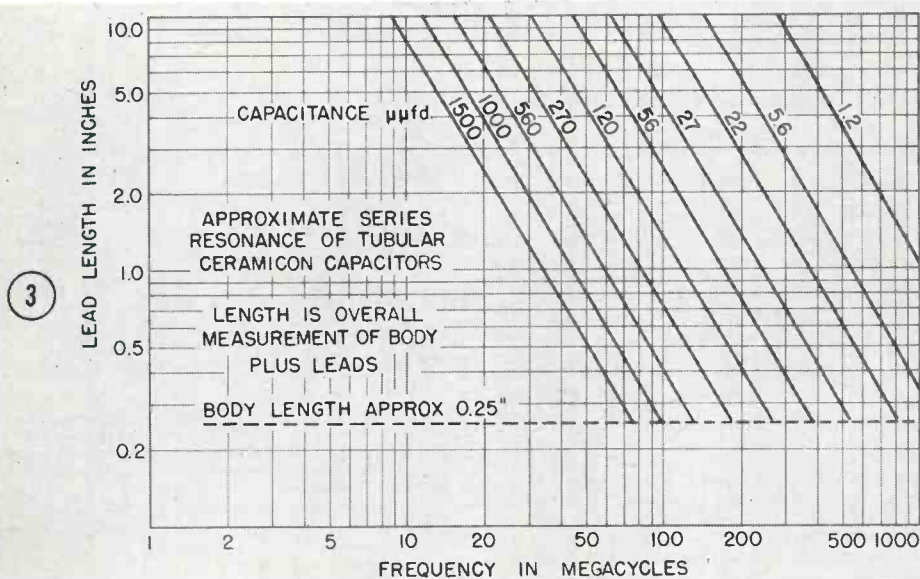
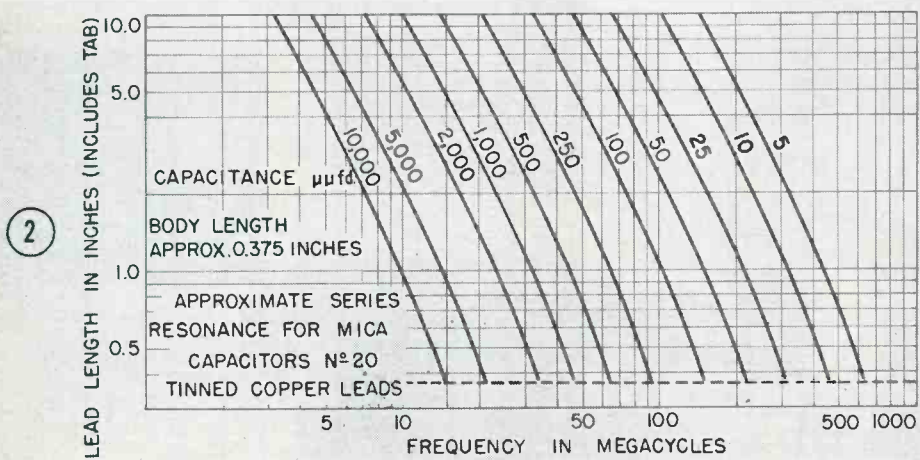

CONTROLLED BEAT-FREQUENCY OSCILLATOR

By ALBERT H. TAYLOR

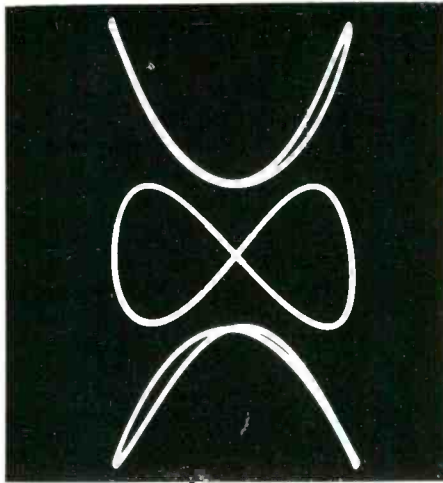

Fig. 1. Lissajous figures (2:1 ratio) corresponding to conditions of Fig. 4.

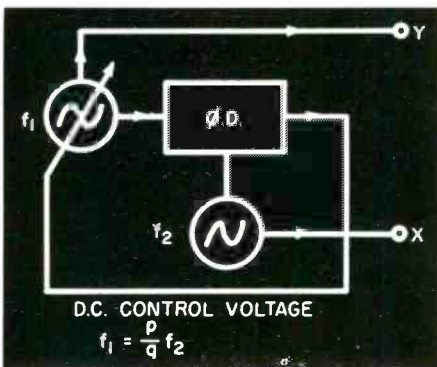

Fig. 2. Fractional frequency generator using a locked oscillator with a reactance tube and a phase detector (Φ.D.).

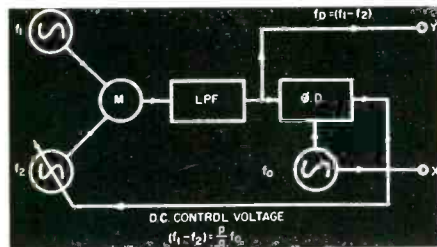
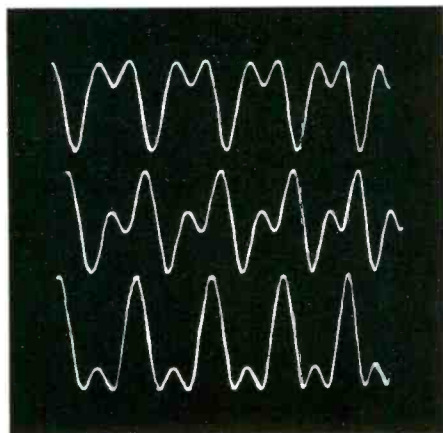

Fig. 3. Incremental frequency generator which makes use of a locked oscillator.

Fig. 4. Mixed 1000- and 2000-cycle signals differing in both amplitude and phase.



Locking a b.f.o. in rational ratios to a fixed standard yields a number of closely spaced, accurate frequencies.

THE beat-frequency oscillator economically covers a wide frequency range without bandswitching, but has the disadvantage of poor frequency precision due to the fact that the output frequency is the difference of two large quantities. For the large class of operations which requires sufficiently fine steps of frequency but not continuous tuning, this disadvantage can be overcome by locking the b.f.o. in rational ratios to some fixed standard frequency.

Since the individual oscillators operate at radio frequencies, they cannot be locked against an audio frequency by means of ordinary locked-oscillator techniques; but the block diagrams of Figs. 2 and 3 illustrate how their difference can be so locked by a.f.c. techniques¹. Figure 2 shows a locked oscillator using a phase detector and a reactance tube, which is mentioned by Terman². It has no advantage over simpler circuits except at complicated ratios where simpler units may not lock. In Fig. 3, f_1 and f_2 are two radio frequencies which are heterodyned in the mixer M . The difference f_0 is separated by the low-pass filter LPF and feeds one leg of the phase detector $\Phi.D.$; while another frequency f_1 , which may be a fixed standard frequency or derived from f_1 , feeds the other leg.

Phase Detector Circuits

The phase detector differs from a discriminator of the Travis or Foster-Seeley type^{3,4,5} only in that it compares two frequencies instead of comparing one frequency with tuned circuits. Further, it does so in the present application not only at 1:1 but at any rational frequency ratio p/q . Figure 7 illustrates a few of the many possible phase detector circuits, all having the

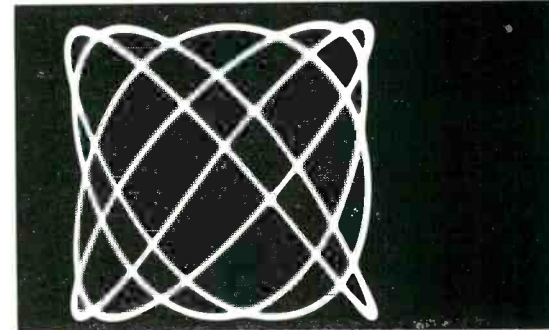

Fig. 5. Lissajous figures (5:4) corresponding to conditions of Fig. 6.

property that the d.c. output voltage is a function of the relative phases of the two input signals and the amplitude of the smaller. The phase detector is commonly used as a differential detector with a.c. bridges.

Figure 7A shows the most familiar form of phase detector circuit and the easiest to analyze theoretically. Of the two transformers in it, T_1 should by rights be a balanced hybrid coil with a shield between windings, but an ordinary push-pull input usually suffices at low frequencies. T_2 has one side grounded for a.c., so that it can be replaced by capacitance coupling to a choke or to a resistor which must have a lower impedance than the diode loads if output is not to be excessively reduced.

The units in Figs. 7B and 7C are less expensive than good transformers and are capable of wider frequency range, but have their own peculiarities with regard to balancing and output. All phase detectors require balancing and may need pentode or grounded-grid amplifiers and trimmer capacitors at high frequencies. Any constant un-

Fig. 6. Mixed 1000- and 1250-cycle signals of different amplitude and same phase.

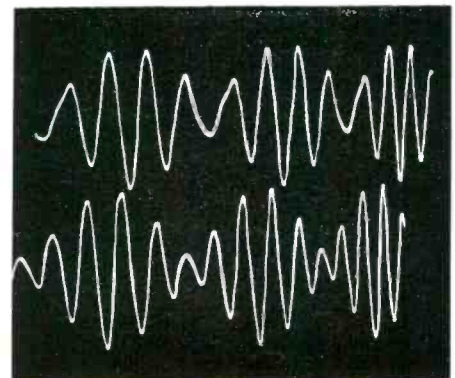

balance in $V_{d.c.}$ shifts the operating point of the reactance tube, which should be kept in the middle of the straight portion of the g_m vs. e_r curve. The push-pull excitation for the rectifiers may come from a push-pull amplifier as shown to the left of AA in Figs. 7B and 7C, or from some type of phase inverter other than the split-load type. This is because the two output impedances of the amplifier or inverter are part of the bridge and must be symmetrical. Cathode and plate impedances are not symmetrical. Fine balancing adjustments shown in Figs. 7B and 7C cancel the direct effect of each input in the output. The portions to the left of AA are interchangeable, but the method shown in Fig. 7B renders the two adjustments less interdependent. The d.c. output and ground connections in Figs. 7B and 7C are both a.c.-hot and therefore must be made through high resistances or inductances. A choke is preferable in the ground side because its lower resistance shorts out an unexplained small d.c. voltage from the whole bridge to ground which otherwise may appear and require off-balance operation to cancel it.

In Figs. 7D and 7E are triode circuits which worked well with the locked oscillator of Fig. 2 to give controlled frequencies between 100 and 1500 kc. from a 1000-kc. crystal. They require little signal in the grid circuit, grid current does not directly appear in the output, and the two inputs are more easily isolated. The circuit in Fig. 7E is the only circuit shown which may be used with the split-load phase inverter.

Frequency Ratios

Early papers on a.f.c. and FM give detailed analyses of the phase discriminator with the same frequency in differ-

ent phases applied to the two legs. The circuit of Fig. 7A will operate without the twin capacitors across the diode loads and they may be omitted sometimes to combat hunting; but the d.c. output is much greater if the RC product is large enough for peak rectification. In that case, assuming a 1:1 ratio in the transformers, if $E_1 = A \sin \omega t$ and $E_2 = B \sin (\omega t - \phi)$, the formula which can be derived either by calculus or by the law of cosines is:

$$V_{d.c.} = \frac{\sqrt{A^2 + B^2 + 2AB \cos \phi}}{\sqrt{A^2 + B^2 - 2AB \cos \phi}} \quad (1)$$

Depending on whether the positive or negative square roots are taken, the maximum control voltages are $2A$ or $2B$ at 0° and $-2A$ or $-2B$ at 180° . The sensitivity is:

$$\frac{dV}{d\phi} = \frac{AB \sin \phi}{\sqrt{A^2 + B^2 + 2AB \cos \phi}} + \frac{AB \sin \phi}{\sqrt{A^2 + B^2 - 2AB \cos \phi}} \quad (2)$$

At 90° , where V is zero, $dV/d\phi$ has as its maximum value:

$$\frac{dV}{d\phi} = \frac{2AB}{\sqrt{A^2 + B^2}} \quad (3)$$

If $A \gg B$, both $V_{d.c. \text{ max.}}$ and $dV/d\phi$ depend on B only, and vice-versa.

When the two applied frequencies are not rationally related, there is no output. In the general rational case of present interest, when the voltages are $A \sin p\omega t$ and $B \sin q(\omega t - \phi)$, ω being the greatest common divisor of the applied frequencies, the trigonometric equations become fearsome and a graphical or experimental treatment is more inviting. Figures 1, 4, 5 and 6 were photographed on the oscilloscope screen with the controlled b.f.o. in operation (as shown in Fig. 10) instead of labo-

riously synthesizing them by adding the ordinates of sine waves.

With a simple ratio such as 2:1 (Figs. 1 and 4), it is quite easy to see the difference in positive and negative peak amplitudes with various phase relationships. Figure 4 shows the actual waveforms as applied to a diode plate of the phase detector: $E = \sin \omega t \pm B \sin 2(\omega t + \phi)$ for $A - B$ and three values of ϕ from top to bottom (45° , 0 and -45°). The d.c. output of one rectifier is proportional to the positive peaks and that of the other proportional to the negative peaks, so that there will be net outputs of opposite sign from the upper and lower waveforms, while that from the center waveform cancels. Figure 1 shows the Lissajous figures corresponding to these three phases, with E_1 and E_2 poled for B to have the minus sign.

With a more complicated ratio such as 5:4 (Figs. 5 and 6), the relationship is not so obvious, and the waveform of $A \sin 4\omega t \pm B \sin 5(\omega t + \phi)$ in Fig. 6 looks a little like a modulation pattern. The phase relationship in both waves of Fig. 6 is the same and lies in the middle of the control range where the Lissajous figure (Fig. 5) opens up symmetrically for easiest counting. The only difference is that in the upper wave the 1000-cycle amplitude is greater and in the lower wave the 1250-cycle amplitude is greater, with no effect on control action. Each wave repeats itself at 250 cycles, the greatest common denominator of 1000 and 1250. The waveform varies with the relative phase of the components at this as at other ratios, and the d.c. output of the phase detector goes through maxima and minima which are smaller the larger the numbers in the ratio p/q but suffice to control a sensitive reactance tube even

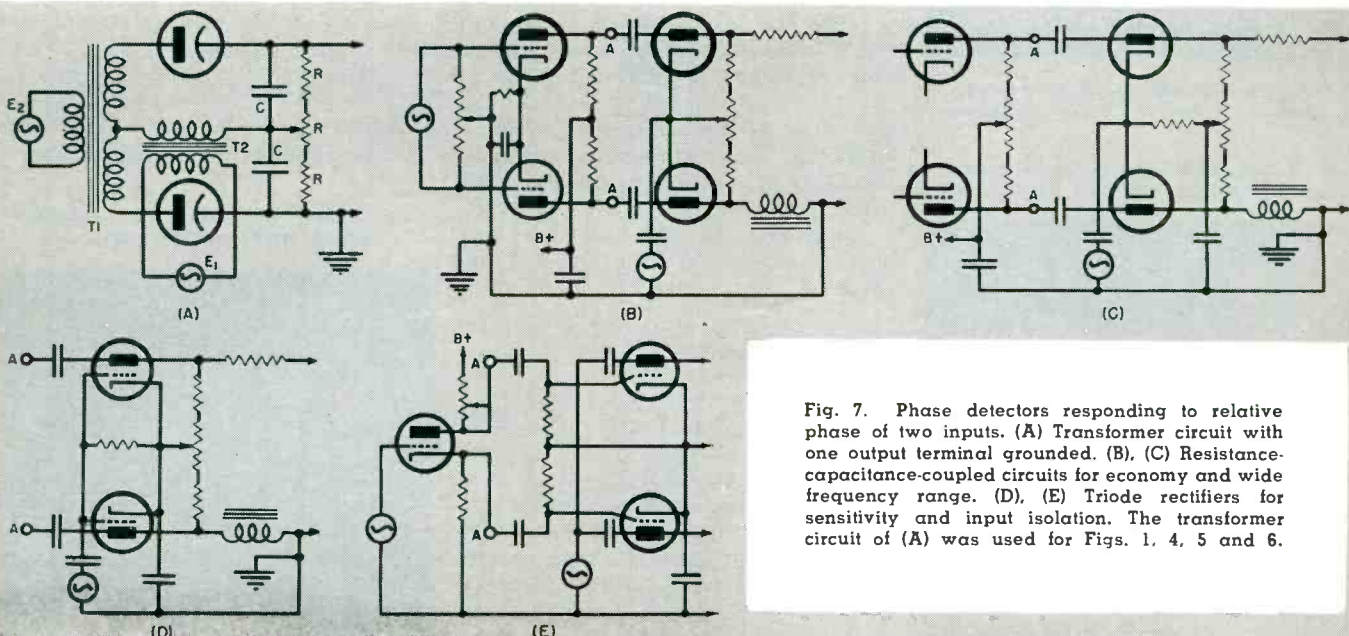

Fig. 7. Phase detectors responding to relative phase of two inputs. (A) Transformer circuit with one output terminal grounded. (B), (C) Resistance-capacitance-coupled circuits for economy and wide frequency range. (D), (E) Triode rectifiers for sensitivity and input isolation. The transformer circuit of (A) was used for Figs. 1, 4, 5 and 6.

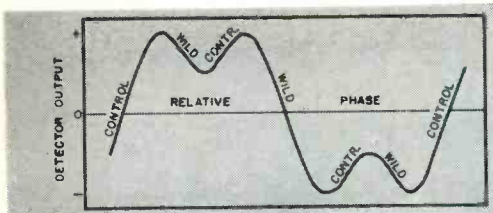

Fig. 8. Phase detector output for complicated ratios can have several maxima and minima, and control slopes as shown.

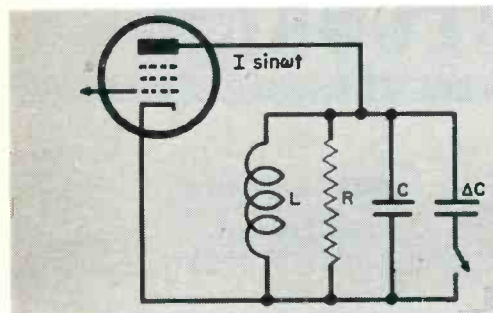

Fig. 9. Sudden detuning causes transients which the control system must damp out.

at ratios like 17:10. Indeed, the p and q that can be handled seem limited only by the stable sensitivity and by the tendency of the oscillators to drop into simple ratios if such ratios are approached too closely.

A curious feature of some ratios is that there may be a number of maxima and minima with control or "wild" slopes between them so that the oscillators will lock in various phase relationships and the composite waves corresponding to those in Figs. 4 and 6 may look quite different. These control slopes do not always pass through zero before $dV/d\Phi$ reverses and control is lost, giving some such characteristic as the fictitious one of Fig. 8. Such an off-center control region shifts the operating point and the oscillator calibration unless the detector is unbalanced or the fixed bias changed to compensate for off-center operation. The lock in one phase relationship is often more stable and less inclined to hunt than in another, and conditions not yet thoroughly studied determine into which phase the oscillator will drop.

Reactance Tube Tuning

Reactance tube circuit design is adequately discussed in the a.f.c. references given. The effective-capacitance type adopted in Fig. 10 is satisfactory at low radio frequencies. For the small r.f. tuning range of this application, the capacity can be on the plate side only of the Colpitts oscillator because the coil has but one winding. If the grid resistor R is small compared to the reactance of the grid-to-plate capacitor, as with the values of 1200 ohms and 30 $\mu\text{fd.}$ shown, the effective capacitance is

$C_i \cong g_m RC$ and the effective shunting resistance is $R_i \cong 1/g_m (R\omega C)^2$. For the 12SG7, as shown, C_i with zero control signal has a value of about 125 $\mu\text{fd.}$ and R_i of about 220K. At high radio frequencies, the grid-to-cathode capacitance requires using the effective-inductance circuit which is customary in receiver a.f.c. In any case, the change required for locking is small if the circuit components are at all stable, and the reactance tube in Fig. 10, for example, can pull the oscillator unnecessarily far from calibration before it lets go of a simple ratio. High sensitivity is necessary for locking complicated ratios but sensitivity should be reduced somewhat for the simple ones.

If the detector d.c. output is monitored with a voltmeter or a 6AL7 tube, the tuning can be calibrated for zero control voltage at each different rational ratio to a standard, locked or unlocked, and reset to calibration after aging shifts by adjusting the reactance tube screen or cathode voltage. Indeed, if f_1 and f_2 are large enough compared to the desired total range of f_0 , the reactance tube can do all the tuning in this way, without L or C being varied mechanically. Finally, a switch to replace the reactance tube by equivalent fixed C and R would change the circuit to that of a conventional b.f.o.

Hunting and Damping

An oscillator governed by a phase detector and a reactance tube, as in Fig. 2, constitutes a feedback system with two or more time delays and as such will oscillate under some conditions. Here, the principal time delays result from: (1) the RC or other ripple filter

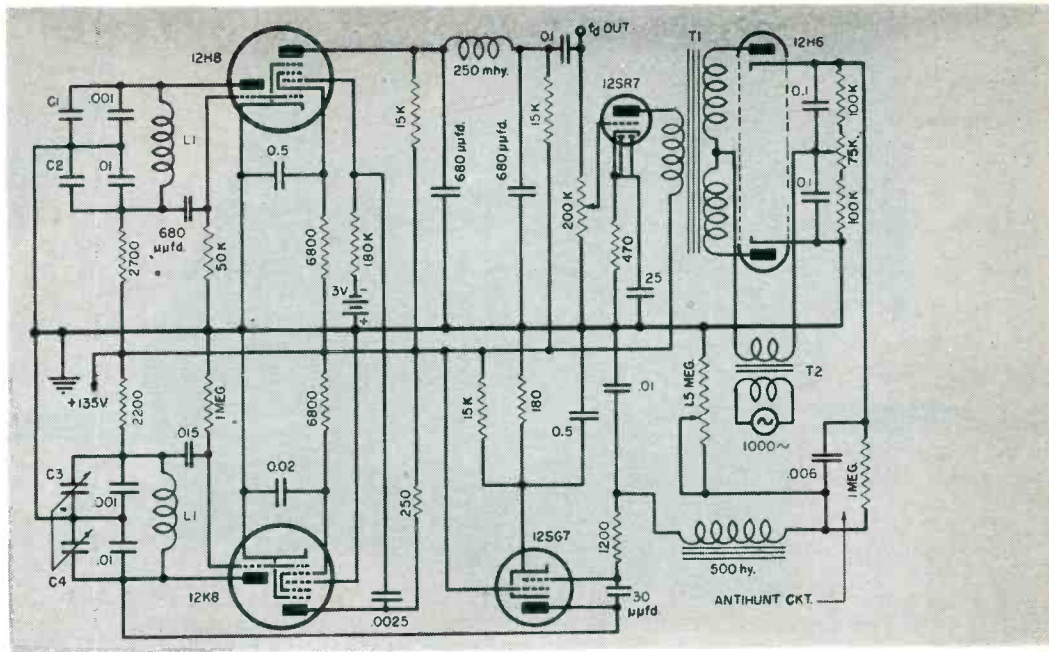

Fig. 10. Experimental controlled b.f.o. C_1 and C_2 adjust the fixed oscillator; C_3 and C_4 are about 300 and 1000 $\mu\text{fd.}$, respectively. T_1 and T_2 are audio transformers.

on the Φ .D. output which is necessary to prevent frequency modulation and/or grid current; and (2) the momentum of the oscillator tank circuit, which resists changes in phase of currents and voltages if it has high enough Q (low enough decrement δ) to oscillate at all. In the unit shown in Fig. 3, the mixer filter also has a delay which is unimportant if f_1 and f_2 are $\gg f_0$.

A rigorous mathematical analysis of the entire loop is very difficult because the differential equation, if an accurate one can be set up at all, will not be linear with constant coefficients; but a hint of what goes on can be gained from considering an LCR tuned circuit suddenly detuned slightly (Fig. 9). If the LCR circuit is assumed to be excited in resonance at constant frequency and current $I \sin \omega t$ by a pentode tube, and suddenly detuned to a new value of C or L , the differential equation of the current in R —which is in phase with the voltage across it—is:

$$\left(D^2 + \frac{1}{RC} D + \frac{1}{LC}\right)i = \frac{I}{RC} \omega \cos \omega t \quad (4)$$

$$i = e^{-\alpha t} (A \cos \omega_s t + B \sin \omega_s t) - \frac{R\omega L (1 - \omega^2 LC)}{R^2 (1 - \omega^2 LC) + \omega^2 L^2} I \cos \omega t - \frac{\omega^2 L^2}{R^2 (1 - \omega^2 LC) + \omega^2 L^2} I \sin \omega t \quad (5)$$

$$\omega_s = \sqrt{\frac{1}{LC} - \frac{1}{4R^2 C^2}} \quad (6)$$

$$\alpha = \frac{1}{2RC} \quad (7)$$

This solution indicates that—as can be verified experimentally—the detuning
(Continued on page 34)

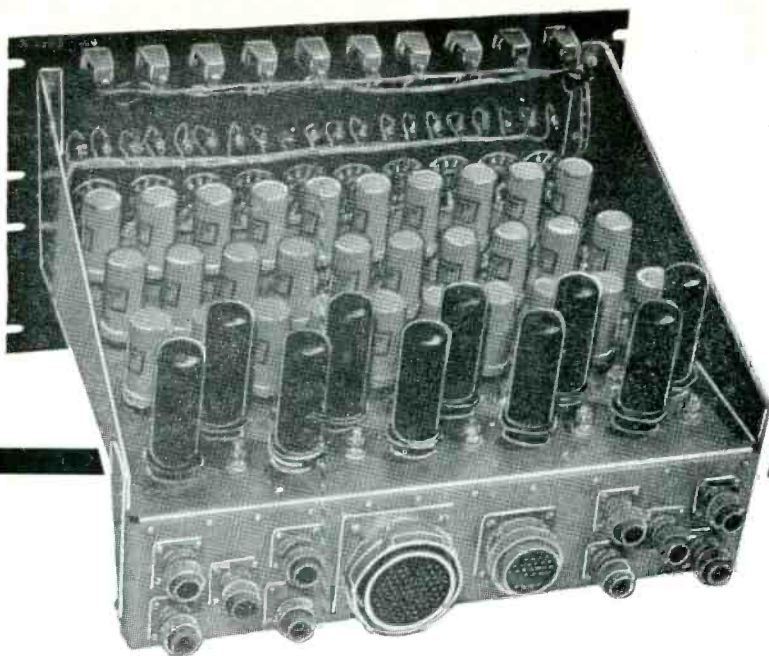
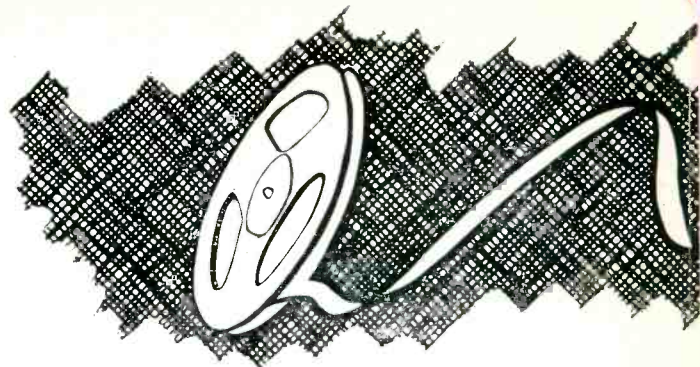
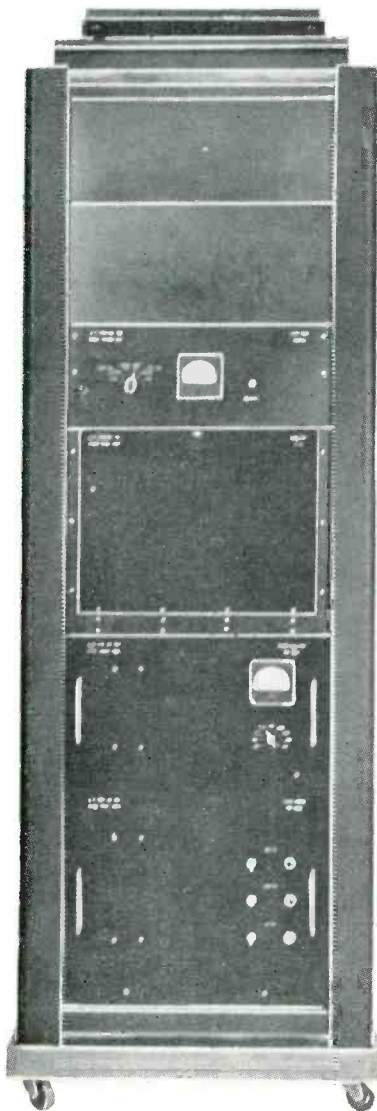

Fig. 1. Top rear view of ten-channel low-noise high-speed electronic commutator.

Fig. 2. Analog-to-digital converter, including the control unit and power supply.



RECORDING

By

LOUIS L. FISHER

Project Engineer
J. B. Rea Company, Inc.

SCIENTIFIC studies require relatively simple, effective methods of recording data obtained from countless different measuring devices. Also, in this age of voluminous records that require analysis, a solution to the problem of handling, storing, reducing and printing out the pertinent information is required. Magnetic tape data recording most nearly approaches the ideal solution.

The reliability of the magnetic tape medium has been greatly improved during the past few years, and even months. In the past, much trouble was encountered with nodules or surface imperfections, which would strike the heads and set up damped oscillations at 3000 cps. Today, selected tapes are available which are relatively nodule-free and exhibit superior qualities for data applications. Moreover, Mylar tape is now commercially available, with its superior physical characteristics over plastic-backed tape.

In general, there are four broad fields of classification for magnetic tape recording: (1) sound recording, (2) video recording, (3) analog data recording, and (4) digital data recording. This article will discuss the forms of digital and analog recording, evaluate the different methods, and present some design principles.

For digital computers, magnetic tape provides auxiliary high-capacity low-access time memory, permitting the storage of tables, subroutines and programming. To increase storage, a number of tape units may be connected to a single computer. They can be used as input or output devices, and will allow speed differential requirements to be met.

For analog computers, magnetic tape recording can be used as a function storage device. It is suited for repetitive programs such as Fourier anal-

ysis or the computation of correlation functions, being superior to photoformer generators for the generation of long-duration signals. Magnetic recording can enlarge a computer setup by supplying storage for complicated problems.

In many analog computing facilities, a highly accurate low-frequency recorder is necessary. Final results are frequently obtained in graphical form; if these are recorded on magnetic tape at the same time, much higher reading accuracy can be obtained and the information will be in a form compatible with further machine analysis. Magnetic recording can also be applied towards the solution of partial differential equations.

Methods of Recording

Of most interest historically and in the audio field is the method of direct recording which uses a d.c. bias or a high frequency carrier in a manner analogous to amplitude modulation. Its use in data recording is limited, however, due to tape variations and flaws; dust, imperfect drive mechanisms, etc., severely limit the possible accuracy. The recorded signal level using amplitude modulation is subject to considerable unpredictable variations, depending upon head design, pressure, techniques, etc. For example, amplitude losses of 40 to 60% may be caused by inconsistencies in the magnetic tape coating material, though considerable improvement has been achieved in recent months. Furthermore, the wavelength and frequency response, which are compensated for by equalization, and the introduction of volume compression at the higher frequencies may lead to poor data response.

As frequency and pulse systems of modulation yield high accuracy and good frequency response for the record-

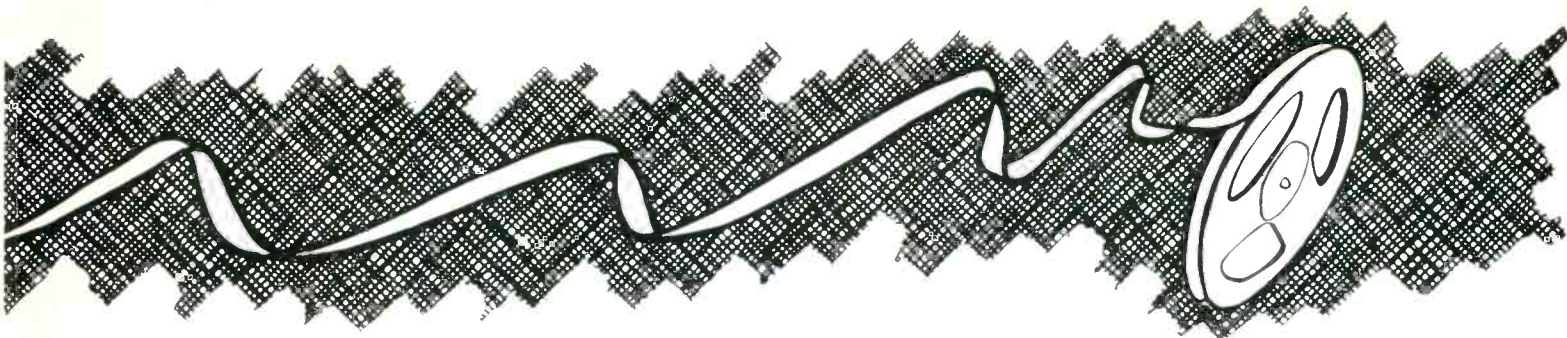

DATA ON MAGNETIC TAPE

Multiplexing techniques are utilized in recording large amounts of digital and analog data with a minimum of tape.

ing of data, they will be discussed in detail. Each system can be multiplexed in order to provide compact storage of many different channels. In order to allow the simultaneous recording of many information channels, various types of space and time sharing techniques are currently employed.

Space division may be defined as a system of storing information on adjacent tracks. Multiple track recording of as many as 25 tracks on a 2"-wide tape is feasible. This technique may be combined with other methods for a further increase in the number of channels.

In frequency division, a number of separate modulated subcarriers are recorded on a single channel, similar to FM-FM and PWM-FM radio telemetering. In recording, the modulated subcarrier signals are combined in a mixing circuit containing suitable isolation. The composite mixed signal is then applied to an audio type of recording amplifier. Alternatively, the composite signal can be used to modulate a wide-band FM oscillator. Demodulation of the several information channels is accomplished by first separating the carriers in suitable bandpass filters and then detecting the signal in discriminator circuits. A particular disadvantage of this system of modulation is the poor signal-to-noise ratio, which may be severely limited due to the narrow deviation ($\pm 7.5\%$) of the subcarrier oscillators.

In time division, the information in the various channels is sampled in sequence by means of a switching device, either mechanical or electronic. The recorded signal consists of a series or group of pulses, each representing the magnitude of a signal channel at a particular instant of time.

Frequency Modulation

By converting the signal to be record-

ed into a frequency-modulated form, the intelligence is recorded on the tape as a variation in frequency. In order to recover the intelligence on playback, demodulation of the signal is performed by counting the rate at which the recorded signal crosses the zero axis.

The recording circuitry is simple, and since demodulation amounts to pulse counting, tape biasing and equalization are unnecessary. In order to eliminate amplitude modulation prior to demodulation, the playback signal is passed through several limiting stages. The output signal is therefore independent of any amplitude variations of the voltage produced in the playback head. A low-pass filter whose cutoff frequency is lower than the lowest excursion of the carrier is an integral part of the demodulator. Its function is to permit only the average value of the pulse train to remain in the output signal. This average is the desired signal originally recorded.

By the use of an FM carrier system, it is possible to record low frequency information down to d.c. with negligible phase shift. Any phase shift which does occur in the system is due to the filter which is used to separate the carrier from the intelligence during demodulation. Clearly, it can be altered to meet particular requirements.

There are at present two principal disadvantages to a frequency modulation system: (1) the problem of long-time stability when measuring d.c., and (2) the problem of noise which is produced by flutter and wow during recording and subsequently in playing back. Since the signal-to-noise ratio of the system is the ratio of the % deviation for maximum signal to the % flutter, it is apparent that a wide deviation is desirable. Therefore, deviations up to $\pm 50\%$ of carrier frequency are employed in most systems of this type.

In general, the circuitry is simple and reliable, and compensation methods are available for correcting errors caused by flutter and wow. For instance, a precise constant frequency can be recorded which, upon playback, may be used as a means for signal correction for the record and playback process, or the playback capstan drive speed may be corrected.

An FM signal requires a larger volume of tape than an amplitude modulation system since FM requires a higher range of frequencies and consequently

Fig. 3. Block diagram of an analog-to-digital converter.

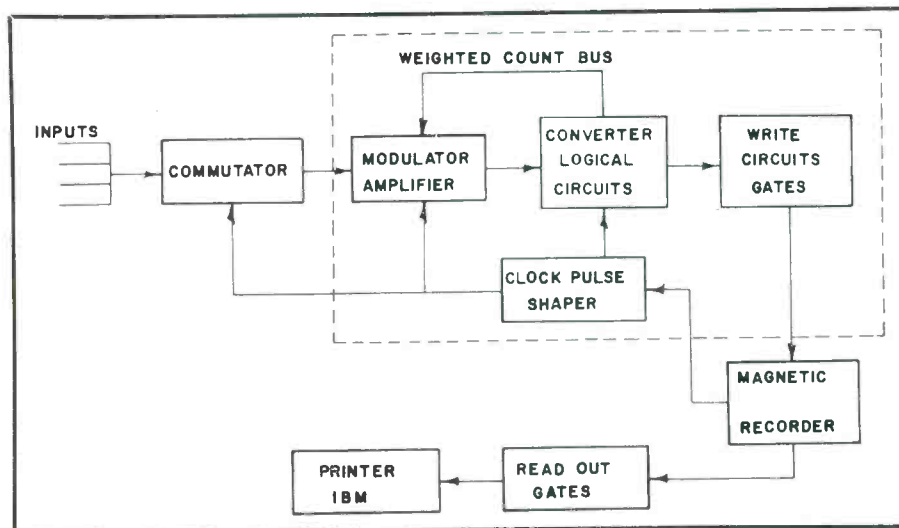

a higher tape speed. For example, using wide-band modulation, a signal range from 0 to 1000 cps requires a carrier of 5000 cps, deviating between 2500 and 7500 cps for a maximum d.c. level. The burden of accuracy is transferred from the tape and pickup heads to the tape drive mechanism, but close tolerances and speed error compensation can yield accurate results.

Time Division

Several methods of time division are available: (1) pulse-amplitude modulation, wherein the amplitude is proportional to the magnitude of the represented signal; (2) pulse-time modulation, in which the time position of the pulse relative to a reference pulse is proportional to the magnitude of the signal; (3) pulse-width modulation, in which the duration of a pulse is proportional to the signal; (4) pulse-code modulation, by which the magnitude of the data signal is converted into a group of pulses representing a binary or similar code; and (5) pulse-position modulation, wherein the ratio of positive and negative rectangular pulses contains the intelligence. The latter three methods will be discussed in some detail.

Pulse-Width Modulation

In this system, the leading edge of the pulse is fixed in time sequence while the trailing edge varies in accordance with the signal. The waveform of the pulse is rectangular and symmetrical during the time when the intelligence amplitude is zero. For other amplitudes, the pulse is made asymmetrical; thus, the period is constant but the ratio of "on" to "off" time is varied by the signal. For example, full-scale positive modu-

lation may be represented by a pulse which is "on" 75% and "off" 25% of the time, and full scale negative modulation by a pulse which is "on" 25% and "off" 75% of the time. These signals are then recorded on the magnetic tape. Upon playback, after suitable amplifying and limiting, the rectangular signal is reconstructed, and if passed through a low-pass filter, the original intelligence is recovered by averaging.

This method has the advantage over some others in that correct amplitude samples result if the tape speed is constant during the period of the rectangular wave since each pulse gives full information. Changes in tape speed give second-order errors only. However, if pulses are packed too closely together, the resolving power is decreased.

In this, as in other methods, bandwidth is sacrificed for accuracy, which results in an upper information frequency limit but no lower limit. It is claimed that because each rectangular pulse completely specifies a given datum PWM allows approximately seven times the packing of information at low frequencies (up to 5 cps) that is possible with other systems. Consequently, seven times the economy of tape would be achieved. However, there is some question as to whether this claim is valid.

A system currently in use for multiplexed information records 28 channels of information between 0 and 5 cps on a single tape track. A 90-position commutator is used, sweeping at 16 times per second, correcting zero and full scale values at the same rate. The accuracy of such a system depends on the resolving power of the playback unit. For this system, the playback unit gives an error of 0.1 to 3%, depending on the

depth of modulation. Tape speed corrections are usually included in order to preserve the time frame of reference.

Although high frequency PWM has been used in some systems, FM is usually acknowledged to be superior for high frequencies.

Pulse-Code Modulation

It has been pointed out that FM is intolerant to flutter and wow, and sensitive to drift in the electronic circuitry; pulse-width modulation methods overcome these failings at the expense of limiting the frequency response. The systems which exhibit the least difficulties are those which employ pulse-code modulation, utilizing only two states of magnetization, i.e., "on" or "off."

At this time, it may be well to review the conclusions of that important article published in the November, 1948, issue of the Proceedings of the I.R.E. entitled, "The Philosophy of PCM," by Shannon, et al. It states that PCM offers more improvement in signal-to-noise ratio than other systems. By using binary PCM, a high-quality signal can be obtained under conditions of noise and interference so bad that it is just possible to recognize the presence of each pulse. By suitable amplifying and reshaping, the initial signal-to-noise ratio can be maintained through a long chain. PCM offers no improvement in areas of high signal or low noise. Although such systems are somewhat more complex, they seem to be ideally suited for multiplex message circuits, where high standards of quality and reliability are required.

Shannon illustrates his argument with a comparison between FM and PCM. To improve the precision in FM by 2:1 requires roughly the same ratio of increase in frequency swing, and hence requires greater bandwidth. In PCM, doubling the bandwidth permits twice the number of digits; therefore, the number of distinguishable levels is squared rather than doubled. The advantage is obvious.

Binary PCM is well suited for the automatic reduction and processing of data. Until recently however, this coding was handicapped by the lack of a high-speed analog-to-digital converter. Such a converter is now available and is shown in Fig. 2.

Pulse-Position Modulation

Pulse-position modulation resembles pulse-width modulation but retains the superior accuracy of pulse-code modulation. Alternate positive and negative pulses are generated in such a manner that the ratio of successive time intervals is a function of the signal amplitude. Since the time-ratio of successive intervals will be nearly independent of

(Continued on page 37)

Fig. 4. Analog-to-digital converter portion of equipment shown in Fig. 2.

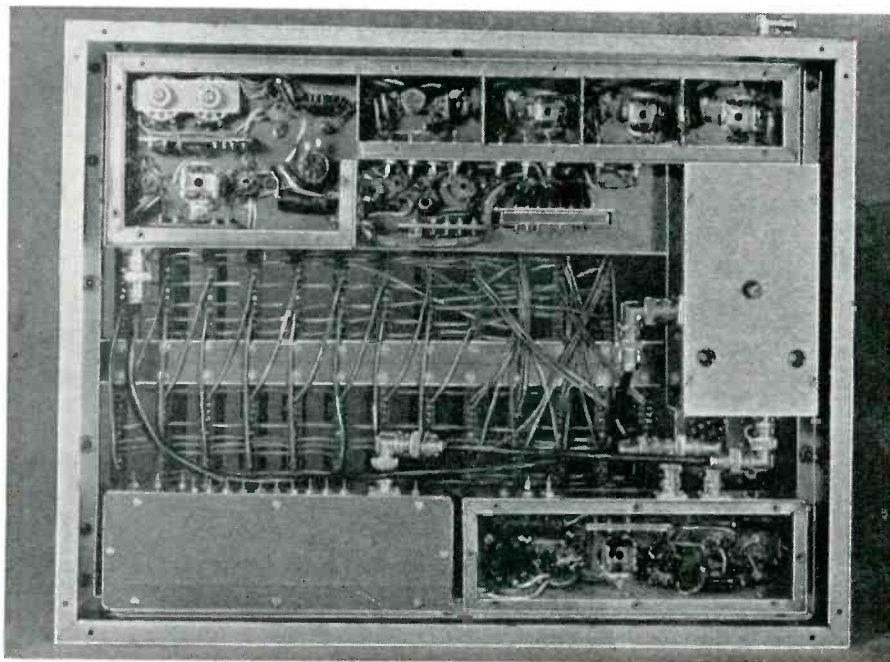

ASCO

EMERGENCY ELECTRICAL CONTROL EQUIPMENT

Automatic Switch Company designs and manufactures *all* electromagnetic control equipment for standby emergency power installations. Dependable ASCO equipment serves hospitals, hotels, television studios, mines, railroad and subway generating stations—wherever continuity of light and power is a necessity. And ASCO equipment is of particular importance in microwave installations.

AUTOMATIC TRANSFER SWITCHES

—Available for all classes of load up to 750 volts AC and 750 volts DC, these switches transfer connected load to emergency power sources when normal power fails or normal voltage is substantially reduced. Once the normal source is again in operating condition, the load is automatically restored. Designed in sizes from 10 to 1000 amperes, ASCO Automatic Transfer Switches are electrically operated, mechanically or magnetically held.

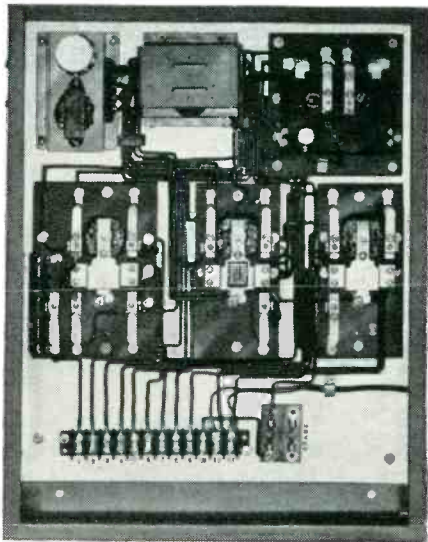
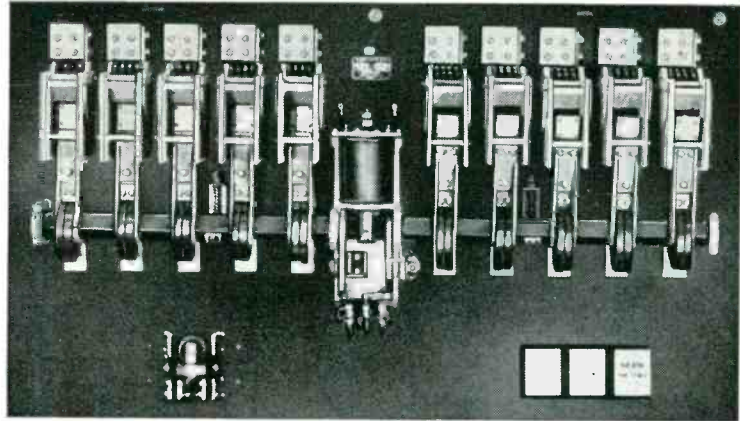

ENGINE STARTING PANEL—Initiates cranking of electrical plant upon normal source failure. Panel relays operate a "pump closing" solenoid to stop the plant upon restoration of normal voltage. Available for both diesel and gasoline engines, designed to your specifications.

To learn more about ASCO Equipment for emergency standby power and other ASCO Electromagnetic Controls—relays, contactors, solenoids, complete control panels—write us today.

ASCO IS WORLD-FAMOUS, TOO, FOR ITS EXTENSIVE LINE OF HIGH QUALITY SOLENOID VALVES.



TIME DELAY RELAYS—Supplied as a "built-in" component of automatic transfer switches, these relays cause the switch to ignore harmless power dips and outages and to transfer load to emergency only if an outage is sustained. Also available as a unit.

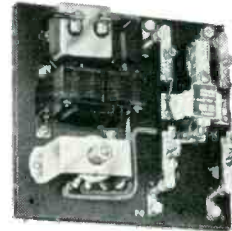

CLOSE DIFFERENTIAL RELAYS—For use with ASCO Automatic Transfer Switches to provide "adequate-voltage" power (overvoltage and undervoltage protection). These relays cause the transfer switch to transfer the load to emergency on a 5% differential in power supply voltage or less if required. Also available for close differential frequency control.

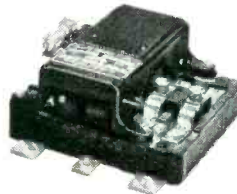

REMOTE CONTROL SWITCHES—Used for remote control disconnect of the distribution circuits. U. L. approved to 600 volts AC, 250 volts DC. ASCO has a complete line of remote control switches from 10 to 1000 amperes.



BATTERY CHARGER—Operating from the normal supply, this charger keeps electric plant starting batteries charged, ready for engine starting. Can supply trickle or high rate charge.

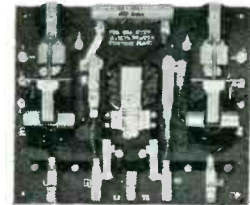

ENGINE GENERATOR CONTROL (Also called Demand Start, Load Start, Fully Automatic, and Lamp Start Relays)—Designed to start engine automatically when any load is applied, and to automatically stop engine when all load is removed. Has built-in device which automatically holds off load until voltage and frequency are at proper ratings.

Automatic Switch Co.

385R LAKESIDE AVENUE • ORANGE, NEW JERSEY



For more information, circle No. 5 on Reader Service Card

NEW TUBES

DUAL-PURPOSE TUBES

The first successful production of dual-purpose "reliable" tubes that provide stable operation as both voltage



regulators and voltage-reference tubes has been announced by *CBS-Hytron*, Danvers, Mass., a division of *Columbia Broadcasting System, Inc.* Types USN-OA2WA and USN-OB2WA are miniature gaseous voltage-regulator tubes manufactured to military control specifications. They are directly interchangeable with the earlier *CBS-Hytron* Types JAN-OA2 and JAN-OB2.

Designed for operation under severe environmental conditions and for a wide range of applications, the USN-OA2WA and USN-OB2WA feature: flat, smooth voltage-current characteristics; greatly improved voltage repeatability; stable electrical characteristics; and dependability under test conditions of shock, vibration, temperature and altitude.

Circle No. 51 on Reader Service Card

BEAM PENTODE

Featuring good performance at low plate voltage, the *Penta* PL-6549 is an aligned-grid pentode conservatively rated at 75 watts plate dissipation. Its quick-heating, 6-volt, thoriated tungsten filament, combined with rugged construction, makes it particularly useful for mobile applications.

The PL-6549 requires very little driving power. As a Class C amplifier, it will deliver an output of 60 watts at 600 volts, 74 watts at 750 volts, and 110 watts at 1000 volts, with the driving power less than 0.75 watt in each case. For higher power use, an output of 250 watts at 2000 volts is obtained with only an 0.8-watt drive.

Electrical and mechanical characteristics, maximum ratings, and typical op-

erating frequencies are given in a four-page bulletin available from *Penta Laboratories, Inc.*, 312 N. Nopal St., Santa Barbara, Calif.

Circle No. 52 on Reader Service Card

SILICON JUNCTION DIODES

Extremely high back resistance is combined with high forward conductance in the *Hughes* line of silicon junction diodes which has just been announced. In several of the diode types, back resistance is of the order of 10,000 megohms, making it possible to use them in many new circuit applications.

Characteristics and specifications for the first eight types in this line have now been established. Types HD6001 through HD6003 and Types HD6005 through HD6009 all have an ambient operating temperature range of from -80 to 200° C. Specification sheets are available from the Semiconductor Division of *Hughes Aircraft Company*, Florence Ave. at Teale St., Culver City, Calif.

Circle No. 53 on Reader Service Card

COMPUTER TUBES

Types GL-5915-A and GL-6211 have been announced by the Tube Department of the *General Electric Company*, Schenectady 5, N. Y., for computer applications.

A dual-control heptode, the GL-5915-A is primarily for use as a coincidence-gating tube. Each of the two independent control grids exhibits a sharp-cut-off characteristic. Electrically and phys-

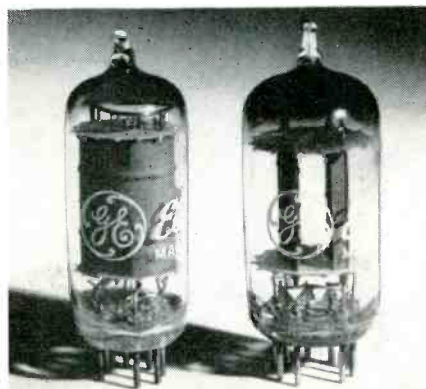

ically, this type may be used as a replacement for the 5915.

The GL-6211 is a 9-pin medium- μ twin triode for binary-counter or amplifier applications. Its electrical characteristics are essentially equivalent to

those of the GL-5844, except that each section of the 6211 is provided with a separate cathode connection.

Circle No. 54 on Reader Service Card

RCA TUBES

The Tube Department of *Radio Corporation of America*, Harrison, N. J., has announced three new tubes: a full-wave vacuum rectifier (RCA-5U4-GB); a medium- μ triode (RCA-6AF4-A); and a medium- μ twin triode (RCA-6CG7).

Of the glass-octal type, the 5U4-GB (right) is intended for use in the power supplies of TV receivers and in radio equipment having high d.c. requirements. It has the same maximum volt-



age ratings as the 5U4-G but higher current ratings.

The 6AF4-A (left) is a 7-pin miniature triode designed especially for use as an oscillator in tuners of u.h.f. TV receivers covering the 470 to 890 mc. range. It is similar to the 6AF4 but is $\frac{3}{8}$ " shorter to permit more compact tuner designs.

A 9-pin miniature version of the 6SN7-GT, the 6CG7 is intended for use as either a vertical or horizontal deflection oscillator in TV receivers. This type is designed with a 600-ma. heater having a controlled warm-up time to insure dependable performance in TV receivers employing a single, series-connected heater string.

Circle No. 55 on Reader Service Card

SELENIUM RECTIFIERS

Two *International* cartridge-type selenium rectifiers have been developed for use as high voltage power supplies in Geiger counters, electrostatic deflection voltage supplies for airborne equipment, and other similar instruments requiring a high voltage and low current. Ratings and specifications are given in Bulletin H-2, available on request from *International Rectifier Corporation*, El Segundo, Calif.

Both rectifiers are half-wave units supplied with pigtail leads. Type U45HP is 2" long, with a $\frac{1}{4}$ " outside

diameter, and will deliver 1.5 ma. maximum at 900 volts, d.c. Type U50HPF measures 1 7/8" in length with a 1/4" out-

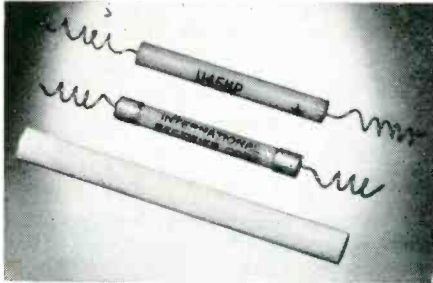

side diameter, is supplied with ferrule terminals, and delivers 1.5 ma. maximum at 1000 volts, d. c.

Circle No. 56 on Reader Service Card

POINT-CONTACT TRANSISTORS

Metropolitan Overseas Supply Corporation has been appointed U. S. distributor for the line of point-contact transistors manufactured by Siemens & Halske Aktiengesellschaft, and is now in a position to supply these transistors in substantial quantities.

Technical data describing the Siemens TS 13 and TS 33 transistors, the characteristics of which correspond to those offered by leading American manufacturers, are given in an eight-page folder available from the Metropolitan Overseas Supply Corporation, 1133 Broadway, New York 10, N. Y.

Circle No. 57 on Reader Service Card

VACUUM GAGE TUBE

A vacuum gage tube designed to retain permanent calibration while withstanding intense vibration, shock and

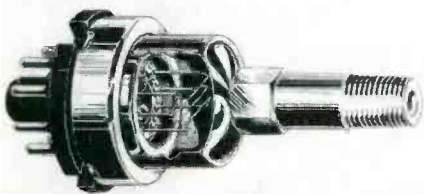

temperature change has been announced by Hastings Instrument Company, Inc., Hampton, Va. It is intended for use with the Hastings vacuum gage and vacuum indicator-controller in the 1-1000 micron range.

Sensing elements of the gage tube are short, butt-welded noble metal thermocouples. The couples are arranged in a thermopile so as to compensate for temperature changes and even rate of change in temperature. According to the manufacturer, the welded construction makes this tube particularly resistant to damage by vibration.

Circle No. 58 on Reader Service Card



Speed, safety . . . even a life . . . may depend upon your transmitter's ability to deliver under emergency conditions. That's why it pays to use dependable RCA Tubes in your mobile equipment. They're built to "take it" in spite of tough field conditions.

Take the RCA-6146 for example. This RCA beam-power tube is used in the output stage of most modern mobile transmitters. Engineered specifically for service in the higher frequencies, this type has proven to be one of the most popular designed. Built to withstand the punishment of mobile operation, the 6146 offers long life at low cost which adds up to reliable and economical operation.

Your local RCA Tube Distributor can supply you with 6146's and other RCA Tubes you need for replacements in communications equipment. For fast, friendly service, call him today.

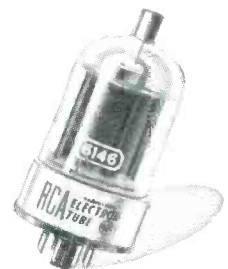

RADIO CORPORATION of AMERICA
ELECTRON TUBES
HARRISON, N. J.

Circle No. 6 on Reader Service Card

NEWS BRIEFS

TESTING A TV TRANSMITTER

Engineers are shown testing a 10-kw. television transmitter plus a complete complement of station equipment before it was shipped to Station WEAT-TV, Channel 12, West Palm Beach, Florida, by *Standard Electronics Corporation*,



289 Emmet St., Newark 5, N. J. The testing program was carried out with the transmitter and station equipment set up as a complete station layout at the factory.

In addition to the 10-kw. high-band TV transmitter, station equipment shipped to WEAT-TV included complete video equipment, a Vidicon film chain, film projectors, two Multicon studio chains, complete master control equipment covering every phase of operation of the new station, and a high gain Alford antenna.

Circle No. 59 on Reader Service Card

APPOINTMENTS AT ARMOUR

Recent appointments made in the Electrical Engineering Research Department at Armour Research Foundation of Illinois Institute of Technology, Chicago, Ill., include that of Alfred J. Hoehn as assistant manager. Formerly supervisor of the communications and radio frequency applications section, Mr. Hoehn was promoted after the section was enlarged and split into two groups.

Three new supervisors were also appointed: Stanley I. Cohn, communications and radio frequency applications section; Harold L. Garbarino, electric machines, components, and measurements section; and Dr. Shizuo Hori, control systems section.

Circle No. 60 on Reader Service Card

"GIANT BRAINS" FOR AIRCRAFT

Completely automatic flight and tactical operation of high speed military aircraft and guided missiles is the

aim of a million-dollar development program planned by *The Ramo-Wooldridge Corporation*, Los Angeles, Calif., and the Baltimore (Md.) Divisions of the *Westinghouse Electric Corporation*.

Financed by *Westinghouse* as part of its long-range development plans, the program calls for *Ramo-Wooldridge* engineers and scientists to develop airborne miniaturized versions of the so-called "giant brains" of business and industry for use by both companies.

Circle No. 61 on Reader Service Card

COMPUTING CENTER LINK

Rapid processing of engineering and research problems is now being accomplished by means of a four-way hookup utilizing two giant computers. Linked in the communications system are *General Electric Company* plants in Evendale, Ohio, where the computing center of the Aircraft Gas Turbine Division is using an *IBM 701*, *G-E* turbine departments at Lynn, Mass., and Schenectady, N. Y., and the Technical Computing Bureau of *International Business Machines Corporation* in New York City where *G-E* is renting a second *IBM 701*.

The link between the computing centers is provided by *IBM's* recently announced electronic data transceiver (shown in the photograph), a device which duplicates sets of punched cards at remote points by means of telephone, telegraph or radio circuits. Problem data originating at Evendale are con-



verted into punched cards and sent via the transceiver to New York for processing, and results can be returned to the point of origin by the same method. Evendale acts as a clearing house for problems received from Lynn and Sche-

nectady and routes them to either its own 701 or the New York 701, depending on the type of problem or machine availability.

Circle No. 62 on Reader Service Card

NBS STAFF ADDITIONS

Appointments made recently for the Boulder, Colorado. Laboratories of the National Bureau of Standards include



that of Dr. Harold A. Thomas (left) as chief of the Radio Standards Division, Kenneth A. Norton (center) as chief of the Radio Propagation Engineering Division, and Dr. Ralph J. Slutz (right) as chief of the Radio Propagation Physics Division.

Dr. Thomas, who came to NBS from the Naval Ordnance Laboratory in Corona, Calif., will head the continuing NBS program for the establishment, maintenance, and improvement of basic standards of measurement in the r.f. range. A member of the NBS staff since 1946, Mr. Norton's primary responsibilities will be tropospheric propagation research and related studies of frequency utilization. Dr. Slutz, known for his work on computers, will direct the Bureau's research on the physics of radio propagation, with particular reference to the ionosphere.

Circle No. 63 on Reader Service Card

KAY LAB TO EXPAND

Plans for the construction of a new 150' x 200' building have been announced by *Kay Lab*, 1090 Morena Blvd., San Diego, Calif. This plant will be located on an industrial tract within eight miles of San Diego's business district, and represents the first step in an expansion program necessitated by the company's steadily increasing production of TV equipment and precision instruments.

Circle No. 64 on Reader Service Card

NUCLEAR DIVISION ESTABLISHED

Establishment of a separate Nuclear Division has been announced by *Martin Aircraft*, Baltimore 3, Md., for the development of nuclear reactors and related components for military, industrial and commercial use. Tibor F. Nagey, former project engineer with the National Advisory Committee for Aeronautics, is the manager of the new division.

A manufacturing organization and nuclear laboratory have been set up to handle the complex and diversified problems involved in insuring the safe control of nuclear energy in power conversion. In addition, the laboratory will devote attention to the application of radioisotopes to manufacturing processes, and conduct studies on the use of special metals at high temperatures and elevated pressures.

Circle No. 65 on Reader Service Card

FIVE-BAY HELICAL ANTENNA

Shown in this photograph is a five-bay helical antenna being shipped by *General Electric Company* from Electronics Park in Syracuse, N. Y., to the new million-watt TV station, WILK-TV, Channel 34, in Wilkes-Barre, Pa. Of standard design, it is destined for use with a *G-E* 45-kw. transmitter, the most powerful for u.h.f. television. The antenna, which has a gain of about 25,

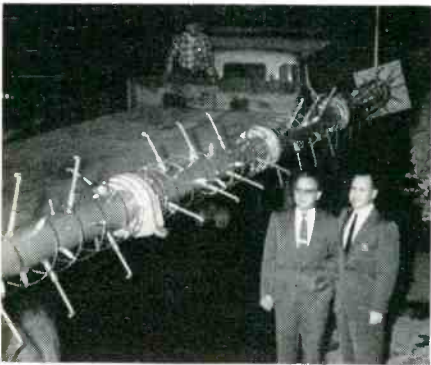

was tested at full power prior to shipment, and individual bays were tested at twice rated power input.

Circle No. 66 on Reader Service Card

RCA ENGINEERING LABORATORY

An engineering laboratory for the development of specialized electronic fire control systems for military aircraft is being established in the greater Boston area of Massachusetts by the Engineering Products Division of *Radio Corporation of America*, Camden, N. J. Dr. Robert C. Seamans, Jr., nationally known authority on airborne electronics, has been appointed manager.

Circle No. 67 on Reader Service Card

COLOR TV SYMPOSIUM

The Philadelphia Section of The Institute of Radio Engineers will hold its Second Annual Color Television Symposium this spring. Outstanding experts in the field have been secured for a series of six lectures to be given on successive Tuesdays beginning March 1. The subject matter is being arranged to emphasize the practical problems involved in the transition from monochrome to color, and special emphasis

(Continued on page 35)

**CUT
YOUR COIL
PRODUCTION
COSTS**

with

**PRECISION COIL
BOBBINS**

Our special machinery and high production methods work in combination with rigid quality control to provide you with the finest in coil bobbins at lowest possible cost.

Your specifications are met to the most critical tolerances. Workmanship is precise and carefully inspected. You can order in quantity, in any size or shape, flanges of all types, and be sure of uniformity throughout. Only fine dielectric materials are used—kraft, fish paper, acetate, phenol impregnated or combinations.

With Precision Bobbins you eliminate rejects, waste, loss of time—get better coils at less cost. Prove it to yourself! Send specifications for samples. Ask for literature.

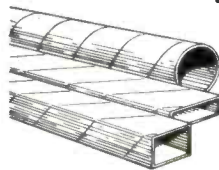

PRECISION LOW COST PAPER TUBES

Order in any length, size, shape, I.D. or O.D. and in any quantity. Precision Paper Tubes are crush resistant and light weight, with excellent dimensional stability. They are fabricated to the same high standards governing Precision Bobbins.

Send for samples and Arbor List of over 2000 sizes

Sales Representatives in:

New England:
Framingham, Massachusetts, Framingham 7091

Metropolitan New York, New Jersey:
Jersey City, New Jersey, Journal Square 4-3574

Upstate New York:
Syracuse, New York, Syracuse 76-8056

Northern Ohio, Western Pennsylvania:
Cleveland, Ohio, Atlantic 1-1060

Indiana, Southern Ohio:
Logansport, Indiana, Logansport 2555

Missouri, Southern Illinois, Iowa:
St. Louis, Missouri, Sterling 2318

Maryland:
Baltimore, Maryland, Plaza 2-3211

Philadelphia, Camden:
Philadelphia, Pa., Chestnut Hill 8-0282

California:
Pasadena, California, Sycamore 8-3919

Canada:
Montreal, Quebec, Canada, Walnut 2715



PRECISION PAPER TUBE CO.

2063 W. CHARLESTON ST.

CHICAGO 47, ILL.

Plant No. 2: 79 Chapel St., Hartford, Conn.

For more information, circle No. 7 on Reader Service Card

NEW PRODUCTS

DOUBLE-RIDGE WAVE GUIDE

Having an extremely broad frequency range, the *Airtron* ARA 136 double-ridge wave guide covers a 3% band-



width at center frequencies of 5400 and 9300 mc. By employing straight sections in association with flexible ridge wave guide, and suitable *E* or *H* plane circular bends, a commercial aircraft manufacturer can install a wave guide system adaptable to weather radars of either the *C*- or *X*-band frequency.

Structurally, double-ridge wave guide has a rectangular cross section, of 1.350" x 1.739" O.D. Two symmetrical flat ridges, running the length of each broad wall center line, provide a practical means for extending the cutoff frequency of rectangular wave guide for a specific broad wall dimension. Further information is available from *Airtron, Inc.*, Dept. A, 1103 W. Elizabeth Ave., Linden, N.J.

Circle No. 68 on Reader Service Card

ACCELEROMETER

Available in ranges between 1 and 3 *g* inclusive, the Model GOH accelerometer announced by *Genisco, Incor-*



porated, 2233 Federal Ave., Los Angeles 64, Calif., is a potentiometer-type in-

strument which has constant operating characteristics over a wide temperature range. An internal, thermostatically controlled heater permits operation (within specification limits) between -50° F and $+160^{\circ}$ F.

Model GOH will withstand steady-state accelerations of 30 *g* on the non-sensitive axes, and 10 *g* on the sensitive axis. Shock accelerations of 40 *g* (5-millisecond duration) on the non-sensitive axes and 10 *g* (5-millisecond duration) on the sensitive axis will not damage the instrument.

Circle No. 69 on Reader Service Card

COMPARISON BRIDGE

Rapid testing of transformers and chokes can be performed under actual operating conditions with the *Freed*

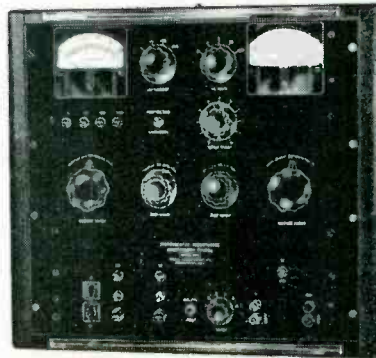

Type 1870 incremental inductance comparison bridge. The unit consists of a variable 0-500 ma. d.c. supply, a 60-cycle 0-135 volt a.c. supply, a comparison circuit and a vacuum-tube voltmeter.

Inductances of 25 mh. to 25 henrys can be compared over a deviation range of $\pm 20\%$ with an accuracy of $\pm 1\%$, and over a deviation range of $\pm 50\%$ with an accuracy of $\pm 5\%$. All controls and power supplies are contained in one unit, and a jack is incorporated for connecting an external oscillator to supply different test frequencies. Further information is available from *Freed Transformer Company, Inc.*, 1715 Weirfield St., Brooklyn (Ridgewood) 27, N.Y.

Circle No. 70 on Reader Service Card

REGULATED OUTPUT AMPLIFIER

When the *Peer* regulated output amplifier is used as a microphone amplifier

feeding a radio transmitter, it is claimed that an average of 95% modulation utilization is possible without any danger of overmodulation. The instrument may also be used in the input to a re-

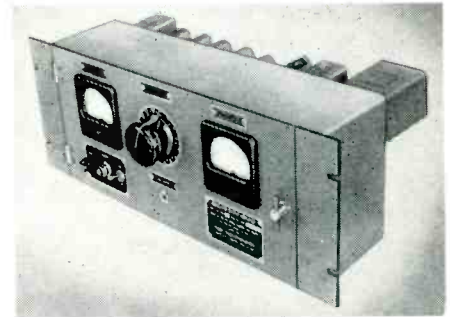

coder, telephone line, P.A. system or any other audio equipment where it is desired to hold the level close to—but not exceeding—a maximum.

Features of this amplifier include: 85-db gain (adequate for all standard microphones), automatic regulation to hold the output within less than 1 db with variations in input of 20 db or more, an output of up to 200 mw., frequency response linear within $\pm 1/2$ db from 200 to 5000 cps, precision step attenuators in both input and output, and low harmonic and hum distortion. Complete information is available from *Peer Incorporated*, 1200 Milton St., Benton Harbor, Mich.

Circle No. 71 on Reader Service Card

VOLTAGE RATIO COMPARATOR

Model 592 standard voltage ratio comparator, introduced by *Telectro Industries Corporation*, 35-18 37th St., Long Island City 1, N.Y., sets accurate voltage ratios—both a.c. and d.c.—by

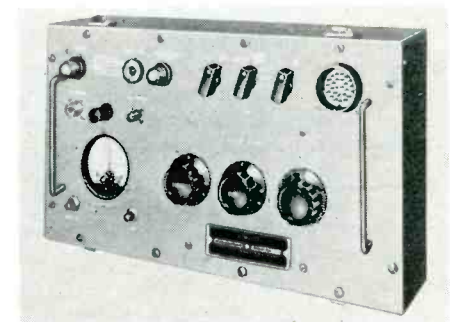

means of an accurately calibrated voltage divider network and a zero-center microammeter. Ratios from 1:1 to 10,000:1 can be measured with an accuracy of 0.01% in an operating temperature range of -40 to 160° F.

This portable unit compares voltage ratios in the range of $+150$ to -150 volts d.c., compares voltages across a 120-volt a.c. 350-cps source, and can be supplied to compare a.c. voltage ratios at any frequency. The Model 592 has three sensitivity ranges and polarity or phase selector switching. It is housed

in an 18"x11"x11" aluminum alloy case and weighs 25 pounds.

Circle No. 72 on Reader Service Card

REGULATED POWER SUPPLIES

Regulated "B" power supplies are available from the *N. J. Electronics Corp.* in two grades, with 32 models of each grade included in the line. The "standard" grade of supply, for bench and production line use, employs conventional circuits, components, and assembly techniques; emphasis is on performance at low initial cost. In the "laboratory" grade of supply, emphasis is on long, maintenance-free life and a high order of stability achieved through premium components markedly derated.

Dual supplies, with special built-in switching, cover a very wide range of

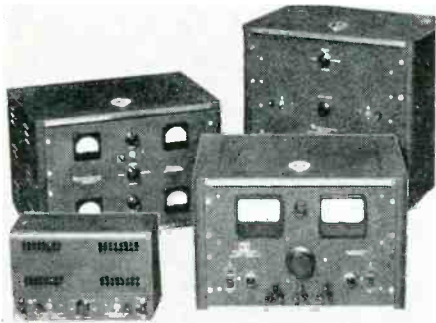

requirements—from 100 volts, 100 ma., to 1200 volts, 1200 ma. Four distinct modes of operation are offered by the switching system: separate supplies, parallel (with single-knob control), series-bucking, and series-aiding. An eight-page catalog, No. PR5, may be obtained from the *N. J. Electronics Corp.*, 345 Carnegie Ave., Kenilworth, N. J.

Circle No. 73 on Reader Service Card

INDUCTION HEATING UNIT

Lepel High Frequency Laboratories, Inc., 55th St. & 37th Ave., Woodside 79, N.Y., has developed a compact and completely self-contained high frequency heating unit combining an induction-heating generator with a refrigerating water recirculator. Easily moved about the plant to any convenient location, this unit can be used effectively for soldering, brazing and heat-treating ferrous and nonferrous metals.

Model RRP eliminates the need for water supply and drainage connections. Once it is filled, there is no water consumption at all since the water in the unit is constantly refrigerated and recirculated. The high frequency generator is designed to permit the use of long, flexible leads between the unit and the work coil.

Circle No. 74 on Reader Service Card

LINEAR DISPLACEMENT TRANSDUCER

Linear motion is converted into an electrical output in the Model 154 linear

displacement transducer—a new type of variable-reluctance pickup announced by *General Cybernetics Corporation*, P. O. Box 987, Beverly Hills, Calif. This unit is designed to be completely free from changes in scale factor with variations in frequency, excitation voltage and temperature over wide ranges of these parameters.

Available in several sizes, the Model 154 consists basically of two coils in



a unique magnetic circuit whose configuration allows an armature shaft to vary the inductance of the two coils when displaced, the inductance being only a function of armature position. The relative shift of inductance is manifested through a simple bridge circuit as an output voltage, which in many applications is high enough to preclude intermediate amplification. Input voltage ranges from 28 to 115 volts.

Circle No. 75 on Reader Service Card

SUBMINIATURE PREAMPLIFIER

Only 2 1/16" wide, 1 3/16" high, and 2 1/4" long, the *Glennite Model F 410* subminiature preamplifier is intended for use with missiles, aircraft, and other devices where size, weight, and power consumption are of paramount importance. Rugged construction permits exacting work in coupling low-level signal devices into standard metering and recording



systems without introducing extraneous noise from vibration.

A four-tube unit designed by the *Gulton Mfg. Corp.*, Metuchen, N. J., Model F 410 incorporates a cathode follower input to give an input impedance of 100 megohms. It has selective gains of 10, (Continued on page 38)

THE TECHNICIAN'S GUIDE TO TV TRANSMISSION AND RECEPTION

...including the latest COLOR, UHF and VHF developments



New 2nd Edition
744 pages
400 illus.
\$7.50

TELEVISION FROM THE "CAMERA SIDE"

Complete coverage of TV broadcasting practices and problems, make this book invaluable to station technicians and engineers. Studio operations, control rooms, networks, over-all relay performance characteristics, equipment maintenance, film production and projection, Monoscope tubes, Orthicon tubes and tele-transcriptions are but a few of the subjects covered.

This big, authentic book—the acknowledged leader in its field—is a comprehensive text on all phases and components of TV transmission and reception, how they work and how they are combined in the modern marvel that is today's television system. Designed either for study or for use as a handy reference guide, it is ideally suited to the needs of engineers, studio technicians, servicemen, sales engineers or students.

Written by Scott Helt of the Allen B. DuMont Laboratories, Inc., PRACTICAL TELEVISION ENGINEERING is based on practical experience and provides a wealth of information that the engineer or studio worker will find invaluable in solving day-to-day problems.

744 PAGES OF TV ENGINEERING "KNOW HOW"

Subjects covered include: Fundamentals of Picture Transmission; The Cathode-Ray Tube; The Oscillograph; Electron Tubes for Image Pick-up; Synchronizing Generators—Timing, Shaping and Deflection Circuits; The Video Amplifier & Cathode Follower; The Voltage-regulated Power Supply; The Television Receiver; The Camera Chain; The Television Transmitter; Television Broadcasting Techniques. In every case, the book includes clear, illustrated explanations of the circuits, construction and performance of the units under discussion. Comprehensive sections bring the reader up-to-the-minute engineering data on the latest UHF, VHF and color television developments.

10-DAY FREE TRIAL

Dept. REN-35, RINEHART & CO., Inc.

232 Madison Ave., New York 16, N. Y.

Send Helt's PRACTICAL TELEVISION ENGINEERING for 10-DAY FREE EXAMINATION. In 10 days, I will either return book postpaid, or send \$7.50 plus a few cents postage in full payment.

Name.....

Address.....

City, Zone, State.....

OUTSIDE U.S.A.—Price \$8.00 cash with order only. Same 10-day return privilege.

Circle No. 8 on Reader Service Card

COMMUNICATION REVIEW

REMOTE CONTROL DESK UNIT

Two-way mobile radio systems can be remotely controlled by a small *Du Mont* desk unit which allows the operator of a two-way commercial radio system to install a base station at an advantageous



location and control the unit's radio transmission and reception from his desk. Detailed information on the Type MCA-902-A/B may be obtained from the Mobile Communications Department, *Allen B. Du Mont Laboratories, Inc.*, 1500 Main Ave., Clifton N. J.

Type MCA-902-A/B connects to base

station equipment by means of ordinary telephone lines and permits operation under normal conditions over a distance of at least 15-20 miles. It provides facilities for keying the transmitter on and off, amplification of incoming audio to loudspeaker level, and amplification of microphone output to telephone line level.

Circle No. 76 on Reader Service Card

CONTROL OF TRAFFIC SIGNALS

Traffic lights at 13 intersections in a heavy traffic area just north of Chicago's Loop will soon be controlled by radio. A radio-controlled traffic light system—the first of its kind in the world—is being supplied to the City of Chicago by *General Electric Company*, Syracuse, N. Y. The radio antenna and transmitter will be located on top of the Board of Trade Building, the highest point in Chicago, with the central control station in City Hall, a short distance away.

At predetermined times each day, a master mechanism in the central control station will activate an electronic

tone signal, which will be carried by underground cable to the transmitter and broadcast to the lights. In the receiver at each intersection, a decoder will select the proper signal and ignore

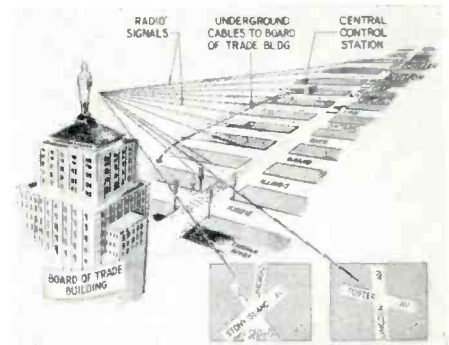

those intended for other intersections. The corresponding tone switch in the traffic light control box will then respond to the received tone signal by changing the program (length of time of green, yellow and red) of the light.

Circle No. 77 on Reader Service Card

TELEPHONE RADIO RELAY

A 160-mile radio relay system, constructed to expand long-distance telephone service between Orlando and West Palm Beach, Fla., has been put into operation by the Long Lines Department of *American Telephone and Telegraph Company*, 32 Avenue of the Americas, New York 13, N. Y. The aerial voiceway was planned and engineered in cooperation with the *Southern Bell Telephone and Telegraph Company* as the final leg in a major system extending from Jacksonville to West Palm Beach.

Circle No. 78 on Reader Service Card

TV-AM-FM SET PRODUCTION

Information based on latest reports from RETMA.

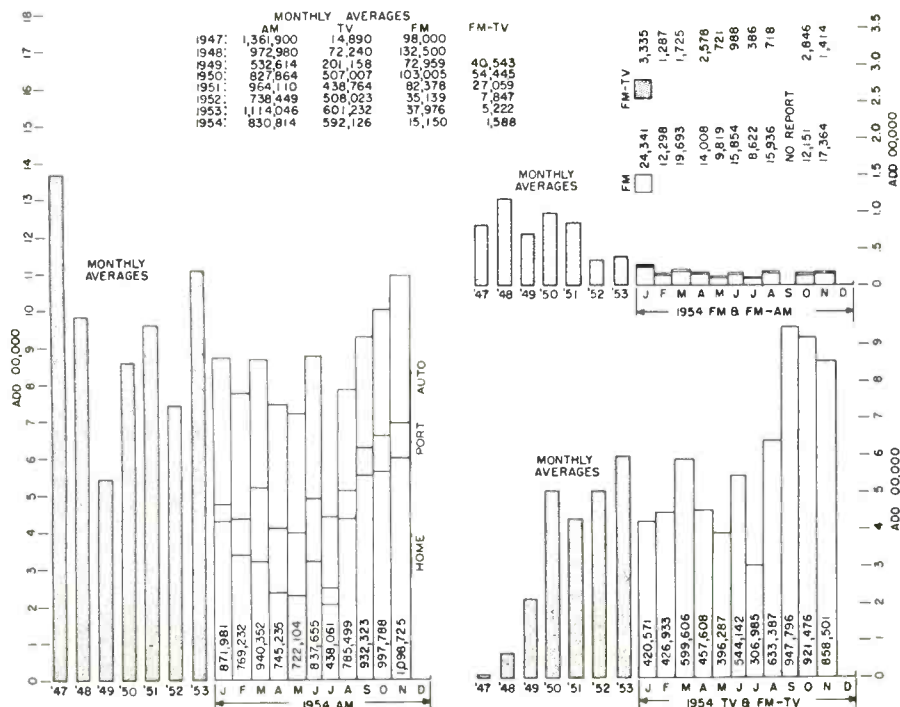

MICROWAVE FOR 2450-2700 MC.

The first microwave system designed for operation in the unused 2450 to 2700 mc. band has been announced by



the Engineering Products Division of *Radio Corporation of America*, Camden, N. J., thus opening up this frequency band for microwave service and permitting the establishment of new stations

in geographic areas already "closed" or crowded. As the RCA MM-26 has approximately one-half the spectrum requirements of most other systems, greater concentration of stations in a given region will also be possible.

Providing up to 30 voice channels, the RCA MM-26 is designed for the application requirements of utilities, pipeline operations, railroads, turnpikes, and commercial carriers. Because of its frequency range, conventional triode electron tubes and standard circuitry can be utilized which will simplify installation, operation and maintenance.

Circle No. 79 on Reader Service Card

MULTICHANNEL MARINE V.H.F. RADIO

Improved communications can be provided by the new *Motorola* multichannel v.h.f. radio for tugs, fishing fleets, and other vessels operating along the coasts, in harbors and in inland waters. Utilizing frequencies in the 156.3 to 157.4



mc. marine band, it should help relieve excessive radio traffic now found in the lower frequency bands.

Three channels are provided, with four available if desired: the 156.3-mc. ship-to-ship channel, the 156.8-mc. safety and calling channel, and one or two ship-to-shore channels in the same band. Automatic channel reverting returns the transmitter and receiver to the safety and calling channel whenever the handset is replaced on the control unit.

Additional information is available from *Motorola Communications and Electronics, Inc.*, Technical Information Center, 4501 W. Augusta Blvd., Chicago 51, Ill.

Circle No. 80 on Reader Service Card

SUPERVISORY CONTROL EXPANSION

Minnkota Power Cooperative, Inc., of Grand Forks, N. D., has recently placed an order with *Motorola Communications and Electronics, Inc.*, 4501 W. Augusta Blvd., Chicago 51, Ill., to expand its present supervisory control and power line carrier system to include two additional remote stations. This expansion is being made to accommodate new in-

terchange tie points which will receive power from the Bureau of Reclamation hydroelectric plant at Garrison Dam, and will bring up to 16 the number of supervisory control stations on the 1200-mile, 69-kv. transmission line.

Circle No. 81 on Reader Service Card

TRUCK RADIO SYSTEM

One of the nation's largest motor transport lines—*Watson Brothers Transport Company, Inc.*, Omaha, Nebraska—is equipping its trucks and key freight terminals with two-way mobile radio in a move to speed and improve customer service and reduce operating costs. Initial radio installations, made by *Radio Corporation of America*, Camden, N. J., will provide a base station at the *Watson* Chicago freight terminal and *RCA Fleetfone* two-way mobile radio units in 38 transport trucks.

Circle No. 82 on Reader Service Card

CALENDAR of Coming Events

MARCH 1-3—Western Joint Computer Conference and Exposition, Hotel Statler, Los Angeles, Calif.

MARCH 21-24—Radio Engineering Show and IRE National Convention, Kingsbridge Armory and Waldorf-Astoria Hotel, New York, N. Y.

MAR. 30-APR. 1—Seventeenth Annual American Power Conference, Sherman Hotel, Chicago, Ill.

APRIL 12-15—Symposium on Modern Network Synthesis, Engineering Societies Building, New York, N. Y.

APRIL 15-16—Cincinnati IRE Annual Spring Technical Conference, Engineering Societies Bldg., Cincinnati, Ohio.

APRIL 21-23—AIEE Conference on Feed-back Control, Claridge Hotel, Atlantic City, N. J.

APRIL 27-29—Seventh Region IRE Technical Conference, Hotel Westward Ho, Phoenix, Arizona.

MAY 4-6—Electronic Components Conference, U. S. Department of the Interior, Washington, D. C.

MAY 9-11—National Conference on Aeronautical Electronics, Biltmore Hotel, Dayton, Ohio.

MAY 18-20—IRE-AIEE-IAS-ISA National Telemetering Conference, Hotel Morrison, Chicago, Ill.

MAY 26-27—IRE-AIEE-RETMA-WCEMA Electronic Components Conference, Los Angeles, Calif.

JUNE 20-25—URSI-University of Michigan International Symposium on Electromagnetic Wave Theory, University of Michigan, Ann Arbor, Mich.

JUNE 21-25—AIEE Summer and Pacific General Meeting, Biltmore Hotel, Los Angeles, Calif.

3 BIG* REASONS

to check BURNELL first!



ROTOROIDS® A continuously variable, stepless toroidal inductor, hermetically sealed, which can provide a 4:1 range of maximum to minimum inductance in 180° rotation of a shaft.



TOROIDS Combining the advantages of toroidal type winding with the molybdenum permalloy dust core and other specially selected materials, these toroids provide higher Q, greater stability of inductance vs. temperature, and level in a smaller space. Supplied to an inductance accuracy of 1%. Available in standard, miniature and sub-miniature sizes.



TELEMETERING FILTERS

Band pass filters available for every channel ranging from 400 to 70,000 cycles for band width between 15-40%. Low pass filters available for operation in either unbalanced or balanced line, and range in cut off frequency from 6 up to 10,500 cycles.



Write for Catalog 102A
Department D

©Copyright and Patent Applied for

BURNELL & CO., INC.

Yonkers 2, New York

TELETYPE: YONKERS, N. Y. 3633

PACIFIC DIVISION: 720 Mission St., S. Pasadena, Cal.

FIRST IN TOROIDS AND RELATED NETWORKS

Circle No. 9 on Reader Service Card

Personals

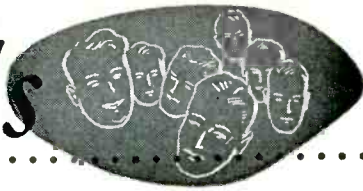

DR. WILLIAM FIRESTONE has been appointed to the newly created position of assistant chief engineer, Research Department, *Motorola Communications and Electronics, Inc.*, Chicago, Ill. In addition to being responsible for specific phases of departmental administration, he will also continue as head of the advanced investigation section of the Research Department. Dr. Firestone received his Ph. D. in 1952 from Northwestern University.



DR. GEORGE L. HALLER, dean of the College of Chemistry and Physics at Pennsylvania State University since 1947, has now been appointed manager of the Laboratories Department of the Electronics Division of *General Electric Company*, Syracuse, N.Y.; for the past two years, he has also acted as a consultant to the Laboratories Department. The author of many technical papers, Dr. Haller is associated with numerous engineering societies.



VICTOR LE GENDRE is the new chief engineer of the *Haydu Brothers Division of Burroughs Corporation* at Plainfield, N. J. Mr. Le Gendre comes to *Haydu* from *Chatham Electronics Corporation* where he served as design and development engineer; he was previously associated with *Tung-Sol Electric, Inc.*, and *National Union Electric*. Holder of a patent on fine pitch grid winding, Mr. Le Gendre has another patent pending on grid winding structures.



VICTOR J. NEXON, vice-president and senior consultant of *Microwave Services, Inc.*, New York, N.Y., since 1952, now becomes the new president of this firm. From 1942 to 1946, Mr. Nexon was with the Signal Corps and Air Force as communication officer on v.h.f. and radar installations; he spent the intervening years with *Federal Telephone and Radio Corporation* as a communications system engineer for wire, carrier and radio transmission equipment.



ROBERT L. ROD has been promoted to assistant to vice-president, engineering, at *Bogue Electric Mfg. Co.*, Paterson, N. J.; he was formerly assistant director of research and development. Before joining *Bogue* in 1951, Mr. Rod was associated with *Melpar, Inc.*, and *Radiomarine Corporation of America*. He has had considerable experience in the development of radar, microwave communications systems and ultrasonic instruments.



A. ROBERT TEASDALE, JR., as chief of electronics design for the Engineering Department of *TEMCO Aircraft Corporation*, Dallas, Texas, will supervise design and installation of electronics systems. Specialist in servomechanisms and automatic controls, Mr. Teasdale was with *Convair's* Fort Worth Division from 1951 to 1954; he has also been a graduate lecturer in electrical engineering at Southern Methodist University since 1951.

Temperature Controller

(Continued from page 11)

chamber. The probe is located on the floor of the heat baffle, above the chamber. Only the heater is cycled; the air circulating fan is always in operation.

Superior control can sometimes be achieved by controlling the fan or blower. There are, however, two limitations. The heater must be capable of withstanding the temperature it may acquire without air circulation. Secondly, in securing low temperature, as in the case of dry ice in the *Statham* acting against the heater, control could not be obtained.

Circuitry of Controller

Electronic circuitry developed to control the *Statham* chamber is basically simple (Fig. 2). An a.c. Wheatstone bridge is utilized to control the grid bias of a thyatron, and the temperature-sensitive element is connected as a resistive element in the bridge circuit. Adjacent to the element is a temperature-control ten-turn helical potentiometer which can be adjusted to a resistance magnitude higher than that of the probe (through -85°F to 350°F).

If this resistance differential corresponds to a required temperature increase, for example, the resulting unbalance of the bridge produces an a.c. signal which is amplified by the 6AU6 and applied to the grid of the thyatron. As the resulting voltage is in phase with the plate voltage (if not, bridge power leads are reversed), the tube commences to conduct. This closes the plate relay and turns on the heater. When the temperature probe reaches the resistance established for the temperature increase required, it is of the same value as that of the control potentiometer, the bridge circuit is balanced and the thyatron is extinguished. The cycle is repeated when the temperature is lowered by the loss of heat through chamber walls, and through action of dry ice in the system.

It should be noted that the ability of the circuit to control temperature without wide fluctuations and with negligible overshoot arises from the combination of an extremely sensitive temperature probe with suitable control amplifier circuitry, and proper heater and chamber configuration.

In a similar manner, the bridge circuit can be utilized to control cooling temperatures. The process can be initiated merely by adjusting the resistance magnitude of the helical potentiometer to a value that is lower than that of the sensitive temperature probe. Under these conditions, bridge unbalance occurs in a direction opposite to that previously described; and, consequently, a 180° out-of-phase signal ap-

appears on the grid of the thyatron which therefore does not fire. The effect of this action is to allow the dry ice to lower the temperature. When the air is cooled to such a degree that the resistance of the sensitive probe is less than that of the control potentiometer, the previously explained cycle of events is repeated.

The input transformer has an impedance ratio of 1000 to 1, which steps up the unbalance bridge voltage by a factor of approximately 30. The single stage of amplification supplies an additional gain of 100-200. Thus, over-all gain lies between 3000 and 5000, and supplies sufficient voltage to fire the thyatron with extremely small changes in bridge balance.

Phase shift between the grid and plate of the thyatron depends upon the characteristics of the individual JO-2 transformer and amplifier. The "asterisked" capacitor in Fig. 2 is used to correct the phase shift as required on the controller. Most controllers require no capacitor, while in others values range up to .05 μ fd.

Before proceeding with maintenance instructions necessary to put the unit into operation, two further details require inspection. The temperature probe should be wired to the controller with Teflon insulated wire. Plastic-covered wire will not stand up under the temperature range to be covered unless the probe electrical connection is external to the "sink." Similarly, tin-lead (50-50) soft solder should not be used to connect the wires if temperatures above 230° F are to be controlled, as this solder melts at 400° F. Another ratio of tin-lead solder with a higher melting point or silver soldering should be utilized. Twisted leads should be employed. Shielding is unnecessary.

Use of the NE-51 neon lamp for voltage regulation of the 6AU6 screen is highly effective in reducing screen voltage degeneration of gain. The desirability of this method of screen bypass can be seen when it is noted that a 40- μ fd. or larger capacitor is required to secure the same amplifier gain at 60 cps.

Operating Procedure

In putting the controller into operation, the first step is to substitute a decade resistance box set at approximately 100 ohms for the temperature probe. The thyatron is removed from its socket and an a.c. voltmeter (Simpson 260 or v.t.v.m.) connected via jacks between the grid of the thyatron and ground. Spinning the ten-turn Helipot dial should result in a bridge balance denoted by an a.c. output level under 3 volts. It is very easy to miss the null unless the voltmeter is stepped down to lower ranges as the bridge is brought into balance.

Nominally, the bridge will balance at a dial reading of about 250. Balancing at 750 indicates that the incorrect end winding of the potentiometer has been connected to the 50-ohm resistor. This resistor is used to prevent burnout of the control potentiometer if a probe lead is accidentally grounded, and to set the cold range limit while allowing expansion of the upper temperature range. Ten-ohm, 10-watt resistors are used for the other half of the bridge in order to secure adequate bridge sensitivity¹.

Leaving the dial set for bridge balance, the voltmeter is removed and the thyatron replaced in its socket. After a few minutes of warm-up, the thyatron bias control is adjusted until the tube fires. The control is then backed off until the tube is extinguished.

The dial is now rotated for a higher reading. Failure of the thyatron to fire indicates incorrect bridge supply phasing, and the power leads thereto are reversed. The dial is then rotated from one extreme to the other. If more than one "on-off" control point is found, the amplifier phasing must be adjusted. This is accomplished by adding capacitors of .01 μ fd. at the point "asterisked" until proper operation occurs.

Returning the dial to the balance (or heater power "off") position, the decade box resistance is lowered until the controller operates. This should require not more than a 0.3-ohm change and preferably one of 0.1 to 0.2 ohms; otherwise, controller sensitivity will be too low. After satisfactory operation is secured, the dial increments may be calibrated in terms of temperature by employing the decade box to simulate the resistance of the probe at discrete temperatures.

It is interesting to note that subsequent variation of the thyatron bias does not change the sensitivity of the controller, but merely shifts the calibration curve up or down. The slope is not affected.

The fixed resistors and potentiometer must be of sufficient wattage and shielded from thermal radiation of tubes and other components to prevent temperature control drift. With a change as low as 0.1 ohm being sufficient to operate the bridge, the use of Evanohm or other precision resistors is not sufficient to preclude the layout design noted. In the prototype unit, the control potentiometer and resistors were placed below the chassis and all hot components above the chassis. A later production model utilized channel construction to limit temperature drift.

REFERENCES:

- Huss, Paul O., "Important Factors in the Design of Bridge Networks Used in Instrumentation," I.S.A. Paper 52-10-2.
- Yaniboski, E. E., "Designing Thermostat Systems," Electrical Manufacturing, August, 1952.

Extra Rugged—Light Weight HIGH ARTICULATION E-V Mobile-Mikes

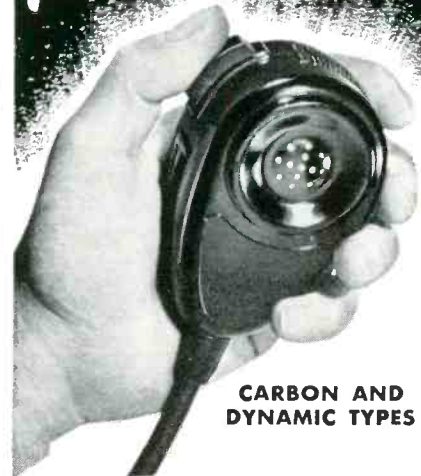

CARBON AND DYNAMIC TYPES

E-V Mobile-Mikes are designed for the ultimate in speech transmission! You get high intelligibility, high output, more usable power level, less listener fatigue and other E-V features. *Proved in toughest service.* Used in public safety, aircraft, railroad and government communications. High impact phenolic case. Permanent finish. Weighs as little as 7 oz. Model 210 Carbon lists at \$28.50. Model 600-D Dynamic lists at \$38.50.

EXACT REPLACEMENT

Carbon Mobile-Mikes also available for exact replacement in current Motorola, RCA, G.E. and similar equipment. You get full advantage of E-V design and performance features.



NOISE-CANCELLING DIFFERENTIAL*



Close-talking, carbon type. Assures clear speech transmission under high ambient noise in any weather or climate. Blast-proof, waterproof, shock-resistant. Model 205 lists at \$38.50. Model 602 Differential Dynamic at \$49.50 list. (*Patent No. 2,350,010)

Send for Bulletin

Electro-Voice

BUCHANAN, MICHIGAN

Export: 13 E. 40th St., N.Y. 16, U.S.A., Cables: Arlab

AUTHORIZED DISTRIBUTORS EVERYWHERE

Circle No. 10 on Reader Service Card

NEW LITERATURE

COIL FORM ARBOR LIST

Specifications on over 2000 coil forms of all shapes, sizes, I.D.'s and O.D.'s are given in a new arbor list recently released by the *Precision Paper Tube Company*. Dated October 15, 1954, it also contains technical data and other information. Copies may be obtained from *Precision Paper Tube Company*, Dept. REN, 2035 W. Charleston St., Chicago 47, Ill.

Circle No. 83 on Reader Service Card

ELECTRONIC COMPONENTS CATALOG

A 20-page, two-color catalog on electronic components for radio and television use is available from *The Fred Goat Co., Inc.*, 314 Dean St., Brooklyn 17, N. Y. Specifications are given for miniature and standard tube shields,

miniature and standard clips, caps and rings. Photographs and dimensional drawings are included for many of these electronic parts and typical installations shown.

Circle No. 84 on Reader Service Card

COLOR TV INFORMATIONAL PACKAGE

Broadcasters, engineers and consultants may obtain a complete *Du Mont* color TV studio equipment informational package from the Television Transmitter Department, *Allen B. Du Mont Laboratories, Inc.*, 1500 Main Ave., Clifton, N. J.

Included in the package is a 36-page book depicting four basic studio color system layouts in detailed diagrammatic form, and a 10-page booklet containing a complete price list of all equipment. An illustrated 20-page brochure de-

scribes the operation of *Du Mont's* color and monochrome multiscanners, and specification sheets are provided for a wide range of color studio equipment.

Circle No. 85 on Reader Service Card

ENGINEERING SERVICE

The extensive experience, facilities and ability of a complete, single-source engineering service are detailed in an eight-page brochure just released by *Pioneer Engineering & Manufacturing Company, Inc.*, Detroit, Mich. Bulletin PE-25 discusses product design and development, manufacturing cost studies and production engineering as applied to industry's engineering requirements, and lists the many types of products that *Pioneer* has successfully developed during the past quarter of a century.

Circle No. 86 on Reader Service Card

SILICONE REFERENCE GUIDE

Dow Corning Corporation, Midland, Mich., has just issued a 1955 reference guide on silicone products which lists some 23 brand-new products besides the 100-odd mentioned in the 1954 issue. Individual products are indexed by application, the index having been increased from 17 to 21 classifications.

Many tables, graphs and photographs are included to give engineers a maximum amount of information in limited space. Comparable data on various silicone products and the organic materials they displace are also given.

Circle No. 87 on Reader Service Card

ALLEGHENY RELAY STEELS

In a revised edition of a 12-page technical data sheet on *Allegheny* relay steels, information is presented on applications, magnetic properties as indicated by graphs of hysteresis loops and magnetization curves, and physical properties. Copies are available from the Advertising Department of *Allegheny Ludlum Steel Corporation*, 2020 Oliver Bldg., Pittsburgh 22, Pa.

Circle No. 88 on Reader Service Card

ELECTRONIC GAUGER SYSTEM

Application Data Sheet 102 covers an electronic gauger system widely used in pipeline operations. Principles of operation, equipment, circuitry, and the use of *Helipot Corporation's* precision potentiometers in this telemetering system are described and illustrated. Copies may be obtained from the Technical Information Service, *Helipot Corporation*, South Pasadena, Calif.

Circle No. 89 on Reader Service Card

PLUG-IN COMPONENTS

EECO Production Company, 827 S. Vermont Ave., Los Angeles 5, Calif.,

ULTRASONIC DRILL

SUCH materials as glass, tungsten carbide, sapphire, ceramic, and hardened steel can be drilled within a tolerance of .0005" (depending upon the size of the abrasive in the slurry) with the Model U 600 ultrasonic drill perfected by the *Vibro-Ceramics Corporation*, Metuchen, N. J., a *Gulton Industries* affiliate. It is possible for this drill to cut a 1/4" square hole in glass with a hollow tool at the rate of .1" in 60 seconds using a 1000-mesh fine abrasive. More rapid cutting action is accomplished with a coarser abrasive in the 200- to 300-mesh range.

Employing a *Glennite* ceramic transducer, the Model U 600 avoids any heating or deformation of the work surface, while tool wear is reduced to a minute fraction of the cutting penetration. The transducer consists of a piezoelectric tube bonded to a mechanical transformer in

the form of an exponentially tapered horn to give unusually large mechanical displacement of a tool. No water cooling of the transducer is necessary.

Interchangeable working tools are screwed directly into the end of the aluminum horn. (The large tools have their screw heads secured with low-melting wax cement.) Tools are brazed onto the end of a hex-head cap screw and can be changed readily with a small wrench. Three horns are available to accommodate 8-32, 1/4-28, and 1/2-20 screws to cover tools through ranges of .01" to .75" in diameter. Interchangeable transducers are held in a split clamp assembly to facilitate easy clamping and removal. The working table is moved vertically by a rack and pinion arrangement, and work can be fed automatically by adjusting the weight of a counterbalance arm. A dial gage indicator provides determination of cutting rate.

Some of the work possible with the Model U 600 in drilling holes in a glass disc is illustrated in the photograph. The irregular holes were cut with hollow tools and the recessed holes were made with screw heads and with a small gear brazed to a cap screw. The grid pattern was made with a "cookie cutter" type of tool for dicing germanium from a single-crystal slice.

Maximum power required to drive the drill is 35 watts. The generator supplied with the unit has an input of 117 volts at 1 ampere a.c., 60 cycles, and is completely contained in a cabinet 9" x 9" x 6". Tuning and power adjustment controls are provided as well as a tuning indicator meter. The entire unit, including drill and generator, is completely portable and weighs 15 pounds.

Circle No. 90 on Reader Service Card

The U 600 drill and generator, with samples of the work which can be done.



subsidiary of *Electronic Engineering Company of California*, has published a catalog covering the plug-in electronic components which it manufactures. Included are linear and pulse amplifiers, cathode followers, diodes, flip-flops, gates, multivibrators, and many others. The catalog also contains a section illustrating some of the more common uses of *EECO* plug-in circuits.

Circle No. 91 on Reader Service Card

VACUUM-TUBE ELECTROMETERS

Vacuum-tube electrometers and accessories are described in a 12-page catalog released by *Keithley Instruments*, 3868 Carnegie Ave., Cleveland 15, Ohio. Designed in part as a manual for engineers and scientists, this catalog includes introductory data on electrometer characteristics, circuit discussions, and equipment photographs. Diagrams show how the instruments are used as ultrahigh input impedance d.c. millivoltmeters, voltmeters, and kilovoltmeters; sensitive microammeters and micromicroammeters; accurate megohmmeters, d.c. preamplifiers, and static detectors.

Circle No. 92 on Reader Service Card

RECORDING INSTRUMENTS

Condensed Catalog 854, published by *The Esterline-Angus Company, Inc.*, P. O. Box 596, Indianapolis 6, Ind., discusses recording instruments for operation under every conceivable condition. Among the *Esterline-Angus* instruments presented are various types of electro-dynamometer measuring elements, permanent-magnet moving-coil recorders, and instruments which incorporate other types of electrically and mechanically actuated measuring elements.

Circle No. 93 on Reader Service Card

ELECTRONIC TEST EQUIPMENT DATA

Results of a research project for the U. S. Air Force on electronic test equipment are now being made available commercially for the first time by *Carl L. Frederick and Associates*. This comprehensive compilation consists of three volumes (2300 pages) and includes descriptive data on approximately 900 test equipment units. The project was originated and monitored by the Wright Air Development Center of the Air Research and Development Command.

Further details may be obtained from *Carl L. Frederick and Associates*, 4630 Montgomery Ave., Bethesda 14, Md.

Circle No. 94 on Reader Service Card

METALLIC RECTIFIER MANUAL

Dealing with types, designs, circuitry, characteristics and applications of selenium and copper oxide rectifiers,

the "Metallic Rectifier Manual" was primarily prepared for the design and development engineer. It is a comprehensive, 128-page illustrated handbook which has been published by *Bradley Laboratories, Inc.*, New Haven, Conn.

To prevent the manual from becoming outdated, *Bradley* plans to mail revisions and additions to all owners as developments in the field warrant them. This service is included in the purchase price of \$2.00 per copy.

Circle No. 95 on Reader Service Card

Transistor Test Set

(Continued from page 9)

R_o should be adjusted for the maximum v.t.v.m. peak reading, and Fig. 9 referred to for equivalent power gain in db.

The grounded emitter connection was used for the following power measurement, as it would be difficult to match the load to the higher output impedance of the grounded base connection. With R_o and R_L set for maximum resistance, V_o will equal .03 volts. Available input power (P_{in}), available output power (P_{out}), and maximum available power gain (G) are then:

$$P_{in} = \frac{V_o^2}{4R_o} = \frac{(.03)^2}{4(5000)} = .045 \times 10^{-6} \text{ watts} \quad (3)$$

$$P_{out} = \frac{V^2}{R_L} = 100 \frac{V^2}{1000} = .1V^2 \quad (4)$$

$$G = \frac{P_{out}}{P_{in}} = \frac{.1V^2}{.045 \times 10^{-6}} \quad (5)$$

so that:

$$V = \sqrt{.45G} \times 10^{-3} \quad (6)$$

The graph in Fig. 9 was made from Eq. (6).

Noise Figure Measurements

Noise figure measurements are made with the transistor connected for

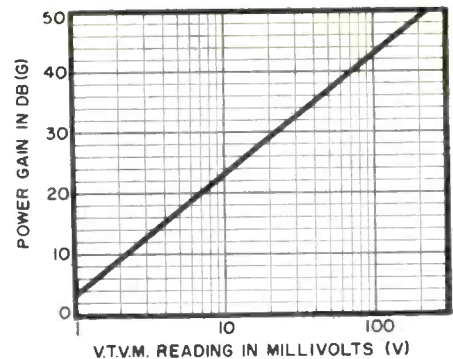

Fig. 9. Graph of Eq. (6) used for obtaining equivalent power gain in db.

grounded emitter operation. Measurements of 3 to 40 db are direct-reading and are made at 1000 cycles with a 100-cycle bandpass filter. Using this small bandwidth, the noise figure is approximately the same as that for a bandwidth of one cycle. For noise figure measurements, controls are adjusted so that the v.t.v.m. reads 5 mv. in all three switch positions (S_1 , Fig. 10); thus, accuracy is not important since the v.t.v.m. is merely an indicator. With the proper bias on the transistor, the oscillator level is adjusted in the first switch position; in the second switch position, an adjustment is made to compensate for variations in transistor voltage gain (A_1); and in the third position, the noise figure (NF) control is adjusted for 5 mv. on the v.t.v.m. Noise figure is then read directly from the NF control setting. The system is calibrated so that the collector noise voltage level will give a direct indication of NF in db.

Neglecting thermal noise originating in R_L of Fig. 7, the noise figure may be defined as the total noise power in the output (P_{nc}) divided by that portion of the noise power (P_1) in the output that results from thermal noise in R_o :

$$NF = \frac{P_{nc}}{P_1} \quad (7)$$

If the mean square value of the noise

Fig. 10. Schematic diagram of setup for making noise figure measurements.

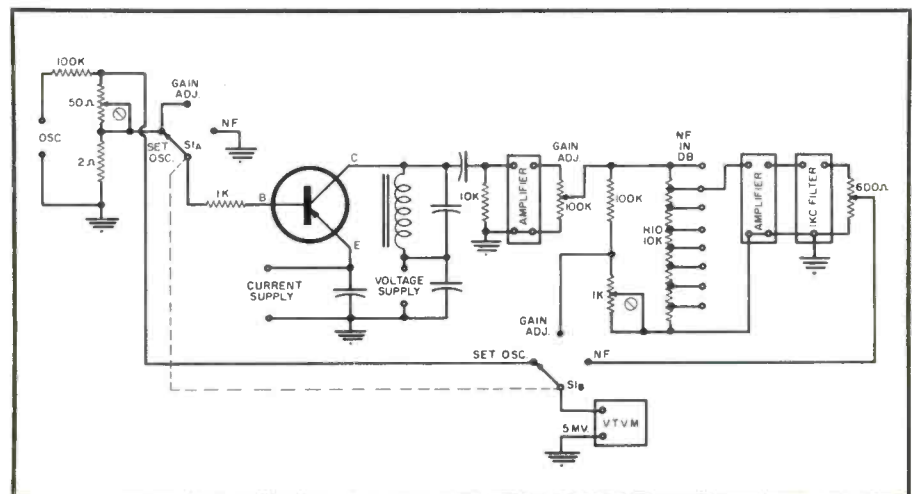

voltage measured across R_L is V_{nc}^2 , then the noise power in the output is:

$$P_{nc} = \frac{V_{nc}^2}{R_L} \dots \dots \dots (8)$$

Thermal noise in R_g may be represented by a noise voltage generator in series with R_g , as in Fig. 7. The mean square value of this voltage is:

$$v_g^2 = 4 k T R_g (f_2 - f_1) \dots \dots (9)$$

where k is Boltzman's constant, T is the absolute temperature in degrees K , and (f_2-f_1) is the bandwidth of the filter. If the ratio of the output voltage v_o to the signal voltage v_g is $A_1 = v_o/v_g$ (Fig. 7), then the noise power in the output due to thermal noise in R_g is:

$$P_1 = \frac{v_g^2}{R_g} \times A_1^2 \frac{R_g}{R_L} \\ = \frac{4kTR_g (f_2 - f_1) A_1^2}{R_L} \dots \dots (10)$$

Therefore², the noise figure is:

$$NF = \frac{P_{nc}}{P_1} = \frac{V_{nc}^2}{4kTR_g (f_2 - f_1) A_1^2} (11)$$

If the circuit constants are substituted in Eq. (11), the only variables at room temperature in determining NF are the transistor voltage gain and the collector noise voltage. Therefore, if the voltage gain is compensated for different transistors, the system can be calibrated to read NF directly from the collector noise voltage level. In this system, the gain is adjusted for each transistor so that $A_1 = 25$. It was felt that a transistor with $A_1 < 25$ would not be a good transistor for most applications.

The oscillator is used in the first two switch positions as a signal source for adjusting the voltage gain for different transistors. In the third switch position, the meter indicates the relative level of collector noise voltage. This level is attenuated in 1-db steps by R_{10} (Fig. 10) until the meter indicates the 5-mv. calibrated level. R_{10} can now be read directly since it is calibrated from 0 to 40 db.

Amplifiers and bias supplies have low noise levels. The collector tuned circuit improves the signal-to-noise ratio in the collector circuit and provides a low resistance path for the d.c. bias.

REFERENCES:

1. Shea, R. F., etal, "Principles of Transistor Circuits," 1st Ed., John Wiley & Sons, Inc., 1953.
2. Keonjian & Schaffner, "An Experimental Investigation of Transistor Noise," Proc. IRE 40, November, 1952, p. 1457.

Fig. 11. Control panel for determining maximum available power gain.



Controlled B.F.O.

(Continued from page 17)

causes a temporary damped oscillation at the new resonant frequency, ω_g , its amplitude and phase being governed by the phase of the old ωt at which detuning takes place. The transient dies away exponentially to leave the voltage across the tuned circuit at the old, forced frequency changed in amplitude and phase. If this voltage actuates a phase detector whose other leg is fed at a fixed $(p/q)\omega$, the detector output will fluctuate in a damped oscillation at $|\omega-\omega_g|$ while the transient lasts. Therefore, if the output is fed back to a reactance tube across LCR , the phase rotation in the loop for $|\omega-\omega_g|$ must be such that the oscillation is damped out, not reinforced. In practice, this means that the phase rotation must be as small as possible and under 180° for the highest $|\omega-\omega_g|$ that occurs.

The experimental controlled b.f.o. of Fig. 10 has not been bad for hunting, but it behaves in accordance with the above theory inasmuch as critical adjustments of control sensitivity and

most of the control voltage, and could be profitably replaced by a suitable transformer; but the 12SG7 is a sensitive reactance tube and requires very little control. The phase detector must operate at higher level the higher the p and q in the ratios to be locked, and in the unit of Fig. 10 the d.c. output is about 30 volts per side, the difference being the control voltage. The feeble output of the pentagrid mixer has to be amplified to give this much voltage, or a better mixer used that gives greater undistorted output.

Applications

Lecture Demonstration

The controlled b.f.o. is ideal for generating Lissajous and other figures for lecture demonstration, the purpose for which it was first conceived. Since it tunes a wide ratio of output frequency with one variable tuning element and no bandswitching, it is cheaper to build and easier to operate than LC or RC oscillators which generate the output frequency directly. It will lock in readily in much more complicated ratios than are ordinarily attained by locked oscillators, and its pure output waveform needs no filtering other than the fixed low-pass mixer filter.

For demonstration where the actual frequencies do not matter, an even better source than the setup of Fig. 3 is the double b.f.o. shown in Fig. 11, using two fixed and one variable r.f. oscillators and two mixers. The two difference frequencies are locked as before and any one of the three r.f. oscillators are also mixed, there will be a third interlocked low frequency equal to the sum of the other two. The required r.f. tuning range is half that for the unit in Fig. 3 because one output frequency rises as the other falls, provided that $f_1 < f_2 < f_3$; and the b.f.o. shown in Fig. 11 is cheaper and less bulky than that of Fig. 3.

Precise Interpolation

Interpolation in precise frequency measurements is another use for the controlled b.f.o. In Fig. 3, f_1 is a fixed standard frequency, and the controlled f_2 differs from it by the interpolation frequency $(p/q)f_0$, i.e., $f_2 = f_1 \pm f_0 p/q$; and if f_0 is in error by Δf_0 , the proportional error in f_2 is $\Delta f_2/f_2 = (f_0/f_2) (\Delta f_0/f_0)$. Note that an undesirable frequency $f_1 \pm f_0 p/q$ is not generated as it would be in the more usual modulation method of adding frequencies which requires a perfectly adjusted single-sideband modulator to exclude the undesired frequency. If higher-order modulation is used in M , the same precision is available in the vicinity of any $(m/n)f_1$; and f_2 is in each case pure, not just one of a jumble of fre-

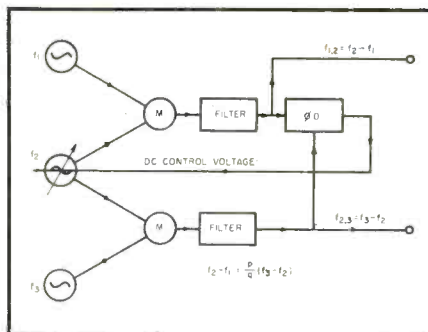

Fig. 11. Block diagram of controlled b.f.o. setup using two fixed and one variable oscillator and two mixers.

antihunt ratio are helpful and sometimes necessary. To get the necessary ripple filtering with as little delay as possible, an LC low-pass filter with cut-off no lower than necessary has shown itself to be more efficient than an RC filter. Preceding it is an adjustable antihunt circuit whose constants are given for this oscillator but would probably be different for another. The reactance tube cathode RC gives some antihunt action also and could perhaps be made to do it all. An antihunt circuit can be regarded as a phase rotator opposing the rotation by the filters, or as a means of opposing quick shifts rapidly but easing up as the quantity controlled yields so as not to overshoot. It is like steering a ship: if she goes off course to starboard, one must give her left rudder, but then "meet her with the helm" and commence checking her swing to port before she comes back on course; otherwise she will yaw. Critical damping is what is wanted in both cases.

Of course, the antihunt circuit wastes

quencies whose heterodynes are heard in headphones in the traditional methods of frequency comparison.

Multiple Frequency Operation

Still referring to Fig. 3, if $f_0 = (h/k)f_1$, f_2 bears an exact ratio to f_1 , when f_0 and $(h/k)f_1$ are locked. f_2/f_1 cannot be counted directly on an ordinary oscilloscope screen, but it is known by the Lissajous figure comparing f_0 and $(h/k)f_1$. For example, this is an easy way to get pure synchronized 99 or 101 kc., etc., from a typical standard-frequency assembly giving 100, 10 and 1 kc. Finally, in the most general case, if modulation in M is of $(m + n)$ th order, if LPF is replaced by tuning, if $f_0 = (h/k)f_1$, and if f_0 is locked at $(p/q)f_0$ as before:

$$f_2 = \frac{1}{n} \left(\frac{ph}{qk} \pm m \right) f_1 \quad (8)$$

Such an arrangement offers a very great choice of pure frequencies controlled by one crystal.

Figure 11, too, has some interesting properties if, as shown, f_2 is controlled and f_1 and f_3 are crystals or derived from one crystal. f_2 and the difference frequencies f_{12} and f_{23} are wholly determined by f_1 and f_3 whenever f_{12} and f_{23} are locked in any ratio of p/q .

$$f_2 = \frac{f_1 + \frac{p}{q} f_3}{1 + p/q} \quad (9)$$

$$\frac{\Delta f_2}{f_2} = \frac{f_1 \Delta f_1}{f_2 f_1} + \frac{p}{q} \frac{f_3 \Delta f_3}{f_2 f_3} \quad (10)$$

$$f_{12} = \frac{p}{q} (f_3 - f_1) \quad (11)$$

$$f_{23} = \frac{f_3 - f_1}{1 + p/q} \quad (12)$$

The error in f_2 thus becomes the mean of the errors of the two crystals when $p/q = 1$; but if f_1 and f_3 are based on one standard, the error is that of the standard.

Analogous relationships apply if f_2 is not between f_1 and f_3 . Here, then, is another method of interpolation in smaller steps than the lowest standard frequency available. It has an advantage over stroboscopic interpolation⁶ (which is very satisfactory for calibrating oscillators) in that the standard frequency varying in fine steps is actually generated and available, not just represented indirectly.

Transmitter Frequency Variation

Some amateurs tune their transmitters through the bands with nearly crystal precision by mixing a crystal with a variable low-frequency oscillator and using the sum or difference⁷. Because the amateur bands are harmoniously related, several can be covered by

using higher-order modulation and/or multiplication. The controlled b.f.o. offers a way of doing this with less risk of spurious radiation, continuously, by means of the circuit of Fig. 3 or in entirely crystal-controlled steps by means of the setup in Fig. 11.

REFERENCES:

1. Langford-Smith, F., "Radiotron Designer's Handbook," McGraw-Hill, 1943.
2. Terman, F. E., "Radio Engineering Handbook," McGraw-Hill, 1943.
3. Travis, C., "Automatic Frequency Control," Proc. IRE 23, Oct., 1935, p. 1125.
4. Foster, D. E., & Seeley, S. W., "Automatic Tuning," Proc. IRE 25, March, 1937, p. 289.
5. Roder, H., "Theory of Discriminator Circuit for AFC," Proc. IRE 26, May, 1938, p. 590.
6. Taylor, A. H., "Stroboscopic Interpolation," RADIO-ELECTRONIC ENGINEERING, Jan., 1954, p. 13.
7. Described to author by W. R. Bliss of Decimeter, Inc., Denver, Colo.

News Briefs

(Continued from page 25)

will be given to receiver problems.

All lectures will be held in the auditorium of the new Physics Building at the University of Pennsylvania and will start at 8:00 P.M. Additional information and registrations forms may be obtained from Mr. R. Bowley, WPTZ, 1619 Walnut St., Philadelphia 3, Pa.

Circle No. 96 on Reader Service Card

ARMOUR LABORATORY PLANNED

Plans have been announced by Armour Research Foundation of Illinois Institute of Technology, Chicago, Ill., for the construction of a million dollar laboratory building to house the Foundation's electrical engineering research facilities and proposed nuclear reactor.

The one-story building, to be located on the Illinois Tech campus, will provide 39,744 square feet of space. Actual construction is expected to get under way about March 15, with completion scheduled for October 1.

Circle No. 97 on Reader Service Card

APPOINTMENTS AT BENDIX

Two appointments have been announced by Bendix Aviation Corporation, 203 W. Third St., Cincinnati 2, Ohio: Mr. A. P. Fontaine has been named director of engineering and Dr. A. C. Hall is the general manager of the research laboratories.

Mr. Fontaine, who will also have jurisdiction over the laboratories of the corporation, has helped direct expanded operations in aircraft control, navigation and instrument equipment, electron tubes, and other products at six of the 24 Bendix manufacturing divisions. Dr. Hall became associate director of the Bendix research laboratories in 1950, and technical director in 1952.

Circle No. 98 on Reader Service Card

STOP

METER DAMAGE

now!

FOR THE FIRST TIME

ONLY

\$70

F.O.B.
Upper Darby, Pa.



Model 430

20,000 OHM/VOLT AC/DC

MULTI-RANGE METER

MADE BY Metrix

WITH AUTOMATIC OVERLOAD CUT-OUT PROTECTION

Sensitivity: 20,000 ohms per volt A.C. and D.C. 33 ranges. A.C. and D.C. volts: 3-10-30-100-300-1000-5000 D.C. current: 50 microA—1-10-100 mA—1-10 Amp. Resistances: 0 to 20 Megohms. Output meter: 3-10-30-100-300-1000 volts. Accuracy: D.C. 1.5%; A.C. 2.5%. Dimensions: 8 1/4 x 5 1/2 x 3 1/2 ins. Weight: 3 lbs. 8 ozs. 30 KV probe and leather case available at extra cost. Other Precision Electronic Instruments Available. Write to:

U. S. A. DISTRIBUTORS

M. E. GERRY & CO., Inc.

230 BAYARD RD., Upper Darby, Pa.

Circle No. 11 on Reader Service Card

GET AHEAD IN ELECTRONICS

Study new, fast, efficient systems of operations and design engineering. Learn how to bypass advanced trig, algebra, calculus. Use your slide rule without equations, employ electronic mental arithmetic. Truly generalized methods taught by mail to advanced technicians, at very reasonable cost. SUPERIOR PROCEDURES, 72 Vendola Drive, San Rafael, Calif.

Circle No. 12 on Reader Service Card

TUBES

70% to 90% DISCOUNT

Government, manufacturers, jobbers, etc. surplus. Guaranteed 1 year. Free catalog on request. CADILLAC TRADING, Dept. W, 231-07 Linden Blvd., Jamaica 11, N. Y.

Circle No. 13 on Reader Service Card

TECHNICAL BOOKS

"SONICS—Techniques for the Use of Sound and Ultrasound in Engineering and Science" by Theodor F. Hueter & Richard H. Bolt, Massachusetts Institute of Technology. Published by *John Wiley & Sons, Inc.*, 440 Fourth Ave., New York 16, N. Y. 456 pages. \$10.00.

As all applications are based on the same physical principles, the unity of sonics is the keynote of this book. Common principles are presented in general form and then applied in many special ways to the design of sonic techniques for a particular medium or frequency range. The underlying physics is covered as simply as possible; it is assumed that the reader has had little or no specialized training in acoustics, but that he has some understanding of electronics.

Relevant fundamentals of vibration and sound are given, followed by the general aspects of transducers for sound generation and reception. Applications are divided into two branches, sonic processing and sonic analysis, with typical examples illustrating operating principles. Molecular aspects of sound propagation in fluids are discussed in the appendix.

"TRANSISTORS: Theory and Applications" by Abraham Coblenz, *Transistor Products, Inc.*, and Harry L. Owens, Signal Corps Engineering Laboratories. Published by *McGraw-Hill Book Company, Inc.*, 330 West 42nd St., New York 36, N. Y. 313 pages. \$6.00.

Covering the theory of transistors from the vantage point of the electronics technician or engineer, this book includes those aspects of transistor manufacture which have a bearing on transistor characteristics and applications. The theoretical matter is presented with a minimum of mathematics and with pronounced emphasis on applications to working circuits. It is designed for technicians of all grades in the electronics field whose mathematical preparation may be limited.

Information contained in this volume has been obtained from a large number of publications, articles, conference notes, and verbal contributions, as well as original work by the authors. Discussing both silicon and germanium transistors, the text proceeds from basic concepts to advanced topics, offering help in manufacturing techniques, precautions and practices, and in testing, evaluating, and using transistors in circuits.

Bypass Nomographs

(Continued from page 14)

inductances, point 1 can be grounded by series resonance.

In essence, series resonance is the technique suggested for u.h.f. bypassing. Whenever possible, a series resonant circuit should be located where a bypass is necessary. To do so requires a knowledge of the actual inductances and capacitances of the circuit components involved. However, many circuit components act differently at u.h.f. than one would ordinarily expect. Capacitors may have sufficient inherent length to pass through series resonance and look inductive, while choke coils may have sufficient distributed capacitance to pass through parallel resonance and look capacitive. Many resistors have lower resistance than the d.c. rating, and, in general, the components cannot be trusted to act in the circuit in the manner which their markings would indicate. Some manufacturers (of resistors, for example) publish high frequency characteristics in curve form which allow reasonable accuracy for design work. Choke coils are usually made to special order so that general design information and stock sizes are not ordinarily available.

However, capacitors are generally available in stock sizes, and, circuitwise, may vary widely from the low frequency markings. The effective reactance of a capacitor with appreciable lead inductance is given by:

$$X_c = \frac{1}{2\pi fC} [1 - (f/f_0)^2]$$

where f is the frequency of operation

Fig. 5. Chart for determining effective capacitance at various frequency ratios.

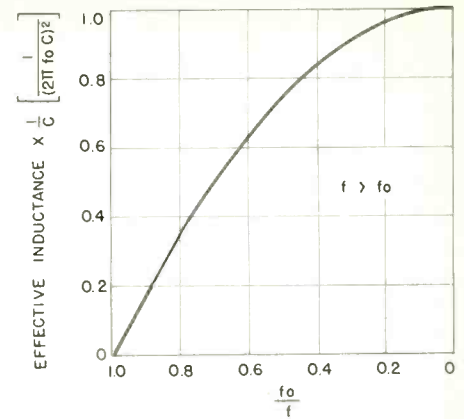
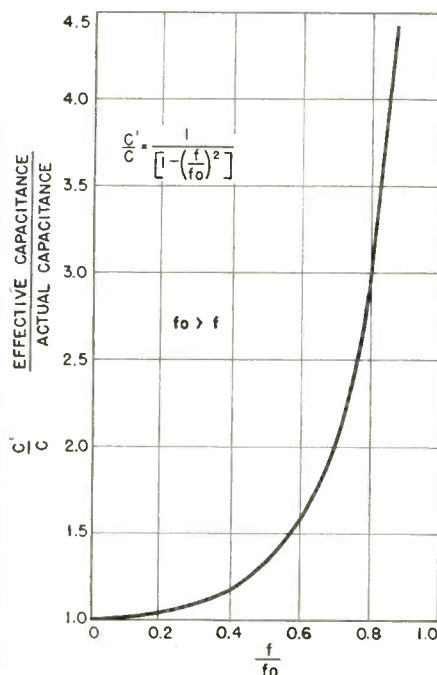

Fig. 6. Chart for determining effective inductance at various frequency ratios.

and f_0 is the self-resonant frequency of the capacitor and its leads.

Determining Effective Values

A series of nomographs designed to simplify the problem of determining the effective value of a capacitor at u.h.f. are presented in Figs. 2 through 6. Figures 2, 3 and 4 show the self-resonant frequencies of representative values of mica, tubular ceramic, and silver button capacitors as a function of the associated lead length. After locating f_0 of the configuration, the effective capacitance (or inductance if $f > f_0$) at any frequency can be determined from Fig. 5.

As an example, consider a screen bypass capacitor for use with subminiature pentode type 5840 at 400 mc. The total screen lead length from the center of the screen structure to the silver button bypass (including the socket pins) cannot be less than 0.75". A capacitor selected for series resonance with this lead length at 400 mc. would put the screen structure at ground. Figure 4 gives a value of 15 $\mu\text{fd.}$ for the required capacitor; such a unit, plus the lead, looks like an infinite bypass capacitor at this frequency.

Now, assume that the stage is retuned to perhaps 300 mc. To determine the effectiveness of the 15- $\mu\text{fd.}$ bypass capacitor at this frequency, enter Fig. 5 with $f/f_0 = 0.75$ and find $C' = 2.35 C$ $\mu\text{fd.} = 35.3\text{-}\mu\text{fd.}$ effective capacitance at 300 mc.; the value of 35.3 $\mu\text{fd.}$ represents approximately 15 ohms reactance. The effectiveness of this bypass would depend upon the impedance levels of the associated circuit. If it is decided to optimize the bypass at 300 mc., a 25- $\mu\text{fd.}$ tubular ceramic could be selected from Fig. 3.

To determine the effective bypass at 400 mc., enter Fig. 6 with f_0/f equal to 0.75 and find that the bypass is a net inductance equal to $0.44C/4\pi^2 f_0^2 C^2$ or 0.005 microhenrys, which is just the opposite of what is desired.

The old reasoning of expecting the better bypassing from the larger ca-

capacitance should be re-examined when high frequencies are involved. Bypass capacitors must be designed to circuit dimensions, not just selected to have a value exceeding a specified minimum.

BIBLIOGRAPHY:

RCA Industry Service Laboratory Report LB-790.
Green, A. P., and McComb, C. T., *Electronics*, March, 1944.

Recording Data

(Continued from page 20)

tape speed variations, flutter and wow in the system do not materially effect its accuracy. Also, since only the pulse position is of interest, pulse-position modulation, like other pulse methods, is not dependent upon the properties of the magnetic tape or heads. It is claimed that this method is accurate to 0.1% of maximum signal, with a low noise level and a frequency response that covers the range from d.c. to several cps.

The modulation circuitry involved is somewhat more complicated in this scheme than with other modulation systems since electronic analog multipliers and accurate "flip-flop" stages are required. A bistable "flip-flop" is used in conjunction with a summing integrator; the sampling rate of the modulator must be many times higher than the highest signal frequency component to insure flat response. The output of the "flip-flop" is differentiated and the resultant leading and trailing edge pulses are recorded on the magnetic tape.

Upon playback, the pulses are recovered, amplified, and are used to trigger a "flip-flop" to reproduce the original signal. A filter is then used to average the output.

General Considerations

To accomplish digital recording, the information must be coded in some binary system and each binary digit must be recorded with a high degree of reliability. The technique does not require amplitude linearity, good signal-to-noise ratio, or a good drive system (flutter and wow up to 10% can be tolerated). Some applications, such as an input system for digital computers, require high speed "start-stop" and utmost reliability. To increase the latter factor, pairs of tracks which are spaced several tape tracks apart are recorded in parallel.

Digital recording is primarily concerned with pulse-packing or the bits per inch that can be reliably placed along the tape. This space density of information is a measure of system performance. Frequency response is a consideration only insofar as the relation between the speed of the tape and the transient response of the magnetic

recording heads affects the highest frequency which can be sampled adequately.

Certain investigators claim that pulses have been read back at a 40:1 speed reduction. This playback was done with the tape traveling at only 0.5 ips, for which case the signal-to-noise ratio was better than 30 db.

The usual figure of merit for reliable information densities is generally assumed to be 100 to 150 bits per inch. A paper by Potter and Michel describes a method of recording reliably at densities up to several hundred bits per inch. The method concentrates on playback waveform rather than recording current, shifting the emphasis from the magnetic storage medium to the reading circuits. As a result, the playback circuits are more complicated.

Digits can be recorded either in series along the tape, or in parallel across the width of the tape using multiple tracks. A limiting factor in the use of multiple tracks is tape skew, a random weaving action.

Complete Data System

A complete magnetic tape data-recording system which uses pulse-code modulation will now be described. It consists of three units: an analog-to-digital converter and binary coder, a multitrack magnetic tape recorder, and a readout device. The converter processes the signal into an acceptable binary-digitized form. This is placed onto a magnetic tape recorder which provides a permanent, accurate record. Information can be recorded at high speeds and reproduced at lower speeds for later computation or printing out.

The analog-to-digital converter

changes the information to a form that is convenient for automatic data reduction. A block diagram of such a unit is shown in Fig. 3. This converter uses a balanced modulator and does not require preamplifiers with their attendant difficulties. The modulator operates with inputs from strain gages, thermocouples, or any devices producing a d.c. voltage input; it gives a digital output count proportional to the input voltage, and the sampling rate for a single channel can be as high as 8000 per second.

The output count is stored on a digital-type magnetic tape recorder which is subsequently played back for computation or tabulation. The storage logic can be modified for special magnetic tape input devices. As the recording is in a binary form, simple specifications are required for the tape drive and associated electronic components in order to yield accurate results.

During reproduction, the readout unit converts the coded information into signals suitable for operating an IBM card punch, or direct input into a computer or other suitable output device. The information consists of time, channel number, the sign and numerical value of the input signal. Some of the circuitry used in the converter can be incorporated in the readout unit where economy of equipment is a desirable objective. A photograph of a converter unit, including control and power assemblies, is shown in Fig. 2; the converter only is shown in Fig. 4.

Current practice usually employed in reducing FM-FM telemetered data requires both pen recorders and film oscillographs. The former are used to obtain a quick and crude indication of

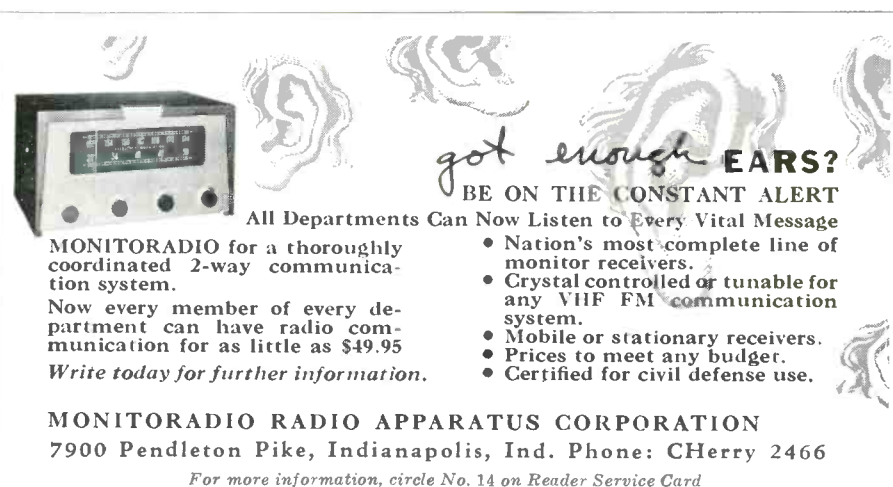

got enough EARS?
BE ON THE CONSTANT ALERT
All Departments Can Now Listen to Every Vital Message

- Nation's most complete line of monitor receivers.
- Crystal controlled or tunable for any VHF FM communication system.
- Mobile or stationary receivers.
- Prices to meet any budget.
- Certified for civil defense use.

MONITORADIO RADIO APPARATUS CORPORATION
7900 Pendleton Pike, Indianapolis, Ind. Phone: CHerry 2466
For more information, circle No. 14 on Reader Service Card

SPLICES MAGNETIC TAPE
Neatly - Quickly - Easily

Kit includes plastic splicer which adheres to recorder or worktable, generous supply of pre-cut tape splicing tabs, handy blade, instructions and plastic case. Only \$1.50 postpaid. If your dealer can't supply you, order from...

COUSINO, INC.
2321 Madison Ave. Toledo 2, Ohio

Circle No. 15 on Reader Service Card

WANTED: TUNING UNITS
FOR
RECEIVER AN/APR-4, AND AN/APR-9

ENGINEERING ASSOCIATES
434 Patterson Road Dayton 9, Ohio

Circle No. 16 on Reader Service Card

the data; the latter provide subsequent accurate manual assessment with the use of optical devices. However, the PCM system described above will replace the tedious manual method by converting the analog information received from the discriminators into digital values on magnetic tape and then into a form suitable for insertion into a high speed digital computer for processing. An essential part of the equipment is the necessary timing and programing circuitry to operate with the time reference from the original signals. Such a system will digitize telemetered data in real time and record that data on magnetic tape in a form suitable for input to a high speed digital computer.



New Products

(Continued from page 27)

30, and 100, and a frequency response from 5 to 20,000 cps. Voltage requirements are: filament, 6 or 28 volts; plate, 105 to 250 volts.

Circle No. 99 on Reader Service Card

DIGITAL DECADE COUNTERS

Two types of digital decade counters, each available in three variations, have

been announced by the *Brush Electronics Company*, 3405 Perkins Ave., Cleveland 14, Ohio, for use wherever high speed electronic counting is required. Each type employs the printed circuit principle, thereby permitting maximum ventilation, lower operating temperature, and longer life.

The type "A" group has decades with a staircase output of voltage propor-

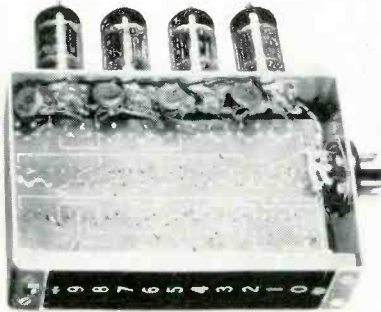

tional to the count, while the type "B" group has decades with a four-line coded output. Both types are applied to Models 100, N-100, and N-101—high speed electronic counters which will accept input pulses at rates varying from 0 to 100,000 counts per second. For each ten impulses which are received at

the input, a single pulse is generated at the output.

Circle No. 100 on Reader Service Card

INSULATION MEASURING INSTRUMENTS

A complete line of insulation measuring instruments, called Tera-Ohmmeters, has been made available for laboratories, factories and field work by the Instrument Division, *Federal Telephone and Radio Company*, Clifton, N. J., a division of *International Telephone and Telegraph Corporation*. With sensitivities ranging from 0.2 megohms to 500 teraohms (500×10^{12} ohms), the various types supply fixed test voltages of 10, 100 or 500 volts.

Tera-Ohmmeters provide high-accuracy measurements . . . $\pm 3\%$ in center of scale for all ranges. Test samples can be measured grounded, ungrounded or with guard ring electrodes, and operation is from line or self-contained batteries. Applications include the testing of resistors, capacitors, cables, switches, tube sockets, transformers and many other components.

Circle No. 101 on Reader Service Card

RECORDER-CONTROLLER

Designed primarily for the measurement and control of levels of liquids, granular solids, interface and other con-

RADIATION-BALANCE MICROCALORIMETER

EMISSION rates of low-activity radioactive sources can be determined precisely by measuring the minute amounts of heat energy which accompany radioactive emission. The radiation-balance microcalorimeter recently developed by Dr. W. B. Mann, of the National Bureau of Standards, Washington 25, D. C., is extremely compact and requires a relatively short time to complete a measurement. It can be used to determine the intensity of a single source or to compare two sources of nearly equivalent energy emission.

The instrument consists essentially of two cups, the temperatures of which are balanced against each other by means of two thermopiles arranged around the equator of each cup and connected in

opposition through a sensitive galvanometer. Thus, when there is no difference in temperature between the cups, there will be no deflection of the galvanometer.

A junction of two dissimilar metals, known as a Peltier junction, is soldered to the bottom of each cup. The two junctions are connected in series in such a way that when an electric current is passed through them one junction cools and the other heats. A radioactive source is placed in cup A, and a current is passed through the junctions so that Peltier cooling occurs in the junction below cup A and Peltier heating in the junction below cup B.

Current can be adjusted (provided that the source of radioactivity has an energy emission below a certain calculable maximum value) so as to balance partially the energy emission in A with Peltier cooling. With the addition of Peltier heating in B, it is possible to achieve temperature balance between A and B. When this balance is achieved, there is normally only a small residual galvanometer deflection. Since the temperature of cup A is now very nearly equal to that of cup B, the heat losses from the cups, which occur chiefly along the thermopile leads, are essentially equal and compensatory.

A number of such radiation balances have now been constructed at NBS, and their application to the measurement of the energy emission from radium has been studied. One of these instruments, with cups of gold, has been used to compare the U. S. and British primary radium standards with the Canadian national radium standard; the standard deviation of the results was only 0.13%.



One of the present group of NBS radiation balances showing two gold source cups and their thermopiles at right.

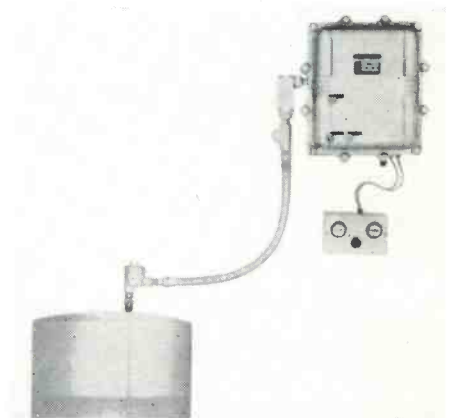
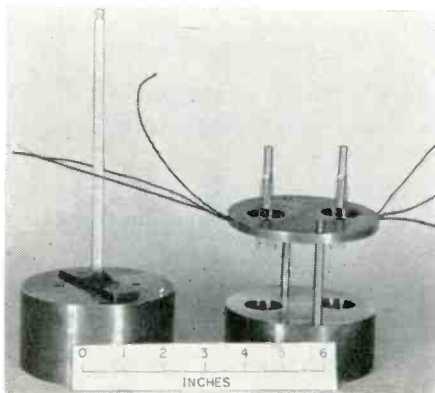

ducting or nonconducting substances, the Series 42 r.f. capacitance bridge is a sensitive and accurate self-balance recorder-controller. It may also be used for other process variables, such as moisture content or composition, which cause a direct change in dielectric constant.

A product of the *Fielden Instrument Division* of the *Robertshaw-Fulton Controls Company*, 2920 N. Fourth St., Philadelphia, 33, Pa., the Series 42 is

PHOTO CREDITS

PAGE	CREDIT
7, 9, 34	General Electric Co.
12, 13	Nat. Bureau of Standards
18, 20	J. B. Rea Co., Inc.

accurate to within $\frac{1}{4}$ of 1%. General specifications include: pen speed, 3.5 seconds for full-scale travel; range of terminal capacitance, 20 to 500 μfd . or higher; range of span, 5 to 200% of terminal capacitance; and sensitivity, $\pm 0.05\%$ of span.

Circle No. 102 on Reader Service Card

LOW FREQUENCY Q INDICATOR

Accuracy of Q measurement has been extended through the low audio and upper ultrasonic frequency range by the redesign of the *Freed* Type 1030-A low frequency Q indicator. Type 1030-A

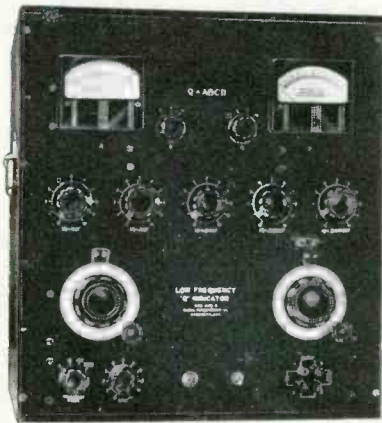

measures directly the Q factor, the inductance, distributed capacity, impedance and dielectric losses of coils and other components. The study of magnetic properties of iron can be rapidly accomplished.

Range of Q factor is from 0.1 to 1000 over the frequency range from 20 to 200,000 cycles, with an accuracy of 5%. The RC oscillator and variable impedance amplifier incorporated in the indicator can be used as a separate low frequency generator with an output of 5 watts into a 50-ohm load. Further information on the Type 1030-A is available from *Freed Transformer Company, Inc.*, 1715 Weirfield St., Brooklyn (Ridgewood) 27, N. Y.

Circle No. 103 on Reader Service Card

DYNAMIC PRESSURE PICKUP

Unusually high frequency response and sensitivity are featured in the *Endevco* Model 2501 dynamic pressure

pickup. The piezoelectric ceramic sensing element eliminates the requirement for external power and permits use of cables up to several hundred feet long.

Model 2501 is presently available in three ranges (0-500 psi, 0-1000 psi, and



0-2500 psi), and full-scale output is in excess of 15 volts. The natural frequency varies upward from 35 kc., permitting the measurement of rise times of the order of 10 μsec . Complete information may be obtained from Mr. William Simpson, *Endevco Corp.*, Dept. P, 180 E. California St., Pasadena, Calif.

Circle No. 104 on Reader Service Card

MINORITY CARRIER TEST SET

Scientific Specialties Corporation, Snow and Union Sts., Boston 35, Mass., has developed a test set for separate measurement of bulk lifetime of minority carriers and the surface recombination velocity constant of germanium and other semiconductors. Operation of the Model GL-131 is based on the photomagneto-electric effect in semiconductors.

As direct measurements are made by a single adjustment of the measuring circuit and the deflection of a d.c. meter, this instrument is especially suitable for

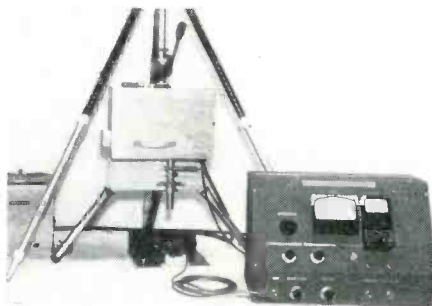

use in large-scale production lines. The entire system is controlled from the cabinet which contains a phase-sensitive voltmeter and current source.

Circle No. 105 on Reader Service Card

A practical guide to the analysis, testing, and processing of materials with acoustical energy...

SONICS

Techniques for the Use of Sound and Ultrasound in Engineering and Science

By THEODOR F. HUETER and RICHARD H. BOLT, both of The Massachusetts Institute of Technology

This new book offers a sound, useful, easy-to-read presentation of the principles and practices of this rapidly expanding field. Techniques and devices ranging from a few cycles per second to hundreds of megacycles per second are covered. You are given a clear and authoritative account of:

- fundamental physics of vibration and sound;
- design principles of electroacoustic and fluid-dynamic transducers;
- choice of sonic variables for systems engineering;
- special techniques for testing and processing;
- the limitations and economic aspects of sonics;
- new information on magnetostrictive transducers, and other topics.

1955 456 pages Illustrated \$10.00

Send for your ON-APPROVAL copy today

JOHN WILEY & SONS, Inc.

440 Fourth Ave. New York 16, N.Y.

Circle No. 17 on Reader Service Card

RADIO OPERATORS

Licensed operators with minimum 2 years' marine or ground station experience.

RADIO, VHF TECHNICIANS

Minimum 5 years' experience maintaining and installing standard commercial radio and VHF communications equipment.

For work in Saudi Arabia.

Write giving full particulars regarding personal history and work experience. Please include telephone number.

Recruiting Supervisor, Box 4

ARABIAN AMERICAN OIL COMPANY

505 Park Avenue
NEW YORK 22, NEW YORK

Circle No. 18 on Reader Service Card

ATTENTION HAMS

We are anxious to secure Frequency Meters such as BG-221s, TS-173s, TS-174s, TS-175s, TS-323s, TS-186s. Please send a complete description to Weston Laboratories, Box 407, Littleton, Massachusetts.

Circle No. 19 on Reader Service Card

INDEX OF ADVERTISERS

NAME	PAGE	NAME	PAGE
Arabian American Oil Company	39	Monitoradio Radio Apparatus Corp.	37
Automatic Switch Co.	21	Precision Paper Tube Co.	25
Burnell & Co., Inc.	29	Pye Limited	3
Cadillac Trading	35	Radio Corporation of America	4, 5, 23
Chicago Standard Transformer Corp.	6	Rinehart & Co., Inc.	27
Cousino, Inc.	37	Superior Procedures	35
Electro-Voice	31	United Transformers Co.	Second Cover
Engineering Associates	37	Weston Laboratories	39
Freed Transformer Co., Inc.	Fourth Cover	Wiley & Sons, Inc., John	39
Gerry & Co., Inc., M. E.	35		

FREED MINIATURE PULSE TRANSFORMERS

USED IN UNIQUE BLOCKING OSCILLATOR CIRCUIT CAN PASS UP TO 200,000 PULSES PER SECOND.

Freed Miniature Pulse Transformers are being used in a novel blocking oscillator circuit which produces sharp pulses at repetition rates up to 200,000 pulses per second. With the circuit constants shown, an output pulse of two microseconds duration, 65 volts amplitude can be obtained with a p.r.f. of 20,000. The rise time obtained with the FREED MPT-8 is less than 0.05 microsecond. This fast repetition rate circuit can be triggered with either a sine or a square wave, and requires a driving voltage of anywhere from one to fifty volts. The bias voltages need not be obtained from a low impedance supply. If a negative pulse output is required, the FREED MPT-7 transformer provides a tertiary winding for this purpose.

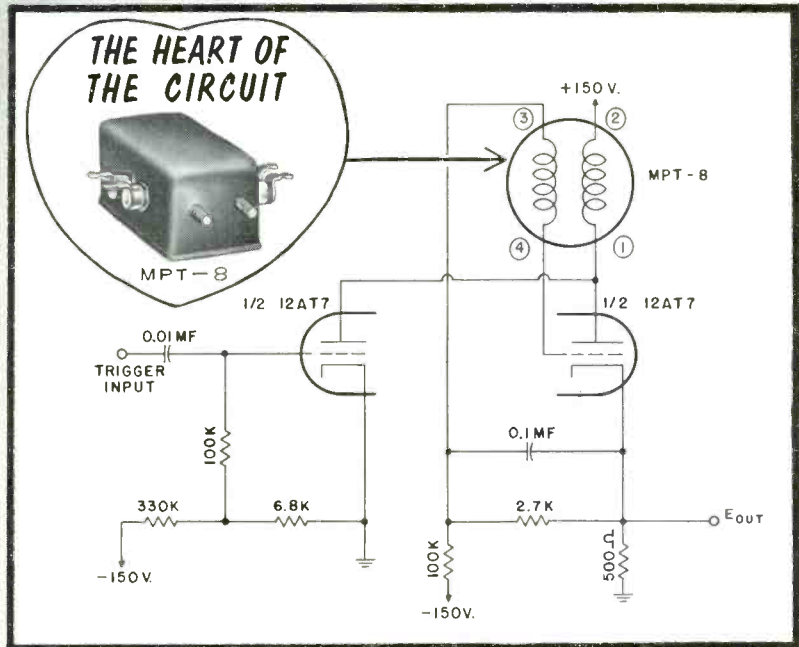

HERMETICALLY SEALED PULSE TRANSFORMERS for use in blocking oscillators, low level interstage coupling, and modulator outputs. Made in accordance with MIL-T-27 specifications. These pulse transformers are designed for maximum power, efficiency and optimum pulse performance. Balanced coil structures permit series or parallel connection of windings for turn ratios other than unity. Pulse characteristics, voltages and impedance levels will depend upon interconnections made.

Catalog Number	Application	Pulse Voltage Kilovolts	Pulse Duration Microseconds	Duty Ratio	Test Voltage KV., RMS	Characteristic Impedance Ohms	Case Size
MPT-1	Blocking oscillator or interstage coupling.	0.25/0.25/0.25	0.2-1.0	.001	0.7	250	DM-12
MPT-2	Blocking oscillator or interstage coupling.	.025/0.25	0.2-1.0	.004	0.7	250	DM-12
MPT-3	Blocking oscillator or interstage coupling.	0.5/0.5/0.5	0.2-1.5	.002	1.0	250	DM-18
MPT-4	Blocking oscillator or interstage coupling.	0.5/0.5	0.2-1.5	.002	1.0	250	DM-18
MPT-5	Blocking oscillator or interstage coupling.	0.5/0.5/0.5	0.5-2.0	.002	1.0	500	DM-12
MPT-6	Blocking oscillator or interstage coupling.	0.5/0.5	0.5-2.0	.002	1.0	500	DM-12
MPT-7	Blocking oscillator, interstage coupling or low power output.	0.7/0.7/0.7	0.5-1.5	.002	1.5	200	DM-18
MPT-8	Blocking oscillator, interstage coupling or low power output.	0.7/0.7	0.5-1.5	.002	1.5	200	DM-18
MPT-9	Blocking oscillator, interstage coupling or low power output.	1.0/1.0/1.0	0.7-3.5	.002	2.0	200	DM-18
MPT-10	Blocking oscillator, interstage coupling or low power output.	1.0/1.0	0.7-3.5	.002	2.0	200	DM-18
MPT-11	Blocking oscillator, interstage coupling or low power output.	1.0/1.0/1.0	1.0-5.0	.002	2.0	500	DM-01
MPT-12	Blocking oscillator, interstage coupling or low power output.	0.15/0.15 0.3/0.3	0.2-1.0	.004	0.7	700	DM-8

OTHER FREED PRODUCTS TRANSFORMERS

- High Fidelity
- High Level Pulse
- High Q Toroids
- Power
- Slug-Tuned
- Hermetically Sealed
- Step-down
- Magnetic Amplifiers
- Miniature Transistor
- High Q Reactors
- High Temperature
- Miniature Audio
- Charging Reactors
- Sub-Minature
- Precision Reactors
- Precision Filters

INSTRUMENTS

- Comparison and Limit Bridges
- Low Frequency "Q" Indicators
- Incremental Inductance Bridges
- Universal Bridges
- Null Detectors and V.T. Voltmeters
- Power Supplies
- A.C. Bridges and Accessories
- Differential Voltmeters
- Harmonic Distortion Meters
- Wide Band Amplifiers
- Decade Amplifiers
- Decade Inductors
- Decade Capacitors
- Megohmmeters
- Filters
- Magnetic Voltage Regulators

Send for further information and catalog

FREED TRANSFORMER CO., INC.

1719 Weirfield St., Brooklyn (Ridgewood) 27, N. Y.

For more information, circle No. 20 on Reader Service Card