

INCLUDING
*Communication
Engineering*
and
*TV & RADIO
ENGINEERING*

RADIO-ELECTRONIC *Engineering*

Reg. U. S. Pat. Off.

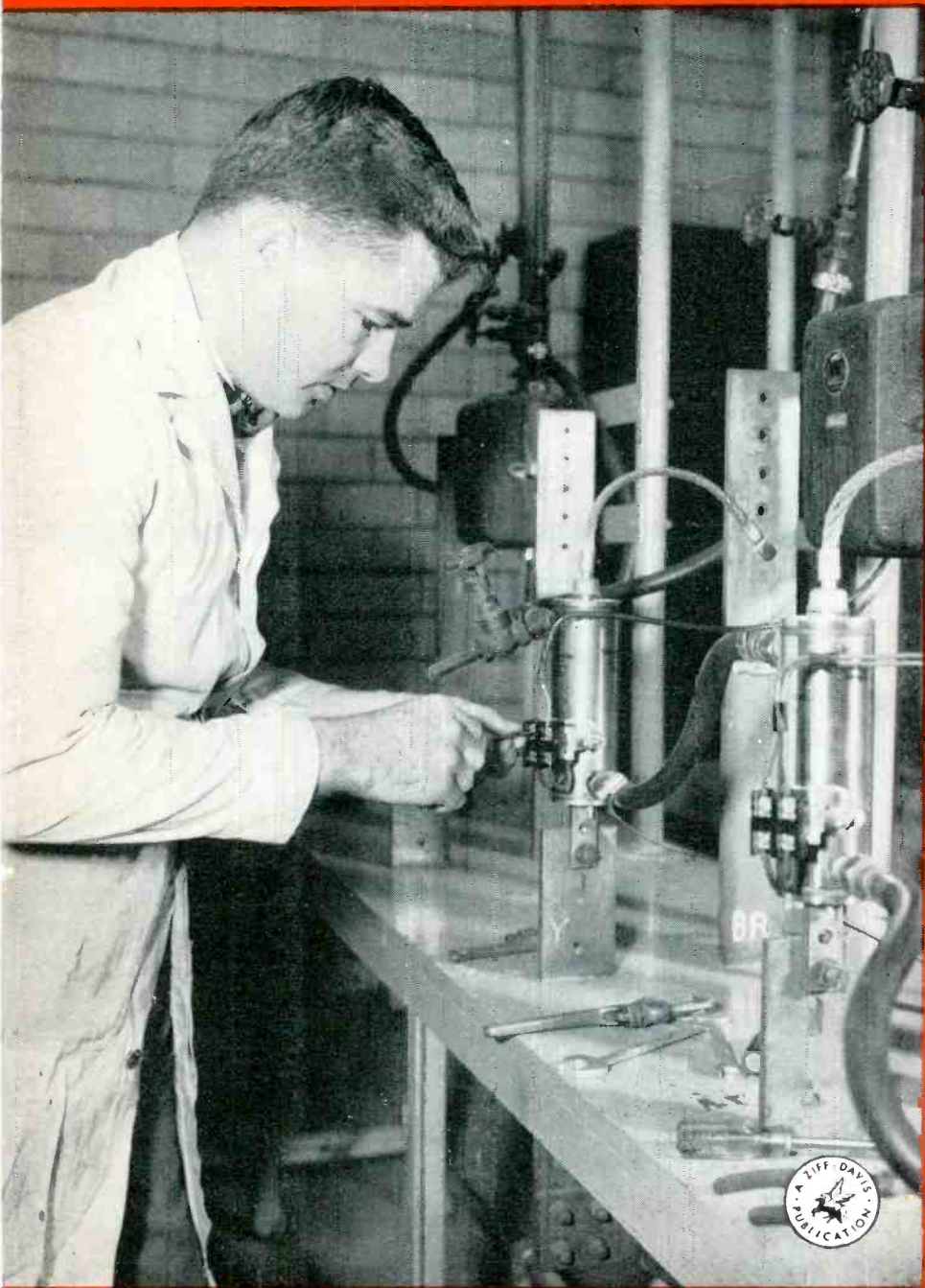

FEBRUARY, 1955

SHAKETABLE RATINGS AND
ACCELEROMETER CALIBRATION
7

SIMPLE Y-FUNCTION PLOTTER
10

CONVERGENCE IN THE
CBS-COLORTRON "205"
12

ONE-MEGACYCLE FREQUENCY
STANDARD
14

REACTANCE ANNULING
FOR HORN LOUDSPEAKERS
15

JOINTLY OPERATED
PRIVATE MICROWAVE SYSTEMS
18

DEPARTMENTS

NEW TUBES	22
COMMUNICATION REVIEW ..	26
PERSONALS	28
NEW PRODUCTS	30
NEWS BRIEFS	32
TV-AM-FM PRODUCTION	32
TECHNICAL BOOKS	33
NEW LITERATURE	34
CALENDAR	37

A technician is shown assembling a thermostatically controlled welding ignitron at the Westinghouse Electric Corporation plant in Pittsburgh, Pa. The thermostat, so mounted as to respond to internal ignitron temperature, controls flow of cooling water.

OUR 10 MILLIONTH MILITARY UNIT SHIPPED THIS YEAR

Military Components FOR EVERY APPLICATION

A HUNDRED STOCK UNITS in our catalog B... 30,000 special designs

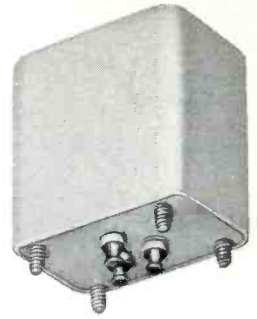

FILTERS

UTC filters, equalizers and discriminators are produced in designs from .1 cycles to 400 mc. Carrier, aircraft, and telemetering types available in standard designs.



POWER COMPONENTS

The scope of military power components produced at UTC ranges from 500 lb. plate transformers to miniaturized 2 oz. units... hermetically sealed and encapsulated... molded types.

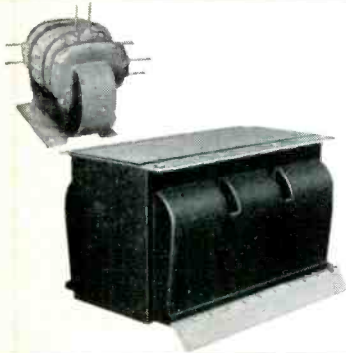
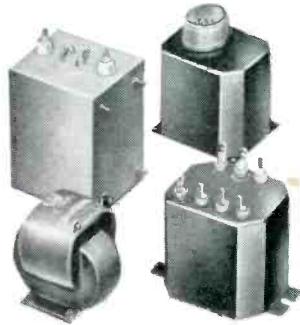

ENCAPSULATED UNITS

8 years of encapsulation experience assure maximum reliability in this class of UTC material.

MOLDED UNITS

UTC molded units range from 1/2 oz. miniatures to the 100 lb. 3 phase unit illustrated.

PULSE TRANSFORMERS

UTC pulse transformers cover the range from molded structures weighing a fraction of an ounce to high power modulator applications.



MINIATURIZED COMPONENTS

UTC H-30 series audios are the smallest hermetic types made. Class A, B, and H power components of maximum miniaturization are regular production at UTC.



AUDIO COMPONENTS

UTC military audio units range from 1 ounce subminiatures to high power modulation transformers. Standard, high fidelity, sub-audio, and super-sonic types.



HIGH Q COILS

Unequaled stability is effected in UTC high Q coils thru special processes and materials. Toroid, mu-core, and variable inductors are available to military standards.

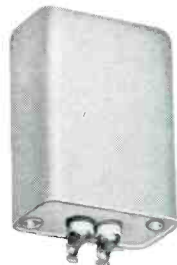

MAGNETIC AMPLIFIERS

In addition to a stock line of servo motor magnetic amplifiers, UTC manufactures a wide variety to customer specifications. Saturable reactors are supplied for frequencies from 1 cycle to 40 mc.



WRITE FOR UTC CATALOG B

... includes complete line of hermetic audios, reactors, magnetic amplifiers, filters, high Q coils, pulse transformers, etc.

UNITED TRANSFORMER CO.

150 Varick Street, New York 13, N. Y. EXPORT DIVISION: 13 E. 40th St., New York 16, N. Y. CABLES: "ARLAB"

a complete NEW line!

RADIART SEAL-VENT Communication Vibrators



Based On Rigid
U. S. Government
Engineering Specifications

NOW... RADIART makes available to you FOR YOUR OWN NEEDS a complete replacement group of COMMUNICATION VIBRATORS that are engineered and designed on U. S. Signal Corps specifications. Don't settle for anything less than the best - and THESE ARE THE BEST!

These Six Types Offer Complete Replacement for ORIGINAL Communication Equipment:

Old No.	New No.
5515	5715
5518	5718
★	5721
5605	5805
5620	5820
5621	5821



THE **RADIART** CORPORATION
CLEVELAND 13, OHIO

TV ANTENNAS • AUTO AERIALS • VIBRATORS • ROTORS • POWER SUPPLIES
For more information, circle No. 2 on Reader Service Card

RADIO-ELECTRONIC ENGINEERING



SPLIT-SECOND "emergency" power

PAT. NO. 2688704

... With **U.S. MICRO-POWER** BEFORE . . . voltage drops below a usable level . . . before there is any loss of power to essential equipment . . . **MICRO-POWER IS IN ACTION.** Completely automatic, Micro-Power operates with the main source of power. No time-consuming "load transfers", no power "outages" . . . **EVEN FOR PRECIOUS SECONDS!**

Micro-Power is a complete standby service that replaces several units of costly, more complicated equipment. Electric plant, rectifier, battery banks and motor-

Write U. S. Motors for complete information, specifications and power curve charts.

generator **CAN ALL BE ELIMINATED** . . . with the installation of a single **MICRO-POWER UNIT.** **NEW INSTALLATIONS — SAVE UP TO \$300 PER MILE!**

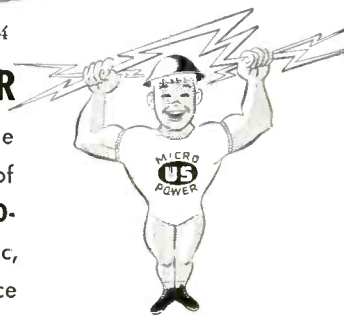

**UNITED STATES
MOTORS CORPORATION**
551 Nebraska Street
OSHKOSH, WISCONSIN

For more information, circle No. 3 on Reader Service Card

RADIO-ELECTRONIC ENGINEERING is published monthly by Ziff-Davis Publishing Company, William B. Ziff, Chairman of the Board (1946-1953) at 64 E. Lake St., Chicago 1, Ill. Entered as second-class matter March 29, 1954 at the post office, Chicago, Ill. **SUBSCRIPTIONS:** Subscribers to Radio-Electronic Engineering automatically receive Radio & Television News. **RATES:** one year U. S. and possessions, and Canada \$6.00; Pan-American Union countries \$6.50; all other foreign countries \$7.00; **SUBSCRIPTION SERVICE:** All communications concerning subscriptions should be addressed to Circulation Dept., 64 E. Lake St., Chicago 1, Ill. Subscribers should allow at least four weeks for change of address.

RADIO-ELECTRONIC
Engineering

INCLUDING

TV & RADIO & Communication
ENGINEERING & Engineering

Edited by **H. S. RENNE**
and the Radio & Television News Staff

VOLUME 24

NUMBER 2

FEBRUARY, 1955

Editor and Asst. Publisher

OLIVER READ, D. Sc.

Managing Editor

WM. A. STOCKLIN, B. S.

Technical Editor

H. S. RENNE, M. S.

Assistant Editor

M. C. MAGNA

Art Editor

FRANK SAYLES

Draftsmen

ALBERT A. GANS
JOSEPH A. GOLANEK

Advertising Director

L. L. OSTEN

Advertising Manager

TED SUITO

Western Adv. Manager

JOHN E. PAYNE

ZIFF-DAVIS PUBLISHING COMPANY

WILLIAM B. ZIFF (1898-1953) FOUNDER
Editorial and Executive Offices
366 Madison Ave., New York 17, N. Y.

President

B. G. DAVIS

Vice-Presidents

H. J. MORGANROTH
M. H. FROELICH

Secretary-Treasurer

G. E. CARNEY

Circulation Manager

M. MICHAELSON

BRANCH OFFICES

CHICAGO (1): 64 E. Lake St.
LOS ANGELES (14): 900 Wilshire Blvd.

RADIO-ELECTRONIC ENGINEERING is published each month as a separate publication and is available by subscription only when purchased with a subscription to **RADIO & TELEVISION NEWS.**

(Average Paid Circulation Over 23,000)

Copyright 1955 by Ziff-Davis Publishing Company
(All Rights Reserved)

Plan for

MORE

MORE

MORE

spots

commercials

profits



*...with **RCA's** low-cost,
high-efficiency broadcast
studio control console **BC-4A***



features of
RCA's BC-4A

- Easily expanded for dual-channel broadcast use
- Single BC-4A controls 9 inputs—four simultaneously
- Paired BC-4A's double facilities—provide dual-channel operation
- Entirely self-contained, completely wired unit—no separate desk required
- Program and audition facilities
- Talkback or program cue to remote lines
- Three preamplifiers—all amplifiers RCA Broadcast "plug-in" type
- High degree of accessibility

Designed originally to meet the need for economy in the smaller station, RCA's Audio Central BC-4A also fills an important place in medium and large stations.

For example—the BC-4A can carry the whole station during slack hours. It is useful as a low-cost, semi-permanent installation in remote locations, such as dance halls or fairs. It is adequate for a new studio, interview room, newsroom, etc. As an "add-a-unit" audio control, it permits "block-building" as needed.

A single BC-4A provides sufficient control and switching facilities for studio, announce booth, turntables, network, remotes and tape recorders. The addition of another BC-4A doubles these facilities and permits complete dual-channel operation.

Let your RCA Sales Representative tell you how the BC-4A can increase your facilities at low cost.

PIONEERS IN AM BROADCASTING
FOR OVER 25 YEARS



RADIO CORPORATION of AMERICA
ENGINEERING PRODUCTS DIVISION **CAMDEN, N.J.**

your "special" transformers are
stock units at *Chicago Standard*

Most CHICAGO-STANCOR transformers are available in at least three different mountings and terminal types . . . some in as many as six! You can get the one that is best for your job . . . and get it fast, from stock, through your CHICAGO-STANCOR distributor.

CHICAGO-STANCOR transformers are the logical choice for

- Industrial and military research and instrumentation
- Prototype production
- Amateur and commercial broadcasting
- Communications
- High fidelity
- Public address



FREE: CHICAGO STANDARD catalogs listing over 1000 transformers for original equipment and replacement applications.



CHICAGO STANDARD TRANSFORMER CORPORATION

ADDISON AND ELSTON
 CHICAGO 18, ILLINOIS

Export Sales: Roburn Agencies, Inc.
 431 Greenwich Street, New York 13, N. Y.

For more information, circle No. 5 on Reader Service Card

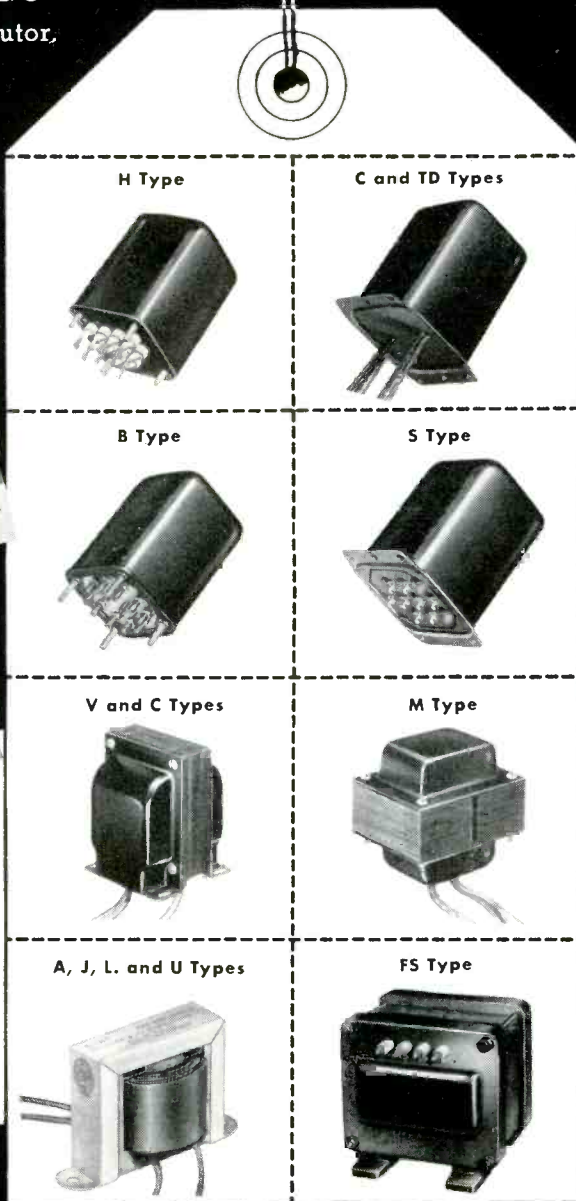

MANPOWER

SOME interesting but alarming facts on technical manpower were disclosed by Dr. Jesse E. Hobson, director of Stanford Research Institute, in a recent address before the 50th Anniversary Convention of Eta Kappa Nu Association, electrical engineering honor society. Excerpts from Dr. Hobson's talk appear below.

"Like explorers, we must at intervals climb high peaks to view the terrain ahead in order to spare ourselves the pain of coming up hard against unforeseen tangles and obstructions. When we do this now, we find some distressing surprises awaiting us. One of the most striking of these is the technical skill of our people, traditionally one of America's greatest resources both in amount and quality. . . .

"Whether we like it or not, we are now in a race for technical supremacy with those who order the affairs of the Communist states. The stake is frightening; it is the continued existence of the free world—and perhaps of man himself. . . .

"As we scan this human resource, we are confronted with disquieting statistics. To be blunt, we are losing ground. We are losing ground badly. There is, furthermore, no prospect of catching up in the immediate future. . . . In this country, we are now replenishing our technical manpower reservoir at the rate of less than 20,000 yearly. That is a record low for recent years, continuing a steady decline from a peak of 52,000 in 1950.

"The output of the technical schools can be expected to rise to about 34,000 in another three years. That is a happy trend, but not happy enough. Russia is currently producing about 50,000 trained men and women annually. The unfavorable ratio, now two and a half to one, is growing, and we may soon find ourselves hopelessly outstripped.

". . . It is a reported fact that the present number of research scientists and engineers in Russia is already approximately equal to the number in our country, some 250,000 to 300,000. In Russia, today, seven-year schools are essentially universal; by 1960, the ten-year school will be universal. A third of the present seven-year curriculum is devoted to mathematics, natural science and the elements of physics and chemistry. Secondary and graduate work is equally intensive.

"In our country, on the other hand, . . . only 6-8% of high school graduates have had courses in chemistry or physics, and only 20% have had even a general science course. Only about 25% of our high school graduates qualified for college actually do continue their education, and of these, less than 6% finish with degrees in science or engineering. . . .

"It is manifest that we must find ways of increasing by a significant amount the appeal of careers in science and engineering to the young people of America. We must improve the teaching of science, particularly at the high school level; we must expand the training of scientists and engineers; we must learn how to make better use of the technically trained people we have; and we must adopt consistent policies for the preservation of professional manpower. All these measures are long overdue. We hope we are not too late."

SHAKETABLE RATINGS AND ACCELEROMETER CALIBRATION

By
ALVIN B. KAUFMAN
Group Engineer
and
PAUL R. MITCHELL
Research Engineer
Northrop Aircraft Co., Inc.

*To calibrate an accelerometer,
the shaketable displacement
must be accurately known and
its motion must be sinusoidal.*



Typical accelerometer calibration setup; Calidyne shaker is positioned horizontally to show optical displacement system.

THE cam- or crank-driven shaketable, while useful as a displacement machine, is not satisfactory for accelerometer calibration. High-frequency harmonic noise components present in this type of machine, although small in amplitude, are high in acceleration value, and will result in highly inaccurate calibration. The calibrating waveform must be "clean" as it is almost impossible to evaluate the harmonic acceleration components.

While the electromechanical, electrodynamic voice coil, or dynamic radio speaker type of shaker, as it is known, is more nearly ideal for the calibration of accelerometers, it too must be used with extreme care or the end results will be unreliable and inaccurate. Such a shaker produces 30 *g* or more in the 20 to 200 cps region, but no means is yet available for generating high *g* forces between 200 and 1000 cps. In that region, only extreme ingenuity can overcome the problems encountered in accurately measuring small displacements.

Considerations of little or no importance at 100 cps become considerations of major importance at 1000 cps¹. Shaker flexures must be accurately parallel, accelerometers must be bolted down carefully to avoid case flexure, lead wire effects on the worktable become appreciable, the center of gravity (c.g.) of all items on the worktable must be at the center of the table, resonances in the shaker flexures must be detuned, etc.

Above 1000 cps and up to 9000 cps,

the piezoelectric vibrator is available. A typical piezoelectric shaker² is the Glennite Model AT-10, which produces 50 *g* at 9 kc. substantially independent of mass loading. A survey of its characteristics shows that its displacements are only within $\pm 10\%$ of being constant with frequency. Other significant characteristics are shown in Fig. 2.

An interferometer may be used for making displacement measurements in the 1-9 kc. range. However, the displacements are not much larger than the distance between fringe lines, so that large inaccuracies occur. Using sodium light, the fringes are 23 micro-inches apart, which is greater than total displacement at 3 kc., 10*g*³. Future developments with other light sources may make this method of displacement measurement practical.

Measurement Methods

In making precise measurements of amplitude and frequency with an electrodynamic shaker, care must be taken to secure good waveform by proper impedance-matching of the driver tubes to the shaketable drive. The impedance of the drive winding changes directly as a function of frequency; and when the exciting frequency is changed, it is imperative that the impedance-matching be adjusted for maximum power into the winding. Any loss of power due to mismatch is inconsequential, normally. The main problem is the reflected load on the driver tubes. If proper match is not made, harmonic distortion will occur with resultant inaccuracies

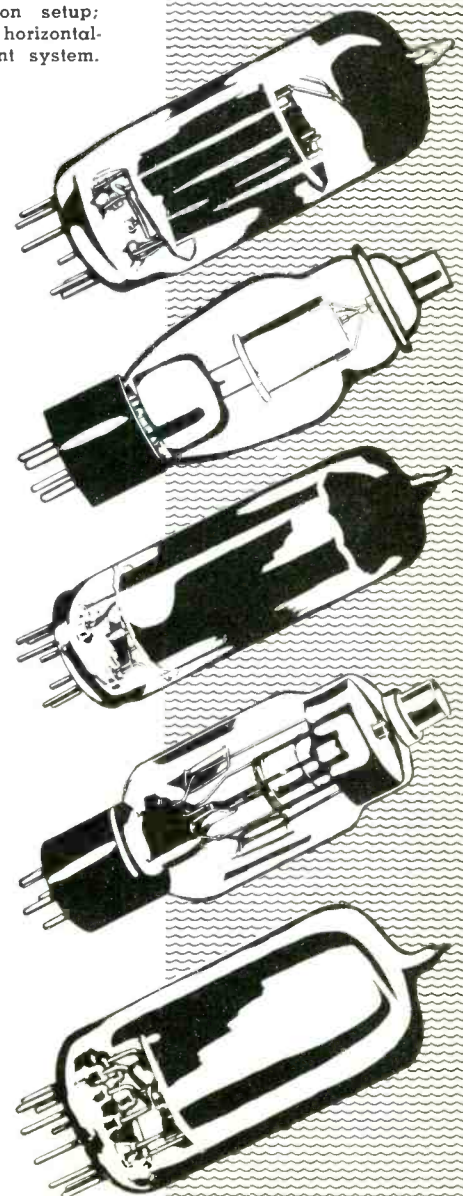



Piezoelectric accelerometer with self-contained cathode follower.



Typical velocity type pickup which must be calibrated on a shaketable.

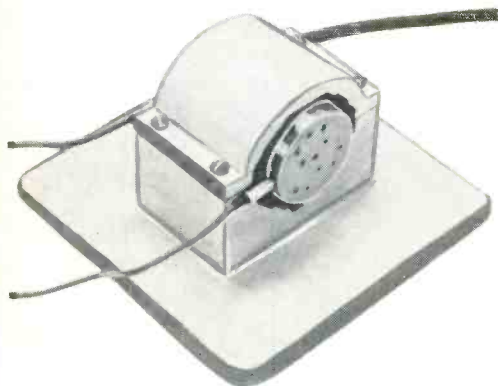

A piezoelectric shaketable vibrator.



Two miniature vibration accelerometers of the piezoelectric type, typical units which require calibration on a shaker.

in calibration. Proper match may be made by watching the waveform output of the accelerometer and making adjustments to secure the best waveform. At this point, the peak-to-peak displacement should also be at a maximum.

Unfortunately, the work platform is also subject to sidewise sway unless the accelerometer is placed so that its c.g. (not seismic mass) is centrally located over the vertical thrust point. The peak-to-peak displacement under an unbalance condition does not represent true travel, or g force developed, because of additional vector forces. This factor can generally be noted by comparing static earth's gravity acceleration vs. dynamic output of 1 g on the shaketable. The sidewise movement of the table can also be noted visually, as will be shown.

In order to determine the acceleration forces, it is necessary to know the r.m.s. or peak-to-peak values of displacement (in inches) of the accelerometer. Normally, peak-to-peak values are desired as the peak-to-peak output voltage determines the swing of an oscillograph galvanometer or a swing in signal level acceptable to a telemetering system. Several methods may be used for measuring displacement.

Signal Coil Output Measurement

A signal coil may be employed which develops an output voltage proportional to displacement at a given frequency, as in the *Calidyne* 6CT shaker. This method of measurement, however, generally does not produce results any more accurate than 5 to 10%, and thus is not a preferred method.

Part of the inaccuracy of this method is due to field flux changes which are caused by power supply variations and temperature effects, and part is due to sidewise motion of the coil which becomes worse at higher frequencies. Also, major inaccuracies occur at frequencies near the mechanical resonance of the armature, where the signal coil may lie nearer or farther from the motional node than the accelerometer being calibrated. Typical vibration meters for measuring signal coil output are the *Calidyne* vibration meter, which

has an accuracy of $\pm 8\%$ of true vector g force, and the *MB* Model M1 vibration meter, with an accuracy of $\pm 5\%$.

Microscopic Observation

A microscope with an internal reticle scale has been adapted very successfully to displacement measurement. In this method, a piece of #320 grit emery cloth is attached to the work platform and illuminated. The microscope, mounted securely on the shaker stand, is focused on the emery particles. Pin-points of light will be noted, as reflected from some of the particles. With vibration, each point will form a "line" whose height can be measured on the reticle scale to indicate the amplitude of motion directly. The diameter of the particle being observed must be subtracted from line height to obtain true displacement.

This method allows visual observation of the direction and form of platform movement in the frequency range from 40 to approximately 150 cps, depending upon the microscope magnification and the particle shape. Any sideway causes the "line" to become an oval, elliptical, or sloping pattern which clearly indicates the exact movement of the table. It is interesting to note that in observing sidewise a small change in drive frequency may, in addition to closing the ellipse to a straight line, rotate the sloping line to the desired vertical orientation. As sideway may occur in either of two planes, it is preferable if possible to rotate the microscope 90° around from the point of first measurement and repeat the operation. For this reason, a shake frequency of best waveform and least sideway adjacent to the nominal calibration frequency should be used. It is a better technique to use the convenient adjacent frequency rather than try to clean up the waveform precisely at the nominal frequency value, since such a clean-up process would be a major time-consuming operation which would have to be repeated for every test.

A variation of this method, employed by the National Bureau of Standards, uses a length of .001" wire in place of the emery particles. To obtain maximum contrast for viewing the wire,

Fig. 1. Force output necessary to produce a specific g with a specific loading.

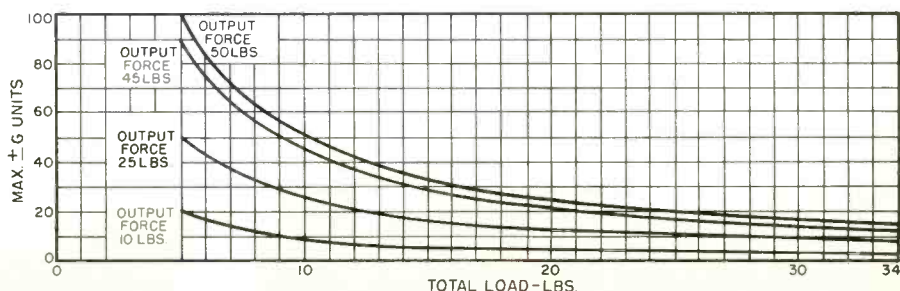

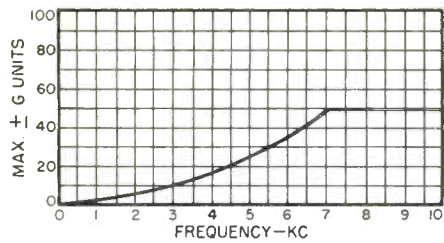

Fig. 2. Characteristics of Glennite Model AT-10 piezoelectric shaker.

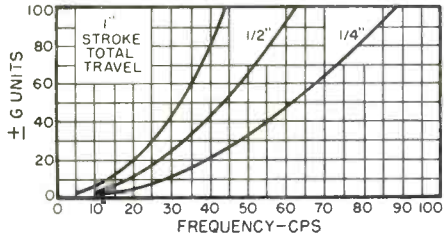

Fig. 3. Frequency vs. g units for various lengths of stroke travel.

it is firmly mounted (to prevent flexure) across a small opening in a black box. The accuracy of displacement readings can thus be determined to about .001", taking into account mechanical flexure as well as optical resolution⁴.

There are two types of microscopes which may be used for these measurements—the scale micrometer and the filar micrometer. The scale micrometer microscope has a reticle which consists of a calibrated scale (generally in thousandths of an inch) on which the table displacement may be read directly; the *Gaertner* microscope #M117A, 40 power, is an example of this type. The filar micrometer microscope also has a reticle, which generally consists of a cross hair. By means of an external micrometer dial, the cross hair is advanced into coincidence first with one end of the "light" line and then with the other. The difference in the micrometer readings then indicates the displacement. This type of unit has the advantage of wide range of measurement, but unless care is taken to turn the micrometer dial in one direction only, backlash may cause errors as high as one-thousandth of an inch. The writers prefer the first type because of ease of reading and faster operation.

Other Methods

At least three other methods are available for measuring displacement. One employs an optical measurement device, available from *The Calidyne Company*, which visually shows the displacement between base and work platform on an illuminated scale; it is accurate enough for most calibration runs. Another method makes use of a vernier micrometer with an attached sensing coil and electronic equipment capable of determining static or dy-

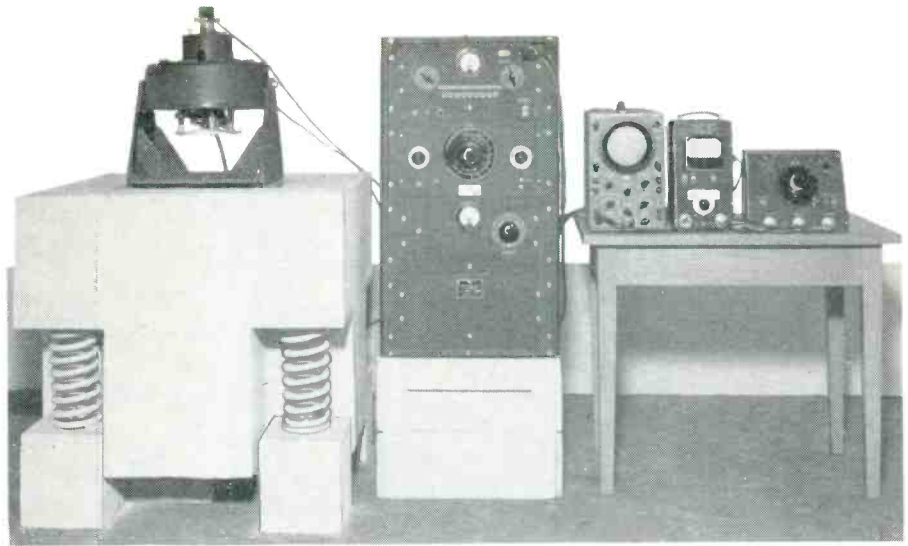

Typical shaker equipment; seismic mounting isolates shaker from ground.

amic displacement of a quarter-thousandth of an inch with four inches of scope deflection. The third method employs a g meter which indicates directly in g 's the output of a calibrated crystal accelerometer of high resonant frequency built into the shaker work platform⁵.

For an accurate determination of the frequency of motion, it is convenient to use an electronic counter, or EPUT meter. An alternative technique is to use a stable audio oscillator calibrated against averaged 60-cycle line frequency.

Calculation of the impressed g force

is carried out using the expression $g = .0511Df^2$, which forms the basis of the nomograph of Fig. 4. In this expression, g is the peak (in one direction from rest, i.e., $\pm g$) or vector value of the acceleration force in common gravitational units (taken as 32.2 ft/sec²), D is the total excursion or peak-to-peak travel in inches, and f is the frequency in cps.

Shaketable Evaluation

Care must be taken to avoid confusion in the use of the r.m.s., vector (SA), and peak-to-peak (DA) nomenclature
(Continued on page 36)

Table 1. Frequency ranges and maximum force outputs of various equipment.

Manufacturer	Model	Maximum Vector Force Output (lbs.)	Maximum Peak Force, No Load ($\pm g$)	Frequency Considerations
Calidyne Co.	6CT/6T Calib. Shaker	50	50	Limited by driver amplifier used
	No. 6 Shaker	25	43	Ref. signal $\pm 1\%$ from 3 to 100 cps
	No. 1 Accel. Calibrator		10	0.5 to 2000 cps range as signal generator; ref. signal $\pm 1\%$ from 3 to 100 cps
MB Mfg. Co.	SD Exciter		17	20 to 500 cps range (20 kc. possible)
	C31 Pickup Calib. Exciter	25	42	Calibration range 4 to 1000 cps; maximum vector force output 25 lbs. at 4 to 600 cps, 15 lbs. at 1000 cps
	C1 Calibrator	50	31	Signal generator accuracy $\pm 1\%$ at 4 to 500 cps; maximum vector force output 50 lbs. from 6 to 350 cps, 45 lbs. from 350 to 500 cps, 25 lbs. at 1000 cps.
	C11 Calibrator	50	23	Signal generator accuracy $\pm 1\%$ from 4 to 2000 cps; maximum vector force outputs same as for C1.

SIMPLE Y-FUNCTION PLOTTER

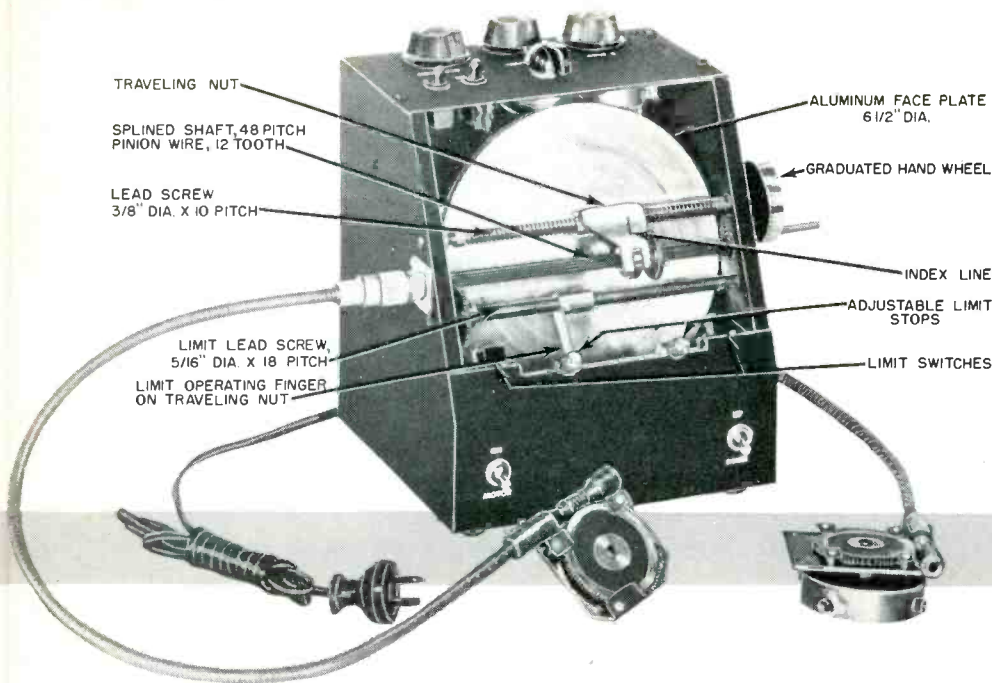

Fig. 1. Front view of plotter showing flexible cables for chart drive and signal-source drive.

ENGINEERING time is a valuable commodity, and a very common product of research or developmental engineering time is a curve. The orthodox method of producing a curve is to arrange an experimental setup; then make changes in, and read and record, values of the independent variable X ; read and record the corresponding values of the dependent variable Y ; then choose scales on graph paper, plot the observed values as points, and finally draw the finished curve through the points. Such a process can consume from five minutes to an hour per curve.

There are X - Y or dual-function recorders presently on the market which require that each variable be available as a d.c. voltage, and also data recorders costing thousands of dollars. This article describes a relatively simple device which automatically will make changes in the independent variable, and plot a curve of the resultant dependent variable, in about ten seconds—for a relative saving in engineering time of 20 to 1 or more. Whereas the progress of an experimental investigation with orthodox methods of curve plotting is often paced by the paper work, with a Y -function plotter the rate of investigation depends more on the engineer's imagination.

Mechanical Details

The Y -function plotter is built of a few gears, a motor, and pieces of flexible shaft. It operates in conjunction with a commercial d.c. electronic recording potentiometer requiring 10 to 100 mv. full scale and 1-second response speed. It drives any of the usual commercial signal sources (r.f. signal generators, audio oscillators, variable-

voltage sources, frequency meters) and takes the X calibration directly from the signal-source dial. The records are plotted on regular $8\frac{1}{2}$ " x 11" cross-section paper to scales selected at option, with an accuracy of 1 to 2%.

Figure 4 is a mechanical schematic of the device. On the recording potentiometer, the strip chart is removed and replaced by a sheet of cross-section paper; small rubber rollers, with front and back guides, are arranged similarly to those in a typewriter to guide the paper around the platen, or drum, leaving room for pen travel. The recorder timing-motor drive is disconnected and replaced by a worm gear and flexible cable going to the chart drum. The worm gear is fastened to the drum with a hand nut, so that during setup the graph-sheet scale can be indexed to the dial scale of the source. Some of the detail on the recorder is shown in the photograph of Fig. 3; some of the detail on the plotter is identified in Fig. 1.

Chart-drive ratios are such as to permit a minimum of 3" paper travel for 40 turns on a signal-source shaft, and a maximum of 10" paper travel for a $\frac{1}{8}$ -turn on the source shaft. The ratio is determined in three ways: (1) by the number of worm gear teeth on both the chart drum and the signal-source drives, (2) by placing the signal-source flexible shaft in one of three drives coming from the gear box, at the rear of the plotter, and (3) by the adjustable friction drive on the face plate. The friction wheel is positioned with a threaded rod and traveling nut; the traveling nut has a proportional scale starting at zero when the friction wheel is at dead center on the face plate. After marking an appropriate X scale on the

graph paper, the procedure in matching it to the signal-source dial calibration is first to approximate registration by means of the worm-gear ratios and choice of flexible-cable connection on the rear of the plotter, and then to make one or two trial runs—noting the relation between the graph paper travel and the dial-scale coverage—and correct the registration accordingly by using the proportional scale on the friction-wheel drive.

It is possible for the scales on the chart and the signal source to be 180° out of phase. In such a case, one or the other of the worm gears could be inverted on the driven shaft; the signal-source flexible shaft might be moved to an adjacent coupling on the plotter and the friction wheel reset; or a 1-to-1 spur-gear reverse unit can be made and inserted at either of the flexible-shaft couplings. The worm gears for driving the signal source and chart drum fit a $\frac{1}{4}$ "-diameter shaft. Adapters

Fig. 2. Block diagrams of arrangements for plotting (A) frequency response curves and (B) germanium diode characteristics.

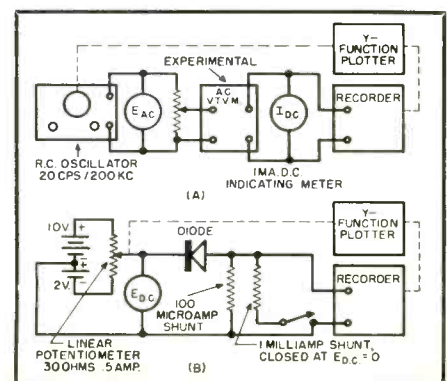

By
G. F. LAMPKIN
 Lampkin Laboratories, Inc.

This device will automatically make changes in the independent variable and plot the resultant dependent variable in ten seconds.

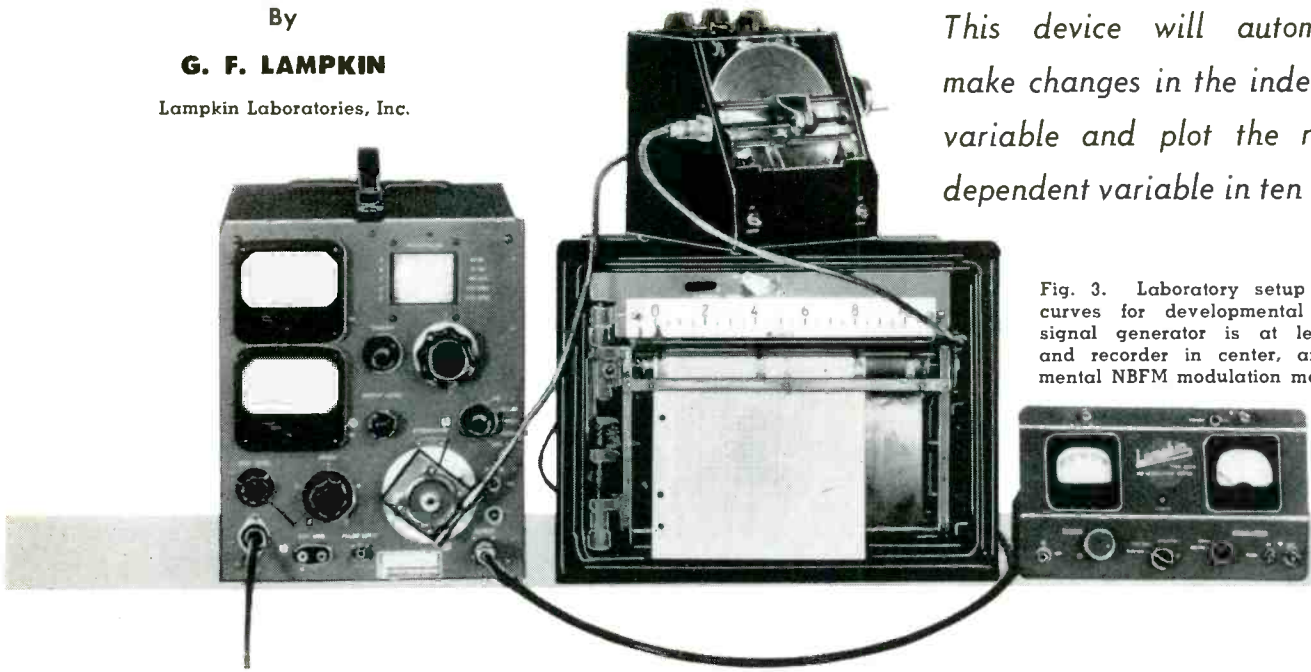

Fig. 3. Laboratory setup for making curves for developmental work. R.F. signal generator is at left, Y-plotter and recorder in center, and developmental NBFM modulation meter at right.

can be made to fit the various types of control knobs on commercial apparatus.

Electrical Layout

Figure 5 shows the simple electrical layout of the plotter. The dependent variable must be available as a d.c. voltage of the order of 10 mv., or more. This is the level of drop across the usual 0-200 d.c.- μ a. or 0-1 d.c.-ma. indicating movement in multimeters, voltmeters, ammeters, vacuum-tube voltmeters, electronic frequency meters, etc. The Y-axis voltage is fed to the recorder input through a potentiometer on the plotter which permits adjusting the graph paper scale to the indicating meter scale. Separate potentiometers are provided to allow inputs to be switched without disturbing the respective calibration settings. For higher levels of voltage or current, of course, shunts or dividers can be assembled. There are several devices available on the market, or described in the literature, for converting a linearly varying current to a logarithmic

response, permitting a log or db scale to be set up on the Y axis.

The centering control on the plotter provides full-scale travel and positioning of the recorder pen, while the "mark" switch gives a fraction-of-an-inch travel for calibration marks. The recorder is a null device which works best out of d.c. resistances of a few hundred ohms; it has slightly reduced speed and resolution when operated out of 10,000 or 100,000 ohms.

In order to prevent overtravel, limit switches are connected into the chart motor supply. These are actuated by a second lead screw and traveling nut, driven from the splined shaft. After the chart drive has been set up, the limit stops are moved into place and locked with thumb screws. A variable autotransformer operates as a speed control, and there is a reversing switch on the motor drive.

Application

One example of an application of this

device is the plotting of the frequency response of an experimental a.c. vacuum-tube voltmeter from 20 cps to 200 kc. A block diagram of the plotting layout is given in Fig. 2A. Since the signal source was an RC oscillator whose dial covered one decade, the curves were plotted in sections of one decade, and the graph paper was shifted between decades.

To get an idea of backlash in the mechanism, one of the curves was plotted with the drive motor running
(Continued on page 39)

Fig. 4. Mechanical schematic diagram of the Y-function plotter.

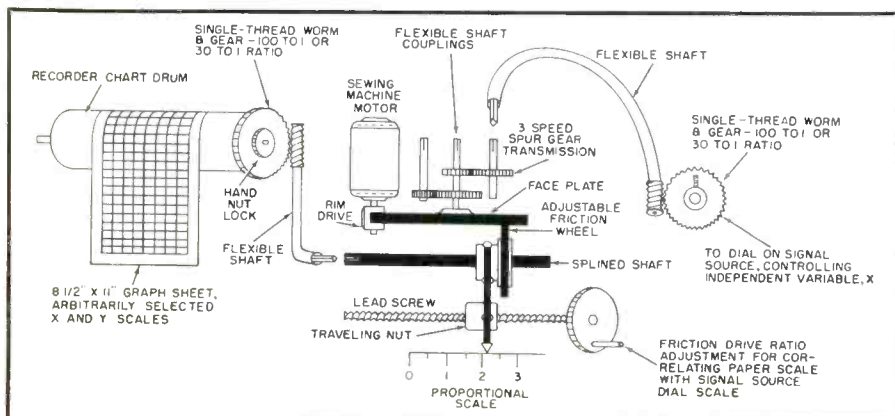
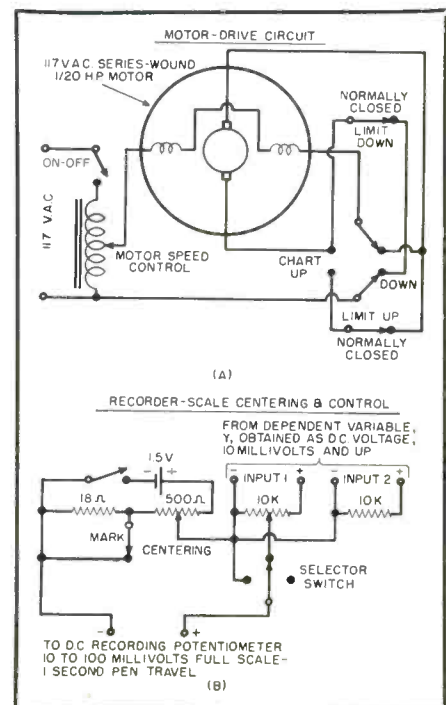

Fig. 5. (A) Motor drive circuit and (B) recorder-scale centering and control.



Convergence in the CBS-Colortron "205"

Design considerations call for a positioning magnet, precise yoke detail, and a dynamic convergence circuit.

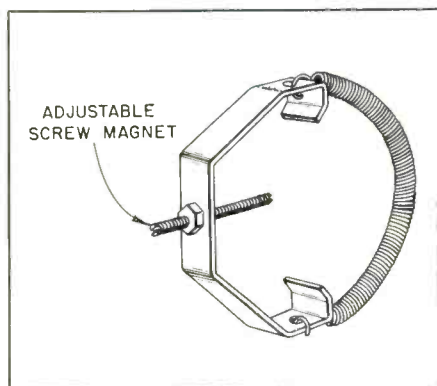

Fig. 1. Positioning device used to provide lateral correction of the blue beam.

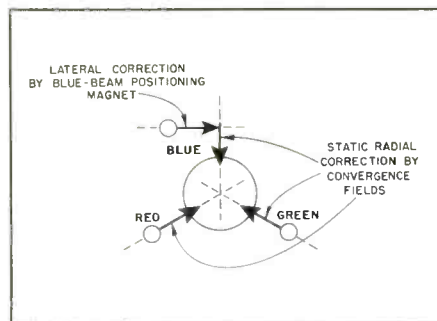
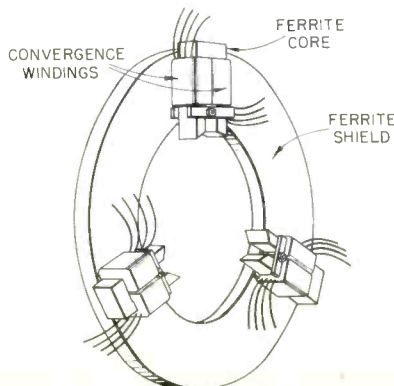

Fig. 2. Possible static error condition and adjustments which should be made.

Fig. 3. Convergence assembly for "205."



ELIMINATION of the high voltage problems associated with electrostatic convergence systems leads to more stable tricolor picture tube operation. Incorporated in the CBS-Colortron "205" tricolor tube is an electromagnetic convergence system which accomplishes this result. Multiple magnetic and mechanical beam convergence features allow numerous approaches to the achievement of accurate raster registration over the entire screen area. Any of these approaches can be divided roughly into two parts: static center convergence and dynamic or over-all convergence.

Static Convergence

To begin with the first of these two types of convergence, static convergence is defined as the accurate superposition of the red, green, and blue beams in the geometric center of the picture tube. In the CBS-Colortron "205," each of the three electron guns is tilted toward the tube axis. In the ideal case, therefore, the three beams will be superimposed at the center of the phosphor screen. Manufacturing tolerances hinder the realization of this ideal and make it the exception rather than the rule. For this reason, small steady-state magnetic fields must be induced in the pole pieces of the gun to correct the resultant registration error. The amount of correction required is a function of the mechanical alignment of the gun itself.

In order to attain static convergence, the induced fields must be capable of producing positive and negative radial deflection of all three beams, and positive and negative lateral deflection of at least one beam. In the "205," the blue gun has a magnetic circuit at-

tached to the focus electrode to facilitate the application of this lateral correction. The external device employed, shown in Fig. 1, contains a small magnetic dipole inserted in a ferrous metal pole piece in such a manner that it can be moved in and out to control the intensity of the induced field.

Radial deflections can be achieved in at least two ways. The first method consists of passing d.c. currents through the windings on the convergence assembly shown in Fig. 3. The second method entails placing small bar magnets at right angles to the tube axis in close proximity to the internal pole pieces of the electron guns. It should be emphasized at this point that serious defocusing of the deflected beams will result if the bar magnets are used to produce anything but radial deflections, or if they are not located directly over the pole piece area so that the induced fields will be reasonably uniform. Figure 2 shows a possible static error condition and the adjustments which should be made to correct it.

Dynamic Convergence

The second part of the general division of convergence requirements, dynamic convergence, is defined as the superposition of the red, green, and blue beams at positions other than at the center of the phosphor screen. This requirement is met by the induction of magnetic fields in the pole piece area. The intensities of these magnetic fields vary roughly as parabolic functions of vertical and horizontal scanning angles. More accurately, the instantaneous intensities are complex circular functions of the scanning angle.

Horizontal Waveforms

Horizontal dynamic convergence waveforms can be approximated with a high degree of registration accuracy by cosine current produced by an LC circuit which is resonant at the horizontal scanning frequency. Excitation for this tuned circuit should be derived from the horizontal scanning system itself in order that accurate synchronization be maintained. Means for shifting the phase of the cosine currents should be provided to correct for slight dissymmetries in waveform and deflection yoke fields. Two circuits which embody this ringing-circuit approach are shown in Figs. 5 and 6.

In the circuit shown in Fig. 5, a 100-

Fig. 4. Layout of external components.

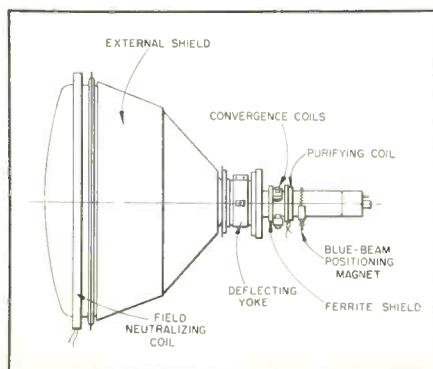

ONE-MEGACYCLE FREQUENCY STANDARD

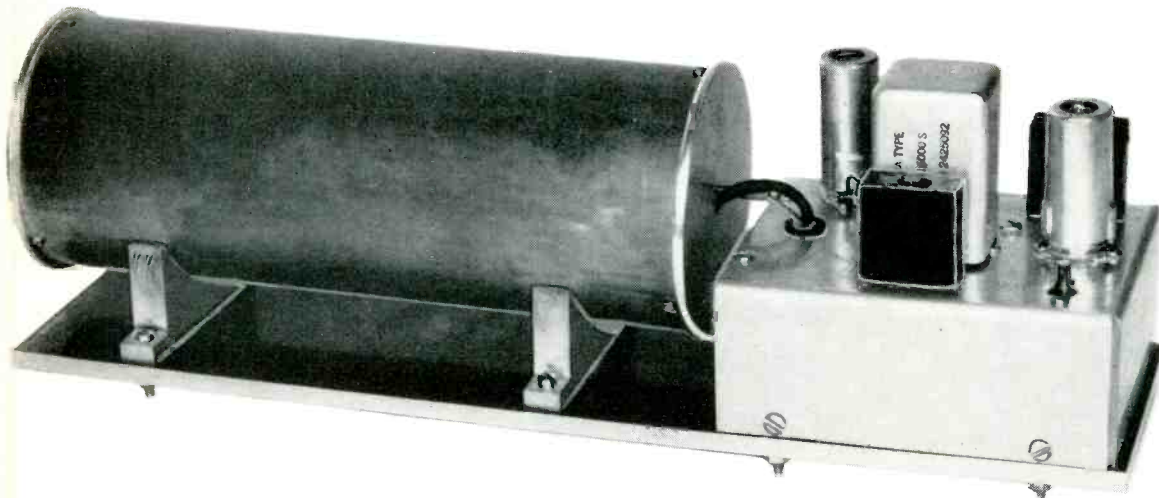

The NBS 1-mc. frequency standard showing the crystal oven (left) and the accompanying electronic equipment (right).

By

PETER G. SULZER

National Bureau of Standards

This crystal-controlled portable frequency standard has a stability of a few parts in 100 million per day.

AS CUSTODIAN of the national standards of physical measurement, the National Bureau of Standards develops and maintains basic standards for electrical quantities at all radio frequencies. From these basic standards are obtained the secondary standards used by research laboratories and the radio industry. As science and technology advance, research must constantly be conducted to meet increasing demands for more precise and reliable secondary standards. In its search for accurate secondary standards of frequency, the Bureau has made a continuous effort to improve the performance of crystal-controlled oscillators. Such oscillators appear to offer the greatest accuracy in the present state of the art.

A portable one-megacycle frequency

standard, stable to a few parts in 100 million per day, has been developed which is expected to have wide application in checking radio transmitters, making frequency measurements, and in various other fields. Employing inexpensive, commercially available components, the compact and relatively simple assembly makes use of a crystal unit to control the frequency of the oscillator. It is sufficiently rugged for general laboratory and field use.

The NBS 1-mc. standard, like other crystal-controlled oscillators of this type, consists of three elements: the crystal unit proper, an amplifier or negative-resistance device to supply the losses in the crystal unit and to deliver power to a load, and an amplitude control. However, the NBS oscillator was specially designed to minimize frequency changes caused by tube or component instability. As a result, the over-all stability of the unit is nearly equal that of the crystal itself.

Any phase shift in the amplifier must be offset by a corresponding but opposite phase shift in the crystal unit, which will produce a frequency change. Such a phase shift can be caused by an actual reactance change or by a variation in the reactive component of the input impedance of the tube. Phase shifts can also be produced by the electronic component of the input capacitance of a tube, by transit time, and by the presence of nonlinearity. In the NBS oscillator, the effects of these amplifier variations are decreased by the use of inverse feedback. The familiar Meacham bridge oscillator circuit is utilized because it gives excellent results with comparatively simple circuitry.

The Meacham bridge consists basically of a crystal resistance R_1 , a pair of resistors R_2 and R_4 , and a lamp resistance R_3 . These components are so arranged that negative feedback occurs through R_1 and R_2 while positive feedback occurs through the lamp R_3 and

(Continued on page 38)

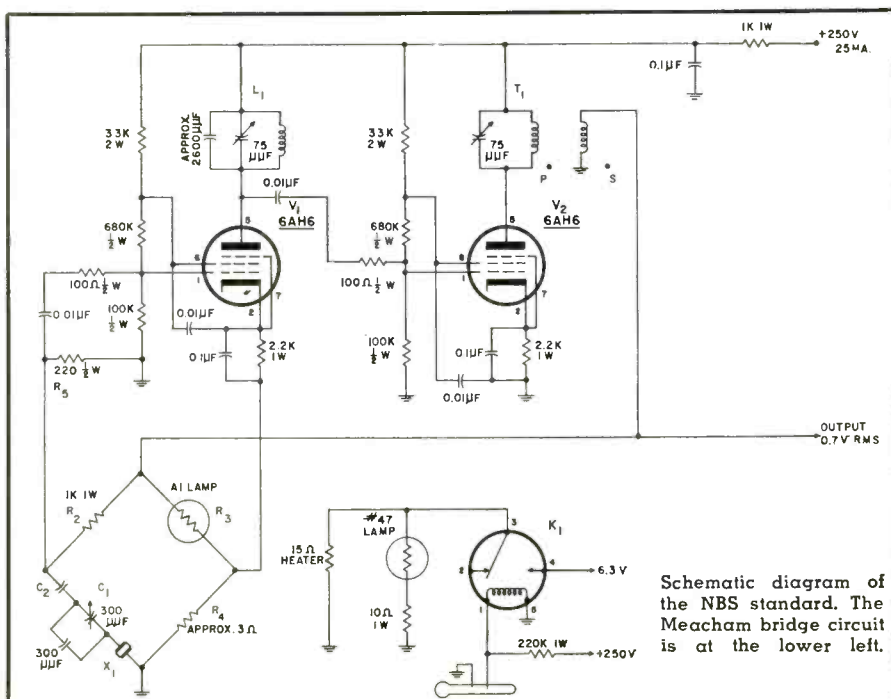

Schematic diagram of the NBS standard. The Meacham bridge circuit is at the lower left.

REACTANCE ANNULING FOR HORN LOUDSPEAKERS

By

DANIEL J. PLACH

Senior Physicist

and

PHILIP B. WILLIAMS

Chief Engineer

Jensen Manufacturing Company

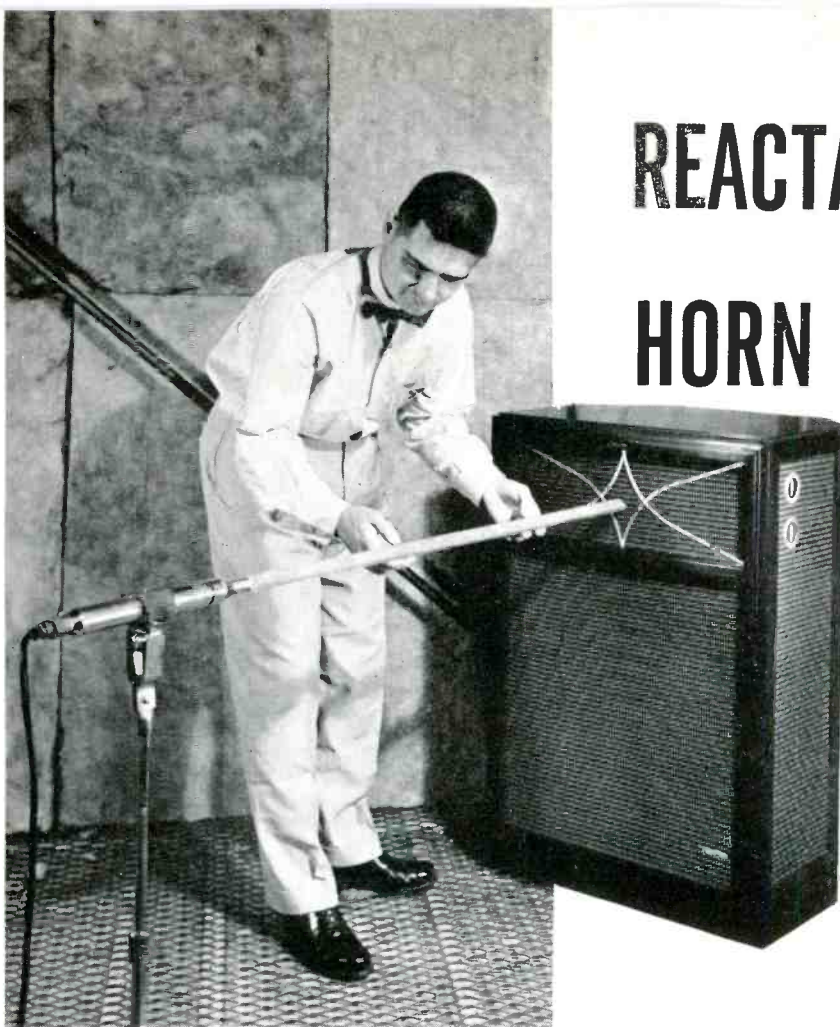

Loudspeaker performance can be improved by the proper choice of horn flare and driver resonance.

Sound pressure measurements being made on 3-channel Triplex in treated room.

TODAY the most important loudspeakers commercially are of the moving voice coil type, with permanent magnet or field coil excitation. They are used in two ways—as direct radiators and as horn-loaded radiators. Direct radiation is the term applied to a speaker with a cone which moves the air directly. Horn loading utilizes an expanding tube between the speaker and the air to match the normally high impedance of the speaker to the relatively low impedance of air. With the construction materials available at this stage of the art, it is not possible to design speakers which will match air impedance and still cover even a moderate frequency range. Thus, the transformerlike action of a horn is necessary for high efficiency performance. In addition, other benefits accrue from proper horn-loading design. The mechanism of operation of the two speaker applications is entirely different in nature.

Output of direct radiators is useful only at the fundamental—or lowest—resonant frequency and above. At resonance, the stiffness of the cone suspension becomes equal, and opposite in sign, to the mass of the moving system

plus the mass of the air moved by it. Output thus is greatest at this point, on the basis of watts input. In commercial amplifiers of moderate or good regulation, however, output may be the same as or less than the output at higher frequencies. As speaker impedance rises at resonant frequency roughly in proportion to the magnet size, large magnet speakers draw less power and so the output is less accordingly.

Above the resonant frequency, the moving system is mass-controlled, and the output would drop off at 6 db per octave due solely to this factor. However, there is an equal and compensating rise with frequency. Radiation resistance of the speaker is proportional to the square of the frequency so that the output remains constant. This relationship is valid up to the point where the effective diameter of the cone is equal to λ/π where λ is the wavelength. Beyond the frequency represented by this wavelength, output does drop, with sound pressure being held up somewhat by polar sharpening. The direct radiator is relatively lightly loaded, even so, and its output efficiency is low. The highest efficiency achieved at the present time is about 12%, and that can only be obtained with extra heavy magnets and voice coils. Paper cone direct-radiator speakers are often used with horn loading for low frequency operation. At higher frequencies, however, transition is made to smaller, lighter,

stiffer radiating elements which operate as “pistons” higher in frequency than paper cone speakers.

The general equivalent circuit of a horn-type speaker is shown in Fig. 1. On the left-hand side are the electrical elements of the horn unit. E_0 is the constant voltage source with its associated internal impedance R_0 , and R_c is the resistance of the voice coil. The inductance of the voice coil can be neglected at low frequencies. The transformer in the equivalent circuit represents the coupling between the electrical and mechanical sides. B is the flux density over the winding length of the coil and l is the total conductor length in centimeters. On the right-hand side of the transformer, R_m represents the losses of the mechanical system that are not useful in radiation. S_d is the stiffness of the suspension system, and can include any stiffness added by an external cavity. The mass M_d represents the total effective mass of the moving system and S_c indicates the stiffness of the air chamber between the driver diaphragm or cone and the throat of the horn. For most low frequency applications where the shunt reactance of S_c is sufficiently large, its effect may be neglected. The parameters R_s (resistance) and M_s (mass) of the horn proper are the values as viewed by the driver diaphragm.

At this point, it is illustrative to show the nature of the load presented

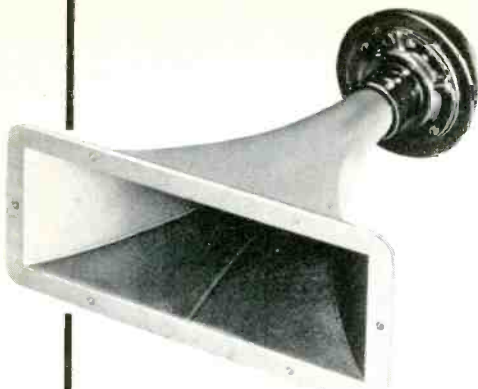

RP-201 mid-channel (600-4000 cps) horn is shown above and RP-102 high frequency tweeter below.

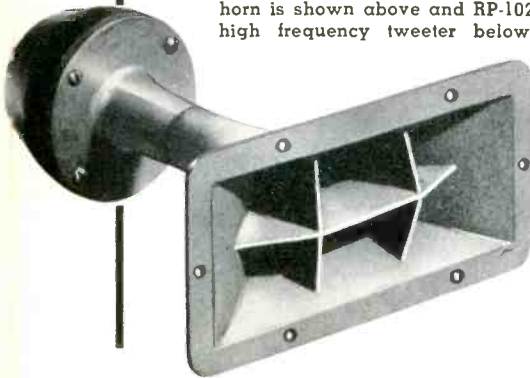

to the diaphragm by the infinite horn, which is an idealized horn long enough so that no mouth reflections occur. A practical horn operates similarly, but with mouth reflections roughening the response if mouth area is too small. The parameters of the horn proper are represented at the right-hand side of Fig. 1 by R_h and M_h .

As seen in the expression for horn air mass in Fig. 1, there is a factor T which determines the type of horn, whether conical, exponential or hyperbolic-exponential¹. The area expansion for the hyperbolic-exponential series is given by the relationship:

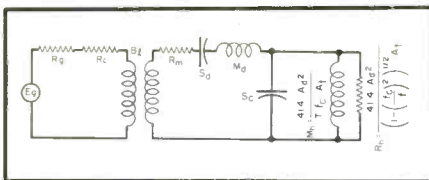
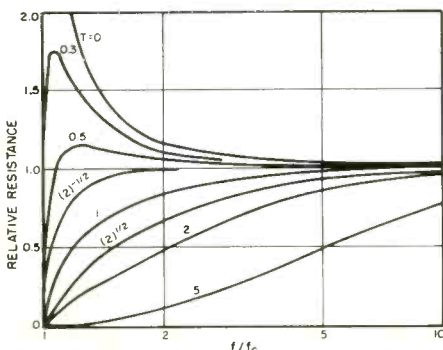

Fig. 1. General equivalent circuit of a horn-loaded loudspeaker.

Fig. 2. Resistive component of speaker impedance vs. frequency for various values of parameter T .



$$A_x = A_t \left(\cosh \frac{X}{X_0} + T \sinh \frac{X}{X_t} \right)^2 \quad (1)$$

The most generally useful type of horn is designed with a T smaller than unity, as will be shown later.

If the horn parameters M_h and R_h are expanded in series form, the following relationship occurs for horn impedance as viewed by the diaphragm:

$$Z_h = 267 \frac{A_d^2}{A_t} \left[\frac{\left(1 - \frac{1}{\mu^2}\right)^{1/2} + j \frac{T}{\mu}}{1 - \left(\frac{1 - T^2}{\mu^2}\right)} \right] \quad (2)$$

A plot of the resistive component against the relative frequency (as a ratio of frequency to cutoff frequency), with T as the parameter, is shown in Fig. 2. It can be seen that the T values near 0.5 give the flattest characteristic down closer to cutoff than the other types, this flatness being desirable because output is then more nearly independent of frequency. It is this control of the resistive component of horn impedance that makes horns having values of T less than unity more useful generally than the exponential horn ($T = 1$). Horns with values of T greater than one are seldom used, because of poor throat resistance characteristics. Plane wave theory of infinite horns predicts zero resistance at cutoff as shown by Fig. 2. Actually, however, for finite horns the resistance is not zero, and the useful range of the horn extends to 10% or 20% below cutoff.

Figure 3 shows the reactance characteristics of horns with various T values, including the exponential. Horn reactance is positive or masslike, but differs from the usual concept of an inductance or mass to the extent that its value does not increase steadily with frequency. Instead, the ultimate value approaches zero at high frequencies; and all horns will act the same at sufficiently high frequencies, presenting only resistive loads.

These unusual horn reactance characteristics can be matched to the driver reactance characteristics to get maximum possible efficiency at the lower end of the passband. Such matching is best done by the reactance annulling principle² which treats the driver and horn as a passband system in such a way as to cancel out mutually all or portions of the undesirable—but inevitable—reactive elements always present in the two components. The need for this cancellation effect can be seen from the acoustic output of a horn loudspeaker system:

$$P_a = \frac{(B1)^2 E_d^2 R_h \times 10^{-9}}{[R_c R_h + (B1)^2 \times 10^{-9}]^2 + R_c^2 [\omega (M_d + M_h) - S/\omega]^2} \quad (3)$$

This equation shows that the mode

A	= area at point x in inches
A_t	= throat area in square inches
x	= distance from horn throat in inches
x_0	= $2155/f_c$
f_c	= cutoff frequency
A_d	= effective diaphragm area in square inches
μ	= f/f_c
ω	= $2\pi f$
ω_c	= angular cutoff frequency of horn
f_r	= unloaded driver resonant frequency

Table 1. Definitions of symbols.

of operation of a horn system is different from that of a direct radiator. At medium and higher frequencies, R_h is constant, and with this condition applying, it can be seen that the output rolls off at 6 db per octave because the system is mass-controlled, as a result of the frequency-dependent terms in the denominator. Output independent of frequency is desirable, which in this case implies resistance control, dictating that the frequency-dependent terms be minimized. It is, of course, possible to cancel frequency-dependent terms by reactance annulling at only one frequency. However, their net value is considerably reduced at other frequencies so that the ratio of resistance to reactance is made much more favorable, and efficiency thereby increased. Exact cancellation is placed at the cutoff frequency of the horn, because resistance there is relatively low, and this reactance cancellation is especially important for a favorable ratio. For zero reactance at cutoff frequency:

$$\omega_c (M_d + M_h) - \frac{S_d}{\omega_c} = 0 \quad (4)$$

which can be reduced to the following relation between speaker resonant frequency and horn cutoff frequency, in terms of the system constants:

$$f_r = \left[f_c^2 + \frac{42.7 A_d^2 f_c}{T A_t M_d} \right]^{1/2} \quad (5)$$

It can be seen from this equation that the speaker resonant frequency must always be larger than the horn cutoff frequency. This relationship, while important in horn speaker design, is not generally known.

One of the major differences between the operation of a cone speaker as a direct radiator in contrast to its use as a horn unit driver is pointed up here. As a direct radiator, the cone speaker cannot be operated satisfactorily below its resonant frequency, due to low output and high distortion. As a horn unit driver, it should be operated below resonant frequency over a substantial part of its low frequency range.

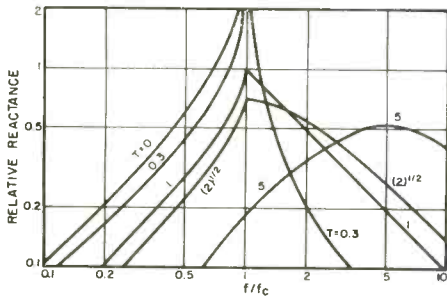

Fig. 3. Reactance characteristics of horns having various values of T .

How this comes about is shown by Fig. 4, which is universal in that it applies to any speaker. Speaker reactance X_s appears as a series resonant circuit, being inductive in nature above resonant frequency, zero at resonant frequency, and capacitive below resonant frequency. In the example, horn reactance is that developed by a flare of $T = 0.7$, as shown by curve X_h . The net or sum-reactance is X_n , which falls fairly close to a zero value over a very wide operating range, giving a favorable resistance-to-reactance ratio for best efficiency. The ratio of resonance to cutoff frequency, in the case of example given, is 2.5 to 1.

Thus, in the example, the system is essentially resistance-controlled between the horn cutoff frequency and resonant frequency, making it possible to achieve maximum efficiency between these frequencies. If the speaker resonance were placed lower, say at horn cutoff, net reactance at and above cutoff would be relatively large, causing a resultant reduction in efficiency. This condition would be further aggravated, as may be expected from the foregoing, if the driver resonant frequency were moved

Reactance and resistance measurements of drivers and horns are made with bridge and vacuum tank.

still further down so that it fell below horn cutoff.

The practical result of reactance annulling in a middle frequency horn-type speaker is shown in Fig. 5. Curve A represents the sound pressure performance of the unit when the resonant frequency of the moving system is properly placed with respect to cutoff, at about 1100 cycles. Curve B represents sound pressure with resonant frequency placed too low, at about 400 cycles.

Figure 6 is a chart based on Eq. (5). It indicates the relationship that must exist between the driver resonant frequency and horn cutoff frequency, in terms of the moving system and horn constants, to obtain reactance annulling at horn cutoff frequency.

For a given driver, the moving system mass and effective area are fixed, so the parameters that are variable are the cutoff frequency, throat size, horn T and driver resonant frequency. The cutoff frequency is chosen on the basis of the lowest frequency to be passed, but in some cases a compromise must be made between cutoff frequency and allowable size. The throat cannot be arbitrarily chosen, as it determines the efficiency and impedance of the horn system. If it is assumed that the driver and horn will be matched so as to minimize the net mechanical reactance between cutoff and driver resonance, the driver appears as a generator having an internal impedance equal to the mechanical losses plus the impedance reflected from the electrical side.

On this basis, the required throat area in square inches is given by:

$$A_t = \frac{267 A_d^2}{R_m + \frac{(B1)^2 \times 10^{-11}}{R_c + R_e}} \quad (6)$$

Magnetic measuring equipment consists of ballistic galvanometer, calibrated by potentiometer and standard cell, and magnetizing system with control and switching equipment, analyzing flux paths in iron and air.

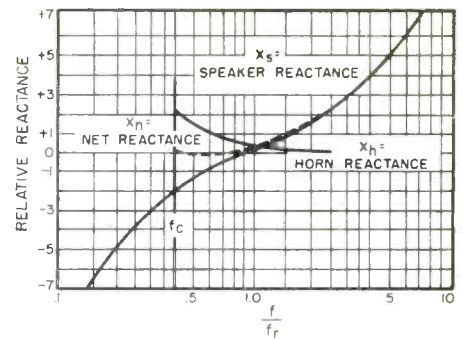

Fig. 4. Relationship between speaker reactance and horn reactance; $T = 0.7$.

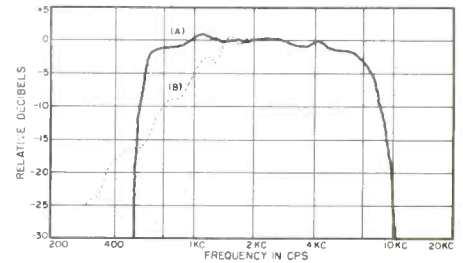
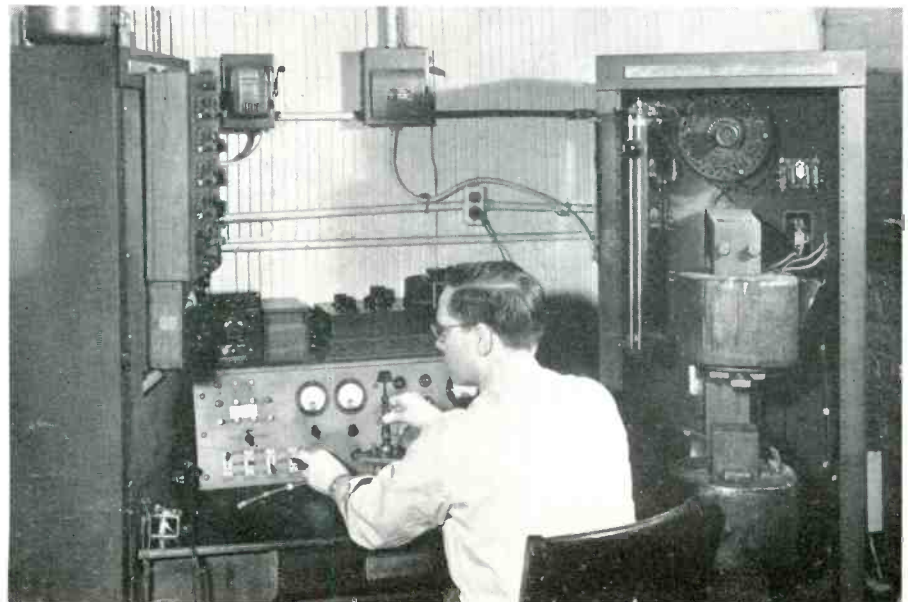

Fig. 5. Sound pressure performance of middle frequency horn-type speaker (A) with resonant frequency of moving system properly placed with respect to cutoff (about 1100 cps), and (B) with resonant frequency low (about 400 cps).

R_m can be determined by vacuum measurements, but in most cases can be neglected. The effective diameter used to obtain the area A_d is roughly 80% of the nominal speaker size.

Because of possible throat air overload, the minimum permissible area of the throat may have to be limited if high power operation over a wide band is required of a single horn unit. With

(Continued on page 35)



JOINTLY OPERATED

By

LEO G. SANDS

Communications Consultant

Map showing locations of repeaters, terminals and junction stations of a suggested relay system linking St. Louis and Chicago which could be used by several railroads serving both or intervening cities. Dotted lines indicate other paths which could readily be added.

posed that five pipeline companies band together and install a jointly operated microwave communications system across the state of Pennsylvania in a zigzag line-up so that repeaters could be located at or near the pumping stations of all five companies. The five companies expressed great interest in the proposal and formed a committee to investigate the possibilities. As a result, two of these companies did get together and are currently installing a jointly operated microwave system.

There are many regions where jointly operated microwave communications systems could be utilized by groups of railroads, for example, to provide each of the participating railroads with several private intercity communications circuits to augment their existing private wire line facilities. The initial cost and maintenance charges could be divided equally or on a prorated per-channel basis between the participating railroads. It is within the realm of possibility that manufacturers or distributors of microwave equipment would be willing to provide complete microwave systems on a lease basis to an organization composed of several railroads. Maintenance could be handled by the operators or the leasing company. Such an arrangement would not place the equipment supplier in the role of a communications common carrier.

A SINGLE microwave radio relay system can be utilized to provide communications facilities for several companies. Under existing Federal Communications Commission regulations, two or more individuals or organizations may jointly own and operate a radio communications system provided that those participating are individually eligible for radio station licenses in the same service.

Several years ago, the writer pro-

Channel distribution chart for hypothetical Chicago-St. Louis microwave system.

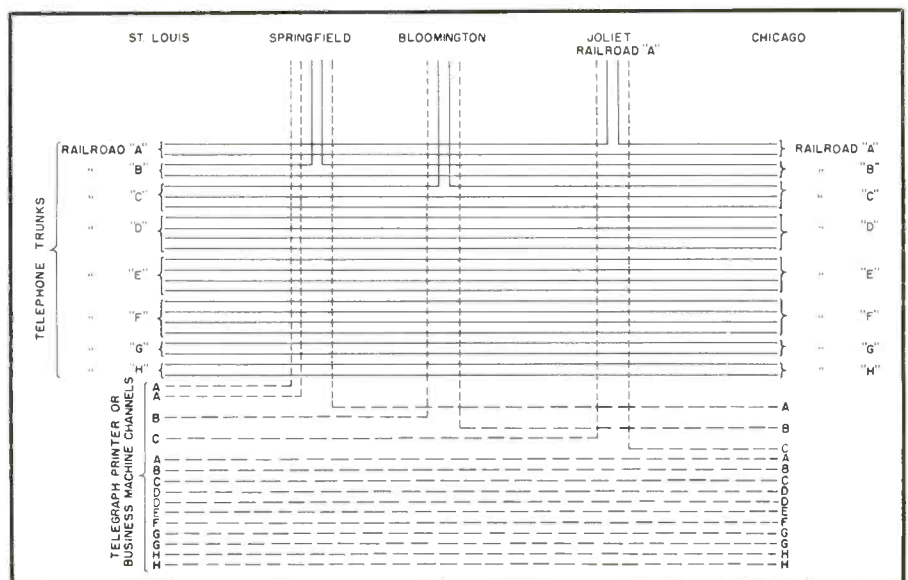

Technician Lloyd Maffett making an adjustment on a microwave transmitter owned by the Atlantic Refining Co.

PRIVATE MICROWAVE SYSTEMS

Operating conveniences and economies may be realized when several organizations utilize a single system.

C. O. Ellis, general superintendent of communications of the *Chicago, Rock Island and Pacific Railroad*, and chairman of the Communications Section of the Association of American Railroads, has frequently advocated the joint use by several railroads of a single microwave system. Mr. Ellis is not only a leader in the railroad communications field but was in charge of the installation and planning of the world's first permanent railroad-operated microwave system which was installed by the *Rock Island Lines* in 1949 and 1950.

Taking the railroad industry as an example, jointly operated microwave systems might be used to mutual advantage in the following regions: Seattle and Portland (*Great Northern, Northern Pacific, Union Pacific*); Seattle and Spokane (*Great Northern, Milwaukee Road, Northern Pacific, Union Pacific*); Chicago and Minneapolis (*Burlington Lines, Chicago Great Western, Chicago and Northwestern, Great Northern, Milwaukee Road, Northern Pacific, Rock Island Lines, Soo Line*); Chicago, Toledo and Detroit (*Baltimore & Ohio, Chesapeake & Ohio, Grand Trunk Western, New York Central, Nickel Plate, Pennsylvania*); Chicago and St. Louis (*Baltimore & Ohio, Chicago & Eastern Illinois, Gulf, Mobile & Ohio, Illinois Central, New York Central, Nickel Plate Road, Pennsylvania, Rock Island Lines*); Chicago and Kansas City (*Burlington Lines, Chicago Great Western, Gulf, Mobile & Ohio, Milwaukee Road, Rock Island Lines, Santa Fe, Wabash*); Washington and Richmond (*Atlantic Coast Line, Chesapeake & Ohio, Richmond, Fredericksburg & Potomac, Seaboard, Southern*).

Use of such jointly operated microwave communications systems would not necessarily be restricted to railroads operating between the terminals or along the route of each microwave system. Communication is often required between two points such as Chicago and St. Louis by railroads serving both cities but not necessarily operating trains between these two cities.

Typical System

Taking a hypothetical case, a microwave system linking St. Louis and Chicago consisting of 14 microwave termi-

nals, repeater and junction stations could be utilized by several major railroads serving both cities. In addition, communications circuits could be dropped off at Joliet, Bloomington, Springfield and East St. Louis for use by railroads serving these points and Chicago or St. Louis. A spur could be run to Decatur, another to Peoria and still another to Danville to provide additional facilities to railroads serving these points.

The installed cost of this hypothetical microwave system is estimated at less than \$600,000. With 10 railroads participating, the cost would be less than \$60,000 per railroad. If a 24 voice channel system were installed, the initial cost per telephone circuit would be under \$26,000. Based on an estimated equipment life of 12 years, the cost would be less than \$2200 per year per voice channel plus maintenance; the actual life of the equipment should be much in excess of 12 years. Any one or more of the voice channels could be subdivided to handle up to 18 teleprinter or business machine circuits, and these channels would cost less than \$120 per year each plus maintenance on a 12-year basis.

Termination of the communications channels does present a problem at the present time. It would require the cooperation of telephone companies to permit termination of these microwave-derived circuits into telephone company-owned switchboards. This would be particularly true if these circuits were to be used for handling intercity communications to points away from company property where telephone company city circuits would be involved.

Even without the cooperation of telephone companies, a microwave system as proposed here could be of great value to participating companies for interconnecting business machines, facsimile transmission, telegraph printer systems, and for telephone circuits terminated in privately owned switchboards and telephone instruments. Distribution of circuits at terminals, drop repeaters and junction points can be effected by utilizing leased wire facilities, if available, or by means of simple microwave leg circuits.

One or more of the voice channels of the microwave system could be utilized for remote control of v.h.f. base



Carrier equipment panels as now used on railroad wire line circuits which can be modified for microwave applications.

stations in extending communications to mobile radio units. By utilizing the microwave towers as v.h.f. antenna supports, a considerable communications range can often be realized and costs can be reduced by avoiding duplication of antenna supports. Several v.h.f. base stations to serve more than one company could be installed at a single site.

The reliability and quality of communications provided by microwave systems often exceed those of wire lines. By employing standby microwave equipment and properly designed emergency power facilities, communications interruptions can be minimized. Since ice won't form on a radio beam and since air turbulence actually improves microwave propagation, microwave performs under conditions when open-wire lines are most vulnerable.

Equipment for a microwave system as proposed here is available from several reputable manufacturers. The equipment offered by different manufacturers is not necessarily alike in basic design but is almost identical from an application viewpoint. All equipment is designed to terminate

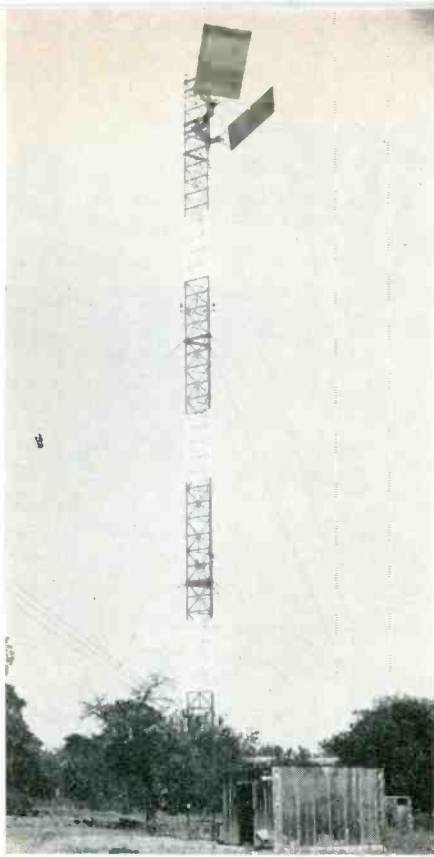

A 6000-mc. microwave repeater station using passive reflectors on tower.

voice circuits on a two-wire basis into switchboards or telephone instruments, or on a four-wire basis for special applications.

Some systems use frequency-division channeling equipment; others use time-division equipment. Systems utilizing standard telephone-type single-side-band suppressed-carrier channeling equipment may offer economic advantages not presented by other types of systems because existing wire line carrier equipment now possessed by prospective microwave operators can be modified for microwave use. However, in planning a totally new system

Relative per-channel-mile cost of a single voice channel of a 24-channel 300-mile microwave system compared with estimated cost of leased wire service.

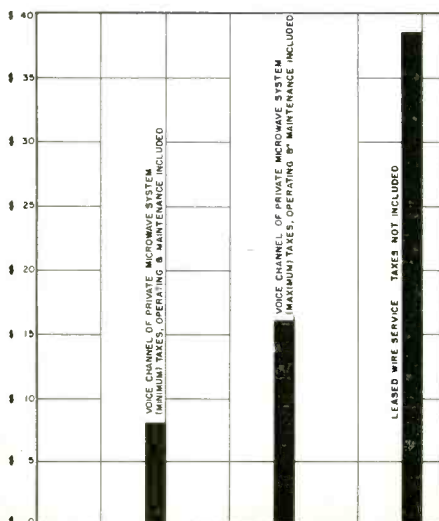

which would be independent of existing private wire line plants, almost any available type of microwave and channeling equipment can be used. Naturally, performance specifications must be consistent with operating requirements and FCC rules.

Bands Available

Transportation companies, industries and public safety organizations are eligible for licenses to install and operate multichannel radio communications systems for point-to-point service in the following segments of the radio spectrum: 952-960 mc., 1850-1990 mc., 2110-2200 mc., 2450-2500 mc., 2500-2700 mc., 6575-6875 mc., 12,200-12,700 mc., 16,000-18,000 mc., and 26,000-30,000 mc.

Equipment is currently available for operation in all but the three highest frequency bands. For the bands above 12,000 mc., equipment is not commercially available and it is highly unlikely that these frequencies will be used for communications for some time to come. The 960-mc. band is currently in wide commercial use for short-haul and leg circuits; since only 8 mc. of band space is available, this band is not well suited for long-haul multichannel systems.

For private long-haul radio relay communications systems, the 2000-mc. band is the most widely used. Operation in this band permits use of inexpensive triode tubes, crystal control for regulation of frequency, and direct coaxial cable feed of antennas. The over-all system distance that can be covered and the number of channels that can be handled vary with different makes of equipment. Systems in excess of 1000 miles in length conveying 24 or more voice channels are considered feasible.

The 6000-mc. band is another popular band suitable for long-haul systems conveying many voice channels. Although the 2000-mc. band enjoys somewhat better propagation conditions, higher antenna gains can be realized at 6000 mc. Since wave guide is expensive and may have an adverse effect on microwave equipment performance, particularly if antenna feed lines are long, passive reflectors are generally used in 6000-mc. systems.

Operators of microwave systems in the 960-, 2000- and 6000-mc. bands all report excellent reliability of communications. In a few areas, all systems suffer to some degree from propagation outages because of natural conditions which can only be alleviated by using shorter hops, diversity reception or possibly higher power. Higher power equipment is being developed particularly for military applications to permit spacing of repeaters at greater

distances. For commercial systems, higher power is not necessarily the best solution as extremely good reliability can be achieved by using shorter hops and more repeaters.

The cost of a microwave system cannot be calculated directly by counting the number of repeaters. If longer hops and fewer repeaters are used, tower heights must be higher and tower costs can offset the savings in equipment cost. There are a sufficient number of microwave systems now in regular operation and rendering excellent service to enable one to reach the conclusion that a well-designed microwave radio relay system is as reliable, if not more reliable, than a well-maintained open-wire line system.

Eligibility

According to FCC rules, cooperative use of facilities is permitted. The rules state that a person who is engaged in an enterprise for which a radio service is available may receive communications service from a station licensed to another person in the same service. It is also stated that facilities in the Land Transportation or Industrial Radio Services shall not be used for communications common carrier service. Contributions to capital and operating expenses may be accepted on a cost-sharing basis provided that records reflecting the cost of the service and details about the nonprofit or cost-sharing nature of the operations are kept and held available for inspection by FCC representatives.

The FCC rules also state that an organization may be considered eligible in the Railroad Radio Service, for example, although not directly engaged in railroad operation, provided that all persons who are members or shareholders of the organization would

(Continued on page 28)

Possible method of distributing microwave-derived channels in a large city when leased wire lines are not available.

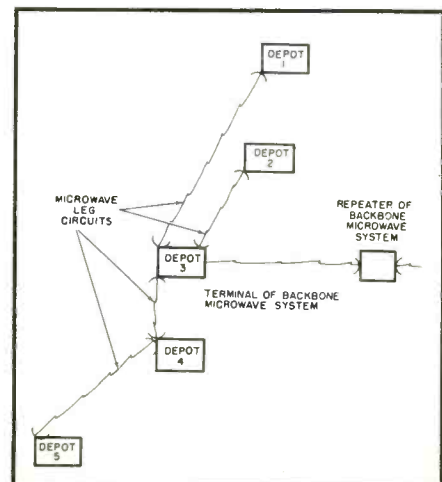

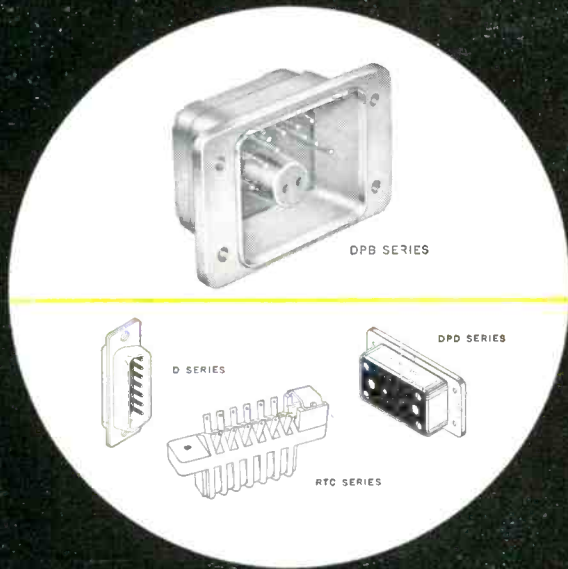

*for rapid disconnect
use cannon
"unit plug-in"
connectors*

speed up inspection...testing...maintenance! facilitate interchangeability!

You can connect, disconnect, interchange, replace, test, and inspect instruments, assemblies, and sub-assemblies easily and rapidly when you use Cannon "Unit Plug-In" multi-contact electric connectors.

You'll find some with shells . . . some without. Shell style units . . . in a wide variety of designs . . . are ruggedly constructed to take the many "in" and "out" operations of rack, panel, chassis, and sub-assembly applications. Varied, simple, but always rigid mounting facilities provided on each connector half. Standard, miniature, sub-miniature sizes.

Either connector half may be made into a plug by use of an end bell.

Up to 156 contacts. And . . . an amazing number of combinations of contacts for control, audio, thermocouple, co-ax, twin-ax, as well as pneumatic connections. In single- or double-gang. Special moisture-proofed types. Standby units feature gold-plated contacts to withstand deterioration and corrosion.

Write for full information. Write TODAY!



first in connectors

CANNON PLUGS

Please refer to Dept. 401

CANNON ELECTRIC COMPANY, 3209 Humboldt Street, Los Angeles 31, California. Factories in Los Angeles; East Haven; Toronto, Canada; London, England. Contact representatives and distributors in all principal cities.

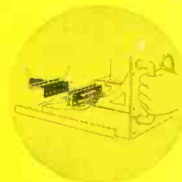

NEW TUBES

SILICON POWER RECTIFIER

Improved performance and reliability of military communications equipment may be attained through the use of a silicon power rectifier developed by the *Transitron Electronic Corporation*, Melrose, Mass. Experimental units are being manufactured under a U. S. Army Signal Corps industrial preparedness program contract.

The silicon rectifier is capable of operating efficiently between 150°C and

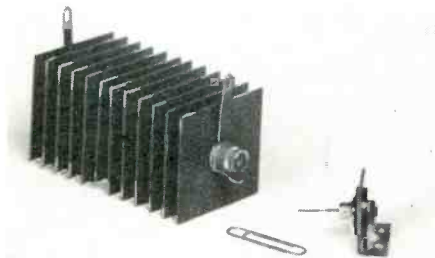

–60°C, and possesses large power-handling ability. There is no filament to cause loss of emission, and it does not exhibit a continuous aging effect. Operating efficiency as high as 98% is possible due to the extremely low losses.

In the photograph, the silicon power rectifier (right) is shown contrasted with a conventional selenium type rectifier. Savings in weight and volume are expected to make this unit especially adaptable for communications in military aircraft.

Circle No. 51 on Reader Service Card

INDUSTRIAL RECTIFIER

For industrial control applications, *National Electronics, Inc.*, Geneva, Ill., has developed a new quick-heating rec-

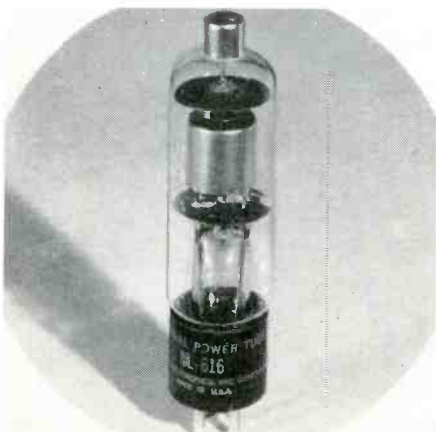

tifier tube. Designated NL-616, it is rated at 2.5 amperes d.c. and 30 amperes peak current. It is gas- and

mercury-filled for quick starting and long life.

The high peak current rating permits use of this tube in motor speed control applications requiring high starting currents. Other ratings are: filament power, 2.5 volts at 9 amperes; peak inverse voltage, 1250 volts.

Circle No. 52 on Reader Service Card

"PREMIUM QUALITY" TUBES

Having a minimum guaranteed life of 10,000 hours, the special group of seven new *Amperex* "Premium Quality" tubes is designed for use in equipment where unsupervised, uninterrupted operation is required. These tubes have all been field-tested in appropriate equipment.

The Type 6085 medium- μ dual triode, Type 6084 pentode amplifier and Type 6277 output pentode are of rugged design and are particularly suited for industrial use where the ability to withstand severe shock and vibration is the prime requisite. Type E83F pentode amplifier and Type E81L output pentode are internally screened and designed for operation in telephone equipment and instrumentation, whereas Type 5920 and Type E92CC are for use in flip-flop circuits in computers, business machines, etc.

A brochure covering the characteristics of the "Premium Quality" line is available from the Engineering Department, *Amperex Electronic Corporation*, 230 Duffy Ave., Hicksville, L. I., N. Y.

Circle No. 53 on Reader Service Card

RAYTHEON TUBES

Raytheon Manufacturing Company has announced the development of two new tubes: Type CK6533, an improved low-noise subminiature triode (shown in the photograph); and Type OB2WA, an improved 108-volt regulator tube. Information on both tubes is available from the Technical Information Service, *Raytheon Manufacturing Company*, 55 Chapel St., Newton 58, Mass.

The CK6533 has a 6.3-volt, 200-ma. heater, an amplification factor of 53, and a mutual conductance of 1750 micromhos. At the standard test condition of 40 cycles, 15 *g* vibration, noise output across 10,000 ohms in the plate circuit is a maximum of 1 mv., with a typical tube usually reading between 100 and 200 μ v. At vibration frequencies as high as 10,000 cycles, 15 *g*, the noise output seldom exceeds 1 mv.

Type OB2WA replaces Type OB2 in critical military and commercial applications. Featuring ruggedness under shock and vibration, tightly controlled



specifications, and 150°C bulb temperature ratings, it is now manufactured to MIL specifications.

Circle No. 54 on Reader Service Card

COLOR RECEIVING TUBES

Three types of electron receiving tubes have been announced by the Tube Division, *Radio Corporation of America*, Harrison, N. J., which are specifically designed with operating characteristics that match the circuit requirements of the RCA 21" color kinescope.

The RCA-6BC5 is a high-perveance, glass-octal type for use as a horizontal-deflection amplifier. Providing full de-

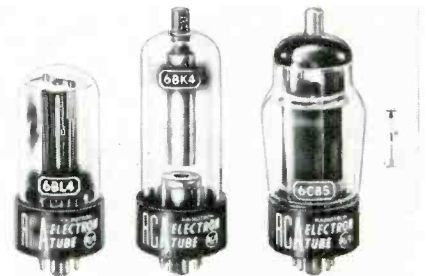

flexion for the 21" color kinescope, it has the following maximum ratings: plate dissipation, 23 watts; grid-2 input, 3.6 watts; peak positive-pulse plate voltage rating, 6800 volts; and negative-pulse voltage rating, 1500 volts.

Designed for regulating the ultor voltage of the 21" color kinescope, the RCA-6BK4 has maximum ratings as follows: d.c. plate voltage, 25,000 volts; d.c. plate current, 1.5 ma.; and plate dissipation, 25 watts.

An octal-type tube for use as a damper diode in color sets, the RCA-6BL4 is rated to withstand a maximum peak inverse plate voltage of 4500 volts, absolute. It can supply a maximum peak plate current of 1200 ma. and d.c. plate current of 200 ma.

Circle No. 55 on Reader Service Card

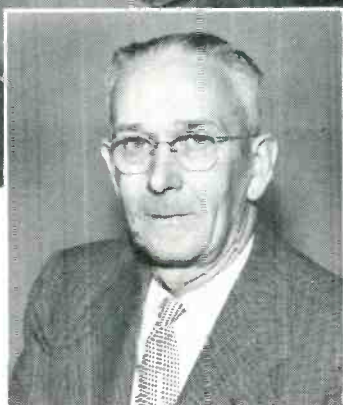
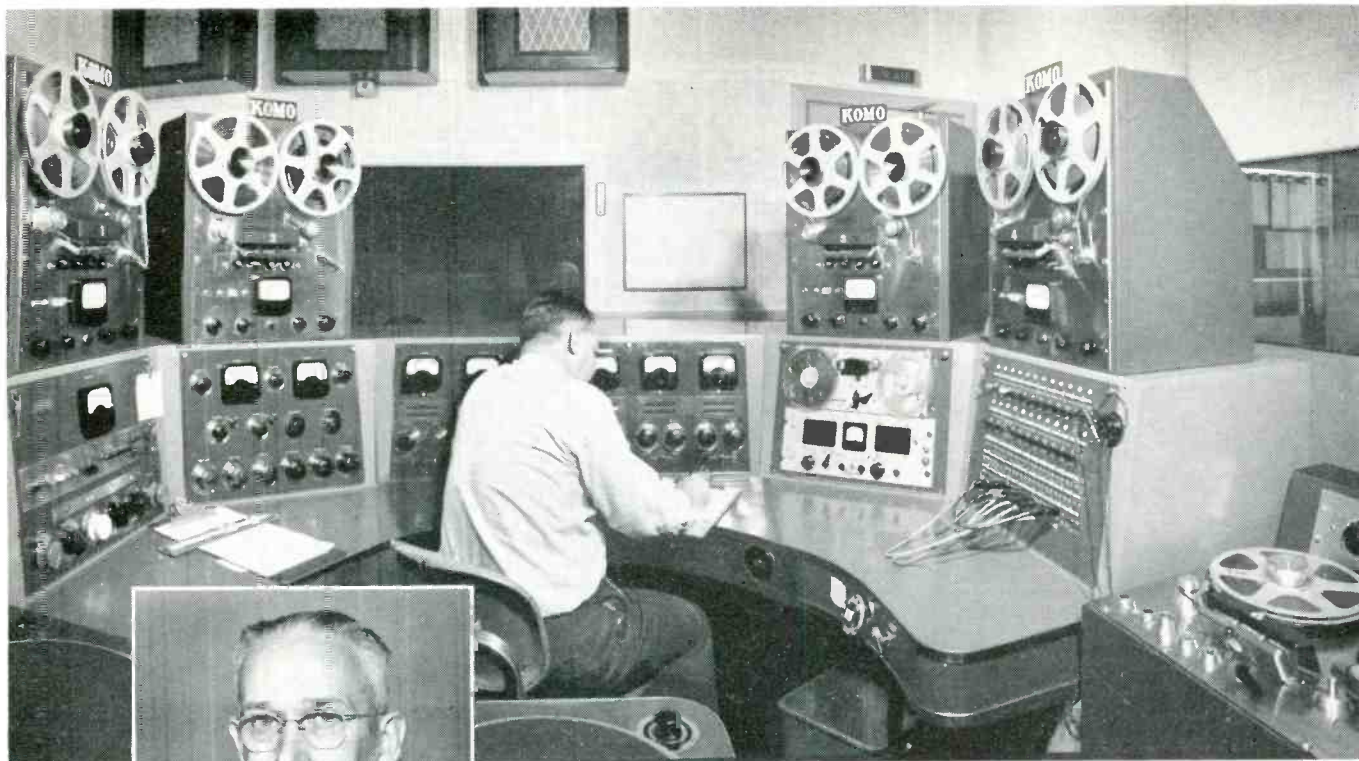

“18,000 HOURS and still within specs”

says Francis Brott, Chief Engineer, KOMO, Seattle

“Our first Ampex recorder showed us what a real professional machine can do. After 18,000 hours of heavy use, the frequency response and audio characteristics of our Model 300 head are still within the original published specifications. This kind of performance sold us completely on Ampex — that’s why we’ve added four Ampex 350’s.”

● NOW an Ampex for every broadcast need

With the addition of the new lightweight Model 600 series, Ampex now offers your broadcast station a superior machine to meet every tape requirement . . . from distant field pickups to major network recordings. For top-ranking performances and rehearsals and programs involving extensive editing, dubbing and “spot” announcements, choose from the Series 350 . . . for recordings “on location” that assure studio fidelity and accuracy, choose from the Series 600. All Ampex recorders have the same basic head design.



This new Model 600 weighs 28 pounds — price \$498 (\$545 including carrying case.) (A matching amplifier-speaker unit, Model 620, weighs 16 pounds, price \$149.50.)

THE ULTIMATE IN PRECISE TIMING WITH HIGHEST FIDELITY

Ampex timing accuracy is so excellent ($\pm 0.2\%$) that tapes are always on speed — without program crowdings or cutoffs. Ampex reproduction is so faithful that it is indistinguishable from a live broadcast — the result of an unsurpassed combination of broad frequency response, wide dynamic range and imperceptible flutter and wow.

AMPEX
CORPORATION

Accepted as the Signature of Perfection in Tape Machines

For a convincing demonstration, contact your Ampex Distributor today (listed in Yellow Pages of Telephone Directory under “Recording Equipment”) Canadian General Electric Company in Canada. Write today for further information and complete specifications; Dept. T-1880.

AMPEX CORPORATION, 934 CHARTER STREET, REDWOOD CITY, CALIFORNIA

For more information, circle No. 7 on Reader Service Card

To the Engineer who is Very Particular



RCA expansion opens the kind of permanent opportunities you'll find most desirable

A whole new program of expansion at RCA—in Research, Systems, Design, Development and Manufacturing—opens a broad variety of permanent positions with all the features that appeal to the alert, creative engineer. These are opportunities with a future . . . available *today* for the man who wants to move ahead professionally with the world leader in electronics. They include work in fields of phenomenal growth. At the RCA engineering laboratories *listed in the chart on the right*, you'll find the kind of living and working conditions attractive to the professional man and his family.

Engineers and scientists find every important factor that stimulates creative

effort . . . including a quality and quantity of laboratory facilities unsurpassed in the electronics industry . . . and everyday association with men recognized at the top of their profession.

RCA's benefits add up to an impressive list of "extras." Among them: tuition for advanced study at recognized universities . . . a complete program of company-paid insurance for you and your family . . . a modern retirement program . . . relocation assistance available.

Your individual accomplishments and progress are recognized and rewarded through carefully planned advancement programs. Financially as well as professionally, you move ahead at RCA!

For more information, circle No. 8 on Reader Service Card

about His Future . . .

What can RCA offer you?

Check the chart below for your career opportunity in

COLOR TELEVISION
AVIATION ELECTRONICS
ELECTRON TUBES
MISSILE GUIDANCE

FIELDS OF ENGINEERING ACTIVITY	TYPE OF DEGREE AND YEARS OF EXPERIENCE PREFERRED											
	Electrical Engineers			Mechanical Engineers			Physical Science			Chemistry Ceramics Glass Technology Metallurgy		
	1-2	2-3	4+	1-2	2-3	4+	1-2	2-3	4+	1-2	2-3	4+
RESEARCH • SYSTEMS • DESIGN • DEVELOPMENT												
COLOR TV TUBES —Electron Optics—Instrumental Analysis—Solid States (Phosphors, High Temperature Phenomena, Photo Sensitive Materials and Glass to Metal Sealing)	L	L	L	L	L	L	L	L		L	L	L
RECEIVING TUBES —Circuitry—Life Test and Rating—Tube Testing—Thermionic Emission	H	H	H		H	H		H			H	H
SEMI-CONDUCTORS —Transistors—Circuitry—Advanced Development	H	H	H	H		H	H	H	H		H	H
MICROWAVE TUBES —Tube Development and Manufacture (Traveling Wave—Backward Wave)		H	H	H			H	H			H	H
GAS, POWER AND PHOTO TUBES —Photo Sensitive Devices—Glass to Metal Sealing	L	L	L	L	L		L	L		L	L	
AVIATION ELECTRONICS —Radar—Computers—Servo Mechanisms—Shock and Vibration—Circuitry—Remote Control—Heat Transfer—Sub-Miniaturization—Automatic Flight—Design for Automation—Transistorization			M			M			M			
RADAR —Circuitry—Antenna Design—Servo Systems—Gear Trains—Intricate Mechanisms—Fire Control			M			M			M			
COMPUTERS (ANALOG AND DIGITAL) —Systems—Advanced Development—Circuitry—Assembly Design—Mechanisms			M			M			M			
COMMUNICATIONS —Microwave—Aviation—Specialized Military Systems			M			M			M			
MISSILE GUIDANCE —Systems Planning and Design—Radar—Fire Control—Shock Problems—Servo Mechanisms			M			M			M			
COMPONENTS —Transformers—Coils—TV Deflection Yokes (Color or Monochrome)—Resistors		C	C		C	C		C	C			
MANUFACTURING	L			L	L		L	L		L	L	
Tri-Color Tubes—Microwave Tubes	H			H								
MACHINE DESIGN		L	L		L	L						
Mechanical and Electrical—Automatic or Semi-Automatic Machines				H	H		H	H				

C—Camden, N. J.—in greater Philadelphia near many suburban communities.

Location Code H—Harrison, N. J.—just 18 minutes from downtown New York.

L—Lancaster, Pa.—in beautiful Lancaster County, about an hour's drive west of Philadelphia.

M—Morristown, N. J.—quiet, attractive suburban community close to Philadelphia.

Please send resume of education and experience, with location preferred, to:

Mr. John R. Weld,
 Employment Manager, Dept. C-4B
 Radio Corporation of America
 30 Rockefeller Plaza
 New York 20, N. Y.



RADIO CORPORATION OF AMERICA

COMMUNICATION REVIEW

RADIO COMMUNICATION EQUIPMENT

Shown in this photograph is some of the point-to-point radio communication equipment now being built by *Westinghouse Electric Corporation*, 401 Liberty



Ave., Pittsburgh 30, Pa., to form a part of the Air Force's global communication system. These sets are patterned after equipment designed about eight years ago that has been highly successful in tropical service in a major Central American and Caribbean commercial communication network; the new units, however, take advantage of the intervening developments in electronic gear and in new ideas for maximum ease of operation and servicing.

Circle No. 56 on Reader Service Card

GLOBAL COMMUNICATIONS

The Armed Forces Communications Association, an organization that brings Signal Corps, Navy, Marine and Air Force members together with manufacturers, will devote its annual convention to the vital topic of "Global Communications." It will meet May 19-21 at the Hotel Commodore in New York City.

On the first two days of the three-day convention, there will be conference meetings, exhibits, a banquet with a nationally known speaker, and committee activities. Armed Forces Day, which comes on the third day of the convention, will be observed by a field trip to Fort Monmouth, the major training and research center for radio and communications of the U. S. Forces. The trip to Fort Monmouth is open only to AFCA members and registered guests of the convention.

Circle No. 57 on Reader Service Card

MICROWAVE LINKS FOR PIPELINES

Two installations of microwave radio equipment have recently been completed by the Engineering Products Division,

Radio Corporation of America, Camden, N. J., for pipelines—the *Colorado Interstate Gas Company* and the *Buffalo Pipeline Corporation*.

A 230-mile turnkey microwave relay now links the *Colorado Interstate Gas Company* at Colorado Springs with its pipeline compressor stations and gas-producing fields in Kansas and Oklahoma. This system utilizes standard *RCA CW-20A* microwave equipment operating in the 2000-mc. band, and provides both voice and v.h.f. control circuits.

The installation for the *Buffalo Pipeline Corporation*, Big Flats, N. Y., is a one-hop microwave system which utilizes standard *RCA CW-5B* equipment. It enables the pipeline station at Caledonia, N. Y., to operate remotely a v.h.f. mobile radio base station at Marrowback Hill, N. Y., 20 miles away.

Circle No. 58 on Reader Service Card

TWO-WAY RADIO IN OIL FIELDS

Instant communication is maintained by the Wyoming District of *The National Supply Company* with its field representatives working out of Casper and Newcastle by means of a mobile two-way radio system furnished by the *General Electric Company*, Syracuse, N. Y. The system was installed by *National Supply*, manufacturer and distributor of oil field machinery and equipment, in order to provide better service to drillers and producers in iso-



lated areas where telephones are few and far between.

Five cars based at Casper and two based at Newcastle are radio-equipped and can communicate instantly with

their headquarters and with any of the other cars within a range of 300 miles. The base station, located on top of Casper Mountain, has a range of approximately 200 miles with 250 watts power, and additional transmitting stations at Casper (shown in the photograph) and Newcastle, are powered at 50 watts each.

Circle No. 59 on Reader Service Card

MARINE RADIOTELEPHONE

Sonar Radio Corporation, 3050 West 21st St., Brooklyn, N. Y., has announced its newest addition to the "Sonafone" line of marine radiotelephones—the Model M35W. According to the manufacturer, this unit is the only portable marine radiotelephone that has an input of 35 watts, and covers five channels plus standard broadcast band.

Other features of the M35W include: dual crystal control, instantaneous push-



to-talk, built-in automatic noise limiter, built-in modulator and r.f. indicator, and harmonic attenuation exceeding 60 db. The "Sonafone" M35W is also available in a fixed model, for table-top or bulkhead mounting.

Circle No. 60 on Reader Service Card

AIRCRAFT RECEIVERS

In view of the increased activity in the aircraft industry and the close connection between the Civil Air Patrol and civil defense, *Monitoradio* aircraft receivers have again been made available to industry. One unit will monitor all aircraft frequencies and also cover the civil defense and part of the amateur two-meter bands. Descriptive literature is available from the *Monitoradio Radio Apparatus Corp.*, 7900 Pendleton Pike, Indianapolis 6, Ind.

Circle No. 61 on Reader Service Card

FIXED-FREQUENCY RECEIVER

A fixed-frequency (single-channel) receiver has been introduced by the *Hammarlund Manufacturing Company, Inc.*, 460 West 34th St., New York 1, N. Y., which is specifically designed for unattended services where tuning remains fixed for considerable periods of time. Based on the general circuitry of the Super Pro-600 and using many of its components, the new receiver can be employed in a diversity system.

Designated the SP-600-F, the unit is a superheterodyne type utilizing double conversion above 6.7 mc. It can be tuned and crystal-controlled on any single frequency from 1.5 to 30 mc. by the



use of any one of six plug-in subassemblies. Each of these subassemblies contains all the r.f. tuned circuits, h.f.o. crystal harmonic amplifier tuned circuits, and the switching circuitry which automatically activates single or double conversion as required.

Circle No. 62 on Reader Service Card

IMPROVED RECEIVER SELECTIVITY

Greater r.f. selectivity and increased reliability are features of an improved mobile universal 6/12-volt radio receiver recently placed in production by *Motorola* which operates in the 450-470 mc. range. Use of a multiple-tuned cavity preselector of unique compact design yields relatively steep-skirted selectivity that maximizes protection against u.h.f. TV interference.

The unusually low insertion loss (less than 2 db) of this preselector combined with an extra-low-noise crystal diode mixer entirely eliminates the need for r.f. amplifier tubes, and servicing is

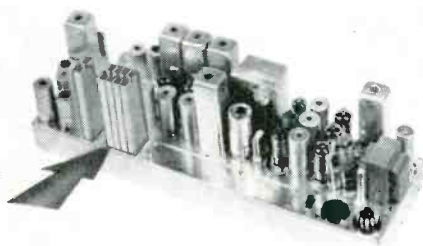

correspondingly simplified. Unlike conventional cylindrical cavities, the new cavity filter (shown by arrow) is of flattened construction with a flat center section; four of these cavities will fit in the space of a single cylindrical one.

More information is available from the Technical Information Center, *Motorola Communications and Electronics, Inc.*, 4501 W. Augusta Blvd., Chicago, 51, Ill.

Circle No. 63 on Reader Service Card

UTILITY TO INSTALL MICROWAVE

Plans have been announced by the *Kentucky Utilities Company*, Lexing-

ton, Ky., for the modernization of its communications by the installation of a 160-mile seven-station microwave system. Manufactured by *Motorola Communications & Electronics, Inc.*, 4501 W. Augusta Blvd., Chicago, Ill., the system will utilize 15 channels and will have an ultimate capacity of 24 channels to provide facilities for voice circuits, telemetering and remote control of v.h.f. base stations. It is scheduled for completion by mid-1955.

Circle No. 97 on Reader Service Card

Convergence

(Continued from page 13)

tor to produce a parabolic waveform. This waveform is passed through a relatively low reactance path consisting of a 150- μ fd. capacitor and a 400-mh. choke in series with a 2500-ohm amplitude control potentiometer. It is returned to B+ through the convergence coil L_R .

A reversible vertical-convergence tilt component is added to the parabolic waveform by passing the vertical output amplifier sawtooth plate current through the 100-ohm, center-tapped, vertical tilt control potentiometers and shunting some of this current through the vertical tilt coil L_{VR} . D.C. plate current is blocked by the 100- μ fd. non-polarized capacitor. In addition, induced horizontal currents are isolated by the 400-mh. choke. Static convergence is supplied by small permanent magnets.

Referring to Fig. 6, a low amplitude parabola is obtained from the vertical amplifier cathode circuit. This signal is amplified by a 12BH7 triode section and then applied through a 1-megohm amplitude control potentiometer to the grid circuit waveshaping network that consists of a 0.05- μ fd. capacitor and a 1.0-megohm potentiometer.

The parabolic signal is then amplified and stepped down through a conventional 9:1 or 10:1 vertical output transformer. It is then applied to L_{VR} . The isolation provided by the transformer allows the use of receiver B+ current through the center-tapped 80-ohm potentiometer and the 100-mh. phase-shifting coils L_{VR} , resulting in radial static convergence adjustment of the beams.

Although dynamic convergence adjustments can be made in many different sequences, the corrections required should be evaluated before attempting adjustment. A desirable method of making this evaluation is to remove all dynamic waveforms and converge the beams statically with the aid of a video pattern of many regularly spaced small dots. The configuration of the dots around the edge of the screen area is then noted. Ideally, the dots will be in

the form of equilateral or isosceles triangles, with the spacing proportional to the distance from the geometric center of the screen. The degree of departure from this ideal will be a measure of the difficulty that will be encountered in obtaining over-all registration. In addition, it is an indication of the resulting inaccuracy of over-all registration that can be expected.

This condition is a function of the yoke field uniformity and the amount of yoke field interaction with the internal and external magnetic convergence devices. Such interaction can be reduced to a negligible factor by careful yoke design and by providing sufficient shielding of the convergence assembly from the back of the yoke.

It is entirely possible to have yoke designs that produce maximum corner convergence errors of less than .050". The opinion of skilled observers indicates that an error of approximately .070" can be tolerated at normal viewing distances. It should be noted that dynamic convergence accuracy does not vary between tubes, but is a function of the yoke and the convergence waveforms.

Figure 7 shows an ideal error pattern, and also indicates the sense and relative magnitudes required to correct it. Dynamic waveforms should be used to form equally spaced equilateral triangles over the entire screen area. Static fields may then be introduced to superimpose all dots simultaneously.

This article has pointed out the advantages of the ringing circuit approach to the derivation of horizontal dynamic convergence waveforms. In addition, the feasibility of employing the integrating approach in the derivation of vertical dynamic convergence waveforms has been discussed. When used with well-designed yokes, the two circuits described provide adequate flexibility with which to register the rasters of the *CBS-Colortron* "205." 

Fig. 7. Ideal error pattern. Dynamic convergence controls are adjusted to form equal size triangles over entire screen area. Static convergence adjustments serve to superimpose dots of all triangles.



Personals

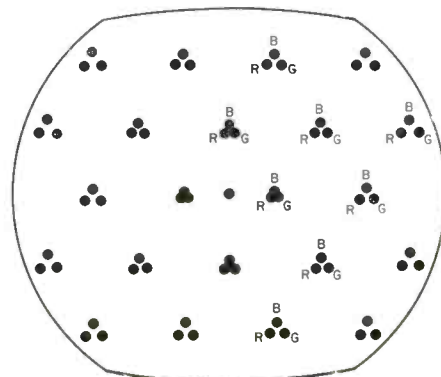
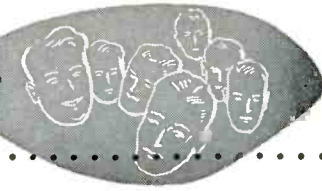

ROYAL V. KEERAN has been appointed director of research and development of *The Brubaker Manufacturing Co.*, Los Angeles, Calif., electronics firm. With the Navy Electronics Laboratory almost from the time of its inception, Mr. Keeran served in many capacities at NEL, most recently as head of the radar branch in San Diego. He received two Navy awards for contributions in the development and testing of i.f.f. and fire control radar.



ROBERT E. KESSLER is the new manager of the Communication Products Division of *Allen B. Du Mont Laboratories, Inc.*, Clifton, N. J. One of the TV and electronic industry's pioneer executives and engineers, Mr. Kessler has been employed by *Du Mont* since 1936. He developed *Du Mont's* first TV synchronizing signal generator, and designed much of the studio equipment and film pickup gear for the experimental TV transmitter W2XVT in 1939.



EDMUND A. LAPORT, chief engineer of the *RCA International Division, Radio Corporation of America*, has now joined the *RCA* research and engineering staff as administrative engineer, communications. Associated with the radio field since 1921, Mr. Laport is the author of "Radio Antenna Engineering," and holds several patents on radio devices. He is a Fellow of the Institute of Radio Engineers and a member of the IRE Standards Committee.



FRANK G. MULLINS, JR., formerly with the Electronic Division of *Westinghouse Electric Corporation*, has joined the *Fairchild Recording Equipment Company*, Whitestone, N. Y., as manager of engineering and special counsel. His extensive background in development and design of both commercial and military equipment, coupled with his past administrative direction of major projects, is expected to aid in the firm's expansion and development.



DR. JOHN D. RYDER, dean of the School of Engineering at Michigan State College, has been elected president of the Institute of Radio Engineers for 1955. Long active in IRE affairs, Dr. Ryder has served on the Board of Directors since 1952, and on numerous IRE committees. He was responsible for many electrical and electronic inventions before turning to the teaching field in 1941, and is the author of three textbooks on electronics and networks.



DANIEL F. SHEA, JR., has been named engineering liaison executive of the government contract division of the *Hallcrafters Company*, Chicago, Ill., radio, TV and communications manufacturer. Before joining *Hallcrafters*, he spent a year and a half with the *Hazeltine Electronics Corporation* as a senior project coordinator. Mr. Shea has been on active naval duty much of the time since his graduation from the U. S. Naval Academy in 1947.

Joint Microwave Systems

(Continued from page 20)

themselves be eligible for licensing in the Railroad Radio Service.

An attorney who was consulted on this matter opined in effect that the FCC rules provide for the licensing of nonprofit organizations, or associations, organized for the purpose of furnishing a radio communications service solely to persons actually in the same identical type of business category. However, it must be borne in mind that all microwave authorizations are currently being granted on a developmental basis and are subject to review and modification. The formation of a nonprofit corporation or association composed of two or more companies obviously requires the services of legal minds, the cooperation of management, and compliance with existing statutes.

One of the microwave systems now under construction is slated to be operated jointly by two companies engaged in similar business and both eligible in the same radio service category. In this case, each company purchases and constructs an equal number of microwave stations. Later, each company will sell the other a 50% interest in the stations it has constructed. Each company is to operate and maintain half of the entire microwave system, divided in the middle so that both will have like responsibilities. Each will lease from the other the 50% interest of the other in the section it operates so that the company operating each section will have the complete control required to satisfy FCC requirements.

In another instance, it has been reported that an organization was formed by 20 companies all engaged in the petroleum industry for the purpose of operating a joint microwave communications system. It has also been reported that membership in this nonprofit organization was later whittled down to six or seven companies because those barred from participation were not considered eligible in the same distinct FCC category of radio service.

Notwithstanding the legal complications and interconnection problems, it is believed that many companies could profit through the use of jointly operated communications systems as proposed here. The railroads, for example, have amply demonstrated their ability to get together in joint ventures as terminal companies and have made combined use of trackage. Just as many railroads have been able to operate such joint ventures, other potential microwave users might also investigate the possibilities of obtaining more communications at low cost through shared effort.



ZOPHAR

WAXES COMPOUNDS

Zophar waxes, resins and compounds to impregnate, dip, seal, embed, or pot, electronic and electrical equipment or components of all types; radio, television, etc.

Cold flows from 100°F. to 285°F.

Special waxes non-cracking at -76°F.

Compounds meeting Government specifications, plain or fungus resistant.

Let us help you with your engineering problems.



ZOPHAR MILLS, INC.
112-130 26th Street,
Brooklyn 32, N. Y.

For more information, circle No. 9 on Reader Service Card

RESINITE

EMBOSSED COIL FORMS

.. can increase efficiency of your iron core insertion production by 20%



Special embossed construction eliminates torque control problems and stripping. Custom fabrication to your exact specification assures correct dimensions to within the most critical tolerances.

We will furnish — without charge — a pilot production run of custom-made embossed forms to fit your particular application.

Contact us now for full details about this special offer. Request technical bulletin, *Use of Threaded Tubes, Threaded Iron Cores VS. Torque Control.*

RESINITE CORPORATION

Sales Representatives in:

- | | |
|---|---|
| New England:
Framingham, Mass., Framingham 7091 | Philadelphia:
Philadelphia, Pa., Chestnut Hill 8-0282 |
| New York, New Jersey:
Jersey City, New Jersey,
Journal Square 4-3574 | Northern Ohio, Western Pennsylvania:
Cleveland, Ohio, Atlantic 1-1060 |
| Upstate New York:
Syracuse, N. Y., Syracuse 76-8056 | Indiana, Southern Ohio:
Logansport, Indiana, Logansport 2555 |
| Maryland:
Baltimore, Maryland, Plaza 2-3211 | Missouri, Southern Illinois, Iowa:
St. Louis, Missouri, Sterling 2318 |
| Canada: Montreal, Quebec, Canada, Walnut 2715 | California:
Posadena, California, Sycamore 8-3919 |

PRECISION PAPER TUBE COMPANY
2035A W. CHARLESTON ST. • CHICAGO 47, ILLINOIS

For more information, circle No. 10 on Reader Service Card

More Engineers on A-N and civilian projects are proving—

It pays to specify

AMPERITE DELAY RELAYS and BALLAST REGULATORS

... they're finest  ... cost less!

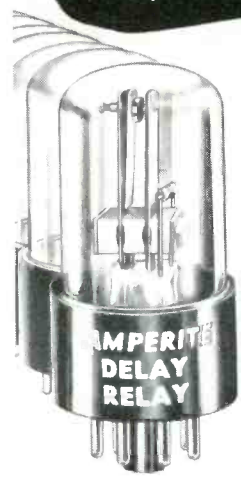

Thermostatic DELAY RELAYS

Provide delays ranging from 2 to 150 seconds.

MOST COMPACT, HERMETICALLY SEALED

- Actuated by a heater, they operate on A.C., D.C., or Pulsating Current.
- Hermetically sealed. Not affected by altitude, moisture, or other climate changes.
- Circuits: SPST only — normally open or normally closed.



Amperite Thermostatic Delay Relays are compensated for ambient temperature changes from -55° to +70°C. Heaters consume approximately 2 W. and may be operated continuously. The units are most compact, rugged, explosion-proof, long-lived, and very inexpensive!
TYPES: Standard Radio Octal, and 9-Pin Miniature.

PROBLEM? Send for Bulletin No. TR-81

Also — a new line of Amperite Differential Relays — may be used for automatic overload, over-voltage, under-voltage or under-current protection.

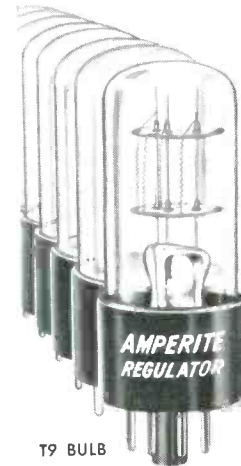

BALLAST REGULATORS

- Amperite Regulators are designed to keep the current in a circuit automatically regulated at a definite value (for example, 0.5 amp).
- For currents of 60 ma. to 5 amps. Operates on A.C., D.C., or Pulsating Current.
- Hermetically sealed, light, compact, and most inexpensive.

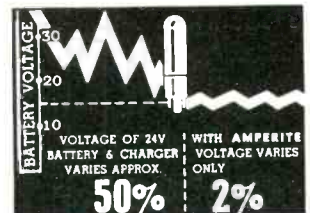
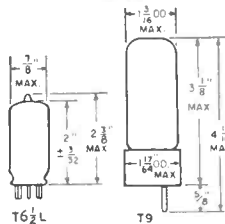

Amperite Regulators are the simplest, most effective method for obtaining automatic regulation of current or voltage. Hermetically sealed, they are not affected by changes in altitude, ambient temperature (-55° to +90°C), or humidity. Rugged; no moving parts; changed as easily as a radio tube.

Write for 4-page Technical Bulletin No. AB-51

AMPERITE CO. Inc., 561 Broadway, New York 12, N. Y.
In Canada: Atlas Radio Corp., Ltd., 560 King St., W., Toronto 2B

For more information, circle No. 11 on Reader Service Card

NEW PRODUCTS

MEGOHMMETER

The *Freed* Type 1620 megohmmeter is valuable for measuring leakage resistance of transformers, insulating materials, cables, motors, stand-off in-

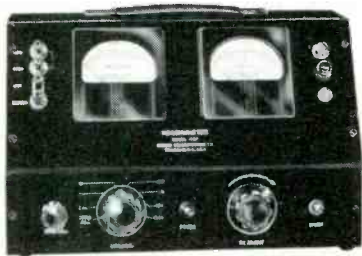

ulators, resistors and capacitors. Announced by *Freed Transformer Company, Inc.*, 1715 Weirfield St., Brooklyn (Ridgewood) 27, N. Y., it is a direct-reading precision-balanced electronic ohmmeter with a d.c. test potential—variable from 50 to 1000 volts—included as part of the unit.

The resistance scale covers from 0.1 megohms to 4,000,000 megohms in six overlapping ranges; readings and applied test voltage are indicated on separate 4" meters. A relay operated from the front panel disconnects the high voltage from the test terminals and eliminates all danger of shock to the operator.

Circle No. 64 on Reader Service Card

WIDE-BAND CALIBRATED AMPLIFIER

With a stabilized fixed gain of 60 db, the *Massa Laboratories* Model M-185 amplifier incorporates an accurate attenuator having six 10-db steps and one continuous 0-10 db step mounted



for convenient use by the operator. Input noise level is less than 10 μ v. for the entire frequency band from 10 cycles to 400 kc. A set of 2-megohm impedance input terminals is available for meters or recorders.

Announced by *Massa Laboratories, Inc.*, 5 Fottler Rd., Hingham, Mass., the Model M-185 provides accurate comparison of sound fields by means of the calibrated attenuator. Extreme care has been exercised in the circuit development to insure both low noise level and excellent transient response.

Circle No. 65 on Reader Service Card

CONTROL SYSTEM

Two essentially independent functions are provided by the Type 51B control system which has been developed by *Lenkurt Electric Co.*, San Carlos, Calif.: (1) a means for supervising conditions at remote locations from

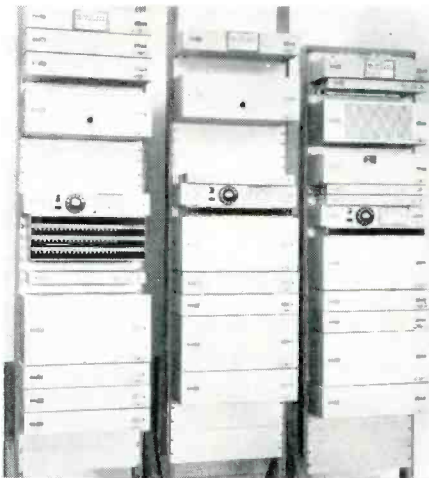

a control center, and (2) a means for controlling the operation of equipment at the remote locations from the control center. Information for both functions consists of d.c. pulses translated into tone signals for transmission over any suitable wire or radio circuit.

Designed primarily for use on multi-station radio routes, Type 51B can also be used wherever information must be gathered from remote stations and transmitted to supervisory personnel at a central attended location. It can supervise as many as 80 remote conditions and control up to 90 remote operations.

Circle No. 66 on Reader Service Card

TELEVISION TRANSMITTER

Specially designed for either color or monochrome operation on any single v.h.f. TV channel, the Type 2123 "Chromatran" is a low-powered TV

picture and sound transmitter which has been introduced by the *Tel Instrument Company, Inc.*, Carlstadt, N. J.

Individual sound and video transmitter units feed into a common output



circuit, providing a maximum of 0.2 volts peak into a 75-ohm load from a 75-ohm source impedance. The sound-video carrier difference of 4.5 mc. is held to well within 1 kc., and video response is essentially flat to 5 mc. Intermodulation distortion (the 920-kc. beat) is better than 55 db below the maximum picture carrier level at maximum modulation.

Circle No. 67 on Reader Service Card

"RESOMAX" POTENTIOMETER

Link Aviation, Inc., Binghamton, N. Y., has introduced the "Resomax" potentiometer, a highly accurate unit with infinite resolution for close servo follow-up loops. Specifications include: resistance ranges of from 500 to 2000 ohms in steps of 500; normal and zero base linearity of 0.02%; a shaft rotation of 60 turns + 10, - 0°; and a power rating of 5 watts at 25° C.

The "Resomax" potentiometer provides a linear resistance change with rotation rather than an incremental change with rotation as found in helically wound types. When used in servo-mechanisms where high accuracy is required, its linear resistance feature pre-

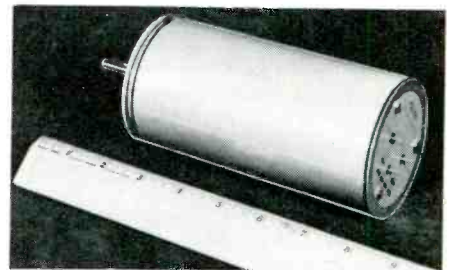

vents undesirable "hunting" or "chatter." Other areas of application are analog computers, test equipment, industrial instruments and process control equipment.

Circle No. 68 on Reader Service Card

IMPROVED "MOTO MAG"

Precision variable phase power control is provided by the improved version of the "MOTO MAG," pre-engineered

magnetic amplifier designed and produced by *Keystone Products Company*. Having a minimum of size and weight, it is intended for use in remote control devices, computers, positioning servos, and any two-phase motor.

In many applications, the new "MOTO MAG" eliminates use of a preamplifier; it operates on a smaller signal and incorporates high-temperature germanium diodes for higher operating temperatures. Six standard models are available.

Complete specifications, performance data, and operating characteristics may be obtained from *Keystone Products Company*, 904 23rd St., Union City 2, N. J.

Circle No. 69 on Reader Service Card

TV PACKAGE LABORATORY

"Packaging" of the *Du Mont* Type 325 TV line selector and Type 327 cathode-ray oscillograph has made

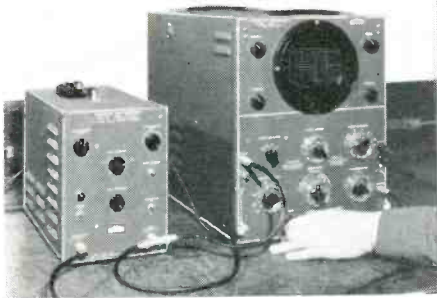

available an inexpensive video-signal monitor, primarily for use in TV broadcasting. The two instruments have been developed by the Instrument Division of *Allen B. Du Mont Laboratories, Inc.*, and complete information may be obtained from its Technical Sales Department, 760 Bloomfield Ave., Clifton, N. J.

Type 325 is operated by three controls which enable the operator to count down to any particular horizontal line, serrated or equalizing pulse of a composite TV signal, at which point it produces a synchronizing signal to trigger the oscillograph and display the signal from the selected point. The d.c. to 5-mc. bandwidth of the Type 327 medium-frequency oscillograph encompasses the frequencies found in the monochrome or color TV signal realm; accurate time and amplitude measuring features are included.

Circle No. 70 on Reader Service Card

ETCHED CIRCUITS

A new departure in packaged circuitry has been announced by *Audio Products Corporation*, 2265 Westwood Blvd., Los Angeles 64, Calif.—circuits etched on impregnated teflon. Offered in three series, under the trade name "Pakaps," the line has wide application in computer and airborne instru-

mentation, laboratory equipment and high fidelity audio amplification. No potting material is used and the units are repairable.

Standard Series 100 and miniature Series 200 can serve as low, medium and high speed binary scalars, cathode followers, multivibrators, pulse form-

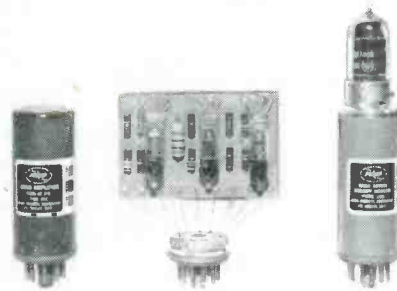

ers, pulse shapers, ring counters and gates. Series 300 "Pakaps" are multi-stage amplifiers available in three ranges of amplification: Model 301 (20 db \pm 1½ db), Model 302 (40 db \pm 1½ db), and Model 303 (60 db \pm 1½ db), flat 20 cps to 40 kc.

Circle No. 71 on Reader Service Card

MINIATURE VARIABLE INDUCTORS

Available both shielded and unshielded, the new *Levinthal* Style A Type 1 variable inductors are supplied in ten standard values from 56 μ h. to 1.8 mh., and up to a maximum of 25 mh. in special units. They feature an inductance variation range of 2:1, *Q*'s of approximately 200, operating temperature range from -50° C to +100° C, and temperature coefficients of inductance less than 50 ppm/°C.

Announced by *Levinthal Electronic Products, Inc.*, 2991 Fair Oaks Ave., Redwood City, Calif., the Style A Type 1 inductors are capable of dissipating 2.5 watts with a temperature rise of 20° C. Imbedment of the entire powdered carbonyl-iron cup cores and coil assemblies in epoxy resin gives them

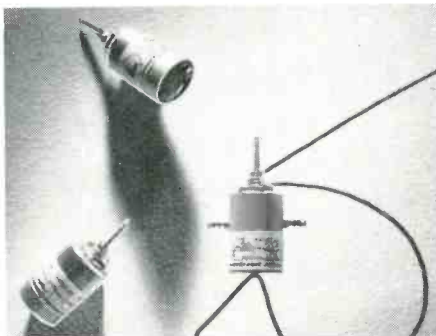

high resistance against the effects of large-amplitude vibration or shock, as well as providing protection against moisture and chemical attack. They are also available in the form of com-

(Continued on page 38)

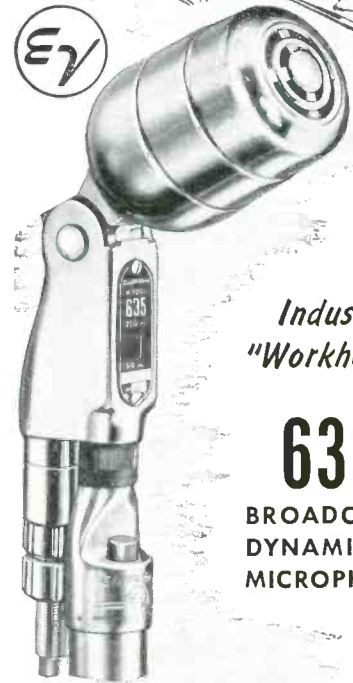

Industry
"Workhorse"

635

BROADCAST
DYNAMIC
MICROPHONE

USED ON

TV
AND
BC



Uniform high quality performance day-after-day in studio and remote pick-ups has proved the rugged dependability of the "635".

Exclusive E-V *Acoustalloy* diaphragm assures smooth, peak-free response 40-15,000 cps. Output is -55 db. 50-250 ohms impedance selector. Tilttable head. 5/8"-27 thread. Cannon XL-3 connector. 18 ft. cable.

List Price \$75.00

Normal trade discount applies.

See your Authorized E-V Distributor or Write for further information.

NO FINER CHOICE THAN

Electro-Voice

BUCHANAN • MICHIGAN

Circle No. 12 on Reader Service Card

NEWS BRIEFS

"SLICING" VACUUM TUBES

Slicing glass vacuum tubes is part of a checking program at the Owensboro, Ky., plant of the *General Electric Com-*

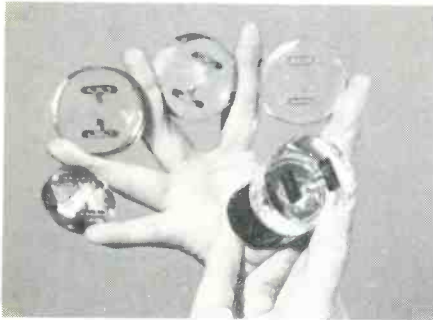

pany, which follows the tubes from arrival of raw materials to shipment of the finished product. Each tube to be checked is immersed in clear, liquid plastic, and its submerged glass tip is cracked off with pliers. As there is a vacuum inside the tube, normal atmospheric pressure forces in the liquid plastic to fill the tube completely. Chemical action and baking harden the plas-

tic in about two hours, with the tube parts undisturbed. Engineers then crack away the glass tube exterior and slice the plastic-encased parts into quarter-inch-thick sections for study under a microscope.

Circle No. 72 on Reader Service Card

SYNTHETIC MICA PLANT

In November, 1954, the *Mycalex Corporation of America* began construction on what is to be the world's first synthetic mica plant. To be known as the *Synthetic Mica Corporation*, a wholly owned subsidiary, the plant is being built at Caldwell, N. J., and is scheduled to begin production early this year. Estimated annual output will be 1000 tons of high grade synthetic mica, about 5-10% of the nation's current requirement.

Mica is used as an electrical insulator in many highly classified defense projects, such as radar, guided missiles, supersonic aircraft and nuclear developments, and more than 90% of it is imported from India. The new plant

actually represents the beginning of a new American industry—an industry which, it is hoped, will eventually reduce U. S. dependence on foreign nations for this highly strategic material.

Circle No. 73 on Reader Service Card

PREDICTING EQUIPMENT RELIABILITY

Engineers at the Silver Spring, Md., laboratory of *Vitro Corporation of America* are developing methods for predicting the reliability of electronic equipment still on the drawing board or in rudimentary form. This effort, supported by a contract with the Bureau of Ships, U. S. Navy, is being directed by Victor Harris and M. M. Tall, who reported their findings recently in a paper at the National Symposium on Quality Control and Reliability in Electronics, sponsored by the Institute of Radio Engineers.

The prediction methods are being developed from a correlation of equipment failure history with design features of the equipment. *Vitro* engineers are analyzing voluminous Navy records and supplementing these records by their own observations aboard ships. Mr. Harris and Mr. Tall believe the work may ultimately enable the Navy to predict the reliability of its electronic equipment before the equipment goes into production or is installed in the fleet.

Circle No. 74 on Reader Service Card

SOUND SYSTEM IN CATHEDRAL

One of the most comprehensive sound systems ever designed has been installed in the Cathedral of the Sacred Heart in Newark, according to the *Radio Corporation of America*, Camden, N. J. Complete with an *RCA* public address sound network, radio and TV facilities, and intercommunication, the system required more than two years for plan-



ning and installation. Some of the portable control equipment is shown in the photograph.

Circle No. 75 on Reader Service Card

THOMPSON MEMORIAL PRIZE

The Browder J. Thompson Memorial Prize for 1955 is being awarded by the Institute of Radio Engineers to Blanch-

TV-AM-FM SET PRODUCTION

Information based on latest reports from RETMA.

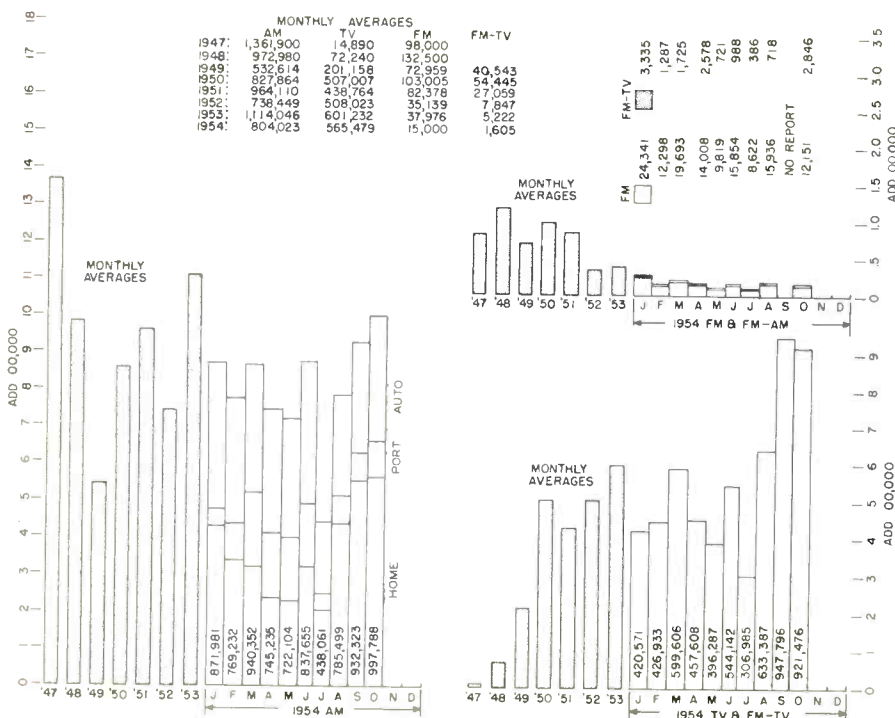

ard D. Smith, Jr., *Melpar, Inc.*, Alexandria, Va., for his paper entitled "Coding by Feedback Methods," which appeared on page 1053 of the August, 1953, issue of the Proceedings of the I.R.E. This award is made annually to an author under 30 years of age at date of submission of manuscript for a paper recently published by the IRE which constitutes the best combination of technical contribution and presentation of the subject.

Circle No. 76 on Reader Service Card

TUBE ALUMINIZING FACILITIES

Production facilities have been completed by the Television Picture Tube Division of *Sylvania Electric Products Inc.*, Seneca Falls, N. Y., which are expected to make possible the production of 25,000 additional large-size aluminized TV picture tubes a month. Automatic and semiautomatic equipment in-

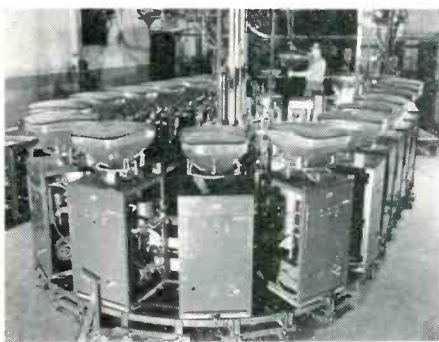

stalled includes bulb washing machines, screen settling belts, screen lacquering belts, in-line aluminizing machines, aging conveyors, and test equipment.

One of the most important additions of equipment at *Sylvania* is the battery of automatic in-line aluminizers shown in the photograph. While slowly moving on a track, these aluminizers evacuate each bulb of air and impurities, and then vaporize pure aluminum within the bulb to create a mirrorlike finish, thus increasing light output of the tube by nearly 100%.

Circle No. 77 on Reader Service Card

1955 FELLOW AWARDS

Seventy-six leading radio engineers and scientists have been named Fellows of the Institute of Radio Engineers—the highest membership grade offered by the Institute and bestowed only by invitation on those who have made outstanding contributions to radio engineering or allied fields.

Presentation of the awards with citations will be made by the President of the Institute at the annual banquet on March 23, at the Waldorf-Astoria Hotel in New York City, during the 1955 IRE National Convention.

Circle No. 78 on Reader Service Card

TECHNICAL BOOKS

"SERVOMECHANISM PRACTICE" by William R. Ahrendt, President, *The Ahrendt Instrument Company*, and Lecturer, University of Maryland. Published by *McGraw-Hill Book Company, Inc.*, 330 West 42nd St., New York 36, N. Y. 349 pages. \$7.00.

Practical aspects of servomechanisms are covered in detail in this book, which describes the many ways in which the essential function of servomechanism components can be accomplished, discusses the problems associated with the operation of servos and their components, and outlines design and manufacturing techniques for optimum performance. Descriptions and detailed design data are given for all the important servomechanism components.

"Servomechanism Practice" deals primarily with circuitry, electrical and mechanical components and the recent advances in their performance and utilization, plus practical problems encountered in servo design and manufacture. Component values are given in the circuit diagrams, and characteristics of typical components are also presented. Material on the theory of servomechanisms is included in the appendix together with useful charts and tables.

"TV STATIONS—A Guide for Architects, Engineers and Management" by Walter J. Duschinsky. Published by *Reinhold Publishing Corp.*, 430 Park Ave., New York 22, N. Y. 136 pages. \$12.00.

Virtually a handbook on TV station planning, this addition to the Progressive Architecture Library is claimed to be the first and only book covering the planning and design of television stations.

"TV Stations" should be useful to architects and engineers because they need to understand all the operations of a TV studio in order to plan the building and the facilities. It should be useful to management because policy planning is possible only if the whole picture of TV station planning can be recognized. And it should be useful to production men because it indicates the long-range aspects of operations which will ultimately determine production.

Part I deals with the master planning which precedes construction, and Part II deals with the practical problems that arise in the operation of a TV station. Supplementing the text are 135 illustrations, showing TV equipment of all types, station facilities, and plant layouts.

655XC

HICKOK

TELEVISION color bar generator



MODEL
655XC

This generator produces a standard 100% fully saturated NTSC color bar pattern on color TV sets. Regardless of future color television receiver design this color bar generator will be compatible.

Produces same type of signal that is transmitted over the air. All literature and alignment data is published around this standard NTSC signal. The Model 655XC provides signal for complete color alignment. When alignment is made with this type of signal, operator is sure that proper program colors will be displayed on the TV receiver.

The color bars appear on the TV screen in the following order from left to right: green, yellow, red, magenta, white, cyan, blue and black.

OUTPUT. . . EITHER R F. or VIDEO

Write for . . .

complete technical literature.

THE HICKOK ELECTRICAL INSTRUMENT CO.
10534 Dupont Ave. • Cleveland 8, Ohio

Circle No. 13 on Reader Service Card

NEW LITERATURE

DIGITAL INSTRUMENTS

Five related digital instruments for automatic counting, recording, and control are detailed in a brochure available from *Brush Electronics Company*, 3405 Perkins Ave., Cleveland 14, Ohio. The four-page folder contains fundamental facts on a cycling counter, time interval meter, combination counter-timer, preset counter, and a recording unit. Basic components for these instruments are also described and illustrated.

Circle No. 79 on Reader Service Card

VOICE COMMUNICATIONS

Expanding the usefulness of a voice communications channel so that it is capable of transmitting from 2 to 18 times as much intelligence is discussed in *Motorola's* Technical Bulletin E-112. Numerous photographs and drawings are used to show how frequency-shift voice frequency carrier can be em-

ployed in virtually any communications network where data can be translated into coded information.

Copies of Technical Bulletin E-112 are available from the Technical Information Center, *Motorola Communications and Electronics, Inc.*, 4501 W. Augusta Blvd., Chicago 51, Ill.

Circle No. 80 on Reader Service Card

FIXED CAPACITORS

"Theory, Characteristics, and Applications of Fixed Electronic Capacitors" is the title of a 91-page report made by Don R. O'Bell, of the Components and Systems Laboratory, Wright Air Development Center. It is available from the Office of Technical Services, U. S. Department of Commerce, Washington 25, D. C., for \$1.25 a copy. Code of report—PB 111368.

Compiled especially for electronics design engineers, this handy volume

brings together a wealth of information on fixed capacitors from such widely scattered sources as books, technical journals and house organs. It is designed to give quick answers to questions that frequently recur at the technician's desk or bench.

Circle No. 81 on Reader Service Card

PULSE TESTING

A simple guide to the speedy assembly of a variety of pulse testing systems is provided in a six-page brochure published by *Burroughs Corporation*, Electronic Instruments Division, 1209 Vine St., Philadelphia 7, Pa. Three precision pulse generators made by the Electronic Instruments Division as part of its line of unitized pulse control equipment are also presented in the brochure; collectively, these generators cover the frequency range from 15 cycles to 4.5 mc. and offer various modes of operation.

Circle No. 82 on Reader Service Card

FREED EQUIPMENT

Comprehensive catalogs covering *Freed* transformers and precision laboratory test instruments are available from *Freed Transformer Company, Inc.*, 1715 Weirfield St., Brooklyn (Ridgewood) 27, N. Y.

Catalog No. 545 is a 24-page bulletin, completely indexed, which contains illustrations, dimension tables, technical specifications, and descriptive material on transformers, filters, magnetic amplifiers, reactors and toroidal inductors.

Catalog No. 546 is a 16-page bulletin describing and illustrating the complete line of *Freed* test instruments, including voltmeters, megohmmeters, filters and magnetic voltage regulators.

Circle No. 83 on Reader Service Card

GERMANIUM TRANSISTORS

Bulletin TE 1312 contains specifications, typical characteristics, and typical collector characteristic curves for *Transitron Electronic Corporation's* new line of germanium transistors. These units feature a "hermetically sealed under vacuum" encapsulation to insure reliability under severe operating conditions; they are small in size and capable of power dissipation up to 375 mw.

Copies of Bulletin TE 1312 are available from *Transitron Electronic Corporation*, Dept. REE, 403 Main St., Melrose, Mass.

Circle No. 84 on Reader Service Card

"THIOKOL" LAMINATES

Typical formulations and methods of processing laminates from "Thiokol" liquid polymer/epoxy resins are presented in an eight-page booklet issued

RESEARCH LABORATORY FOR MILITARY ELECTRONICS

FOUR of the engineering departments of the Communications & Electronics Division of *Motorola Inc.* are now devoted exclusively to military research and development activities. Two of these military engineering groups are located in Chicago, Ill., and a third in Phoenix, Arizona. The fourth is the *Motorola* Research Laboratory at Riverside, Calif., which was dedicated recently.

Providing more than 22,000 square feet of space and the latest test and development equipment, the new laboratory at Riverside will concentrate on operations research and dynamic systems analysis projects in order to better the coordination of military and industrial efforts. These projects cover servo-mechanisms, weapon systems, electronic computer application and design, intelligence systems, ordnance devices, air-frame design and flight simulation.

Major facilities comprise an electronics laboratory and analog computing equipment: the electronics laboratory

is equipped with both standard and specialized modern test equipment in the fields of servo, audio, video, r.f. and microwave circuitry, and the initial computer facility consists of 72 computing amplifiers, 16 nonlinear units, two 4-channel graphic recorders, and one 2-variable plotter. The nucleus of the staff of 200 is an experienced team of 40 scientists and engineers acquired from a former National Bureau of Standards activity which was continuously engaged in guided missile research and development.

The four *Motorola* military electronics laboratories are coordinated and complementary, with each providing specialized services to the others. Whenever the need arises at Riverside for pilot production of an item, such production will be handled by the *Motorola* Phoenix Laboratory. Large-scale production will be allocated to the Chicago facilities.

Circle No. 85 on Reader Service Card

Motorola's new research laboratory which is located in Riverside, California.



by the *Thiokol Chemical Corporation*, 780 N. Clinton Ave., Trenton 7, N. J. The booklet gives starting information on the formulation of binders for laminates from combinations of "Thiokol" liquid polymers with several liquid epoxy resins by wet lay-up methods.
Circle No. 86 on Reader Service Card

SHOCK AND VIBRATION ISOLATORS

Features and uses of the Series 5200 shock and high vibration isolators are discussed in *Barry Corporation's* Product Bulletin #541. Data on isolator loads, shock transmissibility, vibration transmissibility and coupled natural frequencies are given in graph form.

Complete specification data is also given in this brochure, copies of which may be obtained from Department #541, *Barry Corporation*, 1000 Pleasant St., Watertown, Mass.
Circle No. 87 on Reader Service Card

INSTRUMENT COMPONENTS

PIC Design Corp., 160 Atlantic Ave., Lynbrook, L. I., N. Y., has announced a new 64-page catalog which illustrates its complete line of precision shafts, gears, collars, couplings, differentials, breadboard equipment, etc. All items are completely dimensioned for design and detail layout, and complete tolerance specifications enable the designer or engineer to mount associated equipment.
Circle No. 88 on Reader Service Card

MAGNETIC TAPE EQUIPMENT

Various magnetic tape equipment developed by *The Davies Laboratories Incorporated*, 4705 Queensbury Rd., Riverdale, Md., for use in the instrumentation field is presented in Bulletin 54-D. Entitled "Magnetic Tape Data Recording Equipment," it covers such items as compensation, recording and playback heads, portable recorders, laboratory recording-reproducing equipment, tape transports, FM discriminators, and playback amplifiers.
Circle No. 89 on Reader Service Card

PRINTED CIRCUITRY

Advantages of printed circuitry for electrical and electronic systems are covered thoroughly in a 12-page bulletin published by the *National Vulcanized Fibre Company*, Wilmington 99, Delaware. Titled "Mechanize Your Wiring. . . With Copper-Clad Phenolite," the bulletin highlights the numerous potentials printed circuitry offers design engineers and manufacturers. Of particular interest is a discussion of the economies of printed circuit design and construction as compared with conventional hand wiring methods.
Circle No. 90 on Reader Service Card

Reactance Annulling

(Continued from page 17)

the preceding parameters determined, the only remaining variables are the driver resonant frequency and the T of the horn. The resonant frequency of the driver is not necessarily fixed by the elements of the moving system but may be suitably adjusted in the case of many systems. If the f_r/f_e ratio is fixed by other considerations, the required T can be obtained from the chart. If this ratio is not fixed, then a T value of .5 to 0.7 would be a satisfactory choice. The resistive and reactive characteristics associated with various T values give the designer an additional tool for matching the characteristics of more complicated driver systems than those considered here.

A common method of constructing low frequency horns is to take off sound from one side and bury the other side in a sealed cavity. While somewhat more expensive and space-consuming because of the cavity required, there can be one design advantage in this arrangement. It is possible to obtain stiffness control of the woofer by judicious use of the air in the cavity. For proper reactance annulling, the cavity size is made such that its stiffness addition to the speaker gives the proper resonant frequency. Implied here is the fact that the speaker resonant frequency must initially be placed considerably lower than the cavity resonance to allow latitude of adjustment. The great advantage of this method of operation is that the addition of the air stiffness allows a lower resonance speaker, so that speaker suspension nonlinearities are of a lower order. The disadvantage is that higher frequencies have difficulty in transmission through the relatively great path length of the horn. In addition, sometimes it is necessary to fold the horn, and then transmission of highs is impossible above a certain frequency. Experimentally, the cavity size can be determined by adjusting it until the first major speaker impedance rise occurs at the horn cutoff point. This value is quite high and cannot be mistaken easily.

When radiation from both sides of the cone is used, the speaker stiffness can be adjusted experimentally by adding stiffening lacquer to the speaker suspension. This system of front and rear take-off is commonly used to provide frequencies higher than can be transmitted, say, through a rear loading horn only. Front radiation may be direct to the air, or horn loading for the front also may be used.

Photographs at the top of page 16 show *Jensen* commercial high-fidelity horn-loading speaker units which employ reactance annulling through use

ROHN
NEW No. 30
HEAVY-DUTY
COMMUNICATION
and MICRO-WAVE
TOWER

Proved in Construction, Design, and Operation

Truly the finest tower of its kind. Made of heavy-duty tubular steel, electric welded throughout. In 10-ft. sections for easy erection, 18-in. triangular design. Can be used non-guyed to 66-ft.—guyed to 200-ft.

Call your Rohn representative or write, phone or wire: "Pioneer designers and manufacturers of all type towers."

ROHN MANUFACTURING CO.
 DEPT. REE • 116 LIMESTONE, BELLEVUE
 PEORIA, ILLINOIS • PH. 4-9156

Circle No. 14 on Reader Service Card

of low T hyperbolic-exponential flares. These units are manufactured and sold under the *Hypex* trademark for wide-range sound reproduction.

REFERENCES:

1. Salmon, V., U. S. Patent 2,338,262.
2. Plach, Daniel J., "Design Factors in Horn-Type Speakers," *J.A.E.S.*, Vol. 4, October, 1953.

Fig. 6. Chart based on Eq. (5).

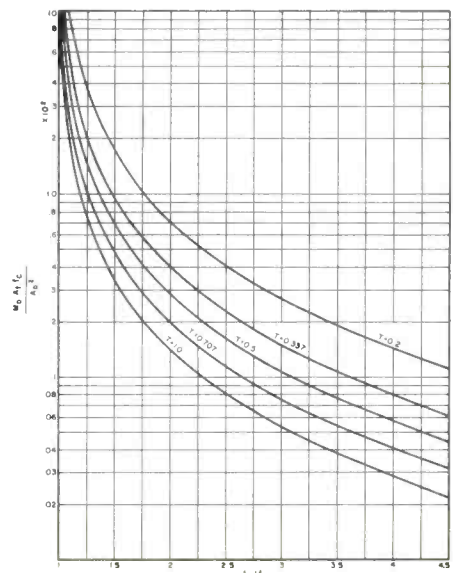

Shaketable Ratings

(Continued from page 9)

variously employed in manufacturers' specification tables. In building up a picture of the use of shaker table specifications vs. the specific job application, a good start can be secured by inspection of Table 1, which shows typical frequency ranges and maximum force outputs measured at no load. Figures 1 and 3 have proven to be helpful in evaluating various shakers.

Assume, for example, that it is desired to shake a 0.25-lb. device at 20 g , 30 cps. Figure 3 shows that a machine of at least $\frac{1}{2}$ " stroke is required to achieve 20 g output at this frequency, and Fig. 1 shows the force output required of the shaker. Considering that most commercial shakers have a weight of moving components exceeding 0.6 lb., the added load of the 0.25-lb. device represents a total load of at least 0.85

lb. This eliminates any shaker of, say, 10-lb. maximum force output; as can be seen from Fig. 1, such a machine delivers only 11.5 g at 0.85-lb. load.

Table 1 shows several shakers having sufficient output for this application provided that the total load, including lead wires, optical devices, etc., is kept below the magnitudes established by the curves of Fig. 1. To make the curves of Fig. 1 convenient to use, they were plotted at values of force output typically found in manufacturers' rating tables showing maximum available g force vs. load. It is, of course, essential to be informed as to the weight of moving components of each shaker under consideration. Note that a shaker of impressively large force output may develop low values of available g force due to heavy moving components.

Minimizing Calibration Errors

At the present time, calibration ac-

curacies of the order of 1% are limited to frequencies between 20 and 150 cps and to accelerations below 1 g . When the errors due to measurements of harmonic content, sideways and resulting crosstalk, amplitude and frequency averaging, and relative phasing of these conditions are combined, it is not surprising to see over-all errors of $\pm 30\%$ unless extreme precautions are employed in conjunction with an appropriate variety of test equipment specially engineered to meet exacting standards.

Output waveform of commercial shaketable amplifiers may have as much as 3 to 5% harmonic distortion even when the equipment is maintained and operated under the best conditions. Periodic inspection of amplifier waveform and appropriate maintenance are required as the quality of waveform is always subject to deterioration.

Shakers in use as calibrators should be mounted on a calibrator stand which may consist of 500 to 1500 lbs. of concrete supported by coil springs such that the suspension resonance is below 2 cps^o. Such a suspension isolates the system from extraneous ground vibration and serves as a dynamically stationary frame to which the calibrator can be bolted. Subsequent measurements of displacement should be mechanically referred to the concrete stand rather than the shaker frame because of the possibility of flexure or resonance of the frame. The line of motion of the shaker should pass through the center of gravity of the block; thus, any use of the shaker for horizontal work when mounted on top of the concrete stand is not conducive to accuracy.

Since the armature structure consisting of the table mass with associated drive winding and drive tube has a local resonant frequency, it is specially important in working near that region to measure the displacement amplitude at a point near the accelerometer case rather than at the opposite end of the armature structure. In all cases, it should be remembered that the accelerometer has a frame of reference in fixed space coordinates that is independent of all external motion.

Flexure resonance in the armature cantilever supports becomes troublesome at various discrete frequencies. Many remedies have been suggested, all of which involve either detuning or damping of the flexures. They may be detuned by clamping weights at appropriate points, or better still, they may be damped by cementing sponge rubber along their full length.

Electrical leads to the accelerometer must be flexible and dressed so as to exert a minimum of interference with the worktable motion. Antinoise rather

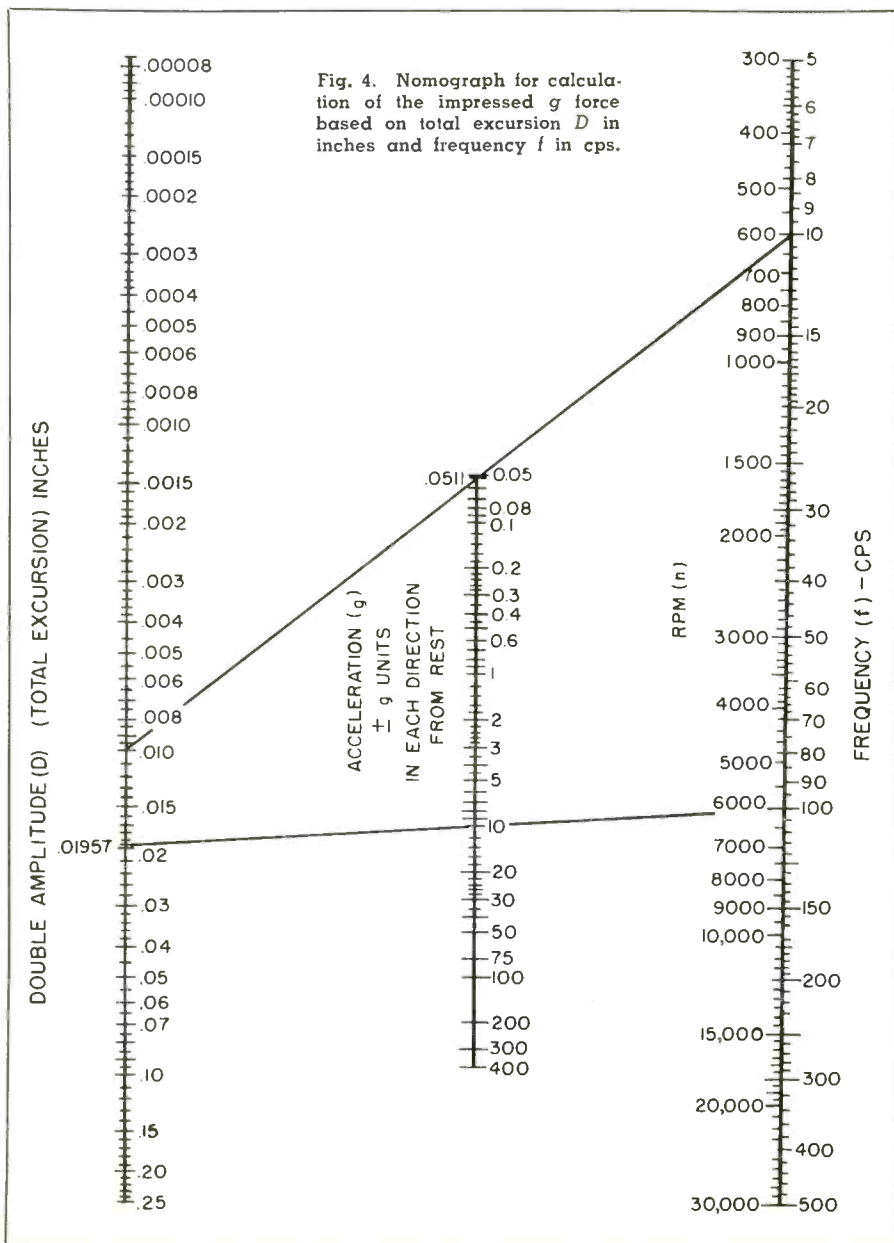

TAKE ADVANTAGE OF THE

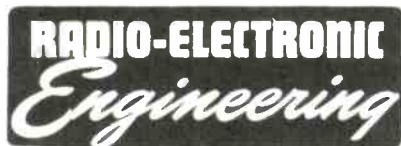

READER SERVICE

Here are the advertisers in this issue of RADIO-ELECTRONIC ENGINEERING. To get more information quickly on their products (listed below), use the convenient post-free inquiry card . . . card also provides for obtaining more information on items mentioned in the various departments.

<i>AD NO.</i>	<i>ADVERTISER</i>	<i>PRODUCTS</i>
(2nd Cover) 1	UNITED TRANSFORMER CO.	Military Components
2	RADIART CORPORATION	Communication Vibrators
3	U. S. MOTORS CORPORATION	Emergency Power Generators
(page 5) 4	RADIO CORPORATION OF AMERICA	Broadcast Studio Control Consoles
5	CHICAGO STANDARD TRANSFORMER CORP.	Transformers
(page 21) 6	CANNON ELECTRIC CO.	Plug-In Electric Connectors
7	AMPEX CORP.	Tape Recorders
8	RADIO CORPORATION OF AMERICA	Employment Opportunities
9	ZOPHAR MILLS, INC.	Waxes & Compounds
10	RESINITE CORPORATION	Embossed Coil Forms
11	AMPERITE CO., INC.	Delay Relays & Ballast Regulators
12	ELECTRO-VOICE	Dynamic Microphones
13	HICKOK ELECTRICAL INSTRUMENT CO.	Television Color Bar Generators
14	ROHN MANUFACTURING CO.	Microwave Towers
15	MONITORADIO RADIO APPARATUS CORP.	Monitor Receivers
16	COUSINO, INC.	Magnetic Tape Splicing Kits
17	CADILLAC TRADING	Tubes (at discount)
18	ELECTRO MOTIVE MFG. CO., INC.	Miniature Mica Capacitors

DETACH AND SEND FOR ADVERTISED PRODUCT & DEPARTMENT INFORMATION

REE 25

PLEASE PRINT

Name _____

Title _____

Company _____

Company Address _____

FOR MORE INFORMATION ON ADVERTISED PRODUCTS, PLEASE CIRCLE NOS.

- 1 2 3 4 5 6 7 8 9 10 11 12 13 14 15 16 17 18 19
 20 21 22 23 24 25 26 27 28 29 30 31 32 33 34
 35 36 37 38 39 40 41 42 43 44 45 46 47 48 49 50

FOR MORE INFORMATION ON DEPARTMENT ITEMS, PLEASE CIRCLE NOS.

- 51 52 53 54 55 56 57 58 59 60 61 62 63 64 65 66
 67 68 69 70 71 72 73 74 75 76 77 78 79 80 81 82 83
 84 85 86 87 88 89 90 91 92 93 94 95 96 97 98 99 100

THIS CARD MUST BE USED BEFORE APRIL 1, 1955

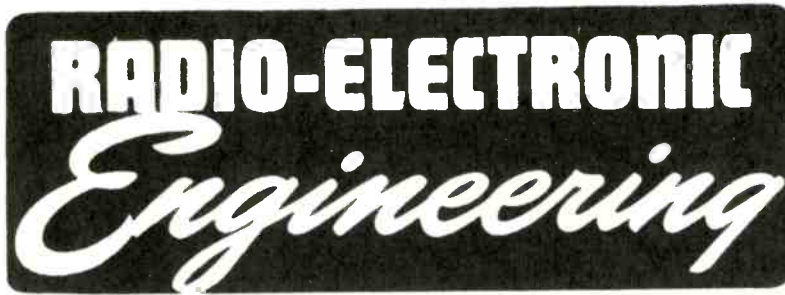

READER SERVICE

RADIO-ELECTRONIC ENGINEERING has always kept its readers up-to-date and well informed on important engineering phases of research, development and application.

The RADIO-ELECTRONIC ENGINEERING Reader Service is designed to provide you with even greater benefits. By taking advantage of this service, you will be able to obtain more detailed information on specific products and department features quickly and easily.

DETACH AND SEND FOR ADVERTISED PRODUCT & DEPARTMENT INFORMATION

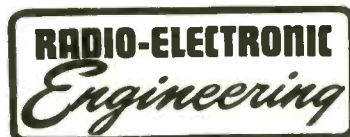
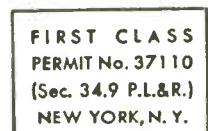

366 MADISON AVENUE
NEW YORK 17, NEW YORK

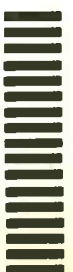

than standard shielded cable must be used when working directly from the high impedance crystal output of an accelerometer. Standard shielded cable exhibits a piezoelectric effect which produces extraneous shake signals when used in a high impedance circuit. Obviously, where high frequency information is desired in such a circuit, accurate equalization must be made for high frequency loss due to shielding capacity. Accelerometers with built-in cathode followers, such as the *Glennite A500C*, have a low output impedance and so do not require the antinoise cable.

Voltmeters and galvanometers used for output measurement must be designed to cover a frequency range that includes the shaker frequency and its significant harmonics.

Specific Techniques

In making *g* calibrations on accelerometers of the velocity, strain gage, or swept potentiometer types, it is necessary to restrict the range of calibration to a maximum of 30% of the natural resonant frequency. In this range, the response is inherently linear and substantially independent of accelerometer damping. However, at higher frequencies, the accelerometers—in addition to becoming nonlinear—become temperature-sensitive due to temperature variation in damping factor. The same characteristics apply to crystal accelerometers; with the latter, inaccuracies and nonlinearity occur in the range of frequencies between zero and a few cps (in some cases as high as 20 cps), the lower limit depending upon the crystal low-frequency roll-off as a function of cathode-follower input resistance and crystal equivalent capacity. To lower the roll-off frequency as much as possible, the cathode-follower input resistance is made as high as possible (100 megohms or more), and the crystal equivalent capacity is also made as high as possible even at the expense of output sensitivity. Furthermore, the electrodynamic shaker waveform tends to deteriorate below 20 cps due to output transformer limitations, so that this region might well be avoided regardless of the accelerometer type. It is good practice, however, to cover a full range of frequencies during calibration, in order to avoid possible errors.

In making frequency calibrations, the *g* value is held constant by resetting the shaker displacement at each calibrating frequency point. Accelerometer output is then plotted against frequency at a *g* value selected for compatibility with convenient measurements of displacement over the frequency range. The precautions previously mentioned in handling resonances, sidesway, wave-

form, etc., must be observed at each new calibration point.

A complete calibration will include two individual transverse sensitivity calibrations taken at right angles and transverse to the accelerometer sensitive axis. For such calibrations, it is essential to use a shaketable of negligible sidesway or transverse motion. A crank-driven machine can be constructed to give 10 *g* at 30 cps with negligible sidesway. This machine is satisfactory provided that a low-pass filter is used at the accelerometer output to remove the harmonic noise components. The transverse sensitivity is commonly given as a percentage of the output obtained along the sensitive axis. For example, 10% transverse sensitivity would mean that the output of the accelerometer for a *g* force along a transverse axis would be 10% of the output obtained when the same *g* force is applied along the sensitive axis.

In some calibration operations, the extensive magnetic field arising from the fixed electromagnetic field system is troublesome and a degaussing device must be employed. Also, in some shakers, the field winding is connected at one end to the 117-volt a.c. line, so that it may be necessary to insulate the accelerometer case from the worktable in order to prevent electrical pickup due to leakage and electrostatic fields.

Careful attention to detail when carrying out accelerometer calibrations or in determining shaketable ratings will result in reliable data.

REFERENCES:

1. Unholtz, Karl, "The Calibration of Vibration Pickups to 2000 cps," *The MB Manufacturing Co., 1960 State St., New Haven 11, Conn.*
2. *Glennite Preliminary Bulletin AT-10, Gulton Mfg. Corp., Metuchen, N. J.*
3. Hardy and Perrin, "The Principles of Optics," p. 579.
4. "Accelerometer Calibrators," *National Bureau of Standards Technical News Bulletin, December, 1948, p. 142.*
5. Kaufman, E. N., "Calibrating Displacement of Shakatables," *Electrical Manufacturing, February, 1954, p. 140.*
6. "Electro-Dynamic Calibrators for Vibration Pickups," *Product Engineering, September, 1951.*

CALENDAR of Coming Events

JANUARY 26—Symposium on Electronics in Aviation, sponsored by IRE, IAS, ION, RTCA, Hotel Astor, New York, N. Y.

JAN. 31-FEB 4—AIEE Winter General Meeting, Hotel Statler, New York, N. Y.

FEBRUARY 10-12—Seventh Annual Conference and Electronics Show, Southwestern Region, IRE, Dallas, Texas.

FEBRUARY 10-13—Third Annual Audio Fair—Los Angeles and Audio Engineering Society Technical Sessions, Alexandria Hotel, Los Angeles, Calif.

FEBRUARY 17-18—National Conference on Transistor Circuits, IRE, AIEE, and U. of Pennsylvania, University of Pennsylvania Auditorium, Philadelphia, Pa.

MARCH 1-3—Western Joint Computer Conference and Exposition, Hotel Statler, Los Angeles, Calif.

MARCH 21-24—Radio Engineering Show and IRE National Convention, Kingsbridge Armory and Waldorf-Astoria Hotel, New York, N. Y.

APRIL 12-15—Symposium on Modern Network Synthesis, Engineering Societies Building, New York, N. Y.

APRIL 15-16—Cincinnati IRE Annual Spring Technical Conference, Engineering Societies Bldg., Cincinnati, Ohio.

APRIL 21-23—AIEE Conference on Feed-back Control, Claridge Hotel, Atlantic City, N. J.

APRIL 27-29—Seventh Region IRE Technical Conference, Hotel Westward Ho, Phoenix, Arizona.

MAY 4-6—Electronic Components Conference, U. S. Department of the Interior, Washington, D. C.

MAY 9-11—National Conference on Aeronautical Electronics, Biltmore Hotel, Dayton, Ohio.

MAY 18-20—IRE-AIEE-IAS-ISA National Telemetering Conference, Hotel Morrison, Chicago, Ill.

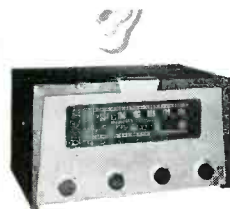

got enough EARS?
BE ON THE CONSTANT ALERT

All Departments Can Now Listen to Every Vital Message

- Nation's most complete line of monitor receivers.
- Crystal controlled or tunable for any VHF FM communication system.
- Mobile or stationary receivers.
- Prices to meet any budget.
- Certified for civil defense use.

MONITORADIO for a thoroughly coordinated 2-way communication system.

Now every member of every department can have radio communication for as little as \$49.95

Write today for further information.

MONITORADIO RADIO APPARATUS CORPORATION

7900 Pendleton Pike, Indianapolis, Ind. Phone: CHerry 2466

For more information, circle No. 15 on Reader Service Card

Frequency Standard

(Continued from page 14)

resistor R_4 . If the amplifier has sufficient gain, oscillation will start at the frequency of minimum degeneration, which is nearly the series-resonant frequency of the crystal, and the lamp resistance will increase with the amplitude of oscillation until the bridge is nearly balanced. When an equilibrium is reached, the bridge attenuation must equal the amplifier gain.

Good amplifier phase stability requires a large voltage gain A and a maximum transmission B through the negative-feedback path. However, certain practical considerations limit the increase of transmission. With a given amplifier, the product of A and B cannot be increased without increasing the crystal current or decreasing the lamp voltage, both of which are undesirable. The 20-ohm glass-enclosed, contoured AT-cut crystal chosen for the present oscillator has a Q of 5×10^5 and a maximum current limitation of 1 ma. The A_1 switchboard lamp R_3 used in the bridge requires at least 0.7 volt for proper operation, so that with a crystal current of 0.7 ma., R_2 is approximately 1000 ohms, and the transmission is approximately 1:50. If the gain equals 1000, then the product of A and B is approximately 20, and a 20-fold reduction in effective phase shift is obtained.

Sufficient voltage gain for good amplitude stability requires two amplifier stages. The crystal current must be kept constant because the resonant frequency is a function of current. With two similar stages, the voltage gain is squared while the shift is at most doubled, permitting sufficient gain without greatly increased phase shift.

A two-stage amplifier with a voltage gain of 1000 exhibits a maximum phase shift of $\pm 10^\circ$ over a two-to-one supply-voltage range. Thus, when the Meacham bridge is used, the maximum expected phase change with feedback becomes $\pm 0.5^\circ$. The crystal must experience the same phase shift, and its frequency will be pulled accordingly. With a Q of approximately 5×10^5 ,

the corresponding fractional frequency change is $\pm 1 \times 10^{-8}$. Thus, with reasonably constant supply voltages, the short-term frequency stability can be expected to be somewhat better than $\pm 1 \times 10^{-8}$ mc., or ± 0.01 cycle. The long-term stability will depend on these and other factors, however, including the drift of the crystal resonator itself.

To obtain the best frequency stability, the AT-cut crystal is kept in an oven at a specified, constant temperature. The oven is a single-stage type, with temperature control provided by a 50° mercury thermostat. A Dewar flask is used to isolate the controlled oven chamber from outside temperature changes. Consequently, the average power requirement is only 0.4 watt at a temperature difference of 25°C . Frequency changes in the crystal due to oven cycling are less than 10^{-9} cps, and normal laboratory temperature changes are apparently not reflected in the temperature of the crystal. ⊕⊖

New Products

(Continued from page 31)

plete sealed tuned circuits with shunt capacitors included to customer specifications.

Circle No. 91 on Reader Service Card

MINIATURIZED DECADE COUNTER

Development of a miniaturized electronic decade counter using the E1T decade scaler tube has been announced by *Ransom Research*, P. O. Box 382, San Pedro, Calif. Four types are available immediately: 20-, 40- and 100-kc. scalars, and an output stage scaler operating at 10 cps which can be used to feed a mechanical counter. The 40- and 100-kc. types can be furnished with or without an input shaper circuit.

The *Ransom* decade counter employs plug-in construction, with an *Alden* 20-pin plug, for quick installation and removal as well as to permit use of a number of counters as building blocks to form any desired combination. All types measure only $1\frac{1}{4}'' \times 3\frac{1}{4}'' \times 3\frac{3}{4}''$ exclusive of tubes, and weigh only 11 ounces with tubes in place; one miniature tube is used in addition to the E1T scaler tube, and when an input shaper circuit is included a second miniature tube is employed.

Circle No. 92 on Reader Service Card

PULSE GENERATOR

Model PG-215 is a mercury-delay plus pulse-forming-line type of generator, available from *Teletronics Laboratory, Inc.*, Westbury, N. Y., which produces rectangular waveforms having rise, duration and decay times in the millimicrosecond range. Rectangular pulses at recurrence rates of 60 or 120

per second are provided, with rise and decay times down to 1.2 millimicroseconds. Minimum width is 1.2 millimicroseconds, and maximum width is unlimited. The amplitude of the output pulse is variable from 0 to 35 volts with a 93-ohm load.

The generator also furnishes an isolated trigger signal, advanced in time with respect to the main pulse,



for synchronizing associated equipment. All of the time parameters are determined by sections of standard coaxial cable supplied by the user or contained in the Model PGA-220 width and delay unit (right), available as a separate accessory, which provides 25 different sets of values of rise and decay time.

Circle No. 93 on Reader Service Card

CALIBRATION PULSE GENERATOR

Precise measurement of studio color-signal voltage by television broadcast stations is facilitated with the calibration pulse generator announced by the Engineering Products Division, *Radio Corporation of America*, Camden, N. J. The WA-9A is particularly suited for calibrating the processing amplifier and other elements of the RCA 3-Vidicon color film camera chain to obtain accurate matching of the red-green-blue color channels. It is also useful with the RCA live color camera, and is applicable for measuring monochrome voltages.

Compact, and featuring a self-contained power supply, the WA-9A can be installed in a TV system as one

PHOTO CREDITS

PAGE	CREDIT
7, 9 . . .	Northrop Aircraft Co., Inc.
8 (except 2nd from top) . . .	Gulston Mfg. Corp.
8 (2nd from top) .	MB Mfg. Co., Inc.
10, 11	Lampkin Labs., Inc.
14	Nat. Bureau of Standards
15, 16, 17	Jensen Mfg. Co.
18	Atlantic Refining Co.
19	Baltimore & Ohio Railroad
20	Collins Radio Co.

SPLICES MAGNETIC TAPE

Neatly - Quickly - Easily

Kit includes plastic splicer which adheres to recorder or worktable, generous supply of pre-cut tape splicing tabs, handy blade, instructions and plastic case. Only \$1.50 postpaid. If your dealer can't supply you, order from . . .

COUSINO, INC.

2321 Madison Ave.

Toledo 2, Ohio

Circle No. 16 on Reader Service Card

TUBES

70% to 90% DISCOUNT

Government, manufacturers, jobbers, etc. surplus. Guaranteed 1 year. Free catalog on request. CADILLAC TRADING, Dept. W, 231-07 Linden Blvd., Jamaica 11, N. Y.

Circle No. 17 on Reader Service Card

input to a switcher, or can be connected to a jack panel to permit quick patching to any part of the system as desired. It can be used to calibrate oscilloscopes and master monitors by merely substituting its output for the normal input signal. When employed as a video input to a switcher, the generator can be switched in and out rapidly for precise matching of video signals from various sources.

Circle No. 94 on Reader Service Card

DELAY LINE

Helipot Corporation, 916 Meridian Ave., S. Pasadena, Calif., has introduced the "Helidel" delay line for use in color TV broadcasting, radar scanning, high frequency oscilloscopes, short-time memory systems and many other applications. The "Helidel" (trade name) is a continuously variable unit of the distributed-constant electromagnetic type affording precise selection of extremely short time intervals with fine linearity and resolution.

Delay is adjustable in increments of only 0.02 millimicroseconds, and signals are transmitted with minor distortion of waveshape. Other features include a rise time of 0.0175 μ sec. maximum, a bandwidth of 20 mc., and negligible overshoot or phase distortion. Two standard models are available: a 10-



turn unit with total delay of 0.2 μ sec., and a 15-turn unit with total delay of 0.3 μ sec. The latter is particularly useful for color television phasing requirements.

Circle No. 95 on Reader Service Card

AUTOMATIC BALANCE CONTROL

One of the most difficult problems with which the color TV broadcaster is faced is that of drift in the modulator sections of the colorplexer. The Model 617-BR automatic balance control developed by Telechrome, Inc., 632 Merrick Rd., Amityville, L. I., N. Y., completely eliminates the drift problem. An ingenious circuit locks the entire color broadcasting equipment in perfect balance within 20 seconds after being turned on; and balance is held to better than 2% after weeks of operation.

This automatic balance control holds balance even under conditions where ordinary colorplexers might go com-

pletely out of control. Tubes may be replaced, room temperature conditions varied, line voltages changed, and manual controls turned without affecting the colorplexer. Warm-up time is unnecessary, saving many engineering hours per week, and need for standby personnel to reset balance is eliminated.

The Model 617-BR is also incorporated in the new Telechrome Model 609-ER colorplexer.

Circle No. 96 on Reader Service Card

Y-Function Plotter

(Continued from page 11)

both forward and backward. The curves followed each other to within 1 or 2%. On some gear combinations, the backlash or "hysteresis" effect is much worse, since only plain gears and auto-speedometer cable are used in this mechanism. If desirable, one could rule his own graph paper in the Y-plotter by setting the pen at points corresponding to the dial calibration and traversing the paper with the centering control.

A multitude of curves for developmental work was made with the laboratory setup shown in Fig. 3. From left to right are an r.f. signal generator, the Y-plotter atop the recording potentiometer, and a developmental narrow-band FM modulation meter. Although the signal generator shown is designed for amplitude modulation, frequency modulation was used instead by adding a capacity modulator (from surplus RT-7/APN-1 radio-altimeter gear) to the master oscillator. With the plotter driving the r.f. attenuator on the signal generator, groups of curves were run off for variable r.f. input levels showing: (1) modulation-meter reading for constant FM modulation, and (2) variation of limiter grid current, used for tuning indication. Each of these characteristics was run at 30, 150, and 450 mc. After initial setup, each curve involved simply setting panel controls and running the drive motor. Excellent correlation between the logarithmic graph-paper scale was obtained.

Typical voltage-current characteristic curves for germanium diodes, made with the Y-function plotter in the arrangement of Fig. 2B, are reproduced

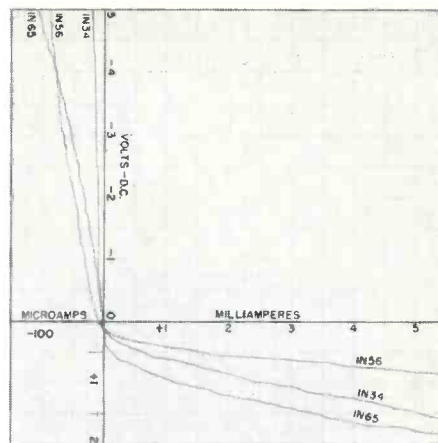

Fig. 6. Typical voltage-current characteristic curves for germanium diodes made with the Y-function plotter.

in Fig. 6. The circuit shows a battery and low-resistance potentiometer as a source of variable d.c. voltage, and a voltmeter to which the voltage scale of the graph paper was matched. In order to spread out the curves, two recorder shunts were provided, one to yield a scale of 50 μ a./cm. and the other 0.5 ma./cm.; as the applied voltage went through zero, coming from a negative direction, the 0.5-ma. shunt was closed manually. Curves such as these can be made rapidly enough for production or inspection purposes.

Advantages

To the engineer, it will be apparent that the Y-plotter is adaptable to a wide variety of situations. Usually, when the engineering or experimental setup of apparatus has been completed, this device will step in and save hours of tedious labor—and to one who has gone through this labor, just watching the unit in action is stimulating. Compared to an X-Y recorder, the Y-plotter costs about half as much and does not require conversion of the X variable to a d.c. voltage—something that is hard to do over a wide range of frequency. The Y-plotter is two or three times more accurate than a cathode-ray curve tracer, and produces a permanent written record.

The work reported herein was supported by the K-F Foundation, Inc., a nonprofit research organization.

INDEX OF ADVERTISERS

NAME	PAGE	NAME	PAGE
Amperite Co., Inc.	29	Monitoradio Radio Apparatus Corp.	37
Ampex Corp.	23	Radiart Corporation	3
Cadillac Trading	38	Radio Corporation of America	5, 24, 25
Cannon Electric Co.	21	Resinite Corporation	29
Chicago Standard Transformer Corp.	6	Rohn Manufacturing Co.	35
Cousino, Inc.	38	U. S. Motors Corporation	4
Electro Motive Mfg. Co., Inc.	40	United Transformer Co.	2
Electro-Voice	31	Zophar Mills, Inc.	29
Hickok Electrical Instrument Co.	33		

...here's new might for miniatures

Dur-Mica DM15

World's Smallest Mica Capacitor
The First Miniature Dipped Mica Capacitors with Parallel Leads.

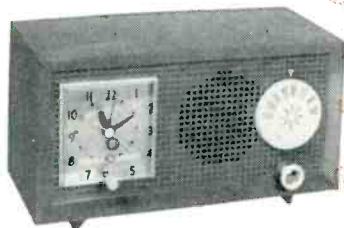

NOW! Also available . . .

El Menco Dur-Mica DM20

1 to 3900 mmf. at 500vDCw

1 to 5100 mmf. at 300vDCw

El-Menco
Dur-Mica

IDEAL FOR PRINTED CIRCUITS. Meets all Humidity, Temperature and Electrical Requirements of MIL-C-5 Specifications. El Menco's Dur-Mica DM15 establishes a "new dimension" in capacitor performance with ranges from 1 to 390 mmf. at 500vDCw and 1 to 510 mmf. at 300vDCw. A new, tougher phenolic casing provides temperature co-efficient and stability equal to or better than characteristic F in all but the lowest capacity values . . . efficient operation at temperatures as high as 125°C. El Menco's Dur-Mica DM15 can be used in a variety of transistor circuits and other miniature electronic equipment in military and civilian applications.

Sells for Less than the famous El Menco CM-15 — Provides Economy of Size with Maximum Performance and Widest Application.

test El Menco "Dur-Micas" for yourself!

Write for free samples and catalog on your firm's letterhead.

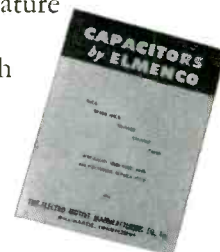

El-Menco
Capacitors

THE ELECTRO MOTIVE MFG. CO., INC.
WILLIMANTIC CONNECTICUT

molded mica · mica trimmer
tubular paper · ceramic

Jobbers and distributors write to Arco Electronics, Inc., 103 Lafayette St., New York, N. Y.

For more information, circle No. 18 on Reader Service Card