

250
No New Stations Conference Decides

Radio Digest

EVERY
WEEK

PROGRAMS
Illustrated

TEN
CENTS

REG. U. S. PAT. OFF. & DOM. OF CANADA

Vol. XV

Copyright 1925
By Radio Digest Publishing Co.

SATURDAY, NOVEMBER 28, 1925

No. 8



*How Hershfield's
"Abie" Met "Mike"*

*New Counterphase—Bridge Tuned R.F. Set; Photos and Stories of WHAZ and KOIL;
The Effect of Broadcasting on Football; Special Weekly Index to Women's Programs*

CINCINNATI TO PLAN BETTER BROADCAST

COMMUNITY PROGRAMS UNDER OLD WLW DIRECTOR

High Class Entertainment from WSAI Will Be Without Mark of Advertising Propaganda

CINCINNATI.—This city, through its chamber of commerce, has appointed a community broadcasting committee which has developed a plan for broadcasting from WSAI a series of twenty Radio programs; the first concert to be given on Monday, November 30. Backed by the principal business interests of the city, the committee has raised a substantial fund for this purpose.

This fund will enable Cincinnati to send out to Radio listeners all over America and in many distant lands twenty of the most wonderful concerts and feature programs that have ever been broadcast. Some of the best-known artists in America have been engaged to appear on these community programs, among them being Marie Morrisey, contralto; Francis McMillen, violinist; Paul Althouse, tenor, and Grace Kerns, soprano.

The Cincinnati community programs will be inaugurated by the Cincinnati Symphony orchestra, under the direction of Fritz Reiner. This remarkable young conductor, because of his combined talent and energy, has made a profound impression upon the public during his three years in America as conductor of the Cincinnati Symphony orchestra. His success as guest conductor last summer, both at the Hollywood bowl and at the New York stadium, convinced musical America of his masterful genius.

History of the Dance

Part two of the opening program will offer a novel history of the dance with a picturesque touch concerning the origin of Cincinnati, featuring the Community Concert orchestra. The evening will conclude with a delineation of modern dance music by the famous Henry Lang and his orchestra.

During the succeeding programs a splendid concert orchestra, made up of the symphony's best musicians and directed by Ary Van Leeuwen, will be ready constantly with feature programs, accompaniments and a reliable background for the great variety of entertainment which will be heard during these Monday night productions. Mr. Van Leeuwen is a musician of great and varied experience, besides being a soloist of international fame. At present he is filling the post of first flutist of the Cincinnati symphony.

Community Spirit Predominates

So completely has the community spirit entered into the plan of these programs that not even the name of the firm owning and operating Station WSAI will be mentioned either over the air or in the press. Neither will the scores of firms whose contributions have made possible these extraordinary programs derive any direct publicity from this enterprise. The announcer will simply give the call letters, WSAI, mentioning Cincinnati, and from time to time "Cincinnati's community program."

Fred Smith, former WLW director, whose articles on "Broadcasting Abroad" recently ran in the Radio Digest, is responsible for the plan, which, he says, is the direct result of his studies of broadcasting conditions in eight countries. Smith will direct and announce the twenty Cincinnati community programs.

KOA TO BROADCAST SHAKESPEARE SCENE

Denver Station to Put Famous "Hamlet" Part on Air

DENVER.—All characters in Shakespeare's famous grave-digger scene from "Hamlet" will be portrayed by a single actor, John Connery, as one of the headline attractions of a two-hour program of dramatics at KOA, Denver, Wednesday evening, December 2. Connery formerly appeared with John Barrymore in this play and recently won wide favor with KOA's listeners in "The Man in the Stalls."

Two one-act dramas featuring the KOA players are also billed. They are "The Twelve Pound Look" and "Passe."

Artists taking part are Iris Ruth Pavey, director of the KOA players, Otis B. Thayer, director of the Otis players, Gertrude M. Richards, Clayton C. Cowan and Clarence C. Moore. Musical interludes between plays will be provided by the KOA orchestra.

Madrid will shortly have a third Radio station. It is being put up by the "Union Radio S. A." and will be opened within the next few weeks with a 6-kilowatt transmitter working on a uniform wave

OLD-TIME MINSTREL REWRITES OLD SONG

NEW YORK.—Two old-time minstrel numbers on the program of "The Gold Dust Twins," broadcast by WEA and nine other stations recently, had a human interest story connected with them. "I'm as Happy as a Big Sunflower," made popular by Billy Emerson and Bobby Newcomb and the team of Delehanty and Hengler, was requested by an old-time minstrel, Al Walker, who has been retired from the boards for thirty years. Although nearly blind, he wrote out the words and music for the Twins who, he says, are the successors of the old-time minstrels. "Shoo Fly," an old-time song and dance that achieved great popularity with Bryant's minstrels in 1869 and 1870, was the other number to be heard during "Goldy" and "Dusty's" program.

FRONT COVER LADY IS KFWB ANNOUNCER

THAT soft, southern voice heard on the Pacific coast announcing visitors at the Hollywood station, KFWB, is none other than that of the beautiful little lady whose picture adorns the Radio Digest cover this week. One guess as to her name, for her beauty won her place through another photograph in these columns last week.

Correct. She is Helene Costello, of course.

Helene is the daughter of the great Maurice, former idol of the screen but not so often seen of late. She is just getting started with Warner Brothers. Directors and cameramen have unanimously voted her into the "million dollar face personality" class. Radio listeners declare that these qualities should also apply to her broadcasting ability.

To Radio Yule Greetings to Canadian Arctic Posts

OTTAWA, Canada, Nov. 7.—Arrangements for special Radio messages, including Christmas and New Year greetings to Mounted Police posts in the Arctic, have been made by the Radio branch of the Canadian department of marine and fisheries. It is announced that the Westinghouse company's broadcasting station at Pittsburgh will carry transmissions addressed to the Royal Canadian Mounted Police on Nov. 21st, December 31st, January 16th and February 20th.

The wave lengths will be 309 meters and 64 meters, both transmissions being made simultaneously on these wave lengths from Pittsburgh.

Hickman's Dance Orchestra Opens New Ziegfeld Palace

LOS ANGELES.—Flo Ziegfeld, known the world over as a picker of feminine pulchritude, has selected Art Hickman and his Los Angeles Biltmore hotel dance orchestra to open his new Ziegfeld Institution at Palm Beach, Florida, which has just been completed at a cost of \$2,000,000.

The orchestra, numbering 13 musicians, are to be paid \$3,000 a week for this engagement, which is said to be a record price for a dance orchestra of this size. Art Hickman and his dance orchestra are well known to listeners in the west as the orchestra has been on the air over KHJ since the Biltmore hotel was built.

CONTENTS

Radio Digest, Illustrated, Volume XV, Number 8, published Chicago, Illinois, November 28, 1925. Published weekly by Radio Digest Publishing Company, 510 N. Dearborn Street, Chicago, Illinois. Subscription rates, yearly, Five Dollars; Foreign Postage One Dollar additional; single copies Ten Cents. Entered as second class matter at the post office at Chicago, Illinois, under the Act of March 3, 1879.

All the Live News of Radio.....	1 to 11
Hersfield's "Abie" Meets "Mike" at WOR.....	4
Broadcasting Stirs Record Interest in Football.....	5
Three Continents Hear WEAZ with 500 Watts.....	6
Iowa's "Big Oil Man" Builds Station KOIL.....	7
Index to Women's Programs.....	11
Advance Programs for the Week.....	13 to 21
Evening at Home with the Listener In, a chart in central time, showing when to listen in for your favorite stations.....	20
Editorials, Indi-Gest and Condensed by Dielectric.....	22
Interesting and Simple Explanation of Radio, Chapter V—Ether Cyclones and Selectivity, by H. G. Tanner.....	23
More About the Underground Antenna System by George W. Gayer.....	24
Counterphase: Perfect Bridge Tuned R.F. Set, Part I—The Whys and Wherefores, by James McDonald.....	25
DX-Seven: Selective D-Coil 7-Tube Super-Het, Part II—Drilling and Assembly, by John G. Ryan.....	27
Clock Case Furnishes Disc Speaker; Other Kinks.....	29
Directory of Radiophone Broadcasting Stations, Part III.....	31

Looking Ahead

Good, Little Old Harmonica—never able to grow up above boyhood days—at last recognized, thanks to Radio. Blows its way into fame through some of our best known broadcasting studios. Gets its picture into next week's Radio Digest. For those who never knew the real family name of the mouth organ, it's harmonica, if you please. And may their tribe prosper! Picture pages will delight the eye as the Radiophone had delighted the ear with some of the most renowned ukulele ladies. No, they are not from Hawaii but you will be just as well satisfied.

WJZ-WJY, New York, is a wonderful broadcasting station with programs that cannot be surpassed. Their artists, glimpses of the studio and operating rooms will be seen in next week's Radio Digest. There also is a romantic story back of the famous WCAD General Electric station located at Canton, N. Y., which rebroadcasts programs produced in half a dozen of the larger eastern cities. Its slogan is "The Voice of the Great North Country."

Operating and Trouble Shooting of Crosley Trirdyn will give the thousands of owners of this popular set some insight into the finer points of using it. These articles on widely used receivers have always been a feature of Radio Digest and this season there will be such an article in practically every issue.

The Assembly of Counterphase 3-Stage Bridge Circuit will be the second article by James McDonald. Next week he gives directions for drilling the front panel and the sub base, and the assembly of the various units on them.

That Compact Little Super, DX-Seven, will reach the wiring stage in next week's issue when John Ryan describes the placing of every wire and, with numbered photos, makes this part of constructing a set so clear that even the newcomer cannot go wrong.

Newsstands Don't Always Have One Left

WHEN YOU WANT

Radio Digest

YOU WANT IT!

BE SURE OF YOUR WEEKLY COPY BY SUBSCRIBING NOW

SEND IN THE BLANK TODAY

Publisher Radio Digest, 510 N. Dearborn St., Chicago, Illinois.

Please find enclosed check M. O. for Five Dollars (Six, Foreign) for One Year's Subscription to Radio Digest, Illustrated.

Name

Address

City..... State.....

FAMED ANNOUNCERS AID WRC IN SIGN-OFF

TWELVE STATIONS CLOSE WASHINGTON PROGRAM

Delegates to Radio Conference Give World's Most Elaborate Closing for Nation's Listeners

WASHINGTON, D. C.—The most elaborate sign-off ever made in the history of Radio was broadcast from WRC, Radio corporation station here, on the night preceding the conclusion of the fourth national Radio conference.

Twelve leading announcers and captains of the Radio industry participated in the notable event when the "good nights" were said by representatives of broadcasters located in every section of the United States.

The voices which preceded those of Norman Brokenshire, giving the formal sign-off for WRC, were Lambdin Kay, "The Voice of the South," of WSB, Atlanta Journal; Powel Crosley, Jr., president of the Crosley Radio corporation, Station WLW, Cincinnati; E. L. Tyson, chief announcer and director of WWJ, the Detroit News; Roy C. Griffin, chief of KVOO, Bristow, Okla.; G. E. Zimmerman, director of KPRC, Houston, Texas; Thomas P. Convey, manager of KMO, "The Voice of St. Louis"; R. G. Bettis, manager of WOQ, Unity School station at Kansas City, Mo.; C. B. Williams, director of the Rhodes store broadcaster, KFOA, Seattle, Wash.; L. B. Henson, supervisor of WFAA, the Dallas News and Journal station, Dallas, Texas; Harold Hough, reported by many to be none other than the famous "Hired Hand" of WBAF, Star-Telegram station at Fort Worth, Texas, and Paul Neal, chief engineer for Chicago Tribune and Liberty stations, WGN and WLIB, Chicago.

All of the "announcers for the night" were delegates to the Radio conference and gathered for the evening as the guests of the Cafe Le Paradis, from where WRC was broadcasting a late program of Meyer Davis dance music, from midnight to 1 o'clock.

Barnum Story Town Is Holder of New Record

Winsted Quartet Takes Barber Shop Ballad Contest

HARTFORD, Conn.—Winsted, Conn., the land from whence comes the weird tales of picking strawberries when the snow is on the ground, of horses with wooden legs, of the hen which rides on the tender of an engine and as she steps off at the next station leaves an egg as fare, has another story to tell.

In the Barber Shop Ballad contest presented Tuesday evening in the studios of WTIC, broadcaster of the Travelers Insurance company, the Julian Brothers quartet from Winsted made a name for themselves and brought more fame to the little town up in the Berkshire hills.

The contest, which was for the Barber Shop Ballad championship of Connecticut, brought nearly as many applause cards as did the broadcasting of the world series. All votes were cast by number and number 26, the quartet from Winsted, received an overwhelming majority of votes as well as the decision of the three judges.

The quartet, by winning the contest staged by WTIC, has the right to take part in the New England finals which will be staged in Boston some time next month.

RADIO EDITOR WILL BE NEW DIRECTOR AT WLS

D. D. Richards Resigns from Post to Assume New Work

CHICAGO.—D. D. Richards, Radio editor of the Chicago Post during the past two years, recently left that position to become assistant director of Station WLS of the Sears-Roebuck Agricultural foundation. In his new capacity, Mr. Richards will do some announcing, but for the most part will be in charge of the extension work of the station, in their rural service department.

Mr. Richards has had many years experience in farm and ranch show production, which will aid him in the broadcast of county and state fairs, a Radio field recently uncovered by WLS. The recent memorial dedication on Armistice Day at Oak Park, near here, was put on the air by him. Vice-President Dawes and General Harbord were the chief speakers on this occasion.

Since switching over to the powerful new transmitter at Crete, Ill., WLS is reaching farther than ever, bringing many more into its Radio family.

NO NEW STATIONS CONFAB DECIDES

YALE TO BE ON AIR WITH PROGRAM SOON

ARRANGEMENTS MADE FOR BROADCASTING SERVICE

University Will Present Many and Interesting Features as Result of Hook-Up

HARTFORD, Conn.—Yale university will soon be linked up with the broadcasting service of the Travelers Insurance company. Programs from both Woolsey hall and Sprague Memorial hall will be put on the air from the Hartford station. Final arrangements have been completed for this exceptional hook-up which is by far the most important among the many which WTIC has made since it began broadcasting last February.

Large Variety of Programs

WTIC will install an amplifying system in New Haven involving many unusual engineering features which will carry the material for broadcasting direct to the



HER SONGS BRING HER PRETTY FURS

KNX Singer Heard by Arctic Trapper Rewarded by Best Winter Fox Pelts

HOLLYWOOD, Calif.—Who says broadcasting doesn't pay! If you don't believe it pays good dividends ask Lilyan May Challenger, the girl with the perfect Radio voice who sings every Monday night from KNX.

This summer Miss Challenger received a letter from William Burges, a fur trapper employed by Rivillion Freres, who spends his winters in the James bay region of the Hudson's bay country, telling her how he enjoyed hearing her over his Radio set. Later she received a fine red fox pelt from the trapper and now she has again heard from him with the promise that she will receive as a gift the very finest pelt he takes this winter season, which, if something like a silver fox, will make Lilyan May Challenger's songs quite valuable.

Mr. Burges is so far off the beaten track that it sometimes takes two months for a letter from Hollywood to reach him, but by means of Radio he can hear the songs of Lilyan May Challenger in the lonely wilds of the far North just as quickly as those who live in the semi-tropical climate of southern California.

HOOVER CONFERENCE GOES ON RECORD FOR PUBLIC INTEREST

Stations to Be Given Privileges According to Service Rendered Listeners—Meeting Rules Against Direct Ads and for License Fees

"RADIO DINNER" NEW IN ENTERTAINMENT

HASTINGS, Nebr.—Enter the Radio dinner! A lady fan recently asked officials of KFKX, Westinghouse broadcasting station here, for any folders or literature they might have pertaining to the station and its activities. She explained that she wanted them to use as favors at a Radio dinner, inasmuch as the Hastings broadcasts were always enjoyed by her friends. She also asked assistance in the planning of an appropriate menu for ardent followers of the dial and vacuum tube.

WASHINGTON.—Overshadowed at all times in its work by the uncompromising attitude of the American Society of Composers, Authors and Publishers, which threatens to extract many hundreds of thousands of dollars from the broadcasting stations, the fourth national Radio conference closed here recently, a declared success in all its major resolutions passed. Over five hundred representatives of the newspaper and Radio press, broadcasting stations and Radio receiver manufacturers attended.

Called by Secretary of Commerce Hoover, who presided at all the general conference sessions, the assemblage accomplished much important work, which may be listed as follows:

1. It was recommended that broadcasting stations should not be used for direct sales efforts, but confine their activities to courtesy and indirect advertising.
2. Power shall not be limited where it

RADIO'S FUTURE BARRYMORES

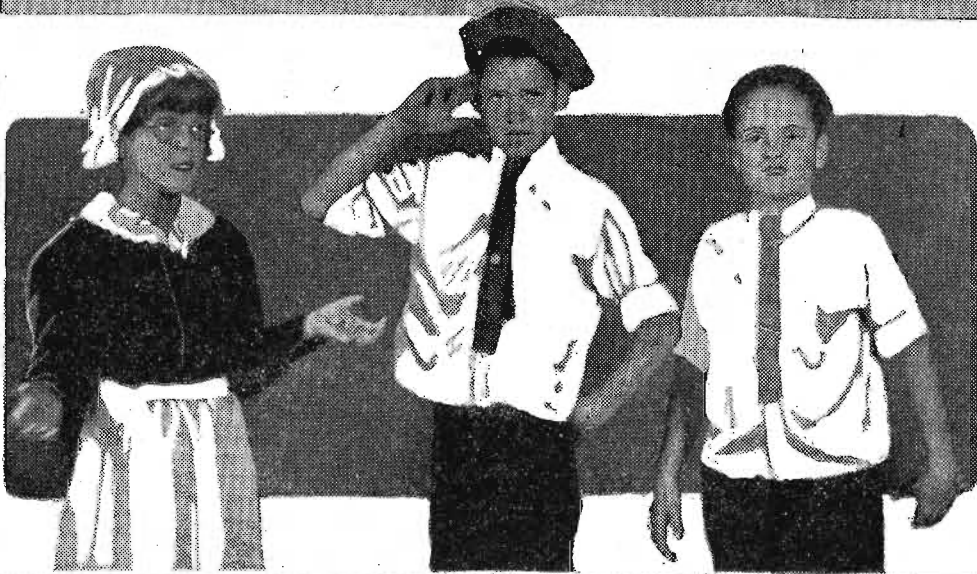

A full hand of Mrs. Whistler's juvenile stars who broadcast from WOAW. The three queens from left to right are: Frances Witzke, Margaret Runsteen and Cleo Scott. The two kings of childhood dramatics are Rodney Runsteen, "Penrod of the Air," at left in the center group, and Harry Runsteen, to the right, star in "His New Brother."

transmitter in Hartford. It is one of the most difficult propositions ever undertaken by any broadcasting station because of the variety of programs involved. The hook-up will enable the university and the station to present educational and entertaining features which would include lectures, chamber music, athletic events, concerts by the Yale glee clubs and symphonic orchestras, and recitals by Professor Jepson on the immense Newbury memorial organ in Woolsey hall. This organ will undoubtedly come in for a big share of broadcasting as it is one of the largest in the world and Professor Jepson is a musician of national fame.

The installation will be such that Woolsey hall may in the near future be used as a central transmitting point for remote controls in and around the university.

CANADIAN RECEIVERS INCREASE OVER 7,000

Licenses Issued Show How Radio Popularity Is Growing

OTTAWA, Ont.—An increase of 7,323 in the number of Radio receiving licenses issued in Canada for the nine months of the present year, as compared with the corresponding period in 1924, is shown by the records of the Radio branch of the department of marine and fisheries.

The number of yearly receiving licenses issued up to the end of September this year totals 64,682, as against 56,859 granted during the same period in 1924. Ontario leads the list with a total at the end of September of 32,833. Quebec ranks second with 9,062, while Saskatchewan is third with 7,729.

WOAW programs have from time to time been featured by the excellent dramatic reading of the pupils of Pearl Stephens Whistler, instructor of expression and dramatic art, in Omaha. Mrs. Whistler, who has resided in Omaha for twenty years, is a newcomer in the field of Radio drama, but her work has shown originality and technical perfection which merits recognition. She specializes in readings which call for elaborate costuming. She was formerly associated with the Misner School of the Spoken Word and Fine Arts, an accredited dramatic school. At one time she was interested in music instruction. Her experience in these fields has qualified her for Radio programs of unusual variety and ability. Through the months of April, June and August of this year she presented Radio programs which were well received by WOAW's listeners, and she is at present arranging and presenting a regular schedule of one-act plays and dramatic readings from WOAW.

Many Child Radio Stars

Among the juvenile talent which Mrs. Whistler has used for Radio entertainment, the Runsteen trio are prominent. Margaret, 11 years old, gives characterizations of Aunt Jane, a well-known character impersonation. Rodney, aged 13, is effective in the role of Penrod, from Tarkington's famous book, adapted as a Radio monolog. Harry Runsteen, 10, features in "His New Brother," and the portrait exhibits his disgust upon being introduced to his new brother.

Cleo Scott, 14 years old, is a promising impersonator, and features especially in the Pollyana impersonations, from Eleanor Porter's works.

Frances Witzke, one of her youngest students, aged 7, shows ability as a comedienne, starring in the characterization of "Miss Dorothy Entertains the Minis-

ter" and, as usual, she spills the family "beans."

Genevieve Moulton is shown in the old-fashioned role, "Little Miss Prim," and although she is but 7, she hits the high spots in dramatic reading; while her sister, Alta Mae, 11, knows how to put the "kick" in such popular pieces as "Betty at the Ball Game."

Little "Alice Blue Gown"

Eva Bernice King, 12, stars in the presentation of "Alice Blue Gown," adapted from the comic opera, "Irene," as a Radio musical reading.

Richard Monroe, 13, who has been studying with Mrs. Whistler for almost two years, takes to the "heavy" type of drama with dignified precocity. Shortly, he expects to qualify for chautauqua work, and his renditions show the inherited ability of the family for dramatic art. He particularly likes to give "Danny of the Patch," the masterpiece of Elias Day.

WOAW is very particular about its juvenile talent. It is the policy of the director to exclude all but genuine talent, for the director believes the day has passed when a child's voice is "cute" over the Radio just because it is a child's. Nor does WOAW tolerate the ordinary "yellocutionists" of the old school. Hence, it is a special tribute to Mrs. Whistler's abilities as an instructor in dramatic art and expression that her work is broadcast by WOAW.

Paraguay to Have Station

WASHINGTON, D. C.—Paraguay is now evidencing interest in Radio broadcasting and it is understood that the ministry of war and marine has already decided to purchase the necessary equipment although it is reported that the decree authorizing this action has not yet been signed, says consular advices to the department of commerce.



does not interfere unduly with other stations or reception by the public.

3. Further time division by existing stations is unnecessary and inadvisable.

4. Stations using more than 500 watts power should have individual wave lengths or frequencies. Stations transmitting with 500 watts or less power will be duplicated in wave length providing duplicating stations are separated geographically by sufficient distance to avoid beat notes or interference.

5. Rebroadcasting of programs should (Continued on page 29)

Hershfield's "Abie" Meets "Mike" At WOR

HARRY HERSHFELD, business manager and promotion director for Abie, the well-known Agent, put the cork in the India ink bottle, wiped a smudge of black stain from his right forefinger and leaned back in his chair for a moment of relaxation. He was evidently very worried.

He had twenty minutes to rest before going over to Radio Station WOR where he regularly informs a listening world what's the latest "what" in the "Roaring Forties" of little old New York. His silver, white hair was a bit ruffled from its usually smooth and well kept appearance. That last idea for the strip had worked out a trifle differently than it had originally presented itself.

Suddenly the cork he had so carefully placed in the bottle crowded itself upward and popped out, flying clear across the room. There was "Abie the Agent," short and grotesque as usual sliding himself down from the drawing table.

"Well, Harry," he said, "what is it yet on your mind that's troubling you? Aint the rent paid?"

"I gotta talk on the Radio and I don't know what to say," answered Harry. His eyes roamed around the walls of the studio as though searching for inspiration from the pictures of his fellow craftsmen (Continued on page 30)

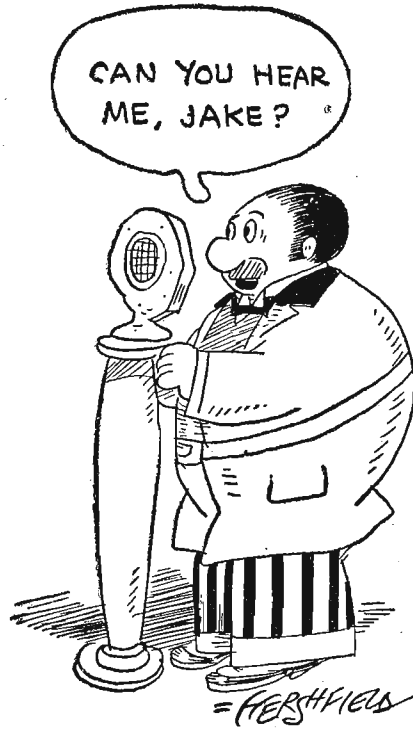

Harry Hershfield, whose strip comic "Abie the Agent" is known wherever American newspapers are read, puts "Abie" through his paces in a studio on the second floor of a building at Columbus Circle. Mr. Hershfield knows his Broadway and has a host of Radio listeners through WOR where he regularly broadcasts Broadway chaff and chatter. At the top is "Abie" who mistakes "Mike" for "Jake." In the circle Mr. Hershfield admits he is not singing but imagines he would look that way if he tried to sing. The accompanist is J. Andrew White, famous sports announcer. The large picture shows Hershfield as he usually appears at WOR.

Broadcasting Stirs Record Interest in Football

By Harold P. Brown

SINCE I was a freshman at the University of Chicago and saw our Walter Eckersall do his famous hurdle in that historic Chicago-Michigan game, never mind the year, my interest in football gradually diminished.

Yes, the old fervor subsided year by year and I was content to take my football in the regular doses prescribed by the keen-eyed sport writers in the dailies. I never whooped. The greatest emotion I could arouse was a sort of "Heh"! It varied in inflections as Chicago won or lost.

But last year I accidentally tuned in my super-het on KYW when they were having a pig skin riot over north of the Midway, Chicago. "Shorty" Fall was calling it off. And man, I was there! I'm telling you, I was there! Never fully appreciated Radio before. I would have picked up my winter coat and golf cap and started straight for old Stagg field, but was afraid I would miss too much on the way. So I stayed in the parlor and got my thrills.

I could see those humped over backs, that crouching backfield all husked out with leather and pads, the lightning change of positions, the plunge, the thud of brawny shoulders—and just what happened, why and who did it.

My habitual "Heh!" expanded into a "Hah!" Even went so far as "Hooray!" when "Shorty" announced a touchdown for the Maroons.

I've been a rooter ever since. Have gone to all the games I could get to see and listened in when I couldn't get there. I give these personal experiences just because I believe my case is typical of thousands of

Looking out for WBAF listeners at the eastern football games. This is the famous team of Graham McNamee (standing), and Phillips Carlin. Below is Jim Murley, sports voice of WBZ.

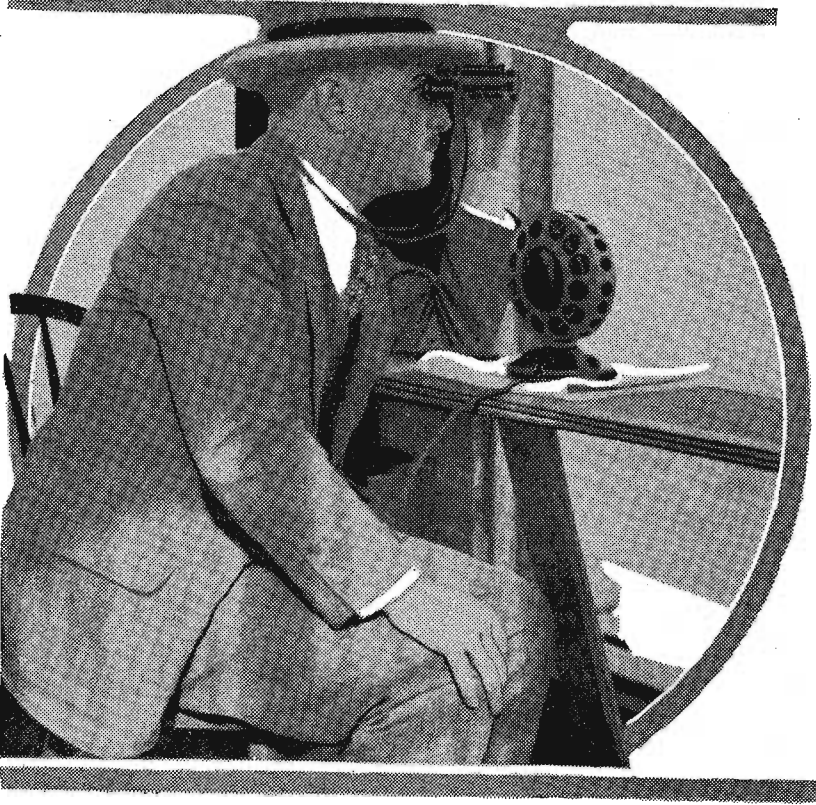

Eyes of the middle-western listeners. Quin Ryan (above), who weathered the terrific rain storm that pelted the Chicago-Illinois game at Champaign, Ill., and made the loud speakers in a hundred thousand homes fairly drip with the flood that utterly ruined four of the WGN microphones. The picture shows him at one of the games where skies were more kindly disposed. Below is H. A. "Shorty" Fall of KYW (standing) and his operating staff on the roof of a university grandstand—a pioneer observer for Radio listeners. "Shorty's" graphic and detailed reports have stimulated a new public interest in outdoor sports, particularly football. Approximately 70,000 sat through the cloudburst at the Chicago-Illini game which resembled water polo.

others and because I believe Radio has helped to bring football to its unprecedented popularity of this season.

Why, I've become a rabid rooter, even. I yell and walk up and down in front of the Victrola-loud speaker and throw the sofa pillows right and left. And mad, say, I simply boiled over when those addle-pated alumni tried a smart trick to infuriate the team to victory by calling them "ladies" at a banquet just before the Maroon-Illini game. I sat down and wrote some of those clatter-tongued squawkers what I thought of them. Wonder how many of those chumps thought enough of the fellows on the team to give them a sick call out of the football season. I didn't see any of them at room 247 in St. Luke's hospital, in Chicago, last summer when "Bub" Henderson, the captain, was having the battle of his life to stay in bed while an operation on an old battle scar healed. No, sir!

That's how interested I got, all through hearing a game broadcast a year ago.

They have a new, big bowl at Champaign. It holds 70,000 when everybody's there. But when the crowd went down for that Chicago-Illini game they almost cracked it, packing them in. I grieved that business made it impossible for me to go. But I got home in time for the second quarter. Heard Quin Ryan's voice rolling out the story over WGN as soon as I turned the latch to open the door.

Found the family grouped around the Victrola, which is con- (Continued on page 30)



Observation post for WMAQ announcers at Stagg field. Through the windows, left to right, are Harold O. Totten and Harry M. Beardsley, both of the Chicago Daily News staff who change positions at the microphone at each quarter. They team on the job similarly to McNamee and Carlin.

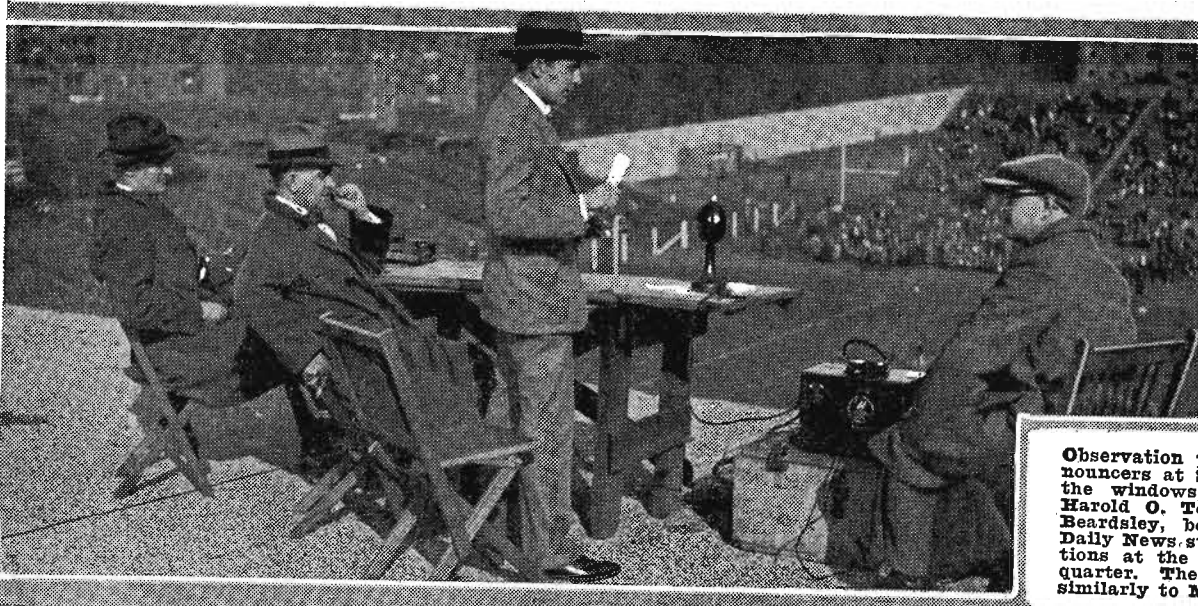

Three Continents Hear WHAZ on 500 Watts

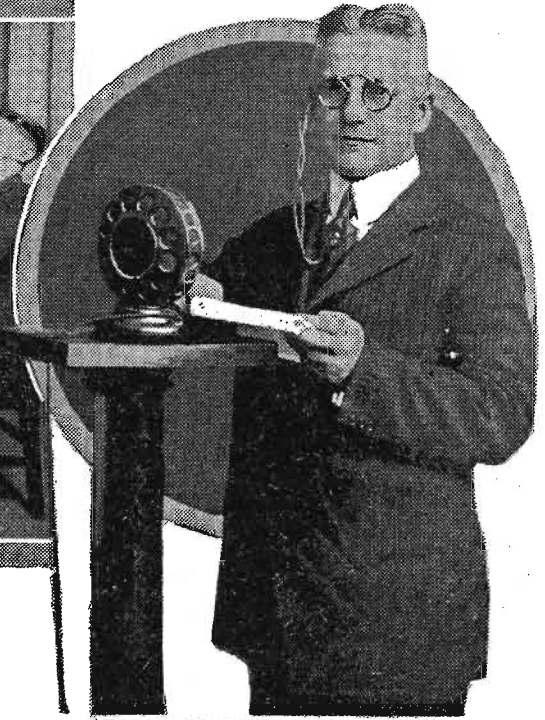
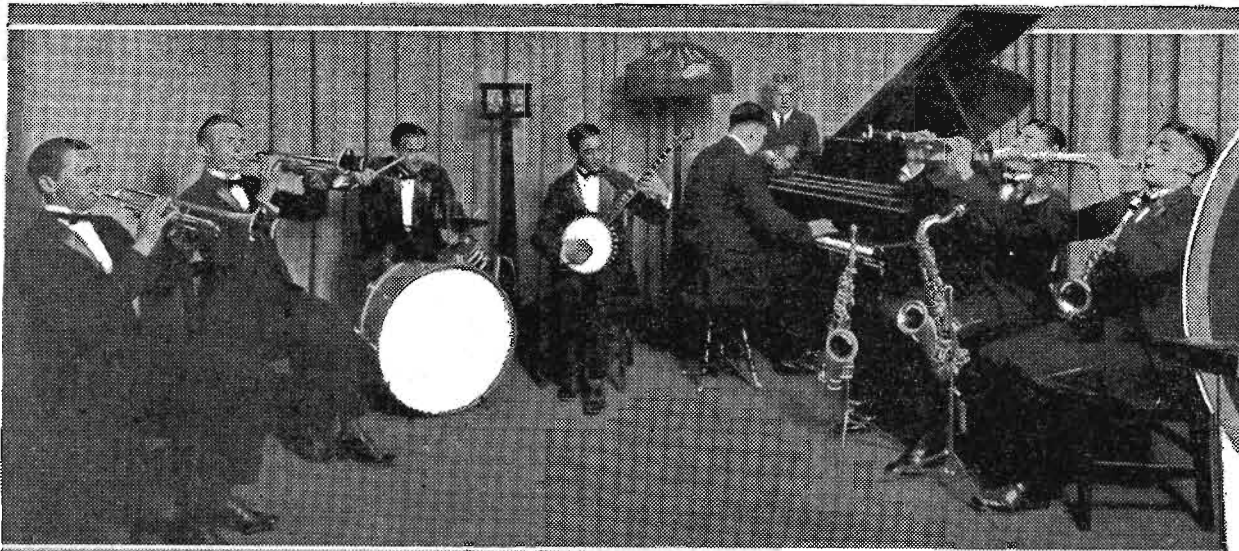

MARVELS of accomplishment do not depend so much on the amount you have to do with as what you do with the amount you have.

You have to hand it to the faculty and students at WHAZ, Radio station of the Rensselaer Polytechnic institute, Troy, N. Y., for the living truth of that statement.

With 500 watts at their disposal they entertain their friends in Europe, South America and the Pacific Islands. They do it regularly and technically correct, which shows what a college education can do for a broadcasting station.

What do they care about all the hue and cry for great superpower stations when you only need 500 watts? All that is necessary is to know how to handle the 500 watts in a way to get the most out of it. They do that at this century-old technical school which did Radiophone broadcasting as far back as 1910 and used an electric current to ring a bell, back in 1831, before the art of telegraphy of any kind was known.

Surprising things always are happening as the result of the ceaseless Radio research work carried on at Rensselaer Tech. They have 30,000 letters from most extraordinary sources. And they are only on the air from two to four hours on Monday evenings forty weeks in the year. They started public broadcasting September 14, 1922. Some of the interesting records in the files of WHAZ are told in a general way as follows:

Chief Lone Eagle, big boss of the Eagle Bar Ranch, Winnett, Montana, stayed up one night last winter to go "fishing" with his new Radio set. He happened to tune in WHAZ just as the Campus Serenaders were getting down to fine terms with

a fast jazz. A smile spread over his face as the barbarous music trickled into his ears through the head phones. He emitted a grunt. A little faster—he chuckled. Faster yet—Chief Eagle answered back with a war whoop so loud Mrs. Eagle fell out of bed and ran into the front room to see what was happening.

A few days later Mr. Rutherford Hayner, director of the WHAZ station, received an epistle from Chief Eagle requesting that the Campus Serenaders take the air again the following Monday when he would entertain about sixty young bucks at a special Indian dance party. The request was granted. The Winnett paper afterward stated that it was THE social affair of the season at Winnett.

From Alaska to Panama and frequently from Hawaii, New Zealand, West Indies, South America, Central America, England and Continental Europe messages have come reporting from one to a dozen concerts at various times. It was one of the first American stations to be heard across the Atlantic, reports coming from France and Belgium in November, 1922, and in Hawaii from four points simultaneously in December, 1922.

One of the interesting experiments attempted was a two-way Radiophone conversation 2,000 miles overland between Troy, N. Y., and CFCN, Calgary, Alberta, Canada, in January, 1923. Success was the result again.

Above, Campus Serenaders at Troy, who furnish music for frat hops on Catalina Island, mid-Pacific Islands, British Isles and South America. Rutherford Hayner, right, program director.

The Troy station has not limited its innovations to technical results but has led in unique feature programs. Mr. Hayner initiated what was called the "hearies" in which a play was rewritten and adapted to Radio, similar to the plays rewritten for "movies." This station presented the first all-Spanish program by Latin-American students which was heard as far south as Peru, the first Far East program broadcast by Chinese, Japanese and Siamese students, first concert by all blind performers, sound of the historic bell used by Professor Joseph Henry in 1831, which he rang in the first use of the electromagnet and which experiment led to the telegraph, telephone and Radio; the first Radio pageant, presenting the sesquicentennial of the Revolution.

In San Salvador, Central America, there is a graduate from R. P. I., who is teaching the young "Salvadoradoes" how to Radio and as one of the regular class stunts he has them tune in WHAZ, which they do very successfully.

One Harry Lauder imitator who came to Troy asked if he
(Continued on page 29)

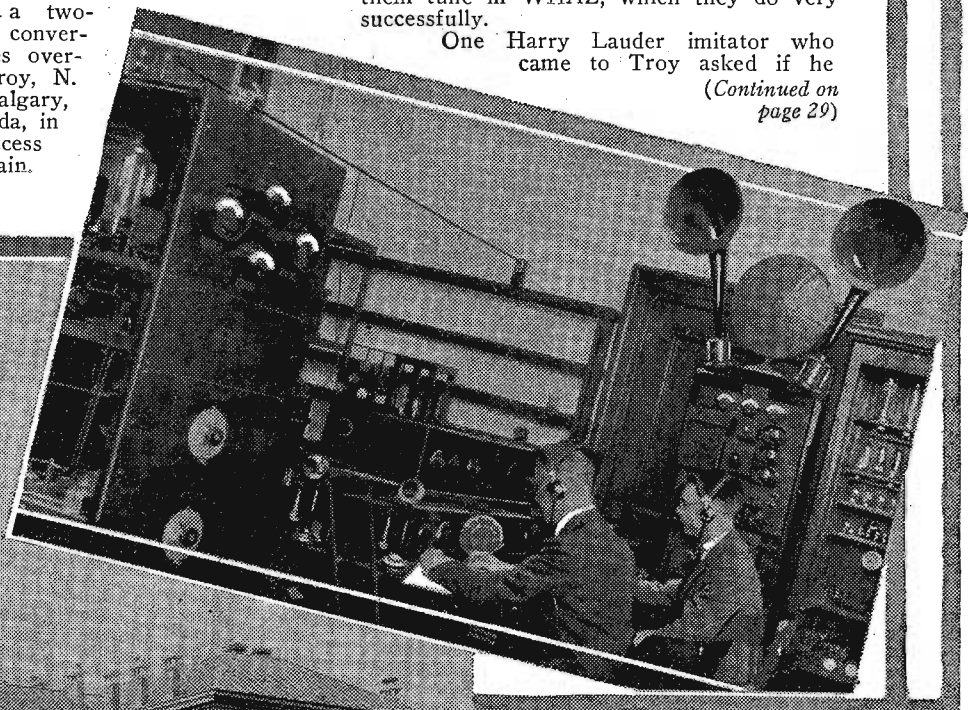

Above is a section of the marvelously efficient operating room of Station WHAZ at the Rensselaer Polytechnic institute, N. Y., where 500 watts excels the performance of most other stations of twice and three times that power. Seated at the left is Professor Harry Mimno and beside him is H. H. Harris, members of the faculty. The building at the left is the Sage building where Station WHAZ is located. This institute recently celebrated its one-hundredth anniversary. Radiophone conversation through WHAZ has been carried on overland for 2,000 miles. Experimental Radiophone broadcasting was accomplished here first in 1910.

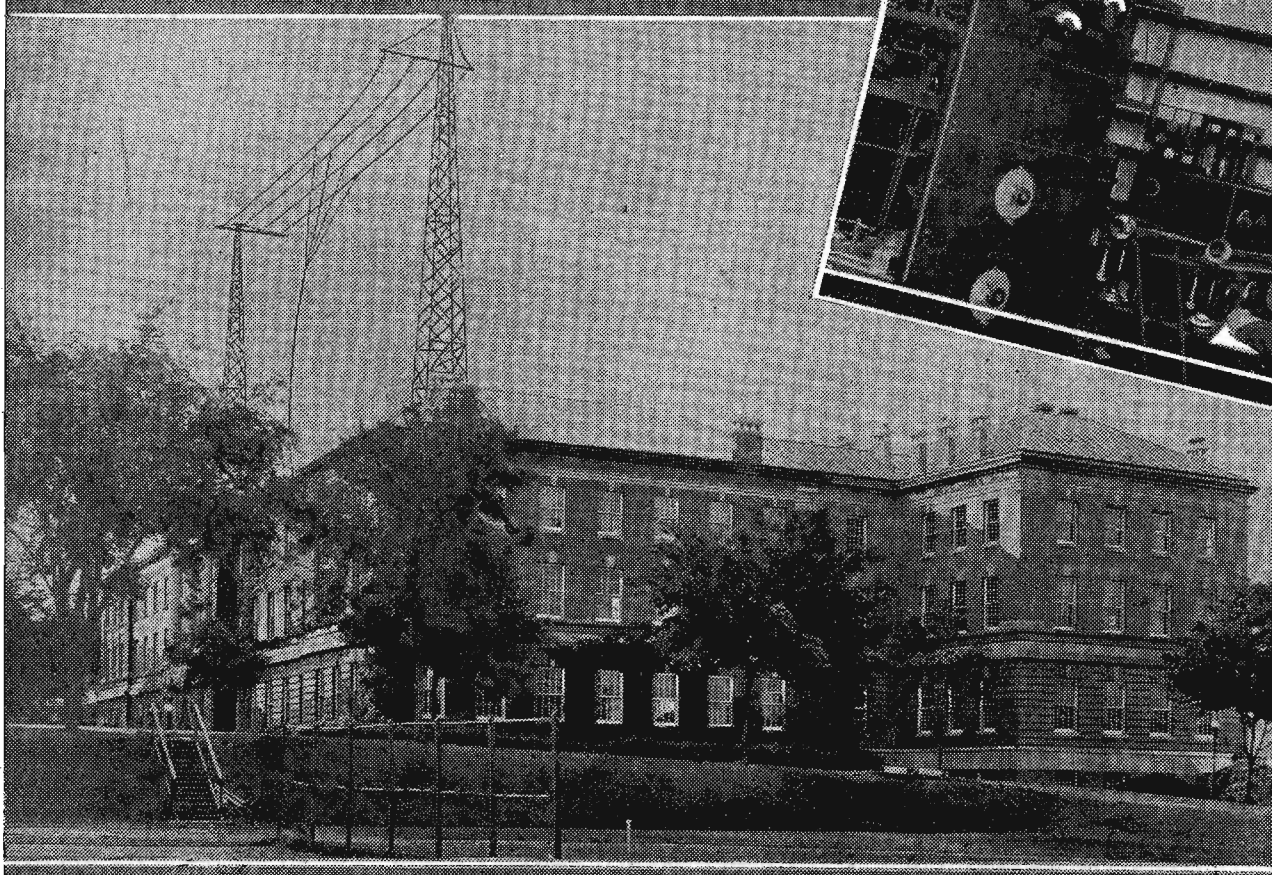

Iowa's "Big Oil Man" Builds Station KOIL



H. A. Searle, right; a corner of KOIL studio, center; H. A. Searle, Jr., above and Howard Martin, program director and announcer, below.

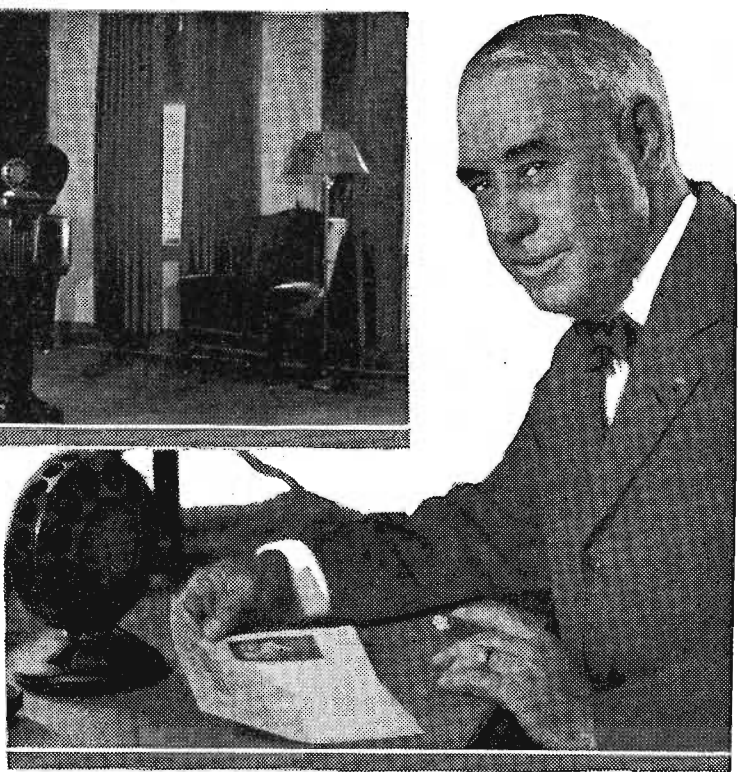
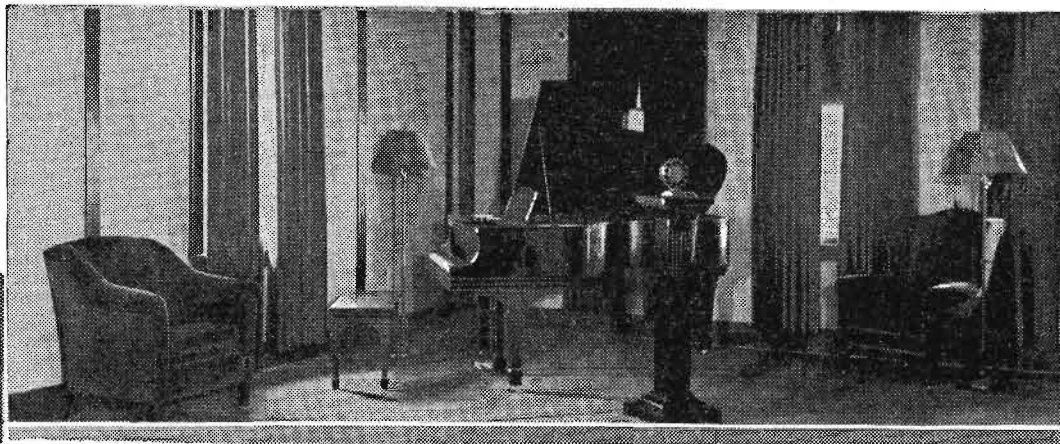

YOUNG BILL HAWKINS nervously shifted from one foot to the other while the corner groceryman at Honey Creek, Pottawattamie county, Iowa, counted out eight dollars in silver. Slowly the coins, quarters, halves and dollars, clinked into a little pile beside the crate of eggs Bill had just brought in and placed on the counter. "What you going to do with all that money," asked the groceryman. "I'm going to buy a kit for a Radio set," answered Bill. "You won't get much for eight dollars." "Reckon I can get a jim dandy one tuber," smiled Bill.

His letter was all ready for mailing and Bill took it to the post office where he converted the cash into a money order and sent to Chicago for the set that very day.

* * *

The above incident happened just about one year ago this present date. In a few weeks after Bill strung his aerial it was evident many of his neighbors had taken up with the new amusement. Aerials and lead-ins could be seen at almost every farm house.

S. A. Searle, the "big oil man" of Council Bluffs came stomping into his office on a December afternoon after a long, tiresome drive through Pottawattamie county.

"I think the country has gone wild over Radio," he said to his son Don who was going over some of the Mona Oil advertising records.

"I noticed it," said Don. "Nobody seems to want to take a chance on getting any of the big sets yet. They appear to be afraid it can't be true and there are only one or two stations they can hear on the crystal and single tube sets. We need another broadcasting station in this neighborhood."

"Just what I was thinking," said Mr. Searle, Sr. He is secretary and general manager for the Monarch Manufacturing Co., and recognized as a sort of public benefactor for the community. After drumming on the table for a few minutes he took out a sheet of yellow paper and began figuring with a pencil.

"How much would a regular bang-up Radio station cost?" he asked.

Nobody in the office had the slightest idea. "There couldn't be a better place in the country than right here," said H. A. Searle, Jr., chief engineer and general superintendent of the plant. He turned toward a window. "We are on the highest hill and right in the center of the United States."

Action followed swiftly. Engineers and surveyors soon were on the scene.

* * *

Last June Bill Hawkins and his dad tuned up the family Ford and drove to Council Bluffs. They snorted up the steep roads and coasted around the sharp turns until they came to the orderly drive of the Searles property. There they paused to gaze up at structural steel workers welding together the braces of the towers at the top of a hill overlooking the Missouri valley. Bill's set had sprouted another tube and he looked upon this enterprise with a deep thrill.

(Continued on page 30)

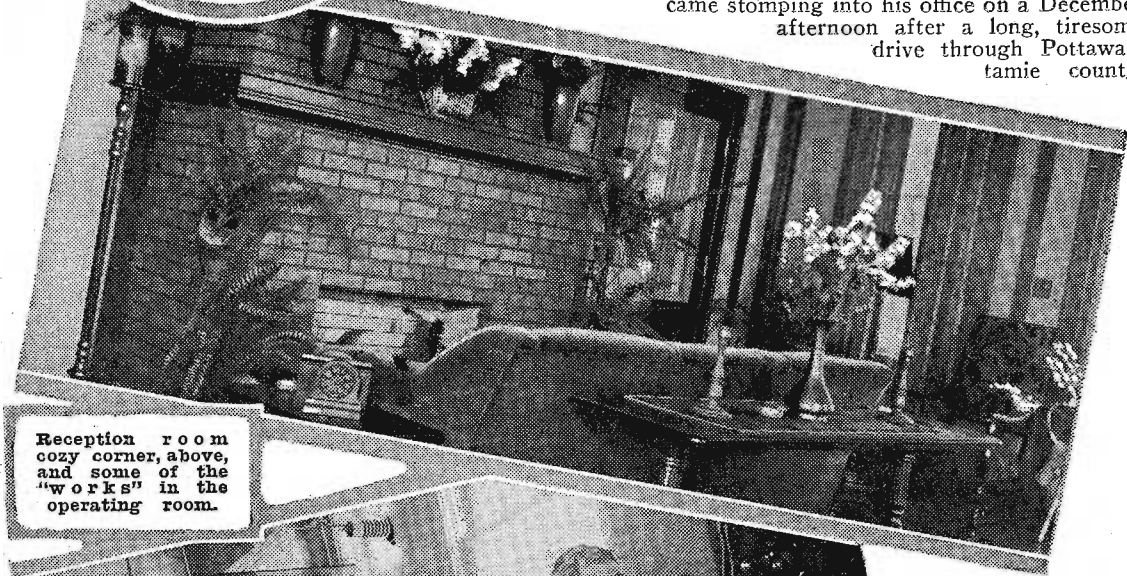

Reception room cozy corner, above, and some of the "works" in the operating room.

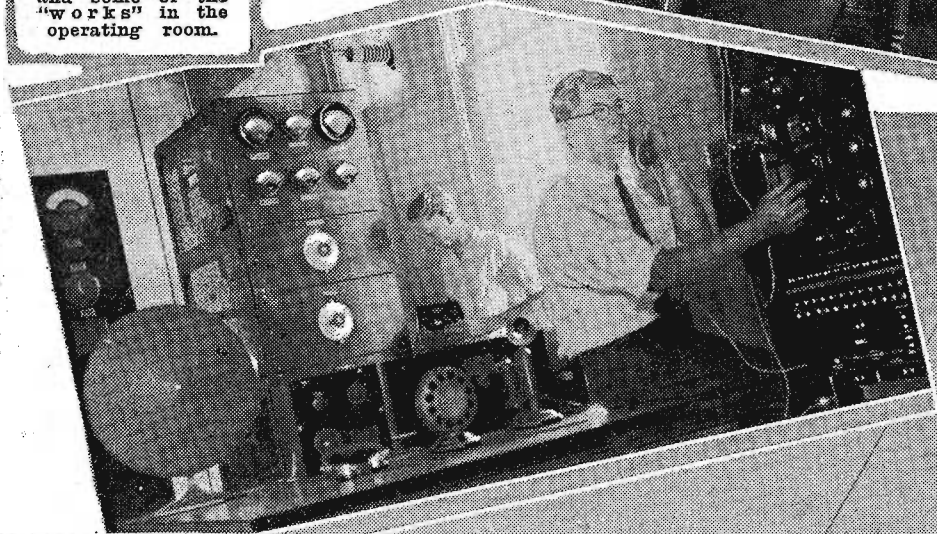

This bungalow broadcasting station, right, located on top of one of the highest bluffs in Council Bluffs has all the comforts and conveniences of a well regulated country club. The Missouri flows 200 feet below.



Don Searle, above, chief announcer and manager of Station KOIL, known to listeners simply as "Don."

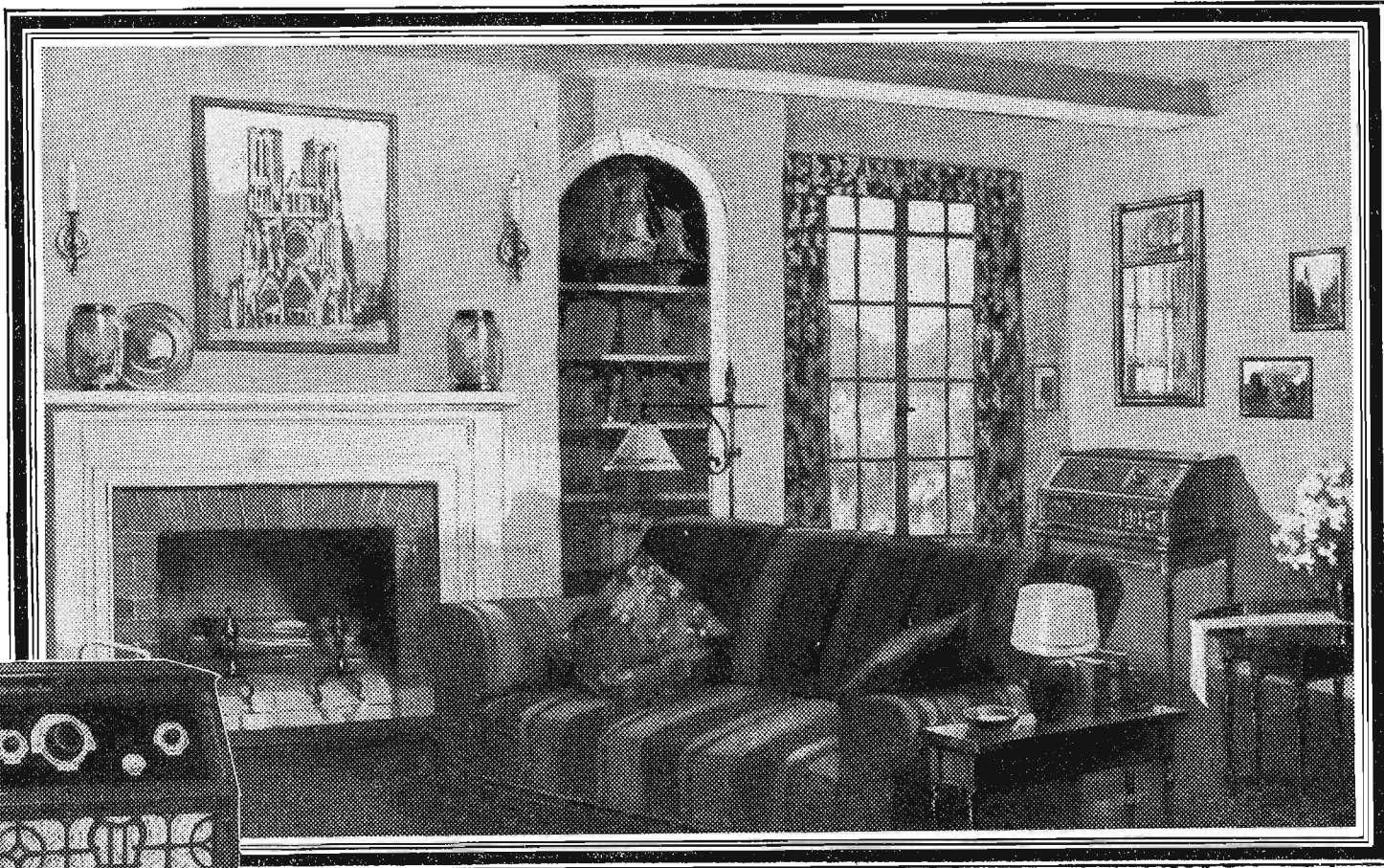

Ten Models
\$50 to \$460
Guaranteed
Unconditionally

Canadian Prices
Slightly Higher



TYPE 215

Remarkable for range, clarity, mellowness. Six tubes, built-in Music Master Reproducer. Beautiful mahogany cabinet and table. Storage battery compartment concealing both batteries and charger. With-out equipment \$215

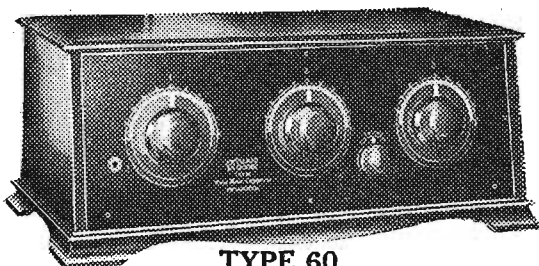

TYPE 60

Five tubes. Special Music Master design. Full, round, natural tone. Three selectors for precise tuning. Without equipment \$60

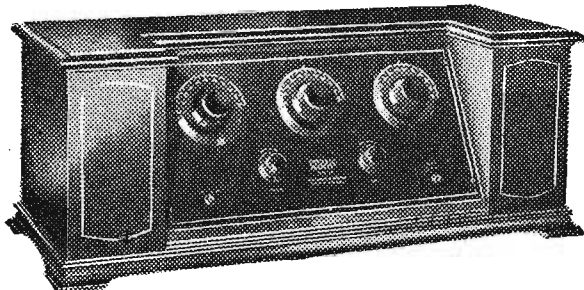

Five tubes. Resonant reproduction, exceptional range. Massive mahogany console cabinet. "B" battery compartments in cabinet. Without equipment \$100

—for every home

A MUSIC MASTER

THERE is a Music Master Receiver for every requirement of taste, every dictate of economy.

Music Master Receivers embody the demonstrated principles of standardized New Era radio. Forming a vital part of the series is the internationally famous Music Master Reproducer, the *Musical Instrument of Radio*, for which there IS no substitute. Thus song, speech and symphony come to you in absolute fidelity to the original through Music Master, Radio's Supreme Musical Instrument.

Ask for a demonstration of Music Master Radio Receiver's distance pick-up, selectivity, clarity, volume, and above all, its supreme Tone Quality developed on the Music Master principle of sound reproduction.

See MUSIC MASTER—hear—compare—before you buy *any* radio set.

Music Master Corporation

Makers and Distributors of High-Grade Radio Apparatus
128-130 N. Tenth Street, PHILADELPHIA
CHICAGO NEW YORK PITTSBURGH

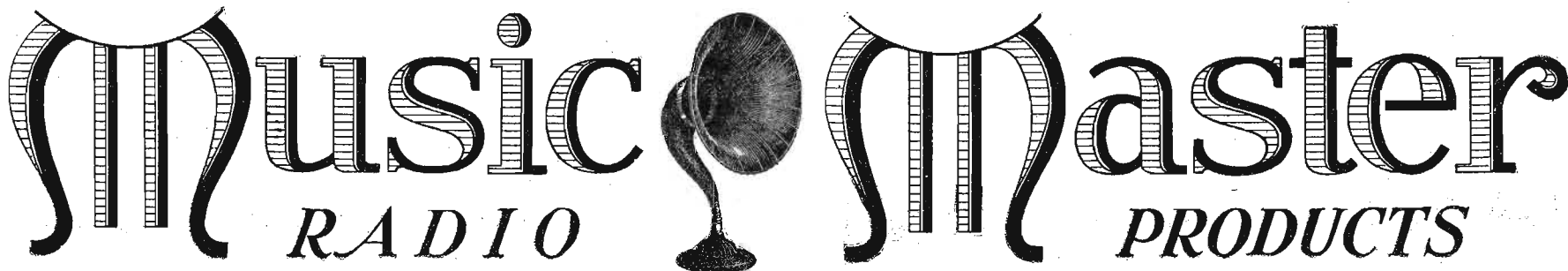

ELECTRIC FOUNTAIN OPERATED BY RADIO

VOICE CONTROLS BEAUTIFUL COLORED PICTURES

Volume and Frequency Changes Utilized to Vary Spectacle at Hot Springs National Park

HOT SPRINGS NATIONAL PARK, Ark.—Guests of the New Arlington hotel and citizens of Hot Springs were treated to one of the most beautiful and unique Radio novelties yet produced when a Radio controlled electric fountain was placed on the plaza opposite the New Arlington hotel, home of Station KTHS here and operated from the waves of KTHS and St. Louis and Chicago stations, including WLS, KSD, WHO and WEBH. Jets of water shooting high in the air and colored lights which illuminated the falling spray rose and fell in cadence with the change in volume and frequencies of the Radio programs being received from KTHS tower. A loud speaker was also operated in connection with the Radio fountain so that the crowds could hear the programs and see the rise and fall of the water and the changing play of color as the music varied.

The fountain was constructed by the Illuminating Engineering and Radio Consulting Laboratories of the General Electric company and was installed by this concern as part of the convention features of the Association of Edison Illuminating companies which recently held its national meeting at Hot Springs National Park.

Not Only a Novelty

In addition to the novelty of the Radio fountain, it demonstrates the new system of power control. The operation of the fountain shows one possibility of the system of controlled power, which is being developed by the General Electric company under the direction of E. F. W. Alexander. This system employs a special gridded mercury arc or thyratron tube to rectify alternating current at the same time it is controlled in amount by a change in grid potentials in a fashion somewhat similar to the action of ordinary receiving vacuum tubes. The fountain was selected to demonstrate the principle as the output of a Radio receiving set supplies a convenient source of changing potential which can be used to control the power input to the fountain motors.

Voice Control Possible

In operating the fountain control can be shifted from a Radio receiver to an ordinary microphone so the voice will control the operation of the five horsepower pump motor used and the fountain will follow the tones of an ordinary conversation. The fountain installed at Hot Springs is the first one of its kind constructed and was shipped from Detroit where it was used as a part of the decorative lighting system for the Society of Illuminating Engineers convention. The set in Hot Springs was in charge of Allan C. Rockwood, one of the General Electric experts.

Fans Taken on World Tour from Station KOA, Denver

DENVER, Colo.—"Round the World in Sixty Minutes," was the theme of another microphone excursion for broadcast listeners conducted Friday evening from the studios of KOA, Denver broadcasting station of the General Electric chain.

Points visited on this tour included Maderia, Gibraltar, Algiers, Monte Carlo, Naples, Jerusalem, Cairo, India, Sumatra, Singapore, Manila, China, Japan, Hawaii, Cuba and the Panama canal zone, and the speaker was Deane H. Dickason, former newspaperman of Denver and official lecturer of the Canadian Pacific cruises.

THIS JACK-O-LANTERN CAN SPEAK



This remarkable looking jack-o-lantern is in reality a crystal Radio set entered by Casper Buger at the Chicago Radio show. Casper named it "Static." You twist its two eyes to tune it in and the best thing about it is "it works." It attracted more attention than any of the other exhibits entered in the home set builder's competition.

CANADIAN OFFICIALS TRY TO CLARIFY AIR

WOULD EDUCATE LISTENERS IN USE OF SETS

Annoying Whistles Will Disappear if Fans Will Follow Bureau's Instructions for Tuning

OTTAWA, Ont.—The Radio branch of the department of marine and fisheries of Canada has issued a circular which is termed the first "gun" in connection with solving the problem of interference produced by reradiating receiving sets. A recent survey of broadcast reception conditions in the more populated centers in Canada indicates that approximately 50 per cent of the preventable interference which prevails is caused through the incorrect operation of reradiating sets by the broadcast listeners.

The survey further indicates that most of this interference is due to a lack of knowledge of correct methods of adjusting a receiving set, and it is accordingly hoped that a material reduction in the same way may be effected if the broadcast listeners can be persuaded to cooperate in an endeavor to clear the air of whistles.

Suggest Tuning Rules

The Canadian officials suggest the following rules for operating a receiver:

1. Practice on tuning powerful stations first and do not try to pick up weak distant stations until you become expert.
2. Use both hands, one hand for the regeneration control (if a regenerative set) and the other hand for the tuning control.
3. Keep the regeneration control always just below the point of oscillation; your set is then in the most sensitive condition.
4. If your set then accidentally breaks into oscillation, turn back the regeneration control at once.
5. Do not try to find a station by the "whistle." If your set is turned just below the whistling point the signals will come in clear and your regeneration control can then be tuned a little further to increase the volume.
6. Do not force regeneration in an attempt to obtain loud speaker volume from a set not designed for the purpose.
7. Do not force regeneration in an attempt to hear stations beyond the range of your set; be content with those you can really hear.

Ask Silent Hour for Test of Overseas Broadcasting

WASHINGTON, D. C.—The executive committee of the National Association of Broadcasters having in charge Radio week has made international broadcasting a special feature of this program. It is their desire during the week of Jan. 24 to 30, 1926, to have all American and Canadian broadcasting stations silent from 11 to 12 o'clock, eastern time.

The question as to whether United States and Canadian broadcasting stations want to shut down during the period indicated was discussed at the recent meeting held here.

Sports Broadcasts

Football

Saturday, November 28

Army-Navy, WCAP (468.5), WEAJ (491.5), WFI (395), WGR (319), WGY (379.5), WJAR (305.9), WJZ (454.3), WSAI, (325.9), WTIC (475.9), WWJ (352.7).

Boston College-Holy Cross College, WEZ (333.1), WTAG (268).

Washington-U. of Southern Calif., KNX (337).

Hockey

Tuesday, December 1

Boston Bruins-Canadians of Montreal, WEZ (333.1).

New Stations

WNBH is now the call of the New Bedford, Mass., broadcaster. This station, under the new management of the New Bedford hotel, is operating on 250 watts. The wave is 248 meters.

Two other stations were licensed last week, KPAF, San Jose, Calif., 50 watts, 217.3 meters, and WJBP, Buffalo, N. Y., 50 watts, 218.8 meters.

Pasadena went on the air recently with KPSN, its new 1,000-watt station. The opening appearance was greeted by fan mail from all over the United States and Canada. The broadcaster is owned by Pasadena Star-News.

Bristow, Okla., is on the air again with a new voice, KVOO. This is a 500-watt station with the wave length 374.8. WBAV, Erner and Hopkins company, Columbus, Ohio, is now WAIU, American Insurance Union of the same city. The power is 500 watts and wave length 293.9 meters. The Muscatine, Iowa, station has changed calls and power. This is now a 500-watt station using the call letters KTNT.

Several changes in calls have occurred during the last week or two. KWUC is the new call for the Le Mars, Iowa, station. KFGD, Chickasha, Okla., is now KOCW. The Chicago station WDBY is now WPCB.

Plans have been drawn for the erection of a 1,500-watt broadcasting station in Hongkong, China. There are at present two small stations operating, one with ten watts and the other 100 watts.

Synthetic Football Is Latest McNamee Stunt

Describes Imaginary Gridiron Struggle for "College Night"

NEW YORK.—One of the most unusual continuity programs ever arranged by the Eveready impresario, Mr. Paul Stacy, in which Graham McNamee, sporting announcer, described part of an imaginary football game, was "College Night," staged in the studio of WEAJ on November 17, and broadcast by WEAJ and the usual chain of stations, including WEEL, WFI, WCAE, WGR, WWJ, WTAG, WOO, WJAR, WCCO, KSD and WSAI.

The "scene" of the hour was laid in a typical college town on the eve of a great inter-sectional football games at which representatives of all the large colleges of the east and west are present. Snatches of college songs from the dormitories, pep meetings, a dinner dance in one of the "frat" houses, and street scenes in which fist fights and wagering depict the enthusiasm of the rooters, were presented one after the other.

The scene then shifted to the stadium for the last few minutes at the thrilling close of the game, which was described by Graham McNamee in his inimitable style just as if he were actually present. The cheers of the crowd as the imaginary "Red Grange" slid across the goal for the winning touchdown were quite realistic.

RADIO VISION IN ENGLAND NEARER

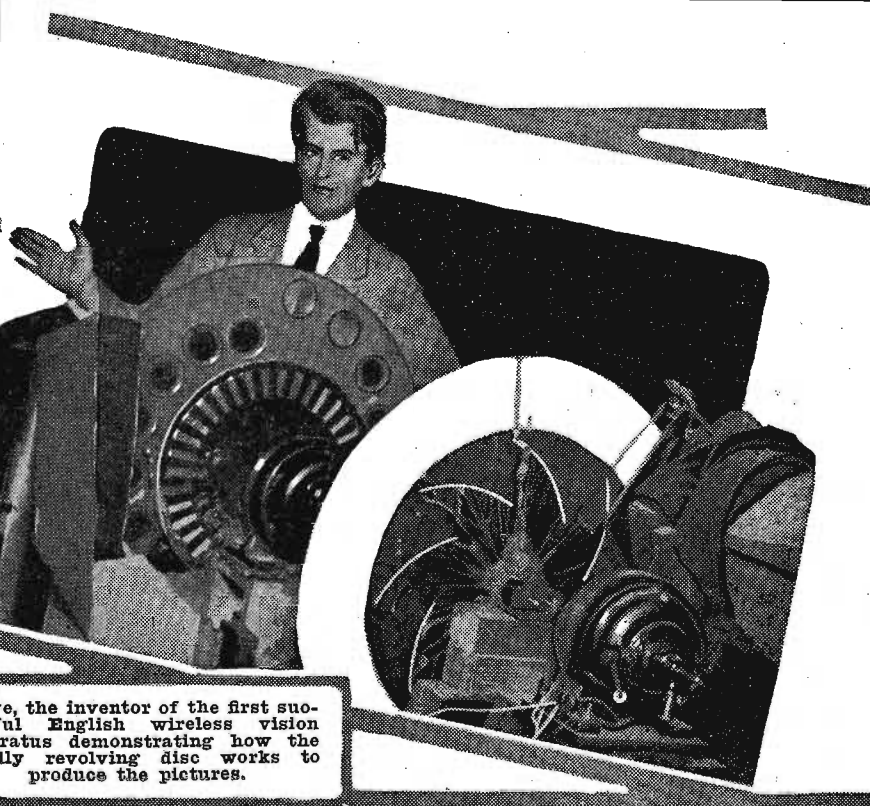

Above, the inventor of the first successful English wireless vision apparatus demonstrating how the rapidly revolving disc works to produce the pictures.

Baird, inventor, below, sending his own image over television instrument. Light falling on a light sensitive cell sets up a pulsating current.

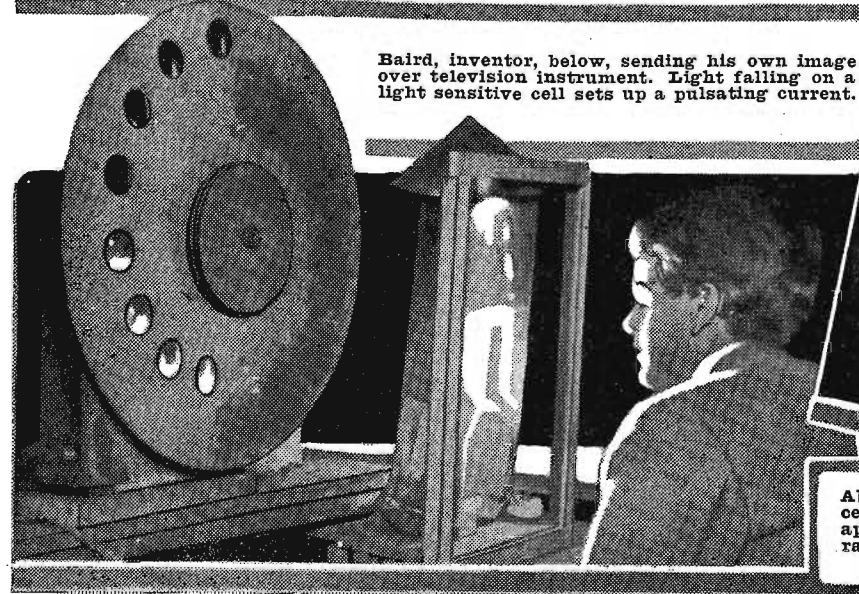

Again They said it couldn't be done!

Here it is

New and Improved **FRESHMAN MASTERPIECE**

But now . . .

Complete with built-in loud speaker of great volume and superb tone quality.

Encased in . . .

As fine a heavy genuine solid mahogany cabinet as ever graced any radio set.

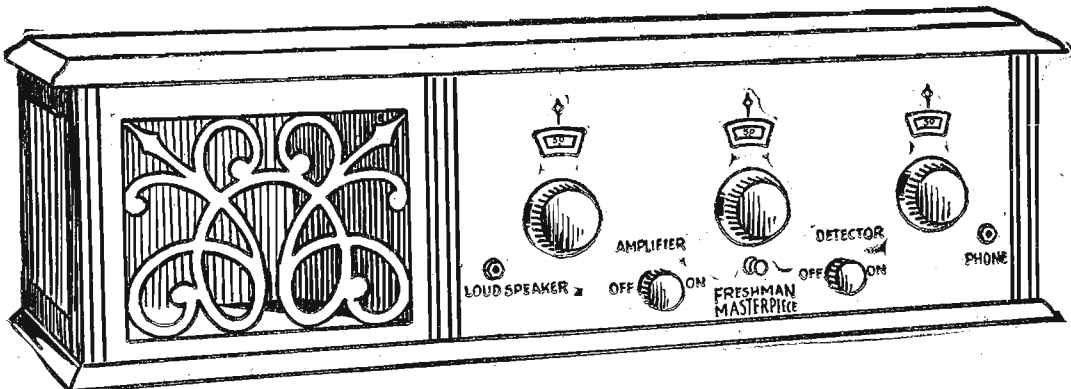

Model
5-F-5

\$60

*Slightly higher
Denver and West*

At sixty dollars . . .

Not only complete with built-in loud speaker and massive mahogany cabinet, but this wonder circuit has been scientifically perfected and each and every single part strengthened and co-ordinated.

For example . . .

The new Freshman Masterpiece straightline wave length condenser with vernier attachment which assures hair-line selectivity—permitting you to tune in the station you want without interference over the entire wave length range. This is merely one exclusive feature of the

World's Greatest Radio Receiver

For Sale at AUTHORIZED FRESHMAN dealers only

Sold on convenient terms by Authorized Freshman Dealers, who also install and service them. Write for illustrated booklet, containing lots of useful information for all radio fans.

CHAS. FRESHMAN CO., INC.
240 W. 40th St. New York
2626 W. Washington Blvd., Chicago

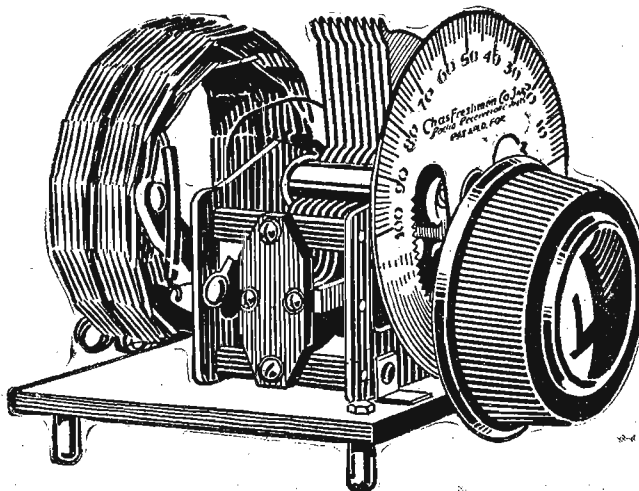

NEWS BRIEFS FROM THE BROADCASTERS

NEW YORK PHILHARMONIC CONTINUES CONCERTS

Lanin Back at WLIT—Psychologist Speaks About Children at KGO—Other Station News

The third of a series of students' concerts by the New York Philharmonic orchestra, under the direction of Willem Mengelberg, will be broadcast November 28 from Carnegie hall, New York city, by stations WRC, WJZ and WGY. It will begin at 8:30 p. m., eastern time.

Fans throughout the country will be glad to know that Howard Lanin, the famous orchestra leader is on the air again with his musicians at WLIT, Philadelphia. They will play every Monday evening beginning at 10:40 p. m., eastern time.

Dr. Albertine Richards Nash, San Francisco consulting psychologist, will again appear before the KGO microphones with a series of talks on child training, the first to be given Monday evening, November 30, at 9:05 p. m., Pacific time. Her subject will be "All About So-called Bad Children."

Arrangements have been made with the Badger Opera company, B. C. Burton, director, to present once a month at WHAD, Milwaukee, excerpts from some of the best known operas.

Charlie Wellman, popular announcer at KPWB, has added to his duties that of studio director for the Warner Brothers movie station.

Paul A. Greene, manager of WSAI, Cincinnati, is still "on tour." He recently was called to Chattanooga, Tenn., where he dedicated WOOD. Mr. Greene's most recent visit was to New York where he conducted the first game of bridge to be played over the WEAJ chain.

Weekly Sunday evening carillon concerts will be given through WJZ and WGY during the winter. The carillon consists of 53 bells which were cast in Belgium. These were presented to the Park Avenue Baptist church by John D. Rockefeller, Jr. The carillonneur is Anton Brees, laureate of the Royal Flemish Conservatory of Antwerp.

The Capitol theater has added a new link to the chain of stations broadcasting its Sunday programs. Station KSD, St. Louis, is the latest addition.

Special syncopation programs for the Pacific coast, the far south and southwest, will be broadcast weekly on Sunday mornings from 1 to 2 a. m., central time, by WBBM, Chicago. The programs will be given by Jack Johnstone's Samovar orchestra, Nate Caldwell, joy digger; Bert Davis, the "clown of the fair"; Eddie Loftus, character singer; Corinne Jordan, pianist, and Garland, baritone and pianist.

Anna J. Peterson, who gives Table Talks from KYW, Chicago, daily, makes excellent cakes. We know! We have tasted them!

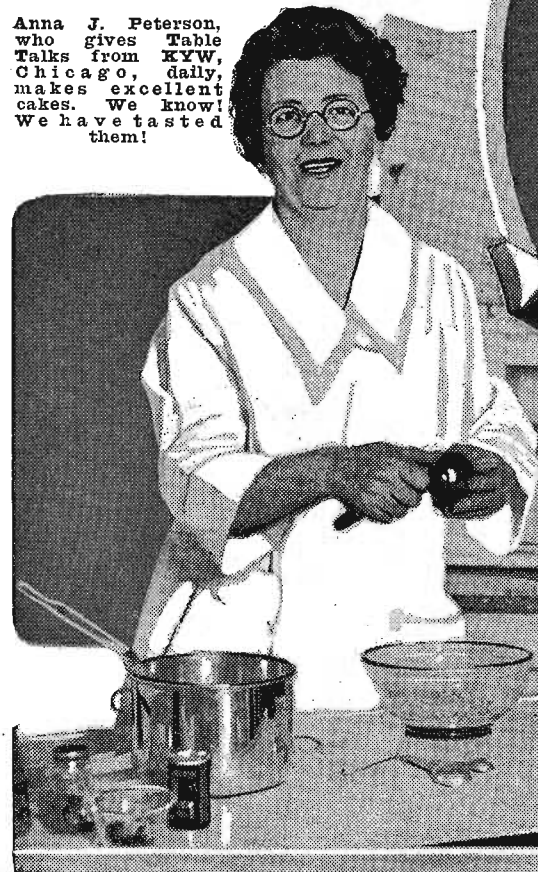

Index to Women's Programs

SATURDAY, NOVEMBER 28				Eastern	Central	Mountain	Pacific
9:30 a. m.	8:30 a. m.	7:30 a. m.	6:30 a. m.	10 a. m.	9 a. m.	8 a. m.	7 a. m.
WWJ (352.7) Tonight's dinner.	11	9	8	WIP (508.2) Menu.	WJZ (454.3) Women's hour.	WRC (468.5) Women's hour.	10:45
WEAR (389.4) Home service talk.	11:45	10:45	9:45	8:45	WCAE (461.3) Gold Medal talk.	WTAG (268) Food Talk.	7:45
WCCO (416.4) Home service talk.	12:35 p. m.	11:35	10:35	9:35	11	10	9
KYW (336) Table talk.	5	4	3	2	WHT (399.8) Women's club.	WNYC (526) Women's program.	8:45
KJR (384.4) Home helps.	11:45	10:45	9:45	8:45	WCCO (416.4) Gold Medal Christmas dinner menu.	WDAF (365.6) Home service talk.	12 n.
Eastern	Central	Mountain	Pacific	10 a. m.	9 a. m.	8 a. m.	7 a. m.
WJZ (454.3) Women's hour.	WRC (468.5) Women's hour.	10:45	9:45	8:45	7:45	6:45	5:45
WEAR (389.4) Home service talk.	WHT (399.8) Women's club.	WNYC (526) Women's program.	11:45	10:45	9:45	8:45	7:45
WCCO (416.4) Christmas Cookies.	WDAF (365.6) Home service talk.	12	11	10	9	8	7
WQJ (447.5) Why Your Teeth Decay.	2:30 p. m.	1:30 p. m.	12:30 p. m.	11:30	10:30	9:30	8:30
WGY (379.5) Cooking lesson, decorations.	3	2	1	12 n.	11 n.	10 n.	9 n.
WCCO (416.4) Women's hour.	WSOE (246) Cooking chats.	4	3	2	1 p. m.	12 n.	11 n.
WIP (508.2) Market hints for housewives.	WQJ (447.5) Using Up the Left Overs.	5	4	3	2	1 p. m.	12 n.
WQJ (447.5) Care of the Hair and Skin.	5	4	3	2	1 p. m.	12 n.	11 n.
KJR (384.4) Home helps.	7	6	5	4	3	2	1
KFOA (454.3) Today's recipe.	KLX (508.2) Women's hour.	8	7	6	5	4	3
Eastern	Central	Mountain	Pacific	9:30 a. m.	8:30 a. m.	7:30 a. m.	6:30 a. m.
WWJ (352.7) Tonight's dinner.	10	9	8	7	6	5	4
KDKA (309.1) The art of sewing.	WIP (508.2) Menu.	WJZ (454.3) Women's hour.	WRC (468.5) Women's hour.	11	10	9	8
WEAR (389.4) Home service talk.	WHT (399.8) Women's club.	WMCA (340.7) Homemaking hour.	12 n.	11	10	9	8
WQJ (447.5) Hats for Christmas Holidays.	How Permanent Waving is Done.	4 p. m.	3 p. m.	2 p. m.	1 p. m.	12 n.	11 n.
WQJ (447.5) Care of the Feet.	5	4	3	2	1 p. m.	12 n.	11 n.
KJR (384.4) Home helps.	WMAQ (447.5) Household art.	5:30	4:30	3:30	2:30	1:30	12:30
KOA (322.4) Housewives matinee.	6	5	4	3	2	1	12
KOA (322.4) Culinary hints.	6:15	5:15	4:15	3:15	2:15	1:15	12:15
KOA (322.4) Fashion review.	7	6	5	4	3	2	1
KFOA (454.3) Today's recipe.	8:30	7:30	6:30	5:30	4:30	3:30	2:30
KGO (361) As a Woman Thinketh.	9:30 a. m.	8:30 a. m.	7:30 a. m.	6:30 a. m.	5:30 a. m.	4:30 a. m.	3:30 a. m.
Eastern	Central	Mountain	Pacific	9:30 a. m.	8:30 a. m.	7:30 a. m.	6:30 a. m.
WWJ (352.7) Tonight's dinner.	10	9	8	7	6	5	4
KDKA (309.1) Home Economics, cooking.	WJZ (454.3) Women's hour.	WRC (468.5) Women's hour.	10:45	9:45	8:45	7:45	6:45
WCAE (461.3) Gold Medal talk.	11:45	10:45	9:45	8:45	7:45	6:45	5:45
WCCO (416.4) A Roly Poly Pudding.	WDAF (365.6) Cooking school.	WEAR (389.4) Home service talk.	WNYC (526) Women's program.	11	10	9	8
WQJ (447.5) Sunday dinner menu.	3 p. m.	2 p. m.	1 p. m.	12 n.	11 n.	10 n.	9 n.
WCCO (416.4) Women's hour.	4	3	2	1 p. m.	12 n.	11 n.	10 n.
WQJ (447.5) Home Economics.	5	4	3	2	1 p. m.	12 n.	11 n.
KJR (384.4) Home helps.	5:30	4:30	3:30	2:30	1:30	12:30	11:30
KOA (322.4) Housewives matinee.	WFAA (475.9) Woman's hour.	6	5	4	3	2	1
KOA (322.4) Culinary hints.	6:15	5:15	4:15	3:15	2:15	1:15	12:15
KOA (322.4) Fashion review.	7	6	5	4	3	2	1
KFOA (454.3) Today's recipe.	8	7	6	5	4	3	2
KLX (508.2) Women's hour.	9	8	7	6	5	4	3

HELPING YOU MAKE HUBBY HAPPY



Husbands who are wise turn on the charger after their evening's chase for DX because they want the batteries in good shape for wife's use in the morning so she can tune in talks by such home economic experts as Bernice Bowser (center), lamp consultant at WMCA, and Ida Bailey Allen (right), international nutritional authority, whose lectures are a weekly feature from the same New York station.

ILLINOIS CENTRAL IS IN RADIO FIELD NOW

LARGE RAILROAD ACQUIRES INTEREST IN STATION

First Large System to Broadcast Regularly Provides Programs Over WGES, Chicago

CHICAGO.—The first large American railroad to enter the broadcast field is the Illinois Central which recently acquired an interest in Station WGES, the Coyne Electrical school of Chicago, with studios located in the Baldwin Piano building. The first I. C. programs were broadcast Saturday, October 31.

The entry of the Illinois Central as a broadcaster, according to officials of the company, is to increase its usefulness as an agency of public service and to make Radio available in times of acute distress and emergencies.

To Entertain Employees and Passengers
Special programs have been prepared to be directed to the great army of Illinois Central employees and to the population along its thousands of miles of lines. All de luxe I. C. trains will be equipped with receiving apparatus and passengers will have Radio entertainment as a special travel feature.

The deal which links the Illinois Central with Radio was arranged by Richmond Harris, director of the reproducing division of the Baldwin Piano company, representing the Coyne interests, with C. L. Markham, president of the Illinois Central system. The amount of the consideration involved was not disclosed.

HOME ECONOMICS TO BE REPEATED COURSE

New York College Invites All Women to Enroll

SCHENECTADY, N. Y.—Encouraged by the results of its first Radio college course, the New York State College of Home Economics, Cornell university, has inaugurated its second course and has invited every woman within hearing distance of WGY to consider herself an enrolled student.

Weekly, on Monday and Thursday afternoons, members of the faculty of New York State College of Home Economics discuss such questions as household management, equipment and budgeting and suggestions will be made on choosing hats, coats and furs.

Specialists on child training and child hygiene will also be heard. Recent discoveries about food and nutrition will be given that can be applied by the woman in the home, and seasonal topics on food preparation will be given each month.

He Tells Ladies How to Cook

CHICAGO.—Station KYW established a precedent November 16 when a man appeared on the women's hour program in the morning. John C. Cutting, known as KYW's "kitchen aid," was the lucky fellow, and he now is giving a ten-minute talk each Monday and Friday morning at 11:15 o'clock, central time. Mr. Cutting tells the ladies what to do with a stew, how to hemstitch hamburger, crochet steaks, etc.

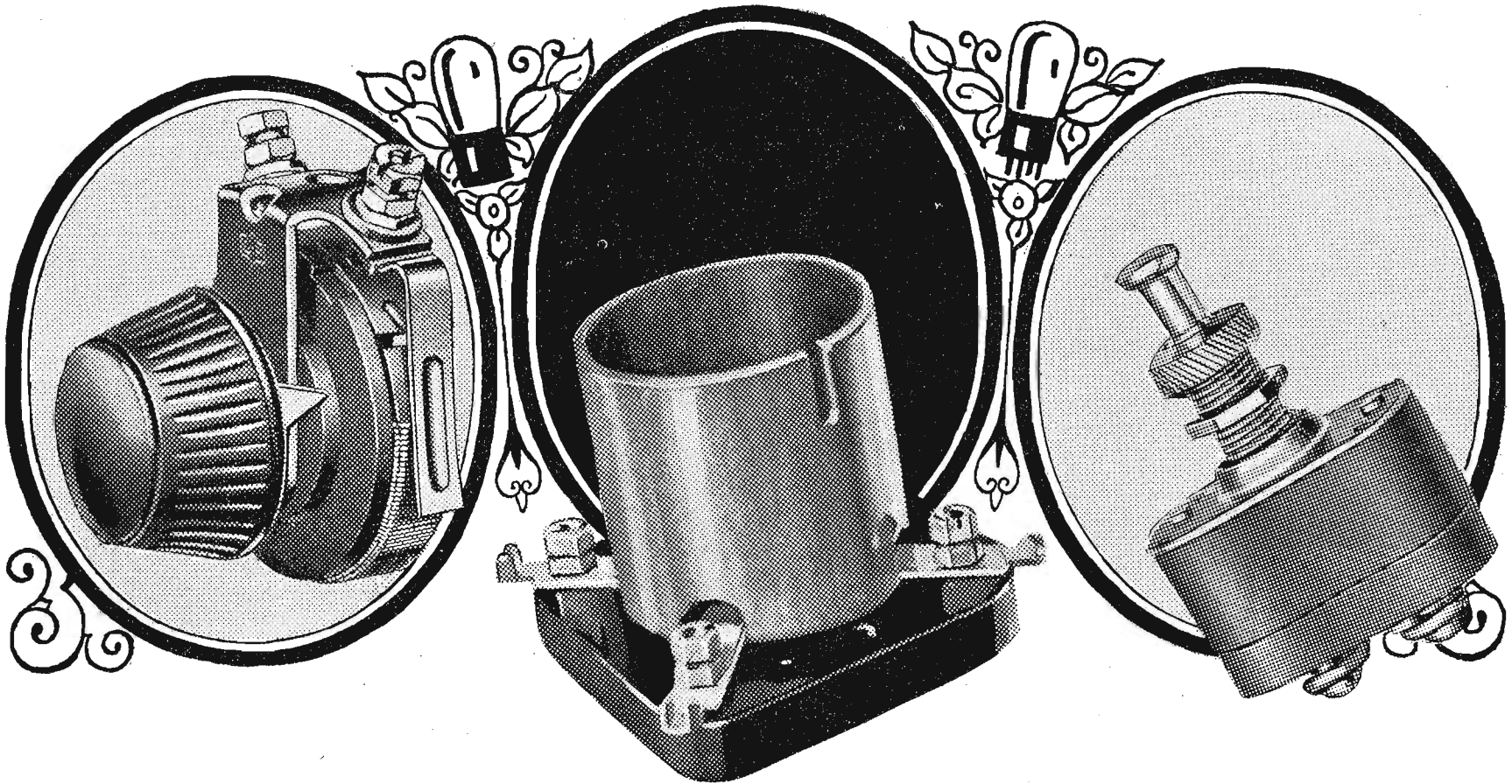

Give Your Tubes a Chance!

*For Real Efficiency Say "Cutler-Hammer"
When Buying These Vital Parts*

**Whether You
Buy or Build**

**Demand the
C-H Trademark**

These are some of the prominent
radio manufacturers using C-H
radio products.

Acme Apparatus Co.
American Bosch Magneto Co.
Astral Radio Corporation
Boissier Radio Corporation
Chelsea Radio Co.
Crosley Radio Corporation
Dayton Fan & Motor Co.
Dictagraph Products Co.
Dubilier Condenser & Radio Corporation
Electrad, Inc.
Freed-Eisemann Radio Corp.
Gared Corporation
Giffill Bros., Inc.
Allen T. Hamscomb
Harding Mfg. Co.
Howard Radio Co.
The Keyport Laboratories
King Electric Mfg. Co.
Kodak Radio Corporation
LeMor, Radio, Inc.
Magnus Electric & Radio Co.
Malone-Lemmon Laboratories
Glenn L. Martin Co.
Wm. J. Murdock
Newport Radio Co.
Phanstiel Mfg. Co.
Philadelphia Storage Bat. Co.
Radio Master Corp. of America
The Radio Compak Co.
R. B. Radio Co.
Robbins Radio Co.
Signal Electric Co.
Silver-Marshall Co.
Simplex Radio Co.
R. E. Thompson Co., Inc.
J. S. Timmons
Workrite Mfg. Co.
Zenith Radio Co.

The very heart of any radio set is the vacuum tube. Its ability to function properly decides to a large extent the range of your set and the quality of your reception.

The Cutler-Hammer engineers have given lengthy study to the design of radio parts vital to tube efficiency. In the new Perfected C-H Rheostats are found features never before obtained. They give marvelously smooth, quiet control with an accuracy that is not disturbed during mounting of the instrument or after continued use. They make set building easy, anchoring absolutely rigid in a single hole in the panel. They add much to the quality of any set—and yet are lower in price.

Likewise, you can put the C-H Low Loss Socket (acclaimed by many engineers as the most perfect socket ever designed) in your set for maximum results, and actually save money in doing so. The same holds true for C-H Radio Switches—switches with real radio mechanisms that have so completely met the approval of the radio public that more than a million are in use today.

Before you build your new set, decide on quality parts. You will be interested in the folder "Radio Parts for Performance." Write for it—it's free.

THE CUTLER-HAMMER MFG. CO.
Member Radio Section, Associated Manufacturers of Electrical Supplies
Works: Milwaukee and New York

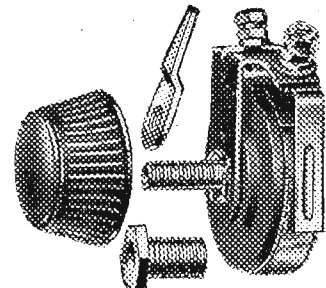

The Perfected C-H Rheostats are of the revolving drum type, designed with the operating parts as a unit. They are not dismantled for mounting, and hence all spring tensions, adjusted at the factory, are undisturbed. 6, 15 and 30 ohms.

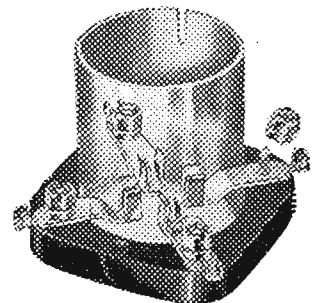

The revolutionary design of the C-H Low Loss Socket created a sensation everywhere. Thin ORANGE Bakelite shell. Base of heatproof Thermopax — terminals cannot loosen under heat of soldering iron. One piece contact springs integral with soldering lugs. Contacts grip both sides of each tube prong and are SILVER plated to prevent corrosion losses. Preferred by careful builders at 90c—now 60c because of huge production savings.

Say

CUTLER-HAMMER

— Buy Your Radio Parts By Name —

ADVANCE PROGRAMS FOR THE WEEK

Saturday, November 28

Headliners Today

Eastern	Central	Mountain	Pacific
8:15 p. m.	7:15 p. m.	6:15 p. m.	5:15 p. m.
WIP (508.2)	Matinee musical club, Opera class.		
8:25	7:25	6:25	5:25
WJZ (454.3), WGY (379.5), WRC (408.5), New York Philharmonic orchestra.			
9	7		6
CNRO (435) Scotch program.			
WSB (428.3) Red head club.			
WTAM (389.4) Coo Coo club.			
10	9	8	7
WOC (483.6) Jack Little.			
11	10	9	8
WSM (282.8) Lion's club concert.			
11:10	10:10	9:10	8:10
KGO (361) Oddfellow's band concert.			
12 m.	11 m.		
KGO (361) Ricketty Rackety minstrels.			
2 a. m.	1 a. m.	12 m.	11
KNX (337) Hollywood night.			
2:30	1:30	12:30 a. m.	11:30 a. m.
KHJ (405.2) Lost Angels of KHJ.			

Saturday, silent night for: CFAC, CFCA, CNRA, CNRC, CNRE, CNRM, CNRR, CNRT, CNRV, CNRW, KFDK, KFMG, KFMA, KFRU, KFJO, KLDS, KLX, KMA, KOB, KSAC, KWSB, KTAB, WBAP, WBY, WCAP, WCAU, WCX, WEAQ, WEBJ, WEEI, WGPC, WGR, WGST, WHAD, WHAZ, WHB, WHN, WHO, WJAD, WJAR, WJAZ, WKAR, WLWL, WQAI, WOS, WTAG, WTIC, WJJ.

Eastern Time Stations

CFCA, Toronto, Can. (356), 11 a. m., Timothy Eaton Memorial church; 7 p. m., Walmer Road Baptist church.

CNRO, Ottawa, Can. (435), 7:30 p. m., Cozy Corner for Boys and Girls, Uncle Dick; 8, Chateau Laurier concert orchestra; 9, Scotch program; bagpipe solo, A. Dunlop; Mona Bloomfield, soprano; C. Williams, cellist; N. T. Allan, bass; A. M. Findlay, readings; Myrlah Kendall, pianist; orchestra.

KKA, Pittsburgh, Pa. (309.1), 7:15-8 a. m., morning exercises, O. Shannon; 8:15 p. m., dinner concert, Westinghouse band; 7:30, Duddy Winkum; 8:30, concert, Westinghouse employees band, T. J. Astine.

PWX, Havana, Cuba (400), 8:30 p. m., concert, Mrs. C. Rivera Baz, A. de Amaya.

WAFD, Port Huron, Mich. (275), 9-11 p. m., studio program; 11:30-2 a. m., musical program, Addison hotel.

WAHG, New York, N. Y. (315.6), 12-12:30 p. m., Joe Zimmerman, pianist.

WBBR, New York, N. Y. (272.6), 8 p. m., Malcolm Carment, clarinetist; 8:10, L. Marion Brown, soprano; 8:20, Bible questions and answers, Judge Rutherford; 8:40, L. Marion Brown, soprano; 8:50, Malcolm Carment, clarinetist.

WEZ, Springfield, Mass. (333.1), 2 p. m., Boston College-Holy Cross football game.

WCAE, Pittsburgh, Pa. (461.3), 3 p. m., music, Aldine theater; 6:30, dinner concert, William Penn hotel; 7:30, children's period; 8, studio concert, Capstan orchestra.

WCAP, Washington, D. C. (468.5), 2 p. m., Army-Navy football game.

WCX, Detroit, Mich. (517), 6 p. m., dinner concert, Book-Cadillac hotel.

WEAF, New York, N. Y. (491.5), 6:45-7:20 a. m., Metropolitan tower health drill; 1:45-5 p. m., Army-Navy football game; Norman Strutt and his Four Towers orchestra; 6-7, dinner music, Waldorf-Astoria; 7-11, Raphael Samuelli, pianist; "America's Most Precious Possession"; John F. Hinson, musical program; 11-12, Vincent Lopez and his orchestra.

WEAR, Cleveland, Ohio (389.4), 11 a. m., home service talk; 7 p. m., Hotel Statler concert orchestra; Maurice Siplany, director.

WFI, Philadelphia, Pa. (395), 1 p. m., Strawbridge and Clothier Tea Room ensemble, Harold Micklin, director; 1:45, Army-Navy football game; 6:30, Bellevue Stratford hotel concert orchestra; 7, Bellevue Stratford hotel dance orchestra.

WGSS, New York, N. Y. (315.6), 10-10:10 a. m., timely talks with Teresa; 10:10-10:15, N. Y. Evening World Kiddie club; 10:40-10:50, Harold Andrews and William Goggin, duets; 10:50-11, fashion talk, Mme. Bill Deane; 1:30-1:35 p. m., scripture readings; 1:35-1:40, Deborah Lipson, soprano; 1:40-2:40, orchestra; 3-3:10, Frederick Maroc, tenor; 3:10-3:20, Ray Lev, pianist; 3:20-3:30, Frederick Maroc; 3:30-3:40, Ray Lev; 3:40-3:50, Frederick Maroc; 3:50-4, Ray Lev; 6-6:30, Uncle Geebee; 6:30-7, Vincent Sorey's trio; 7-7:10, dance lessons, Arthur Murray; 7:10-7:30, H. A. A. harmonica band; 7:50-8, Sarah Mahler, soprano; 8-8:10, negro dialect stories; 8:10-8:20, Winifred Gaynor, contralto; 8:20-8:30, negro dialect stories; 8:30-8:40, Winifred Gaynor; 8:40-8:50, talk, Brig. Edward Underwood; 8:50-9, Captain Clifford Brindley, tenor; 9-9:20, Savino and Ruty, guitar duets; 9:20-10:30, program, Warner's theater; 10:30-11:30, Arrowhead inn dance orchestra.

WGPP, New York, N. Y. (252), 9-3-15 p. m., Henry Rogers, pianist; 3:15-3:30, Henrietta Cross and Maurice Abrahams, songs; 3:30-3:45, orchestra; 4-4:15, Twentieth Century entertainers; 4:15-4:30, Johanna Cohen, ukulele soloist; 4:30-4:45, orchestra; 4:55-5:10, Rust and Benches, banjoists.

WGR, Buffalo, N. Y. (319), 1:45 p. m., WEAF, Army-Navy football game, Pologrounds, New York.

WGY, Schenectady, N. Y. (379.5), 1:30 p. m., United States Military Academy-United States Naval Academy football game; 7:45, bridge lesson, number two; 8:25, Fourth New York Philharmonic Society Student symphony series, Willem Mengelberg, conductor, WJZ; 10:30, Hotel Van Carter dance orchestra.

WHAR, Atlantic City, N. J. (275), 2 p. m., Seaside hotel trio; 7:30, lecture period; 8, Seaside hotel trio.

WIP, Philadelphia, Pa. (508.2), 6:45 a. m., setting-up exercises, Dr. Francois D'Eliseu; 7-10:30, setting-up exercises; 1 p. m., organ recital; 3, Dal Ruch and his Amadians; 6:05, dinner music, Benjamin Franklin concert orchestra; W. Irving Oppenhehn, director; 7, Uncle Wip's bedtime story; songs, Margaret Keenan; 8:15, opera class, Matinee Musical club, Alexander Smallens, director; 10:05, Benjamin Franklin dance orchestra, Howard Lanin, director.

WJAR, Providence, R. I. (305.9), 1:45 p. m., Army-Navy football game.

WJB, Pontiac, Mich. (516.9), 7 p. m., Jean Goldkette's Petite symphony orchestra; 9, Jean Goldkette's serenaders; soloists; 10, Jean Goldkette's Victor Recording orchestra; 11:30, The Jewett Jesters, The Merry Old Chief.

WJZ, New York, N. Y. (455), 1 p. m., Irwin Abrams' Knickerbocker grill orchestra; 1:30, Army-Navy football game; 5, Hotel Lorraine dance orchestra; 7, Bernhard Leviton's Hotel Commodore dinner orchestra; 8, Sherry's dance orchestra; 8:25, Philharmonic society student concert; Willem Mengelberg, conductor; 10:30, Paul Specht's Moulin Rouge orchestra.

WKAR, E. Lansing, Mich. (285.5), 12:30 a. m., dance program.

WMAK, Lockport, N. Y. (265.5), 8:30-9 p. m., Joe Armstrong and his dance orchestra; 9-10, Sunrise Point Development company's hour.

WMCA, New York, N. Y. (340.7), 6-6:30 p. m., Olcott Vail; 6:30-6:45, Theo Alban, tenor; 7-8, The Amphons; 8-8:15, Lillian Jessa, soprano; 8:30-8:45, Robert S. Chree, baritone; 9-9:15, David Segel, violinist; 9:30-10, Cunderella dance orchestra; 10-10:15, Erva Giles, soprano; Edward Morris, pianist; 10:30-10:45, Jack Davis, nad Harvey Simmons; 11-12, Ernie Golden and his Hotel McAlpin orchestra.

WNYC, New York, N. Y. (526), 6-7 p. m., dinner music, Hotel St. George; 7:35-7:45, violinist; 8-9, studio program; 9-9:30, police quartet; 9:30-10:10, instrumental novelties; 10:10-10:30, lecture, board of education.

WOO, Philadelphia, Pa. (508.2), 11 a. m., grand opera; 12 noon, Golden's Crystal Tea Room orchestra; 4:45, Grand organ, trumpets; 7:30, "Christmas Seeds In



Invisible though her twinkling toes will be Thursday evening, Maria Gambarelli entertains with such an airy grace that the listener can easily imagine her as a dancer. She is one of Roxy's gang on the air Thursdays at WJAZ and chain.

Philadelphia", Dr. Harvey Dee Brown; 7:45, Charles Fox, baritone; Harriette G. Ridley, accompanist.

WDR, Newark, N. J. (405.2), 6:45-7:45 a. m., gym classes; 3:15-4 p. m., Ziti's Central Park West orchestra; 6:15-6:17, "Words Often Mispronounced"; 6:17-7:15, dinner music, Hotel Shelton; 7:30-8, Van's collegians; 11-12, Ciro's orchestra.

WRC, Washington, D. C. (468.5), 12 noon, organ recital; 1 p. m., Hamilton hotel orchestra; 6, Hotel Hamilton orchestra; 7, Hotel Washington orchestra; 7:55, Zoological talk; 8:10, Bible talk; 8:25, New York Phil-

harmonic orchestra, WJZ; 10:30, Crandall's Saturday Nighters.

WREO, Lansing, Mich. (285.5), 6-7 p. m., Speed-Wagon serenaders; 10-12, Speed-Wagon serenaders.

WTAG, Worcester, Mass. (268), 12:05-1:40 p. m., WTAG trio; 1:45, Boston College-Holy Cross college football game.

WTAM, Cleveland, Ohio (389.4), 12:15-1:15 p. m., lunch hour music, popular entertainers, Euclid music studio; 6-7, dinner hour music, Hotel Hollenden orchestra; Carl Rupp, director; 8-9, miscellaneous program.

High Lights of the Week

"RICKETY-Rackety-Radio Minstrels" and the "Radio Male Chorus" will give the touch of comedy to the KGO broadcast Saturday night, November 28. The main part of the program will be contributed by the San Jose Odd Fellows band, under the baton of Edward Towner. Those of our readers who are interested in Jack Little will be glad to find him at WOC this evening.

Irish melodies mingle with operatic selections Sunday evening over WEAF and chain during the Atwater Kent hour when Kathryn Meisle, contralto from the Chicago Civic Opera company, and Allen McQuhae, Irish tenor, appear.

Are you a duck? If not tune in and become a member of the Protective Order of Lake Merritt Ducks at KLX, Oakland. The next meeting is Monday and is a special guest night for Knights of Pythias.

Romance. The whole 9:45 p. m., central time, program Tuesday, at WOAW, Omaha, oozes with it. Not

just one banjo and the moonlight, but Francis Potter's whole banjo orchestra will lure fans to dial for this station.

Stirring songs of the World War will float upon the ether Wednesday night from WLW, Cincinnati. "There's a Long, Long Trail A'winding" and "Keep the Home Fires Burning" will take the listener back to other days.

"Rob Roy," the companion opera to "Robin Hood," is the Thursday feature at WBAP, Fort Worth. This is being given by the Los Angeles Institute of Music. The music of this opera is light and gay.

KFAB has an anniversary Friday evening. This station is only one year old and many of the original artists will return to entertain during this program. Harriett Cruise, Oriole contralto and Richard Low, Chinese baritone, are two of the leading artists. The annual fall concert of the Hartford choral club, an organization of 80 male voices, will be broadcast through WTIC this same evening.

Willard studio; 9-12, novelty program, Ev. Jones and the Coo Coo club.

WWJ, Detroit, Mich. (352.7), 9:30 a. m., "Tonight's Dinner"; 12:05 p. m., Jules Klein's Hotel Statler orchestra; 1:45, Army-Navy football game.

Central Time Stations

KFAB, Lincoln Nebr. (340.7), 2 p. m., football returns; 8:30-10:30 Schmoller & Mueller musicals.

KFNF, Shenandoah, Iowa (266), 7 p. m., Pullman quartet.

KFVE, University City, Mo. (240), 8:30 p. m., amusement review, Romaine Fielding, Gene Witacker's orchestra, comedy and jazz.

KMA, Shenandoah, Iowa (252), 11:30-12:30 p. m., garden, flower, orchard talks, Earl E. May; domestic science talk, Leona Teget, June B. Case; 6, Pollyanna stories, Mrs. Dwight Nichols; chimes, William Howie; retailers program, Benedict Piano company; 9-10, May Flower orchestra, June and Jim Taylor, Bobbie Ross; 10-11, William Howie, organist.

KPRC, Houston, Texas (296.9), 7:35 p. m., Universal Bible class, Rev. Claud L. Jones; 8, Frank Tilton, boy pianist; 11, program for West Coast listeners.

KSD, St. Louis, Mo. (545.1), 6:45 p. m., Statler hotel dinner concert; 9, orchestral program; stage specialties, Grand Central theater.

KTHS, Hot Springs National Park, Ark. (374.8), 9-9:05 p. m., address; 9:05-10:15, dance concert, New Arlington orchestra; Clyde Foley and Tony Cochard, singers.

KYW, Chicago, Ill. (535.4), 6:30-7 a. m., exercises; 11:35, table talk, Anna Peterson; 1 p. m., concert, Commonwealth Edison company; 1-2, luncheon concert; Joska DeBabary and his orchestra; Coon Sanders Original Nighthawks; 6:10-6:40, musical concert, Commonwealth Edison company; 6:40-7, bedtime story, Uncle Bob; 7-7:30, dinner concert, Congress hotel; 7:30-8:30, Home "Lover's" hour; 8:30-11, Congress classic, Edwin Borroff, director; 11-1 a. m., Congress classic; 1-2, Insomnia club, Coon Sanders Original Nighthawks.

WAMD, Minneapolis, Minn. (243.8), 12 noon, musical program; Hal Keldal, tenor and pianist; Marion Latta, contralto; 7:05 p. m., musical program; Harmony twins, Minnesota quartet; Irene Lee, Lillian Feetham, violinists; Edna Lee, accompanist; Robert Davis, tenor; Leone Wood Taylor, accompanist; 11, Skyrocket frolic, George Osborn's Hotel Radisson Skyrokers.

WBM, Chicago, Ill. (226), 4-6 p. m., Valentino Inn orchestra; Harry Sosnit, Sandy Meek; Court Banks; Johnny Black; Russell Meyers; 9:30-11, Harry Sosnit, Sandy Meek; Moulin Rouge orchestra; 8, William B. Anderson, steel guitar; George Seaburg; Fred Jacobson.

WBCN, Chicago, Ill. (266), 10-10:30 a. m., shopping talk, Penn. Wise; 3-5 p. m., tea time matinee; Clarence Jones, pianist and song writer; Cecelia and Johanna Arends, violinist and pianist; Marie Welch, soprano; 10-11:15, jazz jamboree, Midway Dancing Gardens orchestra; Cameron and Felt, "The Harmony Wizards," harmony duo; Albert Biaba, concertinist; Johnny Special, the harmonica acrobat; Elizabeth Baumett Malone, soprano; Jack Parker, tenor; 11:15-12, King Statie's court; Frank H. McDonald, "King Statie"; Mary Williams, "Queen Olive"; Harry A. Zook, Jr., "prime minister"; "Big Boy" Yagle, "court jester."

WCCO, Minneapolis-St. Paul, Minn. (416.4), 10:45 a. m., home service talk, Gold Medal Girls' club; 12:30 p. m., concert, Golden Pheasant orchestra; 6:15, dinner concert, Biley's St. Paul hotel orchestra; 8, Reside Philosophies, Rev. Roy L. Smith, pastor; 8:15, musical program; 9, program, Minneapolis Post Office; 10:05, dance program, Arnold Frank's St. Paul hotel orchestra.

WDAF, Kansas City, Mo. (365.6), 3:30-4:30 p. m., Star's string trio; 6-7, School of the Air; address, Roger W. Babson, organist; Trianon ensemble, Hotel Muehlebach; 11:45-1 a. m., Nighthawk frolic; Plantation players; Johnnie Campbell's Kansas City club orchestra; Earl Coleman's orchestra; Eddie Kuhn's Kansas City Athletic club orchestra.

WEBB, Chicago, Ill. (370.2), 7-8 p. m., Oriole orchestra; Radio Sunday school lesson; 9-10, Oriole orchestra; James Murray, tenor; Marie Kelly, reader; Beulah Ladd, violinist; 11-1, Oriole orchestra; Marie Kelly, reader; Frank Greif, tenor; Rick and Snyder; Wayne Myers; Kay Romayne.

WENR, Chicago, Ill. (266), 6-7 p. m., Rauland lyric trio; George Unger, violinist; 8-10, All-American Pioneers; Walter Peterson, soprano; John Papa, concertina soloist; 12-2 a. m., All-American Pioneers; Walter Peterson, Kentucky Wonderbean; Rita McFawn, banjoist.

WFAA, Dallas, Texas (475.9), 12:30-1 p. m., Lindsey Stephens, baritone; Gordon Bishop, pianist; 6:30-7:30, Don Bestor's orchestra; 8:30-9:30, George T. Cobb and musicians; 11-12, Adolphus hotel orchestra.

WGES, Oak Park, Ill. (250), 5-7 p. m., Marge Van, organist; Ruth Kalthoff, mezzo soprano; John Stunford, tenor; Miles Sullivan, players; 8-9, Doc Berendson and his Tiffin theater orchestra; Paola Corado, baritone; Ellen Maurice, pianist; Remington Welsh, organist; 11-1 a. m., the Coyne Serenaders orchestra; Remington Welsh, organist; Sandy McTavish, Scotch comedian; Edith Adams, the girl with the ukulele; Rose Sweeney and Lovetta Chisman.

WGN, Chicago, Ill. (370.2), 12:40 p. m., luncheon concert, Drake and Blackstone hotel orchestras; 3, rocking chair time; music; excerpts from, Chicago Tribune, and Liberty magazine; 5:30, Skeezix time; 6:30-7, dinner concert, Drake and Blackstone hotel orchestras; 8-9, music, WGN string trio, mixed quartet; 10-11, dance program, Drake and Blackstone orchestras.

WHAD, Milwaukee, Wis. (275), 11 a. m., story for children, Faye McBeth; Margaret Cunningham, pianist.

WHAS, Louisville, Ky. (399.8), 4-5 p. m., concert, Harry Curtis's Music Box; Martha Pope, reader; 7:30-9, concert, Down club; Angelina McCook, contralto; 9, special story, Rev. B. B. Crimm, the Fox Hunting Parson; hunting hour.

WHT, Chicago, Ill. (399.8), 10 a. m., Jean Sargent's woman's club, Jelke Good Luck Girl; 11, special studio features; 12 m., Al Carney's organ hour; 1-2 p. m., special studio features; 6, final football scores, classical program, dinner organ recital, Grayling's string trio; Eleanor Kaplan, violinist; Estell Stanley, soprano; Antoinette Bennett; W. A. Dyckman, baritone; Florence White Rush, soprano; 7:45-9:15 (238), musical features; 9:30 (399.8), Jelke entertainers, Kitchen Klezner Klezics, Harry Langdon, harmonica; Marie Wright, soprano; the Golden trio, Oscar Heather, tenor; Al Carney, organist; Badge Four male quartet; Clark Hawaiian trio, Vic Fredericks, baritone; Irene Beasley, "The Girl from Dixie"; Marguerite Morris, "The Girl from Georgia"; Jacobson, humorist; 12, Pat Barnes and Al Carney.

WIBO, Chicago, Ill. (226), 6-8 p. m., dinner concert.

WJBL, Decatur, Ill. (270), 9:30-11 p. m., violin, piano solos and duets.

WJJD, Moecharf, Ill. (302.8), 10 p. m., Rosemary Hughes, Robert Duphney, Robert Dewar, Marie Winters, Log Cabin orchestra; 12, Jack Mason, Fayette Miller, Courtland Banks, Log Cabin orchestra.

WKB, Cincinnati, Ohio (326), 10 p. m., Marion McKay and his Swiss Garden orchestra, studio features.

WLIB, Chicago, Ill. (308.2), 7-8 p. m., dinner concert, Blackstone and Drake hotel orchestras; 9-10, popular, Hamm's orchestra; 11-12, Drake and Blackstone orchestras.

WLS, Chicago, Ill. (344.6), 12-12:45 p. m., Junior R. F. D. Roundup program, trapping series, S. T. Keshen; 7, lullaby time, Ford and Glenn; 7:20, WJLS revue, WLS barn dance orchestra; Ideal quartet, WLS studio trio; Ford and Glenn; Johnny Hays's Kentucky serenaders; Grance Wilson, contralto; 11, Joe Bren's minstrels, Marigold trio; 11:40-12, Ford and Glenn.

WLM, Cincinnati, Ohio (422.3), 7 p. m., Johanna Grosse, organist; 7:30, football results; 7:35, Secretary Hawkins; 8-10:30, Dayton Daily News First Annual Radio show.

WOAW, Omaha, Nebr. (526), 5:40 p. m., Val McLaughlin, the Sandman; 6, Rialto orchestra; 7, Gilbert Jaffy and his Little symphony; 7:30, speakers' hour; 9, program, Omaha Printing company; 11, Arthur Hays and his organ jubilee; Dr. Appliance announcing.

WOC, Davenport, Iowa (483.6), 6:30-6 p. m., Chime concert; 6:30-6:50, Sandman's bedtime stories; 9-10, musical program, choir, St. Ambrose College; Rev. J. B. Code, director; Jack Little, entertainer.

(Continued on page 14)

RICKETY-RACKETY MINSTRELS AT KGO



No one could help liking sopranos after seeing this smiling young lady above. She is Eleanor Gilmour of WHT, Chicago. "Sweetheart of the Air" is the title of Edna Adams, right, who whistles and sings at KPRC, Houston, Texas. Tune in Tuesday, December 1, at 8:30 p. m., central time.

Saturday, November 28

(Continued from page 13)

WMAQ, Chicago, Ill. (447.5), 6 p. m., Chicago theater organ; 6:30, Hotel LaSalle orchestra; 8, Russell Pratt and Frederick Daw; 8:30, "Canadian Trill Riders," Capt. Kilroy Harris; 9, Chicago theater review.

WMBB, Chicago, Ill. (250), 7-8 p. m., Trianon duo; Beatrice Teller, Ralph F. Elliott, Preston Graves, in semi-classical program, direction J. B. Lampe; 9-11, Trianon orchestra, Dell Lampe; Woodlawn orchestra, Armin F. Hand; Ed "Banjo" Hines, A. B. Stephenson, Charles Agne, Hunter Kahler in popular program.

WMC, Memphis, Tenn. (499.7), 8:30 p. m., University of Tennessee doctors' band.

WOI, Ames, Iowa (270), 12:45 p. m., soil problems, Prof. P. E. Brown.

WOK, Chicago, Ill. (217.3), 12-2 p. m., Bob Duffy, tenor; Gus C. Edwards and his orchestra; Banks Kennedy, organist; Bob Mokreis, pianist; WOK string trio; 5:30-7, Howard Will, tenor; Robert York, tenor; Gus C. Edwards and his orchestra; Banks Kennedy, organist; WOK string trio; 10-11, Fred Wilmer, pianist; Gus C. Edwards and his orchestra; Harold Morava, tenor; Herman Shulko, violinist; Harriet Lee, contralto; WOK string trio; Bill Hay, bass; Banks Kennedy, organist; Bob Mokreis, pianist; Paul Vernon, violinist; WOK male quartet; Charles Lord, tenor; Henry Ber, tenor; Ralph Keyes, baritone; N. Bartlett, bass; Honolulu serenade.

WQQ, Kansas City, Mo. (278), 8-9 p. m., musical program; 10-11, musical healing service.

WORD, Batavia, Ill. (275), 8 p. m., concert, orchestra program, Webster hotel; Webster hotel concert trio; Chicago motor club speaker; world news Digest, L. F. Wiebrecht.

WU, Chicago, Ill. (447.5), 11-12 noon, home economics program, Helen Harrington Downing, director; "Too Pat—Too Thin?" J. J. Toedt; talk to mothers, F. E. Ormsby; 3-4 p. m., Koffee Klatsch program; Jerry Sullivan; Rose Vanderbosch, pianist; Hal Lansing, uke soloist; 7-8, Ralph Williams and his Rainbo orchestra; Everett Mitchell, baritone; Marie Duvernoy, Russian soprano; Kane McDuffee, whistler; Ralph Klein, pianologist; Anne Klein, mezzo-soprano; 10-3 a. m., Ralph Williams and his Rainbo Skylark; Dr. Carl Bertschinger, pianist; Grace Wallace, soprano; Jerry Sullivan; Rose Vanderbosch, soprano, pianist; Hal Lansing, uke soloist; Everett George Opie, character reader; June Lee, comedian; Bert Davis, clown of the air; Clarence Theiders, tenor; Rita McGowan, Mary Bieber, harmonica duo; Joey Stood, tenor; Eddie Vogel, baritone; Brundage and Kraemer, harmony singers.

WSAI, Cincinnati, O. (325.9), 12:45-3 p. m., Army-Navy football game; 7:45, children's stories; 8, chime concert, Robert Badgley; 8:15, Bicycle Playing Card sextet; 9:15, Bicycle Playing Card sextet, soloist.

WSB, Atlanta, Ga. (428.3), 8 p. m., Red Head club; 10:45, Hired Help Skylark.

WSM, Nashville, Tenn. (282.8), 6:30-8 p. m., Francis Cruise orchestra; 7, bedtime story, Bonnie Baurhardt; 10-11, studio concert, Lions club.

WSOE, Milwaukee, Wis. (246), 9 p. m., Sunday school lessons, Rev. H. S. Wise; 9:50, musical program, Lake Front studio.

WSUI, Iowa City, Iowa (483.6), 7:30 p. m., Gers dino Mars, pianist; William G. Edmondson, Jr., tenor.

Mountain Time Stations

KFAU, Boise, Idaho (278), 7:30 p. m., dance program.

KFWA, Ogden, Utah (261), 5-6 p. m., Ogden Radio dealers program; 9-12, Olie Reeves and his orchestra.

KOA, Denver, Colo. (322.4), 12:15 p. m., Rialto theater musicale, football finale; 9, Wurtzbach's orchestra.

Pacific Time Stations

KFOA, Seattle, Wash. (454.3), 8:30-9:30 p. m., program; 9:30-11:30, Eddie Harkness and his orchestra.

KFWB, Hollywood, Calif. (252), 7:15 p. m., microphone brevities; 7:30-8, program, Elmer B. Sly company featuring Carey Donaldson Kraft, soprano; Nathan Lestiesky, cellist; 8-10, "Radio Doing Revels," Radio technical talk, Hal Shaw; 10-11, Warner Brothers frolic, direction Charlie Wellman; 11-12, Henry Halstead's Hollywood Roof orchestra.

KGO, Oakland, Calif. (361.2), 7:15-7:30 a. m., health training exercises; Hugh Barrett Dobbs, William Hancock; 7:45 a. m., pep class, Hugh Barrett Dobbs; 8:15-8:30, health training exercises; Hugh Barrett Dobbs; 8:30, daily strength, Cheerio; 11:30-1 p. m., luncheon concert, Pacific States Electric company; 4 to 5:30 p. m., concert orchestra, Hotel St. Francis; 8, band concert, District No. 20 Odd Fellows, direction of Edward Tower; Margaret Jayne Meshery, contralto; Pearl May Poore, soprano; Robert

Smiley, baritone; The Rickety-Rackety Radio minstrels; Radio male chorus; 10-12 midnight, dance music, Hotel St. Francis.

KGW, Portland, Ore. (491.5), 12:30-1:30 p. m., Rose city trio, Pacific States Electric company; 6-7, dinner concert, Olds Worthman & King; 9-12 dance music, Indian Grill.

KHJ, Los Angeles, Calif. (465.2), 6-6:30 p. m., Leighton's Aragon suite; orchestra, Jack Cronshaw, leader; 6:30-7:30, history story, Prof. Hertzog; Jack Soaric, Dolly Wright, Henrietta Poland, David Durand; 8-10, program, Builders Finance association; 10-11:30, Art Hickman's Biltmore hotel dance orchestra; 11:30-2 a. m., Lost Angels of KELL.

KJR, Seattle, Wash. (384.4), 1:15-2 p. m., organ recital; 2-2:15, home help, Bernice Redington; 6-6:30, what's going at the theater; 8:30-10, L. C. Warner company.

KMTR, Hollywood, Calif. (238), 5-6 p. m., home hour, Mammy Simmons and neighborhood children; 7:30, lectures on history and astronomy; 8-11, KMTR concert hour, Turner orchestra, direction Loren Powell.

KNX, Hollywood, Calif. (337), 5:30-6:15 p. m., Wurlitzer pipe organ studio; Town Battle; 6:15, travel talk, W. P. Alder; 6:30-7, Atwater Kent concert orchestra, Paul Plantein, leader; 7, talk on insect life, H. W. McSpadden; 7:15, church announcements; 7:30-8, Wurlitzer pipe organ studio; 8-10, KNX feature studio program; 10-11, Ray West's Cocomat Grove dance orchestra from Ambassador hotel; 11-2 a. m., Hollywood Night program.

KPO, San Francisco, Calif. (428.3), 1-2 p. m., Rudy Seiger's Fairmont hotel orchestra; 2:30, piano solos, duos, Lincoln Batchelder, director; 3:30, Palace hotel concert orchestra; Cyrus Trobe, director; 6:35-7:30, Waldemar Lind and the States Restaurant orchestra; 7-12, Cabrera cafe orchestra, Jack Conkley, director.

KTAZ, Oakland, Calif. (240), 9-9:30 a. m., prayer service, Rev. E. L. Spaulding.

Sunday, November 29

Headlines Today			
Eastern	Central	Mountain	Pacific
7:20 p. m.	6:20 p. m.	5:20 p. m.	4:20 p. m.
WFAF (491.5), WEEI (348.6), WGR (319), WCAE (461.3), WCAP (468.5), WJAR (305.9), WTAG (268), Capitol Gang.	7:15	6:15	
WLAZ (491.5), WEEI (348.6), WGR (319), WCAE (461.3), WCAP (468.5), WJAR (305.9), WTAG (268), KFD (545), WCCO (416.4), WOC (483.6), WOO (508.2), WSAI (326) Atwater Kent hour.	9 p. m.	8 p. m.	7 p. m.
WGY (279.5) Violin recital, Godfrey Ludlow.	11	10	9
KHJ (405.2) Silver Star program.	12	11	10
KWVB (252) Blue Boys; Saxophone sextet.	12	11	10
KNX (337) Raquel Nieto, coloratura soprano.			

Sunday, silent night for: CHIC, CKNC, CNRA, CNRC, CNRE, CNRM, CNRW, CNRR, CNRT, CNRV, CNRW, KFAU, KFAU, KFMO, KFOA, KFPG, KFVE, KFVA, KFX, KMA, KOB, KSAC, KWSG, FWX, WAH, WBAF, WCAU, WCX, WDAF, WEAQ, WEBJ, WGES, WGP, WGST, WHAD, WHAS, WHAZ, WIP, WIAD, WIJZ, WKA, WIR, WLIT, WMC, WNYC, WOK, WOR, WORD, WRC, WSAI, WSM, WTAM, WTK.

Eastern Time Stations

CFCA, Toronto, Can. (356), 11 a. m., service, Timothy Eaton Memorial church; 7 p. m., service, Walmer Road Baptist church.

KDKA, Pittsburgh, Pa. (309.1), 11 a. m., services; 4 p. m., organ recital, Dr. Charles Heinroth; 4:45, vesper services, Shady Side Presbyterian church; Rev. Hugh Thomson Kerr, pastor; 6:30, dinner concert; 7:45, church services.

WBZ, Springfield, Mass. (333.1), 10:30 a. m., church service; 7 p. m., Copley Plaza orchestra; Raymond Simonds, tenor; 8, "What a Scientist-Theologian Believes of Evolution," Rev. M. J. Ahern.

WAFD, Port Huron, Mich. (275), 10-11:30 a. m., services; 7:30-8:30 p. m., musical program.

WCAE, Pittsburgh, Pa. (461.3), 8:45 p. m., Dr. S. P. Cadman; 6:30, dinner concert, William Penn hotel; 7:20, Capitol theater gang; 9:15, Atwater Kent, WFAF.

WCAP, Washington, D. C. (468.5), 11 a. m., services, Vermont Avenue Christian church; 4 p. m., services, Bethlehem chapel, Washington cathedral; 7:20-9:15, Capitol theater program, WFAF; 9:15-10:15, Atwater

Kent hour; Kathryn Meisle, contralto; Allen McQuhae, Irish tenor, WFAF.

WCAU, Philadelphia, Pa. (277.6), 5 p. m., Robert Fraser, gospel singer; Elizabeth Holtz, pianist; 5:15, Undenominational church service, Rev. John Stockwell; 5:25, "Twelve Books of Mystery," Rev. John W. Stockwell; 5:35, recital; 5:45, "A Square Peg," Rev. John S. Stockwell; 6:30, Hotel Pennsylvania trio; 7:30, Cathay Tea Garden concert orchestra; 8:30, Bonwit Teller concert.

WCX, Detroit, Mich. (517), 10:30 a. m., services, Central Methodist Episcopal church.

WEAF, New York, N. Y. (491.5), 2-3:45 p. m., "Sunday Hyman Sing," Greater New York Federation of churches; 3:45-5, men's conference, Bedford branch, Y. M. C. A.; 7:20-9:15, "Capitol Gang," Capitol theatre; 9:15-10:15, Atwater Kent Radio hour, Kathryn Meisle, contralto, Allen McQuhae, Irish tenor.

WEEI, Boston, Mass. (348.6), 10:45 a. m., services, Old South Church; 2:30 p. m., Chamber of Commerce organ recital; 3:45, Dr. S. Parkes Cadman; 7:20, Major Bowes and his Capitol theater family, WFAF; 9:15, Atwater Kent artists, WFAF.

WFI, Philadelphia, Pa. (395), 10:20 a. m., services, Arch Street Methodist Episcopal church; 4:30 p. m., chapel service, Church Federation of Philadelphia, Rev. Dr. John Watchorn.

WGBS, New York, N. Y. (315.6), 3:30-4:30 p. m., program, Warner's theater; 9:30-10, Century string quartet, Calvary Episcopal choir.

WGP, New York, N. Y. (252), 8-8:15 p. m., Charlotte Trystmann, pianist; 8:15-8:20, health talk; 8:20-8:45, Arline Felker entertainers; 8:45-9:15, Rosencranz orchestra; 9:15-9:30, Isabelle Henderson, soprano; 9:30-9:45, Dicks ukulele club; 10:30-10:45, Sylvia Schatz, pianist; 11-12, Strickland's orchestra; 12-12:45, Club Richman entertainers.



WGR, Buffalo, N. Y. (319), 3 p. m., vesper service, Buffalo Council of churches, Rev. John Bettie, Immanuel Reformed church; 7:45, Central Presbyterian church service; 9:15, WFAF, Atwater Kent program, Kathryn Meisle, contralto, Allen McQuhae, Irish tenor.

WGY, Schenectady, N. Y. (379.5), 11 a. m., First Presbyterian church, Rev. William H. Hopkins, pastor; 12:30 p. m., symphony orchestra, WJZ; 5, Dr. Frank Sill Rogers, organist; 7, Carillon program; 7:45, services, First Presbyterian church; 9, WGY studio program; 10, Godfrey Ludlow, violinist, WJZ.

WHAR, Atlantic City, N. J. (275), 10:45 a. m., services; 2:15 p. m., Seaside hotel trio; 2:45, sermon; 7:50, Baptist church; 9, Seaside hotel orchestra; 11:15, Strand theater organ recital.

WHN, New York, N. Y. (361.2), 1-1:30 p. m., Lexington organ recital; 2-3, Christian Endeavor program; 3-4:30, services, Calvary Baptist church; 5-5:30, Roseland dance orchestra; 7:30-10, services, Calvary Baptist church; 10:45-11:15, Janssens' Hofbrau orchestra; 12-12:30, Harry Richman and his entertainers.

WIP, Philadelphia, Pa. (508.2), 10:45 a. m., morning The Merry Old Chief, Jewett Jesters.

WIAR, Providence, R. I. (305.9), 7:20 p. m., Capitol Theatre Gang; 9:15, Atwater Kent radio hour.

WJR, Pontiac, Mich. (516.9), 8:30 p. m., Radio frolic, service, Holy Trinity church; Rev. Floyd W. Tomkins, pastor; 4 p. m., religious services.

WMCA, New York, N. Y. (340.7), 11-12 m., services, Eighth Church of Christ Scientist; 6-7 p. m., Roamer's Homers; 7-7:35, Ernie Golden and his Hotel McAlpin orchestra; 7:35-8, Olcott Vail and his Hotel McAlpin string ensemble.

WREO, Lansing, Mich. (285.5), 10 a. m., Beltry Plymouth Congregational church; 10:30, church service, Plymouth Congregational church; 7:30 p. m., Central M. E. church.

WTAG, Worcester, Mass. (268), 3:45-5:30 p. m., men's conference, address, Dr. S. Parkes Cadman, Y. M. C. A.; George Betts, chime soloist; 7:20-9:15, Major Edward Bowes and the "Capitol Family"; 9:15-10:15, Atwater Kent Radio hour, Kathryn Meisle, contralto; Allen McQuhae, Irish tenor.

WWJ, Detroit, Mich. (332.7), 11 a. m., services, St. Paul's Episcopal Cathedral; 2 p. m., Detroit News orchestra; 7:20, Capitol theater gang, WFAF.

Central Time Stations

KFAB, Lincoln, Neb. (340.7), 4-5 p. m., vesper service, KFDM, Beaumont, Texas (315.6), 8-9 p. m., sacred program.

KFMX, Northfield, Minn. (337), 7-8 p. m., college vesper service.

KFNF, Shenandoah, Ia. (266), 10:45 a. m., Morning worship, First M. E. church; 2:30 p. m., Golden Rule church service; 3, Young People's Sunday school; Zella Neudler, director; 6:30, regular services, Golden Rule Circle; 7:30, Christian church services.

KFOU, St. Louis, Mo. (545.1), 4 p. m., "I am a King," Rev. K. Luecke; 9:15, "The Messiah Was Promised to Come," Prof. W. Arndt.

KIDS, Independence, Mo. (440.8), 11 a. m., Stone church service; 3, Young People's Sunday school; Zella Neudler, director; 6:30, regular services, Golden Rule Circle; 7:30, Christian church services.

KMA, Shenandoah, Iowa (252), 4-6 p. m., services; music; talk, G. H. Van Houten.

KPRC, Houston, Texas (296.9), 10:45 a. m., services, South Main Baptist church, Rev. M. Wolf; Mrs. E. P. McClannahan, director of music; Robert Jolly, superintendent; 7:30 p. m., services, First Christian church, Rev. Claude L. Jones, pastor; Guy E. Curtis,

director of music; Mrs. W. P. Claypool, organist; 9:30, Ray Mullins' orchestra.

KSD, St. Louis, Mo. (545.1), 6:15 p. m., WFAF chain.

KTHS, Hot Springs National Park, Ark. (374.8), 11 a. m., 12-15 p. m., services, Central Methodist church, Rev. J. J. Stowe, pastor; Arthur Platz, organist; 9-10, classic hour, New Arlington Meyer Davis Grand ensemble, Lon Chassy, conductor; 10-11, KTHS Radio special frolic; Benny Ford's DeSoto orchestra.

KYW, Chicago, Ill. (535.4), 11 a. m., Central church services; 2:30 p. m., studio chapel service; 5-6, studio concert, Edwin Harper; 7-9:30, Chicago Sunday Evening club service; 9:30-11, classical concert, Commonwealth Edison company.

WAMD, Minneapolis, Minn. (243.8), 9:30 p. m., mixed quartet; Irving Winslow, violinist; Harriet Johnson, accompanist; Leon Fletcher, baritone; Etta Landry, pianist; 11, Skyrocket frolic; George Osborn's Hotel Radisson Skyrockets.

WBAF, Fort Worth, Tex. (475.9), 11 a. m., services, First Methodist church, Rev. J. W. Bergin, pastor; Florence W. Brush, organist; 12:30 p. m., Kiddies hour, Uncle Billy; 11-12, program of popular music.

WBBM, Chicago, Ill. (228), 12:30-2 p. m., classical program, William P. Zimmer; Wheeler Harold Moravo; Edna Wheeler Ballard; Harry Sosnik, and Sandy Meek; 4-6, Ziegler sisters; Jack Garcia, Hawaiian guitar; Harold Anderson, accordionist; Lester Anderson, banjo; orchestra; Lew Russell; Les Skow; 8-10, Jeane St. Anne, baritone; Christian Grimm, accompanist; Joseph Lincoln, tenor; string trio; Marie Morgott, harpist; Moulou Rouge orchestra; 12-2 a. m., Nutty club; Moulou Rouge orchestra.

WBCN, Chicago, Ill. (266), 10:30-12 m., morning service, People's Episcopal church; talk, Rev. Rufus A. White; 4-5 p. m., Dain & Son classical hour; Velma Cook, soprano; Oriental quartet; male harmony group; Robert Stronach, pipe organist; 7:45-9:15, evening service, Thoburn M. E. church, 40-piece Thoburn semi-symphony orchestra; 80-voice choir, special vocal soloists; speaker.

WBD, Elgin, Ill. (344.6), 8 p. m., Ladies brass quartet; Neocomer and Stewart, cornetists; Mr. & Mrs. P. F. Beld, vocal duets; Mildred Donovan, contralto; Mrs. Mayfield, soprano; P. F. Red, baritone; L. Edwards, pianist; Wesley Carey, reader.

WCCO, Minneapolis-St. Paul, Minn. (416.4), 11 a. m., Westminster Presbyterian church; 4:10, Hope of Home Presbyterian church; 8:15, Atwater Kent program, Kathryn Meisle, contralto; Allen McQuhae, Irish tenor; 9:30, Tuberculosis Sunday Radio talk, Rev. Frederick M. Elliot.

WEBB, Chicago, Ill. (370.2), 10:40 a. m., Seventh Church of Christ Scientist; 5-6 p. m., twilight musicale; 7-8, artists program.

WENR, Chicago, Ill. (269), 4:30 p. m., vesper service.

WENR, Chicago, Ill. (266), 2-4 p. m., Rauland lyric trio; 9:30-11:30, Frank Westpal and his All-American Pioneers; O. T. Norum, pianist; George Unger, violinist.

WFAA, Dallas, Texas (475.9), 2:30-4 p. m., Sunday hour for farmers; 6:30-7:30, Bible class, Dr. William Anderson, pastor; gospel songs; 7:30-8:30, Ervay Street Methodist Episcopal church; Rev. H. Wallace, pastor; 8:30-9:30, Christian church singers' convention program; 9:30-11, Trent's Happyland Syncopters.

WGES, Oak Park, Ill. (250), 5-7:40 p. m., John A. McFarlane, bass; Marge Van, organist; Moody Bible Institute program; Doc Berendson and his Tiffin theater orchestra; 11-1 a. m., John Brown and John Stanton; Remington Welch, fifth theater organist.

WGN, Chicago, Ill. (370.2), 12 m., Uncle Walt; 12:45 p. m., program, Chicago theater; 2:30-3:30, Lyon and Healy, organ recital; 3:30-5, Chicago Musical college concert; 9-10, music, WGN mixed quartet; Drake orchestra.

WHAS, Louisville, Ky. (399.8), 9:57 a. m., Temple Adath Israel, Joseph Kauch, rabbi, choir; Karl Schmitt, organist; Charles Letzler, violinist; Mrs. Lewis W. Cole, soprano; Mrs. William J. Scholtz, contralto; William J. Horn, tenor; Douglas Webb, baritone; 4:30-5:30 p. m., evensong, choral service, Christ church cathedral, Rev. Richard L. McCready, dean; Ernest A. Simon, organist and choir director, boys' choir.

WHO, Des Moines, Iowa, (528), 11 a. m., church service; 7:30-8:30 p. m., Reese-Hughes orchestra.

WHT, Chicago, Ill. (399.8), 12 m., Sunday dinner sacred concert, vocal, instrumental and organ; 12:45 p. m., sunshine hour, special program for the shut-ins and the sick; 1:15, shepard time for the kiddies; 1:30, aerial girl, program; 1:45, Radio rangers, boys' program; 2, Radio calporteur; 2:05, missionary program; 2:15, fellowship program; 2:50, afternoon services, Chicago Gospel tabernacle; 5:30, vesper concert; 5:45, Young women's council; 6:30, concert, tabernacle band and choir, sermon, Paul Rader; 9:30, request program; 10:30, back hour.

WIBO, Chicago, Ill. (226), 6-8 p. m., dinner concert; 10, popular program.

WKRC, Cincinnati, O. (326), 6:45 p. m., songs and service, Rev. J. J. Castleberry; 10, classical program, Merell Schwarz, baritone; Gene Perazzo, pianist.

WLBB, Chicago, Ill. (306.2), 5-6 p. m., jazz scamper, Hamma's orchestra; 6:30-7, WOK string trio; Gus C. Edwards and his orchestra; WOK male quartet; 8-9, popular program Liberty orchestra.

WLS, Chicago, Ill. (344.6), 6 p. m., prelude; 7-7:55, WLS Little Brown church; Ralph Emerson, organist.

WLW, Cincinnati, Ohio (422.3), 9:30, Sunday school, editorial staff, Sunday School publications, Methodist Book concern; 11, morning worship, Seventh Presbyterian church, Jesse Halsey, minister; Dan Beddoe, soloist; Adolph Stadermann; 7, services, First Presbyterian church, Dr. Frederick McMillan, pastor; 8:00, H. & S. Pogue company concert, Walter Esberger, director, Arthur Dondoro, violinist; Arthur Bowen, cellist; Walter Esberger, pianist.

WMBB, Chicago, Ill. (250), 3-5 p. m., Trianon orchestra, Dell Lampe, Woodlawn orchestra, Armin F. Hand; Bob Duffy, Ralph F. Elliott, Earl Smith, Lionel Carter, popular concert; 7:40-8, services, Fifth church of Christ Scientist; 9-11, Trianon orchestra, Dell Lampe; Woodlawn orchestra, Armin F. Hand; Preston Graves, Billie Allen Huff, Jack Goodwin.

WOAI, San Antonio, Texas (394.5), 11 a. m., services, First Presbyterian church, Rev. P. D. Hill, pastor; 7:45, services, Central Christian church, Rev. Hugh McMillan, pastor.

WOAW, Omaha, Nebr. (526), 9 a. m., chapel service, Rev. R. R. Brown; 2:30, matinee program; 9, chapel service.

WOI, Ames, Ia. (279), 10:45 a. m., college chimes; 11, chapel services, Doctor Swihart, pastor.

WOK, Chicago, Ill. (217.3), 1-2 a. m., Harriet Lee, contralto; Herman Sinaiko, violinist; WOK male quartet; 6:30-8:30 p. m., WOK string trio; Gus C. Edwards and his orchestra; WOK male quartet.

WORD, Batavia, Ill. (275), 10 a. m., hymns and sacred songs; duets and solos; 10:15, address, W. H. Woodley; 9 p. m., hymns and sacred songs, I. B. S. A. choral singers; 9:15, Bible lecture, John T. Reed; 9:40, Alice Regina Johnson, pianist.

WQQ, Kansas City, Mo. (278), 11 a. m.-12:30 p. m., services; 7-7:45, services.

WOS, Jefferson City, Mo. (440.7), 9:30 a. m., religious services, Christian church, Rev. Haushalter, pastor; 7:30 p. m., First Christian church, Rev. R. M. Talbert, pastor.

WQJ, Chicago, Ill. (447.5), 9:30-11:30 a. m., sermon and services, People's church; Dr. Preston Bradley; choir; Clarence Eddy, organist; 3-4 p. m., musical concert, Saida A. Ballantine artists, Jerry Sullivan, director; 6-10, Ralph Williams and his Rainbo Gardens orchestra; program, Hinesway Music Conservatory, Helen Holman, soprano; Muriel Keneally, soprano; Louis Perlman, violinist; John Zwick, pianist.

WSB, Atlanta, Ga. (428.3), 8 p. m., Second Baptist church services.

WSM, Nashville, Tenn. (282.8), 10-11 p. m., service, First Presbyterian church.

WSUI, Iowa City, Iowa (483.6), 9:15 p. m., familiar hymns, Clarence Woolridge, tenor.

Mountain Time Stations

KOA, Denver, Colo. (322.4), 10:50 a. m., service of First Church of Christ, Scientist; 3, organ recital, Clarence Reynolds.

KUOM, Missoula, Mont. (244), 9:15 p. m., musical program, choir, The Church of the Holy Spirit; R. G. Bailey, director; Mrs. Ben Boyd, pianist; Rev. John B. Hahn, speaker.

(Continued on page 15)

BANJO ORCHESTRA BRINGS ROMANCE

Index to Popular Concerts

TABULATED below is a time table of the stations giving popular concerts this week. Stations are divided into the four different standard times in use. The hours are given in the kind of time in use at each listed station. By using this table as an index and referring to the complete programs below, full information will be obtained.

SATURDAY, NOVEMBER 28

Eastern	Central	Mountain	Pacific
7:30 p. m.	6:30 p. m.	5:30 p. m.	4:30 p. m.
WFAA.			
8	7	6	5
WLS.			
9	8	7	6
WBBM, WEA, WENR, WGN, WLS, WMAQ, WNYC.			
10	9	8	7
KFAB, KPRC, WBBM, WENR, WGN, WLS, WMBB, WREO.			
11	10	9	8
KFVE, KFWE, KNX, KTHS, WBBM, WMBB, WOK, WQJ, WRC.			
12	11	10	9
KNX, KOIL, KPO, KPRC, WBBM, WLS, WOAW, WOK, WQJ.			
1 a. m.	12 m.	11	10
KFWB, WDAF, WBBM, WEBB, WENR, WOK, WQJ, WSAI.			
2	1 a. m.	12 m.	11
KNX, WBBM, WENR, WQJ.			

Eastern	Central	Mountain	Pacific
11 p. m.	10 p. m.	9 p. m.	8 p. m.
KFVE, KFWE, KNX, WBBM, WHT, WMBB, WOK, WQJ.			
12 m.	11	10	9
KNX, KOIL, KPO, WBBM, WFAA, WKRC, WMC, WOK, WQJ.			
1 a. m.	12 m.	11	10
KFWB, KNX, WFAA, WHT, WOAW, WOK, WQJ.			
2	1	12 m.	11
KFWB, WQJ.			

WEDNESDAY, DECEMBER 2

Eastern	Central	Mountain	Pacific
8 p. m.	7 p. m.	6 p. m.	5 p. m.
KFNE, WAHG, WEBB, WEEL, WMCA.			
9	8	7	6
WBBM, WEBB, WGCP, WNYC.			
10	9	8	7
KFAB, KPRC, WBBM, WGCP, WHO, WMBB.			
11	10	9	8
KFAB, KFVE, KGW, KPO, KWSC, KYW, WBBM, WEN, WMBB, WOK, WQJ.			
12 m.	11	10	9
KFWA, KFWB, KNX, KYW, WOK, WQJ, WSAI.			
1 a. m.	12 m.	11	10
KNX, KYW, WBBM, WHT, WOK, WQJ.			
2	1 a. m.	12 m.	11
KFWB, KNX, WBBM, WOK, WQJ.			

THURSDAY, DECEMBER 3

Eastern	Central	Mountain	Pacific
8 p. m.	7 p. m.	6 p. m.	5 p. m.
WCAE, WEA, WJAB, WMC, WOC, WSAI.			
9	8	7	6
WBBM, WEAD.			
10	9	8	7
KMA, WBBM, WEEL, WHAD, WHN, WMBB, WMC, WNYC, WOAW, WSOE.			
11	10	9	8
KHJ, KMA, KYW, WBBM, WMBB, WOK, WQJ.			
12 m.	11	10	9
KHJ, KTAB, KOIL, WBBM, WDAF, WEAA, WKRC, WOC, WOK, WQJ.			
1 a. m.	12 m.	11	10
KFWB, KHJ, WHT, WOK, WQJ.			
2	1 a. m.	12 m.	11
KNX, WQJ.			

FRIDAY, DECEMBER 4

Eastern	Central	Mountain	Pacific
8 p. m.	7 p. m.	6 p. m.	5 p. m.
WGCP, WJR.			
9	8	7	6
WBBM, WGR, WLS, WOC.			
10	9	8	7
KFAB, WBBM, WMC, WDAF, WHAD, WMBB, WOAW, WSOE.			
11	10	9	8
KFVE, KFWA, KHJ, KLX, KYW, WMBB, WOK, WQJ.			
12 m.	11	10	9
KFWB, KHJ, KNX, KOIL, WMC, WOK, WQJ.			
1 a. m.	12 m.	11	10
KFWB, KHJ, WDAF, WHT, WOK, WQJ.			
2	1 a. m.	12 m.	11
KNX, WQJ.			

SUNDAY, NOVEMBER 29

Eastern	Central	Mountain	Pacific
9 p. m.	8 p. m.	7 p. m.	6 p. m.
WBBM.			
10	9	8	7
WBBM, WMBB.			
11	10	9	8
WMBB.			
12	11	10	9
KNX, KTHS.			
1 a. m.	12 m.	11 p. m.	10
KFWB, WBBM.			
2	1 a. m.	12 m.	11
KFWB.			

MONDAY, NOVEMBER 30

Eastern	Central	Mountain	Pacific
7 p. m.	6 p. m.	5 p. m.	4 p. m.
WBBM, WFAA, WOAW.			
8	7	6	5
WGS.			
9	8	7	6
WCAU, WEA, WGR, WKRC, WOK.			
10	9	8	7
KFAB, WGR, WKRC, WMCA, WOAW, WOK, WSOE.			
11	10	9	8
KFAB, KFVE, WOK.			
12	11	10	9
KLX, KNX, KOIL, WHO, WOK.			
1 a. m.	12 m.	11	10
KFWB, KLX, WAHG, WDAF, WHT, WKRC, WOK.			
2 a. m.	1 a. m.	12 m.	11
KFWB.			

TUESDAY, DECEMBER 1

Eastern	Central	Mountain	Pacific
7 p. m.	6 p. m.	5 p. m.	4 p. m.
WCAU, WOAW.			
8	7	6	5
WBBM, WEAR.			
9	8	7	6
WBBM, WEAR, WBS, WSB.			
10	9	8	7
WBBM, WMBB, WOAW.			

Monday, November 30

(Continued from page 15)

KUOM, Missoula, Mont. (244), 8 p. m., musical program, old favorites; Josephine DeMoss Pearce, director; vocal solos, duets, quartet; Mr. Atkinson, speaker.

Pacific Time Stations

KFDJ, Corvallis, Ore. (282.5), 8 p. m., musical selections; 8:10, Paton reminders; 8:20, "Keeping the Party Rock Laying in Winter," A. G. Lum; 8:35, musical selections; 8:45, "Returns from Farm Flocks of Sheep in Western Oregon," Prof. O. M. Nelson; 9, "Feeding Dairy Cows for Milk Production," Prof. P. M. Brandt; 9:15, Alumni program.

KFOA, Seattle, Wash. (453.3), 6:45-8:15 p. m., Sherman Clay and company program; 8:30-10, Times studio program.

KFWB, Hollywood, Calif. (252), 5-6 p. m., children's hour, Big Brother of KFWE; 7-8, microphone brevities; 8-9, program, Star Motor Car company, Million Dollar Four orchestra; Sol Hoopii's Junior Hawaiian Trio; 9-10, program, Globe Ice Cream company and Weber Baking company; 10-11, Little Eskimos dance orchestra; Three Little Bakers string trio, Star Roscoe orchestra; 11-12, Warner brothers frolic; 11-12, Henry Halstead's Hollywood Roof orchestra.

KGO, Oakland, Calif. (361.2), 7:15-7:30 a. m., health training exercises, Hugh Barrett Dobbs, William H. Hancock; 7:35, pep class, Hugh Barrett Dobbs; 8:15-8:30, health training exercises, Hugh Barrett Dobbs; 8:30-9, string trio, 10:10, Barrett Dobbs; 9-10, program, Oakland Public Schools, sixth grade; 11:30-1 p. m., luncheon concert, Pacific States Electric company; 3-4, musical program, interpretation of the classics, Wilda Wilson church; 5:30-6, Aunt Betty stories, KGO Kiddies club, Ruth Thompson; 6-7, dinner concert, Sherman Clay & Company studio; 8, educational program, health talk, California State Board of Health, "Physical Culture for the Family," Hugh Barrett Dobbs; chats about new books, Joseph Henry Jackson; Spanish names in California, Dr. John T. Grant; "All about Some So-called Bad Children," Dr. Albertine Richards Nash; "The San Francisco Bay Chemical Industries," M. A. Bird, San Francisco professional chapter of Alpha Chi Sigma; "National Farm Radio Council—Boys and Girls Club Work in California," W. R. Ralston; Arion trio.

KGW, Portland, Ore. (491.5), 7:15 a. m., physical culture exercises; 12:30-1:30 p. m., Rose City trio; 6-7, dinner concert, Olds, Worthman and King company; 9-10, concert.

KLX, Oakland, Calif. (508.2), 8-9 p. m., program, Fliggy-Wiggy stories; 9-10, string trio, Moritt Ducks, KFTB, Hollywood, Calif. (238), 5-6 p. m., home hour, Mammy Simmons, Walter Benson, Helen Levy and Ukulele Kids; 7:15, Y. M. C. A. program; 8-10, KMTB concert hour, Turner orchestra, direction Loren Powell.

KNX, Hollywood, Calif. (336.9), 5:30-6:15 p. m., Wurilizer pipe organ studio; Town Tattler; 6:15, travel talk, W. F. Alder; 8:30-9, Alwater Kent concert orchestra, Paul Finstein, leader; 7-7:30, Mutual Motors mirth contest; 7:30-8, program, Columbia Outfitting company; 8-9, program, L. W. Stockwell company; 9-10, program, Listenwaiter and Gough; Rola string quartet; 10-11, Goodrich Silvertown Cord dance orchestra, Lilyan May Challenger, contralto; 11-12, Ray West's Cooconut Grove dance orchestra from Ambassador hotel.

KPO, San Francisco, Calif. (428.3), 1-2 p. m., Rudy Seiger's Fairmont hotel orchestra; 2:30-3:30, matinee

Tuesday, December 1

Headliners Today

Eastern	Central	Mountain	Pacific
8 p. m.	7 p. m.	6 p. m.	5 p. m.
WBZ (333.1) Hockey game.			
8:15	7:15	6:15	5:15
WIP (508.2) "Destiny—A Tale of the Lost Paradise" play.			
8:30	7:30	6:30	5:30
WHAS (309.8) Zoeller's Melodists.			
10:45	9:45	8:45	7:45
WEAF (491.5), WEEL (348.6), WGR (319), WCAE (461.3), WJAR (305.9), WTG (268), WCCO (416.4), WOC (483.6), WSAI (326), Eveready hour.			
11	10	9	8
WJZ (454.3), WRC (468.5), Edison hour.			
10:45	9:45	8:45	7:45
WOAW (528) Banjo orchestra.			
11	10	9	8
KHJ (405.2) "Trees."			
11:10	10:10	9:10	8:10
WTIC (475.9) Travelers Choral club.			
12 m.	11	10	9
KFWB (252) Ethie trio.			
12:45 a. m.	11:45	10:45	9:45
WTIC (475.9) Travelers Lady serenaders.			

Tuesday, silent night for: CFC, CHIC, CKNC, CNRC, CNRE, CNRM, CNRO, CNRT, CNRF, KFAU, KFRU, KFUD, KFVA, KLX, KOA, KOB, KUOM, KWSC, PWX, WAHG, WAMD, WBBB, WCAL, WGCP, WGST, WHAD, WHAZ, WJAD, WJAZ, WLIT, WLWL, WOR, WOS, WSM, WSMB, WSUI, WTAM.

Eastern Time Stations

CFC, Calgary, Can. (435.8), 8-9 p. m., ladies' concert trio, Gladys Webb Foster, director.

KDKA, Pittsburgh, Pa. (309.1), 10 a. m., domestic science and arts for the housewife; 6:15 p. m., dinner concert, KDKA Little Symphony orchestra; Victor Saudek, conductor; 7:30, Daddy Winkum; 7:45, University of Pittsburgh address, "Popular Misconceptions of Public Speaking," Wayland Parrish; 8, Sacred song period; 8:30, "World Cruise," Ross H. Skinner, conductor; musical settings, KDKA Little Symphony orchestra; Victor Saudek, conductor; 9, mandolin sextet; William Kotman, tenor; 11:35, concert, Grand theater.

WAFD, Port Huron, Mich. (275), 8-10 p. m., Port Huron Boy Scout orchestra; 10-12, musical program, Addison hotel.

WAHG, New York, N. Y. (315.6), 12-12:30 p. m., Joe Zimmerman, pianist.

WBZ, Springfield, Mass. (333.1), 6:15 p. m., dinner concert from KDKA; 7:05, Hotel Kimball dance orchestra; 7:20, Marlon B. Tracy, pianist; 8, hockey game, Boston Bruins, Canadians of Montreal.

WCAE, Pittsburgh, Pa. (461.3), 3 p. m., program, Locw's Aldine theater; 6:30, dinner concert, William

Penn hotel; 7:30, Davis Saxophone octet; 8, program from New York; 8:30, Gold Dust Twins; 9, Eveready hour; 10, studio concert.

WCAU, Philadelphia, Penn. (277.6), 7:30 p. m., N. Snellenburg Choral society; 8, building and loan talk; 8:15, Three Brothers; 8:25, National School of Oratory Players; 9:15, Robert Fraser, blind gospel singer; Elizabeth Holts, pianist; 9:40, Harry Link and Willie Horowitz, soloists and jesters; 10:30, Billy Hayes orchestra.

WCX, Detroit, Mich. (517), 8 p. m., dinner concert, Book-Cadillac hotel; 10, the Red Apple club.

WEAF, New York, N. Y. (491.5), 6:45-7:20 a. m., Metropolitan tower health drill; 11-12 m., Henry Dart, pianist; lecture, board of education; 4-5 p. m., New York society trio; women's program; 6-7, dinner music, Waldorf-Astoria; 7-11, lecture, Columbia university; Davis saxophone octet; talk; Gold Dust Twins; Eveready hour; "Your Hour," Vincent Lopez and his orchestra; 11-12, Meyer Davis' Lido-Venice orchestra.

WEBJ, New York, N. Y. (272.6), 7-7:30 p. m., Dan Barnett's orchestra; 7:45-8, Sara Turtis, soprano; 8-8:15, talk, G. T. Geer; 8:15-8:30, W. C. Hiefield, singing pianist; 8:30-8:45, Radio mystery talk; 8:45-9, the Harlemites, direction D. F. McCarthy.

WFI, Philadelphia, Pa. (395), 1 p. m., Strawbridge & Clothier tea room ensemble; 3, program, Daisy Sheppard Burnham; Caroline Hoffman, pianist; 3:45, fashion feature, Eleanor Gunn; 6:30, Bellevue Stratford hotel concert orchestra; 7, Bellevue Stratford hotel dance orchestra; 8, Ross Gorman and his Earl Carroll Vanities orchestra; 8:30, Gold Dust Twins; 9, Eveready hour; 10, your hour; 10:30, Vincent Lopez and his orchestra.

WGBS, New York, N. Y. (315.6), 6-6:30 p. m., Uncle Geebby; 7-8, Arrowhead Inn orchestra; 8-8:30, Y. M. C. A. vocational forum; 8:30-10, Greenwich Village theater ensemble.

WGCP, New York, N. Y. (252), 3-3:15 p. m., Ona Welsh, pianist; 3:15-3:30, Osborne and Meredith, songs; 3:30-3:45, Isabelle Henderson, soprano; 3:45-4, Ukulele Bob McDonald; 4-4:15, Leslie McLeod, tenor; 4:15-5, Streger character players.

WGHP, Detroit, Mich. (270), 8 p. m., Skylark dance band; Leona Mitchell, soprano; William A. Kerr, baritone; Jimmy Higgins, saxophonist.



"Rob Roy," the companion opera for "Robin Hood" is the headliner Thursday for WBAF, Fort Worth. Mary Elizabeth Nelson, above, takes the part of "Janet," Florence Haenle, violinist, is the soloist with the women's symphony orchestra which plays once a month at WFI, Philadelphia.

Nashville has a new addition to its musical colony. Mrs. Vivienne Olson's cello solos at WSM are very popular.

WGR, Buffalo, N. Y. (319), 2:30 p. m., WGR's afternoon program; 6:30, Vincent Lopez Hotel Statler dance orchestra, Harold Giesler, director; 8-11, jointly with WEAF, including Earl Carroll Vanities orchestra, Gold Dust Twins, Eveready hour, Your Hour, and the Vincent Lopez orchestra from the Casa Lopez, New York.

WGY, Schenectady, N. Y. (379.5), 2 p. m., "Home Hygiene and Care of the Sick," Anna McGee; 2:30, Stephen E. Bolsclair, organist; 6:20, "Some Principles of Pruning," Harold B. Duke; 6:30, Hotel Van Carter orchestra; 7:30, "The Development of Steam Power," Prof. Mortimer F. Sayre; 7:45, Stuart Swart, pianist; 8:15, Elmer Tidmarsh, organist; 9, WGY orchestra; Mrs. Winslow Webb Lillie, soprano; Madeline Winchester, contralto; 10, "The Grand Tour, Australia including Munich in Germany, Vienna and the Danube," WJZ; 10:30, W. Spencer Tupman's Hotel Mayflower orchestra, WRC.

WHAB, Atlantic City, N. J. (275), 2 p. m., Seaside hotel trio; 7:30, book review, Mrs. James Lord; 8, Seaside hotel trio; 11:15, Strand theater recital.

WHN, New York, N. Y. (361.2), 12:30-1 p. m., Lexington organ recital; 2:15-3:15, overture and vaudeville, Loew's State theater; 3:15-6:30, Lexington orchestra; 6:30-6:40, Leslie McLeod, tenor; 6:40-7, Sunshine talk, Billy B. Van; 7-7:30, Iceland orchestra; 7:30-8, Will Oakland's Chateau Shanley; 11-11:30, Caravan club orchestra; 11:30-12, Rodeo club orchestra; 12-12:45, Club Kentucky revue and orchestra.

WIP, Philadelphia, Pa. (508.2), 6:45 a. m., start the day right, setting up exercises; 7, exercises; 10, menu; Mrs. Anna B. Scott; 1 p. m., organ recital, Germantown theater; 3, Ruth Rile, contralto; Ada Craig, soprano; pupils of Myrtle C. Eaver Piano studio; 6:05, Joe Ray and the California Night Hawks; 8, Elliott Lester, dramatic critic; 8:15, Villa Nova College dramatic club, "Destiny, A Tale of the Lost Paradise"; 10:30, Pasoda Cafe dance orchestra.

WJAZ, New York, N. Y. (306.9), 1:05 p. m., Providence-Biltmore concert orchestra; 7:30, Brown university band; jazz team; 8:30, Gold Dust Twins; 9, Eveready hour.

WJR, Pontiac, Mich. (516.9), 7 p. m., Jean Goldkette's Petite Symphony orchestra; soloists; 9, Jean Goldkette's symphonists; soloists; 10, menu.

WMCA, New York, N. Y. (340.7), 6-6:30 p. m., Oleotto Yail and his Hotel McAlpin string ensemble; 6:30-7, Frank Gebbia's Red Lion Inn orchestra; 7-8, Jack Wilbur's personalities; 8-8:30, Pace institute program; 9-9:30, Odierno male quartet; 9:30-10, Warburton trio; 10-11, South American Troubadours; 11-12, Lodge orchestra; 11:15, Hotel McAlpin orchestra.

WNAC, New York, N. Y. (526), 6-7 p. m., dinner program, Hotel St. George; 7-7:10, market high spots; 7:10-7:30, song recital; 7:30-7:35, police alarms; 7:35-8, piano recital; 8-9, concert; 9-9:15, violin recital; 9:30-10, male quartet; 10-1:30, Harry Ash's orchestra; 10:35-11, Harry Ash's orchestra.

WDR, Newark, N. J. (405.2), 3:15-4:15 p. m., Clifford Defects of Voice; J. G. Emerson; etiquette; "Manners in Church and at Public Gatherings," Mary P. VanZile; community organization; extension course, "The Substitute Value of Different Concentrates," B. M. Anderson.

KSD, St. Louis, Mo. (545.1), 9:55 p. m., WEAF chain good will program.

KTHS, Hot Springs National Park, Ark. (374.8), 9-10:15 p. m., dance program; New Arlington orchestra; Clyde Foley and Tony Cochard, chorus team; 10:15-10:45, Graham quartet.

KYW, Chicago, Ill. (535.4), 6:30-7 a. m., morning exercises, physical director, Y. M. C. A.; 7:30, Morning Family Worship, Y. M. C. A.; 11:35, table

DANCING

Central Time

Saturday, November 28

8, Wjr, Wncr, Wncr, Wncr; 8:30, Wfaa; 8:35, Wls; 9, Wbbm, Weel, Wwncr; 9:10, Wip; 9:30, Kths; 9:45, Wwr; 10, Kfwa, Koa, Kpo; 10:15, Wgn, Wjr, Wkrc; 10:30, Wncr; 10:45, Wtvm; 11, Kkps; 11:45, Wdab; 12:30, Kfwa, Kgo, Kgw, Wgbu, Wjld.

Monday, November 29

8, Wgcp; 9, Weel, Wwncr; 9:30, Wjld; 9:35, Wjld; 9:45, Wjld; 10, Kths, Wgbu; 10:15, Wncr; 10:30, Kfwa; 10:45, Wjld; 11, Kgw; 11:45, Wdab; 12:30, Kfwa, Kgo, Kgw, Wgbu, Wjld.

Tuesday, December 1

9, Wbbm, Wwncr, Wwncr; 9:30, Weau, Wjld; 9:35, Wjld; 9:45, Wjld; 10, Kfwa, Wjld; 10:15, Wncr; 10:30, Kfwa; 10:45, Wjld; 11, Kgw; 11:45, Wdab; 12:30, Kfwa, Kgo, Kgw, Wgbu, Wjld.

Wednesday, December 2

9, Wwncr; 9:30, Wjld; 9:35, Wjld; 9:45, Wjld; 10, Kfwa, Wjld; 10:15, Wncr; 10:30, Kfwa; 10:45, Wjld; 11, Kgw; 11:45, Wdab; 12:30, Kfwa, Kgo, Kgw, Wgbu, Wjld.

Thursday, December 3

8, Wjr; 9, Wbbm, Wwncr; 9:30, Wjld; 9:35, Wjld; 9:45, Wjld; 10, Kfwa, Wjld; 10:15, Wncr; 10:30, Kfwa; 10:45, Wjld; 11, Kgw; 11:45, Wdab; 12:30, Kfwa, Kgo, Kgw, Wgbu, Wjld.

Friday, December 4

8, Wjr; 9, Wbbm, Wwncr; 9:30, Wjld; 9:35, Wjld; 9:45, Wjld; 10, Kfwa, Wjld; 10:15, Wncr; 10:30, Kfwa; 10:45, Wjld; 11, Kgw; 11:45, Wdab; 12:30, Kfwa, Kgo, Kgw, Wgbu, Wjld.

ANCE TO WOAW; "ROB ROY" AT WBAP



Robin BAP, boy, violin, men's ce a

Skinnod; 6-7, Bill Benning's Milwaukee Athletic club orchestra.

WHAS, Louisville, Ky. (399.8), 4-5 p. m., musical selections, Harry S. Currie; children's stories, Eleanor Huber; editorials, Courier-Journal, Louisville Times; 7:30-9, concert, Carl Zoeller's Melodists; selections, Benjamin trio; three minute thrift talk; Liberty Insurance bank.

WHO, Des Moines, Iowa. (526), 7:30-8 p. m., Raleigh Quintet; 8:15, The Bankers Life trio; direction, Helen Birmingham; 11-12, Bankers Life, little symphonic orchestra, direction, Leon A. Dashoff.

WHT, Chicago, Ill. (399.8), 10 a. m., Jean Sargent's program, woman's club; Borden health talk, Jelke Good Luck Girl; studio music; 11, special studio features, Magnus musical lecture; 12 p. m., Al Carney's complimentary organ recital; 1, special studio program; 6, classical program; dinner organ recital; Grayling's string trio; Eleanor Gibhour, soprano; Oscar Heather, tenor; Loftis half hour of music; Alois Braganolo, basso; 7:45-9:15 (238), musical features; 9:30 (399.8), Jelke entertainers; Kitchen Klenzer Klasiess; Kenneth Clark's Hawaiian trio; Al Carney, organist; Husk O'Hare's orchestra; 10:10, U. S. L. half hour of dance music.

WBO, Chicago, Ill. (226), 2-4 p. m., classical concert; 6-8, studio program; 10-12, popular program; orchestra.

WJJD, Mooseheart, Ill. (302.8), 10 p. m., Rushmore ensemble singers; Clarence Harper; 12, Lee sisters; George Sparks.

WKR, Cincinnati, Ohio (422.3), 10-12 p. m., Doherty's orchestra; Alvin Roeder's orchestra.

WLIB, Chicago, Ill. (302.8), 7-8 p. m., dinner concert, Blackstone and Drake hotel orchestras; 9-10, popular, Hamm's orchestra; 11-12, Drake and Blackstone hotel orchestras.

WLS, Chicago, Ill. (344.6), 12 a. m.-1 p. m., RFD program, Ford and Glenn; 6:15, announcements; 6:30, Ralph Emerson, organist; 7, Ford and Glenn's lullaby time; 7:15, WLS trio, Countess Slija, soloist.

WLW, Cincinnati, Ohio (422.3), 7:30 a. m., morning exercises, William Stradman, Y. M. C. A.; 7:45, morning devotions, auspices of Parkway Y. M. C. A.; 9, Crosley elementary school program; 12:15 p. m., Petronella Trimbler, organist; 4, French lesson, Madame Ida Polynidis; talk, Rev. Ralph Schmidt; 7, Trinity trio, Wm. C. Stoess, violinist; Arthur Knecht, cellist; Rosemary Stoess, pianist; 7:20, Third adaptation of



While in Europe this summer Fred Smith, Cincinnati announcer, received many new ideas for community concerts. Cincinnati's first community program may be heard at WSAI, December 7. Marguerite Mellville Liszewska, above, is the distinguished pianist.

an O. Henry play in radio form; 7:50, talk on dogs, "The Cairn Terrier," Mrs. Harriet L. Price; 8, Crosby Burnt Cokers, The Musicano male quartet, Gaylord Anderson, Clarence Miller; Louis John Johnson, interductor; 8:45, Musical Handshakes, Crosby Hello boys, Bob Crocker and Jim Fischer; 9, concert program, auspices of the Formica Insulation company; the Formica concert orchestra, Wm. C. Stoess, director.

WMAQ, Chicago, Ill. (447.5), 12:45 p. m., Radio Farm school; 2, shut-in program; 4, household arts, Elizabeth Hiller; 4:45, pupils of Maurice Rosenfeld; 6, Chicago theater organ recital; 6:30, Hotel La Salle orchestra; 8, Harry Hansen, book talk; 8:20, musical program; 8:40, Clara Laughlin's travel talk; 9, lecture, U. of Chicago; 9:20, Czechoslovakian program.

WMBB, Chicago, Ill. (250), 7-8 p. m., Trianon duo; Beatrice Teller, Hunter Kahler, Harold Stokes, semi-classical program, direction of J. B. Lampe; 9-11, Trianon orchestra, Dell Lampe; Woodlawn orchestra, Armin F. Hanzel, James T. Carney, Marie Wright, Bob Duffy, Walter Duffy.

WMC, Memphis, Tenn. (499.7), 8:30 p. m., Gladys Barber; 9, auction bridge game; 11, midnight frolic.

WQAI, San Antonio, Texas (394.5), 8:30-9:30 p. m., musical program, Gebhart Mexican players.

WQAW, Omaha, Neb. (526), 12:45 p. m., Gilbert Edwards and his Little symphony; 8, sardania, visit, Val McLaughlin; 6:30, Jack Little; 8:50, Brandeis room orchestra; 9, classical; 9:45, Francis Potter's banjo orchestra; 10:30, Herb Feinman and his Omadala orchestra; 12 midnight, Rialto alarm, Omaha Bee, Pete and Keptie announcing.

WQI, Ames, Iowa (270), 12:30 p. m., college chimes; 12:45, talk, animal husbandry, Professor H. H. Klidde.

WOK, Chicago, Ill. (217.3), 12 m.-2 p. m., Gus C. Edwards and his orchestra; Banks Kennedy, organist; Marianne Powell Babcock, soprano; Thos. B. Stephenson, tenor; Marie Dnerova, soprano; Bob Mokrejs, pianist; WOK male quartet; 5:30-7, Gus Edwards and his orchestra; Genevieve Barry Burnham, soprano; Clement Laskowski, tenor; Bob Mokrejs, pianist; Banks Kennedy, organist; Husk O'Hare and his orchestra; 10-11, Gus C. Edwards and his orchestra; Bill Hay, bass; Herman Simko, violinist; Harriet Lee, contralto; Husk O'Hare and his orchestra; Banks Kennedy, organist; West Town Harmony boys; WOK, male quartet; WOK, string trio; Chas. Lord, tenor; H. Byler, tenor; Jack Keyes, baritone; N. Bartlett, bass.

WQQ, Kansas City, Mo. (278), 8-9 p. m., Devotional musical program.

WORD, Batavia, Ill. (275), 8 p. m., Webster hotel concert trio; 8:15, studio recital, Cosmopolitan School of music; 9, Bible questions and answers, E. M. Rice.

WQJ, Chicago, Ill. (447.5), 11-12 noon, home economics program, Helen Harrington Downing; Hats for the Christmas Holidays; Lillian Russell; "How Permanent Waving is Done"; Leon Tryon; 3-4 p. m., home

Index to Farmers' Programs

Farmer Dinner Concerts		Eastern Central Mountain Pacific			
Daily Except Sunday					
KFNF, 12:15-1:35 (central time).					
WLS, 12 (central time).					
Radio Farm School					
WMAQ, 12:45 (central time); 12:10 on Friday.					
WOC, 12:15-12:25 (central time).					
Talks					
SATURDAY, NOVEMBER 28					
Eastern	Central	Mountain	Pacific		
11:30 a. m.	10:30 a. m.	9:30 a. m.	8:30 a. m.		
KYW (536) farm and home service.					
1:40 p. m.	12:40 p. m.	11:40	10:40		
WOI (270) soils, questions and answers.					
MONDAY, NOVEMBER 30					
Eastern	Central	Mountain	Pacific		
1:35 p. m.	12:35 p. m.	11:35 a. m.	10:35 a. m.		
KSAC (340.7) Farm talk.					
1:15	12:15	11:15	10:15		
WOC (428.3) farm talk.					
1:45	12:45	11:45	10:45		
WOI (270) Dairy production.					
7	6	5 p. m.	4 p. m.		
WGY (379.5) Agricultural program.					
7:30	6:30	5:30	4:30		
WSOE (246) Farm talk.					
8:30	7:30	6:30	5:30		
WOI (270) Poultry short course.					
8:45	7:45	6:45	5:45		
WCCO (416.4) Farm hour. Future courses.					
TUESDAY, DECEMBER 1					
Eastern	Central	Mountain	Pacific		
1:35 p. m.	12:35 p. m.	11:35 a. m.	10:35 a. m.		
KSAC (340.7) Kansas Utility Seed show.					
1:15	12:15	11:15	10:15		
WOC (428.3) Farm talk.					
1:45	12:45	11:45	10:45		
WOI (270) Animal husbandry.					
7:15	6:15	5:15 p. m.	4:15 p. m.		
WKAR (285.5) Agriculture, engineering, soils.					
8	7	6	5		
WOC (428.3) Farm talk.					
WEDNESDAY, DECEMBER 2					
Eastern	Central	Mountain	Pacific		
7:15 p. m.	12:15 p. m.	11:15 a. m.	10:15 a. m.		
WOC (428.3) Farm talk.					
1:35	12:35	11:35	10:35		
KSAC (340.7) What Good Seed Did in 1925. Grape trellises.					
1:45	12:45	11:45	10:45		
WOI (270) Poultry husbandry.					
8:30	7:30	6:30	5:30		
WLW (422.3) Business Outlook for the Farmer.					
THURSDAY, DECEMBER 3					
Eastern	Central	Mountain	Pacific		
1:15 p. m.	12:15 p. m.	11:15 a. m.	10:15 a. m.		
WOC (428.3) Farm talk.					
1:35	12:35	11:35	10:35		
KSAC (340.7) Home Curing of Pork. Renovating the Orchard.					
1:45	12:45	11:45	10:45		
WOI (270) Farm crops.					
7:15	6:15	5:15 p. m.	4:15 p. m.		
WKAR (285.5) Agriculture, engineering and soils.					
7:30	6:30	5:30	4:30		
WOI (270) Dairyman's short course.					
9	8	7	6		
WEAO (293.9) Soils.					
9:30	8:30	7:30	6:30		
KOA (322.4) Farm question box.					
FRIDAY, DECEMBER 4					
Eastern	Central	Mountain	Pacific		
1:15 p. m.	12:15 p. m.	11:15 a. m.	10:15 a. m.		
WOC (428.3) Special farm service day.					
1:35	12:35	11:35	10:35		
KSAC (340.7) Orchard Rodents You Can Poison. Winter Feeds for the Breeding Herd.					
1:45	12:45	11:45	10:45		
WOI (270) Agricultural Economics.					

Markets and Weather

Daily Except Sunday

Eastern		Central		Mountain		Pacific	
9:30 a. m.	8:30 a. m.	7:30 a. m.	6:30 a. m.				
WFAA (475.9) markets.							
WOAW (526) markets.							
9:45	8:45	7:45	6:45				
KDKA (309.1) livestock, grain.							
10	9	8 p. m.	7 p. m.				
WLS (345) livestock, markets, fruit.							
WOS (430.9) hogs.							
10:25	9:25	8:25	7:25				
WWJ (352.7) weather.							
Pacific Time Stations							
KFWA, Ogden, Utah (261), 5-6 p. m., Ogden Radio Dealers program.							
KOA, Denver, Colo. (322.4), 12:15 p. m., Rialto theater musicale; 3:15, relaxing and corrective exercises; 3:30 p. m., matinee for housewives; 4, culinary hints; 4:15, fashion review; 6:30, dinner concert, Brown Palace orchestra, Howard Tillotson; 7:30, News-Times concert.							
Mountain Time Stations							
KFOA, Seattle, Wash. (454.3), 6:45-8:15 p. m., Hopper Kelly company; 8:30-9:30, program; 9:30-11:30, Eddie Harkness dance orchestra.							
KFWB, Hollywood, Calif. (252), 5-6 p. m., children's hour; Big Brother of KFVB; 7, health talk, Dr. W. I. Schuster; 7:15, microphone brevities; 7:30-8, program, Elmer R. Sly company; 8-9, Joe Martin's Famous Studio Six orchestra; Emma Kimmel, soprano; Henry Johnson, tenor; 9-10, program, H. L. Crockett, Elite trio, Louise Sullivan, soprano; Way Watts and his ukulele; 10-11, Warner Brothers frolic, direction Charlie Wellman; 11-12, Henry Halstead's Hollywood Roof orchestra.							
KGO, Oakland, Calif. (381.2), 7:15-7:30 a. m., health training exercise, Hugh Barrett Dobbs; William H. Hancock; 7:45, pep class, Hugh Barrett Dobbs; 8:15-8:30, health training exercises, Hugh Barrett Dobbs; 11:30-1 p. m., luncheon concert, Pacific States Electric company; 4-5:30, concert orchestra, Hotel St.							

DANCING

Central Time

Saturday, November 28:
8:30, Wfaa; 8:35, Wgy; 9, Webh, Weel, Wmbh, Wwyo; 9:15, Wwh; 9:20, Kths, Wgbs, Wgr, Wrc; 10, Kfve, Kfwa, Koa, Kpo, Wcaf, Wcb, Wlr, Wwyo, Wwyo; 10:15, Wwyo; 10:30, Wwyo; 10:45, Wwyo; 11, Kfng, Kfwa, Kfwb, Kpo, Wcaf, Wcb, Wlr, Wwyo; 11:30, Wwyo; 11:45, Wwyo; 12, Kfwa, Kgo, Kgw, Knx, Wgbu, Wjld.

Monday, November 30:
8, Wgcp; 9, Weel, Wgbu, Wjld; 9:15, Wwh; 10, Kths, Wgbu, Wgcp, Wgr, Wwyo; 10:15, Wwyo; 10:30, Kfva, Wgcp, Wwh; 11, Kgw, Koll, Wgbu, Wgcp, Wgr, Wwh; 11:45, Wwyo; 12, Kgw, Kkj, Knx, Kpo, Wjld.

Tuesday, December 1:
9, Weel, Wgbu, Wmbh; 9:30, Wcaf, Wgbs, Wgy; 9:45, Wwyo; 10, Kfve, Wbt, Wcaf, Wgbs, Wgcp, Wwh; 10:15, Kths; 10:30, Kths, Wwh; 10:45, Wgbs; 11, Kgw, Koll, Wgbu, Wjld; 11:30, Kfva; 11:45, Wwyo; 12, Kgw, Kkj, Knx, Kpo, Wjld.

Wednesday, December 2:
9, Wwyo; 9:15, Wwyo; 9:30, Wwyo; 9:45, Wwyo; 10, Wwyo; 10:15, Wwyo; 10:30, Wwyo; 10:45, Wwyo; 11, Wwyo; 11:30, Wwyo; 11:45, Wwyo; 12, Kgw, Kkj, Knx, Kpo, Wjld.

Thursday, December 3:
8, Wjld; 9, Weel, Weel, Wgbu, Wwh; 9:15, Wwyo; 9:30, Wwyo; 9:45, Wwyo; 10, Wwyo; 10:15, Wwyo; 10:30, Wwyo; 10:45, Wwyo; 11, Wwyo; 11:30, Wwyo; 11:45, Wwyo; 12, Kgw, Kkj, Knx, Kpo, Wjld.

Friday, December 4:
9, Wwyo; 9:15, Wwyo; 9:30, Wwyo; 9:45, Wwyo; 10, Wwyo; 10:15, Wwyo; 10:30, Wwyo; 10:45, Wwyo; 11, Wwyo; 11:30, Wwyo; 11:45, Wwyo; 12, Kgw, Kkj, Knx, Kpo, Wjld.

talk, Anna J. Poterson; 12:05-1 p. m., noon-day concert, Commonwealth Edison company; 1-2, luncheon concert, Congress hotel, Coon Sanders original night-hawks and Joska DeBarbary and his orchestra; 4, afternoon frolic; 6:10-8:40, musical concert, Commonwealth Edison company; 6:40-7, children's bedtime story, Uncle Bob; 7-7:30, dinner concert, Congress hotel; Coon Sanders original night-hawks; 7:35-7:53, speeches; 8-9, musical program, Congress hotel; 9-10, an hour of music, Commonwealth Edison company; 10-12, "Evening at Home" program; Coon Sanders original night-hawks, Congress hotel "Insomnia club," Coon Sanders original night-hawks.

WAMD, Minneapolis, Minn. (243.8), 12 noon, musical program; Garrick theater organ recital, Jack Malerick; 12:30 p. m., Russell Murphy, baritone; Thelma Wilson, accompanist; Donald Mensing, violinist; Wayne Hugaboom, pianist.

WBAP, Fort Worth, Tex. (475.9), 12:05-12:50 p. m., Trull Blazers; 6-6:30, dinner music, Texas Hotel Tokio Royals; 7:30-8:30, program, artists, Fine Arts building, E. O. Gilliam, director; 9:30-10:45, Victor B. Acres.

WBBM, Chicago, Ill. (226), 4-6 p. m., Harry Sosnik, Sandy Meek, Arnold Stephenson; Sidney Newman; Harold Morano; Valentino orchestra; 8-9, Harry Sosnik, Sandy Meek; Moulton Rouge orchestra; Phil Flemming; Jean St. Ann; Christian A. Grimm; Bob York; 9-12 p. m., tip trio; Pete Kules; Four Red Peppers; Ziegler sisters; Moulton Rouge orchestra; Harry Bralstorf; Morris Worthley, tenor; Marie Morgott, harpist; Eumelster, Flascote, Hawaiian guitars; George Marbach; Maurice Silverman; Dave Handler, violinist; Moulton Rouge orchestra.

WBCN, Chicago, Ill. (266), 10-10:30 a. m., Penny Wise, the shopper's ready helper; 7-8, Ballantine Electric company classical hour; Robert Sansone, cellist; Gordon A. Nelson, tenor; Ann Kelley, soprano; Pearl Fairchild, pianist; 10-12, jazz jamboree, Highway orchestra; Borden Brothers, harmony duo; Ed Dempsey, tenor; Niles and Niles, banjo bimbos; Drexel quartet, vocal group; Marie Wright, soprano; Finney Briggs, column conductor, "Crazy Quilt" column; Marquette banjo four, string quartet; Frank H. McDonald, radio talk; 12-2 a. m., private ship.

WCCB, Zion, Ill. (344.6), 8 p. m., mixed and string orchestra; Ben and Donovan vocal duets; Hute, violin, and harp trio; Nels Holmstrom, Mrs. Hira, Mrs. Huth; Richard P. Hira, violinist; Mark White, side, baritone; Lillian Detienne, reading; Esther Natziger, pianist.

WCCO, Minneapolis-St. Paul, Minn. (416.4), 12 m., Dick Long's Dayton trio; 4 p. m., readers' club, Eleanor Poescher; 5:30, children's hour; 6:15, Biley's St. Paul hotel orchestra; 7:30, program from WEAP.

WDAF, Kansas City, Mo. (355.5), 3:30-4:30 p. m., The Star's string trio; 6-7, school of the air; address, piano lesson, Maudell Littlefield; 11:45-1, night-hawk frolic; Plantation players; Earl Coleman's orchestra; Eddie Kuhn's orchestra; Johnnie Campbell's orchestra.

WEH, Chicago, Ill. (370.2), 7-8 p. m., Oriole orchestra; Lydia Lochner, contralto; 9-10, Oriole orchestra; Uptown theater; 11-1, Oriole orchestra; Jack Penecwell, twin guitarists; Kay Romayne.

WFAA, Dallas, Tex. (475.9), 12:30-1 p. m., Beaumont band; 6:30-7:30, Baker hotel orchestra, Don Bestor's hosts; 8:30-9, Southern Methodist university; 9-9:30, bridge game; 11-12, Dales Power and Light club entertainers; 12-1, Palace theater.

WGES, Oak Park, Ill. (250), 5-7 p. m., Lydia Werner, soprano; Miles Sullivan players, one-act playlet; Stenstrom sisters, vocal duo; Timin theater organ and orchestra; 8-9, Helen Frahm, soprano; Timin orchestra; 11-1 a. m., Setzer's orchestra; quartet; Remington Welch, organist; Sandy McTavish, Scotch comedian; Ervin Schmidt and his own song; Jack Goodwin, tenor.

WGN, Chicago, Ill. (370.2), 12:40 p. m., luncheon concert, Drake and Blackstone hotel orchestras; 2:30, artists series, Lyon and Healy; 3, rocking chair time, music, excerpts The Chicago Tribune, Liberty magazine; 3:30, tea time music, Marshall Field Tea room orchestra; 6:30-7, dinner concert, Drake and Blackstone hotel orchestras; 8-9, music; 10-11, dance program, Drake and Blackstone hotel orchestras.

WHAD, Milwaukee, Wis. (275), 11 a. m., pianologue, Andy Hertel; "Getting the First Thousand," Carl

(Continued on page 18)

DUCKS WILL MEET MONDAY AT KLX

Wednesday, December 2

Eastern	Central	Mountain	Pacific
8 p. m.	7 p. m.	6 p. m.	5 p. m.
KSD (545.1) St. Louis male quartet.	9	7	6
KYV (536) Sherwood School of Music.			
WEAF (491.5) WEI (358.8) WGB (319) WCAE (481.3) WTAG (388.8) WCCO (416.4) WOC (483.6) Ipana Troubadours.			
9:30	8:30	7:30	6:30
WBZ (333.1) Mme. Louisa Tosi, prima donna soprano.			
WCAU (277.6) Jones' Jolly Four.			
10	9	8	7
KTHS (374.8) Request night.			
WJAR (305.9) Light Opera quartet.			
KFO (428.3) Atwater Kent artists.			
11:45	10:45	9:45	8:45
WLW (422.3) Songs of the World War.			

Wednesday, silent night for: CHIC, CKNC, CNRA, CNRC, CNRE, CNRR, CNRV, KFAU, KFDM, KLDS, KOB, KTAB, KTCL, KUOM, WBBR, WCB, WCBW, WFAA, WGBS, WGST, WHAR, WHAZ, WJAP, WJAZ, WJAZ, WJAZ, WMC, WOAI, WOAW, WORD, WPG, WRC, WREO.

Eastern Time Stations

CFAC, Calgary, Can. (435.8), 4 p. m., Red Cross address; 8-9, Alice Thurston's program.

KDKA, Pittsburgh, Pa. (309.1), 6:15 p. m., dinner concert; 7:30, KDKA Mailbox, Postman Dan; 7:45, University of Pittsburgh, "The Business of Oil and Gas Production," Roswell Johnson; 9, concert.

PWX, Havana, Cuba (400), 8:30 p. m., General staff band.

WAFD, Port Huron, Mich. (275), 10-12 p. m., musical program, Addison hotel.

WAGH, New York, N. Y. (315.6), 12-12:30 p. m., musical program; 7:30-8:15, Billy Eisenhuth's Lybrooklyns; 8:15-8:30, Michael Lambert, cellist; 8:30-8:45, C. C. Jones, baritone; 8:45-9, Bessie Liebowitz, pianist; 9-9:15, Emory Deutsch, violinist; 9:15-9:30, Michael Lambert; 9:30-9:45, C. C. Jones; 9:45-9:55, Bessie Liebowitz; 10-10:15, Emory Deutsch; 10:15-11:15, Joe Zimmernan's orchestra.

WBZ, Springfield, Mass. (333.1), 6:30 p. m., Leo Relsman's Hotel Lenox ensemble; 7:05, Don Ransau's Radio four; 7:30, Radio nature story, Thornton W. Burgess; 8, Mrs. Helen Webster Lilley, contralto; 8:15, Keith-Albee St. James theater, Charles R. Hector's orchestra; 9:30, Mme. Louisa Tosi, prima donna soprano; George Webster, flutist; Mrs. Eleanor Turner Lazazzera, accompanist; 9:50, Anna L. Wilkinson, pianist.

WCAE, Pittsburgh, Pa. (461.3), 3 p. m., Loew's Aldine theater; 6:30, dinner concert, William Penn hotel; 8:30, Footy period; 9, concert.

WCAP, Washington, D. C. (468.5), 6:45-7:45 a. m., health exercises; 7-11 p. m., songs, Army band, Capt. William J. Stannard, leader; Huyler's Bon Bon Buddies, Ipana Troubadours, WEA.

WCAU, Philadelphia, Pa. (277.6), 6:45 p. m., "The Parolians"; 8, "Talk on the Ear," Dr. S. MacCuen Smith; 8:10, Charles Neidhardt, tenor; Ruth Weir, soprano; 9, Mr. Hill's Instrumental trio; 9:30, Jones' Jolly four; 10, Hal Chase's collegians; 10:45, songs of yesterday, Frank Cook.

WCX, Detroit, Mich. (517), 6 p. m., dinner concert, Bank Cadillac hotel; 8, studio concert.

WEAF, New York, N. Y. (491.5), 6:45-7:20 a. m., Metropolitan tower health drill; 10:45-11:05, talk, Betty Crocker; 11:05-11:15, Bessie Booth Dodge, soprano; Winifred T. Barr, accompanist; 11:15-11:30, talk, 11:30-12, lecture, Columbia university; 4-4:15, Harriett A. Spink, soprano; Winifred T. Barr, accompanist; 4:15-4:45, Ray Nichols orchestra; 4:45-5, talk, Dr. Dorothy Brewster; 6-7, dinner music, Waldorf-Astoria; 7-7:30, services, United Synagogue of America; 7:30-8, concert, U. S. Army band; 8-8:30, "Huyler's Bon Bon Buddies"; 8:30-9, Pooley concert; 9-10, Ipana Troubadours; 10-11, musical program; 11-12, Ben Remie and his Hotel Roosevelt orchestra.

WEBJ, New York, N. Y. (272.6), 6:30 p. m., Joan Landers and his Royal orchestra; 8:45-9, Michele Bonampio, baritone; 9-9:30, Jerry Alexander and the Doyle sisters; 9:30-10:30, International dance orchestra; direction, Ed. Behringer.

WFI, Philadelphia, Pa. (395), 10:40 a. m., service talk, Betty Crocker; 1 p. m., Strawberry and Clothier tea room ensemble; 3, "On Christmas Seals," Dr. Harvey Dee Brown; 3:45, Eleanor Gunn Fashion feature; 6:30, Bellevue Stratford hotel concert orchestra; 7, Bellevue Stratford hotel dance orchestra.

WGBS, New York, N. Y. (315.6), 6-6:30 p. m., Uncle Geesbe; 6:30-7:30, Julie Wintz' Jersey collegians.

WGCP, New York, N. Y. (315.6), 3-3:15 p. m., Henry Rogers, pianist; 4:15-4:45, Haines good news party; 4:45-5, Charlotte Trystmann, pianist; 6-6:15, Littmann's orchestra; 6:15-6:30, Daddy Winkum and his rhyme machine; 6:30-7, Littmann's orchestra; 7-8, studio program; 8-8:05, health talk; 8:05-8:20, Frank and Jerome, songs; 8:20-8:35, Charyl de Thomee, pianist; 8:35-8:50, Bert Dagmar, songs; 9:15-9:30, Osborne and Meredith, songs; 9:30-9:45, Hughie Woolford, pianist; 9:45-10, Win Unger, songs; 10-11, Strickland's orchestra; 11-11:30, Connick's orchestra; 11:30-12, Strickland's orchestra; 12-12:30, Richman entertainers.

WGPH, Detroit, Mich. (270), 8 p. m., WGHT Little Symphony; WGPH male quartet; Madame Gizi Szanto, pianist; John Wummer, flutist; Albert Mancini, trumpeter.

WGR, Buffalo, N. Y. (319), 2:30 p. m., WGR's after-noon orchestra; 6:30, Gospel Melodists; 9, Knell's Tokyo dance orchestra; 10, jointly with WEAF, Ipana Troubadours; 11-1 a. m., Vincent Lopez Hotel Statler dance orchestra, Harold Giesler, director.

WGY, Schenectady, N. Y. (379.5), 6:30 p. m., program for children; 6:45, Albany Strand theater orchestra; Floyd H. Walters, organist; 7:30, Book of Knowledge.

WHN, New York, N. Y. (361.2), 6-6:15 p. m., Littmann's orchestra; 6:15-6:30, Daddy Winkum and his rhyme machine; 6:30-7, Littmann's orchestra; 7-7:30, Cotton club orchestra; 10-10:30, Roseland dance orchestra; 11-11:30, Silver Slipper orchestra; 11:30-12, Melody club orchestra; 12-12:30, Barry Richman and his entertainers; 12:30-1, Ted Lewis and his orchestra, reducing exercises, Dr. Francis D'Eliseu; 1 p. m., Gimbel Tea room orchestra; 3, Hyperion School of Music, Franklin Cresson, director; 6:05, Benjamin Franklin concert orchestra; 6:35, "The Farm Boy Makes Good," R. L. Fetterolf; 7, Uncle Wip's bedtime story.

WJAR, Providence, R. I. (305.9), 10 a. m., Mrs. Wood, housewives Radio exchange; 1:05 p. m., studio program; 8:30, orchestra; 7:30, U. S. Army band; 9, musical program; 10, light opera quartet.

WJR, Pontiac, Mich. (516.9), 7 p. m., Jean Goldkette's Petite Symphony orchestra; soloists; 7:45 Goodwill Oakland, Richards Oakland company; 9, Burroughs hour; 11:30, Jewett Jesters, The Merry Old Chief.

WKAR, E. Lansing, Mich. (285.5), 7:15 p. m., Radio school, lectures on zoology, entomology, forestry; 8, musicale.

WMCA, New York, N. Y. (340.7), 6-6:30 p. m., Olcott Vail and his Hotel McAlpin string ensemble; 6:30-7:30, Ernie Golden and his Hotel McAlpin orchestra; 8-8:15, standard statistics; 8:15-8:35, services, Northminster church; 9:45-10, talk, W. Curtis Nicholson; 10-10:30, Nichols trio; 11-11:30, Hofbrau Haus entertainers; 11:30-11:45, Jack Smith, whispering baritone.

WNYC, New York, N. Y. (526), 11-12:30 p. m., women's program; talk; concert, Hotel St. George; 6:20-6:30, pianist; 6:30-7, elementary Spanish lessons; 7-7:30, advanced Spanish lessons; 7:30-7:35, police alarms; 7:30-8:30, dance program; 8:30-10, studio program; 10-10:10, health talk, George A. Keane.

WOR, Newark, N. J. (405.2), 6:45-7:45 a. m., gym classes; 6:15-6:17 p. m., "Words Often Mispronounced"; 6:17-6:30, sports talk, Bill Watten; 8:30-

Index to Classical Concerts

T ABULATED below is a time table of the stations giving classical concerts this week. Stations are divided into the four different standard times in use. The hours are given in the kind of time in use at each listed station. By using this table as an index and referring to the complete programs below, full information will be obtained.

SATURDAY, NOVEMBER 28				SUNDAY, NOVEMBER 29				MONDAY, NOVEMBER 30				TUESDAY, DECEMBER 1				
Eastern	Central	Mountain	Pacific	Eastern	Central	Mountain	Pacific	Eastern	Central	Mountain	Pacific	Eastern	Central	Mountain	Pacific	
9 p. m.	8 p. m.	7 p. m.	6 p. m.	8 p. m.	7 p. m.	6 p. m.	5 p. m.	8 p. m.	7 p. m.	6 p. m.	5 p. m.	8 p. m.	7 p. m.	6 p. m.	5 p. m.	
WCAE, WCBW, WCCO, WEAF, WEEL, WGB, WJAZ, WJAZ, WJAZ, WMAQ, WOC, WORD, WTAG.				KGO, KYW, WEAR, WENR, WMAQ, WNYC, WOAW, WOK, WRC.				KDKA, KFNF, KOHL, KSD, KYW, WBBB, WGN, WMBB, WNYC, WOAW, WQJ.				KFOA, KPRC, KHJ, KYW, WHAS, WIP, WLW, WORD, WSAI, WSOE.				
				9	8	7	6	10	9	8	7	10	9	8	7	
				10	9	8	7	11	10	9	8	11	10	9	8	
				11	10	9	8	12	11	10	9	12	11	10	9	
				12	11	10	9	1	12	11	10	1	12	11	10	

7-30, Jacques Jacobs Hotel Shelton orchestra; 8-8:05, topics of the day, Spencer Armstrong; 8:30 Lucien Lelone, "Preston Day Fashions"; 9-9:15, Sam Siegel, mandolinist; 9:15-10:15, concert from French Liner Paris; 10:15-10:30, talk, Dr. Frank H. Vitzetly; 11-12, Vincent Lopez Hotel Pennsylvania orchestra.

WRC, Washington, D. C. (468.5), 10 a. m., women's hour, WIZ; 11, organ recital, Homer L. Kitt studios; 1, Leo Heise trio; 4:30, musical program.

WREO, Lansing, Mich. (285.5), 6-7 p. m., dinner concert; Speed-Wagon serenaders; Gold Standard ensemble.

WTAG, Worcester, Mass. (268), 10:30 a. m., musical selections; 10:45, food talk, Mrs. Lydia Flanders; 12:05-2 p. m., WTAG trio; 7, talk, Robert K. Shaw; 7:15, The Twinkle Twinkle story teller; 7:40, Spanish lesson, Mrs. De la Parra; 8, concert program.

WTAM, Cleveland, Ohio, (389.4), 12:15-1:15 p. m., lunch hour music, popular entertainers, Euclid music studio; 6-7, dinner hour music, Guy Lombardo and his Royal Canadians; 8-11, organ recital, Arthur Kraft; 11-1 a. m., dance music, Guy Lombardo and his Royal Canadians, music box studio.

WTIC, Hartford, Conn. (475.9), 6:30 p. m., Hotel Bond trio; 10, dance music.

WWJ, Detroit, Mich. (352.7), 7:30-8 a. m., Setting-up exercises, R. J. Horton; 9:30, "Tonight's Dinner," special talk, woman's editor; 12:05 p. m., Jules Klein's orchestra; 3, Detroit News orchestra; 6, dinner concert; 8, News orchestra and soloists; 9, program WEAF.

Central Time Stations

KFAB, Lincoln, Neb. (340.7), 5:30-6:30 p. m., Belshaw's orchestra; Bulek Little symphony; 8:30-10:30, Mart Graenherst, banjo and pianist; Ralph Hall, uke soloist with songs; Whitney sisters; Belshaw's orchestra; Maudeline Schmidt, blues singer; Ruby Teater, Olive Fletcher, double piano selections.

KFNF, Shenandoah, Ia. (266), 7 p. m., concert, Henry Field Seed company.

KFUO, St. Louis, Mo. (545.1), 9:15 p. m., "Lift Up Your Heads, Ye Mighty Gates."

KFVE, University City, Mo. (240), 8:30 p. m., "Amusement Review," Romaine Fielding; Paul and Jack Snyder, Radio entertainers de luxe; Orchestra Romaine.

KMA, Shenandoah, Iowa (252), 11:30-12:30 p. m., RFD program; garden talk, Earl E. May; music; 6-7, dinner program; domestic science topics; Le Ona Teget & June B. Case; program; 9-11, evening program; familiar songs and music; chimes, Wm. Howle, Bobbie Riddle; program, Gertrude May.

KPRC, Houston, Texas (296.9), 12 m., Lions' club luncheon program; 5:30 p. m., Uncle Judd's kiddies' hour; 7:30, Ratty Martin's End O'Main dance orchestra; Mark Westcott, vocalist; 8:30, South End Christian church quartet; 11, Frank Tilton, boy pianist.

KSAC, Manhattan, Kansas (341), 9-9:25 a. m., music, inspirational talks, agricultural primer, calligraphs; 9:55-10:25, readings, backward gossip, all round the ranch, question box; 12:35-1:05 p. m., readings, ques-

tion box; "What Good Seed Did In 1925," L. E. Willoughby; "Grape Trellises," W. R. Martin; 4:30-5, lectures on basketball and baseball; 6:30-7:30, sports, lesson in football, C. W. Bachman; inventions, "Why Zone a City," Paul Weigal; Educational Sociology; "Practical Instruction in Soldering," E. C. Graham; "Recent Developments in Farm Machinery," R. J. Driftmiller.

KSD, St. Louis, Mo. (545.1), 6 p. m., Missouri Athletic association; 7, fur hour, St. Louis male quartet.

KTHS, Hot Springs National Park, Ark. (374.8), 9-9:45 p. m., request night, Mayer Davis Grand ensemble, Lon Chassy, director; 9:45-10:30, dance tunes, Southerners orchestra; blues choruses, Pauline Simpson; 10:30-11, Lon Chassy, violinist; John Heyn, pianist.

KYW, Chicago, Ill. (535.4), 6:30-7 a. m., morning exercises; 7:30, morning family worship, E. M. C. A.; 11:35, table talk, Anna J. Peterson; 12:05-1 p. m., noonday concert, Commonwealth Edison company studio; 1-2, luncheon concert, Congress hotel, Joska DeBarbery and his orchestra; Coon Sanders Original Nighthawks; 7, children's bedtime story, Walter Wilson; 7-7:30, dinner concert, Congress hotel; Congress hotel orchestra; 7:33, talk, Vivette Gorman; 7:45, safety first musical program, Congress hotel; 10-12:30, midnight revue; Paul Ash and his orchestra, McVickers theater; Coon Sanders Original Nighthawks, Congress hotel; Henri A. Keates, organologue; McVickers theater, Art Linkin announcing.

WAMD, Minneapolis, Minn. (243.8), 12 noon, musical program; Jim McDonough, Emory White, banjo duo; Carl Schmid, tenor; Bayne Cummins, accompanist; Harvey Burt, pianist; 7:05, Garrick theater symphony orchestra, Fred Heiseke, director; organ recital, Jack Malerick; 7:15, Olympian trio, Edna Wesso, soprano; Rita Landry, pianist; 11, Skyrocket frolic, George Osborn's Hotel Radisson Skyrockets.

WBAP, Fort Worth, Tex. (475.9), 12:05-12:30 p. m., popular music, Dude Vance, pianist; Gerald Stewart, banjoist; 6-6:30, Texas Hotel Tokio Royals; 7:30-8:30, Panther Hawaiian trio; 9:30-10:45, Texas Hotel Tokio Royals.

WBBM, Chicago, Ill. (226), 4-6 p. m., Harry Sosnik, Sandy Meek; Valentino Inn orchestra; Edna Wheeler Ballard, harpist; Harold Moravo; Johnny Black; Court Banks; 8-10, WBBM string trio; Joseph Lincoln; Clarence Howard, baritone; Hazel McDoom, contralto; Moulton Rouge orchestra; 12 m., 2 a. m., M. Farwell duo, banjo and piano; Russell Duke, piano and songs; Joe O'Sullivan, piano; Jack Seely; Harry Sosnik, Sandy Meek; Lew Russell; Sue Olmstead; Nate Caldwell; Charlie Garland; Two Jays, Jeske and Jordan; Harold Anderson, accordion; Moulton Rouge orchestra.

WBCN, Chicago, Ill. (266), 10-10:30 a. m., Penny Wise, "The Shopper's Ready Helper," shopping talk; 8-4 p. m., tea time matinee, Clarence Jones, pianist and songwriter; Ed Wallace, tenor; beauty culture talk, Margaret Magnus; "Big Boy" Yaagle, pianologist; Mary Williams, blues singer; Julia Jane Abbott, house-hold adviser; Ruth Webster Cross, dramatic reader; 4-5, Oldtimers hour, direction of Merle Yagle; 5-5:15,



Another "Y" girl is Norma Ball who participates in the Friday evening educational programs at KGO, Oakland, Calif.

MEISLE, McQUHAE AT WEA F CHAIN

Wednesday, December 2

(Continued from page 18)

and some of my best Recipes," Mrs. Ralph H. Auch, dietitian; 4, William Dunning, Cincinnati Exchange club; 7, dinner hour concert, Hotel Gibson, orchestra directed by Robert Visconti; 7:30, talk, "The Business Outlook for the Farmer," D. M. Cash; 7:40, Gibson concert; 10, Fourth in a series of "Pop" concerts, Fraternities and Sororities from University of Cincinnati; arranged by Alpha Tau chapter of Kappa Alpha Theta; 10:30, the Trirdyn instrumental trio; 10:45, songs of the World War, The Cino male quartet; 11, Johanna Grosse, organist; 11:15, pianologues, "Newport" Carl Bamberger; 11:30, the Trirdyn instrumental trio.

WMAQ, Chicago, Ill. (447.5), 12:45 p. m., Radio Farm school; 1, Association of Commerce luncheon; 2, Radio show program; 4, Cosmopolitan School of Music; 4:30, "Home Nursing"; 6, Chicago theater organ recital; 6:30, Georgene Faulkner, story lady; 8, lecture, Northwestern university; 8:30, "Birthstones," Fred M. Lund; 9, WMAQ players.

WMBB, Chicago, Ill. (250), 7-8 p. m., Trionon duo; Beatrice Teller, Joseph Kroloff, Ralph Elliott, semi-classical program; 9-11, Trionon orchestra, Dell Lampe; Woodlawn orchestra, Armin F. Hand; Earl Smith, Trionon trio.

WOAI, San Antonio, Texas (394.5), 3 p. m., musical program, Radio Trades association; 8:30-9:30, Army night musical program.

WOAW, Omaha, Nebr. (526), 12:45 p. m., Phyllis Griswold, organist; 5:30, sandman's visit, Val McLaughlin.

WOI, Ames, Iowa (270), 12:30 p. m., college chimes; 12:45, "Poultry Husbandry," Professor H. A. Hittenbender.

WOK, Chicago, Ill. (217.3), 12 m.-2 p. m., Gus C. Edwards and his orchestra; Harold Morava, tenor; Jean Carlson, soprano; Banks Kennedy, organist; Bob Mokrejs, pianist; WOK, male quartet; 5:30-7, Gus C. Edwards and his orchestra; Husk O'Hare and his orchestra; Ed Kemp, tenor; Bryce Talbot, baritone; Banks Kennedy, organist; Bob Mokrejs, pianist; WOK, string trio; 10-1, Gus C. Edwards and his orchestra; Husk O'Hare and his orchestra; Ned Miller, tenor; Rita McFawn, soprano; Herman Sinalko, violinist; Harriet Lee, contralto; Harold Morava, tenor; WOK, string trio; WOK, male quartet; Chas. Lord, tenor; H. Byler, tenor; Jack Keyes, baritone; N. Bartlett, bass.

WORD, Batavia, Ill. (275), 8 p. m., Webster hotel concert trio; 8:15, hymns and sacred songs, I. B. S. A. choral singers; 8:20, beginning of a series of ten lectures, "The Great Pyramid of Egypt," C. H. Swingle.

WQJ, Chicago, Ill. (447.5), 11-12 noon, home economics program, Helen Harrington Downing; "Fish Dinner for Friday," Frank Wendt; "Early Signs of Contagion," Agnes Fuller; 3-4 p. m., home economics, Helen Downing; "Interior Decorating," Sterling McDonald; 7-8, dinner concert, Ralph Williams and his Raibo Gardens orchestra; Delilah Sheffer, contralto; Jean St. Anne, baritone; Christian Grimm, pianist-composer; 10-1 a. m., Ralph Williams and his Raibo company; Dr. John D. Robertson; Mabel Sklyarski; "Safety," Dr. John D. Robertson; Eddie Vogel, baritone; Harry Ians; Clarence Theders, tenor; J. Edwin Peterson, Kendall, guitar and two harmonicas; 1-2, Ginger hour, Ralph Williams and his Little Sklyarski.

WSB, Atlanta, Ga. (428.3), 10:45 p. m., Biltmore Salon orchestra.

WSM, Nashville, Tenn. (282.8), 6:30-8 p. m., Friends Craig's orchestra, 7, bedtime story, Bonnie Barnhardt; 10-11, studio entertainment.

WSUI, Iowa City, Iowa (483.6), 12:30 p. m., phases of zoology; 7:45, college of the air, Christian A. Ruckmick; Millington F. Carpenter, Kirk A. Porter.

Mountain Time Stations

KFWA, Ogden, Utah (261), 5-6 p. m., Ogden Radio Dealers' program; 9-10, studio program.

KOA, Denver, Colo. (322.4), 12:15 n. m., Rialto theater musicale; 6:30, dinner concert, Brown Palace string orchestra, Howard Tillison; 7:30, Book of Knowledge; 8, one act drama, "The Twelve Pound Look," Otis B. Thayer, Gertrude M. Richards and Irish Ruth Pavey, KOA players; grave-digger's scene from "Hamlet"; John Connery, one-act drama "Passe," Otis B. Thayer, Iris Ruth Pavey, Clayton C. Cowan and Clarence C. Moore; instrumental selections, KOA orchestra; 10, dance program, Harmony Peerles orchestra.

Pacific Time Stations

KFOA, Seattle, Wash. (454.3), 6:45-8:15 p. m., Hopper Kelly company; 8:30-10, Times studio program.

KFWB, Hollywood, Calif. (252), 8-6 p. m., children's hour, Big Brother of KFWB; 7, Mutual Motors with contest; 7:30, microphone brevities; 8-9, program, Cheek-Neal Coffee company, Maxwell House Coffee string quartet; Charles Beauchamp, tenor, Lee Kent and her terapach; 9-10, program, Western Pacific Securities company, Hoot Owl orchestra, Peggy Matthews, blues singer; Ray Kellogg and Bill Hatch, the jazz twins; 10-11, Warner Brothers frolic; 11-12, Henry Halstead's Hollywood Roof orchestra.

KGO, Oakland, Calif. (361.2), 7:15-7:30 a. m., health training exercises, Hugh Barrett Dobbs, William



A contralto and a tenor will give a pleasing program (listed below) at WEA F and chain Sunday evening. Kathryn Meisle, right, a member of the Chicago Civic Opera company, and Allen McQuhae, who is not only a tenor but an Irish tenor, sing at 9:15 p. m., eastern time.



Thursday, December 3

Headliners Today

Eastern	Central	Mountain	Pacific
8:30 p. m.	7:30 p. m.	6:30 p. m.	5:30 p. m.
WHAS (399.8) National Musical Sorority.	WEAF (491.5) Roxy and His Gang.	WGB (319), WCAE (461.3), WTAG (268), WCCO (416.4), Pop concert.	
9	8	7	6
KDKA (309.1) Sprague male quartet.	WBZ (333.1) Opera, "Rigoletto."		
10	9		
WGHP (270) Good Ship Skylark.			
10:30	9:30	8:30	7:30
WBAP (475.9) Opera, "Rob Roy."			
11	10	9	8
KGO (361.2) East Bay trio.			
12 m.	11	10	9
WJAZ (322.4) Classical concert.			
12 m.	11	10	9
KFWB (252) Hoppl's Hawaiian trio.			
1:15 a. m.	12:15	11:15	10:15
WLW (422.3) Midnight Bow Wows.			

Thursday, silent night for: CHIC, CKNC, CNRA, CNRE, CNRM, CNRD, CNRR, CNRT, CNRW, CNRF, KFAU, KFDM, KFMO, KFMY, KFOA, KFRU, KFUO, KFVE, KFWA, KGW, KLX, KOA, KOB, KTCL, KWSC, PWX, WAFD, WAHG, WCEE, WEBI, WGGP, WHAD, WHAZ, WIAD, WIJD, WLIT, WOAI, WOR, WOS, WSM, WSUI, WTAM.

Eastern Time Stations

CFAC, Calgary, Can. (435.8), 7 p. m., bedtime story; 9-11, Canadian National Railways program; Andy Davison, tenor; E. L. Tucker, pianist; CNB orchestra.

KDKA, Pittsburgh, Pa. (309.1), 6:15 p. m., dinner concert, Little symphony orchestra, Victor Saudek, conductor; 7:30, Uncle Ed; 7:45, University of Pittsburgh address, Dr. Elmer Graper; 8, program, National Stockman-Farmer studio; 8:30, half hour with famous composers; Antonin Dvorak; Richard Kountz and the KDKA Little symphony orchestra; Victor Saudek, conductor; 9, concert, Little symphony orchestra, Victor Saudek, conductor; Sprague quartet; 11, Pittsburgh Post midnight revue.

WANG, New York, N. Y. (315.6), 12-12:30 p. m., musical program.

WBZ, Springfield, Mass. (333.1), 6:15 p. m., dinner concert from KDKA; 7:05, "Backgrounds of English Literature," "The Celtic Fairy Lore, Gaelic and

Atwater Kent Program, November 29, over WEA F Chain

- | | | |
|---|------------------------------|--------------------------------|
| I. | | |
| a. "Where'er You Walk"..... | SEMELLE..... | } Handel |
| b. "If With All Your Hearts"..... | ELIJA..... | |
| II. | | |
| a. "Morgen Hymne"..... | | } Henschel |
| b. "Turn Ye To Me"..... | | |
| c. "Les Filles di Cadix"..... | | } Leo Delibes |
| Kathryn Meisle | | |
| III. | | |
| "Una Furtiva Lagrima"..... | "L'ELISIR D'AMOUR"..... | } Donizetti |
| Allen McQuhae | | |
| IV. | | |
| Aria: "Amour Viens Aider" from SAMSON et DALILAH..... | | Saint-Saens |
| Kathryn Meisle | | |
| V. | | |
| a. "Mother Machree"..... | | } Old Irish arranged by Hughes |
| b. "Low Back Car"..... | | |
| c. "Londonderry Air"..... | | |
| d. "Kitty My Love"..... | | |
| Allen McQuhae | | |
| VI. | | |
| a. "As Fair Is She as Noonday Light"..... | | } Rachmaninoff |
| b. "The Night Wind"..... | | |
| c. "Ain Folk"..... | | |
| d. "The Birth of Morn"..... | | |
| Kathryn Meisle | | |
| VII. | | |
| Duet: "Ai Nostri Monti"..... | | IL TROVATORE.....Verdi |
| Allen McQuhae and Kathryn Meisle | | |
| Ralph E. Douglas..... | At the piano for Mr. McQuhae | |
| Solon Alberti..... | At the piano for Miss Meisle | |

H. Hancock, accompanist; 7:45, pep class, Hugh Barrett Dobbs; 8:15-8:30, health training exercises, Hugh Barrett Dobbs; 8:30, daily strength exercise; 8:45, Mme Elfrida Wynne, inspirational songs; 11:30-1:00 p. m., luncheon concert, Pacific States Electric company; 3-4 p. m., Oakland High School orchestra program, Ernest Paul Alwyn; Edith Parks Cunningham, soprano; speaker from Williams Institute, Berkeley; 4-5 p. m., concert orchestra, Hotel St. Francis, Vinton La Ferrera conducting; 5:30, Mr. Fix-it; 6-7, dinner concert, Sherman, Clay & company studio.

KGW, Portland, Ore. (491.5), 12:30-1:30 p. m., Rose City trio; 8-9, concert; 10-11, concert, Sherman, Clay and company studio; 6-7, dinner concert.

KHJ, Los Angeles, Calif. (405.2), 6-6:30 p. m., Leighton's Arcade cafeteria orchestra, Jack Cronshaw, leader; 6:30-7:30, history story, Prof. Hertzog; Dick Winslow, screen juvenile and reporter; Mickey McBan, Carl Eastwood and Harold Marshall, saxophonists; 8, Dr. Mars Baumgardt, scientific lecturer; 8:30-10, program, Peerless Laundry company; 10-11, Art Hickman's Biltmore hotel dance orchestra.

KLX, Oakland, Calif. (508.2), 8-9 p. m., educational program, Roy Harrison Danforth, Ad Schuster, Harry Noyes Pratt, Nadine Shepherd, Prof. E. R. DeOng; 9-10, program, Olin S. Grove Radio stores; 10-11:30, Sweet's ballroom, Tom Gernovich and his ballroom entertainers.

KMTR, Hollywood, Calif. (238), 5-6 p. m., home hour, Mammy Simmons and pupils of Geraldine Kasal; 7, "Health," Dr. Dain T. Tasker; 7:30, Miss Nancy of the Bookshelf; 8-10, KMTR concert hour, Turner orchestra, direction Loren Powell.

KNX, Hollywood, Calif. (337), 5:30-6:15 p. m., Wur-litzer pipe organ studio; Town Tattler; 6:15, travel talk, W. F. Alder; 6:30-7, Atwater Kent concert orchestra, Paul Finstein, leader; 7-8, Ambassador hotel concert orchestra, Josef Rosenfeld, leader; 8-9, program, Security Trust and Savings bank; 9-10, program, Hercules Gasoline company; 10-11, dance music.

KPO, San Francisco, Calif. (428.3), 10 a. m., sewing talk, Betsy Ross; 12 m., reading of the scripture; 1-2, Rudy Selger's Fairmont hotel orchestra; 3:30-4:30, matinee program; 8:30, talk on fashions, Ninon; 5:30-6:15, children's hour stories, Big Brother; 6:40-7, Waldemar Lind and the States Restaurant orchestra; 7-7:30, Rudy Selger's Fairmont hotel orchestra; 8-9, program, Atwater Kent artists; 9-10, program, Goodrich Silvertown-cord orchestra; 10-11, Waldemar Lind and the States Restaurant orchestra.

Kymrie," Prof. E. Charlton Black; 7:30, Hotel Khuball dance orchestra; 8, music, Noyes Bulck company; 9, evening of opera, Madame Yinslo-Johnson, director, "Rigoletto," Maestro Pietro Vallini, accompanist; 10:05, McNelly's Singing orchestra.

WCAE, Pittsburgh, Pa. (461.3), 3 p. m., program, Loew's Aldine theater; 6:30, dinner concert, William Penn hotel; 7:30, children's period; 8, Larkin period; 10, Goodrich Zippers.

WCAU, Philadelphia, Pa. (277.6), 6:30 p. m., Billy Hayes' orchestra; 7:30, N. Shelnburg symphony orchestra, John A. Carroll, director; 8, Margaret MacDonald, contralto; Aubrey G. Gummings, baritone; 8:45, The Kandy Kids; 9, Barry O'Moore, the Irish tenor; 9:30, The Musical Chords; 10, Sesqui centennial hour; 11, "The Parodians"; 11:30, Club Cadix revue.

WCX, Detroit, Mich. (517), 6 p. m., dinner concert, Book-Cadillac hotel; 8, studio concert.

WEAF, New York, N. Y. (491.5), 6:45-7:20 a. m., Metropolitan tower health drill; 11-11:10, music; 11:10-11:25, talk, Lily H. Wallace; 11:25-11:30, music; 11:30-12, lecture, Columbia university; 4-4:15, Molly Schneider, soprano; Winifred T. Barr, accompanist; 4:15-4:25, Julia Armbruster, reader; 4:25-4:45, Leona Westhofen Bemm, pianist; 4:45-5, talk, Henry B. Humphrey; 6-7, dinner music, Waldorf-Astoria; 7-7:30, service, Greater New York Federation of churches; 7:30-8, Cushman's serenades; 8-8:30, the Larkinties; 8:30-9, "Pop" concert; 9-10, Roxy and his gang; 10-11, Goodrich Zippers; 11:10, talk on Silver, Arlin Silver company; 11:10-12, Vincent and his orchestra.

WFI, Philadelphia, Pa. (395), 1 p. m., Strawbridge and Clothier tea room ensemble; 3, program, Philomusician club, Mrs. Montrose Graham Tull, president; 6:30, Bellevue Stratford hotel concert orchestra; 7, Bellevue Stratford hotel dance orchestra; 8, Larkinties; 8:30, pop concert; 9, WEA F ensemble; 10, Goodrich Zippers.

WGSS, New York, N. Y. (315.6), 6-6:30 p. m., Uncle Geebee; 7-8, Voltaire hour of music; 8:30-8:45, Paula Fire, soprano.

WGCP, New York, N. Y. (315.6), 3-3:15 p. m., Elvira Rosa Geiger, pianist; 3:15-3:30, songs, Doris Freeman; 3:30-4, studio program; 4:15-4:30, Hughie Woolford, pianist; 4:30-4:45, Bert Dagmar, songs; 4:45-5, Sylvia Schatz, pianist.

WGHP, Detroit, Mich. (270), 10 p. m., midnight mariners, Bernice the Stoway, Cabin boy; Skyrak band.

WGR, Buffalo, N. Y. (319), 2:30 p. m., WGR's after-noon program; 6:30, Vincent Lopez Hotel Statler dance

(Continued on page 20)

Thursday, December 3

(Continued from page 19)

orchestra, Harold Gleser, director; 8-11, jointly with Naima and his orchestra; 8, Hudson-Essex orchestra; 9, Roxy and His Gang; 10, Goodrich Zippers. WGY, Schenectady, N. Y. (379.5), 2 p. m., "How to select Furs," Ruth Scott; 6:30, Tea Ezyk concert trio; 7:30, "WGY Book Chat," William F. Jacob; 8, U. S. Army band, WRC; 9, Royal hour, Royal Salun orchestra; 10, WGY orchestra, Christine Nielson, soprano; 11:30, Staphic City, N. J. (275), 2 p. m., Seaside hotel trio; 7:30, health talk, Dr. Henry Reik; 8, Seaside hotel trio. WHN, New York, N. Y. (361.2), 12:30-1 p. m., Lexington organ recital; 3:15-4:30, Lexington orchestra; 6:40-7, Sunshine talk, Billy B. Van; 7-7:30, Iceland orchestra; 8-8:30, Whit Oakland's Chateau Shanley; 8:30-9, Guardian entertainers; 10:30-11, Club Kentucky orchestra; 11-11:30, Swanee club orchestra; 11:30-12, Rodeo club orchestra; 12-12:30, Ted Lewis and his orchestra. WIP, Philadelphia, Pa. (508.2), 1 p. m., luncheon music, Gimbel Tea room orchestra; 3, artist recital, Philia Jenkins studio; 6:05, Paoli ad cafe orchestra; 8, Sesqui-centennial, talk, Hon. Harry A. Mackey; 8:15, Rhimelo chorus; 9, talk, member Philadelphia Board of Education; 9:15, Celestrio; 10:05, "Believe In and Invest in Philadelphia"; 10:15, Joe Ray and the California Night Hawks. WJAR, Providence, R. I. (305.9), 1:05 p. m., Joe McNamee and his orchestra; 8, Hudson-Essex orchestra; 9, Roxy and His Gang; 10, Goodrich Zippers. WJR, Pontiac Mich. (516.9), 7 p. m., Jean Goldkette's Petite symphony orchestra; soloists; 9, Jean Goldkette's serenaders; soloists; 10, Jean Goldkette's Victor Recording orchestra; 10:30, Dutch Masters, Consolidated Cigar corporation. WKAR, Erie, Pa. (285.5), 7:15 p. m., Radio school, lectures on marketing, English, soils. WMCA, New York, N. Y. (340.7), 6-6:30 p. m., Oleott Vail and his Hotel McAlpin string ensemble; 6:30-7:30, Frank Gebbia's Red Lion inn orchestra; 7:15-7:30, Pace institute program; 7:30-8:30, Lanson's orchestra; 10-10:15, "How to Drive Automobiles," Harry E. Raines; 11-12, Ernie Golden and his Hotel McAlpin orchestra. WNYC, New York, N. Y. (526), 6-7 p. m., dinner music, Hotel St. George; 7-7:10, market high spots; 7:10-7:30, dinner music; 7:30-7:35, police alarms; 7:35-7:45, song recitals; 8-8:15, talk, John B. Foster; 8:15-9:30, concert; 9:30, 10, instrumental quartet; 10-10:15, talk; 10-10:30, Sydney Usher; 10:20-10:30, lecture, board of education. WOR, Newark, N. J. (405.2), 6:45-7:45 a. m., gym classes; 6:15-6:17 p. m., "Words Often Mispronounced"; 6:17-6:30, sports talk, Bill Wathey; 6:30-7:30, Jaque Jacobs Hotel Shelton orchestra. WRC, Washington, D. C. (468.5), 10 a. m., women's hour, WJZ; 12, 12:30, 1, 2, 3, 4, 5, 6, 7, 8, 9, 10, 11, 12, 13, 14, 15, 16, 17, 18, 19, 20, 21, 22, 23, 24, 25, 26, 27, 28, 29, 30, 31, 32, 33, 34, 35, 36, 37, 38, 39, 40, 41, 42, 43, 44, 45, 46, 47, 48, 49, 50, 51, 52, 53, 54, 55, 56, 57, 58, 59, 60, 61, 62, 63, 64, 65, 66, 67, 68, 69, 70, 71, 72, 73, 74, 75, 76, 77, 78, 79, 80, 81, 82, 83, 84, 85, 86, 87, 88, 89, 90, 91, 92, 93, 94, 95, 96, 97, 98, 99, 100, 101, 102, 103, 104, 105, 106, 107, 108, 109, 110, 111, 112, 113, 114, 115, 116, 117, 118, 119, 120, 121, 122, 123, 124, 125, 126, 127, 128, 129, 130, 131, 132, 133, 134, 135, 136, 137, 138, 139, 140, 141, 142, 143, 144, 145, 146, 147, 148, 149, 150, 151, 152, 153, 154, 155, 156, 157, 158, 159, 160, 161, 162, 163, 164, 165, 166, 167, 168, 169, 170, 171, 172, 173, 174, 175, 176, 177, 178, 179, 180, 181, 182, 183, 184, 185, 186, 187, 188, 189, 190, 191, 192, 193, 194, 195, 196, 197, 198, 199, 200, 201, 202, 203, 204, 205, 206, 207, 208, 209, 210, 211, 212, 213, 214, 215, 216, 217, 218, 219, 220, 221, 222, 223, 224, 225, 226, 227, 228, 229, 230, 231, 232, 233, 234, 235, 236, 237, 238, 239, 240, 241, 242, 243, 244, 245, 246, 247, 248, 249, 250, 251, 252, 253, 254, 255, 256, 257, 258, 259, 260, 261, 262, 263, 264, 265, 266, 267, 268, 269, 270, 271, 272, 273, 274, 275, 276, 277, 278, 279, 280, 281, 282, 283, 284, 285, 286, 287, 288, 289, 290, 291, 292, 293, 294, 295, 296, 297, 298, 299, 300, 301, 302, 303, 304, 305, 306, 307, 308, 309, 310, 311, 312, 313, 314, 315, 316, 317, 318, 319, 320, 321, 322, 323, 324, 325, 326, 327, 328, 329, 330, 331, 332, 333, 334, 335, 336, 337, 338, 339, 340, 341, 342, 343, 344, 345, 346, 347, 348, 349, 350, 351, 352, 353, 354, 355, 356, 357, 358, 359, 360, 361, 362, 363, 364, 365, 366, 367, 368, 369, 370, 371, 372, 373, 374, 375, 376, 377, 378, 379, 380, 381, 382, 383, 384, 385, 386, 387, 388, 389, 390, 391, 392, 393, 394, 395, 396, 397, 398, 399, 400, 401, 402, 403, 404, 405, 406, 407, 408, 409, 410, 411, 412, 413, 414, 415, 416, 417, 418, 419, 420, 421, 422, 423, 424, 425, 426, 427, 428, 429, 430, 431, 432, 433, 434, 435, 436, 437, 438, 439, 440, 441, 442, 443, 444, 445, 446, 447, 448, 449, 450, 451, 452, 453, 454, 455, 456, 457, 458, 459, 460, 461, 462, 463, 464, 465, 466, 467, 468, 469, 470, 471, 472, 473, 474, 475, 476, 477, 478, 479, 480, 481, 482, 483, 484, 485, 486, 487, 488, 489, 490, 491, 492, 493, 494, 495, 496, 497, 498, 499, 500, 501, 502, 503, 504, 505, 506, 507, 508, 509, 510, 511, 512, 513, 514, 515, 516, 517, 518, 519, 520, 521, 522, 523, 524, 525, 526, 527, 528, 529, 530, 531, 532, 533, 534, 535, 536, 537, 538, 539, 540, 541, 542, 543, 544, 545, 546, 547, 548, 549, 550, 551, 552, 553, 554, 555, 556, 557, 558, 559, 560, 561, 562, 563, 564, 565, 566, 567, 568, 569, 570, 571, 572, 573, 574, 575, 576, 577, 578, 579, 580, 581, 582, 583, 584, 585, 586, 587, 588, 589, 590, 591, 592, 593, 594, 595, 596, 597, 598, 599, 600, 601, 602, 603, 604, 605, 606, 607, 608, 609, 610, 611, 612, 613, 614, 615, 616, 617, 618, 619, 620, 621, 622, 623, 624, 625, 626, 627, 628, 629, 630, 631, 632, 633, 634, 635, 636, 637, 638, 639, 640, 641, 642, 643, 644, 645, 646, 647, 648, 649, 650, 651, 652, 653, 654, 655, 656, 657, 658, 659, 660, 661, 662, 663, 664, 665, 666, 667, 668, 669, 670, 671, 672, 673, 674, 675, 676, 677, 678, 679, 680, 681, 682, 683, 684, 685, 686, 687, 688, 689, 690, 691, 692, 693, 694, 695, 696, 697, 698, 699, 700, 701, 702, 703, 704, 705, 706, 707, 708, 709, 710, 711, 712, 713, 714, 715, 716, 717, 718, 719, 720, 721, 722, 723, 724, 725, 726, 727, 728, 729, 730, 731, 732, 733, 734, 735, 736, 737, 738, 739, 740, 741, 742, 743, 744, 745, 746, 747, 748, 749, 750, 751, 752, 753, 754, 755, 756, 757, 758, 759, 760, 761, 762, 763, 764, 765, 766, 767, 768, 769, 770, 771, 772, 773, 774, 775, 776, 777, 778, 779, 780, 781, 782, 783, 784, 785, 786, 787, 788, 789, 790, 791, 792, 793, 794, 795, 796, 797, 798, 799, 800, 801, 802, 803, 804, 805, 806, 807, 808, 809, 810, 811, 812, 813, 814, 815, 816, 817, 818, 819, 820, 821, 822, 823, 824, 825, 826, 827, 828, 829, 830, 831, 832, 833, 834, 835, 836, 837, 838, 839, 840, 841, 842, 843, 844, 845, 846, 847, 848, 849, 850, 851, 852, 853, 854, 855, 856, 857, 858, 859, 860, 861, 862, 863, 864, 865, 866, 867, 868, 869, 870, 871, 872, 873, 874, 875, 876, 877, 878, 879, 880, 881, 882, 883, 884, 885, 886, 887, 888, 889, 890, 891, 892, 893, 894, 895, 896, 897, 898, 899, 900, 901, 902, 903, 904, 905, 906, 907, 908, 909, 910, 911, 912, 913, 914, 915, 916, 917, 918, 919, 920, 921, 922, 923, 924, 925, 926, 927, 928, 929, 930, 931, 932, 933, 934, 935, 936, 937, 938, 939, 940, 941, 942, 943, 944, 945, 946, 947, 948, 949, 950, 951, 952, 953, 954, 955, 956, 957, 958, 959, 960, 961, 962, 963, 964, 965, 966, 967, 968, 969, 970, 971, 972, 973, 974, 975, 976, 977, 978, 979, 980, 981, 982, 983, 984, 985, 986, 987, 988, 989, 990, 991, 992, 993, 994, 995, 996, 997, 998, 999, 1000.

AN EVENING AT HOME WITH THE LISTENER IN CENTRAL TIME

Table with columns: Call, Location, Met., Saturday, Sunday, Monday, Tuesday, Wednesday, Thursday, Friday. Lists radio stations and their schedules across various cities.

concert, WEAF concert ensemble, Goodrich Zippers; 10:05, travel talk, National Director Travel Bureau; WDAF, Kansas City, Mo. (365.8), 3:30-4:30 p. m., the Stars, string trio; 6-7, school of the air; address; talk, Louis Mecker; the Tell-Me-a-Story Lady; Trio ensemble; 11:45-1 a. m., Nighthawks frolic; Carl Nordberg's Plantation players; Earl Coleman's orchestra; Eddie Kubn's orchestra; Ted Meyn, organist. WEHI, Chicago, Ill. (370.2), 7-8 p. m., Oriole orchestra; 9-10, Oriole orchestra; Kathryn Forbes soprano; Dick and Snyder, Ruth Flick, Frederick Agard; 11-1, Oriole orchestra; Wayne Myers, Ruth Buhl Flick. WFAC, Dallas, Tex. (475.9), 12:30-1 p. m., address, David McMurtry; Edmund E. Boeticher, Miss Cassidy, pianist; 6:30-7:30, Baker orchestra; 8:30-9:30, choral club, Mrs. G. S. Curtis, director; 11-12, Aida choral club. WGES, Oak Park, Ill. (250), 5-7 p. m., Frederick Irving, basso; Rose Olech, soprano; Stenstrom sisters, vocalists; Miles Sullivan players; John Brown, pianist; Wyebeck trio; Timin theater organ and orchestra; 8-9, Remington Welsh organist; Richard Dale baritone; Ruth Kalthoff, mezzo soprano; Wyebeck trio. WGN, Chicago, Ill. (370.2), 12:40 p. m., luncheon concert, Drake concert ensemble and Blackstone string quintet; 2:30, Lyon and Healy, artist series; 3, rocking chair time, music; excerpts from The Chicago Tribune and Liberty Magazine; 3:30, tea time music, Marshall Field tea room orchestra; 6:30-7, dinner concert, Drake concert ensemble and Blackstone string quintet; 8-9, music; 10-11, dance program, Drake and Blackstone hotel orchestras. WHAD, Milwaukee, Wis. (275), 4 p. m., "News of the Motion Picture World," Iva MacDonald; 6-7, Bill Bennings Milwaukee Athletic club orchestra. WHAS, Louisville, Ky. (399.8), 4-5 p. m., musical selections, Harry S. Curry, director; editorials, The Courier-Journal, Louisville Times; 7:30-9, concert, Delta Omicron National Musical society, Zeta chapter, Louisville Conservatory of Music; Miss Angeline McCordkin, director; Sunday school lesson; welfare talk. WHO, Des Moines, Iowa (526), 7:30-8 p. m., Raleigh quintet; 8-9, Bankers Life trio, direction Helen Birmingham; 11-12, Bankers Life little symphonic orchestra, direction, Leo A. Dashiell. WHT, Chicago, Ill. (399.8), 10 a. m., Jean Sargent's program, woman's club, Jekke Good Luck Girl, studio features; 11, specialties from studio; 12 p. m., Al Carney's complimentary organ hour; 1-2, special study program; 6-7:30, classical program, dinner organ recital, Hathaway, baritone; Ada May Hathaway, violinist; Edw. Kemp, tenor; Genevieve Barry Burnham, soprano; 7:45-9:15, musical features; 9:30, Jekke entertainers; Al Carney, organist; Husk O'Hare's orchestra; Howard Serston, tenor; Rita McFawn, popular songs; 10:10, U. S. L. half hour of dance music; 12, Pat Barnes and Al Carney. WIGO, Chicago, Ill. (266), 6-8 p. m., studio program; 12, popular program. WJAZ, Chicago, Ill. (322.4), 10 p. m., Franz Wagner, cellist; G. Magnus Schutz, bass; Mae Doelling-Schmidt, pianist; Phyllis Barry, cellist; Vere Cory, pianist; Laura Turner, soprano; William J. Hayden, tenor; George Krueger, baritone; J. Edward Martin; chimes; "Phyllis" concert; J. H. H. Gibbon, soprano; Laura Turner, Philemon, William J. Hayden; Vulcan, George Krueger; Jupiter, J. Edwards Martin 12, chimes. WJJD, Mooseheart, Ill. (302.8), 10 p. m., Ruth Allison Lois White, Elizabeth Peppers; I. Larry Shan, George Sparks. WKRC, Cincinnati, Ohio (422.3), 9 p. m., Post Wurlitzer, classic hour. WLBB, Chicago, Ill. (308.2), 7-8 p. m., dinner concert, Blackstone and Drake orchestras; 9-10, popular, Hamon's orchestra; 11-12, dance, Drake and Blackstone orchestras. WLS, Chicago, Ill. (344.8), 12 a. m.-1 p. m., RFD program, WLS trio; 6:15, announcements; 6:30, Ralph Emerson, organist; 7, Ford and Glenn's "Woodshed Theater"; 7:20, Chicago Salvation Army band. WLW, Cincinnati, Ohio (422.3), 7:30 a. m., morning exercises, William Stradman, Y. M. C. A.; 7:45, morning devotions, auspices of Parkway Y. M. C. A.; 12:15, organ concert, Mildred Prigge; 12:30, health talk, Dr. Carl A. Wilzbach; 4, piano recital, Adelaide Arbel and pupil; 7, dinner concert, Mildred Prigge, Robert Visconti, director; 7:30, the "Eyes" Harv. Dr. C. H. Kaufman; 7:40, Gibson concert; 10, three minute message, Civil Service Department of the U. S. Government; 10:03, Doherty melody boys; 10:40, Irene Downing, player-roll artist, with "temperamental" Tommy Reynolds, in late song hits; 11, Crosley station orchestra; 12:15, midnight bow-wows; Kay-Nyne, organist; Chief Bark and Bill-Tin-Kan. WMAQ, Chicago, Ill. (447.5), 12:45 p. m., Radio Farm school; 2, shut-in program; 4, Illinois Federation of Women's clubs program; 4:45, musical program; 5:15, Topsy-Turvy time; 6, Chicago theater organ recital; 8, announced; 8:30, Association of Commerce talk; 8:40, announced; 9, University of Chicago lecture; 9:40, talk, League of Nations association. WNEB, Chicago, Ill. (250), 7-8 p. m., Trioan duo; Beatrice Taylor, Ralph Elliott, Preston Graves, in semi-classical program, direction of J. Bodewalt Lampe; 9-11, Trioan orchestra, Dell Lampe; Woodlawn orchestra, Armin F. Hand; Lionel Carter, Billie Allen Hoff, Jack Goodwin. WMC, Memphis, Tenn. (499.7), 8:30 p. m., I. J. Cooper Rubber company, Hawaiian orchestra. WOAW, Omaha, Neb. (526), 12:45 p. m., Branda's tea room orchestra; 6, sandwich stand, V. McLaughlin; 6:20, classical; 6:50, Randall's Royal Fontenelle orchestra; 9, classical; 10:30, Herb Feilman and his Omaha orchestra. WOI, Ames, Iowa (270), 12:30 p. m., college ehines; 12:45, talk, farm crops, Professor H. D. Hughes; 7:30, dairyman course. WOK, Chicago, Ill. (217.3), 12 m.-2 p. m., Gus C. Edwards and his orchestra; August Bridergard, tenor; Ethel Price, soprano; Banks Kennedy, organist; 5:30-7, Eleanor Gilmour, soprano; Gus C. Edwards and his orchestra; Husk O'Hare and his orchestra, Banks Kennedy, organist; Bob Mokreis, pianist; WOK, string trio; 10-1 a. m., Gus C. Edwards and his orchestra; Husk O'Hare and his orchestra; Harriet Lee, contralto; Herman Sinalko, violin; Bill Bourke and Sony Brown, harmony duet; Banks Kennedy, organist; Bill H. Byler, tenor; WOK, male quartet; C. Lord, tenor; H. Byler, tenor; J. Keyes, baritone, N. Bartlett, bass. WOQ, Kansas City, Mo. (278), 7-8 p. m., Unity educational program; 8-9, concert program. WORD, Batavia, Ill. (275), 8 p. m., Webster hotel concert trio; 8:15, studio recital; Theodore S. Bergey, art talk; Mr. Bergey; 9, International Sunday school lesson, C. B. Schiller. WQJ, Chicago, Ill. (447.5), 11-12 noon, home economics program, Helen Harrington Downing; "Bringing Home the Bacon," Eran J. Bertrams; "Care of the Children's Permanent Teeth," Dr. B. S. Partridge; 3-4 p. m., home economics, Helen H. Downing; "How To Select Your Meat for Your Sunday Dinner," John Harding; 7-8, Ralph Williams and his Garden concert orchestra; James Nobel Hatch, poet; Margaret Cade, coloratura soprano; Clement Laskowski, tenor; Cecelia Arends, violinist; Johanna Arends, accompanist; 10-1 a. m., Ralph Williams and his Rainbo Skylarks; Jerry Sullivan; Rose Vanderbosch, soprano and pianist; Hal Lansing and his uke; Bert Davis, Burt Keim, pianologist; Anne Keim, soprano; Lew Butler, Pish and Lew harmony singers; Edler Yorkson, mezzo-soprano; 1-2, Ginger hour, Little Skylarks. WSB, Atlanta, Ga. (428.3), 8 p. m., Dr. Charles Sheldon, organist; 10:45, entertainment. WSUI, Iowa City, Iowa (463.6), 12:30 p. m., popular physics; Mrs. Preston C. Coast, organist. Mountain Time Stations KFAW, Ogden, Utah (261), 5-6 p. m., Ogden Radio Dealers program. KOA, Denver, Colo. (322.4), 12:15 p. m., Rialto theater musicale; 3:15, relaxing and correct exercises; 3:30, matinee for hosts; 4, cullinary hour; 4:15, fashion review; 6:30, dinner concert, Brown Palace string orchestra, Howard Tillotson; 7:30, Farm question box. KUOM, Missoula, Mont. (244), 8 p. m., musical program; T. A. Price, contralto; Gladys Price, soprano; Grace Gwinn, violinist; Chester Watson, tenor; Joseph Dunham, pianist. Pacific Time Stations KFVB, Hollywood, Calif. (252), 7 p. m., plastic surgery, Dr. T. Floyd Brown; 7:15, microphone brevities; 7:30-8, program, Elmer R. Sly company; 8-9, program, Starr Plano company, Hollywood Rhythm Kings and Ina Mitchell Butler, soprano; 9-10, program, Don P. Smith, Inc., Diana-Moon orchestra; Ashley sisters, vocal duet; Sgt. Hood's Hawaiian trio; 10-11, Warner Brothers frolic, direction Charlie Wollman; 11-12, Henry Haisteud's orchestra. (Continued on page 21)

KFAB CELEBRATES FIRST BIRTHDAY

Thursday, December 3

(Continued from page 20)

KGO, Oakland, Calif. (361.2), 7:15-7:30 a. m., health training exercises; Hugh Barrett Dobbs, William H. Hancock, accompanist; 7:45 p. m., pep class; Hugh Barrett Dobbs; 8:15-8:30, health training exercises; Hugh Barrett Dobbs; 8:30, daily strength, cheerio; 10:40, classroom instruction, Oakland public schools; 11:30-1:00 p. m., luncheon concert, Pacific States Electric company; 4:50-5:30 p. m., concert orchestra, Hotel St. Francis, San Francisco; Vinton La Ferrara conducting; 5:30-6:30 p. m., George W. Ludlow, friend to boys; 8, part one; East Bay trio; Florence Semant Proehl, violinist; Malcolm Rolfs, cellist; Marie Chamblin Himes, pianist; Maurice J. Gursky, tenor; address, "Amusing Typographical Errors"; Fred L. Button; concert, Oakland Real Estate Board glee club; Zura E. Bells, director; 10-12 midnight dance music, Ben Bledsoe's orchestra.

KGW, Portland, Ore. (491.5), 12:30-1:30 p. m., Rose City trio; 7:45-8, lecture, Catholic Truth society.

KHJ, Los Angeles, Calif. (405.2), 6-6:30 p. m., Leighton's Arcade cafeteria orchestra; Jack Cronshaw, leader; 6:30-7:30, history story, Prof. Heitzog; Dickie Brandon, Joyce Adams, screen starlets; bed-time story by Uncle John; 8:45 talk; Dr. Phillip M. Lovell; 8-10, program, Pacific Electric Railway company; 10-11, Art Hickman's Biltmore hotel dance orchestra.

KMTR, Hollywood, Calif. (238), 5-6 p. m., home hour, Mammy Simmons and pupils; Carter Weaver; 7:15, Campus Note, students of University of California, Southern branch; 8-10, KMTR concert hour, Turner orchestra, direction Loren Powell.

KNX, Hollywood, Calif. (337), 5:30-6:15 p. m., Wurflitzer pipe organ studio; Town Tattler; 6:15, travel talk; W. P. Alder; 6:30-7, Atwater Kent concert orchestra; Paul Pinstel, leader; 7-8, program, H. L. Crockett featuring Way Vada and his ukulele; 8-10, KNX feature studio program; 10-11, Ray West's Coconut Grove dance orchestra from Ambassador hotel.

KPO, San Francisco, Calif. (428.3), 1-2 p. m., Rudy Selger's Fairmont hotel orchestra; 2-10 talk, on silverware; Alvin Silver company; 2:30-3:30, matinee program; 3:30-4:30, Cyrus Trolbe's Palace hotel concert orchestra; 6:40-7, Waldemar Lind and the States Restaurant orchestra; 7-7:30, Rudy Selger's Fairmont hotel orchestra; 8-9, program, George W. Caswell office company; Radio Eight Symphony orchestra; Fawn Post, Broadway; 9-10, J. Wintred Curry, pianist; George Bossart, Dr. J. H. Stone, tenors; L. Pearson, cellist; 10-11, Jack Coakley's Cabrians.

Friday, December 4

Headliners Today

Eastern	Central	Mountain	Pacific
7:15 p. m.	6:15 p. m.	5:15 p. m.	4:15 p. m.
WCAP (468.5)	Mozart string quintet.	8:15	7:15
WGYP (379.5)	Rice string quartet.	8	7
WTIC (475.9)	Hartford choral club.	8	7
KDKA (309.1)	Teaberry time.	9:30	8:30
KFAB (340.7)	First Anniversary program.	10	9
WGRT (519)	Guido chorus.	10	9
KSD (545.1)	Special entertainment.	11	10
KTHS (374.8)	Solo night.	11	10
WEBH (370.2)	Light Opera company.	11	10
WSL (344.6)	Old Song hour.	11	10
KNX (336.9)	Order of Optimistic Donuts.		

Friday, silent night for: CHIC, KNCN, GNRG, CNRM, CNRO, CNRR, CNRW, KFMC, KFRR, KFUR, KGO, KLDL, KOB, KPRC, KUOM, PWX, WAFD, WBBR, WCBW, WEAO, WGBS, WGST, WHAZ, WIP, WJAZ, WLW, WLWL, WOR, WRC, WREO, WSAI, WSUI, WSWB, WTAM.

Eastern Time Stations

CFAC, Calgary, Can. (435.8), 7-8 p. m., Salon broadcast, Gladys Webb Foster, director.

KDKA, Pittsburgh, Pa. (309.1), 10 a. m., domestic science and arts for the housewife; 12:20 p. m., Sunday School lesson, James C. Mace; 6:15, dinner concert; 7:30, Auntie Jimmie's letter; 7:45, University of Pittsburgh club; George Bossart; 8:30, Dutch Master half hour; 9, Teaberry time.

WAHG, New York, N. Y. (315.6), 12-12:30 p. m., Sid Cohen, pianist; 7:30-7:45, Sid Cohen; 7:45-8, Trainman's trio; 8-9, Skinner organ recital; 9-9:15, Sid Cohen; 9:15-9:30, Nye Sorenson, baritone; 9:30-9:45, Trainman's trio; 9:45-9:55, Nye Sorenson; 10-10:15, everyday speech, Prof. Richard E. Mayne; 10:15-11:15, Southland dance orchestra.

WBZ, Springfield, Mass. (331.1), 6:30 p. m., Leo Reisman's Hotel Lenox ensemble; 7:15, Baron Beane's Collegians; 8, Joseph Killyffe, tenor; 8:15, Wesley McNeill, pianist; 9, program, courtesy Theodore A. Schroeder; Mrs. Susan C. Downing, mezzo-soprano; Emma Louise Biederman, contralto; Mrs. Florence Chandler, dramatic soprano; Edna Kimball, mezzo soprano; Evelyn Duncanson, lyric soprano; Clinton White, tenor; William Richardson, baritone; Chester Cook, pianist.

WCAE, Pittsburgh, Pa. (461.3), 3 p. m., program, Loew's Adline theater; 6:30, dinner concert, William Penn hotel; 7:30, children's period; 7:45, address, Current motor topics; 8:30, concert.

WCAP, Washington, D. C. (468.5), 6:45-7:45 a. m., health exercises; 7-12 p. m., Popular Science talk; Mozart string quintet; Irving Boernstein's Wardman Park hotel trio; dance music.

WCAU, Philadelphia, Pa. (277.6), 7:35 p. m., talk, Dr. Harvey Deacon; 7:45, Clarence Semant's orchestra; 8:15, chiropractic talk, Douglas-Marsch, College of Chiropractic; 8:30, Houston Hall smoker entertainment; 9, Mr. Hill's instrumental trio; 9:30 Billy and his saxophone; 9:45, Ed Kiefer, Radio humorist; 10, Walter A. McClatchy's Lads O'Melodie; 10:30, Jack Myers' musical architects.

WCG, Detroit, Mich. (517), 6 p. m., dinner concert, Book-Cadillac hotel; 9, studio concert; 10, orchestra, Graystone ballroom.

WEAF, New York, N. Y. (491.5), 6:45-7:20 a. m., Metropolitan tower health drill; 10:45-12, talk, Betty Crocker; musical program; lecture, Columbia university; 1-5 p. m., Marley R. Shevris, baritone; talk, Ida Mellen; 8-7, dinner music, Waldorf-Astoria; 7-11, "A Trip with Santa Claus Through Toyland," James McCree; 8, McCree & company; Sir Hobsart; Blanche Elizabeth Wade; Lucille Blabe, pianist; Happiness Candy Boys; Eagle Neurolyne trio; Spear and company home entertainers; 11-12, Meyer Davis' Lido-Venice orchestra.

WEBJ, New York, N. Y. (272.6), 7-7:30 p. m., Leligh serenaders; 7:45-8, Pauline Spivack, soprano; 8-8:30, Sal Angorah, uke; Ed Collins, guitar; 8:30-9, Red and Gray, vocal duo.

WFI, Philadelphia, Pa. (395), 10:40 a. m., home service talk, Betty Crocker; 1 p. m., Stunbridge and Clothier tea room ensemble; 3 p. m., the Serenaders; 6:30, Bellevue Stratford hotel concert orchestra; 7, Bellevue Stratford hotel dance orchestra.

WGBS, New York, N. Y. (315.6), 6-8:30 p. m., Uncle Sam's orchestra; 8:30-9:30, orchestra.

WGPC, New York, N. Y. (315.6), 3-3:15 p. m., Edna Josephs, pianist; 3:15-3:30, songs, Osborne and Meredith; 3:30-3:45, Samuel Weber, pianist; 4:15-4:30, Hugo Angelo and Len Gray, songs; 4:30-4:45, Charol de Thomee, pianist; 4:45-5, Clarence Proff; 6-6:15, Littmann's orchestra; 6:15-6:30, Daddy Winkum and his rhythm machine; 6:30-7, Littmann's orchestra; 7-7:30, club orchestra entertainers; 7:30-8, studio program; 8-8:05, health talk; 9-9:30, Udale, Bob McDonald; 9:30-9:45, Eva Rothenberg, pianologue;

9:15-10, Piotti and Val, songs; 10-11, Strickland's orchestra; 11-11:30, Connie's orchestra; 11:30-12, Bob Murphy's entertainers.

WGHP, Detroit, Mich. (270), 10 p. m., Skylark dance band; mixed quartet, Ethel McPhee, soprano; Mildred Carner Johnson, contralto; Harry Hayes, banjoist, Arthur Cooper, xylophonist.

WGR, Buffalo, N. Y. (319), 2:30 p. m., WGR's afternoon program; 6:30, Yankee Six club orchestra; 8:45-9, W. H. F. Tenney, poet, with his own works; 9, Murray Whitman's orchestra; 9:30, Guido chorus; 10:30, "Thinking Different"; 11-11:30, Vincent Lopez Hotel Stat-Hewitt Rubber Company's "Thirty Minutes of Somel-der dance orchestra, Harold Gieser, director.

WGY, Schenectady, N. Y. (379.5), 2 p. m., Asia Restaurant orchestra; 2:30, "Health Notes," D. C. W. Woodall; one-act play, "A Pair of Lunatics," WGY matinee players; 6:30, Sunday school lesson; 7, Albany Strand theater orchestra; Floyd H. Walters, organist; 7:30, health talk, 7:40, French by Radio, Leon A. Huguenot; 8:15, Hazel Wehr, soprano; Marjorie Rutson, accompanist; 11:30 string quartet; 10:30, WGY orchestra; Mrs. Burt Newkirk, pianist.

WHAR, Atlantic City, N. J. (275), 2 p. m., Seaside hotel trio; 7:30, talk; 8, Seaside hotel orchestra; 11:15, Strand theater organ recital.

WHN, New York, N. Y. (361.2), 6-6:15 p. m., Littmann's dinner music; 6:15-6:30, Daddy Kinkum's rhyme machine; 6:30-7, Littmann's dinner music; 7-7:30, Harry Richman and his entertainers; 7:30-8, Melody club orchestra; 10:30-11, Roseland dance orchestra; 11-11:30, Caravan club orchestra; 11:30-12, Alabama club orchestra; 12-12:30, Silver Slipper revue and orchestra.

WIP, Philadelphia, Pa. (508.2), 1 p. m., Gimbel tea room orchestra; 3, Anno G. Speck, soprano; Anne Smith, contralto; Joseph C. McNichol, tenor; 6:05, Benjamin Franklin concert orchestra; 7, Uncle Wip's bedtime story.

WJAR, Providence, R. I. (305.9), 10 a. m., Mrs. Wood, housewives Radio exchange; 1:05 p. m., Woodstock entertainers; 7:30, story teller; 7:45, musicale; 8, Margaret Reid; 8:30, Gorman's Jolly Bakers; 11, Providence-Biltmore dance orchestra.

WJR, Pontiac, Mich. (516.9), 7 p. m., Jean Goldkette's Petite Symphony orchestra; soloists; 7:30, Arctic-Condor trio; Arctic Dairy Products company; 8, Summerfield and Hecht.

WKAR, E. Lansing, Mich. (285.5), 7:15 p. m., Radio school, lectures Botany, English, Forestry; 8 educational hour.

WMCA, New York, N. Y. (340.7), 6-6:30 p. m., Olcott Vail and his Hotel McAlpin string ensemble; 6:30-7:30, Ernie Golden and his Hotel McAlpin orchestra; 8:50-9, talk, Adolph Zucker; 9-10, Hardman hour of music; 10:15-10:45, Donald Flamm, dramatic critic.

WNYC, New York, N. Y. (526), 11-12:30 p. m., women's program; talk; concert, Hotel St. George; 6:20-6:30, piano selections; 6:30-7, elementary French lessons; 7-7:30, advanced French lessons; 7:35-8:30, dance program; 8:30-9, recital talk, Herman Neuman; 9-9:45, vocal program; 9:45-10, violin recital; 10-10:20, talk, Prof. Carter Troop; 10:20-10:30, lecture, board of education.

WOR, Newark, N. J. (405.2), 6:45-7:45 a. m., gym classes; 7:45-8, talk, E. T. Adams; 6:15-6:17, "Words Often Mispronounced"; 6:30-7:30, Jacques Jacobs Hotel Shelton orchestra.

WRC, Washington, D. C. (468.5), 10 a. m., women's hour; WJZ; 12 m., organ recital, Otto Beck; 1 p. m., New Willard hotel orchestra; 5, "WRC's Foolish Entertainers," George P. Ross, Ellsworth Tompkins; 6, book reviews.

WREO, Lansing, Mich. (285.5), 6-7 p. m., dinner concert; Speed-Wagon serenaders; Gold Standard ensemble.

WTAG, Worcester, Mass. (268), 10:30 a. m., musical selections; 10:45, musical selections; 12:05-2 p. m., WTAG trio; 8, concert program.

WTAM, Cleveland, Ohio, (389.4), 12:15-1:15 p. m., popular entertainers, Euclid music studio; 6-7, dinner hour music, popular entertainers, Euclid music studio.

WTIC, Hartford, Conn. (475.9), 12:03, luncheon music; 6:30, young people's half hour; 7, Emil Heuberger's Hotel Bond trio; 7:30, Mrs. F. A. Seidler, contralto; 7:55, Eric Texeche, tenor; 8:15, Hartford choral club; 10, Gertrude Preissner, soprano; 10:35, dance music; 11:30, popular half hour.

WJL, Detroit, Mich. (352.7), 7:30-8 a. m., setting-up exercises, R. J. Horton; 9-9:30, "Tonight's Dinner," women's editor; 12:05 p. m., Jules Klier's orchestra; 3, Detroit News orchestra; 6, dinner concert; 8, concert; 9, dance program.

Central Time Stations

KFAB, Lincoln, Neb. (340.7), 5:30-6:30 p. m., dinner hour concert; 8:30-9:30 a. m., First Anniversary program; Harriett Cruise, Oriole of the air; Richard Low, Chinese baritone; Ed Ellington, songbird; Mart Grauenhorst, banjoist; Father Flanagan's Boys' band; Belshaw's orchestra; Mardeline Schmidt, blues singer; Ray Lindemann and Gloomy Gus; Slick Merriam, pianist and vocalist; Nebraskans orchestra; Colonnas orchestra.

KFDM, Beaumont, Texas (315.6), 8-10 p. m., Magnolia Petroleum company's evening band.

KFNH, Shenandoah, Ia. (266), 7 p. m., religious discussion; 7:30, pipe organ concert.

KFVE, University City, Mo. (240), 8:30 p. m., "Amusement Review," Romaine Fielding; regular studio entertainers, selected numbers orchestra Romaine.

KMA, Shenandoah, Iowa (252), 11:30-12:30 p. m., RFD program; 12:30-1:05 p. m., readings, E. May; music; 6-7, dinner program; 8:30, How do you do boys; Grady and Doc, Auntie Blossom and the slumber boat; 9-11, evening program; Snappy Seven, Clarinda, Iowa.

KPRC, Houston, Texas (296.9), 12 m., Frank Tilton, blind wonder boy pianist.

KSAC, Manhattan, Kansas (341), 9-9:25 a. m., music, inspirational talks, agricultural primer, calisthenics; 9:25-10:25, readings, backyard gossip, all round the ranch, question box; 12:35-1:05 p. m., readings, question box; "Orchard Rodents you can poison," Roy Moore; "Winter Feeds for the Breeding Herd," E. W. Kiser; 4:30-5 p. m., lessons in color and design; 6:30-7:30, traveling, Paul Weigel; "Speaking in Public," English literature, "The Organization of the Business Letter," O. Faulkner; "When and How to Inoculate Legumes," P. L. Gainey.

Mountain Time Stations

KSD, St. Louis, Mo. (545.1), 7 p. m., fur hour, Mack Mudd, tenor; 7:30, commerce hour; L. Mack Close, flutist; address, Dr. Isadore Loeb; 8, Lela Marie Bunte, pianist; 9, special entertainment.

KTHS, Hot Springs National Park, Ark. (374.8), 9-10 p. m., solo night, staff artists; Lon Chassy, violinist; Edward Richter, cellist; Tony Cochard, cornetist; Charles Gardner, saxophonist; John G. Heyn, pianist; Louis Culp, organist; 10-11, Pooley hour, Rainbow Garden.

KYW, Chicago, Ill. (535.4), 6:30-7 a. m., morning exercises; physical director, Y. M. C. A.; 7:30, Morning Family Worship; 11:15, "I miss My Swiss Steak," John W. Cutting; 11:55, table talk, Anna J. Peterson; 12-1 p. m., noonday concert, Commonwealth Edison company; 1-2 luncheon concert, Congress hotel, Joska DeBarbary and his orchestra; Coon Sanders, original night Hawks; 6:35-7, children's bedtime story, Walter Wilso; 7-7:20, dinner concert, Congress hotel; 7-7:10, Joska DeBarbary and his orchestra; 7:10, Coon Sanders original night Hawks; 7:30, Joska DeBarbary and his orchestra; 9-10, musical program Commonwealth Edison company; 10-12:30, midnight revue; Coon Sanders original night Hawks; Henri A. Keates, organologue, Art Linick, announcer; 1-2 a. m., Insomnia club, Coon Sanders original night Hawks.

WAMD, Minneapolis, Minn. (243.8), 12 noon, musical program; Whitey Nightingale, tenor; uke soloist; Leone Taylor, pianist; 7:05, Minneapolis Public School hour, T. F. Hiddings, director; 8, Reception Five; 11, Skyrocket frolic; George Osborn's Skyrockets.

WBAP, Fort Worth, Tex. (475.9), 12:05-12:30 p. m., musical program; 6-6:30, dinner music, Texas Hotel Tokio Royals; 7:30-8:30, program of classical music, Mrs. Pearl Calhoun Davis; 9:30-10:45, concert, School of Music, Texas Christian university, Prof. H. D. Guelick, director.

WBBM, Chicago, Ill. (226), 4-6 p. m., Harry Sosnik, Sandy Meek; Valentino orchestra; Harold Morayo; William Dalton; Joe McManus, Moulton Rouge orchestra; 8-10, Tip trio; Four Crows quartet; David Handler; Morris Silverman; Kristi Kallista, cellist; George Seaburg, pianist.

WBCN, Chicago, Ill. (266), 10-10:30 a. m., Penny Wise, "The Shopper's Ready Helper," shopping talk; 5-5:15 p. m., police bulletins; 7-8, Firefire hour, WBCN hobby club; George R. Cleveland, "Big Boy" Yagle, pianist; Will Rossiter, "The Daddy of the Song Publishers," tenor and songwriter; Harold Johnson, boy xylophonist; 10-12, request program; Midway dancing gardens orchestra; Eddie Matis and Billy Donovan, tenor duo; Ed Dempsey, "The Silknet-Voted Tenor"; Alice McAlpin, contralto; "Big Boy" Yagle, pianologue.

WCCO, Minneapolis-St. Paul, Minn. (416.4), 10:45 a. m., "A Roly Poly Pudding," Betty Crocker; 12 m., Dick Long's Dayton trio; 4 p. m., readers' club; Mrs. Walter Stevens; 5:30, court of Gold Medal; 6:15, Dick Long's Nankin Cafe orchestra; 7:45, bee keeping, 1 lesson I.; 8, health talk; 8:15, musicale; 10:05, Emmet Long's Golden Pheasant orchestra.

WDAF, Kansas City, Mo. (365.6), 10:45 a. m., Gold Medal hour cooking school; 6-7 p. m., school of the air; address, Kansas City children's bureau; the Tell-a-Story Lady; Triolet ensemble; 8-10, The Star Radio orchestra, soloists; 11-45 a. m., Nighthawks frolic; the Plantation players; Earl Coleman's orchestra; Kuhn's orchestra.

WEBH, Chicago, Ill. (370.2), 7-8 p. m., Oriole orchestra; Pauline Sachs, soprano; Eleanor Kaplan, violinist; 9-10, WEBH Light opera company; 11-11, Oriole orchestra; Rita McFawn, soprano; Jaek Pennewell, twin guitarist.

WFAA, Dallas, Tex. (475.9), 12:30-1 p. m., address, Dr. Horace M. Whaling, music Alex. Hughes pianist; 2:30-4:30, Sears-Roebuck Agricultural Foundation; home-makers program; 4:30-5, woman's hour, literary review; 6:30-7:30, A. Harris and company's choral club; 8:30-9:30, talent, Tyler Street Methodist church, Mrs. Harry K. Truly.

WGES, Oak Park, Ill. (250), 5-7 p. m., Lydia Werner, soprano; John Brown, pianist; Katherine Gray, contralto; Edwin Kemp, tenor; Tiffin theater organ and orchestra; 8-9, Thomas Pappas, accordion; Tiffin theater organ and orchestra; John Stamford, tenor; McDevitt organ and orchestra; 11-11, m. Benning, W. Welsh, organist; Parish and Ward, "Sandy McTavish," Scotch comedian; Bobb and Cameron, duettists; Thomas Pappas, accordionist.

WHAS, Louisville, Ky. (399.8), 4-5 p. m., musical selections, Harry S. Currie, director; editorials, The Courier-Journal, Louisville Times; police bulletins; 7:30-9 p. m., concert, Southern Baptist Theological seminary, J. H. Drake, director.

WHO, Des Moines, Iowa (526), 7:30-9 p. m., R. B. MacIntosh soprano; Edith Ustry accompanist; artists, Simpson conservatory of music, direction, Prof. Harvey; 11-12, dance program, Corn Sugar orchestra.

WHT, Chicago, Ill. (399.8), 10 a. m., Jean Sargent's program, woman's club, Jelle Good Luck Girl, studio features; 10:45, Betty Crocker home service; 11, special studio features; 12 p. m., Al Carney's complimentary organ hour; 1-2, special studio program, Grayling's string trio; 6, classical program, dinner organ recital, Grayling's string trio; Bob York, tenor; Bernice Taylor, soprano; Mina Smith, violinist; Leola Aikman, soprano; 7:45, (238), musical features; 9:30, Dutch Masters, Lotlis half hour of music, Freddie Whitmer, pianist; Samuel G. Rowe, tenor; Oscar Heather, tenor; Pat Barnes, tenor; Helen Raub, pianist; Husk O'Hares orchestra; 12, Pat Barnes and Al Carney.

WIBO, Chicago, Ill. (226), 6-8 p. m., vocalists; 10-12, popular program; orchestra.

Pacific Time Stations

WJJD, Mooseheart, Ill. (302.8), 10 p. m., Senator Harold C. Kessinger, Emma Bevenssee Butler, Jean St. Anne, Christian A. Grimm; 12, midnight Geneva organ.

WKRC, Cincinnati, Ohio (422.3), 10 p. m., Swiss Garden orchestra.

WLBB, Chicago, Ill. (302.8), 7-8 p. m., dinner concert, Blackstone and Drake hotel orchestras; 9-10, popular, Hamm's orchestra; 11-12, dance, Drake and Blackstone hotel orchestras.

WLS, Chicago, Ill. (344.6), 12 a. m.-1 p. m., RFD program, Ford and Glenn; 6:15, announcements; 6:30, Ralph Emerson, organist; 7, Ford and Glenn's lullaby time; 7:45, Wallace Bruce Amshary's "Poet's Corner"; 8, RFD program; 9, "Old Song Hour"; 10, Ernst Moeller, pianist; 10:40, Ford and Glenn time.

WLW, Cincinnati, Ohio (422.3), 7:30 a. m., morning exercises, William Stratgman, Y. M. C. A.; 7:45, morning devotions, auspices of Parkway Y. M. C. A.; 9-9:30, Crosley elementary school program; 12:15 m., concert.

WMAQ, Chicago, Ill. (447.5), 12:25 p. m., Y. M. C. A. forum; 1, Radio farm school; 2, shut-in program; 4, "The Preschool Child"; 4:30, "Fables of the Moment," Mrs. Graham Aids; 5, Child Life stories; 6, Chicago theater organ; 6:20, Family Life league; 6:30, Wide-Awake club program; 8, Mr. and Mrs. Marx Oberdorfer's musical lecture; 8:30, Whitney trio; 9, lecture, U. of Chicago; 9:20, Elizabeth Stokes, soprano; 9:45, Christian Endeavor topics.

WMBB, Chicago, Ill. (250), 7-8 p. m., Trianon duo; Beatrice Teller, Joseph Kreloff, Frank Brindner, Ralph Elliott, in semi-classical program; 9-11, Trianon orchestra, Dell Lampe; Woodlawn orchestra, Armin F. Hand; Lionel Carter, McCourt and Carney, popular program; Trianon syncopators.

WMC, Memphis, Tenn. (499.7), 8:30 p. m., Atwater Kent concert ensemble.

WOAI, San Antonio, Texas (394.5), 3 p. m., musical program, Kamina's Hawaiians; 8:30, musical program, Menger hotel trio.

WOAW, Omaha, Nebr. (526), 12:45 p. m., Sunshine Sunday dinner menu and recipe service; 1, Randall's Royal Fontanelle orchestra; 4:15, blab blab; 6, sandman; 7, Hal McLaughlin; 6:20, music review, Hester Bronson Copper; 6:45, Brandeis tea room orchestra; 9, program, Emmetsburg, Ia.

WOI, Ames, Iowa (270), 12:30 p. m., college chimes; 12:45, talk, agricultural economics, Professor C. L. Holmes.

WOK, Chicago, Ill. (217.3), 12 m.-2 p. m., Gus C. Edwards and his orchestra; Banks Kennedy, organist; Thos. B. Stephenson, tenor; Marianne Powell Babcock, soprano; Elsie C. Stephenson, pianist; WOK, male quartet; 5:30-7, Gus C. Edwards and his orchestra; Jean Carlson, soprano; Kenyth Dunn, pianist; WOK, string trio; Husk O'Hare and his orchestra; 10-11, Gus C. Edwards and his orchestra; Husk O'Hare and his orchestra; Harry Davis, tenor; Arnold B. Stephenson, musical saw; Harriet Lee, contralto; Herman Stinatto, violinist; Banks Kennedy, organist; WOK, string trio; WOK, male quartet; Chas. Lord, tenor; H. Blyler, tenor; J. Keyes, baritone; N. Bartlett, bass.

WORD, Batavia, Ill. (275), 8 p. m., Webster hotel concert trio; 8:15, Ucle Dan's Radio study club; 8:30, musical program, S. O. Hermanson, director; 9:15, business address.

WQJ, Chicago, Ill. (447.5), 11-12 noon, home economics program, Helen Harrington Downing; Sunday dinner menu, Ted Wilmes; 3-4 p. m., home economics, Helen H. Downing; Essay contest winners readings their papers; 7-8, dinner concert, Ralph Williams and his Rainbo Gardens concert orchestra; Lola Juhl, soprano; Henrietta Nolan, violinist; Everett Mitchell, baritone; Doris Gross, character reader; 10-11 a. m., Ralph Williams and his Rainbo Skylarks; H. Luellie Lee, harmonica player; Eleanor Terry and Marie Polette; Blues Destroyers trio; Melodians; Lean Terrill, baritone; Ed McGinnis, accordionist; Romo Vincent, boy tenor; 1-2, Ginger hour, Ralph Williams and his Little Skylarks.

WSB, Atlanta, Ga. (428.3), 8 p. m., entertainment; 10:45, Carter Electric Radiola orchestra.

WSM, Nashville, Tenn. (282.8), 6:30-8 p. m., Beasley Smith's orchestra; 7, bedtime story, Bonnie Barnhardt; 10-11, Iowa concert.

WSUI, Iowa City, Iowa (483.6), 12:30 p. m., music, faculty of University of Iowa.

Pacific Time Stations

KFAA, Ogden, Utah (261), 5-6 p. m., Ogden Radio Dealers program; 9-10, musical program, Lion Coal company, Ellis Fuel company.

KOA, Denver, Colo. (322.4), 12:15 p. m., Radio theater music; 3:15, relaxing and corrective exercises; 4:30, matinee for housewives; 4, culinary hints; 4:15, fashion review; 6:30, dinner concert, Brown Place string orchestra, Howard Tilletson; 7:30, International Sunday school lesson; 8, studio program, the Warren Memorial quartet; Ruth Hammond Ragatz, soprano; Laura Kemp Anderson, contralto; Bert Dwyer, tenor; Clarence C. Moore, bass; Hazel Dwyer, alto, accompanist; "Old Spanish Names in New America," Rev. Leon C. Hillis; baritone solos, Enrico Rodolfi; KOA orchestra.

KOB, State College, N. M. (346.6), 7:30-8:30 p. m., musical, Presbyterian choir, Rev. Hunter directing.

Mountain Time Stations

KFWA, Ogden, Utah (261), 5-6 p. m., Ogden Radio Dealers program; 9-10, musical program, Lion Coal company, Ellis Fuel company.

KOA, Denver, Colo. (322.4), 12:15 p. m., Radio theater music; 3:15, relaxing and corrective exercises; 4:30, matinee for housewives; 4, culinary hints; 4:15, fashion review; 6:30, dinner concert, Brown Place string orchestra, Howard Tilletson; 7:30, International Sunday school lesson; 8, studio program, the Warren Memorial quartet; Ruth Hammond Ragatz, soprano; Laura Kemp Anderson, contralto; Bert Dwyer, tenor; Clarence C. Moore, bass; Hazel Dwyer, alto, accompanist; "Old Spanish Names in New America," Rev. Leon C. Hillis; baritone solos, Enrico Rodolfi; KOA orchestra.

KOB, State College, N. M. (346.6), 7:30-8:30 p. m., musical, Presbyterian choir, Rev. Hunter directing.

Pacific Time Stations

KFOA, Seattle, Wash. (453.3), 6:45-8:15 p. m., Sherman, Clay and company, studio program; 8:30-10, 11-12, dance program, Corn Sugar orchestra.

KFWB, Hollywood, Calif. (252), 7:30 p. m., "Eyes," Dr. Herbert S. Marshutz; 7:40, microphone brevities; 8-9, program, Min Wright, The Right Tailor, featuring Three Little Tailors trio, John Aason, harmonica, California Blue Boys; 9-10, studio program; 10-11, Warner Brothers, frolic, direction Charlie Wellman; 11-12, Henry Halstead's Hollywood Roof orchestra.

KGO, Oakland, Calif. (361.2), 7:15-7:30 a. m., health training exercise, Hugh Barrett Dobbs, William H. Hancock, accompanist; 7:45 a. m., pep class, Hugh Barrett Dobbs; 8:15-8:30, a. m., daily strength, cheerio; 11:10, Prudence Penny home-making talks; 11:30-1:00 p. m., luncheon concert, Pacific States Electric company; 3-4, "Magazine Article Digest," Library service bureau; program, Pacific Coast Music Review; 4:30-5 p. m., concert orchestra, Hotel St. Francis, Vinton La Ferrara conducting; 5:30-6:00 girls' half hour; 6-7 p. m., dinner concert, Sherman, Clay & company, studio.

KGW, Portland, Ore. (491.5), 7:15 a. m., physical culture exercises; 12:30-1:30 p. m., Rose City trio; 6-7, dinner concert; 9-10:30, concert, Sherman, Clay and company studio; 10:30-12, Hoop Owls.

KHJ, Los Angeles, Calif. (405.2), 6-6:30 p. m., Leighton's Arcade cafeteria orchestra, Jack Cronshaw, leader; 6:30-7:30, history story, Prof. Heitzog; Richard Headrick and Viola Von, screen starlets; 7:30, "Romance of Santa Fe Trail," Gladys De Witt; 8-10, program, Western Auto company; 10-11, Art Hickman's Biltmore hotel dance orchestra.

KLX, Oakland, Calif. (508.2), 8-9:45 p. m., special program; 9:45-10:30, Tom Gernovick entertainers.

KMTR, Hollywood, Calif. (238), 5-6 p. m., home hour, Mammy Simmons and neighborhood children; 7, "Color Photography," Chas. W. Beam; 7:30, "The Wonders of Nature," Prof. Alfred Cookman; 8-10, KMTR concert hour, Turner orchestra, direction Loren Powell.

KNX, Hollywood, Calif. (336.9), 5:30-6:15 p. m., Wurflitzer pipe organ studio; Town Tattler; 6:15, travel talk; W. P. Alder; 6:30-7, Atwater Kent concert orchestra; Paul Pinstel, leader; 7-7:30, El Patio ballroom orchestra; 7:30-8, program, Eastern Outfitting company; 8-9, West Coast theater by remote control; 9-10, Order of Optimistic Donuts, Davis Perfection Bread company; 10-11, dance music; 11-12, Ray West's Coconut Grove dance orchestra from Ambassador hotel.

KPO, San Francisco, Calif. (428.3), 1:30-2 p. m., Rudy Selger's Fairmont hotel orchestra; 6:30-7, Waldemar Lind and the States Restaurant orchestra; 8-11, Palace hotel dance orchestra; Maurice Gursky, tenor; Merton Bories, pianist; Al Jacobs, pianist.

STATIONS IN ORDER OF WAVE LENGTHS USED

Meters Call	Meters Call	Meters Call	Meters Call	Meters Call	Meters Call
217.3 WOK	275 WORD	309.1 KDKA	361.2 KGO	406 WEBR	468.5 WRC
226 WBBM	275.3 WJAS	315.6 KFDM	361.2 WHN	410.7 CKAC	475.9 WBAP
226 WIBO	278 KOIL	315.6 WAHG	365.6 WDAF	416.4 WCCO	475.9 WTIC
240 KFVE	278 WCAU	315.6 WGBS	365.6 WBB	421.1 KJAF	475.9 WFAA
240 KTAB	278 WGBU</				

Radio Digest Illustrated

Published by the Radio Digest Publishing Company, Inc.
510 North Dearborn Street
Chicago, Illinois
Telephones: State 4372, 4373, 4374, 4375

E. C. RAYNER, Publisher

Eastern Office, Park-Lexington Building, 247 Park Ave.,
New York. Telephones: Ashland, 8144, 8145, 8146

Member of the Audit Bureau of Circulations

241
PUBLISHED WEEKLY

SUBSCRIPTION RATES

Yearly in U. S. and Possessions and Canada, \$5.00
Foreign postage, \$1.00 additional. Single copies, 10 cents.

Vol. XV Saturday, November 28, 1925 No. 3

"A New Word"

NOT long ago a Radio Digest reader who is also a reader of the Streator, Illinois, Free Press, wrote a letter to the busy editor of that paper and asked him which was the correct past tense of the verb, "broadcast," stating that he had noticed the said Free Press using "broadcasted." The editor made his reply in an editorial, with a caption (minus the quotes) the same as the above, which has given us a new light on why so many people on farms and in small towns are depending more and more on the Radio for educational advancement rather than on the small town dailies and weeklies.

Excerpts from the editorial follow:

"The word broadcast as a verb is a newly coined word and as yet is not included in the dictionaries." A trip to Webster's International, unabridged of course, would have prevented this editorial slip.

"If the public in general uses 'broadcasted' for the past tense of broadcast then broadcasted will be correct and proper."

In that case we should expect to find the word "ain't" used extensively in the columns of the Free Press.

"From a purely technical standpoint, it is likely that the philologist in analyzing the word broadcast will take into consideration that it is a combination of the words broad and cast and hence take the past tense of cast as the proper form for the past tense of broadcast."

A letter from Streator to Dr. Frank Vizetelly, chief lexicographer for Funk and Wagnalls, publishers of Literary Digest, and a widely known and used dictionary, would have brought the same information to the misinformed editor that it brought to us. The learned doctor informed us that the past tense of the word was "broadcast" now as it has been for years.

To quote from the editorial once more:

"The person who asked the question as to the word says that he has heard that the word 'broadcasted' as past tense for broadcast in the use of the Radio is vulgar. That is all piffle. Some smart alec of an announcer at a radiocast station may have said that 'broadcasted' is vulgar, but he displays his own ignorance any time he makes such a statement."

On rereading the foregoing quotation we pause to wonder why we have made this the subject of an editorial. After all it is a subject for the gentleman in the next column to deal with, but rather than put a fellow editor in the clutch of such scholars as Indi and the Third Trombone Player we will keep this to ourselves and turn in the name of the Free Press editor as a prospect for some dictionary salesman.

Keeps the Home Fires Burning

Radio has become almost a household requisite. Nothing has done more to promote the home-loving instinct than the ever-growing popularity of this great pleasure-giving and educational invention.

From this one may fairly reason that wherever the installing of Radio sets is on the increase the home-loving instinct is certainly not on the wane. And, since the broadcast program is essentially a thing to be enjoyed by the family circle, it is to the family circle that the Radio will cater.

Seldom has the human demand for novel entertainment found so admirable a combination. As the call for more Radio service grows, so also grows the attraction of the home. And as the attraction of the home becomes stronger, so the call for better broadcast programs becomes more insistent.

Everything tends to make the Radio influence a wellspring of good. So excellent a caterer to all that is most desirable in promoting true human happiness certainly deserves the very best of the public to whom it ministers.

Paradoxical, perhaps, but while Radio makes the hearthstone more attractive it also awakens dormant interests in activities outside the home. Forgotten football comes to life and the blood thrills with the announcer's report of the game from the edge of the grid. Mammoth motor races are visualized through the sounds that come through the "mike." We can stay at home and "step out" with the broadcasters.

RADIO INDI-GEST

Solace

The songs fall softly, sweetly in my home,
Tired am I, and the music fills my soul
Soothing the restlessness and tired brain
Like drafts of rare wine from a mediaeval bowl.

I care not for the things of rare repute
But that my home should own a Radio;
When ill at ease and tired of cities mart,
I can tune in with harmonies that flow.

Seems like the vague remembrance of a dream
So softly am I lulled in arms of bliss
Perhaps an echo from another world,—
Sings through all Eternity like this.

RHEA SHELDON.

Which Explains Everything

Hastily connecting up his new Radio, Pa donned the phones just as items from Europe were being relayed. "Technical difficulties" made the voice of the foreign announcer sound like a Czecho-Slovakian debating society.

"The man's talking backwards!" exclaimed the bewildered listener.

Jacky, aged eight, cast a critical eye over the set, and then shouted in a superior voice: "Why, of course! Can't you see you've fastened the aerial and ground wires on the wrong way about!"

LONDON BOBBY.

"Howdy Pap! Gets Roses"

Whenever in search of a good program you be.

Just tune in to WJJD

That's where you'll find an orchestra that's keen,
And red hot music that's what I mean.

Peppy artists and songs galore,

To hear them once, you'll come back for more.

A versatile announcer, so obliging, so pleasant, so true,

With songs and wit he's bound to please you.

Then there's R. S. the "Howdy Pap" man you'll want to hear,

Of course, I'm referring to their handsome engineer.

I know you'll find it worth your while,

So tonight at 12, just set your dial.

"That Red Head Gal"

BOBETTE W.

Bobette, it seems that the mail man was loaded down with poetry this week and were it not for the fact that you are red headed and that we share in your versified views this would have found repose in the same waste basket in which we throw our weekly salary check. Working as we do with such pleasant contributions coming in every mail we do not have the heart to accept a salary. Big hearted, that's us!

Radio Barometer

Over the hill to the poorhouse

He wends his weary way;

He tried to support an eight-tube set

On a two-tube ear phone pay.

GEORGE.

What Shall It Be?

Dear Indi:—I can't sleep nights thinking about the "Gest" part of your column. I think it should be spelled with a "J" because when I think of Indi-Gest I have a tummy ache and it gives me the hiccoughs. Please change it to Indi-Jest. You must or I will have to go to the doctor's to read it.

ANNE TENNA.

We take your above Anne, old girl, for a compliment. If you think this column should be called "Jest" that leads us to believe that we have succeeded in convincing at least one person that we are a Jester. You will remember the confidential positions held by famous Jesters in history. May we also hold the same position in the court of King Radio. But what we really wanted to say was to ask what our other readers think about the proposed change. Tell us shall it "G" or "J"?

Emotional Radio

When I am feelin' awful blue
I find much joy in WCAU

Or when I'm feelin' extra gay
I turn the dial for WQJ

WGN sure does the stuff
When I want something hot and rough

Or when I crave an opera gem
I search the air for WTAM

WGN with it's mellow tone
Often finds my Radio phone

WSUI from loway
Gets the call when grid teams play

But when I want thrills really true
I tune in station YOU.

--BAT--

RADIO EPITAPHS NO. 4 BY THE THIRD TROMBONE PLAYER

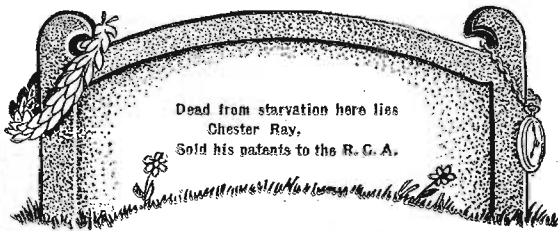

Let's Tune Them Out

HERE'S THE BOY THAT
TALKS FASTER THAN
A BUZZ SAW SAWS!

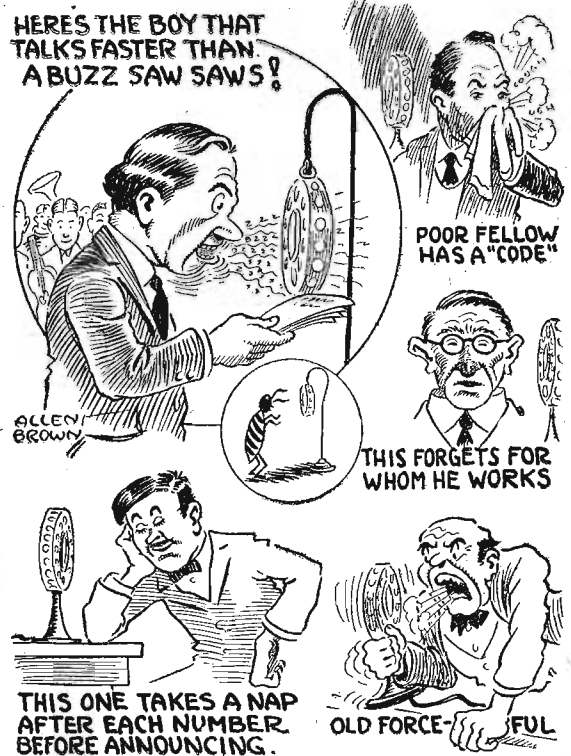

Condensed

BY DIELECTRIC

Each time you meet a Radio listener something is said of the superiority of this season's programs over those of past winters. The remark applies generally, though perhaps more especially to the series of concerts broadcast through WEA, New York, and associated stations presenting artists under contract to A. Atwater Kent. It is not surprising that Mary Lewis has sung her way into the Metropolitan opera company, for she undoubtedly made a very favorable impression on her Radio audience of hundreds of thousands. Paul Kochanski's violin playing revealed the personality of a serious musician thoroughly equipped to interpret the various schools of music. Ole Bull's Strad surely fell into expert hands when this artist acquired it.

There must be some justification for calling a snappy program feature at WLW, Cincinnati, the "Sky terrier program"—perhaps because it is snappy. At any rate the director of these special features does his best to make all eligible canines feel perfectly contented. This popular station has no difficulty in stepping out over considerable distances with diversified numbers that ought to please many folks.

WHO, Des Moines, included in a program recently presented a group of dance numbers played by an orchestra which sounded rather rough in spots. It isn't possible to expect every band of musicians to sound equally well, but it is certain that listeners in look for and select only those musical numbers which show some superiority in their rendition, whether popular or classical. We used to accept what Radio entertainment there was without much cavil but times have changed and so has the standard set up for each type of feature offered.

To some of us who have had the good fortune to be near enough to a large city to attend the theater such presentations as are sometimes made from broadcasting stations find little to interest. A few of the musical numbers sung on the stage years ago have sufficient value to maintain their popularity when heard repeatedly, as for instance selections from the "Prince of Pilsen", which WTAM, Cleveland, placed on one of their programs. Yet it must be kept in mind that a great many are hearing these selections for the first time and neither you nor I constitute the entire body of listeners in.

Some time I must stick around Philadelphia, the Quaker City, long enough to hear something extraordinary. Nearly every time that my dials locate the city there is a dance program in full sway, indicating that the statue of William Penn atop the public buildings has slight significance for modern studio directors. WLIT must be credited with having an orchestra to render fox trots, etc., with all the pep anyone could desire. Still we must search for other things there.

For a time there were several broadcasting stations devoting a part of their programs to instruction in code, but these have decreased in number until now very few allot any space to it. It may be that only a small part of the Radio public cares to avail themselves of an opportunity to learn the meaning of dots and dashes, yet there are such, however few. WGBU, Fulford-by-the-Sea, Fla., has begun a weekly feature covering this subject. If the fascination of understanding a code message is not compelling then surely the practical aid one might give in an emergency should influence more BCL's to learn the code.

Interesting and Simple Explanation of Radio

Chapter V—Ether Cyclones and Selectivity

By H. G. Tanner, Associate Professor University of Oregon

THE very simplest receiving set has been described and its simplicity is really surprising—just a piece of wire for an antenna, a small coil of wire, a crystal on which rests a needle, and a telephone receiver.

of one frequency will be reproduced with far greater efficiency than all others.

Second Coil Is Receiving Antenna

A second coil placed parallel to and on the same axis as the first will act as a receiving antenna and may in turn be con-

By the time the wave has been transmitted several times it is very pure, which means that the interfering stations have been eliminated. The accompanying diagram, figure 1, may make the arrangement clearer.

Coil AB rebroadcasts the waves and they are received by CD. CD is connected to another coil EF. The electronic motion in CD is transmitted to EF (not the ether wave from CD unless the coils are close together). EF becomes a broadcasting station and GH the receiving antenna. By the time the waves have been received in GH, having been broadcast once from AB and again from EF, they are quite pure although they may require further purification which could be done by continuing the process.

All would work very nicely with connections made as in figure 1 until it was desired to tune in another station. There must be some way of changing the tuning of all these circuits when AB is changed to respond to some other broadcasting station.

There are several ways of accomplish-

ing this. One method is to mount these pairs of coils AB, CD and EF, GH so that one coil may be turned at a right angle to the other. Such a pair of coils is called a variocoupler. In the former case (two

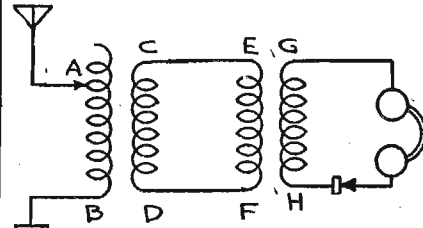
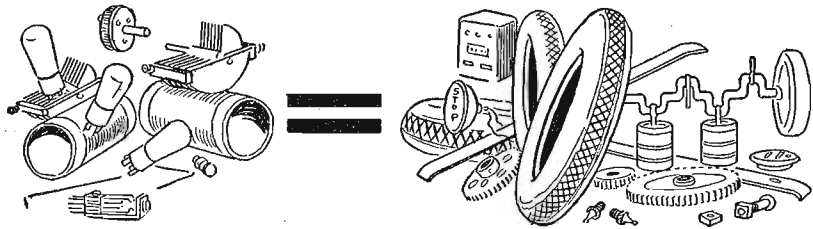

Figure 1.—The above diagram shows how a series of tuned coils act to purify the wave received, and increase the receiver's selectivity.

coils parallel, on same axis, and fixed in position) they were known as a transformer. The broadcasting coil (AB) is called the primary, and the receiving coil (CD) the secondary. When CD picks up

(Continued on page 30)



Why refine the simple crystal set? Vacuum tubes, coils and condensers, are to a Radio set what cylinders, gears, stop lights and shock absorbers are to an automobile.

If a receiving set can be as simple as this you may ask, why should anyone complicate it with variocouplers, grid leaks, etc.? This is like asking if a motor car can be as simple as a Ford why should anyone manufacture anything else. In all the different types of motor cars the fundamental principles applied are the same, but no one will deny that the additional number of cylinders, gears, and shock absorbers contribute to better riding.

Vacuum tubes, coils and condensers, are to a Radio set what cylinders, gears, stop lights and shock absorbers are to an automobile. Let us add them one at a time and see the improvement that is made.

Necessity for Selectivity

In the receiver just described a coil was provided for tuning the antenna to a particular frequency. This tuning might be absolutely exact and yet the antenna will respond to some extent to waves whose frequency (wave length) is close to the former. In the early days of Radio (three or four years ago) there were so few sending stations that their frequencies could be very different from each other, and therefore did not interfere with each other at the receiving station.

Nowadays there are so many broadcasting stations that their frequencies must lie close together and sometimes they are identical. It would be impossible to distinguish two stations in the latter case if their waves were equally powerful, but in the former instance one station can be prevented from interfering with another by employing a receiving set capable of responding to one set of waves very strongly in comparison to all other frequencies.

Receiving Coil Is Miniature Broadcaster

You may recall the description of how an ether wave was produced. Electrons in their effort to ascend the antenna acted like a school of startled fish and created quite a stir in the ether as they wiggled up the wire. On their return they forced the ether in the opposite direction. The two commotions in the ether constituted a wave.

This process was repeated at regular intervals and these waves traveled out toward the receiving station. (If one could get a picture of the ether it would be most beautifully marcelled.) At the receiving station the waves washed the electrons up and down in the antenna which in turn transmitted this motion to electrons in a coil of wire inside the receiving set.

It is this coil of wire which is of immediate concern. Just as soon as the electrons start moving in this coil, they act like all other electrons in motion and create an ether breeze behind them. These electrons are bouncing in step with the electrons in the antenna (assuming the system was tuned) and must necessarily be rebroadcasting, on a miniature scale, ether waves of identical character with those being received by the antenna.

This coil has become a tiny broadcasting station.

What Second Set of Waves Do

Important as this all is there is another fact of still greater importance to notice. There may be other sets of ether waves arriving at the antenna whose frequency is but slightly different from the former set which we assumed was exactly in tune with the antenna system.

These other waves will also agitate the electrons of the system, but their effect on the electrons is weaker, even though the waves may be equally powerful. The tiny rebroadcasting station within the cabinet will faithfully reproduce these waves also, but the all important thing is that they are reproduced very much weaker than the set of waves to which the coil is exactly tuned.

All these sets of waves may be arriving at the antenna equally strong, but when rebroadcast from this coil, waves

connected to still another coil, all being exactly tuned to the one set of ether waves. They, too, will act as broadcasting and receiving stations and each time the wave is received and rebroadcast from the preceding coil it is purified from those not exactly in tune.

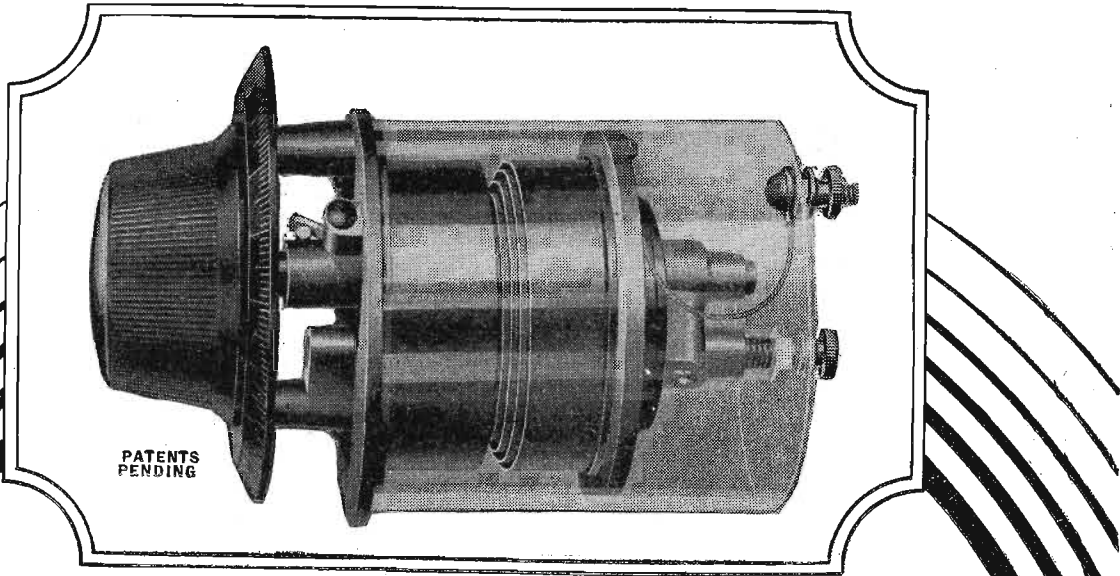

“The Most Practical SLF Condenser I’ve Seen.”

So commented a prominent radio engineer recently, after testing the new Furnell Taper Coil Condenser.

The Furnell stands absolutely alone. It is the first radical improvement in condensers—and the only one of its type on the market.

Literally thousands — including “fans”, manufacturers, engineers, distributors, jobbers, dealers, etc.—have been showing a phenomenal interest in this remarkable new condenser.

Professionals recognize in the Furnell the most practical type of condenser ever designed for Straightline

Frequency tuning. It assures a clean-cut separation of all stations, regardless of wavelength. It affords a smoothness of operation, a tone clarity, and a scientific precision absolutely impossible with the old-style condenser.

And the strong, transparent shield keeps the Furnell absolutely dust-proof, moisture-proof, and damage-proof, insuring permanent accuracy and precision. Made in three capacities—single and multiple.

Exclusive sales franchises are available to reputable jobbers and locations still open. Particulars on request.

Write for Literature

THE FURNELL MANUFACTURING CORP.

24M Scott St., Newark, N. J.

FURNELL

360° TAPER COIL

CONDENSERS

More About the Underground Antenna System

Regeneration Is Essential

By George W. Guyer

IN THE very first try-out I gave my underground antenna system, as described in the issue of Radio Digest of September 26, I discovered a fact, the importance of which I did not realize at that time. I meant to mention this fact in that article, but, owing to my anxiety to cut down space, I overlooked such mention. My discovery came about in this wise. After I had tried out the usual aerial antenna with one of the ground antennas, obtaining only a few carrier-wave signals and intolerable static, I removed the aerial antenna and substituted the other underground antenna, leaving my dials just as they were. My set was now very quiet, with no static and no carrier wave signals. Without moving the dial on the tickler, or regenerative, coil, I turned the tuning dials throughout without getting a carrier wave signal. I began to think my underground system a failure. I then advanced the tickler dial 20 degrees and turned the tuning dials. Signals now came in and were easily tuned down to resonance. What I discovered is that it requires slightly more regeneration to secure reception through the underground antenna system than through the usual aerial antenna and ground system.

This proves that the underground antenna system has the effect of slightly raising, or increasing, the resistance of the grid circuit. Now this increase must be overcome before the grid circuit can be tuned to resonance. This can be accomplished in only one way, by the feedback of energy from the plate circuit to the grid circuit; that is, through regeneration. If a receiving set which has suppressed this principle of signal amplification, by neutralizing, or eliminating, the plate to grid feedback, is hooked to the underground antenna system, nothing more than indifferent results may be expected. This is for the reason that there can be no increase of energy in the grid circuit induced by feedback of the plate circuit in such a receiving set. All neutrodyne and other so-called "balanced, tuned radio frequency" sets will give indifferent results through the underground antenna system, but such results, however otherwise indifferent, will be free from static; all of which attests that

the underground antenna system is not at fault. It would improve results to change the first neutrodon so that slight regeneration is permitted and the effective resistance of the grid circuit lowered.

Kenneth Harkness, in his work, entitled "Radio Frequency Amplification—Theory and Practice," says: "The final amplitude of the oscillations which build up the grid circuit when tuned to resonance, is limited only by the resistance of this circuit. Now if, in some way, it is possible to overcome the resistance reaction of the grid circuit, the oscillations will build up to a greater amplitude than before, so that more energy will be released in the plate circuit and a louder signal heard. It is evident that some value of coupling can be found at which the energy transferred from the plate circuit to the grid circuit exactly equals the amount of energy consumed by the resistance of the grid circuit.

"As the resistance of the grid circuit more closely approaches zero, the signal becomes louder and louder. But, if the coupling is increased to the point when the energy fed back to the grid circuit from the plate circuit completely counterbalances the loss of energy due to the resistance of the grid circuit, the effective resistance is then zero and a more complicated state exists. A free oscillation is self-generated which continues steadily at a constant amplitude irrespective of the signal oscillation. The frequency of this self-generated oscillation is governed by the resonant frequency of the grid circuit; the self-generated oscillation has the frequency to which the grid circuit is tuned.

"If the grid circuit is accurately tuned to resonance with the incoming signal oscillation, the self-generated oscillation and the signal oscillation have the same frequency. If this condition exists the self-generated oscillation very greatly amplifies the signal; in practice, however, it is very difficult to so accurately tune the grid circuit that the self-generated oscillation and the incoming signal oscillation both have absolutely the same frequency."

Now, it is this very existing condition, and its difficulty of adjustment to resonance, that have led Radio engineers

and manufacturers to the manufacture of foolproof receiving sets that entirely suppress, or eliminate, the feedback system that generates this condition with its consequent difficulty of control. But which is more important? The elimination of the great and overpowering annoyance of static, or the elimination of the much less of an annoyance radiation by regenerative receivers, manipulated by persons who have not properly learned the art of "tuning in?" It seems that the underground antenna system has stepped in just at this point in the development of Radio reception to eliminate both of these annoyances and is destined to force attention to its claims by engineers and manufacturers.

Through the underground antenna system the above described condition is easily approached and controlled with a good regenerative receiver. There is no radiation and the amplification is splendid. Ninety per cent of the complaints of indifferent results that have reached me since the appearance of my former article on this subject, from persons who have installed my system, have come from owners of neutrodyne and other so-called non-regenerative sets. The other ten per cent arises from faulty installation. Others have succeeded beyond their expectations and are delighted with the results obtained.

Coils Instead of Straight Wire

Coils are used instead of straight wires because these wires are conductors and also because, to quote Harkness again, "to wind the conductor in the form of a coil increases its inductance." These underground antennas may be considered as two sides of a condenser and the space between them as the dielectric. They should be buried in pure soil, free from contact with any mineral substances. They should be installed as near the receiving set as possible.

It is very plain from the foregoing why the underground system gives splendid results with good regenerative sets and indifferent results only with non-regener-

ative ones, and ought to be the answer to the thoughtful to all the murmurings against the system. It is back to the original Armstrong "feedback system" of regeneration that Radio reception is destined to go, with some modification, perhaps, such as the "reversed feedback," which is almost as foolproof as the neutrodyne, or non-regenerative system. The underground antenna system eliminates both static and so-called re-radiation. It is now November and "Old Man Static" is still dancing occasionally—yes, frequently—on your aerial antenna. But, his jiggling capers are all in the air—not underground—and the underground system works just as well in winter as in summer and can be used any time a station has "pep" enough behind its programs to get through. However, do not discard your aerial antenna. If you have a non-regenerative set it can be used to hold down static and bring up signal strength by hooking it to the antenna post in connection with the underground system.

Advices Use of Larger Wire

I have now answered about all the reasonable objections that can be laid against the underground system of reception. Any one thinking of installing this system is referred to my former article with the insistence that he read it carefully and thoughtfully and then consistently follow the instructions therein set forth. The only change from the specifications therein set forth I would now advise is that a number 8 rubber covered copper wire of the same length be used instead of the number 14 wire there in mentioned. This would increase volume somewhat. If more volume is desired, the new loud amplification tube may be used in the last stage of audio amplification.

I cannot undertake to write personal letters giving further hints upon this system of reception unless the writer encloses \$1 and stamped envelope for reply to pay me for my time. On this basis, address letters to 12 Fourth avenue, Clayton, N. M.

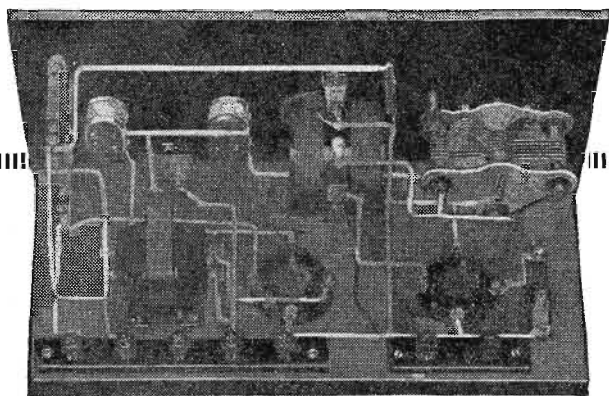

You Can Build This
Efficient Receiver for \$27²⁷

Built Around the
HEATH VARIABLE CONDENSER
By the Citizens Radio Call Book

THE remarkable performance of the Heath .0025 Variable Condenser caused The Citizens Radio Call Book Laboratory to design this remarkable high-power, low-cost radio set. Go to your nearest dealer and get your set of plans—they are **free** with each purchase of a Heath Condenser. Start right now to get the parts to build this super-efficient receiver. You'll have a radio that all your friends will envy. If your dealer doesn't carry Heath Condensers, write us direct.

HEATH RADIO AND ELECTRIC MFG. CO.
206-210 First St. Newark, N. J.

Manufacturers of
HEATH CONDENSERS HEATH SOCKETS HEATH DIALS
HEATH RESISTANCE COUPLED AMPLIFIERS

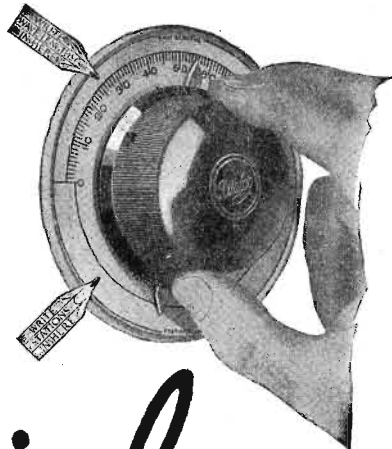

\$1²⁵
With erasable
metal logging disc

Dialog makes
close tuning
quick and easy

NEVER before, such a vernier dial as this. Ratio fine enough for the closest kind of sharp tuning, yet you jump from one end of the scale to the other in an instant! No back lash; just perfectly smooth control. And Dialog never wears out—because it has no gears, cams or levers. Entirely new principle.

Slip off your old dials; slip on Dialogs. No extra holes to drill, no changes to make. Fits any 1/4" shaft, any set. At your dealers, or direct. Get them now—for real tuning fun.

\$1.25 with black bakelite knob and silvered dial
\$1.25 with black bakelite knob and black dial
\$1.50 with brown bakelite knob and gold-finished dial
Dial readings 0-100 or 100-0

WALNART ELECTRIC MFG. CO.

308 So. Green St. CHICAGO
"Makers of Good Goods Only"



Counterphase: Perfect Bridge Tuned R.F. Set

Part I—The Whys and Wherefores

By James McDonald

BACK in June and July, Radio Digest published a series of articles on recent development in tuned radio frequency amplification, chief of which was the application of the long known Wheatstone or A. C. bridge to the prevention of oscillation in one or more tubes used as radio frequency amplifiers. Milo Gurney presented a great deal of valuable information which he had gathered through his long acquaintanceship with some of our leading engineers and concluded the series with the data on a four tube set which, if carefully constructed, was a long range surprise. However, the Digest promised its readers a set with more stages of tuned R.F., presumably one with two stages. It has been a long time in coming, and the technical editor has been written to in no uncertain terms about it, but—the set as it will now be presented is a whole lot better for the delay. The apparatus necessary is now available on the market and there are not only two stages of R.F. amplification but three.

Phase Explained

The name given this receiver is most appropriate, as a little explanation of the principle involved will show. Let us first separate in our minds the two components of electrical energy, current and voltage.

and the voltage rise and fall together, that is, about one million times per second they go from zero to maximum strength and back. In the plate circuit, however, the

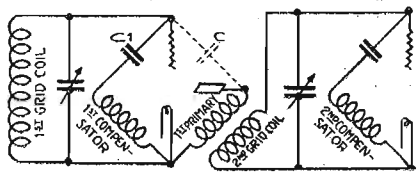

Figure 2

current rises and falls simultaneously with the current in the grid circuit, but the voltage or pressure rises and falls "out of step" with the current. When the current is at maximum, the voltage is at zero, and vice versa. Thus when our

phase", there is a transfer of energy from the plate circuit to the grid circuit which causes the tube to go into uncontrolled oscillations, particularly at the lower

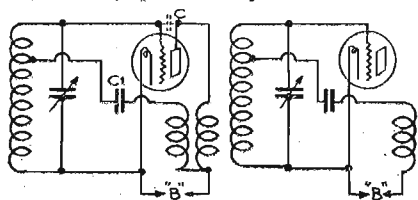

Figure 3

wave lengths. Suppose now, we stick with the grid in this matter of difference in voltages. We will supply the grid with a rising and falling voltage exactly in step or phase, and of equal strength with,

equal the first two. Referring now to figure 2, the condenser identified as C is that within the tube and the coil shown as "first primary" is that necessary in the plate circuit to pass energy to the following tube. Our counter attack consists of the small condenser C₁ and the coil shown as "first compensator." This coil is so arranged with reference to the first primary coil that the voltage rise and fall within it is exactly out of step or phase with the voltage rise and fall in the first primary. This is passed back to the grid through the condenser C₁.

In figure 3, the circuit of figure 2 has been redrawn in the schematic style to which Radio fans are accustomed. You will at once note that the grid side of condenser C₁ does not connect to the grid, but to a point on the grid inductance a

(Continued on page 26)

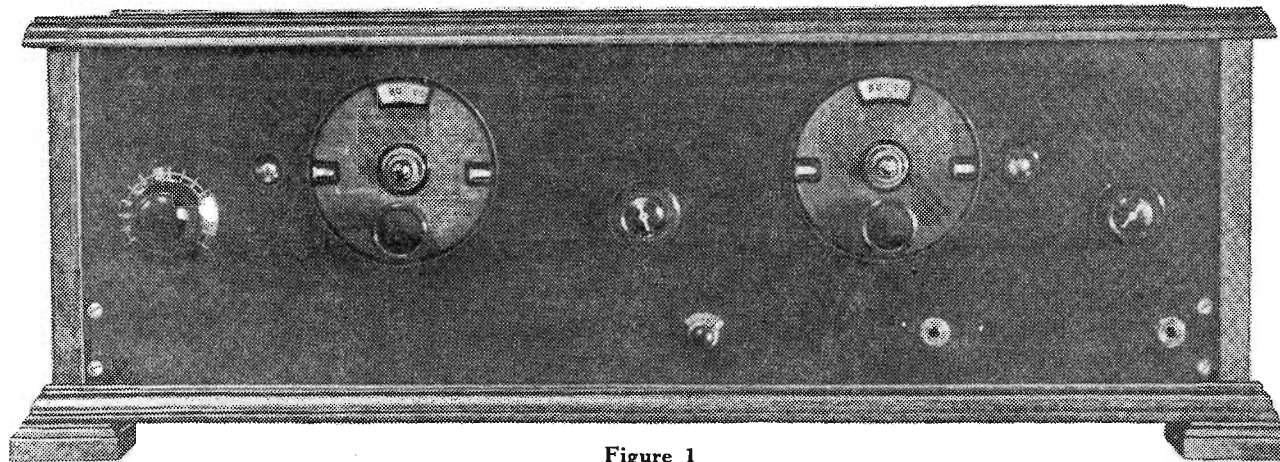

Figure 1

the rising and falling voltage in the plate circuit. In other words we fight back, or counter, with a phase that will prevent the plate from forcing energy back onto the grid.

The electrical circuit from grid to filament, via the plate, is composed of the undesired condenser between grid and plate, and the coil inserted in the plate circuit. We bring into action, therefore, another coil and another condenser, which in their combined effect

LIST OF PARTS

1 B-T Counterphase 6-tube Kit	Bremer-Tully Mfg. Co., Chicago	\$38.50
1 Carter 3-ohm Imp Rheostat	Carter Radio Co., Chicago	1.00
1 Carter Imp Switch	Carter Radio Co., Chicago	.65
1 Carter 9-point Switch	Carter Radio Co., Chicago	1.35
1 Carter 4-spring Jack, No. 104	Carter Radio Co., Chicago	1.00
1 Carter Open Circuit Jack, No. 101	Carter Radio Co., Chicago	.70
3 C-H Sockets, 201A size	Cutler-Hammer Mfg. Co., Milwaukee	1.80
3 Cle-ra-tone Sockets, 201A size	Benjamin Elec. Mfg. Co., Chicago	3.00
1 Pair Benjamin Brackets	Benjamin Elec. Mfg. Co., Chicago	.75
8 Binding Posts	Make carried by local dealer	1.20
2 Mar-co Vernier Dials, 0-Right	Martin-Copeland Co., Providence, R. I.	5.00
1 B-T Euphonic Trans., 4.7 to 1	Bremer-Tully Mfg. Co., Chicago	5.75
1 B-T Euphonic Trans., 2.2 to 1	Bremer-Tully Mfg. Co., Chicago	5.00
1 Formica Walnut Panel, 7x24	Formica Insulation Co., Cincinnati	4.20
1 Formica Black Panel, 9 3/4 x 23 1/2	Formica Insulation Co., Cincinnati	4.20
2 Sangamo Bypass Cond., 1.0 mfd.	Sangamo Elec. Co., Springfield, Ill.	2.50
5 Sangamo Fixed Cond., .00025 mfd.	Sangamo Elec. Co., Springfield, Ill.	2.00
1 Sangamo Fixed Cond., .001 mfd.	Sangamo Elec. Co., Springfield, Ill.	.50
1 Daven Mounting, No. 50	Daven Radio Corp., Newark, N. J.	.35
1 Daven Resistor, 3 megohms	Daven Radio Corp., Newark, N. J.	.50
1 Cabinet 7x24x10 inches	Make carried by local dealer	8.00
Total cost.....		\$87.95

The first is the material part which moves and the second is the energy which pushes it around. When using a vacuum tube as an amplifier, we put in the energy across the grid and the filament and take it out across the plate and filament. In both circuits, the energy increases and decreases at a number of times per second as determined by the incoming wave length. In the grid circuit, the current

voltage in the grid circuit is at maximum, the voltage in the plate circuit is at zero and when that in the grid circuit is at zero, that in the plate circuit is at maximum.

Inside the tube, the grid and the plate are very close together and form a small but most undesired condenser. Since the voltage variations on each are out of step or, as the engineer says, "out of

A FACT! The only man who doubts that a 3-tube set can give better results than a 5-tube set, is the man who has never made a performance comparison between the Crosley Super-Trirdyn and the best 5-tube set built.

Super-Trirdyn Regular, \$45

THE CROSLY RADIO CORPORATION, Cincinnati, Ohio

CROSLY RADIO

BETTER COSTS LESS

Unconditionally Guaranteed

THORDARSON

Super TRANSFORMERS

Standard on majority of quality sets

—AND CHOICE OF MacMILLAN ARCTIC EXPEDITION!

ZENITH
KENNEDY
Radiodyne
Planstiehl
Howard
Thermodyne
OZARKA
Deresnadyne
ADLER-ROYAL
MURDOCK
MU-RAD
Valley
LEICH
Silver-Marshall
GLOBE
Newport
BUCKINGHAM
NUNN-LANDON
KUSTOMBILT and many others

ONE REASON that leading builders of the finest sets use more Thordarsons than all competitive transformers combined is because Thordarsons run ABSOLUTELY UNIFORM — always "match up" perfectly, always amplify evenly. Follow their lead — build or replace with Thordarsons. Unconditionally guaranteed. Recommended by best dealers. Audio frequency: 2-1, \$5; 3 1/2-1, \$4; 6-1, \$4.50. Power Amplifying, pair \$13. Inter-stage Power Amp., \$8. Autoformers, \$5.

Write for Latest Bulletins.

THORDARSON ELECTRIC MANUFACTURING CO.
Transformer specialists since 1895
WORLD'S OLDEST AND LARGEST EXCLUSIVE TRANSFORMER MAKERS
Chicago, U.S.A.

WIRING DIAGRAM FOR COUNTERPHASE RECEIVER

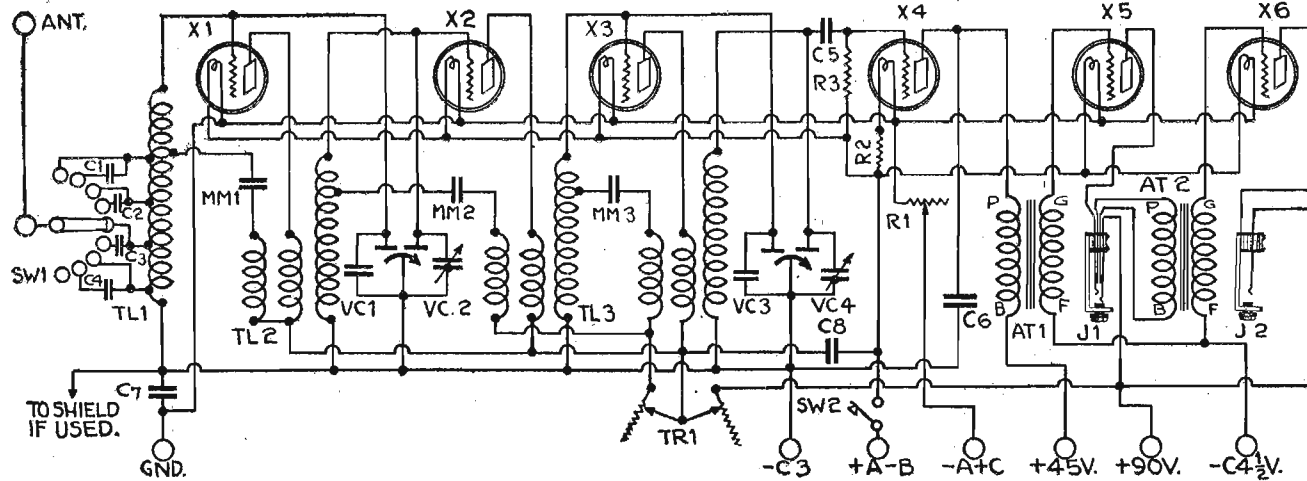

Figure 4

“COUNTERPHASE” SET
(Continued from page 25)

short way from the grid end. The writer will not take up his limited space as to why this is, but asks that you just accept it as necessary to the practical application of the “Counterphase.”

The Torostyle Coil

The essential units for the construction of this set are marketed in one complete kit by Bremer-Tully and, in developing these parts, they went to the limit in efficiency. Some people would have worked out the coil values in coils of the usual type on three inch tubing but B-T have worked them out in toroidal or doughnut types. All the selectivity of three stages of tuned R.F. would have been of but little avail in close proximity to large

broadcasting stations if straight coils were used, as the third and fourth coils would have picked up the programs and there would be little selectivity. Their torostyle coils will pick up but little energy and are so wound that they should be just about as efficient as regards power factor, as the usual inductances. The controls are reduced to two, although there are four tuned grid circuits, by the combining of the variable condensers in pairs. At first thought this seems impractical since it would seem impossible to manufacture coils and condensers so accurately that the four circuits would be in resonance. However, B-T have taken care of this with substantial little three plate condensers attached to the large units. The rear condenser of each pair has a three plate that can be set and left alone;

the front condenser on each twin has a small three plate unit on which the adjustment comes through the panel for fine tuning.

The small neutralizing or compensating condensers are included in the kit as “mikro-mikes,” that being the B-T term for them. Other small but essential parts which would not be readily obtainable in all localities are part of the kit, such as the dual resistance used in the plate circuits and the four ohm fixed unit which B-T have found desirable in the detector filament circuit.

Two Makes of Sockets

It will seem strange to many that two different makes of sockets are utilized in one set, yet when you stop to consider it there is no particular reason why this

should not be. You could use six Cutler-Hammer sockets or you could use six Benjamin sockets. In the writer's opinion, however, there are certain features in the construction of the former that make them especially desirable for use where the tube handles energy at radio frequencies, while in the second named socket there is an exclusive type of construction that makes it unusually well suited to use where the energy is at audio frequencies. Use other makes if you prefer them, or happen to have them, but you cannot beat this combination when building for 100% efficiency at every point.

The panel and sub base are Formica. It drills easily, cuts as easily as can be expected of bakelite, does not warp, is the choice of many large manufacturers of complete sets and is extremely efficient from the engineer's view point. More cannot be asked of a panel, yet Formica has gone further and now have genuine bakelite panels with realistic wood grain finishes that will deceive the eye at five feet. The panel used on the writer's Counterphase has the walnut grain and the price listed for this panel is for one with that finish.

With this set, the writer has the pleasure of introducing Sangamo condensers to Digest readers. Some of the other constructors do not seem yet to have swung away from the older makes, but, after studying these Sangamo units, this writer is convinced that their radical departure from the conventional construction was a move in the right direction. The problem in fixed condenser construction is not so much one of manufacturing condensers of a given capacity as it is building them so they will stay at the capacity intended and not get noisy. Sangamo enclose their assembly of mica and plates in a solid jacket of bakelite and nothing can change the capacity; they can even be boiled in water, dried off and will show no change. Moisture getting into the average condenser could not only cause change of capacity but could make it noisy and give

(Continued on page 28)

Loud Speaker Sensation!

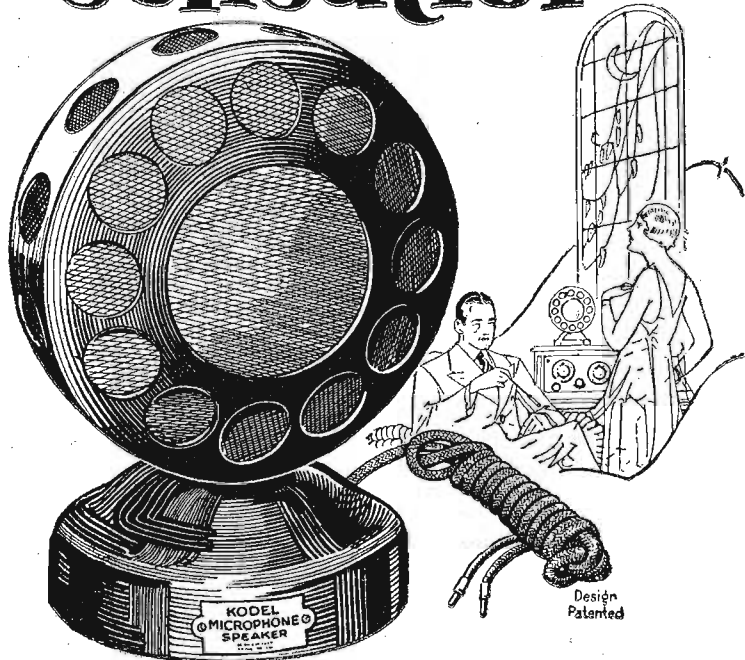

The KODEL MICROPHONE Loud Speaker

THE Loud Speaker that has the whole country talking. An exact replica of the microphone used in broadcasting stations.

The super-sensitive tone unit with the unique construction of the new snail-shell horn inside the microphone case, produces a veritable deluge of volume - - loud - - clear - - every note, every sound as pure and rich as when it enters the broadcasting microphone in the studio.

See the new Kodel Microphone Loud Speaker—hear it—at any radio dealer's. Two Models for your selection—one contains the highly efficient Kodel Junior unit, the other, the super-sensitive Kodel Giant unit.

\$15 and \$20

Write for descriptive literature

THE KODEL RADIO CORPORATION
Owners of Station W K R C
509 E. PEARL STREET CINCINNATI, OHIO

charges A or B Batteries 3 times as fast!

IT takes only one-third as long to charge your batteries as it did with last year's slow 2-ampere chargers. The new 5-ampere GOLD SEAL HOMCHARGER charges 150% faster - - - fully charges the average battery OVERNIGHT!

The new 5-ampere GOLD SEAL HOMCHARGER charges A or B batteries - - is trouble-proof, shock-proof, fire-proof, there are no bulbs to break, no acids to spill, no extras to buy.

Any radio dealer can show you the new 5-ampere GOLD SEAL HOMCHARGER—or can get it for you.

THE KODEL RADIO CORPORATION
Owners of Station W K R C
509 EAST PEARL STREET CINCINNATI, OHIO

The New 5 Ampere GOLD SEAL HOMCHARGER

\$19.50

Free

Write for interesting 16-page booklet "The Secret of Distance and Volume in Radio" contains information for better radio operation.

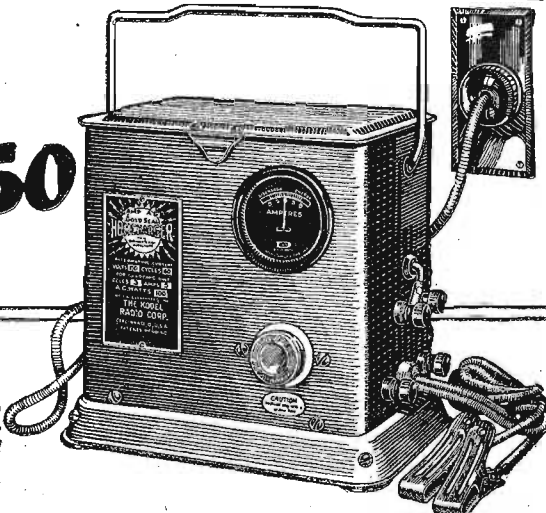

DX-Seven: Selective D-Coil 7-Tube Super-Het

Part II—Drilling and Assembly

By John G. Ryan

THE WRITER is quite sure that when the parts called for by last week's article have been assembled, you will agree that this is one of the trimmest and most compact supers yet presented the Radio public for home construction. It is only 7 by 18 on the panel remember, and the depth is but 7 3/8 inches. Possibly there have been complete full fledged supers that small, but every one the writer has seen were for 199 or 299 tubes. It is a rare occurrence for the old-timer,

tackle its construction without fear of going wrong.

Drilling Templates

Getting down to business, though, the front panel is drilled first, the drawing for this work being figure 2. You can either enlarge the drawing to full size to have a drilling template or write in to Dept. 5, Radio Digest, 510 N. Dearborn street, Chicago, enclosing 25 cents for full size drilling templates of both figures 2 and 3. Be sure and mention that

diameter with a reamer. The meter holes may cause some trouble if you have never put them in sets before. However, this can be overcome either by purchasing a fly-cutter marketed by Jewell for the purpose or by drawing the 2-inch circle on the panel and drilling a number of 9/64" or 11/64" holes clean around and just inside the circle. These should be so drilled that the outer edges of each drill hole just touch the line drawn and are separated from each other by a very thin wall.

the right, is a group of holes consisting of a large hole surrounded by four smaller ones. These mount a Benjamin condenser and a Mar-co dial. The smaller hole below the large shaft hole is the pin for the dial and is not countersunk. The two 3/8-inch holes below and between the meters are for the Carter Imp rheostat and potentiometer.

To the right of them is another group for the second Benjamin condenser and Mar-co dial, while to the very right edge

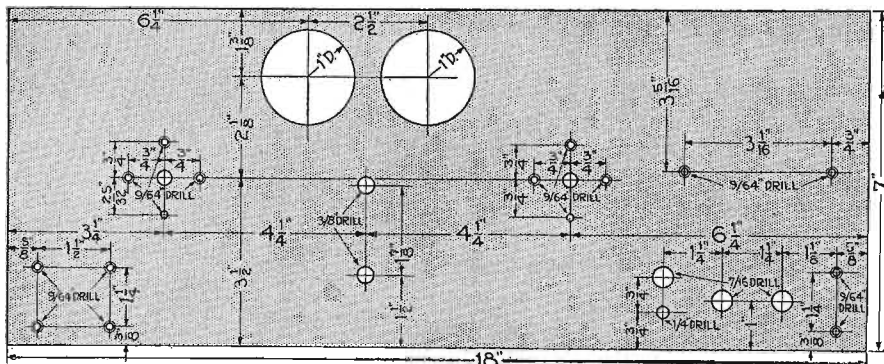

Figure 2

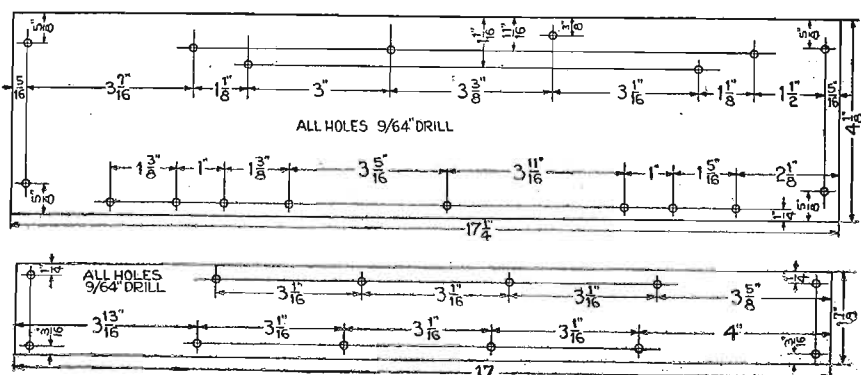

Figure 3

with experience dating back to '08, to get much of a thrill out of a receiver but this one is a delight in so many ways that it would be an exceptionally hard-shelled "op" that wouldn't enthuse over it.

The whole thing is easily held on one hand; if one of the new cabinets with 12-inch depth is used, a Philco glass case storage battery and the B units go inside also. When it is put into operation on a good loop, it goes through locals with a precision and snap not found in previous assemblies used by this writer. The "Simplest Possible" super-heterodyne was all that a super should be, a year ago; this outfit is 50 per cent better from any angle. Added to this, there is so little work to building it, that anyone can

you want DX-Seven blue prints, though, so you will not get those for "Traveler" or "Grand Prix." Enlarging the drawing of figure 2 is not such a job as one might at first suppose. Having either template trimmed to the size of the panel, either paste it to the front of the panel or secure it with small C clamps. At each cross, tap with center punch and hammer and, when you have checked this work over to be sure none are missed, remove template.

All holes are first drilled with the 9/64" drill, then those indicated for a larger size are put through with the proper drill. Should you not have in your collection all the larger sizes shown, drill with the next smaller diameter which you have and enlarge to the correct

With a sharp screwdriver and hammer, these walls can be cut through and the jagged circle broken out. The edges of the holes are then filed down to the line with a half-round file.

Hole Identification

Considering figure 2, the lower left corner, the first two holes are for one of the Benjamin brackets. The next two mount the oscillator coupler of the Celco kit. All four should be countersunk, as indicated by the double circle around them. Above these holes, and slightly to

of the panel are two more countersunk holes, on a horizontal line, for the Erla transformer. Below them, reading from left to right are two holes for the Celco light and switch, hole for the Carter four spring, jack hole for the open circuit jack, and two countersunk holes for the second Benjamin bracket.

Panel Assembly

When assembling these units on the panel, some suggestions may be apropos. The voltmeter goes in the left hand meter (Continued on page 28)



JEWELL JUNIOR TUBE CHECKER



No. 108

"Test your tubes at home"

☞ Your set is no better than the poorest tube in it. With a Jewell Junior Tube-Checker you can test your tubes at home and thus save a lot of trouble and disappointment.

☞ Send for special circular No. 735. Order from your dealer.

JEWELL ELECTRICAL INSTRUMENT CO.

1650 Walnut Street—CHICAGO

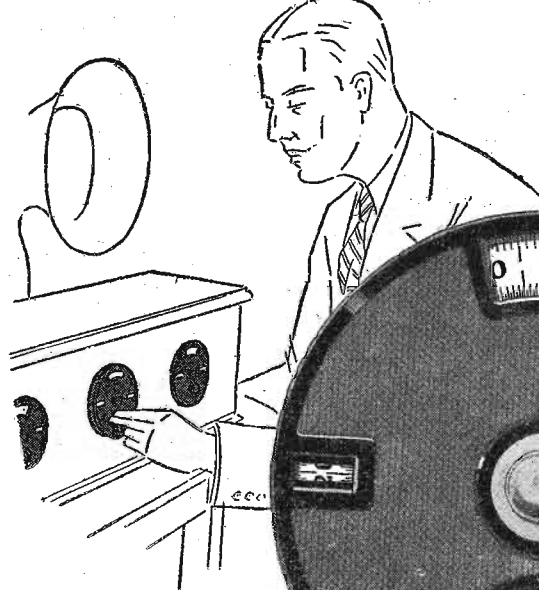

1926

Design In Tuning Controls

The precision tuning that present-day conditions demand, makes old-type dials inadequate. Replace them on the new set you build, or on your present set, with MAR-CO dials—the 1926 model tuning control. Seldom has any radio accessory received the wide-spread endorsement accorded the MAR-CO dial. It is specified equipment for the Radio Digest Super-Heterodyne, for the Radio News "Balanced Intraflex,"

JOT down the call letters in the handy slot—right on the dial itself—and there is your permanent record of the dial settings.



MARTIN-COPELAND CO., Providence, R. I.

MAR-CO

RADIO PRODUCTS

Vernier Dial

COMPLETED ASSEMBLY OF DX-SEVEN SUPER-HET

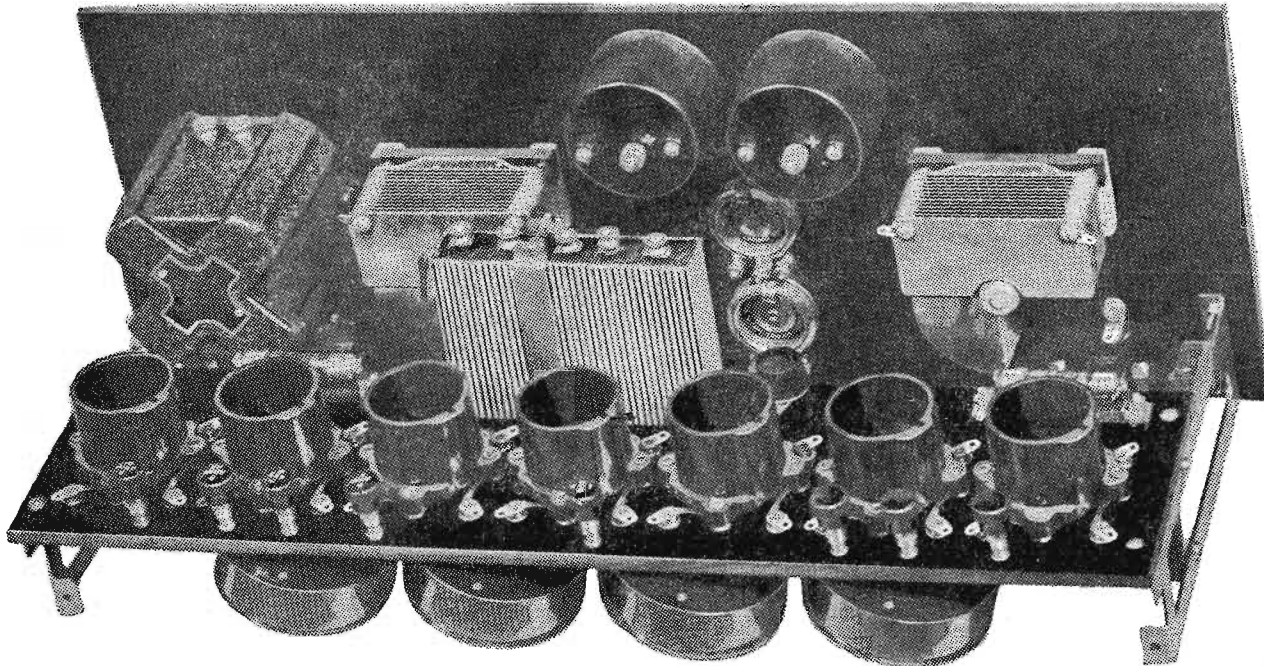

Figure 4

DX-SEVEN, SUPER-HET

(Continued from page 27)

hole; the potentiometer goes in the upper of the two Imp unit holes. The variable condensers are mounted so that the rotor plates swing downward when going out of mesh with the stators. The Erla transformer is put in so that the B and F terminals are toward the top. When putting in the Celco switch, the light goes

plate of the shelf and intermediate transformer strip. The Benjamin gang shelf is sold complete, with all sockets in place and all but three of the holes shown, already drilled. There are a number of other holes also, but they may be disregarded. The upper drawing of figure 3 is the gang shelf and the three holes referred to are on a line 11/16 inch from the top. This drawing, in addition to giving the locations of these

The two holes at each end, and 5/16 inch in from the edge, are for the Benjamin brackets but, before putting on these brackets, four holes must be drilled in them for mounting the intermediate transformer strip. Each bracket has two long strips, one of which contains the flange to hold the shelf. At the front end of each bracket is a right angle bend flange which attaches to the panel. With the ruler against the inside of this front

Going back now to the gang socket shelf, figure 3, the three loop posts are mounted in the three holes 1/4 inch from the rear edge and toward the right, in the upper drawing of figure 3. The next hole toward the left, in that line, is for minus A, the fifth hole is for plus A, the sixth for minus B, the seventh for plus 90 and the last for plus 45. The three holes 11/16 inch from the top edge of the illustration are used as follows: that toward the left is for an Amperite mounting, that near the center holds a piece of strip brass bent to hold the C battery, that at the right secures the second Amperite mounting.

The strip on which the Celco intermediate transformers are mounted comes in next for attention, and the drawing for its drilling is shown as the lower illustration in figure 3. The two holes at each end are for attaching to the small brackets mentioned previously that were attached to the larger Benjamin brackets. The other four pairs of holes are for the mounting of the coils themselves. In attaching these coils, the side with B, N and P terminals is to be downward. When on the subject of mounting apparatus on the front panel, the writer forgot to mention that the oscillator coupler is to go in with B, C and P downward and F, L and G above.

The midget condenser has purposely been left to the last so there would be no chance of its getting damaged during this assembly work. It is to be mounted on the gang shelf in the hole, shown in figure 3, as 3/8 inch from the top edge and to the right of center. Your set is now complete and ready for the wiring.

(Wiring is too long an operation to be included as part of this article, so it will appear next week as the third article of Mr. Ryan's series.—Editor's Note).

"COUNTERPHASE" SET

(Continued from page 26)

rise to sounds resembling static. There is no good reason why the unit should not be sealed permanently.

The Euphonic transformers used are another new innovation to the Radio field. They are of the improved, higher efficiency type that several manufacturers have brought out this season and, in addition, permit mounting in any one of several positions. It is not always possible to so design a receiver that short leads are possible to audio transformers due to the arrangement of binding posts. Leads must cross and bend around apparatus in ways detrimental to results. This B-T Euphonic can be maneuvered to place the G, P, F, B+ terminals just about any way one wants them. The price does not stagger one either.

A complete schematic hook-up of Counterphase is shown in figure 4, with this article, so you can study it while getting the various parts. Particular attention is called to the detector connections. Since the rotor plates of the third condenser go to a C battery and the rotor plates of the third and fourth condensers are all on one shaft, something a little different was necessary. The grid condenser is in the usual position but the grid leak, instead of bridging the condenser, goes from grid to filament. In the positive side of the detector tube filament circuit there will be noted a 4-ohm resistance. B-T have found it desirable to burn the filament of this tube a little lower than the filaments of the rest of the tubes and a Carter unit permits this without another rheostat being added.

(Having explained the circuit and the choice of parts, and presented the circuit itself, as used, Mr. McDonald will next week go into the drilling of the panel and sub base and the assembly of apparatus on them.—Editor's Note).

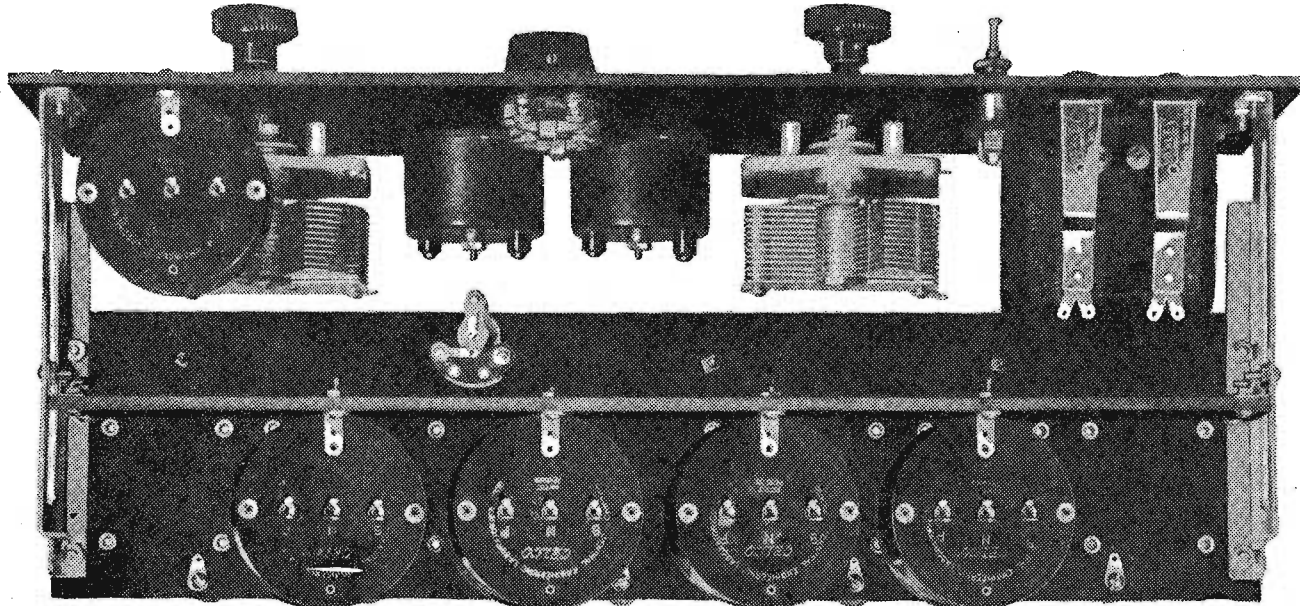

Figure 5

through the upper hole while the switch itself projects through the smaller hole at the bottom. Both Yaxley jacks are rotated, and secured, in such a position that the frames are toward the bottom of the panel. Each Benjamin bracket is arranged so the flange is toward the center of the set; the straight side is outward.

In figure 3 are drawings for the tem-

holes, also shows you which of those found already in the shelf are to be used. Should the home builder care to dismount seven standard Benjamin sockets from their bases and make up his own shelf, this drawing will enable him to place all parts correctly. The sockets are mounted as shown in the photograph, figure 4, with P and G terminals to the rear.

flange, a point is to be marked on both the upper and lower strip of each bracket, 3 3/4 inches back. A 9/64-inch hole is drilled at each of these points and a small right angle 3/8 by 3/8 by 3/8 bracket attached. This work will be made clearer from examination of the photograph, figure 5.

REX

for your B battery eliminator

REX answers the eliminator problem. The B Battery eliminator equipped with Magnatron Rex tubes works day in and day out—silently and economically.

Magnatron Rex is the product of long research by the oldest exclusive manufacturers of thermionic valves in the country. It has been designed primarily and only for eliminator work.

Magnatron and Excellence have come to mean one and the same thing. Impartial laboratories and radio engineers

throughout the country have certified this. Their reports explain why Magnatrons in your set will make it function better.

Your dealer has the Rex as well as the other Magnatrons. Ask him today!

They list for only \$2.50.

Write for your FREE copy of "Pot Pourri—a snappy review of mirth and music," to Dept. D

CONNEWAY ELECTRIC LABORATORIES
Magnatron Building, Hoboken
New Jersey

West Coast supplied from complete stocks carried by PACIFIC RADIO LABORATORIES, 256 South Los Angeles Street, Los Angeles, California

MAGNATRON

Old Tubes Made Good As New

THIS latest Laboratory product will recondition any old, run-down, even worthless tubes, as long as the filament still lights. Makes them as good as new in a few minutes' time. Costs but few cents more than new tubes! Simple, efficient, practical. Big money-saver. Operates on either A. C. or D. C.—110-120 Volts. Model No. 20 for UV-201A (C-301A, etc.) and all similar types. Model No. 10 for UV-199 (C-299, etc.) and all similar types. Bound to do the work on our

Money-Back Guarantee

Money cheerfully refunded if desired results fail. But we are sure you will find the Mack Reconditioner pays for itself in one evening. Many making good money restoring friends' and neighbors' old tubes. You cannot lose! Act quick on this special short-time introductory price. Sent Postpaid with full directions on receipt of \$3.65 (\$3.85 in Canada and foreign countries). Be sure to state Model No. wanted. Our guarantee refund price protects you. Send now.

\$3.65

For fine tone quality, volume, and distance, your tubes MUST be in perfect condition.

MACK RECONDITIONER
"THE CURE FOR RUN-DOWN TUBES"

718 Cass St. MACK LABORATORIES Chicago, Ill.

Clock Case Furnishes Disc Speaker

Replaces Horn and Is Mantelpiece Ornament

The old-style loud speaker seems to have lost favor and more elaborate forms have taken its place. So the fan will no doubt rack his brain for the means of buying, borrowing or building one of

WORKSHOP KINKS EARN A DOLLAR—

THERE are many little kinks worked out at home that would aid your fellow Radio worker if only he knew about them. There are new hook-ups, new ways of making parts and various unique ways of operating sets that are discovered every day. Radio Digest is very much interested in obtaining such material. Send them in with full details, including stamped envelope, so rejected copy may be returned. The work must be entirely original, not copied.

RADIO KINKS DEPARTMENT
Radio Digest
510 North Dearborn St., Chicago

them. Here is one that is as elaborate as any, but is inexpensive and is simplicity itself to make.

The total cost of the parts is low, being something like \$3, including the unit. If the builder happens to have one on hand, or an old phone, the cost is almost nothing. The speaker is of the clock type,

HOW TO MAKE "TALKING" CLOCK

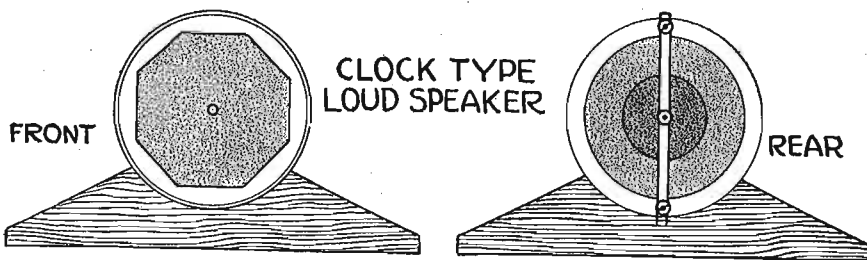

and the necessary parts are an old clock of the round type, a piece of cardboard, an embroidery hoop, and a piece of drawing paper. The cardboard should be cut as shown, the outside rim just to fit into the clock case, and the inside rim 1/8" smaller. The first piece should be cut with an octagonal inner rim, the second, round. The drawing paper is cut the size of the outside of the cardboard disc. The embroidery hoop should be slightly larger than the cardboard.

The clock case, after the works have been removed, will be found to have a narrow edge at the very front, which was used to keep the glass in place. Insert the octagonal-cut piece of cardboard in the case and let it go as far as this edge. Next insert the piece of drawing paper and press the other piece of cardboard on this. Then cut the embroidery hoop so that it fits snugly into the clock. Press this in until it is tightly against the last piece of cardboard. Cut a small cardboard disc, about 1/2" in diameter and paste it in the exact center of the draw-

ing paper, which is now a diaphragm. With a compass or other tool find the true center of the diaphragm of the unit or phone, and solder a sewing needle here. This must be soldered so as to be perpendicular. Drill a hole in the back of the unit, and put a machine screw, any size, into it. This is to mount the unit.

A piece of bushar, bent double, serves as a support for the unit. It is placed vertically across the back of the clock and secured by two screws. The unit is fastened to this by the machine screw and adjusted to the center. It is then tightened. The needle of the diaphragm is pushed into the center of the 1" cardboard disc of the paper diaphragm and adjusted until it just rests on the unit. The cap is then screwed on. A drop of sealing wax is put on the disc where the needle comes through and the speaker is finished.

About 75 per cent of the volume of a good horn may be expected.—M. D. Richardson, Cleveland, Ohio.

that the conference go on record, which it did, as urging congress at its next session to provide sufficient appropriations to the department of commerce for the proper control of Radio.

The committee on interference, reporting to the general conference, suggested several resolutions for the elimination of interference, which were passed with slight modifications.

One of the most important of these was the suggestion that the public be educated through the daily and Radio press, and other means, how to use their Radio receivers so as not to cause reradiation interference, or "birdies."

The conference also adopted a resolution calling for the strict adherence of each broadcasting station to its assigned frequency, and that such stations as still radiate harmonics, immediately equip themselves with harmonic suppressors.

Legislation Most Necessary

Lead by Judge S. E. Davis, the committee referred to the drafting of a report and resolutions on Radio legislation, accomplished much that will be of importance at the next session of congress.

It was agreed by everyone at the conference that legislation was most necessary for the proper administration of Radio broadcasting.

A complete study of the existing rules and regulations was made, and a report drafted on what was needed. This the conference adopted.

(Continued on page 30)

WHAZ AT RENNELAER

(Continued from page 6)

could sing for some of his relatives who had listened in on the Rensselaer station. He was given the microphone and afterward reported that his people had heard him clearly. Listeners in other parts of the British Isles reported hearing this station for seven Monday nights in succession last winter.

A sea captain reported a complete program heard on shipboard in the South Seas, 5,000 miles from Troy. The postmaster at Wailuku, Hawaii, and a Rensselaer graduate with his family in the Hawaiian capital report that they have entertained friends on more than one occasion with programs from WHAZ. Navy vessels often report concerts heard from WHAZ while passing through the Caribbean sea. Certain test programs have brought reports from every state and territory in the Union, seven provinces of Canada, Cuba and Bermuda.

These far-reaching reports show what can be done with half the power used in most of the modern stations when it is handled by experts. The apparatus is described as the standard Western Electric 500-watt outfit, "complete in every detail and installed through a gift of the Roebblings, graduates of the Troy Tech, famous as builders of the Brooklyn bridge."

WHAZ is under the direction of Prof. Wynant J. Williams, associate professor of electrical engineering in charge of the course in communication engineering, assisted by a corps of instructor-operators, Harry R. Mimno, Hiram D. Harris and Bertram H. Cramer, Jr. In physical equipment station WHAZ is similar to many other leading broadcasting stations in the country, but in point of perfect operation, it excels.

HOOVER CONFERENCE

(Continued from page 3)

be prohibited except with the permission of the originating station.

6. In licensing or relicensing stations, the department of commerce should use discrimination looking towards locating such stations outside of congested centers.

7. No new stations are to be licensed until through discontinuance the number of stations is reduced.

8. The broadcasting privilege shall be based on service to the listener.

9. Any practice contemplating the sale of a wave length is looked upon with disfavor and considerable apprehension.

10. Legislation is most necessary at the next session of congress.

Same Wave Band; No Classes

The broadcasting wave band, 545 to 200 meters (550 to 1,500 kilocycles frequency), remains the same as last year.

Class A, B and C will be no more. The conference recommended that the old class idea, reflecting on the quality of A and C stations, be disregarded.

Before erecting a broadcasting station it will now be necessary to get first a permit from the department of commerce.

If permits to build are granted in advance, licenses issued for long terms (five years was term recommended) and the number of stations restricted, the conference recommended that annual fees be charged all broadcasting and commercial land telegraph and telephone stations, the range of such annual fees to be from \$25 to \$5,000. A basis of 10 cents per radiated watt was the thought behind the range of these fees.

Five years was recommended as the term of a license.

The committee on amateur transmitters advised that spark transmitters should no longer be licensed for use by amateurs.

In addition to much other valuable work, the amateur committee suggested

Detector and Amplifier

Types SSP-201A, SSP-199, SSP-12 Bakelite Base Silvered and Blue

THE PERFECT TUBE

THE ELIXIR OF Set LIFE

Just as the heart is the most vital organ of the human body—the tube is the most vital part of the radio set. The Simplex Super Power Tube performs its function in the radio set with the same sensitiveness, accuracy and regularity as a healthy heart in the human body. Rejuvenate your set with the Simplex Super Power tubes, they mean longer life and better reception.

PRICE—Silvered tube.....\$2.00
Blue tube..... 2.50

GUARANTEE: Your dealer is authorized to exchange or return money for any defective tube within ten days.

Titania Manufacturing Company
Makers of the
"SIMPLEX SUPER POWER" RADIO TUBES
105 West 40th Street New York City

IRON-CLAD GUARANTEE

All Cleartron Tubes are guaranteed to deliver positive, perfect service and we authorize our distributors to give refunds, one week's return on the tube price, if the only requirement is that the tube must not have been burned out.

Cleartone Vacuum Tube Co.
28 West 44th St.
New York City

Standard Types **\$2.50**

Read the Guarantee

CLEARTRON

GUARANTEED RADIO TUBES

Why spoil your enjoyment of radio with inferior tubes when Cleartrons are guaranteed to give perfect service—clearer tone, more volume, greater distance and sharper selectivity. Buy quality and service—Cleartrons.

At all reliable dealers

Write for free six page tube folder. CT-101A—A Hi-Mu tube for Resistance-Coupled Amplifiers **\$3.00**

CLEARTRON VACUUM TUBE CO.
28 West 44th Street New York City
Factories
West New York, N. J., Birmingham, Eng.

FOR BETTER RECEPTION

22½ Volt
an-acid
everlasting
rechargeable
"B"
STORAGE
BATTERY
\$2.95
Includes
Chemical

45 volts, \$5.25; 90 volts, \$10.00; 112½ volts, \$12.50; 135 volts, \$14.75; 157½ volts, \$16.80. Truly the biggest buy today. Easily charged on any current including 32-volt systems. Any special detector plate voltage had. Tested and approved by leading authorities such as Popular Radio laboratories. Over 3 years sold on a non-refund 30-day trial offer with complete refund if not thoroughly satisfied. Further guaranteed 2 years. Knock-down kits at great savings. Complete "Hawley" "B" battery charger, \$2.75. Sample cell, 35c. Order direct—send no money—simply pay the expressman cost on delivery. Or write for my free literature, testimonials and guarantee. Same Day shipments. B. Hawley Smith, 317 Washington Ave., Danbury, Conn.

6 **\$49.50**

The Serenader "General", a new six-tube radio receiver with quality so high and price so low that it is easily recognized as the greatest radio value yet offered. Housed in its beautiful cabinet, which reflects refinement of design, this instrument appeals to that ever growing number of people who desire an efficient radio receiver which will improve the beauty of their home. Built in accordance with the latest engineering principles. The Serenader "General" will boost for itself if given a fair trial.

The Serenader "Standard", a six-tube set, of unequalled quality at the price, **\$39.50**

The sensation of the season. The Serenader "Renaissance Console" with built in loud speaker and ample space for all batteries. This beautiful receiver is an asset to the fitments, **\$115.00**

Write for descriptive literature.
Dealers:—Much valuable territory is still open. We would be glad to refer you to a reliable distributor who can serve you.
PARAMOUNT MANUFACTURING CO.
No. 4 W. 14th St. Kansas City, Missouri

Reception Improved 60%

Read this letter from a prominent Doctor of Oakland, Cal.:

3242 E. 18th St., Oakland, Cal., Nov. 3, 1925.

"Kane Antennae Co., Chicago, Ill.
I am enclosing check for \$6.50 for which kindly send me one Kane Antennae for R. C. A. Super-Het. This is my second Kane Antennae and I believe that improved reception thru this Antennae is fully 60%. Kindly send at once.

Sincerely, Dr. F. W. Gehrig."

The reason for this improved reception lies in the fact that the KANE ANTENNAE entirely eliminates all power noises such as leaky transformers, generators, motor hums, Delco Plants, etc. **SURELY 60% IMPROVEMENT IS WORTH THE SMALL PRICE!**

Power noises cause more trouble than all other forms of radio interference. Get rid of them NOW by ordering a KANE ANTENNAE.

See For Yourself Just What the Kane Antennae Is!

We will send you working drawing with instructions for erecting this wonderful Antennae for a dollar bill (a check will do). If, after looking over the drawing, you decide you would rather have a factory-built Antennae, than build one yourself, we will take back the drawing and allow you full purchase price on an order for an Antennae.

The Special Kane Antennae for Radiola Super-Het's.....\$ 6.50
The Regular Kane Antennae for all other sets that use a ground connection..... 13.00
Working drawing with instructions for erecting..... 1.00
(Stamps not accepted)

Postpaid to any part of the United States or sent C. O. D. when 25% of price accompanies order.

THE KANE ANTENNAE CO.
Dept. 823 F., 3343 W. Monroe St. Chicago, Ill.

RADIO AIDS FOOTBALL

(Continued from page 5)

ned with the Radio receiving set. The missus is taking a special course at U. of C., so she is as keen a rooter as I am. "Oh, what a storm! It's a cloudburst! Can't see across to the other side of the field. The water is coming down in sheets. Gee whizz! It's ruining the microphone—wonder if they're hearing me!"

"That was Quin. I used to know him as a newspaper man. Heh—not so bad, getting the game over the Radio on a day like this!"

"The people are sitting right through this rain, rain, rain! They are dressed in oil cloth, linoleum, tablecloths and slickers, a terrace of yellow slickers, a slithery, slickery crowd," drawled Quin. Two other famous announcers in the midwest section are "Hal and Harry," the Chicago Daily News team on WMAQ. Their full names are Harold O. Totten and Harry M. Beardsley. They "spell" each other off in alternate quarters.

There is a famous pair in the East which has been reporting the football games this season and reviving untold volumes of buried enthusiasm on the part of those who have found life too demanding to cling to old campus interests. This pair is Graham McNamee and Phil Carlin of WEAf.

Jim Murley, of Boston, is another football announcer celebrity. His thorough understanding of the game and ability to put it all into spontaneous description over WBZ has brought him life-long fame throughout the New England states.

Murley at WBZ, and the WEAf team, tied in with eight other stations, gave the whole Atlantic seaboard an opportunity to listen in to the great Harvard-Yale game on November 21.

Millions have been brought into contact with this great game through the voices of not more than thirty or forty men—from Loyal Underwood of KLX on the Pacific coast to the Atlantic and the Gulf of Mexico to the shores of the Great Lakes.

Wonder what the Radio hook-up will be for that big East vs. West game on New Year's Day? I'll be listening in, whatever it is, won't you? You KNOW you will.

EXPLANATION OF RADIO

(Continued from page 23)

messages sent out from AB, electricians say a current has been "induced" in CD. The effect of turning one coil so that it is no longer parallel to the other may not be apparent without additional explanation.

How Variocoupler Operates

Imagine two wires AB and CD, figure 2, parallel to each other. We might call

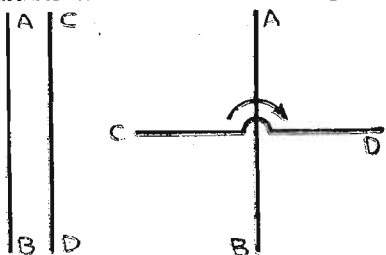

them antennas and arrange for AB to be the sending station and CD the receiver. If electrons are sent upward from B to A the "gust of wind" in the ether will

Here at Last

A limited amount of high class Guaranteed Head Phones for only \$1.95 per set. Send order today.

Money refunded if not entirely satisfied.

N. WARTELL
535 So. Franklin St. Chicago, Ill.

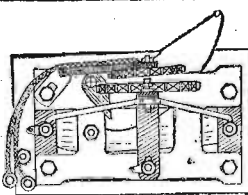

Bradley Automatic Tuner (patented)

Station to station, one dial control, distant day service, get results.

Write F. C. BRADLEY
Union, Miss.

ARE YOU THE MAN

to be first in your town to sell and demonstrate POWEROLA, the famous 5-tube, NO-BATTERY ELECTRIC LIGHT SOCKET RADIO RECEIVER (not an attachment), universal for D.C. or A.C. (100-115 v. 40-60 cycle), now sold and demonstrated by the NEW YORK EDISON CO., public utility companies and radio, electric and music dealers every-where. Absolutely dependable, fully guaranteed, powerful, practical, perfect in performance.

Are You the Man Who Sees Opportunities Ahead for Real Money Making

Write for literature, terms and prices at once.

POWEROLA RADIO CORP.
Dept. R.D., 1845 Broadway New York

blow electrons in the receiver from C to D. But supposing CD and AB were perpendicular to each other as in figure 3. About all the ether current could do would be to blow electrons in CD from one side of the wire to the other and this effect would be difficult to detect.

When AB and CD are wound up as coils the ether breeze from AB is probably a cyclone, but that makes very little difference, except the effect is more concentrated. The best position of CD to have electrons blown along it by this cyclone will be when it is concentric with it. In any other position the effect will be less, and theoretically zero when perpendicular to it.

The speed at which these electrons will be blown from one end of the wire to the other will depend upon the angle CD makes with the ether wind. When parallel to it the electrons will get a greater shove (higher voltage developed), and will move faster. The significance of this is that the rate of flow of electrons in the coil CD or circuit in which CD is placed, can be controlled by rotating CD. This is tuning, which is what we desired to accomplish.

How Selectivity Is Obtained

For tuning in some stations it is necessary to have the variocoupler coils CD and GH, figure 1, very nearly perpendicular to their respective primary coils. When in this position they cannot absorb much energy from the ether cyclones. The total energy involved was all obtained by the antenna from the waves coming from a Radio station many miles away, and this amount is vanishingly small. Unless the broadcasting station's waves are very powerful at the receiving station's antenna, not enough energy will get through the two variocouplers to affect the phones. Either this energy must be more carefully conserved or some more added to it to make up for the losses, or both.

Of course another method would be to remove one of the variocouplers, but this would reduce the selectivity of the set which may not be as much as desired already. A more efficient method of tuning these circuits would be to replace the variocouplers with transformers (coils parallel and fixed) and tune them with the aid of condensers.

(To appreciate what a condenser is and how it tunes a circuit is Mr. Tanner's contribution next week toward "painless" Radio.—Editor's Note.)

KOIL, COUNCIL BLUFFS

(Continued from page 7)

It was July 10, 1925 that KOIL, the Mona Motor Oil Radio Station located at Council Bluffs, Ia., went on the air. A proud and very satisfactory day it was, all around. Dad Searles, as was right and proper, made the dedicatory speech. Bill Hawkins, his father, mother, five brothers and sisters, two hired men,—the hired girl and Shep, the dog, listened in through the new loud speaker and were

GO INTO THE RADIO BUSINESS

We specialize in Equipping New Dealers with entire stock—advice free.

Send for Our Radio CATALOG & BARGAIN LISTS

Wholesale Only

MANHATTAN RADIO COMPANY

112 Trinity Place New York City

CARTER

Latest Improved Radio Parts

For All Circuits

Carter Radio Co.

300 S. Racine Ave. CHICAGO

New Perpetual LOG

Loose Leaf for Revisions—Radio Map FREE

New 64 page log. Corrected sheets published as changes in calls, wave lengths, owners, addresses, etc., occur. 504 stations. 4 dial settings, remarks, etc. Tuning suggestion Station lists by wave lengths—by states, etc. Trouble aids, Dictionary Radio Terms, Repair hints, Trouble Preventors. Other valuable information. So convenient. Worth many times small cost. Only \$1. Pay postman after log and FREE map arrive. Postpaid if pay with order. Money refunded if not delighted. Order today—now. Postal will do. Radio Printers, Dept. 7988, Marengo, Ill.

FREE RADIO STAMPS

168 beautiful copper etched American, Canadian, and European stamps. (8 colors), each with call letters of a station, FREE with latest Ideal 48-page Radio Stamp Album and Log. Also contains complete list of stations both alphabetically and by call letters. As you hear new stations, just put proper stamps in album. A fascinating hobby. Album and stamps become permanent record of stations you hear. You and your children will enjoy it. Complete album, 8"x11", heavy cover, \$1.00 plus postage.

Send No Money

Pay postman after album and FREE stamps arrive. We prepay postage if you prefer to pay with order. MONEY REFUNDED if not DELIGHTED. Send order today—NOW. Postal will do. IDEAL CO., Dept. 9918, 365 Wrigley Bldg., Chicago

deeply grateful to their "big oil man" of Council Bluffs. They heard the voice of Mr. Searle, Sr., coming distinctly through the horn. It said:

"The building has been especially designed as a broadcasting station. Our studio is a room 20x30 feet in addition to the necessary operating and power rooms. We have included a large reception room with broad fireplace, a promenade which gives a magnificent view of the Missouri river for many miles, dining room, kitchen, custodian's quarters and other club features with which we expect to entertain our artists and friends.

"When our plans are completed the surrounding grounds will be beautiful to such an extent that this station will be so attractive it will be well worth while for all visitors to Council Bluffs to call and look it over."

Pottawattamie county and Council Bluffs feel that KOIL is their own. All the community has loud speakers and the programs are "coming in fine."

"ABIE" MEETS "MIKE"

(Continued from page 4)

who smiled down on him from all four sides of the room.

"Talk is cheap— You should worry about talking into the air what don't cost you nothing."

Abie Will Broadcast

"It's all on your account, Abie, they want to hear me because they see your pictures in the papers."

"Then why make it such a fuss for yourself when I am the one they want to hear?"

"Well you poor, dumb scrap of paper what would you do? One look at Mike and you'd crumple up and fall in the waste basket."

"Such a business! You should worry what I would say to this here Mike."

"All right, come on then, you can do the talking yourself."

They paused for a moment in front of the studio at Columbus Circle and then proceeded to WOR.

In the hush of the broadcasting studio Abie began to show nervousness.

"Where is this feller, Mike?" he asked of his creator.

"He's inside of that instrument. Get ready. You're being announced . . . Go on. Go on up there. Hurry."

Hesitates to Face Mike

"But what shall I say? I don't see nobody. What a foolisher am I to be talking my head off into a tin can. I won't do it."

"Your pardon, ladies and gentlemen, Abie the Agent is here but he has a case of stage fright. I'm afraid you will have to excuse him. He promised to do this talking for me. 'But you know Abie, always bluffing and pretending—' Hershfield had stepped to the phone to apologize and had gone this far when Abie caught him by the coat tails and pulled him down. "My boss, Mr. Hershfield, gives you a misrepresentation of me already. He told

me I should meet a feller whose name is Mike what I don't see here. Hello! Hello! Do you hear me Mike? Or was it Jake? If it is Jake I'm speaking to you now. Do you hear me, Jake?"

"Why I'm at the Radio place in the WOR, what is it? I don't know what WOR it is because I don't see no fighting and I'm telling you, Jake, the boss Hershfield wants me to say something. He says Radio fans should be staying home by their own sets so they can hear America first and not the soviets by Europe, a'ready."

"And furthermore this is a free country where all men are broadcast equal, and that's what I'm telling you Jake. It don't cost a nickel."

The announcer cut off the microphone at that stage.

HOOVER CONFERENCE

(Continued from page 29)

(The complete text of the legislative committee's report will appear in the December 5 issue of Radio Digest.—Editor's Note.)

Table Music Fight; Laud Hoover

Just prior to the close of the conference, resolutions from the committee on copyright relations to broadcasting were heard but tabled because it was thought by Secretary Hoover to be more a matter for Congress to decide. Regardless of whether this was the proper thing to do or not, the conference, nearly every member of it, was very much interested in the disposition of this troublesome music problem.

The solution is not in sight.

Lauding Secretary Hoover for his work, a resolution was passed just prior to adjournment of the conference, which in itself was a vote of confidence and thanks to the commerce department's chief.

Inasmuch as the resolution carried, however a rider clause empowering Mr. Hoover to make deviations from the provisions outlined by the conference, it was considered by many to be somewhat of a stroke of politics.

However, the fact that Secretary Hoover has shown himself for the people in so many previous instances, belies the suspicions that the rider was inserted for political purposes.

CLASSIFIED ADVERTISEMENTS

B ELIMINATORS

Make Your Own B-Eliminator with our imported French parts, high quality, minimum cost. Send stamp for details. B-Free Co., 8453 Bosworth, Chicago.

BLUE PRINTS

Ryan's Simplest Super-Het 14 pages, full size working drawings; Neutrodyne, 24 pages with blueprints; Reinartz, 14 pages with blueprints; Radio Circuits, 28 pages with 48 hook-ups; Reflex De Luxe, 16 pages with blueprints; Miloplex, 16 pages with blueprints; Flewelling, 12 pages with blueprints. 3 for one dollar. 50 cents each. Book Department, Radio Digest, 510 North Dearborn Street, Chicago.

BOOKS

Slightly soiled books on Radio. Write for list and prices. Book Dept., Radio Digest, 510 North Dearborn Street, Chicago, Ill.

RADIO

Long Distance Radio \$2.95. Lambert's newest crystal success. No tubes. No batteries. No grief. Always ready. Works 600 miles. Fully guaranteed. We pay postage. Order direct from this ad. Leon Lambert, Wichita, Kansas.

For Sale—Model C-10 E. I. S. Super-Het. Entirely Shielded Mahogany Cabinet, meters, 50 to 600 meters. Very selective. Wonderful tone. Tremendous volume. With ten matched tubes. Price \$250. Bechard Radio Laboratory, Fond du Lac, Wisconsin.

RADIO PARTS

Do not expect results from Grand Prix, Fireside, and Traveler sets unless you use the parts specified by the authors. We can furnish you all parts for the sets described by return mail at prices listed in articles. All Parts Service, 845 S. Harvey avenue, Oak Park, Illinois.

SALESMEN WANTED

Make \$100 WEEKLY in spare time. Sell what the public wants—long distance radio receiving sets. Two sales weekly pays \$100 profit. No big investment, no canvassing. Sharpe of Colorado made \$955 in one month. Representatives wanted at once. This plan is sweeping the country—write today before your county is gone. OZARKA, INC., 126-G, Austin Ave., Chicago.

SALESMEN—We furnish you a new Ford car immediately and set you up in business. You own both car and business. No capital required. Profits \$50 to \$150 per week easy. Exclusive territory, city or country. Biggest opportunity ever offered hustlers. Territory going fast. Write quick for details. W. & H. Walker, Inc., Dept. 41, Herr's Island, Pittsburgh, Pa.

An Up-To-Date BROADCASTING LOG

"THE BLUE BOOK OF THE AIR" is a 24-page Log Book containing all stations (nearly 600) in the U. S.—also principal Canadian and Islands stations—arranged by states and call letters, showing location and power. This book has three blank spaces for your dialings. It is printed on high grade paper—ink will not blur.

Price 50c, Post Paid—3 for \$1.00

Last Year's Log, 10c, Post Paid

Money Refunded if Not Satisfied

An Attractive Advertising Proposition for Radio Dealers—Write Us NOW

ALEXANDER & WATSON
476 Century Bldg. Indianapolis, Ind.



RADIO Storage "B" Battery

Lasts Indefinitely—Pays for Itself Economy and performance unheard of before. Recharged at a negligible cost. Approved and listed as Standard by leading Radio Authorities, including Pop. Radio Laboratories, Pop. Sci. Inst. Standards, Radio News Lab., LeMay, Inc. and other important institutions. Equipped with Solid Rubber Case, an insurance against acid and leakage. Extra heavy glass jars. Heavy, rugged plates. Order yours today!

SEND NO MONEY Just state number of batteries order is received. Extra. Offer 4 batteries in series (66 volts), \$12.75. Pay expressman after examining batteries. 5 per cent discount for cash with order. Mail your order now!

WORLD BATTERY COMPANY
1219 So. Wabash Ave., Dept. 76 Chicago, Ill.
Makers of the Famous World Radio "A" Storage Battery
Prices: 6-cells, 100 Amp. \$11.85; 120 Amp. \$18.25; 140 Amp. \$24.00.
All equipped with Solid Rubber Case.

World STORAGE BATTERIES
Set your Radio Dials at 210 meters for the new 1000 watt World Storage Battery Station. WBSB, Chicago. Watch for announcements.

Radiophone Broadcasting Stations

Corrected Every Week—Part III

FIND MISTAKES AND YOU'LL GET DOLLAR

ONE DOLLAR will be paid to the Radio fan reader of Radio Digest submitting the most errors in any one station's listing in the Directory of Radiophone Stations, which appears in six parts, serially continuously on the next to last page. Letters must reach Radio Digest's office not later than one week from date of issue corrected. Readers are not limited to correcting one station, but such corrections must be verified by the stations themselves, and NOT by comparison to other so-called accurate Radio directories or lists. Verifications must accompany corrections. Turn in corrections for as many stations as you can find—if you can find errors! Use separate sheet of paper for each station submitted and place name and address on each sheet. In case of tie, duplicate awards will be made. Asterisks have been placed in front of corrected listings and new stations in order to distinguish them.

United States (Cont'd)

NOTE—The third part of the schedule list appears below. The fourth part which consists of the remainder of the list will appear next week.

WFAA, Dallas, Tex. 475.9 meters. 500 watts. Dallas News and Dallas Journal. Slogan, "Working for All Alike." Daily, 6:30-7:30 am, exercises; 8:30-9:30, 10:30, 11:30, reports; 12:30, 1:30, 2:30, 3:30, 4:30, reports, news; 5:30, children's hour; 8:30-9:30, concert, weather (silent Wed.). Mon, Tues, Thurs, Fri, Sat, 6:30-7:30 pm, vespers recital, sports. Tues, Thurs, Sat, 11-12 pm, music. Sun, 6:30-7:30 pm, Bible class; 7:30, church service; 9:30-11, music. Central.

WFAM, St. Cloud, Minn. 273 meters. 10 watts. St. Cloud Daily Times. Slogan, "Granite City of the World." Announcer, Otto A. Rupp. Daily ex Sun, 4:45 pm, markets. Central.

WFAV, Lincoln, Neb. 275 meters. 500 watts. Univ. of Nebraska. Central.

WFBC, Knoxville, Tenn. 250 meters. 50 watts. First Baptist church. Announcer, St. John Reynolds. Sun, 10:45 am; 7:30 pm, services; 4 pm, sacred music. Central.

WFDL, Philadelphia, Pa. 234 meters. 5 watts. Gethsemane Baptist church.

WFDE, Seymour, Ind. 228 meters. 10 watts. Van de Valle Music and Radio company. Announcer, John Van de Valle. Eastern.

WFBG, Altoona, Pa. 278 meters. 100 watts. The Wm. F. Gable Co. Announcer, Roy F. Thompson. Slogan, "The Original Gateway to the West." Daily ex Sat, Sun, 11:45 am, music; 3:45 pm, 6:15, Mon, 7:15 pm, 7:30, 8, 9:15, Tues, 8:30 pm, 11:15, Thurs, 7:15 pm, 7:30, 8, 10:30, Fri, 7:15 pm; 7:30, 8:30, 11:15, Sat, 7:30 pm, Eastern.

WFBH, New York, N. Y. 272.6 meters. 500 watts. Concourse Radio Corp. Announcer, Alvin E. Hauser. Slogan, "Voice of Central Park." Daily, 11:30 pm, Mon, Tues, Fri, 2-7 pm, Wed, Thurs, Sat, 2-8 pm, Mon, Sat, 11:30 pm, Sun, 5-8 pm, Eastern.

WFBJ, Camden, N. J. 236 meters. 500 watts. Galvin Radio Supply Co.

WFBK, Collegeville, Minn. 236 meters. 50 watts. St. John's university. Announcer, Hilary Doerfer. Slogan, "In the Heart of the Landscape Paradise." Sun, 7-7:30 pm, Central.

WFBM, Syracuse, N. Y. 252 meters. 100 watts. Onondaga Hotel company. Announcer, Ernest E. Chappell. Mon, Wed, Fri, 3-4 pm, Sat, 9-9:45 pm, Sat, 10-11 am, Sun, 5-6 pm; 6:15-7:15, 7:30, Eastern.

WFBN, Indianapolis, Ind. 268 meters. 250 watts. Merchants Heat and Light company. Announcer, John P. McPhee. Slogan, "The Convention City of America." Eastern.

WFBP, Baltimore, Md. 254 meters. 100 watts. Fifth Infantry, Maryland National Guard. Slogan, "Home of the Star Spangled Banner." Announcer, S. R. Keenan. Daily matinee programs, Tues, Thurs, Sat, evening programs, Sun, afternoon program, Eastern.

WFDZ, Galesburg, Ill. 254 meters. 20 watts. Knox college.

WDFD, Flint, Mich. 234 meters. 100 watts. Frank D. Falain. Slogan, "The Vehicle City." Mon, Wed, Fri, 8 pm, Eastern.

WFI, Philadelphia, Pa. 394.5 meters. 500 watts. Strawbridge & Clothier. Announcer, John Vandersloot. Daily ex Sun, 10:15 am, reports; 10:30, music; 10:40, home service; 1-1:50 pm, orchestra; 1:50, reports; 3-4:30, concert; 6:30-7, orchestra. Tues, Thurs, Sat, 3 concert, Sun, 10:30 am, 7:30 pm, church services alternating; 9:15, alternate Sundays. Eastern.

WFKB, Chicago, Ill. 217.3 meters. 500 watts. Francis K. Bridgman. Announcer, Horace Kehm. Daily ex Sun, Mon, 7-10 pm, Central.

WFL, Brooklyn, N. Y. 205.4 meters. 100 watts. Robert Morrison Lacey.

WGL, Lancaster, Pa. 248 meters. 10 watts. Lancaster Ice Supply Co. Announcer, J. E. Galtner. Slogan, "World's Gardens at Lancaster." Mon, Wed, Fri, 5:45-6:15 pm, dinner concert. Wed, 11:15-11 am, organ, Eastern.

WGBB, Freeport, N. Y. 244 meters. 100 watts. Harry H. Carman. Mon, Wed, Fri, 8-10:30 pm, Sun, 10:40 am, church, Eastern.

WGBD, Memphis, Tenn. 266 meters. 100 watts. First Baptist church. Announcer, M. L. Martin. Slogan, "Radio Bible Class." Sun, 9:55 am, 7:30 pm, Central.

WGBF, Evansville, Ind. 236 meters. 100 watts. The Finke Furniture Co. Announcer, Harold Finke. Daily ex Sun, 7:15 am, family altar; 12:10 pm, weather, markets, news, Tues, Fri, 8-10 pm, music, Fri, 11-12:30 am, Midnight Air Riders. Sun, 9:10-10:30 am, service; 7:30-9 pm, music. Central.

WGBI, Scranton, Pa. 240 meters. 10 watts. Frank S. McGee. Eastern.

WGBK, Johnstown, Pa. 248 meters. 5 watts. Lawrence W. Campbell. Daily ex Sun, 5-6:30 pm, Sat, 8:45-11:45 pm, dance music. Sun, 3-5 pm, Eastern.

WGBM, Providence, R. I. 234 meters. 100 watts. Theo. dore N. Saaty. Mon, 10 pm, Wed, Fri, 6:30 pm, Eastern.

WGBQ, Monomink, Wis. 234 meters. 100 watts. Stout Institute.

WGBR, Marshfield, Wis. 229 meters. 10 watts. George S. Ives. Sun, 2-4 pm, Central.

WGBS, New York, N. Y. 315.6 meters. 500 watts. Gimbel Brothers. Announcer, Floyd Neale. Daily ex Sun, 10-12:30 pm, entertainment; 3-7:30, Tues, 8:30-12:30, 8:30-11 am, Sat, 7:30-12, Sun, 3:30-4:30 pm, Eastern.

WGBU, Fulford By-the-Sea, Fla. 278 meters. 500 watts. Florida Cities Finance Co. Chamber of Commerce. Announcer, Robert H. Nolan. Daily ex Sun, 12-1 pm, music; 6:30-7:30, 10-11 am, Sun, 9:30-11 pm, Eastern.

WGBV, Spring Valley, Ill. 256 meters. 100 watts. Valley Theater. Announcer, Vermer Hicks. Thurs, 10-11:30 pm, Sun, 10:30-12 m, Central.

WGBX, Orono, Me. 252 meters. 100 watts. University of Maine.

WGCP, New York, N. Y. 252 meters. 500 watts. Grand Central Palace. Announcer, Alfred Hall. Slogan, "Four Leaf Clover Station." Daily ex Sun, 3-6 pm, Mon, Wed, Fri, Sun, 8-11 pm, Eastern.

WGES, Oak Park, Ill. 250 meters. 500 watts. Coyne Elec. School. Announcer, John Stamford. Daily ex Sun, Mon, 5-7 pm; 8-9 pm, 11-1 am, Sun, 5-7:40 pm, 11-12, Central.

WGHB, Clearwater, Fla. 266 meters. 500 watts. The George H. Bowles Developments. Mon, Wed, 8:30-10:30 pm, Sat, 9:30-11:30 pm, Eastern.

WGHP, Detroit, Mich. 270 meters. 1,500 watts. George Harrison Phelps, Inc. Announcer, C. D. Tomp. Mon, Tues, Wed, 8 pm, Thurs, 10 pm, Fri, 10 pm, Eastern.

WGMU, Richmond, Hill, N. Y. 236 meters. 100 watts. A. H. Grebe & Co., Inc. (Marine). Yacht M. U. 1.

WGN, Chicago, Ill. 370.2 meters. 1,000 watts. Chicago Tribune. Announcer, Quin A. Ryan. Daily ex Sun, 11:57 am, time; 12:40-2:30 pm, music, 2:30-3 music; 3-3:30; 5:30-5:50, Skeezix time; 5:50-5:57, stocks; 5:57, time; 6-6:30, organ; 6:30-7:30, dinner music; 8:30-9:30, 10-11:30, Tues, Thurs, 12:30 pm, farm talk. Sun, 12-1 pm, 1-2, 2-5, 9-10, Central.

WGR, Buffalo, N. Y. 319 meters. 750 watts. Federal Radio Corp. Announcer, Otto Becker. Slogan, "Key City of Industry." Daily ex Sun, 12 m, reports; 12:45, concert; 2:30; 6:30 pm, music; 7:30, news. Mon, Wed, Fri, 9-11 pm; Tues, Thurs, 8-11 pm, from New York. Sun, 3 pm, vesper; 7:45, 8-11 pm, 9:15, concert, Eastern.

WGST, Atlanta, Ga. 270 meters. 500 watts. Georgia School of Technology. Announcer, J. H. Parsons. Slogan, "The Southern Technical School with a National Reputation." Eastern.

WGY, Schenectady, N. Y. 379.5 meters. 5,000 watts. General Electric Company. Announcer, Kolin Hager. Daily ex Sun, 11:55 am, time; 12:30 pm, stocks, markets; 12:45, weather. Daily ex Sun, 12:40 pm, fruit, vegetable reports; 6, stocks; 6:10, markets; 6:15, sports, news. Mon, Tues, Thurs, Fri, 2 pm, woman's hour, Tues, Thurs, 2:30 pm, organ. Mon, Tues, Thurs, 6:30-7 pm, dinner program; Thurs, 11:30 pm, organ. Fri, 7 pm; Wed, 6:30 stories, Fri, 6:30 pm, Sunday school lesson; 10:30, late program. Second and last Mon, 7:15 pm; agricultural talk. Wed, Fri, 7 pm, orchestra. Sat, 9:30 pm, dance program. Sun, 10:30-12 am, service; 7:30-8:45 pm, service; 8:45 pm, orchestra from WJZ, Eastern.

WHA, Madison, Wis. 335.4 meters. 750 watts. Univ. of Wis. Mon, Wed, Fri, 7:30 pm, Central.

WHAD, Milwaukee, Wis. 275 meters. 500 watts. Marquette University. Milwaukee Journal. Announcer, Ed. Renf. Daily, 11 am, weather, news; 4-5 pm, news, markets, current topics, music; 6-7, organ, orchestra; financial reports. Mon, 8-10 pm, Wed, 10:30-12:30, Fri, 8:30-10 pm, Central.

WHAE, Cincinnati, O. 233 meters. 100 watts. Univ. of Cincinnati. Dept. of Elec. Eng. Announcer, W. C. Osterbrook. No definite schedule.

WHAM, Rochester, N. Y. 278 meters. 100 watts. Univ. of Rochester. Rochester Times-Union. Democrat and chronic. Daily ex Sun, 3:30-4 pm, 5-5:45, 7-7:40, Sun, 3:15, Radio Chapel. Eastern.

WHAP, Brooklyn, N. Y. 240 meters. 500 watts. William H. Taylor Finance Corp. Announcer H. Alvin Simmons. Slogan, "The Station for Public Service." Daily ex Sun, 6-11 pm, Sun, 2-3:30 pm, Eastern.

WHAR, Atlantic City, N. J. 275 meters. 500 watts. Seaside Hotel. Announcer, E. Dennison. Daily ex Sun, 2 pm, 7:30, 8, Tues, Fri, Sun, 11:15 pm, organ. Sun, 10:45 am; 2:15 pm, 2:45, 7:50, 9, Eastern.

WHAS, Louisville, Ky. 399.8 meters. 500 watts. Courier-Journal and Louisville Times Co. Announcer, D. H. Ives. Daily ex Sun, 4-5, 7:30-9, Sun, 9:57-10:45 am, 4-5 pm, church service. Mon night, silent. Central.

WHAT, Minneapolis, Minn. 263 meters. 500 watts. Twin City Business Men's Broadcasting station. Announcer, Dr. George Young. Mon, 6-8 pm, 9-11, Tues, 7-9 pm, Wed, 6-10 pm, Fri, 7-11 pm, Central.

WHAV, Wilmington, Del. 266 meters. 100 watts. Wilmington Elec. Spec. Co. Slogan, "The First Broadcasting Station of the First City of the First State." Temporarily discontinued.

WHAZ, Troy, N. Y. 379.5 meters. 500 watts. Rensselaer Polytechnic Inst. Announcer, Rutherford Hayner. Slogan, "Transcontinental and International Broadcasting Station. Located at the Oldest College of Science and Engineering in America." Club, R. P. I. students. Mon, 9-12 midnight, concert, educational talks, orchestras, features. Second Monday of Month, 12-1:30 am. International test program, Eastern.

WHB, Kansas City, Mo. 385.6 meters. 500 watts. Sweeney Auto & Electric School. Announcer, John T. Schilling. Slogan, "Heart of America." Daily ex Sun, 8:25 am, 9:25, 9:30, 9:35, 10:25, 10:30, 10:35, Daily ex Sun, 11:20, 11:30, 11:35, 11:56, 12:15, 12:20, 1:25, 1:40, 2, 3, stocks, weather, news; 2-3 pm, ladies' hour, Tues, Thurs, 7-7:30, 8-10, Mon, Wed, Fri, 7-8 pm, Sat, 12:15 am, 12:30, 12:25, 1:25, Sun, 9:45-11 am, Central.

WHBA, Oil City, Pa. 250 meters. 10 watts. Shaffer Music House.

WHBC, Canton, Ohio 254 meters. 10 watts. Rev. E. P. Graham. Mon, 8-8:30 pm, Eastern.

WHBD, Bellefontaine, Ohio. 222 meters. 20 watts. Charles W. Howard (Portable).

WHBF, Rock Island, Ill. 222 meters. 100 watts. Beardsley Specialty company. Announcer, C. L. Beardsley. Mon, 8-11 pm, Wed, 7:30-10 pm, Sat, 2-4 pm; 7-9, Central.

WHBG, Harrisburg, Pa. 231 meters. 20 watts. John S. Skana. Mon, Fri, 11:30-12:15 pm, Tues, Thurs, 9-12 midnight, Sun, 9-10:30 pm, Sun, 2-4 pm, Eastern.

WHBH, Culver, Ind. 222.1 meters. 100 watts. Culver Military Academy. Announcer, Charles C. Mather. Mon, 7:30 pm, Sat, 6:30 pm, Central.

WHBJ, Ft. Wayne, Ind. 234 meters. 50 watts. Lauer Auto company.

WHBK, Ellsworth, Maine. 231 meters. 10 watts. Franklin St. Garage, Inc.

WHBL, Logansport, Ind. 215.7 meters. 50 watts. James H. Slusser. (Portable).

WHBM, Chicago, Ill. 233 meters. 20 watts. C. L. Carrell. (Portable).

WHBN, St. Petersburg, Fla. 238 meters. 10 watts. First Avenue Methodist church.

WHBP, Johnstown, Pa. 257 meters. 100 watts. Johnstown Automobile Co. Announcer, J. C. Tully. Slogan, "The Voice of the Friendly City." Wed, 9 pm, Sat, 10 pm, Eastern.

WHBQ, Memphis, Tenn. 233 meters. 50 watts. Men's Fellowship class. St. John's M. E. church. Announcer, Dr. George L. Powers. Slogan, "We Have Best Quartet." Wed, 8-9 pm, music. Sun, 9:45-10:45 am, 11, 7:45 pm, services. Central.

WHBR, Cincinnati, Ohio. 215.7 meters. 20 watts. Scientific Elec. & Mfg. Co. Announcer, Radio House. Slogan, "That's Us." Tues, 8-10:30 pm, Thurs, 10-12 midnight, Sun, 2-4 pm, 9-11, Central.

WHBU, Anderson, Ind. 218.8 meters. 10 watts. Bing's Clothing-Riviera Theater. Announcer, O. B. Robey. Slogan, "The Home of Chief Anderson." Daily ex Sun, 9-9:30 am, 12-12:30 pm, Wed, Fri, Sun, 7-9 pm, Central.

WHBW, Philadelphia, Pa. 242 meters. 100 watts. D. R. Kienzle. Wed evening.

WHBY, West De Pere, Wis. 250 meters. 50 watts. St. Robert's College.

WHDI, Minneapolis, Minn. 278 meters. 500 watts. Wm. Hood Dunwoody Industrial Institute. Announcer, Hal Marston. Mon, 8-9 pm, Wed, Fri, 9-10 pm, Central.

WHED, Rochester, N. Y. 258 meters. 100 watts. Hickson Electric company, Inc. Announcer, J. F. Hitchcock. Slogan, "With Hickson Elec. Co." Daily ex Sun, 6:30-7:30 pm, Eastern.

WHC, Cleveland, Ohio. 273 meters. 250 watts. Radio Air Service Corp., Winton Hotel. Slogan, "Cleveland, the Convention City." Daily ex Sun, 6:30-7:30 pm, Sun, 10:30 am, church service; 6:15-7:15 pm, music; 7:15-9, church service; 9-9:30, Bible lecture. Eastern.

WHN, New York, N. Y. 360 meters. 500 watts. Lowry's State Broadcasting Station. Announcer, N. T. Grandin. Slogan, "The Voice of the Great White Way." Daily ex Sun, 12-1 pm, 2:15-3:15, 8:45-5:30, 8:30-12 midnight, Sun, 3-6 pm, 9:30-12, Eastern.

WHO, Des Moines, Ia. 526 meters. 5,000 watts. Bankers Life Co. Announcer, N. Dean Cole. Daily ex Sun, 9:45 am, 12 m, 2 pm, markets, weather. Mon, Tues, Thurs, Fri, 7:30-9 pm, Wed, 6:30-7:30 pm, 7:30-9-10, 10-11:30, Fri, 11-12 mid, Mon, Tues, Thurs, 11-12 midnight, Sun, 11 am, 1 pm, 7:30-8:30, Central.

WHT, Chicago, Ill. 238-400 meters. 1,500 watts. Wrigley Co. Announcer, Pat Henry Barnes. Daily ex Sun, Mon, (899.8), 11-2, Mon, 7-8:30, 10:30-11; (238), 8:45-10:15, Mon, (399.8), 11-2, 2 pm, Sun, 12-10:30 pm, Paul Rader. Central.

WIAD, Philadelphia, Pa. 250 meters. 100 watts. Howard R. Miller. Slogan, "The Voice from the Birthplace of Liberty." Tues, Fri, 9 pm, Eastern.

WIAS, Burlington, Ia. 254 meters. 100 watts. Home Elec. Co. Announcer, Harry H. Waugh. Slogan, "Burlington on the Mississippi." Tues, 8-9 pm, concert, Thurs, 7-8 pm, concert. Sat, 10:30-11, organ. Sun, 10:30 am, church services. Central.

WIBA, Madison, Wis. 236 meters. 100 watts. The Capital Times. Announcer, Trevor Griffiths. Slogan, "Four Lakes City." Mon, Wed, Fri, 8:45-10 pm, Sat, 12-1 am, Central.

WIBC, St. Petersburg, Fla. 222 meters. 100 watts. L. M. Tate Post. No. 39, Veterans of Foreign Wars. Mon, Wed, 8-10:30 pm, Sat, 8-9 pm, 10:30-12, Eastern.

WIBG, Elkins Park, Pa. 222 meters. 50 watts. St. Paul's Protestant Episcopal church. Announcer, Charles T. Asbury. One Monday a month Ogontz Forum speaks. Sun, 10:45 am, 3:45 pm, Eastern.

WIBH, New Bedford, Mass. 210 meters. 5 watts. Elite Radio Stores. Announcer, J. T. Moriarty. Slogan, "The Voice of New Bedford." Morning and afternoon programs.

WIBI, Flushing, N. Y. 218.8 meters. 5 watts. Frederick B. Zittel, Jr.

WIBJ, Chicago, Ill. 215.7 meters. 50 watts. C. L. Carrell. (Portable).

WIBM, Chicago, Ill. 215.7 meters. 10 watts. Billy Maine. (Portable).

WIBO, Chicago, Ill. 226 meters. 1,000 watts. Nelson Brothers. Announcer, Harry Geise. Daily ex Sun, 2-4 pm, Daily ex Sun, Mon, 6-8 pm, Tues, Thurs, 12-3 am, Wed, 10-12 midnight, Fri, 10-9 am, Sun, 10:15 am, service; 2-4 pm, concert; 6-8, 10-12, Central.

WIBR, Weirton, W. Va. 246 meters. 50 watts. Tri-State Radio Co. Announcer, W. D. Johnston. Slogan, "The Town Where Everybody Works." Fri, 8:30-11 pm, Sat, 11-1 am, Sun, 2-3 pm, Eastern.

WIBS, Elizabeth, N. J. 202.8 meters. 20 watts. New Jersey National Guard.

WIBU, Poyonette, Wis. 222 meters. 20 watts. The Electric Farm.

WIBV, Henderson, N. C. 263 meters. 500 watts. Jewell Radio Co.

WIBW, Logansport, Ind. 230 meters. 100 watts. Dr. L. D. Hill.

WIBX, Utica, N. Y. 205.4 meters. 100 watts. Grid-Leak, Inc.

WIBZ, Montgomery, Ala. 231 meters. 10 watts. Powell Elec. Co.

WIL, St. Louis, Mo. 273 meters. 250 watts. St. Louis Star and Benson Radio Co. Announcer, Billy Knight. Slogan, "Watch It Lead." Mon, Sat, 10-12 midnight, Wed, Fri, 9-11 pm, Thurs, 8-10 pm, Central.

WIP, Philadelphia, Pa. 508.2 meters. 500 watts. Gimbel Bros. Announcer, E. A. Davies. Slogan, "Watch Its Progress." Daily ex Sun, 7-7:30 am, 1-2 pm, 9-4:30, 6-6:45, music; 7-7:30 pm, Tues, Thurs, Sat, 8-12 pm, concert, Sun, 10:45-12 m, 4:15-5:30 pm, 7:45-9, 10-12, Eastern.

WIAD, Waco, Texas. 352.7 meters. 500 watts. Barton's Dyanshine Station. Mon, Fri, 8:30-10 pm, Central.

WIAG, Norfolk, Neb. 270 meters. 200 watts. Norfolk Daily News. Announcer, Karl Stefan. Slogan, "The World's Greatest Country Daily, and Home of Printer's Devil." Daily ex Sun, 12:15 pm; Sun, 8:30-6 pm, music. Central.

WIJK, Greentown, Ind. 254 meters. 50 watts. Clifford L. White. Slogan, "The Radio Parson." Mon, Wed, Fri, 12-1 pm, chapel, Thurs, 6:30 pm, music. Sat, 6:30 pm, Bible school lesson. Central.

WIAM, Cedar Rapids, Ia. 268 meters. 100 watts. D. M. Parham. Daily ex Sun, Sat, 7-10 pm, Sun, 4 pm, vesper service. Central.

WIAR, Providence, R. I. 305.9 meters. 500 watts. The Outlet Co. Announcer, J. A. Reilly. Slogan, "The Southern Gateway of New England." Daily ex Sun, 1:05-2:15 pm, weather, reports, music. Mon, Wed, Fri, 10 am, household hints. Mon, Tues, 7:30-10 pm, Wed, 11-10:30 pm, Thurs, 8-11 pm, Fri, 8-10 pm, 11-10:30 pm, Sun, 7:20-10:15 pm, Eastern.

WIAS, Pittsburgh, Pa. 275 meters. 500 watts. Pittsburgh Radio Supply House. Pickering's Studio. Announcer, Bryan McDonald. Slogan, "World's Jolliest Aerial Station." Daily ex Sun, 7-8 pm, dinner concert; 8-11, Sun, 2 pm, Eastern.

WIAC, Chicago, Ill. 322.4 meters. 1,500 watts. Zenith Radio Corp. Announcer, E. F. McDonald, Jr. Thurs, 10-12 midnight, Central.

WIBA, Joliet, Ill. 206.8 meters. 50 watts. D. H. Lentz, Jr. Tues, 8-11 pm, Central.

WIBB, St. Petersburg, Fla. 254 meters. 100 watts. L. W. McClung.

WIBC, La Salle, Ill. 234 meters. 100 watts. Hummer Furniture Co. Announcer, Harry Halpin. Daily ex Sun, 12:30-1 pm, Mon, 8-11 pm, Central.

WIBG, Charlotte, N. C. 224 meters. 10 watts. Interstate Radio, Inc.

WIBI, Red Bank, N. J. 218.8 meters. 250 watts. Robert E. Johnson.

WIBK, Ypsilanti, Mich. 233 meters. 10 watts. Ernest F. Goodwin.

WIBL, Decatur, Ill. 270 meters. 500 watts. Wm. Gustard Dry Goods Co. Announcer, H. B. Rickards. Mon, Wed, Sat, 9:30-11 pm, Central.

WIBN, Sycamore, Ill. 256 meters. 10 watts. St. John's Lutheran Church.

WIBP, Buffalo, N. Y. 218.8 meters. 50 watts. Seneca Vocational School.

WIBQ, Lewisburg, Pa. 211.1 meters. 100 watts. Bucknell university.

WJD, Granville, O. 217.3 meters. 10 watts. Denison Univ. Announcer, Richard H. Howe. Fri, Sat, 5-6 pm, music, educational lectures. Athletics. Eastern.

WJDD, Moosheart, Ill. 302.8 meters. 500 watts. Loyal Order of Moose Station. Announcer, Jack Nelson. Slogan, "The Call of the Moose." Daily ex Sun, Mon, 4-5 pm, children's program; 6-7 pm, 12-1, Sun, 7:45-8:40 am, services; 9:45-11 am, services; 3-4, Central.

WJR, Pontiac, Mich. 516.9 meters. 5,000 watts. Jewett Radio and Phonograph Co. Slogan, "Where Joy Reigns." Announcer, Leo Fitzpatrick. Daily ex Sun, 7-8 pm, 9-10, Thurs, Sat, 10-11 pm, Mon, Wed, Sat, 11:30-1 am, Sun, 8:30 pm, frolic. Eastern.

WJY, New York City. 405.2 meters. 1,000 watts. R.C.A. Announcer, J. Lewis Reid. Tues, Thurs, Fri, 7:30-11:30 pm, concert, Sun, 8:15-10:30 pm, Eastern.

WJZ, New York, N. Y. 454.3 meters. 1,000 watts. R. C. A. Announcer, Milton J. Cross. Daily ex Sun, 10-11 am, 1-2 pm, 4-6, entertainment; 7-11:30 pm, special program. Sun, 11 am-1 pm, church services; 2:30-5 pm, 7-10:30 pm, Eastern.

WKAA, Cedar Rapids, Ia. 278 meters. 500 watts. H. F. Parr, announcer. Mon, Wed, Fri, 4-5 pm; 8:30-10:30, Sun, 11 am, 5 pm, church service. Central.

WKAF, Milwaukee, Wis. 261 meters. 500 watts. Keselman-O'Driscoll Co. Announcer, Robert F. Hall Co. Mon, Wed, Fri, 10-11 pm, Sun, 4-6 pm, Central.

WKAP, Cranston, R. I. 234 meters. 50 watts. Dutee Wilcox Flint, Inc.

WKAQ, San Juan, Porto Rico. 340.7 meters. 500 watts. Radio Corp. of Porto Rico. Announcer, Joaquin Agusty. Slogan, "The Island of Enchantment, Where the World's Best Coffee Grows." Wed, 8-10 pm, band; Thurs, 8:30-10 pm, Fri, 9-10 pm, band, Inter-colonial.

WKAR, East Lansing, Mich. 285.5 meters. 1,000 watts. Mich. State College. Announcer, Jim Gamble. Mon, Wed, Fri, 7:15-9 pm, Tues, Thurs, 7:15-9 pm, Sat, 12:30-2 am, Eastern.

WKAV, Laconia, N. H. 224 meters. 50 watts. Laconia Radio Club. Fri evening concerts. Sun, 10:30 am; 6:30 pm, Eastern.

WKBB, Joliet, Ill. 214.2 meters. 100 watts. Sanders Brothers.

WKBE, Webster, Mass. 231 meters. 100 watts. K. & E. Electric Co. Mon, 8-12 midnight, Eastern.

WKBG, Chicago, Ill. 215.7 meters. 100 watts. C. L. Carrell. (Portable).

WKBK, New York, N. Y. 209.7 meters. 500 watts. Shirley Katz.

WKRC, Cincinnati, Ohio. 422.3 and 325.9 meters, alternate months, 1,000 watts. Kodel Radio Corp. Announcer, Eugene S. Mittendorf. Mon, 6:15-7 pm, 8-10, 12-1, Tues, Thurs, Sat, 10-12 midnight, Wed, 8-10 pm, Sun, 6:45-7:30 pm; 10-12, Central.

WKY, Oklahoma City, Okla. 275 meters. 100 watts. E. C. Hull, H. S. Richards. Daily ex Sun, 3-4 pm, markets, weather, news. Daily ex Sun, 6:30-8:30 pm, Sun, 9:30-12:30 pm; 7:45-9:45, Central.

WLAL, Tulsa, Okla. 250 meters. 150 watts. First Christian church. Announcer, R. W. Burkhart. Slogan, "The Voice of the Church." Sat, 7:30 pm, Bible class. Wed, 9:30 pm, Sun, 7:30 pm, church. Central.

WLAP, Louisville, Ky. 275 meters. 20 watts. W. V. Jordan. Tues, Fri, 9:20-10 pm, Central.

WLAX, Greensboro, Ind. 231 meters. 10 watts. Green-castle Community Broadcasting Station. Off the atr. WL B, Minneapolis, Minn. 278 meters. 500 watts. U. of Minn., Dept of Elec. Eng.

WLBL, Stevens Point, Wis. 278 meters. 500 watts. Wisconsin Dept. of Markets. Slogan, "Wisconsin Land of Beautiful Lakes." Daily ex Sun, 8:45 am, 9:45, 10:45, 11:45, 12:30 pm, 1:45, markets. Tues, Thurs, 8 pm, Central.

WLBB, Chicago, Ill. 308.2 meters. 2,500 watts. Liberty Magazine. Daily ex Sun, Mon, 7-8 pm, 9-10, 11-12, Sun, 5-6 pm, 6-6:30, 8-9, Central.

WLIT, Philadelphia, Pa. 394.5 meters. 500 watts. Lit Bros. Announcer, Harry E. Ehrhart. Club, "Morning Glory." Daily ex Sun, 12:02 pm, music; 2, music, 4:30 pm, Wed, 7:30 pm, 8, 10, 11 am, Wed, Thurs, 8:45, 10, Eastern.

WLS, Chicago, Ill. 344.6 meters. 5,000 watts. Sears, Roebuck & Co. Slogan, "World's Largest Store." Daily ex Sun, 9 am, 11, 12, 1-2, Tues, 6:15 pm, 6:30-7:55 pm, Wed, 6:15-12:30 am, Thurs, 6:15-7:55, Fri, 6:15-11:30, Sat, 12-12:45 pm, Junior R. F. D. program. Sun, 6:30-7:55 pm, Central.

WLTS, Chicago, Ill. 258 meters. 100 watts. Technical High school. Fri, 1-2 pm, Central.

WLW, Cincinnati, O. 422.3 meters. 500 watts. The Crosley Radio Corp. Announcer, William Stoss. Daily ex Sun, 10:45 am, 11:55, time; 1:30 pm, Daily ex Sun, Fri, 7, dinner hour; 6:55, markets. Daily ex Sat, Sun, 7:45 am, morning devotions; 8, exercises; 12:15, program; 3, 4, reports. Mon, Tues, 8-10 pm, Wed, Thurs, 10-12 mid, Sun, 9:30 am, 11, 7:30 pm, 8:30, Central.

WLWL, New York, N. Y. 288.3 meters. 1,000 watts. The Paulist League. Announcer, James F. Cronin. Slogan, "For God and Country." Sun, Tues, Fri, 8 pm, Eastern.

WMA, Cazenovia, N. Y. 275 meters. 100 watts. C. B. Meredith. No definite schedule.

WMAF, South Dartmouth, Mass. 440.9 meters. 1,000 watts. Round Hills Radio Corp.

WMAK, Lockport, N. Y. 266 meters. 500 watts. Norton Laboratories. Announcer, DeWitt C. Gerritsen. Daily ex Sun, 7:15 pm, News Mon, Sat, 8-9 pm, 9-10, Wed, 7:30-10 pm, Fri, 9-10 pm, Sun, 10:30 am, 7:30 pm, Eastern.

WMAL, Washington, D. C. 212.6 meters. 15 watts. M. A. Leese Optical Co.

WMAN, Columbus, Ohio. 278 meters. 50 watts. First Baptist church. Announcer, Dr. D. F. Rittenhouse. Sun, 10:30-12 m, 7:30-9 pm, church services. Eastern.

WMAB, Chicago, Ill. 447.5 meters. 500 watts. The Chicago Daily News. Announcer, Robert Whitney. Daily ex Sun, Mon, 12-3 pm, 4-7. Daily ex Sun, Mon, 8-10 pm, Central.

WMAY, St. Louis, Mo. 248 meters. 100 watts. Kings-highway Presbyterian church. Slogan, "May Every By-Way Hear Kingshighway." Sun, 11 am, 8 pm, Central.

WMAZ, Macon, Ga. 261 meters. 500 watts. Mercer university. Announcer, Carey O. Pickard. Mon, Thurs, Fri, 10-11 pm, Fri, 9-10 pm, Tues, Fri, 8-9 pm, Wed, 11-12, Eastern.

WMBB, Chicago, Ill. 250 meters. 500 watts. American Bond & Mortgage Co.-Trilanon. Announcer, Clyde Hager. Slogan, "World's Most Beautiful Ballroom." Daily ex Mon, 7-8 pm; 9-11, Sun, 3-5 pm, Central.

WMBC, Detroit, Mich. 256 meters. 100 watts. Michigan Broadcasting Co.

WMBF, Miami Beach, Fla. 384.4 meters. 500 watts. Fleetwood hotel. Daily, 7-8 pm, dinner concert; 8-8:15, news; police reports; 8:15-8:30, dance; 10-12, Eastern.

WMC, Memphis, Tenn. 499.7 meters. 500 watts. The Commercial Appeal. Announcer, Francis S. Chamberlin. Slogan, "Station WMC, Memphis." "Down in Dixie." Club, "Midnight Frolic." Daily ex Sun, 9:45 am, 2:30 pm, weather, markets, music. Daily ex Sun, Wed, 8:30 pm, program; Tues, Fri, 11 pm, Midnight frolic. Sun, 11 am, church service. Central.

WMCA, New York

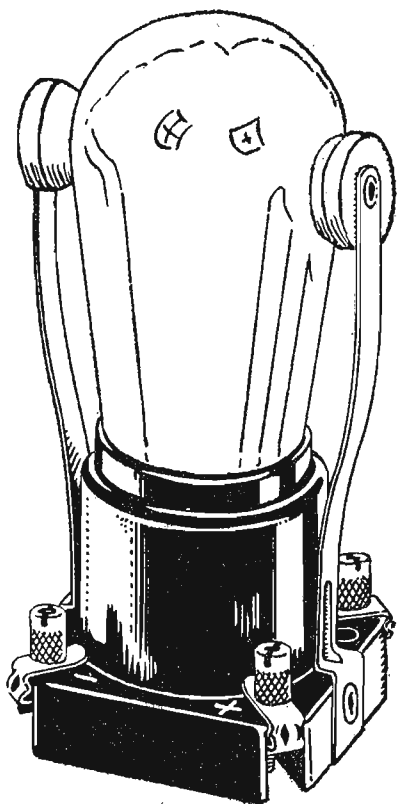

The B-T Answer to Microphonic Noises

are—but a solution that has cured every case we've seen and we've hunted out the worst ones we could find. We have installed "Silent Sockets" on sets that were worthless because of unexplainable noises and made them perfectly quiet and clear. A "Silent Socket" may be what you need. The "Silent" includes a B-T Universal Socket—the best made. **Price \$1.25.** Price of regular type UL Socket—75c.

"Only Bremer-Tully Could Do It"

You've heard that before but never has it meant more than now. Steadily thru the years the B-T reputation has grown, but this years achievements dwarf all others.

Here are two new products but recently announced yet already they are the talk of the land

The B-T "SILENT SOCKET" solves the problem of so-called "Microphonic Noise"—that ringing sound in the horn—that "bong, bong" when you jar the set—that interfering tone, starting slowly and "building up" until reception is ruined.

Increased use of "hard" detectors has apparently multiplied microphonic troubles, and remedies were sought on all sides. We exhausted every conceivable method of spring suspension, cushioning, and even hanging tubes on strings, without any success, and then we found the solution—a simple one—as many real inventions

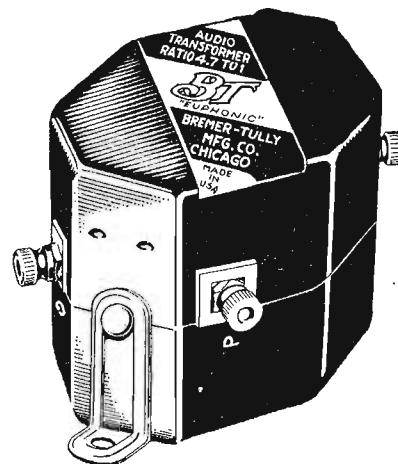

2.2 to 1, \$5.00
4.7 to 1, \$5.75

The B-T Euphonic AUDIO TRANSFORMER

Tone quality such as you never experienced. Pronounced by a leading laboratory the best they ever tested. An entirely new conception of design. Not a monster in iron but **better iron distribution**—and a still **greater increase** in copper. The only transformer that eliminates troubles due to crossed wiring.

Greater improvement than you thought possible—frankly it surprised even us.

We have never offered a radio product with greater assurance of satisfaction, and we firmly believe there is no other system of amplification that even approaches Euphonic quality.

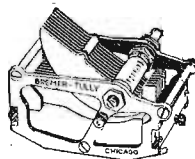

Condensers

With the "LIFETIME" bearings—use a B-T once and you'll never be satisfied with any other.

The closer you examine them the better we like it.

There's been a lot of talk about "straight-line" condensers, as tho that was something new. It may be to many, but this is the **second** year for B-T.

The LIFETIME, Straight Line Wave Length is built with 7, 13, 17, 23 and 35 plates.

The LIFETIME, Straight Line Frequency is illustrated.

.00025.....(13 pl.).....	\$5.50
.00035.....(17 pl.).....	5.75
.0005.....(23 pl.).....	5.75

From Cincinnati

November 5, 1925

The Counterphase is in every particular by far the most efficient receiving set that I have owned or heard in operation. One stage of audio is quite sufficient for ample loud speaker reception in five rooms of all class B stations in the U. S., and many class A.

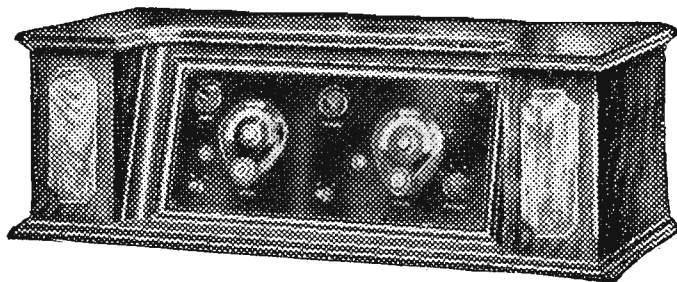

The Counterphase—Six

A complete factory-built Receiver employing the highest-grade parts and the greatest circuit known to radio.

The Counterphase Circuit is the invention of Harry A. Bremer, inventor of the famous "Nameless," the 3-circuit tuner, the wonderful B-T No. 2, the first air core radio transformer, the first 3-circuit transformer, the Euphonic, the silent socket,—and every B-T technical product. You profit by his 20 years of radio and wireless experience when you buy a B-T product.

The Counterphase Six patented June 23, 1925, employs three stages of radio frequency, with but two tuning controls. It is equally efficient on both high and low wave lengths—ask any expert what that means.

The cabinet is completely copper-lined and shielded, shutting out all stray and interfering signals and enabling operation in otherwise impossible locations. Price of cabinet model, with B battery Compartments and multiple connecting plug without tubes \$165.00.

"Better Tuning"

From Ft. Wayne, Ind., Oct. 16, 1925.

I consider "Better Tuning" one of the best and most sensible booklets ever issued by any radio manufacturer.

**80 Pages of Radio Facts
People Like It Because It's Different
Postpaid 10c**

B-T also manufacture:

- Tandem Condensers.
- Tuners.
- Short Wave Outfits.
- Nameless Kits.
- Variable High Resistances.
- Potentiometers.
- Air Core Transformers.
- Choke Coils and

The Best Vernier Dial Made.

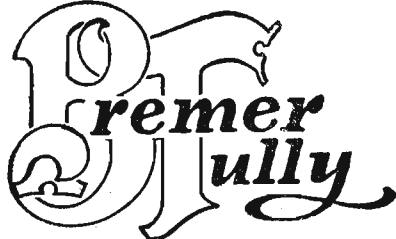

Manufacturing Company
532 So. Canal St., Chicago, Ill.



B-T TOROSTYLE FOR EASY WIRING

B-T Torostyle Transformers

A toroidal transformer in a class that's all its own—the creation of the greatest specialists in inductance design—manufactured by a firm that has never put out a product that was not an overwhelming success.

- Type TA, Antenna Coupler.....\$4.00
- " TC, Intermediate Stages. 4.00
- " T-4, For 4-Tube use..... 4.00

Kit for the 6-tube Counterphase, wires in color cut to length, and the finest 9-color progressive wiring diagram you ever saw.

Price \$38.00

Kit for the 5-Tube Counterphase, Price \$28.50

From Kansas City

November 5, 1925

Summarizing tests on Counterphase Set I can safely say it has more volume, greater selectivity, greater sensitivity, and produces higher quality of reproduction than any receiving set I have ever heard.

Member
R. M. A.

"Pioneers of Better Tuning"

Member
A. E. M. S.