

New Radio Brake Stops Fast Trains

# Radio Digest

EVERY  
WEEK

PROGRAMS  
**Illustrated**

TEN  
CENTS

REG. U. S. PAT. OFF. & DOM. OF CANADA

Vol. XV

Copyright 1925  
By Radio Digest Publishing Co.

SATURDAY, NOVEMBER 21, 1925

No. 7



## *Radio in Roaming Box Car*

*Special DX-Seven Super-Het; WHAR, WBBM Pages;  
Indian Brave Sings Thanksgiving; Football Schedules*

# DEAN FITZER HEADS NEW WDAF STATION

## HOME OF NIGHTHAWKS REBUILT FOR GOOD SERVICE

### Plans Made to Present Type Programs Rather Than Grand Mixture of Everything

KANSAS CITY, Mo.—There is a new voice being heard these days and nights from the studio of WDAF, the broadcasting station of The Kansas City Star, home of the famous Nighthawks. The station's new director and announcer is Mr. H. Dean Fitzter, succeeding Leo Fitzpatrick who has gone to WJR, Detroit.

Mr. Fitzter is a baritone and formerly was a member of The Star's reportorial staff. In the latter capacity he has for three years directed the Midwestern Zone in the National Oratorical contest on the Constitution, his management of that popular and educational project extending from Canada to the Gulf of Mexico and from the Mississippi river to the Rockies. Throughout the war Mr. Fitzter served as a musician aboard the U. S. S. Dixie, stationed in foreign waters.

### Power to Go Up

Along with the change in personnel at the WDAF studio, big plans are in a stage of development for the station's future. A new transmitter, now being installed, will give WDAF 1,000 watts power, twice the power of the present station. This will be a boon to operators of crystal sets and should cause the station to be heard from greater distances. London has heard WDAF many times with its present transmitter.

A large studio is being built for WDAF, as well as spacious rooms for operating equipment. With the exception of the large aerials that now tower above the Star building, the entire station will be new. Special programs will usher in the new WDAF.

### Plan Type Programs

Type programs will be the goal under the new direction. Experience has taught that Radio audiences do not agree on the kinds of programs they prefer would come to them through the ether. And, too, jazz to classical, all within a single program, is an inexcusable conglomeration. In view of this, Mr. Fitzter is planning type programs for certain definite periods.

Programs for the housewives will be offered mornings and afternoons; a matinee string trio; the "School of the Air" and the Tell-Me-A-Story Lady in the early evenings; refined ensemble music for the dinner hour; Monday nights, semi-popular programs in "Around the Town with WDAF;" Wednesday and Friday nights, programs of standard classical music.

Somebody asks, where does the jazz come in? "Stay up for the Nighthawk frolics and you'll be filled full," comes the answer from WDAF.

# SUCCESS MARKS GERMAN TRY OUT

## Stereoscopic Broadcasting Experiment Proves Best in Reproducing Full Natural Effects

BERLIN.—The experiments made by the Rundfunk company in "stereoscopic" broadcasting have proved a brilliant success. The method used was to install two different microphones in the studio; one of them connecting with the neighboring Magdeburger Platz transmitting station, and the other with the Königswusterhausen station.

If the listener picks up both wave lengths, and listens with a phone connected with the Magdeburger Platz at one ear, and another connected with Königswusterhausen at the other, he will obtain a full, normal hearing effect which develops a beautiful quality of tone.

With the ordinary non-stereoscopic broadcasting the listener in either uses one ear piece or head phones, or a loud speaker. In the case of the head phones he hears the sounds simultaneously with both ears. In the case of the loud speaker there is always a refraction from walls or other obstacles. In the case of the single ear phone, the hearing is as imperfect as is sight with only one eye. The stereoscopic method is the only one which gives the full natural effect.

### Y. M. C. A. Gets Radio Sermons

CINCINNATI.—Fred K. Hoehler, executive secretary of the University branch of the Y. M. C. A. here, has completed arrangements to have loud speakers placed in the dormitories to receive the Cadman sermons from the Brooklyn Y. M. C. A., which are a Sunday afternoon feature from WSAI, Cincinnati, and other WEAF chain stations.

## CHIEF OF THE ROOST OF K. C. NIGHTHAWKS



H. Dean Fitzter, as new director of WDAF, automatically becomes head of the Nighthawks of Kansas City.

## COVER BEAUTY, WLS FAMOUS CELLO STAR

"EASY to look at and easy to hear," which, in a word or two, describes the beauty on the cover of Radio Digest this week. She is Miss Goldie Gross of Chicago, one of the regular features of WLS, the Sears Roebuck station. Miss Goldie began her career as a child prodigy when she was introduced to New York and Chicago concert audiences as the "youngest living concert cellist." More recently she has been soloist for the Civic Orchestra of Chicago.

She has the "Radio presence," as the critics say—which means the happy art of knowing how to meet the exact necessities of volume and distance for artistic transmission from the studio, over the air to the receiving set. At WLS Miss Goldie is doubly welcomed because the personnel has both the privilege of seeing and hearing her.

## Graph Charts Enable Fans to Follow Talks in Spain

MADRID, Spain.—A very popular plan has been put into effect by station Radio-Barcelona. Subscribers are supplied with special paper, ruled in very small cross-numbered squares. Directions are then broadcast so that the listener can, with the numbered squares and a pencil trace the drawing indicated.

Cartoons, humorous drawings, astronomical charts, maps to illustrate war news from the Riff, crossword and picture puzzles, are some of the uses to which this method has been put.

Subscribers report that the plan is meeting with very keen appreciation, adding as it does, an element of novelty to listening in.

# PROGRAMS BEST OF ALL TIME THIS YEAR

## CROSBLEY PREDICTS BIG ARRAY OF RADIO ARTISTS

### Manufacturer Says Announcer Should Not Project Personality Over the Microphone When Broadcasting

CINCINNATI.—Radio broadcasting is no longer an experiment. Those in charge of providing aerial entertainment have studied the reaction of the listeners to various types of entertainment and this year will find the greatest array of talent and unique features ever offered any audience. Superpower is in greater use and the owners of receiving sets are increasing in number each day.

The arrival of cooler weather means the opening of the winter broadcasting season and the return to the studios of celebrities of the studio and stage. Changes have been made in the studio staff of superpower broadcasting Station WLW, Cincinnati, with William Charles Stoess, formerly musical director, officiating as studio director, and Louis John Johnen, added in the capacity of program director.

Powel Crosley, Jr., who owns and operates the station, believes Radio audiences are interested primarily in the programs and not in the announcers. He believes "the station's the thing"; just as Shakespeare said, "the play's the thing."

### Announcer Only a Unit.

The announcer is only a unit of the program; his duty is to inform the listeners of what they will hear and the names of the artists providing the entertainment. Under no circumstances should the announcer inject his own personality into the programs but should keep in the background and permit the artists to be the feature attractions, just as the better-class toastmasters refrain from doing anything more than making a plain announcement of the speakers.

With such a wide field of broadcasting stations to choose from and the excellent selectivity of the majority of Radio receivers, audiences tune to the stations which provide them with the kind of program they like. In this connection, it is interesting to note the great demand for the popular type of dance music and the injection of the modern music into the classic programs. The Crosley Radio corporation has arranged with the Society of Composers, Authors and Publishers for the use of the latest music through WLW.

# ENGLAND GETS DX IN SPITE OF 5XX

## Daventry High Power Does Not Prevent Distance Reception According to Tests

LONDON.—An experimental transmission has just been made here in order to test the possibility of bringing the Continental stations, through the high-power station at Daventry (5XX), to the ears of British listeners.

The transmission was made by means of the station at Hayes, Kent, and was a most interesting experiment. Brussels, Rome, San Sebastian, Muenster, Paris and Hilversum, Holland, were picked up during the evening, the atmosphere being very clear and the results promising.

Captain P. P. Eckersely, chief engineer of the British Broadcasting company, maintained a running commentary on the results as they came through.

The fact that it is possible to pick up European stations as far apart as those enumerated is sufficient guarantee that in the future, with improved facilities, British listeners, through the medium of Hayes, via Daventry, may sit comfortably at home and hear the best products of the European stations.

### Half Million Farms Have Radio

WASHINGTON, D. C.—More than 550,000 farms in the United States are now equipped with Radio, the department of agriculture estimates, following a nationwide survey through county agricultural agents. A similar survey last year showed 365,000 farms on which there were sets, and in 1923 only 145,000 farms.

# CONTENTS

Radio Digest, Illustrated, Volume XV, Number 4, published Chicago, Illinois, November 21, 1925. Published weekly by Radio Digest Publishing Company, 510 N. Dearborn Street, Chicago, Illinois. Subscription rates, yearly, Five Dollars; Foreign Postage One Dollar additional; single copies Ten Cents. Entered as second class matter at the post office at Chicago, Illinois, under the Act of March 3, 1879.

All the Live News of Radio.....	I to 10
Box Car Cabinet for "Greatest Portable Set".....	4
Indian Brave Sings of Thanksgiving.....	5
Boy's Hobby Grows Up into Station WBBM.....	6
Wild Ducks Launch WHAR.....	7
Following Sports Through Mike.....	10
Operating and Trouble Shooting.....	11
Advance Programs for the Week.....	13 to 21
Evening at Home with the Listener In, a chart in Pacific time, showing when to listen in for your favorite stations.....	20
Editorials, Indi-Gest and Condensed by Dielectric.....	22
Interesting and Simple Explanation of Radio, Chapter IV—Tuning and How Ether Waves Make Music.....	23
DX-Seven: Selective D-Coil 7-Tube Super-Het, Part I—The Choice of Parts, by John G. Ryan.....	25
Fire-side: 6 Tube Set of Perfect Reception, Part IV—Setting Up and Operation, by Jacques Fournier.....	27
Attractive Speaker Easily Built.....	29
Questions and Answers.....	30
Directory of Radiophone Broadcasting Stations, Part II.....	31

# Looking Ahead

**Counterphase: Perfect Bridge Tuned R.F. Set** is the title of a four-article series by James McDonald which will start in the next issue, explaining and giving full constructional data on a receiver with three stages of tuned R.F. amplification. The new method of controlling oscillation by means of a modification of the Wheatstone bridge is utilized in each stage.

**The Construction of DX-Seven Super-heterodyne** is next week carried into the drilling of the panel and the assembly of parts. Since the socket shelf in this set is purchased complete, the work of drilling and assembling is lightened considerably.

**People around Council Bluffs, Iowa**, found it hard to get loud speaker volume through their crystals and single tubers so H. A. Searle, the big oil man of the town, put his two grown-up sons to work and installed Station KOIL on the tallest of the tall hills thereabouts. Now everybody has plenty of music. Read about it in Radio Digest next week.

**Sport writers are unanimous** in declaring the autumn of 1925 has been the greatest football season in history. Capacity crowds have packed the greatest stadiums holding their seats through the most furious onslaughts of rain and snow. Radio broadcasting of games is credited with stimulating much of this unprecedented interest. Pictures and stories of some of the most famous announcers in next week's issue.

## Newsstands Don't Always Have One Left

WHEN YOU WANT

# Radio Digest

YOU WANT IT!

BE SURE OF YOUR WEEKLY COPY BY SUBSCRIBING NOW

SEND IN THE BLANK TODAY

Publisher Radio Digest, 510 N. Dearborn St., Chicago, Illinois.

Please find enclosed check M. O. for Five Dollars (Six, Foreign) for One Year's Subscription to Radio Digest, Illustrated.

Name .....

Address .....

City..... State.....

# RADIO CONTROL STOPS FAST TRAIN

## METALLIC THORIUM OF BIG RADIO VALUE

WESTINGHOUSE RESEARCH FIND AIDS IN SCIENCE

Substance May Now Be Used Commercially on a Larger Scale Than Before

NEW YORK.—A new metal of immediate value and vast possibilities has been added to the world's technical resources in the form of pure metallic ductile thorium, it was reported recently at the exposition of chemical industries, Grand Central Palace here, by Dr. H. C. Rentschler and Dr. J. W. Marden.

Thorium is of particular interest to the Radio enthusiast because it is the active constituent of practically all Radio tube filaments. It can now be produced commercially in filamentary form, while heretofore it has been used only in combination with tungsten, it was said.

In addition to its use in Radio tubes, this metal is of extreme importance to the medical profession as a target material for X-ray tubes, being much more efficient than the tungsten now in use, it was pointed out.

### Aids X-Ray Therapy

"By utilizing the new metal in these targets," said Dr. Rentschler, "tubes producing about 25 per cent more radiations can be made, and the characteristic radiations from thorium give much deeper penetration in X-ray therapy than do

## SON HELD UP—WHT TELLS FOLKS NEWS

GREEN BAY, Wis.—Twenty minutes after the robbery of the West McHenry, Illinois, state bank, the parents of Carl Stenger, one of the employes who faced the bandits' guns, heard of the affair over the Radio as it was broadcast from Station WHT, in Chicago. They immediately got in touch with their son by telephone and learned that, while the Radio report was true, he was uninjured by the bandits.

## DEVICE REMOVES COLLISION HAZARDS FROM R. R. TRAVEL

New System Flashes Signal for Danger and Automatically Sets Brakes When Light Is Not Heeded; Demonstration Proves Success

DETROIT, Mich.—Continuous train control by means of Radio-operated safety devices was demonstrated recently when a 125-ton locomotive, traveling at a speed of 50 miles an hour, was stopped by automatic application of the brakes by means of a Radio-controlled device weighing less than 100 pounds.

By means of a system of Radio-controlled signal lights installed in the cab of the locomotive, it was demonstrated that the engineer can be forewarned of impending disaster by the timely flashing of signal lights, making it possible for him to know many minutes in advance if danger lies ahead.

The demonstration was on a 10-mile stretch of the Pere Marquette railroad with the locomotive equipped with the Radio-controlled safety devices invented by Thomas E. Clark, head of the Tecla laboratories of this city, in the presence of officials of the Michigan Central, Pere Marquette and Clark interests.

### Waves Flow in Rails

"The success of continuous train control," explained Mr. Clark, "depends on the propagation of electro-magnetic waves flowing in the track rails. These waves are picked up by loop collector coils under the 'cow-catcher,' or pilot.

"The waves are pumped into the rails by means of a roadside unit, consisting of vacuum tubes connected with a transmitter as used in a broadcasting station. They transmit on a wave length of 23,000

## DADDY SHOULD BE PROUD OF HER



Who has forgotten the days when Maurice Costello was the matinee idol of the screen? No more do we see Maurice but here (center) is his daughter, who stars in the Warner Bros. screen productions, and before their KPWB mike. Frances Aldrich, left, a Broadway premier dancer, recently talked over WOR. Marjorie Fringle, right, noted soprano and musical comedy star, sings at WBCN, Chicago.

## "Solemn Old Judge" Hay Is "Back Home in Tennessee"

NASHVILLE, Tenn.—Station WSM announces the addition of George D. Hay, "The Solemn Old Judge," formerly of WLS Chicago and originally of WMC, Memphis, to its staff. Mr. Hay last year won the Radio Digest gold cup awarded for the most popular announcer in the country and his cheery voice, pleasing personality, and native ability, have made him an outstanding figure in the Radio world. His new connection with Nashville's station means a broadening of service and a strengthening of efficiency in every way. Mr. Hay will be associated with Miss Bonnie Barnhardt, one of the few women executives in the country, and Jack Keefe, who will help handle the announcing. The combination of George Hay and Miss Barnhardt, both nationally popular Radio figures, is certain to bring WSM, which is owned and operated by the National Life and Accident Insurance company, Nashville, even more prominently into the spotlight position it already occupies as one of the country's leading broadcasters.

## Hear 1XG in Australia

HARTFORD, Conn.—The experimental and short wave length station of WTIC, 1XG, the broadcasting service of the Travelers Insurance company here, has been heard in Australia. Ernest J. Lord of Bowen Hills, Brisbane, Queensland, Australia, owner and operator of QSL-A, picked up signals from 1XG at 5 o'clock in the morning of August 26 at the time the Travelers' station was calling a man down in Brownsville, Texas.

meters to give clear indication signal and a wave of 22,000 meters to give a caution signal.

The loop collector coils are equipped with variable condensers for tuning each coil to the wave lengths propagated in the rails. These coils pick up the various wave lengths and transmit them to the visual signal device in the engine cab. The visual device consists of three lights, red for danger, yellow for caution, and green for clear track ahead.

"Should the engineer be dead or disabled, this automatic train control system brings the locomotive under control and stops at any danger point, at any time, along the electro-magnetized track.

### Sets Automatic Brakes

The red light is flashed only where there is imminent danger of collision. Should a train be occupying a block, the rest of the rail surface within that block becomes automatically demagnetized and another train entertaining the block from the rear or front will receive the danger signal and an automatic application of the brakes.

Following the demonstration, the railroad officials present expressed the opinion that Mr. Clark's invention, if generally adopted, would result in saving thousands of lives annually by prevention of railroad accidents and millions of dollars in equipment destroyed in wrecks.

(Continued on page 28)



those from tungsten. This deeper penetration is of great importance in the treatment of cancer."

Metallurgical thorium, produced by Drs. Rentschler and Marden, has been manufactured in research laboratories on a commercial scale in the form of rods, discs, turnings and in powdered form, so that it can be made in any shape in which it could possibly be used. This will greatly add to its adaptability in Radio.

# This Is World's "Greatest Portable Set"

## The Radio in Camp

A construction camp, when far from a town,  
Is a lonesome place when the sun goes down:  
For the day's work is done, the men all fed,  
And all but myself have retired to bed.

'Tis then that the Radio proves its worth,  
And livens me up with music and mirth:  
The loneliness goes as I listen and hear  
Both music and voices from far and near.  
(From *Indi-Gest*) GEORGE

THEY are still building trails through deserts and the wilderness for the Iron Horse. Horny handed men of toil are still cleaving mountains, hewing trees and laying rocky beds for the steel rails destined to bear on their slender backs limitless tons of human and mercantile traffic for ages to come.

Human brawn and human hearts are still enacting the drama of the pioneer. In one respect, however, there is a wonderful difference now than that which existed in the middle of the last century when the Iron Horse first puffed his way westward to the Pacific coast.

Radio has come.

And through Radio much of the loneliness of the long, star-lit nights has been banished. Dreary chirping of the desert insects has been drowned out by voices from the gay and brilliant centers of the cities, wafted instantaneously through the great, blue spaces to the isolated camp.

We have today the story of George Donaghy, commissary clerk in a railroad construction camp somewhere in the interior of Colorado. George only hints at his surroundings, saying nothing of the assembled crew of weather beaten men crouch-

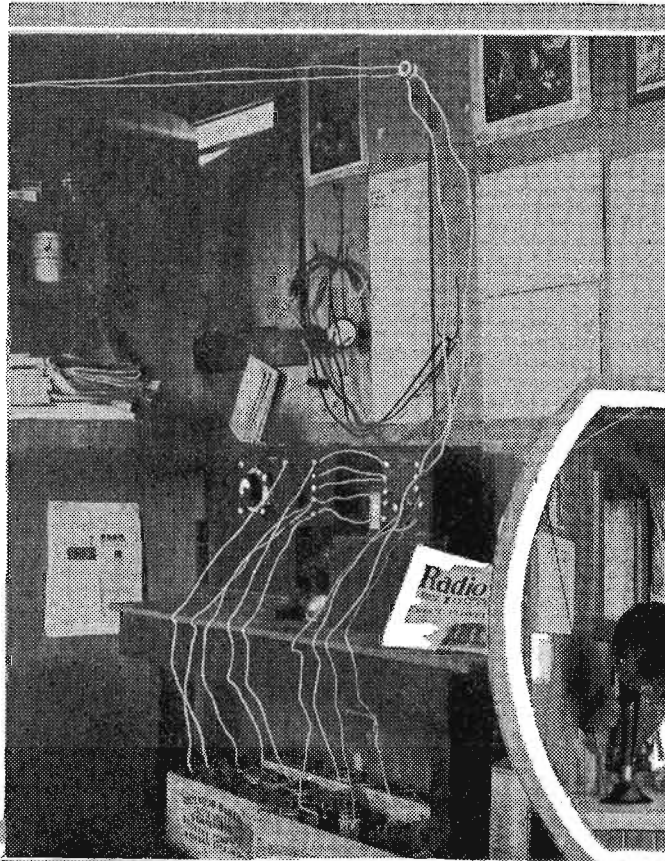

ing on the tie piles and kegs with flickering lantern light touching the highlights of their dark faces as they listen in silence to the lilting notes that pour from the side door of the old box car, where George has placed the loud speaker to his receiving set.

No argument about silent nights where George Donaghy is. He gets everybody everywhere, it seems and he is duly thankful for the increasingly cold nights when the programs come clearer and louder.

Almost as marvelous as the Radio itself is the fact that so many men who live work-a-day lives find keen zest in understanding the why and how of Radio and that these men (Continued on page 10)



Indi calls this the largest "portable receiving set" in existence. You have to get inside the cabinet, which happens to be a box car, to turn the dials. But it isn't any too big for the purpose it serves in bringing the outside world to the hard working men of the C. B. & Q. R.R. now building a railroad line into a remote region of Colorado. George Donaghy, whose contributions are familiar to Radio Digest readers, is shown directly above in his commissary office. Beside this picture is the set described in his story. Even a private compartment in a "side-door Pullman" may be made tidy as shown in George's den at the left. Below is the general view of this remarkable "receiving set," part of the construction gang's train. When evening comes the men gather around while George tunes in cities from all sections of the country. The loud speaker is placed so that all can hear. The distant howl of the coyote and the hoot of the owl are mingled with strains from dining rooms of the greatest hotels. They receive the world news of the hour as it has developed since the evening before.

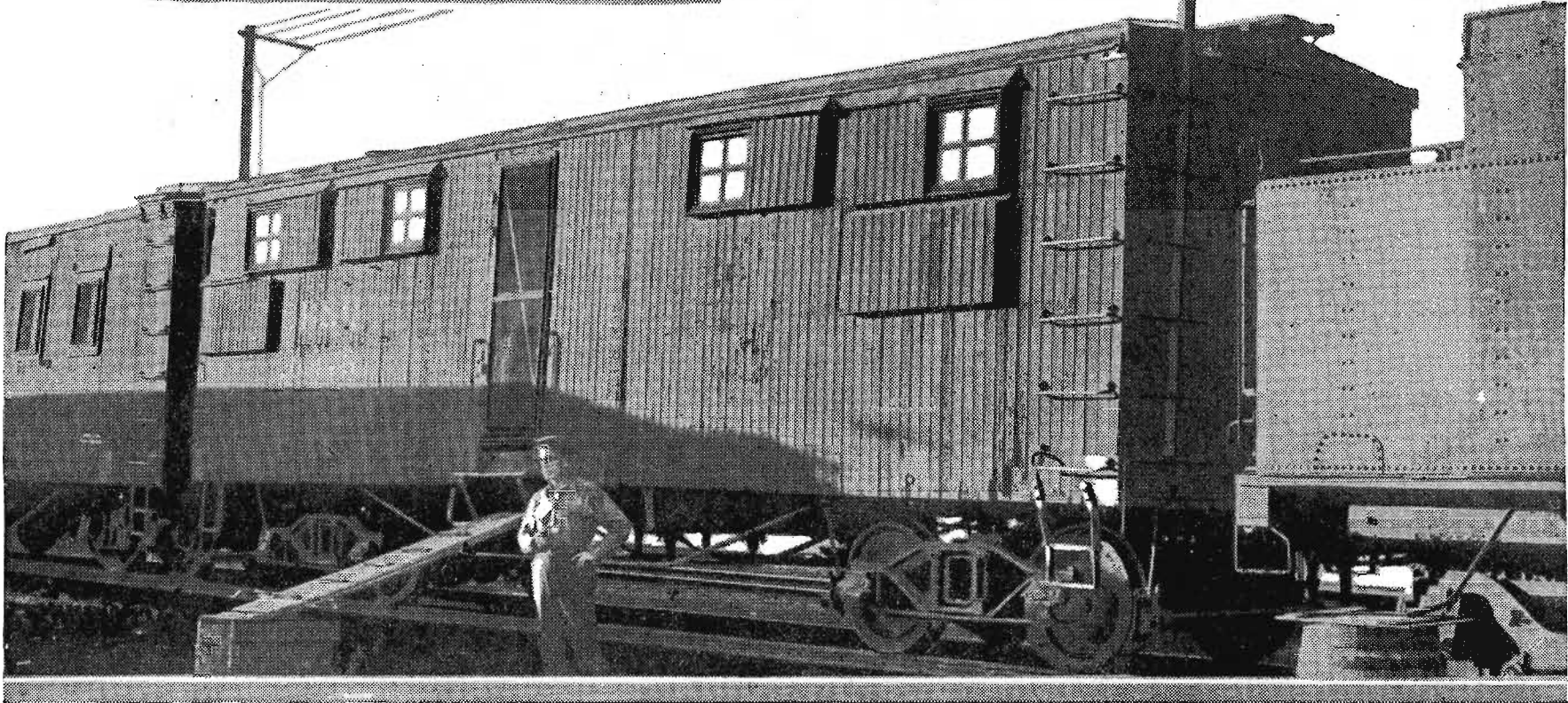

## Indian Brave to Sing Thanksgiving Song

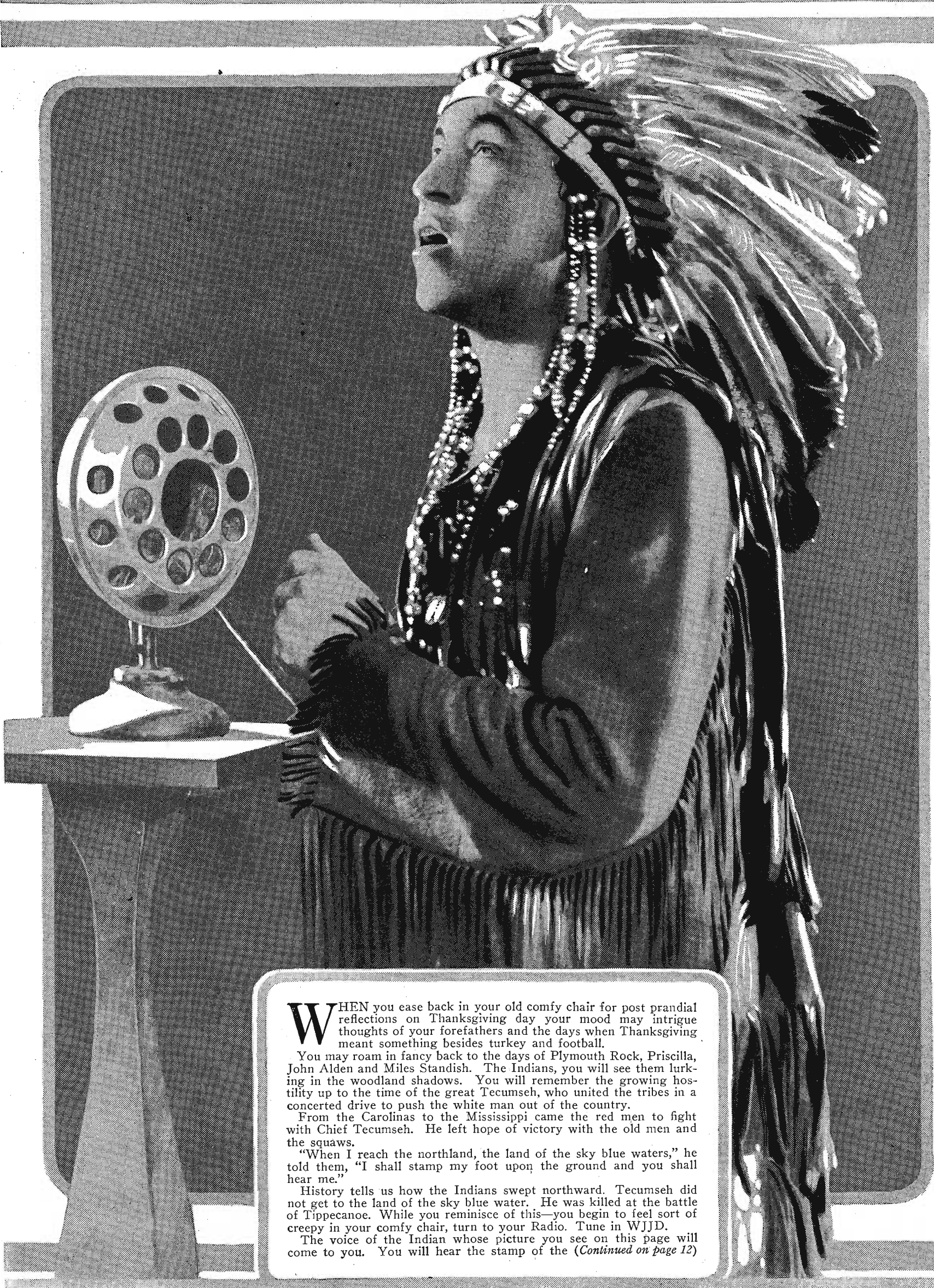

**W**HEN you ease back in your old comfy chair for post prandial reflections on Thanksgiving day your mood may intrigue thoughts of your forefathers and the days when Thanksgiving meant something besides turkey and football.

You may roam in fancy back to the days of Plymouth Rock, Priscilla, John Alden and Miles Standish. The Indians, you will see them lurking in the woodland shadows. You will remember the growing hostility up to the time of the great Tecumseh, who united the tribes in a concerted drive to push the white man out of the country.

From the Carolinas to the Mississippi came the red men to fight with Chief Tecumseh. He left hope of victory with the old men and the squaws.

"When I reach the northland, the land of the sky blue waters," he told them, "I shall stamp my foot upon the ground and you shall hear me."

History tells us how the Indians swept northward. Tecumseh did not get to the land of the sky blue water. He was killed at the battle of Tippecanoe. While you reminisce of this—you begin to feel sort of creepy in your comfy chair, turn to your Radio. Tune in WJJD.

The voice of the Indian whose picture you see on this page will come to you. You will hear the stamp of the (Continued on page 12)

# Boy's Hobby Grows Up Into Station WBBM



Nate Caldwell, chief announcer at WBBM (left). He also twa-i-eeen-nngs a wicked uke when he feels like it. Below, Eddie Loftus, announcing; Louis H. Russell, tenor, and Charlie Garland, program director at the piano. The little lady with the big harp is Miss Marie Morgett, staff artist of WBBM, former concert star known from coast to coast. The trio are in the Stewart-Warner studio of WBBM, one of the remote control stations.



**I**T means literally a "world" of difference whether a new station receives the letter "W" or "K" for its initial call letter. Have you ever noticed what an unusually large number of world beaters have developed with the use of that one little letter "W"?

We have the "World's Largest," the "World's Greatest," the "World's Most" and several other kind of superlative "world's." Never before did the retiring old world get shoved out so forcefully into the limelight. But what could you do with a "K" that could excel the world? It might stand for "King" of this, that or the other thing but kings have become quite passe of late.

All of this leads us to Station WBBM, Chicago. At first we thought this station stood out as a world exception—that "WBBM" simply meant a great big broadcasting station, 1,500 watts strong, and nothing else. But somebody, according to the files, at some time or another hitched the slogan "World's Best Broadcasting Medium" to it and so we now have the World's Best.

If WBBM claims to be the world's best it should be worthy of a visit by the average listener. It's down there near the zero if you don't happen to have the 226 meters mentally logged for this station.

Ah, you have it. That's Charlie Garland, the program director, announcing one of the Chicago Civic Opera stars—these celebrities sing regularly over WBBM, you know. It sounds interesting. Let's transmit ourselves out to the station and get acquainted with the folks.

First, we stop off for a glimpse into the executive office directly across from the Broadmoor hotel, where the original studio and station plant are located. Three studios are now operating from the station. Behind that mahogany

desk heaped up with letters from interested listeners is Mr. H. Leslie Atlass. His brother, Ralph, also has an office here. The Atlass brothers originated Station WBBM in Lincoln, Ill., just two years ago.

For years they had been playing with Radio as a hobby. Then they developed a 200-watt station, brought it up to Chicago and found a place for it on top of the Broadmoor hotel. But you can't do much with 200 watts in Chicago's mad etheric whirl, so last June they threw in 300 more watts. Before the 500-watt job was fairly finished the workmen were instructed to add another thousand watts. Their very able engineer, R. C. Page, says his newest generator can, in a pinch, kick 20,000 watts off the WBBM antenna. It is claimed to be the largest single generator ever built for Radio—hence "World's Best Broadcasting Medium."

This plant you observe in the Broadmoor. Here, too, you more often find Charlie Garland, "ace" of Chicago's program directors. Garland is famous as a baritone, pianist, song writer and organist. His latest popular song, just out from the publishers, is called "Nighttime." He has published twenty-one hits in the last few years.

Then there's Fred L. Jeske, who is too well known in Radio to need any special introduction. He's a newcomer at WBBM but his songs in the short time he has been on the job have proven one of the features of

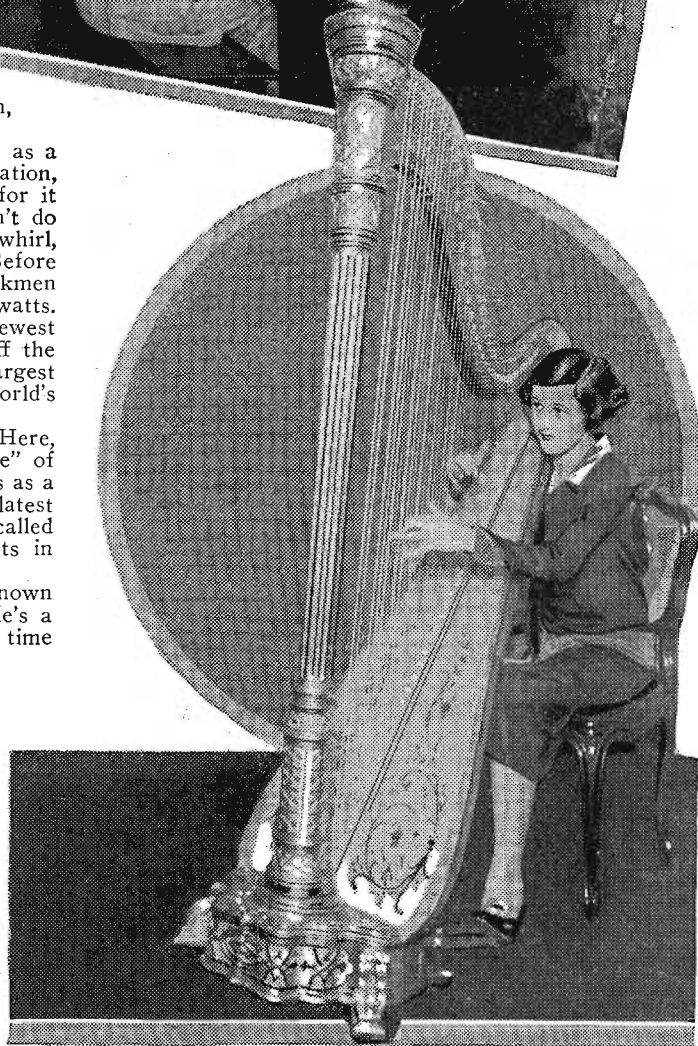

the programs, as attested to by the fans' letters.

Down toward the loop, broadcasting from remote control to WBBM's plant is another WBBM studio located at the Stewart-Warner Speedometer corporation's plant and offices, 1828 Diversey Parkway. This studio is on the air twenty-three hours each week. In the Temple building, under the golden cross at 77 W. Washington st., is the newest of the three studios, that of the North Side Realty Co. Both of these studios are the last word in equipment and efficiency. They are artistically designed and intended as an inspiration to the artists who perform in them.

Another WBBM artist to be heard at one of these studios regularly is Corrine Jordan whose flying fingers tease anything from syncopation to the most difficult operas from the piano keys. Besides her personal contributions she serves as assistant program director and chief-pianist. Tune in on WBBM and, you never can tell—she may be playing.  
(Continued on page 28)

Murray Smith, at microphone and Charlie Garland. Right, the WBBM orchestra with Frank King, 20-year-old leader. The members of the orchestra, left to right, are: Clarence Zylman, Elwood L. Russell, Frank G. King, Jr., Roy Hess, Harold Carlson, Emerson Curtiss, Lawrence Collins and Ted Morrell Vingi.

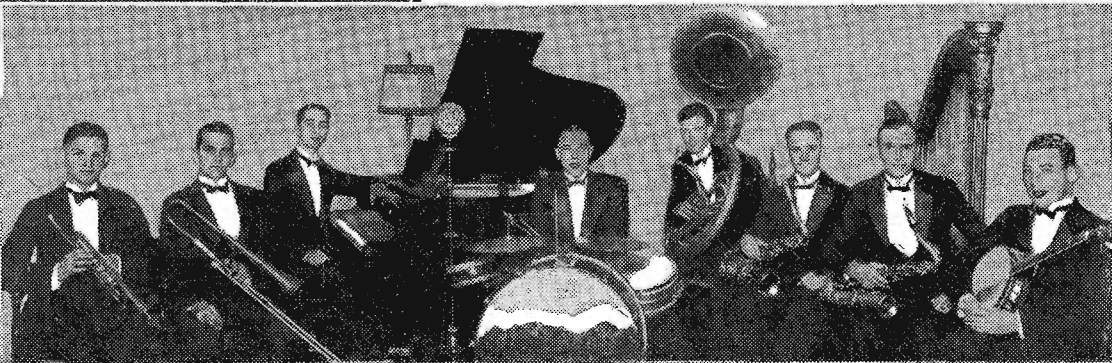

# Wild Ducks Launched WHAR on Its Career

Eastern listeners keep abreast of current literature through the well selected book reviews broadcast by Mrs. James Lord, below.



"Beauty's Capital," that's what they call Atlantic City in September when the beauty queens of the nation hold congress there. At the left is the famous Seaside Hotel, home of WHAR, by-the-broadwalk, and the broad verandas where the fair ones stroll. Below is George E. Dennison, a well-known musical authority whose announcements often are instructive and entertaining as well as informative.

## "WHAR" is WHAR?

If you are within broadcasting radius of Atlantic City, N. J., and that takes in a mighty area, you very well know "whar" WHAR is, as the Yankee farmer says.

You know that it is one of the pioneer broadcasting stations of the United States, located at the Seaside Hotel in the "Bathing Beauty Capital of America."

Where beauty goes romance is. And as Atlantic City is the Mecca for the annual pilgrimage of America's fairest of the fair we expect romance there—and we are never disappointed. You always feel that way when you tune in this station of seaside glamour even as far as Chicago.

Radio at the Seaside Hotel had its inception long before the great majority of the readers of these lines ever dreamed of owning a receiving set. The owners pioneered from the waves at Atlantic beach to the waves of the air and ether.

It began with the amateur enthusiasm rampant before the well-known World war. Harry B. Howell, E. and Harrison B. Cook, owners of WHAR had a shooting lodge up in the marshes about eighteen miles north of Atlantic City. Necessarily they were somewhat cut off from the ordinary methods of communication, wild ducks having a peculiar aversion to telephones and other factors of civilization with visible means of support.

Confronted with the dilemma of ducks or telephones the gentlemen sized Radio by the horn, so to speak, and put in a pair of spark sets. At night with the day's shooting over and business worries flocking in where ducks had flocked before, Mr. Howell would step to the key and simply query through the air, "Well, how is everything in A. C. today?"

Then one of his business associates would code back what had transpired, and in turn he would get decisions from the big boss "right off the bat."

That was the beginning. Then came war and interference. Amateur sets generally were suppressed. But the ardor of these Radio sportsmen did not diminish. When the C W sets came along the old Radio stork dropped little ten watt Western Electric transmitter WHAR down the Seaside Hotel chimney.

How that child did grow! She became the talk of the town. Quite likely there were some squawks and a few shrieks during those infantile days. But now look at her—one of the most dashing and progressive young five hundred watt ladies in the country! And there is talk of endowing her still further with double this power.

Because of the history of WHAR, old-timers are wont to look upon the judgments of its founders with respect and some veneration. This station has consistently maintained its pace. They have been first to introduce many innovations in general use today. They have been looking forward to the demands of tomorrow. "What is the tendency of Radio music?" Mr. Harry B. Cook repeated the question that had been put to him and took not a moment to make his reply.

"Class," he said, "the monotony and thump of jazz rythm has become a bore to the greater number of Radio listeners. You can't expect it to die out all at once but jazz is surely and decidedly on the wane. The fans are tuning it out for the better class of music. Letters and comment show the trend."

"An Hour with the Classics," broadcast each Sunday night by the Seaside Hotel Ensemble has become one of the most popular features of the WHAR programs. Marsden Brooks, leader of the Ensemble is enthusiastic over the way the fans have responded with postal encores. Coordinated with this leaning toward the better things in music are the personalities of the announcer and directress, Eugene E. Dennison and Mrs. A. R. Dennison. Both are accomplished scholars. Mr. Dennison's voice is well adapted to the microphone and he is perfectly familiar with musical lore and musicians.

Mrs. Dennison, directress, has the refined, hospitable manner of a gracious hostess (Continued on page 24)

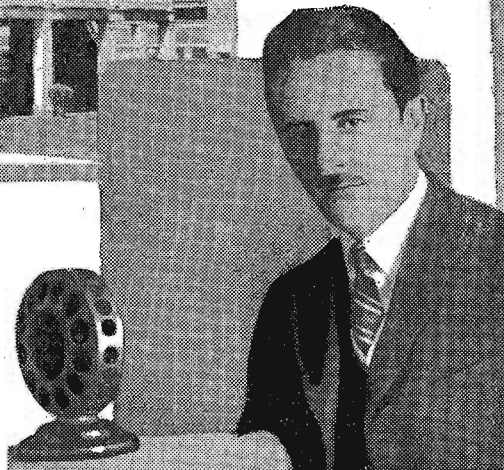

Amelia R. Dennison, above, studio directress who conducts the WHAR parlors as a gracious and hospitable hostess.



Those organ recitals so popular throughout the eastern countryside and along the seashore, tuned in through Station WHAR, come from this awe inspiring keyboard manipulated by the nimble fingers of William Jackson, above. The organ is located in the Strand theater at Atlantic City. To the right is the Seaside Hotel. Our correspondent did not send their individual identities. They are best known by their entity as the trio, is was stated. These two program numbers are considered the leading features of WHAR.

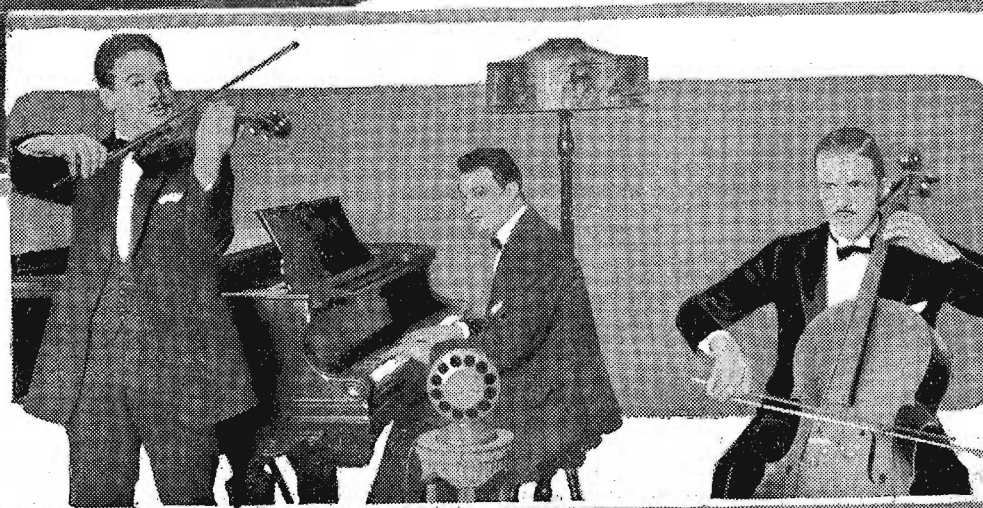

Much of the established prestige of WHAR is due to Earl Godfrey, above, chief operator, responsible for the regular and unfailing technical results.

## CITIZENS' WIRELESS NET WORK IS AID TO NATIONAL DEFENSE PLAN



Above, the three operators in charge of the transmitting and receiving sets at Fort Monmouth have been trained in the U. S. Signal corps school for this work. Center, the 40-meter transmitter in the control station. Right, the control station and aerial for 40-meter transmission.

### AMATEURS TO HELP ARMY RADIO LAYOUT

#### NETWORK TO CONNECT ALL U. S. MILITARY OUTFITS

Fort Monmouth Is Center of System  
for Use in Defense and Other  
Emergency Cases

RED BANK, N. J.—Fort Monmouth, located nearby, is busily putting into effect a far-reaching plan for complete Radio communication for every National Guard and organized reserve unit in the United States Army and a host of civilian Radio operators trained in the methods of the army.

The war department has authorized an agreement between the signal corps and transmitting Radio amateurs, the latter under the supervision of the American Radio Relay league, with headquarters in Hartford, Conn., which will mean much to the welfare of the nation.

#### Country Divided Into Zones

Various zones throughout the country will have in each of them civilian Radio stations ready to function when land lines are down due to storm, civil disturbances or actual warfare. These amateurs will act as communicating stations for battalions, regiments, brigades, divisions and corps area headquarters securing a large reserve of Radio operators thoroughly trained in army methods of procedure and skilled in field work.

In addition the army will have added the facilities of the American Radio Relay league member stations to the Radio experimental section of the signal corps. Considerable experimenting is being carried out with short waves—forty and eighty meters—both in the army and among amateurs.

#### To Relay Army Orders for Practice

Routine reports of National Guard and organized reserve units are to be transmitted by Radio to supply the necessary amount of practice traffic work to properly initiate Radio amateurs into methods of handling army material.

A liaison agent at the Signal School, Fort Monmouth, where the control station of the entire system is located, will direct work in the various zones. Already the large map on the wall of the control station presents a vivid picture of busy amateurs strengthening the network of national protection.

### Small Evansville Station Is Arousing Much Interest

EVANSVILLE, Ind.—Radio Station WGBF here broadcasts a morning family altar worship service each morning at 7:15. This is broadcast under the auspices of the Protestant Deaconess hospital of this city. This service has been on the air for about six weeks and the group of listeners in it steadily increasing. A certificate of membership is sent to those who telephone the station or those who request it by card or letter. The services last for thirty minutes and there has been an unusual amount of interest shown in same. They also broadcast a Radio question and answer program on Tuesday night from 7:30 to 8:00 preceding the musical program, answering all Radio questions pertaining to receiving and transmitting that are sent by the Radio audience. The station is just 100 watts power, but has been heard in practically all parts of the United States and also in Mexico and Canada.

C. C. Brannaman is now the chief announcer at WOS, Jefferson City, Missouri. This station is operated by the state department of agriculture.

### New Stations

"Carry Me Back to Old Virginy" is a favorite selection with Radio artists. Last week fans tuning in on 256 meters noticed that a new powerful station was signing off with this melody played by an orchestra. The new broadcaster is WRVA, the 1,000-watt station at Richmond, Virginia.

The University of Texas at Austin, Texas, has discarded its old 250-watt set operated under the call WCM for a 500-watt equipment. The new call is KUT and the wave 231 meters.

KFON, Long Beach, Calif., dedicated its new 500-watt equipment on Armistice Day, November 11, with a patriotic celebration lasting twenty-four hours. The wave length remains 232.4 meters.

This month brings a change of call to WBBG, Mattapoisett. This station will hereafter be known on the air by the letters WNBH. Wichita, Kansas, will have a 500-watt station this month when WEAH goes up in power.

Other stations licensed last week are: KFYJ, Houston, Tex., 10 watts, 238 meters; WCWS, Providence, R. I., 100 watts, 209.7 meters; WPDQ, Buffalo, N. Y., 50 watts, 205.4 meters.

Two stations were transferred from class A to B, WSM, Nashville, Tenn., and KOIL, Council Bluffs, Iowa.

Stations deleted last month were: KFWD, Arkadelphia, Ark.; WCBU, Arnold, Pa.; KFJZ, Fort Worth, Tex.; WGBG, Thrifton, Va.; WSAU, Chesham, N. H.; WHBB, Stevenspoint, Wis.; KFCC, Helena, Mont.; WIBP, Meridian, Miss.; WTHS, Flint, Mich.; WGBT, Greenville, S. C.; WABB, Harrisburg, Pa.; WEAY, Houston, Tex.; WABA, Lake Forest, Ill.; KFRL, Grand Forks, N. D.; WIBT, New York, N. Y.; KFOL, Marengo, Iowa; WBT, Charlotte, N. C.; WIBK, Toledo, Ohio; KFAN, Moscow, Idaho; WCBG, Ann Arbor, Mich.; KFUT, Salt Lake City, Utah; KFSY, Helena, Mont.; KFUV, Springfield, Mo.; WIBD, Joliet, Ill.; KFUZ, Virginia, Minn.; WSAC, Clemson College, S. C.

#### WTIC Heard on Phone Line

HARTFORD, Conn.—It is reported from Torrington, Conn., some twenty-five miles distant from Hartford, that while talking on the telephone to a friend in Hartford they heard a Radio program being broadcast by WTIC. Both men claim that the tones of a violin could be heard very plainly and there was little or no interference.

### OLD-TIMER BACK AS WJZ FEATURE

Literary Vespers Series Now in  
Fourth Year with Excellent  
Schedule Planned

NEW YORK.—Another of the former favorites returned to the ether recently when Station WJZ broadcast the first of the fifth series of literary vespers conducted annually here in Aeolian hall by Edgar White Burrell. This feature can be considered one of the real old-timers of Radio, having been broadcast by WJZ for over three years.

The opening vespers used the title of "The Radio of Spirit" and the book discussed was O'Henry's "The Green Door." The last two vespers were: "The Outposts of Peace," book, "The Enemy," Pollock, and "The Trail of Rapture," book, "The Green Hat," Arlen.

The following table gives details of future vespers, all of which will be broadcast at 5:45 p. m., eastern time, on Sunday afternoons:

November 22—"The Magic of Memory," book, "When We Were Very Young," Milne.

November 29—"The Ascent of Man," book, "Tintern Abbey," Wordsworth.

December 6—"The Factor of Fate," book, "The Rubaiyat," Khayyam.

December 13—"The Judgments of Men," book, "The White Monkey," Galsworthy.

December 20—"The Triumph of Truth," book, "The Man Nobody Knows," Barton.

January 3—"The Yoke of Yesterdays," book, "Dear Brutus," Barrie.

January 10—"The Hunger for Beauty," book, "Desire Under the Elms," O'Neill.

January 17—"The Rewards of Failure," book, "Blind Raftery," Byrne.

January 24—"The Threshold of Tomorrow," book, "The Great Secret," Maeterlinck.

### Erect Short Wave Station for Transatlantic Service

LONDON.—A beam (short wave) station is being erected at Dorchester by the Marconi company for communication with North and South America. So far five masts have been erected in a straight line at right angles to the direction in which communication is to be established—New York.

E. W. Mathias, engineer in charge of construction, says there exists no theoretical reason why, with a frequency of 3,000,000 cycles (100-meter wave), the speed should not be 100 times as great as that obtainable with a frequency of 30,000 cycles, which corresponds to a long wave length of the order of those used by such high-power stations as Rugby.

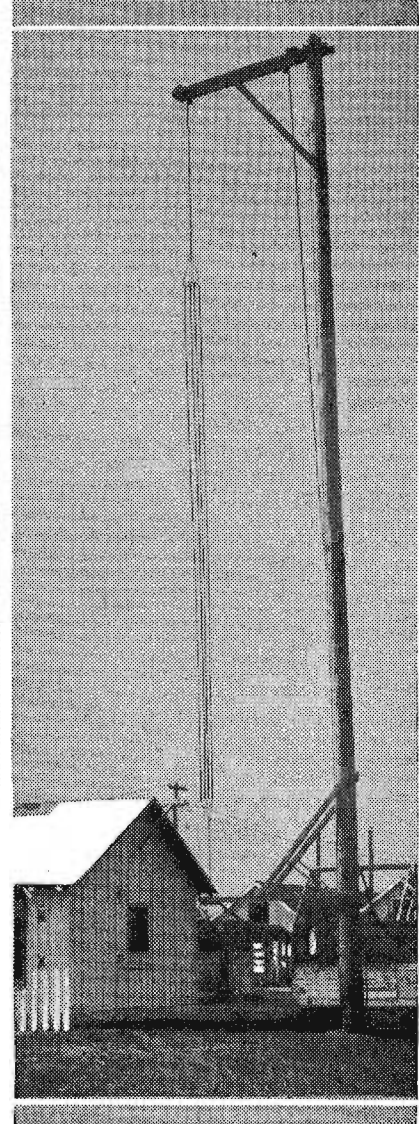

### ENGLISHMAN DEFIES LICENSE COLLECTOR

SAYS "HOUSE IS CASTLE"  
AND ACTS ACCORDINGLY

London Man Holds Radio Inspection  
Is Outrageous; Raises Flag  
and Invites Force

LONDON.—Robert Moffat Ford, the Radio fan who defied the postmaster-general by refusing to pay the license fee for his receiver, and whose action incidentally led to the passing of the Radio Telegraphy (Explanation) act in the last session of parliament, has had a new clash with the postal authorities.

Recently he came out of his house with a flag and a board bearing the words: "This is an Englishman's castle." These he nailed over the door, and, going inside the house again, barred the door. Mr. Ford was expecting a call from the post office Radio officials. Presently they came.

#### Promises Warm Reception

There was no suggestion of force about the officials. One of them said to Mr. Ford: "You have written to the postmaster-general saying that you will give his spies a fitting and hearty reception in an Englishman's home. What do you mean by that?"

"Exactly what it says," replied Ford. "A warm reception—flags and all that in your honor."

He added that he declined to allow them to examine his premises, and did not admit having any Radio apparatus.

"My action," he continued, "is a protest and a resistance to the right of search claimed by the postmaster-general. Domestic search, unless regarding health, is outrageous. It is monstrous when done for the purpose of collecting moneys for a profit-making company." The officials then left.

### "Radioville" Now On Map

DENVER.—Discovery of a new town—Radioville, Alaska, is announced by KOA, General Electric station at Denver. In the meantime, the KOA staff is scrutinizing atlases and railroad and post office records for data giving the city's geographical location. First information of the existence of this far northern point was obtained last week in a telegraphic applause message from Joseph P. Bauer, Radio enthusiast of Radioville. It is assumed that this town is a real DX station.



# 'ROXY AND HIS GANG' HEARD ON AIR AGAIN

## WEAF LINK AGAIN CARRIES MUSIC OF FAMOUS STAR

Many Well-known Artists Listed In Group Noted for Excellent Radio Programs

NEW YORK.—"Roxy and His Gang" have returned to Radio again and are broadcasting an hour of entertainment through WEAF, WCAP, and WJAR, simultaneously. Announcement was made that every Thursday evening these favorites headed by S. L. Rothafel would be heard through WEAF, WEEI, WGR, WTAG, WFI, WSAI, WWJ, WOC, WCCO and KSD from 9 to 10 o'clock, eastern time, 8 to 9 central time.

### Artists Are Well Known

The "Gang" which has been formed again, includes several artists who are well known to the Radio audience. Following is a partial list of those who will participate in these weekly programs:

Duke Yellman and orchestra, Douglas Stanbury, baritone; Jack Oakley, baritone; Joseph Wetzel, tenor; Adrien De Silva, tenor; Frank Moulan, singer-comedian; Max Terr, accompanist; Olive Cornell, coloratura soprano; Phoebe Crosby, soprano; Jessica Dragonette, soprano; Fred-eric Fradkin, violinist; Joseph Stopack, violinist; Florence Mulholland, contralto, and Geoffry O'Hara, noted singer-composer. Many other artists will be included, most of them being old favorites of Roxy's invisible audience.

# SINGER'S BREATHING HEARD IN FAR NORTH

PITTSBURGH.—In a letter received at Station KDKA, here, from the naturalist, Dewey Soper, who is spending two years in the interior of southern Baffinland at the Arctic Circle for the Canadian government was the news that the concerts from Station KFKX, Hastings, Neb., came in so clear and strong that the listeners were able to detect the breathing of a girl singer on the program. Radio has done much to help the scientists wile away the dreary cold nights in the Northland.

# LOOKS BELY VOICES WRITES WOMAN FAN

NEW YORK.—The pulchritudinous attainments of Radio broadcasters are not very high in the opinion of a woman in Belstville, Md., according to a letter received from her by Arthur Bagley, who broadcasts the "Tower Health Exercises" every morning at 6:45 a. m. through Stations WEAF, WEEI and WCAP. "After the exercises," she writes, "I rest by listening to the pianist, but don't send me his photo, as I am so disappointed when I see the pictures of the announcers and broadcasters."

# SPIRITUALISTS SEEK RADIO WAY TO DEAD

## OPEN COMPETITION TO GET HOOK-UP WITH BEYOND

Edison Abandoned Idea Sometime Ago, But Mediums Believe Afterlife Communication via Wireless Possible

LONDON.—The International Spiritualist congress, now being held in Paris, has decided the time has arrived for simplifying the means of communication with the unseen world, and to this end it is proposed to open a competition for the construction of an instrument which would enable the shades of the departed to communicate more easily with the living.\*

Spiritualists attending the congress are convinced that the idea is capable of realization, and the more so because it is reported that time after time in recent messages from the beyond spirits have declared that the discovery of a new system was imminent, and that inquirers had only to search a little while before they found it.

Two inventors already have claimed to have discovered a kind of spiritualist Radio.

(\*The idea is by no means new, for Edison once set his hand to the invention of such an apparatus, but eventually abandoned the attempt.—Editor's Note.)

# Fire Destroys WNOX Plant; Tennessee Station Off Air

KNOXVILLE, Tenn.—Equipment of broadcasting Station WNOX of the People's Telephone and Telegraph company here, was recently destroyed by fire of unknown origin. The transmitting equipment, that of a \$20,000 plant, is completely out of commission. The fire took place about midnight, the station having signed off at 9 o'clock. It is not known whether the station will be rebuilt or not.

"The Ancient Fiddler of Brunswick," a strange character discovered by the MacMillan Arctic expedition in northern New Brunswick. He has entertained the natives for near four-score years. Commander McDonald introduced him to "Mike" and his fiddle was heard in Washington.

# RADIO KILLS ARCTIC ROMANCE

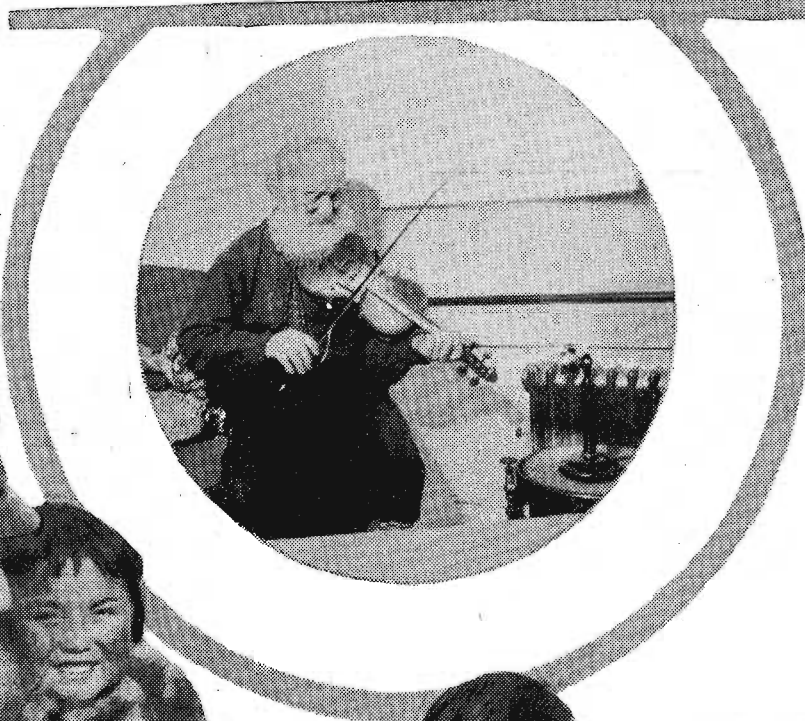

Commander E. F. McDonald of the S. S. Peary with the MacMillan Arctic Exploring expedition telling bed time stories to hard boiled little Eskimos who smoke cigarettes. At the right is the S. S. Peary, which he sailed to within eleven and one-half degrees of the North Pole. Messages from New Zealand were relayed in short waves from here to Chicago.



OH WHAT'S the use, what's the use? All the old kick of sailing away to unknown lands is gone. You're foolish if you aren't equipped with Radio. And to have Radio you can't get away from civilization—not even all the way up to within eleven degrees of the North Pole.

If you don't believe that ask Commander E. F. McDonald, Chicago Radio inventor, just returned from North Greenland, whence he commanded one of the two ships of the MacMillan expedition.

"It's not like the old days," said Commander McDonald, "when the explorer kissed his loved ones farewell, for years probably and maybe forever, and went aboard his ship to penetrate far, far beyond all contact with the civilized world. No, you can't do that any more.

"True enough, to quote the famous cartoonist, 'them days is gone forever.' The world was not looking forward to our story when we returned. They had already read it. They had received it day by day by Radio.

"We had nothing to tell that had not been published in the news dailies of civilization. Then, too, in Arctic explorations of the past the returning explorers eagerly looked forward to the news of the world. MacMillan, for instance, returning in 1917 from four years in the white north learned for the first time that the world had been at war since 1914.

"Returning this year we were looking forward to no news because we had our daily newspaper at our place at the breakfast table each morning, the news items having been received by Radio during the night and typed by our chief Radio operator, Paul McGee."

Commander McDonald said they had followed the search for the Pacific fliers each day, knew of the Shenandoah disaster two hours after it had happened and of Bryan's death within thirty minutes after it had been discovered. They even followed the World's Series games as broadcast from the fields. But still there is something left that calls men to the Arctic.

"Commander MacMillan often tried to make me understand this appeal but words were lacking," said McDonald. "Robert Service in his 'Spell of the Yukon' couldn't make me understand. But I know now thought I cannot tell what it is. I only know I am going back again."

He spoke of the wild and primitive life, the birds, the animals, the fairland of ice and snow, savage grandeur and of the Eskimos as the happiest people in the world. Then he switched back to the Radio as he sat in his richly furnished office in the Straus building, his feet perched on the edge of his desk.

"We sent out over a million and a half of words. I haven't had time to count

what we received but it probably will total half this amount. I was in as close touch with the Zenith Radio corporation as thought I had been sitting at my desk. Mr. S. I. Marks, our general manager, ofttimes had a decision from the Arctic in five minutes after had sent his Radiograms.

"We conquered the twenty-four daylight by using wave lengths ranging from sixteen to forty meters, thirty-seven  
(Continued on page 26)

**FOLLOWING SPORTS THROUGH MIKE**

**TEN PLANTS TO GIVE YALE-HARVARD TILT**

**FOOTBALL "CLASSIC" WILL HAVE LARGE AUDIENCE**

**J. E. Murley Handles Big Eastern Chain Mike; WEAH Link to Handle the Game Also**

BOSTON—From the countless thousands of letters received from football enthusiasts all over the country, it is apparent that the Harvard-Yale game, the leading football classic of the East scheduled for the Harvard stadium grid-iron this year, will be attended through the medium of Radio broadcasting by the largest audience in the history of this annual struggle.



**J. E. Murley**

With the capacity of Harvard stadium approximately 55,000, it is even doubtful if all the alumni of America's two foremost universities will be eye-witnesses of this contest, and arrangements have been made to broadcast a play-by-play description of the colorful battle for the benefit of the hundreds of thousands of listeners unable to secure the priceless pasteboards admitting the holder to Harvard stadium on this gala occasion.

**Jim Murley at Mike**

As station WBZ is now engaged for its second year in broadcasting the home games of the Harvard eleven, it falls upon WBZ to make available for the host of football enthusiasts and listeners of the station through its now famous football announcer, J. E. ("Jim") Murley, former sports writer on several Boston newspapers, and publicity director of Station WBZ, a running account of the game together with such sidelights as the cheering, band music, and general excitement current at important collegiate events.

The annual classic, scheduled to start at 2 o'clock Saturday afternoon, November 21, will be broadcast direct from the Harvard stadium and when "Jim" Murley goes on the air about half an hour before the referee blows the starting whistle, it is doubtful if any other man will have as many people listening to his every word. Not only will his vivid play-by-play description of the game he heard on the WBZ wave, but the voice of this popular football announcer will also be sent out through the Radio Corporation Stations WJZ in New York, WRC in Washington, and the superpower station of the General Electric company, WGY in Schenectady. Station WEAH and the following, WCAP, WJAR, WSAI, WTAG and WTIC, will also broadcast this game.

With these superpower stations along the Atlantic seaboard tied-in with WBZ, and the WEAH link on the air, listeners in the eastern half of the United States and Canada are assured excellent reception of the report of this contest, and so powerful is the range of the stations linked together for this broadcast, listeners in the western half of the country will be able to hear the signals sent out through the ether.

**To Use Sensitive Pick-Up**

Very sensitive pick-up equipment, specially designed for this type of work, has been installed on top of the Harvard stadium. Two microphones are under the control of "Jim" Murley, one suspended by wire into the stadium, and the other used in sending out his play-by-play account of the game. The stadium mike picks up every sound even to the referee's whistle, the thud of the ball and body impacts, and the barking of the quarterback's signals. Add to this, "Jim" Murley's knowledge of the game and his interesting and colorful style of transposing the rapid plays from an eye picture into a word picture, for which he has received the praise of thousands of WBZ's regular listeners, and the football enthusiasts who listen in to one of the stations of this powerful chain are assured an enjoyable broadcast.

**Inspector Hits Music Trust**

SPOKANE, Wash.—Authors and composers who want to be paid exorbitant fees for having their copyrighted songs broadcast are the "greatest danger" confronting the Radio industry, according to Federal Radio Inspector O. R. Redfern, while holding a meeting for Radio fans here recently.

**Football Broadcasts**

**Saturday, November 21**  
**California Bears-Stanford Cardinals,** KLX (508), KPO (428.3).  
**Chicago - Wisconsin,** KYW (535.4), WMAQ (447.5).  
**Harvard-Yale,** WBZ (333.1), WCAP (468.5), WEAH (491.5), WGY (379.5), WJAR (305.9), WJZ (454.3), WRC (468.5), WSAI (325.9), WTAG (268), WTIC (475.9), WGR (319).  
**Idaho-Oregon Aggies,** KFAU (278).  
**Michigan-Minnesota,** WCCO (416.4), WGN (370.2), WJR (517), WWJ (352.7).  
**Northwestern-Notre Dame,** WBBM (226).  
**Ohio State-Illinois,** WEAQ (293.9).  
**Southern California-Iowa,** KNX (337), WOC (428.3).

**Thanksgiving Day**  
**Thursday, November 26**  
**Bucknell College-Detroit U,** WJR (517).  
**Cincinnati-Miami,** WSAI (325.9).  
**Cornell-Pennsylvania U,** WBZ (333.1), WEAH (491.5), WGY (379.5), WJZ (454.3), WTAG (268), WIP (508.2), WCAP (468.5), WGR (319), WJAR (305.9).  
**Iowa State College-Kansas Aggies,** WOI (270).  
**Montana U-Montana State College,** KUOM (244).  
**Multnomah-Gonzales,** KGW (491.5).  
**Nebraska-Notre Dame,** KFAB (340.7), WGN (370.2).  
**New Mexico Aggies-N. M. Military Institute,** KOB (348.6).  
**Pittsburgh-Pennsylvania State College,** KDKA (309.1).  
**Washington-Oregon,** KFOA (454.3), KGW (491.5).  
**Baylor U-Rice Institute,** KRRC (296.9).  
**Vanderbilt-Sewanee,** WSM (282.8).

**Southern California U. Games Are Rebroadcast**

**KNX Picks Up Football on Portable Transmitter**

HOLLYWOOD—KNX, "The Voice of Hollywood," will broadcast play-by-play the following schedule of the University of Southern California, playing in the huge bowl of the Los Angeles Coliseum:  
 Nov. 21—Iowa vs. U. S. C.  
 Nov. 23—Washington vs. U. S. C.  
 Dec. 5—Oregon Aggies vs. U. S. C.  
 Dec. 12—St. Marys vs. U. S. C.  
 The big East vs. West inter-sectional game held annually in the Pasadena Rose Bowl on New Year's day will also be broadcast, but at this time it is not known what teams will compete. Possibly Dartmouth or Penn will journey out to the Pacific this winter and try the Golden Bear team from Berkeley, California.  
 The games are handled by a rebroadcast instead of the usual telephone line connections. 6XA, a 100-watt, mobile transmitter owned by the W. P. Herbert Chandler company, mounted in a Chandler sedan and licensed to broadcast on 110 meters, goes direct to the field where Loyal Underwood of the KNX staff broadcasts the plays as they are made. The signals from 6XA are picked up in the KNX studio and rebroadcast on 337 meters. Rebroadcasts so far have been exceedingly well done.

**WSM GIVES DIXIE ITS FIRST TINY SYMPHONY**

**Nashville Station Presents Orchestra of Exceptional Quality**

NASHVILLE, Tenn.—"The Athens of the South," Nashville, through its great new Station WSM, of The National Life and Accident Insurance company, again adds one more reason for its reputation as a center of culture, in the organization of the South's first little symphony.  
 The little symphony made its debut not only to Nashville, but to the Radio world, in a special advance concert Tuesday, November 3, from 6 to 7 o'clock. The twenty-five leading Nashville musicians assembled in WSM's beautiful new studio at that time and gave a program particularly adapted to Radio transmission and one that was not only of the highest musical standard but tuneful and melodious as well.  
 Nashville's big symphony began its series of Sunday afternoon concerts November 8, and will present one on each of the following dates: December 13, January 17, March 14, April 25. These will be broadcast by WSM.  
 The little symphony movement originated and was launched by Miss Bonnie Barnhardt, director of WSM, and George Allen Jackson, chairman of the board of directors of the Nashville Symphony orchestra.

**NEWS BRIEFS FROM THE BROADCASTERS**

**EDISON HOUR-GRAND TOUR NEW FEATURES AT WJZ**

**KPO's New Entertainer Parrot—Zoo Talks at WRC—English Poet at WKAR**

Due to a conflict in the schedule of Commander Donald B. MacMillan's itinerary, the talk on "The Arctic from the Air," scheduled to be delivered by him through WEAH at 7 p. m., Sunday, November 1, has been indefinitely postponed.

Two new features have been added to the WRC and WJZ programs. They are the "Edison Hour" and the new series of travelogues entitled "The Grand Tour." "The Edison Hour" is scheduled for Tuesday evenings, from 9 to 10 p. m., eastern time, and "The Grand Tour" will follow on the same evening, from 10 to 10:30 p. m.

L. R. Tucker, Big Brother of KPO, is training a parrot to speak over the air. Big Brother, after telling his audience a story about parrots, received a number of requests from children to have a bird broadcast as they had never heard a parrot talk.

Alfred Noyes, the famous English poet, was heard recently at WKAR, East Lansing, Michigan. He gave an interesting lecture on modern poetic tendencies.

"Zoo Talks," prepared under the auspices of the Smithsonian institution and the National Zoological park are broadcast every Saturday through WRC. They are presented by prominent biologists and naturalists.

Adelaide Apfel, a pianist, is a Radio veteran. She has played every Thursday afternoon at 4 p. m., central time, from WLW, for the past three years. She has received thousands of letters from admirers.

Edith Carpenter and Grace Ingram, Chicago's favorite harmony girls, who have successfully entertained thousands of Radio fans, are now with KYW as exclusive artists.

A community sing has been added to the program of WLW. It will be provided by the Cincinnati Conservatory of Music and broadcast the first and third Saturday evenings of each month, at 8 p. m., central time.

"Seckatary" Hawkins, a delightful fiction character, comes to WLW every Saturday evening at 7:30 p. m., central time. He talks to the boys and girls and gives them some of his experiences.

Norinne Gibbons, whose classic blues or blue classics have made her popular on the Post-Wurlitzer concerts from WKRC has again proved that Radio makes an artist popular. She recently signed a contract with a large vaudeville circuit.

Dr. Thatcher Clark of Columbia university, broadcasts each Tuesday from 7:10 to 7:30 p. m., eastern time, at WEAH a course of French conversational lessons. He includes grammar instructions and pronunciation. His course is given in conjunction with the Columbia university home study department. Dr. Clark's unique method of teaching foreign languages promises to make this course not only instructive but entertaining.

The Royal Hour of Music at WEAH will play gypsy music no more. The New Royal Salon orchestra, directed by Bernhard Levitow, will now give orchestra music only. By using an organ specially made by a Viennese organ maker, Mr. Levitow gets the effects of a fifteen-piece orchestra with only eight men.

The Stanley hour of music is a popular feature every Monday evening at 9 p. m., eastern time, from WLIT. The Stanley Symphony orchestra is composed principally of musicians from the Philadelphia Symphony orchestra and is conducted by Sydney Lowenstein.

An operatic and classical program by nationally known artists will henceforth be broadcast every Sunday evening from 8 to 10 o'clock, central time, from WBBM, Chicago. The programs will include Frances Ingram, contralto of the Metropolitan Opera company, New York; Geane St. Anne, French baritone; Joseph Raieff, Russian boy concert pianist; the Sunset male quartet, and Ted Coleman, cellist.

Nashville's Little symphony, composed of twenty-five of the best musicians of this southern city, made its Radio debut last week at WSM.

**LARGEST PORTABLE SET**

(Continued from page 4)

be found even in such remote places as railroad construction camps.

Because George Donaghy is that kind of a man his comrades are made happy. But George gets his enjoyment from the fact that he has developed what he had to such a high point of efficiency.

You can see the ardent radio fan shining through this letter. It follows:

"A Radio in a railroad construction camp is a great boon to its owner and to the many workers in the camp. It provides, when the camp is located between towns, the only form of amusement obtainable outside of card playing and horse-shoe pitching. Newspapers are not always readily obtained and news items broadcast by the various stations within range keep those in the camps posted on much that is going on.

"The set illustrated herewith is a two tube Crosley portable, Model 51, with a one stage amplifier added. In order to secure as much volume as possible for the loud speaker, the amplifier was supplied with separate batteries. Programs from such places as Los Angeles, 980 miles; San Francisco, 1,090 miles; Minneapolis, 580 miles; Chicago, 775 miles; Davenport, 625 miles; San Antonio, 775 miles; Cincinnati, 970 miles and New Orleans, 990 miles come in with sufficient volume to be heard at some distance from the car in which the set is located. Denver, 130 miles distant, is the nearest broadcasting station and, of course, comes in loud and clear at all times unless static is present.

"The furthest reception points noted during the summer on earphones were: East, Altoona, Pa., 1,260 miles; North, Minneapolis, 580 miles; South, New Orleans, 990 miles and West, San Francisco, 1,090 miles. Pittsburgh, Pa., though heard regularly through Hastings, Nebr., was caught direct a number of times. Many of the long distance stations picked up on the phones during the summer are now heard plainly on the loud speaker.

"The tubes in use with this set are the C-301A are each of four No. 6 cells connected in series, giving six volts to each A battery. The B batteries are each made up of four 22½ volt cells, giving 90 volts.

"When using earphones with this arrangement a very small turn of the amplifier rheostat will bring a distant and weak signal up so it is plainly heard. However, at this season of the year this is not often necessary, for, as stated above, long distances are now being handled by the loud speaker which could only be heard through the phones during the summer."

George, incidentally the same George whose name is familiar to readers of Radio Digest in the **Indi-Gest** column where his clever verses and comment always are welcomed, describes the pictures included in his letter as follows:

"1. The exterior of the commissary clerk's car in which he carries a stock of tobaccos, work clothing and various supplies needed by the men employed on the track and boarded in the camp.

"The next car to this contains his supply of groceries, meats and staple foods. Following this car come the diners, kitchen and men's sleeping cars.

"2. This shows the interior of one-half of the car, the counter, loud speaker and in back are the stock shelves.

"3. Opposite end of same car showing clerk's room and the Radio.

"4. The Crosley portable, Model 51, on stand with batteries on shelf below. The wires to the loud speaker may be noted running up the wall at back.

"When used as a portable set the batteries are contained in the cabinet, which has room for three No. 6 cells and three units of B battery 22½ volts for use with earphones. The ground, when the cars are on a siding which joins the main line, is secured by joining the ground wire to the truck of the car.

"When on a spur, which is a track laid especially for the outfit and disconnected from the main line as soon as the cars are run on it, a ground rod must be used. The one used with this set is a ¾-inch rod six feet long, five feet of which are in the ground.

"The truck connection, when the cars are on a siding, needs no ground rod with it as the main line gives a surface as long as the entire railway system and reaches water or some other good ground, somewhere near. The aerial used is a two wire antennae but the wire is continuous being run through the insulators and the ends joined. The car is thirty-four feet long and the aerial is thirty-one feet long.

GEORGE DONAGHY,  
 Eckley, Colorado."

And there you have a letter that in reality is a document, a testimonial of human optimism, a trail blazer for the Iron Horse with a Radio set.

A group of French scientists, artists and men of letters has been formed under the name of "Radio Art et Pensee," with the object of using Radio to disseminate knowledge and appreciation of French achievements in art, science and literature.

# OPERATING AND TROUBLE SHOOTING

**OPERATING and Trouble Shooting**, is a Radio Digest feature the purpose of which is to give practical information on the operation, care and cure of simple troubles in every kind of receiver. Standard Radio receivers of wide distribution and use are studied from the standpoint of instructions for installing and connecting, tuning and operating, and remedying little difficulties. The suggestions below, if executed faithfully, will make winter broadcast listening yield all there is to yield to the reader and give your set a fair chance to show its worth.

## For the Owner of a Fada Neutrodyne Receiver

THESE instructions cover the use of the following receivers when storage battery tubes are used: Neutroceiver, Neutrola, Neutroceiver Grand and Neutrola Grand. These four sets contain the same neutrodyne receiver panel unit, which is a five-tube unit containing two radio frequency amplifying tubes, a detector and two audio frequency amplifying tubes. These tubes and their accessory tuning circuits have been mounted compactly on a slanting bakelite panel which can be readily fitted into the cabinets of any of the receivers listed above. That pictured in Neutrola.

### Connections

Connect 6-volt storage battery and 22½ and 90 volts of B batteries to the proper terminals as indicated on the tags on the leads. The leads for the C battery are short circuited when the receiver leaves the factory. The C battery, if used (3 to

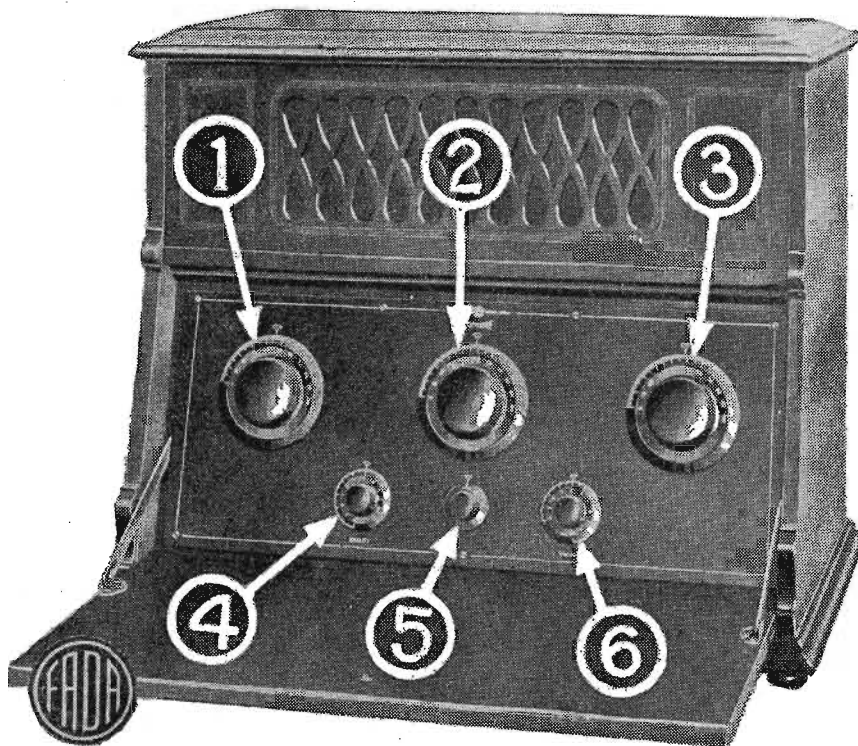

Figure 1

4.5 volts) will not necessarily improve the quality, but will lengthen the life of the B batteries. B batteries are made in both 22½ and 45-volt units. If 22½-volt units are used, it is necessary to use four units instead of two. The negative (—) and positive (+) terminals of the B batteries will be found marked in the insulating wax on the top of the batteries.

To make the proper battery connections, connect a wire from the positive terminal of one battery to the negative of the second, continuing the same series connections if four 22½-volt batteries are used. This will leave a positive and a negative B battery terminal unconnected. These are connected to the receiver as

follows: The lead tagged —B from the set is to be attached to this —B terminal of the batteries while the +B90 lead on the set is to be connected to the +B terminal left on the battery. The last wire to be connected is the detector plate wire. The first B battery figured from the negative end has a positive 22½-volt terminal connected to the negative of the next battery. The lead from the set tagged +B22 is to be connected to this, in addition to the wire leading to the next battery.

In order to get at the connections within the set, it is necessary for the user to remove the battery shelf. This is done

by removing the two small blocks on each side of the receiver cabinet wall which hold this battery shelf in position. (A single nail holds each in position.) These two blocks are used to hold the shelf in place and prevent its knocking around inside in shipment.

Antenna, ground and loud speaker connections should be made before the shelf is put back into position. If one desires to place B batteries within the receiver the connecting leads should be pulled back through the holes in the cabinet, so that they are entirely within the receiver. Then replace the B battery shelf and make connections to the B batteries when in position. In the Neutrola it is important to keep the B batteries toward the antenna end of the receiver, and away from the center of the shelf. Use the vertical types or place horizontal types vertical.

Antenna should be a single wire from 60 to 125 feet long, either inside or outdoor, outdoor preferred. Ground connection should be preferably made to cold water pipe, and to "GND" binding post only; not to any other part of receiver or batteries. If external loud speaker is to be used connect to "HORN" binding posts. Keep the antenna and ground wires away from the set; do not bring them back along the length of the receiver.

### Operation

Insert five "hard" amplifier tubes (type UV 201-A's or C301-A's) in the five-tube sockets of the set. The two tubes on the front sub panel are the radio frequency tubes and the three in the rear, detector and two audio frequency amplifying tubes. The tube to the extreme right is the detector.

Turn "QUALITY" No. 4 and "VOLUME" No. 6 adjustments to right to about "7" each. The No. 4 control adjusts the intensity of the two radio frequency amplifying tubes and the No. 6 control adjusts the intensity of the detector and two audio frequency amplifying tubes. Light the tubes by turning Selector Switch No. 5 around to "LOUD" position. In the "OFF" position the receiver is absolutely dead. In the "MED" position, the filaments of four tubes are lit, and the re-

(Continued on page 12)

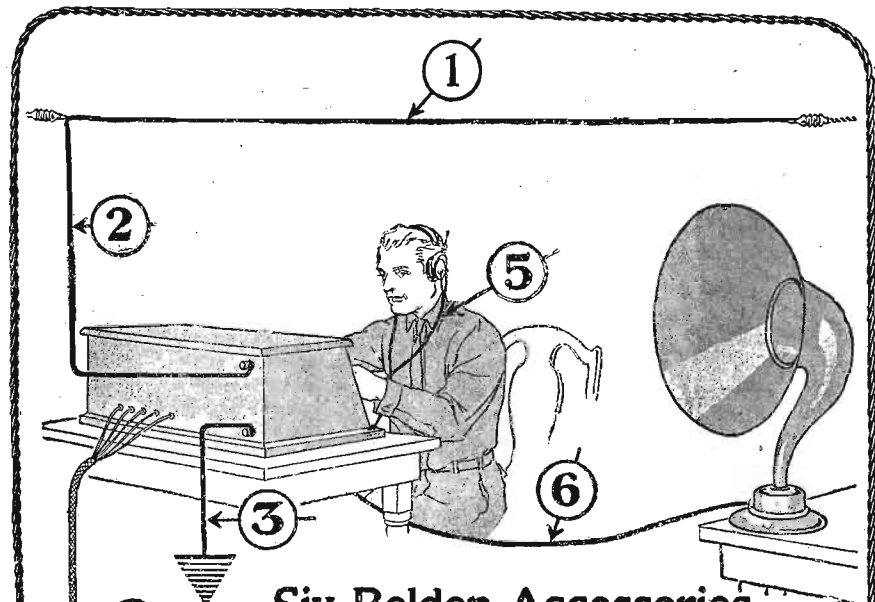

## Six Belden Accessories that improve every radio set!

TUBES and batteries are not the only accessories that must be selected with care. Think of the aerial! A poor aerial will cripple your entire set, no matter how fine the set is. That's why you should always specify a Belden Aerial, the aerial that lasts indefinitely.

And a Belden Radio Battery Cord makes a neat installation. It takes the place of a tangle of messy wires that frequently short-circuit and blow out tubes. And for ground wires, extension cords, receiver cords, and many other essential items, be sure to specify Belden. Every Belden product is distributed in a distinctive carton for your protection. An illustrated booklet, "Helpful Hints for Radio Fans" describes each product and its application. Send for it!

- 1 Belden Aerial Wire, made of 7 copper strands, each coated with baked Beldenamel.
- 2 A continuation of No. 1 connecting aerial to set without joint.
- 3 Special Belden Ground Wire—Rubber covered.
- 4 The well-known 6-ft. Belden Battery Cord with five conductors enclosed in a brown braid.
- 5 Belden Headphone Cord
- 6 Belden 20-ft. Radio Extension Cord.

Mail the Coupon for Free Illustrated Booklet

BELDEN MANUFACTURING CO.  
2310G South Western Ave., Chicago

Please send me your booklet entitled "Helpful Hints for Radio Fans."

Name .....

Address .....

*Belden*

## Take Advantage of this Wonder Principle When Building any Set

NO receiver can be said to be satisfactory unless it has power with its selectivity. Selectivity is easy, but power has been the problem. Now it is the simple, everyday accomplishment of fans who know the secret.

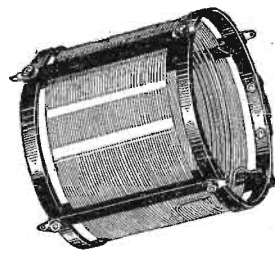

Showing the patented Aero Coil Construction

In any circuit, two factors have largely to do with whether or not the ideal combination of selectivity and power will be enjoyed. These factors are the two major characteristics of the inductances used; their high-frequency-resistance and distributed-capacity. The lower the meas-

urements of these two determinants, the sharper the set will tune into resonance and the more power it will have.

Aero Coils, by reason of their patented construction, have a much lower high frequency resistance and distributed capacity than other types of inductances. This is achieved by their 95% air dielectric, correct proportion and their dopeless, evenly air-spaced windings.

Build a set with Aero Coils. It will cut sharply through strong local interference and bring in the farthest distant stations with amazing volume. Be sure you get Aero Coils.

**BUILD THE Radio Digest "FIRESIDE"**

The powerful, super-selective tuned radio frequency receiver. Obtain Aero Coil Kit No. TRF-120. Price \$12.00.

OTHER AERO COILS AND KITS	
No. CT-80—Three Circuit Tuner.....	Price \$ 8.00
No. RFR-110—R.F. Regenerative Kit.....	Price 11.00
No. WT-40—Wave Trap Coil.....	Price 4.00
No. OS-55—Oscillator.....	Price 5.50
No. AX-45—Antennae Coupler with variable primary.....	Price 4.50

At Your Dealers or Direct from Factory  
**AERO PRODUCTS, INC., 217 N. Desplaines St., Chicago**

**AERO COIL**  
LOW LOSS  
INDUCTANCE SYSTEMS

# OPERATING FADA SET

(Continued from page 11)

ceiver functions as a two Radio, detector and one audio, or four-tube receiver. In the "LOUD" position the second audio amplifying tube is put into circuit, its filament lit, and the loud speaker or phones transferred to its output circuit.

### Tuning

Let us assume that it is desired to receive Station WEAJ, New York, N. Y., which transmits on a wave length of 492 meters. On examining the dial calibrated in station call letters and wave lengths, shown in figure 2, it is seen that this

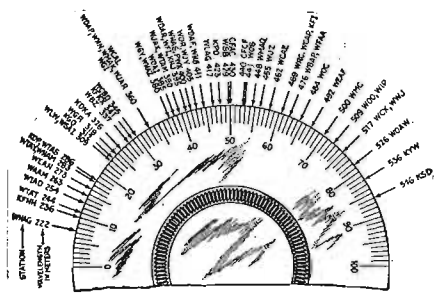

Figure 2

station corresponds to a dial setting of 67 degrees. Set dials 2 and 3 of the receiver at this setting and rotate dial 1 very slowly from 45 to 80. Signals will be obtained either at a setting identical with dials 2 and 3, or more probably a few degrees lower. Then rotate dials 2 and 3 independently very slowly until the maximum signal is obtained. In any particular neutrodyne receiver, dials 2 and 3 may read identically, but in no cases will they differ by more than a degree or two. The first or antenna dial may also read identically with 2 and 3, but in general it is several degrees lower than the other two. A record should now be made of the settings for this station on a log sheet.

WEAF 492 meters 63 66 67

After adjusting the dials for maximum signal strength, turn the No. 6 control until the maximum volume is obtained. Then adjust No. 4 control for clarity and quality of the program desired. At no time turn these controls beyond the point at which the maximum signals are obtained, as this will cause the filaments of the tubes to burn too brightly and reduce the lives of the tubes considerably.

If it is desired to receive any station located at a wave length not listed in figure 2 the procedure is as follows. If you desire to locate a station transmitting at a wave length of 259 meters, note that the arrows show a station at 254 meters at 13 degrees, and one at 263 meters at about 14 1/2 degrees, therefore the station broadcasting at 259 meters will be approximately half way between these.

### Calibration Curves

As a further aid in locating stations, the wave lengths of which are not listed in figure 2, the calibration curve shown in figure 3 can be used. These two tuning aids were determined from representative receivers, but in practice, due to commercial variation, the specific receiver calibration may vary a degree or so from those indicated.

In all cases when tuning a neutrodyne receiver it is best to keep dials 2 and 3 always within one or two degrees of each other and to move them at a slow rate,

about a degree a second. Very often a weak broadcasting station is passed over by moving the dials too fast. One can tell if the receiver is "tuned-in" when the broadcasting station cannot be heard by listening to the intensity of the static noises that are usually present. Variations in the size of the antenna used only

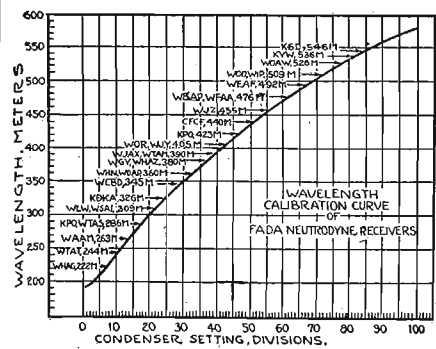

Figure 3

affects the tuning position of the first dial on a neutrodyne. Dials 2 and 3 are not affected by the type, length and kind of antenna. When a short antenna under 75 feet is used, dial 1 will read almost identical with dial 2 for any particular wave length. As the length of the antenna is increased the reading of dial 1 will gradually draw away from dials 2 and 3, reading, in the case of the longer antennas, several degrees below the other two dials. At the short wave lengths, with the long antenna, it may be necessary to insert in series with it a fixed condenser of .00025 mfd. capacity in order that tuning can be accomplished on dial 1.

### Tubes

For the five-tube receivers of the Neutrola and Neutroceiver type, the use of a "soft" tube is to be discouraged. In all cases a hard tube should be used as a detector. Superior results will always be obtained with hard tubes. At times the five-tube receiver will suddenly howl with an intense note, irrespective whether the receiver is tuned to a particular station or not. It can be remedied by substituting a new tube in place of the one which is defective or by interchanging the tubes among themselves. Generally the detector tube will be found faulty.

If no spare amplifier tubes are available for the determination of a possible defective tube, the user of one of the sets under discussion can, by turning the Selector Switch No. 5 to "MED," release his second audio amplifier tube for substitution with the two radio frequency amplifier tubes. Interchanging tubes will usually enable the broadcast listener to find a defective tube.

## Montreal Planning for Big Radio Relay League Meet

MONTREAL, Can.—Great preparations are being made here for the convention of the American Radio Relay league, November 26 to 28, inclusive. From Vancouver to Halifax amateurs are preparing for their talk-fest, and are making arrangements to be in Montreal.

Between two and three hundred are expected to participate in the sessions, which will be presided over by A. H. K. Russell, of Toronto, the Canadian general manager of the league.

## INDIAN TECUMSEH SINGS

(Continued from page 5)

foot of the great, grandson of Chief Tecumseh going out to the tribes of Indians from the land of the sky blue waters as they are in Lake Michigan at Chicago.

There may be a blood curdling yell or two—maybe none at all. And there may be a few of those purring guttural notes for which the American Indian is noted. You probably will enjoy it for Kiutus Tecumseh, great grandson of the old chief, is a singer of fame.

He has been chosen by Jack Nelson, manager of the WJJD station, as the star of an unusual Thanksgiving day program. Kiutus himself feels a dramatic interest in broadcasting from Chicago because of the story he tells of his great grandfather. As a young Indian brave he has a fight of his own in this white man's world. He yearns for the time when he will be given a role in grand opera.

It will not be this young Indian's first appearance before the microphone. Radio audiences have heard him in every section of the United States. He was a favorite at WEAJ in New York when he appeared on the McCormick series of concerts which extended over the WEAJ chain. In Chicago he has been heard at various times since he was first introduced to Radio in the old WDAP station. More recently he has been heard most frequently over WLS and WJJD.

### Coast Knows Him, Too!

The Pacific Coast knows him from the stations in Seattle, Portland, Oakland, San Francisco and Hollywood.

Particularly happy will he be in broadcasting this Thanksgiving day program for up in the state of Washington on the Yakama Indian reservation where he was born and raised his father and mother will be the guests of the Indian agent. They will be listening in at a super-hetrodyne set and they will think of their son fulfilling the part of the prophesy of their distinguished forebear who said he would stamp his foot and the tribes east, west and south would hear him. He will talk to them in the Yakama tongue for his mother is Yakama and his father Cherokee. He will translate his message into English.

And hovering near the singer will be a bronze skinned brother from the far north, Simeon Oliver, an Eskimo of the Aleutian Islands, off the coast of Alaska. Simeon is an orphan boy with longings that brought him down from the rigors of the frigid north to learn the art of

music. He has been working for his bread, taking elementary school work and studying the piano at the Chicago Musical College. He teams well with his chosen companion, Tecumseh, as accompanist.

"How would you spend Thanksgiving if you were home?" The question was asked of both aboriginals in the reception room of the Radio Digest.

"We would have turkey," answered Tecumseh. "We are much the same as other folks. Some of the people of the reservation still keep their teepees in the rear of their little cabins. But we would have our Thanksgiving feast in our cabin. My father and mother will miss me. They want me to come home for this day. That is why I am going to talk to them over the Radio in their own language. I hope they will be able to hear me."

### Eskimo Has Thanksgiving

"My people are all dead, I have no one," said Simeon and he mopped his perspiring face.

"Perhaps the Eskimos do not celebrate Thanksgiving."

"Yes, yes," he smiled a trifle, but he seemed uncomfortably warm in his blue sweater. He wore no coat. Snow was flying outside the window. "We have Thanksgiving. We have wild duck and ptarmigan."

He scorned the suggestion that a plump young walrus might be considered a delicacy.

"Is the government helping you to get your musical education?"

"No," answered the Indian. The Eskimo shook his head.

"We have work we do outside of our study," said Simeon.

"It is well the old chief did not succeed in his enterprise, don't you think?"

"I am not sure," answered Kiutus. "Our people do not like to be held on reservations. In my Thanksgiving day program I am going to sing of the Indian as he was when the white man came to Plymouth Rock and as he lived in 1861 and as he is today. I will sing the song of my race. If you listen you will hear me. I have much to say in my song about my people. I will sing to the white people and they will hear a Thanksgiving anthem of the red man. My great, great grandfather was a brave man. He died fighting for his people."

That was a long speech for young Tecumseh.

Simeon wiped his face again, the two shook hands with the interviewer and departed, solemn and dignified.

**JEWELL**

No. 135-C      No. 135-A

**NEW**

Owners of New Radiola Sets No. 20, 25, 26 and 28 will be interested to have one of our circulars No. 739—just off the press—describing the two new instruments shown above.

AGAIN we are the first to meet a new demand in Radio. The cords and prods on these two instruments plug into the phone jacks on these New Radiola Sets. Check your filament voltage and batteries daily.

**JEWELL ELECTRICAL INSTRUMENT CO.**  
1650 Walnut St., Chicago

**Steinite** Low Loss Interference Eliminator

No Radio Set Complete Without It

Select stations at will. With music and voices crowding the air the average set fails to bring in the desired stations properly. The Steinite Interference Eliminator shuts out local and other interference. You get one station at a time, the one you want, and tune in loud and clear. Operates on any set—attach to aerial wire and to set—no changes—no extra tubes or batteries. Greatest Dollar Value in Radio Today. Over 150,000 Sold

**Fred W. Stein.**

**Improved Results with Tube or Crystal**

Try entirely at my risk the wonderful improvement this inexpensive little device will make in the reception of your set. Improves results on both crystal and tube sets that use any kind of aerial except loop antenna. Clears up reception wonderfully, increases volume, and partially absorbs static. Money-Back Guarantee.

Mrs. Famous 1,500 Mi. Steinite Tube Set, \$6; 1-Tube Set, complete, nothing to buy, \$12.50; 2-Tube Set, \$12.50; 5-Tube Set, \$60; Long Distance Crystal Set, \$6; DeLuxe Crystal Set, complete with headphones, aerial and ground, \$10. FREE descriptive literature on request.

**\$1 Postpaid** If you are not delighted with results you get your dollar back

Put this interference eliminator on your set and note amazing improvement. No tools needed—install in a moments time. Connect with set and follow simple instructions. Money back promptly if not delighted. \$1.00 postpaid anywhere in U. S. when cash with order.

References: Exchange National Bank, Atchison Savings Bank. Order today—a dollar bill will do.

**STEINITE LABORATORIES, 161 Radio Bldg., ATCHISON, KANSAS**

# ADVANCE PROGRAMS FOR THE WEEK

## Saturday, November 21

### Headliners Today

Eastern 11 p. m.	Central 10 p. m.	Mountain 9 p. m.	Pacific 8 p. m.
KMTR (238) Maggie O'Shea 8:15 7:15			5:15
WLS (344.6) Saturday night revue 8:30 7:30			5:30
KDKA (309.1) Opera, "Martha" 9 8 7			6
CNRO (435) Amateur night WRC (469) Two piano recital WLSA (326) Chorus concert 9:05 8:05 7:05			6:05
WEAF (491.5) WEAF Light Opera quartet 9:30 8:30 7:30			6:30
WPAA (475.9) Mozart choral club 10:15 9:15 8:15			7:15
KTHS (374.8) Novelty prog., auto harp, broomstick. 2 a. m. 1 a. m. 12 m.			11 p. m.
KNX (336.9) Hollywood night.			

Saturday, silent night for: CFAC, CFCA, CNRA, CNRC, CNRE, CNRM, CNRR, CNRT, CNRV, CNRW, KFDM, KFMQ, KFMX, KFRU, KFUD, KLDS, KLX, KMA, KOB, KSAC, KWSC, KTAB, WBAP, WBZ, WCAP, WCAU, WCX, WEAD, WEBJ, WEEI, WGGP, WGR, WGST, WHAD, WHAZ, WHB, WHN, WHD, WJAD, WJAR, WJAZ, WKAR, WLWL, WDAI, WOS, WTAG, WVIC, WWJ.

### Eastern Time Stations

CFCA, Toronto, Can. (356), 2:15 p. m., Queens of Kingston-Balm Beach football game.  
 CHIC, Toronto, Can. (356.9), 10 p. m., J. Wilson Jardine and his Palais Royal orchestra.  
 CKNC, Toronto, Can. (357), 8:10 p. m., Charles E. Bodley and his orchestra; Edgar vocal quartet.  
 CNRO, Ottawa, Can. (435), 7:30 p. m., Cozy Corner for boys and girls; Uncle Dick; 8, Chateau Laurier concert orchestra; 9, amateur night, performers who have never broadcast, prizes awarded to artists; Chateau Laurier dance orchestra.  
 KDKA, Pittsburgh, Pa. (309.1), 7:15 a. m., morning exercises; 6:15 p. m., KDKA Little symphony orchestra; 7:45, last minute helps to the Sunday School Teacher, Carman Cover Johnson; 8:30, opera, "Martha," J. L. Rodrigues, director; cast: Lady Harriet, Margaret McLanahan, soprano; Nancy, Lois, Wiley, alto; Lionel, Will Rhodes, tenor; Sir Trilstran, Max Koren, baritone; Plunkett, Doyl Bugher, bass; the Sheriff, Wilson McCalmont, bass.  
 PWX, Havana, Cuba (400), 8:30 p. m., studio concert, Prof. Aurelio Hernandez, Lili Hernandez, Eduardo Hernandez.  
 WAFD, Port Huron, Mich. (275), 9-11 p. m., studio program; 11:30-2 a. m., musical program, Addison hotel.  
 WAHG, Richmond Hill, N. Y. (315.6) 11:55-12 m., time signals and weather report; 12-12:30 p. m., Joe Zimmerman, pianist.  
 WBBR, New York, N. Y. (272.6), 10 a. m., Watchtower orchestra; 10:20, Fred Twarosch, tenor; Bible lecture, Judge Rutherford; 11, Fred Twarosch, tenor; Watchtower orchestra; 9 p. m., I. B. S. A. choral singers; 9:10, Prof. Charles Rohner, Carl Park, violin duets; 9:15, Bible lecture, Judge Rutherford; 9:50, I. B. S. A. choral singers; 10, Prof. Charles Rohner, Carl Park, violin duets; 10:15, I. B. S. A. choral singers.  
 WBZ, Springfield, Mass. (309.1), 2 p. m., Harvard-Yale football game.  
 WCAE, Pittsburgh, Pa. (461.3), 2:10 p. m., Harvard-Yale football game, WEAF; 6:30, dinner concert, William Penn hotel; 7:30, children's period; 8, studio concert.  
 WCAP, Washington, D. C. (468.5), 1:45 p. m., Harvard-Yale football game.  
 WCX, Detroit, Mich. (517), 2 p. m., news of the day; reports; 6, dinner concert, Book-Cadillac hotel.  
 WEAF, New York, N. Y. (491.5), 6:45-7:20 p. m., Metropolitan tower health drill; 1:30-2:15 p. m., Harvard-Yale football game; 4-5, Elmer Gross and his orchestra; 6-7, dinner music, Waldorf-Astoria; 7-7:15, Ethel and Dorothea Ponce, songs; 7:15-7:25, J. J. Derwin, banjoist; 7:25-7:40, Warren Soufield, baritone; 7:40-7:50, J. J. Derwin; 7:50-8, Ethel and Dorothea Ponce; 8-8:10, talk, John P. Hill; 8:10-8:25, Edward Steele; 8:25-8:40, WEAF light opera quartet; 8:40-8:55, talk, Dr. Stephen S. Wise; 8:55-9:05, Edward Steele; 9:05-9:20, WEAF light opera quartet; 9:20-10, Apollo orchestra and the Radio Dream Girl; 10-11, musical program; 11-12, Vincent Lopez and his orchestra.  
 WEAR, Cleveland, Ohio (389), 9:30 p. m., community fund program; 12, community fund program; 7-8, Hotel Statler concert orchestra, Maurice Spitalny, director; 8-9, community fund program.  
 WGBS, New York, N. Y. (315.6), 10-10:10 a. m., timely talks with Terese; 10:10-10:40, N. Y. Evening World Kiddle club; 10:40-10:50, Ethel Derner, pianist; 10:50-11, talk, Mme. Hill Deane; 1:30-1:35 p. m., scripps readings; 1:35-1:45, Mrs. Arnes Verbeekmoes, soprano; 2-3, orchestra; 3-3:10, talk, Helen E. Martin; 3:10-3:20, Frieda and Lillian Drelllich, pianists; 3:20-3:30, talk, Royal Dixon; 3:30-3:40, Frieda and Lillian Drelllich; 6-6:30, Uncle Gee Gee; 6:30-7, orchestra; 7-7:15, dance lessons, Arthur Murray; 7:30-7:40, Rose Karasik, soprano; 7:40-7:50, Percy Boyd, baritone; 7:50-8, orchestra; Wright Brown; 8-8:10, Percy Boyd; 9:20-10:30, program, Warner's theatre; 10:30-11:30, Arrowhead luncheon orchestra.  
 WGBU, Fultford-by-the-Sea, Fla. (278), 6:30-7:30 p. m., Theresa Horn, pianist; 10-12, Miami Daily Tab musical melange; 12-1, Blue Steeles orchestra.  
 WGGP, New York, N. Y. (252), 3-3:15 p. m., Henry Rogers, pianist; 3:15-3:30, Twentieth Century entertainers; 3:30-3:45, John Landers orchestra; 3:45-4, Ukulele Lon Hayes; 4:15-5, Richard Cheatham's Club Basha band.  
 WGR, Buffalo, N. Y. (319), 1:45 p. m., Harvard-Yale football game.  
 WGY, Schenectady, N. Y. (379.5), 1:30 p. m., Yale-Harvard football game; 9, "Community and Health Day," Daniel Chase; 9:45, Hotel Ten Eyck dance orchestra.  
 WHAR, Atlantic City, N. J. (275), 2 p. m., Seaside hotel trio; 7:30, announced; 8, Seaside hotel trio.  
 WIP, Philadelphia, Pa. (508.2), 6:45 a. m., exercises; 7, setting-up exercises; 1 p. m., organ recital; 3, Dal Rich and his Arcadians; 6:05, dinner music; Benjamin Franklin concert orchestra, W. Irving Oppenheim, director; 8, lecture, "More about Color and Colors," Prof. J. W. Sturmer; 8:15, artist recital; Irene Hubbard, cellist; Blanche Hubbard, harpist; Fannie Sharfstein, violinist; 9:30, "Good Cheer," D. L. Anderson; 10:05, Benjamin Franklin dance orchestra, Howard Lanin, director.  
 WJAR, Providence, R. I. (305.9), 1:45 p. m., Yale-Harvard football game.  
 WJR, Pontiac, Mich. (517), 2:30 p. m., Minnesota University-University of Michigan football game; 7, Jean Goldkette's Petite symphony orchestra; 9, Jean Goldkette's serenaders; 10, Jean Goldkette's Victor Recording orchestra; 11:30, Jewett Jesters.  
 WLIT, Philadelphia, Pa. (394.5), 12:02 p. m., Stanley theater organ recital; Arcadia cafe concert orchestra; 2, Arcadia cafe concert orchestra; 4:30, Chas. Coll's dance orchestra; 7:30, Benjamin Franklin concert orchestra.  
 WMAK, Buffalo, N. Y. (266), 7:30-8 p. m., Mabel Haber, pianist; J. N. Dodsworth, reader; 8-9, musical program 8-10, Sunrises Point Development hour.  
 WMOA, New York, N. Y. (340.7), 6-6:30 p. m., Olcott Vail and his Hotel McAlpin string ensemble; 6:30-7:30, Frank Wunderlich and his Stoney Brook orchestra; 9:30-10:30, Cinderella dance orchestra; 10:30-10:45, Erva Giles, soprano; 11-12, Ernie Golden and his Hotel McAlpine orchestra.  
 WNYC, New York, N. Y. (526), 6-7 p. m., dinner theater organ recital; Arcadia cafe concert orchestra; 8-9, studio program; 9-9:30, police quartet; 9:30-10:10, instrumental novelties; 10:10-10:30, lecture, board of education.



Smiling Maggie O'Shea is called the "Blarney Girl of KMTR," Hollywood, because she blarneys her audience whether Irish or not every Saturday evening between 8 and 9 o'clock pacific time.

WOR, Newark, N. J. (405.2), 3:15-4 p. m., Zit's Central Park Casino orchestra; 6:15-6:17, "Words Often Mispronounced," 6:17-6:30, sports talk, Bill Wathey; 6:30-7, Hotel Shelton ensemble; 7:15-7:45, Van's collegians; 11-12, Ciro's orchestra.  
 WPG, Atlantic City, N. J. (299.8), 1:30 p. m., Hotel Morton luncheon music; 6:45, Arthur Scott Brock, organist; 7, Hotel Ambassador dinner music; 8, studio concert; 9, to be announced; 11, dance orchestra.  
 WRC, Washington, D. C. (469), 12 noon, organ recital; 1 p. m., New Willard hotel orchestra; 7, Hotel Wash-

ington orchestra; 7:45, zoological talk; 8:30, Bible talk; 9, two-piano recital, Elizabeth Winston, Caroline Bender; 9:30, "A Memory of the Old South-The Kentucky Cinderella," W. Alfred Falconer; 10:30, Crandall's Saturday Nighters.  
 WREO, Lansing, Mich. (285.5), 6-7 p. m., Speed-Wagon serenaders; Gold Standard ensemble; 10-12, WREO studio dance program, Speed-Wagon's serenaders.  
 WSB, Atlanta, Ga. (428.3), 8 p. m., entertainment; 10:45, Alfred Help Skylark.  
 WSM, Nashville, Tenn. (282.8), 6:30-8 p. m., Francis

## High Lights of the Week

SMILING Maggie O'Shea, above, is the joyous Irish girl who entertains at KMTR, Hollywood. Tune in Saturday between 8 and 9 p. m., Pacific time, and you will hear some rollicking tunes. Saturday marks the beginning of operatic productions at KDKA, Pittsburgh. "Martha" will be the first opera given. Two of the artists taking leading roles may be found on pages 16 and 17.

A pleasant Sunday afternoon may be spent at WLIT, Philadelphia, by tuning in at 2 p. m., eastern time, for the orchestral concert at the Arcadia cafe. Henry Szameth, tenor, will be the solo artist. The Atwater Kent program this week will be given by the State symphony orchestra of New York city, and may be heard over WEAF and chain. Ernst von Dohnanyi is the conductor.

Tour musically with WTAM in a "Trip Around the World," Monday. The Willard Symphony and assisting artists will give "Chimes of Normandy." The quaint, unusual musical instrument, the dulcimer will be found before the microphone of WGR, Monday night. Geo. Marshall is the artist.

The Georgia Minstrels, a gay crew, returns to WGY Tuesday night with a bag full of old-time minstrel favorites. These southern melodies are suited to this male quartet. KHJ, Los Angeles is featuring an all Mexican program with Jose Arias and his Mexican band and entertainers from the old pueblo of La Ciudad.

Musical comedies light in tone and ready to fit upon the ether may be caught on your loud speaker by dialing WSMB's wave length Wednesday evening. If there are any favorite tunes, the artists will be glad to sing them. Lullabies, a whole hour of these soothing familiar melodies to lull into a sweet repose those who wish to retire early this evening, may be found at WBZ, Springfield, played by Arthur Clifton, organist.

The Pan-American union, that interesting organization of North and South American nations, will give a special Thanksgiving program of Latin-American music. This program, which will be given in the beautiful patio of the Pan-American building at Washington, D. C., will be broadcast by WRC. Thursday also marks the return of Roxy and his gang to the air. He will entertain with all his old pep at WEAF and chain. An interesting program celebrating Thanksgiving will be given by two native Americans at WJJD, Mooseheart. Kiutus Tecumseh, an Indian baritone, and Simeon Oliver, Eskimo pianist, will entertain.

Boone, Iowa, will be represented on the 7:30 p. m., central time program Friday at WHO, Des Moines. The Boone mixed quartet directed by Alice Hartman Smith is the feature. Romantic music reminiscent of moonlight and black-haired senoritas marks the evening at KTHS when the orchestra plays Spanish classics.

Craigs orchestra; 10-11, Dutch Ehrhart orchestra; Harry Waugh, violinist.  
 WTAG, Worcester, Mass. (268), 12:05-1:30 p. m., WTAG trio, Harry Smith, director; 1:45, Harvard-Yale football game.  
 WTAM, Cleveland, Ohio, (389.4), 12:15-1:15 p. m., lunch hour music, popular entertainers, Euclid music studio; 6-7, dinner hour music, Hotel Hollenden orchestra, Carl Rupp, director; 8-9, miscellaneous program, Willard studio; 9-12, novelty program, Ev. Jones and the Coo Coo club, assisted by selected artists.  
 WWJ, Detroit, Mich. (352.7), 9:30 a. m., "Tonight's dinner"; 12:05 p. m., Jules Klein's Hotel Statler orchestra; 2, University of Michigan-Minnesota football game.

### Central Time Stations

KFAB, Lincoln, Nebr. (340.7), 8:30-9:30 p. m., Schmolter and Moeller musicale.  
 KFNF, Shenandoah, Iowa (266), 7 p. m., Scotch trio.  
 KFVE, University City, Mo. (240), 8:30 p. m., amusement review, Romaine Fielding; 10, dance night, Gene Wacker's orchestra, comedy and jazz.  
 KPRC, Houston, Texas (296.9), 12 m., popular midday concert; 7:35, Bible class, Rev. M. M. Wolf; 8, Rice Institute student band; 11, studio program.  
 KSD, St. Louis, Mo. (545.1), 7 p. m., Grand Central theater.  
 KTHS, Hot Springs National Park, Ark. (374.8), 9:15-10 p. m., W. L. Maddux, oldtime fiddler; H. M. Gibson, auto harpist; 10-10:40, 10-piece New Arlington hotel orchestra; 10:40-11:10, Natalie Brigham Amoux, violinist.  
 KYW, Chicago, Ill. (535.4), 11:35 a. m., table talk, Mrs. Anna J. Peterson; 12:05-1 p. m., noonday concert, Commonwealth Edison company; 1-2, Congress hotel, Coon Sanders Original Nighthawks; 6-6:10, news; 6:10-6:40, music, Commonwealth Edison company; 6:40-7, children's bedtime story, Uncle Bob; 7-7:30, Congress hotel; 7:50-8:30, home-lovers' hour; 8:30-10:30, classic, Edwin Borroff, director; 11-1, Congress carnival; 1-2, Insomnia club, Coon Sanders Original Nighthawks.  
 WAMD, Minneapolis, Minn. (243.8), 12 m., Marion Latta, Carl Schmid, tenor; Bayne Cummins, accompanist; Russell Murphy, baritone; Thelma Wilson, accompanist; 7 p. m., Liberty Four, Ernie Traep, Ernie Willis, Ray Sundseth, Herb Hallbeck, Katherine Grill, contralto; Lillian Frothingham, Irene Lee, Edna Lee, Harmony Twins, Fred and Bob, Grace Anderson; 11, Skyrocket frolic, George Osborn's Skyrockets.  
 WBBM, Chicago, Ill. (226), 4-6 p. m., Valencino Inn orchestra; Harry Sosnick, Sandy Meek; 8-9:30, Merry Garden orchestra; Burdette Cleveland, pianist; Charlie Garland, Nate Caldwell, Jordan and Jesko; 9:30-11, Merry Garden orchestra; 11-1, Sunset male quartet; Stewart-Warner string quartet; Montmartre orchestra; Lew Russell, George Marbach, tenor; Leona Hayes, harpist; 1-2, Holsy Totsy hour.  
 WBCN, Chicago, Ill. (266), 10:30 a. m., shopping talk, Penny Wise; 3-5 p. m., tea time musicale; Clarence Jones, pianist and song writer; Cecelia and Johanna Arends, violinist and pianist; Marie Wright, soprano; 10-11:15, jazz jamboree, Midway Dancing Gardens orchestra; Cameron and Pett, "The Harmony Wizards," harmony duo; Albert Blaha, concertinist; Johnny Specter, the harmonica acrobat; Elizabeth Emmett Malone, soprano; Jack Parker, tenor; 11-11:15, King Statie's court; Frank H. McDonald, "King Statie"; Mary Williams, "Queen Olive"; Harry A. Zook, Jr., "prime minister"; "Big Boy" Yagie, "court jester."  
 WCCO, Minneapolis-St. Paul, Minn. (416.4), 10:45 a. m., home service talk, Betty Crocker; 12:20 p. m., Golden Pheasant orchestra; 2, football game, Minnesota-Michigan; 6:15, Chadbourne's Nicolet hotel orchestra; 8, freside philosophies, Rev. Roy L. Smith; 8:15, musical program; 10:05, Wallie Erickson's Cell-seum orchestra.  
 WDAF, Kansas City, Mo. (365.6), 3:30-4:30 p. m., string trio; 6-7, address, Roger W. Babson; organ music; 11:45, "Plantation players, Johnnie Campbell's Kansas City club orchestra; Earl Coleman's orchestra; Eddie Kuhn's Kansas City Athletic club orchestra.  
 WEBB, Chicago, Ill. (370.2), 7-8 p. m., Oriole orchestra; Radio Sunday school lesson; 9-10, Oriole orchestra; James Murray, tenor; Marie Kelly, reader; Beulah Lodon, violinist; 11-1, Oriole orchestra; Marie Kelly, reader; Frank Greif, tenor; Rick and Snyder; Wayne Myers, Kay Romany.  
 WENR, Chicago, Ill. (266), 6-7 p. m., dinner concert; Rauland-lyric trio; soprano; twin piano duet; 8:10, popular program; Frank Westphal and his Pioneers; John Papa, concertinist; soprano and baritone solo; Walter Peterson; 12-2 a. m., frolic; All-American Pioneers; Rita McFawn, soprano; Kentucky Wonder-pean, John Papa.  
 WFAA, Dallas, Texas (475.9), 12:30-1 p. m., vocal recital, Robert Pool; 6:30-7:30, Baker hotel orchestra, Don Bestor's Bests; 8:30-9:30, Mozart choral club; 11-12, Adolphus hotel orchestra.  
 WGES, Oak Park, Ill. (250), 5-7 p. m., Marge Van, organist; Ruth Kalthoff, mezzo soprano; John Stanford, tenor; playlet, Miles Sullivan, players; 8-9, Doc Berends and his Tiffin theater orchestra; Paula Corrado, baritone; Ellen Maurico, pianist; Remington Welsh, organist; 11-1 a. m., the Coyne Serenaders orchestra; Remington Welsh, organist; Sandy McTavish, Scotch comedian; Eddie Adams, the girl with the ukc; Rose Sweeney and Loretta Clusman.  
 WGN, Chicago, Ill. (370.2), 12:40 p. m., luncheon concert; Drake concert ensemble; Blackstone quintet; 1:30, Michigan-Minnesota football game; 3:30, Skeezix time, members National Kindergarten and Elementary college; 6:30-7, Drake concert ensemble; Blackstone quintet; 8-9, Tribune string trio and vocal artists; 10-11, Jack Chapman's and Blackstone hotel dance orchestras.  
 WHAD, Milwaukee, Wis. (275), 11 a. m., story for children, Fayc McBeath; Margaret Cunningham, pianist.  
 WHAS, Louisville, Ky. (399.8), 4-5 p. m., concert, Harry Currie's Music Box; readings; Martha Pone Robinson, reader; 7:30-8, concert, Royal Peacock orchestra; 8-9, concert, Nicholas Bohm.  
 WHT, Chicago, Ill. (399.8), 10 a. m., Jean Sargent's woman's club, Jelke Good Luck Girl; 11, special studio features; 12 m., Al Carney's organ hour; 1-2 p. m., special studio features; 6, final football scores, classical program, dinner organ recital; Grayling's string trio, Eleanor Kaplan, violinist, Estell Stanley, soprano, Antoinette Bennett, W. A. Dyekman, baritone; Florence White Rush, soprano; 7:45-9:15 (238), musical features; 9:30 (399.8), Jelke entertainers, Kitchen Klonzer classics, Harry Langdon, harmonica; Marie Wright, soprano; The Golden Trio, Oscar Heather, tenor; Al Carney, organist; Badger Four male quartet; Clark Hawaiian trio, Vic Fredericks, baritone; Irene Beasley, "The Girl from Dixie"; Marguerite Morris, "The Girl from Georgia"; Jacobson humorist; 12, Pat Barnes and Al Carney.  
 WJJD, Mooseheart, Ill. (302.8), 10 p. m., Rosemary Hughes, Marie Winters, Robert Duphney, Robert Dewar, Log Cabin orchestra; 12, Jack Mason, Fayette Miller, Courtland Banks, Dick Vail, Llew Abbott.  
 WKRC, Cincinnati, Ohio (326), 10 p. m., Marion McKay and his orchestra; studio features.  
 WLIB, Chicago, Ill., (308.2), 7-8 p. m., dinner concert, Blackstone and Drake hotel orchestras; 9-10, popular, Hamm's orchestra; 11-12, Drake and Blackstone orchestras.  
 WLS, Chicago, Ill. (344.6), 12:45 p. m., "More Money for Trappers," S. T. Keshen; 7, lullaby time, Ford and Glenn; 7:15-12, Ralph Emerson, organist; WLS barn dance fiddlers; Ford and Glenn; WLS studio trio; Ideal quartet; Johnny Hump and his Kentucky serenaders; Joe Bren's minstrels; Clan McAlpine Kiltie band.  
 WLW, Cincinnati, Ohio (422.3), 7 p. m., Johanna Grosse, organist; 7:30, football results; 7:40, Secretary Hawkins; 8, Crosley Community freside sing, chorus; Cincinnati Conservatory of Music; 8:30, Ohio Wesleyan night, special program, Ohio Wesleyan university, talk, John W. Hoffmann, president of Ohio Wesleyan university.  
 WMAQ, Chicago, Ill. (447.5), 2 p. m., Chicago-Wisconsin football game; 6, Chicago theater organ; 8:30, Hotel LaSalle orchestra; 8, Russell Pratt and Frede-

(Continued on page 14)

# CIRCLE WORLD TO MUSIC AT WTAM



Are you a member of the Coo Coo club which meets regularly on Saturday evenings at WTAM Cleveland? Ev Jones is the official leader of this merry gang and the novel ideas for his programs are his.

## Saturday, November 21

(Continued from page 13)

rick Daw; 8:30, photologue, "The Pilgrim," Dr. Ozora S. Davis; 9, Chicago theater revue.

WMBE, Chicago, Ill. (250), 7-8 p. m., Trianon duo, Beatrice Teller, Ralph F. Elliott, Preston Graves; 9-11, Trianon orchestra, Woodlawn theater orchestra, Walter Duffy, Cecil and Esther Ward, Lionel Carter, Willie Allen Hoff, Ed Banjo Hines.

WMC, Memphis, Tenn. (499.7), 8:30 p. m., Memphis Plectrum orchestra, Robert L. Sharpe, director.

WOAW, Omaha, Neb. (526), 5:40 p. m., Val McLaughlin, bandman; 6, Biako orchestra; 7, Gilbert Jaffy and his little symphony; 7:30, speakers' hour; 9, classical program; 11, Arthur Hays and his organ jubilee, Dr. Applesauce, announcing.

WOC, Davenport, Iowa (483.6), 5:45-6 p. m., chimes concert; 6:30-6:50, Sandman's bedtime stories; 9-10, musical program, First Presbyterian church quartet; 11-12, LeClaire hotel orchestra; Peter MacArthur, baritone.

WOL, Ames, Iowa (270), 12:45 p. m., answers and problems about soils, Prof. P. E. Brown.

WOK, Chicago, Ill. (217.3), 12-2 p. m., Bob Duffy, tenor; Banks Kennedy, organist; Bob Mokreis, pianist; Gus C. Edwards and his orchestra; 5:30-7, Howard Will, tenor; Robert York, tenor; Banks Kennedy, organist; WOK string trio; Gus C. Edwards and his orchestra; 10-1, Fred Witmer, pianist; Harold Morava, tenor; Herman Sinaiko, violinist; Harry Lee, contralto; WOK string trio; Bill Hay, bass; Banks Kennedy, organist; Bob Mokreis, pianist; Paul Vernon, violinist; WOK male quartet; Charles Lord, tenor; Henry Byler, tenor; Jack Keyes, baritone; Norman Bartlett, bass; Honolulu serenaders; Gus C. Edwards and his orchestra.

WORD, Batavia, Ill. (275), 8-10 p. m., Webster hotel concert; World News digest; Chicago motor club speaker; educational week address, J. Lewis Coath.

WQJ, Chicago, Ill. (447.5), 11-12 noon, home economics program; Helen Harrington Downing; "Too Fat—Too Thin?" J. J. Toedt; "Better Dietion," Peggy Richter; 3-4 p. m., Koffee Klatsch musicale; Jerry Sullivan; Rose Vanderbosch, pianist, soprano; Hal Lansing and his uke, artists; 7-8, dinner concert, Ralph Williams and his Rainbo Garden orchestra; Sheppard Levine, tenor; Muriel Kenally, soprano; Edith Dady, whistler; Grace Wallace, soprano; 10-3 a. m., Ralph Williams and his Rainbo Skyarks; Jerry Sullivan, Rose Vanderbosch; Hal Lansing and his uke; Everett Ope, character reader; June Lee, comedian; Bert Davis; Clarence Theaders, tenor; Williamson Brothers steel guitarists; Joey Stool, harmony singer; Eddie Vogel, baritone; Brundage and Kraemer, harmony singers; artists.

WSAI, Cincinnati, Ohio (326), 12:45-3 p. m., football game, Harvard-Yale; 7:45, children's stories, Ethel Berthman; 8, chime concert, Robert Badgley; 8:15, Bicycle Playing card sextet; 9:15, sextet, soloist.

WSB, Atlanta, Ga. (428.3), 8 p. m., T. P. A. program; 10:45, Journal Hired Help program.

WSME, New Orleans, La. (319), 8:30-10:30 p. m., Loyola university choral society.

WSOE, Milwaukee, Wis. (246), 9 p. m., Sunday school concert, Catholic Federation churches, Rev. H. S. Vise, director; 9:30, musical program, Madeline Klein, soprano; other artists.

WSUI, Iowa City, Iowa (483.6), 7:30 p. m., Mrs. Mildred B. Paddock, mezzo-soprano; Mrs. Verness Fraser Ruch, pianist.

**Mountain Time Stations**

KFAU, Boise, Idaho (278), 3 p. m., University of Idaho-Oregon Agricultural college football game; 7:30, dance program.

KFWA, Ogden, Utah (261), 5-6 p. m., Ogden Radio dealers program; 9-12, dance music, Olio Reeves and his orchestra.

KOA, Denver, Colo. (322.4), 12:15 p. m., Rialto theater musicale; 9, Wurtzbach's orchestra.

**Pacific Time Stations**

KFOA, Seattle, Wash. (454.3), 8:30-9:30 p. m., program; 9:30-11:30, Eddie Harkness and his orchestra.

KFWB, Hollywood, Calif. (252), 6:30-7 p. m., program, E. P. Jones, featuring Bill Hatch and Ray Kellogg; 7:15, telephone brekies; 7:30-8 p. m., program, Elmer B. Sly company; 8-10 p. m., "Radio Doings Revel," program by Radio Doings with musical numbers and Radio technical talks; 10-11 p. m., Warner Brothers frolic, direction Charlie Wellman; 11-12, Henry Halstead's Hollywood Roof orchestra.

KGO, Oakland, Calif. (351), 11:30-1 p. m., luncheon concert, Pacific States Electric company; 3:30, concert orchestra, Hotel St. Francis; 8:10, Sherman, Clay and company, numbers from works of Mary Carr Moore, composer; Mary Pasmore, violinist; Dorothy Pasmore, cellist; Flora Howell Bruner, soprano; Ruth Scott Laddlow, contralto; Harold Svaunding, tenor; Albert Gillette, baritone; "A Sound Mind in a Sound Body," J. M. Gwinn; 10-12, dance music, Hotel St. Francis.

KGW, Portland, Ore. (491.5), 12:30-1:30 p. m., Rose City trio, Pacific States Electric company; 2:30, football game, O. A. C. vs. P. of O.; 9-12, dance music, Indian Grill.

(H), Los Angeles, Calif. (405.2), 6-6:30 p. m., Leighton's Arcade cafeteria orchestra, Jack Cronshaw, leader; 6:30-7:30, history story, Prof. Bertozzi; Henrietta Poland, Dolly Wright, Uncle John and others; 8-10 p. m., Los Angeles Enamelers association program, arranged by Walter Biddick; 10-11:30, Art Hickman's Bitmore hotel dance orchestra, Frank Ellis, leader; 11:30-2 a. m., Lost Angels of KJH.

JR, Seattle, Wash. (384.4), 7:15-2 p. m., organ recital, Catholic church; 2-2:15, "Home Heaps," Bernice Redington; 8:30, "What's Going on at the Theaters"; 8:30-10, L. C. Warner company studio program.

LX, Oakland, Calif. (508), 2:30 p. m., California-Stanford football game.

MTR, Hollywood, Calif. (238), 5-6 p. m., home hour, Mammy Simmons; 6-7 p. m., dinner music by Olga Trumbull trio; 7:30 p. m., lecture on history and astronomy; 8-9 p. m., Maggie O'Shea, the Blarney girl; 9-11 p. m., KMTR Rambler's hour; the Jazz Babies of 1885.

NX, Hollywood, Calif. (336.9), 5:30-6:15 p. m., Wurlitzer pipe organ studio; Town Tuttle; 6:15, travel talk, W. F. Alder; 6:30-7, Atwater Kent concert orchestra; Paul Einstein, leader; 7, talk on news; 8-9 p. m., McSpadden; 7:15, church announcements; 8-10 p. m., KNX feature program; 10-11, Ray West's Cocoonat Grove dance orchestra from Ambassador hotel; 11-2 a. m., Hollywood Night.

PO, San Francisco, Calif. (428.3), 1-2 p. m., Rudy Seizer's Fairmount hotel orchestra; 2:30, University of

California Bears-Stanford Cardinals football game; 3:30, Palace hotel concert orchestra; 6:35-7:30, Waldemar Lind and the States Restaurant orchestra; 8-10, Sherman, Clay and company; 10-12, Jack Coakley's Caberians.

## Sunday, November 22

### Headliners Today

Eastern 5 p. m.	Central 4 p. m.	Mountain 3 p. m.	Pacific 2 p. m.
KOA (322.4) Highlander boys.	6:30	5:30	4:30
WCAU (278) Hotel Pennsylvania trio.	8	7	6
WBZ (333.1) Holy Cross college.	8	7	6
WBEH (370.2) Selected artists program.	9	8	7
WEAR (389.4) Organ recital.	9:15	8:15	7:15
WLW (422.3) Sunday evening concert.	9:15	8:15	7:15
KHJ (405.2) Martin Music company.	9:15	8:15	7:15
WEAF (491.5), WEEI (548.6), WGR (319), WCAE (461.3), WCAP (483.5), WJAI (305.9), WTAG (268), KSD (545), WCCO (416.4), WOC (483.6), WSAI (226), State symphony.	10	9	8
KTHS (374.8) Deluxe classic hour.	10:45	9:45	8:45
WIP (508.2) Opera, "Fedora."	10:45	9:45	8:45
WOC (483.6) Palmer Little symphony.			7:45

Sunday, silent night for: CHIC, CKNC, CNRA, CNRC, CNRE, CNRM, CNRO, CNRR, CNRT, CNRV, CNRW, KFAU, KFAU, KFMO, KFOA, KFPG, KFVE, KFWA, KLB, KMA, KOB, KSC, KWS, PWX, WAHG, WBAP, WCAU, WCX, WDAF, WEAU, WEBJ, WGES, WGPC, WGST, WHAD, WHAS, WHAZ, WIP, WJAD, WJAZ, WKAR, WJR, WLIT, WMC, WNYC, WOK, WOR, WORD, WRC, WSAI, WSMB, WTAM, WVIC.

**Eastern Time Stations**

CFOA, Toronto, Can. (356), 11 a. m., Timothy Eaton Memorial church; 7 p. m., St. Paul's Anglican church.

KDKA, Pittsburgh, Pa. (309.1), 10:45 a. m., services; 4 p. m., organ recital, Dr. Charles Heinroth; 5:45, vesper services, Redyside Presbyterian church, Rev.

Tomkins, rector; 10, opera, "Fedora," Germantown theater; WIP Little symphony orchestra.

WJAR, Providence, R. I. (305.9), 7:20 p. m., Capitol Theatre Gang; 9:15, Atwater Kent radio hour.

WJR, Pontiac, Mich. (517), 8:30 p. m., The Merry Old Chief and his Jewett Jesters.

WKAR, East Lansing, Mich. (285.5), 12:30 a. m., dance program.

WLIT, Philadelphia, Pa. (394.5), 2 p. m., Arcadia cafe concert orchestra, Henry Szameth, tenor; 8, Round Table Forum.

WMCA, New York, N. Y. (340.7), 11-12 m., services, Christian Science; 6-7 p. m., Roemer's Homers; 7-7:30, Ernie Golden and his Hotel McAlpin orchestra; 7:35-8, Olcott Vail and his Hotel McAlpine string ensemble.

WREO, Lansing, Mich. (285.5), 10 a. m., Belfry Plymouth Congregational church; 10:30, Plymouth Congregational church; 7:30, Central M. E. church.

WTAG, Worcester, Mass. (268), 3:45-5:30 p. m., Y. M. C. A., address, Dr. S. Parkes Cadman; Gloria trumpet; Howard Wade Kinsey, song leader; Mrs. Howard Wade Kinsey, song leader; George Betts, chime soloist; 7:20-9:15, Major Edward Bowes and the "Capitol Gang"; 9:15-10:15, Atwater Kent Radio hour.

WWJ, Detroit, Mich. (352.7), 11 a. m., services, St. Paul's Episcopal cathedral; 2 p. m., Detroit News orchestra; 7:20, Capitol theater gang, WEAF.

### Central Time Stations

KFAB, Lincoln, Neb. (340.7), 4-5 p. m., vesper service.

KFDM, Beaumont, Texas (315.6), 8-9 p. m., sacred program.

KFMX, Northfield, Minn. (337), 7-8 p. m., college service.

KFNB, Shenandoah, Iowa (266), 10:45 a. m., morning worship, First M. E. church; 3:30 p. m., Golden Rule song service; 3, religious services, Director G. W. Oliniger; 6:30, services, Golden Rule circle; 7:30, Christian church services.

KFRU, Columbia, Mo. (499.7), 7:30 a. m., services; Stephens college quartet; Elizabeth Shields, pianist; reading, Verne Koehian; prayer, Dolores Guyman; 9:20, Burrall Bible class; Jessie Burrall, teacher; orchestra, hymns: Alma Bieber, soloist; 7:30 p. m., First Baptist church services; organ prelude; echo music, chorus and quartet; prayer, Helen Eastland; Valborg Leland, violinist.

KFOU, St. Louis, Mo. (545.1), 4 p. m., "I Am the Light of the World," Rev. A. Doerflinger; 9:15, "The Victory of the Reformation," Prof. J. H. C. Fritz; songs and music.

KLDS, Independence, Mo. (440.9), 11 a. m., Stone church services; Robert Miller, organist; chorus choir;

WDAF, Kansas City, Mo. (365.6), 3:30-4:30 p. m., Park College band, 22 pieces.

WEBH, Chicago, Ill. (370.2), 10:40 a. m., Seventh Church of Christ Scientist; 5-7, twilight musicale; 7-9, artists program.

WENR, Chicago, Ill. (266), 2-4 p. m., classical program; Pauland lyric trio; Mr. and Mrs. John Baker; sacred selections, soprano, solo; 9:30-11:30, popular program; All-American Pioneers; O. T. Norum, tenor; James Beaumont, banjoist; Frank Westphal, Marie Tulley.

WFAA, Dallas, Texas (475.9), 6:30-7:30 p. m., Bible class, Dr. William Anderson; gospel song; 7:30-8:30, services, Westminster Presbyterian church, Dr. T. O. Ferrin, pastor; Daisy Polk, soloist; 8:30-9:30, Dr. Harry Lee Virden; music; 9:30-11, Little symphony orchestra, Grace Methodist Episcopal church, Marie Behrends, director.

WGES, Oak Park, Ill. (250), 5-7:40 p. m., John A. McFarlane, bass; Marge Van, organist; Moody Bible Institute program; Doc Berendson and his Tiffin theater orchestra; 11-1 a. m., John Brown and John Stanford; Remington-Watson Tiffin theater organist.

WGN, Chicago, Ill. (370.2), 12 p. m., radio, comics; 1, program, Chicago theater; 3:30-5, Chicago Musical college concert; 9-10, Tribune string trio and vocal artists.

WHAS, Louisville, Ky. (399.8), 9:57 a. m., organ prelude; 10, services, Virginia Avenue Methodist church, Pastor Dr. Charles A. Humphrey, pastor; 4-5 p. m., evensong choral service, Christ Church cathedral; Ernest Simon, organist and choir master; boys' choir.

WHO, Des Moines, Iowa (526), 11 a. m., church service; 7:30-8:30 p. m., Leese-Hughes orchestra.

WHT, Chicago, Ill. (399.8), 12 m., Sunday dinner sacred concert, vocal, instrumental and organ; 12:45 p. m., Sunday school, special program for the students and the sick; 1:15, shepherd line for the kiddies; 1:30, aerial girls program; 1:45 Radio rangers, boys' program; 2, Radio capoteur; 2:05, missionary program; 2:15, fellowship program; 2:50, afternoon services Chicago gospel tabernacle; 5:30, vesper concert; 6:45, Young women's council; 6:30, concert, tabernacle band and choir, sermon, Paul Rader; 9:30 request program; 10:30, back home hour.

WKRC, Cincinnati, Ohio (326), 6:45 p. m., services, Walnut Hills Christian church, Dr. J. J. Castleberry, pastor; 10, Merrill Schwarz, baritone; Gene Perazzo, pianist.

WLB, Chicago, Ill. (308.2), 4-5 p. m., classical; 5-6, Hamm's orchestra; 6-6:30, Edward Benedict, organist; 8-9, popular program.

WLS, Chicago, Ill. (344.6), 6:30 p. m., Ralph Emerson, organist; 6:50-7:55, Little Brown church, Little Brown church choir, WLS studio trio.

WLW, Cincinnati, Ohio (422.3), 9:30 a. m., Sunday school; editorial staff Publications of Methodist Book concern; 11, services, Seventh Presbyterian church, Jesse Halsey, minister; Dan Beddoe, soloist; Adolph Stadermann, organist; 7 p. m., services, First Presbyterian church, Dr. Fred McMillan, minister; 8, concert, H. & S. Pogue department store, Walter Eiseberger, director; soloists, George Muhlhauer, tenor; Arthur Bowen, cellist; Arthur Dundero, violinist.

WMBB, Chicago, Ill. (250), 3-5 p. m., Trianon orchestra; Woodlawn theater orchestra; Bob Bennett, Earle Smith, Bob Duffy, Clyde Hager; 7:40-9, services, Fifth Church of Christ Scientist; 9-11, Trianon orchestra, Woodlawn theater orchestra; Preston Graves, Ralph F. Elliott, Trianon syncretors.

WOAI, San Antonio, Texas (384.5), 11 a. m., services, First Presbyterian church, R. D. Hill, pastor; 7:45, services, Central Christian church, Rev. Hugh McLellan, pastor.

WOAW, Omaha, Neb. (526), 9 a. m., chapel service, Rev. R. R. Brown; 2:30 p. m., matinee program; 8, chapel service, Trinity Lutheran church.

WOC, Davenport, Iowa (483.6), 1-2 p. m., Palmer Little symphony; 6:30-7:30, Swindell, conductor; Paul Vipperman, tenor; 8:30-7:30, services, Rev. H. C. Gown Stevenson; 9:45-11:45, musical program; Palmer Little symphony, Erwin Swindell, conductor; soloists.

WOL, Ames, Iowa (270), 10:45 a. m., college chimes; 8, chapel services, Fred M. Hanson.

WOK, Chicago, Ill. (217.3), 1-2 p. m., Harriet Lee, contralto; Herman Sinaiko, violinist; WOK string quartet; Bob Mokreis, pianist; 6:30-8:30, WOK string trio; WOK mixed quartet; WOK male quartet; Gus C. Edwards and his orchestra.

WORD, Batavia, Ill. (275), 10 a. m., hymns and sacred songs, duets and solos; 10:15, address, G. A. Hall; 8 p. m., hymns and sacred songs, solos, duets, I. B. S. a. choral singers; 9:15, address, "A Godly Nation Cannot Fall," A. L. Sealey; 9:45, Arlon Emmons, violinist; Elsa Freeman, soprano.

WOS, Jefferson City, Mo. (440.9), 9:30 a. m., Christian church, Rev. Haushalter; 7:30, Presbyterian church, Rev. A. B. Jackson, pastor.

WOT, Chicago, Ill. (447.5), 9:30-11:30 a. m., sermon, Dr. Preston Bradley; 5, bureau voice choir; Clarence Eddy, organist; 3-4 p. m., concert hour, Jerry Sullivan, director; Saida A. Ballantine artists; string trio; Kriste Gallen-Kallala, cellist; Rosalie Saalfeld, violinist; Saida A. Ballantine, pianist; Agnes Light-hall, dramatic soprano; Frederick Clark, tenor; Panny Fuerst, dramatic entertainers; Miss Donke, accordionist; 10, Ralph Williams and his Rainbo Garden orchestra; Fontella trio; Everett G. Mitchell, baritone; Helen Holman, soprano; Madeline Ruff, pianist; Leonard F. Keller, violinist; Elsa Blaggen, lyric soprano; John Zwick, accompanist; Otis Pike Jester, soprano.

WSAI, Cincinnati, Ohio (326), 2:45 p. m., address, Dr. S. Parkes Cadman, Y. M. C. A., WEAF; 7:30, Robert Badgley, chimes; 7:45, sermnette, Radio Bible Service, Inc.; Daniel A. Poling; 8:15-9:15, Atwater Kent Radio hour; New York State symphony orchestra; 9:15, Union Central Life Insurance company orchestra.

WSM, Nashville, Tenn. (282.8), 7:30 p. m., First Presbyterian church service.

WSU, Iowa City, Iowa (483.6), 4 p. m., university choral address, Albert Parker Fitch; 9:15, familiar hymns, Kalona quartet.

**Mountain Time Stations**

CFAC, Calgary, Can. (435.8), 11 a. m., First Church, Christ Scientist.

KOA, Denver, Colo. (322.4), 11 a. m., services, Augustan Lutheran church; 3 p. m., afternoon musicale hour, Thanksgiving program; Highlander boys' quartet band, John S. Lelek, director; 7:30, service, Agostana Lutheran church, Young People's rally of all Lutheran churches.

KUOM, Missoula, Mont. (244), 9:15 p. m., musical program, Hazel Tietjen Forbis; piano solos, Mrs. Herbert Kupke; vocal duets, Mrs. Forbis, Donavan Worden; violin solos, Thula Toole Weisel; vocal solos, compositions, Dean DeLoss Smith school music, sung, Mrs. Forbis' instrumental trio, pianist, Mrs. Forbis.

**Central Time Stations**

KFAB, Lincoln, Neb. (340.7), 4-5 p. m., vesper service.

KFDM, Beaumont, Texas (315.6), 8-9 p. m., sacred program.

KFMX, Northfield, Minn. (337), 7-8 p. m., college service.

KFNB, Shenandoah, Iowa (266), 10:45 a. m., morning worship, First M. E. church; 3:30 p. m., Golden Rule song service; 3, religious services, Director G. W. Oliniger; 6:30, services, Golden Rule circle; 7:30, Christian church services.

KFRU, Columbia, Mo. (499.7), 7:30 a. m., services; Stephens college quartet; Elizabeth Shields, pianist; reading, Verne Koehian; prayer, Dolores Guyman; 9:20, Burrall Bible class; Jessie Burrall, teacher; orchestra, hymns: Alma Bieber, soloist; 7:30 p. m., First Baptist church services; organ prelude; echo music, chorus and quartet; prayer, Helen Eastland; Valborg Leland, violinist.

KFOU, St. Louis, Mo. (545.1), 4 p. m., "I Am the Light of the World," Rev. A. Doerflinger; 9:15, "The Victory of the Reformation," Prof. J. H. C. Fritz; songs and music.

KLDS, Independence, Mo. (440.9), 11 a. m., Stone church services; Robert Miller, organist; chorus choir;

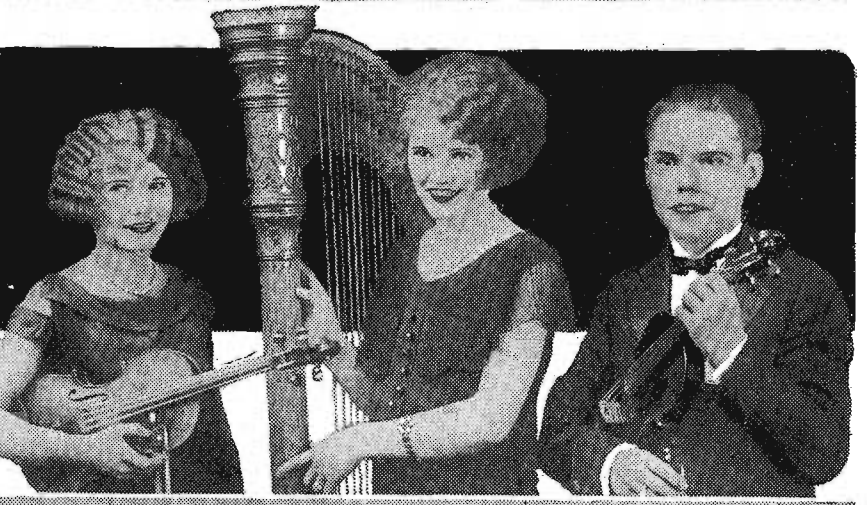

Monday evenings are made delightful at WOAW, Omaha, by the blending of the harp and violins of this talented group of musicians. The Sken trio is so popular with fans it is a regular feature of this station.

Hugh Thomson Kerr, pastor; 8:30, dinner concert; 7:45, church service.

WAFD, Port Huron, Mich. (275), 10-11:30 a. m., services; 7:30-8:30 p. m., musical program.

WAHG, Richmond Hill, N. Y. (495.6), 12-12:55 p. m., musical program; 7:30-7:45, Lon Maurice G. Connolly; 7:45-8:15, Synchronase trio; 8:15-8:30, Adelaide de Luca, contralto; 8:30-8:45, W. Norman Grayson, pianist; 8:45-9, Charles Brass, tenor; 9-9:15, Adelaide de Luca; 9:15-9:30, W. Norman Grayson; 9:30-9:45, Synchronase trio; 10-10:15, Charles Brass; 10:15-11:15, Glenn C. Smith's Paramount orchestra.

WEZ, Springfield, Mass. (333.1), 10:55 a. m., services, South Congregational church, Rev. James Gordon Gilkey, pastor; Prof. Wilson Moon, organist; 24-voice choir; quartet, 8 p. m., program, Holy Cross college; A. Edward Bowler, organist; F. Herbert Kenney; tenor; Paul Diederich, violinist; Joseph Conlin, cellist; Thomas Luffin, tenor; Milton Corbin, flutist.

WCAE, Pittsburgh, Pa. (461.3), 3:45 p. m., Dr. S. C. Cadman; 6:30, dinner concert, William Penn hotel; 7:20, WEAF Capitol theater gang; 9:15, Atwater Kent hour, WEAF.

WCAP, Washington, D. C. (458.5), 10:45 a. m., First Church of Christ Scientist; 7:20 p. m., Capitol theater program; 9:15, Atwater Kent hour.

WCAU, Philadelphia, Pa. (278), 5 p. m., recital; 5:15, Radio church, Rev. John W. Stockwell; 5:25, "Sevop Books of Power," Rev. W. Stockwell; 5:45, "A Message for You," Rev. John W. Stockwell; 6:30, Hotel Pennsylvania trio; 7:30, Catway tea garden concert orchestra; 8:30, Bonwit Teller concert company; 10:20, Jaffe's collegians.

WCX, Detroit, Mich. (517), 10:30 a. m., services, Central Methodist Episcopal church.

WEAF, New York, N. Y. (483.5), 2-3:45 p. m., "Sunday Hymn Sing," Greater New York Federation of churches; 3:45-5:30, men's conference, Bedford branch Y. M. C. A.; 7:26-8:13, "Capitol Gang," Capitol theater; 9:15-10:15, Atwater Kent Radio hour.

WEA, Cleveland, Ohio (384.4), 12-13 a. m., sermo midnight concert; 2 a. m., community song program; 7, Stillman theatre orchestra; 8, Sreside hour; 9, Vincent Percy, organ recital.

WEEI, Boston, Mass. (345.6), 10:30 a. m., morning service, Old South church; 9:45 a. m., Men's conference; 7:20, Major Bowes and his Capitol theater quintet; 9:15, Atwater Kent hour.

WGBS, New York, N. Y. (437.5), 3:30-4:30 p. m., program, Warner's theatre; 9:30-10, Russian program, Raoual Baruch.

WtBU, Fairfield-by-the-Sea, Fla. (278), 9-11 p. m., sacred program.

WGR, Buffalo, N. Y. (439.1), 6 p. m., vesper service, Buffalo Council of Churches, Rev. Mortimer Heisler.

Akron, N. Y., speaker; 7:45, Central Presbyterian church service; 9:15-10:15, WEAF, Atwater Kent Radio hour.

WGY, Schenectady, N. Y. (379.5), 10:30 a. m., service, First Baptist church; 12:30 p. m., symphony orchestra, Rivoli theater, Dr. Hugo Risenfeld, conductor; 5, Dr. Frank Hill Rogers, organist; 7, Carillon program; 7:30, First Baptist church; Godfrey Ludlow, violinist.

WHAR, Atlantic City, N. J. (275), 10:45 a. m., services; 2:15 p. m., Seaside hotel trio; 2:45, sermon; 7:50, Chelsea Baptist church; 9, Seaside hotel orchestra; 11:15, Strand theater organ recital.

WIP, Philadelphia, Pa. (508.2), 4 p. m., services; 7:15, services, Holy Trinity church; Rev. Floyd W.

soprano solo, Corraine Haynes French; sermon Presiding Elder A. Smith; 6:30, vesper service, KLDS ladies quartet, Clara Curtis, soprano; Mary Field, soprano, Mrs. Frank Goode, Gladys Goode contralto; Frank Redfield, tenor; Nelson Goodsmith, cornet soloist; sermon, Elder U. W. Greene; 8, Robert Miller, organist; Milford Nace, baritone horn; Thanksgiving hymns, Nina Smith, soprano; Alvie Burgess, contralto; George Anway, tenor; Frank Russell, bass; sermon, Ralph W. Farrell; Shakespeare and Religion series.

KPRC, Houston, Texas (296.9), 9:45 a. m., Trinity Lutheran church, Rev. J. W. Behnen, pastor; 8 p. m., Trinity Lutheran church; 9:30, Ray Mullins' orchestra.

KSD, St. Louis, Mo. (545.1), 6:55 p. m., WEAF "Good Will" program.

KTHS, Hot Springs National Park, Ark. (374.8), 11 a. m., 12:15 p. m., services, First Presbyterian church, Rev. Chauncey Kieok, pastor; Frances Hardin, organist; 9:10, Deaux classic hour; New Arlington hotel grand ensemble; Meyer Davis string quintet; Lon Chasse, violinist; Harry Roberts, violinist; Edward Richter, cellist; John Heyne, pianist; Henry Haynes, string bass; cello recital, Edward Richter; 10-11:30, Tower frolic, Benny Ford and his DeSoto Garden serenaders.

KYW, Chicago, Ill. (250), 11 p. m., Central church service, Orchestra hall, Rev. Frederick F. Shannon, pastor; 2:30 p. m., studio chapel service; 5, Chicago Evening American studio concert, Edwin Harper, director; 7, Chicago Sunday Evening club service, Dr. W. C. Petty, First Baptist church, Pittsburgh.

WAMD, Minneapolis, Minn. (243.8), 9:30 p. m., Gayle Wood, organist.

WBAF, Fort Worth, Texas (475.9), 11 a. m., First Methodist church, Rev. J. W. Bergin, pastor; Florence W. Brush, organist; 12:30, kiddies' hour, Uncle Billy; 1, program, business and professional men's golf club, Mrs. J. Homer Adams.

WBBM, Chicago, Ill. (226), 12-1 p. m., classical program; Sunset male quartet, Harry Sosnick and Sandy Jeek; William P. Zimner; Harold Morava; Earl Westland, pianist; Kantor A. Kritz; Edna Wheeler Ballard, harpist; 4-6, Stewart Warner program, Harold Anderson; Merry Garden orchestra; Charlie Garland, Maurice Silverman; Burdette Cleveland; Blue Deuces; Zeiler Sisters; 8-10, Frances Ingram, organist; violinist; Jeanne St. Anna, baritone; Christian Grim, accompanist; Ted Coleman, cellist; Joseph Raioff; concert pianist; 12-2 a. m., Nully club request features.

WBCN, Chicago, Ill. (266), 10:30-12 m., morning service, People's Liberal church; talk, Rev. Rufus A. White; 4-5 p. m., Dain & Son classical hour; Velma Cook, soprano; Oriental quartet; male harmony group; Robert Stronach, pipe organist; 7:45-9:15, evening service, Thoburn M. E. church, 40-piece Thoburn semi-symphony orchestra; 80-voice choir, special vocal soloists; speaker.

WCBD, Zion, Ill. (344.6), 8 p. m., male quartet, trombone quartet, celestial bells; John D. Thomas, baritone; Grace and Mrs. Mary Wedeking, vocal duets; George Beem, marimba soloist; Alce Peters, violinist; Teeple, rector; Mrs. Pauline Russell Brown, pianist.

WCCO, Minneapolis-St. Paul, Minn. (416.4), 11 a. m., Westminster Presbyterian church, Rev. John E. Bushnell, D. D., pastor; 4:10 p. m., House of Hope Presbyterian church, Rev. H. C. Swearingen, pastor; 8:15, Atwater Kent program, WEAF.

**Mountain Time Stations**

CFAC, Calgary, Can. (435.8), 11 a. m., First Church, Christ Scientist.

KOA, Denver, Colo. (322.4), 11 a. m., services, Augustan Lutheran church; 3 p. m., afternoon musicale hour, Thanksgiving program; Highlander boys' quartet band, John S. Lelek, director; 7:30, service, Agostana Lutheran church, Young People's rally of all Lutheran churches.

KUOM, Missoula, Mont. (244), 9:15 p. m., musical program, Hazel Tietjen Forbis; piano solos, Mrs. Herbert Kupke; vocal duets, Mrs. Forbis, Donavan Worden; violin solos, Thula Toole Weisel; vocal solos, compositions, Dean DeLoss Smith school music, sung, Mrs. Forbis' instrumental trio, pianist, Mrs. Forbis.

**Central Time Stations**

KFAB, Lincoln, Neb. (340.7), 4-5 p. m., vesper service.

KFDM, Beaumont, Texas (315.6), 8-9 p. m., sacred program.

KFMX, Northfield, Minn. (337), 7-8 p. m., college service.

KFNB, Shenandoah, Iowa (266), 10:45 a. m., morning worship, First M. E. church; 3:30 p. m., Golden Rule song service; 3, religious services, Director G. W. Oliniger; 6:30, services, Golden Rule circle; 7:30, Christian church services.

KFRU, Columbia, Mo. (499.7), 7:30 a. m., services; Stephens college quartet; Elizabeth Shields, pianist; reading, Verne Koehian; prayer, Dolores Guyman; 9:20, Burrall Bible class; Jessie Burrall, teacher; orchestra, hymns: Alma Bieber, soloist; 7:30 p. m., First Baptist church services; organ prelude; echo music, chorus and quartet; prayer, Helen Eastland; Valborg Leland, violinist.

KFOU, St. Louis, Mo. (545.1), 4 p. m., "I Am the Light of the World," Rev. A. Doerflinger; 9:15, "The Victory of the Reformation," Prof. J. H. C. Fritz; songs and music.

KLDS, Independence, Mo. (440.9), 11 a. m., Stone church services; Robert Miller, organist; chorus choir;

**Mountain Time Stations**

CFAC, Calgary, Can. (435.8), 11 a. m., First Church, Christ Scientist.

KOA, Denver, Colo. (322.4), 11 a. m., services, Augustan Lutheran church; 3 p. m., afternoon musicale hour, Thanksgiving program; Highlander boys' quartet band, John S. Lelek, director; 7:30, service, Agostana Lutheran church, Young People's rally of all Lutheran churches.

KUOM, Missoula, Mont. (244), 9:15 p. m., musical program, Hazel Tietjen Forbis; piano solos, Mrs. Herbert Kupke; vocal duets, Mrs. Forbis, Donavan Worden; violin solos, Thula Toole Weisel; vocal solos, compositions, Dean DeLoss Smith school music, sung, Mrs. Forbis' instrumental trio, pianist, Mrs. Forbis.

**Central Time Stations**

KFAB, Lincoln, Neb. (340.7), 4-5 p. m., vesper service.

KFDM, Beaumont, Texas (315.6), 8-9 p. m., sacred program.

KFMX, Northfield, Minn. (337), 7-8 p. m., college service.

KFNB, Shenandoah, Iowa (266), 10:45 a. m., morning worship, First M. E. church; 3:30 p. m., Golden Rule song service; 3, religious services, Director G. W. Oliniger; 6:30, services, Golden Rule circle; 7:30, Christian church services.

KFRU, Columbia, Mo. (499.7), 7:30 a. m., services; Stephens college quartet; Elizabeth Shields, pianist; reading, Verne Koehian; prayer, Dolores Guyman; 9:20, Burrall Bible class; Jessie Burrall, teacher; orchestra, hymns: Alma Bieber, soloist; 7:30 p. m., First Baptist church services; organ prelude; echo music, chorus and quartet; prayer, Helen Eastland; Valborg Leland, violinist.

KFOU, St. Louis, Mo. (545.1), 4 p. m., "I Am the Light of the World," Rev. A. Doerflinger; 9:15, "The Victory of the Reformation," Prof. J. H. C. Fritz; songs and music.

KLDS, Independence, Mo. (440.9), 11 a. m., Stone church services; Robert Miller, organist; chorus choir;

**Mountain Time Stations**

CFAC, Calgary, Can. (435.8), 11 a. m., First Church, Christ Scientist.

KOA, Denver, Colo. (322.4), 11 a. m., services, Augustan Lutheran church; 3 p. m., afternoon musicale hour, Thanksgiving program; Highlander boys' quartet band, John S. Lelek, director; 7:30, service, Agostana Lutheran church, Young People's rally of all Lutheran churches.

KUOM, Missoula, Mont. (244), 9:

# MEXICAN BAND PROGRAM AT KHJ

## Sunday, November 22

(Continued from page 14)

Violinist, Mrs. Weisel; saxophone, Russel Cunningham; Radio sermon, Rev. John R. Hahn, University congregational church.

### Pacific Time Stations

**KFWB, Hollywood, Calif. (252),** 9-11 p. m., late news followed by Warner Brothers movie frolic.

**KGO, Oakland, Calif. (361),** 11 a. m., service, First Baptist church; 3:30 p. m., KGO Little Symphony orchestra; Alice Bradley, guest artist; 7:45, First Baptist church.

**KGW, Portland, Ore. (491.5),** 10:55-12 noon, services, St. Stephens Pro-Cathedral; 7:55-9 p. m., services, First Church of Christ, Scientist.

**KHJ, Los Angeles, Calif. (405.2),** 4-5 p. m., Sunday afternoon musicale, Western Auto Supply company; 6:30-7, Leighton's Arcade cafeteria orchestra, Jack Cronshaw, leader; 7-7:30, organ recital, Arthur Blankely, organist; 8-10, program, Martin Music company, arranged by J. Howard Johnson with Ruth Pitts, soprano, and John Martin, pianist.

**KJR, Seattle, Wash. (384.4),** 11-12:30 p. m., First M. E. church, Dr. Ralph Magee, pastor; 7:15-7:30, organ recital, played Mrs. Montgomery Lynch; 7:30-9, First M. E. church, Dr. J. Ralph Magee, pastor; 9-10:30, Puget Sound Savings & Loan orchestra, direction, Henri Darski.

**KMTR, Hollywood, Calif. (238),** 8-9 p. m., KMTR concert hour, Turner orchestra, direction Loren Powell.

**KNX, Hollywood, Calif. (336.9),** 7-8 p. m., First Presbyterian church; 8-9, Ambassador hotel concert orchestra, Josef Rosenfeld, leader; 9-10:30 p. m., string trio, Raquel Nieto, coloratura soprano.

**KPO, San Francisco, Cal. (428.3),** 9:45-10:45 a. m., "Thanksgiving and Thanksgiving," Dr. W. A. Phillips, pastor; 10:45, "Ye Towne Cryer" and amusement information service; 5-6 p. m., organ recital, Marshall W. Giselman; 6-6:30, Waldemar Lind and the States restaurant orchestra; 6:30, "Ye Towne Cryer"; 6:35-7:30, Palace hotel concert orchestra, Cyrus Trobde, director; 8-8:30, Palace hotel concert orchestra, Cyrus Trobde, director; 8:30-10, Rudy Seiger's Fairmont hotel orchestra.

**KTAB, Oakland, Calif. (240),** 9:45-10:45 a. m., Bible lecture, Prof. E. G. Linsley; 11-12:30 p. m., church service; 7:45-9, church service; 9:30-11, after-service concert.

dinner music, Waldorf-Astoria; 7-7:15, talk, Dr. Henry J. Fisher; 7:15-7:30, Norman Curtis, pianist; 7:30-7:45, Wendy Ross, impersonator; 7:45-8, Rudolph Joskowitz, violinist; 8-8:30, "Your Hour"; 8:30-8:45, Norman Curtis; 8:45-9, tower health talk; 9-10, music, A. and P. Gypsies; 10-11, grand opera, "La Traviata," WEAF Grand Opera company; 11-12, Ben Bernie and his orchestra.

**WEAR, Cleveland, Ohio, (389.4),** 9:30 a. m., Community fund program; 12 m., community fund program; 7 p. m., Allen theatre orchestra; 8, Community fund program.

**WGBS, New York, N. Y. (315.6),** 10-10:10 a. m., timely talks with Terese; 10:10-10:20, Jack Cohen, pianist; 10:20-10:30, talk, Helen M. Hill; 10:30-10:40, Jack Cohen; 10:40-10:50, talk, Lillian Regan; 1:30-1:45 p. m., Henry Rogers, pianist; 2-2:10, talk, Betty Ross; 2:10-2:30, Mrs. Thornton Fischee and Muriel Hall, duets; 3:30-3:40, Mrs. Thornton Fischee and Muriel Hall; 3:40-4, women's program.

**WGBU, Fulford-by-the-Sea, Fla. (278),** 6:30-7:30 p. m., Blue Steele's Fulford-by-the-Sea orchestra; 10-11, Blue Steele's Fulford-by-the-Sea orchestra.

**WGCP, New York, N. Y. (252),** 3-3:15 p. m., Eva Rothenberg, pianologue; 3:15-4, Andy Pendleton's orchestra; 4:15-4:30, Shirley Herman, songs; 4:30-5, Uncle Robert and his little pals; 5:05-5:10, health talk; 6-6:15, Litmann's orchestra; 6:15-6:30, Daddy Winkum; 6:30-7, Litmann's orchestra; 7-8, Dominio Ginger Ale orchestra; 8-8:15, Charles Phillips, pianist; 8:15-8:30, George Hirtze, baritone; 8:30-9, Perry Bradford entertainers; 9-9:15, Bob Ward and the three little Wards; 9:15-9:45, studio program; 10-11, Strickland's orchestra; 11-11:30, Club Ritz orchestra; 11:30-12, Bob Murphy's entertainers; 12-12:30, Connie's orchestra.

**WGHP, Detroit, Mich. (270),** 8 p. m., WGHP Little Symphony.

**WGR, Buffalo, N. Y. (319),** 2:30-4:30 p. m., WGR's afternoon program; 6:30-7:30, Cliff Dwellers orchestra; 8:30-9, Dutch Master's program; 9-10, W. L. MacRae and assisting artists; 10-10:30, George Marshall, playing the dulcimer; 10:30-10:45, Juanita Ansteth, pianist; 11-11 a. m., Vincent Lopez Hotel Stetler dance orchestra, Harold Giesler, director.

**WGY, Schenectady, N. Y. (379.5),** 2 p. m., Asi restaurant orchestra; 2:30, "Day-After-Thanksgiving Menu," Jessie B. Lane; "Winter Decorations From Nature," Annette J. Warner; 6:30, Hotel Van Curler orchestra; 7, WGY agricultural program; 7:45, Royal club dance orchestra; literary appreciation series, William L. Widdemer.

**WHAR, Atlantic City, N. J. (275),** 2 p. m., Seaside hotel trio; 7:30, fashion review; 8, Seaside hotel trio.

**WHAZ, Troy, N. Y. (379.5),** 9 p. m., Lawrence trio, violin, cello and piano; soprano; 9:30, address, William P. Mason; 10:30, King Jazz and his orchestra.

Euclid music studio; 8-11, Willard symphony musical "Trip Around the World" and assisting artists in "Chimes of Normandy"; 11-11 a. m., dance music, Guy Lombardo and his Royal Canadians, Music Box studio.

**WTIC, Hartford, Conn. (475.9),** 6:30 p. m., dinner music, Emil Heimbarger's Hotel Band trio; 7:45, "Volcanoes," Prof. William Garland Foye.

**WWJ, Detroit, Mich. (352.7),** 7:30-8 a. m., settling-up exercises, H. J. Horton; 8:30, "Tonight's Dinner" special talk, Woman's Editor; 11:55, Arlington time relayed Western Union; 12:05 p. m., Jules Klein's Hotel Stetler orchestra; 3, Detroit news orchestra; 6, dinner concert; 8, news orchestra and soloists; A. & P. gypsies.

### Central Time Stations

**KFAB, Lincoln, Neb. (340.7),** 8:30-10:30 p. m., Ed Ellingson, original songbird; Jack Marshall, ragtime kid; Mart Grauenhorst, banjoist soloist; Mrs. Geraldine Jones, soprano; Bleshaw's orchestra.

**KFNF, Shenandoah, Iowa (266),** 7 p. m., old fiddler's contest.

**KFUO, St. Louis, Mo. (545.1),** 8 p. m., "Parent-hood," Rev. H. Claus; songs and music.

**KFVE, University City, Mo. (240),** 8:30 p. m., "Amusements Review," Romaine Melding; concert, popular music, Brunswick-Balke-Collender company, Orchestra Romaine.

**KMA, Shenandoah, Iowa (252),** 11:30-12:30 p. m., RFD program; garden talks, Earl E. May; music, musical saw, J. A. Showers; 6-7, dinner program; Pollyanna stories, Mrs. Dwight Nickols; program, E. J. Andrews dry goods company; 9-11, evening program; How Do You Do Boys, Grady and Doc; Farmham trio.

**KPRC, Houston, Texas (296.9),** 12 m., Frank Tilton, pianist; 5:30, Uncle Judd's Kiddies' hour; 7:30, Record's Ramblers; 8:30, vocal program; 9, Boy Scouts' saxophone band.

**KSAC, Manhattan, Kan. (340.7),** 12:35-1:05 p. m., "Gopher Killing Time," Roy Moore; "Mosaic Diseases in Plants," D. R. Foster; 4:30-5, second year English literature; 6:30-7:30, book review; psychology, P. P. Brainard; "Hogs in Kansas Agriculture," Morris Evans; "Varieties of Grain Sorghums for Kansas," S. C. Salmon.

**KSD, St. Louis, Mo. (545.1),** 7 p. m., "Fur Hour" program announced; 9, artist recital; Grace McGowan, soprano; 10, Dutch Master's cigar period; Steindler string quartet.

**KTHS, Hot Springs National Park, Ark. (374.8),** 9-10 p. m., violin recital, Lon Chassy; Meyer Davis orchestra; 10-11, Rainbow Garden hour; Fenestrick's California serenaders, 555 Service station.

**KYW, Chicago, Ill. (535.4),** 6:30 a. m., morning exercises, Paul A. Leonhardt, physical director, Y.

Here is "Mrs. Schlaugenhauer," who sings "Dat's What Louie Uses" at KYW, Chicago. Art Linick is a favorite German comedian and was famous last season for the way he sang "Katrina" over the air.



Harry Currie's Music box; children's stories, Eleanor Huber; fashion talk, Peggy True; readings.

**WHD, Des Moines, Iowa, (526),** 7:30-8 p. m., advanced students, Drake university conservatory, direction, Dean Holmes Cowper; 8-8, Faculty members, Drake university conservatory; 11-12, organ recital.

**WHT, Chicago, Ill. (399.8),** 10 a. m., Jean Sargent's program, woman's club; Borden health talk, Jelko Good Luck Girl; Helen Rauh, pianist; John Clark, baritone; 10:45, Betty Crocker home service; 11, special studio features; 12 p. m., Al Carney's organ hour; 1, special studio program, Grayling's string trio; 6, classical program, Linner organ recital; Helen Rauh, pianist; Grayling's string trio; Pat Barnes; Helen Axel, soprano; John Clark, baritone; 7, Kitchen Klezzer Classics.

**WIAD, Waco, Texas (250),** 8:30-10 p. m., musical program, Mrs. J. W. Hill, director.

**WKRC, Cincinnati, Ohio (326),** 6:15 p. m., dinner program, Avlin Roehr's Hotel Albus orchestra; 8, Post-Wurlitzer popular series, "Lonesome Times" from mountains of Kentucky; Fred Sankers famous orchestra; 9, American Legion program; Charles H. Partington, accordionist; 12, theatrical stars; 12:30, Wesley Helvey's troubadours, popular orchestra.

**WLW, Cincinnati, Ohio (422.3),** 7:30 a. m., morning exercises, William Stradman, Y. M. C. A.; 7:45, morning devotions, auspices of Parkway Y. M. C. A.; 9, Crosley Elementary school program, musical appreciation lesson, Sarah Y. Cline; 9:10, special music; 9:20, agricultural primer, J. W. Schwab; "When Mr. Pig Is Fat"; 9:25, causthetics, Cincinnati Y. M. C. A.; 12:15 p. m., noonday service, Rev. George H. Kase; 3:30, Monday Musical club program, Mrs. Schatz; Mrs. Robert Finch; Mrs. I. Alexander; O'Brien; Davis Hall; 4, recital, pupils of Leo Stoffregen; 6:30, Crosley theatrical review; 7, dinner hour concert, Hotel Gibson, Robert Wiscott, director; 7:30, basketball talk, G. A. Richardson, coach Central Y. M. C. A.; 7:40, Hotel Gibson concert; 8, Cincinnati Times Star concert; Howard Hafford, tenor; Keefe-Koeker orchestra; Robert Alter trio.

**WMAQ, Chicago, Ill. (447.5),** 12:45 p. m., Radio farm school, 2, Shut-lus programs; 3, Mothers in Council; 4:30, "Fishes of the Moment," Mrs. Graham Aldis; 4:45, Glenn Dillard Gunn School of Music; 5:15, Topsy-Turvy time; 6, Chicago theater organ recital; 6:30, Hotel La Salle orchestra; 6:40, Family Altar league.

**WQAI, San Antonio, Texas (394.5),** 3 p. m., musical program.

**WQAW, Omaha, Neb. (526),** 12:45 p. m., Randall's Royal Fontenelle orchestra; 5:40, Val McLaughlin, sandman; 6, Phyllis Griswold, organist; 6:25, popular song period; 6:50, Randall's Royal Fontenelle orchestra; 9, Skeen trio; Thelma Skeen Swauger, harpist; Lorenda and Allan Skeen, violinists.

**WOC, Davenport, Iowa, (483.6),** 3-3:30 p. m., farm school, hog day, "Rations that Pay in Fall Pig Production," Prof. John Edward; home management schedule, Aunt Jane; 5:45-6, chimes concert.

**WOL, Ames, Iowa (270),** 12:45 p. m., "Dairy Production," Prof. Earl Weaver; 7:30, poultry course.

**WOK, Chicago, Ill. (217.3),** 12-2 p. m., Banks Kennedy, organist; Bob Mokres, pianist; Gus Edwards and his orchestra; 6-1 a. m., Jimmy Watson, baritone; Paul Small, tenor; Gus C. Edwards and his orchestra; Jimmy Cairns, tenor; Herman Sinaiko, violinist; Harriet Lee, contralto; WOK string trio; WOK male quartet; Charles Lord, tenor; Henry Blyler, tenor; Jack Keyes, baritone; N. Bartlett, bass.

**WOS, Jefferson City, Mo. (440.9),** 8 p. m., community sing, student body, Christian college; address, E. E. Underwood; "Forestry in Missouri," Frederick Dunlap.

**WQJ, Chicago, Ill. (447.5),** 11-12 noon, home economics program; Helen Harrington Downing; "Some Holiday Cakes," Cleve Carney; "Three Factors in the Game—Food, Action and Good Will," Dr. Cyrus Gaddis; 3-4 p. m., "Fish Favorites," Helen Harrington Downing; Prof. John Edward; "Money—Money," F. E. Ormsby; "Heating Your Home with Oil," F. A. Jones.

**WSAI, Cincinnati, Ohio (326),** 10-12 midnight, Cincinnati community program.

**WSB, Atlanta, Ga. (428.3),** 8 p. m., entertainment; 10:45, entertainment.

**WSM, Nashville, Tenn. (282.9),** 6:30-7:30 p. m., Beasley Smith orchestra; 7:30-9, weekly community program; 10-11 studio program, Traveler Protective association; Art Gillham, "The Whispering Pianist."

**WSMB, New Orleans, La. (319),** 8:30-10:30 p. m., Dixola novelty orchestra.

**WSOE, Milwaukee, Wis. (246),** 2 p. m., cooking chats, "Prudence Penny"; 5:30, twilight hour, Aunt Harry, children's stories; Miss Laurine Ludwig, soprano; Elmer Inrke, pianist; 9, "Send a Candygram" frolic, Frank Kuhl's Original Edgewater Beach orchestra; E. R. Erving, baritone; Marguerite Kolka, soprano; Van Buren's Hawaiians; Victor Naves, pianist; Charles Bennett, blind piano-accordionist; other "Candygram" artists.

**WSU, Iowa City, Iowa (433.6),** 12-12:30 p. m., Esther Swisher, pianist; address, "What Becomes of Our Textbooks?" Prof. F. C. Ensign; 7:30-8:30, college of the air lectures; 9, Mrs. Preston C. Coast, organist.

## Monday, November 23

### Headliners Today

Eastern 5 p. m.	Central 6 p. m.	Mountain 6 p. m.	Pacific 5 p. m.
KDKA (309.1) Ruud Light opera hour.			
KFNH (266) Old Fiddlers contest.			
WKRC (422.3) Kentucky mountain tunes.			
WTAG (263) Robin Hood Serenaders.			
WTAM (339.4) "Chimes of Normandy," 8:30		6:30	5:30
WBZ (333.1) Henry quartet, 9	8	7	6
WHAZ (380) Lawrence trio, 10	9	8	7
KPCR (296.9) Scouts saxophone band, WEAJ (491.5) Opera, "La Traviata," WGR (319) Dulcimer soloist, WGST (270) Georgia Technical band, 12	11	10	9
KPO (428.3) Philharmonic trio.			

Monday, silent night for: CHIC, CNRA, CNRC, CNRE, CNRM, CNRO, CNRR, CNRT, CNRV, CNRW, KFDW, KFMD, KFMC, KFRR, KHJ, KDSS, KGL, KWB, PWX, WBBM, WCBW, WCLB, WELB, WEP, WENR, WGBS, WGES, WGN, WHAS, WHT, WIB, WJAZ, WJLD, WLBB, WLS, WMAQ, WMBB, WOC, WORD, WQJ, WRC, WRO.

### Eastern Time Stations

**CKNC, Toronto, Can. (357),** 8:30 p. m., master's program, CKNC Little Symphony orchestra; Verdi mixed quartet.

**KDKA, Pittsburgh, Pa. (309.1),** 7:15-8 a. m., exercises, O. Shannon; 6:15 p. m., dinner concert; 7:30, children's period; 7:45, University of Pittsburgh address, "International Art," Mr. Homer Saint-Gaudens; 7:45, University of Pittsburgh address; 8, Ruud Light Opera hour; 9, Spear's Happy home hour.

**WAFD, Fort Huron, Mich. (277.8),** 9-10 p. m., studio program.

**WBBR, New York, N. Y. (275.6),** 8 p. m., Irene Klempner, soprano; 8:10, World News Digest; 8:25, George Tvaroschek, violinist; 8:35, Bible instruction, "The Hour of God"; 8:50, Irene Klempner, soprano.

**WBZ, Springfield, Mass. (333.1),** 8:30 p. m., organ recital, Rene Dagenais; 7:05, "The Psychology of Understanding," Abraham Myerson; 7:30, Capitol theater orchestra; 8, W. Edward Boyle's Copley Plaza orchestra; 8:30, Henry quartet; 9, Aleppo Drum corps or Shriners' band; 9:30, Patrick Giffney, Irish fiddler; Irish dance music; Susanne Peters, pianist; 9:45, Charles Gilman; 10:05, Leo Reisman's Hotel Brunswick orchestra.

**WGAE, Pittsburgh, Pa. (461.3),** 3 p. m., Loew's Aldine theater program; 6:30, dinner concert, William Penn hotel; 7:30, children's period; 8, Nixon orchestra; 9, studio concert; 10, grand opera; 11, Loew's Aldine theater program.

**WCAP, Washington, D. C. (468.5),** 6:45 a. m., Tower health exercises, WEAF; 8:45, Tower health talk, WEAF; 9-10, A. and P. Gypsies; 10-11, grand opera, WEAF.

**WCAU, Philadelphia, Pa. (277.6),** 8 p. m., Carolyn Thomas, soprano; Elmer Glasgow, bass-baritone; Ella Jaquette Kratz, pianist; 9:10, Nikol m. m., Delaware County Serenaders; 10, songs, Freedman and Brantley; 10:20, song hits, James Loughrey; 10:30, Willie Pierce, popular singer; 11, Parodians.

**WCX, Detroit, Mich. (517),** 2 p. m., news of the day; 6, dinner concert, Pook-Cadillac hotel; 8, concert, Betty Crocker; 11:05-11:15, musical program; 11:15-11:30, talk, Leonard Barron; 11:30-12, lecture, Columbia university; 4-4:15, Bess Davis' orchestra; 4:15-4:30, Mildred Arons, reader; 4:30-4:45, Bess Davis' orchestra; 4:45-5, talk, Ethel Peyser; 6-7,



Between the acts of thrilling dramas the Arion trio plays soothing music to prepare the listener for the next time the Radio curtain rises. Tune in Thursday for "The Cinderella Man" at KGO, Oakland.

**WIP, Philadelphia, Pa. (508.2),** 6:45 a. m., setting-up exercises, Francois D'Eliseu; 7, setting-up exercises; 1, luncheon music; Gumbel tea room orchestra; Ray Sten; orchestra; 3, artist recital; Theodore Liedemede, violinist; Margaret E. Riehm, soprano; Flora Ripka, pianist; 6:05, Benjamin Franklin concert orchestra, W. Irving Oppenheim, director; 7, Uncle Wip's bedtime story; dancing lesson, Miss Miller.

**WJAR, Providence, R. I. (305.9),** 10 a. m., studio program; 8, Berry Spring time; 8:30, A. B. Grinnell; 8:50, "Home Care of the Sick," Gertrude Wilcox Harrop; 9, A. and P. Gypsies; 10, WEAF Grand Opera company.

**WJR, Pontiac, Mich. (517),** 7 p. m., Jean Goldkette's Petite symphony orchestra; 9, "Paige Six," "Jewett Six"; 11:30, Jewett Jesters, Merry Old Chief.

**WKAR, East Lansing, Mich. (285.5),** 7:15 p. m., Radio school, lectures on history, English, sociology.

**WLIT, Philadelphia, Pa. (394.5),** 12:02 p. m., Stanley theater organ recital; Arcadia cafe concert orchestra; 2, Arcadia cafe concert orchestra; 2:30, Marty Fortis, soprano; George E. Dubois, bass; Marcela North, pianist; 4:30, Dorothy Humphreys, soprano; Fredrick Sprague, pianist and accompanist; 7:30, Dream Daddy's bedtime stories; 8:10, "Current Events," Dr. George Earl Raugel; 9, Stanley theater hour of Music; 10, Arcadia cafe dance orchestra; 11, vaudeville features from Pay's Knickerbocker theater.

**WMCB, New York, N. Y. (340.7),** 6:45-8:30 p. m., Olcott Vail and his Hotel McAlpin string ensemble; 6:30-7:30, Ernie Golden and his Hotel McAlpin orchestra; 7:30-8, lullaby music; 8-8:45, Knickerbocker Family circle; 8:45-9, Barclay Radio entertainers; 9-10, lecture, Christian Science; 10-11:15, Radio back entertainers.

**WNYC, New York, N. Y. (526),** 11-12:30 p. m., women's program; talk; concert, Hotel St. George; 6:10-6:20, market high spots; 6:20-6:30, pianist; 6:30-7, elementary German lessons; 7-7:30, advanced German lessons; 7:30-7:35, police alarms; 7:35-8:30, dance program; 8:30-9:30, studio program; 10-10:30, lecture, board of education.

**WOB, Newark, N. J. (405.2),** 8:45-4 p. m., talk, Charm magazine; 6:15-6:17, "Words Often Mispronounced"; 6:17-6:30, sports talk, Bill Wether; 6:30-7:30, dinner music, Hotel Shelton; 7:30-8, Eddie Elkins Ciro orchestra; 8:30-9:30, Al Reid's hour; 9:30-9:45, talk, Edward H. Bierstadt; 10-10:30, Ballin and Race, pianist; 10:30-11, Archie Slater's Palais D'Or orchestra; 11:30-12, Irving Aronson's crusaders.

**WRC, Washington, D. C. (468.5),** 10 a. m., women's hour, WJZ; 12 m., organ recital, Homer L. Kitt studios; 1 p. m., Shoreham hotel orchestra; 4:30, musical program.

**WREO, Lansing, Mich. (285.5),** 6-7 p. m., dinner concert, Speed-Wagon Serenaders; Gold Standard ensemble.

**WRVA, Richmond, Va. (256),** 9-12 midnight, orchestra, soloist, signs off with "Carry Me Back to Old Virginia"; 12:30, dinner music, popular entertainers.

M. C. A.; 7:30, "Morning Family Worship," conducted by M. C. A.; 10:55, time signals; 11:15, talk, John C. Cutting; 11:35, table talk, Anna J. Peterson; 12:05 p. m., noonday concert, Commonwealth Edison company; 1, luncheon hour concert, Congress hotel; Jeska De Babary and his orchestra and Coon Sanders' Original Nighthawks; 7, children's bedtime story, Walter Wilson, known as "Uncle Bob."

**WAND, Minneapolis, Minn. (243.8),** 6 p. m., George Osborne's Radioson orchestra; 7, mixed quartet; Donald Mensing, violinist; Wayne Hugaboon, accompanist; Skyrockets.

**WBAP, Fort Worth, Texas (475.9),** 12:05-12:30 p. m., Louine Smith, pianist; 6-6:30, Texas Hotel Tokio Royal; 7:30-8:30, concert, Northern Texas Traction company; 9:30-10:45, "Trail Blazers"; 11-12, Mat-jestic theater.

**WBBM, Chicago, Ill. (226),** 4-6 p. m., popular program, Valentino Inn orchestra, Harry Sosnick and Sandy Meek; Jack Penwell, Twin Six Guitar; Edna Wheeler Ballard; Court Banks, human string bean; Russell Myers; Joe McManus; artists, Hinchaw conservatory; 6-7, Stewart-Warner program; Montmartre orchestra; Edna Wheeler Ballard, harpist; Charlie Garland; The Two Jays; Joske and Jordan; Ted Coleman, cello; Lew Russell; Pete Kules.

**WBGN, Chicago, Ill. (266),** 10-10:30 a. m., Penny Wise, the shopper's ready helper; 3-5 p. m., tea time matinee; Clarence Jones, pianist; song writer; Ed Wallace, tenor; Big Boy; Yagle, pianologist; O'Leary girls, harmony duo and violinist; Alice McAlmon, contralto; Harold Johnson, boy xylophonist; Catherine O'Brien, dramatic reader; Ebleta Kind, soprano; DeLalah Sheffer, girl baritone; Arrowhead Synopators, dance orchestra.

**WCCO, Minneapolis-St. Paul, Minn. (416.4),** 10:45 a. m., "The Thanksgiving Bird," Betty Crocker; 12 m., Donaldson's orchestra; 2 p. m., woman's hour; 2:30, afternoon concert; 4, readers club, Mrs. Walter Stevens; 5:30, children's hour; 6:30, dinner concert, Gordon Cooke ensemble; 7:45, farm lecture, poultry raising, lesson VI; 8, University of Minnesota program; 9, classical concert.

**WDAF, Kansas City, Mo. (365.6),** 3:30-4:30 p. m., Star's Radio orchestra; 6-7, C. M. Ragon, reader; Tell-Me-a-Story, Lady, Trioan ensemble; 8-9, Around the World; 10-11, Plantation players, Ted Meyn, organist; Eddie Kuhn's Kansas City Athletic club orchestra; Earl Coleman's orchestra.

**WFAA, Dallas, Texas (475.9),** 12:30-1 p. m., Ligon Smith's orchestra; 6:30-7:30, Artie Collins and his orchestra; 8:30-9:30, Sears Roebuck agricultural foundation program.

**WGB, Chicago, Ill. (370.2),** 12:40, Drake concert ensemble; Blackstone string quintet; 2, opening meeting, Government club; 2:30, artist series, Lyon and Healy; 3, Rocking Chair time; 3:30, Marshall Field's tea room orchestra; 5:30, Skeezix time, members National Kindergarten and Elementary college; 6:30-7, dinner concert, Drake concert ensemble; Blackstone string quartet.

**WGST, Atlanta, Ga. (270),** 9-10 p. m., Georgia Tech band.

**WHAD, Milwaukee, Wis. (275),** 4 p. m., Trlx Ann Troy, ukulele soloist; Olive Froehlich, pianist; Perry Olds, literary editor; 6-7, Bill Benning's Milwaukee Athletic club orchestra; 8-10, Marquette university studio program.

**WHAS, Louisville, Ky. (399.8),** 4-5 p. m., concert.



The Alappo Drum Corps or Shriners' band is back on the air again at WBZ, Springfield. Louis Harlow is the leader of the famous band and is responsible for the splendid ensemble work.

### Mountain Time Stations

**CFAC, Calgary, Can. (435.8),** 8-9 p. m., studio program, Dean Brothers.

**KFAU, Boise, Idaho (278),** 8 p. m., bedtime stories, Mrs. Forrest Pitts, Star Novelty dance orchestra; 11, Boise Municipal band.

**KFWA, Ogden, Utah (261),** 5-6 p. m., Ogden Radio dealers program.

**KOA, Denver, Colo. (322.4),** 12:15 p. m., Balto theater musicale; 6:30, dinner concert, Trovyn Palace string orchestra; Howard Tiltonson, director; 7:30, sandman's hour; 8, studio program, Hattie Louise Sims vocal studios, variety, solos and duets; Pearl Grace, Mrs. Harry E. Bellamy, Maria Louisa Burns, Anna Bliss Oudner, L. O. Scott and Hannah Berry, sopranos; Bert Duelling and Richard Hynes, tenors; Susan Cleverly, contralto; Edward Walters, baritone; Ruth Meyer, pianist; KOA orchestra.

**KOB, State College, N. M. (348.6),** 7:30-8:30 p. m., "This Year's Cattle Feeding at Tucumcari," Professor Lanlow; "Fall and Winter Gardens," Professor Fite.

**KUOM, Missoula, Mont. (244),** 8 p. m., musical program, furnished by the school of music; Ann Platt, head, Home economics department, timely talks on Thanksgiving suggestions.

### Pacific Time Stations

**KFOA, Seattle, Wash. (453.3),** 6:45-8:15 p. m., Sherman, Clay and company program; 8:30-10, Times studio program.

**KFWB, Hollywood, Calif. (252),** 5-6 p. m., children's hour, Big Brother of KFWB; 6:30-7 p. m., Altadena program, E. P. Jones; 7-8 p. m., microphone brevities; 8-9 p. m., program, Star Motor Car company, featuring Milton Dollar Four orchestra, L. E. Roy Kullberg and his ukulele and others; 9-11, Eskimo revue, courtesy Globe Ice Cream company and Weber

(Continued on page 16)

# KDKA GIVES "MARTHA"; PAN-AMERICA

## Index to Popular Concerts

**T**ABULATED below is a time table of the stations giving popular concerts this week. Stations are divided into the four different standard times in use. The hours are given in the kind of time in use at each listed station. By using this table as an index and referring to the complete programs below, full information will be obtained.

### SATURDAY, NOVEMBER 21

Eastern	Central	Mountain	Pacific
7:30 p. m.	6:30 p. m.	5:30 p. m.	4:30 p. m.
WFSA			
8	7	6	5
WLS			
9	8	7	6
WBBM, WFAA, WENR, WGBS, WLS, WMAQ, WNYC			
10	9	8	7
KFAB, KPRC, WBBM, WENR, WGN, WLS, WMBB, WREO			
11	10	9	8
KFVE, KFVB, KNX, KTHS, WBBM, WL			
12	11	10	9
KNX, KOIL, KPO, KPRC, WBBM, WLS, WOA, WOK, WQJ			
1 a. m.	12 m.	11	10
KFWB, WDAF, WBBM, WEBB, WENR, WL			
2	1 a. m.	12 m.	11
KNX, WBBM, WENR, WQJ			

### WEDNESDAY, NOVEMBER 25

Eastern	Central	Mountain	Pacific
8 p. m.	7 p. m.	6 p. m.	5 p. m.
KFNF, WAHG, WEBJ, WEEL, WMCA			
9	8	7	6
WBBM, WEBJ, WGCP, WNYC			
10	9	8	7
KFAB, KPRC, WBBM, WGCP, WHO, WMBB			
11	10	9	8
KFAB, KFVE, KGW, KPO, KWSC, KYW, WBBM, WEN, WMBB, WOK, WQJ			
12 m.	11	10	9
KFWA, KFVB, KNX, KYW, WOK, WQJ, WSAI			
1 a. m.	12 m.	11	10
KNX, KYW, WBBM, WHT, WOK, WQJ			
2	1 a. m.	12 m.	11
KFWB, KNX, WBBM, WOK, WQJ			

### SUNDAY, NOVEMBER 22

Eastern	Central	Mountain	Pacific
9 p. m.	8 p. m.	7 p. m.	6 p. m.
WBBM			
10	9	8	7
WBBM, WMBB			
11	10	9	8
WMBB			
12	11	10	9
KNX, KTHS			
1 a. m.	12 m.	11 p. m.	10
KFWB, WBBM			
2	1 a. m.	12 m.	11
KFWB			

### MONDAY, NOVEMBER 23

Eastern	Central	Mountain	Pacific
7 p. m.	6 p. m.	5 p. m.	4 p. m.
WBBM, WFAA, WOAW			
8	7	6	5
WGBS			
9	8	7	6
WCAU, WFAA, WGR, WKRC, WOK			
10	9	8	7
KFAB, WGR, WKRC, WMCA, WOAW, WOK, WSOE			
11	10	9	8
KFAB, KFVE, WOK			
12 m.	11	10	9
KLX, KNX, KOIL, WHO, WOK			
1 a. m.	12 m.	11	10
KFWB, KLX, WAHG, WDAF, WHT, WKRC, WOK			
2 a. m.	1 a. m.	12 m.	11
KFWB			

### TUESDAY, NOVEMBER 24

Eastern	Central	Mountain	Pacific
7 p. m.	6 p. m.	5 p. m.	4 p. m.
WBCA, WOAW			
8	7	6	5
WBBM, WEAR			
9	8	7	6
WBBM, WEAR, WBZ, WSB			
10	9	8	7
WBBM, WMBB, WOAW			

### THURSDAY, NOVEMBER 26

Eastern	Central	Mountain	Pacific
8 p. m.	7 p. m.	6 p. m.	5 p. m.
WCAE, WFAA, WJAB, WMC, WOC, WSAI			
9	8	7	6
WBBM, WHAD			
10	9	8	7
KMA, WBBM, WEEI, WHAD, WEN, WMBB, WMC, WNYC, WWAJ, WSOE			
11	10	9	8
KHJ, KMA, KYW, WBBM, WMBB, WOK, WQJ			
12 m.	11	10	9
KHJ, KTAB, KOIL, WBBM, WDAF, WEAA, WKRC, WOC, WOK, WQJ			
1 a. m.	12 m.	11	10
KFWB, KHJ, WHT, WOK, WQJ			
2	1 a. m.	12 m.	11
KNX, WQJ			

### FRIDAY, NOVEMBER 27

Eastern	Central	Mountain	Pacific
8 p. m.	7 p. m.	6 p. m.	5 p. m.
WGCP, WJR			
9	8	7	6
WBBM, WGR, WLS, WOC			
10	9	8	7
KFAB, WBBM, WMC, WDAF, WHAD, WMBB, WOAW, WSOE			
11	10	9	8
KFVE, KFVA, KHJ, KLX, KYW, WMBB, WOK, WQJ			
12 m.	11	10	9
KFWB, KHJ, KNX, KOIL, WMC, WOK, WQJ			
1 a. m.	12 m.	11	10
KFWB, KHJ, WDAF, WHT, WOK, WQJ			
2	1 a. m.	12 m.	11
KNX, WQJ			

## Monday, November 23

(Continued from page 15)

Baking company, featuring the Five Little Eskimos; 11-12 Henry Halstead and his Hollywood Roof orchestra.

**KGO, Oakland, Calif. (361), 7:15-7:30 a. m.**, health training exercises; 7:45, pep class, Hugh Barrett Dobbs; 8:15-8:30, health training exercises; 10:45, classroom instruction, Oakland Public Schools, sixth grade; 11:30-1, luncheon concert; 3-4, musical interpretation of the classics, Wilda Wilson Church; 6-7, dinner concert, Baldwin Piano company; 8, health talk, California State Board of Health; Hugh Barrett Dobbs; "The World Court," "Chats About New Books," Joseph Henry Jackson, "The San Francisco Bay Chemical Industries," W. D. Ramage, A. P. St. Clair; "National Farm Radio Council, Cinderella and the Flank Steak," Belle De Graf; Arlon trio.

**KGW, Portland, Ore. (491.5), 7:15 a. m.**, physical culture exercises; 12:30-1:30 p. m., Rose City trio; 6-7, dinner concert, Olds, Worthman and King company; 9-10, concert.

**KJR, Seattle, Wash. (384.4), 10:30-11:30 a. m.**, Fredrick & Nelson, musical program, and talks Home-A-Furnishings; 1:15-2 p. m., organ recital, Columbia theater; 2-2:15, "Home Helps" talk, Bernice Redington; 6-6:30, "What's doing at the theaters"; 7-8:30, Sears-Roebuck & company, studio program; 8:30-10, Post Intelligence studio program; 10-11, dance program, Gordon Kilbourne and his orchestra.

**KLX, Oakland, Cal. (508.2), 4-5 p. m.**, women's hour; 5-5:30, "Aunt Elsie's" sunset matinee; 7-7:30, news; 8-9, program, through Remar Bread company; 9-10:30, meeting Protective order Lake Merritt Ducks.

**KMTR, Hollywood, Calif. (238), 5-6 p. m.**, home hour, Mammy Simmons with Walter Benson, Helen Levy and Ukulele Kids; 7:15 p. m., program by Los Angeles Y. M. C. A.; 8-10 p. m., KMTR concert hour with Turner orchestra, Loren Powell, director.

**KNX, Hollywood, Calif. (336.9), 5:30-6:15 p. m.**, Wurlitzer pipe organ studio; Town Tattler; 6:15, travel talk, W. F. Alder; 6:30-7, Atwater Kent concert orchestra, Paul Finstien, leader; 7-7:30, Mutual Motors mirth contest; 7:30-8, program, Columbia Outfitting company; 8-9, program, L. W. Stockwell company; 9-10, program, Ward Gas Floor Heater company; 10-11, Goodrich Silvertron Cord dance orchestra; Lilyan May Challenger, contralto; 11-12, Ray West's Coconut Grove dance orchestra from Annapolis.

**KPO, San Francisco, Cal. (428.3), 7-7:30 a. m.**, daily dozen exercises, direction V. M. C. A.; 10:30, "Ye Towne Cryer" and amusement information service; 12 m., time signals, scripture reading; 1-2 p. m., Rudy Seiger's Fairmont hotel orchestra; 2:30-3:30, program, trio, Truett-George studio, soprano solos, Genevieve Sillman; 5:30-6:15, children's hour stories, Big Brother taken from the Book of Knowledge; 6:30-6:40, "Ye Towne Cryer" and amusement information service; 6:40-7, Waldemar Lind and the States restaurant orchestra; 7-7:30, Rudy Seiger's Fairmont hotel orchestra; 8-8:45, Uda Waldrop, organ recital; 8:45-9, talk, Willey Winsor, director Daily Dozen, on "What Is Corrective Exercise"; 9-10, program, featuring baritone solos, Austin Black; trio selections, the Philharmonic trio from Modesto, Uda Waldrop, accompanist; 10-11, Waldemar Lind and the States restaurant orchestra.

**KPSM, Pasadena, Calif. (315.6), 8-10 p. m.**, opening program.

## Tuesday, November 24

**KTAB, Oakland, Calif. (215), 9-9:30 p. m.**, prayer service, Rev. E. L. Spaulding; 4-5 p. m., women's club notes; 8-10, Western States Life Insurance company.

**KWSC, Pullman, Wash. (348.6), 7:30 p. m.**, Margaret Pfarr, reader; Mildred Charoigis, pianist; Norman Benson, vocalist; string trio, Ruth Coates, Clarabelle Connor, Catherine Conner; "Ten Years Highway Progress in Washington, No. 2," Prof. E. E. Phelps.

Headliners Today			
Eastern	Central	Mountain	Pacific
7:45 p. m.	6:45 p. m.	5:45 p. m.	4:45 p. m.
WGY (379.5) Georgia Minstrel boys			
8	7	6	5
WTIC (475.9) Thanksgiving program			
9	8	7	6
KYW (536) Edison company hour			
WBZ (333.1) Tech. Musical clubs			
WVP (508.2) Celesta trio			
9-10	8-9	7-8	6-7
KPRC (296.9) Arabia Temple Shrine band			
10	9	8	7
WCX (517) Red Apple club			
11	10	9	8
KHJ (405.2) All Mexican program			
12	11	10	9
KGO (381.5) Harmony and Hysterics			
KHJ (252) Elite trio			
1 a. m.	12 m.	11	10
KNX (336.9) Movie night			

Tuesday, silent night for: CFCR, CHIC, CKNC, CNRA, CNRE, CNRM, CNRO, CNRW, CNRT, KFAU, KFRU, KFUD, KFVA, KLX, KOA, KOE, KUOA, KWSC, PWX, WAHG, WAMD, WBBR, WCAL, WGCP, WGST, WHAD, WHAZ, WJAD, WJAZ, WLIT, WLWL, WOB, WOS, WSM, WSWB, WSUI, WTAM.

**Eastern Time Stations**  
**CNRA, Moncton, Can. (291), 7, juvenile program.** Prof. C. M. Wright; 8, program; Little bit of everything; V. C. Blackett, pianist; George Davidson, bass; Vern Miller, whistler; Edgar O'Brien, reader; quartet; Gordon Douglas, saxophonist; Charles Dodge, bass; 10, CNRA dance orchestra; Walter Neale; Mrs. I. Malcolm, accompanist.

**KDKA, Pittsburgh, Pa. (309.1), 7:15 a. m.**, 8, exercises, O. Shannon; 10 a. m., domestic science and arts for the housewife; 6:15, dinner concert, KDKA Little symphony orchestra, Victor Saudok, conductor; 7:30, Daddy Winkum; 7:45, book night, George Carver, Pittsburgh university; 8, sacred song period; 8:30, word cruise, Ross Skinner, conductor; musical settings, KDKA Little symphony orchestra, Victor Saudok, conductor; 9, KDKA Little symphony orchestra; West Leeburg quartet; 11:35, concert, Grand theater.

**WAFD, Port Huron, Mich. (275), 8-10 p. m.**, Port Huron Boy Scout orchestra; 10-12, musical program, Addison hotel.

**WAHG, Richmond Hill, N. Y. (315.6), 12-12:30 p. m.**, Joe Zimmerman, pianist.

**WBZ, Springfield, Mass. (333.1), 6:30 p. m.**, Leo Relsman's Hotel Lenox ensemble; 7:05, Hotel Kimball dance orchestra; Bob Patterson, director; 7:20, announced; 7:35, Hotel Kimball dance orchestra; 8, musical program, Noyes Bulch company; 9, program, Tech Musical clubs; William Lowell, director; glee

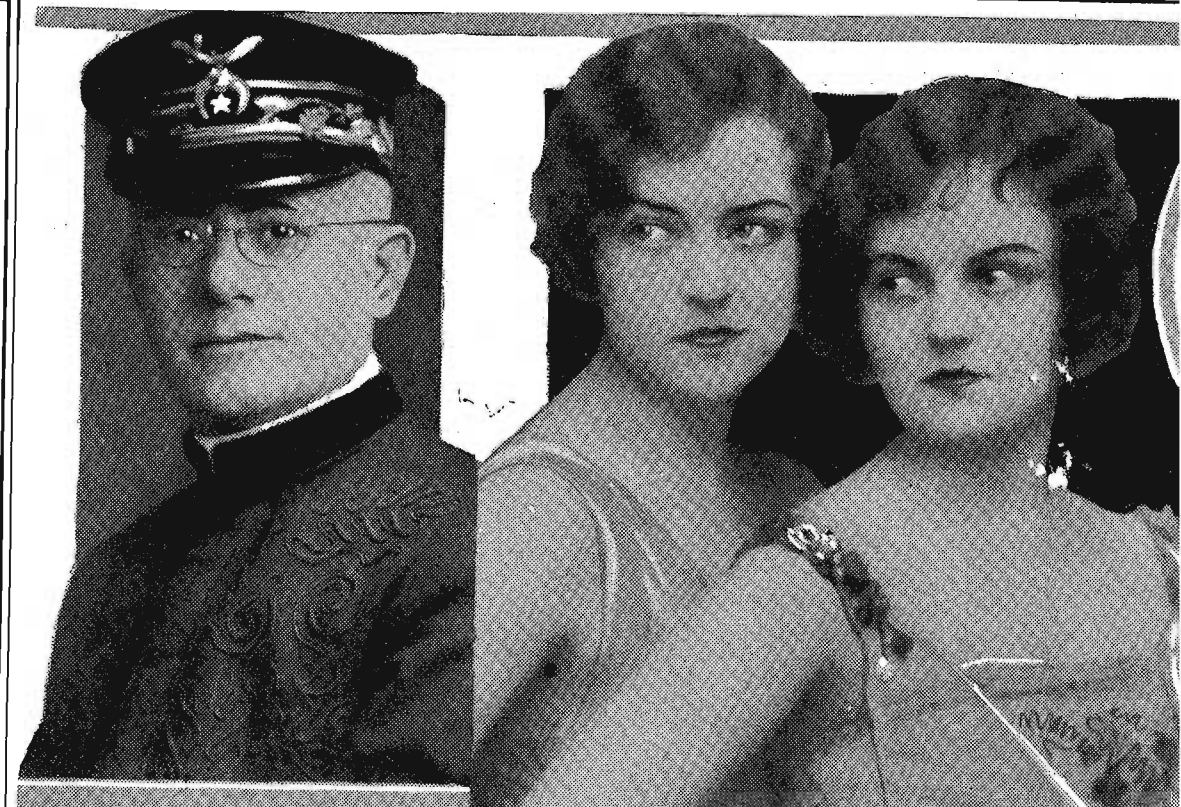

The Highlander Boys, an eighty-piece band of Denver, will give a pre-Thanksgiving program at KOA, Sunday afternoon at 3 p. m., mountain time. John S. Leick, above, is the bandmaster.

club, banjo club, mandolin club, specialty acts; 10:15, "Have You Often Wished You Could Sing?" George Dwight.

**WCAE, Pittsburgh, Pa. (461.3), 3 p. m.**, Loew's Aldine theater program; 6:30, dinner concert, William Penn hotel; 7:15, children's period; 7:30, Davis saxophone octette, WDAF; 8, WEAFA program; 8:30, Gold Dust Twins, WFAF; 9, Eveready hour; 10, studio concert.

**WCAU, Philadelphia, Pa. (277.6), 7:30 p. m.**, recital, Snellenburg and company; Florence Haenle, violinist; James Davenport, tenor; 8, building and loan talk, Fernand Baruch; 8:10, The Three Brothers; 8:20, National School of Oratory Players; 9:15, Robert Fraser, Blind Gospel singer; Elizabeth Holtz, pianist; 9:30, songs and jests, Harry Link and Willie Horowitz; 10:30, Billy Hayes and his Cathay Tea Garden orchestra.

**WCX, Detroit, Mich. (517), 2 p. m.**, news of the day; 6, dinner concert, Book-Cadillac hotel; 10, Red Apple club.

**WEAF, New York, N. Y. (491.5), 6:45-7:20 a. m.**, Metropolitan tower health drill; 11-11:10, musical program; 11:10-11:25, lecture, board of education; 11:25-11:35, musical program; 11:35-11:45, talk, Adele Woodard; 11:55-12, music; 4-4:30, New York society trio; 4:30-5, women's program; 6-7, dinner music, Waldorf-Astoria; 7-7:10, Jevv Blix, contralto; 7:10-7:30, lecture, Columbia university; 7:30-8, Davis saxophone octette; 8-8:10, talk, Dudley F. Fowler; 8:10-8:30, Ross Gorman and his Earl Carroll Varieties orchestra; 8:30-9, Gold Dust Twins; 9-10, Eveready hour; 10-10:30, Radio auction bridge game; 10:30-11, Vincent Lopez and his orchestra; 11-12, Meyer Davis' Lido-Venice orchestra.

**WEAO, Columbus, Ohio (293.9), 9 p. m.**, chimes; farm topics, "Soils," Prof. Bear, music.

**WEAR, Cleveland, Ohio (390.4), 9:30 a. m.**, community fund program; 12 m., community fund program; 6:30 p. m., community fund program; 9, State theatre vaudeville and music; 10, Stewart-Warner Radio artists.

**WEI, New York, N. Y. (272.6), 7-7:30 p. m.**, Dan Barrett's orchestra; 7:45-8, recitations, De Keller Stamey; 8-8:15, railroad talk, G. T. Coer; 8:15-8:20, Milton Yokeman, tenor; 8:20-8:30, Doris Sheldon, contralto; 8:30-8:45, radio chats; 8:45-9:15, Highland collegians.

**WBSB, New York, N. Y. (315.6), 10-10:10 a. m.**, timely talks with Terese; 10:10-10:20, Emma Bullis, pianist; 10:20-10:30, talk, Phoebe Cole; 10:30-10:40, Emma Bullis; 10:40-10:50, talk, Margaret Savory; 10:50-11, Emma Bullis; 3-3:10 p. m., recitations; Julia Armbruster; 3:10-3:20, Gertrude Seiderman and Henrietta Menscher, pianists; 3:20-3:30, talk, Rosalio Manning; 3:30-3:40, Gertrude Seiderman and Henrietta Menscher; 3:40-3:50, piano lessons, Dr. Alfred G. Robyn; 3:50-4, Gertrude Seiderman and Henrietta Menscher; 8:10-8:20, Christine Church, soprano.

**WGBU, Fulford-by-the-Sea, Fla. (278), 6:30-7:30 p. m.**, Blue Steele's orchestra; 10-11, Blue Steele's orchestra; Theresa Horn, pianist.

**WGCP, New York, N. Y. (252), 3-3:15 p. m.**, Ona Welsh, pianist; 3:15-3:30, Nat Osborne and Eddie Meredith, songs; 3:30-3:45, Isabella Henderson, soprano; 4-4:15, Leslie McLeod, tenor; 4:30-4:45, Gertrude Guarente, pianist; 4:45-5, J. Vincent Moore, tenor.

**WGHP, Detroit, Mich. (270), 8 p. m.**, Skylark dance band.

**WGR, Buffalo, N. Y. (319), 2:30-4:30 p. m.**, WGR's afternoon program; 6:30-7:30, Vincent Lopez Hotel Statler dance orchestra, Harold Gieser, director; 8-11, jointly with WEAF, including Ross Gorman and his Earl Carroll Varieties orchestra, Gold Dust Twins, Eveready hour, Radio auction bridge and Vincent Lopez and his own orchestra from the Casa Lopez, New York.

**WGY, Schenectady, N. Y. (379.5), 2 p. m.**, "Home Hygiene and Care of the Sick—Art," Anna McGee; 2:30, Stephen E. Bolscclair, organist; 6:30, Hotel Van Curier orchestra; 7:30, "Development of Steam," Mortimore F. Sayre; 7:45, Georgia Minstrel Boys; 10, "German"; WJZ; 10:30, Spencer Tupman's Hotel Mayflower orchestra, WRC.

**WHAR, Atlantic City, N. J. (275), 2 p. m.**, Seaside hotel trio; 7:30, book review, Mrs. James Lord; 8, Seaside hotel trio; 9, concert; 11:15, Strand theater troupe.

**WIP, Philadelphia, Pa. (508.2), 6:45 a. m.**, 7, setting-up exercises, Dr. Francis D'Eliscu; 10, men's, Anna B. Scott; 1, organ recital, Germantown theater; 3, "The Majestic One," W. D. Haensler; 3:15, artist recital, John Thomas studio; Flora Ripka, accompanist; 6:05, Joe Ray and the California Nighthawks; 7, Unto Wip; 8, Elliott Lester, dramatic critic; 8:15, "The Song of Thanksgiving"; Haddonfield Community choir; 9, Celesta trio; 10:30, Pagoda cafe orchestra, Charles Verna, director.

**WJAR, Providence, R. I. (305.9), 1:05 p. m.**, Providence-Biltmore concert orchestra; 7:30, musical program, Donauts orchestra; 8:30, Gold Dust Twins; 9, Eveready hour.

**WJR, Pontiac, Mich. (517), 7 p. m.**, Jean Goldkette's Petite symphony orchestra; 9, Jean Goldkette's serenaders.

**WKAR, East Lansing, Mich. (285.5), 7:15 p. m.**, Lec-

tures on marketing, agricultural engineering and soils.

**WLIT, Philadelphia, Pa. (394.5), 11 a. m.**, organ recital; 12:02 p. m., Stanley theater organ recital; Arcadia cafe concert orchestra; 2, Arcadia cafe concert orchestra; 2:30, Dorothy Taylor, pianist; Marcela North, accompanist; 7:30, Dream Daddy's bedtime stories.

**WMAA, New York, N. Y. (340.7), 11-12 m.**, Ida Dingley Allen's home-making hour; 6-6:30 p. m., Oloffe Vail and his Hotel McAlpin string ensemble; 6:30-7, Cinderella dance orchestra; 7-8, Jack Wilbur's personalities; 8-8:30, Pace Institute program; 9-10, Hardman hour of music; 10-10:30, South American Troubadours; 10:30-10:45, Catherine Harvey, soprano; 11-12, Ernie Golden and his Hotel McAlpin orchestra.

**WNYC, New York, N. Y. (526), 6-7 p. m.**, dinner music, Hotel St. George; 7:10-7:30, song recital, 7:30-7:35, police alarms; 7:35-8, piano recital; 8-9, concert; 9-9:15, violin recital; 9:30-10, male quartet; 10-10:30, Harry Ash's orchestra; 10:30-10:35, police alarms and weather forecast; 10:35-11, Harry Ash's orchestra.

**WOR, Newark, N. J. (405.2), 3:15-3:45 p. m.**, Clifford Lodge orchestra; 6:15-6:17, "Words Often Mispronounced"; 6:17-6:30, sports talk, Bill Whelan; 6:30-7:30, dinner music, Hotel Shelton.

**WRC, Washington, D. C. (468.5), 10 a. m.**, women's hour, WJZ; 12 m., organ recital, Otto F. Beck; 1 p. m., Hotel Washington orchestra; 6, Hotel Hamilton orchestra; 6:50, "Show Shopping," Leonard Hall; 7, Lee House trio; 8, musical program; 9, "N. Y. Edison hour," WJZ; 10, "The Grand Tour," WJZ; 10:30, W. Spencer Tupman and his Hotel Mayflower orchestra, WJZ and WGY; 11:30, organ recital, Otto F. Beck; 12, "Meyer Davis' Le Paradis orchestra."

**WROD, Lansing, Mich. (285.5), 6-7 p. m.**, dinner concert; Speed-Wagon serenaders; Gold Standard ensemble; 8:15, Red band, Carl Dewey, conductor; Red glee club; Fred Kileen, director; vocal and instrumental solos.

**WTAG, Worcester, Mass. (268), 12:05 p. m.**, WTAG trio; 8-8:



# AMERICAN THANKSGIVING MUSIC AT WRC



These pretty sisters, left, appear every Monday evening at W.M.C.A., New York. They are Alice and Rita Coakley and they are too charming to be hidden behind a microphone although their voices sound lovely over the



"Martha," the opera by Plotow, will be given Saturday night at KDKA, Pittsburgh. Margaret McLanahan, above in the circle, takes the role of Lady Harriet or Martha. Wilson McCalmont, above, is the sheriff. He has a splendid bass voice.

WFAA, Dallas, Tex. (475.9), 12:30-1 p. m., Beaumont band, KFDJ; 6:30-7:30, Don Bestor's orchestra; 8:30-9:30, Southern Methodist university school of music; 11-12, Gertrude Day, pianist and assisting musicians; 12-1 a. m., special program, Palace theater.

WGES, Oak Park, Ill. (250), 5-7 p. m., Lydia Werner, soprano; Miles Sullivan players, one-act playlet; Stenstrom sisters, vocal duo; Tiffin theater organ and orchestra; 8-9, Helen Frahm, soprano; Tiffin orchestra; 11-1 a. m., Serenaders orchestra; quartet; Remington Welch, organist; Sandy McTavish, Scotch comedian; Erwin Schmidt and his own song; Jack Goodwin, tenor.

WGN, Chicago, Ill. (370.2), 12:40 p. m., Drake concert ensemble, Blackstone string quintet; 2:30, artists series Lyon and Healy; 3, rocking chair time; 3:30, Marshall Field's ten room orchestra; 6:30-7, dinner concert; 8-9, WGN string trio and vocal artists; 10-11, dance program, Jack Chapman's and the Blackstone hotel dance orchestras.

WHAD, Milwaukee, Wis. (275), 11 a. m., pianologue, Andy Hertel; "Getting the First Thousand," Carl Skirwood; 6-7, Bill Benning's Milwaukee Athletic club orchestra.

WHAS, Louisville, Ky. (399.8), 4-5 p. m., concert, Harry Currie's music box; children's stories, Eleanor Huber; Art Gillham, whispering pianist; readings; 7:30-9, concert, Eddie Rosson and his orchestra.

WHO, Des Moines, Iowa, (526), 7:30-8 p. m., The Raleigh Quintet; 8-9, The Bankers Life trio, direction, Helen Birmingham; 11-12, Bankers Life Little Symphony orchestra, direction, Leon A. Dashoff.

WHT, Chicago, Ill. (399.8), 10 a. m., Jean Sargent's program, women's club; Borden health talk, Jelke Good Luck Girl; studio music; 11, special studio features, Magnus musical lecture; 12 p. m., Al Carney's complimentary organ recital; 1, special studio program; 6, classical program; dinner organ recital; Grayling's string trio; Eleanor Gilmour, soprano; Oscar Heather, tenor; Loftis half hour of music; Alois Bragagnolo, basso; 7:45-9:15 (238), musical features; 8:30 (399.8), Jelke entertainers; Kitchen Klenszer Klans; Kenneth Clark's Hawaiian trio; Al Carney, organist; Husk O'Hare's orchestra; 10:10, U. S. L. half hour of dance music.

WJJD, Meosheart, Ill. (302.8), 10 p. m., Rushmore ensemble singers; Clarence Harper; 12, rebroadcasting.

WKRC, Cincinnati, Ohio (326), 10 p. m., Dutch Masters dance program; 10:30, popular songs; 11, Doc Howard's entertainers; quartet; orchestra.

WLIE, Chicago, Ill. (308.2), 7-8 p. m., dinner concert, Blackstone and Drake hotel orchestras; 9-10, popular, Hamm's orchestra; 11-12, Drake and Blackstone hotel orchestras.

WLS, Chicago, Ill. (344.6), 12 noon, Ford and Glenn; 2:30, Ralph Emerson's organ concert; 7, lullaby time; 7:15, Paul Egan, tenor; 7:30 WLS trio, Songs, American composers.

WLW, Cincinnati, Ohio (422.3), 7:30 a. m., morning exercises, William Stradman, Y. M. C. A.; 7:45, morning devotions, auspices Parkway Y. M. C. A.; 9, Crosley elementary school program, musical appreciation lesson, Sarah Y. Cline; 9:10, talk, "Talking Turkey," Assistant Prof. Hendrickson; 9:20, agricultural primer, "Mr. Pig's First Trip to the Stockyards," J. W. Schwab; 9:25, callisthenics, direction of Cincinnati Y. M. C. A.; 12:15, organ concert, Petronella Trimbura; 4, French lesson, Madame Ida Teimplidis; talk, Rev. Ralph Schmidt, Ft. Thomas, Ky.; 7, the Tridyn instrumental trio; 7:30, Mary Barbara, Sweetheart of Radio; 7:50, "General Care and Training of Cakes," F. W. Avery; 8, Crosley WLW feature orchestra in a Henry Pinmore program; 8:30, the Musicone quartet, William Drexler, first tenor; Erwin Meyer, second tenor; Edwin Weidinger, baritone; John Dodd, bass; Howard Evans, accompanist; 8:40, the Crosley "Hello Boys," Bob and Jim; 8:50, poems by James Whitcomb Riley, Mary Barbara; 9, Formica concert orchestra, William Steers, director.

WMAQ, Chicago, Ill. (447.5), 12:15 p. m., world court luncheon; 12:45, Radio farm school; 2, shut-in program; 4, household arts, Elizabeth O. Hillier; 4:45, Columbia Music school pupils; 8, Chicago theater organ recital; 6:30, Hotel LaSalle orchestra; 8, book talk, Harry Hansen; 8:29, Amanda Burhop, pianist; 8:40, travel talk, Clara E. Laughlin; 8, lecture, U. of Chicago; 9:20, Irma Fisher, soprano; 9:45, talk.

WMBB, Chicago, Ill. (250), 7-8 p. m., Trianon duo, Beatrice Teller, Frank Bordner, Joseph Kreloff; 9-11, Trianon orchestra, Woodlawn theater orchestra; Bob Duffy, A. B. Stephenson, Walter Duffy, Stokes & King.

WOAI, San Antonio, Texas (394.5), 8:30-9:30 p. m., musical program, Gebhart Mexican players.

WOAW, Omaha, Neb. (526), 5:40, Val McLaughlin; sandman; 6, classical; 6:30, orchestra; 7:10, Radio review, Neal Jones; 8, de luxe program; 12, Rialto alarm.

WOC, Davenport, Ia. (483.6), 12:15-12:25 p. m., farm school, Poultry Day; "Methods of Feeding," Prof. A. G. Phillips; 3-3:30, home management schedule,

### Index to Farmers' Programs

**Farmer Dinner Concerts**  
Daily Except Sunday  
KFNF, 12:15-1:35 (central time).  
WLS, 12 (central time).

**Radio Farm School**  
WMAQ, 12:45 (central time); 12:10 on Friday.  
WOC, 12:15-12:25 (central time).

**Talks**

**SATURDAY, NOVEMBER 21**

Eastern	Central	Mountain	Pacific
11:30 a. m.	10:30 a. m.	9:30 a. m.	8:30 a. m.
KYW (536) farm and home service.			
1:40 p. m.	12:40 p. m.	11:40	10:40
WOI (270) soils, questions and answers.			

**MONDAY, NOVEMBER 23**

Eastern	Central	Mountain	Pacific
1:35 p. m.	12:35 p. m.	11:35 a. m.	10:35 a. m.
KSAC (340.7) Gopher killing time.			
1:15	12:15	11:15	10:15
WOC (428.3) Fall pig production.			
7	6	5 p. m.	4 p. m.
WGY (379.5) Agricultural program.			
7:30	6:30	5:30	4:30
WSEO (246) Hog raising.			
8:45	7:45	6:45	5:45
WCCO (416.4) Poultry raising.			
9:30	8:30	7:30	6:30
KOB (348.6) Cattle feeding at Tucumcari; fall and winter gardens.			

**TUESDAY, NOVEMBER 24**

Eastern	Central	Mountain	Pacific
1:35 p. m.	12:35 p. m.	11:35 a. m.	10:35 a. m.
KSAC (340.7) The International Hay and Grain show.			
1:15	12:15	11:15	10:15
WOC (428.3) Poultry day; methods of feeding.			
7:15	6:15	5:15 p. m.	4:15 p. m.
WKAR (285.5) Agriculture, engineering, soils.			
8	7	6	5
WOC (428.3) How to prevent and control micro-bacillus in hogs.			

**WEDNESDAY, NOVEMBER 25**

Eastern	Central	Mountain	Pacific
1:15 p. m.	12:15 p. m.	11:15 a. m.	10:15 a. m.
WOC (428.3) How to build up a herd from what you have.			
1:35	12:35	11:35	10:35
KSAC (340.7) Talking turkey.			

**THURSDAY, NOVEMBER 26**

Eastern	Central	Mountain	Pacific
1:15 p. m.	12:15 p. m.	11:15 a. m.	10:15 a. m.
WOC (428.3) Legume day.			
1:35	12:35	11:35	10:35
KSAC (340.7) Is my soil sour.			
7:15	6:15	5:15 p. m.	4:15 p. m.
WKAR (285.5) Agriculture, engineering and soils.			
8	7	6	5
WEAO (293.9) Soils.			
9:30	8:30	7:30	6:30
KOA (322.4) Farm question box.			

**FRIDAY, NOVEMBER 27**

Eastern	Central	Mountain	Pacific
1:15 p. m.	12:15 p. m.	11:15 a. m.	10:15 a. m.
WOC (428.3) Special farm service day.			
1:35	12:35	11:35	10:35
KSAC (340.7) Winter management of broad saws.			
9	8	7 p. m.	6 p. m.
WOS (440.9) Some facts seldom told.			
10:25	9:25	8:25	7:25
KTIS (374.8) Farm talk.			

### Markets and Weather

**Daily Except Sunday**

Eastern	Central	Mountain	Pacific
9:30 a. m.	8:30 a. m.	7:30 a. m.	6:30 a. m.
WFAA (475.9) markets.			
WOAW (526) markets.			
9:45	8:45	7:45	6:45
KDKA (309.1) livestock, grain.			
10	9	8 p. m.	7 p. m.
WLS (345) livestock, markets, fruit.			
10:25	9:25	8:25	7:25
WWSJ (352.7) weather.			

**Mountain Pacific**

Mountain	Pacific
8:30 a. m.	7:30 a. m.
8:45	7:45
9:15	8:15
9:30	8:30
9:45	8:45
10:15	9:15
10:30	9:30
10:45	9:45
11:15	10:15
11:30	10:30
11:45	10:45
12:15	11:15
12:30	11:30
12:45	11:45
1:15	12:15
1:30	12:30
1:45	12:45
2:15	1:15
2:30	1:30
2:45	1:45
3:15	2:15
3:30	2:30
3:45	2:45
4:15	3:15
4:30	3:30
4:45	3:45
5:15	4:15
5:30	4:30
5:45	4:45
6:15	5:15
6:30	5:30
6:45	5:45
7:15	6:15
7:30	6:30
7:45	6:45
8:15	7:15
8:30	7:30
8:45	7:45
9:15	8:15
9:30	8:30
9:45	8:45
10:15	9:15
10:30	9:30
10:45	9:45
11:15	10:15
11:30	10:30
11:45	10:45
12:15	11:15
12:30	11:30
12:45	11:45

### DANCING

**Central Time**

**Saturday, November 21:**  
8:30, Wfaa; 8:35, Wgy; 9, Webh, Weef, Wmbb, Wnyc, Wrea; 9:10, Kths, Wip; 9:30, Kths, Wgbs, Wor, Wrc; 10, Kive, Kfwa, Koa, Kpo, Weaf, Wgn, Wjr, Wkrc, Wmca, Wnyc, Wor, Wj, Wreo, Wtam; 10:05, Wco; 10:30, Wamd; 10:45, Wls; 11, Kfpg, Kfwa, Kfwb, Kpo, Weh, Wfaa, Wgbu, Who, Woe; 11:30, Kfoa; 11:45, Wdaf; 12, Kfwa, Kgo, Kgw, Knx, Wgbu, Wjld.

**Monday, November 23:**  
8, Wj; 9, Weef, Wgbu, Wjar, Wjr; 9:15, Wabg; 10, Kths, Wibu, Wjcp, Wgr, Wnyc, Wjg; 10:15, Wor; 10:30, Kfoa, Wgcp, Wwh; 11, Kgw, Koll, Wgbu, Wgcp, Wgr, Wwh, Wwo; 11:45, Wdaf; 12, Knx, Kpo.

**Tuesday, November 24:**  
9, Webh, Wgbu, Wmbb; 9:30, Wcau, Wgbs, Wgy, Wip; 9:35, Wnyc; 10, Kfve, Wbbm, Weaf, Weh, Wgbu, Wgn, Wwh, Wmca, Wnyc, Wpg; 10:15, Kths; 10:30, Kths, Wwh; 10:45, Wsb; 11, Kgw, Koll, Wgbu, Wwh; 11:30, Kfoa; 11:45, Wdaf; 12, Kgw, Khj, Knx, Kpo, Wdaf; 1, Wj.

**Wednesday, November 25:**  
9, Weaf, Wex, Weh, Wgbu, Wgcp, Wwh, Wwo, Wmbb, Wmca, Wnyc; 9:15, Wabg; 9:30, Whap, Wwh, Wwo; 10, WKfve, Wbap, Weaf, Wgbu, Wgcp, Wj; 10:05, Wco; 10:30, Wbap, Wwh; 11, Koll, Kpo, Weh, Wgbu, Wgcp, Wgr, Wwh; 11:45, Wdaf; 12, Kfwa, Knx, Kpo, Wjld.

**Thursday, November 26:**  
8, Wj; 9, Weh, Weef, Wgbu, Wwh, Wwo; 9:15, Wabg; 9:30, Whap, Wwh, Wwo; 10, WKfve, Wbap, Weaf, Wgbu, Wgcp, Wj; 10:05, Wco; 10:30, Wbap, Wwh; 11, Kfwb, Knx, Kpo, Weh, Wgbu, Wgcp, Wgr, Wwh, Wwo; 11:45, Wdaf; 12, Kfoa, Khj; 12:30, Wdaf.

"The International Hay and Grain Show," H. R. Summer; "The Big Steer and His Ration," R. W. Kiser; 4:30-5, women's club program; 6:30-7:30, better speech; "Community Organization," Walter Burr; "What Kind of Cattle Shall I Feed," B. M. Anderson; "Reproducing the Plock," L. F. Payne.

KSD, St. Louis, Mo. (545.1), 6:55 p. m., WEAF "Good Will" program.

KTIS, Hot Springs National Park, Ark. (374.8), 9:30-9:45 p. m., organ recital; W. O. Brown, baritone; Arthur Platz, accompanist; 9:45-10:30, dance concert, New Arlington hotel orchestra, Lon Chassy, director; vocal choruses, Clyde Foley, Tony Cochard.

KYW, Chicago, Ill. (335.4), 6:30-7 a. m., morning exercises, Physical director, Y. M. C. A.; 7:30, "Morning Family Worship," conducted by M. C. A.; 11:35, table talk, Anna J. Peterson; 12:05 to 1 p. m., noon-day concert, Commonwealth Edison company; 1-2, luncheon concert, Congress hotel, Coon Sanders original nighthawks and Jeska DeBarbery and his orchestra; 4, afternoon frolic; 6:10-6:40, musical concert, Commonwealth Edison company; 6:40-7, children's bedtime story, Walter Wilson, known as "Uncle Bob"; 7-7:30 dinner concert, Congress hotel; Coon Sanders original nighthawks; 7:30, Congress hotel orchestra; 7:35-7:55, speeches; 8-9, musical program, Congress hotel; 8-10, one hour musical, Commonwealth Edison company; 10-12, "Evening at Home" program; Coon Sanders original nighthawks, Congress hotel; 10:40 and 11:10; 1 a. m., "Insomnia club," Coon Sanders, original nighthawks.

WBAP, Fort Worth, Texas (475.9), 12:05-12:30 p. m., "Trall Blazers," 6-6:30, Texas Hotel Tokio Royals; 7:30-8:30, concert, Mrs. Norton Longabaugh, classical; 9:30-10:45, musical program, Mrs. W. Bryan Urey.

WBBM, Chicago, Ill. (228), 4-8 p. m., popular program; Valentino Inn orchestra; Harry Sosnick and Sandy Meek; Russell Myers; Joe McManus; Harold Morava; Sidney Nierman; Arnold Stephenson, sax soloist; 8-9, popular program; Moulin Rouge orchestra; Phil Fleming; Bob York; Jean St. Anne, Christian Grimm; Russell Myers; 9-10, WBBM string quartet; Harold Anderson, accordion; Four Crows quartet; Charlie Garland; "The Two Jays," Jordan and Jeska; Moulin Rouge orchestra; 10-12, Stewart-Warner program, Montmartre orchestra; Stewart-Warner string quartet; Lew Russell, tenor; Manhat, tan quartet; Voris Worthley, tenor; "The Two Jays," Jordan and Jeska.

WBEW, Chicago, Ill. (266), 10-10:30 a. m., Penny Wise, the shopper's ready helper; 7-8, Ballantine Electric company classical hour; Robert Sansone, cellist; Gordon A. Nelson, tenor; Ann Kelley, soprano; Pearl Fairchild, pianist; 10-12, jazz jamboree, Midway orchestra; Borden Brothers, harmony duo; Ed Dempsey, tenor; Niese and Nete, banjo bimboes; Drexel quartet; vocal group; Marie Wright, soprano; Finney Briggs, column conductor, "Crazy Quilt" column; Marquette banjo four, string quartet; Frank H. McDonald, Radio talk; 12-2 a. m., pirate ship.

WCCB, Zion, Ill. (344.6), 8 p. m., violin quartet, mixed quartet, celestial bells; Wiedman Sisters; Esther Wiedman, soprano; Mr. and Mrs. David McElroy, piano duet; Ruth Reed, reader.

WCCO, Minneapolis-St. Paul, Minn. (416.4), 9:30 a. m., program for the day; 12 m., Dick Long's Dayton trio; 4 p. m., readers' club, Eleanor Poehler; 5:30, children's hour; 6:15, dinner concert, Chadbourne's Nicolet hotel orchestra; 7:30, program WEAF. Gold Dust Twins, Eveready hour, bridge lesson.

WDAF, Kansas City, Mo. (365.6), 8:30-4:30 p. m., Star's string trio; 6-7, piano tuning in number on the Duo-Art piano lesson, Maudell Littlefield; Tell-Me-A Story Lady; Trianon ensemble; 11:45-1, Plantation players; Earl Coleman's orchestra; Eddie Kuhn's Kansas City Athletic club orchestra; Johnnie Campbell's Kansas City club orchestra.

WBH, Chicago, Ill. (370.2), 7-8 p. m., Oriole orchestra; Lydia Lochner, contralto; 9-10, Oriole orchestra; Uptown theater; 11-1, Oriole orchestra; Jack Penewell, twin guitarist; Kay Ronayne, Irene Beasley.

WENR, Chicago, Ill. (266), 6-7 p. m., dinner concert; Rauland-Lyric trio; George Unger, violinist; soprano, pianist; 8-10, popular program; All-American Pic-nickers; Loretta Giles, popular songster; Al Tween, harmonica and guitar soloist; Philip Millville, American Hawaiian trio; Bert Davis.

(Continued on page 18)

# LULLABIES OF WBZ TO SOOTHE FANS



The Y. W. C. A. work at KGO, Oakland, is directed by this capable young woman, Gertrude Matthew. Every Friday evening a class of girls assemble before the KGO microphone with the speaker. After the talk the girls ask questions so that the silent listener can have his own mental questions answered.

## Tuesday, November 24

(Continued from page 17)

program, Mary Pasmore, violinist; Robert Rourke, violinist; Lew Garcia, pianist; Carolyn Grey, Hill soprano; Merrill Jordan, flutist; "Harmony and Hysterics"; Gleason male quartet; 9:30, Auction bridge feature; 10-11, Hotel St. Francis.

KGW, Portland, Ore. (491.5), 12:30-1:30 p. m., Rose City trio; 6-7, dinner concert; 7:45-8, talk; 8-10, educational program; "Sound Investments"; George H. Burr; Auction bridge lessons; style talk; Melbrow quartet; 10-12, concert; dance music, Multnomah hotel.

KHJ, Los Angeles, Calif. (405.2), 6-6:30 p. m., Leighton's Arcade cafeteria orchestra, Jack Cronshaw, leader; 6:30-7:30, history story, Prof. Hertzog; weekly visit of Queen Titania and her Sandman; Chas. Leslie Hill, readings and Louis F. Klein, autograph and harmonica; 7:30, talk on dogs, H. M. Robertson; 8-10, All Mexican program, Jose Arias and his Mexican band and entertainers from the old pueblo of La Ciudad de Los Angeles; 10-11, Art Hickman's Billmore hotel dance orchestra, Frank Ellis, leader.

KJR, Seattle, Wash. (384.4), 10:30-11:30 a. m., Music gram and talk; 1:15-2 p. m., organ recital, Wurlitzer organ, Columbia theater; 2-2:15, "Home Helms"; Bernice Redington; 6-6:30, "What's doing at the Theaters"; 8:30-10, Puget Sound Savings & Loan Ass'n orchestra, direction Henri Damski.

KMTR, Hollywood, Calif. (238), 5-6 p. m., home hour with Mammy Simmons and Billy Lou with Margaret Bond and neighborhood children; 7:30 p. m., "The Diamond Mines of South Africa," E. P. Barclay; 8-10 p. m., KMTR concert hour, Turner orchestra, Loren Powell, leader.

KNX, Hollywood, Calif. (336.9), 5:30-6:15 p. m., Wurlitzer pipe organ studio, Town Fattler; 6:15, travel talk, W. P. Alder; 6:30-7, Aviator Kent Radio orchestra, Paul Finslein, leader; 7-7:45, dinner hour music; 7:45, talk on health, Dr. Robt. T. Williams; 8-9, program, Zinke's Rebottoming shoe company; 9-10, KNX studio feature program; 10-12, movie night at the Ambassador, Ray West's Cocoonat Grove dance orchestra.

KPO, San Francisco, Cal. (428.3), 7-7:30-8 a. m., daily dozen exercises, direction Y. M. C. A.; 10, talk, domestic science, Virginia Tappan; 10:30, "Ye Townsman" and amusement information service; 12 m., time signals, reading of the scripture; 1-2 p. m., Rudy Seiger's Fairmont hotel orchestra; 2:30, studio matinee program; 3:30-4:30, Cyrus Trobbs' Palace hotel concert orchestra; 7:30-8:15, children's hour stories, Big Brother from Book of Knowledge; 8:30, "Ye Townsman" and amusement information service; 6:40, Waldemar Lind and the States restaurant orchestra; 7-7:30, Rudy Seiger's Fairmont hotel orchestra; 8-9, studio program; 9-10, program, Mona Major Oil company, Gypsy and Marta, Mona Motor Oil trio; 10-11, Jack Coakley's cabriars, Cabiria cafe.

KTAB, Oakland, Calif. (240), 9-9:30 a. m., prayer service, Rev. G. W. Phillips; 8-10, mutual Stores.

## Wednesday, November 25

### Headliners Today

Eastern 8 p. m.	Central 7 p. m.	Mountain 6 p. m.	Pacific 5 p. m.
KFNH (266) Thanksgiving Day concert.	RSD (545.1) Fur hour.	WQJ (447.5) Hinshaw Conservatory of Music.	5:30
WBP (475.9) Panther Hawaiian trio.	8	7	6
WBZ (333.1) Program of lullabies.	WDAF (365.6) Kansas City Quill club.	9:30	8:30
WSMB (319) Musical comedy.	12	11	10
WMCA (340.7) Duplex Serenaders.			9

Wednesday, silent night for: CHIC, CKNC, CNRA, CMC, CNRE, CNRR, CNRV, KFAU, KFDM, KLDS, KOB, KTB, KTCL, KUOM, WBBR, WCAL, WCBG, WFAA, WGBS, WGST, WHAR, WHAZ, WIP, WJAD, WJAZ, WLWL, WMC, WOAI, WOAW, WORD, WPG, WRC, WREO.

### Eastern Time Stations

CFCA, Toronto, Can. (356), 7-8 p. m., Rivendale band of the Salvation Army; concert, Augustus Bride, director; 11, Gilbert Watson and his orchestra.

CNRM, Montreal, Can. (411), 8:30 p. m., Jack Grace's minstrels; monologue, "The Virginia Judge," Jim Connolly; popular hits of yesterday, Jack Grace's minstrels.

CNRO, Ottawa, Can. (435), 7 p. m., Aunt Bessie's bedtime story and lullaby; 8, Chateau Laurier concert orchestra; 9, "Les Ouyriers" drama; S. Lapensee, soprano; Chateau Laurier concert orchestra.

KDKA, Pittsburgh, Pa. (309.1), 7:15-8 a. m., morning exercises, O. Shannon; 6:15, dinner concert; 7:30, Postman Dan; 7:45, "The Origin and Accumulation of Oil

## Index to Classical Concerts

**T**ABULATED below is a time table of the stations giving classical concerts this week. Stations are divided into the four different standard times in use. The hours are given in the kind of time in use at each listed station. By using this table as an index and referring to the complete programs below, full information will be obtained.

### SATURDAY, NOVEMBER 21

Eastern 6 p. m.	Central 5 p. m.	Mountain 4 p. m.	Pacific 3 p. m.
WCX, WEAF, WMCA, WREO.			
7	6	5	4
KGO, KYW, WEAR, WENR, WMAQ, WNYC, WOAW, WOK, WRC.			
8	7	6	5
KDKA, KFNH, KOIL, KSD, KYW, WBBR, WGN, WMBB, WNYC, WOAW, WQJ.			
9	8	7	6
KFOA, KPRC, KHJ, KYW, WHAS, WIP, WLW, WORD, WSAI, WSOE.			
10	9	8	7
KNX, KYW, WEAF, WMAQ, WMC, WOAW, WOC, WORD.			
11	10	9	8
KGO.			
12 m.	11	10	9
WOAW.			

### SUNDAY, NOVEMBER 22

Eastern 6 p. m.	Central 5 p. m.	Mountain 4 p. m.	Pacific 3 p. m.
WCAU.			
7:20	6:20	5:20	4:20
WCAE, WCAU, WEAF, WEAR, WEEL, WJAR, WTAG, WWJ.			
9	8	7	6
KYW, WBZ, WEAR, WGBS, WGCP, WKAQ, WLS, WORD.			
10	9	8	7
KFDM, KPRC, KSD, WBZ, WCAU, WCBG, WCO, WEAR, WGY, WHAR, WHI, WNYC, WQJ.			
11	10	9	8
WDEL, WJAR, WTAG.			
8:15	7:15	6:15	
12	11	10	9
KHJ, KNX, KTHS, KYW, WCO, WFAA, WNYC, WOC, WQJ, WSOE.			
11	10	9	8
12 m.	11	10	9
1 a. m.	12 m.	11	10
KNX.			

### MONDAY, NOVEMBER 23

Eastern 6 p. m.	Central 5 p. m.	Mountain 4 p. m.	Pacific 3 p. m.
WGX, WCAE, WMCA, WREO, WWJ.			
7	6	5	4
KMA, WCO, WEAF, WEAR, WHAD, WJR, WOAW, WOK.			
8	7	6	5
KFNH, KSD, WBBR, WBZ, WCAU, WCBG, WHAR, WHI, WJAR, WLW, WMBB, WTAG, WTC.			
9	8	7	6
KFOA, KGO, KHJ, KPRC, WBBR, WCO, WBZ, WCAE, WEEL, WHAD, WHO, WJAR, WLW, WORD, WOS.			
10	9	8	7
KMA, KPO, KPRC, KSD, KTHS, WCO, WEAF, WHAD, WJAR, WOAW, WSUL, WTAG.			
11	10	9	8
KGW, KHJ, KMA, KSD, KTHS, KWSC, WHN, WSAI.			
12 m.	11	10	9
1 a. m.	12 m.	11	10
KHJ.			

### TUESDAY, NOVEMBER 24

Eastern 6 p. m.	Central 5 p. m.	Mountain 4 p. m.	Pacific 3 p. m.
WCX, WEAF, WMCA, WREO, WWJ.			
7	6	5	4
KGO, KMA, WEAR, WEEL, WGBS, WHAD, WJR, WMAQ, WOAW, WOK, WOR, WTC, WWJ.			
8	7	6	5
KFNH, KSD, KYW, WBZ, WCAE, WCAU, WCBG, WEAR, WEEL, WGR, WHAR, WEI, WLS, WMBB, WQJ, WRC, WTC.			

and Gas," Roswell H. Johnson; 9, Dry Slitz hour of music.

KFRU, Columbia, Mo. (499.7), 8 p. m., musical program, faculty and students, Stephens college; sextet; string ensemble; Valborg Leland, violinist; Ruth Goodsmith, pianist; Katherine Farrar, soprano; Basil D. Gauntlett, pianist; Ernest Cox, bass.

PWX, Havana, Cuba (400), 8:30 p. m., General staff band, Cuban army.

WAFD, Port Huron, Mich. (275), 10-12 p. m., musical program, Addison hotel.

WAHG, Richmond Hill, N. Y. (315.6), 12-12:55 p. m., musical program; 7:30-8:30, Billy Eisenhuth's Lyndbrooklyns; 8:30-8:45, Samuel Gray, baritone; 8:45-9, Serenaders Pleetrum quintet; 9-9:15, Viola Scherer, soprano; 9:15-9:30, Serenaders Pleetrum quintet; 9:30-9:45, Samuel Gray; 9:45-9:55, Bill Morgan, pianist; 10-10:15, Viola Scherer; 10:15-11:15, dance orchestra.

WBZ, Springfield, Mass. (333.1), 6:30 p. m., Leo Reisman's Hotel Lenox ensemble; 7:05, program, Don Ramsay; 7:30, Radio nature story, Thornton Burgess; 8, Leon Hatton, uke soloist with songs; 8:15, Denis Dowd, baritone; Pauline Kelleher, accompanist; 8:30, Doris Cowan, violinist; Helen Raymond, pianist; 9, program of lullabies, Arthur Clifton, organist; 9:30, Philip A. Dundon, baritone; Herbert Irvin, pianist; Marlon Howard, violinist.

WCAE, Pittsburgh, Pa. (461.3), 3 p. m., Loew's Alldred theater program; 6:30, dinner concert; 7:30, children's period; 8:30, Pooley period; 9, concert.

WCAP, Washington, D. C. (468.5), 7:30 p. m., U. S. Army band; 8, Huyler's Bon Bon Buddies; 10-11, Ipana troubadours; 11, Carolinians dance orchestra.

WCAU, Philadelphia, Pa. (272.5), 6:45 p. m., Parodians; 8, stage dancing lesson, Al White; 8:15, Aubrey Cummings, baritone; Florence Jackson, soprano; 9, Hill's instrumental trio; 9:30, "Teeth Extraction from the Specialist's View Point," Dr. L. Biddle Duffield; 9:40, songs and jests, Moe and Joe; 10, Hal Chase's Penn-dashery Collegians; 10:30, songs, Morris Wager; 10:45, songs of yesterday, Frank Cook.

WCF, Detroit, Mich. (517), 2 p. m., News of the day; 6, dinner concert, Book-Cadillac hotel; 8, studio program.

WEAF, New York, N. Y. (491.5), 6:45-7:20 a. m., Metropolitan tower health drill; 10:45-12, talk, Betty Crocker; Beatrice MacCue, contralto; lecture, Columbia university; 4-5 p. m., Ray Nichols orchestra; "When the Frost is on the Pumpkin," D'Kelly Slamy; 6-7, dinner music, Waldorf-Astoria; 7-11, services, United Synagogue of America; concert, U. S. Army band; "Huyler's Bon Bon Buddies"; Pooley concert; Ipana troubadours; 11-12, Ben Bernie and his Hotel Roosevelt orchestra.

WEAO, Columbus, Ohio (293.9), 8 p. m., "Eye Conservation," Prof. Michin; 9, May Furniture company hour of music.

WEAR, Cleveland, Ohio, (389.4), 11 a. m., Betty Crocker home service; 7 p. m., Hotel Cleveland orchestra, direction Ivan Francis.

WEJ, New York, N. Y. (272.6), 8-8:30 p. m., Balconades orchestra; 8:45-9, Philip Krumholtz, tenor; 9-

Eastern 9 p. m.	Central 8 p. m.	Mountain 7 p. m.	Pacific 6 p. m.
KFDM, KFOA, KGO, KHJ, KLDS, KYW, WCAE, WCBG, WCO, WEAF, WEEL, WGR, WHAS, WHAR, WLW, WMAQ, WOC, WORD, TAG.			
10	9	8	7
KFAB, KFDM, KFMQ, KMA, KNX, KPRC, KTHS, WCAE, WCO, WEAF, WEAR, WEEL, WLW, WCAE, WOC, WSAI, WSOE, WTAG.			
11	10	9	8
KGO, KHJ, KMA, KYW, WSAI.			
12 m.	11	10	9
KPO, KYW, WHO, WMC.			

### WEDNESDAY, NOVEMBER 25

Eastern 6 p. m.	Central 5 p. m.	Mountain 4 p. m.	Pacific 3 p. m.
WCX, WEAF, WMCA, WREO, WWJ.			
7	6	5	4
KGO, WEAR, WHAD, WJR, WMAQ, WOK, WTC.			
8	7	6	5
KFNH, KPRC, KSD, KYW, WBZ, WCX, WEAF, WEEL, WHI, WLW, WMBB, WMCA, WQJ, WTAG, WWJ.			
9	8	7	6
KFOA, KGO, KPRC, KSD, KYW, WBZ, WCO, WDAF, WEEL, WGR, WHAD, WHAS, WJAR, WMAQ, WOR, WOS, WORD.			
10	9	8	7
KFMX, KMA, KNX, KTHS, WCO, WEAF, WEEL, WGR, WHAD, WJAR, WLS, WMAQ, WNYC, WOC, WSOE.			
11	10	9	8
KGO, KGW, KMA, KPO, KTHS, WCAE, WLS, WLW, WOC, WSAI.			
12	11	10	9
1 a. m.	12 m.	11	10
WLW.			

### THURSDAY, NOVEMBER 26

Eastern 6 p. m.	Central 5 p. m.	Mountain 4 p. m.	Pacific 3 p. m.
WCX, WCAE, WIP, WMCA, WREO, WWJ.			
7	6	5	4
KGO, KSD, WEAF, WEAR, WGBS, WHAD, WJR, WMAQ, WOAW, WOK, WWJ.			
8	7	6	5
KW, WBBR, WBZ, WCAU, WCO, WCX, WEAR, WEEL, WGR, WGY, WHAR, WHI, WLS, WLW, WMBB, WOAW, WQJ, WTAG, WTC.			
9	8	7	6
KHJ, KLDS, WBP, WCAE, WCAU, WCBG, WCO, WEAF, WEEL, WGR, WHAR, WHAS, WJAR, WNYC, WOC, WORD, WRC, WSAI, WSB, WTAG.			
10	9	8	7
KNX, KPRC, KTHS, KYW, WGR, WGY, WHAD, WMC, WOAW, WOC, WSAI.			
11	10	9	8
KGO, KPO, KTHS, WBP, WKRC.			
12 m.	11	10	9
1 a. m.	12 m.	11	10
KGW, KPO, WHO, WKRC.			

### FRIDAY, NOVEMBER 27

Eastern 6 p. m.	Central 5 p. m.	Mountain 4 p. m.	Pacific 3 p. m.
WCX, WMCA, WREO, WWJ.			
7	6	5	4
KGO, WEEL, WGY, WHAD, WJR, WMAQ, WOAW, WOK, WOR, WTC.			
8	7	6	5
KYW, WAHG, WBZ, WCAU, WCX, WEEL, WEEL, WHI, WLS, WQJ, WTAG, WTC, WWJ.			
9	8	7	6
KFDM, KFNH, KFOA, KGO, KHJ, KSD, KYW, WEAF, WCAU, WDAF, WEEL, WHAD, WHAS, WJAR, WMAQ, WMCA, WOS, WSAI, WTC.			
10	9	8	7
KFAB, KFDM, KOA, WCO, WHAD, WMAQ, WNYC.			
11	10	9	8
KEMX, KHJ, KNX, KPO, KWSC.			
12 m.	11	10	9
KPO.			

9:15, Rudolph Joskowitz; 9:15-9:45, Neopolitan troubadours.

WGBS, New York, N. Y. (315.6), 10-10:10 a. m., timely talks with Terese; 10:10-10:20, June Warren, pianist; 10:20-10:30, talk, Kathleen Mary Quinn; 10:30-10:40, June Warren; 10:40-10:50, talk, Olive Koch; 1:30-1:45 p. m., Robert Soffer, pianist; 3-4, hospital program; direction, Uncle Gee Bee, Uncle George, Teresa Rose Nagel.

WGBU, Fulford-by-the-Sea, Fla. (278), 6:30-7:30 p. m., Theresa Horn, pianist; 10-11, Blue Steele's orchestra; talk on Florida, M. C. Tebbetts.

WGCP, New York, N. Y. (252), 3-3:15 p. m., Henry Rogers, pianist; 3:15-3:30, studio program; 3:45-5, Clarence Williams trio; 4:15-4:45, Haines Good News party; 4:45-5, Charlotte Tristram, pianist; 6-6:15, Littmann's orchestra; 6:15-6:30, Daddy Winkum; 6:30-7, Littmann's orchestra; 7-8, Dominion Ginger Ale orchestra; 8-8:05, health talk; 8:05-8:20, Charol de Thomee, pianist; 8:20-8:35, Hock and Jerome, songs; 10:30-11:30, Strickland's orchestra; 11:30-12, Connie's orchestra; 12-12:30, Club Richman entertainers.

WGHP, Detroit, Mich. (270), 8 p. m., WGHP little symphony.

WGR, Buffalo, N. Y. (310), 2:30-4:30 p. m., WGR's afternoon program; 6:30-7:30, Harmony Six orchestra; 8-9, Adam, Meldrum & Anderson program; 9-10, program by Charles Duff, the blind musician, and the Charles Duff quartet, Niagara Falls, N. Y.; 10-11, jointly with WEAF, Ipana troubadours; 11-11 a. m., Vincent Lopez Hotel Statler dance orchestra, Harold Gieser, director.

WGY, Schenectady, N. Y. (379.5), 6:30 p. m., program for children; 6:45, Albany Strand theater orchestra; Floyd H. Walter, organist; 8, 105th Infantry band.

WIP, Philadelphia, Pa. (508.2), 6:45 a. m., 7, setting-up exercises, Dr. Francois D'Eliseu; 10, menu, Anna B. Scott; 1, Gimbel tea room orchestra; Ray Steen, director; 3, Nicola Montani, Caroline Montani, vocalists; Flora Ripka, accompanist; 6:05, Benjamin Franklin concert orchestra; W. Irving Oppenhehr, director; 7, Uncle Wip.

WJAR, Providence, R. I. (305.9), 10 a. m., Mrs. Wood, housewives Radio exchange; 1:05 p. m., studio program; 7:30, U. S. Army band; 9, Waterman's points of progress; 10, musical program.

WJR, Pontiac, Mich. (517), 7 p. m., Jean Goldkette's Petite symphony orchestra; 9, Burroughs hour; 11:30, Jewett orchestra.

WKAR, East Lansing, Mich. (285.5), 7:15 p. m., Radio school, lectures on zoology, entomology, forestry; 8, musical.

WLIT, Philadelphia, Pa. (394.5), 12:02 p. m., Stanley theater organ recital; Arcadia cafe concert orchestra; 2, Arcadia cafe concert orchestra; 7:30, Dream Daddy's bedtime stories; 8, Fireside quartet; 10, Arcadia cafe dance orchestra.

WMCA, New York, N. Y. (340.7), 6-6:30 p. m., Olcott Vail and his Hotel McAlpin string ensemble; 6:30-7:30, Ernie Golden and his Hotel McAlpin orchestra; 7:30-7:45, Luella E. Burns, soprano; 8-9, services, Northminster church; 10-11, Andy Asclutto's Paragon dance orchestra; 11-11:30, Hofbrau Haus entertainers; 11:30-

12, Jack Smith, songs; 12-12:30, Duplex serenaders. WNYC, New York, N. Y. (526), 11-12:30 p. m., women's program; talk; concert, Hotel St. George; 6:10-6:20, market high spots; 6:20-6:30, pianist; 6:30-7, elementary Spanish lessons; 7-7:30, advanced Spanish lessons; 7:30-7:35, police alarms; 7:35-8:30, dance program; 8:30-10, studio program; 10:10-10:20, health talk, George A. Keane.

WOR, Newark, N. J. (405.2), 6:15-6:17 p. m., "Words Often Mispronounced"; 6:17-6:30, sports talk, Bill Wathey; 6:30-7:30, dinner music, Hotel Shelton; 7:30-8, Vincent Lopez orchestra; 8-8:10, topics of the Spencer Armstrong; 8:10-9, Sam Siegel, mandolin virtuoso; 9:15-9:30, talk, Dr. Frank H. Vitzetely; 11-12, Zit's Central Park Casino orchestra.

WRC, Washington, D. C. (468.5), 10 a. m., women's hour, WJZ; 12 m., organ recital, Homer L. Kitt studios; 1 p. m., Lee House trio; 4:30, musical program.

WREO, Lansing, Mich. (285.5), 6-7 p. m., dinner concert; Speed-Wagon serenaders; Gold Standard ensemble.

WTAG, Worcester, Mass. (268), 10:45 a. m., talk to housewives, Mrs. Lydia Flanders; 12:05-2 p. m., WTAG trio; 4:45, interesting talk, Robert K. Shaw; 8, Spanish lesson, Mrs. De La Parra; 8:15, concert program.

WTAM, Cleveland, Ohio, (389.4), 12:15-1:15 p. m., lunch hour music, popular entertainers, Euclid music studio; 6-7, dinner hour music, Guy Lombardo and his royal Canadians, music box studio; 8-11, organ recital, William Metcalf, assisted selected artists; 11-1 a. m., dance music, Guy Lombardo and his Royal Canadians, music box studio.

WTIC, Hartford, Conn. (475.9), 6:30 p. m., dinner music, Hotel Bond trio; vocalists; 7, dinner music; 10, dance music, Bill Tassillo's orchestra.

WWJ, Detroit, Mich. (352.7), 7:30-8 a. m., setting-up exercises, I. T. Horton; 9:30, "Tonight's Dinner" special talk woman's editor; 12:05 p. m., Jules Klein's Hotel Statler orchestra; 8, Detroit news orchestra; 6, dinner concert; 8, news orchestra and soloists; 9, program through WEAF.

### Central Time Stations

CNRW, Winnipeg, Can. (384.4), 7:30 p. m., Aunt Aimee's bedtime story; 7:50, farmers' agricultural service talk; 8, musical program; 8:40, program; brass band, J. T. Cocking, director; D. J. Edwards, contralto; 10, supper-dance program, Ft. Gary hotel orchestra; A. Kilgour, artist.

KFAB, Lincoln, Neb. (340.7), 8:30-10:30 p. m., Mel-shaw's orchestra; Ralph Hall, banjoist; Geraldine Blander, soprano; Cow Bell Boys; Waikiki trio.

KFMX, Northfield, Minn. (337), 9-10 p. m., musical program.

KFNH, Shenandoah, Iowa (266), 7 p. m., Melody Maids. KFUD, St. Louis, Mo. (545.1), 9:15 p. m., "Praise God From Whom All Blessings Flow," Rev. E. Biegener, songs and music.

KFVE, University City, Mo. (240), 8:30 p. m., "Amusement Review," Romaine Fielding; Paul and Jack Snyder, Radio entertainers de luxe orchestra Romaine.

KMA, Shenandoah, Iowa (252), 11:30-12:30 p. m., RFD program; garden talk, Earl E. May; music; 6-7, dinner program; domestic science topics; Leona Teget & Jones B. Case; program, Anshutz Jewelry company; 9-11, evening program; familiar songs and music; chimes; Wm. Howie, Bobbie Riddle; program, Gertrude May.

KPRC, Houston, Texas (296.9), 12 m., studio program; 5:30, Uncle Judd's Kiddies hour; 7:30, Eddie's symphonists; 8:30, Mrs. Laura Stevens Storey, pianist; Jean and Marjorie McFarland, cellist, violinist; 9, Adolphe Jimenez, Spanish grand opera tenor; Patricio Gutierrez, accompanist; 11, Edna Adams, whistler, vocalists.

KSAC, Manhattan, Kan. (340.7), 12:35-1:05 p. m., "Talking Turkey," I. N. Chapman; "Lessons Learned from Club Fairs," M. H. Coe; 4:30-5, basketball lecture; 6:30-7:30, inventions; educational sociology, Y. L. Strickland; "Keeping the Farm Tools Sharp," E. C. Graham; "How Tractors Solve the Labor Problem," W. H. Sanders.

KSB, St. Louis, Mo. (545.1), 6 p. m., dinner music, Missouri Athletic Association; 7, "Fur Hour," program announced.

KTHS, Hot Springs National Park, Ark. (374.8), 9-9:40 p

# BOONE MIXED QUARTET VISITS WHO

## Wednesday, November 25

(Continued from page 18)

tralto; Merry Garden orchestra; Burdette Cleveland, concert pianist; "The Two Jays," Jordan and Jeske; 12-2 a. m. Stewart-Warner program, Harold Anderson, accordion; Montmartre orchestra; Burdette Cleveland, concert pianist; Charlie Garland; Fred L. Jeske and Corine Jordan, "The Two Jays," Uler and Farwell, banjo and piano; Harry Sosnick and Sandy Meek. **WBCN, Chicago, Ill. (266)**, 10-10:30 a. m., Penny Wise, "The Shopper's Ready Helper," shopping talk; 3-4 p. m., ten time matinee, Clarence Jones, pianist and songwriter; Ed Wallace, tenor; beauty culture talk; Margaret Magnus; "Big Boy," Yaagle, pianologist; Mary Williams, blues singer; Julia Jane Abbott, household adviser; Ruth Webster Cross, dramatic reader; 4-5, Oldtimers hour, direction of Merle Yaagle; 5-5:15, police bulletins; 7-8, Amber Furniture company classical hour; 10-11, Harry J. Mapp, Inc., popular program; Midway orchestra; Mae Skoglund, "The Girl Tenor"; John F. Curtis, musical saw artist; Ray Hibbeler, tenor and songwriter; Harry J. Mapp, speaker on automobile subjects; 11-12, "The Bunch's Hour."

**WCCO, Minneapolis-St. Paul, Minn. (416.4)**, 9:30 a. m., program for the day; 10:45, "The Festive Cranberry," Betty Crocker; 12:30 p. m., talk, The Barred Plymouth Rock club, Herbert S. Harrison, state secretary; 2, woman's hour; 2:30, afternoon concert; 4, readers' club, Eleanor Poehler; 5:30, children's hour; 7, midweek church service, Salem English Lutheran church, Rev. Edwin F. Marker, pastor; 9, WEAJ, Ipana Troubadours; 10:05, dance program, Wallie Erickson's coliseum orchestra, St. Paul; 11:30, organ recital, Eddie Dunstetter.

**WDAF, Kansas City, Mo. (365.6)**, 10:45 a. m., Betty Crocker Cold Medal Flour home service talk; 3:30-4:30, Star's string trio; 6-7, address, speaker, Health (conservation) association; address, Ralph E. Herrick; Tell-Me-a-Story; Trianon ensemble; 8-9:30, Kansas City Quill club, Dolly Breitenbach, director; 9:30-10, Dutch Master musical program; 11:45-1 a. m., Plantation players; Eddie Kuhn's Kansas City Athletic club orchestra; Earl Coleman's orchestra.

**WDBH, Chicago, Ill. (370.2)**, 7-8 p. m., Oriole orchestra; Florence Behrend, soprano; "Books of the Day," Lewellyn Jones; 9-10, Oriole orchestra; Florence Behrend, soprano; Frank Bordner, baritone; 11-1 a. m., Oriole orchestra; Florence Behrend, soprano; special impromptu revue, Oriole orchestra.

**WENR, Chicago, Ill. (266)**, 6-7 p. m., dinner concert, Rauand-Lyrie trio; cello and violin solos; 8-10, popular program; Frank Westphal and his All-American Pioneers; Archie Rawls, Hal Lidge, saxophonists; J. E. Peterson, pianist; Floyd Faleh, baritone; 12-2 a. m., frolic, All-American Pioneers; vocal selections; James Beaumont, banjoist.

**WFAA, Dallas, Texas (475.9)**, 12:30-1 p. m., Sears-Roebuck agricultural foundation program.

**WGES, Oak Park, Ill. (250)**, 5-7 p. m., Betty Bebb and Helen Cameron, vocal duo; McDewitt sisters; pianists; Tiffin theater organ and orchestra; 8-9, Ethel Giese, soprano; Ruth Kalthoff, contralto; Peter Mathews; basso; John Stanford; Tiffin theater organ and orchestra; 11-1 a. m., Phillips twins, vocal duo and ukulele soloists; Tiffin theater organ and orchestra; Serenaders; Morris Hoffman, tenor.

**WGN, Chicago, Ill. (370.2)**, 12:40 p. m., Drake concert ensemble; Blackstone string quintet; 2:30, artists series, Lyon and Healy; 3, rocking chair time; 3:30, Marshall Fields' ten room orchestra; 6:30-7, dinner concert; 8-9, WGN string trio; vocal artists; 10-11, Jack Chapman's and the Blackstone hotel dance orchestras.

**WHAD, Milwaukee, Wis. (275)**, 4 p. m., Jesse Whitmore, contralto; Louise Aldrich, accompanist; "With the Humorists," John R. Wagon, the Journal paragrapher; 6-7, Arthur Lichter, organist; 10:30-11:30, Wisconsin Garden, Dexter's Wisconsin and Elger's Creole roof orchestra; 11:30-12:30, Edmund Fitch, organist.

**WHAS, Louisville, Ky. (399.8)**, 4-5 p. m., concert, Harry S. Currie's Music box; readings; Art Gillham, whispering pianist; 7:30-9, concert, K and I Terminal Railroad orchestra; Art Gillham, whispering pianist. **WHO, Des Moines, Iowa, (526)**, 6:30-7:30 p. m., The Reese-Hobinson, banjo duetists; Madrid mixed quartet; talk, "Santa Claus," Harris-Emery company; Kate Miller, whistler; Maude Hughes, accompanist; "Old King Cole" and Leonard Kirkwood, popular songs; 9-10:30, dance program, Cotillion ball-room.

**WHT, Chicago, Ill. (399.8)**, 10 a. m., Jean Sargent's program, woman's club, Borden health talk, Leika Good Luck Girl, studio musical; 10:45, Betty Crocker home service; 11, special studio features; 12 p. m., Al Carney's complimentary organ hour; 1-2, special studio program, Grayling's string trio; 6-7:30, classical program, dinner organ recital, Pauline Cachs, Phyllis Burton, violinist, Pauline Peebles, pianist, Jean Carlson, soprano, Hugh Aspinwall, tenor, Grayling's string trio; 7:45-9:15, (238), musical features; 9:30, (399.8), Borden request organ recital, Hickox and Johnson, harmony, Carl Stridel, baritone, Leota Laabe, soprano; Irene Beasler, "The Girl from Dixie"; Northland trio; Vic Fredericks, baritone; Chas. R. Hall, tenor; Badger Four male quartet; Ray Lawsen, tenor; 12, Pat Barnes and Al Carney.

**WJJD, Mooseheart, Ill. (302.8)**, 10 p. m., Winifred Konigsmark, Alois Bragagnolo, Marie Winters, Courtland Banks, Burdette Cleveland, 12, George Sparks, Lee sisters, Walter Fetz, Leo Cameron.

**WKRC, Cincinnati, Ohio (326)**, 8 p. m., book review, Alice Coy; 8:15, Marion McKay and his Swiss Garden orchestra; 8:45, popular songs; 9:15, Marion McKay's Swiss Garden orchestra.

**WLBB, Chicago, Ill. (308.2)**, 7-8 p. m., dinner concert, Blackstone and Drake hotel orchestras; 9-10, popular, Hamm's orchestra; 11-12, Drake and Blackstone hotel orchestras.

**WLS, Chicago, Ill. (344.6)**, 12 noon, Ford and Glenn; 6:30, Ralph Emerson's organ concert; 7, Ford and Glenn's Lullaby Time; 7:15, Belle Nigodsky, soprano; 7:30, WLS trio; 7:45, WLS theater; 8:15, Alice La Tarte, pianist; 8:30, nurses Glee club, Wesley memorial hospital; 9:30, Pan Dandy trio; 9:50, Esther Leven—reader; 10, Rhodeaver program; 10:40, Ford and Glenn time; 11, Ralph Emerson's popular organ concert.

**WLW, Cincinnati, Ohio (422.3)**, 7:30 a. m., morning exercises, William Stratman, Y. M. C. A.; 7:45, morning devotions, auspices of Parkway Y. M. C. A.; 12:15, musical program, Irene Downing, player-club artist; 3:30, American educational week program, Wm. Dunning; 7, Cincinnati program, Hotel Gibson orchestra, Robert Visconti, director; 7:30, National Radio Farm Council talk; 7:40, Cincinnati program; 9:30, Thanksgiving play, "Little Seafarer"; Schuster-Martin school, supervision, Helen Rose; 10:30, Thanksgiving program, Northside Presbyterian choir, direction of Walter Devaux; soloists; member, Cino male quartet; 11, organ concert, Johanna Grosse, organist; pianologues, "Newport" Carl Bamberger.

**WMAQ, Chicago, Ill. (447.5)**, 12:45 p. m., Radio farm school; 1, luncheon, Chicago Association of Commerce; 2, Shut-in program; 4, Cosmopolitan School of Music; 4:30, Red Cross talk; 6, Chicago theater organ recital; 6:30, George Fawcett story lady; 8, North-western university lecture; 8:30, Northland trio; 9, WMAQ players.

**WMBB, Chicago, Ill. (250)**, 7-8 p. m., Trianon duo, Beatrice Teller, Ralph T. Elliott, Genevieve Burnham; 9-11, Trianon orchestra, Woodlawn theater orchestra; Harry Davis; Marquette banjo four; Lionel Carter, Conlin brothers.

**WOAI, San Antonio, Texas (394.5)**, 3 p. m., musical program, Radio Trades association; 8:30-9:30, Army night musical program.

**WOC, Davenport, Ia. (483.6)**, 12:15-12:25 p. m., farm school; Dairy Day; "How to Build Up a Herd from What You Have," Prof. H. H. Kildee; 3-4, home management schedule, Aunt Jane; 4-4:45, E. De Vorelaere, pianist; M. E. Cohen, tenor; James Woods, pianist; Jack Little, popular entertainer; 5:45-6, chimes concert; 6:30-6:50, Sandman's bedtime stories; Ipana Troubadours, WEAJ; 10-11, Edwin Swindell,

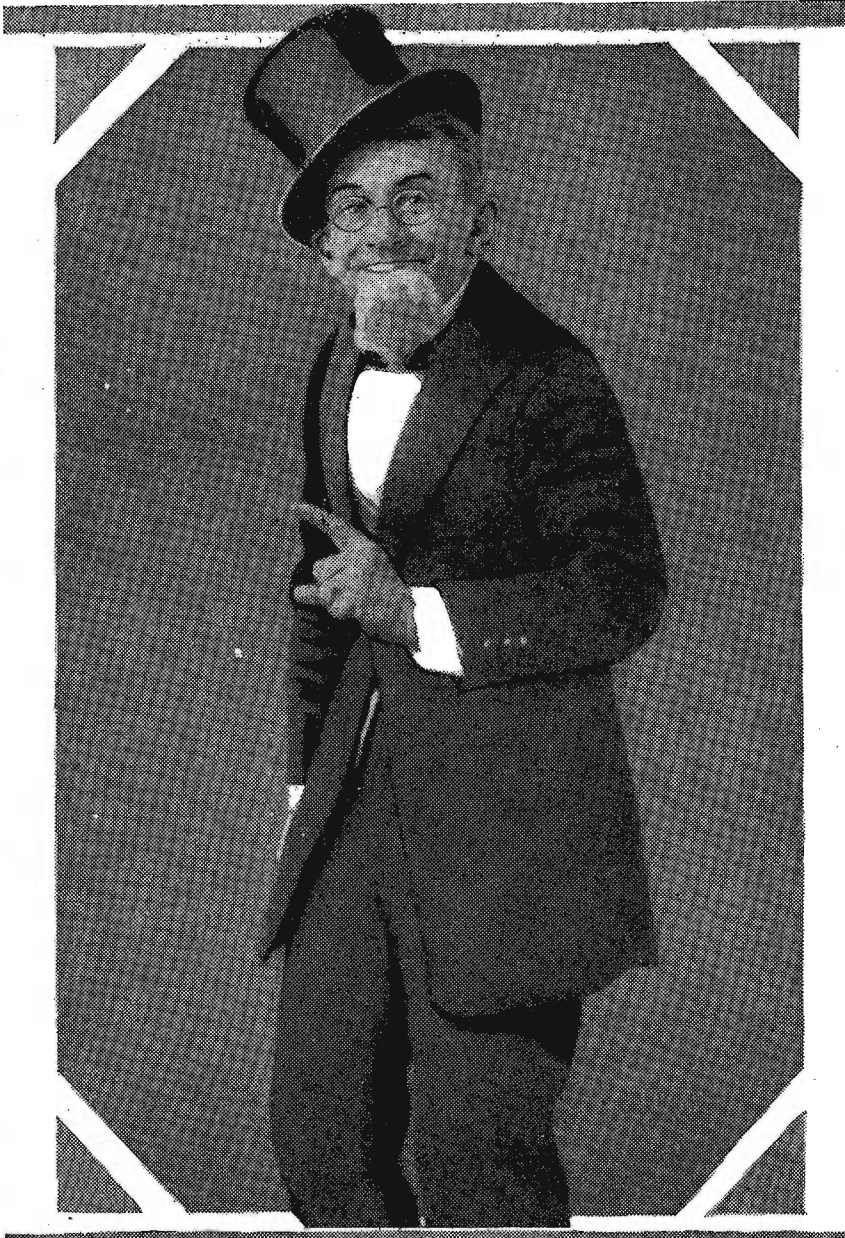

Up in Minneapolis and St. Paul, around the studios of WCCO and WAMD, they called him the "Singing Electrician" because he used to steal away from his work in a nearby power plant to help put on afternoon surprise shows. Now Clarence Booth is known as the "little blonde tenor" of the KYW Hearst building studio gang. This is the make-up he uses when he sings the hick version of "Yes, Sir, That's My Baby."

organist; John McGreevy, baritone; Jack Little popular entertainer.

**WOL, Ames, Iowa (270)**, 12:45 p. m., "Poultry Husbandry," Prof. H. A. Bittenbender.

**WOK, Chicago, Ill. (217.3)**, 12-2 p. m., Harold Morara, tenor; Gus C. Edwards and his orchestra; Jean Carlson, soprano; Banks Kennedy, organist; Bob Mokrejs, pianist; WOK quartet; 5:30-7, Ed Kemp, tenor; Gus C. Edwards and his orchestra; Bryce Talbot, baritone; Banks Kennedy, organist; Bob Mokrejs, pianist; WOK string trio; 10-1 a. m., Ned Miller, tenor; Rita McFawn, soprano; Gus C. Edwards and his orchestra; Herman Sinaiko, violinist; Harriet Lee, contralto; Harold Morara, tenor; WOK male quartet; Chas. Lord, tenor; Henry Byler, tenor; Jack Keyes, baritone; Norman Bartlett, bass; Banks Kennedy, organist; WOK string trio.

**WORD, Batavia, Ill. (275)**, 8 p. m., Webster hotel concert trio; 8:15, hymns and sacred songs, I. B. S. A. choral singers; 8:30, Bible lecture, B. F. Hollister.

**WOS, Jefferson City, Mo. (449.8)**, 8 p. m., "County and State Taxation," L. D. Thompson; musical program, Mrs. L. O. Caswell, director.

**WQI, Chicago, Ill. (447.5)**, 11-12 noon, Friday fish dinner menu, Frank Wendt; "Child Welfare," Dr. Lena K. Sadler; 3-4 p. m., "English Recipes," Helen Harrington Downing; "Meat Cookery," Martha Logan; "Modern Design as Expounded by the Paris Exposition This Year," Sterling Bryan McDonald; 7-8, dinner concert, Ralph Williams and his Rainbo Garden orchestra; Marvin Hibshaw and artist pupils; 10-11 a. m., Ralph Williams and his Rainbo Skylarks; Mediodians; Eshter Trostrud, mezzo-soprano; Clarence Theodors, tenor; J. E. Peterson, basso; Joey Stool harmony singer; Eddie Voge, baritone; 1-2, Ginger hour, WSAI, Cincinnati, Ohio (326), 7:45 p. m., "Art Talk," Cincinnati Art club; 10, Congress Playing Card string quartet.

**WSB, Atlanta, Ga. (428.3)**, 10:45 p. m., Biltmore salon orchestra.

**WSM, Nashville, Tenn. (282.8)**, 6:30-8 p. m., Francis Craigs orchestra; 10-11, studio concert.

**WSMB, New Orleans, La. (319)**, 8:30-10:30 p. m., musical comedy, light opera night, Mendelson's Radio concert band.

**WSOE, Milwaukee, Wis. (246)**, 5:30 p. m., twilight hour, Aunt Julie, children's stories; Elmer Ihrike, pianist; Van Buren's Hawaiians; 9, musical selections staff artists, "Electric Spark" discharges; "Contacts" Students and Alumni; "Current," topics, S. O. W. Faculty and other prominent engineers and industrial executives; Radio dictionary; four-corners Radio club; "Electrinspect"; 9:30, musical selections, staff artists; "The Voices of our Dumb Animals," report of current week's humane work; short humane talk; slogan suggestions, "How to Make Milwaukee More Humane," J. Hugh Malne; musical selections, staff artists.

**WSUI, Iowa City, Iowa (483.6)**, 9 a. m., high school assembly program; 12 m., "Collecting Fishes and Birds of Old Mexico," Prof. Homer R. Dill; 7:45-8:45, college of the air lectures.

**Mountain Time Stations**

**CFAC, Calgary, Can. (435.8)**, 4 p. m., Red Cross address; 8-9, concert party, direction, H. E. Starr.

**KFWA, Ogden, Utah (261)**, 5-6 p. m., Ogden Radio Dealers program; 9-11, dance music, Oile Reeves and his orchestra.

**KA, Denver, Colo. (322.4)**, 12:15 p. m., Rialto theater orchestra, 6:30, dinner concert, Brown Palace string orchestra, Howard Tillotson, director; 7:30, Book of Knowledge; 8, studio program; miscellaneous presentation, instrumental selections, KOA orchestra; harp solos, Frances Cornwall; piano solos, Edna May

Crothers; KOA book chat, "Insurance for Women," Vena Allen Bryan; choir, First United Presbyterian church; cantata, "A Joyful Thanksgiving," direction, Eric E. Faber; 10, dance program, Harmony Peerless orchestra.

**Pacific Time Stations**

**KFOA, Seattle, Wash. (454.3)**, 6:45-8:15 p. m., Hopper Kelly company; 8:30-10, Times studio program.

**KFWB, Hollywood, Calif. (252)**, 5-6 p. m., children's hour, Big Brother of KFWB; 6:30-7, Altadena program, E. P. Jones; 7-7:30, Mutual Motors mirth concert; 7:30, microphone brevities; 8-9, program, Cheek-Neal Coffee company, Maxwell House Coffee string quartet; Verna Kloess, concert pianist; Ashley sisters and others; 9-10, program, Western Pacific Securities company of Santa Monica; 10-11, Warner brothers frolic, direction, Charlie Wellman; 11-12, Henry Halstead and His Hollywood Roof orchestra.

**KGO, Oakland, Calif. (361)**, 11:30-1 p. m., luncheon Pomeroy, accompanist; Alice Bradley, soprano; 4-5:30, concert; 9-4, Marie Shane, contralto; Esta Marvin concert orchestra, Hotel St. Francis; 6-7, dinner concert, Baldwin Piano company.

**KGW, Portland, Ore. (491.5)**, 7:15 a. m., physical culture exercises; 12:30-1:30 p. m., Rose City trio; 6-7, dinner concert, Oids, Worthman and Kling; 8-9, band concert, 7th U. S. Infantry band; 10-11, concert, Sherman, Clay and company studio.

**KHJ, Los Angeles, Calif. (405.2)**, 6-6:30 p. m., Leighton's Arcade cafeteria orchestra, Jack Cronshaw, leader; 6:30-7:30, history story, Prof. Hertzog; Dick Winslow, juvenile reporter; Mickey McLean, screen juvenile and Piggy Wiggy Girls string trio; 8, Dr. Mars Baumgardt, scientific lecturer; 8:30-10:30, studio program, arranged by J. Howard Johnson; 10:30-11:30, Art Hickman's Biltmore hotel dance orchestra, Frank Ellis, leader.

**KJR, Seattle, Wash. (384.4)**, 1:15-2 p. m., organ recital, Wuriltzer organ, Columbia theater; 6-6:30, "What's doing at the theaters"; 7-8:30, "Sears-Roebuck & company studio program; 8:30-10, Post Intelligence studio program.

**KLX, Oakland, Cal. (508.2)**, 4-5 p. m., women's hour; 5-5:30, Aunt Elsie's sunset matinee; 7-7:30, news; 8-9, educational program, Roy Harrison Danforth, Ad Schuster, Harry Noyes Pratt, Madine Shephard, Prof. E. R. deOng, other experts Tribune and University of California, Weekly safety council; 9-10, band concert; 10-11:30, Sherman's ballroom, Tom Gernovich and his ballroom entertainers.

**KMTR, Hollywood, Calif. (238)**, 5-6 p. m., home hour, Mammy Simmons and pupils of Geraldine Kasal; 7, talk on health, Dr. Dain T. Tasker; 7:30, Miss Nancy of the Bookshelf; 8-10, KMTR concert hour, Turner orchestra, Loren Powell, leader.

**KNX, Hollywood, Calif. (399.9)**, 5:30-8:15 p. m., Wuriltzer pipe organ studio, Town Tattler; 6:15, travel program, W. E. Alder; 6:30-7, Atwater Kent concert orchestra, Paul Finstein, leader; 7-8, Ambassador hotel concert orchestra, Josef Rosenfeld, leader; 8-9, program, Security Trust and Savings bank; 9-10, KNX feature program; 10-11, dance music.

**KPO, San Francisco, Calif. (428.3)**, 7-8 a. m., daily dozen exercises, direction, Y. M. C. A.; 10, sewing talk, Betsy Ross, Bleding, Bros.; 10:30, "Ye Towne Cryer," and amusement information service; 12 m., Ilme signals; reading of the scripture; 1-2 p. m., Rudy Selger's Fairmont orchestra; 2:30, Duke Kamekui's Royal Hawaiians; 3:30, talk on fashions, Ninon, fashion critic; 5:30-6:15, children's hour stories, Big Brother Cryer," and amusement information service; 6:40-7, Waldemar Lind and the States Restaurant orchestra;

7-7:30, Rudy Selger's Fairmont hotel orchestra; 8-9, program, Atwater Kent artists, direction, Ernest Ingold, Inc.; 9-10, program dance music, Goodrich Silvertown Cord orchestra; 10-11, Waldemar Lind and the States Restaurant orchestra.

**KPSN, Pasadena, Calif. (315.6)**, 6:30-8:30 p. m., musicale.

**KTAB, Oakland, Calif. (240)**, 9-9:30 a. m., prayer service, Rev. G. V. Phillips.

**KWSC, Pullman, Wash. (345.6)**, 7:30 p. m., Clelah Cooper, reader, Cougar Co-ed's jazz orchestra; Ruth Falkner, pianist; Gladys Wren, violinist; Edna Daw, drummer; Fay Norris, banjoist; Clarice Shattuck, saxophonist; Olive Price, vocalist; "Cutting Cost of Production," George Severance.

## Thursday, November 26

Headliners Today			
Eastern 7 p. m.	Central 6 p. m.	Mountain 5 p. m.	Pacific 4 p. m.
WJJD (302.8)	Special Thanksgiving program.		
8	7	6	5
WRC (468.5)	Pan-American program.		
8:30	7:30	6:30	5:30
WHAS (399.8)	Art Gillham, 7, whispering pianist.		
9	8	7	6
KDKA (309.1)	Old-fashioned quartet.		
WCBQ (344.6)	22nd annual Thanksgiving concert.		
WEAF (491.5)	Roxy and his gang.		
WKRC (422.3)	American music.		
10	9	8	7
WOAW (526)	Sunshine program.		
10	9	8	7
KGO (361)	"Cinderella Man," comedy.		
KHJ (405.2)	"Thanksgiving Day" program.		
WSB (428.3)	Footlight frolic.		
12 m.	11	10	9
WFAA (475.9)	Aida choral club.		

Thursday, silent night for: CHIC, CKNC, CNRA, CNRE, CNRM, CNRO, CNRR, CNRT, CNRV, CNRW, KFAB, KFAU, KFDM, KFMM, KFPA, KFPA, KFUA, KFUB, KFVC, KFVW, KGLW, KKLX, KOA, KOB, KTCG, KWSC, PWX, WAFD, WAHG, WCEE, WEBC, WGGP, WHAD, WHAZ, WIAD, WJJD, WLIT, WMAQ, WOAI, WOR, WOS, WSM, WSUI, WTAM.

**Eastern Time Stations**

**KDKA, Pittsburgh, Pa. (309.1)**, 7:15 a. m., 8, exercises, O. Shannon; 6:15, dinner concert, KDKA Little symphony orchestra; Victor Saudek, conductor; 7:30, Uncle Ed; 8:30, with famous composers; Charles Camille Saint-Saens, KDKA Little symphony orchestra; Victor Saudek, conductor; 9, KDKA Little symphony orchestra, Victor Saudek, Old-fashioned quartet; Irma Carpenter, soprano; Viola Byrson, contralto; Ray Strayer, tenor; Raymond Griffin, bass; 11, Pittsburgh Post revue.

**WAHG, Richmond Hill, N. Y. (315.6)**, 12-12:30 p. m., musical program.

**WBRR, New York, N. Y. (272.6)**, 8 p. m., Carl Park, violinist; 8:10, vocal selections, Ruth de Boer, Elvira Kiefer; 8:20, Sunday school lesson for November 29, S. M. Van Sipma; 8:40, vocal selections, Ruth de Boer, Elvira Kiefer; 8:50, Carl Park, violinist.

**WBZ, Springfield, Mass. (333.1)**, 6:30 p. m., announced; 7:30, Hotel Kimball dance orchestra, Bob Patterson, director; 8, New Keith-Albee St. James theater opening; Charles Hector's orchestra, vaudeville.

**WCAE, Pittsburgh, Pa. (461.3)**, 3 p. m., Loew's Al-dine theater program; 6:30, dinner concert, Wigham Penn hotel; 7:30, children's period; 8, Larkin period; WEAJ; 10, Goodrich Zippers.

**WCAP, Washington, D. C. (468.5)**, 1:45 p. m., Cornell-Pennsylvania football game.

**WCAU, Philadelphia, Pa. (277.6)**, 6:30 p. m., Billy Hayes and his Cathy Tea Garden orchestra; 7:30, recital, N. Schlenker and company; Philomela quartet; 8, Puccini Instrumental trio; 9, Barry O'Moore, Irish tenor; 9:15, Central Radio Synopators; 9:30, Musical Chets; 9:45, Barry O'Moore; 10, Sesqui Centennial hour; 11, Parodians.

**WCX, Detroit, Mich. (517)**, 2 p. m., news of the day; 6 p. m., dinner concert, Book-Cadillac hotel.

**WEAF, New York, N. Y. (491.5)**, 1:45-4 p. m., Cornell-Pennsylvania football game; 4-5, The Tennesseeans dance orchestra; 6-7, dinner music, Waldorf-Astoria; 7-7:30, services, Greater New York Federation of Churches; 7:30-8, Cushman's Serenaders; 8-8:30, the Larkinites; 8:30-9, "Pop" concert; 9-10, "Roxy and His Gang"; 10-11, "Goodrich Zippers"; 11-12, Vincent Lopez and his orchestra.

**WEAR, Cleveland, Ohio, (389.4)**, 11 a. m., home service talk; 7 p. m., Hotel Statler concert orchestra, direction Maurice Spitalny; 8, R. T. L. program; 9, Dutch Master artists; 10, Vincent Percy, organ recital.

**WGBS, New York, N. Y. (156.6)**, 8-4 p. m., orchestra; 8:30-8:45, talk, W. Allerton; 9:30-10:30, X. M. C. A. program.

**WGBU, Fulford-by-the-Sea, Fla. (278)**, 6:30-7:30 p. m., Blue Steele's orchestra; 10-1, Blue Steele's Fulford-by-the-Sea orchestra; Theresa Horn, pianist.

**WGCP, New York, N. Y. (252)**, 9-9:15 p. m., Mrs. Elvira Rosa Geiger, pianist; 9:15-9:30, Bert Daxmar, songs; 9:30-4, orchestra; 4-4:15, Hughie Woolford, pianist; 4:15-4:30, studio program; 4:45-5, Harry Spear, songs; 5-5:15, Sylvia Schatz, pianist.

**WGHP, Detroit, Mich. (270)**, 10 p. m., midnight mariners.

**WGR, Buffalo, N. Y. (319)**, 1:45 p. m., WEAJ, Cornell vs. Pennsylvania football game; 6:30-7:30, Vincent Lopez Hotel Statler dance orchestra, Harold Gieser, director; 8-11, jointly with WEAJ, including Larkinites, Pop concert, Roxy and His Gang and the Goodrich Zippers.

**WGY, Schenectady, N. Y. (379.1)**, 2:15 p. m., Cornell-University of Pennsylvania football game; 6:30, Ten Eyck concert trio; 7:30, WGY book chat, L. I. Hopkins; 7:45, "Ben Bolt," Peter Schmidt; 7:45, "Our American Thanksgiving," Rev. Thomas R. Good; program, United States Army band, WRC; 9, WGY orchestra; 9:30, Royal hour, Royal Salon orchestra; 11:30, Stephen E. Boisclair, organist.

**WHAR, Atlantic City, N. J. (275)**, 2 p. m., Seaside hotel trio; 7:30, health talk; Dr. Henry Reik; 8, Seaside hotel trio.

**WIP, Philadelphia, Pa. (508.2)**, 2 p. m., Pennsylvania-Cornell football game; 6:05, Pagoda cafe orchestra; Charles Verna, director; 8, The Sesqui Centennial; Hon. Harry A. Mackey; 8:15, program announced; 8:45, Institute of Musical Art program, Ben Stad, director; 10:05, Joe Ray and the California Night Hawks.

**WJAR, Providence, R. I. (305.9)**, 1:05 p. m., Cornell-Pennsylvania football game; 9, Hudson-Essex orchestra; Roxy and His Gang; 10, Goodrich Zippers.

**WJR, Pontiac, Mich. (517)**, 2:30 p. m., Bucknell college-University of Detroit; 7, Jean Goldkette's Petite symphony orchestra; 9, Jean Goldkette's serenaders; 10, Jean Goldkette's Victor Recording orchestra; 11, Dutch Masters program.

**WKAR, East Lansing, Mich. (285.5)**, 7:15 p. m., Radio school, lectures on marketing, agricultural, English, soils.

**WMCA, New York, N. Y. (340.7)**, 6-6:30 p. m., Oitcott Fall and his Hotel McAlpin string ensemble; 6:30-7:15, Frank Gebbia and his Red Lion lion orchestra; 7:15-7:30, Pace Institute program; 7:30-8, Lanson's orchestra; 8-8:30, Hale and Hearty; 8:30-9:30, Cindrella dance orchestra; 10-10:15, "How to Drive Automobiles," Harry Rainess; 10:30-11, Manhattan Serenaders; 11-12, Ernie Golden and his Hotel McAlpin orchestra.

**WNYC, New York, N. Y. (526)**, 6-7 p. m., dinner music; Hotel St. George; 7-7:10, market high spots; 7:15-7:30, dinner music; 7:30-7:35, police alarms; 7:35-7:45, song recitals; 8-8:15, talk, John B. Foster; 8:15-9:30, concert; 9:30-10, instrumental quartet; 10:10-10:20, talk, Dr. Sydney Ussher; 10:20-10:30, lectures, board of education.

**WOR, Newark, N. J. (405.2)**, 2:45-3 p. m., talk, Dr. George Watson Little; 6:15-6:17, "Words Often Mispronounced"; 6:17-6:30, sports talk, Bill Wathey; 6:30-7:30, dinner music, Hotel Shelton.

(Continued on page 20)

Thursday, November 26

(Continued from page 19)

WRC, Washington, D. C. (468.5), 10 a. m., women's... WJZ, 12 m., organ recital, Homer L. Kitt studios; 1 p. m., Hotel Mayfair orchestra; 6, Hotel Hamilton orchestra; 6:56, Shoreham hotel orchestra; 7:45, Smithsonian talk; 8, "Pan-American Night"; 9:30, Royal Salon orchestra, WJZ, WGY; 10:30-11:30, Meyer Davis' "Swanee" orchestra.

WREO, Lansing, Mich. (285.5), 6-7 p. m., dinner concert, Speedwagon serenaders; Gold Standard ensemble; 8:15, string quartet; Thomas Metzger, flutist; vocal and instrumental solos; Radiator quartet.

WVVA, Richmond, Va. (256), 9-12 midnight, orchestra, soloist, signs off with "Carry Me Back to Old Virginia".

WTAG, Worcester, Mass. (268), 1:45 p. m., Cornell University of U. football game; 8-8:30, "The Larkinities"; 8:30-9, WEAF; 9-10, program, WEAF; 10-11, Goodrich Zippers.

WTAM, Cleveland, Ohio, (369.4), 12:15-1:15 p. m., lunch hour music, popular entertainers, Euclid music studio; 6-7, dinner hour music, Hotel Hollenden orchestra, Carl Rupp, director.

WTG, Hartford, Conn. (475.9), Cornell University of Pennsylvania football game, 6:30, dinner music; Hub restaurant trio; 7:30, "Travel," Mrs. Patty Lee Clark; 7:45, dinner music.

WVJ, Detroit, Mich. (352.7), 8 p. m., concert from New York through WEAF.

Central Time Stations
KFMQ, Fayetteville, Ark. (299.6), 8 p. m., "Our Neighbor Mars," A. M. Harding; "In Peace and War," Harrison Hale; "Inter-County Population Movements and Their Significance," J. A. Dickey; "Egyptian Architecture," W. B. Allen; "Relation of Home Equipment to Health and Sanitation," D. G. Carter; "The Greater American Novelists," V. L. Jones; "How to Measure Other People," G. C. Fracker.

KLDS, Independence, Mo. (440.9), Thanksgiving cantata, Walnut Park choir; Mrs. Austin M. Dobson, director; John Reynolds and Mrs. W. C. Norman, accompanists.

KMA, Shenandoah, Iowa (252), 11:30-12:30 p. m., RFD program; garden talks, Earl V. May; music; 12 m., flower talk, Lina Ferguson; 1-2, dinner program; Iowa Federated Women's club program, Mrs. John Fox Lake; 9-11, evening program; Delmonico Dreamers, Walter Nixon, pianist, director; E. J. Gottsch, soloist; orchestra.

KPRC, Houston, Tex. (293.9), 12 m., Thanksgiving day program; 3-4, Baylor Radio Institute; 4-5, "Economic oratorical," Ruth, choir of St. Paul's Methodist church; Edith Brown, organist.

KSAC, Manhattan, Kan. (340.7), 12:35-1:05 p. m., "Is My Soul Sour?" E. B. Wells; graden talk, A. J. Schott; 4:30-5, community civics; 6:30-7:30, music, art, Business English, J. O. Faulkner; "The Labels on Your Clothes," A. L. Hinn; "Labor-Saving Devices," Harriet W. Alla.

KSD, St. Louis, Mo. (545.1), 7:55 p. m., WEAF "Good Will" program.

KTHS, Hot Springs National Park, Ark. (374.8), 9:15-9:30 p. m., piano and organ duets; 9:30-10:30, Thanksgiving dance program, Meyer Davis orchestra.

KWB, Chicago, Ill. (535.4), 6:30-7 a. m., morning exercises; 7:15, morning family fellowship; 7:15-8, table talk, Anna J. Peterson; 12:05-1 p., noon-day concert, Commonwealth Edison company; 1-2, luncheon concert, Congress hotel, Coon Sanders original night Hawks; 4, afternoon frolic; 6:10-6:30, musical concert, Commonwealth Edison company; 6:40-7, children's bedtime story, Walter Wilson; 7-7:30, dinner concert, Congress hotel, Coon Sanders original night Hawks; 7:30, Congress hotel orchestra; 8-8:20, twenty minutes, Good reading, Rev. G. J. Pernin; 9:15, musical program, Congress hotel; 12, "Evening at Home" including Coon Sanders, night Hawks; 1 a. m., "Insomniac club," Coon Sanders original night Hawks.

WAB, Minneapolis, Minn. (243.6), 8 p. m., Radisson orchestra; 7, University of Minnesota; 10, Coilla Dare, Cec Lovell; 11, Skyrokers.

AN EVENING AT HOME WITH THE LISTENER IN FOR PACIFIC TIME

Table with columns: Call, Location, Met., Saturday, Sunday, Monday, Tuesday, Wednesday, Thursday, Friday. Lists various radio stations and their broadcast schedules.

WJAZ, Chicago, Ill. (322.4), 10-12 p. m., Fery Lulek, baritone; Ruth Ford, contralto; Alexander Sebald, violinist; Monica Stults, soprano; Walter Stults, baritone; Helen Hawk, pianist, accompanist; E. Warren K. Howe, director.

WJJD, Mooseheart, Ill. (302.8), 6-7 p. m., special Thanksgiving program; Klutus Teumseh; Simeon Oliver, Eskimo pianist.

WKRC, Cincinnati, Ohio (326), 10 p. m., Post-Wurlitzer classical series, "Early American Music"; 11, mixed program.

WLIB, Chicago, Ill. (308.2), 7-8 p. m., dinner concert, Blackstone and Drake orchestras; 9-10, popular, Hamm's orchestra; 11-12, dance, Drake and Blackstone orchestras.

WLS, Chicago, Ill. (344.6), 12 noon, WLS studio trio; 6:30, Ralph Emerson's organ concert; 7, Ford and Glenn's Woodshed theatre; 7:30, special Thanksgiving program.

WLW, Cincinnati, Ohio (422.3), 7:30 a. m., morning exercises, William Stradman, Y. M. C. A.; 7:45, morning devotions, auspices of Parkway Y. M. C. A.; 12:15, organ concert, auspices of Parkway Y. M. C. A.; 12:30, Johann Grosse; 12:30, Mildred Priggs, pupils of Wiltzback, Central Y. M. C. A.; 12:35, musical numbers, members of Mu Phi Epsilon sorority; 4, piano recital, Adelaide Aphel and pupils; 7, Hotel Gibson, Robert Visconti, director; 7:40, talk on Gibson concert; 8-10:30, Kaufman; 7:40, continuation of Gibson concert; 8:10-8:30, Trianon duo; Beatrice Teller, Ralph Elliott, Preston Graves; 9-11, Trianon orchestra, Dell Lampe's Woodlawn theater orchestra; Lionel Carter, A. Stephenson, Lou Butler, Stub Pon, Stella Stanley.

WVA, Omaha, Neb. (526), 5:40 p. m., Val Mel-Leghlin Sandman; 6, classical; 6:50, Randall's Royal Fontanelle orchestra; 9, Sunshine program.

WOC, Davenport, Ia. (483.6), 12:15-12:25 p. m., farm school; "Legume Day," Red W. Jones; "Sometimes Fails—What are the Reasons?" Prof. John Pieper; 5:45-6, chimes concert; 6:30-6:50, Sandman's bedtime stories; 7-7:30, The Larkinities, WEAF; 7:30-9, WEAF's program; 9-10, Goodrich Zippers, WEAF; 11-12, "The Larkinities" orchestra; Peter MacArthur, baritone; Jack Little, popular entertainer.

WOL, Ames, Iowa (270), 12:45 p. m., "Farm Crops," Prof. H. D. Hughes; 7:30, dairyman's course.

WOK, Chicago, Ill. (217.3), 12-2 p. m., August Briedermeier, tenor; Gus C. Edwards and his orchestra; Fred Price, soprano; Banks Kennedy, organist; WOK string quartet; 5:30-7, Eleanor Gilmore, soprano; Gus C. Edwards and his orchestra; Banks Kennedy, organist; Bob Mokreis, pianist; WOK string quartet; 10-1 a. m., Herman Sinaiko, violinist; Gus C. Edwards and his orchestra; Harriet Lee, contralto; Bill Bourke and Sonny Brown, harmony duo; Banks Kennedy, organist; Bill Hay, bass; WOK string quartet; Jack Keyes, baritone; Norman Bartlett, bass.

WORD, Batavia, Ill. (275), 8 p. m., Webster hotel concert trio; 8:15, Thanksgiving service, I. B. S. A. choral singers, Marvel Larson, soprano, John T. Read, bass; 8:30, address, L. M. Smith; Marvel Larson and John T. Read.

WQJ, Chicago, Ill. (447.5), 3-4 p. m., Thanksgiving Day musical program; 7-8, dinner concert, Ralph Williams and his Rainbo Gardens orchestra; Clement Laskowski, tenor; Katherine McDevitt, Dorothy B. Devitt, piano duettists; Gertrude Wolf Quantin, soprano; 10-1 a. m., Ralph Williams and his Rainbo Gardens; Jerry Sullivan; Rose Vanderbosch, soprano and pianist; Eda Lansing and her ukulele; Bert Davis; June Lee, comedienne; Ralph Keim, pianologist; Anne Keim, mezzo-soprano; Marie Wright, soprano; Lew Butler; Lillian Schoessling, mezzo-soprano; Parish and Ward, harmony singers; Edlen Yorkson, mezzo-soprano; 1-2, Ginger hour.

WSA, Cincinnati, Ohio (326), 2 p. m., U. of Cincinnati Radio actors; 8, Silvertown Cord orchestra.

WSB, Atlanta, Ga. (429.3), 8 p. m., Dr. Charles A. Sheldon, Jr., organist; 10:45, footlight frolic, Howard Theater backstage bunch.

WSM, Nashville, Tenn. (282.8), 2:15 p. m., Vanderbilt-Swanee football game.

WSNB, New Orleans, La. (319), 8:30-10:30 p. m., Eddie Keady and his Kokomo serenaders, Liberty theater orchestra.

WSOE, Milwaukee, Wis. (246), 5:30 p. m., twilight hour, Victor Maves, pianist; "Jimmy the Bookworm" mouth accordionist; other artists; 8:45, automobile trouble shooting, Doc Otto; 9, diversified program, featuring the Milwaukee school orchestra and glee club; Fritz Chitz, director.

WSU, Iowa City, Iowa (483.6), 12 m., Mrs. Preston C. Coast, organist.

Mountain Time Stations

CFAC, Calgary, Canada, (435.8), 7 p. m., bedtime story, Radio lady; 9:11, Canadian National Railways program, Mrs. McCalla, pianist; Mrs. Tom Scott, vocalist and pianist; Gwen Biggs, cello; George Bell, bass.

CNRC, Calgary, Can. (435.8), 7 p. m., kiddies' bedtime story; 9, program; Gwenllian Biggs; cello; George Bell, bass; vocal duets, solos; Mrs. McCalla, cellist; Mrs. Scott, pianist.

KOA, Denver, Colo. (322.4), 10:30 a. m., public Thanksgiving service, speakers, music; 8:30, dinner concert, Brown Palace string orchestra, Howard Tillotson, director; 7, football finals; 7:30, farm question box.

KOB, State College, N. M. (348.6), 3 p. m., football game, New Mexico College of Agriculture-New Mexico Military Institute.

KUOM, Missoula, Mont. (244), 9:30 p. m., homecoming dance; music, Sheridans orchestra.

Pacific Time Stations

KFWB, Hollywood, Calif. (252), 6:30-7 p. m., Altadena program, E. P. Jones; 7, talk, Dr. T. Floyd Brown on plastic surgery; 7:15, microphone brevities; 7:30-8, program, Elmer R. Sly company; 8-9, program, Starr Piano company with Hollywood Rhythm Kings and Ina Mitchell Butler, soprano; Estelle Shake, blues singer; 9-10, program, Don E. Smith, Inc. Diana-Morgan orchestra, Ashley sisters, Sol Hoopii's Hawaiian Trio; 10-11, Warner Brothers frolic, direction Charlie Wellman; 11-12, Henry Halstod's Hollywood Roof orchestra.

KGO, Oakland, Calif. (361), 4-5:30 p. m., concert orchestra, Hotel St. Francis; 8, "Cinderella Man," KGO players; Arion trio; 10-12, Ben Black's orchestra.

KGW, Portland, Ore. (491.5), 12:30-1:30 p. m., Rose City trio; 2:30, U. of Oregon-U. of Washington football game; 6-7, dinner concert; 7:45-8, lecture, Catholic Truth Society.

KHJ, Los Angeles, Calif. (405.2), 8-11 p. m., special Radio Thanksgiving day program, Los Angeles Soap company, arranged by J. Howard Johnson.

KJR, Seattle, Wash. (384.4), 10:30-11:30 a. m., Frederick & Nelson, musical program and talks, Home Furnishings; 1:15-2, organ recital, Columbia theatre; 2-2:15, "Home Helps," Bernice Redington; 6-6:30, "What's doing at the theatre," 8:30-9, "Fuguet Sound Savings & Loan Ass'n" orchestra, direction, Bert Damski; 10:30-12, Post-Intelligencer presenting "Keep Joy Radiating Order of Bats."

KMTR, Hollywood, Calif. (238), 5-6 p. m., home hour, Georgia Simmons and pupils of Carter Weaver; 7:15 p. m., "Campus Nite," students University of California; 8-10, KMTR concert hour, Turner orchestra, direction Loren Powell.

KNX, Hollywood, Calif. (336.9), 5:30-6:15 p. m., Wur-litzer piano organ studio, Town Tattler; 6:15, travel talk, E. Alder; 6:30-7, Atwater Kent concert orchestra, Paul Einstein, leader; 7-8, program, H. L. Crockett, Way Watts and ukulele and H. L. Crockett, baritone; 8-10, program, Willys-Overland dealers of Southern California; 10-11, Ray West's Coconut Grove dance orchestra from Ambassador hotel.

KPO, San Francisco, Cal. (428.3), 7-7:30 a. m., daily dozen exercises, direction Y. M. C. A.; 10, talk, domestic science, Virginia Tappan; 10:30, "Ye Towne Cryer" amusement information service; 12 m., time signals, reading of the scripture; 12 m., special Thanksgiving services, Old St. Mary's; 1-2 p. m., Rudy Seiger's Fairmont hotel orchestra; 2:30-3:30, studio matinee program; 3:30-4:30, Cyrus Trobbe's Palace hotel concert orchestra; 5:30-6:15, children's hour stories, Big Brother; 6:30, "Ye Towne Cryer"; 7, E. Alder; 6:30-7, Atwater Kent concert orchestra, Paul Einstein, leader; 7-8, program, H. L. Crockett, Way Watts and ukulele and H. L. Crockett, baritone; 8-10, program, Willys-Overland dealers of Southern California; 10-11, Ray West's Coconut Grove dance orchestra from Ambassador hotel.

KWB, Hollywood, Calif. (252), 6:30-7 p. m., Altadena program, E. P. Jones; 7, talk, Dr. T. Floyd Brown on plastic surgery; 7:15, microphone brevities; 7:30-8, program, Elmer R. Sly company; 8-9, program, Starr Piano company with Hollywood Rhythm Kings and Ina Mitchell Butler, soprano; Estelle Shake, blues singer; 9-10, program, Don E. Smith, Inc. Diana-Morgan orchestra, Ashley sisters, Sol Hoopii's Hawaiian Trio; 10-11, Warner Brothers frolic, direction Charlie Wellman; 11-12, Henry Halstod's Hollywood Roof orchestra.

KGO, Oakland, Calif. (361), 4-5:30 p. m., concert orchestra, Hotel St. Francis; 8, "Cinderella Man," KGO players; Arion trio; 10-12, Ben Black's orchestra.

KGW, Portland, Ore. (491.5), 12:30-1:30 p. m., Rose City trio; 2:30, U. of Oregon-U. of Washington football game; 6-7, dinner concert; 7:45-8, lecture, Catholic Truth Society.

KHJ, Los Angeles, Calif. (405.2), 8-11 p. m., special Radio Thanksgiving day program, Los Angeles Soap company, arranged by J. Howard Johnson.

KJR, Seattle, Wash. (384.4), 10:30-11:30 a. m., Frederick & Nelson, musical program and talks, Home Furnishings; 1:15-2, organ recital, Columbia theatre; 2-2:15, "Home Helps," Bernice Redington; 6-6:30, "What's doing at the theatre," 8:30-9, "Fuguet Sound Savings & Loan Ass'n" orchestra, direction, Bert Damski; 10:30-12, Post-Intelligencer presenting "Keep Joy Radiating Order of Bats."

KMTR, Hollywood, Calif. (238), 5-6 p. m., home hour, Georgia Simmons and pupils of Carter Weaver; 7:15 p. m., "Campus Nite," students University of California; 8-10, KMTR concert hour, Turner orchestra, direction Loren Powell.

KNX, Hollywood, Calif. (336.9), 5:30-6:15 p. m., Wur-litzer piano organ studio, Town Tattler; 6:15, travel talk, E. Alder; 6:30-7, Atwater Kent concert orchestra, Paul Einstein, leader; 7-8, program, H. L. Crockett, Way Watts and ukulele and H. L. Crockett, baritone; 8-10, program, Willys-Overland dealers of Southern California; 10-11, Ray West's Coconut Grove dance orchestra from Ambassador hotel.

KPO, San Francisco, Cal. (428.3), 7-7:30 a. m., daily dozen exercises, direction Y. M. C. A.; 10, talk, domestic science, Virginia Tappan; 10:30, "Ye Towne Cryer" amusement information service; 12 m., time signals, reading of the scripture; 12 m., special Thanksgiving services, Old St. Mary's; 1-2 p. m., Rudy Seiger's Fairmont hotel orchestra; 2:30-3:30, studio matinee program; 3:30-4:30, Cyrus Trobbe's Palace hotel concert orchestra; 5:30-6:15, children's hour stories, Big Brother; 6:30, "Ye Towne Cryer"; 7, E. Alder; 6:30-7, Atwater Kent concert orchestra, Paul Einstein, leader; 7-8, program, H. L. Crockett, Way Watts and ukulele and H. L. Crockett, baritone; 8-10, program, Willys-Overland dealers of Southern California; 10-11, Ray West's Coconut Grove dance orchestra from Ambassador hotel.

KWB, Hollywood, Calif. (252), 6:30-7 p. m., Altadena program, E. P. Jones; 7, talk, Dr. T. Floyd Brown on plastic surgery; 7:15, microphone brevities; 7:30-8, program, Elmer R. Sly company; 8-9, program, Starr Piano company with Hollywood Rhythm Kings and Ina Mitchell Butler, soprano; Estelle Shake, blues singer; 9-10, program, Don E. Smith, Inc. Diana-Morgan orchestra, Ashley sisters, Sol Hoopii's Hawaiian Trio; 10-11, Warner Brothers frolic, direction Charlie Wellman; 11-12, Henry Halstod's Hollywood Roof orchestra.

KGO, Oakland, Calif. (361), 4-5:30 p. m., concert orchestra, Hotel St. Francis; 8, "Cinderella Man," KGO players; Arion trio; 10-12, Ben Black's orchestra.

KGW, Portland, Ore. (491.5), 12:30-1:30 p. m., Rose City trio; 2:30, U. of Oregon-U. of Washington football game; 6-7, dinner concert; 7:45-8, lecture, Catholic Truth Society.

KHJ, Los Angeles, Calif. (405.2), 8-11 p. m., special Radio Thanksgiving day program, Los Angeles Soap company, arranged by J. Howard Johnson.

KJR, Seattle, Wash. (384.4), 10:30-11:30 a. m., Frederick & Nelson, musical program and talks, Home Furnishings; 1:15-2, organ recital, Columbia theatre; 2-2:15, "Home Helps," Bernice Redington; 6-6:30, "What's doing at the theatre," 8:30-9, "Fuguet Sound Savings & Loan Ass'n" orchestra, direction, Bert Damski; 10:30-12, Post-Intelligencer presenting "Keep Joy Radiating Order of Bats."

KMTR, Hollywood, Calif. (238), 5-6 p. m., home hour, Georgia Simmons and pupils of Carter Weaver; 7:15 p. m., "Campus Nite," students University of California; 8-10, KMTR concert hour, Turner orchestra, direction Loren Powell.

KNX, Hollywood, Calif. (336.9), 5:30-6:15 p. m., Wur-litzer piano organ studio, Town Tattler; 6:15, travel talk, E. Alder; 6:30-7, Atwater Kent concert orchestra, Paul Einstein, leader; 7-8, program, H. L. Crockett, Way Watts and ukulele and H. L. Crockett, baritone; 8-10, program, Willys-Overland dealers of Southern California; 10-11, Ray West's Coconut Grove dance orchestra from Ambassador hotel.

KPO, San Francisco, Cal. (428.3), 7-7:30 a. m., daily dozen exercises, direction Y. M. C. A.; 10, talk, domestic science, Virginia Tappan; 10:30, "Ye Towne Cryer" amusement information service; 12 m., time signals, reading of the scripture; 12 m., special Thanksgiving services, Old St. Mary's; 1-2 p. m., Rudy Seiger's Fairmont hotel orchestra; 2:30-3:30, studio matinee program; 3:30-4:30, Cyrus Trobbe's Palace hotel concert orchestra; 5:30-6:15, children's hour stories, Big Brother; 6:30, "Ye Towne Cryer"; 7, E. Alder; 6:30-7, Atwater Kent concert orchestra, Paul Einstein, leader; 7-8, program, H. L. Crockett, Way Watts and ukulele and H. L. Crockett, baritone; 8-10, program, Willys-Overland dealers of Southern California; 10-11, Ray West's Coconut Grove dance orchestra from Ambassador hotel.

KWB, Hollywood, Calif. (252), 6:30-7 p. m., Altadena program, E. P. Jones; 7, talk, Dr. T. Floyd Brown on plastic surgery; 7:15, microphone brevities; 7:30-8, program, Elmer R. Sly company; 8-9, program, Starr Piano company with Hollywood Rhythm Kings and Ina Mitchell Butler, soprano; Estelle Shake, blues singer; 9-10, program, Don E. Smith, Inc. Diana-Morgan orchestra, Ashley sisters, Sol Hoopii's Hawaiian Trio; 10-11, Warner Brothers frolic, direction Charlie Wellman; 11-12, Henry Halstod's Hollywood Roof orchestra.

KGO, Oakland, Calif. (361), 4-5:30 p. m., concert orchestra, Hotel St. Francis; 8, "Cinderella Man," KGO players; Arion trio; 10-12, Ben Black's orchestra.

KGW, Portland, Ore. (491.5), 12:30-1:30 p. m., Rose City trio; 2:30, U. of Oregon-U. of Washington football game; 6-7, dinner concert; 7:45-8, lecture, Catholic Truth Society.

KHJ, Los Angeles, Calif. (405.2), 8-11 p. m., special Radio Thanksgiving day program, Los Angeles Soap company, arranged by J. Howard Johnson.

KJR, Seattle, Wash. (384.4), 10:30-11:30 a. m., Frederick & Nelson, musical program and talks, Home Furnishings; 1:15-2, organ recital, Columbia theatre; 2-2:15, "Home Helps," Bernice Redington; 6-6:30, "What's doing at the theatre," 8:30-9, "Fuguet Sound Savings & Loan Ass'n" orchestra, direction, Bert Damski; 10:30-12, Post-Intelligencer presenting "Keep Joy Radiating Order of Bats."

KMTR, Hollywood, Calif. (238), 5-6 p. m., home hour, Georgia Simmons and pupils of Carter Weaver; 7:15 p. m., "Campus Nite," students University of California; 8-10, KMTR concert hour, Turner orchestra, direction Loren Powell.

KNX, Hollywood, Calif. (336.9), 5:30-6:15 p. m., Wur-litzer piano organ studio, Town Tattler; 6:15, travel talk, E. Alder; 6:30-7, Atwater Kent concert orchestra, Paul Einstein, leader; 7-8, program, H. L. Crockett, Way Watts and ukulele and H. L. Crockett, baritone; 8-10, program, Willys-Overland dealers of Southern California; 10-11, Ray West's Coconut Grove dance orchestra from Ambassador hotel.

KPO, San Francisco, Cal. (428.3), 7-7:30 a. m., daily dozen exercises, direction Y. M. C. A.; 10, talk, domestic science, Virginia Tappan; 10:30, "Ye Towne Cryer" amusement information service; 12 m., time signals, reading of the scripture; 12 m., special Thanksgiving services, Old St. Mary's; 1-2 p. m., Rudy Seiger's Fairmont hotel orchestra; 2:30-3:30, studio matinee program; 3:30-4:30, Cyrus Trobbe's Palace hotel concert orchestra; 5:30-6:15, children's hour stories, Big Brother; 6:30, "Ye Towne Cryer"; 7, E. Alder; 6:30-7, Atwater Kent concert orchestra, Paul Einstein, leader; 7-8, program, H. L. Crockett, Way Watts and ukulele and H. L. Crockett, baritone; 8-10, program, Willys-Overland dealers of Southern California; 10-11, Ray West's Coconut Grove dance orchestra from Ambassador hotel.

KWB, Hollywood, Calif. (252), 6:30-7 p. m., Altadena program, E. P. Jones; 7, talk, Dr. T. Floyd Brown on plastic surgery; 7:15, microphone brevities; 7:30-8, program, Elmer R. Sly company; 8-9, program, Starr Piano company with Hollywood Rhythm Kings and Ina Mitchell Butler, soprano; Estelle Shake, blues singer; 9-10, program, Don E. Smith, Inc. Diana-Morgan orchestra, Ashley sisters, Sol Hoopii's Hawaiian Trio; 10-11, Warner Brothers frolic, direction Charlie Wellman; 11-12, Henry Halstod's Hollywood Roof orchestra.

KGO, Oakland, Calif. (361), 4-5:30 p. m., concert orchestra, Hotel St. Francis; 8, "Cinderella Man," KGO players; Arion trio; 10-12, Ben Black's orchestra.

KGW, Portland, Ore. (491.5), 12:30-1:30 p. m., Rose City trio; 2:30, U. of Oregon-U. of Washington football game; 6-7, dinner concert; 7:45-8, lecture, Catholic Truth Society.

KHJ, Los Angeles, Calif. (405.2), 8-11 p. m., special Radio Thanksgiving day program, Los Angeles Soap company, arranged by J. Howard Johnson.

KJR, Seattle, Wash. (384.4), 10:30-11:30 a. m., Frederick & Nelson, musical program and talks, Home Furnishings; 1:15-2, organ recital, Columbia theatre; 2-2:15, "Home Helps," Bernice Redington; 6-6:30, "What's doing at the theatre," 8:30-9, "Fuguet Sound Savings & Loan Ass'n" orchestra, direction, Bert Damski; 10:30-12, Post-Intelligencer presenting "Keep Joy Radiating Order of Bats."

KMTR, Hollywood, Calif. (238), 5-6 p. m., home hour, Georgia Simmons and pupils of Carter Weaver; 7:15 p. m., "Campus Nite," students University of California; 8-10, KMTR concert hour, Turner orchestra, direction Loren Powell.

KNX, Hollywood, Calif. (336.9), 5:30-6:15 p. m., Wur-litzer piano organ studio, Town Tattler; 6:15, travel talk, E. Alder; 6:30-7, Atwater Kent concert orchestra, Paul Einstein, leader; 7-8, program, H. L. Crockett, Way Watts and ukulele and H. L. Crockett, baritone; 8-10, program, Willys-Overland dealers of Southern California; 10-11, Ray West's Coconut Grove dance orchestra from Ambassador hotel.

KPO, San Francisco, Cal. (428.3), 7-7:30 a. m., daily dozen exercises, direction Y. M. C. A.; 10, talk, domestic science, Virginia Tappan; 10:30, "Ye Towne Cryer" amusement information service; 12 m., time signals, reading of the scripture; 12 m., special Thanksgiving services, Old St. Mary's; 1-2 p. m., Rudy Seiger's Fairmont hotel orchestra; 2:30-3:30, studio matinee program; 3:30-4:30, Cyrus Trobbe's Palace hotel concert orchestra; 5:30-6:15, children's hour stories, Big Brother; 6:30, "Ye Towne Cryer"; 7, E. Alder; 6:30-7, Atwater Kent concert orchestra, Paul Einstein, leader; 7-8, program, H. L. Crockett, Way Watts and ukulele and H. L. Crockett, baritone; 8-10, program, Willys-Overland dealers of Southern California; 10-11, Ray West's Coconut Grove dance orchestra from Ambassador hotel.

KWB, Hollywood, Calif. (252), 6:30-7 p. m., Altadena program, E. P. Jones; 7, talk, Dr. T. Floyd Brown on plastic surgery; 7:15, microphone brevities; 7:30-8, program, Elmer R. Sly company; 8-9, program, Starr Piano company with Hollywood Rhythm Kings and Ina Mitchell Butler, soprano; Estelle Shake, blues singer; 9-10, program, Don E. Smith, Inc. Diana-Morgan orchestra, Ashley sisters, Sol Hoopii's Hawaiian Trio; 10-11, Warner Brothers frolic, direction Charlie Wellman; 11-12, Henry Halstod's Hollywood Roof orchestra.

KGO, Oakland, Calif. (361), 4-5:30 p. m., concert orchestra, Hotel St. Francis; 8, "Cinderella Man," KGO players; Arion trio; 10-12, Ben Black's orchestra.

KGW, Portland, Ore. (491.5), 12:30-1:30 p. m., Rose City trio; 2:30, U. of Oregon-U. of Washington football game; 6-7, dinner concert; 7:45-8, lecture, Catholic Truth Society.

KHJ, Los Angeles, Calif. (405.2), 8-11 p. m., special Radio Thanksgiving day program, Los Angeles Soap company, arranged by J. Howard Johnson.

KJR, Seattle, Wash. (384.4), 10:30-11:30 a. m., Frederick & Nelson, musical program and talks, Home Furnishings; 1:15-2, organ recital, Columbia theatre; 2-2:15, "Home Helps," Bernice Redington; 6-6:30, "What's doing at the theatre," 8:30-9, "Fuguet Sound Savings & Loan Ass'n" orchestra, direction, Bert Damski; 10:30-12, Post-Intelligencer presenting "Keep Joy Radiating Order of Bats."

KMTR, Hollywood, Calif. (238), 5-6 p. m., home hour, Georgia Simmons and pupils of Carter Weaver; 7:15 p. m., "Campus Nite," students University of California; 8-10, KMTR concert hour, Turner orchestra, direction Loren Powell.

KNX, Hollywood, Calif. (336.9), 5:30-6:15 p. m., Wur-litzer piano organ studio, Town Tattler; 6:15, travel talk, E. Alder; 6:30-7, Atwater Kent concert orchestra, Paul Einstein, leader; 7-8, program, H. L. Crockett, Way Watts and ukulele and H. L. Crockett, baritone; 8-10, program, Willys-Overland dealers of Southern California; 10-11, Ray West's Coconut Grove dance orchestra from Ambassador hotel.

KPO, San Francisco, Cal. (428.3), 7-7:30 a. m., daily dozen exercises, direction Y. M. C. A.; 10, talk, domestic science, Virginia Tappan; 10:30, "Ye Towne Cryer" amusement information service; 12 m., time signals, reading of the scripture; 12 m., special Thanksgiving services, Old St. Mary's; 1-2 p. m., Rudy Seiger's Fairmont hotel orchestra; 2:30-3:30, studio matinee program; 3:30-4:30, Cyrus Trobbe's Palace hotel concert orchestra; 5:30-6:15, children's hour stories, Big Brother; 6:30, "Ye Towne Cryer"; 7, E. Alder; 6:30-7, Atwater Kent concert orchestra, Paul Einstein, leader; 7-8, program, H. L. Crockett, Way Watts and ukulele and H. L. Crockett, baritone; 8-10, program, Willys-Overland dealers of Southern California; 10-11, Ray West's Coconut Grove dance orchestra from Ambassador hotel.

KWB, Hollywood, Calif. (252), 6:30-7 p. m., Altadena program, E. P. Jones; 7, talk, Dr. T. Floyd Brown on plastic surgery; 7:15, microphone brevities; 7:30-8, program, Elmer R. Sly company;

# KTHS TO FEATURE SPANISH MUSIC

## Friday, November 27

### Headliners Today

FRIDAY—	Central	Mountain	Pacific
5 p. m.	4 p. m.	3 p. m.	2 p. m.
WRC (468.5) Foolish entertainers.			
7:30	6:30	5:30	4:30
WJR (517) Arctic Condon trio.			
7:45	6:45	5:45	4:45
WGY (379.5) "The Better Understanding," drama.			
8:30	7:30	6:30	5:30
WHO (526) Boone mixed quartet.			
9	8	7	6
KDKA (309.1) Teaberry time.			
WDAF (365.6) Temple orchestra.			
9:10	8:10	7:10	6:10
WYIC (475.9) Readings, John Greenleaf.			
9:15	8:15	7:15	6:15
WOS (440.9) Colored fiddlers.			
9:30	8:30	7:30	6:30
KFAB (340.7) Petr. Pan Jazzettes.			
10	9	8	7
WEBB (370.2) Light Opera company.			
10:30	9:30	8:30	7:30
KTHS (374.8) Spanish classics.			
11:45	10:45	9:45	8:45
WSD (428.3) Nunnally's miniature symphony.			

## STATIONS IN ORDER OF WAVE LENGTHS USED

Meters	Call	Meters	Call	Meters	Call	Meters	Call	Meters	Call	Meters	Call
217.3	WOK	275	WORD	309.1	KDKA	361.2	KGO	406	WBAR	468.5	WRC
226	WBMM	275.3	WJAS	315.6	KFDM	361.2	WHN	410.7	CKAC	475.9	WBAP
226	WIBO	278	KOIL	315.6	WAHG	365.6	WDAF	416.4	WCCO	475.9	WTIC
240	KFVE	278	WCAU	315.6	WGBS	365.6	WHB	421	KIAP	475.9	WFAA
240	KTAB	278	WGBU	319	WGR	370.2	WEBB	422.3	WLW	480	CYL
240	WOAX	278	WOQ	319	WSMB	370.2	WGN	422.3	WKRC	483.6	WOC
243.8	WAMD	280.2	WNAC	322.4	KOA	374.8	KTHS	428.3	WSB	483.6	WSUI
250	WGBS	282.8	WOAN	322.4	WJAZ	379.5	WGY	428.3	KPO	491.5	KGW
250	WMBB	282.8	WSM	325.9	WSAI	379.5	WHAZ	434.5	CNRO	491.5	WEAF
252	KFWB	285.5	WKAR	333.1	WBZ	384.4	CKY	434.5	NAA	499.7	WMC
252	WGCP	285.5	WREO	336.9	KNX	384.4	KJR	434.5	CFCN	508.2	KLX
265.6	WMAK	288.3	KFKX	337	KFMX	384.4	WMBF	435	AT9	508.2	WIP
266	KFNF	288.3	WLWL	340.7	KFAB	389.4	WEAR	440.9	KLDS	508.2	WOO
266	WBCN	293.9	KTBI	340.7	WKAQ	389.4	WTAM	440.9	WDWF	516.9	CJCA
268	WTAG	293.9	WBAO	340.7	WMCA	394.5	WFI	440.9	WOS	516.9	WCX
270	WGHP	296.9	KPRC	344.6	WCBD	394.5	WLIT	447.5	WMAQ	516.9	WJR
272.6	WBRR	299.8	KFMQ	344.6	WLS	394.5	WOAI	447.5	WQJ	526	WHO
273	KWKH	299.8	KSL	348.6	KOB	399.8	WHAS	454.3	KFOA	526	WNYC
272.6	WEBJ	299.8	WPG	348.6	KWSC	399.8	WHT	454.3	WJZ	526	WOAW
272.6	WFBH	302.8	WJJD	348.6	WBEI	400	FWX	455	KTW	535.4	KYW
273	WRW	302.8	WLBI	352.7	WWJ	405.2	KHJ	461.3	WCAE	535.4	WHA
275	WHAD	305.9	KTCL	356.9	CFCA	405.2	WJY	467	KFI	545.1	KFUO
275	WHAR	305.9	WJAR	356.9	CKNC	405.2	WOR	467.5	WCAP	545.1	KSD

Pette symphony orchestra; 7:30, Arctic-Condon trio; 8, Summerfield and Hecht presentation.

WABR, East Lansing, Mich. (285.5), 7-15 p. m., lecture on Botany, English, forestry; 8, educational program.

WLIT, Philadelphia, Pa. (394.5), 12:02 p. m., Stanley theater organ recital; Arcadia cafe concert orchestra; 2, Arcadia cafe concert orchestra; 2:30, playlet, students National School of Elocution and Oratory; 4:30, Al. Hughes' dance orchestra; 7:30, Philadelphia Record Sunshine Club party; Dreda Daddy medley stories; 8, Greater Philadelphia talk; 8:10, sports talk; 8:30, Christmas Seal talk; 10, Morning Glory Club concert; Arcadia cafe dance orchestra; Taylor and Smith's vaudeville review.

### Eastern Time Stations

CNRA, Moncton, Can. (291), 7 p. m., "kiddies" period, Aunt Ida; 8, program; L'Assomption band, Ferdinand Malenfant; Wilhelmina Plett, violinist; Rosella Plett, pianist; Alyre LeBlanc, trombonist; 10, CNRA dance orchestra, Walter Neale; Mrs. I. Malcolm, accompanist.

CNRT, Toronto, Can. (356.9), 6:30 p. m., dinner concert; King Edward hotel concert orchestra; 9, The Music Makers; J. Campbell McInnes, director; Arthur Semple, futeist; John Adaskin, cellist; L. A. Hamilton, pianist; Helen Williams, pianist; 11, Luigi Romanelli and his King Edward hotel dance orchestra.

KDKA, Pittsburgh, Pa. (309.1), 7:15 a. m., 8, exercises O. Shannon; 10, Domestic science and arts for the housewife; 12:20 p. m., Sunday School lesson, James Mace; 6:15, dinner concert; 7:30, Auntie Jim's letter; 7:45, "Home Treatment of Minor Injuries"; R. M. Entwistle; 8:30, Dutch Master half hour; 9, Teaberry time.

WAHG, Richmond Hill, N. Y. (315.6), 12-12:30 p. m., Sid Cohen, pianist; 8:45, Skinner organist; 9:10-9:55, "Humor"; 10-10:15, everyday speech, Prof. Richard E. Mayne; 10:15-11:15, Bernice Fletcher and his orchestra.

WBZ, Springfield, Mass. (333.1), 3:30 p. m., Leo Reisman's Hotel Lenox ensemble; 7:05 "Civil Service Examinations"; 7:15, "Old English Story Telling"; Prof. E. Charlton Black; 8, Springfield Conservatory of Music; Anna Richter, pianist; Hazel King, soprano; 8:30, Pizzetti's Strummers; 9, Whatdoyoucallit club; 10:05, McEnelly's Singing orchestra.

WCAE, Pittsburgh, Pa. (461.3), 10:45 a. m., Gold Medal talk; 3, Loew's Aldine theater program; 6:30, dinner concert, William Penn hotel; 7:30, children's period; 7:45, address; 8:30, concert.

WCAP, Washington, D. C. (468.3), 7:45 p. m., scientific talk, Nat. Research Council; Mozart string quintet, dance music, Warden Park hotel ballroom.

WCAU, Philadelphia, Pa. (277.6), 7:15 p. m., Clarence Seaman and his Hotel Pennsylvania orchestra; 8:15, Chiropactic talk; 8:30, Houston Hall Smoker entertainment; J. Hill's instrumental trio; 9:30, Billy and Cornack; songs; 10:30, Ed Kiefer, humorist; 10, Rennie WCM, Detroit, Mich. (517), 2 p. m., News of the day; 6, dinner concert, Book-Cadillac hotel; 9, musical program; 10, Jean Goldkette's Victor Recording orchestra.

WEAF, New York, N. Y. (491.5), 6:45-7:20 a. m., Metropolitan tower health drill; 10:45-12, talk, Betty Crocker; musical program; lecture, Columbia University; market and weather reports; 4-5 p. m., R. Lee Gilliam, baritone, Nickels instrumental trio; Charles H. Hochblin, Baritone, Elizabeth Wady, Happiness Cady Boyd, Eagle Neurodyne trio; Paul Jelenek, pianist; 11-12, Meyer Davis' Lido Venice orchestra.

WEAR, Cleveland, Ohio, (389.4), 11 a. m., Betty Crocker, home service; 7 p. m., Wormack's singing syncopators from Far East restaurant; 8, talks; 8:30, F. W. Roberts kindergarten program; 9, Radio travelogue, Captain Kilroy Harris; 9:30, musical program, students and faculty Hiram college; 10:30, Radio plays, Bradley Yorkers.

WEBJ, New York, N. Y. (272.6), 7-7:30 p. m., Blenheim theatre ensemble; 7:45-8, Fred Steele, Billy Heagney, songs; 8:15-8:30, Jeanne d'Air, soprano; 8:30-9:30, orchestra.

WGBS, New York, N. Y. (315.6), 10-10:10 a. m., timely talks with Terese; 10-10:20, Lorna Leeds, soprano; 10:20-10:30, Ed Kiefer, humorist; 10, Lorna Leeds; 10:40-10:50, fashion talk, Sonia Rosenberg; 1:30-1:40 p. m., Rosa Karasik, soprano; 3:10-3:20, Max Tepperman, violinist; 3:20-3:40, talk, Tuberculosis association; 3:40-3:45, composition lessons, Dr. Alfred G. Robyn.

WGBU, Fullford-by-the-Sea, Fla. (278), 6:30-7:30 p. m., Blue Steele's orchestra; 10-11, Blue Steele's orchestra.

WGCP, New York, N. Y. (252), 3-3:15 p. m., Osborne and Meredith, songs; 3:15-3:30, Ona Welsh, pianist; 3:30-3:45, Leslie McLeod, tenor; 3:45-4, Samuel Weber, pianist; 4:15-4:30, Hugo Angelo, tenor; 4:30-4:45, Charol de Thomee, pianist; 5-5:15, Janet Estelle Levy, songs; 6-6:15, Littmann's orchestra; 6:15-6:30, Doray Wilkum; 6:30-6:45, W. H. King's orchestra; 7-8, Dominion Ginger Ale orchestra; 8-8:05, health talk; 8:05-8:30, Clarence Williams trio; 8:45-9, Jack Davis, songs; 9-9:15, Shirley Herman, songs; 9:15-9:30, Ukulele Bob McDonald; 9:30-9:45, Eva Rothenberg, pianologue; 9:45-10, Jimmy Flynn, songs; 10-11, Strickland's orchestra; 11-11:30, Club Ritz orchestra; 11:30-12, Bob Murphy's entertainers; 12-12:30, Connie's orchestra.

WHP, Detroit, Mich. (270), 10 p. m., Skylark orchestra and soloist.

WGR, Buffalo, N. Y. (319), 2:30-4:30 p. m., WGR's afternoon program; 6:30, Clef trio; 9-9:30, Winger's Crescent Park entertainers, "The Village Blacksmith Shop"; 9:30-9:45, John Blosek, pianist; 9:45-10, Edna Hurd, pianist; 10-10:30, Gertrude Hutchinson and assisting artists; 10:30-11, Hewitt Rudder company program, "Thirty Minutes of Something Different"; 10-11 a. m., Vincent Lopez Hotel Statler dance orchestra, Harold Gieser, director.

WGY, Schenectady, N. Y. (379.5), 2 p. m., Asia Restaurant orchestra; 2:30, "Health Notes"; Dr. C. W. Woodall; "Finders Keepers"; WGY matinee players; 6:30, international Sunday school lesson; 7, Albany Strand theater orchestra; Floyd H. Walter, organist; 7:30, health talk; 7:45, "The Better Understanding"; WGY players; 10:30, WGY orchestra; Avia Larsen Richardson, pianist; Phyllis Frear, soprano; William Fay, tenor.

WHAR, Atlantic City, N. J. (275), 2 p. m., Seaside hotel trio; 7:30, talk; 8, Seaside hotel orchestra; 11:15, Strand theater organ recital.

WIP, Philadelphia, Pa. (508.2), 6:45 a. m., 7, setting-up exercises, Dr. Francois D'Eliseu; 1 p. m., Gimbel Theater room orchestra, Ray Steen, director; 5, Frank Oglesby, vocalist; Flora Ripka, accompanist; 6:05, Benjamin Franklin concert orchestra, W. Irving Openheim, director; 7, Uncle Wip's bedtime story.

WJAR, Providence, R. I. (305.9), 10 a. m., Mrs. Wood, housewives Radio exchange; 1:05 p. m., Woodstock entertainers; 8, Margaret Reid; 8:30, Gorman's Jolly Bakers; 11, Providence-Biltmore dance orchestra.

WJR, Pontiac, Mich. (517), 7 p. m., Jean Goldkette's

### Central Time Stations

KFAB, Lincoln, Neb. (340.7), 8:30-10:30 p. m., Florence Cave and trio; Ruth Zimmerman, alto; Bea Marshall, soprano; Joseph J. Van Alken, violinist; Mary and Edna Lawie, vocalists; Mrs. Hazel Wilson, Opal Ashford, vocalists; Peter Pan Jazzettes, orchestra.

KFDM, Beaumont, Texas (315.8), 8-10 p. m., Magnolia Petroleum company's refinery band.

KFMX, Northfield, Minn. (337), 10-11 p. m., organ recital.

KFNF, Shenandoah, Iowa (266), 7 p. m., half-hour discussion, Sunday school lesson; 7:30, Wagnor sisters.

KFVE, University City, Mo. (240), 8:30 p. m., "Amusement Review" Romaine Fielding; regular studio entertainers, selected numbers orchestra Romaine.

KMA, Shenandoah, Iowa (252), 11:30-12:30 p. m., RFD program; garden talks, Earl E. May; music; 6-7, dinner program; 6:30, How do you do boys, Grady and Doc, Connie Forte and the slumber boat; 9-11, evening program, band music, Elks Municipal band, Harry Day, director.

KPRO, Houston, Tex. (296.9), 12 m., Frank Tilton, pianist.

KSAC, Manhattan, Kan. (340.7), 12:35-1:05 p. m., "Winter Management of Brood Sows," C. G. Eilling; "Poison Versus Bounty," A. E. Oman; 4:30-5, Lesson in Color and Design; 5:30-7:30, travelogue; English literature, C. W. Matthews; "The Characteristics of Effective Business Letters," J. O. Faulkner; "The Prevention and Treatment of Diphtheria," L. D. Bushnell.

KSD, St. Louis, Mo. (545.1), 7 p. m., "Fur Hour," program announced; 7:30, Commerce Hour, play, direction, Ruth Keise-Renfrow; 8:15, recital; Eleanor Cobb, violinist; Helen R. Hill, pianist.

KTHS, Hot Springs National Park, Ark. (374.8), 9-9:25 p. m., New Arlington string trio; Lon Chassy, violinist; Edward Richter, cellist; John G. Heyn, pianist; 9:25-9:30, farm talk, E. G. Matthew; 9:30-10, Spanish classics, orchestra, Lon Chassy, director; 10-11, Pooley company entertainers, Rainbow Garden.

KYW, Chicago, Ill. (535.4), 6:30-7 a. m., morning exercises; physical director, Y. M. C. A.; 7:30, "Morning Family Worship"; 11:15, "I miss My Swiss Steak"; John W. Cutting; 11:55, table talk, Anna J. Peterson; 12-1 p., lunch concert, Congress hotel, Jeska DeBarbery and his orchestra; Congress hotel, Jeska DeBarbery and his orchestra; Congress hotel at 10:40-11:10, 12, Henri A. Keates, organologue, McVickers theatre-Art Linkin, announcing; 1-2 a. m., "Insomnia club"; Coon Sanders original nightawks, Congress hotel.

WAMD, Minneapolis, Minn. (243.8), 9-12 p. m., Minneapolis public schools; 11, Skyrockets.

WAP, Fort Worth, Texas (475.9), 9:30-10:30 p. m., Shelly Lee Alley and his entertainers; 6-6:30, Texas Hotel Tokio Royals; 7:30-8:30, Will Foster, organist; 9:30-10:45, program, Aylen Hoffman.

WBBM, Chicago, Ill. (226), 4-6 p. m., popular program; Valentino Inn orchestra; Harry Sosnick and Sandy Meek; Harold Morava; Harold Anderson; Joe McManus; 8-10, Stewart-Warner program; Ted Coleman, cello; Manhattan quartet; Burdette Cleveland, concert pianist; Carl Strodel, baritone; Montmartre orchestra; string trio.

WBCN, Chicago, Ill. (266), 10-10:30 a. m., Penny Wise, "The Shopper Ready Helper," shopping talk; 5-5:15 p. m., police bulletins; 7-8, Fireside hour; WBCN hobby club; George R. Cleveland, "Big Boy" Yagle, pianist; Will Rossiter, "The Daddy of the Song Publishers," tenor and songwriter; Harold Johnson, boy xylophonist; 10-12, request program; Midway dancing gardens orchestra; Eddie Matis and Billy Donovan, tenor and pianist; West End Harmony boys, instrumental duo; Ed Dempsey, "The Silken-Voiced Tenor"; Alice McMahon, contralto; "Big Boy" Yagle, pianologue.

WCCO, Minneapolis-St. Paul, Minn. (416.4), 9:30 a. m., program for the day; 10:45, "Successful Meat Cookery," Betty Crocker; 12 m., Dick Long's Dayton trio; 2 p. m., woman's hour; 4, readers' club, Mrs. Walter Stevens; 5:30, court of gold medal; 6:15, dinner concert, Emmet Long's Golden Pheasant orchestra; 7:45, farm lecture, Garry farming, lesson VI; 8, health talk; 8:15, musical program; 10:05, dance program, Dick Long's Nankin cafe orchestra.

WDAF, Kansas City, Mo. (365.6), 10:45 a. m., Betty Crocker series; 3:30-4:30 p. m., Star's string trio; 6-7, piano tuning in number; address, speaker Kansas City Children's bureau; Tell-Me-a-Story Lady; 11:45, L. Plantation players; Eddie Kuhn's Kansas City Athletic club orchestra.

WEBB, Chicago, Ill. (370.2), 7-8 p. m., Oriole orchestra; Pauline Sachs, soprano; Eleanor Kaplan, violinist; 9-10, WEBB Light opera company; 11-11:15, Oriole orchestra; Rita McFawn, soprano; Jack Pennington, violinist; Irene Beasley, vocalist.

WENR, Chicago, Ill. (268), 6-7 p. m., dinner concert; Rauland-lyric trio; twin piano duets; vocal selections; Russel Hendrickson, cellist; 8-10, popular program; All-American Pioneers; Jack Todd, baritone; George Moran, Hawaiian guitarist; Harmony four; C. J. Blimm, concertinist; Frank Westphal.

WFAA, Dallas, Tex. (475.9), 12:30-1 p. m., address, 7:45, Horace M. Whaling, Alex Hughes, music; 3:30-4, Sears-Roebuck agricultural foundation home makers' program; 4:30-5, woman's hour and literary review; 6:30-7:30, Sam Houston State Teachers' college band recital; 8:30-9:30, Nelle B. Lowrey, soprano, and assisting musicians.

WGES, Oak Park, Ill. (250), 5-7 p. m., Lydia Werner, soprano; John Brown, pianist; Katherine Gray, contralto; Edwin Kemp, tenor; Tiffin theater organ and orchestra; 8-9, Thomas Pappas, accordion; Tiffin theater organ and orchestra; John Stamford, tenor; McDevitt sisters; vocal duo; 11-11 a. m., Remington Welsh, organist; Parish and Ward, Sandy McTavish, Scotch comedian; Bobb and Cameron, duettists; Thomas Pappas, accordionist.

WGN, Chicago, Ill. (370.2), 12:40 p. m., Drake concert ensemble; Blackstone string quintet; 2:30, artists series, Lyon and Healy; 3, rocking chair time; 3:30, Marshall Field's toy room orchestra; 6:30-7, dinner concert; 8-9, string trio, vocal artists; 10-11, Jack Chapman's and the Blackstone hotel dance orchestras.

WHAD, Milwaukee, Wis. (275), 11 p. m., pianologue, Andy Hertel; 4 p. m., Ira Schnell, baritone; Blanche O'Callahan, contralto; Thelma Johnson, soprano; Olive Frolich, pianist; 6-7, Arthur Richter, organist; 7:05, Bill Jubre's Radio Cartoon game; 8:30-10, Wisconsin theater revue; 85-piece Wisconsin theater concert orchestra; Dexter's Wisconsin theater concert orchestra.

WHAS, Louisville, Ky. (399.8), 4-5 p. m., Harry S. Peterson, recital; 7:30, concert, Liberty Insurance bank, Joseph Eisembels, director.

WHO, Des Moines, Iowa (526), 7:30-9 p. m., Boone mixed quartet, Alice Smith, director; 11-12, dance program.

WHT, Chicago, Ill. (399.8), 10 a. m., Jean Sargent's program, woman's club, Jolke Gook, Luck Girl studio features; 10:45, Betty Crocker home service; 11, special studio features; 12 p. m., Al Carney's complimentary organ hour; 1-2, special studio program, Grayling's string trio; 6, classical program, dinner organ recital, Grayling's string trio; Bob York, tenor; Bernice Taylor, soprano; Mina Smith, violinist; Leola Atkins, soprano; 7:45, (298), musical features; 9:30, Dutch Masters' Loftis half hour of music, Freddie Whitmer, pianist; Samuel G. Rowe, tenor; Oscar Heather, tenor; Pat Barnes, tenor; Helen Rauh, pianist; Husk O'Hares orchestra; 12, Pat Barnes and Al Carney.

WIAD, Waco, Texas (250), 8:30-10 p. m., Dyanshire dance program, Raleigh hotel roof garden orchestra.

WIJD, Mooseheart, Ill. (302.8), 10 p. m., Emma Bevensee Butler; Senator Harold C. Kessinger; Jean St. Anne; Christian A. Grimm; 12, Geneva organ.

WLIC, Chicago, Ill. (308.2), 7-8 p. m., dinner concert, Blackstone and Drake hotel orchestras; 9-10, popular, Hamm's orchestra; 11-12, dance, Drake and Blackstone hotel orchestras.

WLS, Chicago, Ill. (344.6), 12 noon, Ford and Glenn; 6:30, Ralph Emerson's organ concert; 7, Ford and Glenn's Lullaby Time; 7:15, WLS trio, Musical Tour Around the World; 9, Little symphony Chicago, second radio concert; 10, Baroness Olga Von Turk-Rohn.

WLW, Cincinnati, Ohio (422.3), 7:30 a. m., morning exercises, William Stratman, Y. M. C. A.; 7:45, morning devotions, auspices of Parkway Y. M. C. A.; 9-9:30, Crosley elementary school program; 12:15 p. m., noonday concert.

WMAQ, Chicago, Ill. (447.5), 12:25 p. m., WMCA Forum; 1, Radio farm school; 2, Shut-In program; 4, "The Pre-School Child"; 4:30, "Fables of the Moment"; Mrs. Graham Aldis; 5, "Child Life stories"; 6, Chicago theater organ; 6:30, Family All Star League; 6:30, Wide-Awake club program; 8, musical lecture, Mr. and Mrs. Marx E. Oberdorfer; 8:30, Whitney trio; 9, U. of C. football conference talk; 9:20, Elizabeth Stokes, soprano.

WMBB, Chicago, Ill. (250), 7-8 p. m., Trianon duo, Joseph Kreloff, Ralph Park, Frank Bordner; Marie Caruso; 9-11, Trianon orchestra; Woodlawn theater orchestra; Hunter King and Agne, Trianon syncopators; Harold Stokes.

WOAI, San Antonio, Texas (394.5), 3 p. m., musical program, Kamama's Hawaiians; 8:30, musical program, Menger hotel trio.

WOAW, Omaha, Neb. (526), 12:45 p. m., Sunshine Sunday dinner menu; 1, Gilbert Jaffy and his little

symphony; 5:40, Val McLaughlin, sandman; 6, music review, Hester Bronson Copper; 6:30, orchestra; 7:10, weekly sports talk, Ivan L. Gaddis.

WOC, Davenport, Ia. (483.6), 12:15-12:25 p. m., special farm service; 8-8:30, home management schedule, Aunt Jane; 8:45, Crescent orchestra; 5:45-6, chimes concert; 6:30-8:50, Sandman's bedtime story; 8:50 musical program; WOC minstrels, Gene Welch, director; Jack Little popular entertainer.

WOI, Ames, Iowa (270), 12:45 p. m., "Agricultural Economics," Prof. C. L. Holmes.

WOK, Chicago, Ill. (217.3), 12-2 p. m., Banks Kennedy, organist; Gus C. Edwards and his orchestra; Thos. B. Stephenson, tenor; Marianne Powell Babcock, soprano; Elsie C. Stephenson, pianist; WOK male quartet; 5:30-7, Jean Carlson, soprano; Gus C. Edwards and his orchestra; Kenyth Dunn, pianist; WOK string trio; 10-11 a. m., Harry Davis, tenor; Arnold B. Stephenson, musical saw soloist; Harriet Lee, organist; Herman Snaoko, violinist; Banks Kennedy, organist; WOK string trio; WOK male quartet; Charles Lord, tenor; Henry Bayer, tenor; Jack Keyes, baritone; Norman Bartlett, bass; Gus C. Edwards and his orchestra.

WORD, Batavia, Ill. (275), 8 p. m., Webster hotel concert trio; 8:15, Uncle Dan's Radio WORD study club; 8:30, Diana Stryker, soprano, Raymond Schadinger, baritone; Helen Flech and Rose Sutton, piano duets; 9, Dr. William O. Krohn, lecture on mental hygiene.

WOS, Jefferson City, Mo. (440.9), 8 p. m., address, "Fish and Game in Missouri," Keith McCance; "Some Facts Seldom Told," Samuel M. Jordan; address, George A. Pickens; old-time fiddlin'.

WSB, Atlanta, Ga. (428.3), 8 p. m., Carter Electric Radiola orchestra; 10:45, Five Nunnally's miniature symphony orchestra.

WSM, Nashville, Tenn. (282.8), 6:30-8 p. m., Beasley Smiths orchestra.

WSOE, Milwaukee, Wis. (246), 5:30 p. m., twilight hour, Aunt Julie, children's stories; Caroline Bamminger, soprano; Claudine Clark, pianist; 8:45, week end's best books, "Bookworm"; 9, diversified studio program, featuring Creation Tamburica orchestra, "Villa," Anton Koaman, director; Lucille Melster, violinist; Irma Frankenstein, soprano.

WQJ, Chicago, Ill. (447.5), 11-12 noon, Sunday dinner menu, Ted Wilmes; 3-4 p. m., "Eight Domestic Science Lessons," Helen Harrington Downing; special children's program; Louise Terrill Bray, accompanist; Marian A. Bray, pianist; 7-8, dinner concert, Ralph Williams and his Rainbo Gardens orchestra; Sheppard Levine, tenor; Helen Reed, accompanist; Maude Shapton Couse, lyric soprano; Henrietta Nolan, violinist; Eleanor Wassertrass, whistler; 10-11 a. m., Ralph Williams and his Rainbo Skylarks; West Brothers, Hawaiian guitarists; H. Lucille Long, woman harmonica player; Melodians; Leon Terrill, baritone; Ed McGinnis, accordionist; Blues Destroyers trio; Marvyl Larnis, soprano; 1-2, Ginger Hoyer.

WSUI, Iowa City, Iowa (483.6), 12 m., Dr. Philip Greeley, pianist.

### Mountain Time Stations

CNRE, Edmonton, Can. (518.9), 7:30-8 p. m., children's half hour; 8:30-10:30, concert, Alberta College North Musical club.

KFAU, Boise, Idaho (278), 8 p. m., Thanksgiving cantata, Mrs. Edward Bell, director.

KFWA, Ogden, Utah, (261), 5-6 p. m., Ogden Radio Dealers program; 9-10, musical program, presented, Lion Coal company and Ellis Fuel company.

KOA, Denver, Colo. (322.4), 12:15 p. m., Rialto theater musical; 3:15, relaxing and corrective exercises; 3:30, matinee for housewives; 4, culinary hints; 4:15, fashion review; 6:30, dinner concert, Brown Palace string orchestra, Howard Tillotson, director; 7:30, Preview of International Sunday school lesson; 8, studio program, Central Christian quartet; Bertha van Norman Jones, humorist, readings; Mrs. Loyola C. Fulerwider, contralto; Edith K. Bindquist, Mrs. Thos. E. Campbell, piano duettists; KOA orchestra, classical selections; book chat.

KOB, State College, N. M. (348.6), 7:30-8:30 p. m., musical concert; Margaret Vear, pianist; Elsie Garey Roberts, soprano.

### Pacific Time Stations

CNRV, Vancouver, Can. (291), 8 p. m., address; 8:30, program, Nestor Hudson, contralto; Sidney Nicholls, tenor; William Hudson, bass-baritone; Paul C. Daugherty, pianist; 10:30, Cabaret Belmont dance orchestra; Bebe Muller, soprano.

KFOA, Seattle, Wash. (453.3), 6:45-8:15 p. m., Sherman, Clay and company, studio program; 8:30-10, Times studio program; 10-11:30, Eddie Harkness and his orchestra.

KFWE, Hollywood, Calif. (252), 6:30-7 p. m., Aldena program, E. P. Jones; 7, Eye-o-logue, Dr. Marshall; 7:45, microphone brevities; 8-9, program, John Wright, The Right Tailor with Ray Bailey's trio; 9-10, program, Paralytic studio; 10-11, The Campers frolic, direction Charlie Wellman; 11-12, Henry Halstead's Hollywood Roof orchestra.

# Radio Digest Illustrated

Published by the Radio Digest Publishing Company, Inc.  
510 North Dearborn Street  
Chicago, Illinois  
Telephones: State 4372, 4373, 4374, 4375

E. C. RAYNER, Publisher

Eastern Office, Park-Lexington Building, 247 Park Ave.,  
New York. Telephones: Ashland, 8144, 8145, 8146

Member of the Audit Bureau of Circulations



241 PUBLISHED WEEKLY

SUBSCRIPTION RATES

Yearly in U. S. and Possessions and Canada, \$5.00  
Foreign postage, \$1.00 additional. Single copies, 10 cents.

Vol. XV Saturday, November 21, 1925 No. 7

## Arrest the Speeding Announcer

NOW that we've once more dusted off the cobwebs from our trusty receiver and listened to a flock of long-distance stations, it behooves us to turn critic this week and review what was wrong and what was right with the stations we heard. Not usually do we devote this space to criticism of broadcast presentation, but there are some things that need attention.

Probably the summer season blinded our eyes, or perhaps the problems of the alleged American society music hold-up, or that of too many stations, for too few waves, have kept us fairly well occupied.

In a nutshell, many announcers, and speakers other than announcers, need some special training in micro-phonology, or use of the "mike."

It seems to us that too many Radio speakers are suffering with bad attacks of haste, and can't seem to get there quickly enough. They hurry along with their words, running one into another, and stumbling, in fact, falling over a number, until it is next to impossible for the average listener—aye, experienced listener—to comprehend what the sounds are all about.

Very few times have we heard the criticism offered that so-and-so talked too slowly, or that Announcer Blank gave his call signal with pauses entirely too long between the letters.

Our good friend Eric Palmer—whose travels over the country with Friend Radio set are known to every initiated member of the Royal Order of the Radio Audience—has the same "bone to pick." He writes that most of the lecturers and announcers seem to be everlastingly essaying an oratorical Charleston. And most of them fancy they are just oozing "personality" through the ether. They may be, to people nearby who know them well and who are accustomed to their methods, but pity the poor DX fan, straining his ears to get stations 1,500 to 3,000 miles off and trying to make sense out of the verbal marathon.

Mr. Palmer says a lot we should like to have said. At any rate we'll quote him just to show how much we value his criticism:

"The announcers are the ones to whom the people look, or listen rather, for calm and careful explanation of what is going on—and if the mouths of these announcers are full of hyphens (as Demonsthenes' tongue used to revolve about pebbles), they confer a tremendous favor upon the invisible audience in the vast open spaces. Of course, practice makes perfect; the announcers become entirely at ease before the microphone; words come easily, but too easily, from the DX fans' standpoint.

"Every announcer tries to be distinctive and must necessarily project, if he can, a smile through the ozone, selling himself, in other words, but he can more readily accomplish his object by sticking in a hyphen now and then, not to speak of a few periods.

"Listening in on trains, where reception is naturally imperfect, I must confess to have had, many times, a desire to send mildly spanking letters to certain announcers, because they spoke so quickly, but perhaps they had no idea that it was so difficult to understand them at times when the signals of the stations were weak and distorted by atmospheric and other disturbances. B, G, and E, at 2,000 miles, are sometimes confusing.

"It is with the announcers that the reform must lie. They have only to stop and consider that away out in the forests, on lakes, and up in the mountains, men and women, and children to, are eagerly listening in, and that to them the voice cannot come in strong and clear unless the speaker proceeds moderately and occasionally stops for breath.

"If this policy is pursued, more people will be inclined to fish for DX among the lesser known stations, which is so much more advertising and good will for the communities represented by these broadcasters and so much more acclaim for their artists.

"The mile-a-minute brigade is not making such a hit, after all."

So, Mr. Announcer, please realize your duty to the public by doing your duty to your station. The public wants to know who and what it is hearing, and we are sure your station wants them to know, or it would not be on the air. Perhaps the local chief of police will permit you to put one of his "Go Slow" traffic signs up before your microphone.

## RADIO INDI-GEST

### 'Mid Lonely Mountains

Here in the lonely mountains  
That are so cold and still;  
I turn and twist my dials  
And hear a songster trill.  
I hear the friendly voices  
Friends in my radio;  
Its cozy round my fireside,—  
Though mountains sleep in snow.

RHEA SHELDON

Perhaps November might seem a bit too early for poems about snow, but with so many people blaming unusual weather conditions on the Radio, we are taking a chance that some Florida real estate man will invent a wireless device for sending snow and cold weather to any part of the country still holding out on buying lots in the Fountain of Youth country.

### Questions and Answers and Work Shop Kinks (All rolled in one.) Use Bank-Wound Coils

(711) COD, Teaneck, N. J.  
I got my Radio from a bank. It contains a box for holding coins. The idea is to have a combination bank and Radio. It worked fine at first, but since I have been putting coins in the bank the music don't come through so good. What to do?  
A.—This is due to the coins exercising a capacity effect. Please send the Radio-bank to me. I will remedy the trouble and return the bank.



Do you get an A. C. hum from your A battery? Neither do we, but should you be so troubled the remedy is to take a stout copper wire and connect the terminals of the battery. The hum will disappear pronto.



**So's Your Old Man**  
(32345876987648) GK, Roundup, Mont.  
I can't get a darn thing on my Super-Simple-Complex-12 four tube set. What to do?  
A.—Sell it to the next sucker.

**Inspirational Guidance**  
(333333333333) MR, Pgoosh, R. I.  
1. How can I become a Radio engineer?  
A.—Why pick on that when there are so many better ways of starving to death?  
2. Have you a good recipe for ginger snaps?  
A.—No, have you?  
Home James, and don't spare the cylinders!  
THE THIRD TROMBONE PLAYER

### Grand Stand and Radio Football

Dear Indi: Listening in to a football game by Radio may beat standing in the cold stands a mile and all that, but I got an extra thrill out of the Illinois-Pennsylvania game the other day that you can not get through a loud speaker. When Red Grange made his third touchdown, the little girl in the big seal skin coat at my left was so elated that she just threw her arms around my neck and that crash of static you thought you heard was not static at all. We were ten feet from the WGN mike and the oscillation was caused by the osculation.  
THE BIG SAILOR

Very nice for you, but how about us. The little fan-ette that helped us listen in on that game turned her black eyes away from the loud speaker long enough to look at our blonde head and say, "Gee, I wish I was 'Red' Grange's girl!"

A news note from dear ol' Lunnon tells how the BBC conducted a test to determine who would handle the mike on overseas broadcasting and rebroadcasting. Only three out of five hundred passed, the big stumbling block being the language test which required that the man be able to speak at least seven lingos. It is said that most of them failed on the American language, being unable to properly pronounce such words as: "Pro-grum," "pre-form-ance," "waitaminutt," "tee-a-tor," "orkestra," "i-dea-er," "dead-E-kashun," "sir-pran-no," and "She-caw-go."

### An Oct-Tuber Tragedy

Over the hill to the poorhouse  
He wends his weary way;  
He tried to support an eight-tube set  
On a two-tube ear phone pay.

GEORGE.

We would not dare show pictures of the place where the Third Trombone Player writes his stuff, because the Milwaukee sheriff does not permit photographers in the death cell. But if you will turn back to the front pages of this issue (we know you read Indi-gest first) you will find pictures and a story that will explain why we called George "The Wandering Minstrel."

### RADIO EPITAPHS NO. 3 BY THE THIRD TROMBONE PLAYER

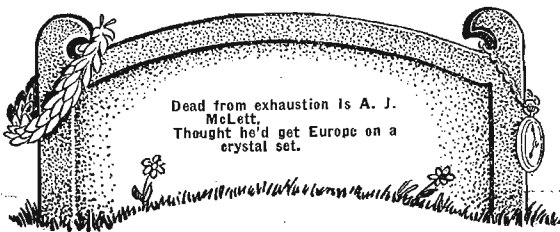

## No Need for a Gun



## Condensed

BY DIELECTRIC

There is much that is useful to a large body of Radio listeners coming from broadcasting stations now—and has been—which receives too little mention. We are so engrossed in the purely entertaining features that this side of broadcasting service is not called to the attention of fans. Sometime I expect to give you a resume of the educational advantages presented from stations which, but a short time ago, had not been aroused to the possibilities in this field of broadcasting. With the tremendous influx of visitors to Florida, many of whom go there by auto, it is fair to assume the advice given through WMBF, Miami Beach, as to road conditions is most welcome and assurance is made that any such information is gladly given from this station.

It is quite noticeable this winter that a decided effort is put forth by certain interests to provide musical entertainment to compare favorably with the best classical concerts of which any city may boast. From Station WJZ has come more recently a series of recitals presenting some of the world's greatest musical artists, such as Josef Hofmann, whose piano playing has enraptured audiences throughout the world. These Steinway concerts in New York city are bringing their share of pleasure to the cognoscenti and opening a new musical vista to those formerly unacquainted with the best in music and musicians.

Station WCB, Zion, Ill., had the good fortune to be able to let their Radio audience listen to a band concert which was rendered both in manner and matter to suit a catholicity of taste. Real good band concerts are not overcrowding our programs as there are but few properly classified as such. With the exception of our military bands I can point to a very small number on the air classed as good.

The cornet is another instrument which is seldom used as a solo instrument in Radio broadcasting, although it has many admirers and loses little if any of its characteristic timbre in transmission. KYW, Chicago, entertained with several cornet solos of old, well-known songs.

There may be avid listeners to Radio campaign speeches from statesmen of reknown (though even these are few in number) who follow them about from broadcasting station to broadcasting station, but I question if half the population of this country spend their evenings at their sets drinking in the oratorical wisdom of lesser lights expounding some principle in political lore which Noah knew—but didn't use. And now it has entered the Canadian broadcasting arena where impassioned speeches in French were made for the edification of local voters. CNRO, Canada, picked up the fluent speakers addressing these groups and gave us all a sample of Canadian electioneering, not unlike our own.

Way down in New Orleans there is a station, WSMB, which may be referred to as "as good as the average." I listened to an orchestra giving the very same jazz numbers you get seven nights a week from about five hundred broadcasting stations all over this fair land. It was a poor night to choose, possibly, for at another time they might have had a diversified program to offer. Then, too, the announcer still holds on to the custom of reading telegrams from far and near, requesting some number to be repeated. That takes valuable time from entertainment and compels all third parties to listen to numbers over again, or tune out. But they come in strong.

# Interesting and Simple Explanation of Radio

## Chapter IV—Tuning and How Ether Waves Make Music

By H. G. Tanner, Associate Professor University of Oregon

THERE may be hundreds of ether waves sweeping an antenna at the same time. All of them will be trying to agitate the electrons their own way. For example, Station A may be broadcasting waves at a frequency of 1,000,000 per second. When these waves strike the receiving antenna they try to bounce the electrons at this rate.

Station B may be sending out 2,000,000 waves per second and this set of waves will try to wash the electrons of the antenna back and forth with this same frequency.

It is very fortunate that a given wire will not accommodate both frequencies equally well. This does not mean that one will be entirely excluded and the other completely allowed. Both waves will have their effect, but one will have a greater effect than the other, even though both sets of waves are of equal intensity on arriving at the antenna.

### Selective Property of Antenna

This selective property of the antenna depends upon many things, such as the length of the wire, its diameter, the material of which it is composed (high or low resistance), whether it is straight, bent or wound up into a coil, etc. All of these factors influence to some extent the rate at which the electrons can surge back and forth.

In a long antenna the electrons have a chance to gain momentum in a given direction and consequently it takes a longer time for them to stop and reverse. This means that a long antenna will respond better to the waves of lower frequency (long wave length).

### Lengthening and Shortening Antenna

One is enabled to tune an antenna to waves of a given frequency (wave length) by adding to or cutting off some of its length.

When an antenna is connected to a receiving set and ground this added length of wire must be considered as part of the antenna. It makes little difference whether we change the length of this antenna system in the middle or at the end, and since it is inconvenient to go up on the roof to add or subtract length, the changes are made by connecting more or less wire which is coiled up inside of the receiving cabinet. All this is done by a simple twist of the wrist—but the mystery has disappeared.

### Getting Music from the Ether Waves

If a receiving station consisted merely of an antenna of adjustable length connected to the ground, it would be useless to have alternating currents set up within unless these currents could be converted into music, voice, etc. In the ordinary telephone the part called the receiver makes this conversion. It consists of a magnetized piece of steel bent double and having a great many turns of wire wound on each leg. In front of this magnet is suspended a thin disc of spring steel.

When electrons pass around the wire in one direction the magnetism is increased and if in the reverse direction the magnetism is diminished. When the magnetism is increased the steel disc is bowed toward the magnet and returns when the magnetism is decreased.

Every time the disc bows down and springs back it produces a puff of air in front of it. Successive puffs of air at regular intervals constitute sound. Human ears can detect these puffs if they occur at the rate of about 10 per second as in the rumble of thunder, and up to about 20,000 per second. The squeak of a mouse is near the latter frequency.

The bulk of sounds which we hear are in the neighborhood of 1,000 vibrations (puffs) per second. A good telephone receiver is constructed to respond most readily to sounds of about this pitch.

### How Broadcasting Waves Jerk Electrons

When broadcasting was being discussed there was described a station which produced waves at the rate of 600,000 per second, and every thousandth wave was a very high one.

There were 600 of these high waves every second. If these waves strike a receiving station tuned to this frequency they will cause electrons in the wire to move up and down 600,000 times per second and 600 of these times the electrons will be given an unusually powerful jerk.

Let the tuned antenna be connected through a pair of telephone receivers to the ground. One might expect that the phones would convert the alternating current—at least the 600 big strokes—into sound, but this does not happen.

### Electrons Haven't Time to Get Through Telephone Receivers

On each of these 600 extra big waves the electrons are given a big downward thrust along the antenna toward the ground, but unlike the condition in the ordinary wire telephone, the electrons are

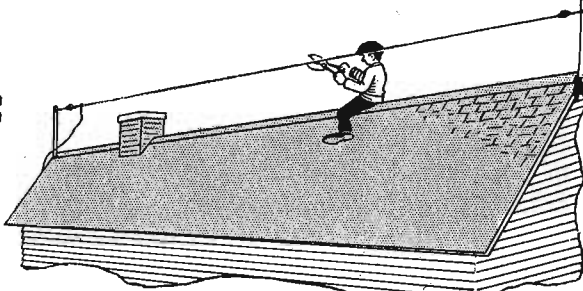
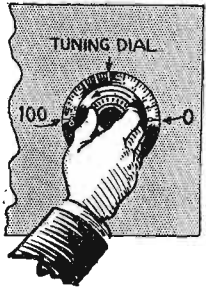

Turning a tuning dial from 100 toward 0 is the same as climbing up on the roof and cutting off a length of the aerial. Turning the tuning dial from 0 to 100, or the reverse, is equivalent to stringing additional wire onto the end of the aerial.

immediately called by the latter half of this ether wave, to return and go to the uppermost end of the antenna. Contrary to popular belief, electrons (electricity) do not move at the speed of light and seldom anywhere near it. Their rate of travel is quite variable. If it were not, a Radio set could not be tuned.

So in this case, the electrons do not

have time to get through the several miles of wire on the phone magnets. They are yanked back before they have hardly started, and if they do not get through the phone windings they cannot affect the diaphragm and make puffs of air or sound.

### Detector Makes Receiver One-Way Road

But supposing it could be arranged to exempt the electrons that enter the phones

from answering the call to return, and that they always enter at the same end. They could then get through very easily on this one-way road and register their passage on the diaphragm.

To do this requires a device called a detector. Those of us familiar with a pipe wrench would call the detector a check valve.

The detector is a simple contrivance consisting of a crystal which may be any one of a number of things—iron pyrites is very good—upon which rests a needle point. These crystals contain microscopic spots on their surfaces which will allow electrons to enter from the needle but no (or at least comparatively few) electrons can go from the crystal back through the needle. Let us see what difference the introduction of a detector in the circuit makes.

Let the connections be as represented herewith:

### Detour Through Phones to Get Back

A Radio wave strikes the antenna and the first half of it sweeps electrons toward the ground. A few of them attempt passage through the phones but find it a

(Continued on page 24)

## for easier building and better operation

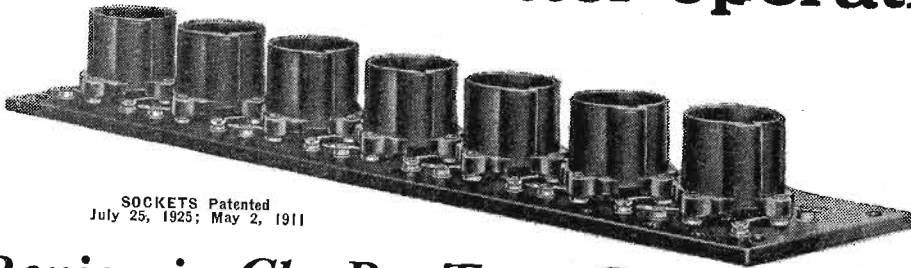

SOCKETS Patented July 25, 1925; May 2, 1911

### Benjamin Cle-Ra-Tone Gang Sockets Shelf Type

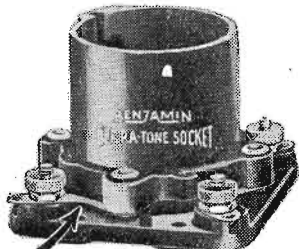

SPRING SUSPENDED SHOCK ABSORBING

Patented July 25, 1925; May 2, 1911

Cle-Ra-Tone Socket for Separate Mounting

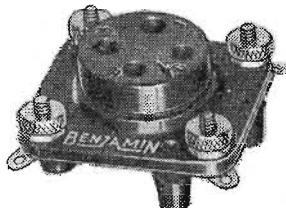

Patented July 25, 1925; May 2, 1911

Push Type Cle-Ra-Tone Socket

For the new UX Push Type Radio Tubes. Not used in Gang Mounting



Shelf Brackets

For use, in pairs, with Benjamin Gang Sockets

A MOST desirable innovation in set building. Gives more compact construction, with ample room on and under the shelf for accessory parts. Made of black polished Bakelite in a number of combinations of sockets for almost any type of circuit, with holes drilled for binding posts and space for markers. Possesses all the wonderful features of the famous Shock Absorbing Cle-Ra-Tone Socket, balanced on four delicately adjusted springs, which improves reception by eliminating tube noises and preventing outside vibrations from being transmitted into microphonic disturbances.

### Maximum Range Condenser

Patents Pending

First of all, a wonderfully well built condenser. The shape of the rotor blades eliminates bunching of stations on any part of the dial. Makes tuning easier and separates sharply over the entire broadcast range. Each user can adjust the turning tension to suit his personal wishes by means of a bearing adjustment disc, without throwing rotor blades out of alignment. Finished in dull silver. In three sizes: 13 plate for .00025 Mfd.; 17 plate for .00035 Mfd.; 25 plate for .0005 Mfd. Drilling template furnished with each condenser.

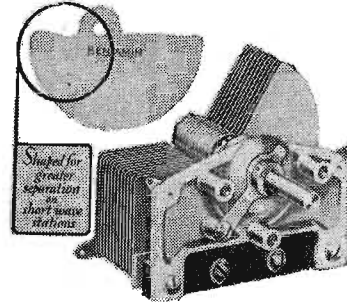

### Double Amplification

### Tuned Radio Frequency Transformers

Patents Pending

Built on the vital principle of space winding and maximum degree of air insulation. These coils show truly marvelous results and will positively cut through powerful local stations and bring in clear, strong signals from extreme distances. Careful tests show practically double amplification, compared with other coils, with greater range in tuning and improved tonal fidelity. Used with Benjamin Maximum Range Condensers, they have doubled the efficiency of some of the most popular circuits.

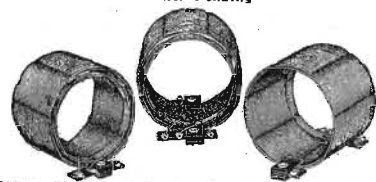

Sold by Radio Jobbers and Dealers Everywhere

Made Exclusively by

**BENJAMIN ELECTRIC MFG. CO.**

120-128 S. Sangamon Street, Chicago

247 W. 17th Street, New York

448 Bryant Street, San Francisco

Manufactured in Canada by the Benjamin Electric Mfg. Co. of Canada, Ltd., Toronto, Ontario

## DETECTOR IS ONE-WAY STREET

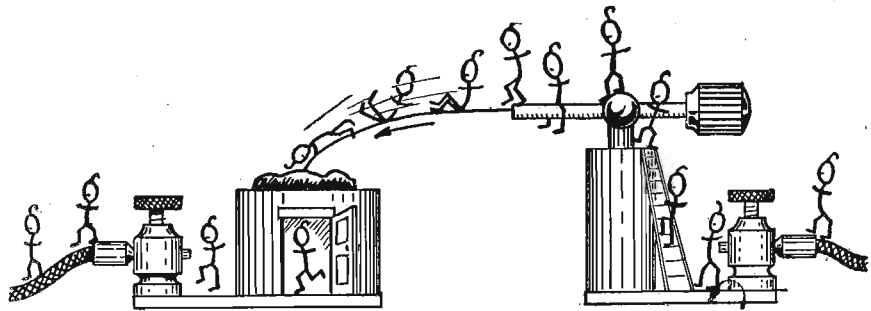

In a crystal detector, the electrons can "slide down the chute" (wire with needle point) and into the crystal, but cannot get back up the chute. The detector makes the electrons go one way, just as if it were a one-way street.

## EXPLANATION OF RADIO

(Continued from page 23)

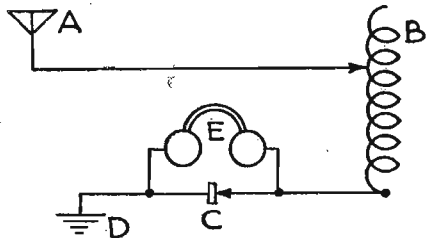

A represents the antenna, B is a coil of wire permitting the antenna to be tuned, C is a detector (one-way street), D is the ground, and E the head phones.

narrow and difficult road. Their brothers have found an easy passage through the needle point into the crystal and thence into the ground and practically all of them go this way. An instant later the other half of the ether wave is sweeping electrons upward.

Electrons are pulled up out of the ground in order to satisfy the deficiency at the lower end of the antenna, but they no longer have an easy path as in going downward. They are compelled to detour to the only road available which is through the phones, and so in they rush. This first squad may not reach the antenna for the first wave, but if tuning be correct there will soon be sets of electrons reaching the antenna in step with the waves, and that is all that is required.

### Squads Travel Pretty Fast

Each ether wave, or more precisely the corresponding half of each ether wave, pulls squads of electrons through the phones. These squads follow each other in rapid succession (600,000 of them per second). They are like so many compression waves of electricity.

Each squad exerts a tiny pull on the diaphragm but it is followed so closely by the next squad that the diaphragm doesn't have time to spring back and send out a puff of air before the next one comes along. They are coming at radio frequency.

Every once in a while an unusually big squad comes through—in fact 600 of them every second. They are due to the big audio waves sweeping the antenna as explained before. These big squads of electrons register a very heavy pull on the diaphragms. As soon as they have passed the diaphragm springs back to normalcy and waits for the next big squad. In springing back a puff of air is sent into the ear of the listener. There will be 600 of these puffs per second.

Sound has been produced from ether waves!

(Why, if the above simple receiver works, do we complicate it with variocouplers, grid leaks and other devices? Mr. Tanner will explain how selectivity is increased, and why, in his next interesting article.—Editor's Note.)

An aerial that is badly corroded can be cleaned with a rag saturated with gasoline or alcohol.

## The Reader's View

### Short Wave Interference

The question of interference in broadcast reception is one of the most serious problems of today and mong all the interference named the writer has seen no reference made to short wave telegraph. The writer has in mind now the short wave telegraph which is stated to be the station of the Radio corporation known as WIR, New Brunswick, N. J., operating on 74½ meters. The interference from this station is the worst of anything not excepting static, as the frequencies of this station pick up with the harmonics of the broadcasting stations or other short wave stations and produce radio frequency disturbances, which distort the signal to which you might be listening, and also interfere with reception of outside stations. This interference is very noticeable on all superheterodynes and radio frequency amplifiers.

The statement of the inspector of the second district is to the effect that this station is being operated to make short wave transmission tests between this country and other counties, presumably to ascertain just what the condition of signals will be over an extended period. We have every sympathy for all investigations of this kind and do not wish in any way to complain against any reasonable amount of this kind of disturbance, but when this becomes a continuous performance, as in the case of this station, which starts at 6 o'clock in the evening and continues on throughout the night, with not as much as one minute's let-up, then we believe it is time to complain.

If all short wave telegraph stations should set up interference the same as from this station, then any broadcast reception would be almost impossible, inasmuch as we know that there are hundreds of these short wave stations, and while their power is not as great yet their interference close up would be equally as bad, and while, of course, we do experience some interference from amateur stations, this interference is nothing compared with the other.

If these experiments are going to be continued they should be done at such times that it would not interfere with the evening reception.

The writer would appreciate it if you would investigate this matter and try to have this disturbance discontinued.—V-63, Pittsburgh, Pa.

## WILD DUCKS AND WHAR

(Continued from page 7)

toward all visitors at the studio. Beneath her unassuming manner, however, is the power of knowledge. Her musical education was completed in Paris and Milan. She speaks three languages fluently. She takes pride in her studio and invites the whole world to come and visit.

Some of the far points where it is claimed WHAR programs have been heard distinctly are England, Canada, South America, Mexico and western extremities of the United States. One of the peculiarly interesting subjects broadcast regularly in season is a talk to women listeners by Gladys Stoudte as to the frills and frillies being worn by milady on beach and boardwalk.

## Dr. Rogers, Radio Inventor in Patent Fight with U. S.

BALTIMORE, Md.—A fight for title to the patent rights to the latest improvement to submarine and underground Radio transmission and reception apparatus was begun last week in the United States district court here, with Dr. James Harris Rogers, world famous inventor of Hyattsville, Md., as defendant.

Plaintiffs are the United States, John O. Willoughby and P. D. Lowell. The two men and the government charge that in March, 1918, while Willoughby and Lowell were employed in the bureau of standards, they jointly became the inventor of new and useful improvements to submarine Radio apparatus.

Editor's Note—Dr. Rogers is the inventor of the underground aerial, described a number of times in Radio Digest, which has been so successful in eliminating static or decreasing the static-signal ratio.

## Farthest North Station Opens

OTTAWA, Ont.—The Arctic Circle is now in daily touch with civilization, through the formal opening to the public by the Canadian department of the interior, of the most northerly commercial Radio station in Canada. This station is located at Aklavik, at the mouth of the Mackenzie river, and lies 1,300 miles beyond the Arctic Circle. It is cut off from the world about nine months each year.

# The New Radio Book

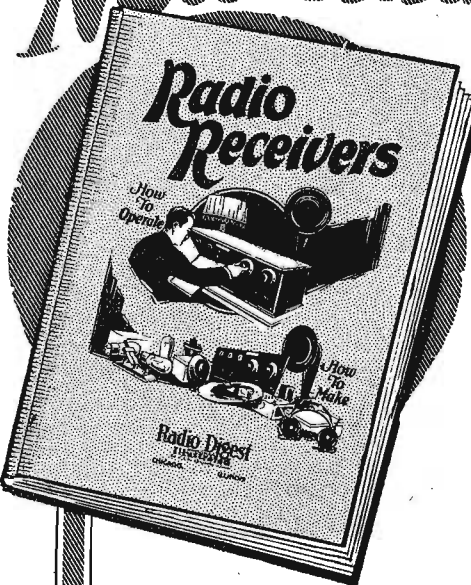

# HOW TO

Operate Sets  
Construct Parts  
Improve Reception  
Understand Radio  
Assemble Circuits

The greatest assemblage of facts and hints, from actual everyday practice, ever gotten together. Edited by the technical staff of Radio Digest, it supplies the demand for a book covering every phase of Radio. Starts at the beginning with simple explanation of Radio reception, with technical explanations of the different parts and leads right on to the more advanced instruction. A complete handbook serving as a ready reference in the Radio field. It gives suggestions on parts and sets which will prove to be a money saver. Blue prints and diagrams are essentially an important part of this book. Special chapter is devoted on "How to Operate," which gives detailed information on the operation of many well known sets.

A general information is vital to the knowledge of anyone interested in Radio. It gives a complete list of all broadcasting stations with a colored map showing their location. The workshop kinks will save you time and money. Now is the time to take advantage of this exceptional offer. **Mail coupon today!**

RADIO DIGEST,  
510 N. Dearborn Street,  
Chicago, Illinois.

Enclosed find \$5.00 for one year's subscription to Radio Digest. The new Radio Book, "Radio Receivers," will be mailed FREE, postage prepaid. This offer only good on subscriptions sent directly to this office, not through agents or agencies.

Name .....  
Address .....  
City ..... State .....

## WE SOLD 4000 SETS

Had 4000 Favorable Reports

Before We Felt  
Justified to Say



### Quality Radio Apparatus

Now we invite you to go to your Apex Dealer who will be glad to make a personal demonstration for you in your home or in his store. A demonstration will prove to you that Apex Radio Receivers will give you everything you can possibly wish for in a radio receiver from the standpoint of selectivity, clarity, volume, distance and attractiveness of design.

- The APEX Super Five without accessories.. \$80
- The APEX De Luxe without accessories... 135
- The APEX Baby Grand Console without accessories..... 225
- The APEX Utility Radio Table..... 75
- The APEX Entertainer (Loud Speaker)..... 22.50
- The APEX Console Entertainer..... 27.50

Upon request we will gladly mail you descriptive folder.

APEX ELECTRIC MFG. CO.  
1410 W. 59th St., Dept. 1105A  
CHICAGO

Prices West of Rockies slightly higher. Canadian prices approximately 40% higher

FREE!

Write for  
Autoformer  
Hook-Up  
Bulletin

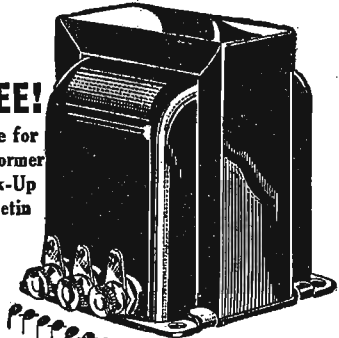

There is no variation in amplification over the entire range of musical frequencies with Thordarson Autoformers. No note is too low—no note is too high to be fully amplified by the Autoformer.

Unconditionally Guaranteed

# THORDARSON Autoformer

Trade-Mark Registered

## All Frequency Amplifier

Introduces Four Great Improvements in Amplification:

- 1 Full amplification of those bass notes hitherto largely "lost"
- 2 Greater clarity on all signals
- 3 Improved reception of distant programs
- 4 Better volume control

This latest Thordarson development—the Autoformer—utilizes for the benefit of your radio set, the same principle used in the line amplifiers adopted by the more recent high-powered broadcasting stations. The excellent tone quality of these stations—due to perfect amplification—offers proof of Autoformer effectiveness. Write for hook-up bulletin.

Autoformer amplification is for those who seek the finest reproduction of programs to be had. May be used with any set in place of regular audio transformer hook-up. Full directions, with diagrams, supplied with each instrument. Autoformers are \$5 each.

Sold by the leading dealers

THORDARSON ELECTRIC MFG. CO. CHICAGO



# DX-Seven: Selective D-Coil 7-Tube Super-Het

## Part I—The Choice of Parts

By John G. Ryan

WHEN any of us plan to build a new receiver, especially a super, we usually have in mind two chief points, namely, range and clearness of reproduction. If the builder of the contemplated set happens to live far out in the country miles away from class B and super power stations, he is not quite so concerned with selectivity and is willing to sacrifice something of this quality for range. However, the builder living in large cities where there is at least one powerful broadcaster, and possibly fourteen, must rank selectivity of equal importance in his plans, with range and clearness. As a rule, metropolitan and most home builders east of the Mississippi, have finally chosen a compromise that was about 75 per cent efficient in each of these particulars, as compared with the ideal.

**The Problem Overcome**  
The writer lives in Chicago where eight wave channels are divided up among about fifteen stations and form a barrier to distance that is a veritable wall, against which one bangs his receiver at setting after setting only to find a local station

problem. Sensitivity is not sacrificed for selectivity, nor has either quality been cut to get clearness. It is called by the writer "DX-Seven" because it will do DX anywhere, and is a seven tube set instead of a straight eight.

The sensitivity of a super-heterodyne is governed largely by the efficiency possible in the intermediate stages. If, due to feedbacks within these stages, the amplification per stage, within the tubes, has to be cut down with the potentiometer, the range is at once seriously impaired. Which brings us to the choice of intermediate frequency transformers. The Celco trans-

formers, in the matter of quietness. Due to the D construction, the secondary circuits cannot pick up stray noises such as static, power hum or long wave signals which originate outside the

benefit from the use of Celco transformers, in the matter of quietness. Due to the D construction, the secondary circuits cannot pick up stray noises such as static, power hum or long wave signals which originate outside the

Only the desired current or signal picked up by the loop can flow in the transformer.

These transformers can be assembled in a receiver so closely that the edges touch, or in any relation to each other as regards angles, without fear of having to lower the efficiency with the potentiometer. High grid bias can be put on the grids of the intermediate stages without tendency to oscillate, giving extremely great amplification and low B battery drain. Result, range and economy. There is, however, another

(Continued on page 26)

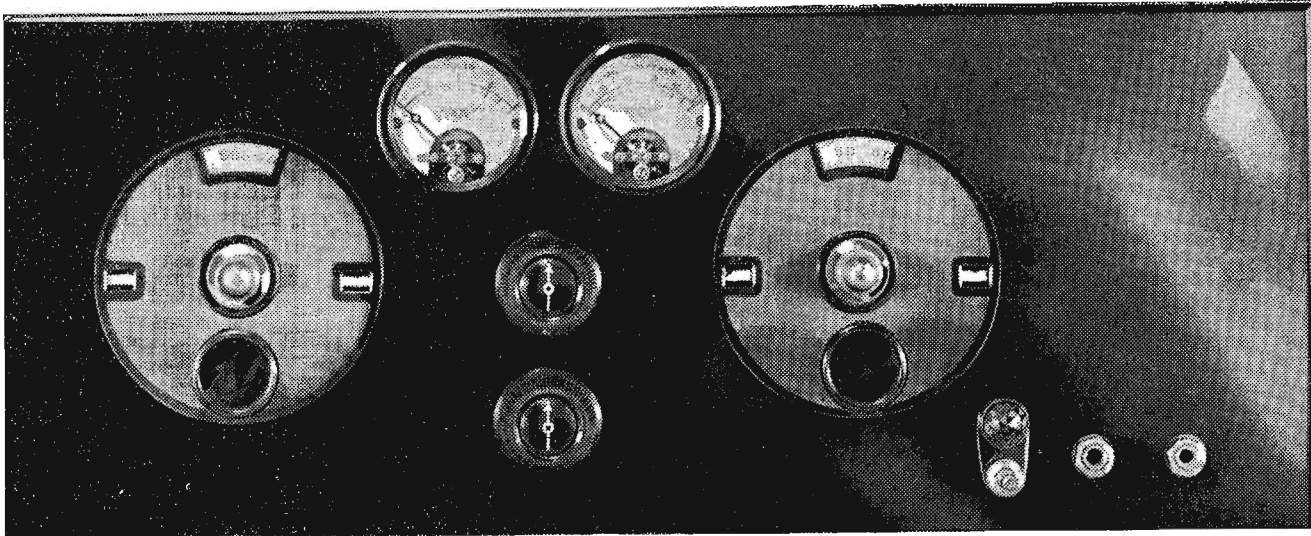

Figure 1

### LIST OF PARTS

1 Celco Super Kit	Central Engineering Lab., Chicago	\$27.50
2 Benjamin .0005, type 3662 Cond.	Benjamin Elec. Mfg. Co., Chicago	10.00
2 Mar-co Vernier Dials, Nickel	Martin-Copeland Co., Providence, R. I.	5.00
1 Benjamin 7-tube Gang Shelf	Benjamin Elec. Mfg. Co., Chicago	9.50
1 Pair Benjamin Brackets	Benjamin Elec. Mfg. Co., Chicago	.75
1 Gleason Midget 14-plate Cond.	The Gleason Corp., Chicago	1.50
2 Amperite Resistors, 201A	Radiall Company, New York City	2.20
1 Carter Imp Rheostat, 6 ohms	Carter Radio Co., Chicago	1.00
1 Carter Imp Rheostat, 10 ohms	Carter Radio Co., Chicago	1.00
1 Carter Imp Potentiom., 200 ohms	Carter Radio Co., Chicago	1.25
1 Celco Indicating Switch	Central Engineering Lab., Chicago	1.35
1 Yaxley 4 spring Jack, No. 4	Yaxley Mfg. Co., Chicago	.30
1 Yaxley Open Circuit Jack, No. 1	Yaxley Mfg. Co., Chicago	.50
1 Erla Concert Grand Transformer	Electrical Research Lab., Chicago	10.00
1 C Battery, 7 1/2 volts	Burgess or Diamond	.85
1 Dubilier .002 mfd. fixed Cond.	Dubilier Radio & Cond. Corp., N. Y. C.	.40
1 Dubilier 601G .00025 with clips	Dubilier Radio & Cond. Corp., N. Y. C.	.45
1 Dubilier 1.0 mfd. bypass Cond.	Dubilier Radio & Cond. Corp., N. Y. C.	1.25
1 Daven Leakandenser, 5 megohms	Daven Radio Corporation, Newark, N.J.	1.00
1 Daven .05 megohm resistor	Daven Radio Corporation, Newark, N.J.	.75
8 Walnut Binding Posts	Walnut Electric Mfg. Co., Chicago	.88
3 loop, 1 neg. A, 1 plus A, 1 neg. B, 1 det. B, 1 amp. B		
1 Bakelite Panel, 18x7x3/16	Formica Insul. Co., Cincinnati	3.00
1 Jewell Panel Voltmeter, 0-8	Jewell Elect'l Instr. Co., Chicago	7.00
1 Jewell Panel Millimeter, 0-25	Jewell Elect'l Instr. Co., Chicago	7.00
1 Set Crowe Cable Markers	Crowe Name Plate Mfg. Co., Chicago	.25
1 Strip Bakelite 17x1 1/8 x 3/16	Formica Insul. Co., Cincinnati	.75
1 Cabinet, 18x7x8		8.00
4 Small Right Angle Brackets	Make carried by local dealer	.10
1/8 x 1/8 x 1/8	At 5 and 10 cent store	
Total cost.....		\$104.03

spread strongly over several points. Some may offer the advice of getting or constructing a "good" set, but when one lives within the 100 per cent strength zone of five powerful nationally-heard stations, that is not so easy. After trying combinations of apparatus without number, the set to be described was evolved, and is a most satisfactory solution of the

formers, finally chosen by the writer, are constructed on the principal of two D's, each facing the other edgewise, and resulting in a closed magnetic field which cannot be affected by currents other than those put into each transformer by the preceding tube via the primary winding. An undesired current striking one of these transformers sets up a current in each

# ERLA's New Audio Gives Marvelous Tone Curve

Exact laboratory tests show that no other audio gives such perfect reproduction. Note how uniformly and evenly all notes are amplified at frequencies from 32 to 10,000 cycles.

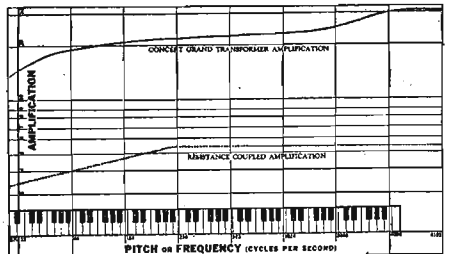

Note the smooth, even progression of the Concert Grand curve, revealing supreme uniformity of amplification, from lowest notes to highest in the musical scale.

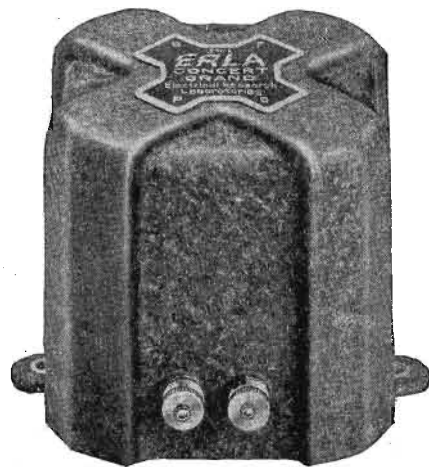

One-piece drawn steel shell provides perfect magnetic shielding. Finished in black crystalline lacquer and attractive in appearance.

AN amazing improvement has been made in audio amplification. A new transformer—the Erla Concert Grand—gives results far superior to any other system of amplification.

### Amazing improvement

Ordinary designs permit too much leakage to amplify properly at low frequencies. So we use the "quadriform type," heretofore unknown in radio work. In this design magnetic leakage is practically eliminated by providing twice as many paths for the magnetic field and by a better distribution of the core metal around the copper wire coils. Each of the four core units are complete magnetic circuits within themselves without breaks or joints to the main central core, and it will also be noticed that the central core section has a far greater area than conventional core types. The large area thus obtained reduces the effect of the direct "B" battery current on the pulsating voice currents and eliminates a cause of distortion common to transformers using smaller core sections.

The Concert Grand saves you money, too. Resistance coupling depends solely

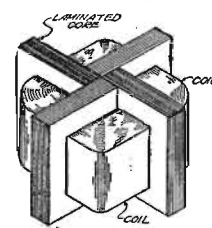

Note the quadruple core surrounding the coil, forming an almost perfect path for the flux within the coil. The core is a special grade of laminated silicon steel that provides highest permeability and lowest hysteresis loss, with consequent maximum conductivity in the magnetic circuit of the transformer. Price \$10. West of Rocky Mountains, \$10.50.

upon the tubes for amplification. Consequently they must be operated at maximum for efficiency, requiring more "A" battery current and higher plate voltage—135 to 150 volts. Filaments wear out more rapidly as a result and battery life is more than cut in half. The higher initial cost of Concert Grand amplification is therefore saved many times over, not only in improved performance but also in lowered upkeep cost.

### Booklet sent FREE

Get the Audio Grand at your dealer's today. See what a tremendous difference it will make in your set. If you wish to return the coupon, we will send you a new booklet giving the latest information on audio frequency amplification.

Electrical Research Laboratories  
Chicago, U. S. A.

Electrical Research Laboratories,  
2500 Cottage Grove Ave., Dept. 7-B, Chicago

Send me information about the Erla Concert Grand Audio. Also latest developments on audio frequency amplification.

Name .....

Address .....

City.....County.....State.....

# REX

**for your B battery eliminator**

REX answers the eliminator problem. The B Battery eliminator equipped with Magnatron Rex tubes works day in and day out—silently and economically.

Magnatron Rex is the product of long research by the oldest exclusive manufacturers of thermionic valves in the country. It has been designed primarily and only for eliminator work.

Magnatron and Excellence have come to mean one and the same thing. Impartial laboratories and radio engineers

MAGNATRONS

throughout the country have certified this. Their reports explain why Magnatrons in your set will make it function better.

Your dealer has the Rex as well as the other Magnatrons. Ask him today!

They list for only \$2.50.

Write for your FREE copy of "Pot Pourri—a snappy review of mirth and music," to Dept. D

CONNEWEY  
ELECTRIC LABORATORIES  
Magnatron Building, Hoboken,  
New Jersey

West Coast supplied from complete stocks carried by PACIFIC RADIO LABORATORIES, 236 South Los Angeles Street, Los Angeles, California

# ERLA

**DX-SEVEN, SUPER-HET**

(Continued from page 25)

set. Thus they cannot be amplified and reach the second detector and the set is surprisingly quiet. A pleasant surprise. Since each transformer is air core and tuned, the grid circuits are very sharp, which eliminates much of the undesirable noise that comes in on the loop, and interfering signals. The sharpness of these circuits augments the selectivity of the heterodyning or frequency changing. The writer is satisfied that they are responsible for the greater part of the success of this outfit.

The Benjamin condensers you have heard of before. Jacques Fournier introduced them to Radio Digest readers in his Fireside set which, incidentally, was a good example of what a tuned radio frequency set can be. Their first appeal for this set was their compactness or small size. The era of huge, unwieldy receivers is about over, and small, better designed layouts have taken their places. DX-Seven, as you will note is but 18 inches long and 7 inches high. If apparatus of high quality can be obtained in small size it suits our purpose admirably. As to technical characteristics, Benjamin condensers are straight line wave length which seems to give plenty of separation on the lower wave lengths and leave good spacing on those in the upper half of the broadcast range. They are finished in unpolished silver which has long been known as a good idea, not for looks alone, but also for results. A rather cleverly designed friction adjuster in the form of a disc is supplied and but one strip of dielectric is used to hold rotor and stator plates in their proper positions. The more you study these units the better you'll like them.

**Mar-co Dials**

The problem of the dial manufacturer has always been, to the writer, an interesting one. There must be a satisfactory ratio between the movement of the control knob and that of the condenser plates. There must be no "backlash," or what the automobile owner calls "play" in his steering wheel. Backlash is present if, when you stop turning a dial, let us say, to the right, and you turn it to the left, there is a slight movement possible of the control knob before the condenser plates begin to revolve to the left. Such a condition makes accurate, on-the-peak tuning very difficult. Then too, the dial must be attractive in appearance; it should provide not only readings on a scale, but also space for putting down the letters of preferred stations.

All these points have been covered to perfection by the Martin-Copeland company in their Mar-co dial. It is, to put it mildly, handsome in appearance. There is not a trace of backlash in any of the half-dozen the writer has. The ratio is such that it does not take too many turns of the knob to go from end to end of the scale, yet one can split a degree on the scale in setting the condenser. Station call letters can be logged right on the dial, and the smoothness of turning is a pleasure to use.

In choosing the Benjamin gang socket for this set, the writer saved himself and incidentally, you, a lot of work. The seven sockets come all mounted, each on springs, assembled in a line on a 1 7/8" by 4 1/2" shelf. Connections can be readily made either above or below this shelf without drilling holes; the nonmicrophonic qualities of the socket are unaffected by the use of stiff bus bar, a type of wiring which you may have noticed was used in "Simplest Super" and "Traveler." The nonmicrophonic quality mentioned is obtained by supporting the barrel of the socket on four springs which also provide contact to the pins of the tube. Any jar or vibration which may reach the tube bases is taken up by these springs and does not reach the tube to cause vibration of the filament and loud growls in the speaker. So convenient to use is this gang arrangement that future sets presented by the writer will, many of them, have this feature.

Since this set was expected to be sharp, and a comparatively large sum of money had to go into parts, it was decided to even go so far as to get a low loss midge condenser. Many designers wouldn't, for these midges all look pretty much alike. After examining several, the James, Jr., made by the Gleason corporation, was chosen. Its skeleton frame looked free from losses and there is a very small area of contact where end plates meet dielectric. Construction is rugged though the unit is very small, and the contact spring giving connection to the rotor plates has ample bearing surface on the shaft. In capacity it is rated at .000045 mfd.

**Erla's Concert Grand**

When many of you see the price of the audio frequency transformer you will sit aghast and remark that the writer must think you're a mint. It isn't as bad as all that and might have been worse. Remember, this set was built with tone quality as one of the three principle features to be kept in mind. Few will deny that each stage of audio frequency amplification added, brings with it some distortion. Therefore, if we can cut off one of the usual two stages and make the remaining

one extremely efficient, not only in quality but in amplifying power, we are going to get living room volume of remarkable purity. In the writer's opinion, two stages of audio amplification in a super are unnecessary. The signal strength after the second detector should be sufficient, if the front part of the set is correct, to operate a speaker on anything within range. The "Simplest Super" only had one, as long-time Digest readers will remember.

The Erla Concert Grand transformer is a very unusually constructed unit. The average core in an audio transformer provides two diametrically opposite paths for the magnetic lines of force to travel in, from end to end of the winding. Erla have added two more by what they term "cruciform" construction and provided a large central leg on which primary and secondary are wound. The net result is less distortion by the D. C. current from the B battery on the pulsating voice currents, more even amplification of the voice frequencies between 32 and 8,000, and greater amplification over the entire range. Thus we eliminate the distortion that would creep in from a second stage yet get all the amplification of the audio frequencies required in a super-heterodyne and a purity of reproduction not usually obtained from a single stage. You won't need any more tubes if you build this set carefully and this last stage gets all the strength it should.

You will find the Carter rheostat and potentiometer perfect examples of compact but dependable construction. Their makers claim them the smallest units made for their respective purposes; I do not doubt it. In spite of their diameter of but 1 1/2 inch and projection behind panel of but 3/8 inch, nothing has been skimped or cut down. There is plenty of bearing, the shaft is husky enough for a much larger unit. The contact arm makes firm contact with the resistance wire and operation is smooth. The one hole mounting feature saves worry and work.

**Small Parts**

Care was used by the writer in selecting the miscellaneous small parts that make up this set. In the matter of a battery switch, Celco again was the choice. This little unit, in addition to being provided with a heavy duty wiping contact, also provides a small indicating light which, at a glance, tells one whether the tubes are burning. The experience of finding the battery run down because the set was not turned off the night before a football game at the writer's alma mater, recently convinced that such a device was most useful. The small bulb adds but little to the battery load. Yaxley jacks went into the set because the writer paid a visit to the factory not so long ago and watched the care with which they are assembled and the seeming disregard for expenses with which defective parts or assemblies are thrown out. You'll get a strong positive contact between springs and no weakening through use.

The Daven Leakandenser is a comparatively new unit on the market and a unique one. There is no grid condenser, as we usually expect to find it. The "condenser effect" is obtained, however, by the use of two wires. One is connected to the cap at one end of the cartridge, the other is connected to the other cap. The two are wound parallel to, but insulated from, each other, each forming the plate of a condenser. Such a winding can be made to give the exact capacity specified. Within the bakelite tube on which this wire is placed, there is a resistor unit of the usual type which, on test, will be found to be surprisingly exact. Laboratory tests by the writer showed these to run so exact they might be called perfect. The other Daven product, the .05 megohm resistor, is made with equal care and this constructor long since found he could with confidence stick to Daven in this matter of fixed cartridge units.

**Jewell Meters**

Why more designers do not specify and more builders use meters, this writer cannot see. To have them, gives a feeling of confidence in the operation of a set that is most pleasant. You know exactly what voltage the tubes are getting and, to some extent, the condition of the battery. One knows at all times what current is being drawn from a B battery. Very soon, from practice, you set controls and turn dials, largely from meter readings with more consistent satisfactory results. Jewell has turned out, in the units chosen, two units that are not one bit less efficient in construction or use than their bigger brothers, yet are only 2" in diameter across the containing case. The voltmeter is of the high resistance type and far more accurate than any of the cheaper low resistance types could possibly be.

(Having explained his various choices in the matter of parts, Mr. Ryan will next week explain their assembly and the drilling of the panel and sub shelf. You will not go wrong on this super. We have heard it.—Editor's Note.)

During 1925, Radio in Sweden has progressed at an exceedingly rapid rate. The number of official licenses for receiving sets granted in Sweden on January 1 of this year was 39,800. This, by August 1, had jumped to 102,500. During July the increase was over 3,400.

**Oil and Gas Wells on KDKA College Series**

**University Authority Will Cover Petroleum Field in Lectures**

PITTSBURGH.—"Oil and Gas" will be the subject of a new series of Wednesday evening talks to start this week from the University of Pittsburgh studio of KDKA. The series, consisting of six talks, will be given by Roswell Hill Johnson, professor of oil and gas production of the University of Pittsburgh School of Mines. Professor Johnson has for twenty years been a consulting geologist, having been influenced to blaze the trail along this line by his father who was an oil producer and who saw the need of application of geology to that work. His travels through every state in the Union and through many foreign countries as well have given Johnson a wide knowledge of the oil centers of the world. He is in demand as a lecturer and has written extensively on the subject of oil and gas production. Professor Johnson's talks will be broadcast as follows:

Wednesday, November 25: "Oil Finding."

Wednesday, December 2: "The Business of Oil and Gas Production."

Wednesday, December 9: "Choosing Oil Investments."

Wednesday, December 16: "The Newer Methods of Extracting Petroleum."

Wednesday, December 23: "Resources."

**Two Southern Sea Islands Hear Number From KHJ**

LOS ANGELES.—While letters from the Pacific Isles are not unusual exhibits at Pacific coast Radio stations, still the arrival at KHJ of two letters in one day, one from the Fiji Islands and the other from New Zealand, both commenting upon reception of the same program and numbers is a bit out of the ordinary run of studio correspondence.

The listener in the Fiji Island used an eight tube, while the man in New Zealand tuned in on a two tube regenerative set. Both made mention of the violin playing of Vera Barstow, who is known the world over as one of our greatest women violinists.

**RADIO KILLS ROMANCE**

(Continued from page 9)

meters being used most consistently and dependably. One peculiarity was the complaint that our signal swayed in variation of about three meters. We experienced this same phenomena in receiving.

"At all times we were in communication with the United States, England, Scotland, France, Holland, Italy, Hawaii, New Zealand and Australia. The greatest distance was a two-way communication with Box Hill, Victoria, Australia. This was nearly half way around the earth on thirty-seven and one-half meters. We sent them the voice of the Eskimo from our position eleven and one-half degrees from the pole.

"We received official Radiograms of congratulations both from the governor-general of New Zealand and the governor-general of Australia. Lieutenant Fred Schnell, with his short wave apparatus on the U. S. Seattle, relayed a Radiogram through us in the Arctic to the convention of the American Radio Relay league held in Chicago on August 16. His ship was laying off Wellington, New Zealand. We picked up the message from our most northern point and relayed it back to Chicago, consuming less than five minutes."

The short wave length is McDonald's answer to daylight transmission and he considers that demonstration the greatest accomplishment of his share in the expedition.

Interesting tests have just been carried out by the English with the object of improving the acoustics of both houses of parliament. By means of microphones and concealed amplifiers it is hoped to overcome existing defects and to increase the audibility in the press and public galleries of speakers in the debates.

**NOW!**  
Sub-Panel Mounting Type Thordarsons are on sale. Permit neater assembly, shorter leads, concealed wiring—as in the factory built sets.

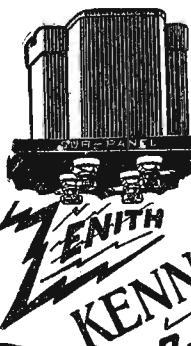

**KENNEDY**  
Radiodyne  
Planstiehl  
Howard  
Thermiodyne  
**GLOBE**  
Deresnadyne  
ADLER-ROYAL  
MURDOCK  
MU-RAD  
Valley  
Silver-Marshall  
OZARK  
ULTRADYNE  
Newport  
LEICH  
NUNN-LONDON  
KUSTOMBILT and many others

**ALSO—**  
Choice of MacMillan Arctic Expedition

*The finest sets have*



**THORDARSON**  
Super  
AMPLIFYING TRANSFORMERS  
Standard on the majority of quality sets

Follow the lead of the leaders. Build or replace with Thordarsons. Dealers everywhere. Hook-up bulletins free. Write to THORDARSON ELECTRIC MFG. CO., CHICAGO

**YOU don't need "B" Batteries if you use the FRESHMAN MASTER "B" Battery Eliminator**

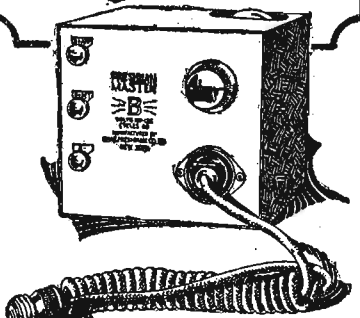

Connects from any electric light socket right to your radio set;—that's all there is to it.

With the Freshman Master "B" Eliminator your set will always be supplied with constant and uniform power. Noiseless in operation; your reception will not be marred by the snap and crackle due to chemical action in "B" batteries.

A. C. Model \$20.00 for alternating current  
A. C. Model requires a Rectifying Tube.  
Freshman Rectifying Tube \$2.50

We also recommend the new R. C. A. Rectron Tube UX 216-B

D. C. Model \$17.50 for direct current

Prices slightly higher in Denver and West, and Canada.

**Sold by AUTHORIZED FRESHMAN DEALERS only**

Write for 24-page illustrated booklet full of useful information for all radio fans.

**Chas. Freshman Co., Inc.**  
NEW YORK CITY, 240-248 W. 40th St.  
CHICAGO, 2626 W. Washington Blvd.

# Fireside: 6 Tube Set of Perfect Reception

## Part IV—Setting Up and Operation

By Jacques Fournier

**B**EFORE going into the matter of connecting this outfit to its accessories and putting it into operation, I wish to call your attention to page 28 of last week's issue dated November 14. In the right hand column of that page are operations 36 and 37. In some way an error crept into those paragraphs in referring to the Autoformers; in paragraph 36 it should be Autoformer 1 between sockets 3 and 4, while in paragraph 37 it should be Autoformer 2 between sockets 4 and 5. Many of you probably caught this in examining figure 8, when wiring the set, but there may be some who did not.

### Cable Identification

With the Cabelug, there are provided a number of little cardboard tags for identification of the wires where they join the batteries. Slip the plus A tag on the heavy red wire, the negative B on the dark green, the negative C on the pale blue, the plus 45 on the yellow and the plus 90 on the pink covered lead. The six volt storage A battery and the two blocks of B battery of 45 volts each should be placed together. The two C batteries can, as explained before, be placed either under the sub base or just behind the cabinet. If outside and behind, take twin conductor put in as operation 20 and identify the loose ends with slips of cardboard, that going from socket 2 being C1 plus and that to the joint of wires 9 and 10 being C1 negative. Twin conductor put in as operation 33 is to be treated the same way, the wire going to resistor R5 being C2 negative and that going to the 1.0 mfd. condenser being C2 positive.

The twin conductors can now be passed out through small holes in the back of the cabinet, and the Cabelug through a larger hole. A single dry cell can be used as the C battery C1, or the usual 4½ volt C battery can be used by connecting between plus and the negative 1½. For C2, a regular C battery is used and the end terminals connected so that the bias on the audio stages will be 4½ volts. The Cabelug is then carried to the A and B batteries to be connected as follows: the heavy red wire is to be connected to

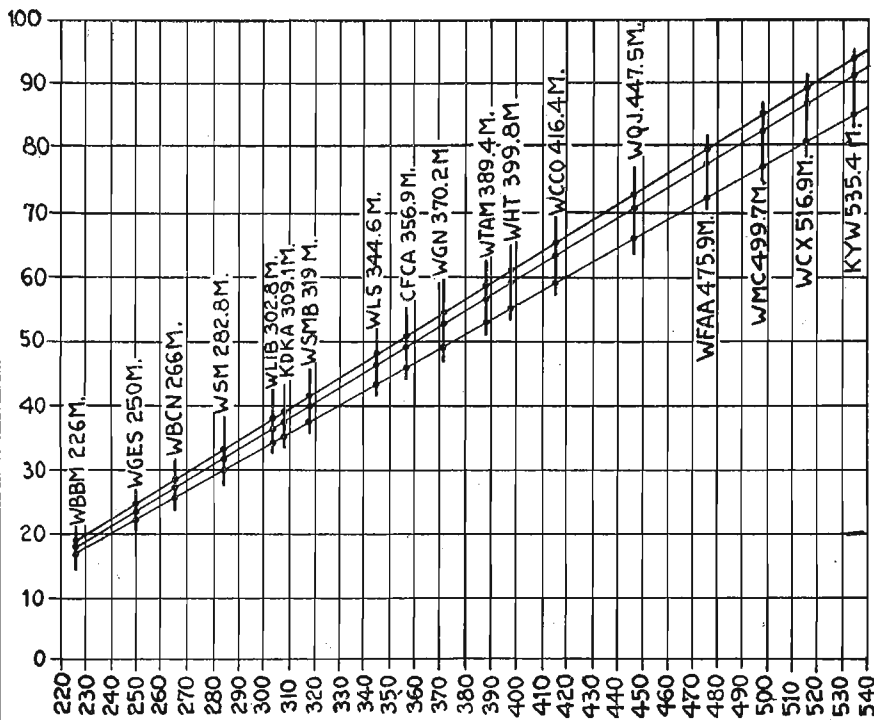

Figure 9

the positive or plus terminal of the storage battery, which may be marked POS or + or with red paint. The heavy green wire goes to the negative terminal of the storage battery marked with NEG or a - sign.

Each of the two B units, whether dry cell or storage, has a negative (-) terminal and a plus (+) terminal. Connect the thin, pale blue wire to the negative terminal of one of these units. To the plus terminal of that same unit connect the yellow wire of the Cabelug

and a 6 inch piece of wire, the other end of which goes to the negative terminal of the second B unit. The pink wire of the cable goes to the remaining plus terminal of the second B unit.

### Antenna, Ground and Speaker

The lead-in wire from the antenna, whether of the outdoor or indoor type, is

to be brought into the cabinet through a small hole behind the left binding post of the two in the rear corner of the sub base. Another small hole is to be drilled about 1 inch to the right of it for the ground wire, which should be connected to the second of that pair of binding posts. Do not bore but one hole and bring both antenna and ground through it. A phone plug should now be attached to the speaker cord tips. It will be noticed that one of the leads from the speaker is marked with a tracer thread of red or blue or some other bright color. The plug includes a small ball tip and an outer tube which are insulated from one another. Connect that speaker cord wire which has the identifying thread to the plug terminal going to the ball tip. Thus the marked lead will go to the positive of the B battery, within the set, rather than to the plate of the last tube.

This receiver has been designed for the use of six hard or "A" tubes. Turn the small filament switch to the "Off" position and turn both rheostats to the left with an anti-clockwise motion as far as they will go. Now insert a tube in socket 2 and one in socket 3. Turn switch to "On" position and slowly turn left hand rheostat to the right. Tube in socket 2 should light up if all connections have been correctly made. Turn the other rheostat to the right and the tube in socket 3 should light up. If all seems O. K., insert the remaining four tubes in sockets 1, 4, 5, 6. The accessories having all been made ready, slip the speaker plug in the jack and we are ready to try tuning.

The primary of the first Aero coil, that on the left, is movable in its relation to the secondary. Adjust it so that its lower and inner edge is about ¼ inch clear of the end of the secondary. The C-R-L unit at the left end of set is turned so that the arrow points, about horizontal,

(Continued on page 28)

## CELCO PRODUCTS

Specified for

## DX-SEVEN D-COIL RECEIVER

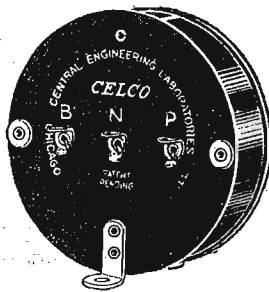

### D-COIL

Intermediate Frequency Transformer

Positive Separation of Stations  
NO INTERSTAGE COUPLING  
NO SHIELDING NECESSARY

5 Units  
INCLUDING COUPLER  
\$27.50

### Indicating Battery Switch

There need be no more annoyance over tubes burning all night if a Celco Battery Switch is in your set. The jeweled pilot light emits a soft golden glow that makes it as hard to forget to turn off as it is easy to turn on. Simple to install—only two holes to be drilled in panel, one for pilot light and one for switch.

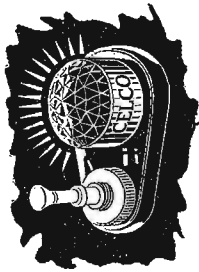

\$1.35 Including Lamp

### Baseboard and C-Battery Mounting Bracket

Designed especially to accommodate the new type of tubes when used with a 7" panel and to provide a place for the C-Battery.

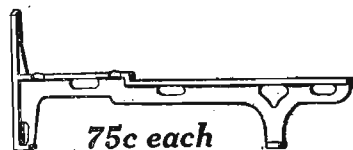

75c each

If dealer cannot supply you, send his name with your remittance and we will supply you direct. Inquiries invited from dealers and jobbers.

CENTRAL ENGINEERING LABORATORIES

3345 No. Lincoln St., Chicago, Ill.

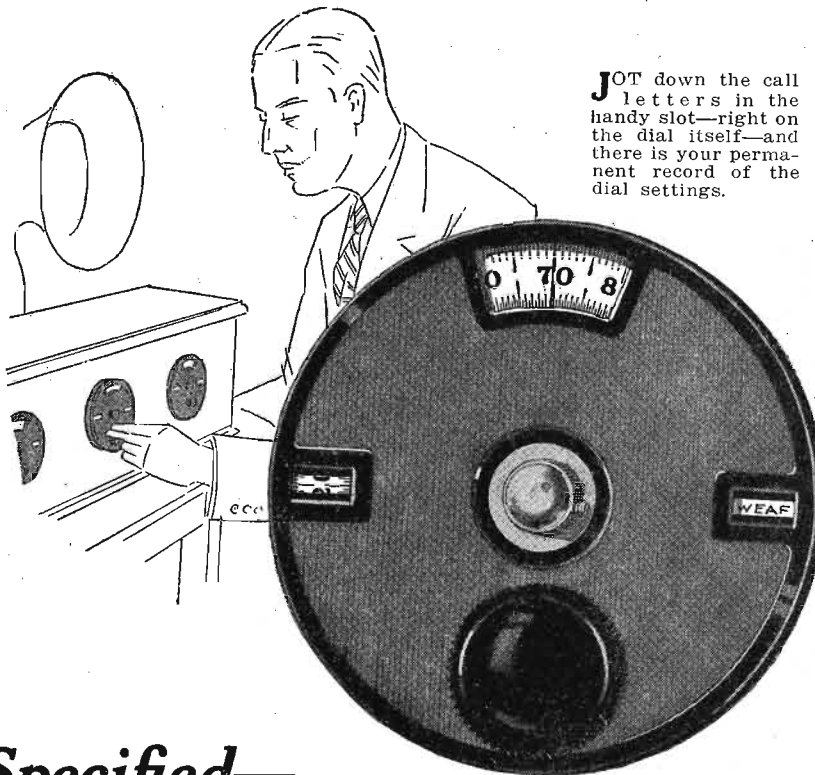

**J**OT down the call letters in the handy slot—right on the dial itself—and there is your permanent record of the dial settings.

## Specified— for the Radio Digest Super-Heterodyne

This season's conditions demand precision tuning. Yet the modern receiver must be easy to control.

This necessity for combining supreme accuracy with simplicity led the designers of the Radio Digest Super-Heterodyne to use and specify the new MAR-CO dial—the 1926 model tuning control.

The MAR-CO dial splits a single degree into hair's breadth divisions.

It responds to the slightest touch without the least suggestion of backlash. Handsome, responsive, and supremely accurate,—use them on the set you build,—put them on the set you buy.

Nickel-plated, \$2.50—Gold-plated, \$3.00. Supplied with scales reading 0 to 100, or 100 to 0, as preferred. Made by Martin-Copeland Company, Providence, Rhode Island. At all good parts dealers.

MARTIN-COPELAND CO., Providence, R. I.

**MAR-CO** Vernier Dial  
RADIO PRODUCTS

## "FIRESIDE" RECEIVER

(Continued from page 27)

to the left. The C-R-L unit at the right is turned that its arrow points upward; that will give medium volume. While, theoretically, the three dials should run together throughout the scale, this does not work out, as a rule, in actual practice. The effect of the coupling of the antenna to the first secondary, throws the settings of the first dial somewhat above the other two and differences in the wiring of the second and third grid circuits throws the third slightly below the second.

### Tuning Charts

To make tuning easier, and much more clearly understood, I am going to digress from the set itself for a few paragraphs to explain the making of a chart for your dial settings. This chart is not hard to make and has two excellent reasons for its use. First, you can tell at a glance where to set the dials to return to a station; second, this chart will tell you where to set your dials to find new ones. From three to seven stations must be tuned in by the search and hunt system, the readings noted carefully, and then we can make our chart.

The chart for my second Fireside is shown here as figure 9 with, of course, some of the fine lines omitted. Graph paper, ruled into inch squares, which are in turn divided by fine lines into small squares, 10 each way, can be purchased at any drafting or artists supply house. Your chart can be as large or as small as you wish, depending on how many meters horizontally each line is to represent and how many condenser divisions each square represents vertically. You will note in figure 9 that the straight line wave length condensers made by Benjamin, and the Aero coils, work together so perfectly that the result is an absolutely straight line when stations are "plotted."

That you may have some approximate settings to go by, I'll put in a few as they appear on my chart. WBBM, 226 meters, 19, 18, 17; WBCN, 266 meters, 29, 28, 26; WSM, 282.8 meters, 33, 31, 29½; WLIB, 302.8 meters, 38, 36½, 34½; WSMB, 319 meters, 42, 41, 38; CFCA, 356.9 meters, 51, 50, 46; WTAM, 339.4 meters, 59, 58, 54; WCCO, 416.4 meters, 66, 64, 60; WFAA, 475.9 meters, 80, 78, 73; WCX, 516.9 meters, 89, 86, 82; KYW, 535.4 meters, 94, 92, 86. The settings for your first dial may not agree with mine and the settings for your third may be a little different, but I have an idea your second dial settings will be just about those settings given for the stations listed.

### Short Antenna Better

No tuned radio frequency receiver, nor one of the neutrodyne class, should be operated on too long an antenna, that is, one that is over 90 feet including the lead-in wire. Of course a Montana, Wyoming or Idaho location would permit of a longer stretch, but east of a line drawn through Ft. Worth, St. Louis, Kansas City and Minneapolis the shorter aerial is advisable. Fireside should bring in both coasts and New Orleans on any antenna, well insulated, between 70 and 90 feet overall. The movable antenna coupling coil is provided on the first Aero unit to allow for differences in location with respect to stations. The further in you can use it without interference between stations, the louder the signals on distant stations; if you have a number of powerful locals it will be necessary to pull it out slightly and sacrifice a little volume. However, with the three stages of Autoformer coupling provided, there should still be plenty of volume on anything within range. I keep my antenna coil in the position suggested earlier in this article.

The sensitivity control provided by the C-R-L unit at the left is worked, to some extent, in conjunction with the dials. Near the lower end of the scale on the

tuning dials, the arrow on this control will have to point almost downward while on the higher wave stations found at the upper end of the scales on the dials, the sensitivity control can be advanced considerably before distortion, due to too much regeneration, will creep in. The modulator at the right end of the set gives a perfect, smooth control of volume from the faintest of whispers at the left end of rotation to a roar that few speakers can handle, at the right end.

### Switching Tubes

You will find it desirable to switch tubes around in the sockets quite a bit. The two in the sockets to the left should, if possible, have characteristics pretty much alike so that both will approach oscillation together, on the one sensitivity control. Some tubes make better detectors than others for use in socket 3. The last tube, for use in socket 6, will have to be a good one if strong volume is to be expected without blur due to the tube choking up. You may find it advisable to experiment a little with the resistor cartridge in the grid circuit of the last tube. The value given is correct for average tubes and the average volume expected. Greater volume may call for a different value of leak. One thing you will soon find out, burn the detector tube very low. On mine, the rheostat pointer is down and to the right while the rheostat controlling the other five tubes points horizontally to the left and is only about ¼ inch from being full on.

If there is a high steady whistle or faint howl, which does not vary when the tuning controls are varied, it is probably in the audio frequency part of the set and due to some peculiarity of your wiring, tubes or parts. The wire put in as operation 42 should eliminate any such tendency as it grounded the cores and frames of the Autoformers. However, if it did not entirely do so, connect a .00025 mfd. fixed condenser from the G terminal of the third Autoformer to the negative filament wire 1c and 1b. That is about the last suggestion I can give you. You now have every detail of construction as it appears on my Firesides and all the data on operation I have been able to gather on their operation.

(CONCLUSION)

## STOPS SPEEDING TRAIN

(Continued from page 3)

To demonstrate the practicability of continuous train control by radio under practical operating conditions the Michigan Central railroad has equipped ten locomotives and ten miles of double track between Jackson and Rives with the Clark Radio control devices.

With witnesses riding in the cab of the engine the following control tests were successfully made:

### How It Is Worked

The train entered the stretch of train control territory near the Division road and the green light of the safety signal devices flashed indicating that the track ahead was clear. The approach was made at a speed of 35 miles an hour.

The engineer threw open the throttle and soon the locomotive was speeding at 50 miles an hour.

This speed was maintained until the red signal flashed danger ahead. The engineer crawled down from his seat, it being assumed that he was suddenly taken ill and unable to perform his duties. Immediately the Radio controlled safety device automatically applied the air brakes and the locomotive was stopped with the throttle still wide open.

### Green Light Shows

Again taking charge of the locomotive the engineer closed the throttle, released the brakes and proceeded forward at slow speed. Traveling slowly at 15 miles an hour the green light, indicating a clear track ahead, was flashed in the cab and

the engine soon was speeding at 50 miles an hour.

A yellow light flashed in the cab, which told the engineer that a train was stalled on the track 8,000 feet ahead. Shortly after the caution or yellow light flashed, a barely perceptible application of the brakes was noticed and the locomotive slowed down to 30 miles an hour, or what Mr. Clark chose to call "permissive speed," meaning that the Radio device will not permit the engine to move faster.

Proceeding at "permissive speed" for some distance the red light again flashed telling the engineer that the train was in the danger zone, but still at a safe distance from the train stalled on the track ahead. Being forewarned of the automatic brake application by a little whistle which precedes brake application, the engineer used a Clark device for forestalling full application of the air brakes, but slowed the engine to 15 miles an hour. This speed Mr. Clark called "permissive forestalling speed." Shortly the green light flashed, the engineer opened the throttle and the run ended as the engine pulled into the local yards of the Pere Marquette.

Mr. Clark said the continuous control system insures absolute automatic control of a railroad train going at the slowest or fastest speed and that it positively eliminates head-on or rear-end collisions even should the engineer drop dead in the engine cab.

Mr. Clark said that any tendency of the engineer to exceed the speed necessary in the caution zone results in a partial brake application so that on entering the real danger zone he gets a further automatic brake application which brings the train to a stop within the shortest possible distance within the limits of the block and within safe stopping distance of the train ahead.

## Student Concerts Are New WGY-WJZ Treat

### Mengelberg of Philharmonic Will Conduct Excellent Series

SCHENECTADY, N. Y.—WGY's 379.5-meter wave will carry another exceptional musical treat to the listeners, Saturday evenings during the winter. The Philharmonic Society's student concerts will be broadcast by WGY in cooperation with WJZ of New York on the following dates: November 28, December 19, January 2 and 30, February 6 and 13, March 20 and 27, and April 3.

Willem Mengelberg will conduct the concerts.

## Six Hour Program Features KDKA's Second Anniversary

HASTINGS, Neb.—The second anniversary of Westinghouse Station KFKX was observed with a six-hour program one Monday, November 16. The program began at 7 p. m. and continued until 1 a. m.

KFKX was originally established as a "repeater" station, to repeat for parts of the west which were out of the consistent range of the Westinghouse stations in Chicago, Pittsburgh and New England, the programs from these stations, especially KDKA at Pittsburgh, were experiments with the short wave were being carried on. It also originates programs.

## BOY'S HOBBY STATION

(Continued from page 6)

ing the accompaniment for Charlie Garland's "Mississippi Blues," Nate Caldwell's mournful blues or the operatic selections of Frances Ingram, Metropolitan and Chicago Civic Opera star, who is now broadcasting over WBBM every Wednesday and Sunday nights. She is also one of the new Radio team of the "Two Jays," Jordan and Jeske.

Down in the North Side Realty company studios, Harry Sosnick and Sandy Meek are in charge with Philip Friedlander, the "voice of the air," as announcer. Sosnick is the "boy with the dizzy fingers" you've tuned in so often and Meek is the Scotch tenor. They are in charge of the studio, and in addition to having the "know-how" of putting on programs that make the fans stay tuned in, they also do their own stuff when necessary.

Four of "Chicago's finest" syncopation orchestras broadcast regularly over WBBM. They include those of the Valentino Inn, the Moulin Rouge, the Merry Gardens and the Montmartre Cafe. Supporting these staff artists is an array of other "regulars," inclusive of Harold Anderson, Ted Coleman, Frances Ingram, Jeanne St. Anne, Lew Russell, Pete Kules, the Zeigler Sisters, Wendell Weigert, Christian Grim, the Sunset Male quartet, the Stewart-Warner String quartet, Maurice Silverman, Manhattan quartet, the Devon Comedy Four, Leona Hayes, Voris Worthley, the Four Crows quartet, William Molnaire, Claire Burdette Cleveland, Carl Strodel, George Marbach and a host of others.

WBBM, as may have been gathered from the foregoing, is primarily a "musical" station. Charlie Garland, program director, has ruled that programs, as a whole, must be "95.99" per cent musical or entertaining. Long speeches are barred. Practically the only talks now being broadcast are those of foreign consuls who supervise the "Know the World" arts and musical programs every Thursday night at 8 o'clock.

Among the outstanding national "institutions" of WBBM is the "Nutty Club" from 12 to 2 every Monday morning. It's put on mostly by staff artists, and to be appreciated it must be heard. It's a favorite, judging from letters received, of the "DX" fishermen.

And that, Radio Digest audience, is WBBM, Chicago.

## Field's Station Replaces Pup for Small Montana Lad

SHENANDOAH, Ia.—A boy in Montana, who isn't very strong, lost a puppy to which he had become greatly attached, and after the puppy's death the lad was inconsolable. So his mother wrote to Henry Field, here, who read the letter over KFNH. He announced that if anyone had a good dog they wanted to give away, this would be a good chance for some charity work.

Immediately the calls began to pour in and it seemed as if everyone in the country had a pup to give away. It was a difficult task to pick one out of the many offered, but finally a pup, offered by people at Rock Port was picked out. It is a beautiful snow white collie, with black eyes, and answers to the name of "Cotton." It will surely delight the boy as the puppy is only three months old.

**Send for this RADIO BOOK FREE**



**1926 Catalog of Everything New in RADIO**

at a Big Saving in Price

## The World's Largest Exclusive Radi Mail Order House Will Send You This Wonderful Book FREE

64 illustrated pages containing thousands of bargains in radio sets, semi-finished sets and radio kits of all styles, sizes and approved circuits. Beautiful models of the very latest designs and types. Elaborate console models with loud speakers built right into cabinets of genuine mahogany and walnut. ALL SETS GUARANTEED.

Our line includes all popular sets, such as Superheterodyne, Neutrodyne, Ultra-dyne, Reinartz, Regenerative, Radio Frequency, Browning-Drake, Reflex and all other latest circuits. Kits, sets and parts manufactured by all well known manufacturers, such as: Frost, Howard, Baldwin, Brandes, Western Electric, Columbia and others.

**Our Guarantee**  
Every article exactly as represented. Every article is tested before shipping. Complete satisfaction or money cheerfully refunded.

**Don't Buy Anything in Radio Until You Get Our Big Money Saving Catalog**

**RANDOLPH RADIO CORPORATION**

The Largest Exclusive Radio Mail Order House in the World

159 N. Union Ave., Dept. 148, Chicago, Ill.

**Our Catalog**  
includes complete list of broadcasting stations and general information and facts about our free service division. Our radio engineers will help you solve all your radio problems. Send your name and address on a card or in a letter. We will send catalog FREE.

A FACT!

The only man who doubts that a 3-tube set can give better results than a 5-tube set, is the man who has never made a performance comparison between the Crosley Super-Trirdyn and the best 5-tube set built.

**Super-Trirdyn Regular, \$45**

THE CROSLY RADIO CORPORATION, Cincinnati, Ohio

# CROSLY RADIO

BETTER • COSTS LESS

# Attractive Speaker Easily Built

## Stands Fifty-six Inches High and Rests on Floor

I built this loud speaker myself and it contains nothing but paper and paste. We make this paper and paste here on the banks of the Wabash so this is entirely a homemade speaker. The only metal

### WORKSHOP KINKS EARN A DOLLAR—

THERE are many little kinks worked out at home that would aid your fellow Radio worker if only he knew about them. There are new hook-ups, new ways of making parts and various unique ways of operating sets that are discovered every day. Radio Digest is very much interested in obtaining such material. Send them in with full details, including stamped envelope, so rejected copy may be returned. The work must be entirely original, not copied.

RADIO KINKS DEPARTMENT  
Radio Digest  
510 North Dearborn St., Chicago

about it is the stand. The horn is sixteen inches in diameter and stands fifty inches high, and is so finished that it is a real ornament for a room. The interior of the horn is finished with a mixture of green, cerise and blue metallic flitters.

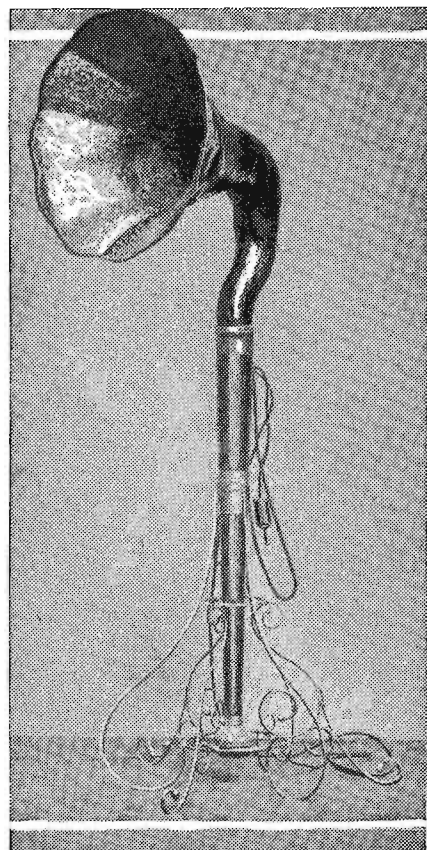

With No. 12 wire make a frame or form as shown in figure 3. Then cut some heavy wrapping paper into wedge shaped pieces 14 inches long, 3 inches at the top and 6 inches at the bottom. A dozen are needed. Dampen with water on both sides



**3.25**  
22 Cells  
24 Volts  
**RADIO Storage "B" Battery**  
Lasts Indefinitely—Pays for Itself  
Economy and performance unheard of before. Recharged at a negligible cost. Approved and listed as Standard by leading Radio Authorities, including Pop. Radio Laboratories, Pop. Sci. Inst. Standards, Radio News Lab., Lefax, Inc., and other important institutions. Equipped with Solid Rubber Case, an insurance against acid and leakage. Extra heavy glass jars. Heavy, rugged plates. Order yours today!

**SEND NO MONEY** Just state number of batteries wanted and we will ship day order is received. Extra Offer: 4 batteries in series (96 volts), \$12.75. Pay expressman after examining batteries. 5 per cent discount for cash with order. Mail your order now!

**WORLD BATTERY COMPANY**  
1219 So. Wabash Ave., Dept. 76 Chicago, Ill.  
Makers of the Famous World Radio "A" Storage Battery.  
Prices: 6-volt, 100 Amp. \$11.25; 120 Amp. \$13.25; 140 Amp. \$14.00.  
All equipped with Solid Rubber Case.

Set your Radio Dial at 210 meters for the new 1000 watt World Storage Battery Station, WSBG, Chicago. Watch for announcements.

**World STORAGE BATTERIES**

KDKA - WEAZ - WGN - WJS - KHJ - KGO - KFAP - WJW - KOP

## PAPER, PASTE AND WIRE USED

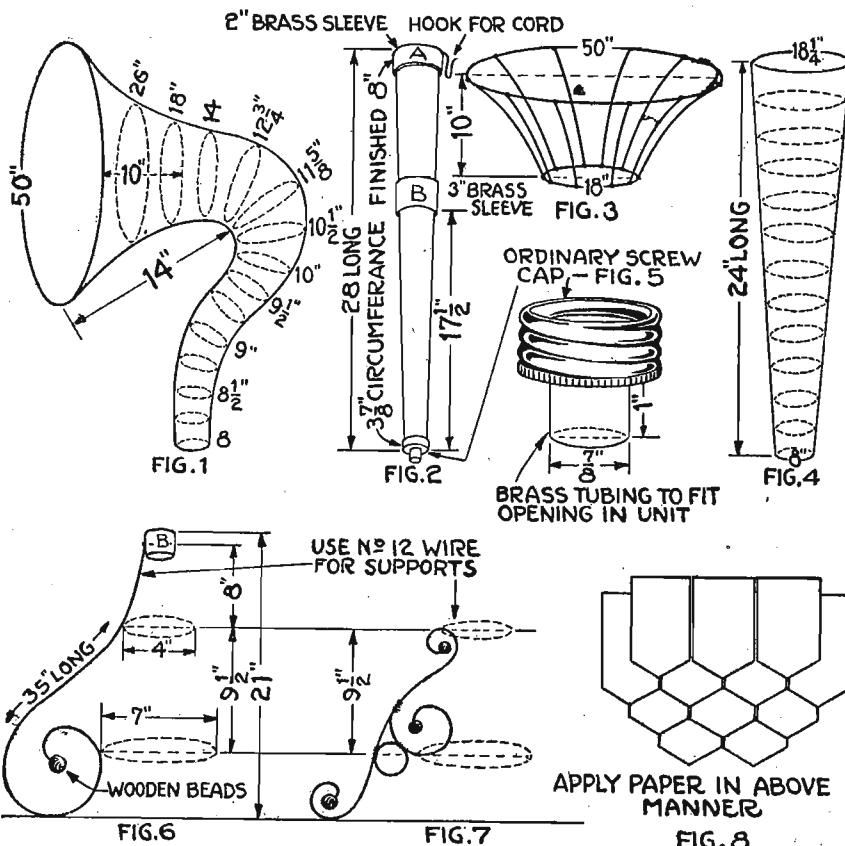

and smear paste all around the edges and cover the frame with them. This gives you a lap of 2 inches above and below; it is best to use thick paste such as that used by paperhangers. When this is thoroughly dry, take pieces of newspaper cut into similar pieces as above only not quite as long and apply about eight layers. Then give three days to dry.

The part shown in figure 4 comes next and here some stiff cardboard will make an easy form to work on. The paper here can be cut in larger sizes and always see that the bubbles are expelled from under each layer, using the same number of layers as in the previous form. The stem is constructed in the same way following the dimensions given in figure 2. Now cut up the tube constructed from figure 4 into pieces 2 inches wide and by cutting a few notches in one side of each lower one, you can slip the next larger one over it and you have the opportunity to form it approximately as shown in figure 1. Smoothen out the inner surfaces and paste a little gummed paper over each joint on the inside. Small deviations from my drawing in the shape of the curve will not make any difference.

Make sure the end of the horn is the same size as the top of the stem because the latter will act as a shoulder for your horn and make it easy of rotation. With your curve now constructed you can begin to apply more layers of paper making a total of 15 layers but more can be applied

if you care to. As a finishing effect cut out some small size and pointed pieces from heavy wrapping paper 1 1/2 by 2 1/2 which should be applied in the same manner as shingles, overlapping each other as in figure 8. The inside of the horn may be finished in the same manner or with smooth layers of heavy paper. The stem also, can have some of this treatment and, when completely dry, a thin piece of brass or tin about 1/4-inch wide is put around the top to keep it from wear if the horn is revolved on it. See figure 2. The bottom piece is an ordinary cap off a catsup bottle through which a suitable metallic tube 1-inch long is soldered into the center of the cap, as in figure 5. This is to give adjustment to the rubber holder on the unit.

The stand is made from No. 9 wire and may be constructed in many artistic ways. Scrolls of all kinds, and designs to suit the individual fancy, may be used in it. The above pattern is composed of 2 sets of legs, 3 each, and those which are attached to the smaller ring come out a

## TELEVOCAL QUALITY TUBES

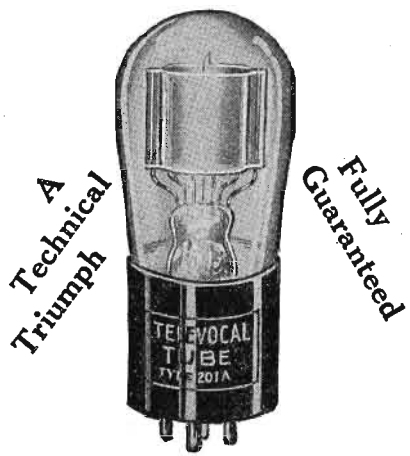

**TELEVOCAL CORP'N**  
67-A Fifth Ave. NEW YORK

A Technical Triumph

Fully Guaranteed

## YAXLEY APPROVED RADIO PRODUCTS



**RADIO JACKS**  
Jacks to fill every need in the finest radio sets. One nut mounts in 7/16" panel hole. Genuine phosphor bronze springs, with pure silver contact rivets and terminals tinned for soldering.  
**No. 1 Open Circuit Jack 50c**  
At the best radio dealers  
**YAXLEY MFG. CO., Dept. L**  
217 N. Desplaines St., Chicago, Ill.

## ELIMINATE STATIC!

Enjoy perfect reception regardless of weather conditions! The Static Eliminator—the newest and most startling thing in Radio—cuts out practically all static without loss of volume!  
And in addition it will help increase selectivity, tune out local stations, sharpen signals, remove noises, lessen interference and prevent re-radiation!  
Use it with any receiving set—simply hook up to your aerial lead-in and enjoy perfect reception unmarred by static \$1.00 postpaid. Satisfaction guaranteed. Money refunded at once if returned within 5 days.  
**\$1.00 Postpaid**

## Grand Prix Correction

IN PART III of the instructions for building Grand Prix Super-heterodyne, which appeared in the November 7 issue, an error was made in operation 41, on page 28. As printed, this reads: "Put in a wire from the upper terminal, bent to the left and slightly back, down through the hole provided, then to the right 1/2 inch to wire 9." The last phrase should have read: "then to the right 1/2 inch to wire 27." The wire put in as operation 41 can be seen as connected to wire 27 in the photograph reproduced as figure 8 and we hope that builders of this set caught this in the illustration and connected the wire correctly.

In the correspondence relative to Grand Prix, which has come in to Mr. McDonald, there was considerable reference to spaghetti tubing. This should be used wherever wires come unusually close; the writer used a form of covered wire marketed as Celatsite and available in different colored insulations. Grid circuit wires are green, plate wires are red, positive filament wiring is in black and negative filament wiring is in yellow.

little farther than those which are fastened to the sleeve (figure 2, item B). They have a spread of 11 and 9 inches, respectively, which gives this stand a very rigid footing. The stem, with the unit at the bottom, should be about 2 1/2 inches from the floor as in the photograph.

A good suggestion to follow is, when you have made the necessary legs and the 2 rings, fasten your legs in place by fine copper wire. This will give you an opportunity to adjust the legs and rings correctly before soldering them; besides it will be easier for the solder to hold. The whole speaker can now be painted to suit the woodwork in the room, and the inside of the horn, after you have applied the last coat of paint, may be sprinkled with various colors of metallic flitters obtainable at any paint shop. This will add greatly to its appearance.—H. L. Bernheimer, Terre Haute, Ind.

A single circuit set is not as selective as a three circuit receiver.

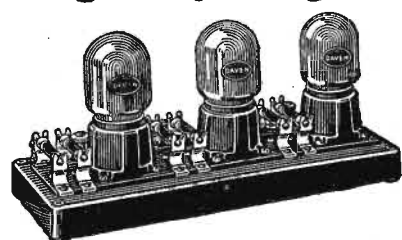

## How to Get LOUD-SPEAKER VOLUME

**EASY. Inexpensive. Results guaranteed.** Hook up a Daven Super-Amplifier. Adds three stages of audio amplification—Daven Resistance Coupled—no labor of assembly—positively no distortion—perfect reception. Daven precision-built unit with Bakelite base. Wonderful assembly. Compact, beautiful—\$15.00. Knock-down Kit (build your own)—\$9.00.

For volume, use two Daven High Mu Tubes—\$4.00 each, and one Mu-6 (for last or output stage)—\$5.00.

Mail the coupon for complete information.

*The Star of Noctis*  
**DAVEN RADIO CORPORATION**  
Resistor Specialists  
Reg. U. S. Pat. Off.

Newark New Jersey

DAVEN RADIO CORPORATION I-11-25  
168 Summit Street, Newark, N. J.  
Please send me the following:  
.....Resistor Manual. 80c is enclosed.  
.....Complete Catalogue (free).  
Name.....  
Address.....

Get the Handbook of Resistance Coupled Amplification. At Dealer's 25c. By mail 30c.  
FOR DEALERS: Send your letterhead and we will have our nearest distributor communicate with you.

**THE BIG LITTLE THINGS OF RADIO**

# Questions and Answers

### Underground Antenna System

(14851) GFL, York, Pa.  
I was very much interested in the Guyer underground aerial system, but did not quite get his idea relative to a vaseline bottle filled with melted paraffine wax. Would it be possible to have him explain how he handles this on the wire; is each end of the two coils that go into the ground inserted in a vaseline bottle which is filled with melted paraffine wax? And, if this bottle is left underground or where is it put?

A.—It is necessary to melt the wax, which may be obtained from any hardware or grocery store, it being the kind used by housewives in canning preserves and jellies. Insert one end of the wire of one coil down in the bottle and pour in the molten wax. Permit this to harden and put the whole thing in the ground. Do the same with the other coil.

### Use Better Ground

(14864) RAC, Galesburg, Ill.  
What would you advise on a small lot on which it is possible to get only a 25-foot three wire antenna, which with 25 feet lead-in gives loud speaker volume with a neutrodyne set only on WOC and one or two nearby stations. The same set on a good antenna gave tremendous volume.

A.—It seems that it may be your ground connection that is at fault. Fifty feet with lead-in should be ample antenna to give you good volume on the set you describe. Try using several ground lines running them to water, gas, and radiator pipes. A piece of ordinary one-inch water pipe not less than fifteen feet long driven into the ground and kept well soaked with water makes an excellent ground connection.

### Skeeter's Set Again

(14835) HFR, Houston, Texas.  
Is it possible in building the Skeeter's Wheatstone bridge set to use .00035 condensers instead of the ones described in his article; can I use all 201-A tubes; can I follow Mr. Skeeter's diagram of coils, winding them on the thirteen peg low loss type? Also is it possible to use three stages of Radio frequency instead of two, as described in this article?

A.—If you mean the Skeeter's article which appeared in our August 15 number, you can use the .00035 condensers, all 201-A tubes, and can wind your coils on pegs the same number of turns as shown. There is only one stage of Radio frequency shown in this circuit, but an additional stage may be added if so desired. The additional transformer will be identically the same as the one that is shown. Use the same number of turns of wire that are specified for coils L-1 and L-2. The correct number of turns for coil L-3 is to be 30.

### Lighting Plant Interference

(14917) CMH, Cadillac, Sask.  
We are having considerable interference from our electric lighting plant and we would appreciate your sending an idea to do away with it. Our plant consists of a Cushman 4 h. p. battery ignition engine and a 32-40 D. C. Fairbanks Morse generator. We also have storage batteries for the above plant.

A.—In the August 1 and 8 issues of

### DIRECTIONS FOR REQUESTING INFORMATION

The Questions and Answers department offers service to Radio Digest subscribers without charge and, to those not subscribers, the same service with a charge of 50c for each letter requiring up to three answers or diagrams. We feel that this policy is necessary for the protection and best interests of our regular readers, as the volume of correspondence to this department has increased to such an extent that it is almost impossible to give our subscribers' letters adequate attention nor a complete answer. To those who have long been newsstand readers this may, at first, seem an injustice but a little thought on the matter will show that this is the only possible solution of what has been, to the technical department, a very perplexing and difficult problem. We ask that the following suggestions be read carefully before writing:

- 1—Search carefully the back issues which you have, as the point in question has probably been covered several times before.
- 2—The book, "Radio Receivers," given free with each yearly subscription (when received by Radio Digest direct with full remittance of \$5), contains the answers to the majority of the questions asked. If you have this book, go through it thoroughly and it is probable that you will find the solution of your problem.
- 3—Letters for this department should be kept separate from all correspondence to other departments and on other subjects.
- 4—Questions should be written on one side of paper only and each sheet should bear the sender's name and address. All letters should be accompanied by a self-addressed stamped envelope of standard business size.
- 5—Unsigned (or anonymous) letters cannot be answered, either on

this page or by letter, nor can those without address.

6—No comparative statements on advertised apparatus will be given except as to efficiency in some particular circuit.

7—Drawing diagrams on a separate sheet of paper will save time and enable us to give all questions more attention.

8—Write each question as a separate paragraph.

9—Keep a copy of your letter and diagrams, to which we can refer without re-drawing.

10—The names and addresses of the writers of letters published will not be released except with the writer's permission.

11—We want to be of assistance to you in your difficulties, but are sometimes limited because of the length and time required for the proper consideration of the questions asked. Therefore, please make your letters brief.

Radio Digest we ran articles telling how to deal with interferences of this sort. Back copies containing this information may be obtained from our circulation department for ten cents per copy.

### Heteroflex Coils

(14822) HMC, Houtzdale, Penn.  
Am building the Heteroflex as described in Radio Digest August 1. Can you help me, in designing the right size coils doughnut type of the three intermediate frequency transformers? How many turns and what size air core? An experienced Radio man here tells me the size of the core has no effect on the operation of the transformer but recommends a small core as requiring less wire. If this is so why are 3-inch cores or larger so often recommended for Radio frequency transformers. My idea is a core for doughnut type at least 1 1/2 inches in diameter in order to

keep the magnetic flux inside of the coil.

A.—The intermediate transformers of the Heteroflex circuit are long wave and are of a special make and design. Doughnut coils or coils of like nature cannot be used in the intermediate stages of this circuit. The conventional type of Radio frequency transformers are designed to cover the broadcast band. It is practically an impossibility for an amateur to construct a coil of this nature as it requires special instruments to calibrate them after they have been constructed.

### Still Covers Wave Band

(14817) JCT, Albany, N. Y.  
About two years ago I constructed the King Miloplex set and it was a wonder

## FREE Radio Club Membership

Local chapters of LOG CLUB, largest radio club in the world, are now forming everywhere. FIRST member in each chapter is given membership absolutely FREE and is appointed president of his local club. He is then paid a large bonus on new members. The club furnishes members radio map, verification cards, etc., a 64 page perpetual loose leaf log and sends new pages as changes occur. Log contains call letters, city, also space for 4 dial settings, wave length, remarks, etc. Also "Repair Hints," "Tuning Suggestions," "Dictionary of Radio Terms," "Trouble Finders," "Trouble Preventers," "Station list numerical by wave lengths," "List station owners and addresses," and much other valuable information. Local chapter enjoy meeting and other CLUB privileges. Be FIRST member from your town. Write today—NOW. Postal will do. LOG CLUB, Dept. 7998, 203 S. Dearborn St., Chicago

### \$1.50 For Your Old Radio Tubes

regardless make or condition, toward purchase of each new standard \$2.50 tube. Positively guaranteed. We do not sell rebuilt or bootleg tubes. Agents wanted.

**SUPER-SERVICE LABORATORIES**  
Dept. E, Room 58, 39 West Adams, Chicago, Ill.

### FAMOUS 'COAST TO COAST' MIRACO GUARANTEED

**RADIO'S-FACTORY PRICES GET SPECIAL OFFERS**  
SAVE 1/3 TO 1/2

Users everywhere report Miraco Radios set programs coast to coast on loud speaker; other form sets three times as costly. Many hear foreign countries. Radio's most amazing values in guaranteed factory built, factory tested long distance sets—let testimony of users convince you.

Powerful New Miraco tube Miraco gets long distance on loud speaker. Set, \$27.35

FREE! Literature on latest improved 1 to 5 tube models, new low prices, testimony of users and SPECIAL OFFERS. Write AGENTS DEALERS Write!

**MIDWEST RADIO CORP'**  
Pioneer Builders of Sets  
437-C E. 6th St., Cincinnati, Ohio

### Takes Place of Tube

The Tower Radio Mfg. Co., 2620-C Victor St., Kansas City, Mo., has manufactured a real Fixed Detector known as RADETEC which is Highly Successful in both Crystal and Tube Sets.



It is a Crystal Set in itself with greater distance Reception. Wonderful for Redex—Save A and B Battery. Prolong Tube Life. Get better detection. Every one guaranteed. Money Back if not satisfied. Price \$1 Postpaid including Brackets for mounting. Some Dealer Territories still open. WRITE TODAY.

## FREE RADIO STAMPS

168 beautiful copper etched American, Canadian, and European stamps, (8 colors), each with call letters of a station. FREE with latest Ideal 48-page Radio Stamp Album and Log. Also contains complete list of stations both alphabetically and by call letters. As you hear new stations, just put proper stamps in album. A fascinating hobby. Album and stamps become permanent record of stations you hear. You and your children will enjoy it. Complete album, 8"x11", heavy cover. \$2.00 plus postage.

**Send No Money**

Pay postman after album and FREE stamps arrive. We prepay postage if you prefer to pay with order. **MONEY REFUNDED** if not DELIGHTED. Send order today—NOW. Postal will do. IDEAL CO., Dept. 8418, 366 Wrigley Bldg., Chicago

for selectivity, volume and DX. Would the same circuit work today on the present wave band?

A.—The Miloplex circuit that you constructed two years ago will still cover the broadcast band. However, we recommend a thorough overhauling and the replacing of any antiquated parts by new ones of the low loss variety.

### Four Filter Super

(14792) FJE, Oklahoma City, Okla.  
I have just finished building Mr. Fournier's Four Filter Super and would like a little information as same does not appear to work satisfactory in every respect. I find that I have very little control over oscillation with the potentiometer. At just one point, about one-half inch from the negative side, I can get the rushing sound. Also when way over to the negative post it picks up a spark station. Is not clear but distorted, especially on the higher waves. I have checked all circuits as specified in Mr. Fournier's article and can locate no error, also had potentiometer and condensers tested.

A.—Suggest that you omit the regeneration on the first tube and also the center tap on the secondary of the coil. Connect the lower end of the secondary of this coil or the loop to the variable condenser and the plus filament. If you make these changes we feel that the trouble will be remedied.

To find the positive and negative posts on a storage battery, dip the wires in a diluted solution of salt in water. The most bubbles will form on the wire attached to the negative terminal of the battery.

## CLASSIFIED ADVERTISEMENTS

### AGENTS WANTED

**Sensational Radio Offer! Guaranteed 5-Tube Set at low price. Unique selling plan. \$50 to \$150 weekly easy. No experience required. Free outfit offer. Act quick. Zeus Radio Co., Dept. F, 440 Wrigley Bldg., Chicago.**

### B ELIMINATORS

**Make Your Own B-Eliminator with our imported French parts, high quality, minimum cost. Send stamp for details. B-Free Co., 6453 Bosworth, Chicago.**

### BLUE PRINTS

**Ryan's Simplest Super-Het 14 pages, full size working drawings; Neutrodyne, 24 pages with blueprints; Reinartz, 14 pages with blueprints; Radio Circuits, 28 pages with 48 hook-ups; Reflex De Luxe, 16 pages with blueprints; Miloplex, 16 pages with blueprints; Flewelling, 12 pages with blueprints. 3 for one dollar. 50 cents each. Book Department, Radio Digest, 510 North Dearborn Street, Chicago.**

### BOOKS

**Slightly soiled books on Radio. Write for list and prices. Book Dept., Radio Digest, 510 North Dearborn Street, Chicago, Ill.**

### PATENTS

#### PATENT ATTORNEYS

**PATENTS. Booklet free. Highest references. Best results. WATSON E. COLEMAN, Patent Lawyer, 644 G Street, Washington, D. C.**

### RADIO

**Long Distance Radio \$2.95. Lambert's newest crystal success. No tubes. No batteries. No grief. Always ready. Works 600 miles. Fully guaranteed. We pay postage. Order direct from this ad. Leon Lambert, Wichita, Kansas.**

### RADIO PARTS

**Do not expect results from Grand Prix, Fireside, and Traveler sets unless you use the parts specified by the authors. We can furnish you all parts for the sets described by return mail at prices listed in articles. All Parts Service, 845 S. Harvey avenue, Oak Park, Illinois.**

### SALESMEN WANTED

**Make \$100 WEEKLY in spare time. Sell what the public wants—long distance radio receiving sets. Two sales weekly pays \$100 profit. No big investment, no canvassing. Sharpe of Colorado made \$955 in one month. Representatives wanted at once. This plan is sweeping the country—write today before your county is gone. OZARKA, INC., 126-G, Austin Ave., Chicago.**

### TELEGRAPHY

**Telegraphy—Both Morse and Wireless taught thoroughly. Big salaries. Wonderful opportunities. Expenses low; chance to earn part. School established fifty years. Catalog free. Dodge's Institute, Sixth St., Valparaiso, Ind.**

Where you see these signs in circuits—use

**Potter**  
BY-PASS  
**Condensers**  
At your dealer's  
Potter Manufacturing Co., North Chicago, Ill.

**CARTER**  
Latest Improved  
Radio Parts  
For All Circuits  
**Carter Radio Co.**  
300 S. Racine Ave. CHICAGO

## Tuning Suggestions

**SEND NO MONEY**

Two pages of Tuning Suggestions is just one advantage in the new 64-page loose leaf perpetual log. Corrected sheets may be secured as changes in calls, wave lengths, owners, addresses, etc., occur. Holds 504 stations with 4 dial settings, remarks, etc. Station list numerical by wave lengths in meters and kilocycles—another list alphabetical by states, etc. Dictionary of Radio Terms. Trouble Finders. Repair Hints. Trouble Aids. Pull of other valuable information. So convenient. Worth twenty times small cost. Only \$1.

**Large Colored RADIO MAP FREE With First Order**

Send no money. Pay postman after log and FREE map arrive. Postpaid if pay with order. Money refunded if not delighted. Order today—RIGHT NOW.

**Radio Printers, Dept. 8918, Marengo, Ill.**

**AMBASSADOR**  
KITU JUNEAU ALASKA

SEND FOR FREE 4 PAGE COIL FOLDER!  
**COILS ARE WONDERS FOR DX RECEPTION OF KITU VERIFIED.**

AMBASSADOR SALES CO. 108 Greenwich St., N.Y.

PATERSON, N.J.

# Radiophone Broadcasting Stations

## Corrected Every Week—Part II

### FIND MISTAKES AND YOU'LL GET DOLLAR

ONE DOLLAR will be paid to the Radio fan reader of Radio Digest submitting the most errors in any one station's listing in the Directory of Radiophone Stations, which appears in six parts, serially continuously on the next to last page. Letters must reach Radio Digest's office not later than one week from date of issue corrected. Readers are not limited to correcting one station, but such corrections must be verified by the stations themselves, and NOT by comparison to other so-called accurate Radio directories or lists. Verifications must accompany corrections. Turn in corrections for as many stations as you can find—if you can find errors! Use separate sheet of paper for each station submitted and place name and address on each sheet. In case of tie, duplicate awards will be made. Asterisks have been placed in front of corrected listings and new stations in order to distinguish them.

### United States (Cont'd)

(Note—The second part of the schedule list appears below. The first appeared last week.)

**KPO**, San Francisco, Calif. 428.3 meters. 1000 watts. Hale Bros., and the Chronicle. Announcer, Clair E. Morrison. Slogan, "The City by the Golden Gate." Daily ex Sun, 7:30 am, 8 daily dozen; 10:30 am, amusement service; 12 m, time, scriptures. Daily ex Sun, Fri, 1-7:30 pm, music, markets. Mon, Tues, Wed, Thurs, Fri, 8-11 pm, entertainment. Tues, Thurs, 10 am, household hour. Tues, Wed, Thurs, 10:35 am, markets. Wed, 5:30 pm, style talk. Fri, 12:30 pm, luncheon; 5:30-7:30 pm, Sat, 8-12 midnight. Sun, 9:45 am, service; 5-6 pm, organ; 6-6:30, orchestra; 6:30, baseball; 6:35-7:30, orchestra; 8-10, music. Pacific.

**KPC**, Pasadena, Calif. 228.9 meters. 500 watts. Pasadena Presbyterian Church. Announcer, G. Anton Fohlman. Wed, 7:30-9 pm; Sun, 10:30-12:30 pm; 6:45-9 pm, Pacific.

**KPRC**, Houston, Texas. 296.9 meters. 500 watts. Houston Post-Dispatch. Slogan, "Kotton Port Rail Center." Announcer, Alfred P. Daniel. Daily ex Sun, 10:55 am, 5:30 pm; 11, weather; 12 m, entertainment. Daily ex Sat, Sun, Fri, 8:30 am, Radio Judge's Kiddies hour; 7:45-9:30, concert. Sat, Wed, 11-12 midnight. Sun, 10:45 am, 8 pm, services; 10-11 pm, music. Central.

**KPSN**, Pasadena, Calif. 315.6 meters. 1000 watts. Pasadena Star-News.

**KQP**, Portland, Ore. 231 meters. 500 watts. H. B. Read Incorp. Announcer, H. B. Read. Slogan, "Hood River Apples from Portland, Ore."

**KQV**, Pittsburgh, Pa. 275.2 meters. 500 watts. Double-day-Hill Elec. Co. Daily ex Sat, Sun, 10:30 am, music; 11, weather; 12:15, weather, music; 3, music. Eastern.

**KQW**, San Jose, Calif. 227 meters. 500 watts. Charles D. Herrold. First Baptist church.

**KRE**, Berkeley, Calif. 258 meters. 150 watts. Daily Gazette. Announcer, Harold Kirby. Mon, Tues, 8-10 pm, Wed, 8-10 pm, kiddies hour; 8-12, dance program; Tues, 9-11 pm, Thurs, 9-10 pm, 10-11, Fri, 9-12 midnight. Fri, 8:30-12, dance program. Sat, 8-12, dance program. Sun, 10-11 am, church; 6:30-7:30 pm; 8-9, 9-10, Pacific.

**KSAC**, Manhattan, Kan. 340.7 meters. 500 watts. Kansas State Agricultural College. Announcer, Sam Pickard. Daily ex Sun, Sun, 9:55, 12:35 pm, 4:30, 6:30, Sat, 12:35 pm, Central.

**KSD**, St. Louis, Mo. 545.1 meters. 500 watts. St. Louis Post Dispatch. Daily ex Sun, 8:40 am, 9:40, 10:40, 11:40, 12:40 pm, 1:40, 2:40, 3:40. Mon, 7 pm, 10:30, 11, Tues, 6:35 pm, 7, 8, 9, 10. Wed, 7 pm, 8, Fri, 7:30 pm, 8, 9, 10, 11, Sat, 7 pm, 8:30. Thurs, 6:45 pm, Sun, 7:55 pm, Central.

**KSL**, Salt Lake City, Utah. 299.8 meters. 1000 watts. Radio Service Corp. of Utah. Announcer, Charles H. Hays. Mon, Wed, Fri, 7-11 pm, Tues, Thurs, Sat, 7:30-11 pm, Sun, 9-11 pm, Mountain.

**KSO**, Clarinda, Iowa. 242 meters. 500 watts. A. A. Berry Seed Co.

**KTAB**, Oakland, Calif. 240 meters. 1000 watts. Tenth Ave. Baptist Church. Daily ex Sun, 9-9:30 am, prayer service. Mon, Tues, Thurs, Fri, 8-10 pm, Wed, 9-10:30 pm, Sun, 10 am, 11, 7:45, 9:30-11 pm, Pacific.

**KTBI**, Los Angeles, Calif. 293.9 meters. 750 watts. Bible Inst. of Los Angeles. Announcer, M. E. Carrier. Mon, 8-9:30 pm, Tues, Wed, Thurs, 8-9 pm, Fri, 7-9 pm, Sun, 10:45-12:30 pm, 6-6:45, 7:15-9:30, church services. Pacific.

**KTBR**, Portland, Ore. 263 meters. 500 watts. Brown's Radio Shop.

**KTCL**, Seattle, Wash. 305.9 meters. 1000 watts. KTCL Broadcasting Co. "Know the Charmed Land." Tues, 7-8 pm, 8-9, Wed, 8-9 pm, 9-10, Fri, 7-8 pm, 9-10, 10:15-12. Sun, 1-2 pm, 9:10-10:10, church service. Pacific.

**KTHS**, Hot Springs National Park, Ark. 374.8 meters. 750 watts. The New Arlington hotel. Announcer, G. C. Arnoux. Slogan, "Kum to Hot Springs." Daily ex Sun, 12:30-1 pm, markets, weather; 9-11 pm, concert. Sun, 11-12:30 pm, church services; 9-10 pm, classic; 10-11:30, frolic, classical. Central.

**KTW**, Seattle, Wash. 454.3 meters. 1000 watts. First Presbyterian church. Announcer, J. G. Priestly. Slogan, "Hear Ye, hear ye, the Gospel." Sun, 11-12:30 pm, 3-4:30, 7-9:30, church service. Pacific.

**KUD**, San Francisco, Calif. 246 meters. 250 watts. San Francisco Examiner. Slogan, "The Voice of the West." Temporarily off the air.

**KUOM**, Missoula, Mont. 244 meters. 500 watts. University of Montana. Mon, Thurs, 8 pm, Sun, 9:15 pm, Mountain.

**KUSD**, Vermillion, S. D. 278 meters. 200 watts. "Univ. of S. D. Announcer, Sidney Lawton. Slogan, "South Dakota University for South Dakotans." Wed, 8-9:30 pm, Central.

**KUT**, Austin, Texas. 231 meters. 500 watts. University of Texas.

**KWG**, Stockton, Calif. 248 meters. 500 watts. Portable Wireless Telephone Co. Announcer, Paul C. Schulz. Slogan, "Voice of the San Joaquin Valley." Daily ex Sun, 4-5 pm, news, concert, markets. Tues and Fri, 8-9 pm, concert. Sun, 2-3 pm, concert. Pacific.

**KWKC**, Kansas City, Mo. 236 meters. 100 watts. Wilson Duncan studio. Slogan, "Keep Watching Kansas City." Tues, Wed, Thurs, Fri, 9:15 pm, Central.

**KWKH**, Shreveport, La. 261 meters. 500 watts. W. G. Patterson. Henderson Iron Works & Supply Co. Announcer, W. G. Patterson. Mon, 8-9 pm, music. Tues, Sat, 9-12 midnight. Sun, 9:30-10:30 pm, Thurs, 8-9:30 pm, Sat, 9-12, dance. Sun, 9:30-10:30 am, music. Central.

**KWSC**, Pullman, Wash. 348.6 meters. 500 watts. State College of Washington. Announcer, Phil Hitchcock. Mon, Wed, Fri, 7:30-9 pm, music. Pacific.

**KWWG**, Brownsville, Texas. 278 meters. 500 watts. Brownsville Municipal Broadcasting Station. Slogan, "Kum to the World's Winter Garden." Tues, Thurs, Sat, 8:30 pm, Central.

**KYW**, Chicago, Ill. 535.4 meters. 2,000 watts. Westinghouse Elec. & Mfg. Co. Announcer, Edward Boroff. Daily ex Sun, Sat, 5:30 am, exercises; 6:30, church; 9:55, time; 10, markets; 10:35, table talk; 11, weather; 12:30 pm, reports; 1:15, reports; 5:02-5:18, markets. Tues, Wed, Thurs, Fri, 5:35 pm, children's hour; 6:30, Sun, Tues, Wed, Thurs, Sat, 1 pm, motor club, talks. Mon, 1:30 pm, markets, Tues, Thurs, 1:35-3 pm, frolic. Wed, 6:33 pm, 6:45, 7-9, 9-11:30, Thurs, 9:30 am, 6:30-8:50 pm, farm bureau; 7-8:15, 8:20, talk; 9-10:30, Fri, 7-7:30 pm, 9-11:30, Sat, 5:30 am, 6:30, 8:30, 10:35, 11, 12:30 pm, 1, 1:15, 1:35-3, 5:02-5:18, 6-6:30, 7-8, 8:35-10:30, Sun, 10 am, 6:4 pm, World Crier every half hour. Central.

**KZKZ**, Manila, P. I. 272 meters. 500 watts. Radio Corporation of the Philippines.

**KZM**, Oakland, Calif. 242 meters. 100 watts. Western Radio Institute (Hotel Oakland). Announcer, Elbert Cowan. Daily ex Sun, 6-7 pm, orchestra. Pacific.

**KZRO**, Manila, P. I. 375 meters. 500 watts. Far Eastern Radio, Inc. Slogan, "Radio Manila."

**KZUY**, Baguio, P. I. 360 meters. 500 watts. F. Johnson slser.

**NAA**, Radio, Va. 435 meters. United States Navy Dept. Daily ex Sun, 10:05-10:20 am, 3:45-4 pm, 10:05-10:20, Wed, 7:25-7:40 pm, Daily ex Sun, 9:30 am; 9:45 am, 8 pm, lecture, War dept. Tues, Thurs, 12:45-3 pm, Dept. of Commerce. Fri, 7:45-8 pm, Treasury dept.

**WAAB**, New Orleans, La. 273 meters. 100 watts. Valdemar Jensen. Sun, 2-4 pm, Central.

**WAAC**, New Orleans, La. 273 meters. 100 watts. Tulane Univ. Announcer, P. S. Leloup. Fri, 7:15-7:30 pm, reports; 8-9:30, educational and entertainment program. Central.

**WAAD**, Cincinnati, O. 258.6 meters. 25 watts. Ohio Mechanics Inst. No regular schedule.

**WAFF**, Chicago, Ill. 278 meters. 200 watts. Chicago Daily Drovers Journal. Announcer, Carl Ulrich. Daily ex Sun, 8-40 am, 10:30, 10:45, 12:30 pm. Daily ex Sun, Sat, 12:45, 3, 4:30, live stock and weather reports. Central.

**WAAM**, Newark, N. J. 263 meters. 500 watts. I. B. Nelson Co. Announcer, H. E. Beaver. Daily ex Thurs, Sun, 6-11 pm, Eastern.

**WAAW**, Omaha, Neb. 384.4 meters. 500 watts. Omaha Exchange. Slogan, "Where Agriculture Accumulates Wealth." Daily ex Sun, 9:30 am; 9:45 am, 10:15, 10:45, 11:15, 11:45, 12:15 pm, 12:45-3 pm, markets; 8-8:30, marketgrams talk. Central.

**WABC**, Asheville, N. C. 254 meters. 20 watts. Asheville Battery Co., Inc.

**WABI**, Bangor, Maine. 240 meters. 100 watts. First Universalist church.

**WABO**, Rochester, N. Y. 278 meters. 100 watts. Lake Avenue Baptist church. Announcer, Morse Clark. Sun, 10:15-12 m, 7-15-9 pm, Eastern.

**WABQ**, Haverford, Pa. 261 meters. 100 watts. Haverford College Radio club. Announcer, William S. Halstead. Mon, 7-8 pm, organ, Fri, 10-11, Eastern.

**WABR**, Toledo, O. 263 meters. 50 watts. Scott High School. Sat, football game.

**WABW**, Wooster, O. 206.8 meters. 50 watts. The College of Wooster. Dept. of Physics. Announcer, Frank C. Isely. Irregular schedule.

**WABX**, Mt. Clemens, Mich. 246 meters. 150 watts. Henry B. Joy.

**WABY**, Philadelphia, Pa. 242 meters. 50 watts. John Magaldi, Jr. Slogan, "Quaker City Sleep, Dodgers' Club, The American Broadcasting Club." Sun, 9 pm, music; 10:30, "Sleep Dodgers' Session." Eastern.

**WABZ**, New Orleans, La. 275 meters. 50 watts. The Coliseum Plaece Baptist church. Announcer, V. W. Bradbury. Slogan, "The Station with a Message." Sun, 11-12:15 pm, 7:30-8:45, church service. Central.

**WADC**, Akron, Ohio. 258 meters. 500 watts. Allen Theater Broadcasting station. Daily ex Sun, 11 am, 8:30 pm, Mon, Wed, Sat, 7:30 pm, Tues, 8 pm, Thurs, 8:30 pm, Fri, 8 pm, 9, 10, Sun, 12:30 pm, 6:30 pm, Eastern.

**WADF**, Port Huron, Mich. 275 meters. 500 watts. "Albert B. Parfet Co. Announcer, Stanley G. Smith. Slogan, "Gateway to the Great Lakes." Mon, Wed, 9-11 pm, Sat, 11-1 am, Sun, 10-11:30 am, Eastern.

**WAHG**, Richmond Hill, N. Y. 815.6 meters. 500 watts. Grebe & Co. Slogan, "Wait and Hear Grebe." Daily ex Sun, 12:30-1:15 pm, Mon, Wed, Fri, 7:30-11:30 pm, Sat, 12-2, Eastern.

**WAIT**, Taunton, Mass. 229 meters. 10 watts. A. H. Waite & Co., Inc.

**WAIU**, Columbus, Ohio. 293.0 meters. American Insurance Union. Daily ex Sun, Sat, 3-4 pm, 6-7. Mon, Wed, Fri, 10-11 am, Mon, Fri, 8-10 pm, Sat, 12-1 pm, 9-11, Eastern.

**WAMJ**, Minneapolis, Minn. 243.8 meters. 1,000 watts. Hubbard Co. Hotel Radisson. Slogan, "The Voice of the Great Northwest." Daily ex Sun, Mon, 12-1 pm, organ; 6-7, orchestra; 7-8, popular, farm, hour-10-12, popular program. Sun, 8:30-11, old fashioned program. Central.

**WAPI**, Auburn, Ala. 248 meters. 500 watts. Alabama Polytechnic Institute.

**WBAW**, W. Lafayette, Ind. 273 meters. 250 watts. Purdue University. Daily ex Sun, 9:50 am, stocks, markets, weather. Mon, Fri, 7:15 pm, special program. Central.

**WBAK**, Harrisburgh, Pa. 275 meters. 500 watts. Pennsylvania State Police. Announcer, A. E. Poorman. Daily ex Sun, 10 am, 1:30 pm, 5:45, police reports, fire protection, markets; 12 mid. police reports. Mon, Tues, Wed, 7:30 pm, special. Eastern.

**WBAD**, Decatur, Ill. 270 meters. 100 watts. James Millikin Univ. University activities. No definite schedule.

**WBAP**, Fort Worth, Tex. 475.0 meters. 1,500 watts. Fort Worth Star-Telegram. Announcer, "The Hired Hand." Club, "Radio Truth League." Daily ex Sun, 10, 11, 12 m, 1 pm, 2, market reports, weather; 4, "Port of Missing Men." Mon, Tues, Wed, Thurs, Fri, 12:05-12:30 pm, 7:30-8:30, 9:30-10:45, concert. Sat, 7 pm, Bible lesson. Sun, 11 am, church; 4 pm, concert; 11, midnight frolic. Central.

**WBAR**, Sishit, Wis. 408 meters. 500 watts. Kopp Radio Co. Slogan, "The Station of Northern Wisconsin." Mon, 9-10 pm, Wed, 8-9 pm, Thurs, 7:30-8:30, Sun, 10-11 pm, Central.

**WBAV**, Columbus, O. 293.9 meters. 500 watts. The "Erner and Hopkins Co. Announcer, Roy Snowfer. Slogan, "We Broadcast a Variety." Daily ex Sun, 12-1 pm, 3-4, 5-6, Eastern.

**WBAX**, Wilkes-Barre, Pa. 250 meters. 100 watts. John H. Stenger, Jr. Slogan, "In Wyoming Valley, Home of the Anthracite."

**WBBA**, Newark, Ohio. 225.5 meters. 20 watts. Plymouth Congregational church.

**WBBL**, Richmond, Va. 229 meters. 150 watts. Grace Covenant Presbyterian church. Announcer, Herbert C. Taylor. Tues, 8 pm, Sun, 11 am, 8 pm, Eastern.

**WBMM**, Chicago, Ill. 226 meters. 1500 watts. Atlas Investment Co. Announcer, Nate Caldwell. Slogan, "World's Best Broadcast Medium." Daily and Sun, 4-6 pm, Mon, 6-7 pm, Tues, Thurs, Sat, 8-12 midnight. Wed, Fri, Sun, 8-10 pm, Sun, 12-3 am, Central.

**WBPP**, Potoskey, Mich. 288 meters. 200 watts. Potoskey High School. Announcer, Carl Bowman. Wed, 9:30-10:30 pm, popular program. Fri, 8-9:30 pm, athletics. Sun, 10:30 am, service; 3 pm, sacred concert. Central.

**WBRR**, Staten Island, N. Y. City, N. Y. 272.6 meters. 500 watts. International Bible Students' Association. Mon, Thurs, Sat, 8-9 pm, lectures, music. Sun, 10-11:30 am, 9-10:30 pm, Eastern.

**WBSS**, New Orleans, La. 252 meters. 50 watts. First Baptist church. Slogan, "The Gospel Wave." Sun, 11 am, 7:30 pm, service. Central.

**WBUB**, Monmouth, Ill. 224 meters. 10 watts. Jenks Motor Sales Co. Mon, Thurs, 8 pm, Central.

**WBWV**, Norfolk, Va. 222 meters. 50 watts. Ruffner Junior High School. Announcer, Lee M. Klinefelter. Slogan, "The School You'd Like to Go to."

**WBBY**, Charleston, S. C. 238 meters. 10 watts. Washington Light Infantry. Announcer, Hugh Easterly. Eastern.

**WBBZ**, Chicago, Ill. 215.7 meters. 50 watts. C. L. Carrell.

**WBON**, Chicago, Ill. 286 meters. 500 watts. Southtown "Economist" Announcer, Larry A. Zook, Jr. Slogan, "World's Best Community Newspaper." Daily ex Sun, 5-5:15 pm, police. Daily ex Sun, Mon, 7-8 pm, Mon, Wed, Sat, 3-5 pm, Tues, 10-12 midnight; 12-2, pirate ship. Wed, Fri, Sat, 10-12 midnight. Thurs, 10-1 am, Sun, 10:30-12 m, church service; 4-5 pm, 7:45-8:15 pm, church service. Central.

**WBDC**, Grand Rapids, Mich. 256 meters. 50 watts. Baxter Laundry and Dry Cleaning Co. Announcer, Richard Smith.

**WBES**, Takoma Park, Md. 222 meters. 100 watts. "Bliss Elec. School. Fri, 6-7 pm, Eastern.

**WBNY**, New York, N. Y. 209.7 meters. 500 watts. "Warners' Theater. Announcer, S. N. Baruch. Daily ex Sun, 4-5 pm, 7-10, Eastern.

**WBOQ**, Richmond Hill, N. Y. 236 meters. 100 watts. A. H. Grebe & Co., Inc.

**WBR**, Butler, Pa. 1189 meters. 100 watts. Pa. State Police. Announcer, E. T. Denton.

**WBRC**, Birmingham, Ala. 248 meters. 50 watts. Bell Radio Corporation. Mon, Wed, 8 pm; Sat, 9-12 midnight. Central.

**WBRE**, Wilkes-Barre, Pa. 231 meters. 100 watts. Baltimore Radio Exchange. Wed, Fri, Sun, 8:30-11:30 pm, Eastern.

**WBT**, Charlotte, N. C. 275 meters. 250 watts. Charlotte Chamber of Commerce.

**WBZ**, Springfield, Mass. 333.1 meters. 2000 watts. Westinghouse Elec. & Mfg. Co. Announcer, A. E. Bach. Daily ex Sat, Sun, 6-8 pm, music, markets; 8-10:15, music. Sun, 8 pm, organ; 8:30, concert. Eastern.

**WBZA**, Boston, Mass. 242 meters. 250 watts. Westinghouse Elec. & Mfg. Co.

**WBZC**, Storrs, Conn. 275 meters. 500 watts. Connecticut College. Announcer, Daniel E. Noble. Slogan, "From the Nutmeg State." Mon, Wed, Fri, 7:15-9 pm, Eastern.

**WCAD**, Canton, N. Y. 263 meters. 250 watts. St. Lawrence Univ. Announcer, Ward C. Priest. Slogan, "The Voice of the North Country." Daily, 11 am, weather, reports, time. Wed, 8 pm, Eastern.

**WCAE**, Pittsburgh, Pa. 461.3 meters. 500 watts. Kaufman & Baer Co., Pittsburgh Press. Announcer, Joseph Sartory. Daily ex Sun, 12:30 pm, news; 3, theater program; 4:30, reports; 6:30, music; 7:30, Sunshine Girl. Mon, 7:45 pm, police reports; 8:30, 9, 11, Tues, 7:45 pm, 8, 8:30, 9, 10, Wed, 7:45 pm, 8:30, 9, 11, Thurs, 8 pm, 8:30, 9, 10, Fri, 7:50 pm, 8:30, 10, Sat, 7:45 pm, 8, 8:15, 8:30, Sun, 3:45 pm, 6:30, 7:20, Eastern.

**WCAH**, Columbus, O. 266 meters. 500 watts. Entreklin Elec. Co., Central.

**WCAI**, Univ. of Nebr. 254 meters. 300 watts. "Nebr. Wesleyan Univ. Announcer, J. C. Jensen. Daily, 4:30 pm, weather. Mon, 8 pm, music, lectures. Central.

**WCAL**, Northfield, Minn. 336.9 meters. 500 watts. Dept. of Physics, St. Olaf College. Announcer, Kenneth Onsgard. Slogan, "The College on the Hill." Daily ex Sun, Thurs, 9:45 am, chapel, Thurs, 9 pm, music. Fri, 8:30 pm, talk. Sun, 8:30 pm, sermon, music. Central.

**WCAN**, Baltimore, Md. 275 meters. 100 watts. Albert A. and A. Stanley Brager. Announcer, R. E. Brunner. Slogan, "The People's Store." Mon, Wed, Fri, 6:30-8 pm, dinner music; 8-9:30; 9:30-11, Eastern.

**WCAP**, Washington, D. C. 468.5 meters. 500 watts. Chesapeake & Potomac Tel. Co. Announcer, O. P. Gascoigne. Mon, 7-12 pm, Wed, 7-12 pm, Fri, 7-12 pm, Sun, 11 am, 4 pm, 7:20-10:15 pm, Eastern.

**WCAR**, San Antonio, Texas. 263 meters. 500 watts. "Southern Radio Corp. of Texas. Announcer, L. Tatom. Club, "Royal Order of Prevaricators." Mon, Thurs, Sat, 8:30-9:30 pm, concert. Wed, Sat, 11 pm, Central.

**WCAT**, Rapid City, S. D. 240 meters. 50 watts. S. D. State School of Mines. Announcer, J. O. Kammerman. Daily ex Sun, 9:30 am, 12:30 pm, weather, reports. Thurs, 7:30 pm, concert. Mountain.

**WCAU**, Philadelphia, Pa. 278 meters. 500 watts. United Broadcasting Company. Announcer, Eddie Malle. Mon, 8-11 pm, Tues, 7:30-12, Wed, 7:30-11, Thurs, 6:30-12 midnight, Fri, 7:45-12:30 am, Sun, 5-11:20 pm, Eastern.

**WCAX**, Burlington, Vt. 252 meters. 100 watts. University of Vermont. Slogan, "The Voice of the Green Mountains." Mon, 8-9:30 pm. Closed after August 16 for rest of Eastern.

**WCAY**, Carthage, Mo. 248 meters. 50 watts. Carthage College. Wed, 9-10 pm, Central.

**WCBA**, Allentown, Pa. 254 meters. 15 watts. Queen City Radio station. Wed, 8:15-11 pm, Fri, 6:45-7:45 pm, bedtime stories, Bible lessons. Sun, 7 pm, church service. Eastern.

**WCBD**, Zion, Ill. 344.6 meters. 5000 watts. Wilbur Glenn Fugate. Announcer, J. H. DeFev. Slogan, "Where God Rules, Man prospers." Tues, Thurs, 8-10:30 pm, concert. Wed, 12-1:15 pm, organ. Thurs, 2:30-3:45 pm, service. Sun, 9-10:45 am, Bible school; 2:30-6 pm, church services. Sun, 8-10:30 pm, Central.

**WCBE**, New Orleans, La. 263 meters. 500 watts. Unait "Second Radio Co. Announcer, Joe Ubalk. Slogan, "Second Post U. S. Army. 7:30-8:30 am, dance. Sun, 12:30-2 pm, dinner concert; 9, dance music. Central.

**WCBG**, Herrin, Ill. 268 meters. 10 watts. Howard S. Williams.

**WCBH**, Oxford, Miss. 242 meters. 50 watts. U. of Mississippi. Announcer, W. L. Kennon.

**WCBM**, Baltimore, Md. 229 meters. 50 watts. Hotel Chateau. Announcer, Harry Dobb. Tues, 11:30-1 am, Thurs, 9:30-11 pm, Sat, 10-12, Sun, 9:45-11:30 pm, Eastern.

**WCBQ**, Nashville, Tenn. 242 meters. 100 watts. First Baptist church. Announcer, Harry Stone. Sun, 7:30 pm, Central.

**WCBR**, Providence, R. I. 205.4 meters. 30 watts. Charles H. Messier. (Portable).

**WCCO**, Minneapolis-St. Paul, Minn. 416.4 meters. 5,000 watts. Washburn-Crosby Co. Announcer, Paul Johnson. Slogan, "Service to the Northwest." Daily ex Sun, 9:30 am, program; 9:30, news; 9:45, 10:30, 11:30, markets; 12, noon concert; 2:05 pm, woman's hour; 3, markets. Daily ex Sun, 10 pm, gram, markets; Mon, Wed, 2:30 pm, Thurs, 2:30 pm, dance. Sat, Sun, 5:30 pm, children's hour. Mon, 6:05 pm, 6:45, P. & R. Family; Tues, 6:15 pm, 7:30, 8, 9, Wed, 6:30 pm, reports; 7, 7:30, 8, 8:30, 9, 10:30, 11:30, Thurs, 7-10 pm, 10, weather. Fri, 6:15 pm, music; 8, 8:15, 10, Sat, 2 pm, 9, 9:35, 9:40, 11:30, news; Sun, 10:20 am, church; 4:10 pm, service; 8:15 pm, music; 9:15, weather; 9:20, concert. Central.

**WCLO**, Camp Lake, Wis. 231 meters. 50 watts. C. E. Whitmore.

**WCLS**, Joliet, Ill. 214.2 meters. 150 watts. Harold M. Couch. Slogan, "Will County's Largest Store." Mon, Wed, Fri, Sat, 8-12 midnight. Central.

**WCSH**, Portland, Maine. 258.3 meters. 500 watts. Congregational church.

**WCSD**, Springfield, O. 248 meters. 100 watts. Wittenberg college. Announcer, Lester Crowl.

**WCWU**, Worcester, Mass. 238 meters. 250 watts. Clark University, Collegiate Dept. Fri, 8-11 pm, concert. Eastern.

**WCWS**, Providence, R. I. 209.7 meters. 100 watts. Charles W. Ham. Selen.

**WCX**, Annapolis, Md. 518.9 meters. 5,000 watts. The Detroit Free Press. Announcer, R. C. L'Amoreaux. Club, "Red Apple Club." Daily ex Sun, 2 pm, news; 3, stock reports, weather, markets; 6, dinner concert; 8, orchestra. Tues, 10-2, club. Fri, 9-11, dance. Sun, 10:30 am, 6 pm, orchestra. Eastern.

**WDAD**, Nashville, Tenn. 226 meters. 150 watts. Dad's Auto Accessories, Inc. Announcer, Dean N. Smith. Slogan, "The Athens of the South." Daily ex Sun, 3:30-4:30 pm; 7:30-9. Central.

**WDAE**, Tampa, Fla. 273 meters. 250 watts. Tampa Daily Times. Announcer, Dave Ginsburg. Daily, 7:30, Tues, 8-10 pm, Thurs, 8-10 pm.

**WDAF**, Kansas City, Mo. 305.6 meters. 1,000 watts. "Kansas City Star. Announcer, Dean Fitzer. Club, "Nighthawks." Daily ex Sun, 3:30-4:30 pm, music; 5:50, markets, weather; 6-7, educational, bedtime story, music; 11:45, Nighthawks. Mon, Wed, Fri,

8-9:15 pm, concert. Mon, Wed, Fri, 10:45 am, home service talks. Tues, 4-15 pm, service. Central.

**WDAG**, Amarillo, Tex. 263 meters. 100 watts. J. Lawrence Martin. Slogan, "Where Dollars Always Grow." Daily ex Sun, 8 pm, Central.

**WDAY**, Fargo, N. D. 261 meters. 500 watts. Radio "Equip. Corp. Announcer, K. M. Hance. Slogan, "The Biggest Little City in the World." Daily ex Sun, 9:30 am, markets, weather, news; 10-11:30, markets; 12:30, music; 3 pm, Radio farm school; 1:10, markets; 5, music; 5:30, news. Tues, Thurs, Sat, 7:30 pm, musical. Sun, 10:30 am, church services. Sun, 4 pm, music; 7:30 pm, church. Central.

**WBBC**, Lancaster, Pa. 258 meters. 50 watts. Kirk Johnson & Co., Inc.

**WBDE**, Atlanta, Ga. 278 meters. 100 watts. Gilham-Schoen Elec. Co. Announcer, E. E. Floyd. Slogan, "We Distribute Better Equipment." Tues, Sat, 9-10 pm, music. Central.

**WBBI**, Roanoke, Va. 229 meters. 50 watts. Richardscr Wayland Elec. Corp. Announcer, Glen Baylor. Slogan, "Roanoke Down in Old Virginia." Daily ex Sun, 12-1 pm, music; 5:30-6:45, music, news, weather, baseball, Wed, Sat, 9 pm, concert. Eastern.

**WBCK**, Cleveland, Ohio. 227 meters. 100 watts. M. F. Broz Furniture. Tues, Sat, 8-12:30 am, Eastern.

**WBDO**, Winter Park, Fla. 240 meters. 100 watts. Rollins College, Inc. Slogan, "Wander Down by Orlando."

**WBQ**, Salem, N. J. 234 meters. 10 watts. Morton Radio Supply Co. Announcer, Wm. T. Gallaway. Irregular weekly schedule.

**WBRR**, Boston, Mass. 261 meters. 100 watts. Tremont Temple Baptist church. Announcer, Raymond H. Meader. Fri, 7:30-8:30 pm, Sun, 10:30 am; 6:30 pm, church services. Eastern.

**WBRY**, Chicago, Ill. 258 meters. 500 watts. North Shore Congregational church. Announcer, Rev. J. C. O'Hair. Wed, 7-8 pm, Fri, 7:30-9 pm, Sun, 11-12:30 pm; 3:30-5, service. Central.

**WBZB**, Kingston, N. Y. 233 meters. 100 watts. Boy Scouts of America. Announcer, G. Henry Nesslage.

**WDCH**, Hanover, N. H. 256 meters. 100 watts. Dartmouth College.

**WOOD**, Chattanooga, Tenn. 256 meters. 500 watts. Chattanooga Radio Co., Inc. Announcer, Dick L. Park. Slogan, "Wonderful Dynamo of Dixie." Mon, 7-8 pm, 8:15, 8:30-9:30, Tues, 2 and 4 of each month, 9-10 pm, Wed, 7-8 pm, 8:30-9:30, Fri, 7-3 pm, 8:30-11:30, Sun, 7:30 pm, Central.

**WDRG**, New Haven, Conn. 263 meters. 100 watts. "Doolittle Radio Corp. Mon, 8:15 pm, Daily ex Sun, 6:45-7:15 pm, news service. Sun, 11 am, Eastern.

**WDWF**, Providence, R. I. 440.9 meters. 500 watts. Duce W. Flint, Inc. Slogan, "Quality First." Tues, 8:30 pm, Thurs, 6:30-8 pm, talks. Sun, 10 am, 5 pm, Eastern.

**WDZ**, Tuscola, Ill. 273 meters. 100 watts. James L. Bush. Daily ex Sun, 9:30 am, 11, 10:30, 11, 11:30, 12 m, 12:30 pm, 1, 1:15, Chicago Board of Trade quotations. Central.

**WEAF**, New York, N. Y. 491.5 meters. 5,000 watts. "A. T. & T. Co. Slogan, "The Voice to the Millions." Daily ex Sun, 6:45-7:45 am, Mon, Wed, Fri, 10:45-12, Tues, Thurs, 11-12 m, Daily ex Sun, 4-5 pm, Mon, 6-11:30 pm, Daily ex Sun, Mon, 6-12 midnight. Sun, 2-5 pm, 7:30-10:15, Eastern.

**WEAH**, Wichita, Kan. 268 meters. 500 watts. Hotel Lassen.

**WEAI**, Ithaca, N. Y. 286 meters. 500 watts. Cornell Univ. Irregular.

**WEAM**, North Plainfield, N. J. 261 meters. 250 watts. Borough of N. Plainfield. Announcer, H. W. Blackford. Slogan, "America's Pioneer Municipal Broadcasting Station." 8-12 pm, concert, talks. Eastern.

**WEAN**, Providence, R. I. 270 meters. 500 watts. "The Shepard Stores. Announcer, Chester H. Miller. Daily ex Sun, 12-1 pm, 4-5, music, reports, weather, concert; 6:30-10:30, Sun, 10:45-11:30 am, 7:30-8:45 pm, church service. Eastern.

**WEAO**, Columbus, O. 293.9 meters. 500 watts. Ohio State Univ. Daily ex Sun, 9:45 am, 11-1 pm, markets, weather; 8 pm, music, lectures. Eastern.

**WEAR**, Cleveland, Ohio. 389.4 meters. 750 watts. "The Goodbye Sign & Rubber Co. Announcer, H. K. Carpenter. Slogan, "Goodbye Tires WEAR." Daily ex Sun, 11-12:10 pm, Daily ex Sat, Sun, 3:30-4:10 pm, markets, weather. Daily, 7 pm, Thurs, Thurs, Fri, 8-11 pm, Sun, 3:30-5 pm, 7-10, Eastern.

**WEAU**, Sioux City, Ia. 275 meters. 100 watts. Davidson Bros. Co. Announcer, B. M. Smith. Slogan, "The Heart of the Corn Belt." Daily ex Sun, 9 am, 10, 11, 12 m, 1 pm, 5, markets, weather, sports. Central.

**WEBA**, New Brunswick, N. J. 233 meters. 15 watts. The Electric Shop, George N. DeLapina. Slogan, "Wonderful Evenings by Air WEBA." Mon, Thurs, 8-10 pm, music. Eastern.

**WEEB**, Superior, Wis. 242 meters. 100 watts. Walter Cecil Bridges. Daily ex Sun, 6:15-8 pm, Mon, 8:30-9:30 pm, Wed, Sat, 9-11 pm, Central.

**WEEC**, Anderson, Indiana. 246 meters. 15 watts. Elce. Equip. & Service Co. Announcer, F. R. Fulwider. Tues, Fri, 8:30 pm, Sun, 7:30 pm, service. Central.

**WEEB**, Cambridge, Ohio. 234 meters. 10 watts. Roy W. "Walter. Off the air

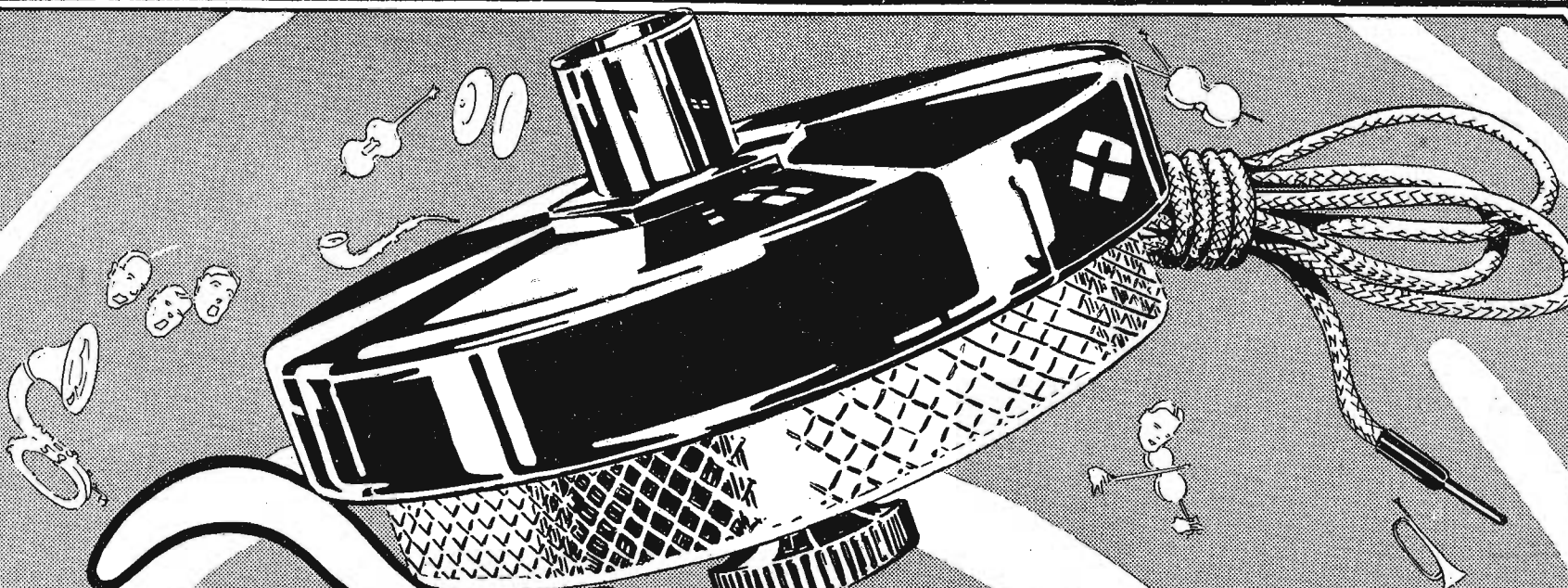

**\$3.95**

# Tower

## Phonograph Attachment

### Put Your Phonograph to Work!

**All Tower Loudspeakers equipped with adjustable units**

The Tower Adjustable Phonograph Unit enables you to transform your phonograph into a loud speaker. Fits all standard makes of talking machines. Easily applied. Being adjustable, this Tower attachment meets the latest broadcast requirements.

Whether this Tower Phonograph attachment, latest type of Speaker, or Headset, you'll find a Tower quality product—tested by use—to fit your taste and pocketbook.

*Wherever there are ears that hear, there's a Tower product for your pleasure and enjoyment.*

*On Sale at Reliable Dealers Everywhere*

**TOWER MFG. CORPORATION**  
 98 BROOKLINE AVE. BOSTON MASS.

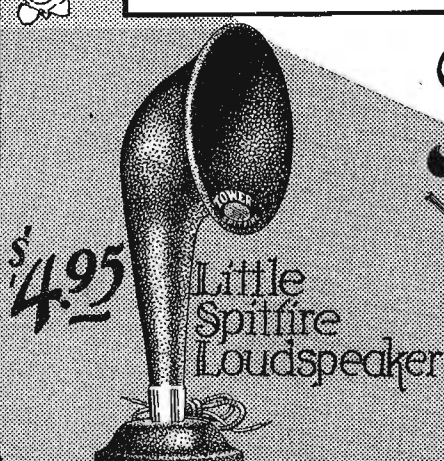

**\$4.95**  
 Little Spiffire Loudspeaker

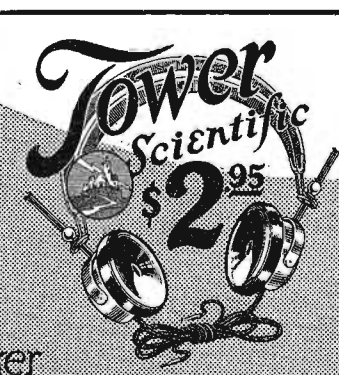

**Tower Scientific**  
**\$2.95**



**\$8.50**  
 Scientific Loudspeaker

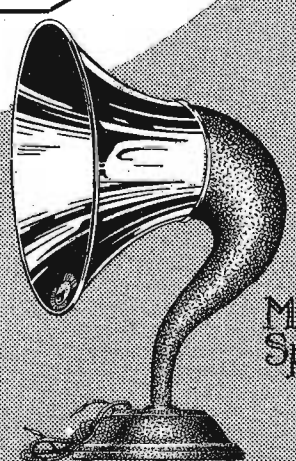

**\$15.00**  
 Meistersinger Speaker

**WORLD'S GREATEST LOUDSPEAKER VALUES**