

New "Traveler" Doughnut Coil Tuned R.F. Receiver; Radio Football Schedules; KSD, St. Louis, in Pictures; Do's and Don'ts of Antennas; A-B-C's of Radio

Radio Digest

EVERY WEEK

PROGRAMS Illustrated

TEN CENTS

REG. U. S. PAT. OFF. & DOM. OF CANADA

Vol. XV

Copyright 1925
By Radio Digest Publishing Co.

SATURDAY, OCTOBER 10, 1925

No. 1

BIG LOSS SAYS MARCONI

'LET PUBLIC CENSOR' SAY BROADCASTERS

ASSOCIATION ASKS CHANGE IN COPYRIGHT STATUTE

Refer Wave Allotment Muddle to Committee; WEAJ Joins National Organization; New Officers

NEW YORK.—Among the more important topics discussed by the National Association of Broadcasters at their annual convention, held here, recently, were the music copyright situation, censorship of Radio programs, the use of superpower, and wave allotments.

The consensus of opinion in regard to the all important matter of censorship is expressed in the words of a resolution passed by the association: "—Any agency of program censorship other than public opinion is not necessary and would be detrimental to the advancement of the art."

Radio Depends on Good Will

In passing the above resolution the members of the association realized that the very life of broadcasting depends on the good will of the Radio audience and that all censorship must therefore come from them. Too many arts have been hampered in this country by censorship from more or less disinterested parties, and in expressing themselves early in the growth of the newest art, the broadcasters are paving the way to keep Radio free from narrow minded oppression under the guise of censorship.

It was decided to submit the following resolution to all broadcasters in the country for their action: "—That the prin-

(Continued on page 2)



Down in the left corner is Emily Schneider, soprano, heard from WJJD's Palmer House studio. The captivating smile in the center is that of Marian LaCour, who took a leading part in W K R C's "Ye Old Time Opera Show." Lower right, Bertha Frid, South America's leading soprano, recently sang at WOR.

WASTE WAVES WITH PRESENT BROADCASTS

Inventor Favors Beams

Smaller Stations Best—Expensive High Power Not Necessary for Long Distance Work

LONDON, Eng.—"Electric waves are far too valuable to be always broadcast in all directions, especially when it is desired to communicate only with one particular place or area," said Senatore Guglielmo Marconi, in inaugurating the Radio exposition here.

"For this reason," continued the great inventor, "the beam station being erected for communication between Britain, Canada, Australia, India, and South Africa are likely to provide what might almost be considered a new method of communication destined to fill a position of the greatest importance for cheapening communication throughout the world."

(Continued on page 2)



RADIO CONFAB DATE STILL WAITS TERRELL

Latter Part of October or Early November Probable

WASHINGTON, D. C.—While no date for the fourth Radio conference here has been set by Secretary of Commerce Hoover, there is a general impression that the conference will be held the latter part of October, or early in November.

The setting of the date for the conference depends almost entirely upon the return to the United States of William Terrell, chief of the Radio section of the department of commerce, and Representative Wallace White of Maine, sponsor of the many times tabled Radio bill.

If the Paris conference is not concluded within a reasonable period of time it is expected that the secretary will cable Mr. Terrell to return.



NATIONAL ASSN. OF BROADCASTERS MEETS; ELECTS DR. F. W. ELLIOTT HEAD



A high distinction was voted Dr. F. W. Elliott, vice-president and general manager of the Palmer School of Chiropractic at Davenport, Ia., owners of Station WOC, when the National Assn. of Broadcasters met recently in New York and elected him president for the ensuing year. Dr. Elliott is shown at the left. Group picture, showing a few members of the association, includes, left to right: front row, A. H. Grebe, WAHG; Powel Crosley, WLW; President Elliott, WOC; Paul Klugh, executive secretary; back row, Judge C. H. Tuttle, legal adviser; H. J. Powers, WARC; W. A. Heinz, WHO; John Shepard III, WNAC, and George Morris, WGN. E. F. McDonald, Jr., retiring president of the association, was unable to be present. He is aboard the S.S. Feary, returning with the MacMillan polar expedition.

SAVE WASTE—MARCONI

(Continued from page 1)

"Telephonic broadcasting," he continued, "is rapidly becoming a necessity in every civilized country as a potent means of disseminating instructions, information, and entertainment.

"We should not, however, forget what Radio has done for many years for commercial telegraphic communications, the important part it played in the great war, and, above all, in diminishing the perils of navigation and in the saving of life at sea.

"But the art of Radio-communication is now undergoing a complete process of evolution, the effects of which are still difficult to foresee." (Senatore Marconi is obviously referring here to the beam system of directional transmission).

Short Wave Possibilities Great

"The extraordinary result obtained in recent years by means of short waves, and the possibility of projecting them in beams covering only a limited area, seems to indicate that the previously planned powerful and very expensive stations will no longer be necessary for long distance communication, and that better and more reliable services can be established and maintained by means of much less costly stations, working at higher speed and utilizing a far smaller amount of electrical energy."

Senatore Marconi confessed to "being at times amused at the discussions which occasionally take place as to who is the real inventor of Radio."

"To my mind," declared the great inventor, "Radio existed when prehistoric man first understood or felt the meaning of a smile of encouragement from the prehistoric girl, when human beings first succeeded in talking to each other or were able to understand or decipher signals or signs made to them from a distance.

"What I think I did discover is that electric waves are capable of travelling and being received across very great distances."

Original Waves Very Short

Senatore Marconi recalled that his original apparatus of 30 years ago utilized waves far shorter than the shortest waves which have recently been attracting the attention of the Radio world. Speaking of his early work, he paid a warm tribute to the late Sir William Preece, engineer-in-chief of the British post office 30 years ago.

"Sir William," he said, "was one of the very few scientists who at that early date realized something of the enormous possibilities of electric waves. I shall ever be grateful to his memory and also to those authorities of the post office who realized so soon the importance of the work on which I was engaged."

ASK PUBLIC BE CENSOR

(Continued from page 1)

principle involved in the reproduction of music by mechanical means, now embodied in the present copyright law, be extended to the reproduction of music by Radio."

In explanation to the foregoing it was brought up in meeting that ever since broadcasting was started there has been a conflict between the publishers of music

and the broadcasting stations over the public performances of music. At first broadcasters took the position that the copyright law did not contemplate, and therefore did not cover broadcasting of music, for the reason that such broadcasting is in the nature of a public service and is without any means of having

direct pecuniary return from the listeners. For various reasons the position of the broadcasters is now changed to one desiring to see that the writers of songs themselves as well as their assignees, shall be paid a fair sum.

No agreement could be reached on the matter of superpower, hence no resolution

was passed. The trend of opinion, however, among the stronger stations was definitely toward increased power, the only limitation being, in their opinion, that any increase of power be based upon non-interference with other stations.

The untangling of the wave allotment problem was referred to a committee to look into and submit a report at the next meeting.

WEAF Joins Association

The membership committee reported favorably upon a large number of applications, principal among which was Station WEAF, the American Telephone and Telegraph company of New York. All were unanimously elected to membership. Mr. Harkness, speaking for the A. T. & T. company, in addressing the convention, dwelt upon the necessity of having all small stations members, and he stated that the association should pay particular attention to the problems of small stations.

Upon vote it was decided that the country be divided into five divisions, New England, Atlantic, Great Lakes, Central and Pacific, with regional chairman to be charged with the duty of calling meetings for their regions when matters were up for decision which could not be delayed until the time of meetings of the whole association. These chairmen are in charge of the activities of their various region.

Elect New Officers

New officers were elected as follows: President, WOC, Frank W. Elliot, Davenport, Iowa; Vice President, WHO, Wm. H. Heinz, Des Moines, Iowa; Vice President, WLW, Powel Crosley, Jr., Cincinnati, O.; Secretary, KFI, A. F. Kales, Los Angeles, Cal.; Treasurer, WNAC, John Shepard III, Boston, Mass.; Executive Chairman, Paul B. Klugh, New York city.

Regional Chairmen

For New England, WTIC, W. G. Cowles, Hartford, Conn.; for Atlantic, WAHG, Alfred H. Grebe, New York City; for Great Lakes, WJR, E. H. Jewett, Pontiac, Mich.; for Central, WHO, George Kuhns, Des Moines, Iowa; for Pacific, KFI, Earle C. Anthony, Los Angeles, Cal.

Directors

KFAB, Charles Stuart, Lincoln, Nebr.; KFIX, Arthur B. Church, Independence, Mo.; KFWA, Robert Nevins, Ogden, Utah; KLLX, J. R. Knowland, Oakland, Calif.; KPO, R. B. Hale, San Francisco, Calif.; WCCO, Prof. C. M. Jansky, Jr., Minneapolis-St. Paul, Minn.; WEAF, W. E. Harkness, New York City; WFBG, Walter S. Greevy, Altoona, Pa.; WGHP, George Harrison Phelps, Detroit, Mich.; WGN, George Morris, Chicago, Ill.; WGR, W. W. Kidney, Buffalo, N. Y.; WHT, H. H. Blight, Chicago, Ill.; WIP, Richard Gimbel, Philadelphia, Pa.; WJAZ, E. F. McDonald, Jr., Chicago, Ill.; WLS, Edgar Bill, Chicago, Ill.; WTAM, S. E. Baldwin, Cleveland, Ohio.

Fans Want WORD Lifted

WASHINGTON, D. C.—The department of commerce is in receipt of a petition signed by several thousand listeners, requesting the department to give Station WORD at Batavia, Illinois, a higher wave length. No action has yet been taken.

WKAR Resumes Schedule

LANSING, Mich.—WKAR, at Michigan state college, resumed its regular schedule on October 1. The power of the station has been increased from 500 to 1,000 watts.

CONTENTS

Radio Digest, Illustrated, Volume XV, Number 1, published Chicago, Illinois, October 10, 1925. Published weekly by Radio Digest Publishing Company, 510 N. Dearborn Street, Chicago, Illinois. Subscription rates, yearly, Five Dollars; Foreign Postage One Dollar additional; single copies Ten Cents. Entered as second class matter at the post office at Chicago, Illinois, under the Act of March 3, 1879.

All the Live News of Radio.....	1 to 7
KSD, "The Station Without a Slogan".....	5
Advance Programs for the Week.....	8 to 13
Following Sports Through Mike.....	14
An Evening at Home with the Listener In, a chart in central and eastern time, showing when to listen in for your favorite stations.....	15
Editorials, Indi-Gest and Condensed by Dielectric.....	16
"Traveler": Doughnut Coil Tuned R.F. Receiver, Part I—Analysis of Parts Used, by John G. Ryan.....	17
A. B. C. Course in Radio Fundamentals, Chapter XXIX—Applications of the Electron Tube Oscillator, by David Penn Moreton.....	19
The Do's and Don'ts of Antenna Construction, Part II—Outdoor Antennas, by William Fenwick.....	20
Three Tube Reflex Free of Static? Other Kinks.....	21
Questions and Answers.....	22
Directory of Radiophone Broadcasting Stations, Part II.....	23

Looking Ahead

"Where Joy Reigns!" That is the slogan of the station to be described in word and picture next week. It is also the station now the home of the "Merry Old Chief," formerly of WDAF; C. W. Kirby, formerly of WWJ, and Howard Campbell, once chief engineer at WWJ. This station is located in Pontiac, Michigan, but the studio is in Detroit, and its call letters are WJR.

Following Sports Through Mike, the first Radio sporting page, will continue to be the source of the most complete information obtainable of sporting events that are sent out on the ether from stations all over the country. If you can't go back to the old school for home-coming, listen to them defeating the old hated rivals over the Radio.

The Radio Digest Grand Prix Super-Heterodyne, the real receiver for all of you who like to make them, will be a surprise to anticipate. It's coming soon, perhaps next issue, but not later than that dated October 24.

Drilling Layouts for the "Traveler" Receiver will be included by Mr. Ryan in next week's installment on the construction of this set. There will also be photos showing the work at various stages in its assembly and wiring. Readers who have hesitated at constructing a receiver can follow this series with confidence of success.

Construction of Masts for Outside Antenna Installation will be the subject taken up next week by William Fenwick in the third article of his series on aerials. Before it gets too cold get that new antenna up and get it up right, away from metal roofs and clear of chimneys and trees.

Newsstands Don't Always Have One Left

WHEN YOU WANT

Radio Digest

YOU WANT IT!

BE SURE OF YOUR WEEKLY COPY, BY SUBSCRIBING NOW

SEND IN THE BLANK TODAY

Publisher Radio Digest, 510 N. Dearborn St., Chicago, Illinois.

Please find enclosed check M. O. for Five Dollars (Six, Foreign) for One Year's Subscription to Radio Digest, Illustrated.

Name

Address

City State

Comman of the ill-story bef-times on so that States and the thrill-braved de

Coon an hawks of son on S were hear tion KYV heard fro

Abe Ly ing orche of WLS, evening, aggregati Hotel Sh intervals tinue all

Vincent vania of from WE —every from 11 time.

In view in the a week to Period" (an autog to those

WTIC, pany at appointr manager Billings resigned.

Instea around t 10, KTF going ti feet to party o receiving

Additi a mam WSB's ard the creasing listener: frolics :

Jack its pho harmon its orig cago T They a 10:30 a

"The initial Westin ing of entirely circles. implies to the tery to The ne

Radi Hector tainer from t be ple this o Tuesda

Thu and 1 "Expr Crothe by ten the di

Six songs Electi durin nesda 8:10 c given tone :

The Oakla undei natio solois addre churc

NEWS BRIEFS FROM THE BROADCASTERS

TRANSPACIFIC FLYERS AT KGO MIKE THRILL ALL

Coon and Sanders Back at KYW; WLS Adds Recording Orchestra; Other News Notes

Commander John Rodgers and the crew of the ill-fated seaplane PN-9 told their story before KGO microphones three times on their arrival in San Francisco so that Radio listeners in the United States and Canada could hear first hand the thrilling experiences of the men who braved death and won.

Coon and Sanders, the original Night-hawks of the air, opened their winter season on Saturday, October 3, when they were heard again over Westinghouse Station KYW. This famous orchestra was heard from KYW all last winter.

Abe Lyman and his Brunswick recording orchestra are now a regular feature of WLS, the Sears-Roebuck station every evening. Dance music by this celebrated aggregation of artists at the College Inn, Hotel Sherman, Chicago, is broadcast at intervals during the evening and will continue all winter.

Vincent Lopez and his Hotel Pennsylvania orchestra are now broadcasting from WEAJ under a new time schedule—every Thursday and Saturday evening from 11 o'clock to midnight, eastern time.

In view of the interest of the listeners in the artists who entertain them from week to week, the sponsors of "Pooley Period" over WEAJ have decided to send an autographed photo of any guest artist to those who request one.

WTIC, The Travelers' Insurance company at Hartford, Conn., announces the appointment of Hanford S. Billings as manager in charge of broadcasting. Mr. Billings succeeds Elliot Buse, recently resigned.

Instead of trying for long distance around the world Saturday night, October 10, KTHS will experiment with waves going through the earth's surface 1,000 feet to Diamond cave, Jasper, Ark. A party of Radio fans equipped with a receiving set will report results.

Addition of a symphony orchestra and a mammoth new orchestral organ to WSB's weekly broadcasts from the Howard theater, Atlanta, are bringing an increasingly heavy response from belated listeners who tune in to the footlight frolics at 10:45 p. m., central time.

Jack Chapman's orchestra, famous for its phonograph records and syncopated harmony, has resumed broadcasting from its original home, Station WGN, The Chicago Tribune station on the Drake hotel. They are heard every evening between 10:30 and 11:30, central time.

"The Whatdoyoucallit Club" made its initial bow to the Radio audience over Westinghouse Station WBZ on the evening of October 2. The club is composed entirely of members prominent in musical circles. As the name of the organization implies, there is an element of mystery to the club and a similar degree of mystery to the program that will be given. The next program is on October 16.

Radio listeners who tuned in Charles R. Hector's orchestra, a regular WBZ entertainer last season broadcasting direct from the St. James theater, Boston, will be pleased with the announcement that this orchestra returned to the WBZ air, Tuesday evening, October 6.

Thursday night, October 15, between 8 and 10 o'clock, pacific time, a comedy, "Expressing Willie," written by Rachel Crothers for the stage, will be recreated by ten of the KGO dramatic players under the direction of Wilda Wilson Church.

Six of Harry Lauder's most popular songs will be heard over KOA, General Electric broadcasting station at Denver, during a two-hour studio program, Wednesday evening, October 14, beginning at 8:10 o'clock mountain time. They will be given by Walter G. Tripp, popular baritone and Scotch comedian of Denver.

The late Sunday programs of KTAB, Oakland, at 9:30 p. m. hereafter will be under the auspices of the various denominations around the bay, consisting of the soloists from the best choirs with an address by the pastor of that particular church.

KIDS LIKE MARKETS—ELDERS LIKE TALES

SAN FRANCISCO.—Letters from listeners to Station KGO here show that there are many kiddies who listen to market reports, agriculture lectures, and talks dealing with the realities of life from choice rather than to the bedtime stories and fairy tales. Likewise the letters show that there are just as many grown-ups who listen to the "Children's Half Hour" as there are children to whom the broadcasts were directed.

COMMUNITY SET IN UP-TO-DATE VILLAGE

LOGANSPORT, Ind.—A community Radio set is being operated at the town of Roann, Ind., near here, to furnish entertainment for the 500 people in the village and country nearby. The village also has community motion picture shows, and sometimes the Radio set is operated while the pictures are being shown. Hawaiian programs are especially liked by the citizens, a Roann business firm reports.

CALIFORNIA GIRL IS MISS AMERICA



Immediately after the judges had proclaimed Miss California (Fay Lamphier) queen of American loveliness at the Atlantic City beauty pageant she stepped to the microphone of Station WPG and greeted the Radio audience scattered from coast to coast.

SILENT NIGHT BACK IN CHICAGO AT LAST

ALL STATIONS BUT ONE OFF AIR ON MONDAYS NOW

Strike Ends When Stations Meet Demands Automatically with Change from Daylight Saving Time

The ending of the summer daylight saving time period marked the end of the Chicago silent night squabble which resulted in the first strike of broadcast listeners ever recorded in the short history of Radio. On Monday, September 27, when the time changed back to Central Standard in this area, all of the stations which had been broadcasting seven nights a week in opposition to the striking fans, capitulated and went off the air. That is all except one station did this. WOK, the last plant in the area to go on the air, announced that it would not be silent on Mondays.

Some months ago several of the stations listed by the strikers as "unfair" stated that they would go back on the silent Monday schedule at the end of the summer period. They claimed that during

the static season, a large majority of the fans could not get satisfactory DX anyway and would prefer to listen to Chicago programs rather than to be without entertainment on the one night. WHT, the first broadcaster to make this proposition, merely announced its observance of the Monday silence by leaving that date off the programs issued for nights after the time change. WJJD did the same thing.

They Watch Each Other

Station WORD, at Batavia in the strike area, sent word to the local press of their silence on Mondays starting September 28. WTAS and WCEE, the stations of Attorney Charles Erbstein, announced over the air that his plants would probably observe the rule. His decision depended on the action of the other stations.

WOK, the only station included in the Broadcast Listeners' association's strike which has not signified that it will remain silent on Monday evenings, has many arguments for not doing so. In the first place its wave (217.3 meters) is low and out of the interference area. The nearest class B stations operating on Monday nights are KFVE, St. Louis, 240 meters, and KFWE, Hollywood, Calif., or WGCP, New York, both working on 252 meters. Unless interference with DX reception by WOK is reported by a number of listeners, it is not probable that the station will get off the air.

KENT PROJECT PUTS OPERA STARS ON AIR

RECEIVER MAKER CLOSES DEAL FOR BEST MUSIC

Homer, Hempel, Lashanska, Werrenrath and Brailowsky Among Many Stars on Schedule

NEW YORK.—For the first time in the history of Radio broadcasting, Metropolitan Opera stars and other leading artists of the musical world will broadcast regularly over the Radio.

Announcement has been made by A. Atwater Kent, Radio manufacturer of Philadelphia, that he had closed arrangements under which a group of the best-known concert artists of the United States and Europe will broadcast from Station WEAJ, the American Telephone and Telegraph company, New York, and through other stations with which WEAJ is connected.

The programs will begin at 9:15 o'clock eastern time each Sunday evening and will continue for one hour, with one leading artist, properly assisted. The first program was broadcast Sunday evening, October 4. Reinald Werrenrath, well-known baritone, was the principal artist at that time.

Renowned Artists Scheduled

Artists who are definitely announced for the series are the following:

Louise Homer, contralto; Mabel Garrison, soprano; Anna Case, soprano of the Metropolitan Opera company; Frieda Hempel, soprano; Maria Kurenko, soprano, of Russia; Florence Austral, soprano of Covent Garden, London; Hulda Lashanska, soprano; Reinald Werrenrath, baritone; Edward Johnson, tenor of the Metropolitan Opera company; Albert Spalding, violinist; Alexander Brailowsky, pianist; Paul Althouse and Arthur Middleton of the Metropolitan Opera company; the London String Quartet, of London, England, and the State Symphony orchestra of New York.

Other famous artists will be heard on the air provided permission for broadcasting can be secured from recording and opera companies.

Overcomes Many Obstacles

Mr. Kent, a member of Secretary Herbert Hoover's committee on broadcasting problems, said he made the arrangement in the interest of better Radio programs and as a contribution to the listeners in.

"There has been much discussion of the improvement of broadcasting programs," he said. "I have given considerable thought to how that might be done and decided that if it were possible to bring it about, the American Radio audience should be permitted to hear the best artists the world affords. We had considerable difficulty in securing the services of these artists owing to a variety of obstacles.

"These, however, have been overcome and I am glad to be able to announce definitely that contracts have been signed, under which a large group of the leading artists of the world will be heard on the air each week during the fall and winter Radio season."

New Stations

To New York, already well supplied with Radio stations, is to be added WENY, owned by the Warner theater. This station will broadcast from the theater on 209.7 meters.

At the other side of the world is the new broadcaster KZUY, owned by F. Johnson Elser. This 500-watt station is located at Baguio, Philippine Islands, and may be heard on 360 meters.

Other stations licensed during the month are: KFXH, El Paso, Texas, 50-watts, 242 meters; KFXJ, Denver, Colorado, (portable) 10-watts, 215.7 meters; WDAD, Nashville, Tenn., 150-watts, 226 meters; WRST, Bay Shore, N. Y., 250-watts, 215.7 meters.

A change of call to be noted this week is that of WGAZ, the South Bend Tribune station of South Bend, Indiana, which has become WSBT.

New WRR, Dallas, Will Open Saturday, Oct. 10

DALLAS, Tex.—Radiophone WRR, the municipal plant of this city, returns to the air on Saturday, October 10, with a new 500-watt outfit to replace the old 50-watt pioneer transmitter. John Thorwald and Dr. Dudley V. Wilson, both formerly of WFAA, the Dallas News station, will be identified with the new plant as chief announcer and supervisor respectively. WRR is located in the state fair grounds, owned by the city and used for eleven months of the year as a public park. It is under the direction of a commission, headed by James E. Forrest.

COLLEGE PROFESSOR NOW AT WSM 'MIKE'

NASHVILLE STATION MAN A HARVARD GRADUATE TOO

Jack Keefe's Career Reads Like Romance from School Days to Radio Days

NASHVILLE, Tenn.—Jack Keefe, the only living personification of Ring Lardner's famous comic character, is the vocal pilot of Station WSM, the new 1,000-watt Western Electric plant installed by the National Life and Accident Insurance Co., Inc., of this city.



Jack Keefe

Mr. Keefe made his formal bow to the radio world on WSM's great inaugural program, Monday night, October 5.

The important post of announcer and studio director was given Jack Keefe, because of his many sterling qualities, not only as one of the most popular citizens of Nashville, but as one of the South's most cultured, educated, and gifted gentlemen.

His life reads like a romance and few men have accomplished as much as has Mr. Keefe, in the short span of years he has lived. In 1908 he was graduated from Harvard university, and during that same year he played second base on the varsity ball team, and was feature soloist of the glee club.

Taught in West

From Harvard Mr. Keefe went West and took the position of professor of science and coach of the athletic teams of the Eastern Oregon State Normal school. Thence to Pendleton, as managing secretary of the chamber of commerce. Here he helped organize the famous Pendleton Round-Up.

In 1912 he was musical director for Miller and Draper, producers, and handled Elk minstrel shows in various sections of the United States. He was a member of the vaudeville team of Keefe and Adams, which played on Orpheum and Kelth circuits till 1917.

Has Varied Experience

During the world war he was connected with the bureau of aircraft production of the United States army and navy. He was chief chemist of the alcohol plant in Tennessee until the armistice, then he continued on with the Bon Air Coal and Iron corporation till 1922.

From there he took the chair of assistant professor of bacteriology at Vanderbilt university where he taught in the Vanderbilt laboratory and studied law at the same time. He was graduated from the law school this year. At Vanderbilt he won the Founders Medal, the highest scholarship for the full law course.

And now he has come to Station WSM as announcer and studio director, a position he is fully capable of filling with the highest degree of success.

Education and Culture Are Program Keynotes

KOA Plans Call for Instructive Winter Schedules

DENVER.—Distinctly cultural and educational programs are to hold sway at KOA here during the coming winter season.

KOA's plans call for a university course which includes talks on better English, complete instruction in Spanish and popular chats on history, science and kindred subjects.

Also, it is planned to give to the world much of the richly imaginative Indian lore and legends of the Rocky Mountain West.

Establishment of an open forum, patterned after the Areopagus in its earliest uses, is under consideration as a new attraction. Dramatic productions will continue to command an important place in regular schedules.

Lighter forms of amusement of all kinds will be continued. As in the past, however, these will be chosen with such care that KOA's international audience of listeners may tune in any time and find nothing to offend one's religion, politics, nationalism or artistic sense.

ST. LOUIS PLANS FOR HUGE PLANT

Missouri Merchants Join in Building 5,000-watt Station to Boost City

ST. LOUIS.—Superpower and superprograms will be the keynote of the new 5,000-watt station to be constructed here soon and dedicated as St. Louis' Christmas gift to the nation under the name of the "Voice of St. Louis, the Capital of the Forty-ninth State."

This station, the call letters of which have not as yet been assigned, will be constructed about sixteen miles outside of the city in order not to interfere with local stations now broadcasting. Sixteen firms will cooperate in the organization of a company to erect and operate this plant. The movement for this organiza-

tion was instigated by Thomas P. Convey, manager of the St. Louis Radio Trades association and director of the Southwest National Radio exposition to be held here the week of October 12.

The entire enterprise has been inspired by the civic interest among the organizers, who expect the project to prove an important factor in fostering the development of the city and community. The charter members of the organization are: St. Louis Globe-Democrat, The Merchants' Exchange of St. Louis, The Brown Shoe company, Skouras Brothers' enterprises, C. F. Blanke Tea and Coffee company, Colin B. Kennedy corporation, Wagner Electric corporation, St. Louis Radio Trades association and George Kilgen & Son, Inc.

The Radio club in Berne, Switzerland, is endeavoring to install a broadcasting station with funds raised by public subscription. Half the required amount has been subscribed.

Short Circuit Causes WIBO Assistant Severe Injuries

CHICAGO.—L. G. Rasmussen, assistant operator at Station WIBO, Nelson Brothers-Russo-Florito Orchestral Exchange here, was severely burned recently when the gold frame of his glasses came in contact with a motor generator in the WIBO generator room. Harry Geise, announcer, went to Rasmussen's assistance. He was unconscious and the frame of the glasses had melted. His face, hands, and chest had been burned.

The injured man will recover.

Asia Hears KDKA at Last

PITTSBURGH.—Asia, the last continent to hear Westinghouse Station KDKA's international short wave relay system, has reported reception of the stations programs. A program relayed by the station to the American fleet cruising in Pacific waters was picked up in Yokohama.

The New WAVE MASTER—a Radio Set Worthy to Bear the KELLOGG Name



The Wave Master Console Model
A handsome genuine mahogany design with battery compartments and inbuilt horn. Price, \$275.00
Without battery table, price \$225.00
Also made in the beautiful Console model, genuine mahogany, price, \$235.00

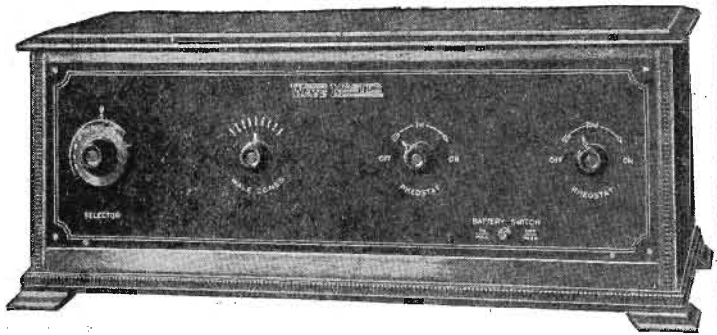

A Year Ahead! The WAVE MASTER, 5-Tube Standard Model
Cabinet of solid, Genuine Mahogany, beautifully finished, 28 inches long, 11 inches high. Price, \$125.00

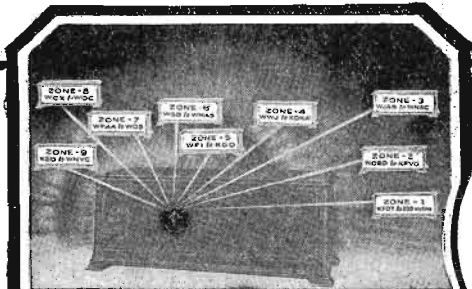

A Separate Circuit for Each 40 Meter Wavelength Band
One-Dial Control, Yet Greater Selectivity.



Kellogg Symphony Reproducer \$25.00

"I never dreamed it was such fun"

"I used to be content to enjoy radio merely as a listener, never realizing how much greater pleasure I was missing. I had no idea of the fascinations of radio tuning—the fun of going after any station and getting it."

WHEN you make a telephone call, the operator connects you first with the "exchange" and then with the desired number of that group or division.

To "connect" the WAVE MASTER instantly with any desired broadcasting station, you first set the pointer for the "Exchange" or wave zone group to which the station belongs and then merely turn the Station Selector dial. "Expert" tuning becomes child's play. To separate stations very close together in their wavelengths, is astonishingly easy. When buying any radio set, protect yourself by learning something about the firm that produced it—their reliability and experience. For 28 years Kellogg has produced the finest of telephone apparatus. Since radio began Kellogg has built the highest quality parts.

If you do not know where you can see, try and hear the WAVE MASTER in your neighborhood, write us. We'll give you the name of your nearest dealer, and, if you wish it, a full technical explanation of the Wave Master Circuit. Ask for Folder No. 4J.

Radio Dealers and Jobbers

The WAVE MASTER franchise backed by Kellogg resources and our powerful advertising campaign, is most valuable. Open territories are being rapidly taken up. If interested, wire or call on us promptly for our money-making proposition.

Kellogg Switchboard & Supply Company
1066 West Adams Street, Chicago, Illinois

KELLOGG WAVE MASTER SWITCHBOARD & SUPPLY CO.

KSD, "The Station Without a Slogan"



Left, Max Steindel, solo cellist, St. Louis Symphony orchestra. Right, Gené Rodemich, conductor of his own Brunswick record orchestra, Grand Central theater. Both are regulars at KSD.

Left, Michel Gusikoff, concert master, St. Louis Symphony orchestra. Circle, Arne Arnesen, regular violin soloist. Both are Victor artists.

STATION KSD was the first Radio broadcasting station to be given a class B license by the United States government. On August 31, 1922, just two months after the station opened, broadcasting was begun at 8 p. m. on the old wave length of 360 meters with a player piano role of Sousa's march, "The Stars and Stripes Forever." At the conclusion of this the KSD announcer told the world of a new honor just conferred upon the station and stated that after an intermission of five minutes the station would again go on the air with its new wave length of 400 meters as a class B station.

The program on this evening was given by Mrs. W. E. Hindle, coloratura soprano, M. A. Worthelmer, violinist, and C. G. Werner, pianist, all St. Louis artists.

In those days all class B stations were on a wave length of 400 meters and class A stations on 360 meters and it was not until the following spring that the wave bands were divided by governmental order, and KSD was assigned its present high wave length of 545.1 meters.

KSD is notable for having made a specialty of high class music. It has broadcast many important addresses, public events, sporting events, etc., but its greatest achievement has been the broadcasting of every symphony program played in St. Louis by the St. Louis Symphony orchestra during the three years of the station's existence. Classical music while a specialty at KSD, has not occupied all the music programs. Many jazz orchestras of national fame have been broadcast by this station, but in jazz, as in classical music, KSD always has stood for the best, and has insisted upon every performance coming up to an established standard.

In some other respects besides the fact that it was the first class B station, KSD has been a pioneer and has set the pace for other stations. It was the first station to make the experiment of broadcasting in the open air. On June 26, 1922, the station was formally opened. It was tested out the preceding night in a manner which not only tested the station, but gave Radio transmission experts an idea of the practicability of a new form of broadcasting. A microphone was placed in the footlights on the immense stage at the municipal open air theater in Forest Park, and was connected by remote control apparatus and land wire to the operating room at KSD. One entire act of DeKoven's "Highway-



Seth Abergh, left, pianist, composer and conductor of the concert ensemble, weekly KSD feature. Right, Esmeralda Berry Mayes, featured violinist.

man" was sent out to the listening public with the simple announcement, "KSD testing." This not only proved the efficiency of the station, but it also was a demonstration of the feasibility of broadcasting open air performances.

KSD has never had any regular station entertainers. Its idea on this subject has been that variety was the thing most desired. It has, however, had some regular features, notably, the orchestras of the Grand Central, Missouri and Lyric theaters, City club, Missouri Athletic association, and Statler and Jefferson hotels, theater productions, entire performances of grand opera, light opera, and other exercises of all sorts also have been broadcast.

KSD was the only station in America to broadcast any of the concerts given by the Sistine choir of Rome, Italy, during its tour of this country in 1923-1924, and was the first station to broadcast high mass from a Catholic cathedral. It also was the first station to send out the voice of a president of the United States. On June 21, 1923, President Harding was in St. Louis on the first lap of the tour which ended with his very sudden and tragic death. He made an address at the St. Louis Coliseum on the world court, and KSD broadcast this speech. Later on KSD broadcast the message to congress of President Coolidge and has (Continued on page 6)

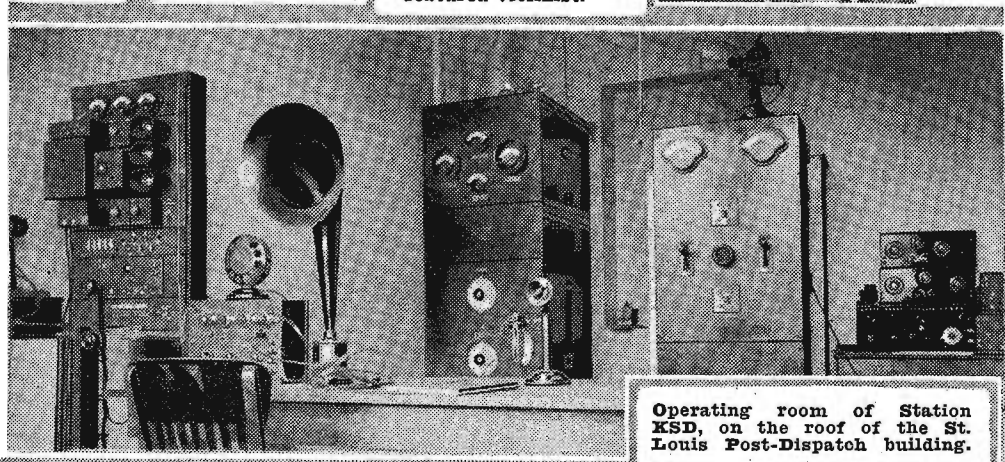

Operating room of Station KSD, on the roof of the St. Louis Post-Dispatch building.



Above, studio of KSD with its three pianos and chimes. The bird's nest above the center piano is really a microphone. Right, the antenna tower with a portion of the city of old St. Louis visible in the background.



Cricket on 'Mike' Is Latest at WSAI

If Dickens Was Right About Insect Good Fortune Is Station's Own Now

CINCINNATI.—Radio fans listening to WSAI's program on a recent Saturday night secured an added feature that was not scheduled or even announced.

The chime concert had been announced and Robert Badgley, chime soloist, began playing "I Can't Tell Why I Love You, But I Do" when a wee small voice joined in the chorus in perfect harmony with a modulated chirp, chirp, chirp. Investigation by operators of WSAI brought to light that a cricket was nonchalantly poised before the microphone and "doing his stuff."

The microphone for the chimes is located on the tower of the United States Playing Card company, and the birds of the air as well as the crickets thus have access to the ether.

This is the first time, however, as far as can be ascertained, that a Radio station has broadcast the song of a cricket.

Dicken's famous story, "Cricket on the Hearth," told of the good fortune that would come to a home which had a cricket in it. With the advent of modern Radio, it will not be necessary to go cricket hunting, but just tune in on the chimes at WSAI, Tuesday or Saturday nights, or Sunday afternoon, and if Miss or Mr. Cricket is not in a temperamental mood listeners will hear the chirp, chirp of the cricket.

KSD WITHOUT SLOGAN

(Continued from page 5)

sent out several speeches by President Coolidge as well as addresses by practically all the cabinet officers, by all the candidates for president in the last national election, and the entire proceedings of the Democratic and Republican National conventions.

Some of the world's greatest statesmen and most famous artists have been given to the public through this station. Fifteen countries of the world have been represented on the programs and all five races of man have had their representatives in the studio on various KSD programs.

In several respects KSD is unique. It has no slogan. It does not issue Ekko stamps. It does not read telegrams or letters to its Radio audience, and does not permit persons on its programs to say "hello" to their listening friends. It is unique, also, in having the only woman announcer who has been on the job since Radio started. She has announced all programs of every description, night after night, except in vacation intervals, since the station was opened. It has been said of KSD that the voice of "Miss Jones announcing" is sufficient identification for the station without the call letters or the name of the city in which it is located.

(Editor's Note.—Unfortunately, the press representative of KSD neglected to submit a picture of "Miss Jones," so the fans will have to be content with merely hearing "Miss Jones announcing." Her full name is V. A. L. Jones.)

The German stations are paying increasing attention to Esperanto.

The Sensation of the Season!

Model 5-F-5

New and Improved FRESHMAN MASTERPIECE FIVE TUBE TUNED RADIO FREQUENCY RECEIVER

Encased in as fine a solid mahogany cabinet as ever graced any radio set. Complete with built-in loud speaker of great volume and superb tone.

\$60

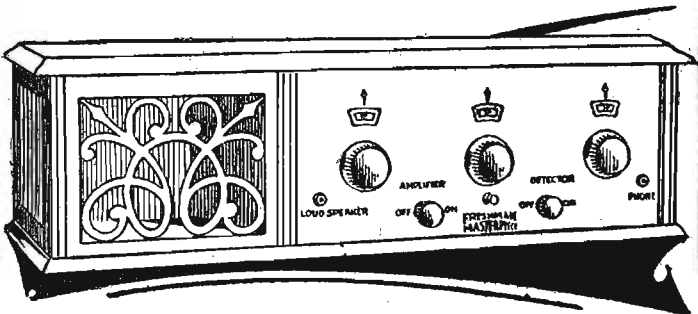

Yes, it is equipped with

the new Freshman straight-line wave length condenser, with vernier attachment, which assures hair-line selectivity—permitting you to tune in the station you want without interference, over the entire wave length range.

For Sale by Authorized Freshman Dealers Only

Sold on convenient terms by Authorized Freshman Dealers, who also install and service them. Write for illustrated booklet, containing lots of useful information for all radio fans.

Chas. Freshman Co. Inc.
Radio Receivers and Parts
FRESHMAN BUILDING
240-248 WEST 40TH ST.—NEW YORK, N.Y.
CHICAGO OFFICE — 327 S. LA SALLE ST.

ECONOMY

No ONE size or type of battery can be economical on every type of receiving set. That's why Eveready Radio Batteries are made in different sizes and types—so that every radio user can enjoy the economy that is to be had by fitting exactly the right Eveready Battery to his receiver. For owners of sets with five, six, eight or more tubes, and power amplifiers, there is the extra-large, powerful and unusually long-lasting Eveready "B" Battery No. 770. There is an Eveready dealer nearby.

Manufactured and guaranteed by

NATIONAL CARBON COMPANY, INC.
New York San Francisco

Canadian National Carbon Co., Limited, Toronto, Ontario

EVEREADY HOUR EVERY TUESDAY AT 9 P. M.

Eastern Standard Time

For real radio enjoyment, tune in the "Eveready Group."

Broadcast through stations—

- | | | |
|------------------|-----------------|--------------------|
| WEAF New York | WGR Buffalo | WCCO { Minneapolis |
| WJAR Providence | WCAE Pittsburgh | { St. Paul |
| WEEI Boston | WSAI Cincinnati | WOC Davenport |
| WFI Philadelphia | WWJ Detroit | WCTS Worcester |

EVEREADY Radio Batteries

—they last longer

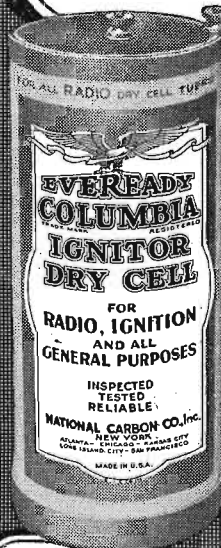

Eveready Columbia Ignitor "A" Battery, the proven dry cell for all radio dry cell tubes 1½ volts

No. 770
45-volt
Extra-Large
Vertical
Price
\$4.75

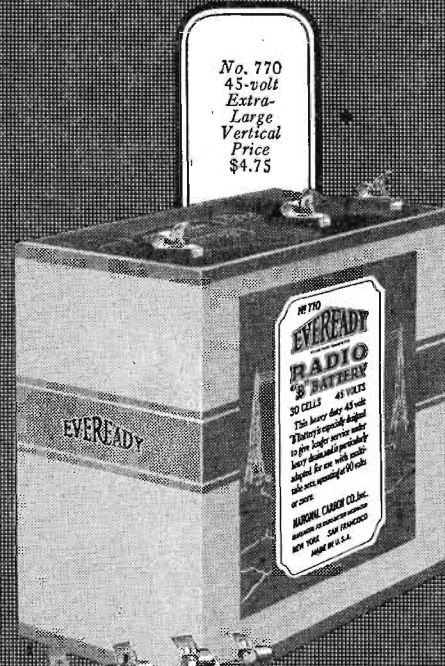

No. 766
22½-volt
Large
Horizontal
Price
\$2.00



FROM MICROPHONE TO OPERA STAGE

Herbert Johnson, impresario of the Chicago Civic Opera company, recently toured all Europe searching for a contralto who could fill the exacting requirements of grand opera, only to return without what he sought. But here he did find an American girl, Devora Nadworney, picture herewith, whose Radio work over WEAJ had brought much comment. And so Radio shall lose her for the time being to opera.

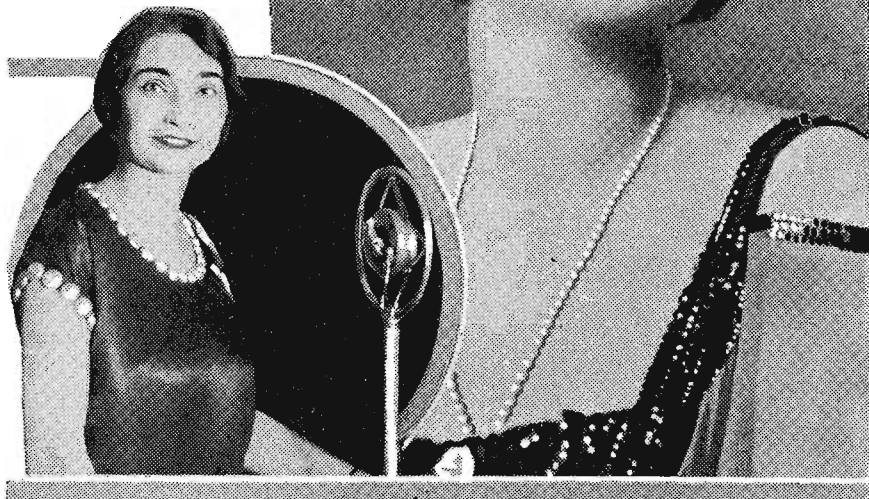

NEW YORK.—Radio fans will soon miss one of the finest voices on the air, for the Chicago Opera company has claimed Devora Nadworney, contralto of the WEAJ Grand Opera company, whose singing has contributed so much to the success of the Radio tabloid opera presentations. As a farewell to her friends in the audiences of WEAJ, WEEI, WGR, WCAE, WWJ, WCCO, WCTS and WFI, she will be featured in the first three productions which will open the WEAJ 1925-1926 opera season, singing the title

roles in "Il Trovatore," "Carmen," and "Samson and Delilah." On October 13, Miss Nadworney will sing "Carmen" in the opera of the same name and on Tuesday, October 20, at 10 p. m., she will be featured in the role of "Delilah" in "Samson and Delilah" to be broadcast by the usual chain of stations. This will be her farewell appearance for an indefinite time. Miss Nadworney's career has been a steady rise to the heights of musical fame, with the latest step a striking one.

Two wonderful new Walnut Tuning Units Assure SELECTIVITY

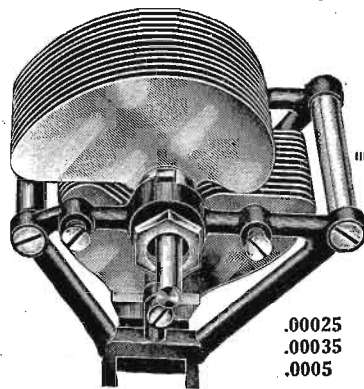

and
Dialog

The World's Smoo-oothest VERNIER DIAL

Another Walnut achievement—and truly, the only practical tuning control. No gears or cams to wear out; nothing to get out of order. Continuous, smooth, fine tuning, station-selecting action from 0 to 100 with absolutely no backlash! And—it requires no extra drilling to attach to any condenser shaft. Put Dialogs on you set—now!

\$1.25 with black bakelite knob and black dial plate
\$1.25 with black bakelite knob and silvered dial plate
\$1.50 with brown bakelite knob and gold finished dial plate

WALNUT ELECTRIC MFG. CO.

308 So. Green St. CHICAGO
"Makers of Good Goods Only."

Now—selectivity is no longer a dream. You can enjoy it! These two new Walnut units are the very essence of selectivity.

The Walnut Condenser is not a straight line wave length nor a straight line frequency—but, a station-selecting condenser! Exactly what you have hoped for. Uncrowds all the stations making it easy for anyone to turn to the right condenser setting for any station.

Put Walnut Station-Selecting Condensers in your set. Radio will mean more to you—from that day on.



\$1.25

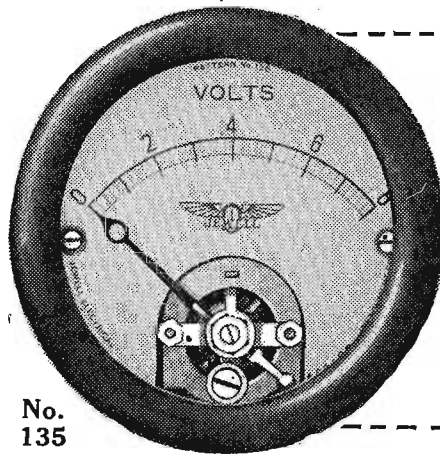

No. 135

2 Inches

This cut is actual size. Diameter of case is only 2 inches.

NEW—



Jewell Panel Cutter, made in 2, 2 1/2 and 3 inch sizes.

\$1.25 Complete

Send for circular No. 776 describing our new line of two inch diameter instruments designed for radio set panels.

To thoroughly enjoy a radio set the owner should know just what his set is doing. Control of filament and checking of batteries is essential and can only be done accurately by the use of a voltmeter.

The Jewell "Two Inch" No. 135 and No. 140 voltmeters are of the high resistance type and are conceded to be the most sturdy and accurate small radio instruments manufactured.

Jewell Instruments Are Carried by Leading Dealers

JEWELL ELECTRICAL INSTRUMENT CO.
1650 Walnut St., Chicago

AMERICA DEMANDS



MILLIONS

ALL-AMERICAN

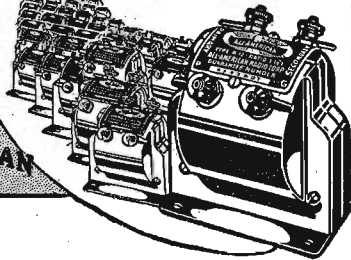

In transformers, as elsewhere, the public is the final judge. Good design and precision manufacture, insuring reliable and accurate amplification, the Guarantee Number on each instrument—all these suggest why ALL-AMERICAN continues its leadership—
Largest Selling Transformers in the World

ALL-AMERICAN RADIO CORP.
E. N. Rauland, Pres. 4203 Belmont Ave., Chicago

OWNING AND OPERATING STATION WENR—266 METERS
ALL-AMERICAN
Pioneers in the Radio Industry

COLUMBUS DAY PROGRAM AT WBZ

Saturday, October 10

Saturday, silent night for: CFCA, CHNC, CNRA, CNRE, CNRM, CNRR, CNRT, CNRW, KFAB, KFDM, KFVK, KFMO, KFMY, KLDS, KOB, KTAB, WBAP, WBZ, WCAU, WCTS, WDX, WEAQ, WEBJ, WEEL, WGPC, WHAD, WHB, WHN, WHO, WJAR, WKAQ, WLIT, WOS, WSMB, WTIC, WWJ.

Eastern Time Stations

CHIC, Toronto, Can. (357), 9:45 p. m., J. Wilson Jardine and his Palais Royale orchestra.

CKNC, Toronto, Can. (356.9), 8 p. m., Charles E. Hoadley and his orchestra; Dwight Wilson, baritone; Bert Peck, elocutionist.

CNRO, Ottawa, Can. (435), 8 p. m., Chateau Laurier concert orchestra; 9, Tony Paladino, accordionist; Ernest Botten, bass; Queen Allan, cellist; Mrs. J. D. Robertson, soprano; Kendall McNeil, reader; George White, tenor; Chateau Laurier dance orchestra.

KDKA, Pittsburgh, Pa. (309.1), 8:30 p. m., Westinghouse band, Ruth Hamilton Ross, soprano; Roy John, baritone; Fred T. Johnson, tenor.

WAHG, Richmond Hill, N. Y. (315.6), 12-2 a. m., dance program.

WBRR, New York, N. Y. (272.6), 8 p. m., Dr. Hans Haag, violinist; 8:10, Fred Twaroschek, tenor; 8:20, Bible questions and answers, Judge Rutherford; 8:40, Fred Twaroschek, tenor; 8:50, Dr. Hans Haag, violinist.

WCAE, Pittsburgh, Pa. (461.3), 6:30 p. m., dinner concert, William Penn hotel; 8:30, concert.

WCX, Detroit, Mich. (517), 4:15 p. m., The Detroit Symphony trio; 6, dinner concert, Book-Cadillac hotel.

WEAF, New York, N. Y. (491.5), 4-5 p. m., Elmer Grosse and his orchestra; 6-7, dinner music, Waldorf-Astoria; 7-7:15, "Old New York," Henry Collins Brown; 7:15-7:30, Jeanne Laval, contralto; Kathleen Stewart, accompanist; 7:30-7:45, Boris Popovitzky, pianist; 7:45-8, Pasadena Warblers; 8-8:10, Boris Popovitzky; 8:10-8:30, Pasadena Warblers; 8:30-10, concert, United States Army band; 10-10:15, Edgar Gruen, baritone; Kathleen Stewart, accompanist; 10:15-10:25, Caroline Powers Thomas, violinist; 10:25-10:40, WCAE light opera quartet; 10:40-10:50, Caroline Powers Thomas; 10:50-11, WEAF light opera quartet; 11-12, Vincent Lopez and his orchestra.

WEAR, Cleveland, Ohio (389.4), 7 p. m., Marjorie Moore's Melody Maids.

WGBS, New York, N. Y. (315.6), 6-6:30 p. m., Uncle Geebee; 6:30-7:30, Duclmerians orchestra; 8-9, Bayona Standard Oil band; 9-9:15, Paula Fire, soprano; 9:30-10:30, program, Warner's theater; 10:30-11:30, Arrowhead Inn orchestra.

WGR, Buffalo, N. Y. (319), 2:30 p. m., world series game.

WGY, Schenectady, N. Y. (379.5), 8 p. m., Cypress Temple band; 9:30, Hotel Ten Eyck orchestra.

WHAR, Atlantic City, N. J. (275), 7:30 p. m., lecture period; 8, Seneca hotel band.

WIP, Philadelphia, Pa. (508.2), 6:05 p. m., Benjamin Franklin concert orchestra; 8, "The Flight of the Ball Through the Air," Dr. George Rosengarten; 8:15, Mandolin club; 10:05, Benjamin Franklin dance orchestra; 11:05, organ recital, Germantown theater.

WJR, Detroit, Mich. (517), 7 p. m., studio orchestra, Jean Goldkette, 9, Jean Goldkette's savanaders; 10, Jean Goldkette's Victor Recording orchestra.

WMCA, New York, N. Y. (340.7), 6-6:30 p. m., Oieott Vail and McAlpin string ensemble; 6:30-7:15, Andy Asauto's Paragon dance orchestra; 8-8:15, "What's Happening Now," George Bogner; 11-12, Ernie Golden and his Hotel McAlpin orchestra.

WNYC, New York, N. Y. (328), 7-7:30 p. m., Chateau Four; 7:35-8, Chateau Four; 8-8:05, football scores; 8:05-8:45, song recitals; 8:45-9, violinist; 9:15-9:30, instrumental novelty; 9:30-10, pollee quartet; 10-10:30, talk, Board of Education.

WOO, Philadelphia, Pa. (508.2), 7:30 p. m., Hotel Adelphia orchestra.

WOR, Newark, N. J. (405.2), 3:45 a. p. m., talk, Charm Magazine; 6:15-6:17, "Worlds Often Mispronounced"; 6:17-7, Hotel Shelton ensemble; 7:15-7:30, sports talk; 8:30-9:30, Al Reid's hour; 9:30-9:45, talk, Edward H. Bierstadt; 10:30-11, Archie Slater's Palais D'Or orchestra.

WPG, Atlantic City, N. J. (299.8), 6:45 p. m., Arthur Scott, Brook, organist; 7, Hotel Elmsador dinner concert; 10:30, Silver Slipper.

WRC, Washington, D. C. (469), 7 p. m., Hotel Washington orchestra; 8, Bible talk; 8:15, musical program; 10:30, Crandall's Saturday Nighters.

WREO, Lansing, Mich. (285.5), 6-7 p. m., dinner concert; 10-12, Speed-Wagon serenaders.

Central Time Stations

KFNF, Shenandoah, Iowa (266), 7 p. m., old time music, Vermillion, Kan.

KFVE, University City, Mo. (240), 10 p. m., Gene Wilbacker's orchestra.

KMA, Shenandoah, Iowa (252), 6-7 p. m., popular concert, chimes, William Howie; 9-11, program.

KOIL, Council Bluffs, Iowa (278), 7:30 p. m., Girls' glee club; 11, Hotsy-Totsy hour.

KPRC, Houston, Texas (296.9), 7:30 p. m., Mrs. E. G. Rountree, organist; 8, studio concert; 8:30, old time fiddlers; 11, Dr. Barle J. Shay, tenor; J. H. Kobusch, pianist.

KSD, St. Louis, Mo. (545.1), 7 p. m., Grand Central theater.

KTHS, Hot Springs National Park, Ark. (374.8), 9:10-10:30 p. m., Southerners' orchestra for Radio experimenters 1,000 feet below surface in Diamond cave.

KYW, Chicago, Ill. (535.4), 7-7:30 p. m., Congress hotel; 8-9, Maria Duprova, soprano; Jimmie Vandervosh, violinist; Alice Kearns, pianist.

WAMD, Minneapolis, Minn. (243.8), 7 p. m., popular novelty program; Katherine Grill, contralto; Lurry Dunn, baritone; George Sankey, pianist; Al Wilson, tenor.

WBAP, Fort Worth, Texas (475.9), 7:30 p. m., Sunday school lesson, Mrs. W. F. Barnum.

WBBN, Chicago, Ill. (226), 8-11 p. m., Samovar orchestra; Sunset male quartet; M. L. Jones celeste bells; Babbe and Barr; Jimmy Eggert; 11-1, Stewart-

Headliners of the Week

THE NATIONAL convention of the American Legion will occupy the first half of the week at Omaha. WOAW will have the privilege of broadcasting speeches by President Coolidge and other men of national importance. Two wave lengths will be used, 526 from 4-9 p. m. and 454.3 from 9 a. m. to 4 p. m. "Old New York," the city of the "Gay Nineties," is the subject of reminiscences given by Henry Collins Brown every Saturday night. Mr. Brown, the director of the Museum of the City of New York, remembers the famous Gypsy encampment on Broadway, the fire warden looking over the city through his telescope, the parlor elocutionist, and the old time department store. The Pacific coast also schedules a unique feature Saturday night. Henry Jackson will review a book to music, but as the book is "Barber Shop Ballads," perhaps this is not so queer. The California male quartet will assist during the review. WRR, the Dallas municipal station, opens Saturday night. Music lovers will welcome the news that the concerts made famous through WIP from the Germantown theater will be resumed Sunday evening. Ben Stad, the famous Dutch

violinist and conductor, has gathered orchestral novelties from France and Italy.

Monday, October 12, is Columbus Day. WBZ, Springfield, celebrates with a special program directed by the Knights of Columbus. WAMD, Minnesota, is one of the stations traveling around the world. Monday's stop will be Russia with songs by Peter Tkack, baritone.

Welsh music has become popular since Radio introduced it to the world. Wednesday night WLS advertises the Celtic quartet with Welsh songs and stories. The gay music of "The Bohemian Girl" will be presented by the WEAR grand opera company.

Quartets are common to almost all stations but quintets are more rare. Tune in for WHO Thursday night and listen to the Raleigh quintet. Evelyn Scott, a well-known Memphis musician, is conducting the program at WMC this evening.

An amusing musical comedy in three acts, "The Hidden Idol," will be presented by the WGY players, Friday. Admirers of Edgar Allen Poe will enjoy the Poe program at WTIC. Mrs. Clara M. Coe Byrne will read his poems.

Warner studio; Jim Gleason, Lew Russell, Paul Small, Marie Rayzor, Glen Daley, Jimmy Jordan, Joseph Raifei, College trio; Harmony King; 1-2, Hotsy-Totsy hour, Samovar orchestra, Charlie Garland, Eddie Loftis, Nate Caldwell.

WCCO, Minneapolis-St. Paul, Minn. (416.4), 6:15 p. m., Dick Long's Nankin cafe orchestra; 8, fire-side philosophies, Rev. Roy L. Smith; 8:15, musical program; 10:35, Dick Long's Nankin cafe orchestra.

WDAF, Kansas City, Mo. (365.6), 6-7 p. m., piano tuning-in number on the Duo-Art; address, Roger W. Babson; Trianon ensemble; 11:45-1, Merry Old Chief, Plantation players; Johnnie Campbell's Kansas City club orchestra; Earl Coleman's orchestra; Eddie Kuhn's Kansas City Athletic club orchestra.

WFAA, Dallas, Texas (475.9), 6:30 p. m., music, State Fair grounds; 8:30, State Fair grounds; 11-12, Baker hotel orchestra.

WGES, Oak Park, Ill. (250), 7-9 p. m., Frank Greif, tenor; Franklin Horstmeier, bass; Bryce Talbot, baritone; 11-2 a. m., Kampus Kollegians orchestra; Phil Wilcox, Erwin Schmidt, Parrish and Ward, Phil Fleming, Lew Butler.

WGN, Chicago, Ill. (370.2), 6:30-7:30 p. m., Drake concert ensemble, Blackstone string quintet; 8:30-9:30, WGN string trio; 10:30-11:30, jazz scamper program, Jack Chapman's and the Blackstone dance orchestras.

WHAD, Milwaukee, Wis. (278), 6-7 p. m., Arthur Richter, organist.

WHAS, Louisville, Ky. (399.8), 7:30-8:45 p. m., Barney Rapp and his orchestra; 8:45-9, Mrs. Guy S. Meador, soprano; Susie Elvira Williams, accompanist.

WKRC, Cincinnati, Ohio (422.3), 10 p. m., Marion McKay and his orchestra.

WLS, Chicago, Ill. (344.6), 7 p. m., lullaby time; 7:20, Tony Coreoran, Marguerite Garrity; 8, George French's Radio stars; 10, dance music; 11, Joe Brenz minstreis.

WLW, Cincinnati, Ohio (422.3), 7 p. m., Johanna Grosse, organ soloist; 7:25, instrumental trio, violin, cello and piano; 7:35, Sectary's Hawkins.

WMAQ, Chicago, Ill. (447.5), 2 p. m., Ohio State-Chicago; 6, Chicago theater organ; 8:30, Hotel LaSalle orchestra; 8, Day and Pratt; 8:30, "The Chicago Fire," Carolyn McIlwain; 9, Chicago theater program.

WMBB, Chicago, Ill. (250), 7-8 p. m., Trianon duo, Beatrice Tallor, Lindsey McPhail, John Ewerett, M. Morgan, Hazel O'Neil, Jean Ballard, Paul Cadeux; 9-11, Trianon orchestra, Dave Williams, Elsie White, Edward Hines, Jimmy Eggert, Woodlawn theater orchestra, Clyde Hager.

WMC, Memphis, Tenn. (499.7), 8:30 p. m., Memphis Spectrum orchestra.

WOAW, Omaha, Nebr. (526), 6 p. m., American Legion; 9, American Legion.

WOC, Davenport, Iowa (483.6), 9-10 p. m., May Chambers, soprano; Ted Sloat, baritone; Emil Huss, reader; 11-12, LeClaire hotel orchestra; Peter MacArthur, baritone.

WORD, Batavia, Ill. (275), 8-10:30 p. m., Webster hotel concert; Webster hotel concert trio; Chicago motor club speaker.

WOS, Springfield, Mo. (440.9), 2:30 p. m., Missouri-Nebraska football game.

WQJ, Chicago, Ill. (447.5), 7-8 p. m., Ralph Williams and his Rainbow Gardens orchestra; Sheppard Levine, tenor; Helen Reed, accompanist; Otis Pike Jester, soprano; Mary Thrash House, pianist; Kathryn Snyder, reader; 10-3, Ralph Williams and his Rainbow Skylarks;

Ellen Cook, mezzo soprano; Jerry Sullivan; Rose Vandebosch, soprano; Hal Lansing; Melodians; Everett George Opie, reader; Tillie Miller, contralto; Bert Davis, Clown of the Air; Bob Birdson, Ben Burke; Clarence Theders, tenor; Sandy Meek, Scotch tenor; Harry Sosnick, pianist; Williamson brothers.

WSAI, Cincinnati, Ohio (326), 2:30 p. m., University of Cincinnati-Georgetown; 7:15, children's stories, Mrs. Ethel Knapp Behrman; 8, WSAI Radio chimes, Robert Badgley; 8:15, Bicycle playing card sextet; 9, U. S. playing card weekly news review; 9:15, Bicycle playing card sextet; Waldene Johnston, violinist.

WSB, Atlanta, Ga. (428.3), 8 p. m., Griffith handjazz symphony orchestra; 10:45, week end skylark, Journal help.

Mountain Time Stations

KOA, Denver, Colo. (322.4), 9 p. m., dance program.

Pacific Time Stations

KFOA, Seattle, Wash. (454.3), 8:30-9:30 p. m., program; 9:30-11:30, Eddie Harkness and his orchestra.

KFWB, Hollywood, Calif. (252), 7:30 p. m., Microphone brovities; 8-9, variety program, Hollywood string quartet; Syd Lippman, violinist; Myrtle Watters, soprano; Billy Dunn, pianist; 9-10, Warner brothers synopators; Violet Preston, blues singer; 10-11, Warner brothers frolic, direction Charlie Wellman, All-Southern male quartet; Losers' Hawaiian trio.

KGO, Oakland, Calif. (361), 8:10 p. m., A. L. Daniele, piano-accordionist; G. de Martin, tenor; Joe Farmania, accordionist; J. Garcia, baritone; C. Memmud, tenor; Ezio Taecola, tenor; Roy Banducci, accordionist; Beatrice L. Sherwood, pianist; Mary E. Newson, soprano; Glee stories, Al Evers; Jack Holworthy, tenor; Christian and Missionary Alliance Colored Male quintet; 10-12, Hotel St. Francis dance music.

KGW, Portland, Ore. (481.5), 10-12 midnight, music, Indian Grill.

KHJ, Los Angeles, Calif. (405.2), 5:30-6 p. m., Leighton's Arcade cafeteria orchestra, Jack Cronshaw, leader; 6-6:30, Art Hickman's Biltmore hotel concert orchestra, Edward Fitzpatrick, director; 6:30-7:30, Radio kiddies hour with Henrietta Poland in a bon voyage to Uncle John sailing to Honolulu; 8-10, C. Luxe program arranged and presented by J. Howard Johnson; 10-11:30, Art Hickman's Biltmore hotel dance orchestra, Frank Ellis, leader; 11:30-2 a. m., Lost Angels of KHJ, Walter Biddick, chief harpist, Lost Angels orchestra.

KJR, Seattle, Wash. (384.4), 8:30-10 p. m., L. C. Warner company.

KNX, Hollywood, Calif. (336.9), 5:30-6:15 p. m., Wurlitzer pipe organ studio, Town Tattler; 6:15, travel talk, W. F. Alder; 6:30-7, Atwater Kent Radio orchestra, Paul Flinstein, leader; 7, insect life, Harry W. McSpadden; 7:15, church announcements; 7:30-8, Wurlitzer pipe organ studio; 8-10, open house at KNX in celebration of its first birthday; 10-11, Roy West's Coconut Grove dance orchestra from Ambassador hotel; 11-2 a. m., continuation of KNX's birthday party.

KPO, San Francisco, Calif. (428.3), 6:35-7:30 p. m., Waldemar Lind and the States Restaurant orchestra; 8-12, Cabrera cafe orchestra.

KTCL, Seattle, Wash. (305.9), 6:50-7:15 p. m., Hermie King and his super-soloists; 8:30-12, Uncle Hal and his stars of Radio.

Sunday, October 11

Sunday, silent night for: CHIC, CHNC, CNRA, CNRC, CNRE, CNRM, CNRO, CNRR, CNRT, CNRW, KFAB, KFAB, KFVK, KFMO, KFOA, KOB, KSD, KYW, WAHG, WBAP, WCAU, WCEE, WCX, WDAF, WEAQ, WEBJ, WFI, WHAS, WHAS, WJR, WLIT, WMC, WOK, WOD, WOR, WORD, WRC, WSAI, WSMB, WTIC.

Eastern Time Stations

KDKA, Pittsburgh, Pa. (309.1), 10:45 a. m., church service; 3:45 p. m., Shadyside Presbyterian church; 7:45, church service.

WBRR, New York, N. Y. (272.6), 9 p. m., I. B. S. A. choral singers; 9:15, Watchtower string quartet; 9:30, Bible lecture, Judge Rutherford; 10, Watchtower string quartet; 10:15, I. B. S. A. choral singers.

WBZ, Springfield, Mass. (333.1), 10:45 a. m., services, Church of the Unity; Rev. Charles A. Wing, pastor; Philharmonic quartet; Robert Field, organist; 8 p. m., program, Holy Cross College.

WCAE, Pittsburgh, Pa. (461.3), 3 p. m., People's Radio church service; 6:30, dinner concert, William Penn hotel; 7:30, Capitol theater gang.

WCAU, Philadelphia, Pa. (277.6), 6 m., Hotel Pennsylvania concert orchestra.

WCTS, Worcester, Mass. (268), 7:20-9:15 p. m., Major Edward Bowes and the Capitol gang; 9:15-10:15, musical program.

WCX, Detroit, Mich. (517), 10:30 a. m., services, Central Methodist Episcopal church.

WEAF, New York, N. Y. (491.5), 2-3:45 p. m., "Sunday Hymn Sing," Federation of churches; 3:45-5:30, men's conference, Bedford branch, Y. M. C. A.; 7:20-9:15, "Capitol Gang," Capitol theater; 9:15-10:15, musical program.

WEAR, Cleveland, Ohio (389.4), 3:30 p. m., Goodyear concert orchestra; 7, Park theater orchestra; 8, evening hours, WEAR mixed quartet, Francis instrumental quartet.

WEEL, Boston, Mass. (348.6), 7:20 p. m., Major Bowes and his Capitol theater; 9:15, program.

WGBS, New York, N. Y. (315.6), 9:30-4:30 p. m., program, Warner's theater; 8-9, opera in conjunction with Corriere D'America.

WGPC, New York, N. Y. (315.6), 8-8:15 p. m., Charlotte Trystmann, pianist; 8:15-8:30, Ralph Hersh, violinist; 8:30-8:45, Milton Yokeman, tenor; 8:45-9, Ona Welsh, pianist; 9-9:15, Mildred Newmann, soprano; Sylvia Newmann, accompanist; 9:15-9:30, Billy Rhodes, tenor; 9:30-9:45, Mme. Marie Barrier Houston, soprano; 9:45-10:15, Bernstein trio; 10:15-11:15, Strickland's orchestra.

WGR, Buffalo, N. Y. (319), 2:30 p. m., world series game; 8, Central Presbyterian church service; 9:15-10:15, Atwater Kent program through WEAF.

WGY, Schenectady, N. Y. (379.5), 10:30 a. m., First Lutheran church; 12:30 p. m., Revolt theater; 7:30, First Lutheran church; 9, "The Daughters of the American Revolution," Godfrey Ludlow, violinist, WJZ.

WHAR, Atlantic City, N. J. (275), 2:15 p. m., Seaside hotel trio; 7:30, Chelsea Baptist church; 9, Seaside hotel trio; 11:15, Strand theater organ recital.

WHN, New York, N. Y. (361.2), 1-1:30 p. m., Marsh McCurdy, organist; 2:30-3:30, Christian Endeavor program; 5-5:30, Roseland dance orchestra; 7:30-10, service, Calvary Baptist church; 10:45-11:15, Janssen's Hofbrau orchestra.

WIP, Philadelphia, Pa. (508.2), 7:45 p. m., service, Holy Trinity church service; 9:30, Ben Stad and the Little WIP symphony orchestra.

WIP, Providence, R. I. (305.9), 7:20 p. m., Capitol theater gang; 9:15, J. Atwater Kent program, WJZ.

WMCA, New York, N. Y. (340.7), 6-7 p. m., Roemer's Homers; 7-7:30, Ernie Golden and his Hotel McAlpin orchestra; 7:35-8, Olcott Vail's string ensemble.

WNYC, New York, N. Y. (526), 9-11 p. m., program, Brooklyn Mark Strand theater.

WOO, Philadelphia, Pa. (508.2), 10:45 a. m., Bethany Presbyterian church; 2:30 p. m., Bethany Sunday school; 6, Clarence K. Rowden, organist.

WREO, Lansing, Mich. (285.5), 10 a. m., chimes, Betty Plymouth Congregational church; 10:30, First Baptist church; 7:30 p. m., Central M. E. church.

WWJ, Detroit, Mich. (352.7), 11 a. m., St. Paul's Episcopal cathedral; 7:20, Capitol theater gang.

Central Time Stations

KFDM, Beaumont, Texas (315.6), 8-9 p. m., sacred program.

KFMX, Northfield, Minn. (337), 7-9 p. m. vesper service.

KFNF, Shenandoah, Iowa (266), 11:45 a. m., First M. E. church; 2:30 p. m., Golden Rule song service; 3, Pentecostal assembly; 6:30, Golden rule circle; 8, Christian church.

KFVE, University City, Mo. (240), 10 p. m., "Friendship," Rev. C. W. Davis.

KLDS, Independence, Mo. (441), 11 a. m., Stone church services; 6:30 p. m., vesper service, Thelma Vincent, soprano; Velma Nunn, contralto; Louis Joernik, tenor; Paul Craig, bass; Wesley Brown, saxophonist; sermon by Apostle Paul M. Hanson; 9, Robert Miller, organist; ladies quartet; Phillip Turner, euphonium soloist; Mrs. Frank Ebeling, contralto.

KMA, Shenandoah, Iowa (252), 4-6 p. m., vesper service.

KOIL, Council Bluffs, Iowa (278), 11 a. m., First Congregational church; 7:30, Monarchs.

KPRC, Houston, Texas (296.9), 10:45 a. m., services, First Methodist church; Rev. A. Frank Smith, pastor; E. G. Rountree, organist; Mrs. J. Graham, choir director; 8 p. m., services, South Main Baptist church; Rev. M. M. Wolf, pastor; 9:30, Julian Blitz and his Hotel Brazos orchestra.

KTHS, Hot Springs National Park, Ark. (374.8), 11 a. m., services, First Presbyterian church; 9-10, New Arlington hotel orchestra; 10-11, Bennie Ford's orchestra.

KYW, Chicago, Ill. (535.4), 11 a. m., Central church service; 4-5 p. m., studio concert; 7, Chicago Sunday evening club.

WAMD, Minneapolis, Minn. (243.8), 6 p. m., dinner

(Continued on page 9)

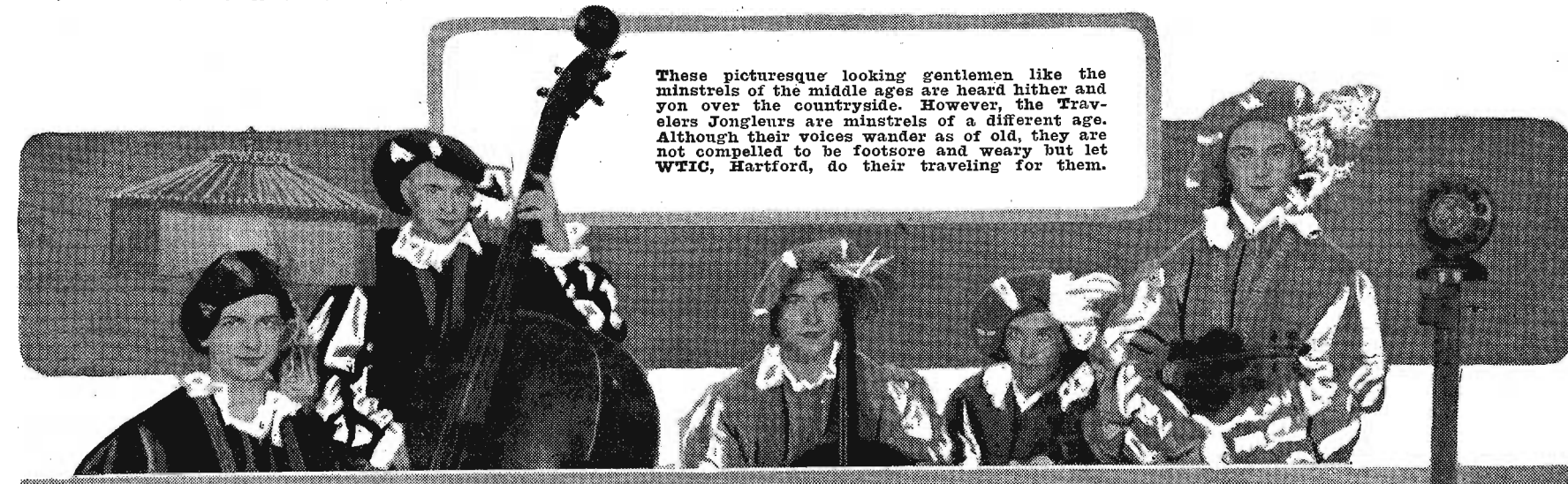

WEAR COMPANY GIVES 'BOHEMIAN GIRL'

Monday, October 12

(Continued from page 9)

KGW, Portland, Ore. (491.5), 8-9 p. m., concert; 9-10, Hodson and Essex orchestra.
 KJR, Seattle, Wash. (384.4), 7-8:30 p. m., Sears-Lobuck and company; 8:30-10, Post-Intelligencer studio program; 10-11, Gordon Kilbourne and his orchestra.
 KNX, Hollywood, Calif. (336.9), 5:30-6:15 p. m., Wur-litzer pipe organ studio, Town Tattler; 6:15, travel talk, W. F. Alder; 6:30-7, Atwater Kent Radio orchestra, Paul Finstein, leader; 7-7:30, Mutual Mofors birth contest; 7:30-8, program, Columbia Out-fitting company; 8-9, program, L. W. Stockwell com-pany; 9-10, KNX feature program; 10-11, Goodrich Silverton Cord dance orchestra.



Madame Ida Tsimpidis, WLW's well-known French teacher, is again giving her radio lessons for this year. Here is an opportunity to take French lessons once a week from a teacher who speaks with a remarkably pure accent. Classes meet Tuesdays.

KTAB, Oakland, Calif. (215), 8-10 p. m., Western States Life Insurance company.

Tuesday, October 13

Tuesday, silent night for: CFCA, CHIC, CHNC, CNRA, CNRE, CNRM, CNRO, CNRW, CNRT, KFKX, KOA, KOB, WAHG, WAMD, WBBR, WCTS, WEAO, WGCP, WHAD, WKAQ, WLIT, WOS, WSMB.

Eastern Time Stations

CNRA, Moncton, Can. (291), 7 p. m., juvenile program, Prof. C. M. Wright, director; 7:30, CNRA in a lighter mood, old-time and novelty program; CNRA orchestra.
 KDKA, Pittsburgh, Pa. (309.1), 6:15 p. m., dinner concert; 7:30, children's period; 7:45, "Some High Lights in Modern Physics," Dr. A. G. Worthing; 8:30, world cruise by Radio, Ross H. Skinner; KDKA Little Symphony; 10:30, Grand theater.
 WBZ, Springfield, Mass. (333.1), 6:30 p. m., Leo Belsman's Hotel Lenox orchestra; 7:05, musical program, talk; 8:15, Charles Hector's orchestra; 9:30, Goldie Shour, violinist; Dorothy Kraemer, pianist.
 WCAE, Pittsburgh, Pa. (461.3), 6:30 p. m., dinner concert, William Penn hotel; 8, program, New York; 8:30, Gold Dust twins; 9, Eveready hour; 10, Grand opera.
 WCAU, Philadelphia, Pa. (277.6), 7:30 p. m., recital, Shenellen and company; 8, civic music league hour; 9, "How Many Kinds of Psychology Are There?" Rev. John W. Stockwell; 9:15, program; 9:30, Harry King; 10:30, Cathy Tea Garden orchestra.
 WCTS, Worcester, Mass. (268), 8-8:30 p. m., Ross Gorman and his Earl Carroll Vanities orchestra; 8:30-9, program; 9-10, Eveready hour; 10-11, operatic concert, WEAF Grand Opera company.
 WCX, Detroit, Mich. (517), 4:15 p. m., The Detroit Symphony trio; 6, dinner concert, Book-Cadillac hotel; 10, The Red Apple club.
 WEA, New York, N. Y. (491.5), 6-7 p. m., dinner music, Waldorf-Astoria; 7-7:10, music; 7:10-7:30, lecture, Columbia university; 7:30-8, "The Rising Star Octette," direction, Clyde Doerr; 8-8:10, talk, Dudley F. Fowler; 8:10-8:30, Ross Gorman and his Earl Carroll Vanities orchestra; 8:30-9, Gold Dust twins; 9-10, "Eveready Hour"; 10-11, "Samson and Delilah," WEAF Grand Opera company; 11-12, Meyer Davis' Lido Venice orchestra.
 WEAR, Cleveland, Ohio (389.4), 7 p. m., Vincent Percy, organist; 8, Lesco entertainers; 9, State theater vaudeville and music; 10, "Bohemian Girl," WEAR Grand opera company.
 WEEI, Boston, Mass. (348.6), 7:30 p. m., Elliot Daniel, pianist; 7:45, Verna Ruben, soprano; Ella McKenzie, pianist; 8, Ross Gorman's Earl Carroll theater orchestra; 8:30, Gold Dust twins; 9, Eveready hour; 10, WEAF Grand Opera company.
 WGBS, New York, N. Y. (315.6), 6-6:30 p. m., Uncle Geebee; 6:30-7, ballroom dancing, Arthur Murray; 7-7:15, Arrowhead Inn concert orchestra; 7:15-7:30, interview, George Jessel; 7:30-8, Arrowhead Inn concert orchestra; 9-9:30, Lovitt pipe band; 10:30-11:30, Arrowhead Inn dance orchestra; 11:30-12, "Polly," Cherry Lane theater.
 WGR, Buffalo, N. Y. (319), 2:30-4:30 p. m., WGR's afternoon program; 6:30-7:30, Vincent Lopez Hotel Statler dance orchestra, Harold Giesler, director; 8-11,

jointly with WEAF, including Gold Dust twins, Eveready hour, and grand opera program.
 WGY, Schenectady, N. Y. (379.5), 6:30 p. m., Hotel Van Curler orchestra; 7:30, "Discovery of Electrons," Prof. Peter I. Wold; 7:45, WGY orchestra; Frank Erwin, tenor; 10, travel talk, WJZ; 10:30, Speneer Tupman's Hotel Mayflower orchestra.
 WHAR, Atlantic City, N. J. (275), 7:30 p. m., book review, Mrs. James Lord; 8, Seaside hotel trio; 11-13, Strand theater organ recital.
 WHN, New York, N. Y. (361.2), 12:30-1 p. m., Marsh McCurdy, organist; 2:15-3:15, overture and vaudeville, Loew's State theater; 3:15-4:30, Lexington theater orchestra; 7:30-8, Will Oakland's Chateau Shanley; 11:30-12, Club Rodeo; 12-12:45, Club Kentucky orchestra.
 WJAR, Providence, R. I. (305.9), 7:30 p. m., musical program; 8, speaker, Providence Safety council; 8:05, musical; 8:30, Gold Dust twins; 9, Eveready hour.
 WJR, Detroit, Mich. (517), 7 p. m., studio orchestra, Jean Goldkette; 9, Jean Goldkette's serenaders.
 WMCA, New York, N. Y. (340.7), 12-12:30 p. m., Olcott Vail's string ensemble; 6-6:30, Olcott Vail; 6:30-7, Frank Gibbia's Red Lion Inn orchestra; 7-8, Jack Wilbur's personalities; 8:30-9, Sheppard-Knapp entertainers; 11-12, Ernie Golden and his Hotel Me-Alpin orchestra.
 WNYK, New York, N. Y. (526), 7-7:10 p. m., market high spots; 7:10-7:30, the Canadians; 7:30-7:35, police alarms; 7:35-8, the Canadians; 8-8:15, baseball talk, John B. Foster; 8:15-9, song recitals; 9-9:30, instrumental trio; 9:30-10, musical recital; 10:10-10:30, lecture, Board of Education.
 WOO, Philadelphia, Pa. (508.2), 7:30 p. m., Davis Baking Powder saxophone octet.
 WOR, Newark, N. J. (405.2), 6:15-7 p. m., Hotel Shelton ensemble; 7:15-7:30, sports talk; 7:30-8, Vincent Lopez orchestra; 8-8:15, Spencer Armstrong; 8:15-8:30, Gormen string trio; 9-9:30, Sam Siegel, mandolinist; 9:30-9:45, talk, George W. Wadsworth; 11-12, Florence Richardson Casino orchestra.
 WREO, Lansing, Mich. (285.3), 6-7 p. m., dinner concert; 8:15, Ree Motor Car company band; Carl Dewey, conductor; glee club, Fred Killen, director; Maria Van Keuren, pianist; Kenneth Buckingham, baritone.
 WTIC, Hartford, Conn. (475.9), 6:30 p. m., Hub Restaurant trio; 7, Russell Besser, tenor; 8, McDowell music, Travelers male quartet; Travelers Ladies quartet; 9:30, organ recital.
 WWJ, Detroit, Mich. (352.7), 6 p. m., dinner concert; 8, concert from WEAF.

Central Time Stations

KFAB, Lincoln, Neb. (340.7), 5:30-6:30 p. m., Buick Little Symphony.
 KFDM, Beaumont, Texas (315.6), 8-10 p. m., musical program.
 KFMX, Northfield, Minn. (337), 9:30-10 p. m., Frederick Locke Lawrence, pianist.
 KFNF, Shenandoah, Iowa (266), 7 p. m., concert, Sidney, Iowa, W. W. Carlisle, director.
 KFVE, University City, Mo. (240), 10 p. m., Brunswick-Balke-Collender company; Orchestra Romaine.
 KLD, Independence, Mo. (441), 7 p. m., Carolyn Elmer Hayes, pianist; James Prior, baritone.
 KMA, Shenandoah, Iowa (252), 6-7 p. m., May Flower orchestra; June and Jim Taylor, Bobbie Ross; flower talk, Lina Ferguson; 9-11, May's Mandolin musicians.
 KOIL, Council Bluffs, Iowa (278), 7:30 p. m., Junior artists night, program, Madge West Stupphen, director, Corinne Benson, pianist; Donald Baird, pianist; Barbara Albert, pianist; Harold Pace, violinist; Genevieve Powelson, soprano; Roy Frohardt, violinist; Herbert Klettek, violinist; William Remond, violinist; Jay Madden, banjoist; Loren Davidson, tenor; 8:15, Francis Fodrea, violinist; 9, Creighton university educational period, "Hospitals and their Relation to the Community," Dr. Herman Von W. Schulte; 11, Art Cocherill and his orchestra.
 KPCC, Houston, Texas (286.9), 7:30 p. m., Billie Mack and his orchestra; 8:30, Frank Tilton, blind boy pianist.
 KSD, St. Louis, Mo. (545.1), 6:45 p. m., Aborgh's concert ensemble.
 KTHS, Hot Springs National Park, Ark. (374.8), 9-9:30 p. m., New Arlington hotel orchestra; 9:30-9:45, cello and piano presentations; 9:45-10, Arthur Platz, tenor; 10-10:30, dance selections.
 KYW, Chicago, Ill. (535.4), 7-7:30 p. m., dinner concert, Congress hotel; 8-8:20, artists; 8:20-8:45, speeches, American Farm Bureau federation; 8:45-9:20, musical program; 10-11:30, evening at home, Applesauce club, Loos Brothers, Art Lindick, Lee Sims, Bobbie Brown.
 WBAP, Fort Worth, Texas (475.9), 7:30-8:30 p. m., musical program; 9:30-10:45, European club.
 WBBM, Chicago, Ill. (226), 8-10 p. m., Samovar orchestra, Nate Caldwell, Charlie Garland; Eddie Loftus, Doris Ryan, Fred Jesko, Frank Nuber, Bert Davis; 10-12, Paul Small, Joseph Raleff, Marie Morgott, Alamo orchestra, Corinne Jordan, Vera Gilbert, Devon Comedy Four.
 WCB, Zion, Ill. (344.6), 8 p. m., Junior choir; vocal trio; Mrs. Beem's soprano; Mrs. Grove, contralto; Mrs. P. M. LaRose, contralto; R. F. Reid, baritone; Carl Newcomer, saxophonist; Mrs. Mable Gustafson, reader; John Mehaffey, pianist.
 WCCO, Minneapolis-St. Paul, Minn. (416.4), 6:05 p. m., Biley's St. Paul hotel orchestra; 7:30, program, WEAF Gold Dust Twins, Eveready hour; 9-10, Grand opera; 10:05, St. Paul Community chest song.
 WDAF, Kansas City, Mo. (355.8), 6-7 p. m., address, Tell-Me-a-Story, lady; Trianon, ensemble; 11:45-11, Merry Old Chief, Plantation players; Earl Coleman's orchestra; Eddie Kuhn's Kansas City Athletic club orchestra.
 WEBH, Chicago, Ill. (370.2), 7-8 p. m., Oriole orchestra; Lydia Loehner, contralto; Uptown theater; 9-10, Oriole orchestra; songs, Paul Small; 11-11 a. m., Oriole orchestra; Sandy Meek, tenor; Harry Sosnick, accompanist; Jack Penowell, twin guitarist, songs; Paul Small.
 WFAA, Dallas, Texas (475.9), 6:30-7:30 p. m., Ford and Glenn and the Solemn Old Justice; 8:30-9:30, Mrs. Albert E. Smith, soprano; 11-12, Majestic theater entertainers; 12-1, Palace theater entertainers.

WGES, Oak Park, Ill. (250), 7-9 p. m., Frank Ernest, pianist; Norman Kilgus, baritone; Harold Weaver, pianist; Christine Nisted, violinist; 11-12 a. m., Novelty Broadcasters' orchestra; Phil Wilcox, Clarence Parrish, Pat Ward, Harber trio, Sandy McTavish, Coyne Electrical school serenaders, Marie Wright.
 WGN, Chicago, Ill. (370.2), 6:30-7:30 p. m., Drake concert ensemble, Blackstone string quintet; 8:30-9:30, WGN string trio; 10:30-11:30, jazz scampers; Jack Chapman's and the Blackstone dance orchestras.
 WHAD, Milwaukee, Wis. (278), 6-7 p. m., Arthur Richter, organist.
 WHAS, Louisville, Ky. (399.8), 7:30-9 p. m., Eddie Rosson and his orchestra; Hardin Shaw, entertainer; three-minute thrift talk, Liberty Insurance bank.
 WHB, Kansas City, Mo. (365.6), 7-7:30 p. m., Morrell Moore, organist; 8-9:30, Mrs. Herbert Frey, whistler; Mrs. W. C. Magner, accompanist.
 WHO, Des Moines, Iowa (526), 7:30-8 p. m., Balfogh quintet; 8-9, Bankers Life trio; 11-12, Bankers Life Little Symphony orchestra.
 WKRC, Cincinnati, Ohio (422.3), 10 p. m., George Weber, tenor; Maxim Eastylock, Russian baritone; George Egbers, tenor; Carolyn Schlosser, reader; Tommy Reynolds, Irene Downing; Gene Perazzo, pianist.
 WLS, Chicago, Ill. (344.6), 6:30 p. m., Ralph Emerson, organist; 7, lullaby time; 7:20, "Songs of Ireland," Rex Maupin, director.
 WMAQ, Chicago, Ill. (447.5), 6 p. m., Chicago theater organ recital; 6:30, Hotel LaSalle orchestra; 8, literary sidelights, Harry Hansen; 8:20, Harriet Case, soprano; 8:40, travel talk, Clara E. Laughlin; 9, lecture, University of Chicago; 9:20, Mayfair M. E. choir.
 WMBB, Chicago, Ill. (250), 7-8 p. m., Trianon duo; Beatrice Teller, Lindsey McPhill, Clarence Jacobs, Hazel O'Neil, Mildred Matejka, Jean Ballard, Babbe and Barr, Paul Cadieux; 9-11, Trianon orchestra, Rilhe Allen, Hoff, A. Stephenson, Jimmy Eggert, Wood-lawn theater orchestra.
 WMC, Memphis, Tenn. (499.7), 8:30 p. m., program, Henri Bonner, director; 11, midnight frolic.
 WOAW, Omaha, Nebr. (526), 6 p. m., classical; 6:30, orchestra; 7:10, Neal Jones; 9, program, Hannan-Van Brunt company, Ford dealers; 12, Rialto Alarm.
 WOC, Davenport, Iowa (483.6), 5:45-6 p. m., chimes concert; 6:30-6:50, Sandman; 7:30-8, WEAF Gold Dust twins; 8-9, WEAF Eveready hour; 9-10, Crescent orchestra.
 WOK, Homewood, Ill. (217.3), 6-7 p. m., Genevieve Barry Northam, soprano; Clement Laskowski, tenor; LeRoy Burn, pianist; Banks Kennedy, organist; 10-11, Kraft Harmony boys; Bill Hay, bass; Evelyn Johnson, contralto; Jack Armstrong, violinist; Wildoy and Sheehan, Harmony duet; Carl Stoenberg, harmonica soloist; Harriet Lee, contralto; Banks Kennedy, organist; Herman Shalke, violinist.
 WORD, Batavia, Ill. (275), 8 p. m., Webster hotel concert trio; 8:15, World News Digest; 8:30, Cosmopolitan School of Music; 9:30, Bible questions and answers.
 WQJ, Chicago, Ill. (447.5), 7-8 p. m., Rainbo Gardens orchestra; Henrietta Nolan, violinist; Clement Laskowski, tenor; Helen Holman, soprano; 10-11, Rainbo Skyarks; Adelaide Steeg, contralto; Jerry Sullivan; Rose Vandenberg, Hal Lansing, Alma Adair, Bert Davls, Cloun of the Air; Frank Blasco, Jerry tenor; Will Rossler; Mack sisters; Merrill Carder; 1-2, Ginger hour.

Mountain Time Stations

KOA, Denver, Colo. (322.4), 6:30 p. m., Herbert White and his Silver State orchestra; 7:30, News-Times concert.

Pacific Time Stations

KFOA, Seattle, Wash. (454.3), 6:45-8:15 p. m., Rhodes Department store; 8:30, program; 9:30-11:30, Eddie Harkness and his orchestra.
 KFPG, Hollywood, Calif. (238), 5-6 p. m., home hour with Georgia Simmons and the neighborhood children; 8-9, Harold Hynes and his gloom chasers, a frolic; 9-10, Ruth Leonard's golden melody hour featuring popular melodies.
 KFWB, Hollywood, Calif. (252), 6-7 p. m., children's hour, Big Brother of KFWB; 7, Howard Beall, golf instructor; 7:45, microphone brevities; 8-9, program, Western's super-service garage, Hollywood string trio, Ray Kellogg and Bill Hatch, jazz twins; Warner Brothers syncretors; 9-10, program, H. L. Crockett Hudson-Exsex dealer; E. L. Crockett and his quartet; Elite trio; Louise Sullivan, soprano; Way Watts and ukulele; 10-11, Warner Brothers frolic, direction Charlie Wellman.
 KGO, Oakland, Calif. (361), 6-7 p. m., dinner concert, Kohler and Chase Ampico studios; Theodore Strong, organist; 8, National Carbon company program; Julia Hanna Cochran, violinist; Dorothy Dukes Dimm, cellist; Dorothy Vines Reed, pianist; Eileen Pligott, soprano; Ruth Hall Grandall, contralto; Philip Ashcraft, tenor; Charles Lloyd, bass.
 KGW, Portland, Ore. (491.5), 8-9 p. m., "Sound Investments"; style talk, Rose City trio; 9-10, General Cord orchestra; 10-12, dance music.
 KHJ, Los Angeles, Calif. (405.2), 5:30-6 p. m., Leighton's Arcade cafeteria orchestra, Jack Cronshaw, leader; 6-6:30, Art Hickman's Biltmore hotel concert orchestra, Edward Fitzpatrick, director; 6:30-7:30, weekly visit of Queen Titania and Sandman from Fairyland, Chas. Leslie Hill, readings; Louis F. Klein, auto-harp and harmonica; 7:30, talk on dogs, H. M. Robertson; 8-10, program, Broadway Department store, arranged by J. Howard Johnson; 10-11, Art Hickman's Biltmore hotel dance orchestra, Frank Ellis, leader.
 KJR, Seattle, Wash. (384.4), 8:30-10 p. m., Puget Sound Savings and Loan association concert orchestra.
 KNX, Hollywood, Calif. (336.9), 5:30-6:15 p. m., Wur-litzer pipe organ studio, Town Tattler; 6:15, travel talk, W. F. Alder; 6:30-7, Atwater Kent Radio orchestra, Paul Finstein, leader; 7-8, an hour of classical music; 8-10, KNX's regular feature program, arranged by Carrie Preston Rittmeister; 10-12, movie night at the Ambassador, Ray West's Coconut Grove dance orchestra.
 KTAB, Oakland, Calif. (215), 9 a. m., prayer service, Rev. Phillips; 8-10, program, Mutual stores Spanish program.

Wednesday, October 14

Wednesday, silent night for: CHIC, CHNC, CNRA, CNRE, CNRM, CNRR, CNRW, CNRT, KFKX, KOA, KOB, WAHG, WAMD, WBBR, WCTS, WEAF, WFI, WGCP, WGY, WHAR, WIP, WMCO, WOAW, WOR, WORD, WREO.

Eastern Time Stations

CNRO, Ottawa, Can. (435), 8 p. m., Chateau Laurier concert orchestra; Stafford Salmon, baritone; S. Green, French horn soloist; Mrs. J. R. Pontifex, contralto; Sybil G. Braithwaite, violinist; Clara Baxter, soprano; Henry W. Wings, habitant; Stafford Salmon, baritone; Chateau Laurier dance orchestra.

Dr. C. W. Woodall is the "air doctor" who gives weekly health and first aid talks from WGY, Schenectady. Dr. Woodall allows his invisible patients to ask him questions and has given advice to many millions of fans. His health talks occur on Fridays at 6:30.



KDKA, Pittsburgh, Pa. (309.1), 6:15 p. m., dinner concert; 7:30, children's period; 7:45, "The Evolution of Crime," Dr. W. T. Root; 8:30, Dry Siltz hour of music.
 WAHG, Richmond Hill, N. Y. (315.6), 7:30-7:45 p. m., Joe Zimmerman, pianist; 7:45-8, Jean Black, uke and songs; 8-8:15, Gerlich and Cornish, saxophone and piano; 8:15-8:30, Judith Roth, soprano; 8:30-8:45, William Townsend Taylor, baritone; 8:45-9, Gerlich and Cornish; 9-9:35, Jamaica club; 10:05-10:15, Judith Roth; 10:15-11:15, Joe Zimmerman and his orchestra.
 WBEZ, Springfield, Mass. (333.1), 6:30 p. m., Hotel Kimball trio; Jan Geerts, director; 7:05, W. Edward Boylie's Copley Plaza orchestra; 7:30, Radio Nature League, Thornton Burgess; 8, concert, Gibbs Piano company; Helen Campbell Triplett, soprano; William Spittall, tenor; Ruth Ekberg, contralto; Walter Marsh, bass; 9, Alandale hour.
 WCAE, Pittsburgh, Pa. (461.3), 6:30 p. m., dinner concert, William Penn hotel; 8:30, Pooley period; 9, Waterman hour.
 WCAU, Philadelphia, Pa. (277.5), 7:30 p. m., Lew Chapman and his Hotel Pennsylvania orchestra; 8, stage dancing lesson, Al White; 8:15, Pucell trio; 9, Hill Instrumental trio; 9:30, "Prevention Treatment of Diabetes Mellitus," Dr. A. I. Rubenstone; 9:40, Eddie Malle's Melody Masters.
 WCTS, Worcester, Mass. (268), 8 p. m., concert.
 WCX, Detroit, Mich. (517), 4:15 p. m., The Detroit Symphony trio; 6, dinner concert, Book-Cadillac hotel; 8, musical program.
 WEAF, New York, N. Y. (491.5), 6-7 p. m., dinner music, Waldorf-Astoria; 7-7:30, services, United Synagogue of America; 7:30-8, concert, United States Army band; 8-8:30, "Huyler's Bon Bon Buddies"; 8:30-9, Pooley Period; 9-10, "Waterman's Point of Progress-Crownell, the Protector"; 10-11, Ipana Troubadours; 11-12, Ben Bernie and his Hotel Roosevelt orchestra.
 WEAO, Columbus, Ohio (293.9), 8 p. m., faculty lecture; 8:15, Mrs. Arthur Roberts, contralto; 9, May Furniture company ladies orchestra.
 WEAR, Cleveland, Ohio (389.4), 7 p. m., Hotel Cleveland orchestra.
 WEEI, Boston, Mass. (348.6), 7:30 p. m., Henry Volk, violinist; 8, Huyler's Bon Bon Buddies; 8:30, Earl Nelson and his uke; 9, Waterman's Points of Progress, Magna Charta; 10, Ipana troubadours.
 WGBS, New York, N. Y. (315.6), 6-6:30 p. m., Uncle Geebee; 6:30-7:30, Yerkes Flotilla orchestra.
 WGCP, New York, N. Y. (315.6), 8-8:15 p. m., Ukulele Lou Hayes; 8:15-8:30, Andy Ruzaf trio; 8:30-8:45, Dick and Flo Bernard, songs; 8:45-9, Hoch and Jerome; 9-9:15, William J. Rietz, songs; 9:15-10, Indianans orchestra; 10-10:15, Sam Williams and Al Piantodosi; 10:15-11:15, Strickland's Clover Gardens orchestra.
 WGR, Buffalo, N. Y. (319), 2:30-4:30 p. m., WGR's afternoon program; 9-11, jointly with WEAF, including Waterman's Points of Progress and the Ipana Troubadours; 11-11 a. m., Vincent Lopez Hotel Statler dance orchestra, Harold Giesler, director.
 WGY, Schenectady, N. Y. (379.5), 6:45 p. m., Albany Strand theater orchestra; Floyd H. Walter, organist; 7:30, Book of Knowledge program.
 WHN, New York, N. Y. (361.2), 10-10:30 p. m., Roseland dance orchestra; 11-11:30, Silver Slipper revue; 11:30-12, Ted Lewis orchestra.
 WJAR, Providence, R. I. (305.9), 7:30 p. m., U. S. Army band; 9, Waterman's Points of Progress; 10, program, New York.

(Continued on page 11)

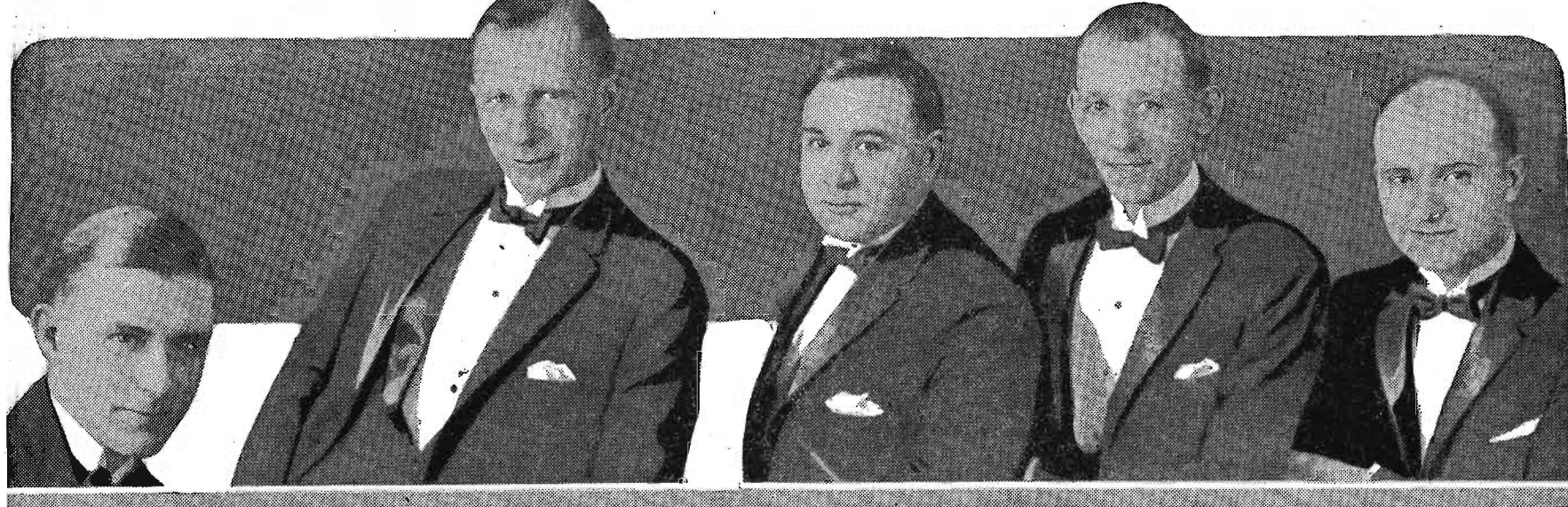

The Indiana male quartet which was popular with the invisible audience of WEBH last year has returned with the fall to this Chicago station. They are from left to right: Del Anderson, accompanist; A. M. Hagberg, bass; D. E. Kestler, 2nd tenor; M. H. Marquardt, baritone; R. Paul Smith, 1st tenor. Tune in for them some night.

WELSH MUSIC WEDNESDAY AT WLS

Wednesday, October 14

(Continued from page 10)

WJR, Detroit, Mich. (517), 7 p. m., studio orchestra, Jenn Goldkette, director; 9, Burroughs hour.

WKAQ, San Juan, P. R. (340.7), 7-9 p. m., municipal band, Prof. Manuel Tizol, director.

WLS, Chicago, Ill. (344.6), 6:30 p. m., Ralph Emerson; 7, lullaby time; 7:20, WLS trio; 7:45, Grace Wilson; 8, Syncopation hour, Clarence Jones, director; 9, Elizabeth Post, soprano; 9:10, Welsh songs and stories; Keltic quartet; 10, Abe Lyman and his College Inn orchestra; 10:10, Metropolitan community choir, J. Wesley Jones, director; 11, Ralph Emerson.

WMCA, New York, N. Y. (340.7), 12-12:30 p. m., Olcott Vail's string ensemble; 6-6:30, Olcott Vail;

Gallery, tenor; Lew Russell, Sue Olmstead, ukulele soloist; DeWitt & Owen; Evans Lloyd, baritone.

WGN, Chicago, Ill. (370.2), 6:30-7:30 p. m., Drake concert ensemble, Blackstone string quintet; 8:30-9:30, WGN string trio; 10:30-11:30, jazz scamper, Jack Chapman's and Blackstone orchestras.

WHAD, Milwaukee, Wis. (278), 6-7 p. m., Arthur Richter, organist; 8-10, Wisconsin Roof garden orchestra.

WHAS, Louisville, Ky. (399.8), 7:30-9 p. m., Royal Peacock orchestra.

WHB, Kansas City, Mo. (365.6), 7-8 p. m., classical music, automotive talk, John Burns.

WHO, Des Moines, Ia. (526), 6:30-7:30 p. m., Reese-

WOS, Jefferson City, Mo. (440.9), 8 p. m., address, Charles U. Becker; boy scouts program.

WQJ, Chicago, Ill. (447.5), 7-8 p. m., Rainbo Gardens orchestra; Esther Welss, soprano; Edith Dady, whistler; Maryl Larson, soprano; 10-11, Ralph Williams and his Rainbo Skyliners; Melodians; Esther Trostrod, mezzo soprano; Fred A. Jacobsen, reader; Clarence Theders, tenor; Fontella trio; Sandy Meek, Scotch tenor; Harry Sosnick, pianist; J. Edwin Peterson, bass; Tillie Miller, contralto; 1-2, Ginger hour.

Mountain Time Stations

KOA, Denver, Colo. (322.4), 6:30 p. m., Herbert White and his Silver State orchestra; 8, scientific football,

KHJ, Los Angeles, Calif. (405.2), 5:30-6 p. m., Leighton's Arcade cafeteria orchestra, Jack Cronshaw, leader; 6-6:30, Art Hickman's Biltmore hotel concert orchestra, Edward Fitzpatrick, director; 6:30-7:30, Radio kiddies' hour with Dick Winslow, juvenile reporter; Mickey McBan, screen juvenile; 8, Dr. Mars Braumgardt, scientific lecturer; 8:30-10:30, program, B. F. Miller Hudson Essex company, arranged by J. Howard Johnson; 10:30-11:30, Art Hickman's Biltmore hotel dance orchestra, Frank Ellis, leader.

KJR, Seattle, Wash. (384.4), 7-8:30 p. m., Sears-Roebuck and company; 8:30-10, Post Intelligence studio program.

KNX, Hollywood, Calif. (336.9), 5:30-6:15 p. m., Wuritzer pipe organ studio, Town Tattler; 6:15, travel talk, W. F. Alder; 6:30-7, Atwater Kent Radio orchestra, Paul Finstein, leader; 7-8, Ambassador hotel concert orchestra, Josef Rosenfeld, director; 8-9, KNX feature program; 9-10, program with a kick, Hercules Gasoline company featuring Elmer, Mandy and the Mule; 10-11, hour of dance music.

Thursday, October 15

Thursday, silent night for: CHIC, CHNC, CNRA, CNRE, CNRO, CNRR, CNRT, CNRV, KFAB, KFDM, KFKX, KFMQ, KFMX, KFOA, KFVE, KGW, KOA, KOB, KSD, KTCL, PWX, WAHG, WCEE, WEAQ, WEBJ, WHAD, WIJD, WLIT, WOR, WOS.

Eastern Time Stations

CNRM, Montreal, Can. (411), 8:30 p. m., Capitol grand opera quartet.

KDKA, Pittsburgh, Pa. (309.1), 6:15 p. m., dinner concert; 7:30, children's period; 7:45, "Through the Saragossa Sea and Galapagos Islands," J. F. W. Pearson; 8:30, KDKA Little Symphony orchestra; J. Lloyd Mahony, baritone; 10:30, midnight concert.

WBBR, New York, N. Y. (272.6), 8 p. m., Instrumental trio, John Yankee, George Twarosch, Charles Rohner; 8:15, Barbara Jonash, soprano; 8:25, Sun-



Mrs. Charles Ghinski is one of the reasons for the popularity of KFDM. Her soprano tones carry well over the Radio.

6:30-7:30, Ernie Golden and his Hotel McAlpin orchestra; 9-10, Philmont orchestra; 11:30-12, Jack Smith, songs.

WNYC, New York, N. Y. (526), 7-7:10 p. m., market high spots; 7:10-7:30, dance program; 7:30-7:35, police alarms; 7:35-8, dance program; 8-9, Spanish lessons, V. Harrison Berlitz; 9-10, artist-pupil's recital; 10-10:30, piano duets.

WOC, Philadelphia, Pa. (508.2), 7:30 p. m., Hotel Sylvania orchestra; 8, U. S. Army band; 8:30, Pooley period; 9, Waterman's Points of Progress; 10, Mary E. Vogt, organist; 10:30, Ritz-Carlton hotel orchestra.

WOR, Newark, N. J. (405.2), 2:45-3 p. m., talk, Dr. George W. Little; 6:15-7:15, Hotel Shelton ensemble; 7:15-7:30, sports talk.

WEO, Lansing, Mich. (285.5), 6-7 p. m., dinner concert.

WTIC, Hartford, Conn. (475.9), 6:30 p. m., dinner concert; 7:20, dinner music; 10, Bill Tassilo's orchestra.

WWJ, Detroit, Mich. (352.7), 6 p. m., dinner concert; 8, News orchestra; 9, dance program.

Central Time Stations

CNRW, Winnipeg, Can. (384.4), 8:10 p. m., Fort Garry hotel concert orchestra; 9:45, dance program, Fort Garry hotel; Al Kilgour.

KFAB, Lincoln, Nebr. (340.7), 5:30-6:30 p. m., Bulck Little Symphony; 8:30-10:30, Belshaw's orchestra; Walkiki trio; Ralph Hall, banjoist; A. E. Meyers, mouth harpist.

KFMX, Northfield, Minn. (337), 9-10 p. m., musical program.

KFNF, Shenandoah, Iowa (266), 7 p. m., concert, Henry Field Seed company.

KFVE, University City, Mo. (240), 10 p. m., Paul and Jack Snyder; Orchestra, Romaine.

KMA, Shenandoah, Iowa (252), 8:45 p. m., domestic science timely topics, Le Ona Teget, June B. Case; 9-11, Farmham trio.

KOL, Council Bluffs, Iowa (278), 7:30 p. m., Harmo Jazz orchestra; J. Stanley Davis, reader; Mrs. Antonio, soprano; Agnes Fountain, contralto; 11, The Nauticals, "The Seaman without a Ship."

KPRC, Houston, Texas (252), 5:30 p. m., Uncle Judd's Kiddies' hour; 7:30, Rice Institute student band, Lee Chatham, director; 8:30, Margaret Britton, soprano; Ewing Werlein, basso; 9, Wilson Fraser, composer-pianist; 11, Seger Ellis, blues pianist.

KSD, St. Louis, Mo. (545.1), 7 p. m., Benjamin Rader's orchestra.

KTHS, Hot Springs National Park, Ark. (374.8), 9:45 p. m., New Arlington orchestra; 9:45-10:30, Charles Elliott, saxophonist.

KYV, Chicago, Ill. (535.4), 7-7:30 p. m., dinner concert, Congress hotel; 8-9, Adele Brandt, contralto; Sallie Brandt, pianist; Charlie Schultz, tenor; Art Linick; 10-12:30, Coon-Sanders Original Nighthawks; Albert Haislalte, organist.

WAMD, Minneapolis, Minn. (243.8), 6 p. m., dinner concert; Hilda Kiehne, soprano; I. B. Curtis, accompanist; 7, musical program; banjo quartet; DeMolay quartet; Sandy Ecklund, tenor; Lila Thompson, accompanist; Melvin Ginzberg, violinist; 8, Marion Latta, contralto; Merle Fuller, pianist; George Getze, tenor; Thelma Wilson, accompanist; Sylvan Frase, banjoist.

WBAP, Fort Worth, Texas (475.9), 7:30-8:30 p. m., Panther Hawaiian trio; 9:30-10:45, program, popular music.

WBBM, Chicago, Ill. (226), 8-10 p. m., Charlie Garland, Nate Caldwell, Eddie Loftus, Samovar orchestra; Hazel McBroom, William Molnair, Corinne Jordan; 12-2, Alamo orchestra; Honky Tonk Gloem chasers; Earl Bergman, Harold Anderson, Charlie Garland, Nate Caldwell, Eddie Loftus, Lew Russell, Murray Smith.

WCCO, Minneapolis-St. Paul, Minn. (416.4), 7 p. m., church service, Rev. E. Doer; Acappella male chorus; 8, Gordon Cooke ensemble; 9, program, Ipana troubadours; 10:05, St. Paul Community chest song; 10:10, dance program; 11:30, Eddie Dunstedter, organist.

WDAF, Kansas City, Mo. (365.6), 6-7 p. m., address, speaker, Health Conservation association; address, Ralph E. Herrick; Tell-Me-a-Story lady; Trianon ensemble; 8-9:15, classical music, Star's Radio string orchestra; 11:45-1, Merry Old Chief; Eddie Kuhn's Kansas City Athletic club orchestra; Earl Coleman's orchestra.

WEBH, Chicago, Ill. (370.2), 7-8 p. m., Oriole orchestra; Florence Behrend, soprano; 9-10, Oriole orchestra; Correll and Gosden; Robert York, tenor; 11-1, Oriole orchestra; Correll and Gosden; Robert York, tenor; Oriole orchestra.

WGES, Oak Park, Ill. (250), 7-9 p. m., Richard Dalo, baritone; Louise Wyse, soprano; John MacFarlane, bass; John Stamford, tenor; 11-2 a. m., Kampus Kollegians orchestra; Rose Sweeney, soprano; Frank



Lois Elizabeth Powell sings request songs at KWKH, Shreveport. Miss Powell has studied both in Boston and New York. Nelson B. Bell, right, is the impresario and director of Crandall's Saturday Nighters heard Saturday nights at WRC.

Hughes orchestra; 7:30-9, Smith sisters, Harmony girls; Harry Armigido, banjoist; colored ladies quartet; 9-10:30, Corn Sugar orchestra; 10:30-12, dance program.

WKRC, Cincinnati, Ohio (422.3), 8 p. m., book review, Alice B. Coy; 8:15, Marion McKay and his orchestra; 8:45, popular studio features; 9-15, Marion McKay and his orchestra.

WMAQ, Chicago, Ill. (447.5), 6 p. m., Chicago theater organ recital; 6:30, Georgene Faulkner, story lady; 8, lecture, Northwestern university; 8:25, Mrs. Hilda Butler Parr, pianist; 8:35, lecture, University of Chicago; 9, WMAQ players.

WMBB, Chicago, Ill. (250), 7-8 p. m., Trianon duo, Beatrice Tallor, Florence White Bush, Joel Lay; 9-11, Trianon orchestra, Marquette Bando Four, Billie Allen Hoff, Woodlawn theater orchestra.

WOC, Davenport, Iowa (483.6), 5:45-6 p. m., chimes concert; 6:30-6:50, Sandman; 9-10, Ipana Troubadours, WEAF; 10-11, Erwin Swindell, organist; A. P. Griggs, contralto.

WOK, Homewood, Ill. (217.3), 6-7 p. m., Robert York, tenor; Eleanor Gilmour, soprano; Banks Kennedy, organist; LeRoy North, pianist; 10-11, Ned Miller, tenor; Rita McEawn, soprano; Cy Berg, ukulele soloist; Herman Sinaiko, violinist; Banks Kennedy, organist; Williamson brothers, mandolin guitarist; Harold Morava, tenor; Harriet Lee, contralto; LeRoy North, pianist.

WORD, Batavia, Ill. (275), 8 p. m., Webster hotel concert trio; 8:15, I. B. S. A. choral singers; 8:30, address, Calvin H. Swingle.

Tom McNamara; 8:10, "Why Save," A. A. Reed; Walter G. Tripp, baritone; Otis B. Thayer, reader.

Pacific Time Stations

KFOA, Seattle, Wash. (454.3), 6:45-8:15 p. m., Hopper Kally company; 8:30-10, Times studio program.

KFFG, Hollywood, Calif. (238), 5-6 p. m., home hour with Georgia Simmons and the neighborhood children; 8-9, Maggie O'Shea, the blarney girl and her rollicking girls from Cork; 9-10, KFFG concert orchestra, presented by C. Harold Ramey.

KFWB, Hollywood, Calif. (252), 6-7 p. m., children's hour, Big Brother of KFWB; 7, Mutual motors mirth contest; 7:45, microphone brevities; 8-9, program, John Wright, the right tailor; John Wright's orchestra; Lee Kent, blues singer; Kathryn Martin, soprano; Rogers' Hawaiian trio; 9-10, Joe Martin's Studio Six dance orchestra; Violet Preston, blues singer; 10-11, Warner Brothers frolic, direction, Charlie Wellman.

KGO, Oakland, Calif. (361), 6-7 p. m., Theodore Strong, organist.

KGW, Portland, Ore. (491.5), 7:45-8 p. m., book review, J. K. Gill company; 8-9, Western Auto Supply company; 10-11, Sherman, Clay and company.

day school lesson, S. M. Van Sidma; 8:45, Barbara Jonash, soprano; 8:50, instrumental trio.

WBZ, Springfield, Mass. (333.1), 6:30 p. m., Leo Reisman's Hotel Brunswick orchestra; 7:05, sextet of children, Lancaster theater; 7:30, "The Story of the Drama of Ideas," Channing Pollock; 7:45, Daniel J. Morgan, tenor; 8, program, Noyes Buick company; 9, "Aida," opera, Madame Vinello-Johnson, director.

WCAE, Pittsburgh, Pa. (461.3), 6:30 p. m., dinner concert, William Penn hotel; 8, Larkin period; 9, Atwater Kent Radio artists; WCAE; 10, Silvertown Cupid orchestra.

WCAU, Philadelphia, Pa. (277.6), 6:30 p. m., Cathay Tea Garden orchestra; 7:30, Snellenburg male quartet; 8, Florence Haenle, violinist; Dorothy Butterworth, soprano; Eric West, cellist; Frances Butterworth, pianist; 9, Barry O'Moore, Irish tenor; 9:15, Central Radio artists; 9:30, Frank Cook; 10, Sesqui Centennial hour.

WCTS, Worcester, Mass. (268), 8-8:30 p. m., Larkinites; 8:30-9, program from New York; 9-10, miscellaneous program; 10-11, Silvertown Cord orchestra.

WCX, Detroit, Mich. (517), 2 p. m., News and markets; 4:15, The Detroit Symphony trio; 6, dinner concert, Book-Cadillac hotel; 8, musical program.

WEAF, New York, N. Y. (491.5), 6-7 p. m., dinner music, Waldorf-Astoria; 7:30, service, Greater New York Federation of Churches; 7:30-8, Cushman's serenaders; 8-8:30, "The Larkinites"; 8:30-9, talk, George Elliott Cooley; 9-10, Atwater Kent Radio artists; 10-11, Silvertown Cord orchestra; 11-12, Vincent Lopez and his orchestra.

WEAR, Cleveland, Ohio (389.4), 7 p. m., Marjorie Moore's Melody Maids; 8, R. T. L. program; 9, Chauncey Lee's orchestra; 10, Vincent Percy, organist.

WEEL, Boston, Mass. (348.6), 7:30 p. m., Earl Alpine, baritone; Alberta Derry, pianist; 8, Larkinites; 8:30, pop concert; 9, Atwater Kent Radio artists; 10, Goodrich Silvertown Cord orchestra.

WGBS, New York, N. Y. (315.6), 6-6:30 p. m., Unehle Geebee; 6:30-6:45, Ted Snyder; Bill Helms; 7-8, Voltaire hour of music; 8-8:30, May Singhi Breen; Peter de Rose; Jack Rose male quartet; 8:30-9, "Footlight and Lamplight," Oliver Saylor.

WGR, Buffalo, N. Y. (319), 2:30-4:30 p. m., WGR's afternoon program; 6:30-7:30, Vincent Lopez Hotel Stadler dance orchestra, Harold Gieser, director; 8-11, jointly with WEAF, including the Larkin program and the Goodrich Silvertown Cord orchestra.

WGY, Schenectady, N. Y. (379.5), 6:30 p. m., Ten Eyck trio; 7:30, WGY book chat, L. L. Hopkins; 7:45, Mrs. William J. Breslin, contralto; Ethel Osterhour, pianist; 8, Pan-American program, WRC; 10, Royal hour; WJZ; 11:30, Stephen E. Boisclair, organist.

Index to Farmers' Programs

Farmer Dinner Concerts
Daily Except Sunday
KFNF, 12:15-1:35 (central time).
WLS, 12 (central time).

Radio Farm School
WMAQ, 12:45 (central time); 12:10 on Friday.
WOC, 12:30-12:40 (central time).

Talks
KMA, 11:30-12:30 (central time).
WCCO, 7:45 (central time) Monday and Friday.

Market Reports and Dairy Quotations
Central Time (Daily Except Sunday)

KTHS, 12:30-1; KYW, 11, 6:02; WCCO, 9:45, 10:30, 11:30, 1:30, 3; WDAF, 5:50; WFAA, 11:30-12, 12:30-1, 1:30-2, 2:30-3; WHAD, 11, 5:50-6; WHAS, 4:50; WHB, 8:25, 9:25; 10:25, 11:20, 11:56, 12:10, 1:25, 3; WMC, 9:45 1:30, 8:30, except Wednesday; WQAW, 8:15, 10:30, 12:30, 1:45, 4; WOC, 2-2:10.

Eastern Time (Daily Ex. Sunday)
KDKA, 9:45, 12, 3:20, 12, 7:10;
WCAE, 4:30; WCTS, 11:15; WCX, 2;
WEAR, 11:30, 4:30.

(Continued on page 12)

AGAIN AT WIP; POE PROGRAM AT WTIC

picture comedian, is shown below giving orchestra conductor, a few pointers in his ivory; gold embossed baton during his WKRK and hear her direct with it.



Helen Vallon is the attractive pianist who appears regularly before the microphone of KPO, San Francisco.

DANCING

Central Standard Time
Saturday, October 10:
 Kgw, Wgy, Wmbb, Wmas; 8:05, Wip; 9:30, Wwb, Wgy, Wmb; 10:30, Wmaf, Wmca, Wrc, Wreo, Wtas; 11:00, Wcb, Wco, Wgs, Wgn; 11:45, Wrc; 10:30, Wcb, Wco, Wgs, Wgn; 11:45, Wrc; 10:30, Wcb, Wco, Wgs, Wgn; 11:45, Wrc; 12:30, Kgw, Khj, Knx.
Monday, October 12:
 Wkr, Wmb, Wtas; 10:30, Wwb, Wgy, Wmb; 11:00, Wcb, Wco, Wgs, Wgn; 11:45, Wrc; 10:30, Wcb, Wco, Wgs, Wgn; 11:45, Wrc; 10:30, Wcb, Wco, Wgs, Wgn; 11:45, Wrc; 12:30, Kgw, Khj, Knx.
Wednesday, October 14:
 Kgw, Wmad, Wbn, Wrc, Wwb, Wtas; 10:30, Wwb, Wgy, Wmb; 11:00, Wcb, Wco, Wgs, Wgn; 11:45, Wrc; 10:30, Wcb, Wco, Wgs, Wgn; 11:45, Wrc; 12:30, Kgw, Khj, Knx.
Friday, October 16:
 Kgw, Wmad, Wbn, Wrc, Wwb, Wtas; 10:30, Wwb, Wgy, Wmb; 11:00, Wcb, Wco, Wgs, Wgn; 11:45, Wrc; 10:30, Wcb, Wco, Wgs, Wgn; 11:45, Wrc; 12:30, Kgw, Khj, Knx.

WOO, Philadelphia, Pa. (508.2), 7:30 p. m., Hotel Ritz-Carlton orchestra; 8, R. C. O. military band; 8:45, Madame Milda Robinson Townsends soprano; Dulce E. Townes, contralto; Sadler's Roadside orchestra; 10, music; 10:30, Hotel Ritz-Carlton orchestra.
WDR, Newark, N. J. (405.2), 6:15-7:15 p. m., Hotel Shelton ensemble; 7:15-7:30, sports talk; 7:30-8, Florence Richardson's Casino orchestra.
WREO, Lansing, Mich. (285.5), 6-7 p. m., dinner concert.
WTIC, Hartford, Conn. (475.9), 6:30 p. m., young people's half hour; 7, Emil Heimbarger's Hotel Bond trio; 8:30, Benjamin M. Knox, baritone; 9, an evening with Edgar Allen Poe, Mrs. Clara Coe Byrne, reader; music, pupils of Benjamin M. Knox; 10:05, Hotel Bond orchestra; 11:30, popular half hour for distant listeners, Donaldson, Murphy, Bennett.
WWJ, Detroit, Mich. (352.7), 8 p. m., dinner concert; 8, News orchestra; 9, dance program.

Central Time Stations
KFAB, Lincoln, Neb. (340.7), 8:30-10:30 p. m., entertainers, Auburn, Neb.
KFDM, Beaumont, Texas (315.6), 8-10 p. m., band concert, Magnolia Petroleum company's refinery band.
KFMX, Northfield, Minn. (337), 10-11 p. m., organ recital.
KFNF, Shenandoah, Iowa (266), 7 p. m., half hour discussion, Sunday school lesson; 7:30, pipe organ concert.
KFVE, University City, Mo. (240), 10 p. m., Olin Gibson, Henry Miller, Orchestra Romaine.
KMA, Shenandoah, Iowa (252), 9-11 p. m., musicale.
KOIL, Council Bluffs, Iowa (278), 7:30-8:30 p. m., Dick Magulson, pianist; Ina Pfaff, soprano; Marie Merrill, pianist; Hallmark Six orchestra; 8:30, Creighton educational period; 11, Broadway theater.
KSD, St. Louis, Mo. (545.1), 7:30 p. m., commerce hour, artist recital, Mrs. Dorothy Coates Coe, harpist; 8, Radio show.
KTHS, Hot Springs National Park, Ark. (374.8), 9:10-10 p. m., New Arlington hotel classical ensemble.
KYW, Chicago, Ill. (535.4), 7-7:30 p. m., dinner concert, Congress hotel; 7:30-8:30, home lovers' hour; 10:12-30, midnight review, Albert Hay Malotte, organist.
WAMB, Minneapolis, Minn. (243.8), 6 p. m., concert orchestra, Charles Teret, tenor; A. E. Swan, accompanist; 7, musical program, Minneapolis public schools; 8, Benson string quartet; Margaret King, soprano; Lowell Handshaw, baritone; Merle Fuller, pianist.
WBAP, Fort Worth, Texas (475.9), 7:30-8:30 p. m., Texas Christian university; 9:30-10:45, musical program.
WBBM, Chicago, Ill. (226), 8-10 p. m., Alamo orchestra, Lew Russell, Murray Smith, Earl Bergman, Stewart-Warner xylophone trio; Marie Morgott.
WCCO, Minneapolis-St. Paul, Minn. (416.4), 8:15 p. m., dinner concert; 7:45, farm lecture; 8, musical program; 10:05, St. Paul Community Chest song; 10:10, dance program.
WDAF, Kansas City, Mo. (365.6), 6-7 p. m., address; Tall Mc-a-Story lady; Trianon ensemble; 8-9:30, Star's Radio orchestra; 11:45-1, Merry Old Chief, Plantation players; Earl Coleman's orchestra; Eddie Kuhn's Kansas City Athletic club orchestra; Earl Coleman's orchestra.
WEBB, Chicago, Ill. (370.2), 7-8 p. m., Oriole orchestra; Uptown theater; 9-10, Oriole orchestra; Katherine Forbes, soprano; Beulah Laxon, violinist; 10-11 a. m., Oriole orchestra; stories, Wayne Myers; Paul Small.
WFAA, Dallas, Texas (475.9), 6:30-7:30 p. m., Ford and Glenn and the Solomon Old Judge; 8:30-9:30, Amphion male quartet.
WGES, Oak Park, Ill. (250), 7-9 p. m., John Rankel, baritone; Ruth Kalthoff, soprano; Emma Butler, contralto; Gladys Weige, violinist; John Stamford, tenor; 6:45-7, lecture, E. L. Richards; 11-2 a. m., Norely Broadcaster's orchestra; Marie Wright, Evans Lloyd, Coyne Banjo trio; Kenneth Nelson.
WGN, Chicago, Ill. (370.2), 6:30-7:30 p. m., Drake concert ensemble, Blackstone string quintet; 8:30-9:30, WGN string trio; 10:30-11:30, Jazz scamper program, Jack Chapman's and Blackstone dance orchestras.
WHAD, Milwaukee, Wis. (278), 6-7 p. m., Arthur

Richter, organist; 7:05, Bill Juhre's Radio Cartoon game; 8:30-10, Wisconsin theater revue.
WHAS, Louisville, Ky. (399.8), 7:30-9 p. m., glee club, Louisville and Jefferson county children's home; talk, George A. Colvin; four minute talk, Mrs. George Walton.
WHB, Kansas City, Mo. (365.6), 7-8 p. m., Glenn Durrell's Sweeney Radio orchestra.
WHO, Des Moines, Iowa (526), 7:30-9 p. m., Garber entertainers; 11-12, dance program.
WLS, Chicago, Ill. (344.6), 6:30 p. m., Ralph Emerson, organist; 7, lullaby time; 7:30, old English songs, WLS trio; Rex Mauyard, director; 7:45, Tony Corcoran, baritone; 8, R. F. D. program, WLS trio; 9, Abe Lyman and his College Inn orchestra; 9:10, Rudolph C. Bryant and his banjo quartet; 9:45, Abe Lyman's College Inn orchestra; 10, Alexander Nakutim's Better Music hour; 10:45, Abe Lyman's orchestra.
WMAQ, Chicago, Ill. (447.5), 6 p. m., Chicago theater organ; 6:30, Wideawake radio program; 8, musical lecture, Mr. and Mrs. Marx E. Obendorf; 8:30, Whitney trio; 9, University of Chicago lecture; 9:20, Mrs. Mae Graves Atkins, soprano; 9:45, Christian Endeavor talk.
WMB, Chicago, Ill. (250), 7-8 p. m., Trianon duo, Beatrice Teller, Jeana St. Anne, Florence White Rush; 9-11, Trianon orchestra, Edward Hines, Stokes and Agne, Morey Alsvang, Jack Murnane, Cecil and Esther Ward.
WMC, Memphis, Tenn. (499.7), 8:30 p. m., Atwater Kent Radio company; 11, midnight frolic.
WOM, Omaha, Neb. (526), 6 p. m., music review, Hester Bronson Copper, music editor; 6:30, orchestra; 7:10, sports talk, Ivan L. Gaddis; 9, program, Union Pacific Railroad company.
WOC, Davenport, Iowa (483.6), 5:45-6 p. m., chimes concert; 6:30-6:50, Sandman; 8-9, German music, Davenport Turners' society, Ernst Otto, director.
WOK, Homewood, Ill. (217.3), 6-7 p. m., Ed Kemp, tenor; Jean Carlson, soprano; Kenyth Dunn, pianist; 10-11, Harry Davis, tenor; Haymakers trio; brass trio; Berger Webber, tenor; Arnold B. Stephenson, musical organ; 6:30, Rosemary Hughes, soprano; Ed Kemp, tenor; Harriet Lee, contralto; Herman Sinalko, violinist; Banks Kennedy, organist; LeRoy North, pianist.
WORD, Batavia, Ill. (275), 8 p. m., Webster hotel concert trio; 8:15, WORD Radio Studio club; 8:30, Marvel Larson, soprano; Esther Arneson, pianist; 9, Lake View Kiwanis club speaker, Ed Schoenenberger; 9:15, Marvel Larson, soprano; Esther Arneson, pianist; 9:15, WOS, Jefferson City, Mo. (440.9), 8 p. m., A. B. C.'s of Bacteriology, "Friendly Bacteria and How They Benefit Us," Homer A. Wilson; old time fiddlin' Bryan Williams, Louis Barton.
WQJ, Chicago, Ill. (447.5), 7-8 p. m., Rainbo Gardens orchestra; Merrill Garder, tenor; Gertrude Hardeman, contralto; 10-11 a. m., Ralph Williams and his Rainbo Skylarks; West brothers; William Richardson, baritone; Dr. H. Lucille Long, woman harmonica player; Eleanor Terry, Marie Polette, Alma Adair, prima donna; Harmony Singers; Larry Shay, soloist; 1-2, Ginger hour.

Mountain Time Stations
KOA, Denver, Colo. (322.4), 6:30 p. m., Herbert White and his Silver State orchestra; 8, scientific football, Tom McNamara; 8:10, Emma Maclear Murphy, soprano; Louis E. Shrevesbury, tenor; Belle Kimball Pratt, pianist; Gracey Barzer, violinist; Mrs. M. E. Shuck, reader; Dr. Cornelius De Bey, bass.

Pacific Time Stations
KFOA, Seattle, Wash. (454.3), 6:45-8:15 p. m., Sherman, Clay and company studio program; 8:30-10, Times studio program; 10-11:30, Eddie Harkness and his orchestra.
KFPG, Hollywood, Calif. (238), 5-6 p. m., home hour with Georgia Simmons and neighborhood children; 8-9, studio program of classical numbers by KFPG orchestra; 9-11, Freeman Lang, the bald-headed sisk of Sawtelle and his playmates, a frolic.
KFWB, Hollywood, Calif. (252), 7:30 p. m., Microphone brevities; 8-9, program, Monte Mar Vista sub-dividers, Monte Mar Vista orchestra, Hollywood string trio; 9-10, Bill Theek's Southern Five dance orchestra, Alma Lou Barnes, blues singer; 10-11, Warner Brothers frolic, direction, Charlie Wellman.
KGO, Oakland, Calif. (361), 6-7 p. m., Theodore Strong, organist.
KGW, Portland, Ore. (491.5), 9-10:30 p. m., concert, Sherman, Clay and company; 10:30-12, Hoot Owls, Rose City trio, Pentages Acts.
KHJ, Los Angeles, Calif. (405.2), 5:30-8 p. m., Leighton's Arcade cantata orchestra; Jack Cronshaw, leader; 6-6:30, Art Hickman's Biltmore hotel concert orchestra, Edward Fitzpatrick, director; 6:30-7:30, Radio kiddies' hour with Richard Headrick and Viola Von, screen starlets, bed-time story; 7:30, Romance of Santa Fe trail, Miss Gladys DeWitt; 8-10, program, Western Auto Supply company, arranged by J. Howard Johnson; 10-11, Art Hickman's Biltmore hotel dance orchestra, Frank Ellis, leader.
KJR, Seattle, Wash. (384.4), 8:30-10 p. m., Post-Intelligence studio program; 10-11, Gordon Kilbourne and his orchestra.
KNX, Hollywood, Calif. (336.9), 5:30-6:15 p. m., Wuritzer pipe organ studio, Town Tattler; 6:15, travel talk, W. F. Alder; 6:30-7, Atwater Kent Radio orchestra, Paul Finstein, leader; 7-7:30, program, Beverlyridge company; 7:30-8, program, Eastern Outfitting company; 8-9, West Coast theaters; 9-10, Royal Order of Optimistic Donuts, Davis Perfection Bread company; 10-11, popular song hour; 11-12, Ray West's Coconut Grove dance orchestra from Ambassador hotel.
KTAB, Oakland, Calif. (215), 8 p. m., program, Breuner's.
KTCL, Seattle, Wash. (305.9), 7-8 p. m., Simonds Saw and Steel company; 9-10, Western Auto Supply company; 10:10-12, Jackie Souder's dance orchestra.

Index to Classical Concerts

TABULATED below is a time table of the stations giving classical concerts this week. Stations are divided into the four different standard times in use. The hours are given in the kind of time in use at each listed station. By using this table as an index and referring to the complete programs below, full information will be obtained.

Classical

Eastern Time Stations
Saturday, October 10: 6, WCX, WEAF, WMCA, WREO; 6:17, WOR; 6:30, WCAE; 7, WEAR, WNYC, WRC; 7:15, WEAF; 7:35, WEAF; 8, WBBR, WNYC; 8:15, WRC; 8:30, WCAE; 8:40, WBBR; 9:30, WEAF; 10, WEAF.
Sunday, October 11: 6, WCAU; 6:30, WCAE, WOR; 7, WEAR; 7:20, WCAE, WCTS, WEAF, WEEI, WWJ; 8, WBZ, WEAR, WGBS, WGCP, WKAQ; 8:30, KDKA, WBZ, WGCP; 9, WBZ, WEAR, WGY, WHAR, WNYC; 9:15, WCAE, WCTS, WEAF, WEEI; 9:20, WNYC; 9:45, WCTS, WGCP; 10, WNYC; 11, WHN; 11:15, WHAR.
Monday, October 12: 6, WCX, WEAF, WMCA, WREO, WWJ; 6:05, WIP; 6:30, CFCA, WBZ, WCAE, WGY, WTIC; 7, WEAF, WEAR, WJR, WOO; 7:15, WEAF; 7:30, WEEI, WGY, WMCA; 8, WBBR, WBZ, WCAU, WCX, WHAR, WTIC; 8:15, WBZ, WHAZ, WNYC; 8:30, CHNC, KDKA, WBBR, WBZ, WGCP; 8:45, WEAF, WOO; 8:55, WBBR; 9, WBZ, WCAE, WEEI; 9:10, WLIT; 9:15, WGCP; 9:30, WBZ; 10, CHNC, WEAF, WOO; 10:10, WEEI; 10:15, WOO; 10:30, KDKA; 10:40, WEEI; 11, WHN.
Tuesday, October 13: 6, WBZ, WCX, WEAF, WMCA, WREO, WWJ; 6:05, WIP; 6:17, WOR; 6:30, WCAE, WGY, WTIC; 7, WEAR, WEBJ, WGBS, WJR, WOR, WTIC, WWJ; 7:20, WTIC; 7:30, WCAU, WEAF, WOO; 7:45, WEBJ; 8, WBZ, WCAE, WCAU, WCX, WEAR, WEEI, WGR, WHAR, WRC, WTIC; 8:05, WNYC; 8:15, WEBJ; 8:30, KDKA, WBZ, WCAE, WCTS, WEAF, WEEI, WFI, WGR; 9, WCAE, WCTS, WEAF, WEEI, WFI, WGR; 9:15, WREO; 9:30, WBZ, WHN, WRC, WTIC; 10, WCAE, WCTS, WEAF, WEAR, WEEI, WFI, WMCA; 10:30, WGR; 11:15, WHAR.
Wednesday, October 14: 6, WCX, WEAF, WMCA, WREO, WWJ; 6:05, WIP; 6:30, WBZ, WCAE, WGY, WGT; 7, WEAR, WJR; 7:20, WTIC; 7:30, WCAU, WEAF, WOO; 7:45, WEBJ; 8, WBZ, WCAE, WCAU, WCX, WEAR, WEEI, WGR, WHAR, WRC, WTIC; 8:05, WNYC; 8:15, WEBJ; 8:30, KDKA, WBZ, WCAE, WCTS, WEAF, WEEI, WFI, WGR; 9, WCAE, WCTS, WEAF, WEEI, WFI, WGR; 9:15, WREO; 9:30, WBZ, WHN, WRC, WTIC; 10, WCAE, WCTS, WEAF, WEAR, WEEI, WFI, WMCA; 10:30, WGR; 11:15, WHAR.
Thursday, October 15: 6, WBZ, WCX, WEAF, WMCA, WREO, WWJ; 6:05, WIP; 6:17, WOR; 6:30, WCAE, WGBS, WGY, WOR, WTIC; 7, WEAF, WEAR, WGBS, WJR, WWJ; 7:30, WCAU, WEEI, WHN, WOO, WRC; 7:45, WGY, WTIC; 8, WBBR, WBZ, WCAU, WCX, WEAR, WEEI, WGR, WGY, WHAR, WIP, WTIC; 8:15, WNYC; 8:30, KDKA, WBZ, WCTS, WEEI, WHN, WMCA, WREO; 8:40, WBBR; 8:45, WBZ; 9, WCAE, WCAU, WEAF, WEEI, WFI, WGR, WHAR, WNYC, WRC; 9:30, WREO; 10, WCAE, WCAU, WCTS, WEAF, WEAR, WEEI, WGR, WGY; 10:15, KDKA; 11:30, WGY.
Friday, October 16: 6, WCX, WMCA, WREO, WWJ; 6:05, WIP; 6:30, CNRT, WBZ, WCAE; 7, WEBJ, WGY, WJR, WOR, WTIC; 7:30, WEEI, WOO, WTIC; 7:45, WEBJ; 8, WAHG, WBZ, WCAU, WCTS, WCX, WEBJ, WEEI, WTIC, WWJ; 8:05, WNYC; 8:10, WHAR; 8:30, KDKA, WCAE, WEBJ, WOO; 8:45, WAHG, WBZ; 9, CNRT, WBZ, WCAU, WEEI, WMCA, WOO; 9:30, WEEI; 10, WEEI, WNYC, WOO; 10:30, WGR, WGY; 11:15, WHAR.
Central Time Stations
Saturday, October 10: 6, KFAB, WENR, WMAQ, WOAW, WOK; 6:15, WCCO; 6:30, WGN; 7, KOIL, KSD, KYW, WGN, WMBB, WQJ; 7:30, WEBH, WGN, WHAS; 8, KFNE, KPRC, KYW; 8:15, WCCO; 8:30, KYW, KPRC, WFAA, WHAS, WMC; 9, WKRC, WMAQ, WOAW, WOC; 9:15, KPRC; 9:30, WOC.
Sunday, October 11: 6:30, KLDS, WHT; 6:45, WORD; 7, KYW, WLS, WORD; 7:30, WHO; 8, KFDM, KPRC, WCBD, WFAA, WGN, WQJ; 8:30, WLB, WOC; 8:45, WNYC; 9, WBBR, WNYC, WRC; 9:15, WNYC; 9:45, WNYC; 10, WNYC; 11, WHN; 11:15, WHAR.
Monday, October 12: 6, KFAB, KMA, WHAD, WMAQ, WOK; 6:05, WCCO; 6:30, WFAA, WGN, WLW; 6:45, KSD; 7, KFNE, KYW, WHT, WLS, WMBB, WQJ; 7:30, KOIL, WCCO, WHAS, WHO, WOC; 7:45, WSAI; 8, KFDM, KLDS, KYW, WCBD, WCCO, WLW, WMAQ, WOC, WORD; 8:30, KPRC, WGN, WLW, WMC, WOAL, WORD; 8:45, KYW; 8:50, WMAQ; 9, KFDM, KFMQ, KMA, KPRC, KTHS, WCCO, WHAS, WLW, WOC, WSAI; 9:25, KTHS; 9:30, WBAP; 10, KMC, KYW, WSAI; 11, WHO.
Tuesday, October 13: 6, KMA, WHAD, WMAQ, WOK; 6:15, WLS; 6:30, KOIL, WGN, WHO; 7, KFNE, KPRC, KYW, WHT, WLW, WMBB, WQJ; 7:30, WHAD; 8, KPRC, KYW, WCCO, WDAF, WHAD, WMAQ, WOC, WORD; 8:30, KPRC, WGN, WLW, WMC, WOAL, WORD; 8:45, KYW; 8:50, WMAQ; 9, KFDM, KFMQ, KMA, KPRC, KTHS, WCCO, WHAS, WLW, WOC, WSAI; 9:25, KTHS; 9:30, WBAP; 10, KMC, KYW, WSAI; 11, WHO.
Wednesday, October 14: 6, KMA, WHAD, WMAQ, WOK; 6:15, WLS; 6:30, KOIL, WGN, WHO; 7, KFNE, KPRC, KYW, WHT, WLW, WMBB, WQJ; 7:30, WHAD; 8, KPRC, KYW, WCCO, WDAF, WHAD, WMAQ, WOC, WORD; 8:30, KPRC, WGN, WLW, WMC, WOAL, WORD; 8:45, KYW; 8:50, WMAQ; 9, KFDM, KFMQ, KMA, KPRC, KTHS, WCCO, WHAS, WLW, WOC, WSAI; 9:25, KTHS; 9:30, WBAP; 10, KMC, KYW, WSAI; 11, WHO.
Thursday, October 15: 6, KMA, WHAD, WMAQ, WOAW, WOK; 6:30, WGN; 7, KYW, WHT, WLS, WLW, WMBB, WOAW, WQJ; 7:30, KFNE, KOIL, WHAD, WHO, WSAI; 8, KLDS, WBAP, WCBD, WCCO, WOC, WORD, WSAI, WSB; 8:20, KYW, WMAQ; 8:30, KPRC, WFAA, WGN, WHAD, WMC, WOAI; 8:35, WMAQ; 9, KPRC, KTHS, KYW, WCCO, WHAD, WOAW, WOC, WSAI; 9:10, KTHS; 9:30, WBAP; 9:45, KTHS; 10, WBAP; 10:40, WLW; 11, WHO.
Friday, October 16: 6, WHAD, WMAQ, WOAW, WOK; 6:15, WCCO; 6:30, WGN; 6:50, WMAQ; 7, KYW, WHT, WLS, WQJ; 7:30, KFNE, KOIL, KSD, KYW, WBAP, WHAD, WHO; 8, KFDM, WCCO, WDAF, WHAD, WMAQ, WSAI; 8:30, KFAB, WFAA, WGN, WHAD, WHO, WMAQ, WMC, WORD; 9, KFDM, KFXX, WHAD, WMAQ; 9:05, WCCO; 9:10, KTHS; 9:30, KFAB, KTHS, WBAP; 9:45, KTHS; 10, KFXX.
Mountain Time Stations
Monday, October 12: 6:30, KOA; 8:10, KOA.
Tuesday, October 13: 6:30, KOA; 7:30, KOA.
Wednesday, October 14: 6:30, KOA; 8:10, KOA.
Thursday, October 15: 6:30, KOA; 9, CNRC.
Friday, October 16: 6:30, KOA; 8:10, KOA; 8:30-10:30, CNRE.
Pacific Time Stations
Saturday, October 10: 6, KFOA, KHJ; 6:30, KNX; 6:45, KFOA; 7, KNX; 7:30, KNX; 8:10, KGO; 8:15, KHJ.
Sunday, October 11: 6:30, KHJ; 6:35, KPO; 7, KHJ, KNX; 8, KHJ, KNX, KPO; 9, KHJ, KNX; 10, KNX.
Monday, October 12: 6, KFOA, KGO; 6:30, KNX; 6:45, KFOA; 7, KPO; 7:30, KNX; 8, KGW, KHJ; 9, KGW; 10, KHJ.
Tuesday, October 13: 6, KFOA, KGO, KHJ; 6:30, KNX; 6:45, KFOA; 7, KNX; 8, KGO, KHJ; 8:30, KFOA; 9, KGW, KPO.
Wednesday, October 14: 6, KFOA, 8:30, KNX; 7, KNX; 8, KGO, KGW, KPO; 9, KGW, KPO.
Thursday, October 15: 6, KHJ; 6:30, KNX; 7, KNX; 8, KGO, KPO; 9, KGW, KPO.
Friday, October 16: 6, KFOA, KGO, KHJ; 6:15, KPO; 6:45, KFOA; 7:30, KFAB, KNX; 8, KHJ, KNX, KPO; 8:30, KFAB; 9, KPO.

FOLLOWING SPORTS THROUGH MIKE

EIGHT MORE 'MIKES' TO CARRY FOOTBALL

TO AIRPHONE ALL IMPORTANT COLLEGE GAMES

Play-by-Play Accounts Direct from Gridirons to Be Heard from Many Stations

Footballs are going to fill the ether as well as the air this season, according to game schedules to be broadcast that have been announced during the past week.

Seven stations are on the list. Iowa State's home contests will go over WSUI. University of Michigan's warriors when playing at home will be described via WWJ, Detroit. University of Minnesota home gridiron tangles will be picked up by WCCO. The strong Nebraska team's home contests will be heard from KFAB, Lincoln. Northwestern games will be broadcast by WBBM, Chicago. WEAQ announces it will give play-by-play all Ohio State games, and KDKA, while not definitely arranged at the time of going to press, promises all University of Pittsburgh home kick-offs.

WEAF announces a series of the most important eastern college football.

Chicago games over WMAQ and KYW, Harvard over WBZ, Cincinnati over WSAI, best conference contests over WGN, and a picked assortment of the chief eastern rivals from WGY and WJZ, were announced last week.

Schedules; Iowa State, WSUI (483.6)

The schedules of the newly announced play-by-play broadcasts of college football games follow. The first is that of Iowa State's home games over WSUI, 483.6 meters.

Oct. 10, Iowa State-Kansas U.

Oct. 24, Iowa State-Washington U. (St. Louis).

Nov. 7, Iowa State-Grinnell.

Nov. 26, Iowa State-Kansas Aggies.

U. of Michigan, WWJ (352.7)

Oct. 10, Michigan-Indiana (providing world's series is not being played on this date).

Oct. 31, Michigan-Navy.

Nov. 14, Michigan-Ohio State.

Nov. 21, Michigan-Minnesota.

U. of Minnesota, WCCO (416.4)

Oct. 10, Minnesota-Grinnell.

Oct. 17, Minnesota-Wabash.

Oct. 24, Minnesota-Notre Dame.

Oct. 31, Minnesota-Wisconsin.

Nov. 7, Minnesota-Butler.

Nov. 14, Minnesota-Iowa State.

Nov. 21, Minnesota-Michigan.

Nebraska, KFAB (340.7)

Oct. 17, Nebraska-Washington U. (St. Louis).

Oct. 24, Nebraska-Kansas U.

Make \$100 Weekly— I Will Show You How!



YOU can do it in your spare time—evenings. Lay the foundation for a permanent, profitable business of your own. Give it all your time when you've proven the big opportunities it holds for you. Sell what the public wants—

Sell Radio In Spare Time!

Demonstrate the Ozarka in your own home or in your prospect's home. Sales experience not necessary—we teach you! Ozarka instruments priced right, with sales helps, national and local advertising, make your selling easy.

12 Selling Lessons FREE!

The Ozarka plan of selling radio is entirely different. Most practical—easier to explain. Sales are made quicker and easier. Knowledge of radio not necessary—we teach you every detail without charge! Our success with 8,100 men proves the merit of our teaching.

3,100 Men Are Doing It!

The Ozarka organization today consists of 3,100 men. In territory not now covered the right man is wanted. \$100 weekly in spare time is not unusual. Many Ozarka men are making far more—some have been with us for three years.

FREE Book Tells How—

Write me personally—tell me about yourself, and I'll see that my 64 page book, Ozarka Plan No. 100, is sent you without cost. Please mention the name of your county. To be sure of my personal attention, attach coupon below, to your letter.

J. Matheson Bell, Pres.

OZARKA INCORPORATED
122 Austin Avenue C, Chicago, Illinois

Gentlemen: 9-25-122C

I am greatly interested in the FREE BOOK "The Ozarka Plan" whereby I can sell your radio instruments.

Name.....

Address..... City.....

County..... State.....

Sport Broadcasts

FOOTBALL

Saturday, October 10

Carleton College-Northwestern, WBBM (226).

Chicago-Ohio State, KYW (535.4), WMAQ (447.5), WEAQ (293.9).

Cincinnati-Georgetown, WSAI (325.9).

Harvard-Middlebury, WBZ (333.1).

Iowa-Kansas, WOJ (270).

Michigan Aggies-U. of Michigan, WWJ (352.7). (Providing World Series is not being played on this date).

Minnesota-Grinnell, WCCO (416.4).

Pittsburgh - West Virginia, KDKA (309.1).

WORLD'S SERIES

Opening Date, October 7

KDKA, KFOA, KOA, KPRC, KSD, KTBS, KYW, WBZ, WCAE, WCAP, WCCO, WCTS, WDAG, WEAQ, WEAF, WEEL, WGBF, WGN, WGR, WGY, WJAG, WJAR, WJZ, WMAQ, WOO, WRC, WSB, WTIC, WWJ.

(See page 15 for wave lengths.)

AIRPLANE RACES

Saturday, October 10

12 P. M., Central Time

Mitchell Field, WGY (379.5); WJZ (454.3).

Oct. 31, Nebraska-Oklahoma.

Nov. 26, Nebraska-Notre Dame.

Northwestern, WBBM (226)

Oct. 10, Northwestern-Carleton.

Oct. 17, Northwestern-Chicago.

Oct. 24, Northwestern-Tulane.

Oct. 31, Northwestern-Indiana.

Nov. 7, Northwestern-Michigan.

Nov. 14, Northwestern-Purdue.

Nov. 21, Northwestern-Notre Dame.

Ohio State, WEAQ (293.9)

Oct. 10, Ohio State-O. Wesleyan.

Oct. 17, Ohio State-Chicago.

Oct. 24, Ohio State-Iowa State.

Oct. 31, Ohio State-Wooster.

Nov. 7, Ohio State-Indiana.

Nov. 14, Ohio State-Michigan.

Nov. 21, Ohio State-Illinois.

Pittsburgh, KDKA (309.1)

Oct. 10, Pittsburgh-West Virginia U.

Oct. 17, Pittsburgh-Gettysburg.

Oct. 24, Pittsburgh-Carnegie Tech.

Oct. 31, Pittsburgh-John Hopkins.

Nov. 7, Pittsburgh-W. and J.

Nov. 14, Pittsburgh-U. of Penn.

Nov. 26, Pittsburgh-Penn. State.

Big Eastern Games, WEAF (491.5)

Oct. 17, Army-Notre Dame.

Oct. 24, U. of Penn.-Chicago.

Add Eight Stations to Long Ball Series List

Diamond Classic Is Most Broadcast Sport Event

CHICAGO.—Besides the twenty-one stations announced last week as to carry the world's series play-by-play results, later information includes seven other stations: KSD, St. Louis; WCAP, Washington; WCTS, Worcester, Mass.; WEEL, Boston; WGBF, Evansville, Ind.; WJAG, Norfolk, Nebr.; WJAR, Providence, R. I., and WOO, Philadelphia.

The twenty-nine broadcasters listed this week in the "Sport Broadcasts" schedule of Radio Digest, are not alone, however, in giving the instant results over the air. Many other stations, it is believed, are broadcasting the series without having announced their plans.

The 1925 world's series is so far the most broadcast sport event in history. Associated Press and United Press play-by-play reports, together with WEAF and WJZ linked descriptions direct from the fields of play, have made this possible.

Radio Does Not Keep Ball Fans Away Atlanta Proves

ATLANTA.—Play-by-play broadcasting of ball games does not hurt local attendance. It helps. Managers, write that down in your pocket notebook.

The fallacy that broadcasting the baseball games cut the gate receipts was exploded decisively by the official figures set up during the Atlanta, Ga., club's 1925 season, where all Southern league attendance records, including Atlanta's, were shattered by more than 41,000 paid admissions above previous totals.

WSB, the Atlanta Journal's station on the Atlanta Biltmore, has for three years broadcast all of the local team's games, at home and on the road, giving play-by-play reports. Radio is given the credit for the increasing attendance.

Oct. 31, Yale-Army.
Nov. 7, Harvard-Princeton.
Nov. 14, Princeton-Yale.
Nov. 21, Harvard-Yale.
Nov. 26, Cornell-U. of Penn.
Nov. 28, Army-Navy.

In addition to the above schedules, WHA, the station of the University of Wisconsin, at Madison, has announced that it will broadcast some of the Wisconsin home games.

The President of Bolivia recently issued a decree permitting the installation of Radio transmitting stations in Bolivia.

Cupid Hits Station WEEL; Bob Emery Now a Benedict

BOSTON.—Claire Robbins Emery, the "Big Brother" announcer at WEEL, has just been married to Miss Katherine Nee, secretary of the station, at Waltham, the ceremony taking place at the home of Rev. E. B. Rideout, who performed the ceremony. The best man was Russell Francis and the matron of honor was Mrs. Francis. Mr. and Mrs. Emery were deluged with telegrams of congratulation for some time following the announcement of the engagement, and another flood has begun to pour in on the heels of the story of their marriage.

Harvard-Middlebury Tilt Interests

BOSTON.—Football followers in the East and all Harvard alumni will be interested Saturday, October 10, in the WBZ play-by-play results of the Harvard vs. Middlebury football game broadcast direct from the Harvard stadium. Little Middlebury gave mighty Harvard a terrible scare last year, and scouts recently visiting Middlebury report the small school predict a repetition this year.

WTIC-WEEI Keep Traded Waves

HARTFORD, Conn.—With the consent of the government, WTIC, the Travelers station here, will permanently accept 475.9 meters as its wave length. Some weeks ago WTIC and WEEI of Boston made an experimental exchange of wave lengths. The two stations were so well satisfied that the exchange has been made permanent.

Germans Adopt Our Style

BERLIN.—The "Berliner Funk Stunde" announces that it is going to model after some of the American broadcasting stations in sending out the words of command for morning physical exercises.

The Wilson "B" Radiopower Unit

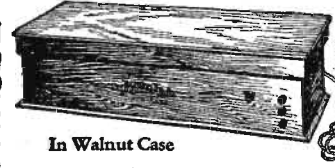

In Walnut Case

Operates from light socket. Supplies the uniform voltage necessary for perfect reception. Absolutely noiseless. Guaranteed not to set up the slightest hum.

No acid to spill. No moving parts to get out of order. Requires no attention. As easy to operate as switching on a light. Convenient and dependable. The least expensive plate current supply because of its long life. In handsome walnut case. Price complete, \$35. Your dealer can supply you.

The Andrews Paddlewheel Coil



Price \$3.00

Improves tone quality. Increases selectivity, range and volume. Losses are negligible. Has exceptionally high ratio of inductance to resistance with minimum distributed capacity.

Used in well-known receivers such as the Deresnyne and Buckingham. Can be used in any standard hook-up. Ask your dealer for blue-prints of circuits employing this coil.

Our Technical Dept. will answer inquiries.

Duo-Spiral Folding Loop

Highly directional and very selective. Reduces static and helps to cut out interfering stations.

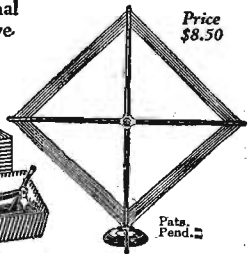

Price \$8.50

Handsomely finished in silver and mahogany. Easily portable. Has long handle and graduated dial. A special model for every circuit.

See these standard units at your dealer's or write for complete information.

Radio Units Inc.
Maywood, Illinois

1306 First Avenue

Perkins Elect. Ltd., Montreal, Toronto, Winnipeg

A REAL RADIO SET for \$27.27 Built Around THE HEATH CONDENSER

Designed by Citizen's Radio Call Book Laboratory

NOW you can build a super-efficient radio set at an extremely low cost.

The well-known performance of the Heath Condenser caused the Citizen's Radio Call Book Laboratory to design a radio set featuring this remarkable Condenser. There are two points of vital interest about the HEATH CONDENSER—

1. Permanent Flat Plates—stamped under huge presses to absolute flatness and tempered to prevent warping.
2. A micrometer geared vernier that reduces ordinary adjustments to hair breath distinction.

To each purchaser of a Heath .0025 Variable Condenser we are giving a complete set of plans, and instructions on how to build this high quality, low cost radio set. See your dealer and get yours today, or if your dealer cannot supply you, order direct, giving your dealer's name.

HEATH RADIO AND ELECTRIC MFG. COMPANY
206-210 First St. Newark, N. J.

MANUFACTURERS OF
Heath Condensers Heath Sockets Heath Dials
Heath Resistance Coupled Amplifiers

An Evening at Home with the Listener In

FOR EASTERN TIME

(Tabular form and listings copyrighted. Reproduction is forbidden.)

FOR CENTRAL TIME

Main table containing radio station call letters, locations, and broadcast schedules for Eastern and Central Time zones. Columns include Call, Saturday, Sunday, Monday, Tuesday, Wednesday, Thursday, Friday, Call, Location, Met., Saturday, Sunday, Monday, Tuesday, Wednesday, Thursday, Friday, Call. Stations listed include AT9, CFCA, CFCN, CHNC, CJCA, CKAC, CKY, CNRO, CYB, CYL, etc.

Radio Digest Illustrated

Published by the Radio Digest Publishing Company, Inc.
510 North Dearborn Street
Chicago, Illinois
Telephones: State 4372, 4373, 4374, 4375

E. C. RAYNER, Publisher

Eastern Office, Park-Lexington Building, 247 Park Ave.,
New York. Telephones: Ashland, 8144, 8145, 8146

Member of the Audit Bureau of Circulations

241
PUBLISHED WEEKLY

SUBSCRIPTION RATES

Yearly in U. S. and Possessions and Canada, \$5.00
Foreign postage, \$1.00 additional. Single copies, 10 cents.

Vol. XV Saturday, October 10, 1925 No. 1

Think While You Listen

"EDUCATIONAL material over Radio will be beneficial if wisely used and will become a stimulus and a guide to action, but intellectual flabbiness is likely to be the result of absorbing education through the ears alone," warned Dr. Ralph Barton Perry, professor of philosophy at Harvard, in a recent talk over KGO. The eminent professor's view on Radio education is worth pondering over, especially for those of us who are taking advantage of the valuable opportunities now presented via broadcasting to improve our knowledge of certain subjects.

"Education cannot be passively received," said Dr. Perry. "The similarity between education and physical strength is closer than one assumes. One doesn't become a runner without running; one doesn't acquire ideas until one arrives at their meaning, earns their proofs and how to use them. The only way to develop power to think is to think. In broadcast education the impulse to think has to be checked during the speech lest one miss the thread."

Perhaps the taking of notes and reviewing them following a broadcast educational speech might help to make Radio education more active. The use of a syllabus, or generally accessible text book, in conjunction with broadcast courses, would likewise be a worth while feature tending to create thinking on the part of the listener. Examinations, by correspondence, would help, but we cannot add to Radio the personal guidance of the class room teacher. Even at that, the crowded high schools and universities of today have but little personal touch in their class room instruction.

Censorship Unnecessary

"ANY agency of program censorship other than public opinion is not necessary and would be detrimental to the advancement of the art." So reads a resolution passed by the National Association of Broadcasters, recently in convention assembled.

In our opinion that resolution is very important. It is to be hoped that the United States congress and all reform bodies keep their hands off Radio. Broadcasting has developed into a vital, clean and dignified service to the public without outside help or influence. The broadcasters, aided by public opinion, have made the art what it is today. It will not be necessary for reform and censorship bodies, or an extremely top-heavy bureaucracy, to add their mite in the form of hindering censorships, now that broadcasting has attained its manhood.

To our mind the best thing that censorship bodies do for mankind is to provide paying jobs for otherwise useless citizens of our fair land. We will modify by saying a few worthy accomplishments can be attributed to these bodies. But as a general rule public opinion would have effected these accomplishments more satisfactory, if left alone and allowed to do so. Also, we believe that these so-called accomplishments, if brought about by public opinion alone, would enjoy more wholesome respect in the eyes of the public.

Let Radio remain untrammelled. Keep the long-faced blue law advocates from interceding in a perfectly respectable enterprise.

Fooling the Metropolitan Opera

FINISHED pianists, opera stars, violinists of the highest class and the best representatives of what we consider as good in music are being heard weekly through WEA and linked stations as a result of the negotiations recently concluded by A. Atwater Kent, prominent leader in the Radio industry.

Three years ago Radio Digest attempted to persuade the Metropolitan Opera company to permit a microphone in their opera house so that the beautiful operas, adapted to broadcasting, could be heard by the multitudes outside who were unable to purchase seats.

Would the Metropolitan Opera company allow such a thing? No! The opera must have its "pound of flesh."

We are glad to see that Mr. Kent has paid the bill and made it possible to put many of the Metropolitan stars on the air—regardless of the holdout of the policy-bound (?) opera management.

RADIO INDI-GEST

SOPRANOS

Sopranos are many, but few of them sing;
They glide up and down like a bird on the wing.
Those thrillings and quavers
don't suit me a bit;
A factory whistle has that
sort of wit.



High Seas

'Tis a joy to tune in on a singer like that,
But for one who stands forth so, a hundred fall flat.
GEORGE.

Listen, George, you have never heard the soprano whose picture was on the front page last week! We, too, have the same general regard for the girls with the high range voices that you have, but when Jean LaDonne warbles into the KYW mike, we just stand up and give three cheers for high "C". Maybe we can get your soprano and ours together some evening and have a little song contest of our own.

"Ham" Love Department

Dear Indi: My shiek is one of those there Radio Hams and the other night when we were sitting on the veranda, he pulls this one on me:

"Say, kid, when I try to kiss you, you always remind me of DX on a summer afternoon."

Now please, Indi, tell me what he meant. Do you suppose he has another girl named Delia Xavier or something like that?
BROKEN HEARTED.

Although we do not pretend to be running a help to the lovelorn column, we will advise, for the sake of the advancement of science, that next time he pulls this line, you just answer him by saying, "QRV," and act accordingly.

Radio Hygiene

During a hygiene lesson in a London school the class was asked: "What poisonous air do we breathe out?"
Back came the answer promptly: "ZLO."

But it's so
Doncha know
That we do breathe
ZLO —
Yah shure!

Indi was gloomy! The flag on the Tribune tower was at half-mast! The rent was over due! The birds and the missus were getting ready to go South for the winter! In other words things were in a mess, the janitor having refused to cart away no-account mash unless he was raised a quart a month. It was no time for feeling funny and yet there was a goodly portion of the column to fill. And then, ah then! Our good friend up in Milwaukee, suddenly recovered from dandruff by drinking hair tonic and kicked in with the following, thus saving the day, week, and month.

Stanley, Where Should I Stand?

BY THE THIRD TROMBONE PLAYER
(Before we proceed it is well to know that the title hasn't a thing to do with the story—save your specks.)

"Helsbells!" cried baby Rayjo as she busted a thermionic valve against the spittoon, "its something fierce when I can't even tune in the psalm singers at WZZD. Helsbells!"

"And a cup of coffee!" boomed the deep voice of papa Rayjo as he made his way from the cellar where he had been busy steaming a batch of Ryars Hoot Beer. Then adding with a cheerful smile, "When better Radio sets are designed some guy in Chicago will build them and sell them at a cut rate."

At this critical moment a feeble knock was heard. Papa Rayjo dashed to the peephole with which every door in Milwaukee is equipped. He looked over the situation and finally decided to take a chance. A miserable, down-and-out stranger stood in the driving rain.

"And who are you?" exclaimed Ma Rayjo, who up to this time had been busy wrapping spent mash in newspapers preparatory to taking it out in the family Scripps-Booth to be left by the wayside. "Who are you, I prithee?"

"I am Madeyour Harmstrong," replied the stranger with a hollow groan as thick tears rolled down his neck, "Madeyour Harmstrong, the guy who made the first squawker set."

"Quick now, bring on a bottle of Bevo, can't you see the man's fading out!" A bottle was at once rushed out and between gulps of the strong stimulant, the Madeyour told this sad tale. But not until next week!

Just a Smell Matter

"Broadcasting 'direct from the stockyards' is now a daily event in Chicago."—News item.

Nothing new! We have lived in the Windy City off and on between jumps from coast to coast and pole to pole and we are here to tell you that the stockyards had the first wireless outfit in the city. Our nose knows!

A Bit of Harmony



Condensed

BY DIELECTRIC

In a recent editorial appearing in this paper you listeners were reminded of the fact that YOU constitute the tribunal of last resort where broadcasters are found pleading their case. The sentence is pronounced by you collectively. As an instance of broadcasting in which censorship is exercised I would call attention to that station in New York city broadcasting a meeting in Tammany Hall. One of the speakers indulged in profanity to the point where most of his oration never got beyond the roomful of politicians—silence following silence. Why broadcast a meeting where the English language is discarded for oaths?

Reference may have been made in these columns to one feature appearing on the programs of WJR, Detroit, which is rapidly becoming synonymous with the call letters: Goldkettes serenaders. These players, are perfectly competent to render any popular dance number with that irresistible appeal which draws the awkward youth from his place on the side lines to the very center of the dance floor.

I haven't mentioned before any of the special broadcast features from the Radio World's Fair and Grand Central Palace, but there are some observations to make and a few at first-hand. Most of you had at least a portion of the broadcasts come into your receivers from one or other of these great Radio exhibits, but thousands were unable to be there. It was interesting to observe the artists at work in the studio set up in the armory, especially the jazz players: Maybe they like to have those on the outside of the glass walls see how hard they work. Every set in the exhibits was superior to every other for receiving programs listed in Radio Digest each week. And that gold cup Graham received was the center of attraction! Personally, I felt relieved to know that with all the parts at hand—potential missives of displeasure—no one knew my identity. Better plan to attend the next. See you in Chicago.

Seldom have I enjoyed a program during these summer months as that presented by the Fornica orchestra from Station WLW, Cincinnati. Many of the numbers were chosen from the classics and displayed good taste. Their manner of rendering and interpretation were of a high order. It no doubt was indicative of the good things in store for us listeners from this station the coming winter. At least, we hope so.

We are becoming accustomed to hear anniversary programs from broadcasting stations, and while they differ little from those ordinarily heard throughout the year, it serves to remind us how few months really have elapsed since this wonderful thing came into our midst. WHAZ, Troy, N. Y., celebrated their third anniversary not long ago with a program up to their standard, which means of general interest. There are few stations enjoying the distinction of having reached so far over the globe with their entertainment as this one. Many of us recall the occasions upon which records were made by WHAZ and we congratulate them upon the consistency of their distant reception.

KDKA, one of the stations in the United States for which even the newest recruit of the BCL's requires no city address, gave an educational program of distinction on the day set apart for commemorating the birth of the constitution of our land. Addresses by men thoroughly conversant with its content and history left no loophole for continued ignorance of any listener on a subject vital to every citizen.

'Traveler' Doughnut Coil Tuned R.F. Receiver

Part I—Analysis of Parts Used

By John G. Ryan

IN DESIGNING this receiver the writer has not attempted to accomplish anything revolutionary nor to present civilization with anything that will "upset all our ideas of Radio communication." Rather, this receiver is presented as an easily constructed combination of sound Radio design, attractive appearance and some of the refinements in parts construction that have made their appearance in recent months.

There are five tube receivers on the market that can be purchased at a price below the total cost of the parts for Traveler, but in from two to a dozen particulars such a set will be lacking when compared with this set.

Considering now the refinements which, when all is considered, are really what distinguish this receiver from others. In any part of the country where one is within 20 to 25 miles of a superstation or 10 to 12 miles of a standard class B broadcaster, the ordinary type of coil will pick up signals, and the possibility of entirely eliminating that station at will, is out of the question. Whether the coils are wound on solid tubes or are self supporting, whether they are set at the magical angle of 57 degrees or are vertical, does not matter. This seems to have been pretty well proven in Chicago, which is one of the finest testing grounds in the world. One of the summer's developments is the doughnut type of coil, also known as the toroid. The writer does not say that it will not pick up signals—it probably will to a slight extent—but it does this to a lesser degree than any other type of commercially practical inductance. The Thorola doughnut coils used are an excellent example of this type of inductance and the method of keeping down distributed capacity by crimping the wire, is especially to be noted. They can be placed in practically any relation to each other and, used with good condensers, give sharp tuning.

It was but natural that straight line frequency condensers be used. The department of commerce allocates the sta-

tions into wave channels on the frequency basis, all channels being an equal distance apart in kilocycles. If we want our channels, and therefore the stations, to come in at regular intervals on the dials, what is more natural than to use a condenser which will tune a coil so that the dial readings, when plotted, will give a straight line. There are those who will claim that coil and condenser should be designed to work together if the plotted line is to be absolutely straight and the stations exactly spaced around the dial. That is true and the curve resulting from the use of Thorola coils and Karas condensers is not absolutely straight, but it is very close to it. Karas condensers

this type that would probably test just as high in efficiency but the writer doubts very much if any would show up better. They certainly are low in losses, have pig-tails, smooth turning bearings and two methods possible of mounting on the panel.

Many readers are going to get a shock at seeing vernier dials on a tuned radio frequency set. This is not general practice, of course, but the writer's experience with a

really selective five tube job, properly and efficiently operated, indicates that such dials are most desirable. You can get squarely on the peak of a sharply tuned DX station which increases the volume surprisingly and helps to break through locals. Dialogs are chosen because they are just as smooth to operate as any other, show no backlash and have little to get out of order. Their price is also a very pleasant surprise.

Before going on with the discussion of the various parts used by the writer and their merits, I wish to refer you to the completed receiver's front view picture, designated here as figure 1, and the wiring diagram (on the succeeding page) shown as figure 2. Note the symmetry of the panel layout. The spacing of the dials are all that could be asked. The wiring diagram will be explained later.

Walbert sockets have two distinct advantages to recommend them. The springs in the bottom are integral with the terminals and provide both bottom-of-pin contact and side wiping. There is a (Continued on page 18)

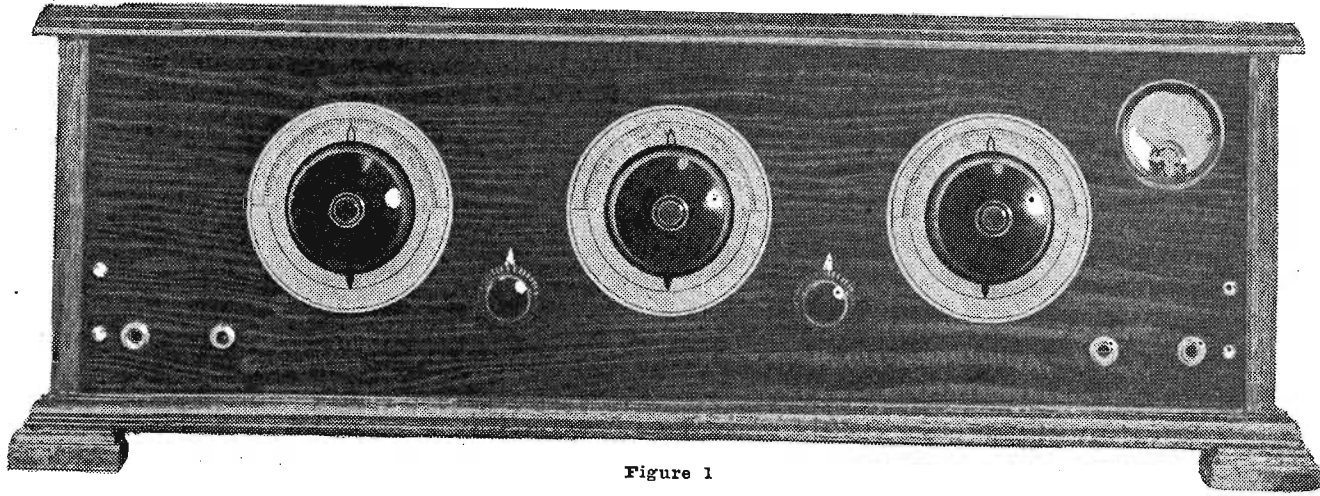
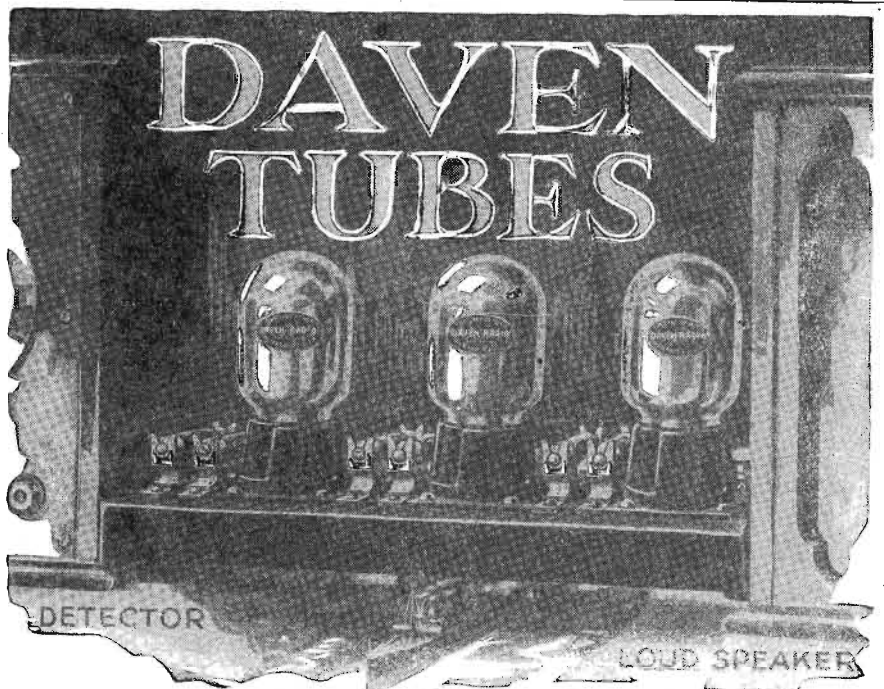

Figure 1

LIST OF PARTS

1 Kit of 3 Thorola Coils	Reichmann Co., Chicago	\$12.00
3 Karas .0005 mfd. Condensers	Karas Electric Co., Chicago	21.00
3 Dialog Vernier Dials	Walnut Electric Mfg. Co., Chicago	3.75
2 Fantab Jacks, No. 231	Herbert H. Frost, Inc., Chicago	1.80
1 Fantab Jack, No. 235	Herbert H. Frost, Inc., Chicago	.95
1 C-H Rheostat, 15-Ohm	Cutler-Hammer Mfg. Co., Milwaukee	.75
1 C-H Rheostat, 30-Ohm	Cutler-Hammer Mfg. Co., Milwaukee	.75
1 Voltmeter, Pattern 135, 0-8	Jewell Elect'l Instr. Co., Chicago	7.00
2 Formica Panels, 7 x 24	Formica Insul. Co., Cincinnati	6.72
2 Audio Transformers, 3½ to 1	Thordarson Elec. Mfg. Co., Chicago	8.00
1 Bradleyswitch	Allen-Bradley Co., Milwaukee	.60
1 Bradleyleak, with condenser	Allen-Bradley Co., Milwaukee	2.20
5 Walbert Sockets, 201A size	Walbert Mfg. Co., Chicago	3.75
9 Engraved Binding Posts	Walnut Elec. Mfg. Co., Chicago	.99
2 Amperite Units, No. 1-4	Radiall Co., New York City	2.20
1 Erla Fixed Condenser, .005 mfd.	Electrical Research Lab., Chicago	.65
1 Erla Fixed Condenser, .001 mfd.	Electrical Research Lab., Chicago	.35
1 Can Kester Solder	Chicago Solder Co., Chicago	.25
1 Cabinet, 7 x 24 x 10		10.00
Miscellaneous, such as brackets, bus bar, screws, etc.		2.00
Total Cost		\$85.71

were chosen because it is evident that much care went into their design, and precision care seems to be used in manufacture. There are other condensers of



The Bridge To Amplification Without Distortion

Daven engineers were pioneers. They blazed the way for others to follow. They designed and built the first Resistance Coupled Amplifier offered to the public. They found resistance coupling in an experimental stage. They perfected it.

Daven Resistance Units, Amplifier Kits and Super-Amplifiers are accepted by the foremost authorities in Radio as standard. The Daven Super-Amplifier, for use in any known set or circuit, is priced at \$15.00.

A NEW TUBE BY DAVEN

To meet the exacting requirements of Resistance Coupled Amplification the Daven Radio Corporation has created a new product, the DAVEN HIGH MU VACUUM TUBE, Type MU 20. It is designed for one specific purpose only—to increase the amplification of the Daven Resistance Coupled Amplifier so as to exceed that of ordinary audio frequency coupling. The Daven High Mu is a 6 volt, ½ ampere tube with an amplification constant of 20. The price is \$4.00. Daven Power Tube Type MU 6 is recommended for last or output stage. Price \$5.00.

Daven products are sold only by good dealers

"The Sine of Merit"

DAVEN RADIO CORPORATION
Resistor Specialists

NEWARK Reg. U. S. Pat. Off. NEW JERSEY

CLIP THIS COUPON

Daven Radio Corporation
158-160 Summit Street
Newark, New Jersey

Please send me the following on Resistance Coupled Amplification:—

Check one.
 Resistor Manual. 30c is enclosed.

Complete Catalog (free)

Name

Address

For Dealers: Send your letter, head or card, or this coupon and we will have our nearest distributor communicate with you.

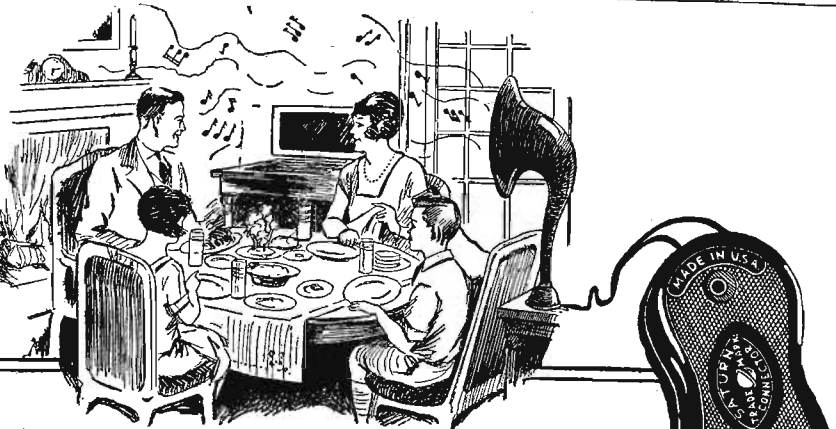

THE SATURN CONNECTOR

Brings Radio to Every Room

The Saturn Plug is the Best Plug on the Market

Place your loud speaker in any room regardless of the location of your receiver. Hook up a Saturn Connector between them—it's done in a flash. The result—enjoyment of radio reception where you want it. Think of the convenience! Music with your meals, music in your bedroom, music in the sickroom, music anywhere.

No assembling—just plug in the wires from your receiver at one end and from your loud speaker at the other end. A slide snap releases the tips. No levers to pull or buttons to press. No loss of tone or volume—the Saturn Connector grips the wires with bulldog tenacity and releases them with ease. You'll want to have this modern radio convenience, also the wonderful Saturn Plug which gives the quickest and surest connection of any plug on the market.

At your dealers or Send 80c Today for the Saturn Connector and Plug. Money Refunded if You Are Not Satisfied.

The SATURN MFG. and SALES CO., Inc.
48 Beekman St. New York City
Jobbers and Distributors: Write for Attractive Proposition

Buy Them as a Combination Only 80c or 40c for either the plug or connector. Needed Wherever THERE'S A RADIO

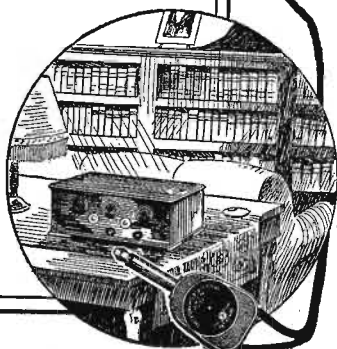

THE BIG LITTLE THINGS OF RADIO

"TRAVELER" RECEIVER

(Continued from page 17)

metal ring around the tops of the cylindrical wall to prevent breaking the top edge when inserting or removing a tube. Certain engineers might criticize the construction, but that is true of any socket. These sockets have their good points, as mentioned, which is also true of any others.

The audio frequency transformers were chosen largely on past performance in other sets and the fact that Thordarson transformers are the choice of many leading set manufacturers. The ratio between primary and secondary turns is a good one for two stages in a set of this kind where the input and output energy of the detector will be comparatively high.

Cutler-Hammer rheostats are favored by the writer for a set to be constructed at home because the fan does not have to dismantle them to mount them on the panel. All spring tensions are adjusted by the builders before shipment and there is not much chance of the home builder upsetting these when putting C-H rheostats in place. The one hole mounting also appeals as it eliminates the chance of not getting three holes correctly drilled. The Frost Pantab jacks have long had an enviable reputation for consistently reliable operation and the spaced soldering tabs are easy to get at. While their advantage of providing a bracket for sub panels has not been utilized in this receiver, it is a most convenient feature when designing sets.

There is no peer to the Bradleyleak for quiet, smooth variation of resistance in the biasing of the detector grid, and tuned radio frequency circuits certainly require a unit of this kind for very best results. Once the rheostat on the radio frequency tubes has been set, it will surprise many to note the difference in range and volume possible by adjustment of the grid leak. A condenser is made by Allen-Bradley for this unit which just fits across the terminals and this is specified in the list of parts. The switch used is also made by Allen-Bradley and provides a sharp, clean break of the circuit and compactness. There is little mechanism and nothing to get out of order.

Not much can be said about the Amperites except that they do what is required of them and do it well. On tubes used as audio frequency amplifiers, which are not critical, they enable one to get

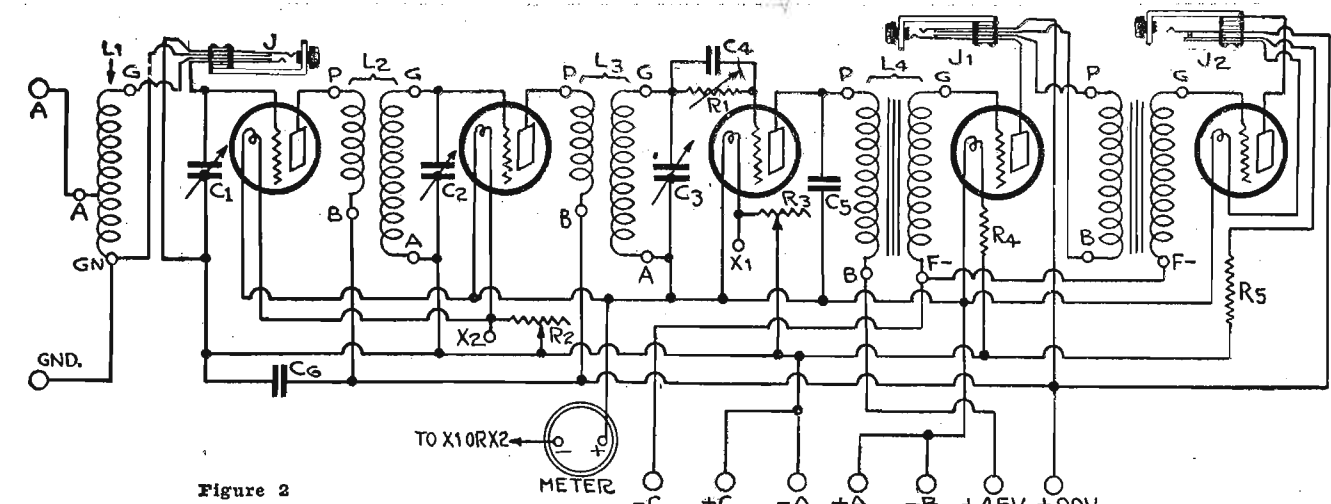

Figure 2

rid of another control on the panel and keep the applied voltage at about 5; this will vary slightly depending on the charge in the battery but is close enough. Erla fixed condensers are the writer's choice because their construction would seem to keep the capacity close to rating.

Meter Is Desirable

If you've ever sat gazing at a receiver that refused to "get out of town" and wondered whether the tubes were getting enough filament voltage, you can appreciate that voltmeter. The Jewell meter specified is, at the same time, both accurate and compact, which is an unusual combination in meters suitable for panel mounting on receivers. You do not keep it connected all the time but, by means of a flexible lead, clip the negative terminal to either of the points designated as X1 and X2 to learn if the first three tubes are getting a potential of 5 volts or better. If they are, it can be taken for granted that the last two are, through the Amperites.

If you have not as yet tried Walnart's binding posts, you have yet to see the cleverest bit of mechanical designing yet applied to this item in set construction.

The writer has suggested Kester solder, as soldering is difficult for the average fan anyway, and this product, containing as it does, the flux, makes soldering much easier and surer.

As to panels there is not much choice between the various bakelite types put out, but Formica has been chosen for a long time by the writer on the assumption that if many of our leading manufacturers of sets use it, it must run consistently good. It can be had in black, mahogany or walnut to suit the fancy of the individual builder.

In one set, therefore, you can now have doughnut coils, straight line frequency condensers, vernier dials, exact knowledge of tube voltage and filament control on the last tube. When the speaker or phone plug is in the first jack, only four tubes are lighted and drawing current; if it is then moved to the second jack, the last tube automatically is lighted and comes into use. Drilling dimensions for front panel and base panel will be exact for the parts specified and, if directions are followed precisely, the finished set

will work and work extraordinarily well. As to performance, Traveler will do what any other well designed, carefully built outfit will do, but for all around efficiency it surpasses others which the writer has seen. It is doubtful if it could be placed within a couple of blocks of a 1,000-watt station and still bring in DX on wave lengths but 10 or 15 meters away. It will, however, cut through in any but the most extremely congested locality, it has a splendid range and the tone is all that anyone could ask.

(In an attempt to give constructional directions so complete that the chance of failure is practically eliminated, Mr. Ryan has specified the parts required to duplicate his set and his article in next week's issue will include panel and sub base layouts with the exact location of every hole shown. Later, the insertion of every wire will be detailed.—Editor's Note.)

New Radio Static Filter

Increases Volume Decreases Interference

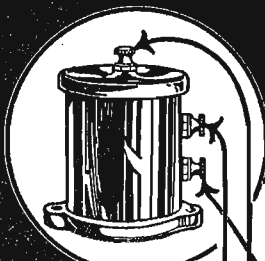

Easily Attached

This new radio invention actually separates radio tones from static, clearing reception by detouring static.

Study the diagram shown at the side of this ad. It shows where the static and radio tones enter the Filter together. Inside the Filter, the static and radio tones are separated, the static being detoured to the ground through the "A" Storage battery. But the radio tone waves are filtered through entering the set purified, clearer and increased in volume.

Attach the Filter to any set—no matter what kind—note the reception—cut out the Filter—note the difference.

With the "A B C" Filter attached to your set, you hear music as it is really played by the artists—you hear the dramatic climaxes of speeches—you understand the market reports and other announcements. Distant stations are brought in easier, due to the increased volume.

Lightning Proves Claims

We have on file a sworn statement by a Stockton, Illinois, business man. Lightning struck his building and was carried by a radio aerial to a set equipped with the "A B C" Filter. The lightning was carried through the Filter to the ground with absolutely no injury to the tubes, batteries, tuning unit or cabinet. The building was unharmed. The Filter is a perfect lightning arrester. If it will detour lightning—it will detour static. Write for a copy of the sworn statement. In event your dealer cannot supply you with the "A B C" Filter, simply mail us \$5.00, and we will send one direct with full instructions for attaching. Full guarantee with each Filter.

Static and radio tones enter Filter here, coming direct from aerial.

Static or lightning detoured here through the "A" Storage Battery to the ground.

Radio tone waves leave Filter here, purified, clearer and in greatly increased volume.

DEALERS
If you have a store or business of your own and are prepared to work cooperatively with aggressive sales and advertising help, write us today for full particulars about our proposition to dealers. We are desirous of forming connections with responsible dealers interested in selling a product of real merit, and the "A B C" has demonstrated itself to be this.

THE FREEPORT RADIO CORPORATION
Manufacturers "A B C" Static Filter. (Patent Pending)
11-15 West Stephenson Street Freeport, Illinois, U. S. A.

Sold On Money Back Guarantee

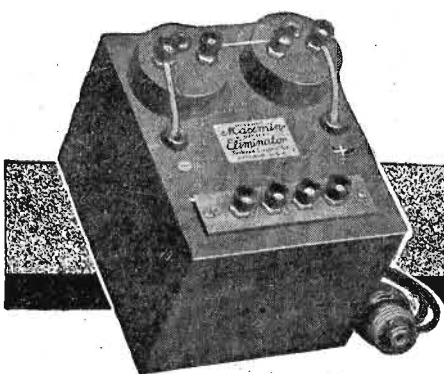

Superior Results Guaranteed

\$9.75

Now—Plate Voltage for any Set—and You can afford it!

First Cost Economy now makes it possible for EVERYONE to obtain efficient "B" current supply right from their electric light socket. Now one of the biggest improvements in modern-day radio reception is placed within the reach of all. Think of it! A perfect, always efficient source of plate voltage for any set for \$9.75! It marks a revolutionary step forward and will be welcomed by millions of radio enthusiasts.

Ferbend "B" Eliminator

The price of this remarkable new unit is spectacular in more than one way. Besides saving you from \$15 to \$50 it is amazingly low considering the quality and superiority. You may ask "how could it be possible to build such a unit for the ridiculously low price of \$9.75?" True mechanical genius and resourcefulness alone are responsible. But the logical way to answer this question is to equip your set at once with this marvelous unit and be convinced.

ASK YOUR DEALER—OR SEND DIRECT



This company also manufactures the famous Ferbend WAVE TRAP—the instrument which has been widely imitated but never equaled. It is the only original and genuine.

Until nation-wide distribution is completed it is possible that your dealer hasn't stocked the MAXMIN "B" Battery Eliminator as yet. So you will not have to wait, we will make prepaid shipment direct to you upon receipt of \$9.75, or C. O. D., plus postage. Remember, superior results are guaranteed or your money back. Be one of the first to own and use the Ferbend MAXMIM "B" Battery Eliminator.

Use the COUPON NOW!

Ferbend Electric Company
427 West Superior Street
Chicago, Ill.

Ferbend Maxmin "B" Eliminator

FERBEND ELECTRIC CO.
427 West Superior St., Chicago
 Send Postpaid. I am enclosing \$9.75.
 Send C. O. D. Plus few cents postage.
 Send Literature.

Name.....
Address.....
City.....
State.....

Complete, nothing else to buy.

Operates at maximum efficiency at all times on either direct or alternating current, any frequency.

Delivers unlimited current to any receiving set regardless of number of tubes.

Delivers 100 volts to ANY set.

Cost of operation less than 50c a year.

It lasts indefinitely.

All parts are specially designed and manufactured by us for this purpose only.

Unconditionally Guaranteed

to be equal or superior to any eliminator on the market, regardless of price.

A. B. C. Course in Radio Fundamentals

Chapter XXIX—Applications of the Electron Tube Oscillator

By David Penn Moreton

VACUUM tube oscillator circuits, of the nature of those described in the previous chapter, are used for undamped wave Radio telegraph transmitting and receiving and in Radiophone receiving circuits such as the super-heterodyne method of reception.

In the case of undamped wave Radio telegraph transmitting, there is produced, in the antenna oscillatory circuit, undamped alternating currents which are generated by a vacuum tube circuit combination suitably tuned and coupled. The

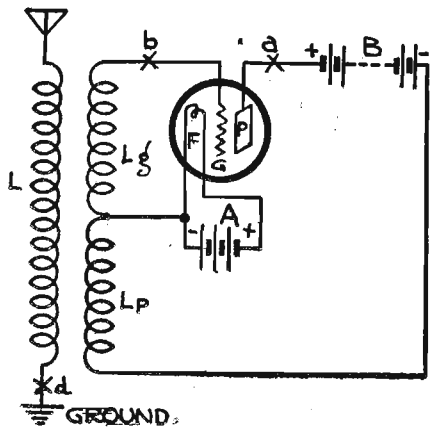

Figure 119

antenna circuit, being of itself an oscillatory circuit, may be used directly in any one of the vacuum tube circuits described in the previous chapter, in place of one of the oscillatory circuits coupled or connected to the tube circuits.

Since the primary object is to transmit signals, care should be taken to arrange the circuits in such a way that there will be produced, in the antenna circuit, a maximum amount of oscillatory energy. Some of the special conditions resulting from this application of the

vacuum tube oscillator circuits will be described in the following paragraphs.

Transmission Uses

A simple circuit is shown in figure 119, and this circuit is essentially the same as the one shown in figure 111 with the exception that the oscillatory circuit in figure 111 is here an open radiating oscillatory circuit instead of a closed non-radiating circuit. A circuit of this kind may be so designed that no coupling adjustment is required for quite a range of wave lengths. The only adjustment required is the tuning of the antenna circuit so that it will have a natural wave length equal to the wave length to be transmitted. This tuning of the antenna circuit is accomplished by means of a variable inductance or capacity inserted in the antenna circuit.

The greater the decrement of the oscillatory circuit, the greater the amount of power to be supplied to that circuit by the plate circuit of the tube in order to compensate for the energy losses and sustain an undamped oscillation. There is also an upper limit to the alternating power which may be supplied by any tube operating under given direct current conditions of filament, grid and plate voltages, which is reached when the alternating current grid potential oscillates between values corresponding to the upper and lower bends of the plate-current, grid-voltage characteristic curve. As a result of these combined conditions, it may be seen that a given tube will sustain undamped oscillations in an oscillatory circuit, provided the latter has a decrement smaller than a certain critical value. In the case of the circuit shown in figure 119, the oscillatory circuit continually loses energy by radiation into space, and the greater the percentage of energy this circuit radiates the better it is performing its function as a transmitting antenna.

On account of the large energy loss in the antenna circuit of figure 119, a vacuum tube of large power capacity is

required for satisfactory operation. The circuit will fail to operate satisfactorily with a low power tube and large antenna, and may even be entirely inoperative with an antenna circuit having too large a radiation for the tube in use. Several tubes may be connected in parallel and the available power output increased, or a single tube may be used that operates on a high plate potential, the maximum alternating current power being equal to the product of the plate potential and current variations.

Inserting the Key

A circuit such as the one shown in figure 119 is not complete without a telegraph sending key. The function of this key is to let the antenna circuit radiate energy at a certain predetermined wave length when the key is closed, and to interrupt such radiation when the key is open. There are two means of accomplishing this result: first, the key, when open, will stop entirely the generation of the oscillations, or second, that the key will simply detune the oscillatory circuit which will then radiate at a different wave length when the key is open and, therefore, not energize the receiving circuit, which is tuned to the wave length corresponding to the closed position of the key.

The oscillations may be stopped by placing the key at "a", see figure 119, in order to open the direct current plate circuit of the tube and thus cut off the power supply. The key may be inserted in the grid circuit as shown at "b" in figure 119. Opening the key when it is connected in the grid circuit does not stop the electron flow from the filament to the plate, and merely disconnects and insulates the grid, which then accumulates a negative charge, as explained in a previous chapter.

When the key is then closed to start the oscillations, this charge must first leak off, and a certain lag occurs, in the building up of the oscillations to their final value, which is objectionable as it introduces harmonics in the radiated wave train. This objection, however,

may be partly overcome by shunting the key contacts with a high resistance of the order of several megohms to provide a leakage path for the charge from the grid to the filament while the key is open.

The key may be placed directly in the antenna circuit at "d" as shown in figure 119. This arrangement has the disadvantage that the key contacts, when closed, may introduce a high resistance which would prevent the oscillations from reaching their full amplitude. This is particularly noticeable when operating at high speed, when the dots are made by a very rapid and light closing of the key.

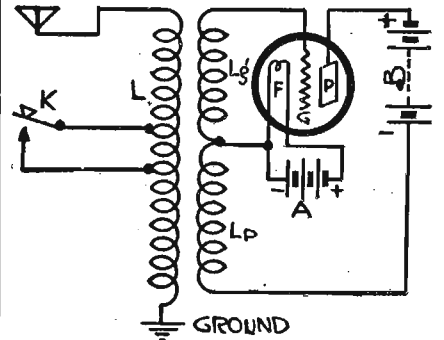
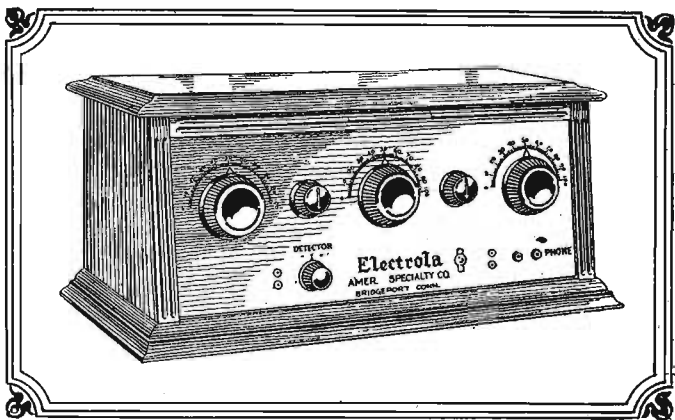

Figure 120

The detuning method can be applied as shown in figure 120, by connecting the key across one or a few turns of the antenna inductance. The closing of the key then short circuits part of the antenna inductance and as a result alters the natural frequency and wave length of the antenna circuit. The antenna will radiate energy continually at one wave length when the key is open and at a somewhat shorter wave length when the key is closed. Sharp tuning of the receiving station, resulting from the use of undamped waves, requires that the difference between the signaling and the detuned (Continued on page 20)



Just Hear It!

You need only listen to the new improved "Electrola" to realize at once the difference between the "Electrola" and all the other receivers you have heard. Regardless of price, the "Electrola" challenges any receiver on the market to direct comparison for purity of tone, beauty of appearance, and efficient performance over the entire wave length range.

Five tubes, tuned radio frequency. Rich mahogany cabinet, 7" x 22", with a beautiful etched metal panel. Equipped with the famous line of Kelford parts, made by us in our own factory. **\$59.50**

Model 18—Rich mahogany cabinet, 7x24 inches, \$80

Write for free descriptive booklet and name of nearest dealer.

THE AMERICAN SPECIALTY CO., BRIDGEPORT, CONN.
America's Pioneer Manufacturers of Radio Parts

Electrola



There's a Real Thrill in trying the New Hook-Ups!

WHEN you try the new circuits, be assured of success by using quality parts, such as Allen-Bradley Perfect Radio Devices. The Allen-Bradley Line includes practically every type of control device used on a radio set. For perfect performance and fine appearance, be sure to ask your dealer for Allen-Bradley Perfect Radio Devices. They always work!

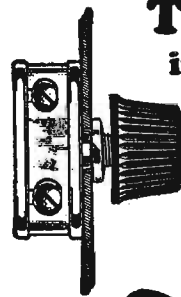

Bradleystat



Bradleyleak



Bradleyswitch

MAIL COUPON for latest literature on all Allen-Bradley Radio Devices.

Allen-Bradley Co., 290 Greenfield Ave., Milwaukee, Wisconsin. Please send me your latest literature on the complete Allen-Bradley line of Perfect Radio Devices.

Name.....

Address.....

The Dos and Don'ts of Antenna Construction

Part II—Outdoor Antennas

By William Fenwick

OF THE many different varieties of outdoor antennas, no more than three are in common use; viz., the inverted-L and the T flat top types, and the cage type. Probably the latter is best described by European terminology, "sausage aerial." The first mentioned, the inverted-L, has gained world wide popularity amongst the broadcast listeners, this being due mostly to the fact that a single wire inverted-L antenna is the simplest and the easiest to erect, needing neither knowledge nor skill on the part of the constructor, and, furthermore, by merely observing a few precautions while installing, is the most efficient from a receiving point of view.

T Type vs. Inverted-L

The T type of antenna is almost identical to the inverted-L, the only difference being where the down lead is taken off. In the case of the latter, the down lead is formed by attaching a wire to either end and bringing it to the apparatus, whereas with the T aerial it is fastened at, or near, the center. The cage antenna differs a great deal from the flat-top in that it necessarily has to be constructed as a multi-wire aerial, while the other may consist of anywhere from one to ten or even more wires. The reason the latter type of antenna is usually referred to as the "flat tops," is due to the wires being all arranged on the same plane, i. e., no wire is higher than another, whereas with the cage, the wires are fastened equidistantly around the periphery of hoops, usually made of a thick gauge wire, thereby giving it the appearance of a very much overgrown sausage. For a certain reason, the T cage (down lead taken from center) is to be preferred for transmission purposes, while for reception, an inverted-L flat top or cage antenna is best, but as the cage does not possess any remarkable advantages over the flat top when used for receiving and, furthermore, as the latter is much more simpler and easier to construct and install, it is advisable that the novice choose it to begin with.

As to what the size of an outdoor antenna should be for broadcast reception, a single wire between 65 and 90 feet long, and varying from 30 to 40 feet in height may be called the ideal for town or city. Not much is gained, if anything, by having it longer than 100 feet, while one less than 25, if rather low, cannot be expected to receive other than local stations with one vacuum tube. But, if the latter happens to have a height of, say, 50 feet or over, then it will work very nicely. As one necessarily has to fit the antenna to the location, consequently the exact dimensions cannot be given, but single wire aeriels made in accordance with the following seldom fail to give excellent results: Not shorter than 25 feet and not longer than 100, and from 30 feet in height upwards.

Before closing with outdoor antennas, a few helpful hints might be added for the benefit of the vacationist.

The best type of antenna to use in a

permanent camp, that is, when you intend to stay in the same spot for a few weeks or so, is the inverted-L. Sometimes, though, the conditions present are not favorable for this sort, such as when the camp is pitched in the middle of the span of the aerial. When this occurs, the T type should be resorted to.

When the direction in which the down lead end may point is optional, remember that you can receive the farthest from the particular end chosen, providing, of course, that it is not shielded by any large objects. Therefore, the logical thing to do is to point it in the direction

A. B. C. RADIO COURSE

(Continued from page 19)

wave lengths used be only a few meters. In general both waves are received, and when the beat or heterodyne method of reception is used, two notes are heard, one corresponding to the dots and dashes of the signals, and the other representing the intervals between. It might be possible under certain conditions to adjust the frequency of the locally generated waves for heterodyne, to the same frequency of the incoming detuned wave so that there would be no note heard in the intervals.

Circuit for Small Tubes

The circuit shown in figure 121, is used to overcome the difficulty of low power tubes tending to refuse to oscillate. For-

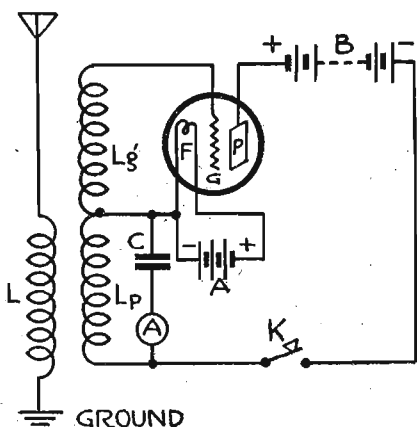

Figure 121

getting that there is an antenna circuit, the layout of figure 121 corresponds to figure 112, given in one of the previous chapters. For a suitable value of plate-to-grid coupling, strong undamped oscillations are set up in the plate oscillatory circuit LpC. If now, the antenna circuit is tuned to the circuit LpC and coupled to it as shown in figure 121, the current in the plate oscillatory circuit will induce undamped oscillations in the antenna circuit, and these oscillations, due to the large resonance currents in the circuit

(Continued on page 22)

in which you expect to do the most receiving.

About the easiest aerial to erect when a tree is at hand—and what is a camp's landscape without one—is to tie a weight to a good length of fairly strong fishing tackle and throw it over the tree top. Having fastened the other end of the tackle to an insulator and it in turn to the wire that is to act as the aerial proper, you may now hoist it into position, securing the tackle to some low branches so as to keep the antenna aloft.

If another tree is not near enough to support the opposite end, it is quite all right to attach a 10 or 15 foot pole to the tent or to the auto, if you happen to have one with you. So long as one end has a height of 40 or 50 feet and the antenna proper has a length of 75 to 100 feet, a single tube outfit can generally be relied upon for consistent reception up to a few hundred miles from a moderately powerful station.

The frame aerial serves an admirable purpose when used in camp on account of its ease of conveyance. To take full advantage of this excellent quality it should be of the spiral type (i. e., having two sticks crossed and the wire wound on one side), say, two to three feet square and consisting of 10 to 20 turns of No. 18 or 20 sec. or bare copper wire. It may be well to note here, though, that this type of antenna requires at least two stages of radio frequency amplification or a good three tube reflex receiver to maintain dependable reception if the location is more than 100 miles or so from the broadcasting station.

The vacationists who spend a good deal of their leisure hours out on some sailing craft may also make use of several methods in which they can rig up their antenna. For this purpose it is advisable that the receiver consist of not less than two tubes in a straight circuit or a good single tube reflex with crystal detection.

If the pleasure boat has sails, the mast may also be used as a support, while the opposite end of the antenna can be attached to a pole fastened to the stern. On motor boats, and others minus sails, at least two poles will be necessary. Some have very successfully employed antennas having three supports, a short one being placed at each end and a long one in the center of the span, the wires attached to the latter having insulators separating them from it. This sort of an installation is to be preferred to the other mentioned in this paragraph as it gives the aerial a larger span, thereby increasing its inductance.

The installing of a permanent antenna is not advisable on a canoe for the reason that a pole on each end and wires overhead is anything but convenient on account of the small space available. If the owner has a small set which will not operate successfully with a loop (frame) aerial, the best one for him is that known as a "ship-to-shore" antenna. This is merely 100 feet or so of wire stretched from a tree, or other high object, on land to the canoe. The obvious disadvantage here is that the set can only be operated when the canoe is anchored, and also it must necessarily be quite near to something which possesses a good height.

About the only alternative of the "ship-to-shore" type for use with a canoe, with the exception of a loop, is a wire approximately 75 feet long and dropped over the side of the boat. This wire must be kept well insulated from the water, even the dead-end being covered which is easily done by employing rubber covered wire for the purpose, wrapping one end with ordinary insulating tape and then dipping it (the end) in paraffine.

(It is realized that every fan will not have convenient high points on which to secure his antenna so next week Mr. Fenwick tells of the construction of antenna masts.—Editor's Note.)

EVERYWHERE!

Wherever you may be, there is an authorized Crosley sales and service station nearby--usually the most dependable, progressive radio establishment in the community.

THE CROSLLEY RADIO CORPORATION, Cincinnati, Ohio

CROSLLEY RADIO

BETTER · COSTS LESS

Send for this **RADIO BOOK** FREE

1926 Catalog of Everything New in RADIO

at a Big Saving in Price

The World's Largest Exclusive Radio Mail Order House Will Send You This Wonderful Book FREE

64 illustrated pages containing thousands of bargains in radio sets, semi-finished sets and radio kits of all styles, sizes and approved circuits. Beautiful models of the very latest designs and types. Elaborate console models with loud speakers built right into cabinets of genuine mahogany and walnut. ALL SETS GUARANTEED.

Our line includes all popular sets, such as Superheterodyne, Neutrodyne, Ultradyne, Reinartz, Regenerative, Radio Frequency, Browning-Drake, Reflex and all other latest circuits. Kits, sets and parts manufactured by all well known manufacturers, such as: Frost, Howard, Baldwin, Brandes, Western Electric, Columbia and others.

Our Guarantee
Every article exactly as represented. Every article is tested before shipping. Complete satisfaction or money cheerfully refunded.

Don't Buy Anything in Radio Until You Get Our Big Money Saving Catalog

RANDOLPH RADIO CORPORATION

The Largest Exclusive Radio Mail Order House in the World

159 N. Union Ave., Dept. 24, Chicago, Ill.

Our Catalog

Includes complete list of broadcasting stations and general information and facts about our free service division. Our radio engineers will help you solve all your radio problems. Send your name and address on a card or in a letter. We will send catalog FREE.

pep up your set with good tubes

TUBES make all the difference in the world. You'll agree with that statement the moment you switch to MAGNATRONS, the moment you notice how clearly and powerfully these tubes bring the concerts to you.

MAGNATRONS are for sale by the better dealers everywhere. The type DC-199, the DC-201A, and the DC-199 with large base each sell for only \$2.50.

CONNEWEY ELECTRIC LABORATORIES
Magnatron Building Hoboken, N. J.

MAGNATRONS

Three Tube Reflex Free of Static?

Secret of Circuit Is 400-Ohm Potentiometer

The principle feature of the above circuit, which is of my own origin, is that summer static is reduced to practically nothing. Yet, the signal strength is

WORKSHOP KINKS EARN A DOLLAR—

THERE are many little kinks worked out at home that would aid your fellow Radio worker if only he knew about them. There are new hook-ups, new ways of making parts and various unique ways of operating sets that are discovered every day. Radio Digest is very much interested in obtaining such material. Send them in with full details, including stamped envelope, so rejected copy may be returned. The work must be entirely original, not copied.

RADIO KINKS DEPARTMENT
Radio Digest
510 North Dearborn St., Chicago

greater than any of several regenerative sets that I have tried. This, I think, is due to the variable resistance in the aerial circuit. Its selectivity is as good as a well made, five tube, tuned radio frequency set, while its DX record is as good as my neutrodyne. When properly adjusted and tuned to any wave length, I have found its tone quality to be superior to any set I have heard.

The only time I am annoyed with ether disturbances is when an electrical storm is within a radius of five miles. Ordinary static, while very annoying on radio frequency or regenerative circuits, is not troublesome on this one.

The potentiometer shown is of 400 ohms resistance. Only the arm and one of the end terminals are used. Coils L and L1 are spider webs. Twenty-four turns of the secondary are wound on, then the primary of 10 turns, and finally the

HOOK-UP WITH CONSTANTS SHOWN

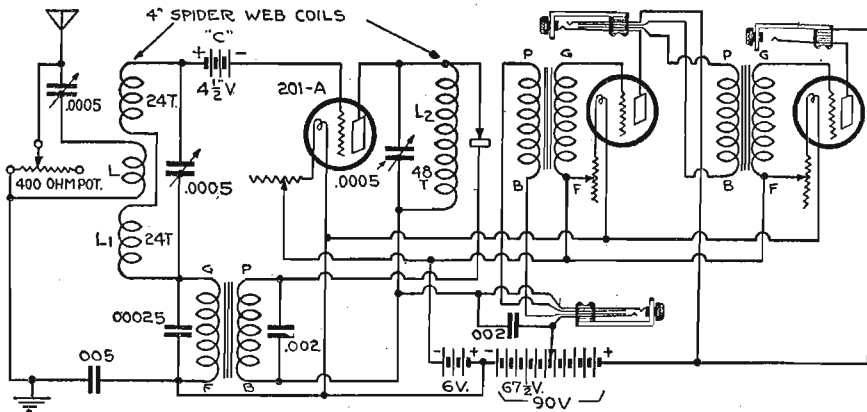

remaining twenty-four turns of the secondary. Both coils are wound clockwise, and both are No. 22 double silk covered wire. The crystal detector may be either fixed or variable. When the variable condenser in the aerial circuit and the potentiometer are adjusted to the aerial being used they can be left alone, which leaves only two controls to tune. The potentiometer may be used as a volume control and to control oscillation.—William L. Travis, Birmingham, Mich.

Lead-In Insulator

Many fans use porcelain tubes as insulators when bringing the lead-in

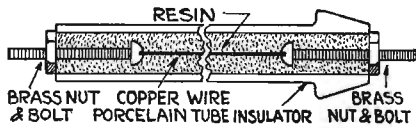

through the window sashes. However, as commonly used, they are unsatisfactory since they allow snow, rain and

cold air to enter the house. The illustration shows a cross section of an improved insulator.

Two one-inch brass bolts with small heads are soldered to a piece of No. 14 copper wire as shown. The wire should be of such a length that the bolts extend from the ends of the tube about one-half inch. A nut is put on one bolt, and the other bolt and wire are inserted in the tube. The tube is then stood on end and filled with melted resin. A nut on the topmost bolt completes the insulator.—W. G. Hensel, Navarre, Ohio.

Remember, in aerial construction, that four lengths of wire, each 25 feet long, are by no means equal to one wire 100 feet in length.

New!

The biggest little thing in Radio

this season

DURHAM Variables

Panel Mount \$1.00
Standard 75c

Bring control of high resistance to the panel

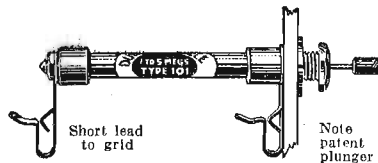

Both types in three sizes:
No. 100—1000 to 100,000 ohms
No. 101—0.1 megs. to 5 megs.
No. 201A—2 megs. to 10 megs.

Always a one-finger control and now at your finger-ends—that's the new DURHAM Variable. The familiar ease and accuracy of these standard high resistance units in their latest form may be placed anywhere on your panel, preferably near the tube they control. Only a 1/4" hole required.

For most hook-ups, you'll need two DURHAMS—detector and audio.

Look for the plunger

The patented DURHAM combination of sliding plunger and non-wear compound is your protection and guarantee for accurate, high resistance control.

DEALERS: Get this
Order from jobber now specifying type, panel mount and standard.

This style fits any clipped condenser

75c or DURHAM Bases, 30c-45c

DURHAM & CO., Inc.
1930 Market St., Philadelphia

Uniformity Guaranteed!

LEADING builders of fine sets use more Thordarsons than all competitive transformers combined because Thordarsons run absolutely alike, absolutely uniform; always "match up" perfectly; always amplify evenly. A prominent set maker recently stated: "Any radio manufacturer who is sincerely desirous of producing an instrument of the volume necessary and of a tone superior to anything else on the market, must be absolutely forced to use Thordarson transformers sooner or later." Follow the lead of the leaders—build or replace with Thordarsons. Unconditionally guaranteed. Any store can supply you. Thordarson Electric Mfg. Co., Chicago.

THORDARSON
Super
AMPLIFYING TRANSFORMERS
Standard on the majority of quality sets

ZENITH
KENNEDY
Radiodyne
Planstiehl
Howard
Thermodyne
GLOBE
Deresnadyne
ADLER-ROYAL
MURDOCK
MU-RAD
Valley
Silver-Marshall
OZARKA
ULTRADYNE
Newport
LEICH
NUNN-LANDON
KUSTOMBILT and many others

Also choice of the MacMillan Arctic Exposition

WE SOLD 4000 SETS

Had 4000 Favorable Reports

Before We Felt Justified to Say



Quality Radio Apparatus

Now we invite you to go to your Apex Dealer who will be glad to make a personal demonstration for you in your home or in his store. A demonstration will prove to you that Apex Radio Receivers will give you everything you can possibly wish for in a radio receiver from the standpoint of selectivity, clarity, volume, distance and attractiveness of design.

- The APEX Super Five without accessories... \$95
- The APEX De Luxe without accessories... 135
- The APXE Baby Grand Console without accessories... 225
- The APEX Utility Radio Table... 75
- The APEX Entertainer (Loud Speaker)... 22.50
- The APEX Console Entertainer... 27.50

Upon request we will gladly mail you descriptive folder.

APEX ELECTRIC MFG. CO.
1410 W. 59th St., Dept. 1005
CHICAGO

Prices West of Rockies slightly higher. Canadian prices approximately 40% higher

Reactivating Tubes Easily

Tubes of the 201A type, which may have become weakened through excessive filament current or long use, but in which the filament still lights, may be reactivated by the application of alternating current to the filament by means of a bell-ringing transformer. Most of these transformers are so constructed that voltages of 6, 8 and 14 may be taken off the secondary.

The method of reactivation is simplicity itself. First apply the full 14 volts to the filament of the tube for 45 seconds, then finish off with 8 volts for 10 minutes. This may seem a very high voltage for tubes of this type but it is a very rare occurrence for one to burn out when alternating current is used as above directed, unless the transformer is defective. Tubes that formerly were so weak that it was almost impossible to hear signals at all, will function like new in practically all cases.—Floyd Welsh, Laclede, Mo.

Morrison

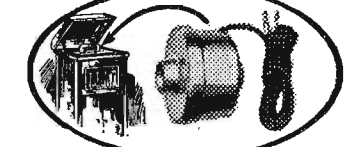

Loud Speaker

Mocking Bird Unit

PATENTED

Price \$7.50

All fans remember the pioneer of adjustable units—Morrison Model C. For 3 years this unit was a standard of comparison. In trend with radio's great growth Morrison now offers the Mocking Bird Unit, the peer of all units.

You cannot equal the tone reproduction of the Mocking Bird Unit attached to the tone arm of your phonograph. Adjustment of volume to suit your taste requires only a slight turn of the little dial on the back of the unit. Radio assumes new delights—purity of tone and remarkable volume are marvelous.

If your dealer cannot supply you send check or money order to factory or we will ship C.O.D. Absolute money-back guarantee if not satisfied.

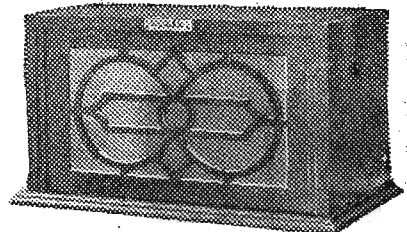

The Mocking Bird Cabinet

The handsome Mocking Bird Cabinet at \$30 list is a real musical masterpiece. Morrison Mocking Bird Units and Cabinets at most good dealers.

Set Mfg'rs. Attractive quantity prices on Units to build into your Sets.
Dealers Morrison has always been a merchandising leader. New schedule of discounts ready—write or wire.

Morrison Laboratories
343 E. Jefferson Ave. Detroit, Mich.

Questions and Answers

ANNOUNCING A CHANGE IN THIS DEPARTMENT

Effective with the October 10 issue, the Questions and Answers department offers service to Radio Digest subscribers without charge and, to those not subscribers, the same service with a charge of 50c for each letter requiring up to three answers or diagrams. We feel that this policy is necessary for the protection and best interests of our regular readers, as the volume of correspondence to this department has increased to such an extent that it is almost impossible to give our subscribers' letters adequate attention nor a complete answer. To those who have long been newsstand readers this may, at first, seem an injustice but a little thought on the matter will show that this is the only possible solution of what has been, to the technical department, a very perplexing and difficult problem. We ask that the following suggestions be read carefully before writing:

- 1—Search carefully the back issues which you have, as the point in question has probably been covered several times before.
- 2—The book, "Radio Receivers," given free with each yearly subscription, contains the answers to the majority of the questions asked. If you have this book, go through it thoroughly and it is probable that you will find the solution of your problem.
- 3—Letters for this department should be kept separate from all correspondence to other departments and on other subjects.
- 4—Questions should be written on one side of paper only and each sheet should bear the sender's name and address. All letters should be accompanied by a self-addressed stamped envelope of standard business size.
- 5—Unsigned (or anonymous) letters cannot be answered, either on this page or by letter, nor can those without address.
- 6—No comparative statements on advertised apparatus will be given except as to efficiency in some particular circuit.
- 7—Drawing diagrams on a separate sheet of paper will save time and enable us to give all questions more attention.
- 8—Write each question as a separate paragraph.
- 9—Keep a copy of your letter and diagrams, to which we can refer without re-drawing.
- 10—The names and addresses of the writers of letters published will not be released except with the writer's permission.
- 11—We want to be of assistance to you in your difficulties, but are sometimes limited because of the length and time required for the proper consideration of the questions asked. Therefore, please make your letters brief.

Enamelled wire has been proven by many tests to be the best for use in building aerials. Bare wire becomes coated with soot, which causes certain electrical losses, and fabric covered wires absorb moisture that also causes losses. The wire used should be of the best grade copper.

When laying out wires for the aerial, take care that all kinks and twists are avoided, but if formed, these should be straightened out carefully in order not to weaken the wires.

25 RADIO STAMPS FREE

With World Radio Stamp Album and Log. Contains ruled spaces for stamps of stations in U. S., Canada, Europe, etc. Stick stamps in proper spaces as stations are heard. Also contains convenient Log and complete list of stations, call letters, wave lengths, etc. Send 35c for album and get 25 genuine radio stamps. FREE. Order NOW.

WORLD TRADING CO., Dept. 4417, 366 Wrigley Bldg., Chicago

New Perpetual LOG

Loose Leaf for Revisions—Radio Map FREE
New 64 page log. Corrected sheets may be secured as changes in calls, wave lengths, owners, etc., occur. Holds 304 stations. Shows call, city, wave lengths, dial settings, remarks, etc. Tuning suggestions. Station list by wave lengths—by states, etc. Owners. Trouble aids. Other valuable information. So convenient. Worth many times its cost. Only \$1. Pay postman after log arrives. Postpaid if pay with order. Money refunded if not delighted. Order today—now. Radio Printers, Dept. 9817, Marengo, Ill.

FREE RADIO STAMPS

616 beautiful genuine copper etched American and Canadian stamps FREE, yes, absolutely FREE, with order for a genuine Bryant 48 page stamp album (8 in. x 11 in.). Also contains log showing stations, locations, wave lengths, dial settings and date. As you hear new stations just stick the proper stamps in your album. Colored individual stamp for each station. So convenient. So enjoyable. You will be proud to show this album to your friends. You and your children will enjoy it. Complete album \$1.00 plus postage.
Send No Money

Just pay postman after album and stamps arrive. I prepay postage if you prefer to pay with order. MONEY REFUNDED if not DELIGHTED. Send order today—NOW. Postal will do. P. M. BRYANT, Dept. 9917, 366 Wrigley Bldg., Chicago

Aerial Mast Seats and Fittings

4 Sizes and 3 Styles of Aerial Fittings
We make the "Freitag" Mast Fittings and the well-known line of "Bull Dog" Mast Seats formerly made by the Mast Seat Mfg. Co., of Minneapolis.
Made under Patents allowed and pending

Jobbers write for our prices and discounts. If your Dealer cannot supply you send for our folder.
FREIDAG MFG. CO.,
Freeport, Ill.
Jobbers and Dealers—Send your orders direct to us. We have no Agents.

A. B. C. RADIO COURSE

(Continued from page 20)

L_pC , will be of sufficiently great amplitude to operate the circuit despite the radiation of energy from the antenna.

The adjustment of a circuit of this kind to radiate a certain wave length may be made as follows: The antenna circuit is opened, or its coupling so reduced, that it will not be appreciably energized by the vacuum tube circuit and may be considered as not present. A hot wire ammeter Z is connected in the plate oscillatory circuit L_pC , and the tube is made inoperative by opening the key K, or cutting off the filament current. The circuit L_pC is then tuned to the desired wave length by exciting it with a wave of known frequency and varying the condenser C or inductance L_p until resonance is obtained, as indicated by a maximum reading of the ammeter A. The tube is then energized, the key closed and the vacuum tube circuit adjusted for maximum oscillation generation by varying the grid-to-plate coupling until a maximum reading is obtained on the ammeter A. The antenna circuit is then loosely coupled to the plate oscillatory circuit, and is tuned to that circuit by varying its inductance or capacity.

RADIO Salesmen for territory not now covered by our representatives; exclusive lines; protected territory. Full or part time. WELLSTON RADIO CORPORATION, St. Louis, Mo.

PATENT ATTORNEYS

PATENTS. Booklet free. Highest references. Best results. WATSON E. COLEMAN, Patent Lawyer, 644 G Street, Washington, D. C.

GO into the RADIO BUSINESS

We specialize in Equipping New Dealers with entire stock—advice free. Send for our Radio CATALOG & BARGAIN LISTS Wholesale Only
MANHATTAN RADIO COMPANY
112 Trinity Place New York City

Hear What YOU Like

YOUR OWN Name and Address
Printed Free on Applause Cards
Stations gladly put on requested numbers. We print special cards that get ATTENTION. Applaud your favorites.
Send No Money
100—\$1.45; 200—\$1.95; 300—\$2.45.
MONEY REFUNDED if Not Delighted. Order Today. Quality cards. High grade printing. All the rage. A joy to use. With 1st order: log for your set. Shows calls, cities, wave lengths, dial positions, remarks, etc.
FREE Radio Printers, Dept. 8917, Marengo, Ill.

Any Radio Map a Month Old Is Out of Date

Unless It Has a Monthly Supplemental Service
THE AIR-LINE RADIO MAP and LOG
With Patented Movable Mile Scale Has This Service
Lists stations by call letters, also by wave lengths. UNIQUE BROADCASTING SCHEDULE. LOG shows location; difference in time; power, meters and kilocycles; spaces to list dial settings; time heard, distance, signal strength. Whether you use outdoor aerial or loop, direction of loop, phones or loud speaker.
An Individual Log for Every Station
If you do not find this the most complete serviceable RADIO MAP and LOG published, we will refund your money.
Price 50 Cents
At your dealers, or sent postpaid. Dealers and Jobbers Write at Once.
MULTIVIDER CO. ST. JOHN and ASKEW KANSAS CITY, MO.

World Storage "B" Battery

WORLD BATTERY COMPANY
1219 So. Wabash Ave., Dept. 76, Chicago, Ill.
Makers of the Famous World Radio "A" Storage Battery
Prices: 6-volt, 100 Amp. \$11.25; 120 Amp. \$13.25; 140 Amp. \$14.00.
All equipped with Solid Rubber Cases.

Jones Cabelug

4 Foot \$1.00
8 Foot \$1.25
HOWARD B. JONES 618 S. CANAL ST. CHICAGO, ILL.

Announcing a new and very practical battery connector, the Jones Cabelug consists of a five wire coded cable, anchored to an insulated block, cable ends projecting from the block serving as terminals for the set leads. The block is permanently mounted on the panel or sub-panel, allowing the set builder to complete his wiring arrangement, and leaving nothing to connect but the battery ends. No binding posts required.
HOWARD B. JONES
618 S. Canal St. CHICAGO

At resonance, the antenna circuit draws the greatest amount of energy from the plate oscillatory circuit, and the condition of resonance is indicated by a minimum reading on the ammeter A. The coupling between the antenna and plate oscillatory circuit which results in the antenna drawing the greatest amount of energy from the plate circuit exists when the reading on the ammeter A is a minimum.

(There are so many practical applications of oscillators that they could not all be taken up in one installment, so Prof. Moreton will continue the uses of oscillators in next week's issue.—Editor's Note).

Quality Radio Cabinets, Tables. L. H. Bazuin, 153 Lowell Ave., Grand Rapids, Michigan.

Long Distance Radio \$2.95. Lambert's newest crystal success. No tubes. No batteries. No grief. Always ready. Works 600 miles. Fully guaranteed. We pay postage. Order direct from this ad. Leon Lambert, Wichita, Kansas.

100 RADIO CARDS

Thank the broadcasters with attractive Radio Appreciation Cards. Printed in two colors on high grade white Post Card. \$1.00 brings 100 cards postpaid. Order today.
\$1.00
Radio Card Co., 220 Franklin Buffalo, N. Y., Dept. D

NEW BIG POWERFUL 5 TUBE RADIO

MIRACO ultra 5 TUBE RADIO
now only \$59.99 retail
GET SPECIAL OFFER
Factory prices save you 1-3 to 1-2. Users everywhere report Miraco ultra 5 gets programs coast to coast, Canada to Gulf Coast and clear on speaker; outperforms \$100 to \$250 sets. Many hear Europe. Marvelous value—let testimony of users convince you. Smaller sets \$13.75 up. Write. AGENTS: MIDWEST RADIO CORPORATION, 437-D E. 8th St., Cincinnati, Ohio

RADIO Storage "B" Battery
22 Cells
24 Volts
Lasts Indefinitely—Pays for Itself
Economy and performance unheard of before. Recharged at a negligible cost. Approved and listed as Standard by leading Radio Authorities, including Pop. Radio Laboratories, Pop. Sci. Inst. Standards, Radio News Lab., Lefax, Inc., and other important institutions. Equipped with Solid Rubber Cases, an insurance against acid and leakage. Extra heavy glass jars. Heavy, rugged plates. Order yours today!
SEND NO MONEY Just state number of batteries wanted and we will ship you in order is received. Extra Offer: 4 batteries in series (96 volts), \$12.75. Pay expressman after examining batteries. 5 per cent discount cash with order. Mail your order now!
WORLD BATTERY COMPANY
1219 So. Wabash Ave., Dept. 76, Chicago, Ill.
Makers of the Famous World Radio "A" Storage Battery
Prices: 6-volt, 100 Amp. \$11.25; 120 Amp. \$13.25; 140 Amp. \$14.00.
All equipped with Solid Rubber Cases.

World STORAGE BATTERIES
Set your Radio Dials at 210 meters for the new 1000 watt World Storage Battery Station, WSDC, Chicago. Watch for announcements.
KOKA—WEAF—WGN—WJZ—KHJ—KGO—KFA—WUX—KO

TELEVOCAL QUALITY TUBES

TELEVOCAL CORP'N
67-A Fifth Ave. NEW YORK
A Technical Triumph Fully Guaranteed



22½ VOLT \$2.95
It's OUT—Complete over-lasting ready to run non-acid, non-sulphating 22½-volt rechargeable "B" storage battery, \$2.95. Includes chemical. Does not lose its charge standing idle. Special 2-22½ volts (45 volts) \$5.25; 90 volts \$10.00; 112½ volts \$12.50; 135 volts \$14.75; 157½ volts \$16.80. Nearly 3 years sold on a non-red tape, 30-day trial offer, with complete refund if not thoroughly satisfied. Further guaranteed 2 years. Knock-down kits at still greater savings. Complete ready to run "B" battery charger \$2.75. Sample cell 55c. Order direct—send no money—simply pay expressman its cost on delivery, or write for my free literature, testimonials and guarantee. Same day shipments. My large 36-page radio goods catalogue 10c. B. D. Smith, 31 Washington Ave., Danbury, Conn.