

How to Make New Four Filter Super-Het; Neutralizing First Reflex Tube; Operating and Trouble Shooting the Grebe Synchronphase; Pictures of KFKX

Radio Digest

EVERY WEEK **Illustrated** PROGRAMS **TEN CENTS**

REG. U. S. PAT. OFF. & DOM. OF CANADA

Vol. XII

Copyright 1925
By Radio Digest Publishing Co.

SATURDAY, MARCH 14, 1925

No. 10

OFFERS NEW WAVE PLAN

PLANE DROPS BOMB, BUT WITHOUT PILOT

BRITAIN SOON TO PERFECT
WEAPON OF WARFARE

Experiments in Radio Control Have
Gone on Since 1915—Much
Secrecy Guards Tests

LONDON, England. — Remarkable results have been obtained in a long series of tests which have been carried out by the British Air Ministry's experts in the radio control of airplanes. These experiments have been executed with the greatest secrecy in a lonely district on the English south coast.

A small pilotless airplane has been sent on flights of several miles, guided by radio from an apparatus—which is always closely guarded—and landed safely at will. The machine has been made to perform all the stunts. It does its looping, turning, rolling and spinning just as though an expert pilot is aboard.

Infinitely more has been done in these secret trials than ever before. Dummy bombs, operated by levers, have been dropped on pre-arranged spots with uncanny accuracy. The tests have demonstrated the probability of a terrible weapon of warfare being perfected within a comparatively short time.

Experiments in radio control have been going on in Britain since 1915, and the many series of trials have been carried out at different places in order to prevent leakage of information.



BOOST FOUR DIVISION IDEA AS SOLUTION

S. M. Kintner Is Sponsor

Westinghouse Engineer Presents
Scheme to Avoid Station Inter-
ference and Heterodyning

PITTSBURGH.—S. M. Kintner, research engineer for the Westinghouse Electric and Manufacturing company here, has outlined a new plan of wave length allocation and station classification which may, it is said, eliminate 95 per cent of the present objectionable interference.

Mr. Kintner, one of the best informed men in radio, insists that reclassification of the broadcasters is very necessary. His opinion is backed by many other prominent leaders.

His plan, briefly, is to have a four-station classification, the most important of which will be known as the super de luxe stations, confined within the wave length range of 300 to 416.6 meters with power varying from 5,000 to 50,000 (50 kilowatts), and limited in number to fifteen.

(Continued on page 2)



Miss Gertrude Bryan, shown above, who plays the leading role in "The Way of the World," at the Princess theater, New York, recently broadcast from Station WOR. Left, Mary Craig, with the Craig sisters, was heard recently in a little close harmony from WLW. Right, Renee Adoree, one of the screen's favorite players, who recently appeared at KFI.

PROPOSED WAVE BAND ASSIGNMENT FOR BROADCASTERS

Table with 7 columns: Station Class—(Waiting List), Number of Channels Available, Power Allowed, Wave Lengths, Number Stations on Same Band, Number of Time Divisions, Number Assignments Possible. Rows include IV, III, I, and II.

Radio relays on short wave channels in bands of 50 kc. width from reservations 50-55 meters, 60-65 meters and 70-75 meters.

NEW WAVE BAND PLAN

(Continued from page 1)

The accompanying tabulation includes all data pertaining to the new plan which has been designed strictly with the thought in mind of giving the utmost good service to the Radio listener.

In an explanation of the plan Mr. Kintner states:

"In the tabulation the several classes of stations appear in the order of their wave lengths. It will be more readily understood, however, if it is studied in the order of the station classes. Class I is for a limited number of stations that can classify for a de luxe service.

"Each of these stations is assigned an exclusive wave channel of 20 kilocycles breadth and permitted to use larger power, from 5-50 kilowatts. It is expected that general interest will exist in what each of these stations has to offer and it is desirable to protect them from taking or giving interference.

Class II and III Stations

"Class II stations are those of less national importance and yet whose facilities entitle them to be ranked above and given superior opportunities over the stations in the lower classes. The standard

Foreign Notes

Programs may be expected shortly from a new station which the Norwegian Broadcasting company is constructing, and which should be ready for transmission about the end of March.

The Societe Francaise d'Etudes de T. S. F. have decided to transfer their whole technical laboratory and transmitting sets to an old tugboat which travels up and down the Seine.

News of another long-distance Radio reception record comes from North Borneo. On three different occasions the programs broadcast by the London 2LO station have been heard distinctly, although the distance between the listeners in and the transmitters was approximately ten thousand miles.

An invention by which refrigeration can be broadcast by Radio is claimed by a Scandinavian. His plans include a municipal transmitting station to broadcast the "Radio-ice," and he states that all that is necessary to keep the food cool in the hottest weather, is to keep the receiver tuned in to the central station.

Four months ago, the word "Radio" signified to the average person in Vienna only a newspaper expression, often used to describe the latest craze which had hit America. Today there is an antenna on almost every housetop, and thousands of loops are hidden away in the houses.

There are now four stations in Sweden broadcasting programs regularly. SASA at Stockholm, operating on a wave length of 430 meters; SABS at Goteborg, on 290; SASC at Malmo, on 270; and the station at Boden, transmitting on 2,500 meters.

Although a new station has been erected at Moscow to work on a wave length of 1,200 meters, Russian amateurs do not expect a great deal from the new station. Radio development has been very slow in Russia.

British tube manufacturers have cut the price of their products. The statement issued when the price cut was announced was to the effect that, "it was done in order to encourage the building of tube sets in place of the popular crystal type."

Receiving sets will be installed in the various army barracks by the British government. The army council has recognized the pleasures that may be derived from this form of entertainment.

Spain will open two new broadcast stations in the near future. One will be located at Bilbao, and the other at Cadiz.

A resident of Sevenoaks, Kent, England, advertised in a local newspaper, "wireless in maid's room." The idea was successful.

In order to eliminate personal publicity for members of their staff the British Broadcasting company have lately cut the names of announcers out of programs. Other well-known names are also being less mentioned, especially those of artists in the regular employment of the B. B. C.

of this class should be maintained and none from lower classes admitted unless fully competent, regardless of the number of vacancies in this class.

"Class III would contain that large number of small stations whose influence is very local. This class of station is limited in power to 100 watts, in order to minimize its interference with other stations on the same wave channel, but located a sufficient distance geographically to cause little or no interference with the large majority of local listeners, i. e., the ones who can logically be assumed to be the regular listeners to that station.

"Class III stations need fulfill a less rigid set of conditions than those of higher classes.

Class IV Is Waiting List

"Class IV is the waiting list. Into this class all newcomers must go and await an opening to a higher class as a vacancy arises.

"A principle that should govern in the selection of applicants for admission to the several classes, is the one of purpose in broadcasting. Are those operating stations interested in developing the art of broadcasting? It must be apparent that the art of broadcasting has a better chance of growing and becoming a more permanent institution if those broadcasting are interested in developing broadcasting equipment and methods rather than simply trying to let you know that some particular article of merchandise entirely foreign to broadcasting is the best of its kind.

"Provision is also made for reservations for Radio relay connections so that it may be possible for some of the Class III or Class IV stations to secure national programs for their use and thus make them available locally to those listeners not equipped with the more sensitive receivers."

Station Changes

With the final reallocation of wave lengths along the Pacific coast, Radiophans may once again log their stations with the fair assurance that they will be heard again on the recorded dial settings. The new lengths are:

KNX, Los Angeles, 336.9; KFAE, Pullman, Wash., 348.6; KGO, Oakland, 361.2; KFOA, Seattle, 384.4; KHJ, Los Angeles, 405.2; KPO, San Francisco, 420.3; KFI, Los Angeles, 468.5; KGW, Portland, Ore., 491.5, and KLX, Oakland, 508.2.

Wave lengths held in reserve in the West for expected stations have also been announced. These are:

Corvallis, Ore., 280.2; Los Angeles, 293.9; Phoenix, Ariz., 299.8; Seattle, Wash., 305.9; Pasadena, Calif., 315.6; Salt Lake City, 333.1; Missoula, Mont., 394.5, and Seattle, 454.3.

Newly licensed class A stations, announced during the past week by the department of commerce, are: KFVF, Clarence B. Juneau, Hollywood, Calif., 208.2 meters; WAMD, Hubbard & Co., Minneapolis, Minn., 244; WAFD, Albert B. Parfet Co., Port Huron, Mich., 233; WHBD, Chas. Howard, Bellefontaine, O., 222; WHBC, Rev. E. P. Graham, Canton, O., 254; WRAK, Economy Light Co., Escanaba, Mich., 256.

WKAQ, the Radio Corporation of Porto Rico at San Juan, has been given a class B license with a wave length of 340.7 meters.

WDAG, Amarillo, Texas, is back on the air after several months with no programs.

CKY, Winnipeg, Manitoba, may change its wave length from 450 meters to 384.4 because of heterodyne interference with a number of American broadcasters.

Broadway's great White Way is now represented by a new station, WMCA, the Hotel McAlpin, New York. It is class B with a 428.6-meter wave length.

CONTENTS

Radio Digest, Illustrated, Volume XII, Number 10, published Chicago Illinois, March 14, 1925. Published weekly by Radio Digest Publishing Company, 510 N. Dearborn Street, Chicago, Illinois. Subscription rates, yearly, Five Dollars; Foreign Postage One Dollar additional; single copies Ten Cents. Entered as second class matter at the post office at Chicago, Illinois, under the Act of March 3, 1879.

Table listing contents: All the Live News of Radio (1 to 8), KPFX—Hastings, Nebraska—Old Bill's Own (5), An Evening at Home with the Listener In, a chart showing when to listen in for your favorite station (3), Advance Programs for the Week at All the Larger Stations (9 to 14), Operating the Grebe Synchronizer Receiver (15), Editorials; Indigest; Condensed by Dielectric (16), Four Filter Eight Tube Super-Heterodyne, Part II—Construction of the Filters, by Jacques Fournier (17), Broadcast Listener's Reference Library, Part VI—Audio Frequency Amplification, by E. T. Jones (19), Neutralizing First Tube in Reflex, by C. K. Beebe (21), Questions and Answers (22), Radiophone Broadcasting Stations, Part II (23).

Looking Ahead

Operation of Multi-Tube Receivers will be discussed by Edward T. Jones in his next article, which is part of the Broadcast Listener's Library series. The complicity of such sets makes any suggestions on them of value.

WEEL, Edison Electric Illuminating company of Boston, and WTAT, the only "Seagoing Broadcast Station," together with the people behind the transmissions of both, will be described by word and photograph in the March 21 issue to appear next week. "Big Brother" Emery and "Whit," of course, will be there.

The Remarkable Selectivity of the Fournier Super is due, in part, to the oscillator coupler included. Its construction, and the layout drawings for filter cover and baseboard, are presented in next week's issue.

Another Inductance Article by David B. Arnold is now ready, this time on the use of double silk covered wire. Data is given for sizes 20 to 30 inclusive on three diameters of tubing, to be tuned by any one of three values of condensers.

Newsstands Don't Always Have One Left

WHEN YOU WANT

Radio Digest

YOU WANT IT!

BE SURE OF YOUR WEEKLY COPY BY SUBSCRIBING NOW

SEND IN THE BLANK TODAY

Form for subscription: Publisher Radio Digest, 510 N. Dearborn St., Chicago, Illinois. Please find enclosed check M. O. for Five Dollars (Six, Foreign) for One Year's Subscription to Radio Digest, Illustrated. Fields for Name, Address, City, State.

London, Madrid Newcastle, Aberdeen--

that's just a few of them

AGAIN Elgin Super-Reinartz leads all others! Every trans-Atlantic report investigated was found to be ABSOLUTELY authentic! Many happy owners of Elgin sets again tuned in the European stations.

ELGIN Super-Reinartz "The Ford of Radio"

will give you the selectivity and distance it has given others. And you can save \$50.00. Let us tell you how—

FREE

Mail the coupon TODAY for the complete working drawings of the famous Elgin Super-Reinartz, the set that gets the distant stations. They are free—no obligations, just a stamp for postage, please!

tear out this coupon—

Coupon form: ELGIN RADIO SUPPLY CO., Dept. A, 207 E. Chicago St., Elgin, Illinois. Send the FREE drawings of the Elgin Super-Reinartz at once. Also tell me how I save \$50.00 on this set. I enclose a stamp for postage. Fields for Name, Address (Please PRINT in pencil).

The "Goode" Two-o-One

A

Le Ton d'argent

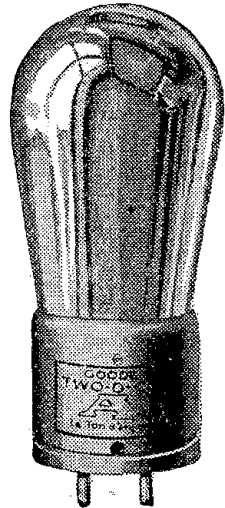

Guaranteed

BY MAIL ONLY

\$2.00

Postpaid

QUARTER AMPERE AMPLIFIER-DETECTOR RADIO TUBE

GUARANTEED SATISFACTORY

All "GOODE" Tubes Sold Direct to the Consumer—No Dealer Profits

ONE—"Goode" Detector-Amplifier..... \$2.00

THREE—"Goode" Detector-Amplifiers..... 5.50 (All postage prepaid)

The "Goode" Two-o-One A Tube amplifies or detects. It is a quarter ampere, 475 volts, standard base silvered tube. Send express or postal money order—New York draft—or personal check to—

The Goode Tube Corporation

Owensboro (Dept. A) Kentucky

NEWS OF STATIONS AND THEIR ARTISTS

A. T. & T. LINK FURNISHES WONDERFUL CONCERTS

KYW Now Forms "Insomnia Club" to Replace "Midnight Sons"—Bi-Weekly Dance at Denver

Broadcasting simultaneously from ten stations, namely, WEA, New York; WEEI, Boston; WGR, Buffalo; WFI, Philadelphia; WCAE, Pittsburgh; WJAR, Providence; WEAR, Cleveland; WWJ, Detroit; WOC, Davenport, and WCCO, St. Paul-Minneapolis, the Silvertown Cord orchestra is on the air each Tuesday and alternate Thursday evenings. This aggregation of artist musicians, under the direction of Joseph Knecht, brings to the Radio audience one of the highest forms of program presentations.

WOR, Newark, N. J., has inaugurated a novel series of programs called the "Radio Congress of States." Every week a different state will have its sons and daughters broadcast.

Station KSD, St. Louis, Mo., recently paid the St. Louis symphony society \$5,000 for the privilege of broadcasting the season's concerts.

Two new orchestras have been added to the list of WOR's entertainers. They are the Commander's orchestra and a Meyer Davis orchestra.

An intimate picture of Pope Pius XI was broadcast recently from WJY, New York, when William H. Crawford, journalist and author, told of a meeting when the Pope was known as Father Achille Ratti.

Bi-weekly dance music is now being broadcast every Wednesday evening at 10 o'clock from KOA, Denver, Colo., by Joe Mann and his Rainbow-Lane orchestra from the Shirley-Savoy hotel.

"Conversations with a Philosopher" is the subject of the new series of Wednesday night educational talks being broadcast from the University of Pittsburgh studio of Station KDKA.

In keeping with its plan of education promotion, Station WBZ, Springfield, Mass., will begin a new series of university extension courses this month.

"Midnight Sons" are a thing of the past. This was the name of the KYW club which kept fans sitting 'till the wee sm' hours. Now the name has been changed and it is known as the "Insomnia Club." Between the dance numbers, Fred A. Hill acts as announcer. The orchestra is Coon Saunders famous "Nighthawks," and the leader will endeavor to entertain the fans with a little impromptu entertainment during the evening.

A most successful Radio contest has come to a close. Station WAHG recently received more than forty-eight thousand replies from the United States, Canada, Cuba and South America during their St. Valentine contest.

Radio lessons in golf will commence at KGO, Oakland, Calif., March 19, at 7:15 p. m., Pacific time. At eight o'clock, the KGO players will produce "Billy," a comedy in three acts.

Production of the Gilbert and Sullivan opera, "H. M. S. Pinafore" marked the first time that the Buffalo Players, Inc., ever appeared at WGR in a dramatic offering for the station's listeners.

Art Gillham, the "whispering pianist," while broadcasting from WMC, Memphis, Tenn., recently acquired a cat. Not the ordinary kind, he explained, but one derived from the popular pastime of "feeding the kitty."

The Marquette studio of Station WHAD, Milwaukee, Wis., is now open every Monday instead of Wednesday night.

Verdi's opera "Aida," was presented by the Philadelphia National Grand Opera company on March 3, from Station WIP, Philadelphia, Pa. The performance was given for the benefit of the Veterans of Foreign Wars.

A three-hour classical program is broadcast every Sunday afternoon by WGN, Chicago.

PENCIL THAT WRITES RADIO MUSIC



Of course it doesn't literally write Radio music, but the performance is figuratively carried out by this Radio pencil crystal receiver. Although but a novelty, the small set held by the charming young lady has been known to receive local stations quite efficiently. P. & A. Photo

Station WGY, Schenectady, N. Y., recently celebrated its third birthday. A system of remotely controlled stations can be cut in on the regular program on short notice.

The Boston studio of WBZ, celebrated its first birthday recently, and the features on the program were similar to those broadcast on the dedication program. The program began at 8 o'clock, and ran until midnight.

Billy Sunday, the rip-roaring, devil-defying evangelist, was broadcast by Station WMC during a recent visit to Memphis. During the closing week of his campaign, when the repentant sinners were hitting the sawdust trail to the Municipal auditorium, WMC broadcast his afternoon sermons.

Wisconsin Girl Winner of Crosley Radio Beauty Test

CINCINNATI.—Phyllis Sacia of Galesville, Wis., received the largest number of telegraphed votes in the recent second annual WLW Radio beauty contest, thus winning first prize of \$300 and title of "Radio Beauty of 1925." Those who listened to the contest will remember her as "number 4" when the entrants were described by Judge J. H. Woeste. Rhoda Bogardus, Warsaw, Ky., won second; Melba Hardert, Cincinnati, third; Mrs. Vera Fisher Webber, Cincinnati, fourth, and Lavera M. Bourgeois, Cincinnati, fifth prize.

Baking an apple pie for a prize was the latest stunt broadcast from WJZ, New York, N. Y.

MILLIONS LISTEN TO CEREMONY MARCH 4

INAUGURAL MARKS A NEW RADIO ACHIEVEMENT

Great Audience Pauses at Work While Chief Executive Is Given the Oath of Office

WASHINGTON.—"Good morning, ladies and gentlemen of the Radio audience," came the familiar voice of Graham McNamee on the eventful morning of March 4, at 11:15 a. m. Eastern Standard time. His voice came through strong and clear, for it was being broadcast simultaneously by over a score of stations scattered from coast to coast, from the Canadian boundary to Texas.

It was the beginning of the first Radio broadcast presidential inauguration ceremony.

It has been estimated that 25,000,000 citizens turned to the loud speaker and listened to this unprecedented achievement. Stores, offices and factories stopped their work for the moment. The employees were numbered in the great invisible audience that was to hear President Coolidge take the oath of president for the next four years.

Ceremony Simple but Sufficient

The ceremony was simple but sufficient. Following a brief description of the scene before him, Graham McNamee introduced the United States Marine band, which was heard until three minutes to twelve o'clock. At that time a fanfare of trumpets called the assemblage to order and the justices of the Supreme court approached the platform followed by the chief justice, cabinet members and President Coolidge.

At high noon the oath of office was administered. Then followed a short prayer, after which the visible and invisible audiences heard President Coolidge make his inaugural address.

Playing of the "Star Spangled Banner" by the Marine band concluded the ceremony. Mr. McNamee was heard again, this time announcing the calls of the many stations which had participated. All was over.

A new Radio achievement had gone down in history.

KPO Sees Audience Two Millions of Fans

Receives 70,000 Communications on Birthday Party Program

SAN FRANCISCO.—That KPO, Hale brothers here, broadcasts to a daily audience of well over 2,000,000, and that this vast audience is located throughout the length and breadth of the land, was the startling disclosure of a novel experiment conducted by the station.

On January 16 KPO celebrated its second birthday with a special program. The staff received the surprise of their lives when on that night 1,551 prepaid telegrams poured into KPO's headquarters. Following these, 68,937 letters and postcards were received.

It has been estimated by broadcasting station directors that only one-half of 1 per cent of their total audience responds to a request for a written communication. Just about one person in fifty that tuned in on KPO took the trouble to respond with birthday greetings. Multiplying 70,000 by fifty gives 3,500,000. Thus the audience of KPO is estimated at well over 2,000,000 people.

In a group of semi-classical selections, the Collegian string trio, of Station WEMC, Berrien Springs, Mich., gave Radiophans a real treat on March 9.

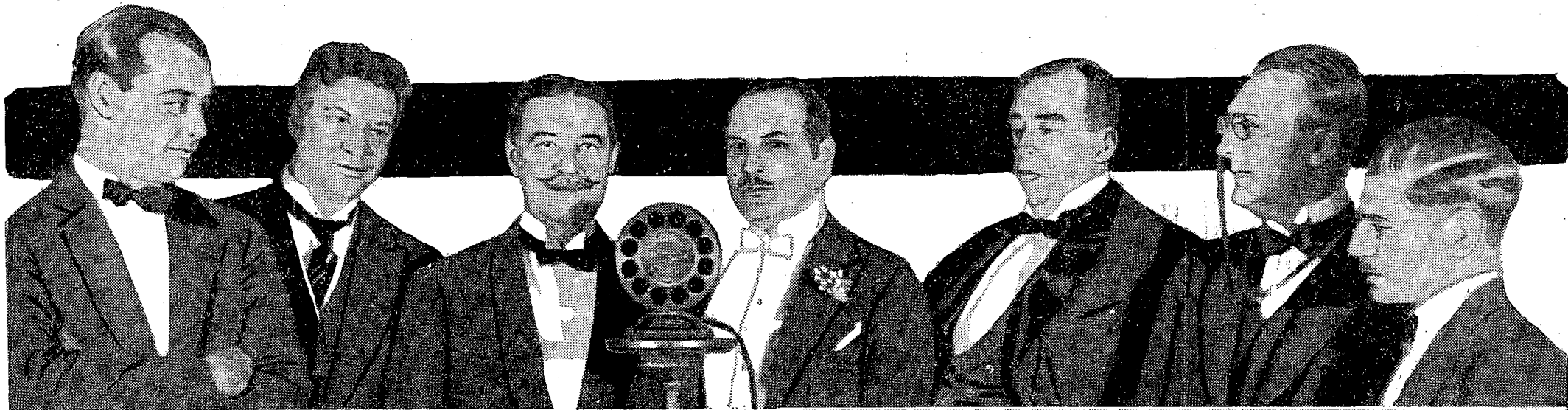

Stage, screen and bookdom shook hands with Radio at the recent opening of New York's latest, WMCA, atop the Hotel McAlpin. Among the notables present were the above. Left to right, Johnny Hines, motion picture star; Arthur Lee, director of WMCA; Col. B. B. McAlpin, proprietor of the hotel; Holbrook Blinn, actor; Irvin S. Cobb, humorist and writer; Major Andrew White, famous sport announcer, and Paul Dumont of WMCA staff. "Eddie" Squires is announcer for WMCA.

UNIFIED PROGRAM IS E. S. NESBITT'S IDEA

PLAN TO HOLD ATTENTION OF LISTENERS

WHB Man Puts "Piggly Wiggly Girls" on with Special Radio Libretto

KANSAS CITY, Mo.—Radio is entering the program development period. Only incidentally is it catering to the distance seeker or the Radiophan of mechanical mind. The people who have been purchasing recently three to five hundred dollar receiving sets are naturally a more critical audience than those with crystal sets. They have spent money freely. Now comes their demand for 100 per cent entertainment in Radio-casts.

Ideas will play a large part in program development. One voice can create as much volume over Radio as a hundred piece orchestra. If the speaker be possessed of sufficiently brilliant ideas, he may furnish better entertainment than his hundred-voiced competitor.

Such is the reasoning of Earle S. Nesbitt, Kansas City, Mo., a newcomer in Radio circles from out the realm of motion pictures and vaudeville. In other



Earle S. Nesbitt

words, Mr. Nesbitt is a showman proceeding to demonstrate that fact over Radio. He is working at present with WHB. And from that station he has proven his point in the presentations prepared for the "Piggly Wiggly Girls."

Girls Unified in Program

On each Friday afternoon, this trio has been giving programs enhanced in their appeal by ideas. Their first offering was entitled "Versatility," and served as an introduction of the girls under the assumed names of Sue, Prue and May. On that first program, in rhyme and melody, they quarreled for honors before the microphone and incidentally established in the minds of their listeners their names, personalities and ability. Each strove to outdo the other in demonstrating their own talent. The second program was linked to the first by the continued quarreling of the three girls during the intervening week.

Since then many programs have been given and others are to follow, each one with a distinctive idea. "Songs of Yesterdays and Today" will be a diminutive musical history of the various epochs in our country's life.

The programs are illustrative of the point that Mr. Nesbitt is emphasizing; programs with an idea. He points out that once a listener tunes in on such a program, they will stay with it until its close because there is unification of the entire program, a protracted interest; and as well, such listeners will look forward to and pick up promptly the next week's offering.

Announcers at Kansas City Show to Form Special Club

CHICAGO, Ill.—An attempt was made to form an announcers club by officials of Station WDFW, at Providence, R. I., at the Biltmore hotel on March 2. Owing to the absence of several of the more popular announcers at the Kansas City show, the plan fell through.

It is rumored that the announcers at the Kansas City show will form the nucleus of a similar organization. The decision will be published in a later issue.

Eight marine hospitals located in various parts of the country are now engaged in furnishing medical advice by Radio.

BROADCAST ANIMAL CALLS; CATS DEPART

DENVER, Colo.—When Chiefs Evergreen Tree and Riding Sun of the Pueblo Indian tribe broadcast their interpretation of wild birds and animals, they caused quite a furore among Radiophans. Cats of every known variety, ranging from the well known great American alley cat to the pedigreed blue bloods, jumped "high and wide," when the program started. Fans complained that during the mimicking of a coyote call, the cats left the house and haven't been seen since. Station officials at KOA are still trying to explain.

Medford, Ore., Has Club

MEDFORD, Ore.—The Rogue River Radio club has been formed here to cooperate with telephone, telegraph and power companies to remove sources of interference.

The Panels That Produce Results

A superior panel will increase the efficiency of your reception through reducing surface leakage. You can be certain of this if your set is built with—

ELECTRASOTE PANELS

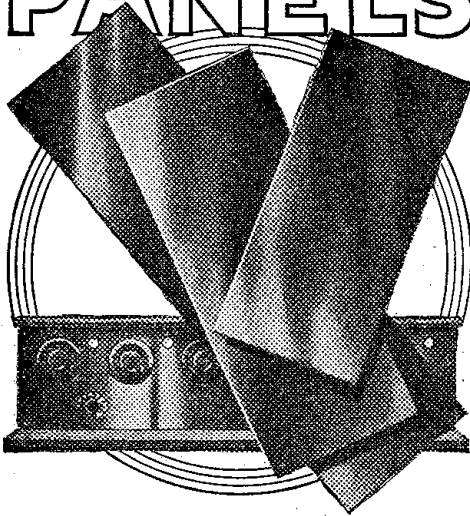

These beautifully finished panels will neither warp nor change color. They are scientifically constructed to reduce surface leakage to a minimum, hence assure increased efficiency of the set.

One of the famous "sote" products introduced by The Pantasote Company, Inc., Electrasote Radio Panels are sold strictly on their merits—yet are

Lower Priced than other standard panels

Make your Set an "Electrasote Panel Set"—and get results!

On Sale at good Radio Dealers

M. M. FLERON & SON, Inc.

Sole Sales Agents

Trenton - New Jersey

STATOR **ROTOR**

A Full-Floating Automobile Axle

Notice the two bearings for the wheel. The axle shaft only turns the wheel and carries no load.

Allen-Bradley Co.
Electric Controlling Apparatus

General Office and Factory: 290 Greenfield Ave., Milwaukee, Wisconsin

Bradleydenser

PERFECT VARIABLE CONDENSER

The Condenser with the "full floating axle"

The striking feature of the Bradleydenser is the rigid double bearing, based on the principle of the "full-floating" automobile axle, that eliminates the usual outer pivot-bearing for the rotor shaft, and still provides a non-sagging support that insures perfect alignment of the rotor plates.

The rotor plates, soldered on a long, hollow tube extending from [7] to [8], revolve on a hollow steel stem provided with two bearings [4] and [5]. The alignment and support of the rotor is independent of the condenser shaft [1], as shown by the first photograph at the left. The shaft [1] merely turns the rotor. It slips through the hollow steel stem and its threaded end [3] is secured to the rotor at [8] with the nut [9] as shown in the second photograph. The spring [6] prevents end-play.

This design, combined with the use of soldered brass plates, results in a rugged, long-life condenser of extremely high efficiency. For superior service use the Bradleydenser.

KFKX—Hastings, Nebraska—Old Bill's Own

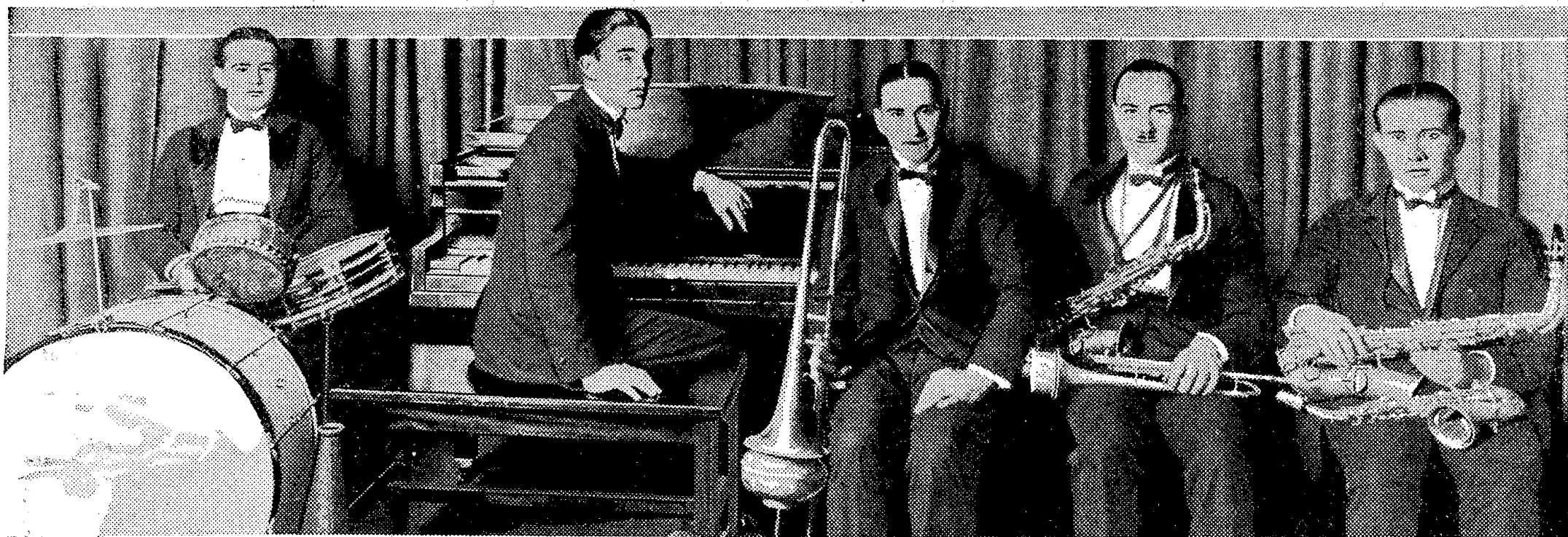

Above, the Hastonians dance orchestra in the studio at Hastings. This orchestra is well known to thousands of fans throughout the country. Left, Miss Clarice Saunders, contralto, and one of Mr. Hay's voice pupils, a favorite at KFKX.



William G. (Bill) Hay, director and announcer at Station KFKX, well known to thousands.



FOUR years ago, William G. Hay (otherwise Bill) and Mrs. Bill arrived in Hastings. Today he is director of the First Methodist church choir, Hastings lyric glee club of twenty men's voices, a chorus of business and professional men and a bulging-hour vocal class. Occasionally Bill sings on the Radio by special request and then always Mrs. Bill is at the piano.

Now Mrs. Bill has an identity all her own as well as being Bill's life partner. Besides being an accomplished musician and accompanist in particular, she handles Bill's personal mail and details of his busy teaching and business career.

KFKX opened on November 15, 1923, primarily as a short-wave rebroadcast from Station KDKA at East Pittsburgh. KFKX belongs to the Westinghouse company and is its "half-way house" to the Pacific coast.

The short-wave signals from KDKA are picked up in a farmhouse about a mile from the main transmitter of KFKX and then sent through telephone wires to the station in the same manner that the program at the studio is sent to the station. A special receiving set is located at this farmhouse together with a special receiving antenna designed to pick up these short waves from the East without any interference from the transmitter of KFKX.

There is no studio at the Hastings station, but the broadcasting studio is located on the second floor of the Gaston Music and Furniture company on Hastings'

main street. KFKX talent is gleaned from local organizations, artist pupils of Bill Hay, colleges and clubs from nearby towns. Many small colleges in eastern Nebraska assist materially in sending frequent evening programs of college timbre to the Hastings studio from their home towns. A weekly farm letter is furnished and read by a Nebraska farm journal.

KFKX has been heard in France; in Hong Kong little Chinese beauties have swayed to the Hastonians dance orchestra and in Uruguay, South America, they report KFKX, sopranos coming in fine.

On November 15, 1924, their first anniversary program was given on the air with the same artists appearing who had opened the station. Several hundred telegrams were received and letters from everywhere came for the following two weeks.

Two characteristics are outstanding at KFKX—one is its exceptional clarity in rebroadcast operated by Harold Roess—the other is the voice of its local announcer. Beloved by his listeners, Bill Hay's bi-weekly announcing is within the schedule of the farmer, city man, home fireside, college student and the man about town. Each is a member of his admiring group. This God-fearing Scot whose burr is only noticeable when he gets angry or excited, is a big man with a voice of fine quality and without exception, the best diction on the air today.

Bill Hay was asked what he considered the first essential of a Radio voice. His answer came as deliberate as he moves: "Be yourself," and then paused to light his pipe. The interviewer felt startled as though he were ac-

(Continued on page 6)

Right, Mrs. "Bill" Hay, whose accompaniments for KFKX artists have won so much favorable comment. Below, interior of KFKX. Kneeling in the corner is Harold Roess, chief engineer.

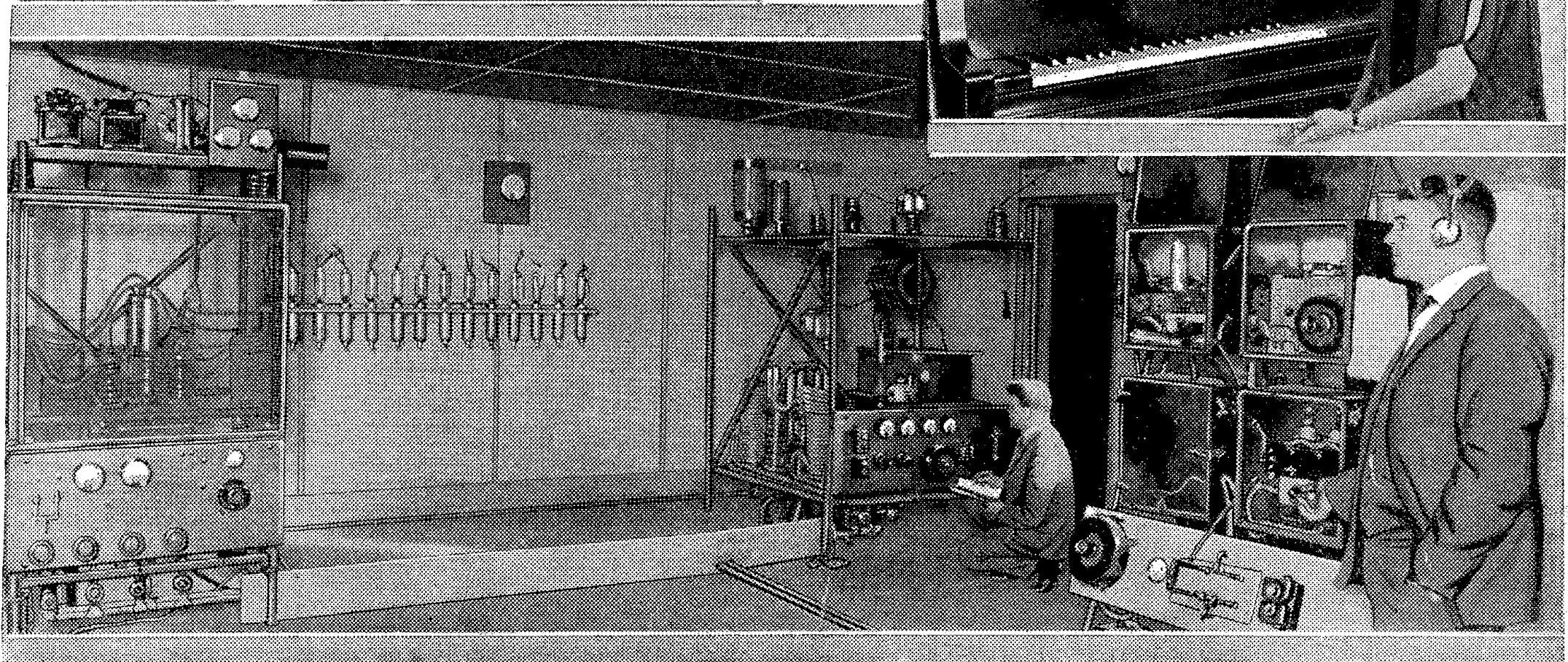
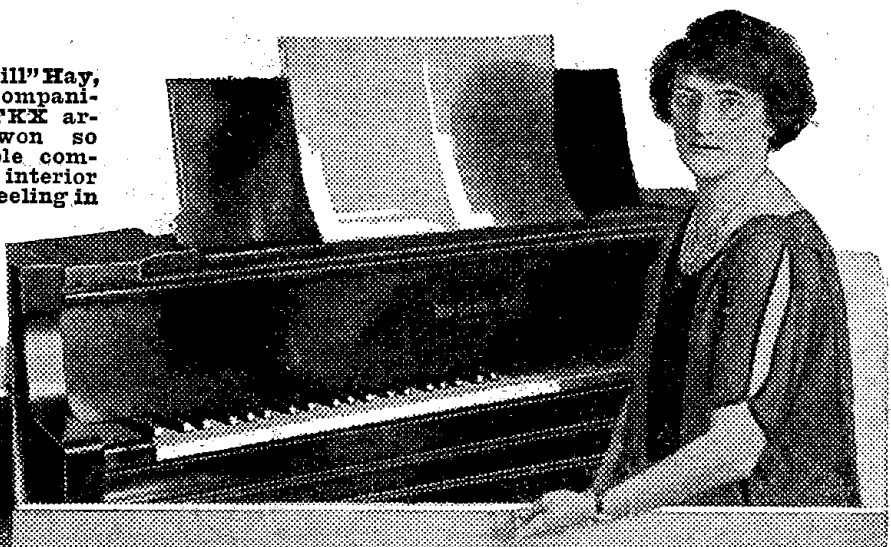

VACUUM TUBES OF PAST AND PRESENT

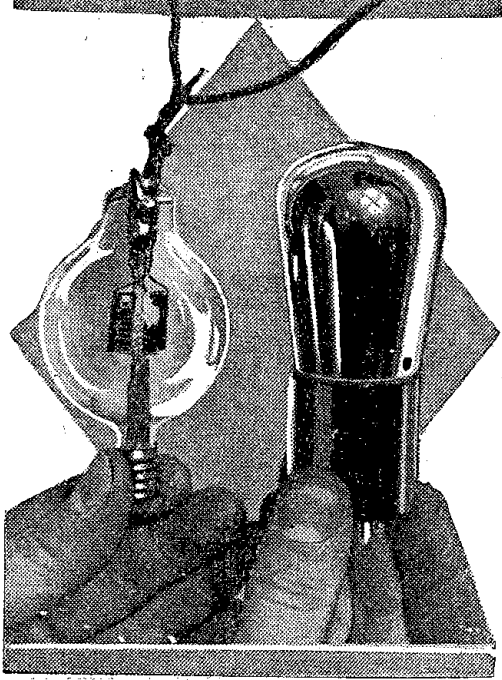

Here are shown the latest type of vacuum tube and the one used ten years ago. Two filaments were provided in the old tube, a thing unheard of now.

KFKX — OLD BILL'S OWN
(Continued from page 5)

cusing him in street parlance of trying to be funny—but his continued remark was reassuring.

"Not more than one voice in a hundred is a real Radio voice," he went on, "and that one sometimes doesn't know how to use it."

"The Radio voice is the properly placed singing or speaking voice, using the same correct tone placement at the microphone as on the platform or stage. And that's why I say to be yourself, for if you are natural and talk naturally your voice will come over the microphone naturally, too."

That's why they ask Bill Hay from way out in California if they may call him Uncle Bill as familiarly as they do their own beloved Uncle John of KHJ.

That's why the shut-in, who is bed-

ridden in a Colorado mining shack and can scarcely write from rheumatic cramp, scrawls a page of appreciation to his Radio friend—Bill Hay.

That's why the man in Missouri wrote "There are three things which put KFKX above every other station—clarity of transmission, unusually high class programs and the best announcer in the world."

They write to Bill Hay in French, Spanish, German and Mexican and a wee note in Scotch as well, as frequently they "murder the king's English!"

Perhaps some college will confer a degree of Doctor of Satisfaction on a Radio announcer. If so, we nominate Bill Hay for an early candidate!

R. H. L. to Broadcast from WOC with His Contributors

DAVENPORT, Iowa.—Have you ever read the "Line O' Type" column in the Chicago Tribune? If so, here's your chance to hear the conductor and some of his "contribs" perform in person. Tune in to Station WOC, located in this city, on March 14 and hear them.

Richard Henry Little, better known to the readers of the paper as "R. H. L.," will journey down to Davenport for the occasion and bring his troupe with him. During his appearance at WGN, the station is flooded with telegrams until the end of the program, showing how popular he and his "colyum" really are.

Will Hold Radio Monopoly Hearings in But Two Cities

WASHINGTON, D. C.—It is probable that hearings in the Federal trade commission's case against the Radio Corporation of America and others in an alleged monopoly will be held only in New York and Washington, although a final decision on this point has not yet been reached. Edward L. Smith, attorney for the commission in this case, and James A. Horton, his assistant, have left for New York to interview witnesses and gather data in connection with the taking of oral testimony. This is to begin in New York on March 13.

Radio Recovers Automobile

SALT LAKE CITY.—Radio assisted the local police here recently when the automobile of Dr. C. F. Pinkerton was stolen. Less than one hour after broadcasting news of the theft the car was recovered.

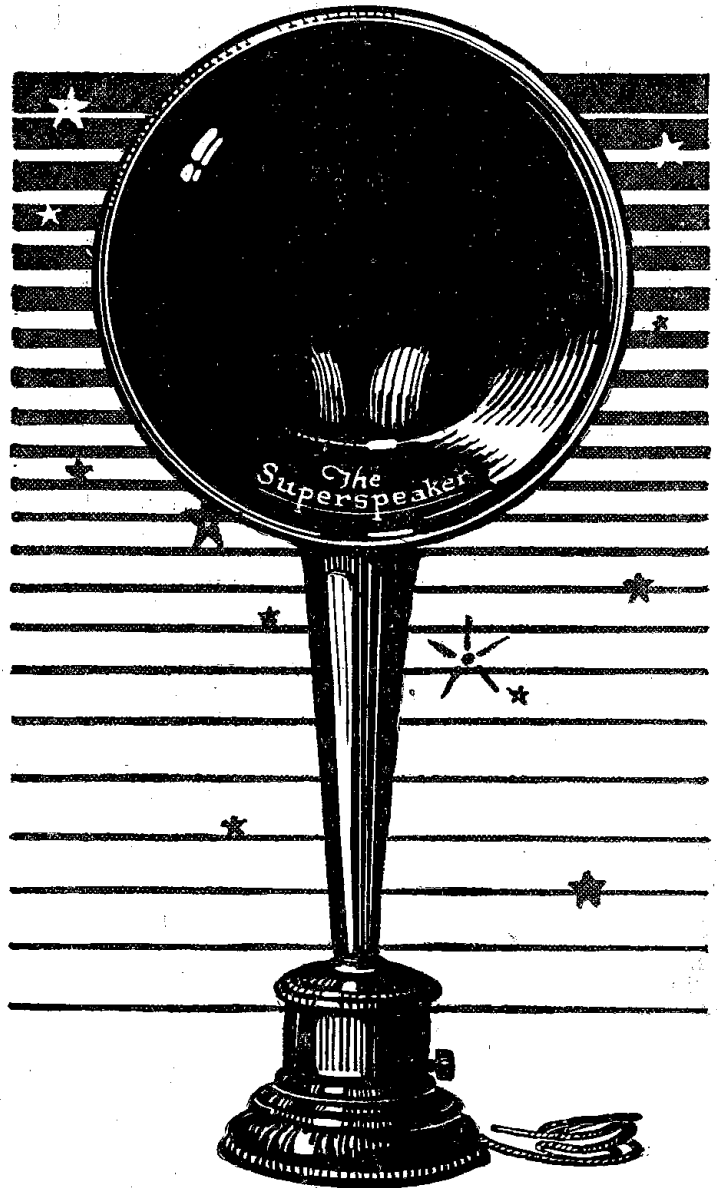

Sweep the Ether

with a Jewett Superspeaker and learn the amazing difference that has led Radio laboratories, the world over, to install this instrument as their standard for measuring all others. Stow away your headphones!

A big, beautiful musical instrument, built by musical instrument makers, of experience and reputation—No extra batteries—Straight throat eliminates bugling—Exclusive adjustment gives you absolute control of volume without detuning. Just try it!

"THERE IS NO SUBSTITUTE FOR THE BEST"

The
Superspeaker,
Trademark Registered

Jewett Radio & Phonograph Co.
DETROIT 5680 Twelfth Street MICHIGAN

You'll be neighbor to Havana



Licensed under U. S. Patent Office Serial No. 719,264 for Radio Receiver Systems.

This signature—*Smith Harkness* makes it genuine.

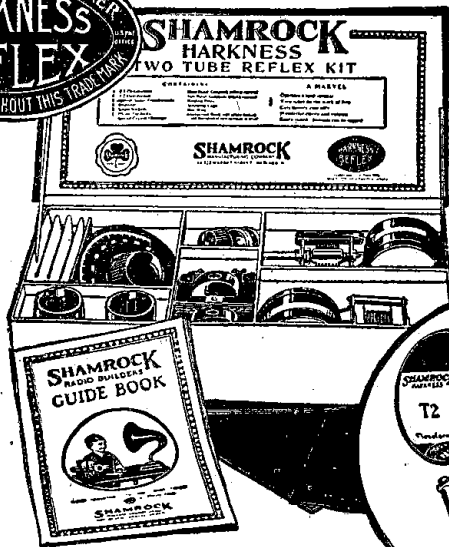

Kit Complete
PRICE
\$35

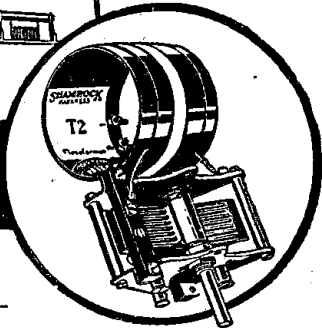

Also Ask to See
THE IMPROVED Shamrock-Harkness Three-Tube Counterflex
The Wonder Set
\$39.50

LISTEN to it! Hear the Shamrock-Harkness Two-Tube Reflex for five minutes—notice how distant stations come in as though they were near at hand.

Radio frequency, controlled by variable condensers mounted on air core transformers, gives the Neutrodyne its remarkable distance. The Shamrock-Harkness Two-Tube Reflex uses these transformers (flexo-formers).

Build your own set at half the cost. All parts necessary to make this marvelous set, including full directions, simply told, furnished in Shamrock Kit.

SHAMROCK MANUFACTURING CO.
Dept. 26-C, Market St., Newark, N. J.

SHAMROCK
FOR SELECTIVE TUNING

Theset for the masses as well as the classes

SHAMROCK MFG. CO., Dept. 26-C, Market St., Newark, N. J.
Please send me a copy of "Shamrock Radio Builder's Guide Book" containing diagrams and complete instructions for building 10 sets at prices ranging from \$15 to \$50. I enclose 10 cents (U. S. stamps or coin.)

Name.....
Address.....

WLS DRAMAS HAVE MUSIC BACKGROUND

RALPH EMERSON ACCOMPANIES PLAYERS

WOC Drama Leader Says Broadcast Plays Not Easy to Do as the Legitimate Variety

CHICAGO.—Broadcasting Radio plays with musical accompaniment has proven a success over WLS, the Sears-Roebuck station, according to Harry Saddler, who has charge of the productions of the WLS theatrical company. Several tests have been made and several plays produced. The last big production two weeks ago was "In Old Kentucky," the famous race play.

The broadcasting was done from the Barton studio in the Mallers building, with special musical accompaniment by Ralph Emerson at the organ.

Mr. Emerson when at the organ always has a Radio headset on so he can hear his own playing on the air, as well as the lines read by the actors and actresses.

Broadcast Drama Not So Easy

DAVENPORT, Iowa.—Roy Van Allen, director of the Palmer School (WOC) Dramatic club, rises to say that broadcast plays are not as easy to produce as they might seem. The man on the street thinks it is much easier to act before the microphone than before a crowded house of a theater. But such is not the case.

Mr. Allen stresses the point that the feelings of the audience behind the footlights, which are practically lost to the Radio studio, act as a guide and inspiration to the actor of the legitimate stage. Then, too, the characters in the cast of a legitimate production are always in the costume of the part they are portraying, another aid which Radio drama does not always have. A further hindrance to the histrionic expression of the Radio actor is that he must keep close to and not wander away from the microphone.

So broadcast drama isn't as easy as it looks.

UNIFORMITY VITAL IN TRANSFORMERS

Experienced set-builders agree that the trouble with most makes of transformers is lack of uniformity. Thordarsons are the exception—they run absolutely alike, absolutely uniform; always "match up" perfectly; always amplify evenly over the entire musical scale. That is one of the big reasons why leading makers use more Thordarsons than all competitive transformers combined. Partial list below:

- ZENITH
- KENNEDY
- RADIODYNE
- THERMIODYNE
- ULTRADYNE
- MURDOCK
- QZARKA
- Pfanstiehl
- MICHIGAN
- Deresnadyne
- MALONE LEMON
- MASTER RADIO
- ROYAL
- Super-Het Builders!
- For the "Best" 45,000 Cycle Super-Heterodyne "RADIO" and other leading publications recommend in highest terms the Thordarson 2:1 ratio transformers. Take no others!
- Howard
- Pathe
- HARTMAN
- AUDIOLA
- EAGLE
- GLOBE AND MANY OTHERS

The finest sets have THORDARSON Super TRANSFORMERS

Follow the lead of the leaders—build or replace with Thordarsons. Unconditionally guaranteed. Recommended by best dealers. Audio frequency 2-1, \$5; 3½-1, \$4; 6-1, \$4.50. Power Amplifying, pair, \$13. Interstate Power Amplifying Transformer, \$8. Write for latest bulletins. THORDARSON ELECTRIC MFG. CO. CHICAGO.

FAN RECEIVES TRIP FROM STATION KTHS



Lloyd H. Jordan

HOT SPRINGS, Ark.—The days of fairy dreams and fairy godmothers are not over, at least that's the way Lloyd H. Jordan of Gordon, Neb., who is the first Radiophan in America to be given a de luxe free trip together with entertainment, feels.

When Station KTHS, the New Arlington broadcaster, took the air in December, the Junior Chamber of Commerce decided in order to make the station's slogan, "Kum to Hot Springs," a reality, to bring one Radiophan a month to Hot Springs, with all expenses paid.

The New Arlington hotel agreed to entertain the fan and the citizens generally to enter into the plan by providing an elaborate program of entertainment.

He was accompanied on the trip by his father, John Jordan. During his stay here, he talked to Radioland nightly, telling of his impressions of the resort.

Telephone Subscribers Get Broadcast Service Gratis

PITTSBURGH, Pa.—Engineers of the telephone company are busily engaged combing over the Forest Hills district near this city to ascertain what is causing the trouble with the telephones in the neighborhood.

A short time ago, one of the subscribers picked up a phone to give a number when he was astonished to hear the strains of "It Ain't Gonna Rain No Mo'" played by an orchestra. The theory is that a powerful short wave station in the vicinity is responsible for the trouble.

Low Loss Equipment Stands Out at Amateur Convention

NEW YORK.—Low loss designs of Radio equipment stood out paramount as the latest development in apparatus at the fifth annual Radio show and convention of the A. R. R. L. executive Radio council held last week at the Hotel Pennsylvania here. Broadcasts from the convention hall were made through Station WJZ Tuesday and Thursday nights.

Radio at Open House

NORMAN, Okla.—At the University of Oklahoma engineering open house, now on here, and continuing to March 17, a number of Radio tricks and unusual Radio control apparatus are on exhibit. The open house celebrates the opening of the university's new engineering building. All interested are invited to attend.

WJJD OPENS GAROD STUDIO AT CHICAGO

ON AIR EVERY NIGHT FROM NEW PALMER HOUSE

Thirty-seven Miles of Wires in Link to Station of Loyal Order of Moose

CHICAGO.—Heralded by a program par excellence, the Garod studio at the Palmer house here of the Loyal Order of Moose station, WJJD, Mooseheart, Ill., was officially opened on Monday night, March 9. Listeners in tuned to 302.8 meters had a treat not often found on the air.

Notables from every Chicago station, Potter Palmer, proprietor of the Palmer house; Mayor William E. Dever and his official family, Secretary of Labor James J. Davis, opera singers, theatrical lights and representatives of the Radio press were in attendance. News reel motion pictures were taken of the opening ceremonies.

The new studio of WJJD will be heard nightly, beginning at 10:30 p. m. Central time. It is provided by the Garod Radio corporation and the Palmer house in co-operation with the Loyal Order of Moose. Thirty-seven miles of wires connect the studio to the station at Mooseheart, where the equipment is located.

Earn \$50 to \$200 a Week in RADIO

You can! Hundreds of ambitious men are already earning thousands of dollars in this wonderful new industry—you, too, can get your share. Mail coupon below for Free Book which describes fully the amazing money-making opportunities in Radio and tells you how YOU can earn from \$5,000 to over \$10,000 a year.

THE astounding growth of Radio has created thousands of big money opportunities. Millions of dollars were spent during the past year on Radio, and thousands of young men are needed right now to meet the ever-increasing demand of work.

Men are needed to build, sell and install Radio sets—to design, test, repair—as radio engineers and executives—as operators at land stations and on ships traveling the world over—as operators at the hundreds of broadcasting stations. And these are just a few of the wonderful opportunities.

Easy to Learn Radio at Home in Spare Time

No matter if you know nothing about Radio now, you can quickly become a

Radio expert, by our marvelous new method of practical instruction—instruction which includes all the material for building the latest up-to-date Radio apparatus.

Scores of young men who have taken our course are already earning from \$75 to \$200 a week. Merle Wetzel of Chicago Heights, Ill., advanced from lineman to Radio Engineer, increasing his salary 100%, even while taking our course! Emmett Welch, right after finishing his training, started earning \$300 a month and expenses. Another graduate is now an operator of a broadcasting station—PWX of Havana, Cuba—and earns \$250 a month. Still another graduate, only 16 years old, is averaging \$70 a week in a Radio store.

Wonderful Opportunities

Hardly a week goes by without our receiving urgent calls for our graduates. "We need the services of a competent Radio Engineer." "We want men with executive ability in addition to Radio knowledge to become our local managers." "We require the services of several resident demonstrators"—these are just a few small indications of the great variety of opportunities open to our graduates.

Take advantage of our practical training and the unusual conditions in Radio to step into a big paying position in this wonderful new field. Radio offers you more money than you probably ever dreamed possible—fascinating, easy work—a chance to travel and see the world if you care to, or to take any one of the many Radio positions all around you at home. And Radio offers you a glorious future!

The National Radio Institute is one of America's Pioneer Radio Schools—established in 1914. Our course is an absolutely complete one which qualifies for a government first-class commercial license. It gets you bigger paying jobs in Radio.

Send for FREE RADIO BOOK

Learn more about this tremendous new field and its remarkable opportuni-

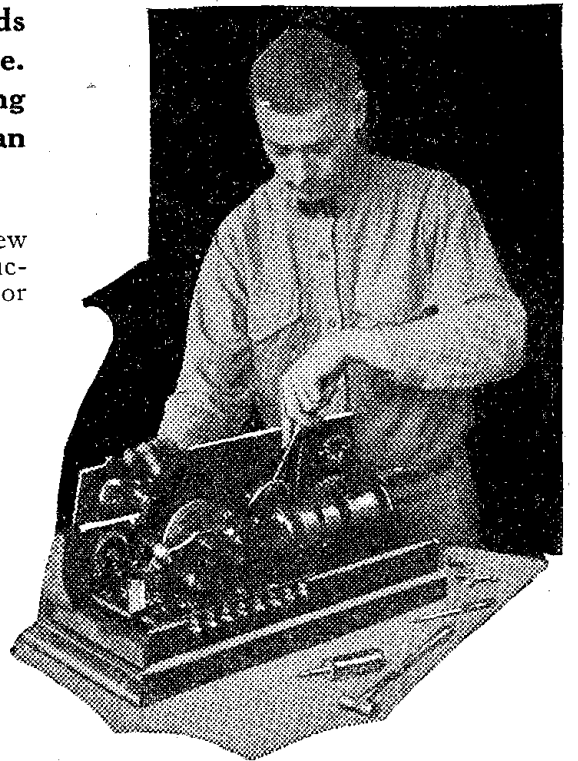

ties. Learn how you can quickly become a Radio expert and make big money in Radio.

We have just prepared a new 32-page booklet which gives a thorough outline of the field of Radio—and describes our amazing practical training in detail. This Free Book, "Rich Rewards in Radio," will be sent to you without the slightest obligation. Mail coupon for it now!

For a short time we are offering a reduced rate to those who enroll at once. Act promptly and save money.

National Radio Institute
Dept. 55-EB.
Washington, D. C.

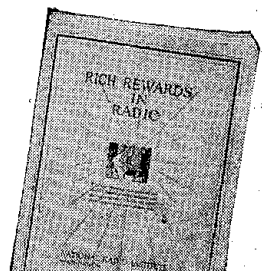

NATIONAL RADIO INSTITUTE,
Dept. 55-EB, Washington, D. C.

Please send me without the slightest obligation your Free Book, "Rich Rewards in Radio," and full details of your special Free Employment Service. Please write plainly.

Name..... Age.....
Address.....
City..... State.....

Pay Increases Over \$100 a Month

I am averaging anywhere from \$75 to \$150 a month more than I was making before enrolling with you. I would not consider \$10,000 too much for the course.
(Signed) A. N. Long, Greensburg, Pa.

Doubles Salary

I can very easily make double the amount of money now than before I enrolled with you. Your course has benefited me approximately \$3,000 over and above what I would have earned had I not taken it.
T. Winder, Grand Junction, Colo.

From \$15.00 to \$80.00 a Week

Before I enrolled with you I was making \$15 a week on a farm. Now I earn from \$2,080 to \$4,420 a year, and the work is a hundred times easier than before. Since graduating a little over a year ago, I have earned almost \$4,000 and I believe the course will be worth at least \$100,000 to me.
(Signed) Geo. A. Adams, Tamaqua, Pa.

AN EVENING AT HOME WITH THE LISTENER IN IN EASTERN TIME (SEE INSTRUCTIONS FOR USE BELOW)

Table with columns for Station and City, Met., Saturday, Sunday, Monday, Tuesday, Wednesday, Thursday, Friday. Lists radio stations and their broadcast times.

Instructions for Use—All the hours above are given in Eastern Standard Time. If your city uses Central Time, subtract one hour from each of the periods stated; if your city uses Mountain Time, subtract two hours; if your city uses Pacific Time, subtract three hours. This table includes only the evening and, on Sunday, the late afternoon programs.

STATIONS IN ORDER OF WAVE LENGTHS USED

Table with columns for Meters Call, Meters Call, Meters Call, Meters Call, Meters Call, Meters Call. Lists stations in order of wave lengths.

There's more life in Eveready Batteries

EVEREADY HOUR EVERY TUESDAY AT 9 P. M., E. S. T. For real radio enjoyment, tune in the "Eveready Group." Broadcast through stations WEAF New York, WJAR Providence, WEEI Boston, WFI Philadelphia, WCAE Pittsburgh, WGR Buffalo.

Dry "B" Batteries are an economical, dependable and convenient source of plate current!

Buy Eveready "B" Batteries and you get electricity in its surest, safest and most compact form. They reduce your operating expense. New developments in the Union Carbide and Carbon Research Laboratories, Inc., have been converted into new manufacturing processes in the Eveready factories. Good as they always have been, Eveready "B" Batteries are much better today.

The Eveready achievement of giving you more hours of "B" Battery service for less money has cut the cost of running receivers in half, and in some cases the new Evereadys make "B" Battery expense only a third of what it used to be.

There is an Eveready Radio Battery for every radio use.

Manufactured and guaranteed by NATIONAL CARBON Co., Inc. Headquarters for Radio Battery Information New York San Francisco Canadian National Carbon Co., Limited Toronto, Ontario

EVEREADY Radio Batteries - they last longer

No. 7111 1 1/2-volt Dry Cell "A" Battery for all dry cell tubes

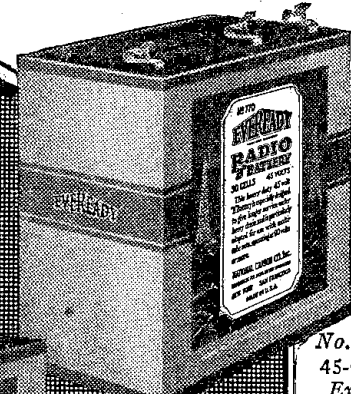

No. 772 45-volt Large Vertical Price \$3.75



No. 771 4 1/2-volt "C" Battery improves quality, saves "B" Batteries Price 60c



No. 771 4 1/2-volt "C" Battery improves quality, saves "B" Batteries Price 60c

CONSTANCE TALMADGE GUEST OF KNX

Saturday, March 14

Eastern Time Stations

The following schedules of programs are given in Eastern time. To change to Central time, subtract one hour; Mountain time, subtract two hours; Pacific time, subtract three hours.

Saturday, silent night for: AT9, CFCA, CKY, CNRO, CNRT, KFDM, KFAB, KFAE, KFKU, KFKX, KFMQ, KFMX, KFUO, KKLX, KOB, KSAC, WBAP, WCAU, WCBQ, WDFW, WEAD, WEAR, WEBJ, WEBW, WEEI, WGST, WHA, WHAD, WHAZ, WHB, WHO, WKAG, WQAI, WOI, WOO, WJY, WOS.

CHNC, Toronto, Can. (350), 9-11 p. m.; CHNC dance orchestra, Charles E. Bodley, director; Ernest Caldwell, baritone; L. Grace Nicholls, reader.

CKAC, Montreal, Can. (411), 7 p. m., kiddies' stories; 7:30, Windsor hotel dinner concert; 8:30, La Presse studio concert; 10:30, Windsor hotel grill dance orchestra.

CNRO, Ottawa, Can. (435), 7:30 p. m., bedtime story and lullaby, Aunt Agnes; 8, James McIntyre and his Chateau Laurier concert orchestra; 8:30, Irene Babin, soprano; A. Lewis, saxophonist; Gordon Rogers, reader; Frank A. Sim, tenor; C. G. Ballantyne Fuller, pianist; "Geology in the Development of Mineral Resources," E. D. Ingal; dance music.

KDKA, Pittsburgh, Pa. (309.1), 6 p. m., Westinghouse band; 7:30, Richard the Riddler; 7:45, last minute helps to Bible school teachers, Carman Cover Johnson; 8, Richard the Riddler, for the grownups; 8:30, Westinghouse band, E. J. Vastine, director; Mrs. Jessie Santmyer, soprano; Herbert Dugan, baritone.

PWX, Havana, Cuba (400), 8:30 p. m., studio concert, Cesar Simone, Augusto Caruncho, tenors; Emma Roldan, soprano; Prof. Julian de Campo.

WAHG, Richmond Hill, N. Y. (315.6), 12-2 a. m., special program, Glen C. Smith's Paramount orchestra.

WBBR, New York, N. Y. (272.6), 8 p. m., Syrian Oriental musicians, Toufic Moubaid, Elizabeth Awad; 8:15, Bible questions and answers, Judge Rutherford; 8:45, Syrian Oriental musicians.

WCAE, Pittsburgh, Pa. (461.3), 2:30 p. m., tea-dansant, Nixon restaurant; 4:30, orchestral program, Ed Lally's Rendezvous cabaret orchestra; 6:30, dinner concert, William Penn hotel; 7:30, Uncle Kaybee; 7:45, special feature; 8:30, artist-students, studios Charles le Sueur.

WCX, Detroit, Mich. (516), 6 p. m., dinner concert, Book-Cadillac hotel.

WEAF, New York, N. Y. (491.5), 4-4:10 p. m., Jack Holcombe, baritone; 4:10-5, Eugene Ingraham's orchestra; 6-7, dinner music from Waldorf-Astoria hotel; 7-7:15, David Williams, Welsh tenor; 7:15-8, Lincoln High school orchestra of Jersey City; 8-9, Delta Upsilon glee club; 9-9:45, Waldorf-Astoria concert orchestra; 9:45-10:20, Mabelanna Corby and others; 10:20-10:50, Francis Moore, pianist; 11-12, Vincent Lopez Hotel Pennsylvania orchestra.

WFI, Philadelphia, Pa. (394.5), 3:30 p. m., Ethel Powell Eckard, soprano; Edna Lerieux, contralto; Mary Houser, songs; duet, Mae Heart, Edith Prettyman; 4,



hotel orchestra; 8, Bible talk; 8:30, talk on psychology, Mabel Dill; 9, banquet, American society Naval Engineers; 10, dance music, Vincent Lopez and his Hotel Mayflower orchestra; 11, Crandall hour of music, Crandall's Metropolitan theater; 12, organ recital, Otto P. Beck.

WREO, Lansing, Mich. (285.5), 10-12 midnight, Frank Logan and his orchestra.

WTAM, Cleveland, Ohio (389.4), 6-7 p. m., dinner music, Hotel Statler studio; 9-12, Ev. Jones and his WTAM dance orchestra; Marian Stevens, blues singer; George Luntz, boy baritone; Empire Hawaiian quintet.

WWJ, Detroit, Mich. (352.7), 3 p. m., Detroit News orchestra.

Central Time Stations

The following schedules of programs are given in Central time. To change to Eastern time, add one hour; Mountain time, subtract one hour; Pacific time, subtract two hours.

KFNF, Shenandoah, Iowa (266), 6:30 p. m., orchestra from Morton Mills, Roy Rockwell, director.

KSD, St. Louis, Mo. (545.1), 8 p. m., St. Louis Symphony orchestra, Rudolph Ganz, director.

KTHS, Hot Springs National Park, Ark. (374.8), 8:30-10 p. m., singers, bird imitators, old time fiddlers, Mount Ida; 9:45-10:45, Meyer Davis New Arlington orchestra.

KYW, Chicago, Ill. (535.4), 6:35-7 p. m., children's bedtime story; 7-7:30, dinner concert, Congress hotel 8-8:58, Nina Heden, contralto; Evelyn Parker, reader; Kathleen Kearney, Capt. Thomas J. Caughlin in Irish songs; 9:05, "Income Tax," H. A. Harris; 9:35-11:30, Congress classic; 12-1, Congress carnival; 1-2, Ansonia club.

WBCN, Chicago, Ill. (266), 6-6:45 p. m., Blue Bird serenaders; 7-8, fireside hour, Lucas sisters; 8-1 a. m., Midway Gardens orchestra; George Cleveland, reader; Hazel O'Neil, soprano; Elizabeth Emmett, Malone, soprano; Arion glee club.

WCAL, Northfield, Minn. (336.9), 12 p. m., midnight musical.

WCCO, Minneapolis-St. Paul, Minn. (416.4), 2:30 p. m., Soo Line Brotherhood of Railway and Steamship Clerks; 8, fireside philosophies, Rev. Roy L. Smith; 8:30, concert; 10, Joe Peyer's St. Paul Athletic club orchestra; Gold Medal Radio quartet.



Teresa R. Nagel (left) interviews some person of importance afternoons at WGBS, New York, and also gives timely morning. Rev. James W. Fifield, a national preacher, lecturer, traveler and Radio speaker, is on the staff of WHE, Kansas City, and is heard every Tuesday.



Thyrsa Sloan Stein, soprano of WFI, also writes many of the talks on music given from this station. She has become well known in Philadelphia for her musical criticisms.

Headliners of the Week

CONSTANCE Talmadge, a favorite with the motion picture audiences, will soon become popular with Radiophans. She will be on the air Saturday at 11 p. m., Pacific time from KNX. R. H. L. and his Line O' Type artists are becoming wanderers of the air. They will spend Saturday at WOC, Davenport.

Sunday night the Theater Guild and Vaudeville Tapestry Ball and Buffet Supper will be broadcast by WGBS, New York. Among the merry guests and entertainers will be Jascha Heifetz, Laurette Taylor and the Duncan Sisters. KFI, Los Angeles, is featuring this same evening Estelle Heart Dreyfus in a Lenten hour. She will sing songs of faith.

The WTAM program scheduled for Monday night will commend itself to fans. The WTAM Symphonic ensemble, Edwin Arthur Kraft, organist, and Marie Simmelink, soprano, are well-known WTAM artists.

Songs, jiggs and reels of old Ireland will fill the ether Tuesday. KGO plans a special Irish program with

explanations on how St. Patrick's day began. Jay Bruce, a real lion hunter, who hunts for a living will also tell how one may become proficient in this occupation.

The Waterloo fiddle band, champions of Nevada County, Arkansas, will return to KTHS, Hot Springs National Park, Wednesday, and play all sorts of country quartets and specialties. Artists of campus fame will take the air this evening at KFMX, Carleton college.

The Euterpean club of Fort Worth and the Texas Christian university will divide the air Thursday at WBAP. These two organizations were well known throughout Texas and are now known nationally due to their good work on the air.

The WGY Opera company will sing the popular grand opera "Il Trovatore." The entire four acts will be given. James Crapp, Viola Hailes, Rose Mountain, Marion Brewer, A. O. Coggeshall and Joseph Kopczynski are taking the principal roles. The work of this opera company does not need any recommendation.

Ralph Walter's dance orchestra; 6, Rev. Elrae dance orchestra; 6:30, Meyer Davis Bellevue Stratford concert orchestra; 7, Sunny Jim, the kiddies' pal; 8, Indian program, Deskeska, chief of six nations.

WGBS, New York, N. Y. (315.6), 3:10-3:20 p. m., Nelson Van Horn, pianist; 6-6:30, Uncle Geebee; 6:30-7:30, Harwood's Musical Aces; 9:30-9:45, "Inside Movie Chats," Sam Conly; 9:45-10, San Souci ladies trio; 10-10:30, songs, Kenneth Burdick; 10:30-11, Newman Levy and Frank Sullivan, the world's best humorists; 11-12, music.

WGR, Buffalo, N. Y. (319), concert ensemble; 2:30-4:30 p. m., Radio dealers' musical program; 6:30-7:30, Hallpyrd string quartette.

WGY, Schenectady, N. Y. (379.5), 9:30 p. m., dance music, Phil Romano's orchestra.

WHN, New York, N. Y. (361.2), 6:30-7 p. m., violin solos, Olcott Vail; 7:30-7:55, health talk, Dr. Landis; 7:55-8, Hotel Carlton Terrace orchestra; 8:30-9, Strand Roof orchestra; 9-10, Northminster Interdenominational church service; 11:30-12:30 a. m., Roseland dance orchestra.

WIP, Philadelphia, Pa. (508.2), 4:15 p. m., mental hygiene talk; 6:05, Charles Masters dance orchestra; 7, Uncle Wip's bedtime stories; 8, Lenten talk; 8:15, concert, students Penn Charter school; 10:05, Howard Lanin's dance orchestra; 11:05, organ recital, Karl Bonawitz.

WJZ, New York, N. Y. (454.5), 7-8 p. m., Freddie Rich and Hotel Astor orchestra; 8-8:10, "Art for Laymen," Walter M. Grant; 8:15-8:30, popular songs, Sanchez and Milstead; 8:30-9:30, Liederkranz society concert.

WLIT, Philadelphia, Pa. (394.5), 7:30 p. m., Arcadia cafe concert orchestra.

WNYC, New York, N. Y. (526), 6:30-7:30 p. m., Club Alabama orchestra; 7:35-8, Chateau Four; 8:15-8:25, talk; 9:30-10, song and instrumental recitals; 10:10-10:30, travel talk.

WOO, Philadelphia, Pa. (508.2), Wanamaker crystal tea room orchestra, Robert E. Golden, director; 4:45, organ recital, Mary E. Vogt.

WPG, Atlantic City, N. J. (299.8), 9 p. m., concert, Hotel Traymore ensemble; 10:10, dance music, Chalfonte-Haddon hall orchestra.

WRC, Washington, D. C. (468.5), 6:45 p. m., children's hour, Madge Tucker; 7, Irving Boernstein's Washington

WCEE, Elgin, Ill. (275), 7 p. m., The Boss' Own orchestra, Fred Hamm, director; Eddie Loftus, WCEE Radio stars; 11, midnight dance program, "Boss' Own" orchestra, Fred Hamm, director; Eddie Loftus, Frank Morris and other features.

WDAF, Kansas City, Mo. (365.6), 3:30-4:30 p. m., Star's Radio orchestra; 6-7, piano tuning-in number on the Duo-Art; address, Roger W. Babson; Tell-Me-a-Story Lady; Trionon ensemble; 11:45-1, Merry Old Chief, Plantation players; Eddie Kuhn's Kansas City Athletic club orchestra.

WEBH, Chicago, Ill. (370.2), 7-8 p. m., Edgewater Beach Oriole orchestra; Radio Sunday School lesson; 8, musical bits from Balaban & Katz Riviera theater; 9-10, Edgewater Beach Oriole orchestra; Eleanor Gil-mour, soprano solos; 10, Pat Barnes, songs and stories; Langdon Brothers, Hawaiian guitars; Marie Kelly, readings; 11-12, Edgewater Beach Oriole orchestra; Banks Kennedy, songs; 12, Loos Brothers, songs; Langdon Brothers, Hawaiian guitarists; Ned and Ches, songs; Wayne Meyers, stories; Kay Ronayne, songs; Marie Kelly, readings.

WEAA, Dallas, Tex. (475.9), 6-7 p. m., vesper recital, Honey Boys orchestra; 8:30-9:30, John Thorwald, baritone; 11-12, Adolphus hotel orchestra.

WGN, Chicago, Ill. (370.2), 6 p. m., organ recital, Lyon & Healy; 6:30-7, Drake concert ensemble, Blackstone string quintet; 8-9, Maxwell Adams; 10-11, Don Bestor Drake dance orchestra; Jerry Conley Blackstone dance orchestra.

WHAS, Louisville, Ky. (399.8), 4-5 p. m., Louisville Conservatory of Music, Alamo theater organ; 7:30-9, Sylvian trio; T. H. Graf, pianist.

WLBL, Stevens Point, Wis. (278), 12 midnight, "Enemies of Sleep."

WLS, Chicago, Ill. (344.6), 7 p. m., lullaby time, Ford and Glenn's trip to Chicago; 7:20, barn dance, Glenn's Threshers; Nubs Allan, Harmony Girls, Seats-Roebuck Four Aces of Harmony, Walter Peterson, Ford and Glenn, Ralph Emerson, Dave Nudelman; 11:15, Senate theater review.

WLW, Cincinnati, Ohio (423), 2:30 p. m., WLW program, Radio show; 6, dinner hour concert, Selinsky instrumental quintet; Lafafone, E. D. Leonard.

WMAQ, Chicago, Ill. (447.5), 6 p. m., "Daddy," Church Athletic association; 8, Russell Pratt, "Fred Day"; 8:30, "Russia," Frederick A. Mackenzie; 9, weekly Balaban & Katz Chicago theater review.

WMC, Memphis, Tenn. (449.7), 8:30 p. m., program, students of the U. of T. doctors.

WOAW, Omaha, Neb. (526), 6 p. m., Davis Studio of Expression; 6:30, music; 6:45, dinner program, Brandeis store restaurants; 7:30, weekly address, auspices Omaha Chamber of Commerce; 9, Saxon Family orchestra; 10, Randall's Royal Fontenelle orchestra; 11, Frank W. Hodek, Jr., and his Nightingale orchestra; 11:30, Arthur Hays, organist.

WOC, Davenport, Iowa (483.6), 6:30 p. m., sandman's visit, Val McLaughlin; 6:50, international Sunday school lesson, Rev. M. A. Getzendaner; 9, R. H. L. and his "Line o' Type or Two" artists, Melo'd, Peter Pan, Lunde, Helen Henna, Snowhose AI; 11.

(Continued on page 10)

"R. H. L." OF LINE FAME TO VISIT WOC

Saturday, March 14

(Continued from page 9)

Louis Connor and his LeClaire hotel orchestra; Peter MacArthur, baritone.
WQI, Chicago, Ill. (447.5), 7-8 p. m., Ralph Williams and his Rainbo Garden orchestra; Elsie Orr, soprano; Anne Burrows, accompanist; Agatha Karlen, reader; 10-2, Ralph Williams and his Rainbo Skylarks; Jerry Sullivan; Harry Geise; Melodians; Alfred Tweed; Clarence Theaders, tenor; George A. Little, Larry Shay; Yukona Cameron, soprano; Rick, Whalen, Gardner; Clyde Hager, "The Dynamic Delineator of Characterization in Song."
WSB, Atlanta, Ga. (428.3), 6 p. m., Sunday school lesson, Dr. Martin McHull; 8-9, Ed and Grace McConnell; 10:45, Robert Fulton orchestra.
WTAS, Elgin, Ill. (302.8), 8 p. m., WTAS dance program, "Boss' Own" orchestra, Fred Hamm, director; Eddie Loftus and other features.

Mountain Time Stations

The following schedules of programs are given in Mountain time. To change to Eastern time, add two hours; Central time, add one hour; Pacific time, subtract one hour.

KOA, Denver, Colo. (322.4), 9-12 midnight, dance music, Joe Mann and his Rainbow-Lane orchestra.

Pacific Time Stations

The following schedules of programs are given in Pacific time. To change to Eastern time, add three hours; Central time, add two hours; Mountain time, add one hour.

KFI, Los Angeles, Calif. (468.5), 5:30-6 p. m., Examiner's musical half hour; 6:45-7, Radiatorial; 7-7:45, Lake Arrowhead dance orchestra, Mel Lemmon, leader;



Luetta Minnick is one of the Seedhouse bunch which entertains regularly at KFNF, Shenandoah. This bunch is noted for its singing of old-fashioned songs in an old-fashioned way. No blues music is heard at this station.

7:45-8, the bookshelf, Nancy; 8-9, Examiner, Trojan Five, dance orchestra; 9-10, male and mixed quartet in comic opera favorites; 10-11, Packard Radio club; The Varsity trio, Ruth and Lilah Carlson, Way Watts of the A. E. E. Blackface trio, Barney Weber, tenor.
KFOA, Seattle, Wash. (384.4), 8:45-8:55 p. m., Rhodes Department store program; 8:30-10, Seattle Times dance music; 10:05-11, Eddie Harkness and his orchestra.

KGO, Oakland, Calif. (361.2), 8 p. m., Hawaiian music, Studebaker Hawaiian orchestra; "Thrills of Surf Riding at Waikiki," Harold H. Yost; James Harrison, baritone; Carl Anderson, tenor; Joyce Holloway Bartholson, pianist; Orville de Pauw, contralto; Helen Goodfellow, pianist; Roy Bailey, boy soprano; Dick Stutz, reader; Victoria Hartman, violinist; Carmen Rushing, pianist; Hawaiian orchestra; Carl Anderson, tenor; "Preparing for the Honey Flow," George W. Phillips; Lionel L. Hartman, cornetist; James Harrison, baritone; 10-11, Henry Halstead's orchestra.
KGW, Portland, Ore. (491.5), 10 p. m., Colburn's Melody Men.

KHJ, Los Angeles, Calif. (405.2), 6-6:30 p. m., Art Hickman's Biltmore hotel concert orchestra, Edward Fitzpatrick, director; 6:30-7:30, little stories, American history, Prof. Walter Sylvester Hertzog; Helen Pirie, Henrietta Poland, screen juveniles; Elma Roberts, Betty Reames, readings, Uncle John; 8-10, program, Win. H. Hyatt, Inc., arranged by J. Howard Johnson; 11-2 a. m., The Lost Angels of KHJ, Charlie Wellman as Chief Lost Angel.

KNX, Hollywood, Calif. (336.9), 5:45-6:15 p. m., Wuritzer pipe organ studio; 6:30-7:30, sports talk; Sid Zis; 6:15-7:30, dinner hour music; 8-10, KNX feature program; 10-11, Abe Lyman's Cocomat Grove dance orchestra from Ambassador hotel; 11-1 a. m., Hollywood night, presenting Constance Talmadge, famous cinema star.
KPO, San Francisco, Calif. (420.3), 3:30-5:30 p. m., tea dansant, Gene James' Rose Room Bowl orchestra; 6-20, garden hints; 8-12, Art Weidner's dance orchestra.

Sunday, March 15

Sunday, silent night for: AT9, CHNC, CKAC, CNRO, CNRT, KFAB, KFAE, KFNU, KFVK, KFMO, KOB, KSAC, WATG, WEAV, WDAF, WEAD, WEAR, WEEI, WEST, WHA, WHAD, WHAS, WHAZ, WJF, WKAQ, WLBL, WLIT, WOI, WRC, WTAM, WWJ.

Eastern Time Stations

CFCA, Toronto, Can. (356), 11 a. m., services, Bloor Street Baptist church, Rev. W. A. Cameron.
CKAC, Montreal, Can. (411), 4:30 p. m., band, City of Granby; talk, Mayor Bolvin.
KDKA, Pittsburgh, Pa. (309.1), 11 a. m., services, East End Christian church; 2:30 p. m., concert; 4, Dr. Charles Heinrich, organist; 4:45, vesper services, Shadyside Presbyterian church; 6:30, dinner concert, Pittsburgh Athletic association; 7:30, Calvary Episcopal church.

WBBH, New York, N. Y. (272.6), 10 a. m., T. Armstrong, violinist; Mrs. L. M. Brown, soprano; 10:30, Bible lecture; 11, Rita Rozada, soprano; 11:15, piano solos; 9 p. m., Mrs. Hans Haag, pianist; 9:10, I. B. S. A. choral singers; 9:25, Bible lecture, Judge Rutherford; 10, I. B. S. A. choral singers; 10:10, Dr. Hans Haag, violinist; 10:25, choral singers.
WCAE, Pittsburgh, Pa. (461.3), 10:45 a. m., services, Rodet Shalom temple; 3 p. m., People's Radio church services; 4, Prof. Otto Kallies, pianist; 6:30, dinner concert, William Penn hotel; 7:20, Roxy and his gang.
WCAU, Philadelphia, Pa. (278), 5:15 p. m., recital; 5:30, sermon, Rev. Dr. John Stockwell; 6, Hotel Pennsylvania Meyer Davis concert orchestra.
WCX, Detroit, Mich. (516), 7:15 p. m., services, Central Methodist Episcopal church.
WDWF, Providence, R. I. (440.9), 10 a. m., chimes; 5-6:45, Venetian serenaders; Philharmonic pipe organ.
WEAF, New York, N. Y. (491.5), 8:15-9:20 p. m., Roxy and his gang, Capitol theater; 9:20-10:15, organ recital.
WEAR, Cleveland, Ohio. (589.4), 1-2 p. m., Allen theater orchestra; 3:30-5, twilight concert, Ivan Francis and his Hotel Cleveland orchestra.

WEEI, Boston, Mass. (475.9), 3:45-5:30, men's conference, Y. M. C. A.; 7:20-9:15, "Roxy and His Gang," New York Capitol theater; 9:15-10:15, organ recital, Columbia university.
WFI, Philadelphia, Pa. (394.5), 4:30 p. m., studio chapel services; 7:30, services, Arch Street Presbyterian church.
WGSS, New York, N. Y. (315.6), 3:30-4:30 p. m., program, Piccadilly theater; 9:30-12, program, Theater Guild, Vaudeville Tapestry Ball, Buffet Supper, Jascha Heifetz, Laurette Taylor, Duncan Sisters.
WGR, Buffalo, N. Y. (319), 3-4 p. m., vesper service, Rev. F. L. Gangway, Westminster Presbyterian church; 4-5, Randolph Maynard, organist; 7:15, Central Presbyterian church service, William Wall Whiddit, organist, and Dr. Robert J. MacAlpine, speaker.
WGY, Schenectady, N. Y. (379.5), 11 a. m., First Presbyterian church; 3:35 p. m., WGY Symphony orchestra; 5, Dr. Frank Sill Rogers, organist; 7:30, First Presbyterian church; 8:45, Waldorf-Astoria orchestra, WJZ; 10, Tuskegee institute quartet, WJZ.
WHN, New York, N. Y. (361.2), 3-4 p. m., program, Queens County Christian Endeavor; 4:30-5, Collegiate dance club; 5-5:30, Roseland dance orchestra; 5:30-6, Olcott Vail and his string trio; 10-10:45, Gem Razor entertainers; 10:45-11:15, Janssen's Hofbrau Commanders orchestra; 11:15-11:45, Connel's Inn revue; 11:45-12:15 a. m., Harry Richmond and his entertainers.
WJY, New York, N. Y. (405.2), 8:15-9:15 p. m., Bernhard Levitov, Hotel Commodore orchestra; 10-10:10, "Reminiscences of a Reporter," William H. Crawford.
WJZ, New York, N. Y. (454.3), 4-5 p. m., Vesper services, St. Georges church; 7-8, Nathan Abas' Hotel Pennsylvania orchestra; 10-10:20, Hampton Institute quartet.

WLIT, Philadelphia, Pa. (394.5), 2 p. m., Lenten services; 2:30, Arcadia cafe concert orchestra.
WNYC, New York, N. Y. (526), 9-11 p. m., Brooklyn Strand theater program, Edward L. Hyman, director, and program from stage and studio of Rialto theater.
WOO, Philadelphia, Pa. (508.2), 6 p. m., organ recital, Clarence K. Bawden; 7:30, services, Bethany temple; organ recital, Caroline Quipp; sermon, Rev. Gordon A. MacLennan.
WRO, Lansing, Mich. (285.5), 10 a. m., chimes, belfry Plymouth Congregational church; 10:30, services, Plymouth Congregational church, Dr. Edwin W. Bishop, pastor; 7 p. m., Central M. E. church, Rev. Frank Kingdon, pastor.
WWJ, Detroit, Mich. (352.7), 11 a. m., services, St. Paul's Episcopal cathedral; 2 p. m., Detroit News orchestra; 7:20, Roxy and his gang.

Central Time Stations

CKY, Winnipeg, Can. (450), 7 p. m., service, Home Street Church of Christ; 8:45, First Baptist church.
KFMX, Northfield, Minn. (336.9), 7 p. m., vesper speaker, Dr. Frederick F. Kramer.
KFNF, Shenandoah, Iowa (266), 10:45 a. m., First M. E. church; 3 p. m., services, Christian church; 6:30, services, Golden Rule circle; 8, Christian church.
KFUO, St. Louis, Mo. (545.1), 4 p. m., program, children, Holy Cross Lutheran school; 9:15, "Weep Not for Me, but Weep for Yourselves and Your Children," Rev. E. L. Roschke.
KTHS, Hot Springs National Park, Ark. (374.8), 11 a. m., First Presbyterian church, Rev. Chauncey Hickok, pastor; 8:30-10, operatic night, Jacques Renard, director; New Arlington orchestra; 10-11:15, dance frolic, Phil Baxter and his singing orchestra.
KYW, Chicago, Ill. (536), 7 p. m., Chicago Sunday Evening club; musical program, Edgar Nelson, director; speaker, Robert Bruce Taylor.
WBAP, Fort Worth, Tex. (475.9), 11 a. m., St. Paul's M. E. church, Rev. C. D. Meade; 4 p. m., Rialto theater; 11, midnight frolic, Kerner's Crazy hotel orchestra.
WBCN, Chicago, Ill. (266), 7-8 p. m., Franz Lauzarus, violinist; 8-10:30, Roland Hinkle, tenor; Midway Gardens orchestra; Mrs. Charles Connell, soprano; Harry Moon, tenor; Florence Eastman, contralto; Borden brothers.
WCAL, Northfield, Minn. (336.9), 8:30 p. m., sacred program, Macdowell; Louise Stenseth, pianist; Marion Llandahl, mezzo-soprano; Scripture reading, Rev. Nils Kleven; Loyal Tallakson, tenor.

Call, minister; Velda Grant Kelleher, soprano; Reginald W. Billin, baritone.
WKB, Kansas City, Mo. (365.6), 9:40-11 a. m., Linwood Boulevard Christian church, Dr. Burris A. Jenkins, minister; 2:45 p. m., Christian Science services; 8-9, Independence Boulevard Christian church, Dr. R. H. Miller; 9-10, special classical program.
WHO, Des Moines, Iowa (526), 11 a. m., University Church of Christ, Dr. Charles S. Medbury; 4 p. m., program, Dean Holmes Cowper, director; 7:30, Reese-Hughes orchestra.
WLS, Chicago, Ill. (344.6), 6:30 p. m., Ralph Emerson, organist; 7, Apollo quartet, Nemeroff string trio.
WLW, Cincinnati, Ohio (423), 9:30 a. m., school, Editorial staff of Sunday school publications, Methodist book concern; 11, Church of Covenant, Dr. Frank Stevenson; 7:30 p. m., services, First Presbyterian church, Dr. Frederick McMillan; 8:30, Western and Southern orchestra, William Kopp, director; Carl Wunderle, zither soloist.
WOAI, San Antonio, Tex. (394.5), 11 a. m., First Presbyterian church; 7:30, Central Christian church; 9:30, WOAI entertainers present "Cavalleria Rusticana."
WOAW, Omaha, Neb. (526), 9 a. m., Radio chapel service, Rev. R. R. Brown; 1:30 p. m., matinee program, May Seed and Nursery company; 6, Bible study period, Mrs. Carl R. Gray; 9, chapel service, Zion English Lutheran church, Rev. Nels Lundgren, pastor; Bernard Johnston, choir director; Evan Nelson, organist.
WOC, Davenport, Ia. (483.6), 8 p. m., St. Katherine's Episcopal school, Rev. Giles Sharpley; 9:30, Palmer Little symphony.
WOI, Ames, Iowa (270), 10:45 a. m., college chimes; 11, chapel services, Dr. Gerald Birney Smith.
WORD, Batavia, Ill. (275), 7-8 p. m., I. B. S. A. choral singers; musicals; A. L. Seelye, Bible lecture.
WOS, Jefferson City, Mo. (440.9), 7:30 p. m., services, First Christian church, Rev. Robert M. Talbert, pastor.
WQJ, Chicago, Ill. (447.5), 10:30 a. m., Dr. Preston Bradley's sermon, People's church; Clarence Eddy, organist; 8-10, Ralph Williams and his Rainbo Garden orchestra; Jeanette Van Lennep, soprano; Mary Van Lennep, accompanist; Herman J. Techantine, baritone; Oscar H. Williamson, tenor; Harry Abernethy, accompanist; Albert M. Tilton, Jr., tenor; Marie Watson Tilton, accompanist.
WSAI, Cincinnati, Ohio (325.9), 3 p. m., sermonette and Atlanta.
WSB, Atlanta, Ga. (428.3), 11 a. m., First Presbyterian church service; 5-6 p. m., First Georgia Methodist Bethany church; 7:30, Wesley Memorial church service.
WTAS, Elgin, Ill. (302.8), 7 p. m., midnight star program, Kimball hall, "Boss' Own" orchestra, Fred Hamm, director; WTAS Radio Stars, Eddie Loftus, Frank Morris and other features.

Mountain Time Stations

KOA, Denver, Colo. (322.4), 11 a. m., Unity church, Dr. George Gilmour, pastor; 4 p. m., Unity church organ recital; 7:45, service, Unity church.

Pacific Time Stations

KFI, Los Angeles, Calif. (468.5), 10 a. m., L. A. Church Federation service, "Up a Tree," O. D. Conroy of Rescue Mission; 10:45-12:30 p. m., Temple Baptist church, Dr. J. Whitcomb Brougher, pastor; Dr. Ray Hastings, organist; 4-5, vesper service, Federated Church Musicians; 6:45-7, music appreciation talk, Paul Reese; 7-8, specialties and orchestra from Metropolitan theater; 8-9, Lenten song hour, Estelle Hearty-Dreyfus, soprano; Jay Plowe, flutist; Grace Andrews, accompanist; 9-10, municipal concert, G. Colburn concert orchestra, Hotel Portland; Intermission solos.
KHJ, Los Angeles, Calif. (405.2), 10 a. m., Rev. C. S. Prout of Seventh Day Adventist church; 10:30-12:30 p. m., First Methodist Episcopal church, organ recital, Arthur Blakely, E. E. Helms, pastor; 6:30-7, Art

Boy Scout meeting; 8:15, address, University of Pittsburgh; 8:30, concert.
WAHG, Richmond Hill, N. Y. (315.6), 8-8:15 p. m., songs, Bernice Walker; 8:15-8:45, Walter Scott, violinist prodigy; 8:45-9, songs and monologues, Evan Davies; 9-9:30, Synchronaphase string trio; 9:30-9:45, Jack Shatter, tenor; 9:45-10, Synchronaphase string trio; 10-10:15, Margery Crego, soprano; 10:15-10:30, Evan Davies; 10:30-10:45, Maude Mason, pianist; 10:45-11, Jack Shatter; 12-2 a. m., special program, Adamo Symphonie concert orchestra.
WBBR, New York, N. Y. (272.6), 8 p. m., vocal duets, Irene Kleinpeter, Fred Twarosch; 8:10, Irene Kleinpeter, soprano; 8:20, world news digest, editor of Golden Age magazine; 8:40, Irene Kleinpeter, soprano; 8:50, vocal duets.
WCAE, Pittsburgh, Pa. (461.3), 6:30 p. m., dinner concert, William Penn hotel; 7:30, Uncle Kaybee; 8:30, concert; 9, concert, A. & P. Gypsy string ensemble; 11, mythical dirigible, Press-Kaybee; Blackstone theater orchestra.
WCX, Detroit, Mich. (516), 6 p. m., dinner concert, Book-Cadillac hotel; 7, musical program.
WEAF, New York, N. Y. (491.5), 4-4:15 p. m., Beatrice Melaragno, soprano; 6-7, dinner music from Waldorf-Astoria hotel; 7-7:15, Ralph W. Tagg, baritone; 7:15-8:30, Strand theater program; 8:30-9, Cashman's Sons, Inc.; 9-10, A. & P. Gypsies; 10-10:30, Hamilton college choir; 10:30-11:30, Ben Bernie's Hotel Roosevelt orchestra.
WEAR, Cleveland, Ohio. (389.4), 7-8 p. m., musical program, Loew's State theater.
WEEI, Boston, Mass. (475.9), 6:30 p. m., Big Brother club; 7:15, Pathe News flashes; 7:30, Dok-Eisenbourg and his Sinfolians; 8, Bailey's Whispering Jazz orchestra; 9 A. & P. Gypsies; 10, concert, May Delaney Bell.
WFI, Philadelphia, Pa. (394.5), 3 p. m., Japanese concert, students of University of Pennsylvania; talk, Dr. A. Walter Stevenson; 6:30, Meyer Davis' Bellevue Stratford concert orchestra; 7, Sunny Jim's bedtime stories.
WGSB, New York, N. Y. (315.6), 3-3:10 p. m., interview, Louis Furlong, Terese Rose Nagel; 3:10-3:30, Genevieve Williams, soprano; 3:30-3:50, program, United Parents association; 3:50-4:40, Genevieve Williams; 3:40-3:50, Spanish lessons, Professor Perez de Vegas; 3:50-4, Genevieve Williams; 6-6:30, Uncle Geebee; 6:30-7:30, Lew Krueger's Alladin orchestra.
WGR, Buffalo, N. Y. (319), 6:30-7:30 p. m., dinner

Norma Farnsworth, a pretty Phi Beta Phi sorority girl of the Junior Beloit college, Wisconsin, is the versatile artist on the programs of WEBW. She sings, whistles and plays the piano.



A pirate ship sails across the ether every Tuesday night from midnight to 2 a. m., via WBCN, Chicago, carrying this crew of fierce pirates and cannibal princesses. Doughtery Iron Knuckle, the first mate, is here shown with his head on the block. The Captain, Bloody Bill McDonnell, the man at the right, has ordered the third mate, Terrible Terry Yagle, to cut off the head of Iron Knuckle. Princess Coo Coo Downs and Princess Kazooza Hoyt are pleading for his life. The Pirates conduct a real treasure hunt Tuesdays.

Monday, March 16

Monday, silent night for: AT9, CKY, CNRO, CNRT, KFDM, KFMO, KFNU, KFVK, KGW, KYW, WBAV, WBCN, WCAU, WDFW, WEAD, WEBB, WEBI, WFI, WGN, WHAS, WIP, WKAQ, WLBL, WLS, WMAQ, WOAI, WOC, WJY, WPG, WQJ, WRC, WRO.

Eastern Time Stations

CFCA, Toronto, Can. (356), 6:30-7:50 p. m., dinner music, Hippodrome theater.
CHIC, Toronto, Can. (350), 10-11:30 p. m., classical studio concert.
CHNC, Toronto, Can. (350), 8:30 p. m., CHNC Little Symphony orchestra, Charles E. Bodley, director; mixed quartet, Norma Wilcox, soprano, Jessie Butt, contralto, Albert David, tenor, Charles Leslie, baritone.
KDKA, Pittsburgh, Pa. (309.1), 6:15 p. m., KDKA Little Symphony orchestra; 7:30, children's period; 8,

CFAB, Lincoln, Nebr. (240), 7:30-9 p. m., Orville Andrews, Bulck song bird; musical program, Lincoln Telephone & Telegraph company; Walter R. Carpenter, baritone; Mrs. Hazel Miller, soprano.
KFKU, Lawrence, Kan. (275), 6:50 p. m., piano tuning-in number; 7, music; 7:15, "The Hurdle Races," Karl Schlademan; 7:30, play production, "Selecting the Cast," Prof. Allen Crafton; 7:45, Spanish lesson XI.
KFKX, Hastings, Neb. (288.3), 9:30-11:30 p. m., program, auspices Gaston Music and Furniture company.
KFNF, Shenandoah, Iowa (266), 6:30 p. m., seedhouse concert.
KSAC, Manhattan, Kan. (340.7), 7:20 p. m., college band, H. P. Wheeler, director; 7:30, "The Shepherd of Sheep," E. E. Reed; 7:40, college band; 7:50, "Production of Wholesale Dairy Products," N. E. Olson.
KSD, St. Louis, Mo. (545.1), 8 p. m., Morning Etude piano quartet; Mrs. Edward Melsenbach, soprano; 10, Ruth Hazlett Wunder, soprano; Paul Friess, pianist.
KTHS, Hot Springs National Park, Ark. (374.8), 8:30-10 p. m., All Star quartet, Louis Davis, Charles McGill, director; Peter Penn jazz orchestra; 10-11, dance music, Charles L. Fischer orchestra; 12:15, Charles L. Fischer, dance lark.

(Continued on page 11)

ST. PATRICK'S DAY JIGS TUESDAY

Monday, March 16

(Continued from page 10)

WBAP, Fort Worth, Texas (475.9), 7:30-8:30 p. m., "Camp Fire Girls" program, Lucia Walker, director; 9:30-10:45, Ward's Trail Blazers.

WCAL, Northfield, Minn. (336.9), 11 p. m., organ recital, Ellnor Overland, Grand theater.

WCBD, Zion, Ill. (344.6), 8 p. m., mixed quartet, trombone quartet; Fred Paassen, organist; Carl Newcomer, saxophonist; flute duets, DePew, Randall; vocal trio; Carey sisters; Emma Reynolds, soprano.

WCCO, Minneapolis-St. Paul, Minn. (416.4), 6:15 p. m., dinner concert; 8, boys and girls club work; T. A. Erickson, University Farm school; 8:15, lecture; 8:30, hockey game; 10:30, Dick Long's Nankin cafe orchestra.

WCEE, Elgin, Ill. (275), 11 p. m., the Charline Star Monday midnight program, Kimball hotel; the "Boss"

9-10, program, Walter M. Murphy Motors company, Apollo male quartet; Virginia Flohr, soprano; Hazel Schertzinger Brewster, harpist; 10-11, Examiner, Ray West and his Alexandria hotel dance orchestra.

KFOA, Seattle, Wash. (384.4), 6:45-8:15 p. m., Sherman Clay and company program; 8:30-10, Seattle Times studio program.

KGO, Oakland, Calif. (361.2), 8 p. m., Arlon trio; address on agricultural subjects; "A Lesson in English," Wilda Wilson Church; "How to Improve Your Memory," Albertine Richards Nash; "On Being a Good Hostess, and on Being a Good Guest," Edith Stevens; "Chats about New Books," Joseph Henry Jackson; 10-11, Henry Balstead's orchestra.

KGW, Portland, Ore. (491.5), 6 p. m., William Robinson Boone, organist.

KLX, Oakland, Calif. (508.2), 9:30-10 p. m., American theater orchestra; 10, meeting of the Lake Merritt Ducks.

KNX, Hollywood, Calif. (336.9), 5:45-6:15 p. m., Wurliizer pipe organ studio; sports talk by Sid Ziff; 7-8, program, West Coast theaters, Inc.; 8-10, program, Los Angeles Ice and Cold Storage company; 10-11, Goodrich Silvertown Cord orchestra; Lillian May Challenger,

ply company; 8-8:15, talk, Bank of America; 8:15-8:30, Le Roy Fisher, baritone; 8:30-9, Gold Dust twins; 9-10, Eveready hour.

WEAR, Cleveland, Ohio (389.4), 7-8 p. m., Vincent H. Percy, organist; 8-10, concert from WEAF.

WEBI, New York, N. Y. (233), 7-7:15 p. m., Lillian Buckman, soprano; 7:30-7:45, E. De Bona, tenor; 7:45-8 songs, Victor Wilbur and Joe Macey; 8-8:10, railroad talk, G. T. Geer; 8:15-9, Johnny Basilone and his Harlem Tea Garden orchestra.

WEET, Boston, Mass. (475.9), 6:30 p. m., Big Brother club; 7:15, Fleur Brousseau, mezzo-soprano; 7:30, Dek-Eisenburg and his Simfonians; 8, from New York; 8:30, Gold Dust Twins; 9, Eveready hour; 10, Goodrich Silvertown Cord orchestra.

WFI, Philadelphia, Pa. (394.5), 3:45 p. m., Camp Fire Girls' concert; 6:30, Meyer Davis' Bellevue Stratford concert orchestra; 7, Boy Scouts; 8, concert from WEAF; 9, Eveready hour; 10, banquet, Friendly Sons of St. Patrick.

WGBS, New York, N. Y. (315.6), 3-4 p. m., St. Patrick's day program with Uncle Hoo Bee, Teresa Rose Nagel and children; 6-6:30, Uncle Geebee; 6:30-7:30, Jersey Collegians orchestra; 9-9:30, John Murry, alley

WOO, Philadelphia, Pa. (508.2), 4:45 p. m., organ recital, Mary E. Vogt.

WRC, Washington, D. C. (468.5), 6:45 p. m., children's hour, Peggy Albion; 7, Meyer Davis' New Willard hotel orchestra; 8, show shopping, Leonard Hall; 8:10, to be announced; 8:30, "The Political Situation in Washington Tonight," Frederick Wm. Wile; 9, Brunswick music memory contest, WJZ, WGY, KDKA and KYW; 10:30, Meyer Davis' Le Paradis band, WJZ and WGY.

WREO, Lansing, Mich. (285.5), 8:15-9:45 p. m., musical program, Leo Broadcasting band, Carl Hall Dewey, director; Leo male glee club; local artists.

WTAM, Cleveland, Ohio (389.4), 6-7 p. m., dinner music, Hotel Statler orchestra, Maurice Spitalny, director.

WWJ, Detroit, Mich. (352.7), 3 p. m., Detroit News orchestra; 6, dinner concert; 8, concert from New York.

Central Time Stations

CKY, Winnipeg, Can. (450), 7:30 p. m., lecture, Prof. W. T. Allison; 8, Irish concert, Henderson's orchestra; 9, Capitol theater, Earl Hill's orchestra.

KFDM, Beaumont, Tex. (315.6), 7:30 p. m., children's half hour; 8-10, program, Gladys Harned, violinist.

KFMQ, Fayetteville, Ark. (299.8), 9 p. m., selections for two pianos, Mr. Tovey, Mrs. Shannon Bohart; Dr. Allen Gilbert, baritone; D. C. Hansard, violinist; Men's glee club.

KSAC, Manhattan, Kans. (340.7), 7:20 p. m., college quartet; 7:30, "Control of Alfalfa Diseases," L. E. Melchers; 7:40, college quartet; 7:50, "Types of Poultry Houses for Kansas," J. H. McAdams.

KSD, St. Louis, Mo. (545.1), 6 p. m., Benjamin Rader's orchestra; 9, Irish program, John A. Wynn, baritone; Emma O. Walter, pianist; address on Ireland; 10, program, Evelyn Fraley, director.

KTSS, Hot Springs National Park, Ark. (374.8), 8:30-9:45 p. m., St. Patrick's night, Irish folk songs, Charles L. Fischer orchestra; Tubby Veil, tenor; 9:45-10:45, Meyer Davis' New Arlington hotel orchestra.

KYW, Chicago, Ill. (536), 6:35-7 p. m., Uncle Bob's bedtime story; 7, dinner concert, Congress hotel; 7:33, "Distribution to the Farm Factory," H. M. Hallsback; "Some Lessons from European Farmers," editorial staff, Orange Judd Illinois Farmer; 8, Brunswick hour of music; 9, musical program, artists announced; 10, evening at home; 11:05, Applesauce club, Ransom Sherman; 1-2 a. m., Insomnia club; Coonsanders Original nightawks.

WBAP, Fort Worth, Texas (475.9), 7:30-8:30 p. m., classical music, Mrs. Helen Brandies; 9:30-10:45, E. Clyde Whitlock's violin ensemble.

WBCN, Chicago, Ill. (266), 7-8 p. m., Katherine Thomas J. Coughlin, Kathleen Kearney, Irish singers; 8-12, Midway Gardens orchestra; Marie Wright, soprano; Axel Christensen, pianist; Melody girls; Radio talk, F. H. McDermald; 12-2 a. m., Pirate ship.

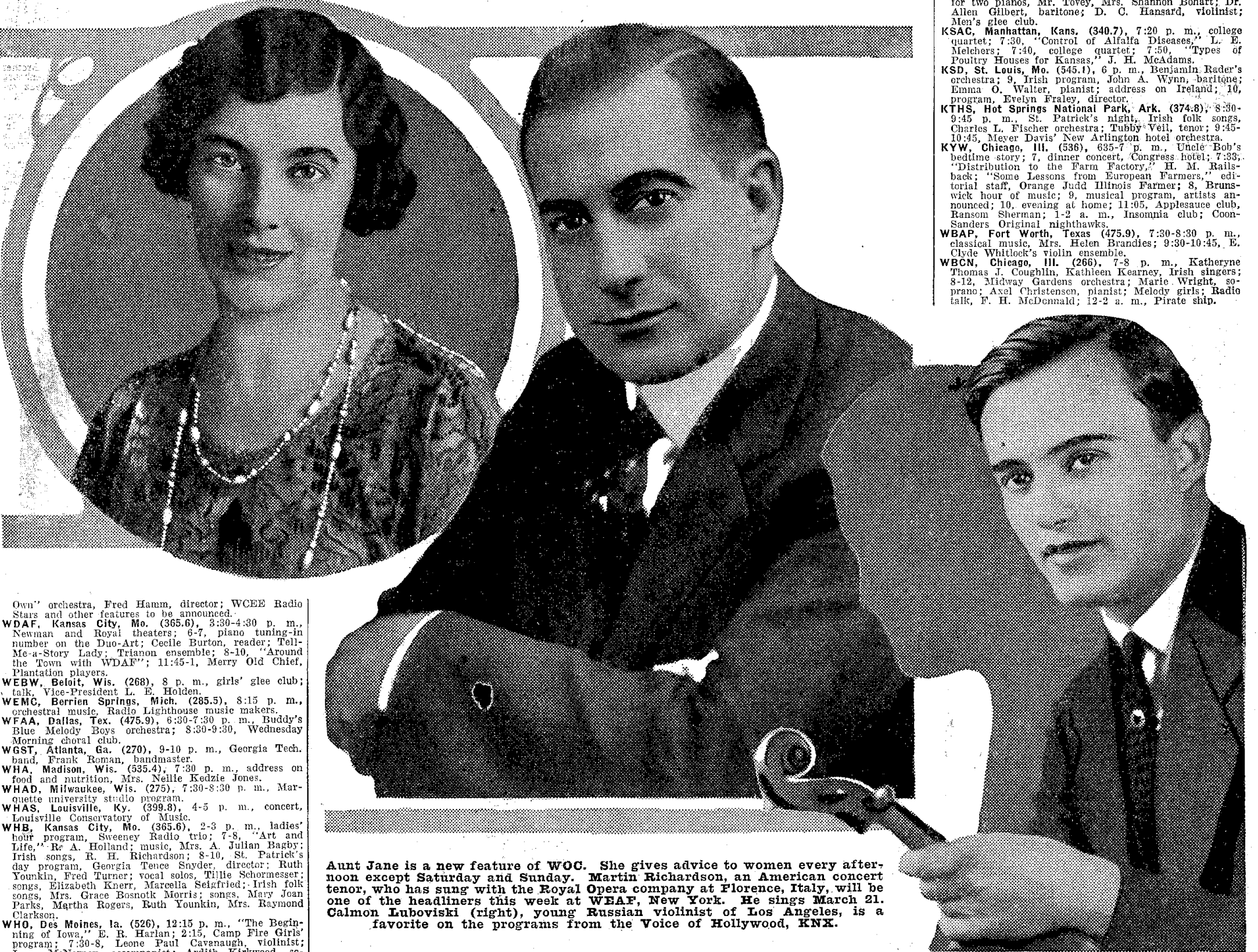

Aunt Jane is a new feature of WOC. She gives advice to women every afternoon except Saturday and Sunday. Martin Richardson, an American concert tenor, who has sung with the Royal Opera company at Florence, Italy, will be one of the headliners this week at WBAF, New York. He sings March 21. Calmon Luboviski (right), young Russian violinist of Los Angeles, is a favorite on the programs from the Voice of Hollywood, KNX.

Own" orchestra, Fred Hamm, director; WCEE Radio Stars and other features to be announced.

WDAF, Kansas City, Mo. (365.6), 3:30-4:30 p. m., Newman and Royal theaters; 6-7, piano tuning-in number on the Duo-Art; Cecile Burton, reader; Tell-Me-a-Story Lady; Trianon ensemble; 8-10, "Around the Town with WDAF"; 11:45-1, Merry Old Chief, Plantation players.

WEBW, Beloit, Wis. (268), 8 p. m., girls' glee club; talk, Vice-President L. E. Holden.

WEMO, Berrien Springs, Mich. (285.5), 8:15 p. m., orchestral music, Radio Lighthouse music makers.

WFAA, Dallas, Tex. (475.9), 6:30-7:30 p. m., Buddy's Blue Melody Boys orchestra; 8:30-9:30, Wednesday Morning choral club.

WGST, Atlanta, Ga. (270), 9-10 p. m., Georgia Tech. band, Frank Roman, bandmaster.

WHA, Madison, Wis. (535.4), 7:30 p. m., address on food and nutrition, Mrs. Nellie Kedzie Jones.

WHAD, Milwaukee, Wis. (275), 7:30-8:30 p. m., Marquette university studio program.

WHAS, Louisville, Ky. (399.8), 4-5 p. m., concert, Louisville Conservatory of Music.

WHB, Kansas City, Mo. (365.6), 2-3 p. m., ladies' hour program, Sweeney Radio trio; 7-8, "Art and Life," Re A. Holland; music, Mrs. A. Julian, Bagby; Irish songs, R. H. Richardson; 8-10, St. Patrick's day program, Georgia Tenor Snyder, director; Ruth Younkia, Fred Turner; vocal solos, Tillie Schormesser; songs, Elizabeth Knerr, Marcella Seifried; Irish folk songs, Mrs. Grace Bosnolk Morris; songs, Mary Joan Parks, Martha Rogers, Ruth Younkia, Mrs. Raymond Clarkson.

WHO, Des Moines, Ia. (526), 12:15 p. m., "The Beginning of Iowa," E. R. Harlan; 2:15, Camp Fire Girls' program; 7:30-8, Leone Paul, Cavannah, violinist; Irene McNamey, accompanist; Ardith Kirkwood, soprano; Bernard Mason, violinist; Edith Usry, accompanist; 8-9, program, Dean Holmes Cowper; 11-12, L. Carlos Meier, organist.

WLW, Cincinnati, Ohio (423), 6 p. m., dinner hour concert; 8, Legion-Alr night, American Legion; 9, Times-Star program; Karl Kirksmith, cellist; Howard Hafford, tenor; Senator Schultz; Times-Star orchestra, William Koop, director.

WOAW, Omaha, Nebr. (526), 6 p. m., Arthur Hays, organist; 6:30, music; 6:45, dinner program; 9, program, auspices Hannan-Van Brunt company.

WOI, Ames, Ia. (276), 10 p. m., popular music.

WOS, Batavia, Ill. (275), 7-8 p. m., children's hour, Uncle Jim; 8-9, orchestra, duets.

WSD, Jefferson City, Mo. (440.9), 8 p. m., addresses, Homer P. Williams, Earl E. Roberts, Lon S. Hayes; "Relation of Physical Education to Racial Survival," Dr. Henry S. Curtis; Prof. F. J. Zeisberg, pianist.

WSAI, Cincinnati, Ohio (325.9), 10 p. m., Cliff Burns' Country club orchestra.

WSB, Atlanta, Ga. (428.3), 8-9 p. m., anniversary program; 10:45, Warners Seven Aces.

WTAS, Elgin, Ill. (302.8), 8 p. m., Villa Oliva Monday night radio concert; the "Boss' Own" orchestra, Fred Hamm, director; Eddie Loftus, Frank Morris and other features.

Mountain Time Stations

KOA, Denver, Colo. (322.4), 8 p. m., ten minutes of music, Fred Schmitt and his Rialto theater orchestra; 8:10, Irish numbers; educational description of Irish songs, Rev. William O'Ryan; Irish skit, "The Courtship of Widow Malone."

KOB, State College, N. M. (348.6), 7:30-8:30 p. m., "Superstitions in Medicines, Part II," Dr. R. E. McBride; "The Spring Flower Garden," member Agricultural faculty; "The Home Garden."

Pacific Time Stations

KFAE, Pullman, Wash. (348.6), 7:30-9 p. m., marimba-phone duets, readings, Cooper sisters; Velma Olson, soprano; old-fashioned songs; "Opportunities in Civil Engineering," Prof. M. K. Snyder; "Can We Legislate Morals?" Rev. Clay E. Palmer; "Opportunities with Bummer Lamb," C. M. Hubbard; "Diseases Affecting Animals and Men," Dean E. E. Wegner.

KFI, Los Angeles, Calif. (468.5), 5:30-6 p. m., Examiner's musical half hour; 6:45-7, Radditorial talk; 7-8, Evening Herald, Radiolans' dance orchestra; Charlie Melson, tenor; 8-9, Indian program, Coso Hot Springs;

soprano, courtesy B. F. Goodrich Rubber company; 11-12, Abe Lyman's Coconut Grove dance orchestra from Ambassador hotel.

KPO, San Francisco, Calif. (428.3), 4:30-5:30 p. m., Rudy Seiger's Fairmont hotel orchestra; 8-9, Irish folk love, P. J. Kelleher; Irish "Folk Music," Redfern Mason; 9-10, program, Emile Lichtig, baritone.

Tuesday, March 17

Tuesday, silent night for: AT9, CHNC, CNRO, CNRT, KFAB, KFAE, KFNF, KFKU, KFKX, KFMX, KFUO, KLX KOA, KOB, WAHG, WBAV, WBBR, WCAI, WGBD, WEAD, WEMC, WGST, WHA, WHAD, WHAZ, WHO, WOI, WOO.

Eastern Time Stations

CKAC, Montreal, Can. (411), 7:30 p. m., Windsor hotel dinner concert; 8:30, Irish hour; 10:30, Windsor hotel dance orchestra; 12 midnight, frolics.

CNRA, Moncton, Can. (313), 6:30 p. m., juvenile artists; 7:30, artists from St. Peters Bay, Laura E. Wightman, director; Rainbow Melody Boys.

KDKA, Pittsburgh, Pa. (309.1), 8:15 p. m., dinner concert, Pittsburgh Athletic association; 7:30, children's period; 7:45, "Overcoming Racial Prejudice," Dr. John Ray Ewers; 8, concert; 9, Brunswick hour of music; 11, Pittsburgh Post studio; 11:30, concert, Grand theater.

WCAE, Pittsburgh, Pa. (461.3), 6:30 p. m., William Penn hotel concert; 8, program from New York; 9, Eveready hour; 10, Goodrich Silvertown Cord orchestra.

WCAU, Philadelphia, Pa. (278), 6 p. m., Paul Specht's dance orchestra; 7:30, recital, N. Snellenger store; 8, Cleve-Chandler Hawaiians; 8:20, Media Melodians; 8:40, Symphonic Surety orchestra; 9, recital.

WCX, Detroit, Mich. (516), 6 p. m., dinner concert, Book-Cadillac hotel; 10, The Red Apple club.

WVAF, Providence, R. I. (440.9), 8:30-9 p. m., Vincent Lopez, Aradia dance orchestra.

WEAF, New York, N. Y. (491.5), 4-4:15 p. m., Sara Hammond, soprano; 4:30-5, women's program; 6-7, dinner music from Waldorf-Astoria hotel; 7-7:15, Sophie Soop, soprano; 7:20-7:30, Charles C. Green, advertising agent; 7:30-8, Royal Eastern Electric Sup-

organ; 9:45-10, Irish melodies, Christine Thompson, pianist; 10-10:30, Irish playlet.

WGR, Buffalo, N. Y. (319), 6:30-7:30 p. m., Hallpyrd string trio; 8-11, joint broadcasting with WEAF, 9-10, Eveready hour.

WGY, Schenectady, N. Y. (379.5), 6:30 p. m., New Kenmore hotel orchestra; 7:30, "Financing a College Education," Hartley F. Dewey; 7:40, WGY orchestra; Joseph Cuhane, tenor; 9, Brunswick hour of music.

WJZ, DRC, KDKA, KYW, 10:30, Meyer-Davis orchestra, WJZ, WRC; 11:30, Stephen E. Boisclair, organist.

WHN, New York, N. Y. (361.2), 6:30-7 p. m., Strand roof orchestra; 7:30-7:35, health talk, Dr. Landis; 7:35-8:15, Mah Jong Inn orchestra; 8:30-9, Dave Harman and his Cinderella orchestra; 9-9:15, Bob Miller and Jimmy Flynn, popular songs; 10-10:30, St. George hotel orchestra; 10:30-11, the New Rockwell terrace revue; 11-11:30, Everglades revue; 11:30-12, Club Alabam orchestra; 12-12:30 a. m., Parody club orchestra and revue.

WIP, Philadelphia, Pa. (508.2), 3 p. m., Wayne Branchman, tenor; Margaret Anders, soprano; Flora Ripka, accompanist; 6:05, songs, Mark Fisher and Joe Burke; 6:15, Harvey Marburger's dance orchestra; 7, Uncle Wip's bedtime stories; 8 two-piano recital; 8:15, "The Theater," Elliott Lester; 9, Boy Scouts' concert; 9:15, "The Kiwanis Scout Exhibit" talk; 9:30, recital, George T. Hottel; 10:05, "Emo's Weekly Movie Broadcast"; 10:30, Harvey Marburger's dance orchestra.

WJY, New York, N. Y. (405.2), 8:30-9 p. m., Estey organ recital; 9:15-9:30, Lynch and Irish orchestra; 9:30-10:15, Camp Fire Girls' program.

WJZ, New York, N. Y. (454.3), 7-7:15 p. m., dog talk, Frank Dole; 7:15-8, Joseph Strissof's Hotel Vanderbilt orchestra; 8-8:10, Wall Street Journal review; 8:10-8:20, N. Y. U. Air college; "Foreign Trade," Prof. J. Anton De Haas; 9-10, Brunswick hour; 10-10:15, Irish songs, Mme. Marie Narelle.

WKAG, San Juan, P. R. (340.7), 8-9:30 p. m., Euterpe Jazz band.

WNYC, New York, N. Y. (526), 7:20-7:30 p. m., sports talk, Thornton Fisher; 7:35-8:45, Riesenfeld's Rialto program; 8:45-9:45, concert program from studio; 10:10-10:20, lecture service, board of education.

WCCO, Minneapolis-St. Paul, Minn. (416.4), 6:15 p. m., dinner concert, Dick Long's Nankin cafe orchestra; 7:30, lecture; 8, national program, from New York.

WCEE, Elgin, Ill. (275), 7 p. m., the "Boss' Own" orchestra, Fred Hamm, director; Eddie Loftus, Frank Morris, WCEE Radio Stars; 11, midnight dance program; the "Boss' Own" orchestra, Fred Hamm, director; Eddie Loftus, Frank Morris and other features.

WDAF, Kansas City, Mo. (365.6), 3:30-4:30, Star's Radio trio; 5-5:30, weekly child talent program; 6-7, piano tuning-in number on the Duo-Art; Tell-Me-a-Story Lady; Maudellen Littlefield, pianist; Trianon ensemble; 11:45-1, Newman Nighthawk night.

WEBH, Chicago, Ill. (370.2), 7-8 p. m., Edgewater Beach Oriole orchestra; Dan Russo, violinist; Ted Florito, celeste; 9:10, Edgewater Beach Oriole orchestra; Dennis sisters, songs; Dean Remick, pianist; Kay Ronayne, songs; 11-12, Edgewater Beach Oriole orchestra; Loos brothers, songs; Jack Kenewell, twin guitar; Frank Magini, songs; Barks Kennedy, songs.

WEBW, Beloit, Wis. (268), 8 p. m., concert, band, Barks Kennedy, songs and company, E. R. Lhotak, director.

WFAA, Dallas, Tex. (475.9), 6:30-7:30 p. m., Hauula School of Hawaiian music, J. B. Stevenson; 8:30-9:30, Camp Fire Girls' Schubert choral club; 11-12, Palace theater organ recital, Dwight Brown.

WGN, Chicago, Ill. (370.2), 6 p. m., organ recital, Lyon & Healy; 6:30-7, dinner concert, Drake concert ensemble, Blackstone string quintet; 8-9, St. Patrick's day, Hermanus T. Baer, baritone; 10-11, Don Bestor Drake dance orchestra.

WHAS, Louisville, Ky. (399.8), 4-5 p. m., Louisville Conservatory of Music; Alamo theater organ; 7:30-9, Carl Zoeller's Melodists; chapter Billy and Jane stories.

WHO, Des Moines, Ia. (526), 12:15 m., "The Beginning of Iowa," E. R. Harlan; 2:15, Camp Fire Girls' program.

WLB, Stevens Point, Wis. (278), 8 p. m., music, auspices Stevens Point Chamber of Commerce.

WLS, Chicago, Ill. (345), 6:30 p. m., Ralph Emerson, organist; 6:50, Senate theater studio; 7, lullaby time, (Continued on page 12)

IRE OPERA, "IL TROVATORE," FRIDAY



Ray Tellier is the leader of Tellier's Cinderella Ballroom orchestra broadcasting exclusively every Tuesday from KPO, Hale Brothers, San Francisco.

ING
(Time)
March 14: 8, 9, KFI, Wrc; 9:05, Ckac, Wpg; 9, KFI, Koa, Weaf, Wgbs, 10:30, Kfoa, Wahg, Webh, Woc; 12, Kgw, Knx;
March 15: 3, KFI, Kpo, Wlt; 9:30, Woc; 9:45, Kths, Wgr; Wht; 11:30, Kgo, Kpo;
March 16: 8, 9, KFI, Kpo, Weel, Whn; Wgy, Whn; 9:45, Kths, Wht; 10:30, Wht; 11:30, Kgo, Knx; 12:05, K, Kyw;
March 17: 3, KFI, Kpo, Wlt; 9:30, Woc; 9:45, Kths, Wgr; Wht; 11:30, Kgo, Knx; 12:05, K, Kyw;
March 18: 8, 9, KFI, Kpo, Weel, Whn; Wgy, Whn; 9:45, Kths, Wht; 10:30, Wht; 11:30, Kgo, Knx; 12:05, K, Kyw;
March 19: 8, Wtas, Wwt; 9:30, Woc, Webh, Wgt; 9:45, Kths, Wht; 10:30, Wht; 11:30, Kgo, Knx; 12:05, K, Kyw;
March 20: 8, Wtas, Wwt; 9:30, Woc, Webh, Wgt; 9:45, Kths, Wht; 10:30, Wht; 11:30, Kgo, Knx; 12:05, K, Kyw;

KFOA, Seattle, Wash. (384.4), 6:45-8:15 p. m., Hopper-Kelly company studio program; 8:30-10, Seattle Times studio program.
KGW, Portland, Ore. (491.5), 6 p. m., dinner concert; 8, concert; 10, Columbia's Melody men, Hotel Portland.
KHJ, Los Angeles, Calif. (405.2), 6-6:30 p. m., Art Hickman's Biltmore hotel concert orchestra, Edward Fitzpatrick, director; 6:30-7:30, little stories American history, Prof. Walter Sylvester Hertzog; Baby Muriel McCormac, Mickey McBan, screen juveniles; Dick Winslow, juvenile reporter, Uncle John; 7:30-8, program, University of Southern California; 8, scientific lecture, Dr. Mars Bumgardner; 8:30-10, program, Broadway Department store; 10-11, Art Hickman's Biltmore hotel dance orchestra, Earl Burnett, leader.
KLX, Oakland, Calif. (508.2), 6-7 p. m., organ recital; 8-10, American theater orchestra; 10-11:30, Sweet's ballroom.
KNX, Hollywood, Calif. (336.9), 5:45-6:15 p. m., Wur-litzer pipe organ studio, sports talk, Sid Ziff; 6:15-7, dinner hour music; 7-8, Ambassador hotel concert orchestra, Josef Rosenfeld, director; 8-10, KNX feature program; 10-12, Hollywoodland dance orchestra.
KPO, San Francisco, Calif. (423.3), 2:30-3:30 p. m., Johnny Bulek's Amphians; 4:30-5:30, Rudy Selger's Fairmont hotel orchestra; 5:30-6:30, children's hour stories, Big Brother; 7-7:30, Rudy Selger's Fairmont hotel orchestra; 7:30-8, Conn Band Instrument company; 8-11, Wilma Dainty, pianist; Melvina H. Cohn, soprano; two piece band, Hamme Brothers.

Thursday, March 19

Thursday, silent night for: **CHNC, CNRO, CNRT, KFAB, KFDM, KFAE, KFMC, KFOA, KFUD, KLX, KOA, KOB, WAHG, WIP, WCEE, WDFW, WEAD, WEBJ, WEBW, WEMC, WHA, WHAD, WHAZ, WLBL, WOO, WOS, WSUI.**
Eastern Time Stations
AT9, Fort Bragg, N. C. (435), 8 p. m., "Citizens Military Training Camp," Brigadier General Albert J. Bowley.
CKAC, Montreal, Can. (411), 4:45 p. m., Harold Leonard's Red Jackets; 8:30, program, CNRM.
CNRM, Montreal, Can. (425), 8:30 p. m., Markowski's trio; Viola Benoit, soprano; J. T. Livingstone, Hawaiian guitarist.
KDKA, Pittsburgh, Pa. (309.1), 6:15 p. m., Broudy's orchestra; 7:30, children's period; 8, program, National Stockman and Farmer; 8:30, concert; 11, concert, Pittsburgh Post studio.
WBBR, New York, N. Y. (272.6), 8 p. m., Watchtower orchestra; 8:15, Watchtower string quartet; 8:20, Sunday school lesson, S. M. Van Sipma; 8:40, Watchtower orchestra.
WCAE, Pittsburgh, Pa. (461.3), 6:30 p. m., dinner concert, William Penn hotel; S. Moore's Cafeteria Radio review, E. T. Moore, manager; 9, concert, Atwater Kent Radio artists.
WCAU, Philadelphia, Pa. (278), 7:30 p. m., N. Snel-lenburg and company, symphony orchestra; 8:40, "What We See and Hear in Music," Maude Hanson Pettit; 9, Paul Specht's dance orchestra; 10, talk on the new psychology; 10:30, Paul Specht's dance orchestra.
WCX, Detroit, Mich. (516), 4:15 p. m., musical program; 6, dinner concert, Book-Cadillac hotel.
WEAF, New York, N. Y. (491.5), 4-4:15 p. m., Loraine Osborne, soprano; 6-7, dinner music from Waldorf-Astoria; 7-7:30, services, Federation of churches; 7:30-7:45, art talk, 7:45-8, Hermina West, soprano; 8-8:20, Doris Bernstein, pianist; 8:30-9, Packard Motor company; 9-10, Atwater Kent Manufacturing company; 10-11, WEAF studio hour; 11-12, Vincent Lopez and his Hotel Pennsylvania orchestra.
WEAR, Cleveland, Ohio (389.4), 7-8 p. m., Vincent H. Percy, organist; 8-11, program from WEAF.
WEEI, Boston, Mass. (475.9), 6:30 p. m., Big Brother club; 7-25, Greater Boston Federation of churches; 7:55, Pathé News flashes; 8, from New York.
WFLI, Philadelphia, Pa. (394.5), 3 p. m., Housewives'

Radio exchange, direction Mabel Swint Ewer; 6:30, Meyer Davis Bellevue Stratford concert orchestra; 7, Sunny Jim, bedtime stories; 8, concert from WEAF; 9, Atwater Kent concert; 10, dance orchestra from WEAF.

WGBS, New York, N. Y. (315.6), 3-3:10 p. m., interview with Alma Talley, Terese Rosa Nagel; 3:10-3:20, Willard J. Ferrier, baritone; 3:20-3:30, book review, John Cutting; 3:30-3:40, Willard J. Ferrier; 3:40-3:50, "Home Architecture," E. Amory; 3:50-4, Willard J. Ferrier; 6-6:30, Uncle Geebee; 6:30-7:30, Dave Harman's Cinderella orchestra; 8:30-9, "Footlights and Lamplights," Oliver Stanley; 9-9:30, duets, Marie Nicholson and Elizabeth Gibbs; 9:30-11:30, program, Piccadilly theater studio; 11:30-1 a. m., Russian Eagle orchestra.
WGR, Buffalo, N. Y. (319), 6:30-7:30 p. m., dinner music, Halcyon string trio; 8-11, jointly with WEAF, including 9-10, Atwater Kent.
WGY, Schenectady, N. Y. (379.5), 6:30 p. m., Hotel Ten Eyck orchestra; 7:45, WGY orchestra; 8:15, "Agatha's Aunt," WGY players; 11:30, Stephen E. Boisclair, organist.
WHN, New York, N. Y. (361.2), 12:30-1 p. m., Charles Strickland's Palais D'Or orchestra; 6:30-7, violin solos, Olcott Vail; 7-7:30, Silver Slipper revue with Harry Rose; 7:30-7:35, health talk, Dr. Landis; 8-8:30, Chateau Stanley Restaurant orchestra; 8:30-9, Everglades revue; 9:30-10, O'Meara Garden Ballroom orchestra; 11-11:30, Connie's Inn revue; 11:30-12, intermission; 12-12:30 a. m., Parody Club orchestra and revue.
WIP, Philadelphia, Pa. (508.2), 3 p. m., Celeste trio; 4, Harmonica band; 6:05, Benjamin Franklin hotel concert orchestra; 7, Uncle Wip's bedtime stories; 9:30, Philadelphia police band; 11, Harvey Marburger's dance orchestra.
WJY, New York, N. Y. (405.2), 8:15-8:25 p. m., "A Stronger Immigration Law," Harold Fields; 8:30-8:45, Wanamaker organ recital; 9:30-9:45, Olive Badie, contralto; 9:45-10, Sandu Albu, violinist.
WJZ, New York, N. Y. (454.3), 7-8 p. m., Bernhard Levitow's Hotel Commodore orchestra; 8-8:10, Wall Street Journal review; 8:10-8:20, N. Y. U. Air college; 8:25-9:40, Joseph Pavloff, baritone; 9:45-10:15, Crescent ensemble; 10:30-10:45, popular songs, Sanchez and Miltstead.
WKAQ, San Juan, P. R. (340.7), 7:30-9 p. m., musical concert, La Cafetera.
WNYC, New York, N. Y. (526), 7:20-7:30 p. m., sports talk, Thornton Fisher; 7:30-8:15, Irving Bloom and his Cub Tokio orchestra; 8:15-8:25, "Timely Topics," Francis P. Bent; 8:30-10:15, concert program.
WOO, Philadelphia, Pa. (508.2), 11 a. m., organ recital, Mary E. Vogt; 12:02 p. m., Wanamaker crystal tea room orchestra, Robert E. Golden, director; 4:45, organ recital, Mary E. Vogt.
WRC, Washington, D. C. (468.5), 6:45, children's hour, Peggy Albion; 7, Shoreham hotel orchestra; 8, talk, auspices of the Smithsonian institute; 9, dialect stories, W. Alfred Falconer; 10, dance music, Vincent Lopez and his Hotel Mayflower orchestra.
WREO, Lansing, Mich. (285.3), 8:15-9:45 p. m., Reo broadcasting orchestra, Carl Hall Dewey, director; Reo male quartet.
WTAM, Cleveland, Ohio (389.4), 6-7 p. m., dinner music, Hotel Statler studio, Hotel Statler concert orchestra.
WWJ, Detroit, Mich. (352.7), 3 p. m., Detroit News orchestra; 6, dinner concert; 8, concert from WEAF.

Central Time Stations
CKY, Winnipeg, Can. (450), 7:30 p. m., French lecture, Prof. A. C. de la Lande; 8, Canadian National Railways program.
CNRW, Winnipeg, Can. (450), 8:15 p. m., bedtime travel tales; 8:30, Fort Garry hotel trio; Alceve male quartet; 10, Frank Wright's Country club dance orchestra.
KFKU, Lawrence, Kans. (275), 6:50 p. m., piano tuning-in number; 7, music; 7:15, "The Place of Animals in the Flower Border," Prof. W. C. Stevens; 7:30, "Industrial Uses of Alcohol," Dr. Raymond C. Brewster; 7:45, educational psychology, lesson XI, Dean R. A. Schwieger.
KFMQ, Fayetteville, Ark. (299.8), 7:30 p. m., "Need for Science in Arkansas Educational Program," M. F. Showalter; "What is Organized Society," A. W. Jamison; "Every Efficient Housewife a Bacteriologist," W. L. Blecker; "Building a Rural Community," D. T. Gray.
KFNF, Shenandoah, Iowa (266), 6:30 p. m., program from Brooks, Mrs. T. D. Lincoln, director.
KSAC, Manhattan, Kans. (340.7), 7:20 p. m., music; 7:30, "Selection of Hangings and Their Relation to the Room," Harriet W. Allard; 7:40, music, L. R. Putnam, director; 7:50, "Vitamins Up-to-Date," Pearl E. Ruby; 8-9, St. Patrick program, music, Prof. P. P. Bralnard, director.
KSD, St. Louis, Mo. (545.1), 4 p. m., home hour; 8, old-fashioned dance music, J. O. Sturdy and company; "Homing Pigeons in War and Peace," Frank Hollmann; 10, Mrs. Oran Lamke, soprano; Frederick Eves, baritone; Martha Short, violinist; Mrs. George Gehart, reader.

(Continued on page 14)

Index to Popular and Classical Concerts

TABULATED below is a time table of the stations giving popular and classical concerts this week. The concerts are divided into two classes, popular and classical. Stations are likewise divided into the four different standard times in use. The hours are given in the kind of time in use at each listed station. By using this table as an index and referring to the complete programs below, full information will be obtained.

Popular

Eastern Time Stations
Saturday, March 14: 6:30, WGBS, WRC; 7:35, WNYC; 8:15, WJZ; 9:45, WEAF; 10, WGBS; 10:20, WEAF; 10:30, WGBS.
Sunday, March 15: 7:20, WCAE; 8:15, WEAF; 9, WNYC; 9:30, WGBS; 10, WHN, WNYC; 10:30, WGBS; 11:30, WGBS.
Monday, March 16: 7, WCX, WEAR; 7:15, WEAF; 7:30, WEEL; 8, WAHG, WEEL; 8:30, WEAF; 8:40, WJZ; 8:45, WAHG; 9, WAHG, WHAZ, WRC; 9:15, WJZ; 9:30, WAHG; 10:15, WAHG, WLIT; 10:30, WRC; 10:45, WAHG; 11, WHAZ, WHN.
Tuesday, March 17: 6:30, WRC; 7:30, WEEL; 7:45, WNYC, WEBJ; 8, WCAU, WRC; 8:20, WCAU; 8:30, WCAE, WEAF, WEEL; 9, WCAE, WEAF, WEEL, WFL, WGBS, WHN, WRC; 10, WCAE, WJZ; 10:30, WGBS; 12, CKAC.
Wednesday, March 18: 6, WWJ; 7, WCAE, WEBJ, WGY; 8, WEBJ; 8:30, WAHG; 9, WJZ; 11, WAHG, WHN.
Thursday, March 19: 6, WTAM; 8, WRC; 8:15, WGY; 8:30, WEAF; 9, WEAF, WRC; 9:30, WGBS; 10, WRC; 10:30, WGBS, WJZ.
Friday, March 20: 6, WTAM; 6:30, WCAE, WGY; 7:40, WGY; 7:45, WEBJ; 8, WEAF, WEBJ; 8:30, WEAF, WEEL; 8:40, WJZ; 9:30, WCAU; 10, WRC.

Central Time Stations
Saturday, March 14: 7:15, WLS; 8, WLS, WMAQ; 9, WLS; 9:30, WEBH; 10, KYW, WLS, WQJ; 11, WEBH, WQJ; 11:15, WLS; 11:45, WDAF; 12, KYW, WQJ; 1, KYW, WQJ.
Sunday, March 15: 7:30, WHO; 8:30, WLW; 9:30, WFAA; 11, WBAP; 10, WOI; 11, WCEE; 11:45, WDAF.
Monday, March 16: 6:30, WFAA; 7, WCEE; 9, CKY, WEBH, WOAW; 10, WEBH, WQJ; 11, WCEE, WEBH, WQJ; 11:45, WDAF; 12, WEBH, WLBL, WQJ; 1, KYW, WQJ.
Tuesday, March 17: 6:30, WFAA; 7, WCEE; 9, CKY, WEBH, WOAW; 10, WEBH, WQJ; 11, WCEE, WEBH, WQJ; 11:45, WDAF; 12, WEBH, WLBL, WQJ; 1, KYW, WQJ.
Wednesday, March 18: 7, WCEE; 8, WGN; 9, KFMX, WEBH; 10, WEBH, WQJ; 11, WEBH, WQJ; 12, WEBH, WQJ; 1, KYW, WQJ.
Thursday, March 19: 8, KSAC; 9, WEBH; 10, WEBH, WQJ; 11, WEBH, WQJ; 12:15, KTHS; 1, KYW, WQJ.
Friday, March 20: 7, WCEE; 7:30, KFAB, WHO; 8, WDAF; 8:30, KTHS; 9, KYW, WCCO, WDAF, WEBH; 10, KYW, WEBH, WQJ; 11, KYW, WEBH, WQJ; 11:45, WDAF; 12, WEBH, WQJ; 1, KYW, WQJ.

Pacific Time Stations
Saturday, March 14: 8, KGO, KHJ; 9, KFI; 10, KFI; 11, KHJ, KNX; 12, KNX.
Sunday, March 15: 7, KFI; 8, KHJ; 9, KNX; 10, KNX.
Monday, March 16: 7, KNX; 8, KFI; 8:30, KFOA; 9, KFI.
Tuesday, March 17: 8, KFI, KGO, KHJ, KNX; 9, KFI, KNX; 10, KFI, KNX.
Wednesday, March 18: 8:30, KFOA, KHJ; 9, KFI; 10, KFI.
Thursday, March 19: 8, KFI, KGO, KHJ; 9, KFI, KHJ, KNX; 9:30, KHJ; 10, KFI.
Friday, March 20: 8, KHJ, KNX; 8:30, KFOA; 9, KHJ, KNX; 10, KNX; 10:30, KGW.

Classical

Eastern Time Stations
Saturday, March 14: 6, WCX, WEAF, WTAM; 6:20, WEEL; 6:30, WCAE, WFL, WHN; 7, WEAF, WRC; 7:15, WEAF; 7:30, CKAC, WLIT; 7:45, WCAE; 8, CNRO, WBBR, WEAF, WFL; 8:15, WCAE, WIP; 8:30, CNRO, CKAC, KDKA, PWX, WCAE, WJZ, WNYC; 8:45, WBBR; 9, WEAF, WPG; 9:30, WNYC; 9:45, WGBS; 11, WRC; 11:05, WIP; 12, WRC.
Sunday, March 15: 6, WCAU, WOO; 6:30, KDKA, WCAE; 7, WREO; 8:45, WGY; 9, WBBR, WJZ; 9:20, WEAF; 10, WBBR, WGY.
Monday, March 16: 6, WCX, WEAF, WTAM, WWJ; 6:30, CFCA, WCAE, WFL, WHN, WRC; 6:40, WGY; 7, WEAF; 7:30, WGY, WOO; 8, WBBR, WLIT, WOO, WTAM; 8:15, WAHG; 8:30, CHNC, KDKA, WCAE, WNYC; 8:40, WBBR; 9, WCAE, WTAM; 9:30, WLIT; 10, CHIC, WHAG, WEAF, WEEL, WHAZ, WRC; 10:03, WOO; 10:30, WAHG; 11, WCAE, WTAM; 12, WAHG.
Tuesday, March 17: 6, WCAE, WEAF, WTAM, WWJ; 6:30, WCAE, WFL, WGY; 7, WEAF, WEAR, WEBJ, WRC; 7:15, WEEL; 7:30, CKAC, WCAU, WEAF; 7:40, WGY; 8, KDKA, WEAR, WEEL, WFL, WIP, WWJ; 8:15, WEAF, WKAQ, WREO; 8:30, CKAC, WJY; 8:40, WCAU; 8:45, WNYC; 9, KDKA, WCAU, WGY; WKAQ, WIP, WJZ, WRC; 9:30, WIP; 9:35, WJY; 9:45, WGBS; 10, WFL, WGBS; 11, KDKA; 11:30, KDKA.
Wednesday, March 18: 6, WCAE, WCAU, WEAF, WTAM, WWJ; 6:05, WIP; 6:30, WCAE, WFL, WHN; 7, WEAR, WKAQ; 7:25, WEEL; 7:30, WAHG, WEAF, WOO; 8, CNRO, WEAO, WRC, WTAM; 8:15, WOO; 8:20, WEAF; 8:30, KDKA, PWX, WCAE, WEEL, WLIT; 8:45, WCAU; 9, WEEL; 10, WAHG, WEAF; 10:03, WOO; 10:15, WJZ; 10:30, WCAE, WEAF.
Thursday, March 19: 6, WCAE, WWJ; 6:30, WCAE, WGY, WHN, WRC; 7, WEAR, WRC; 7:30, WCAU, WKAQ; 7:45, WEAF, WGY; 8, AT9, WBBR, WCAE, WEAR, WEEL, WFL, WWJ; 8:15, WREO; 8:25, WJZ; 8:30, CKAC, CNRM, KDKA, WJY, WNYC; 8:40, WBBR; 9, WCAE, WFL, WGBS; 9:30, WIP, WJY; 9:45, WJY, WJZ; 10, WEAF; 11, KDKA; 11:30, WGY.
Friday, March 20: 6, WCAE, WEAF, WWJ; 6:30, CNRT, WCAE, WFL, WHN, WRC; 7, WCAU, WEAF, WEAR, WJZ; 7:30, WEEL, WOO; 7:45, WEAF, WNYC; 8, WAHG, WBAV, WEAR, WEEL, WRC, WWJ; 8:15, WAHG, WOO; 8:30, CNRT, KDKA, WCAE; 8:45, WAHG; 9, KDKA, WAHG, WBAV, WNYC, WRC; 9:15, WJZ; 9:45, WAHG; 10, WEEL; 10:03, WOO.

Central Time Stations
Saturday, March 14: 6, WFAA, WGN, WLW; 6:30, KFNE, WGN; 6:45, WOA; 7, KYW, WEBH, WQJ; 7:30, WJZ; 8, KSD, KYW, WGN; 8:30, KTHS, WCCO, WFAA; 9, WMAQ, WMC; 9:35, KYW; 11:30, WOA; 12, WCAL.
Sunday, March 15: 6:30, WLS; 7, KYW, WEBH, WLS, WORD; 7:30, WFAA; 8, WCCD, WQJ; 8:15, WEMC; 8:30, KTHS, WCAL, WFAA; 9, WGN, WHB, WOAW, WQJ; 9:15, WCCO; 9:30, KTHS, WCCD, WOAL, WOC.
Monday, March 16: 6, WGN, WLW, WOAW; 6:15, WCCO; 6:30, KFNE, WFAA, WGN; 6:45, WOA; 7, WEBH; 7:30, KFAB, WHAD, WHO; 8, WCCD, WEAF, WHO, WLW, WORD, WTAS; 8:15, WEMC; 8:30, KTHS, WFAA; 9, WGST, WLW, WOAW; 9:30, KFKX; 11, WCAL, WHO.
Tuesday, March 17: 6, WGN, WLW; 6:15, WCCO; 6:25, WOAW; 6:30, WGN; 7, KYW, WEBH, WQJ; 7:30, WBAP, WHAS; 8, CKY, KFDM, KYW, WCCO, WEBW, WGN, WHB, WLBL, WLW, WOC, WORD; 8:30, KTHS, WFAA, WLW, WOA; 9, KFMQ, KYW, WOAW; 9:30, WBAP; 10, KYW; 11, WFAA.
Wednesday, March 18: 6, WGN, WLW; 6:30, KFNE, WGN, WHO; 7, KYW, WEBH, WQJ; 7:30, KFAB, WBAP, WHAS, WHO; 8, KYW, KSAC, WDAF; 8:15, WEMC; 8:30, KTHS, WHO; 9, KYW, WCCO, WHA, WOC; 10, WLW.
Thursday, March 19: 6, WGN, WLW; 6:30, KFNE, WFAA, WGN; 7, KYW, WCCO, WEBH, WGST, WOC, WORD, WQJ; 7:30, WBAP, WHAS; 8, CKY, WCCD, WCCO, WGN, WHB; 8:15, WOI; 8:20, KYW; 8:30, KTHS, WFAA, WHB; 9, KTHS, WCAL, WCCO, WOAW, WOC; 9:30, KFKX, WBAP; 10, KYW; 10:03, WLW; 11, WFAA.
Friday, March 20: 6, WGN; 6:15, WCCO; 6:30, KFNE, WFAA, WGN, WOAW; 7, KYW, WEBH, WQJ; 7:30, WBAP, WHAS; 8, CKY, KFDM, WCCO, WEBH, WGN, WHAD, WOC, WORD; 8:30, WFAA; 9, KFDM, WEMC, WOAW; 9:30, WBAP.

Mountain Time Stations
Monday, March 16: 8, KOA; 8:10, KOA.
Tuesday, March 17: 6, KOA; 8, CNRR.
Wednesday, March 18: 9, CNRC.
Thursday, March 19: 9, CNRC.
Friday, March 20: 8, KOA; 8:10, KOA.

Pacific Time Stations
Saturday, March 14: 6, KHJ; 6:15, KNX; 6:45, KFOA; 8, KNX.
Sunday, March 15: 6:30, KHJ; 7, KGW, KHJ, KNX; 8, KFI, KNX, KPO.
Monday, March 16: 6, KLX; 6:45, KFOA; 8, KNX, KPO; 9, KPO.
Tuesday, March 17: 6, KHJ; 6:30, KNX, KPO; 6:45, KFOA; 8, KPO; 8:30, KGW.
Wednesday, March 18: 6, KGW, KHJ, KLX; 6:15, KNX; 6:45, KFOA; 7:30, KFI, KHJ, KPO; 8, KGW, KLX, KNX, KPO; 9, KPO.
Thursday, March 19: 6, KHJ; 7, KFI; 8, KGW, KNX, KPO; 9, KPO.
Friday, March 20: 6, KGW, KHJ, KLX; 6:30, KNX; 6:45, KFOA; 7, KFI; 7:45, KLX; 8, KFI, KPO; 10, KFI.

Thursday, March 19

(Continued from page 13)

KTHS, Hot Spring National Park, Ark. (374.8), 8:30-9 p. m., Meyer Davis comedy trio; Phil Wall, pianist; Sam Izen, soloist; Jack Cressy, clarinetist; 9-10, Lawson Reid, organist; 12:15-1:45, Phil Baxter and his singing orchestra.

KYW, Chicago, Ill. (536), 6:35-7 p. m., Uncle Bob; 7, Congress hotel dinner concert; 7:33, "What Dairy Club Work Means to Dairyland," Wm. E. Skinner; "What Farm Community Life Means to Illinois," Paul A. Potter; 8, "Twenty Minutes of Good Reading," Rev. C. J. Perlin; 8:20-9, musical program; Caroline Encell, soprano; Kirk Taylor, baritone; Blanch McGuire, pianist; 9:05, safety first talk; Bert Vandervort; 10-11:30, evening at home program; 1-2 a. m., Insomnia club, Coon-Sanders Original night-hawks.

WBAP, Fort Worth, Tex. (475.9), 7:30-8:30 p. m., Enterpean club; 9:30-10:45, artists, Texas Christian university.

WBCN, Chicago, Ill. (266), 7-8 p. m., classical program; 8-12, Elmer Jordan jamboree; 12-1 a. m., popular program.

WCAL, Northfield, Minn. (336.9), 9 p. m., musical program, Mrs. Sara Bjorseth Brye, pianist; Alice Stibb, pianist; Herbert Hauge, saxophonist; John Gaardsmoen, baritone.

WCBB, Zion, Ill. (344.6), 8 p. m., mixed quartet, string quartet; Mr. and Mrs. R. M. Steel, tenor and soprano; Mrs. Beem, Mrs. Crow, soprano and contralto; Erwin Rendall, flutist; Grace Detienne, reader; Evelyn Uhlik DePew, pianist.

WCCO, Minneapolis-St. Paul, Minn. (416.4), 7 p. m., National program, from New York.

WDAF, Kansas City, Mo. (365.6), 3:30-4:30 p. m., Star's Radio trio; 6, piano tuning-in number on the Duo-Art; 6:15, piano talks, Louis Mecker; Tell-Me-a-Story lady; Trionan ensemble; 11:45-1 a. m., Merry Old Chief, Plantation players; Eddie Kuhn's Kansas City Athletic club orchestra.

WEBB, Chicago, Ill. (370.2), 7-8 p. m., Edgewater Beach Orleole orchestra; Dan Russo, violinist; Ted Beach, Orleole; Celeste; musical bits, Balaban & Katz Riviera theater; 9-10, Edgewater Beach Orleole orchestra; Belle Forbest Cutler, soprano; Howard Neumiller, accompanist; John Stamford, tenor; 11-12, Edgewater Beach Orleole orchestra; Banks Kennedy, songs; Dean Remick, pianist; Loos Brothers, songs.

WFAA, Dallas, Texas (475.9), 6:30-7:30 p. m., Lone Star Five's orchestra; 8:30-9:30, Baptist quartet; 11-12, Edward Cramer, violinist.

WGN, Chicago, Ill. (370.2), 6 p. m., organ recital, Lyon & Healy; 6:30-7, Drake concert ensemble, Blackstone string quintet; 8-9, Marie Sharp Heriden; 10-11, Hiram college glee club; Don Bestor's Drake dance orchestra.

WGST, Atlanta, Ga. (428.3), 7-8 p. m., string quartet, W. W. Leffingwell, violinist; Mrs. Mary Emma Phillips, violinist; Mary Leffingwell, violinist; Van Pergurson, violinist; T. S. Dunn, Prof. of geology and metallurgy.

WHAS, Louisville, Ky. (399.8), 4-5 p. m., Louisville Conservatory of music; 7:30-9, Happy Hoosier harmonists.

WHB, Kansas City, Mo. (365.6), 2-3 p. m., ladies' hour program; 7-8, "The Church a Community Asset," Dr. Henry C. Rogers; 8-10, Jack Roberts, pianist; Mrs. Nellie Heatherford, soprano; trio, Jack Brill, violinist; John Kane, cellist; Jack Roberts, pianist; Jack Roberts, tenor; Lyra Ferguson, reader; O. Kane, cellist.

WHO, Des Moines, Iowa (526), 11-12 m., Melo-Blue dance orchestra.

WLS, Chicago, Ill. (345), 6:30 p. m., Ralph Emerson, organist; 6:50, Senate theater studio; 7, lullaby time, Ford and Glenn; 7:20, Mele Hawaiian studio; 7:40, Phyllis Campbell, contralto.

WLW, Cincinnati, Ohio, (423) 4 p. m., French lesson, Madame Ida Telpmidis; Adelaide Apfel, pianist; 6, dinner hour concert; 10, three minute message, Civil Service Department of United States Government; 10:03, concert program, Cooper corporation; Cooper orchestra, directed by William Stoess; male quartet; piano accordion solos, Larry Grueter; popular program, The Doherty Melody Boys.

WMAQ, Chicago, Ill. (447.5), 6 p. m., Chicago theater organ recital; 6:25, Hotel LaSalle orchestra; 6:50, "Daddy," 8, garden talk, James H. Burdett; 8:15, Boy Scout talk; 8:30, Estelle L. Welch, reader; 8:50, U. of C lecture; 9:15, announced.

WOAI, San Antonio, Texas (394.5), 9:30 p. m., Jimmie Joy's Hotel St. Anthony orchestra.

WOAW, Omaha, Nebr. (526), 6 p. m., every child's story hour, Grace Sorenson; 6:20, music; 6:45, Randall's Royal Fontenelle orchestra; 9, J. E. Brill, violinist; 10, music; 10:30, Frank W. Hodek, Jr., and his Nightingale orchestra.

WOC, Davenport, Ia. (483.6), 6:30 p. m., sandman's visit; 7, program from WEAF; 11, Louis Connor and his LeClaire hotel orchestra; Peter MacArthur, baritone.

WOI, Ames, Iowa (270), 8:15 p. m., musical program, land, soprano; Mrs. Roscoe Struyker, mezzo-soprano; Victor Lowry, tenor; E. H. Druggett, violinist; John Berger, inaplist; E. H. Druggett, violinist; John concert trio; Sunday school lesson, B. F. Hollister.

WOL, Chicago, Ill. (447.5), 7-8 p. m., dinner concert, Ralph Williams and his Rainbo Garden orchestra; Mrs. Lydia Lochner, contralto; Dorothy David Dilloy, soprano; Blanche E. Robinson, pianist; Mildred Perlin, prano; Blanche E. Robinson, pianist; and his Rainbo reader; 10-1 a. m., Ralph Williams, director; Lew skylarks; Verdil trio, Louis Sabella, director; James J. Whalen, tenor; 1-2, Hotsy Totsy hour, Ralph Williams, the gingerman, Hotsy skylarks.

WSAI, Cincinnati, Ohio (325.9), 7 p. m., hookup with WEAF, Victor record artists.

WSB, Atlanta, Ga. (428.3), 8-9 p. m., Ritz Harmony Boys orchestra; 10:45, Dr. Charles A. Sheldon, organist.

WTAS, Elgin, Ill. (302.8), 7:15 p. m., WTAS dance program, "Boss' Own" orchestra.

Mountain Time Stations

CNRC, Calgary, Can. (450), 9 p. m., CNRC's Little Symphony orchestra; B. Joyce, clarinetist; E. Harris, soloist; Alf Carter, flutist.

Pacific Time Stations

KFI, Los Angeles, Calif. (468.5), 5:30-6 p. m., Examiner's musical half hour; 6:45-7, Radiatorial talk and Judge Albert H. Scott of Y. M. C. A.; "Crooks and Citizenship," 7-7:30, Celia Lewis, 13, pianist; Harold Lewis, 15, flutist; 7:30-8, The Sizer trio; 8-9, Standard Oil company, "The Missions of Program," Standard Oil company; Helen Dosh, San Diego; 9-10, Mt. Phi Epsilon trio, Helen Dosh, pianist; Marion Sisco, cellist; Dorothy Cameron, violinist; 10-11, Examiner, League of American Penwomen.

KGO, Oakland, Calif. (361.2), 7:15 p. m., golf lesson, Joe Novak; 8, "Billy," KGO players; Arion trio; 10-1.

KGW, Portland, Ore. (491.5) 8 p. m., Oregonian concert orchestra; 10, Multnomah Hotel Strollers.

KHJ, Los Angeles, Calif. (405.2), 6-6:30 p. m., Art Hickman's Biltmore hotel concert orchestra, Edw. Fitzpatrick, director; 6:30-7:30, little stories, American history, Prof. Walter Sylvester Hertzog; Dickie Brandon, screen starlet; Uncle John; 7:30, "Art," Harold Swartz; 7:45, "Care of Body," Dr. Philip M. Lovell; 8-10, program, Ray F. Chesley, Ford dealer; Piggly Wiggly girls trio; 10-11, Art Hickman's Biltmore hotel dance orchestra, Earl Burnett, leader.

KNX, Hollywood, Calif. (336.9), 5:45-6:15 p. m., Wurlitzer pipe organ studio; sports talk, Sid Ziff; 6:30-7:30, Ziegler's orchestra, presented by L. A. County Association of Optometrists; 8-10, KNX feature program; 10-11, Abe Lyman's Coccanut Grove dance orchestra.

KPO, San Francisco, Calif. (428.3), 5:30-6:30 p. m., children's hour, Big Brother; 7-7:30, Theodore J. Irwin, organist; 9-10, Patricia Galloway, soprano; 10-11, Gene James' Rose Room Bowl orchestra.

Friday, March 20

Friday, silent night for: AT9, CHNC, CKAC, CNRO, KFKU, KFKX, KFMQ, KFMX, KFUG, KGO, KSD, WBAY, WBBR, WCBD, WEAD, WEAQ, WEEW, WFI, WGST, WHAZ, WIP, WJAZ, WLAL, WLW, WOAI, WOI, WRO, WREO, WSAI, WSUI.

Eastern Time Stations

CKAC, Montreal, Can. (411), 8 p. m., orchestra.

CNRA, Moncton, Can. (313), 6:30 p. m., bedtime stories, Uncle Alf; 7:30, Moncton Knights of Columbus, R. F. Ward, director; K. of C. male quartet; J. B. Connolly, baritone; Mrs. Raymond Legree, violinist; Frank Lynch, tenor; R. J. Ward, bass; address; K. of C. orchestra; Mrs. Warrnie Garnet, contralto; Emelia Richard, pianist; Anna Malenfant, contralto; James Kelly, mouth organist; K. C. male quartet; Rainbow Melody Boys.

CNRT, Toronto, Can. (356), 6:30-8 p. m., Luigi Romanelli and his King Edward hotel concert orchestra; 8:30-10, male choir, Toronto club of Printing-House craftsmen; Muriel Young, soprano; F. L. Plant, pianist; 9, address; 10:30-12, Luigi Romanelli and his King Edward hotel dance orchestra.

KDKA, Pittsburgh, Pa. (309.1), 6:15 p. m., dinner concert, Charlie Gaylord's orchestra; 7:30, children's period; 7:45, "How Costs Control Prices," Marcus Rauh; 8:15, address, University of Pittsburgh company; concert; 9, concert, courtesy Reick-McJunkin company.

WAHG, Richmond Hill, N. Y. (315.6), 8-8:15 Anthony Pesci, tenor; 8:15-8:30, Emery Deutsch, violinist; 8:30-8:45, Martha Brauningner, soprano; 8:45-9, Bessie Liebowitz, pianist; 9-9:30, Michael Lambert, cellist; 9:30-9:45, Anthony Pesci; 9:45-10, Emery Deutsch; 10-10:15, Radio question box, William E. Diehl; 10:15-10:30, Martha Brauningner; 10:30-11:30, dance music; 12-2 a. m., special program, Glen C. Smith's Paramount orchestra.

WBAV, Columbus, Ohio (293.9), 8-10 p. m., concert, Columbus division, Pennsylvania railroad.

WCAE, Pittsburgh, Pa. (461.3), 6:30 p. m., dinner concert, William Penn hotel; 8:30, concert, Schubert club.

WCAU, Philadelphia, Pa. (278), 7 p. m., Hotel Pennsylvania Meyer Davis concert orchestra, Lon Chassy, director; 9:30, The Musical Chef; 9:40, Helper's International Sunday school notes; 10:20, Paul Specht's dance orchestra.

WCX, Detroit, Mich. (516), 4:15 p. m., musical program; 6, dinner concert, Book-Cadillac hotel; 7, musical program; 10, dance music, Arcadia ballroom.

WDWF, Providence, R. I. (440.9), 8 p. m., lectures and talks, faculty, Brown university.

WEAF, New York, N. Y. (491.5), 4-4:15 p. m., Mayme Anderson, soprano; 4:15-4:30, C. Brody, Little, baritone; 6-7, dinner music from Weymouth-Astoria; 7:15, Premier male quartet; 7:30-7:45, children's stories; 7:45-8, Nancy McCord, soprano; 8-8:30, Happiness Candy Boys; 8:30-10:30, Rutgers College musical club; 11-12, Meyer Davis' Lido Venice orchestra.

WEAR, Cleveland, Ohio (389.4), 7-8 p. m., program, alumni of Akron university; 8-10, International quartet; Florence Wasson, soprano; James Blair, bass; Marie Simmelnik, contralto; Sam Roberts, tenor; Mrs. J. Powell Jones, accompanist; Rudolph Ringwald, violinist; Budd Cross, pianist.

WEJ, New York, N. Y. (233), 7-7:30 p. m., Dan Barnett's orchestra; 7:45-8, Eddie Burke, Irish pipe; 8-8:15, The 345 duo; 8:15-8:30, Eddie Burke; 8:30-9, Cliff Crest Society orchestra.

WEEL, Boston, Mass. (475.9), 6:30 p. m., Big Brother club; 7:30, program, Whittings Milk company; 8, program, Neapolitan male quartet; 8:30, Sedrian trio; 9, Broderick's orchestra; 10, Louis Weir, organist.

WFI, Philadelphia, Pa. (394.5), 8 p. m., "Story of Kenneth," Chauncey Shortlidge; 6:30, Meyer Davis Bellevue Stratford concert orchestra; 7, Sunny Jim, bedtime stories.

WGBS, New York, N. Y. (316), 3-3:10 p. m., interview with Adele Klaer by Terese Rose Nagel; 3:10-3:20, Marjorie Fouts, soprano; 3:20-3:30, interview, David Robinson; 3:30-3:40, Marjorie Fouts; 3:40-3:50, theory and composition lessons, Dr. A. G. Robyn; 3:50-4, Marjorie Fouts; 6-6:30, Uncle Geebee; 6:30-6:40, "Radio Problems," Herman Bernard; 6:40-7:30, Larry Funk's orchestra.

WGR, Buffalo, N. Y. (319), 6:30-7:30 p. m., dinner music, Buffalo Trust company; 8-9, educational opera entertainment, Director, Eleanor D. Baker; 9-10, University of Buffalo musical program; 10-11, Larkin string orchestra; 11-1, supper-dance music, Vincent Lopez Hotel Statler dance orchestra, Harold Gieser, director.

WGY, Schenectady, N. Y. (379.5), 7 p. m., Albany Strand theater orchestra; 7:30, health talk; 7:40, "I Trovatore," WGY opera company.

WHN, New York, N. Y. (361.2), 6:30-7 p. m., violin solos, Oleott Vail; 7-7:30, Harry Richman and his entertainers; 7:30-7:35, health talk, Dr. Landis; 8-8:10, fashion chats, Mme. Belle; 8:30-9, Dave Harmon and his Cinderella orchestra; 9:30-10, Dan Gregory and his Crystal Palace orchestra; 10:25-10:30, "Storage Batteries," H. B. Shontz; 10:30-11, Rose-land dance orchestra; 11-11:30, Everglades revue; 11:30-12, Club Alabam orchestra; 12-12:30 a. m., Parody club orchestra and revue.

WIP, Philadelphia, Pa. (508.2), 3:15 p. m., Robert Horzog, violinist; 6:05, songs, Mark Fisher, Joe Burke; 6:15, Harvey Marburger's dance orchestra; 7, Uncle Wip's bedtime stories.

WJY, New York, N. Y. (405.2), 7:30-8:30 p. m., Billy Wynne's Greenwich Village Inn orchestra; 10-10:30, Monte Carlo Virginians.

WJZ, New York, N. Y. (454.3), 7-7:30 p. m., Savarin ensemble; 8-8:10, Wall Street Journal review; 8:10-8:20, N. Y. U. Air college; 8:30-8:55, Harry J. Coffey, tenor; 9:15-9:45, U. S. Navy; 10:30-11:30, Duke Yellman and his Irene Castle orchestra.

WLIT, Philadelphia, Pa. (394.5), 7:30 p. m., Dream Daddy's bedtime stories; 8, book review; 8:15, Sam Wingfield's humor talk; Philadelphia Ulster Pipe band; 10:03, Arcadia cafe dance orchestra; Morning Glory club concert.

WNYC, New York, N. Y. (526), 7:35-7:45 p. m., resume of meeting of Board of Estimate; 7:45-8:45, instrumental program; 9-10, German music hour; 10:10-10:30, book talk, Professor J. G. Carter Troop.

WOP, Philadelphia, Pa. (508.2), 4:45 p. m., organ recital, Mary E. Vogt; 7:30, A. Candelori's orchestra from Hotel Adelphi; 8:15, recital; 9, Astor dance orchestra from WEAF; 10:03, organ recital, Mary E. Vogt; 10:30, Vincent Rizzo's dance orchestra.

WREO, Lansing, Mich. (285.5), 1 a. m., special orchestra program for Pacific Coast.

WTAM, Cleveland, Ohio (389.4), 6-7 p. m., dinner dance music, Guy Lombardo and his Royal Canadians.

WWJ, Detroit, Mich. (352.7), 3 p. m., Detroit News orchestra; 6, dinner concert; 8, Detroit News orchestra; 9, Jean Goldkette's Victor Recording orchestra.

Central Time Stations

CKY, Winnipeg, Can. (450), 7:30 p. m., university lecture; 8, studio program.

KFAB, Lincoln, Nebr. (240), 7:30-9 p. m., Buick entertainers; 9-9:30, Serenaders orchestra.

KFDM, Beaumont, Tex. (315.6), 7-7:30 p. m., children's half hour; 8-10:30, band concert, Magnolia Petroleum Company's Refinery band.

KFNH, Shenandoah, Ia. (266), 6:30 p. m., concert.

KSAC, Manhattan, Kan. (340.7), 7:20 p. m., college quartet; 7:30, "The Sanitary Control of the Milk Supply," A. C. Fay; 7:40, college quartet; 7:50, "Third Claimant," T. J. Anderson.

KTHS, Hot Springs National Park, Ark. (374.8), 8:30-9 p. m., Fischer orchestra trio; 9-10, Meyer Davis Arlington concert; ensemble, Jacques Renard.

KYW, Chicago, Ill. (536), 6:35-7 p. m., Uncle Bob; 7-7:30, Congress hotel dinner concert; 9-1 a. m., mid-night revue; 1-2, Insomnia club, Coon-Sanders Original night-hawks.

WBAP, Fort Worth, Tex. (475.9), 4 p. m., weekly book review, Peter Molyneux; 7:30-8:30, Wagner's old time fiddlers; 9:30-10:45, Texas Woman's college.

WBCN, Chicago, Ill. (266), 7-9 p. m., Becker Ryon company popular program; 9-10, Tegtemier classical program; 10-10:30, orchestra.

WCAL, Northfield, Minn. (336.9), 8:30 p. m., book talk, Dr. George Weida Spohn.

WCCO, Minneapolis-St. Paul, Minn. (416.4), 6:15 p. m., dinner concert, Minneapolis Athletic club orchestra; 7:30, lecture; 8, St. Cloud night; 9, The F. & R. Family; 10, Original George Osborn's Niccollet hotel orchestra.

WCEE, Elgin, Ill. (275), 7 p. m., "Boss' Own" orchestra, Fred Hamm, director; Eddie Loftus, WCEE Radio Stars; 11 p. m., midnight dance program, Fred Hamm, director; Eddie Loftus and other features to be announced.

WDAF, Kansas City, Mo. (365.6), 3:30-4:30 p. m., Star's Radio trio; 6-7, piano tuning-in number on the Duo-Art; book talk, Louis Mecker; Tell-Me-a-Story Lady; Trionan ensemble; 8-10, popular program; 11:45-1, Merry Old Chief, Plantation players.

WEBB, Chicago, Ill. (370.2), 7-8 p. m., Edgewater Beach Orleole orchestra; Cambridge Sisters, songs; musical bits, Balaban & Katz Riviera theater; 9-10, Edgewater Beach Orleole orchestra; Rita McFawn, soprano; Jack Penewell, Twin Guitarists; Sandy Meek, tenor; 11-12, Edgewater Beach Orleole orchestra; Three Musketeers, songs; Jack Penewell, Twin Guitar; Dennis Sisters, songs.

WEMC, Berrien Springs, Mich. (285.5), 9 p. m., "Famous Reformation Hymns," Radio choir; Opal Hoover, saxophonist; Bible chat, Fred Mote.

WFAA, Dallas, Tex. (475.9), 6:30-7:30 p. m., vesper recital, Jack A. Davis, pianist; 8:30-9:30, municipal band, Dr. C. J. Hicks, manager.

WGN, Chicago, Ill. (370.2), 6 p. m., organ recital, Lyon & Healy; 6:30-7, Drake concert ensemble, Blackstone string quintet; 8-8, Knupper School; 10-11, Don Bestor Drake dance orchestra.

WHA, Madison, Wis. (535.4), 9 p. m., "The Law—Do We Know It," Prof. W. H. Page; University Haresfoot club.

WHA, Milwaukee, Wis. (279.5), 8-10 p. m., program, Wisconsin theater.

WHAS, Louisville, Ky. (399.8), 4-5 p. m., Louisville Conservatory of Music; Alamo theater organ; 7:30-9, Original Kentucky Night Owls; fifteen-minute specialty, C. A. Elliott; civil service talk, O. A. Beckman.

WHB, Kansas City, Mo. (365.6), 2-3 p. m., ladies' hour, Piggly Wiggly Girls; 7-8, "The Making of a Modern Community," Dr. James W. Fifield; Mrs. A. G. Stannard, musical director.

WHO, Des Moines Ia. (526), 2:15 p. m., Camp Fire Girls' program; 7:30-9, Tommie Malie, Sammie Stept; Verba Parker, soprano; Cora Jan Burberry, comedian; Williamson Brothers.

WLS, Chicago, Ill. (345), 6:30 p. m., Ralph Emerson, organist; 6:50, Senate theater studio; 7, lullaby time, R. E. D. program; Ford and Glenn; "John Turnipseed" series; "Safe Adapted Seed for American Farmers," Prof. J. F. Cox; "Uniformity in Marketing Through Standard Grades and Classes," J. S. Campbell; 9, Glenn's Cornhuskers orchestra; 9:10, WLS theater; 9:30, Nubs Allan, contralto; 9:40, Senate theater synopating orchestra; 10, Senate symphony orchestra; 10:10, Mt. Greenwood Girls' glee club.

WMAQ, Chicago, Ill. (447.5), 6 p. m., Chicago theater organ recital; 6:30, Hotel LaSalle orchestra; 8, Wide-Awake club program, Frances M. Ford; 8:30, musical geography, Mr. and Mrs. Marx E. Oberdorfer; 9, Christian Endeavor talk; 9:15, musical program.

WOAW, Omaha, Nebr. (526), 6 p. m., story hour, Doris Claire Secord, 6:20, to be announced; 6:30, Harry Brader, violinist; Frank Strawn, pianist; 7, to be announced; 7:15, current sport events, Ivan L. Gaddis; 9 program, auspices Chicago, Burlington & Quincy Railroad company; 10:30, Eddie Kuhn's orchestra.

WOC, Davenport, Ia. (483.6), 6:30 p. m., sandman's stories, Val McLaughlin; 6:50, "The Care of Farm Machinery," Carl H. Gamble; 8, Davenport Zither club.

WORD, Batavia, Ill. (275), 8-9 p. m., East Aurora High school orchestra; Chas. L. Daniels, lecture on dentistry.

WOS, Jefferson City, Mo. (440.9), 8 p. m., "Sowing Alfalfa in Springtime," Samuel M. Jordan; original poems, LeRoy H. Kelsey; St. Pat's ball.

WQJ, Chicago, Ill. (447.5), 7-8 p. m., dinner concert, Ralph Williams and his Rainbo Garden orchestra, Herman J. Techtentine, baritone; Edith Phillips Heller,

pianist; Henrietta Nolan, violinist; 10-1, Ralph Williams and his Rainbo Skylarks; Rogers Boys; West Brothers; Lauretta Giles, soprano; Nate Caldwell, pianist; Zeigler Sisters; 1-2, Hotsy Totsy hour, Ralph Williams.

WSB, Atlanta, Ga. (428.3), 8-9 p. m., Kimokaloahs Honolulu Maids; 10:45, entertainment.

WTAS, Elgin, Ill. (302.8), 8-11 p. m., WTAS dance program, "Boss' Own" orchestra, Eddie Loftus and other features.

Mountain Time Stations

CNRE, Edmonton, Can. (517), 7:30 p. m., children's half hour; 8:30, Gitsy Mahaffy, violinist; Mary Paradis, soprano; W. E. Buckley, vocalist; vocal duet, Mary Paradis, Emilie Paradise; Marguerite Patzig, pianist; Vivian Anderson, reader; Gitsy Mahaffy, vocalist.

KOA, Denver, Colo. (322.4), 8 p. m., Fred Schmitt and his Rialto theater orchestra; 8:10, Blanche Dinsley-Mathews Piano Work, Inc., program; "Music in the Life of the Child," Mrs. Frederica H. Wadley; KOA orchestra.

KOB, State College, N. M. (348.6), 7:30-8:30 p. m., popular science course, Dr. D. S. Robbins; "The Datal and Gila National Forests," John D. Jones; musical numbers, Prof. and Mrs. John C. Overpeck.

Pacific Time Stations

KFAE, Pullman, Wash. (348.6), 7:30-9 p. m., Vera Bohle, soprano; Marguerite MacLachlan, violinist; "Keeping Rabbits," Charles Stone; "What is Worth Seeing in Paris," Prof. Carl M. Brewster; "Planning Spring Pageants," Prof. M. L. Daggy; book chat, Alice Lindsey Webb.

KFI, Los Angeles, Calif. (468.5), 5:30-6 p. m., Examiner's musical half hour; 6:45-7, Radiatorial talk; 7-8, Examiner, vocal recital, pupils of Thomas Taylor Drill; 8-9, Dan McFarland, organist; 9-10, Evening Herald's hour of dance music; 10-11, Marguerite Goebel Le Grand, concert pianist.

KFOA, Seattle, Wash. (384.4), 6:45-8:15 p. m., Sherman Clay and company program; 8:30-10, Seattle Times studio program; 10:05-11, Eddie Harkness and his orchestra.

KGW, Portland, Ore. (491.5), 6 p. m., dinner concert; 8, lecture, University of Oregon Extension division; 10:30, Hoot Owls.

KHJ, Los Angeles, Calif. (405.2), 6-6:30 p. m., Art Hickman's Biltmore hotel concert orchestra, Edward Fitzpatrick, director; 6:30-7:30, little stories, American history, Prof. Walter Sylvester Hertzog; Richard Headrick, screen juvenile; 7:30, "The Santa Fe Trail," Gladys De Witt; 8-10, program, Western Auto Supply company, arranged by J. Howard Johnson; 10-11, Art Hickman's Biltmore hotel dance orchestra, Earl Burnett, leader.

KLX, Oakland, Calif. (508.2), 6-7 p. m., organ recital; 7:45-9:45, studio program; 9:45-10:30, Sweet's ballroom.

KNX, Hollywood, Calif. (336.9), 5:45-6:15 p. m., Wurlitzer pipe organ studio; sports talk, Sid Ziff; 6:30-7:30, dinner hour music; 8-10, college "frat" program; 10-11, June Pursell, the KNX girl, singing popular songs; 11-12, Abe Lyman's Coccanut Grove dance orchestra from Ambassador hotel.

KPO, San Francisco, Calif. (428.3), 4:30-5:30 p. m., Rudy Seiger's Fairmont hotel orchestra; 8-10, Cleveland Six orchestra; one act play, members Theater Arts club, Talma Zetta Wilbur, director.

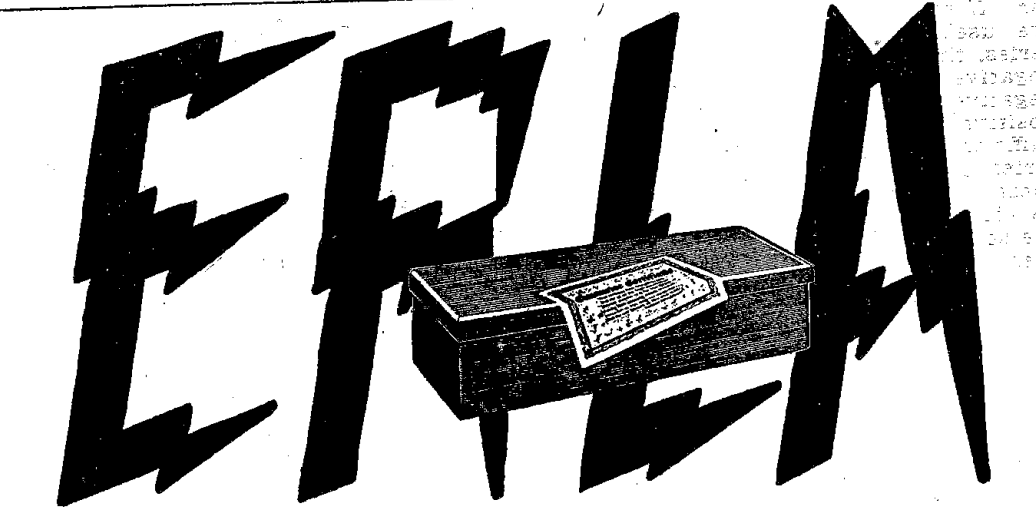

Supereflex Means MORE POWER PER TUBE

Erla Supereflex makes tubes do triple duty. One tube actually does the work of three that would be needed otherwise. Three tubes do the work of five, unquestionably! That is why simple, compact, inexpensive Erla Supereflex receivers equal or surpass the performance of costliest, temperamental multi-stage radio sets.

More power, tube for tube, is basic in Erla Supereflex. Nothing else can "make up for it." Greater power in Erla Supereflex just simply means finer radio, which you can afford.

CIR-KIT is a complete array of Erla Scientific Precision Apparatus, especially created to make Supereflex possible. CIR-KIT provides clear, simple instructions for perfect assembly. Blueprints are full size. The panel is pre-drilled for you. The baseboard is marked to locate every unit accurately. The famous Erla Solderless Connectors do away with soldering entirely.

For you yourself can confidently build these matchless Erla circuits with Erla Supereflex CIR-KIT.

With screwdriver, pliers and CIR-KIT you are sure of a set that will make you proud, both for appearance and performance. The cost is very moderate. Yet the range, volume, selectivity AND TONE PURITY are rarely equaled at any price, because Supereflex does give you more power, tube for tube.

Electrical Research Laboratories
Department A, 2500 Cottage Grove Avenue, Chicago

CIR-KIT

OPERATING AND TROUBLE SHOOTING

For the Owner of a Grebe Synchronphase Receiver

THIS receiver possesses several unusual features both as to appearance and construction which make it materially different from any other receiver on the market. While it would come under the general classification of tuned Radio frequency, the transformers used to couple the tubes are radically different from any others and there is an unique volume control provided in the audio frequency part of the set. As can be seen from the illustration there are no dials on the face of the cabinet as is the usual practice but instead A. H. Grebe & company have utilized their well-known method of rheostat control and adapted it to tuning. The shafts of the condensers are vertical instead of horizontal and only the edges of the dials protrude through openings in the panel while, at the bottom of the panel, three knurled discs protrude which can be easily moved with the thumb. There is a vernier action, between the bottom controls and the dials, of about five to one. In the illustration, 1, 2 and 3 are the graduated dials while 4 is the volume control and 5 is the rheostat.

Connecting Accessories

The equipment required with this set consists of five 201A tubes, one 6-volt storage battery, 96 volts of B battery, one 4½-volt C battery and one loud speaker. This receiver was tested on a 60-foot vertical aerial with a ground that was known to be good, connected to the radiator. If four 22½-volt dry cell B batteries are used they should be connected in series, that is, the positive of one to the negative of the next. This will leave a negative terminal open at one end and a positive terminal at the other. Wires sufficiently long to reach from the batteries to the set should be connected to these open terminals and a third should be connected to the positive terminal of the second battery from the negative end; there should be two B battery units be-

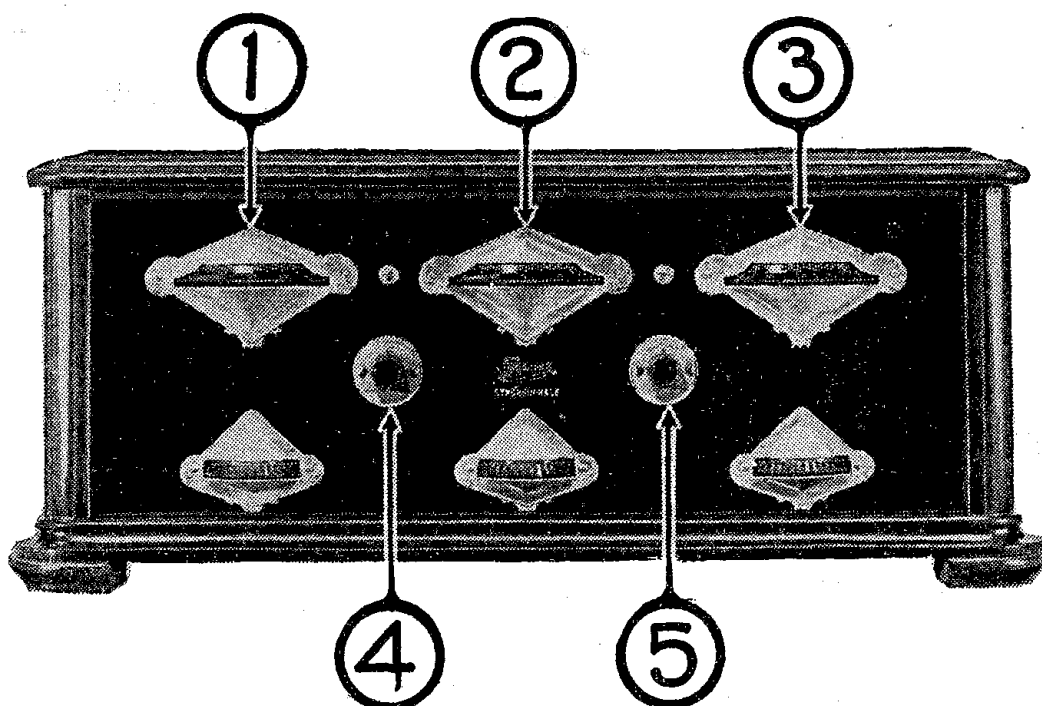

tween the negative terminal and this third wire. In our tests 45-volt storage B units were used of which there were two; thus there was only one jumper wire between units and our third wire was attached to this jumper. Two more wires will be required that will reach from the storage A battery to the set. For this purpose it will be found very convenient to use the five-wire cables which have recently made their appearance on the market. The connections for the accessories will be found on the bottom of this set and it will be necessary to tip the receiver back on its rear edge to connect the wires mentioned above. Before connecting any wires, the rheostat knob 5 should be turned to the extreme left.

The antenna binding post will be found as a Fahnestock clip at the left end of the row, the ground is next, the third is for a loop if used, the unmarked loud speaker wire connects to the fourth, the plus speaker cord goes to the fifth, the B battery plus is next, then the wire from the center of the series of B units and

the minus C connects to the eighth. Plus C and minus A should be attached to the ninth clip while minus B and plus A go to the last one to the right. The C battery should be placed close up behind the cabinet and as it is small it cannot be seen.

Tuning

Now, with volume control knob 4 at maximum to the right and the rheostat knob 5 turned so the pointer is under the letter A in the word increase, one is

ready to tune for stations. It will be found that dials 2 and 3 run practically identical throughout the scale while dial 1 will not vary from their settings by more than one or two dial divisions.

We first tried for Station WEAF with a wave length of 492 and found it at dial settings of 84.5, 83, 83: Going down the scale, WCAP at Washington, D. C., on 469 was heard with maximum volume at 75, 74, 73 and just why the last dial deviated from the setting of number 2 is hard to say. The selectivity was well demonstrated on WCAP and KFI of Los Angeles, both of which were supposedly on 469 meters, and probably were not more than two meters apart. A turn of all three dials, one-fourth of a division to the left from the WCAP setting, brought in KFI and the Hotel Alexandria orchestra.

Dials 2 and 3 were moved together, one division at a time to the right and dial 1 was kept slightly above them. At settings of 62, 62, 62 we found WDAR of Kansas City on 411 meters. Going further down to 59, 58, 58 the east was heard from through WDAR of Philadelphia on 395 meters.

All this time we were, of course, going through local stations and it was at these points that the volume control came in handy. The energy put into the loud speaker by this set is terrific and, without reduction, is apt to cause distortion due to the inability of the last tube and the speaker to handle it. Once the program from a moderately strong station is tuned in, the volume control can be set at the point where volume and clearness balance for enjoyable reception.

Provision is made for the many types of antennas which purchasers can put (Continued on page 20)

The NEWEST Schickerling Tube!

A standard base
5 volt tube consuming but
16/100 amperes!

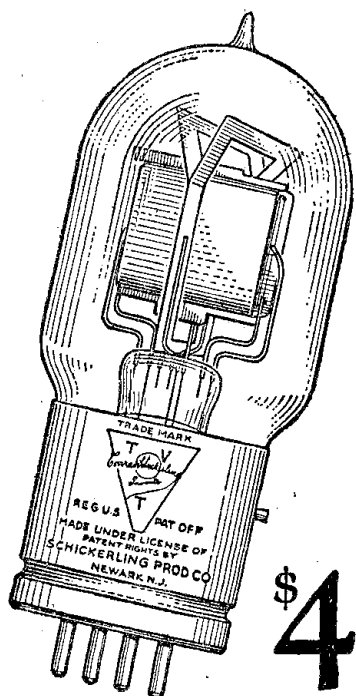

MODEL S-1600

a 5 volt, standard base 16/100 amp., Oscillator, Detector, Amplifier. Plate voltage, 16 volts to 90 volts. Operates on a 20 ohm rheostat with a 6 volt storage battery or 3 to 4 dry cell batteries in series.

OTHER MODELS

- 5 volt—¼ amp. Standard Base
- Model S-200 Detector . . . \$3.00
- Model S-4000 Amplifier . . \$3.00
- Model S-700 Special Oscillator and Power Tube for all multi-tube sets . . . \$7.00
- 3 volt—1/10 amp. Miniature Base
- Model S-600 Det.-Amp. . . \$3.00

THINK of it! A big husky tube with the equal volume and sensitivity of the quarter ampere tube, yet consuming only 16/100 ampere filament current!

This combined Detector, Oscillator, Amplifier tube is the true economy tube for multi-tube sets. Imagine—a 5 tube set equipped with these new Schickerling tubes will consume only 8/100 of an ampere as against 1¼ amps using the usual ¼ ampere tubes.

Can be used in all sets now using ¼ amp. tubes, with absolutely no changes necessary.

Call at any authorized Schickerling dealer—at our factory—or at any of our branches and listen to an actual demonstration. It's the most convincing test.

Sold with a written 10 day guarantee
SCHICKERLING PRODUCTS CORP.

Executive Offices and Factory
401-407 Mulberry St., Newark, N. J.

New York Sales Offices
Knickerbocker Bldg., Broadway at 42nd Street
Jewelers Bldg., 36 West 47th Street
Havemeyer Bldg., Cortlandt at Church Street

Philadelphia Sales Office
Jefferson Bldg., 1015 Chestnut Street

Chicago Sales Office:
220 South State Street

Address all correspondence and mail orders to executive office and factory at Newark or to our nearest branch office.

SCHICKERLING
RADIO TUBES
With the Stabilizing Triangular Plates

Sold only by authorized Schickerling dealers

Be sure — that your transformers are giving you Amplification without Distortion

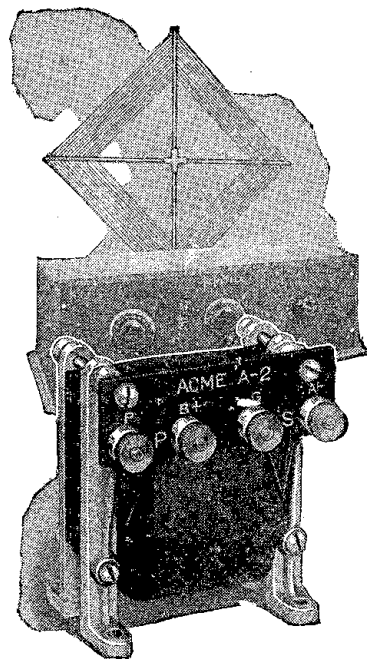

Acme Transformers give maximum of sound, clearly and distinctly

WHEN you put a lot of time and money into a radio set you want to be sure that it will give the best results. You want to know that your set will bring in the stations so that you can enjoy listening and be proud to call in your friends. You want Amplification, but above all you want Amplification without Distortion. Be sure to use amplification transformers that increase the sound without spoiling the quality.

The Acme A-2 Audio Amplifying Transformer is the result of 5 years of research and experimenting. It gives amplification without distortion to any set. Whether you have a neutrodyne, superheterodyne, regenerative or reflex, the addition of the Acme A-2 will make it better.

If you are not getting loud, clear radio try Acme Transformers and note the difference.

Each transformer is tested and carries a guarantee tag. If you want Amplification without Distortion use Acme Transformers in the set you build and insist on them in the set you buy. (That's one of the big reasons why the Acmelex Kit-set gives such good results—it uses Acme Transformers.) Send for our 40-page booklet which explains how to get the best results by proper amplification and also contains a number of valuable wiring diagrams. It will help you build a set. Mail the coupon with 10 cents.

ACME APPARATUS COMPANY
Transformer and Radio Engineers and Manufacturers
Dept. N-3, Cambridge, Mass.

Have the fun of making your own radio set

ACME
~ for amplification

ACME APPARATUS COMPANY,
Dept. N-3, Cambridge, Mass.
Gentlemen: I am enclosing 10 cents (U. S. stamps or coin), for a copy of your book, "Amplification without Distortion."
Name.....
Street.....
City.....State.....

Radio Digest

PROGRAMS
Illustrated

Published by the Radio Digest Publishing Company, Inc.
510 North Dearborn Street
Chicago, Illinois
Telephones: State 4372, 4373, 4374, 4375

E. C. RAYNER, Publisher

Eastern Office, Park Lexington Building, 247 Park Ave.,
New York. Telephones: Murray Hill 0106, 0107, 0108.

Member of the Audit Bureau of Circulations



241
PUBLISHED WEEKLY

SUBSCRIPTION RATES

Yearly in U. S. and Possessions and Canada, \$5.00
Foreign postage, \$1.00 additional. Single copies, 10 cents.

Vol. XII Saturday, March 14, 1925 No. 10

Don't Blame Amateurs

WHEN broadcasting started a few years ago there were many complaints of interference caused by amateur transmitting sets, and thanks to proper legislation and a spirit of co-operation, this bugbear has almost completely disappeared.

There is no excuse for an amateur transmitter to cause interference, if a decent Radio receiving set is used and tuned properly. Most broadcast listeners use aerials which are far too long and these are bound to pick up a lot of interference. Naturally an amateur station a short distance away is going to cause some trouble if this is the case.

Picking up interference of this kind is probably more the fault of the receiving set than the transmitter.

It should be possible to completely cut out any transmitting station within less than ten meters, and there is no broadcasting station within ten or even twenty meters of an amateur station. Amateurs are observing the rules and regulations and actual cases where the amateurs have been at fault are mighty few and far between.

It is hardly fair that any one class should have the air all the time and the amateur has shown his willingness to co-operate fully. It is now up to the broadcast listener to do the same. If you hear an amateur after 10:30 at night, or during the day, you have no cause for complaint. Remember the amateur is giving up his choicest evening hour so that you may enjoy your broadcasting. You can hardly expect him to "stay off the air" altogether.

The amateur as a general rule is a "good scout" and will be more than willing to help you over the bumps. A little diplomacy may do a whole lot more good than calling down the wrath of the gods on his head.

Tune in While You Sleep

WE HAVE had all kinds of sets, sets in clocks, in home savings banks, in hats, in automobiles, railroad parlor cars and all manner of places where a built-in cabinet can be used, but now comes the latest which is built into a bed. An ideal place. Why didn't some inventive genius think of this before? The old-time bed spring is right there for the aerial and the mantel head provides a place for the loud speaker. The cabinet can be placed below the loud speaker where the dials may be turned by the hands, or at the foot where a skillful operator can tickle the dials with his toes. What a joy for the DX hound who can take his ease and bring in all stations when he is dressed for dreaming. The manufacturer expects to roll in wealth on the Radio wave.

Penetrating Steel Walls

A NEWS item has this heading, "Bank Vault's Walls Penetrated by Radio." In order to satisfy themselves that Radio can enter their strong box the board of directors stepped into their own vault with a super-heterodyne set and listened in to a concert with the ten-ton door closed and locked and twenty-seven inches of concrete and steel surrounding them. To the minds of the masses the Radio is most mysterious, to the ones who have made it a study, perplexing, and a great many theories have been propounded, but the great mystery of all, how do Radio waves get through such walls? Is it a wave or not?

Make Speeches Short

AN ANALYST of Radio program reception says the average fan will not listen to a single feature for more than twelve minutes. Many of them will not let their dials alone longer than a minute or two, he says, except when they are staging a party and dancing to Radio music.

This is offered as a suggestion to both program managers and broadcast lecturers who want to retain the attention of their audiences during their talks. The answer seems to be—hold talks, speeches and lectures to about ten minutes or less!

RADIO INDI-GEST

Walla Walla Expedition Near Port (Continued from Last Week)



During the night, Henry, who is better known on board as "Sparks," crawled from his bunk and tied the leader of the buccaneers hand and foot. After doing this, he called Capt. Oneoar and they began to beat up the rest of the pirates. The pirates, unable to stand the punishment inflicted upon them, jumped into the sea and were drowned.

During the mele, the pirate chief loosed his bonds and tried to escape. "Sparks," ever alert and on the job, saw him running down the deck and pursued him. Seeing that the chief was about to escape, "Sparks" picked up a marlin spike and threw it at the chief's head. The shock was so great that it knocked the chief overboard and he met the fate of the rest of his crew.

When the sun arose that morning, Capt. Oneoar took bearings with his sextant and then rechecked the bearing again at noon. When he entered the mess room he addressed the crew:

"Gentlemen adventurers, unaccustomed as I am to public speaking, it behooves me on this grand and auspicious occasion to say a few words to those of you who have suffered since we started on this trip. In a few days, we will be in the vicinity of Walla Walla. At that time, I will thank you one and all for the bravery shown during the crisis that we have just gone through.

"There is one thing that I want you to bear in mind, and that is this: beware of the chief of the island of Walla Walla. He is a ferocious cannibal, and not the least bit adverse to taking a few bites from the leg of any man. I say this, just to show you how democratic he is. He plays no favorites, and may pick on any one of you for the feast. That is all that I can say." As he uttered these words, the crew cheered for the brave commander.

Now Ma's a Radiophan

Dear Indi:—As my husband and I are great admirers of "Radio Digest" and have noticed your "Radio Indi-Gest" column, I thought you may be able to use the following poem, which I composed after observing the fact that in most cases it is the man who first becomes interested in Radio, and as he installs a Radio in spite of his wife's wishes, it is she, who, in a short time, becomes the most enthused of the two.

Who'll put the ban on the Radiophan?
He's a nuisance, I won't have him 'round!
He has talked my old man
Into joining his clan,
And now he's a Radio hound.

All night until morn, goes the musical horn,
For the want of sweet sleep I could cry;
I don't mean to scorn,
But why was he born—
The man who urged hubby to buy.

Come, leave it alone! Can the warble and groan!
You're not satisfied when you do get a town—
You shift this and turn that
'Til it howls like a cat,
For two cents, I tear the thing down!

Let me try it, old man—Oh, I've got it! My land!
Wait, I'll try this—No, I'll tune in on that!
Shucks! I bet a pin
I had Frisco just then,
Here's Chicago, right off the bat!

Well, go to bed then, if you're felling like sin!
Good-night dear! No, I'll not be sore—
I'll just listen in
Until 'round about ten,
Sweet baby! It's quarter past four!

MRS. FAN.

Radio Reactions

We are average folks and so
We endure a Radio—
Pa's the owner, I'm the "Op,"
Tinker, fixer, batt'ry man,
Gran'pa, Gran'ma, Ma and Sue
Constitute the Listen-Clan.

'Course I'm pestered with advice,
Told what's swell or bunc or nice—
Guess you think Dad wants a speech,
Or that Ma want recipes;
Gee! You're off your base because
All they say is "Tune off, please!"

Old Time Fiddlin' pleases Dad;
'Nuff of jazz Ma's never had;
Sister Sue likes rustic dance,
Barn affairs and such, you know—
Oh, I never please 'em all,
Don't care where the dials go!

"Darlin' I Am Growin' Old"
Sends my Gran'ma to behold
In the glass how true it is;
"Maggie, When We Both Was Young"
Causes Gran'pa to instruct,
"Let's hear somethin' lively sung."

(Continued next week)

All in the Day's News



Condensed

By DIELECTRIC

Do not be surprised if, on tuning in on the new movie station in Hollywood, KFVB, Warner Brothers, you find a familiar voice handling the microphone. Edward Murphey, he of the deep voice, was drafted from the ranks of KHJ for the new station, as was Roi Cronkheit, former chief of the monitor room at KHJ. This brings up a question. How shall we phrase the fact that an announcer has left the microphone at one station for a very similar looking microphone at another? Like the minister, shall we say he has accepted a call?

And while we are speaking of KFVB do all the movie fans realize that Monte Blue is one of Warner Brothers' stars, and that Monte, by reason of his many appearances from KFI, makes an unusually good announcer? Personally, I'm willing to lay odds that while Mr. Murphey may be announcer at KFVB, more often than not we will find Monte Blue introducing his fellow stars from that station whenever he is not out of town on location, or forced by an unfeeling director to work nights on the lot.

Prisoners are having their chance to show what talents they possess as Radio entertainers, incidentally, to reach the members of society against whom they have sinned. When WEEI Radiocast a concert from Charlestown state prison, listeners were impressed with the skill of a violinist and quality of voice of a baritone soloist. These men no doubt enjoyed the experience as much as those for whom they sang and played. I feel some of the artists in should be out, and some out—in!

WSB gave us a very entertaining evening as we were escorted through rows of cotton plants, down in the sunny southland, picturing the scene by aid of banjos and singing. Many of those old melodies haunt one's memory for a long time after the music ceases.

If you choose a Saturday night to visit Philadelphia the jazz bands will be found to be in full action and nothing slow about it either. With my three dials set in position there was nothing to stop WOO from filling the loud speaker with syncopation from the Sylvania orchestra. An especially attractive feature is the blank space where, in so many programs, appears this: "Waiting for the Sunrise."

What an evening KSD made for lovers of violin art in presenting a full program by that eminent American virtuoso Francis Macmillen. Nights when the phonograph companies allow us to hear their artists, only a few numbers are given by each, but here was a complete program of classical selections from those demanding purely musicianship to others calling for the utmost in technical proficiency. What a treat!

Special programs are featured by many of the Radiocasting stations, which include addresses in a foreign tongue and music by composers speaking the same language. One of these was presented through WEBH with Dr. Steinbach, German consul general, addressing his invisible audience both here and abroad. It's the thrill of imagining a vast group of listeners across the pond which makes such features of interest.

Four Filter Eight Tube Super-Heterodyne

Part II—Construction of the Filters

By Jacques Fournier

THE intermediate amplifiers of this receiver are not particularly difficult to make and materials which are available to everyone are used in the construction. The writer has used 1/8-inch thick cardboard, but the man who has a fret saw and a number of cigar boxes can make the necessary discs from them. There will probably be many other fans who have a supply of 1/8-inch fiber or

Item "C" is 1/8-inch cardboard, such as may be found on the back of a writing pad, or it may be cut out from a cardboard box. It is the same diameter as the larger discs. The two slots at one end which are isolated from the rest by item "C" are for the primary windings. Three forms are to be constructed as shown and the fourth one differs from the rest only in that four small discs

2,100 turns for the secondary. Each of the four forms which were made from the discs are to be wound in this way, either clockwise or anti-clockwise, but all windings in same direction. In cutting the threaded brass rod which passes through the center, or when choosing a machine screw on which to stack the discs, a length should be selected which will leave 1/2 inch protruding so that there will be room for a nut on the end, 1/8 inch, to pass through the small panel on which these transformers are mounted, and 1/8 inch for another nut on the other side of the panel; 2 1/2 inches is about right.

num capacity of from .00004 mfd. to .00005 mfd.

While the layout for the baseboard of the receiver was promised for this issue, it will have to be held over due to lack of space and the layout for the small panel which makes the cover for the filter box will be presented with it next week.

The box is to be divided into four compartments by three pieces of copper or brass as shown in figure 3. These are

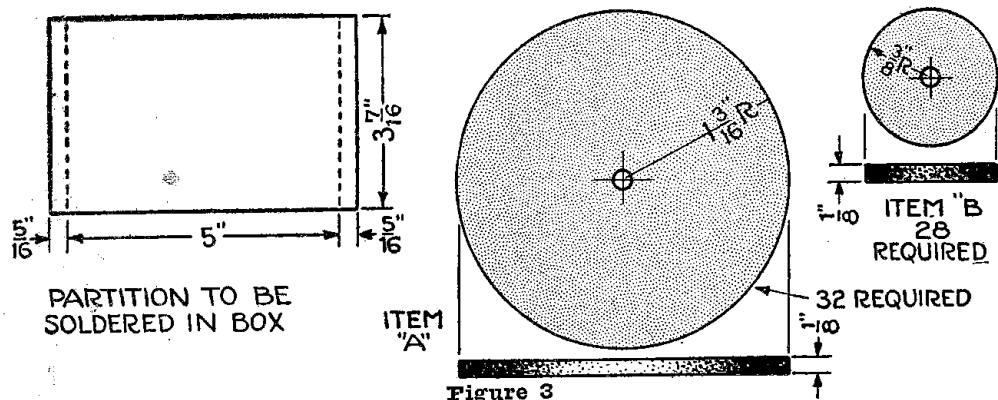

Figure 3

bakelite or hard rubber, and any of these materials are just as good and possibly better than the heavy cardboard.

In figure 3 is shown the dimensions for the discs, and it will be noted that the larger discs are 2 3/4 inches in diameter and 32 are required, while the smaller discs are 1/4 inch in diameter and 28 are required. No matter what material these are made from, care should be used in cutting them out and smoothing the edges so that when they are assembled into forms, the small discs will fit together smoothly as the core on which the wire is wound and the larger discs will pack tightly against them with no sharp edges to cut the fine wire to be wound on the forms.

Transformer Assembly

In figure 4 is shown the assembly for one of the transformers. Each of the discs must have a hole in the center about 1/8 inch in diameter for the 2 1/2-inch threaded brass rod or long machine screw on which the discs are to be stacked.

separate the primary from the secondary instead of the large 1/8-inch disc, item "C." The insertion of these smaller discs moves the primary 1/2 inch from the secondary, which makes for looser coupling in the one transformer. The wire to be used in winding these transformers is number 32 dsc., of which one pound will be enough for the whole job.

Winding of the primary is begun at the end away from the secondary and 525 turns are to be wound in the first slot. The wire is then carried over the large disc and 525 more turns are put in the second slot. This completes the primary, giving a total of 1,050 turns. The winding of the secondary is begun in the end nearest the primary and 525 turns are wound in the first secondary slot, the wire is then carried over into the second slot and 525 more turns wound on. From the second slot it is carried over to the third and from the third it is continued in the fourth slot. Each of these is to be wound with 525 turns, giving a total of

The Shielding Box

The start of the primary winding which, was an inside end, is to be the B plus connection, while the outside or finishing end of the primary in the second slot is the P or plate connection. The starting or inside end of the secondary winding, which is in the slot nearest the primary, is to be the F connection, while the outside or finishing end at the last slot of the secondary is the G or grid connection. The copper or brass box in which these transformers are to be enclosed is shown in figure 4. This pattern may be enlarged on paper and traced on to the sheet metal or may be laid out directly on the sheet metal itself. As shown in figure 4, the sides and ends are bent up toward the reader and the 1/8 inch flanges are to be bent inwards. The flaps which were left at the ends of the side walls are to be bent in, of course, and are to be soldered to the end walls. When these have been soldered sufficiently to hold the sides and ends together, solder should be run along the corners so that an airtight box will result. The transformers described above, and the four small condensers with which they are to be tuned, will be suspended from the top of the box and the edges will be sealed. There are several small condensers on the market, any make of which may be used to tune the secondaries. These small variable condensers should have a maxi-

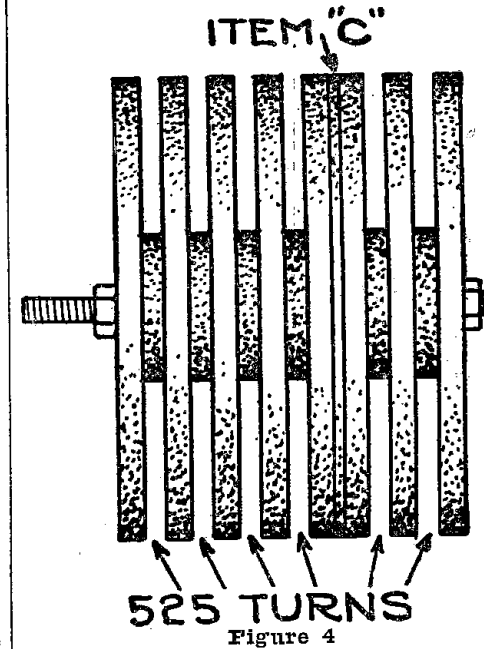

Figure 4

5 by 3 7/8 inches and flaps are provided at each side so they may be bent over at right angles and soldered to the side walls of the box. Copper or brass are specified as solder can be used on these materials. Aluminum might make a lighter and possibly a more workable material, but it is almost impossible for the home builder to solder to it. The points at which the dividing pieces are to be soldered to the side walls are indicated in figure 4, and if soldered as shown, and the small panel (Continued on page 18)

The Maker's Name-- A Public Promise

"BRISTOL" on the new Bristol's Loud Speakers indicates established responsibility and safeguards the buyer who knows the name.

Technical engineers know that for 36 years The Bristol Company has made for the great plants of America, highly accurate and sensitive Recording Instruments, and that they are fully qualified to make loud speakers of great excellence. They

know that Bristol experience, scientific knowledge and honest purpose, must be this loud speaker's full inheritance.

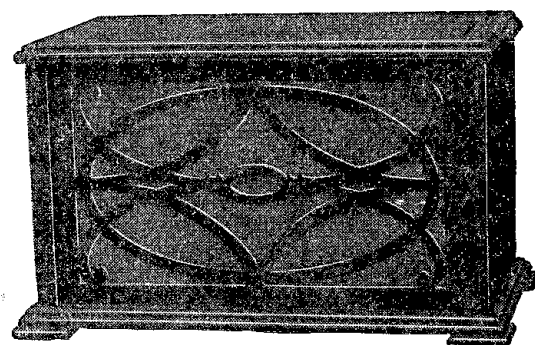

Cabinet Model, \$30.00

There are five loud speakers, but all alike in those essentials, which give true quality to the reproduction of voice or instrumental music. The "Voice" is not a mere phone unit, but an electromagnetic device, and the horns of non-metallic material with long sound chambers allow free and full vibration. Prices \$12.50 to \$30.00. If not at your dealer's, send for Bulletin AY-3022.



Model "S" Audiphone \$25.00

Horn 14 1/2" diameter. Velvet mat finish of bronze and gold. Classic base.

BRISTOL AUDIOPHONE Loud Speaker

The BRISTOL COMPANY, Waterbury, Conn.

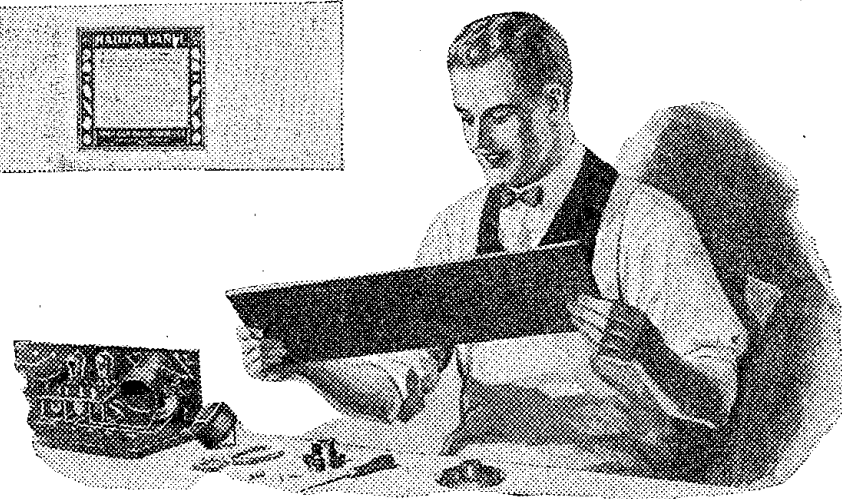
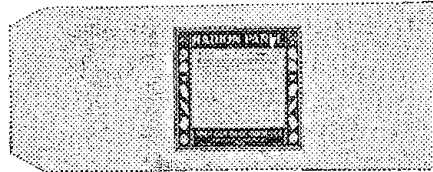
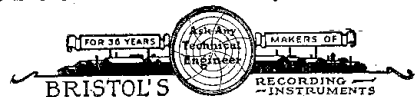

Notice the rich finish on this panel —built to order for radio

A SURFACE that is good-looking and useful, too. That was one of the demands we made of the engineers who developed Radion especially to order for radio purposes.

The high-polished, satin-like finish of Radion Panels does more than add to the beauty of your set. It keeps out dirt and moisture, thus preventing the possibility of causing short circuits from this source and reducing good reception.

Lowest losses and greater efficiency

But the worth of Radion is not just on the surface. Authoritative laboratory tests give it the highest

rating as radio-frequency insulation. It reduces surface leakage and leakage noises. This means lowest losses and greater efficiency, especially noticeable in super-sensitive circuits.

Radion Panels resist warping. It's the easiest material to cut, saw or drill. It comes in eighteen stock sizes and two kinds, Black and Mahogany.

Send for our new booklet, "Building Your Own Set," giving wiring diagrams, front and rear views, showing a new set with slanting panel, sets with the new Radion built-in horn, lists of parts and directions for building the most popular circuits—mailed for ten cents. Mail coupon today.

AMERICAN HARD RUBBER COMPANY, Dept. DE-3, 11 Mercer St., New York City
Chicago Office: Conway Building
Pacific Coast Agent: Goodyear Rubber Co., San Francisco - Portland

RADION The Supreme Insulation PANELS

Dials, Sockets, Binding Post Panels, etc.

American Hard Rubber Company
Dept. DE-3, 11 Mercer St., New York City.
Please send me your new booklet "Building Your Own Set" for which I enclose 10 cents (stamps or coin).
Name.....
Address.....
City..... State.....

LAYOUT FOR FOURNIER FILTER BOX

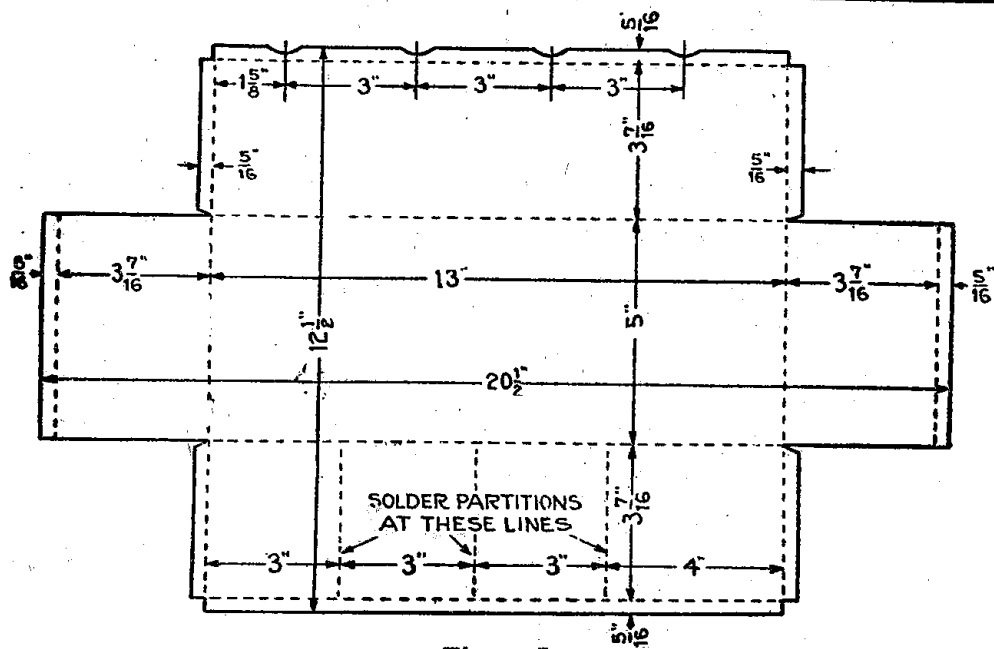

Figure 5

FOUR FILTER SUPER

(Continued from page 17)

layout to be shown next week is followed carefully, the transformers and condensers will fit into their respective compartments with good clearance all around. (The assembly will be gone into next week and the sharpest super made will begin to take tangible form.—Editor's Note.)

The Reader's View

Announcers Reading Telegrams

In your excellent publication, for which I am a subscriber, you have frequently commented editorially upon the station director who fails to announce his station frequently. I heartily concur in your comments.

Realizing that the policy of broadcasters is fixed largely by public opinion and that public opinion can be made known only through the expression of a large number of individual opinions, I am submitting the following for your consideration.

In my opinion the most objectionable feature of present-day broadcasting is the reading of telegrams and telephone messages received, with comments thereon. At some stations this consumes 50 per

cent of the time. I invariably tune them out. I believe that nearly all telegrams sent are sent for egotistical reasons by people who want to hear their names broadcast. (This does not apply to applause cards or letters of appreciation, of which I approve, nor do I object to the sending of telegrams to encourage the artists at the time. It is the broadcasting of them that I object to.) Now, I believe that most stations sincerely try to please their patrons or circle of listeners. Suppose a station has 5,000 listeners on a certain broadcast period and that it receives and reads 50 telegrams. Then for every person they please by reading a telegram they annoy one hundred. I believe these figures are conservative and that the annoyance is much worse.

Another point is the objection raised by music publishers to the broadcasting of their copyrighted music. As one example of the result—yesterday my wife bought six pieces of music. She does this at irregular intervals. All this music is music she has heard over the Radio and music which otherwise she would not have heard or would not have known the name or title, if she had heard it in a movie theater. Multiply this by many thousands and where have the publishers any kick?

Still another point of controversy—the broadcasting of music by opera and other famous stars by the Brunswick and Victor

people. We enjoy hearing them out here but never have an opportunity to hear or see them in person. So our hearing them does not cut down the attendance at the theater. Neither do I believe it reduces the attendance in New York, Boston, Chicago or other large cities. Having heard them by Radio I know that if I were in a city where they were appearing I would go to see them. In other words, in my case, hearing them by Radio gives me enjoyment that otherwise I might never have and increases my desire to hear them and see them in person and to have their records. And I believe my case is typical of many thousands.—Robt. Whitfield, Fort Sam Houston, Texas.

Silent Night for New York

One of the best moves in favor of the DX hound would be a silent night for New York and vicinity. They are having silent nights for the western stations, why can't we follow suit? At present there are over a dozen Radiocasting stations in this locality including Newark and New York city. To receive real distance one has to sit up until most of the locals sign off which usually means one o'clock in the morning. It isn't a case of

selectivity to tune the locals during the time they're on, to get distance. It is a case though of bringing the long DX stations through with sufficient volume to enable one to about hear the call letters when all locals are going strong. Most DX hams listen in about eleven o'clock for distance. Everyone doesn't want to sit up until one and two o'clock in the morning to get DX. Most of us are tired out and eleven o'clock is the limit.

You may say, what about the poor fellows with crystal sets? They can take care of themselves, one or two of the locals could remain broadcasting for their benefit, those of the weaker stations for instance. One silent night a week would be the limit and surely crystal set users, if they didn't want to do without listening in altogether, could satisfy themselves with the one or two weaker locals which would be on.

I hope the above will be taken into consideration as it is a very vital subject pertaining to the welfare of Radio.

In conclusion I want to say this; everyone should have some interest in the receiving of distant stations as DX lends enchantment and will be Radio's future.—Chas. Stevenson, Hasbrouck Heights, N. J.

Ward's Radio Catalogue

The best Radio Experts made this catalogue—men who devote their entire time to Radio—who are up to the minute with everything new, who tell you the best hook-ups, who have selected for you the best tested parts, who have chosen the best sets—so simple that you yourself can easily install them—so reliable that we guarantee them to give satisfaction. Write for your copy of this Catalogue. See for yourself the low prices. Buy your radio at Radio Headquarters.

Our 53 Year Old Guarantee
Ward's has dealt with the American people for 53 years under a definite guarantee of "Money back if you are not satisfied." All our Radio sets are guaranteed to give satisfactory results and back of this guarantee is a reliability that for 53 years has not been questioned. Address our house nearest you. Dept. 41-R.

ESTABLISHED 1872
Montgomery Ward & Co.
The Oldest Mail Order House is Today the Most Progressive
Chicago Kansas City St. Paul Portland, Ore. Oakland, Calif. Fort Worth

Why it is Better

"MASTER of Every Note in the Orchestral Range" is the proven claim of the Federal No. 65 Audio Frequency Transformer! Volume without distortion is the basis for the beauty of Federal Tone.

From its oversize locking nuts to its heavy brass mounting feet the Federal No. 65 Transformer incorporates the same engineering skill that has made Federal the recognized leader in electrical communication apparatus since 1890.

Insist upon Federal parts for your "pet" hook-up. There are over 130 standard parts bearing the Federal iron-clad performance guarantee.

FEDERAL TELEPHONE MANUFACTURING CORP.
Buffalo, N. Y.

Boston
New York
Philadelphia
Pittsburgh

Federal
Standard RADIO Products

Chicago
San Francisco
Bridgeburg
Canada

Broadcast Listener's Reference Library

Part VI—Audio Frequency Amplification

By Edward Thomas Jones, A. I. R. E.

AFTER the signals have passed through the detector, they are no longer currents changing their direction of flow at the Radio frequencies of one to three million a second, but are

must be connected to the detector tube, figure 14. This circuit from the antenna and ground to the points A and B is the usual nonregenerative hook-up. While three methods of coupling amplifiers to

B battery, or 22 or 45 volts. Since only changes in a current are passed from a primary to a secondary, this steady unvarying flow does not affect the secondary. If, now, incoming signals cause this current to vary by one or two volts, this change causes a current in the secondary which has a voltage bearing the same ratio to the change as the ratio of turns between primary and secondary windings. Thus, if it is a three-to-one transformer and the secondary has three times as

which time has developed is the practice of using a single A and a single B battery. Figure 15 shows the circuit in which both filaments are lighted from one source and both plates kept at positive potential by one set of plate batteries. Battery Y is a 22½ volt unit, as is battery Z. If you will trace the circuit from the plate of the detector tube and through the primary of the transformer, you will see that only battery Y supplies the detector plate. Starting at the amplifier plate, however,

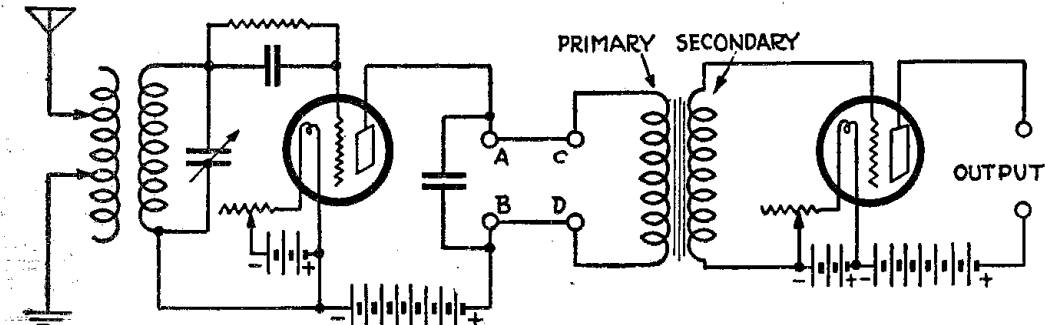

Figure 14—A step of audio frequency amplification added to a three-circuit receiver.

now direct current flowing continuously in one direction and varying in strength from 16 to 20,000 times a second. Passed into the head receivers, they cause the diaphragms to vibrate at this rate which makes air waves following each other at audible frequencies.

Pulsating Direct Current

The currents to be strengthened then, so that they will actuate a loud speaker,

the detector and to each other, are possible—by resistances, by impedances, and by transformers—we show, and will discuss here, only the transformer method, which is recognized as the simplest and is almost universally used.

The Audio Frequency Transformer

In figure 14, points A and B are connected to C and D, which are the input terminals of an audio frequency trans-

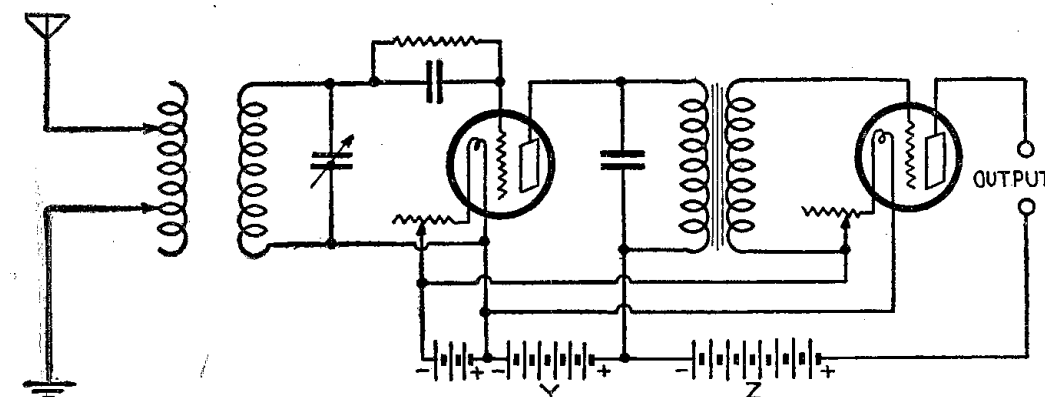

Figure 15—A single A battery and single B battery may be used for a number of tubes.

are not Radio frequency currents but varying direct current. The piece of apparatus which will accomplish this strengthening or amplification is a vacuum tube identical in construction with that used for detection.

Let us consider how this second tube

former. Such a transformer consists of an iron core, made either of iron wire or thin flat strips, on which are wound several layers of fine wire, called the primary, and many thousand additional turns called the secondary. Through the primary flows a steady current, from the

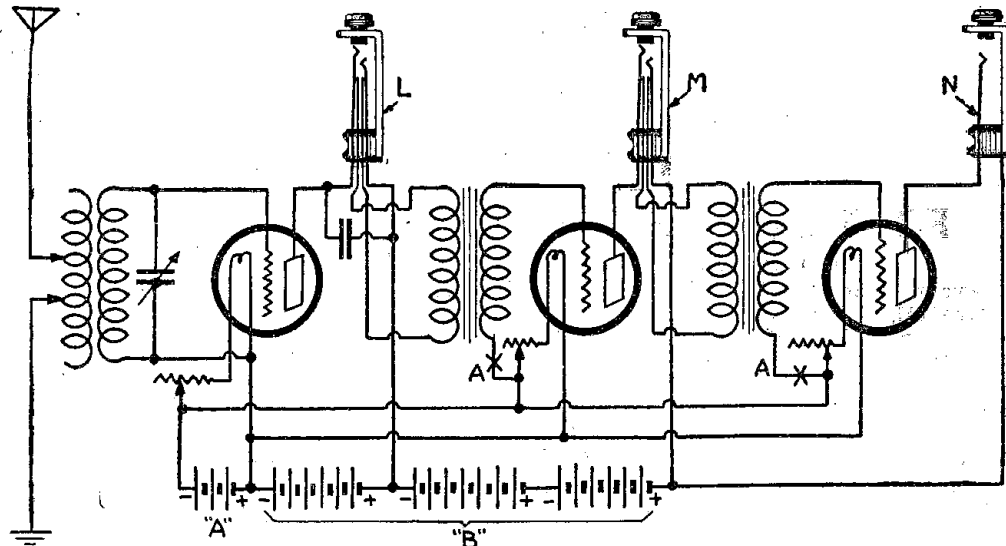

Figure 16—Jacks in each stage of amplification permit use of any number of tubes.

many turns as the primary, the voltage in the secondary will be three when the changes in the direct current in the primary is one volt more or less than normal.

The Single Current Source

The circuit shown in figure 14 contains two filament or A batteries and two plate or B batteries. Early experimenters naturally connected their current sources in this way, but among other improvements

we find that we must go through the phones and both batteries Y and Z before reaching the filament. The load on Y is double that on Z.

Jacks

This practice of utilizing but two sets of batteries for more than one tube can be carried out indefinitely, as shown by figure 16. In this diagram we have added (Continued on page 20)

Hear What YOU Like

Thank You for the pleasing program heard between 9:30 P.M. and 10 P.M. on Mar 1 1925. Special Crosley "52" set. We have a child who enjoyed Uncle Bob, Remarks: could hear every word. We would appreciate hearing Al Jolson or Eddie Cantor.

CHESTER A. WHEELER,
640 E. 47th St. No., Portland, Ore.

Applaud Your favorites

Save Time Writing Letters

Stations are glad to put on numbers at your request. We print special postal "Thank You" cards that get ATTENTION. See the name CHESTER A. WHEELER on illustration. That is where YOUR OWN name will be. Your INDIVIDUAL cards show more than ordinary interest and stations appreciate them and consider your request.

Speakers and musicians deserve and appreciate applause for radio programs just the same as from the stage. Their entertainment makes your radio possible. Encourage them. Help bring the best talent to radio. Send YOUR "Thank You" card of appreciation. Let the children write Uncle Bob. It makes them happy. They cost so little. A joy to use.

FREE LOG With 1st Order

Contains stations, cities, wave lengths, 4 dial settings, remarks, etc. Station list by wave lengths. Distance map. Other valuable information. Very convenient.

Save Time, Stationery, Telegrams and Postage

Cards have post card backs and require only 1c stamp. Can fill out in 1 minute. Less time, less postage than a letter. So convenient. A pleasure to use. Order Today.

Send NO Money

Good quality cards. High grade printing. New attractive special radio design. They get results. Other valuable information. Very convenient.

Money Returned if not DELIGHTED

100—\$1.35; 200—\$1.95; 300—\$2.45; 500—\$3.45; 1000—\$5.45 (about 1/2c each). Don't send one cent. Just pay postman after cards arrive. Prepaid if you prefer to pay with order. We GUARANTEE Satisfaction. Order Now. Or Send Postcard.

Mail Coupon Today-NOW

RADIO PRINTERS, Dept. 7413, MENDOTA, ILL.

Send _____ applause cards with my name and address printed FREE. Enclose Log absolutely FREE. I will pay postman for cards. You are to return my money if I am not DELIGHTED. I am to be the sole judge.

Name (Print Clearly).....
Address.....
City..... State.....
Postage prepaid if you prefer to pay with order

Increase the Efficiency of Your Reflex

by adding the Toroformer Attachment ahead of the Circuit.

The diagram above illustrates the Toroformer in use as a stage of tuned Radio frequency amplification.

Attachment furnished complete on Panel for.....\$22.00
Or in Kit form for.....\$18.00

A full size drawing of the separate Toroformer Attachment Unit is available for 25c postpaid.

The Toroformer
(A transformer for Tuned Radio Frequency Amplification)

Overcomes Local Interference
Gives Greater Distance
Increased Selectivity

Vastly improves any Reflex or Radio Frequency set, such as Acme, Murad, De Forest Reflex, Powr, Erla Loop Aerial Sets.

Does not pick up stray or unwanted signals, is unaffected by other parts of the circuit, and has no effect on other instruments.

Toroformer with printed diagrams and hook-ups.
Price \$5.00

At any First Class Radio Dealer or direct from us postpaid.

DEALERS wanted everywhere

THE SEARS MANUFACTURING CO.
1455 Leader-News Bldg., Cleveland, O.

Mail this coupon for free folder

Please send me your free folder on the TOROFORMER.

NAME.....
ADDRESS.....

THE SEARS
FRANCE
Super-Charger

No Bulbs
No Acids
No Sticking or Sparking Contacts

A new application of the push-pull principle eliminates all the old drawbacks of battery charging. No noise, no odors, no trouble, it is truly the ideal charging unit for the home.

UP TO 120 VOLTS OF "B" BATTERY CAN BE CHARGED IN SERIES. No fuss or trouble, just connect the charger clips to the battery terminals and turn on the current. Simple—Speedy and Efficient. The France Super-Charger also charges 2, 4, 6 or 8 volt radio or auto batteries at a 5 to 7 ampere rate, tapering as the battery is charged.

Price of Super-Charger, \$22.00; West of the Rockies, \$23.00. Canadian prices furnished on request. Write today for complete information on this highest attainment in battery charging.

DEALERS AND JOBBERS
Write today for sales proposition and literature.

The France Mfg. Co.
10321 Berea Rd., Cleveland, O.

REFERENCE LIBRARY

(Continued from page 19)

a further improvement: jacks which permit the use of the detector only, one stage of amplification or two stages. A device known as a phone plug is attached to the

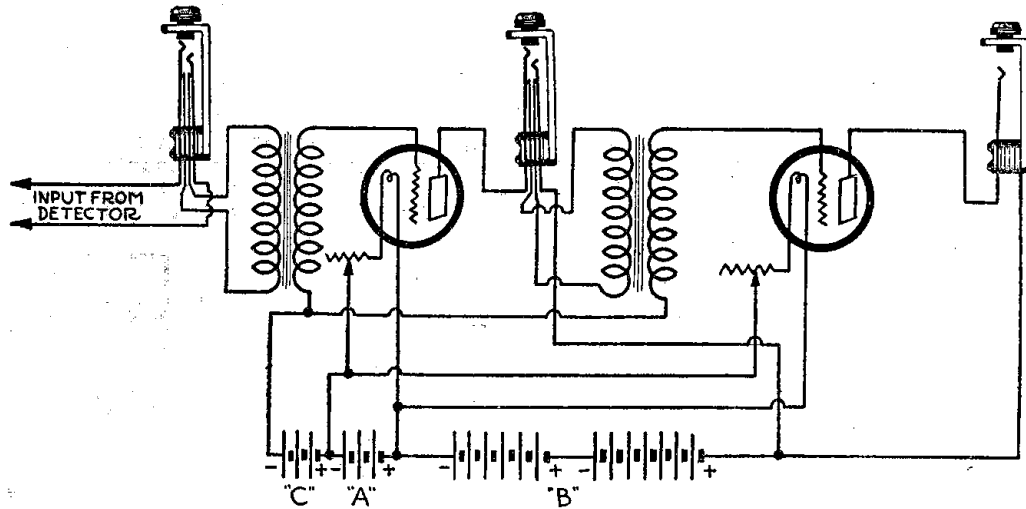

Figure 17—A C battery, used when 45 to 100 volts are put on the plates, will prevent distortion and give more volume.

tips of the cord of the head receivers and may be inserted either in jack L, jack M or jack N. Jacks M and N are known as two-circuit jacks, because, when no plug is inserted in jack M, the plate circuit includes the primary of the first audio frequency transformer; when the phone plug is inserted, the primary is eliminated and the phones substituted for it. Jack N is a single open-circuit jack because, when the plug is out, the single circuit which is possible is open (not completed). This last may also be a double-circuit jack, in which case the phones are in circuit when the plug is in, and the loud speaker horn is automatically connected when the phone plug is withdrawn.

The C Battery

Another refinement of audio frequency amplification, and one which is very recent—it came in with the thoriated-tungsten filament tubes—is the use of a third or C battery. It was found, when using the four tubes UV-201A, C-301A, UV-199 and C-299, that, if more than 45 volts were applied to the plates, distortion was likely to occur, and a volume less than that expected was produced. Tests and experimentation showed that the insertion of a third battery which would make the grid 4½ or 6 volts nega-

tive in relation to the filament would help. (See figure 17.)

To Clear Up Signals

It will frequently be found, when using two or three stages of audio frequency amplification with 90 volts on the plates, that the voice and music which comes out

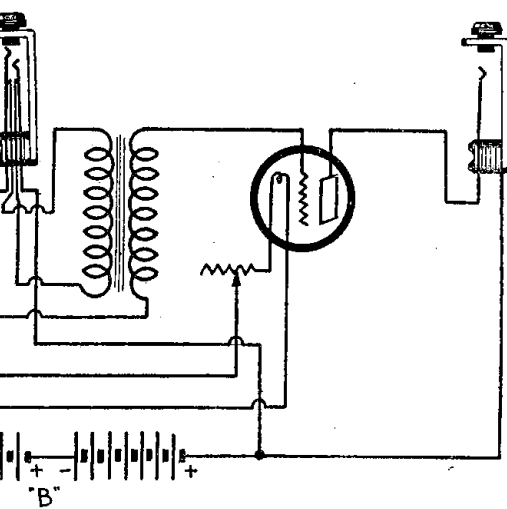

of the horn, while enjoyably loud and clear, has what Radio men call "whiskers" on it. This term has been applied because the only adjective that suitably describes the phenomenon is "fuzzy." The letters c, s, and z have a peculiar sibilant quality

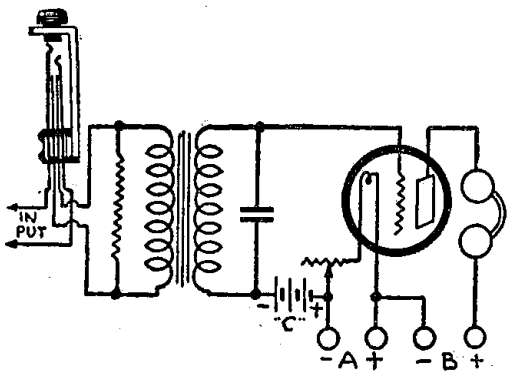

Figure 18—A leak across the primary or a condenser across the secondary will usually clear up reproduction.

and the higher notes from stringed and reed instruments seem to hang on, instead of breaking off sharply as they should. Since it is usually impossible to determine just what part of the amplifying system is at fault, the two slight addi-

tions shown in figure 18 should be tried separately. First try connecting a small fixed mica condenser of .00025 or .0005 mfd. capacity across the secondary of the last audio frequency transformer and, if readily available, even a .001.

If this does not remedy the objectionable fuzziness, try grid leaks of various values connected across the primary. One or the other of these methods should clear up the reproduction. This may cut down the volume from three to five per cent, but the gain in faithfulness to the original music more than offsets it.

(Multi-tube receivers contain many places where trouble may occur, so Mr. Jones will take up the operation and kinks of larger sets in his next article.—Editor's Note.)

HOW TO OPERATE SET

(Continued from page 15)

up and the various lengths are taken care of by a link connecting two binding posts on the rear left corner of the baseboard. If the antenna is very long, or one is located unusually close to a high-power broadcast station, this link is to be released from one of the posts. If a short antenna is in use, or the owner is located out in the country, the link should be closed and greater volume will result.

Due to the use of binocular coils, operation on a loop was very successful. There is no external field around these coils and the use of a loop, usually impractical in tuned R. F. sets, because of feedback between coils and loop, is permitted. Another movable link enables the owner of Synchronphase to use either loop or outside antenna. Thrown to the right, the former functions while, to the left, the latter is utilized.

After trying out various combinations of antennas and link positions, we resumed our tuning and, at 41.5, 41, 41.5, found WCAL of Northfield, Minn., with a wave length of 360 meters. WHK of Cleveland uses 283 meters so we swung to them and found their settings to be 23.5, 23, 24. It was plain from the curve we were drawing that this set would go down below the broadcast range so tuning further was unnecessary.

Trouble

The construction of this receiver is exceptionally good and it is extremely unlikely that anything will go wrong inside. Should howls or whistles develop, the accessories and connections should be examined carefully before complaint is made to the dealer. High class tubes were found essential to clearness in our tests,

and seven were juggled around from one socket to another before two were eliminated and we were satisfied that the full possibilities in this set were being realized.

Be sure that corrosion or jar has not produced a poor connection at one of the Fahnestock clips as anything but a perfect electrical contact in any of them will manifest itself as whistles or scratchy sounds in the speaker. Test the A, B and C batteries frequently and recharge or replace before any of them get too low.

Antenna and ground should be examined at frequent intervals, especially if they were not soldered. If they were not, the connections should be scraped and remade at least every three months.

Tapped Honeycomb Coil

In experimenting with honeycomb coils I have found a very good coil which may be made at the cost of a very few cents that will work efficiently. The coil is varied by means of taps.

If a coil is desired for the amateur and music wave lengths a 150-turn coil is about the best. This can be made up of a 50-turn coil as a base. The other turns are placed on and taps taken at every

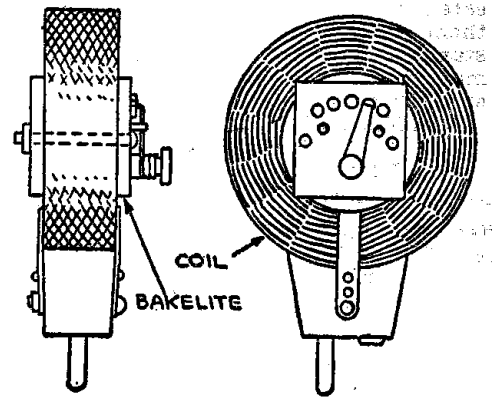

25 turns and at the end. The wire may be wound in the ordinary manner.

A piece of panel material 1½ by 2 inches is placed across the center of the coil. A small switch and five taps are put on the piece. The five wires leading from the coil are soldered to the tap bolts. The connections from the coil are from the open coil end and from the switch lever center.—Walter W. Mulchay, Sparks, Nevada.

The cause for unsteady regenerative tuners is too large a tickler coil or too much regeneration.

Apex Super 5

This highly efficient tuned radio frequency receiver is the most advanced in design and construction. It is an instrument that meets every critical expectation of the seasoned radio enthusiast.

Buy the Apex Super 5. You will have a radio receiver that brings in distant stations clear and distinct. Select the station you desire in your log book, turn the marvelous Apex Vernier Dials to that number, and there you are—perfect reception. No greater selectivity can be had than is easily obtained with the Apex Super Five.

Housed in a highly finished walnut cabinet, complete with Jones Multi-plug Battery Cable. All settings highly gold plated. Sells for \$95 complete excepting accessories.

At All Good Dealers
Apex Elec. Mfg. Co.
1410 W. 59th St.
Dept. 000
Chicago

on the dot

MECO AMPLIFIER 5 VOLTS

The Password to Better Reception

"By their tubes you shall know them." There are two kinds of Radiophans. Those who are satisfied with ordinary clearness and volume, and those particular ones who demand the utmost in enjoyment from their sets. In the sets of the first kind you may find any make of tube—good, bad or indifferent. In the sets of a swiftly growing majority of the other kind Meco Tubes have become standard.

Greater volume without sacrificing clear, distinct receptive tones are the reason for Meco popularity.

Your dealer has Meco Tubes in 3 and 5 volt sizes or can get them for you from recognized Radio Jobbers.

Metropolitan Electric Co.
Des Moines, Iowa

MECO RADIO TUBES

THE NEW CROSLLEY 51 SPECIAL

\$23.50

Of Course the Famous Crosley 51 Regular at \$18.50 Will Be Continued

HERE is the popular Crosley 51 dressed up in new clothes. It is known as the Crosley 51-Special. This two tube, genuine Armstrong regenerative receiver is exactly the same as the nationally known Crosley 51, except it is installed in a larger cabinet in which there is room for dry cell batteries. Also there is the slanting panel, a feature that adds to the appearance of the set and makes operation more comfortable. This radio is as artistic as it is efficient, appealing to the housewife who demands beautiful appearance and elimination of visible batteries. All Crosley radios are licensed under Armstrong Regenerative U. S. Pat. 1,113,149. Other models priced from one tube 50 at \$14.50, to the Tridyn Special with sloping panel, at \$65. For sale by good dealers everywhere. Prices quoted are without accessories.

Prices West of Rockies—Add 10%
Write for Complete Catalog

The Crosley Radio Corporation
Powel Crosley, Jr., President
3492 Sassafras St. Cincinnati, Ohio
Crosley owns and operates Broadcasting Station WLW

Lincoln
RADIO PRODUCTS
Collapsible Loop Aerials
Standard of the Radio Industry

The only loops of their kind sold at popular prices.

Built by radio engineers—electrically and mechanically correct—beautifully finished and sturdy. A touch and a new station comes in—or one is cut out. Their selectivity is remarkable.

And remember that Lincoln Loops sell at moderate prices. No other loops of their kind or efficiency sell at these low prices.

Lincoln 4-point Tapped Loop \$8.00

Built for any circuit where it is desired to vary the inductance of the loop. Exceptionally fine for super-heterodynes.

Lincoln Center-Tapped Loop \$6.50

For any set employing radio frequency amplification. For certain Super-heterodynes requiring a center tap.

Write to Lincoln
If your dealer cannot supply you, order direct giving your dealer's name. Lincoln Loops are fully guaranteed. Send for literature. We welcome correspondence with legitimate dealers and jobbers.

Lincoln Radio Corporation
224 North Wells Street CHICAGO

Neutralizing First Tube in Reflex

Radiator, Long Battery Leads Cause Trouble

After building a four tube reflex set and had it working very well a certain high-powered station leaked through too much, even on a loop, also the directional

WORKSHOP KINKS EARN A DOLLAR—

THERE are many little kinks worked out at home that would aid your fellow Radio worker if only he knew about them. There are new hook-ups, new ways of making parts and various unique ways of operating sets that are discovered every day. Radio Digest is very much interested in obtaining such material. Send them in with full details, including stamped envelope, so rejected copy may be returned. The work must be entirely original, not copied.

RADIO KINKS DEPARTMENT
Radio Digest,
510 North Dearborn St., Chicago

effect was not pronounced enough to suit me. This I lay to long battery leads and the close proximity of a large radiator and it was impossible to alter conditions so I approached it in another way which was none other than neutralizing the first tube. This I did and was really astonished at the improvement in selectivity, directional effect and decreased tendency to oscillate.

The neutralization was accomplished in the following manner: The connections on the primary of the first Radio frequency transformer were reversed, i. e., the plate of the first tube was connected to the terminal marked B+ and the B battery was connected to the terminal marked P. It was necessary to do this to make the grid of the second tube out of phase with the grid of the first tube, then a regulation neutralizing condenser of the sleeve type was connected, one side to the grid of the first tube and the other to the grid of the second tube. The filament of the first tube was turned out and the strongest station at home tuned in as loud as possible then the sleeve was moved until the signal entirely disappeared and it really did entirely dis-

ALL SHOT

That's the common expression of dry cell "B" batteries. Purchase the economy way and enjoy freedom from hissing and frying, clearer reception, and greater volume. Put together an everlasting "HAWLEY" rechargeable "B" storage battery. Nickel-iron alkaline type. No former experience or soldering necessary. Put up in both assembled and knock-down types. The knock-down units contain all actual material for building battery and are put up in 90 volts @ \$8.95; 100 volts, \$9.95; 120 volts, \$11.00; 135 volts, \$12.75; 150 volts, \$13.90; 200 volts, \$17.50. Guaranteed for 2 years with a 30-day trial offer of complete satisfaction or return of your money without any ifs nor ands. Complete sample cell 35c prepaid. 8-page illustrated folder of instructions showing simple putting together, making charger and charging, free with all orders. Complete manufactured "B" battery charger \$2.75. Order direct or write for my literature, guarantee, and testimonials. Same day shipments.

B. D. SMITH
31 Washington Ave. Danbury, Conn.

REVERSING CONNECTION TO PLATE

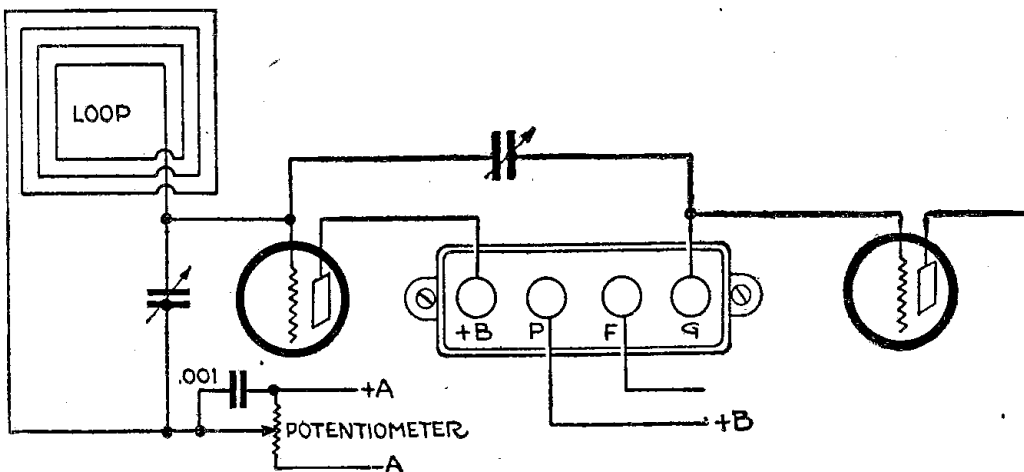

appear. The results were very gratifying. The complete diagram is not shown because it is the regulation four tube reflex hook-up. This same scheme could be used on any set using untuned Radio frequency amplification, although on some transformers it may not be necessary to reverse the primary connections because the grids may be out of phase in their normal conditions.—C. K. Beebe, Chicago, Illinois.

Space Parts

Electrical losses through improper placement of parts are considerable in many home made sets. Inductances should be placed so that the magnetic fields of no two coils inter-act on each other. This can be done by placing the coils at right angles to each other; but even when so placed, it is advisable to lay the parts out, so that the coils will be as far apart as possible, without too greatly increasing the length of coil leads.

It is not a good policy to construct a three-tube set on a panel that is only large enough for a one-tube set.

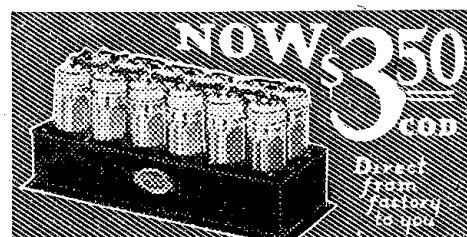

THE RABAT SENIOR
1200 M.P.H. AMPERS CAPACITY

FOR A LIMITED TIME ONLY

You can purchase for \$3.50 a 12 cell 24 volt RABAT SENIOR battery. Saving \$6.10 through direct buying. The Jobber and Dealers profit now is yours. 24 cell 48 volt size \$7.00.

Rabat Senior Batteries

are neat, powerful, noiseless and will harmonize with any Radio Set. Separate cells and patented rubber cork prevent current leakage and clear glass tubes give vision of the condition of battery. Heavy duty plates 3-16 x 1-1/2 x 2-1/2 with staggered ribbed grid form the backbone of this sturdy battery. Shipped completely charged ready for instant use. And you can save \$6.10 by ordering now.

RABAT JUNIOR BATTERY \$2.15 c. o. d.

(12 CELLS 24 VOLTS 1200 M.P.H. CAPACITY)
Incomparable in price and performance. Designed to satisfactorily operate sets equipped with 3 tubes or less. Constructed of the same high grade materials as used in our Senior battery. Shipped dry, uncharged. Order today and save \$1.80.

Rabat Super-Charger \$3.00 c. o. d.

Is specially designed to satisfactorily recharge any make of storage "B" battery. Shipped complete ready to use, including lamp socket, attach ment plug and cord. You save \$1.80 by ordering direct.

SEND NO MONEY

But write us today, advance quantity and type wanted. After examining and approving these wonderful batteries then pay the Expressman the small C.O.D. charges.

The Rabat guarantee is back of all our products. DON'T WAIT! ORDER TODAY and save the middleman's profit.

THE RADIO RABAT COMPANY
1767 St. Clair Avenue, Cleveland, Ohio

Station or Set at Fault

Noise and distortion are inexcusable faults, but it is well to remember it isn't always the fault of the receiving set. Background noises which can be heard under the voice, as well as certain classes of distortion, are sometimes actually transmitted and there is little you can do to get away from it. This can be checked up by listening in to one or two other stations. If the signals come through clean cut and free from noise, rest assured your set is O. K. and the broadcasting station is at fault.

Socket Base Mounting Attached to Rheostat

A small sheet of aluminum makes a substantial bracket for mounting a sub base to a panel. The aluminum bracket is held to the panel with the screws that

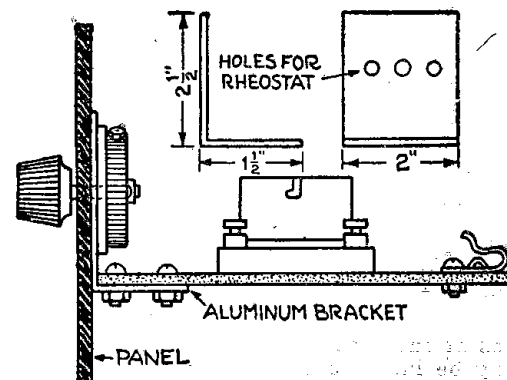

fasten the rheostat in place. The illustration gives details of its construction.—F. A. Mann, Hinsdale, Ill.

The Crystalstat

PRICE \$2.50



The Ideal Reflex Detector but equally suitable for crystal sets. The Crystalstat embodies the following features: A super-sensitive crystal in an air tight enclosure. A brush cat whisker of gold tinsel strands. A micrometer adjustment by means of which the most delicate adjustment may be had. The multiple contacts of fine gold filaments prevent howling and give light but sure contact. The crystal is our wonderful Star-ite, the pick of the Barth's best crystal.

The Crystalstat attaches through one 5/16" hole in the panel so that only the control knob shows on the face of the panel. Packed in one dozen lots for dealers. Ask your dealer to supply you or you may send for one C. O. D. with your money back if not completely satisfied.

DEALERS and JOBBERS please get our catalog of crystals and detectors and our liberal distributing proposition.

Star Crystal Co.
147 N. 525 Woodward Avenue
DETROIT - MICHIGAN

The Quiet NILES

Battery Charger

Costs Less Per Charge

A vibrator charger built on a new principle. Takes less time and costs less to operate—because it converts 72% of current into battery charge. Charging rate (8 to 10 amp.) automatically controlled. Model A for 6-volt batteries, \$19.00; Model AB for 6-volt and 24-volt batteries, \$21.00. West of Rockies, \$1 extra.

Ask Any Radio Dealer
NILES MANUFACTURING COMPANY
Dept. 64, Ypsilanti, Mich.

Our Discounts Talk!

Listen to them! You can make money if you buy right—here's the place to do it.

Standard lines—sets, parts, accessories—shipped now! Our fast service puts goods on your shelves when you want them. The scarce items, too, hard to get elsewhere, are waiting for you at Fuetterer's.

Our catalogue No. 8 shows you—tells you—sells you!

Write for it now, and note our prices

FUETTERER
RADIO SUPPLY CO.
2121 LOCUST ST.
ST. LOUIS, MO.

Order those hard-to-get items from FUETTERER

\$1.50 now for the Ideal Radio Rheostat

The old story of big demand and quantity production making for price reduction has worked out for the Marshall-stat, the ideal radio rheostat. Its new price is \$1.50 now.

For your money you get the smoothest accurate adjustment rheostat on the market. It gives vernier precision throughout its entire range from 100 to 0.2 ohms. Yet there is only one adjustment to make—only one dial to turn.

In addition, it is compact (illustration above full size), requires only one hole in panel, and can be used with any tube or combination of tubes. You can't go wrong with the Marshall-stat.

MARSHALL ELECTRIC CO.
3231 Locust Boul. St. Louis, Mo.

Get the Marshall-stat at radio dealers everywhere. Write us for descriptive literature.

BARKELEY

Attachments for Radiola III and III-A

Antenna Selector Switch

The full range of antenna adjustments can be made by simply turning the two knobs and without loosening a nut. Remove the knurled nuts, slip the switch on the binding posts and replace the nuts. The antenna wire attaches to the one binding post on the rear.

No. 624 Price \$1.00

Four Phone Post

This post will take any number of head sets from one to four and all in series. It is equipped with prongs that push through the phone holes in the face of the panel.

No. 603 Price \$1.50

THE BARKELEY ELECTRIC MFG. CO.
Middletown, Ohio, U. S. A.

NEW YORK, 157 Chambers St. WASHINGTON, D. C., Mills Bldg. CHICAGO, 15 Clinton St., S. SAN FRANCISCO, 75 Fremont St. SEATTLE, 1014 Sixth Ave., S. LOS ANGELES, 443 S. San Pedro DENVER, Denham Bldg. MINNEAPOLIS, 1017 Lumber Ex. BOSTON, 31 Bedford St. TORONTO, 7 Grange Ave.

Questions and Answers

Plate Voltage

(12349) CEJ, Little Rock, Ark.
My set consists of three tubes with a regenerative detector built after one of your articles which appeared last summer. At first I had 67 volts on the plates of the amplifier tubes and later I put on 90. This seemed to increase the volume a great deal, but there was a slight blur in the signals. After reading over the article on C batteries I put in one of these units and the signals cleared up so that the tone is now very pleasing. All of your diagrams call for 90 volts on amplifier tubes and I have never seen you specify anywhere a higher voltage. Is there any reason why I cannot use a higher voltage on these tubes and get more volume?

A.—You do not state what tubes you are using, but we presume they are of the 6-volt filament type, such as UV-201A or C-301A. Voltages up to 125 can be applied on these tubes, but the increase in volume over that found at 90 volts is imperceptible and not worth the extra expense. At the same time there is some harm done the tubes as too high a plate voltage will pull the thorium off the filament and considerably decrease the efficient life of the tube. The filament will light, but signals will be weak and wavy. When tubes reach this stage it is necessary to disconnect the B battery and light the tubes brilliantly for two or three hours, which usually will restore a layer of thorium on the surface of the filament and enable the tube to function for many more hours of service. This will not be necessary, however, if 90 volts are used.

Radio Tables, Cabinets. Get our prices.
L. H. Bazuin, Grand Rapids, Mich.

PATENT ATTORNEYS

PATENTS. Booklet free. Highest references. Best results. WATSON E. COLEMAN, Patent Lawyer, 644 G Street, Washington, D. C.

Raulf Radio Consoles. The ideal radio cabinet, built in genuine mahogany or walnut. Send for descriptive circular. Raulf Manufacturing Company, 564 Vedder St., Chicago, Ill.

It's your money and you can spend it for tubes or batteries if you want to; but I can show you how to bring distant stations in on a simple crystal set. Same plans increase range of tube sets also. Copyrighted plans \$1.00. Complete parts for long distant crystal sets \$5.00. Leon Lambert, 501 Kaufman Bldg., Wichita, Kansas.

PATENTS

Write for my free Guide Books "How to Obtain a Patent" and "Invention and Industry" and "Record of Invention" blank before disclosing inventions. Send model or sketch of your invention for instructions. Promptness assured. No charge for above information. Clarence A. O'Brien, Registered Patent Lawyer, 2008 Security Bank Building, directly across street from Patent Office, Washington, D. C.

Make \$100 Weekly—sell RADIO

Demonstrate Once—Results Mean Sure Sale
Coast to coast, lowest prices, attractive four-tube instrument \$39.50. Big commission to you. Exclusive territory to proven salesmen. Territory going fast, write today for large illustrated book No. 100. Don't fail to name your county.



Eureka "B" and "C" Batteries are assembled with infinite care from first quality materials. Their LONG LIFE IS GUARANTEED.
Ask Your Dealer or Write Us.

Distributors Wanted
EUREKA BATTERY CO., Inc.
101 Wooster St. New York City

Low Loss in One Tube Hook-up

(11456) RWS, Lexington, Ky.
Please illustrate a one tube hook-up incorporating Mr. Jacques Fournier's low

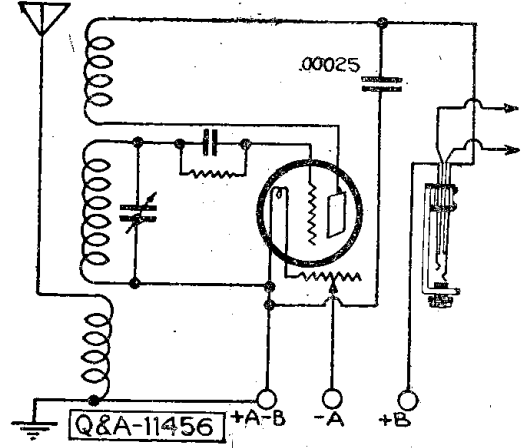

loss inductance described in the Radio Digest of November 29, 1924.

A.—We are presenting herewith hook-up suitable for the inductance described in Radio Digest.

X Wire Key to Neurodyne Success
(12330) GWS, Youngstown, Alberta, Can.
In your December 27 issue there appeared an article on "X Wire Key to Neurodyne Success." How do you neutralize this new circuit and could you

Men to build radio sets in spare time.
Leon Lambert, 501-H Kaufman Bldg., Wichita, Kansas.

\$10.00 IS ENOUGH

You can get programs 400 to 1,000 miles away on Lambert Crystal Sets, and you don't need tubes or batteries.

Tell your dealer "nothing else will do"
Picture of Set and Particulars Free.
LEON LAMBERT
501 Kaufman Bldg., Wichita, Kan.

YOU GET WONDERFUL DISTANCE

Marvelous Selectivity, Beautiful Tone and Tremendous Volume if you use in your set
the **NEW TUN-A-FAR COIL**
LOW LOSS
The New Radio Wonder for One Knob Reflex or Radio Frequency
TUN-A-FAR No. 1 \$1.25, No. 2 \$1.50
FREE Diagram for One Knob
FREE Hook-up with Each Coil.
A. H. WAAGE 6 Reade St., New York, N. Y.

100 RADIO CARDS

Thank the broadcasters with attractive Radio Appreciation Cards. Printed in two colors on high grade white Post Card. \$1.00 brings 100 cards postpaid. Order today
\$1.00
Post Paid
Radio Card Co., 220 Franklin Buffalo, N. Y., Dept. D

Radio Dealers HEADQUARTERS

Dealers—if you want the finest products, fastest shipments and best discounts write on your letterhead for catalog AC1003.

WAKEM & McLAUGHLIN
225 E. ILLINOIS ST. — CHICAGO



\$3.50
RADIO Storage "B" Battery
Lasts Indefinitely—Pays for Itself
Economy and performance unheard of before. Recharged at a negligible cost. Approved and listed as Standard by leading Radio Authorities, including Pop. Radio Laboratories, Pop. Sci. Inst. Standards, Radio News Lab., Lefax, Inc. and other important institutions. Equipped with Solid Rubber Case, an insurance against acid and leakage. Extra heavy glass jars. Heavy rugged plates. Order yours today!
SEND NO MONEY Just state number of batteries wanted and we will ship day order is received. Extra Offer: 4 batteries in series (36 volts), \$13. Pay expressman after examining batteries. 5 per cent discount for cash with order. Mail your order now!

WORLD BATTERY COMPANY
1219 So. Wabash Ave., Dept. 76, Chicago, Ill.
Makers of the Famous World Radio "A" Storage Battery
Prices: 6-volt, 100 Amp. \$12.50; 120 Amp. \$14.50; 140 Amp. \$16.00.
All equipped with Solid Rubber Base.

World FOR STORAGE BATTERIES RADIO

give me any pointers on it? Can I use a 5-plate condenser in place of the 7-plate one in the "Hetduogen," recently described in your paper?

A.—Answering your letter of February 9, the procedure for adjusting the third neutrodon is as follows:

The third neutrodon is set at minimum and two individual tube neutrodons are adjusted in the usual manner by placing a small piece of paper on one of the filament springs. When the circuit has been adjusted in this as far as possible the dials are then adjusted for resonance on a low wave length, and if there is a tendency for the receiver to oscillate the third neutrodon is increased in capacity until the tendency to whistle disappears. If this latter part of the procedure is done on the lowest wave length one wishes to receive, there will be no whistle

Roosevelt Musical Association. Music for all occasions. Fitzroy Brown, 158 Lefferts Place, Brooklyn, N. Y.

NEW 64-Page LOG. Holds 400 stations. Shows stations, cities, wave lengths, dial settings, remarks. Distance map. TROUBLE AIDS. Station lists by wave lengths, by states, etc. TUNING SUGGESTIONS. Other valuable information. Only \$1. Genuine leather cover. SEND NO MONEY. Pay postman. Order NOW. RADIO PRINTERS, Department 6413C, Mendota, Illinois.

\$1.50 Protects Against LIGHTNING EVERY RADIO NEEDS A KEYSTONE Approved ARRESTER

RADIO CLUB PINS

Pins shown designed especially for RADIO CLUBS. Words "Radio Club" cannot be changed. Other lettering can, only name must not exceed 8 letters. Silver plate, 25¢ ea., \$2.50 doz. Sterling silver, 40¢ ea., \$4.00 doz.
SEND FOR FREE CATALOG
BASTIAN BROS. CO. 603 - Bastian Bldg., Rochester, N. Y.

FREE The very latest up-to-date radio wall map 28 by 34 inches. Shows call letters, locations, wave lengths, and kilocycles of all radio broadcasting stations, U. S., Canada, and Mexico, relay divisions and radio districts. Also a scale for measuring distance. This wonderful map postage paid, ABSOLUTELY FREE. Merely send us a list of stores in your city which handle radio apparatus. Be sure and give the street address, and if you know the manager's name, give it also. DO IT TODAY before this offer is withdrawn.
OZARKA, Inc. 808 Washington Blvd., Chicago, Ill.

CARTER Portable Jack



For extending head set or loud speaker into another room, or sun porch any distance from set.
Carter construction and quality.
Takes wires—cords or cord tips.
Any dealer can supply

In Canada—Carter Radio Co., Limited, Toronto
Carter Radio Co.
720 S. STATE STREET CHICAGO

ask "are they genuine Radiotrons?"

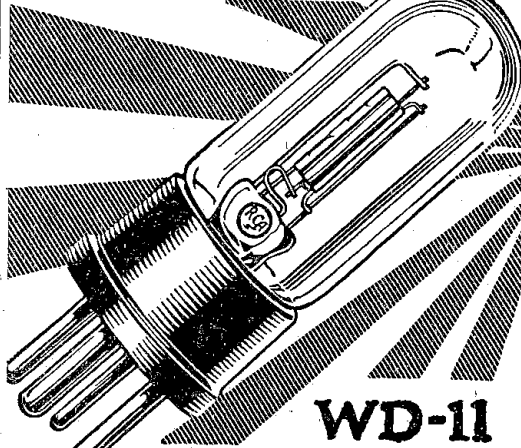

Radiotron

or oscillation on any wave lengths above it.

Relative to the use of a 5-plate condenser in place of a 7-plate unit in the Hetduogen, we must advise that this will not be large enough, as a 7-plate just covers the range as it is. In fact, if the 7-plate condenser happens to be made with rather small plates and large spacing between plates the builder of this set is unable to get above 485 meters.

Wanted by large manufacturer, a well designed modern variable condenser including designs, tools, etc. Cash. Explain fully. Box 904, Radio Digest.

GO into the RADIO BUSINESS

We specialize in Equipping New Dealers with entire stock—ADVICE FREE. Send for Our Radio CATALOG & BARGAIN LISTS Wholesale Only
MANHATTAN RADIO CO.
112 Trinity Place New York City

MOGG'S AERIALS

Mogg's special radio aerials, inside or outside type; designed and perfected by our Radio Engineer. Send 25c for blue print of complete plan and details.

INDIANAPOLIS REFLEX RADIO CO.
1502 Fletcher Trust Bldg. Indianapolis, Ind.

Mailing Lists

Will help you increase sales Send for FREE catalog giving counts and prices on thousands of classified names of your best prospective customers—National, State and Local—Individuals, Professions, Business Concerns.
99% Guaranteed 5¢ each
1055 Commercial St. 315 N. 5th St. S. D. 57000

Log YOUR Radio Send NO Money

NEW Log. GENUINE leather cover. Holds 400 stations. Shows call, city, wave lengths, 4 dial settings, remarks, etc. Stations by wave lengths. Stations alphabetically by states and cities. Valuable tuning suggestions. Station owners. Distance map. So convenient. Trouble aids. Other valuable information. Worth many times small cost. With beautiful rippled cover 75c; GENUINE De Luxe leather cover, only \$1.00. Order NOW. **MONEY REFUNDED if Not Delighted**
Don't send a cent. Pay postman after log arrives. If you pay with order we pay postage. You will enjoy this log. Just what you need. Order today—NOW. Postal will do.
RADIO PRINTERS, Dept. 8413 MENDOTA, ILL.

World's Finest Toned Low Priced Speaker



It isn't a genuine WD-11 unless it's a Radiotron

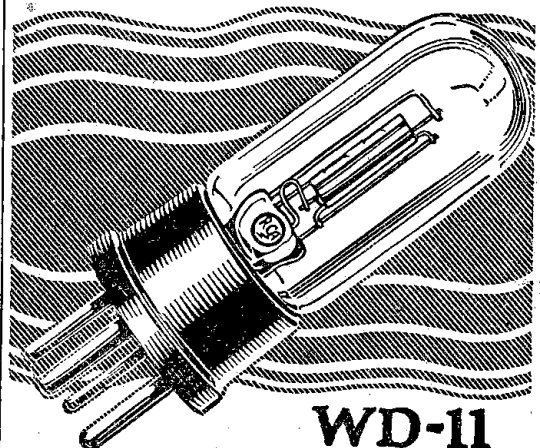

Radiotron

