

Radio Digest

EVERY
WEEK

Illustrated

TEN
CENTS

REG. U. S. PAT. OFF. & DOM. OF CANADA

Vol. VII Copyright 1923 By Radio Digest Publishing Co. SATURDAY, DECEMBER 22, 1923 No. 11

RAILROADS USE RADIO



RAIL HEADS GIVE O. K. TO AIR CONTROL

Radio Relay League Plans to
Serve with Roads as Emer-
gency Dispatchers

Many Amateurs Enrolled

CHICAGO.—Three years, more or less, of intensive study as to the feasibility of Radio in the operation of trains, steam and electric, has resulted in the opinion of railroad executives that not only will the electromagnetic wave probably be practicable soon but that it is extremely necessary in emergencies such as blockades caused by storm or flood. The coming winter will undoubtedly see Radio used widely in short range relief work.

This is the gist of the latest report of the committee on telegraph and telephone of the American Railway Association of which committee J. D. Jones, eastern region, Pennsylvania system, is chairman, and A. R. Belmont of the Boston and Albany; G. Y. Allen and L. M. Aspinwall, Westinghouse Electric; A. H. Armstrong, General Elec-

(Continued on page 5)

HOOVER ASKS FOR OVERSEER OF AIR

URGES CONGRESS TO SET
UP RADIO POLICY

Points to Necessity of Agency to En-
force Laws on Com-
munication

By Carl H. Butman

WASHINGTON.—Reiterating his plea for Radio legislation made last year, Secretary of Commerce Hoover explains the present Radio situation in his recent annual report and urges Congress to designate someone to handle Radio regulation.

"The rapid growth of Radio communication makes necessary an affirmative declaration by Congress of a governmental policy in accordance with which the art is to be conducted, and the empowering of some agency to carry that policy into effect," the secretary states. "This can only be done through an officer with discretionary powers and under the regulations which will be made by him in conformity with the general terms of the

(Continued on page 2)



At the extreme left Cyrena van Gordon, and at the right, above, Rosa Raisa, stars of the Chicago Civic Opera company. Radiophans have had opportunities to listen in to both of these artists if they have tuned in KYW or WMAQ



At the left, dainty Dorothy Wallace Portingall, thirteen-year-old saxophone player and vocalist who often entertains listeners in to WHN, Loew's broadcasting station, New York City, with solos

Broadcast Music from Phonograph Studios

Columbia Company to Give Con-
cert Twice Weekly

NEW YORK.—That the phonograph industry realizes the publicity and advertising value of broadcasting is evidenced by the recent arrangement made between the Columbia Phonograph Company and Station WEAJ here by which the Columbia Company will broadcast twice a week.

The broadcasting will be done directly from the recording studios and carried by wire to WEAJ.

FEW WAVE SNAGS NOW, SAYS HOOVER

WASHINGTON, D. C.—There is very little interference in broadcasting at the present time, according to Secretary of Commerce Hoover. Mr. Hoover feels that the last Radio conference held in Washington was especially responsible for the better conditions which now exist. Whether or not another Radio conference will be held in the Spring has not yet been decided.



Miss Amy Dennis, who took the part of the boy-girl "Pat O'Rat" in "Little Old New York," as broadcasted recently from WOC, Davenport, Iowa

Extend Contest Deadline
SCHENECTADY, N. Y.—The Radio drama prize competition, inaugurated by Station WGY, General Electric Company here, has been extended one month and will close December 31 instead of November 30, as originally announced.

WORD TO AND FROM POLE IN 5 MINUTES

AVALON, CALIF.—All amateur speed records as to transmission were said to have been broken here recently when Major Lawrence Mott relayed a message from Hartford, Conn., to the schooner Bowdoin, exploring near the North pole, and then received and sent its answer to Hartford in five minutes and six seconds, using a Grebe CR13 receiver.

COLUMNIST PLEASES WJAX LISTENERS IN



Ted Robinson, poet and writer, well-known conductor of the Cleveland Plain Dealer's "Philosophy of Folly" column, recently delivered a most entertaining talk from WJAX

BE-RIBBONED SWEETS REWARD FOR "J. M. B."

J. M. Barnett's Girl Accompanist at WOR Now Expects Cigars

NEWARK, N. J.—Few features of the WOR program have made such a decided impression on WOR listeners as the dinner period which was instituted by J. M. Barnett, the popular manager of the New Jersey station. Speaking of "J. M. B." recently, she said one calculated that the number of other local stations and with the number of the service... a large, ribbon-bedecked package of chocolate confections and shortly afterwards a telegram was delivered to him which explained the candy was sent in appreciation of the splendid WOR programs and particularly to reward him for the song numbers which he frequently sings from WOR. Louise Egner who plays all the accompaniments for "J. M. B." says she expects a box of cigars most any evening.

De Forest Offers Set as Prize for Best Scenario

Inventor Seeks Comedy Suitable for Adaptation to Phonofilm

NEW YORK.—Dr. Lee De Forest wants to know whether there are any scenario writers among the Radiophans. He intends to produce a Radio comedy via the phonofilm and has indicated his willingness to receive suggestions from fans all over the country. Just to make it more interesting, he will give one of the new De Forest D-10 reflex sets as a reward for the best comedy scenario submitted, provided it is available for production in the phonofilm studio. The phonofilm is a combination of motion pictures and voice or music or any other sound the action calls for. It is all photographed and reproduced in synchronization.

ALASKA TOWNS SEND MESSAGE OF THANKS

Space Is Only Limit on Number of Listeners at Receivers

LOS ANGELES.—A message of appreciation was brought from the many listeners in far-away Alaska, to The Los Angeles Times station, KHJ, recently, by John Hooper, president of the Canadian Tourist Society. He said: "No one but those in the Far North can realize the splendid work that Radio has done for Alaska, where there are infrequent monthly or fortnightly mails, and no telegraph or telephone connection between towns. The number of people who enjoy KHJ in Alaska is limited only by the capacity of room for the listeners about each instrument."

French Amateur on 100 Meters Heard in States

First Trans-Atlantic Success for Such Low Wave Length

HARTFORD, CONN.—The greatest distance ever covered by amateur Radio on a wave length of 100 meters was reported recently at American Radio Relay League headquarters here. Signals of the French amateur station 8AE, operated by Leon Deloy, were copied on 100 meters by F. H. Schnell, traffic manager of the A. R. R. L., listening at his station, 1MO, here. The feat was attempted through special arrangement with the French amateur and the Radio inspector for this district as one phase of the league's investigation of the value of short waves for long-distance transmission. Amateurs have transmitted short distances on 100 meters, but it has never been done before across the Atlantic.

HOOVER ASKS OVERSEER

(Continued from page 1) law," he adds, commending the matter to the attention of Congress. Work of revising and simplifying the White Bill, which passed the House last session, is known to be under way, and Secretary Hoover believes no opposition will be found when the new bill is presented. While he is not seeking extra work required in the bill for his department, Radio regulation of course is now under his direction and it is known that Mr. Hoover is greatly interested in its development.

WOR BLAZES RADIO TRAIL TO NIPPON

Newark Station Tests Ability to Transmit Voice Half Around World

NEWARK, N. J.—Tests as to whether Station WOR, L. Bamberger and Company of this City, is powerful enough to transmit the human voice half way around the world, that is, from this city to Tokio, Japan, were completed here recently. The results of the tests will be made known soon. Negotiations to consummate the test were begun last August between Jack R. Poppele, chief Radio operator for WOR, and Hiroshi Ando of Station JFWA, Tokio, rated as the leading Radio experimenter of his country. The tests, which were begun on December 1 and ended December 15, were made daily from 4 to 6 o'clock in the morning, so as to avoid interference with or by other broadcasting stations. On a wave length of 405 meters or 740 kilocycles, the tests were made according to the following time schedule: Eastern time, 4 to 6 a. m.; Central time 3 to 5 a. m.; Mountain time, 2 to 4 a. m.; Pacific time, 1 to 3 a. m.; Honolulu time, 11 p. m. to 1 a. m. While Station WOR was blazing the Radio trail, Shag Valley station, New Zealand, and members of the Australian Radio Relay League at Auckland, New Zealand, were scheduled to listen in. Radio inventors have produced practically nothing to eliminate static from the wave lengths for broadcasting.

CONTENTS

Radio Digest, Illustrated Volume VII, Number 11, published Chicago, Illinois, December 22, 1923. Published weekly by Radio Digest Publishing Company, 123 West Madison Street, Chicago, Illinois. Subscription rates, yearly, Five Dollars; Foreign Postage One Dollar additional; single copies, Ten Cents. Entered as second-class matter at the postoffice at Chicago, Illinois, under the Act of March 3, 1879.

Table listing contents: "All the Live News of Radio" (1 to 9), Charts and Lessons in Dancing to Accompany Arthur Murray Broadcasts (4), An Evening at Home with the Listener (8), Methods of Securing the Neutrodyne Effect (9), R.D.-107 Hook-Up (10), Further Details of Milplex Hook-Up (11), Advance Programs for Current Week (12), Simple Explanation of Radio for Everybody, Chapter VII, Part II—Antennas and Grounds, by H. W. Thompson (15), Editorials; Indi-Gest; Condensed, by Dielectric (16), Latest Development in Grimes' Inverse Duplex, Part V—Crystal Detectors and Extra Radio Amplification, by David Grimes (17), Super-Triplex Selective Receiver Construction, Part III—Conclusion, by H. J. Marx (19), Inside Mounting for Honeycomb Coils (21), Questions and Answers (22), Broadcasting Stations, Part III (23), Radio Illustrated, a Page of Pictures (24)

Looking Ahead

Neutrodyne Scores Again Next Week—with a second article by H. J. Marx. There's a lot to learn about neutralizing the inter-tube capacities, You will get all in the understandable style of Mr. Marx. Super Heterodyne Coming Soon! It's a Wow—Simplified but yet refined enough to hold its own as a Rolls-Royce receiver. The last goal of the amateur builder. Dr. Lee De Forest Has Written an Article for You—Being less occupied in commercial Radio, the eminent inventor of the vacuum tube you use, has prepared an exclusive article for Digest readers. No, not next week, but during the month. And Another Father of Radio—Dr. A. Meisner—has signed an exclusive contract to write for Radio Digest. "Your publication is careful to be accurate," says the DeForest of Germany. Dr. Meisner may soon tell you how a "feedback" or regenerative set was in use in Germany in 1904, nine years before Armstrong's patent here. Grimes Will Tell You About Tuned Radio Frequency and how it acts in his Inverse Duplex Monotrol set. Scheduled for next issue. Form in line at the right. R. F. and A. F. with a Special Transformer—Made by an Omaha reader and is unusual. Read the "Kinks" page next week. A Picture Hook-Up for Beginners that beats them all. See the Simplex Diagram next issue. Spider web coils are used. Thompson Will Tell You How to Hang That Antenna for the wife and kiddies' Radio. Very appropriate coming right after Christmas, isn't it? And Besides, Next Issue You'll Have: Hook-Up R. D.-108, a two step tuned R. F. amplifier circuit, and data on honeycomb coils by H. J. Marx.

Newsstands Don't Always Have One Left WHEN YOU WANT

Radio Digest

YOU WANT IT!

BE SURE OF YOUR WEEKLY COPY BY SUBSCRIBING NOW

SEND IN THE BLANK TODAY

Form for subscription: Publisher Radio Digest, 123 West Madison St., Chicago, Illinois. Please find enclosed check M. O. for Five Dollars (Six, Foreign) for One Year's Subscription to Radio Digest, Illustrated. Name, Address, City, State.

WALNART New INDUCTANCE SWITCH



Replaces switch points. Insures positive contact and better radio results.

Only one hole to drill in panel, 1 to 10" points.

Bakelite Knob and numbered dial. Position of contact always visible.

Terminals mounted on bakelite base. Can be used in small space.

Costs less than switch points and gives much better results.

Price \$1.25

ASK YOUR DEALER

Catalog mailed on request

WALNART ELECTRIC MFG. CO.

Dept. 314, 1249 West Van Buren Street CHICAGO

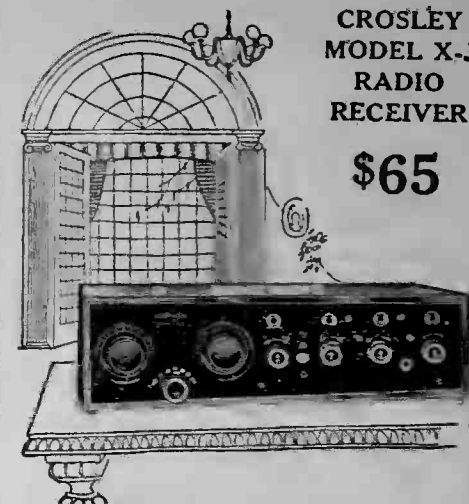

CROSLY MODEL X-J RADIO RECEIVER

\$65

Tune Out Local Interference

ENJOY the many interesting programs that may nightly be received from distant broadcasting stations.

With a Crosley Model X-J you can easily do this. This 4-tube radio receiver, consisting of one stage of tuned radio frequency amplification, detector and two stages of audio frequency amplification, is daily making new distance records.

Unsolicited letters from all parts of the country tell us of the farthest distant stations being brought in clearly and distinctly.

You, too, can enjoy the best programs if you own a Crosley Model X-J—Price only \$65.

Under actual tests, it has proven that for bringing in distant stations no set, can excel it.

For Sale by Good Dealers Everywhere

Crosley Manufacturing Company POWEL CROSLY, Jr., President 12494 Alfred Street, Cincinnati, O.

EXPOSE OF MUSIC TRUST PRINCIPLES

PUBLISHER OF OLD DAYS WELCOMED ADVERTISING

Mechanical Reproduction and Radio Makes Song Hits for Publishers Now Crying at "Injuries"

(The following article is one of a series which is being published with the express purpose of explaining to the Radio public the situation existing between the broadcasting stations and the American Society of Composers, Authors and Publishers. The series tells in detail the reasons why the National Association of Broadcasters was organized, and why certain popular songs, the copyrights for which are controlled by the "music trust," are not being broadcast.—The Editor.)

PART VI

IN THE days preceding and up to "After the Ball," popular "hits" were rare. Comparatively few songs were composed. A "hit" took years to "get over" and once well launched lasted years. The "publishers' plugging machinery" was crude and squeaky. The profits were meager; the game was not strenuous. The public were satisfied, when once they landed on a tuneful hit, to stand by it. There were no phonographs or piano players.

Music was universally poorly played as compared with today—it was before the two-step. There were the waltz, polka, schottische, and the square and round dances. Music at that time was composed especially for these dances. Waltzing was taught in the old foreign style by the dancing master "hop-a-leetle, hop-a-leetle—waan-two-tree."

Fast and Present

Supposing that some good fairy could have whispered in the ears of a publisher of those days the following: "I will provide a phonograph and a piano player which will mechanically play your song in a more perfect manner than any ordinary pianist. Your song will never be heard on these instruments unless they are played by the world's most competent professionals."

"That is good advertising. Your songs are now murdered by the playing of mediocre home talent. That's poor advertising. Then I will provide a projecting mechanism which will carry your song electrically into the homes of millions of people. That is super-advertising. And all of this without cost to you."

Could Have Jumped at Opportunity

Would that publisher have grasped the opportunity? He would. His chief problem was to get his music heard. He could only reach a small percentage of the population. The avenues now open to the modern publisher would have meant great wealth to the old-timer.

As time went on the commercial instincts of the popular music publisher developed rapidly. Modern mechanism for mechanical reproduction was at first welcomed by the publisher as an advertising means. And they profited in full measure in those days. It is not a far cry from what we are pleased to term the "commercial instinct" to avarice.

In the old days popular music wholesaled at about seven cents a copy. The price is now about fifteen cents. And a popular hit will reach well up to two million copies.

Publishers Make Bold Stroke

Early in this century, publishers in surveying their opportunities and profiting greatly from the benefits of advertising coming to them through perfectly played mechanical reproductions determined upon a bold stroke. They showed positive genius. Some publishers who must have been as smart as the man who invented interest, must have said: "If we could only get these mechanical people who are spending so very much money in advertising to pay us for the privilege of doing so we would have a fat income."

Then someone must have said: "You cannot do this. They are doing us a great service. Without cost they are giving us

TALKS FROM AIR TO HELPMET ILL IN BED

INDIANAPOLIS, IND.—Lieut. Harold Harris, commanding officer of the Barling bomber, largest United States airplane, talked to his wife, who is ill in a local hospital, over a new type of Radiophone transmitter as the bomber circled over the hospital a few days ago. A Radio receiving set had been installed in Mrs. Harris' room.

CALM AT FIRE TILL AERIAL IS DAMAGED

NEW YORK.—Herman Brookman, thirteen, showed the results of school-taught discipline a few days ago when his home in the Bronx was in flames, and stood quietly by watching the firemen at work—until suddenly he shouted in wild alarm as he saw the fire fighters tearing down his antenna. He almost collapsed.

SOCIETY TAKES UP LISTENING IN



New York society has been bitten by the Radio bug, as witness this photograph of Miss Irene Beadston, one of the great metropolis' Four Hundred. The picture was taken at a benefit fair at which Radio sets were raffled K. & H. Photo

hundreds of thousands of dollars worth of free advertising. How could you ever make them pay for this privilege?"

Play Both Ends Against Middle

And then the shrewd one retorted: "Easiest thing in the world. We will claim that they are injuring our business. We don't have to show any books. Nor exhibit any balance sheets. We will just make the unsupported claim and demand payment."

And so they did, and so was born the unheard of policy of the advertising

medium paying for the privilege of advertising the advertiser. It would be just as sensible for a safety razor concern to ask the Saturday Evening Post to pay for the privilege of running a razor advertisement.

This policy has been developed step by step until hundreds of thousands of dollars are annually rolling into the coffers of that aggressive minority known as the American Society of Composers, Authors and Publishers.

(TO BE CONTINUED.)

HALF-HOURLY NEWS BY 'WORLD CRIER'

TWO PAPERS WITH KYW IN 24-HOUR SERVICE

Chicago Publications Give Listeners Bulletins of Earth's Affairs Throughout Day and Night

CHICAGO.—Airy news vehicles have been established here by a morning and an evening publication through KYW, Westinghouse station here.

Instead of broadcasting bulletins at certain times during the day, the evening paper transmits news every thirty minutes, on the half-hour and the hour, from 5 o'clock in the morning until 5 o'clock in the evening; the morning publication, whose ownership is the same as the evening paper, broadcasts at similar intervals from 5 o'clock in the evening to 5 o'clock in the morning.

Sets Example for A. S. C. A. P.

The twenty-four hour service, known as the "World Crier," enables thousands of listeners in from the Great Lakes to the Panama Canal Zone and from the Atlantic to the Pacific ocean to keep abreast at all times with affairs all over the earth.

The evening newspaper, in connection with the "World Crier," sends the correct time every half-hour.

"The World Crier," conceived by Wilson J. Wetherbee, director of KYW, is another instance called to the attention of the Association of Composers, Authors and Publishers, of the manner in which Radio spurs business. Instead of lowering the circulation of the newspapers, the "World Crier," it was said, has tended to raise it.

BLAME SHIPS FOR BIG INTERFERENCE

Reradiation Held Second Main Disturbance by Radio Club of America

NEW YORK.—Radio interference problems were discussed at the last meeting of the Radio Club of America, held in Schermerhorn Hall, Columbia University. A general committee reported the results of an investigation conducted relative to various types of interference each could be eliminated.

Observations made by the committee showed that code interference caused by ships and commercial shore stations using spark transmitters was the chief disturbance in the ether. Reradiation of regenerative receiving was rated second.

Paul Godley, a member of the Investigating Committee, points out that the bulk of interference from code in the New York district was caused by Station WNY, Bush Terminal; NAH, Brooklyn Navy Yard; Cape May, N. J., and New London, Conn.

Professor L. A. Hazeltine, inventor of the Neutrodyne circuit, declared it scientifically impossible to design a receiving set to cut out spark interference. Such disturbance is not caused by the nominal frequency of the spark, but by one of its many side frequencies.

Station WTAY, Oak Park, Rebuilt with More Power

CHICAGO.—Station WTAY, the Pioneer Publishing Co., Oak Park, Ill., has been rebuilt under the supervision of R. H. G. Mathews to have an antenna input of 500 watts. Mr. Mathews had much to do with the construction of Station WJAZ, Zenith-Edgewater Beach Hotel, here. The studio of WTAY is now located in the Oak Park Arms Hotel, and microphones have been installed in the lounge and dining rooms. Hugh B. Marshall, former studio manager of WJAZ, has taken the same position at WTAY. The new station will work on a wave length of 244 meters.

THE ANTENNA BROTHERS

Spir L. and Lew P.

Unnecessary Programs

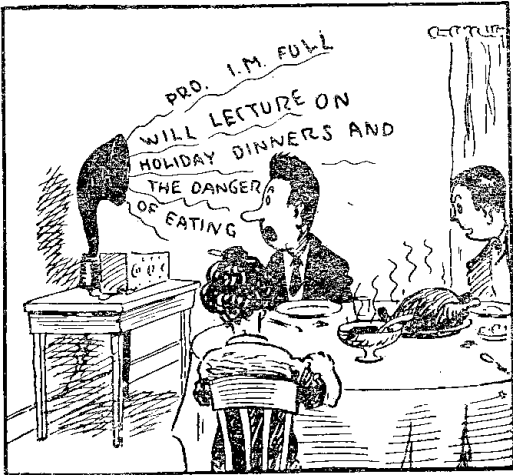
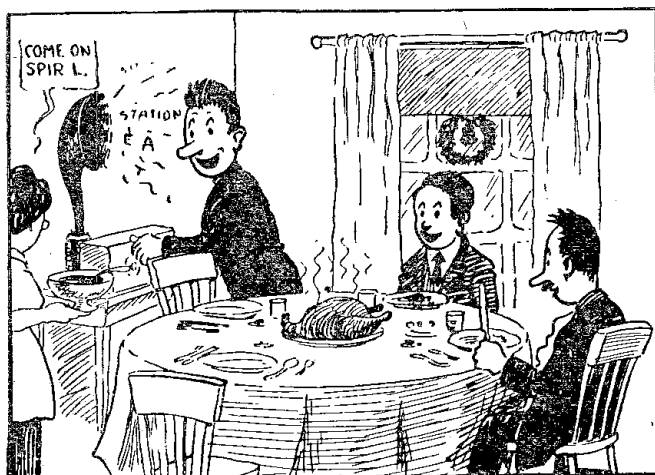

SIXTH LAST DANCE LESSON BROADCAST

REPEAT LESSONS II AND III FOR LATE COMERS

Instructions Republished to Meet Demand from Listeners in Who Missed First of Series

Learn to dance by listening in! Radio Digest has perfected an arrangement with Arthur Murray, nationally known teacher of ballroom dancing, whereby Mr. Murray is broadcasting dancing lessons from WOR, L. Bamberger and Company, Newark, N. J., and a score of other prominent stations. Radio Digest exclusively will give the charts and instructions which apply to the lessons broadcast by Mr. Murray personally at WOR and by the other stations. WOC, WBAP, WNAC, WLW, WLAG, WRW, WHAS, WFI, KPO, CFCF, WSAD, WHTAS, WGY, WMC, KDKA, WRC, WGI, WCAE, WHAM, WBZ, WGR, and KYW are broadcasting the series of lessons. The series below may be used in conjunction with or after hearing the broadcast lessons. Save the lessons to use with the broadcasts.

—The Editor.

Lesson VI—Review By Arthur Murray

WE HAVE now completed the most important steps one should know to become a good dancer. The final lesson, as broadcast, is a review. Study over the first five lessons. Read carefully and practice diligently.

If you have been unable to secure a complete file of Radio Digest, start saving the copies now. Due to demands for the charts, Radio Digest is republishing the entire series in turn. The second and third lessons, the Forward Waltz and the Backward Waltz, respectively, are given following the conclusion of this, the last lesson. Lesson I was repeated last week.

There are several points in etiquette the beginner should do well to have in mind before ending this series. I will discuss them here briefly.

How to Leave One Partner to Dance with Another

After dancing with a girl, if a young man wishes to seek another partner, he should leave his first partner with friends or the chaperons and seek another gentleman to dance the next dance with his original partner. He can leave his partner by explaining that he wishes to hunt a friend whom he is anxious for her to meet.

When a hostess sees some neglected girl, she will seek out a partner for her and present him with some word of pleasantry, "Miss West, may I present Mr. Adams? He hopes that you can spare him a dance," or, to a closer friend, "Lucia, Mr. Adams has asked to be presented to you. My friend Miss Kent, Mr. Adams."

Two California Amateurs Get Messages from Java

LOS ANGELES.—Radio messages from Bondo, Java, have been picked up at Santa Barbara by two amateurs. The distance is more than 12,000 miles. The Santa Barbara stations are three miles apart and they have been picking up the Java messages at intervals for a month. The Panama-Pacific liner Finland, just arrived in this port from New York, all the way from the canal was in touch with both WEAJ, New York, and KHJ, Los Angeles.

Introductions and Asking for Dance
To a strange young man, the hostess may say, "Mr. Brown, my sister would like to know you. May I introduce you?" It is the duty of the hostess and other chaperons to make introductions whenever possible, especially among the younger people, and see that the dancing men are presented to the young women, so that no one will be neglected.

The gentleman places himself in the position of asking for the favor when he asks the lady to dance. At the end of the dance he thanks her and makes some complimentary remark to the effect that

ing this most important dance. Build a good foundation and you will always be a good dancer.

Do not be content with simply learning how to do the steps; each movement should be practiced until you can do it very rapidly and almost mechanically. Practice each step until you have perfected it to such an extent that you do not need to count or even think of your feet. When you waltz with a partner you will not have sufficient time to think of the step.

The Waltz steps here described may also be done to Fox Trot and One-Step music.

First and Second Part of Forward Waltz Step Combined

Here is the count for the complete Forward Waltz Step:

1. Step forward on left foot;
2. Step diagonally forward to right;
3. Draw left up to right, weight on left;
4. Step directly forward with right;
5. Step diagonally forward to left;
6. Draw right foot up to left, weight on right.

Practice this step around the room

going in the line of direction. Study Figure 3 carefully and follow the numbered foot-steps. The right foot is shaded.

How to Waltz to Music

Dance the Forward Waltz step beginning with the left foot forward. As you go through the steps, sing or hum, counting ONE—two—three. Remember that the first of every three beats is counted louder. Count: ONE—two—three—FOUR—five—six.

Lady's Part of Waltz Movement Backward

The Backward Waltz movement is just the opposite of the Forward Waltz movement. When the man does the forward movement, the lady does the Backward Waltz.

1. Step backward with right foot;
2. Step back, slightly to left, with left foot;
3. Draw right foot up to left; weight on right (see diagram);
4. Step directly backward with left foot;
5. Step back, slightly to right, with right;
6. Draw left foot up to right, weight on left.

That's all. Study Figure 4 carefully.
(TO BE CONTINUED.)

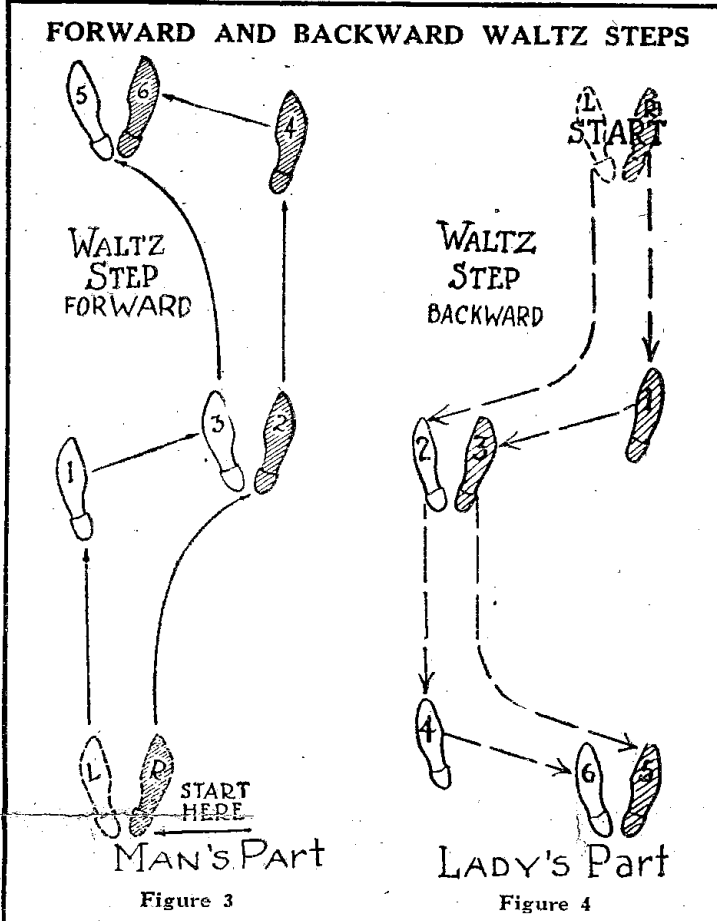

World's Biggest Battery Bargain



Hydrometer and "B" Battery FREE
READ THIS SPECIAL CHRISTMAS OFFER. THEN ACT!

Thousands of Radio Digest Readers will profit by this amazing offer. They will buy the famous 2-year guaranteed World Battery at the lowest price ever quoted. They will get a hydrometer and a "B" Battery FREE. And they get the best battery built. It is "World" quality that makes possible our 2-year ironclad guarantee. It is "World" quality that makes "World" owners "tell their friends." That's the best proof of performance any product can have.

SEND NO MONEY
You need not send a penny. Just clip this ad and attach your name and address. The battery will be shipped to you the day your order is received. When the battery arrives, inspect it—read our 2-year guarantee before you pay one penny. Convince yourself you are protected from every angle—that the World battery price saves you 50%. Get the "B" Battery and hydrometer FREE. Order today.

Special Christmas Offer
Clip and mail this ad with your World battery order and get this hydrometer and "B" battery FREE.

World Battery Co., Dept. L, 60 E. Roosevelt Rd., Chicago, Ill.

World

Send your order today.

he enjoyed the dance. Perhaps the most commonly used form of asking for a dance is to say, "May I have the pleasure of a dance?" or, "May I have the next dance?" It is poor taste to say, "Have you the next dance?" And then if a negative answer is given, to ask for the dance. Often a girl does not like to admit that her dances are not taken and this question is not at all pleasant.

(THE END.)

Lessons II and III—Forward and Backward Waltz By Arthur Murray

THE WALTZ is recognized as the foundation of all ballroom dancing. It is therefore, essential to go very slowly and practice faithfully while learn-

PACIFIC COAST BRANCH:
329 Union League Bldg.
LOS ANGELES

The Superlative Inductance
Four years of careful attention to the details of manufacture of this type of inductance unit has yielded a product of unquestioned superiority. And with increased efficiency in manufacturing methods, moderate prices prevail for all sizes.
Ask Your Dealer
Coto-Coil
"Built First to Last"

COTO-COIL CO. PROVIDENCE

GREBE RADIO

All Batteries Concealed
No unsightly batteries mar the appearance of your living room with

The New GREBE Broadcast Receiver

Compartment is provided in the attractively finished walnut cabinet for both A and B dry cells. Ask your Dealer for a copy of "Grebe Radio in the Well-Appointed Home."

Licensed under Armstrong U. S. Pat. No. 115149

A. H. GREBE & CO., Inc.
Richmond Hill, N. Y.
Western Branch—451 East 3rd St., Los Angeles, Cal.

“HELLO CHILDREN, THIS IS SANTA”

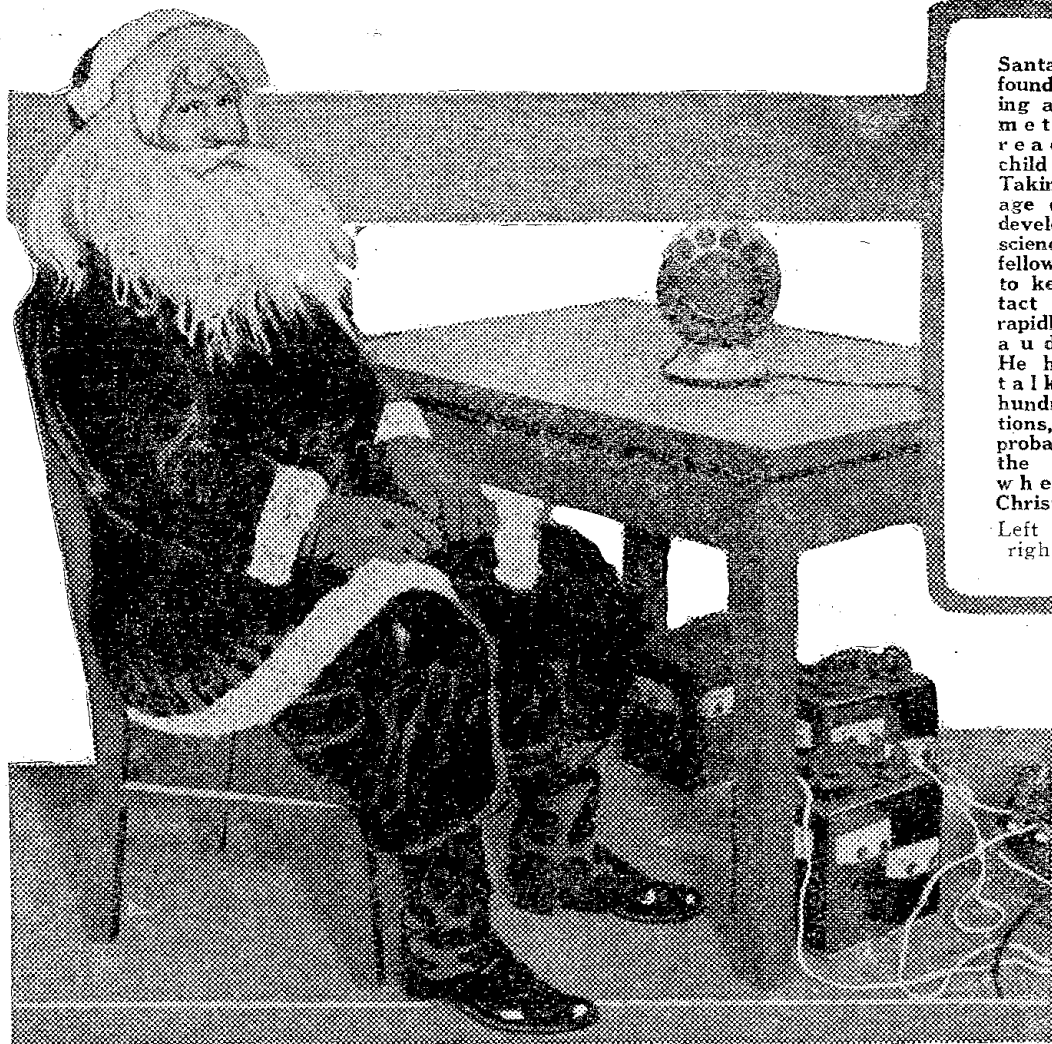

Santa Claus has found broadcasting a very good method of reaching his child admirers. Taking advantage of the new developments of science, the old fellow manages to keep in contact with his rapidly growing audience. He has already talked from hundreds of stations, and will probably be on the air everywhere before Christmas.

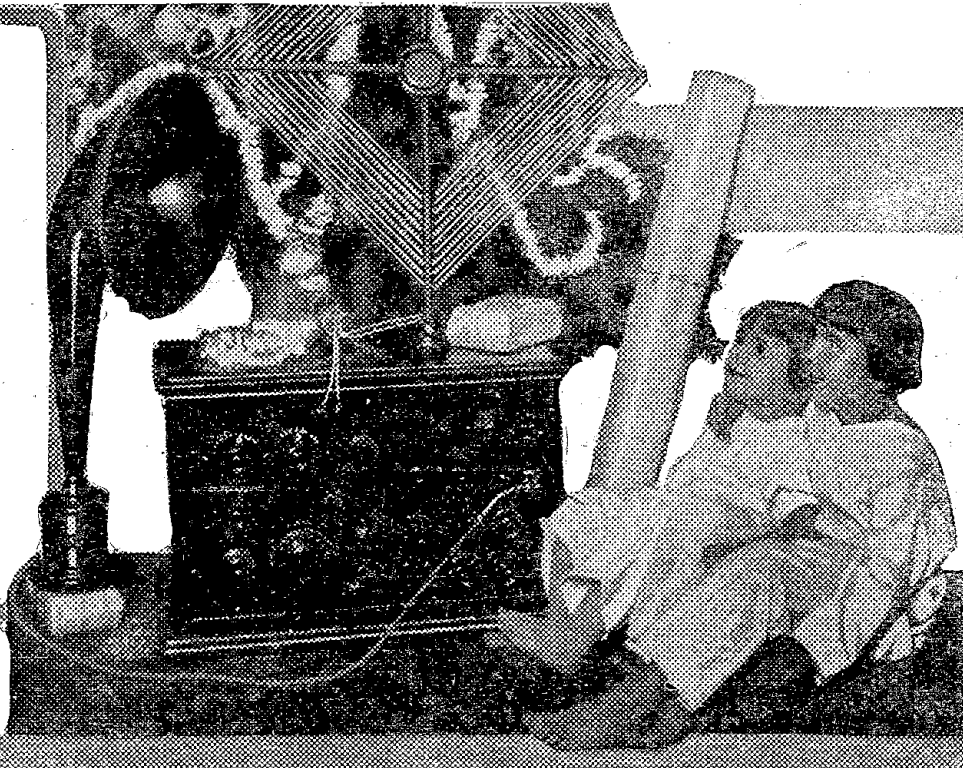

Left Photo Int., right Keystone

Railroaders Okeh Radio Dispatching

KYW to Be Central Relief Center in Emergency Control System—Amateurs Volunteer Services

(Continued from page 1)

eric; J. J. Graf, Delaware, Lackawanna and Western; R. J. Mathews, Chicago Radio Laboratory; Elam Miller, American Telephone and Telegraph; D. Sarnoff, Radio Corporation of America, and G. T. Stanton, Cleveland, Cincinnati, Chicago and St. Louis railway, are the other members.

Relay League as Volunteers

Co-operation effected recently between the American Railway association, perhaps the most powerful body of its kind, and the American Radio Relay League, headquarters Hartford, Conn., has thus far resulted in an arrangement said to be the greatest step toward the application of Radio to the movement of trains. The latter association has obtained the co-operation of a great number of its members throughout the country by means of which they will serve as volunteers when railway traffic is impeded by fire, storm, flood or like causes. For each railroad in the United States there will be an emergency Radio manager (many have already

been named) whose duty will be to organize, either by division or by the entire railway system, a mode of communication with railway transportation or telegraph (or telephone) officials. Amateur stations in the jurisdiction of the A. R. R. L. division chief are to be enrolled (many of them have already been enlisted) to serve in emergency. As an instance of the progress of the work—125 DX operators from Chicago to Fargo, N. D., and as far west as the Missouri river have already entered into an emergency arrangement with the Chicago, Milwaukee and St. Paul railway, headquarters Chicago.

KYW Relief Center

With Station KYW of Chicago (as an instance) as a central point the amateurs in the region outlined will in time of stress assist railway officials in finding trains that have been "lost" and thus help to restore traffic. In that way the superintendent of a railway division will be guided not only as to the operation of his own trains but as to those of connecting divisions. The amateurs will aid too in furthering communication with wrecking crews along blockaded railway lines.

The telegraph and telephone committee of the American Railway association has been instructed to study and has already reported favorably, in a sense, the use of Radio in relation to the dispatching of trains en route, that is, from caboose or coach to engine, and from tug to shore. The committee, which had been instructed

to confer with manufacturers of Radio apparatus, reported that the American Telephone and Telegraph company is experimenting with short wave devices, that the Westinghouse company and the General Electric companies are proceeding along similar lines and that the Radio Corporation of America "is now in position to furnish portable Radio transmitting and receiving equipment for short range emergency work" along railway (and tug) systems.

Vacuum Tube Seen Best

In referring to the various opinions of Radio engineers as to the relative values of the arc transmitter and the vacuum tube the telephone and telegraph committee said that Radio "is intended not only as a reserve in emergency when the wire circuits are out of commission but . . . at all times to augment the wire circuits." The use of undamped wave Radio transmitters is becoming more common, according to the report of the committee,

because of its "increased efficiency when compared with the usual spark set." Use of the undamped waves in the future will be almost compulsory because of the sharply tuned transmission it affords. The vacuum tube continuous wave transmitter, said a prior report, is the only type of Radio transmitter which will meet the ultimate requirements of commercial railroad communication.

Station KFYV Now KFIQ

YAKIMA, WASH.—The call of Station KFYV, formerly owned by a Radio shop here but now the property of the Yakima Valley Radio Broadcasting association of listeners in, is now KFIQ. The plant is the only one in the United States, perhaps in the world, owned and operated by listeners in.

Direct Radio communication has been established between Punta Arenas, South America, and Stanley, Falkland Islands.

THE

AUDIOPHONE

Quality of reproduction such as only the original itself can equal. Speech that is so distinct that the voice heard is the actual voice of the speaker. Music that requires no tolerant imagination to be recognized as music of the finest type.



Bristol's Single Stage Power Amplifier

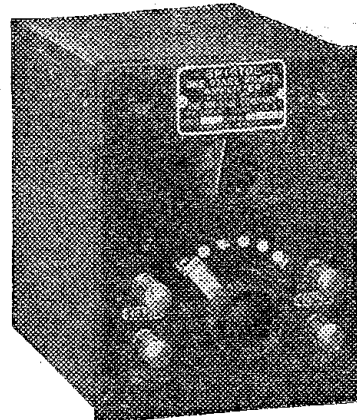

gives additional VOLUME with any two stage amplifier. No C batteries required. It provides the additional volume necessary to bring in very distant stations on the loud speaker.

Write for bulletin and address of the nearest dealer handling our instruments

THE BRISTOL COMPANY

WATERBURY, CONN.

Boston New York Philadelphia Pittsburgh Detroit Chicago St. Louis San Francisco

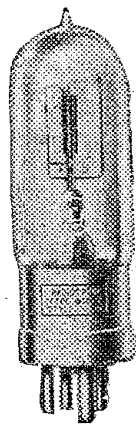

WD-11

Radiotron WD-11 is famous as the tube that really made possible the swift growth of radio in the home, as we know it today.

Inexpensive to operate—using but one 1½-volt dry cell—doing away with the need for storage batteries—it has lowered the cost of radio.

Price \$6.50

Radio Corporation of America

Sales Offices—Dept. 3002
233 Broadway, New York



This Symbol of quality is your protection

10 South LaSalle St., Chicago, Ill.

433 California St., San Francisco, Cal.

Be sure that every vacuum tube you buy is marked RADIOTRON

Radiotrons

REG. U. S. PAT. OFF.

'LITTLE OPIUM' CRIES FOR VERACIOUS DAD

FOUNDER OF RADIO TRUTH SOCIETY DENIES BABE

Station WBAP's Tale about Hired Hand's Parenthood Laid by Him to Jealousy

FORT WORTH, TEXAS.—If there's to be any crushing of Truth here or elsewhere, let the Radio Truth Society, founded and operated by Station WBAP (Star-Telegram) of this city, help it arise again, for the Radio Truth Society admits that Truth must be protected from abuse—and overwork.

The Hired Hand is chief champion of Truth. His headquarters are in the boiler room of Station WBAP where the heat has accustomed him, he said recently, to the hot air attacks on Truth, his fair charge. The toplofty temperature of his offices has prepared him, he declared, for that of the county seat just south of the sky to which he has often been consigned by those whom he has defeated in defense of Truth.

Well Known Like Truth—Almost

Truth may be a stranger in the land below, but the Hired Hand, according to himself, is known so well that a letter addressed a few days ago by J. A. Bucke in Lincoln, Ill., to The Hired Hand, Cowbells, Somewhere in the U. S., was delivered to the Hired Hand forty-eight hours afterward. As president of the Radio Truth Society the Hired Hand's assertions must be true, it is said.

Like Truth, the Hired Hand was almost crushed the other day. In his extremity he made known the following appeal:

WBAP Presents Him with "Offspring"

"The regular announcer of Station WBAP recently started broadcasting the untrue information that a little Hired Hand had arrived at my boarding house and that its name was to be 'Opium.'" (The Hired Hand is substitute announcer for Station WBAP; whenever the regular announcer is invited out, Hired Hand takes his place. He has already helped the regular out of several homes.) A doll which yelled "Mama" when squeezed before the microphone, was said to have been little Opium crying for Mrs. Hired Hand.

WBAP'S HIRED HAND ANNOUNCING TRUTH

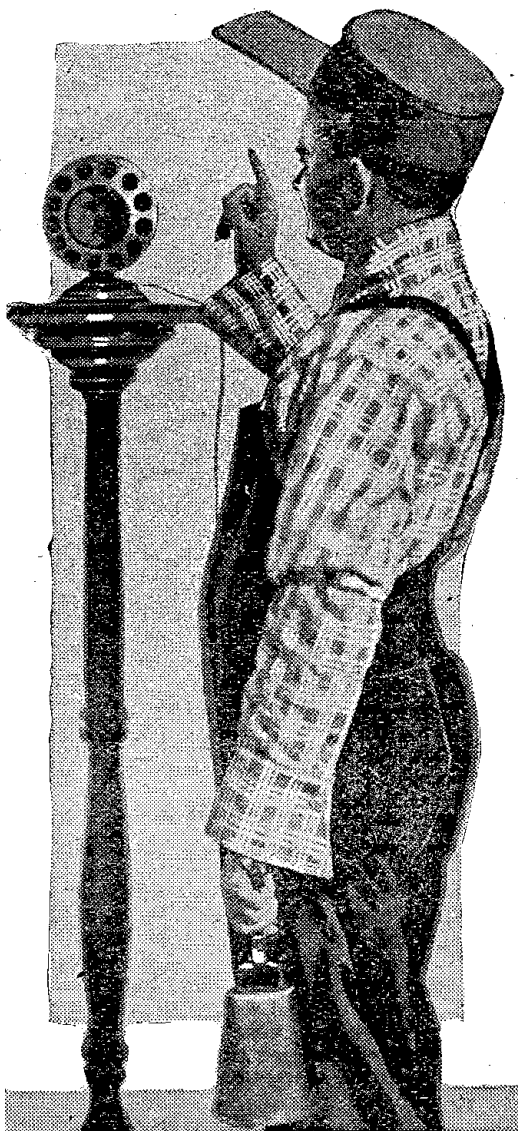

The Hired Hand, president of the Radio Truth Society, founded and directed by Station WBAP, Fort Worth Star-Telegram, who usually, as substitute announcer, prefaces his talk with cowbells. The Hired Hand and his friend and ward, Truth, have been in quite a mess since WBAP's chief announcer announced that the Hired Hand was father of "Little Opium"

"As president of the Radio Truth Society I hereby solemnly declare and as-

severate that there is no Little Opium, and that there probably won't be unless some one of the big mail order houses place him in their next catalog."

The Hired Hand insisted that Station WBAP's announcers would not rectify their errors as to Little Opium. "Just because I'm president of the Radio Truth Society the static cussers won't believe me," he said.

"I had about decided to quit my protest and to let Truth lie in the mud," continued the Hired Hand, "when I received a letter from a Radiophan in Chicago in which he congratulated me on the safe arrival of Little Ethiopian."

"I hereby make known to the world that I am the father of neither Little Opium nor of Little Ethiopian and that I can lick anybody who says I am."

Thrills from Radio

No. 8 of a Series Featuring Experiences of "ALL-AMERICAN" Users

Have Boosted My List to 102 Stations

By Joseph Kemmerter, Jefferson, Wis.

"I have just built a four-tube set consisting of two stages of R. F., F. T. Detector and one stage A. F. and wish to compliment you on the good transformers you manufacture."

"I use 'All-Americans' throughout. Am hearing WOAI San Antonio, WDAL Jacksonville, and KHJ Los Angeles (very powerful). WJAX Cleveland can be heard all over the room from the phones."

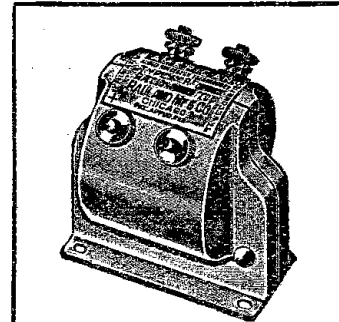

All-American Audio Frequency Transformers come in three ratios: 3:1, 5:1, 10:1, \$4.50 to \$4.75.

"I have heard 90 stations on my three circuit regenerative type set—but with the four-tube set, and the pick-up ability of your transformers, I can get the small stations and the distant ones much easier. Have already boosted my list of stations to 102 on this set."

"Will always boost 'All-Americans' for distance as I sure am getting it."

Special Offer!

All-American diagram and circular describing Power Amplification; also Book of Hook-ups containing 22 tested circuits. Send 4c in stamps.

All the better dealers sell "ALL-AMERICAN"

RAULAND MFG. CO., 200 N. Jefferson St., CHICAGO PIONEERS IN THE INDUSTRY

AUDIO AND RADIO FREQUENCY

POWER AMPLIFYING INPUT AND OUTPUT



ALL-AMERICAN AMPLIFYING TRANSFORMERS

Largest Selling Transformers in the World

RADIO TALKS

High grade Radio apparatus is so essential to a set that often times it is a real good investment to purchase an article at even three or four times the price of the article in its cheapest form.

Lessons from the bitter school of experience have firmly impressed this angle upon the writer.

E. J. Flewelling

E. J. Flewelling Tuner

Made of sheet bakelite and nickel plated parts, this instrument is the ultimate in tuning units. Neat, compact and of rigid construction. No loss producing taps. No unsightly lead wires. Mounting requires only one panel hole and but little cabinet space. Tuning is simplified to one condenser setting and adjustment of tuner to maximum volume. Practically all solid dielectrics are eliminated from coil field. No wood or fiber forms are used and coils are made to stand more than average abuse. A large wave band can be reached without changing coils. It is a unit that produces volume and clarity.

BUELL MANUFACTURING COMPANY

2977 COTTAGE GROVE AVE. CHICAGO

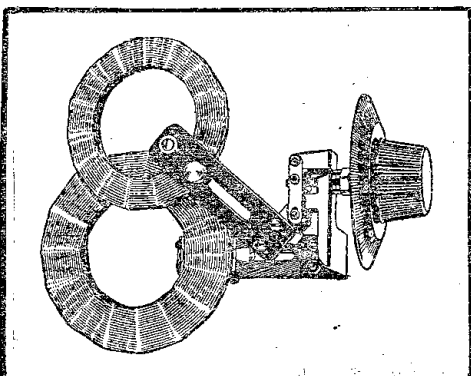

\$ 8⁰⁰ At your dealers or post paid.

A Merry GIFT for a Merry Christmas

NATIONAL MONODYNE TUBE SET MODEL GT-1



Without Tube

\$ 10⁰⁰

The Monodyne One Tube Radio Receiver will be treasured by all who receive it.

No technical knowledge is required for operation.

Only one tuning control.

Long distance as far as London, England, has been received clear and loud without distortion.

The wonderful performance of this little set astonishes the most skeptical.

With the single tuning knob, you can tune in on all wave-lengths with perfect selectivity.

A loud speaker can be used in connection with the Monodyne single stage amplifier unit retailing at \$8.50.

Two stages of amplification give perfect results.

16-22 Hudson St.

NATIONAL AIRPHONE CORPORATION

NEW YORK

PRESIDENT'S WORD DIRECT TO PUBLIC

COOLIDGE RADIO ADDRESS SETS HISTORY EPOCH

More Than 1,500,000 Listeners Receive Speech by Means of Plants Across Country

By L. M. Lamm

WASHINGTON.—Few of the 1,500,000 or more listeners in the recent message of President Calvin Coolidge to Congress, realized, it was said, that the electromagnetic wave virtually had solved one of the most vexing problems of government.

From the time that man, for self-protection, had to live with his fellows, through the ages to the ancient Solons of Rome and the days of the American and French revolutions, one of the hardest problems of government has been to reach the ears of all the governed at the same time, thus to insure their widest and fairest representation. That was why the fathers of the constitution conceived the government of this country as a republic in a democracy — there was no way in which to crowd all the people in one place. Hence the election of representatives.



Tells Citizens Policies of Nation

Thus did the Radio delivery of the president's speech solve in a sense a primary problem of government. From coast to coast, from the great lakes to the gulf, even in Canada and Mexico, hundreds of thousands of men, women and children heard the voice of the chief executive outline the policies of the administration.

It was the first instance in recorded history in which the leader of a people talked directly to them over an area of millions of square miles. This feat, which in past eras, would have been considered

SET RECORDS MESSAGES IN TYPE

This receiving set records messages in typewriting just like an ordinary telegraph apparatus. It is connected into the circuit in place of the phones and may be used with any set using two or more tubes. The inventor, F. W. Dunsmore, of the Radio division of the Bureau of Standards, is here seen demonstrating the instrument, which he calls the "Radio Relay Recorder" Photonews Photo

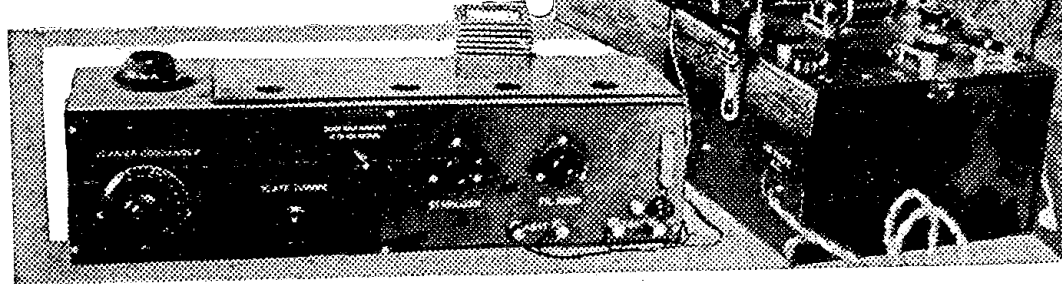

miraculous, was scheduled for repetition by the Radio delivery of the president's eulogy of the late Warren G. Harding to the people of the United States.

3,800 Miles of Wire

For the consummation of what is considered one of the greatest achievements of man the American Telephone and Telegraph company and like concerns worked hard and long. It is estimated that 68 experts and 3,800 miles of telephone wires were employed in the broadcasting of President Coolidge's address.

Microphones placed before the president as he stood at the speaker's table in the House of Representatives here were connected by long distance telephone lines with broadcasting plants in various parts of the country. A shielded cable from the speaker's table to the basement of the capitol, where input equipment had been installed, passed the president's voice to Station WCAP (Chesapeake and Potomac Telephone company), Washington, D. C.; WBAF (American Telephone and Telegraph Company), New York City; WJAR (the Outlet company), Providence, R. I.; KSD (Post-Dispatch), St. Louis, Mo.; WBAF (The Star), Kansas City, Mo., and WFAA (The News), Dallas, Texas.

Fifty repeater stations were required at intermediate points. All of the tele-

phone equipment, including the circuits, was duplicated to provide for emergencies. In addition, a network of telegraph wires connected the various broadcasting and repeating stations. Crowds (they numbered thousands) outside the capitol heard the address by means of loud speakers on the steps of the building.

So that there would be no interference during the delivery of the eulogy to Harding, the secretary of commerce, Herbert Hoover, urged that the air be cleared for 15 minutes. Stations WBAF, WCAP and WJAR were scheduled to broadcast Coolidge's encomium.

Michigan "Aggie" Outfit Can Now Cover 1,000 Miles

DETROIT.—The Michigan Agricultural College station, WKAR, at Lansing, Mich., has been equipped for transmitting over a radius of 1,000 miles. Acting President R. J. Shaw is planning an elaborate Radio extension service for the winter months, covering matters of particular interest to farmers. There will be talks on engineering and other interesting scientific matters as well. No decision has yet been reached regarding musical entertainment in connection with the extension talks.

REPORT MONOPOLY IN RADIO INDUSTRY

R. C. OF A. IS DECLARED "DOMINANT FACTOR"

Trade Board Offers No Conclusions to Question of Anti-Trust Law Violation

WASHINGTON.—Not only does the Radio Corporation of America control commercial Radio communication between the United States and foreign countries but it has virtually established a monopoly in sale of Radio devices. This is the gist of the recent report to Congress of the federal trade commission.

Reviewing the history of Radio in this country from 1899, when the Marconi Wireless Telegraph Company of America (a British corporation) was authorized to operate in the United States, to the present, the commission cites the methods by which the Radio Corporation of America, which was organized by the General Electric company, obtained control of the distribution of Radio devices manufactured under 2,000 patents.

Says Sea Folks Monopolized

Communication by Radio from ship to ship and from ship to shore is dominated, the commission asserts, by the Radio Corporation. The arrangements which the concern has established with other companies practically precludes, the commission contends, competitive trans-oceanic Radio communication.

The refusal by the Radio Corporation to sell or lease apparatus to enable competitors to effect cross-sea communication was cited by the commission. Devices sold by the company bear licenses which, the report declares, restricts their use to amateur and experimental purposes. Contrivances for use aboard ships or airplanes carry licenses issued by the company which prevents any other use.

Sales Conditions Cited

Independent manufacturers of receiving sets cannot buy vacuum tubes manufactured by the Radio Corporation for resale with the sets, the commission reported. Lack of substantial evidence was admitted in this instance.

The federal trade commission ended its report by saying that it submitted no conclusions as to whether or not the tactics of the Radio Corporation constituted violation of anti-trust laws.



The name Federal on Radio Products

is a guarantee that the part or set is of unusual quality and capable of producing unusual results.

Each of the more than 130 radio products, designed, manufactured and guaranteed by Federal, is on a par with the Federal head set, which built an international reputation for Federal by serving five governments efficiently during the world war.

Price 2200 OHMS \$7.00

Federal Standard RADIO Products

IT DIDN'T take the boys of the nation long to wake up to the fact that they could get De Forest Audions for their Radio Receiving Sets. They knew De Forest was the inventor of the vacuum tube—they knew that every tube made, no matter what set it works in, was based on De Forest patents. So they are all insisting on De Forest Audions, and they are getting the DX and clear reception results they deserve. Three types available—DV 6-A Universal at \$5.00—DV-1 for dry cell use at \$6.50—and DV-2 Power Amplifier Audion are suitable for use with receiving sets of all makes, and they work particularly well in the famous cross-continent Reflex Radiophones with indoor loop—D-7-A at \$125.00 and D-10 Portable (dry cells enclosed in cabinet) at \$150.00. To prices quoted add approximately 6% for transportation for territories west of the Rocky Mountains.

Send for circular "What Tubes Shall I Use?" which gives full details and table of various tubes for different receiving sets.

DE FOREST RADIO TEL. & TEL. CO. Dept. R. D. 4 JERSEY CITY, N. J.

If Located West of Pennsylvania address DE FOREST RADIO TEL. & TEL. CO. Western Sales Division Dept. R. D. 4, 5680 12th St. DETROIT, MICH.



AN EVENING AT HOME WITH THE LISTENER IN

(SEE INSTRUCTIONS FOR USE BELOW)

Table with columns: Station and City, Mct, Monday, Tuesday, Wednesday, Thursday, Friday, Saturday, Sunday. Lists various radio stations and their broadcast times.

Instructions for Use.—All the hours above are given in Central Standard Time. If your city uses Eastern Time, add one hour to each of the periods stated; if your city uses Mountain Time, subtract one hour; if your city uses Pacific Time, subtract two hours. This table includes only the evening broadcasts, and on Sunday, the late afternoon program.

YOU NEED



The Original Automatic COMSCO

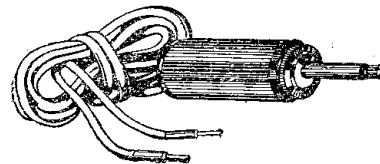

Bull Dog Grip Telephone Plug

(Licensed under Pat. Pend. Serial No. D 3010—No. 578540)

WE GUARANTEE

Simple to operate

that with this plug you will not demagnetize your phones, ruin your transformers, short-circuit your batteries, have battery kicks, or break your finger nails. The COMSCO PLUG is the last link in perfect reception. At a small cost it is the final refinement for your set.

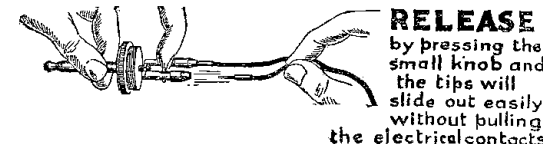
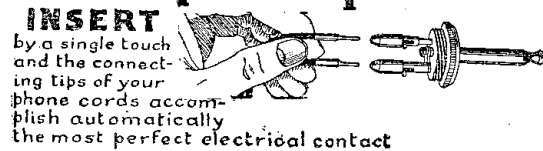

Your Money Back

IF NOT BETTER THAN ANY OTHER



Bull Dog Grip Plug

Price for one pair of Phones.....\$1.00 Price for two pair of Phones..... 1.50

FOR SALE AT YOUR DEALER

Otherwise send purchase price direct to us and you will be supplied

GENERAL INSTRUMENT CORP.

123 Liberty Street NEW YORK CITY

RADIO AT N.Y. PRICES Daily Parcel Post

HOW TO ORDER—Write your order plainly: state number, description and price of items wanted. Send Post Office or Express Money Order, personal check or bank draft.

Moulded Bakelite Variometer or Variocoupler C79 Each \$4.95. List.....\$7.00 A high grade instrument. Takes in the wave lengths from 250 meters to 800 meters. Table or Panel Mounting.

VARIOCOUPLER C77 High Grade 180 Degree Coupler, made of Bakelite tubing wound with green silk wire. Special.....\$2.45 C78 Variometer, same specifications..... 2.45

DIETZEN SUPER HEAD SET C181 2200 Ohms.....\$2.95 Reg. Price, \$5.00 per Pair. Since we are wholesale distributors for this wonderful headset we pass this bargain on to you. The Tone quality is of unusual volume. These phones can be used as a loud speaker unit. Sold with a money back guarantee, if not satisfactory.

INSULATORS These are very strong strain type Insulators. C158 Moulded insulator shown above. Each.....10c; Dozen.....\$1.10 WAVE TRAP Simplifies tuning. Eliminates interfering stations, thereby improving the selectivity of your set. Selects between conflicting stations. Special while quantity lasts. C131 Each.....\$4.95

STANDARD BRAND HEAD PHONES C134 Brandes Superior.....\$5.25 C135 Dictograph..... 6.75 C136 Baldwin Type "C" Double..... 9.85 C137 Baldwin Type "C" Single..... 4.95 C138 Western Electric..... 10.50 C139 Dietzen Navy Type, 3000 ohms. 4.95 List price \$8.00.

JACKS AND PLUGS Jacks are polished nickel constructed with pure silver contacts. C118 One spring open circuit.....\$.39 C119 Two spring closed circuit..... .49 C120 Round plug as illustrated..... .49

MISCELLANEOUS C163 Spaghetti Tubing per yard.....\$.09 C164 Synthetic Crystal..... .30 C165 Ground Clamps..... .17 C166 Black Rubber Binding Posts..... .05 C167 Nickel Plated Binding Posts, 2 for..... .05 C168 No. 18 Annunciator Wire, half lb. coil..... .39 C169 6 ft. Phone Cord with Tips..... .79 C170 20 ft. Extension Cord with Tips..... 1.95 C171 Wall Insulators, Porcelain..... .05 C172 Tubular Porcelain, Lead-in Insulators, 6-in..... .10 C173 Reinartz Coil..... 1.45 C174 Cockaday Coil..... 2.45 C175 2 in. Dial and Knob..... .25 C176 3 in. Dial and Knob..... .35 C177 Switch Arm Tapered Knob..... .19

FILAMENT CONTROLLED RHEOSTATS Highest grade of material used, tapered knob. C104—6 ohm.....\$.39 C105—30 ohm..... .49 C106—200 ohm Potentiometer..... .79 C107—400 ohm Potentiometer..... .79

AUDIO FREQUENCY TRANSFORMERS The following transformers are guaranteed standard makes, and will produce very efficient results. C63—Dietzen 3 to 1 Ratio.....\$3.95 C64—Dietzen 5 to 1 Ratio..... 3.95 C65—Dietzen 10 to 1 Ratio..... 3.95 C66—Acme Audio..... 3.95 C67—Amertran..... 5.95 C68—U.V. 712 R.C.A..... 5.75 C69—U.V. 714 R.C.A..... 5.75



71 Cortlandt Street NEW YORK, N. Y.

America's Greatest Radio Mail Order House ELEVEN NEW YORK STORES

SUPER VALUES

HAZELTINES NEUTRODYNE

The ultimate receiver for local and long distance Radio concert reception

THE MOST TALKED ABOUT SET OF TODAY

- 1. SIMPLICITY (A child can operate it) 2. SELECTIVITY (You can tune out local stations) 3. STABILITY (Always ready to entertain) 4. DISTANCE (Average range about 2000 miles) 5. NOISELESS (No squeals, no howls, no whistles)

Complete Parts for Building This Master Receiver \$49.65 AS LISTED BELOW, ONLY

Table with columns: Stock No., Quantity, Description, Price. Lists various components for the receiver set.

Table with columns: Stock No., Quantity, Description, Price. Lists accessories necessary to complete the set for operation.

OUR SPECIAL COMBINATION OFFER \$47.35

To each purchaser of the above parts and accessories for the HAZELTINE NEUTRODYNE RECEIVER at the low price of.....\$97.00 we will, without cost to you, ship a Genuine HANES-ZENER special hand rubbed solid mahogany cabinet. Value.....\$10.00

Each of the above parts are of the highest standard grade, and carry the HANES-ZENER guarantee and can be purchased separately at our special prices. The Radio Mail Order House Known for Low Prices Send Money Order, Including Postage

WRITE FOR OUR CATALOGUE B



3 WEST 29TH STREET, NEW YORK CITY

Methods of Securing the Neutrodyne Effect

Capacity and Inductance Employed in Balancing

By Harry J. Marx

FEW will disagree with the statement that the most popular form of circuit at the present time is the Neutrodyne type. The keynote of the neutrodyne circuit is the neutralization of the intertube capacity. Now the strange part of it all is the fact that very few succeed in prop-

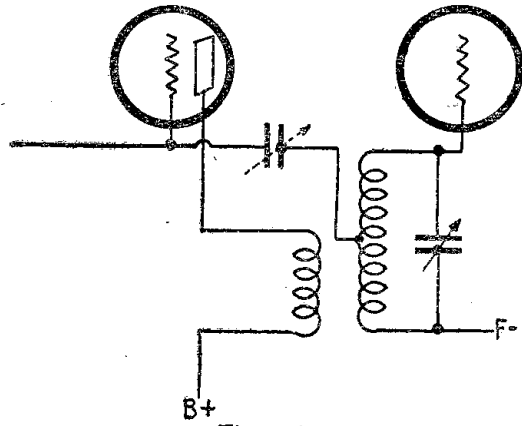

Figure 1

erly neutralizing their circuits. Fortunately tuned transformer coupled Radio frequency amplification is very efficient, and for this reason there have not been many fans who found any serious objection, or possibly even realized that the set was not properly balanced. As long as some of those long distance fellows came hammering in, even if the whistle was there, they had no kick coming.

Theory of Neutralization

In order to present the theory of neutralization, a long introduction dealing with equations, formulas, tube characteristics, transformers, capacity reactions, and what not, would be required; so, possibly, analogy will do more toward explaining the situation than a theoretical discussion that will leave the fan bewildered and knowing even less than he did before. In boring underground, in tunnels or subways, to run under streams or bodies of water there is likely to be a constant seepage or inflow of water. This inflow of water is naturally due to the pressure of the stream above it. A method employed in work of this nature is the use of a coun-

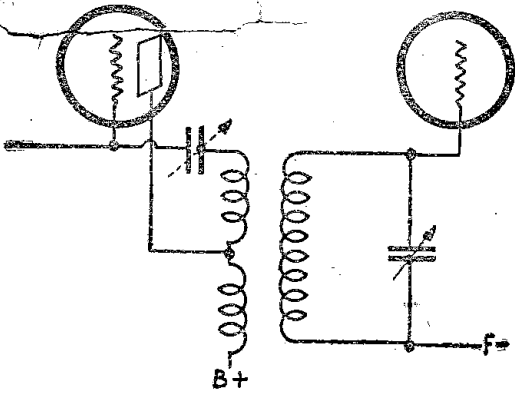

Figure 2

teracting air pressure in the excavation, sufficient to overcome the natural external pressure. To compare this, then, with the situation in Radio frequency circuits, we would state that there is a leakage, or what might be termed a detrimental pressure, mainly between the grid and plate of each tube. In addition, we have considerable leakage throughout the windings of

the transformers, the wiring of the set and in numerous other parts of the apparatus. Now, if there can be created a counterpressure that exactly balances the detrimental pressure or leakage, we have balanced the set. If the counterpressure is insufficient, we have only partially remedied the trouble, whereas if our counterpressure is too great we have introduced a new trouble. We find, therefore, that neutralization, unless properly adjusted, is valueless and might even be detrimental.

Methods Employed

At the present there are two methods employed in creating a counterpressure for neutralization. The better known is the capacity method, the other—not quite so well-known but used in a half-understanding manner in the past—is the inductance method.

In the capacity method, although only one form was originally introduced, a number of other types are now in vogue and have been found to operate very successfully.

In Figure 1 is shown the popular method of applying a neutrodon between the grid and the secondary winding of the neutroformer. Although the reaction is in the

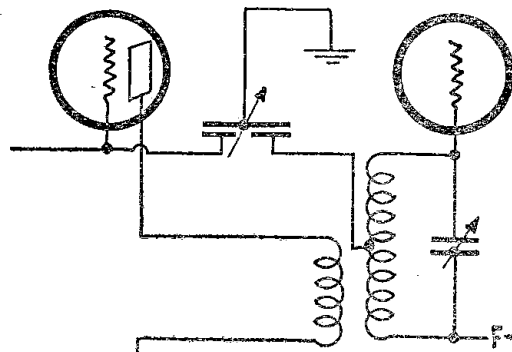

Figure 3

form of a capacity value, yet the induction, or number of turns in the secondary winding of the neutroformer, must be taken in consideration. There is one point, and this point or tap on the winding, in conjunction with the proper adjustment of capacity in the neutrodyne, gives the required balance.

A common difficulty in this method has been due mainly to two causes. First, that the fan was too anxious to make his own neutroformer, in spite of the fact that it was a patented article, and usually placed the tap anywhere on the secondary winding that happened to be convenient; and second, that the neutrodons that were first placed on the market, and some that are on the market even now, showed little or no intelligence on the part of the designers. Their adjustment is a sort of hit-and-miss operation; it stays put for about five seconds and then varies every time somebody looks at the set. As a rule, no ten of them, of the same type, have anywhere near a consistent range covering the minute capacity value required. For this reason the fan often discovers that it doesn't seem to make any difference at all where he adjusts it. Fortunately, new designs with decided improvements are now available and the fan has a better opportunity of successfully neutralizing his receiver.

Another way of obtaining neutralization,

by the same method applied in a slightly different manner, is shown in Figure 2. Here the neutralizing capacity is placed

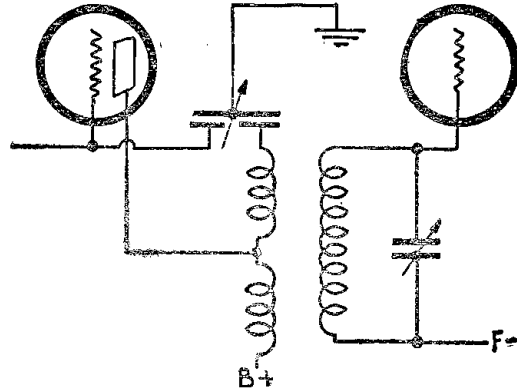

Figure 4

between the grid and the primary of the neutroformer. A number of turns connected in series to the primary winding are added and in this way the proper inductive value, used in conjunction with the capacity adjustment, gives us the required balance. The difficulties mentioned

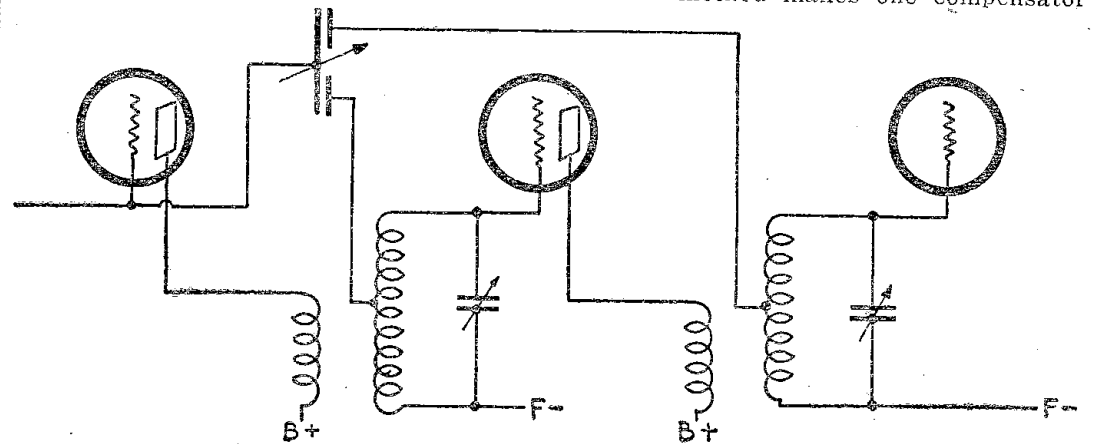

Figure 5

in connection with the original neutrodons apply here.

Compensating Condensers Of different construction (Figures 3 and 4), but operating fundamentally in the same

cover the work of two neutrodynes. The method, however, is not as satisfactory as might be desired.

(Continued on page 14)

Complete Parts for Miloplex Circuit—Cabinet Free

1 .0005 Variable Condenser, Vernier..... \$6.00	3 3/4-inch Dials, each 75c... \$2.25	1 B Battery, Burgess, 22 1/2 volt..... \$3.00
1 Estru Variometer..... 2.00	1 Potentiometer, 1850 ohm... 2.20	3 Dry Cells..... 1.35
1 .00025 Variable Condenser... 2.00	1 Rheostat..... 1.00	12 ft. sq. brass bus wire..... .30
1 Variable Grid Leak..... .75	1 Socket Bakelite Base..... .90	1 Set Readem Bind. Posts..... .75
1 .00025 Mica Fixed Condenser .40	1 Bakelite Panel 9x14x 1/2..... 2.50	
2 .002 Phone Condensers..... .80	1 DeForest D.V. 6 Tube..... 6.50	
TOTAL..... \$35.70		

Our Price Only \$28.50 Blue print FREE only with order for complete parts

Complete Parts for One Tube Reflex

1 Radiometer..... \$ 3.00	1 23 Plate Condenser..... 3.00
1 Tricoil Transformer..... 4.00	1 Audio Transformer..... 4.00
1 199 Socket..... .90	1 199 Tube..... 6.50
1 Baseboard, 7x9..... .25	1 7x9x 1/2 Bakelite Panel..... 1.25
1 Set Readem Binding Post..... .75	2 .002 Mica Fixed Condensers..... .80
1 Type B. B. Metal Detector..... 1.50	1 Cabinet, 7x9x8..... 2.50
Complete \$22.45	TOTAL \$28.45

Complete Parts RD 99 Long Distance Receiving Set

(See Radio Digest, September 29th issue)

3 Bakelite Base Sockets..... \$ 2.25	3 Rheostats..... 3.00
2 A. F. Transformers..... 8.00	2 Double Circuit Jacks..... 1.90
1 Open Circuit Jack..... .75	1 Estru Variometer..... 5.00
1 Variable Grid Leak and Condenser..... 1.00	1 .0005 Variable Condenser with Vernier..... 6.00
1 .005 Fixed Condenser..... .75	1 75-turn Honeycomb Coil, mounted..... 1.20
1 Single Coil Mounting..... .50	1 Set Readem Binding Post..... .75
1 Panel Bakelite, 7x16x 1/2..... 2.25	1 Cabinet, 7x16x8, fine mahogany finish..... 6.00
Our price complete with panel drawing \$30.25	TOTAL \$39.25

Complete parts for a Neutrodyne Tube Set. Nothing extra to buy in parts. The complete parts are of the highest quality apparatus.

NEUTRODYNE

This is your opportunity to secure the parts for this famous set at a decided reduction in price. Nothing extra to buy, as this price includes all parts essential to build it..... **\$45.50**

Same parts complete with 1 UV-200 and 3 UV-201A Tubes; 3 22 1/2-volt large size B Batteries; 1 Storage A Battery, 110-ampere; Baldwin Head Phones and Aerial Equipment..... **\$92.15**

This set would cost you \$181.65 if it was bought ready made.

Crystal Set Complete

With Phones, Aerial, Lead-in Wire, Insulators. An attractive Christmas Gift..... **\$8.50**

Above Set alone, without Phones or Aerial Equipment..... **\$2.50**

CABINETS

9x14x8, mahogany finish..... \$3.25	7x9x8, mahogany finish..... 2.75
7x21x8, mahogany finish..... 3.50	

MUST SEND POSTAGE

Complete Parts for a Neutrodyne Tube Set

Variable Condenser, .0005 (Same as 23 plate)..... \$1.95	Variable Condenser with Vernier, .0005 (Same as 23 plate)..... 3.45
Variable Condenser, .001 (Same as 45 plate)..... 2.35	Variable Condenser, with Vernier, .001..... 3.95
Walnut Variable Condenser, .00025..... 1.75	H. C. Coil Mounting Gearing..... \$4.50
C. R. L. Grid Leak and Condenser..... \$1.59	C. R. L. Grid Leak..... 1.29
C. R. L. Potentiometer, 1,850 ohms..... 2.00	Marco Armored Potentiometer, 600 ohms..... 1.75
3-Coil Mounting, geared..... \$4.50	3-Coil Mounting (Crown)..... 3.85
Radion Panels, black or mahogany—all standard sizes, 1 1/2" c per square inch..... \$2.45	\$3.00 Electric Soldering Iron, guaranteed..... \$2.45
Spaghettil, yellow or black, 36 inches..... \$ 1.0	Taft Dials, 3 inch..... \$.90
Taft Dials, 4 inch..... 1.30	1 Special Voltmeter, from 0 to 50 volts, for your A and B Batteries..... \$1.19

Our Price Only \$28.50

Blue print FREE only with order for complete parts

Complete Parts for One Tube Reflex

1 Radiometer..... \$ 3.00	1 23 Plate Condenser..... 3.00
1 Tricoil Transformer..... 4.00	1 Audio Transformer..... 4.00
1 199 Socket..... .90	1 199 Tube..... 6.50
1 Baseboard, 7x9..... .25	1 7x9x 1/2 Bakelite Panel..... 1.25
1 Set Readem Binding Post..... .75	2 .002 Mica Fixed Condensers..... .80
1 Type B. B. Metal Detector..... 1.50	1 Cabinet, 7x9x8..... 2.50
Complete \$22.45	TOTAL \$28.45

SPECIAL PRICE ITEMS

PHONES

Mico Double Phones "Sealed—Guaranteed" with Head Bands..... \$7.00	Double Phone Cord..... .75
Genuine Baldwin Type C Unit..... 6.00	Genuine Baldwin Type C Double..... 4.39
Loud Speaker Cord, 20 ft., 4 tips, our price..... 1.00	

RHEOSTATS AND SOCKETS

MARVEL Rheostat, 6 ohms..... \$.35	MARVEL Rheostat, 20, 25 and 30 ohms..... .45
MARVEL Rheostat, 40 ohms..... .55	MARVEL Rheostat, 50 ohms..... .65
Potentiometer, 200 ohms..... .75	Potentiometer, 400 ohms..... .75
Potentiometer, 1,850 ohms..... 2.00	Standard Sockets, bakelite base, \$1.25..... .75
Na Ald Sockets, 35c; 3 for..... 1.00	All-American Audio Transformers, 1-5 or 1-10..... 3.95
Webster Audio Transformers, 1-4 or 1-8..... 3.39	SPAGHETTI, black or yellow, 36"..... .10

VARIOMETERS

Moulded Variometer..... \$6.00	Estru Split Variometer..... 4.50
Variometer, All Circuits..... 5.50	Readem Binding Posts. Set composed of 1 antenna, 1 ground, 1 A Battery + 1 B Battery + 2 telephones, 1 B Battery + 1 B Battery..... \$.75
Phone Plugs..... \$.39	Knock-down Loop Aerial, Special..... .85
UV-199 Adapter..... .69	UV-199 Socket..... .69
WD-11 Socket..... .69	

VARIABLE CONDENSERS

Variable Condenser, .0005 (Same as 23 plate)..... \$1.95	Variable Condenser with Vernier, .0005 (Same as 23 plate)..... 3.45
Variable Condenser, .001 (Same as 45 plate)..... 2.35	Variable Condenser, with Vernier, .001..... 3.95
Walnut Variable Condenser, .00025..... 1.75	H. C. Coil Mounting Gearing..... \$4.50

RADECO SAFETY FUSES

(Patented)

Now available for DEALERS' SALE

Radio users have learned that Radeco Safety Fuses are a necessary tube protection—that their price (50 cents) is small compared with the great service they render.

The merit of the fuses, their low price and our extensive advertising have created a ready sale.

Up to now these fuses have been sold direct by mail, but the demand is so great that we want to distribute them in larger units through the trade channels. You will find Radeco Fuses a profitable item to add to your stock.

To assist you in handling them, we have made up attractive display boxes in colors containing an assortment of two dozen fuses.

Price per box (2 dozen fuses) \$12.00

Subject to Regular Trade Discounts

ORDER TODAY

Radio Fans! Radeco Fuses can now be purchased at your Dealers.

RADIO EQUIPMENT COMPANY
New England's Oldest Exclusive Radio House
20 STUART STREET BOSTON, MASS.

Further Details of the Famous Miloplex Hook-Up

Part XII—King "X" Works with or without Antenna or Ground

By the Mystery Man

SO THIS is Xmas—or the ragged edge—two days more for Santa to get close to the chimney so he can fill the little stockings and big socks. Mercy, one can hardly realize it has happened 1923 times—time surely do fly.

Thanksgiving was some day. You know after not eating (regularly) for some weeks, I copied in my notebook all the goodies I was going to masticate besides his honor the Turk (you know what I mean) and then—but why should I tell the sad story other than to casually mention that on that eventful day of eats, my tummy went "blooie"—stalled flat—about one hour and seven minutes before the herald announced "let's eat," and as a result when the Doctor had finished giving me the once over and handed Maggie two messages in code for the druggist, besides telling her to "Keep hot bricks on his feet," I kissed Mr. and Mrs. Gobbler goodby.

Introducing King X

But, Oh Boy! Soon is Xmas and my canteen is ready. I'll say it's Christmas and here's your Xmas present circuit—the King "X," your present from the Mystery Man as a token of my appreciation for your interest in my previous try at pleasing you. Even my closest friends (you know the kind I mean—those you ask to help you inventory your basement

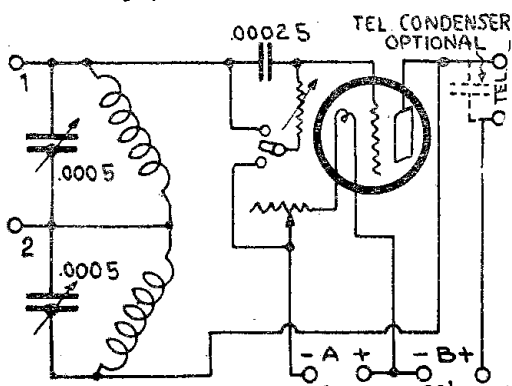

stocks) haven't had a ghost of an inkling on this new circuit.

How does it work? Answer, with or without antenna or ground; speaks all languages and you fans who stumbled on

RADIO WALL MAP 10c

Up to date, just off the press. Shows call letters, location, wave length, and kilocycles of all radio broadcasting stations; also American Relay divisions and radio districts. Complete with scale for measuring distances. Size 28x34 inches, printed in three colors. Postpaid for a dime.

OZARKA, INC.

864 Washington Blvd., CHICAGO

2-LO, LONDON, ENGLAND ON ONE TUBE

Another Record for the

ELGIN SUPER-REINARTZ

Tuesday, November 27, during the test period between 9 and 9:30 P. M., Rev. E. A. Cole in the residence of J. A. Melver, of Roodhouse, Ill., while operating a set made of materials and in accordance with the hookup furnished by the ELGIN RADIO SUPPLY CO., tuned in 2-LO, London, England, using receivers and but one tube. Later another tube was lighted and the loud speaker used, so that four people could hear the program and concluding announcement. The numbers, time, and the order in which they were played were

Officially Confirmed

by the St. Louis Post Dispatch in conjunction with the National Association of Broadcasters, who had charge of the tests. (See page 34, St. Louis Post Dispatch, Dec. 2, 1923.) This same hookup has been advertised extensively as the one which brings in stations 2000 miles overland on a loud speaker and one tube; and this has been demonstrated so often as to need no repetition.

Send a two-cent stamp for circular giving one, two, and three tube hookup, and price list of parts for this remarkable circuit. Address the

ELGIN RADIO SUPPLY CO.

207 Chicago St.

ELGIN, ILL.

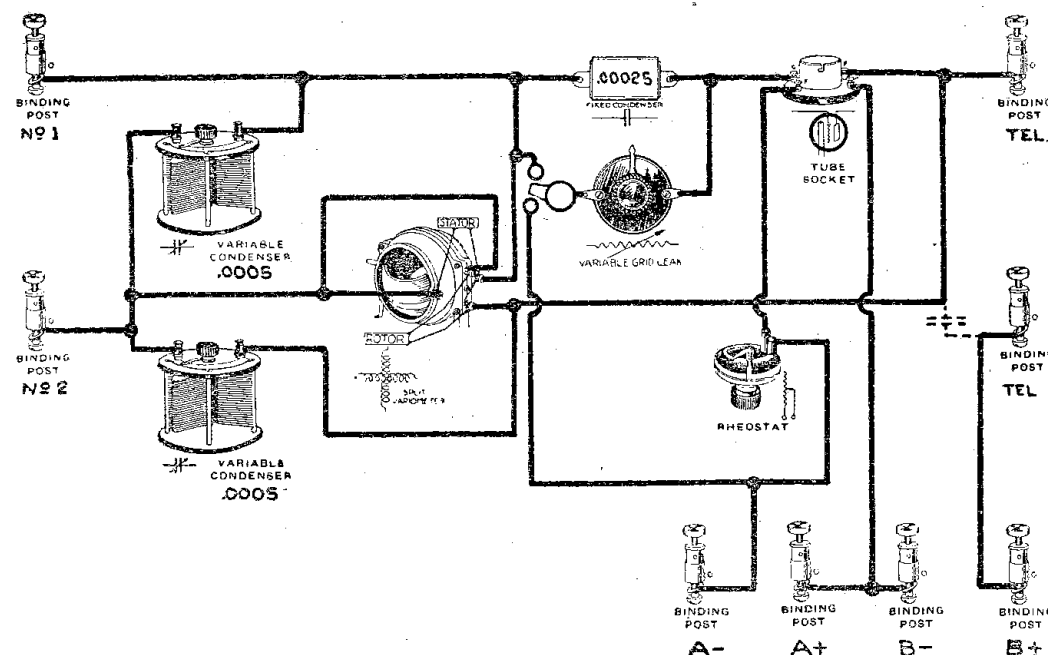

the King can build the King "X" sure fire or I'll have to go back to crystal circuits.

Description of the Circuit

And the whole circuit is nothing more than a couple of good condensers—most any kind of energy collector—a socket and ordinary fixings. Diagram shows my using a variometer (sure—I'm a variometer hound). Try it on local and DX and see it—hear it work!

A couple of honeycomb coils will work just as well, but remember, both coils

must be of the same number of turns. Whatever you use for energy collector makes little difference so long as the one going to grid is of the same inductance value as the one going to plate.

Next week I'll tell you the whole story about this new pet.

Think you will find that using a ground connection won't help you a bit. Antenna should go on point number 1, though you

REINARTZ COILS

IMPROVED COILS MADE TO COVER NEW WAVE LENGTHS

- 21 tap coils.....\$1.00
- 16 tap coils..... .90

Above prices include coil mounting and also circuit diagram. Sent postpaid upon receipt of money order.

Attractive discounts to dealers.

KINLEY RADIO CO., Box 185, Detroit, Mich.

NEW EASY WAY

To Get Real Long Distance

Ashe variable Grid Leak (Patented) gives a smooth, positive contact—automatically renews graphite path—10 times greater capacity. Fool-proof, supersensitive control assures perfect results from ultra Audion, Flewelling, R. C. S., or any regenerative receiver. Test one on your own set. Just send name and address.

Deposit \$1.40 (plus postage) with Postman. Cash in full with order, postage prepaid. If, after ten days trial, you are not delighted, money back quick. You see you take no risk, so send name and address at once to Lucken Radio Sales Co.

Dept. 6,
501 S. Dearborn St.,
Chicago

may like it better on point 2. If you do, use ground with antenna, then antenna goes on 1 and ground on 2.

Look this little fellow over and get ready for Santa Claus. Anyway, the King "X" is different and "do work." Hain't that enough for Xmas?

Howler the dog is hungry, Maggie opines she is famished and, well, I'm a customer. Let's Eat, and get ready to welcome the Kiddie's King Santa Claus.

(TO BE CONTINUED.)

KEYSTONE RADIO LIGHTNING ARRESTERS

\$2.00

Should be on every aerial the year 'round. Provides highly efficient lightning and static protection for the home. Fully approved by Fire Underwriters. Can be installed outdoors. Has no vacuum to lose. Install one in your aerial lead now—be safe. This pioneer radio arrester is backed by 31 years' experience in lightning arrester design. For sale by Dealers everywhere, or sent postpaid for \$2.00. Write for circular.

Electric Service Supplies Co.
178 Cambria Sts.
Philadelphia
Monadnock Bldg., Chicago
50 Church St., New York

WILLARD RADIO COMPANY

291 Broadway

New York City

"The Best for Less"

REINARTZ CIRCUIT EVERY PART COMPLETE

1 Reinartz wound coil, 1 tube socket, 1 rheostat, 1 23-plate .0005 MFD. variable condenser, 1 13-plate .00025 MFD. variable condenser, 3 inductance switches, 23 switch points and nuts, 6 switch stops and nuts, 8 binding posts, 2 3" dials, 1 variable grid leak, 1 .002 MFD. phono condenser, 23 feet bus bar wire, 1 high-grade panel ALREADY DRILLED AS PER DIAGRAM \$10.95 and complete instructions.....

Two-Stage Audio Frequency Amplifier—Parts complete in every detail for this Circuit—\$11.00 Specify type of tubes you intend using

FLEWELLING CIRCUIT EVERY PART COMPLETE

2 honeycomb coils, 1 2-coil mounting, 2 coil plugs, 3 .006 condensers, 1 variable grid leak, 1 grid leak, 1 23-plate .0005 MFD. variable condenser, 1 Vernier rheostat, 1 tube socket, 8 binding posts, 20 feet bus bar wire, 1 3" dial and 1 high grade panel ALREADY DRILLED AS PER DIAGRAM IN BOOKLET OF INSTRUCTION sent free..... \$11.95

Two-Stage Audio Frequency Amplifier—Parts complete in every detail for this Circuit—\$11.00 Specify type of tubes you intend using

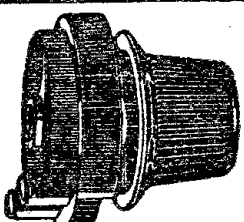
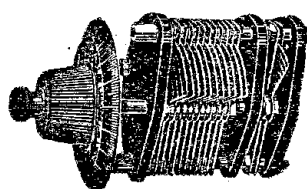

CONDENSERS

- 3 Plate Variable; value, \$1.75.....\$1.05
- 11 Plate Variable; value, \$2.50..... 1.20
- 13 Plate Variable; value, \$2.50..... 1.20
- 17 Plate Variable; value, \$3.50..... 1.35
- 23 Plate Variable; value, \$3.50..... 1.35
- 43 Plate Variable; value, \$4.50..... 1.95
- 13 Plate VERNIER; value, \$5.50.....\$3.75
- 23 Plate VERNIER; value, \$6.00..... 4.00
- 43 Plate VERNIER; value, \$6.50..... 4.25

BEST QUALITY JACKS, Single Circuit; value, 65c; special at.....\$.30 Double Circuit; value, 90c; special at......45

MULTIPLE POINT INDUCTANCE SWITCH with Knob and Dial (15 Switch Points).....\$1.25

LIGHTNING ARRESTERS approved by underwriters.....\$.90

THREE-INCH DIALS—Unbreakable—heat resisting composition—high finish; special.....\$.30

TWO-INCH DIALS—Same design—for rheostats and potentiometer; special at.....\$.25

TELEPHONE PLUGS.....\$.60

- Filament Rheostat, 6 ohm......65
- Filament Rheostat, 20 ohm......80
- Filament Rheostat, 50 ohm......90
- With 2" Dial, 15c extra.

- Honeycomb Coils, 50 turns mounted.....\$.95
- Honeycomb Coils, 75 turns mounted..... 1.00
- Double Coil Mountings..... 2.45
- Triple Coil Mountings..... 3.35
- Reinartz Coils, increased wave-length and mounting..... 1.95

AUDIO FREQUENCY TRANSFORMER—Designed for use with W. D. 11 \$2.75 Tubes, list, \$4.50; price.....

BALL BEARING INDUCTANCE SWITCH—value, 75c; special.....\$.25

V. T. SOCKETS—Nickel-plated, brass sleeve, composition base; value, \$1.00; special at......40

EXTRA SPECIAL—Telephone 3000 Ohms Headsets; \$9.00 value; reduced to..... 3.50

Vernier Dial Adjuster. List, 35c; special......25

FRESHMAN VARIABLE RESISTANCE LEAK and MICA CONDENSER Combined... .75

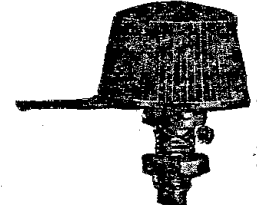

Every article advertised above is guaranteed by the manufacturer and by us—Mail orders filled immediately—transportation PREPAID on all orders of \$5.00 or over east of the Mississippi River. Send cash, check or money order—absolutely no goods sent C. O. D.

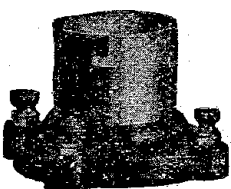

SANTA WITH HIS CHRISTMAS CAROLS

These Stories Will Aid Opera Listeners

STORY OF LA FORZA DEL DESTINO, WMAQ, DECEMBER 19

DON ALVARO, a young Indian prince, attempts to elope with Leonora, the daughter of the Marquis of Calatrava, a Spanish nobleman. They are discovered and the Marquis in his anger accidentally discharges his pistol killing himself. Don Carlo, Leonora's brother, swears that he will kill both Don Alvaro and Leonora when he finds them. Leonora seeks refuge in a monastery, where dressed as a man she becomes a mysterious friar who inhabits a cave. The Abbot puts a curse on anyone who seeks to learn her identity.

Meanwhile, Don Alvaro has joined the Spanish army. He saves the life of a wounded fellow soldier who turns out to be Don Carlo. Never having seen each other they become friends. When Alvaro is wounded in battle he makes Don Carlo promise that he will destroy a casket filled with letters and pictures. Although Don Carlo does not open this box, he discovers a picture of his sister, and when Don Alvaro recovers, he challenges him to a duel in which Don Carlo is wounded.

Poor Don Alvaro does not feel that he can now find Leonora with the blood of both her father and brother on his hands. Here Don Carlo, recovered, seeks him out and arouses the kindly priest to fight a duel with him. The hillside they choose is near the cave in which Leonora is confined. Don Carlo is again wounded, this time fatally. Unable to give the dying man the last sacraments due to the ban placed upon this hillside by the Abbot, Don Alvaro calls the friar who lives in the cave. Leonora seeing that her brother is dying rushes to embrace him. Don Carlo seeing her in the presence of Don Alvaro, suspects them both and stabs her as her arms go about him. Don Alvaro now feeling that he has been the cause of three deaths, throws himself over the cliff as the monks arrive singing a Miserere.

STORY OF HANSEL AND GRETEL, KYW, DECEMBER 20

THIS opera will please you all I am sure, with its happy hilarious ending. Nor is it sentimental and weepy which is a relief, is it not? If you want an evening of pure fun and unadulterated by any grown-up emotion listen in to Hansel and Gretel, and let your imagination wander on impossible things. Remember that Hansel and Gretel are the children of Peter, a broom-maker, and his wife Gertrude. They are very poor. In the first act the wife comes home with nothing for her children to eat. Cross and tired the mother send the children into the woods to gather strawberries. They wander here and there eating the berries until the next morning pours into their eyes. The next morning when they are awakened by the Dewman, the Dawn Fairy, they see a wonderful gingerbread house. As hungry Hansel begins to eat this attractive dwelling, old pops the old witch. She puts Hansel into the barn to fatten on almonds and raisins and makes Gretel make the fire which is to bake him into gingerbread. Gretel promises she will not make the fire burn. When the witch pokes her head in the stove to see what the matter is, the little girl pushes her in and closes the door. When Hansel is released and the other little children have been turned back from gingerbread into real boys and girls, they dance and sing together.

—THE PROGRAM LADY.

Tuesday, December 18

- CKAC, Montreal, Can. (Eastern, 430), 7:00 p. m., Kiddies' stories in French and English; 7:30, Orchestra; 8:15, Concert, Raoul Venant, director.
- KDKA, E. Pittsburgh, Pa. (Eastern, 326), 6:15 p. m., Grand Symphony Orchestra; 7:45, Children's Period; 8:15, "A Visit to Rome and St. Peter's Church," Dr. John B. Ewers; 8:30, Clara B. Elder, soprano; Flora S. Ringstad, pianist; Minard Lozier, tenor; Bess H. Vetter, accompanist; 11:30, Queen City Sereaders.
- KFI, Los Angeles, Calif. (Pacific, 469), 6:45-7:30 p. m., Concert, George J. Birkle Music Co.; 10:00-11:00, Sol Cohen, violinist.
- KGW, Portland, Ore. (Pacific, 492), 3:30 p. m., Talk by Jeannette P. Oramer; 8:00, Talk for farmers, George W. Kalle; 10:00, Dance music, George Olsen's Metropolitan Orchestra.
- KHJ, Los Angeles, Calif. (Pacific, 395), 2:30-3:30 p. m., Matinee musicale; 6:45-7:30, Weekly visit of "The Sandman"; 8:00-10:00, Golden West Commandery Band, S. H. Perline, director; E. Alexander Hyer, tenor; "Art and Stars," Dr. Thomas Lutman; 10:00-12:00, "Mud Hickman's Orchestra."
- KPO, San Francisco, Calif. (Pacific, 423), 6:00-7:00 p. m., Dinner program, Studebaker "6" (Royal Hawaiian Orchestra); 8:00-10:00, Symphonic Ensemble of San Francisco, George Siavsky, director; 10:00-11:00, Palace Hotel Orchestra.
- KSD, St. Louis, Mo. (Central, 546), 8:00 p. m., Choir of Union Methodist Episcopal Church; Address, H. E. Dahm.
- KYW, Chicago, Ill. (Central, 536), 2:35 p. m., Studio program; 6:50, Children's bedtime story; 8:01-8:28, Program, American Farm Bureau Federation; 8:35-9:00, Elaine DeSelle, soprano; Birr's Orchestra; E. Dauphinais, trombonist; I. Freedman, banjoist; E. Dauphinais, trombonist; Mary McAuliff, pianist; Charles E. Birr, violinist; Earl Bown, saxophonist; Robert Daker, drummer; Nick Varzos, cornetist; 10:00-12:30 a. m., Midnight Revue; Herbie Miltz, pianist; Wendell W. Hall, KYW's Music Maker; "Sen" Kane, specialty act; W. Remington Welch, organist.
- WBAP, Fort Worth, Texas (Central, 476), 7:30-8:30 p. m., Concert arranged by E. Clyde Whitlock, violinist, featuring his artistic pupils; 9:30-10:45, Fort Worth Harmony Club.
- WBZ, Springfield, Mass. (Eastern, 337), 7:00 p. m., "Winter Courses at the College for Farmers," John Phelan; 7:30, Bedtime Story for Kiddies; "Social Values in the Home," Agnes H. Craig; 8:00, Christmas Organ recital, Arthur H. Turner.
- WDAR, Philadelphia, Pa. (Eastern, 395), 12:00 m., Organ recital, Stanley Theater; Piano solos, Edna Finestone; 2:00-3:00 p. m., Concert Arcadia Cafe Concert Orchestra, Feri Sarkozl, director; 7:30, Bedtime stories, Dream Daddy; 7:45, Dramatic review, Walter Greenough.
- WEAF, New York, N. Y. (Eastern, 492), 11:00-11:20 a. m., Y. W. C. A.; 11:20-11:35, Board of Education; 11:35-11:50, Adele F. Woodward; 4:00-4:30 p. m., Helen Graves, mezzo soprano; 4:30-5:00 p. m., Guy Hunter, singer and pianist; 5:00-5:30, Christmas program for children; 7:30-7:40, Thornton Fisher's Sport Talk; 8:19-8:20, American Surety Co.; 8:30-8:40, Brooklyn Daily Eagle; 8:40-9:00, Arline Thomas, dram. soprano; 9:15-9:30, Columbia Phonograph Co.; 9:30-10:30, Old-Fashioned Minstrel Show.
- WFAA, Dallas, Texas (Central, 476), 12:30-1:00 p. m., Address, DeWitt McMurray; 8:30-9:30, C. M. Saner, tenor; 11:00-12:00 midnight, Harris Bros. Orchestra.
- WGY, Schenectady, N. Y. (Eastern, 380), 2:00 p. m., "Solving the Gift Problem with Books," 7:45, An all-star revuesical comedy, entitled, "Up and Down Broadway," WGY Players.



To the left and above we present Miss Bernice Carlton, popular violinist in the Texas Christian University semimonthly programs broadcast from WBAP, and Helen Bell Rush, coloratura soprano, who will sing from WEAF Wednesday evening, December 19. Above, in the center, is Santa himself, who is busy these days and even working overtime to be able to talk from all the stations to his particular friends, the kiddies, and to the grown-ups too Santa, K. & H. Photo



- WHAS, Louisville, Ky. (Central, 400), 4:00-5:00 p. m., Strand, Theater Orchestra; "Just Among Home Folks," Selections, Walnut Theater Orchestra; 7:30-9:00, Concert, Williams L. Vick, director.
- WIN, New York, N. Y. (Eastern, 360), 3:45-4:30 p. m., William A. Pycha, Orchestra; 4:30-5:00, Program by the "Cosmopolitan Singers"; 5:00-5:30, The "Hollywood Serenaders"; 9:30-9:45, Lew Holz, famous Broadway comedian of the "Tent"; 9:45-10:30, Chas. Hathway's Orchestra; 10:30-11:00, Shapiro Bernstein Music Co.; 11:00-12:00, Ernest Graepffel's Castle House Orchestra from the Punch and Judy Theater.
- WIP, Philadelphia, Pa. (Eastern, 509), 1:00 p. m., Karl Bonawitz, organist; 3:00, George Kelly and his record-recording orchestra; 6:05, Dick Began and his WIP Little Symphony Orchestra; 7:00, Uncle Wip's bedtime stories; 8:00, Dramatic review, Lester Lester; 10:15, Charlie Kerr and his orchestra from Hotel St. James.
- WJAX, Cleveland, Ohio, (Eastern, 390), 7:30 p. m., Program arranged by the Cleveland News-Leader; Bedtime story, E. O. Johnson; Santa Claus talk to the children; 7:45, Concert program by the professional department of the Francis J. Sedler Studio of Music, Specialty numbers by favorite artists.
- WJAZ, Chicago, Ill. (Central, 447.7), 10:00 p. m.-2 a. m., Helen Hawle, pianist; Helen Greim, pianist; J. Henry Welton, tenor; Walter Borchard, violinist; Oriole Orchestra.
- WJZ, New York, N. Y. (Eastern, 455), 8:00 p. m., "Broadwaying Broadway," 8:15, "Retail Advertising," University of the Air talk, Frank Arkins; 8:30, Estey Organ Recital; 9:30, Charles D. Isaacson concert; 10:30, Dance program, Hotel Astor Dance Orchestra.
- WLW, Cincinnati, Ohio (Central, 309), 4:00 p. m., Current Topics for Women; 10:00, Special program given by the Knox Presbyterian Church, D. L. M. DeVaux, director; Idella Banker, soloist; William H. Grubbs, accompanist; Herbert Hevlet, minister; Ora May Ballinger, violinist; Inspirational talk by May Cornell Stolber; 11:00, The Pansy Entertainers.
- WMAQ, Chicago, Ill. (Central, 447.5), 4:30 p. m., Glenn Dillard Gunn School of Music; 7:00, Talk on eyes, Dr. L. E. Barnes; Wm. Bothke of LaSalle Extension University; 8:30, WMAQ Orchestra; 9:00, LaSalle Hotel Trio; 9:15, Lyon & Healy program.
- WMC, Memphis, Tenn. (Central, 500), 8:30 p. m., Program arranged by Marguerite Storch; 11:00, Regular Midnight Frolic.
- WOC, Davenport, Iowa, (Central, 484), 12:00 m., Chimes; 3:30 p. m., "Sleeping Sickness," A. G. Hinrichs; 5:45, Chimes.
- WWJ, Detroit, Mich. (Eastern, 517), 9:30 a. m., "Tonight's Dinner," Woman's Editor; 9:45, "Ironing Day," Fred Shaw; 3:00 p. m., Nichol's Blossom Death Inn Orchestra; 8:30, Detroit News Chorists; The Detroit News Chorists.
- WYF, Philadelphia, Pa. (Eastern, 509), 6:05 p. m., Jordan-Lewis dance orchestra, direction Bob Lewis; 7:00, Uncle Wip's bedtime stories.
- WJAZ, Chicago, Ill. (Central, 447.7), 10:00 p. m.-2 a. m., Helen P. Barth, contralto; Max Kosner, baritone; Sisson Trio; Oriole Orchestra.
- WJZ, New York, N. Y. (Eastern, 455), 3:00 p. m., Frieda Levin, soprano; 3:15, First Symphony Cella Quartet; 4:30, Tea music, Hotel Commodore Orchestra; 7:00, "The Adventures of Peter," a Shadowland story, Florence Vincent; 7:30-8:15, Piano recital, Frederick Cheeswright; "The Progress of the World," a review of Reviews talk; Frank Jacod, French tenor; 8:30, Address, Joseph A. Alexandr; 8:45, Frank Jacod; 9:00, "First Aid for Christmas Shoppers," Anne Lewis Pierce; 9:15, "United States Navy Night," Rear Admiral E. R. Stitt.
- WLW, Cincinnati, Ohio (Central, 309), 4:00 p. m., Paderewski, the Pianist and Composer, William Afsprung; 7:30, Special half-hour program for children; Laura Edith French, pianist; Radario, "Fari-sado," Crosby Radarians; 8:00, Grove's Orchestra; 8:30, Cincinnati College of Music, Estelle B. Whitney, reader; 8:50, Cincinnati Zither Quartet; 8:15, Grove's Orchestra; Bertha Kershner, violinist; Dorothy Klein, soloist; Cincinnati Zither Quartet.
- WMAQ, Chicago, Ill. (Central, 447.5), 1:00 p. m., Chicago Ass'n. of Commerce luncheon; 4:30, Pupils of Cosmopolitan School of Music; 6:30, Georgene Faulkner, story lady, tells Christmas stories; 7:00, Weekly lecture from Northwestern University; 8:00, "La Forza Del Destino," opera at the Auditorium Theater, by Chicago Civic Opera Co., opera in Italian, music by Verdi, libretto by Piave, four acts, cast: Margulis of Calatrava, Alexander Kiprian; Donna Leonora, Claudia Muzio; Don Carlo, Cesare Formichi; Don Alvaro, Giulio Crimi; Abbot of the Franciscan Friars, Virgilio Lazzari; Melitone, a friar, Vittorio Trevisan; Crezibionia, Kathryn Meisle; Maid of Donna Leonora, Beryle Brouka; Mule Driver, Lodovico Oliviero; Alcalde, Milla Luka; Conductor, Georgio Polacco.
- WOC, Davenport, Iowa (Central, 484), 12:00 m., Chimes; 3:30 p. m., "The Value of Urinalysis," Clyde G. Kern; 8:50, Sandman's Visit; 7:00, "The Winter Poultry Flock," M. H. Hoffman; 8:00, Mrs. Frank W. Elliott, organist; 9:00, Two-hour concert, Schmidt Music Co. orchestra; Analia Schmidt-Gobble, soprano; Maud Marshall Bond, reader; Mrs. E. H. Hipple, saxophonist; Earl Hipple, xylophonist; Henry

Wednesday, December 19

- KDKA, E. Pittsburgh, Pa. (Eastern, 326), 6:30 p. m., Pittsburgh Athletic Association Orchestra; 7:30, Talk on Books, Priscilla Guthrie's Book Store; 7:45, John Martin's evening with the children; 8:15, "The Advantage of Physical Examination in Industry," 8:30, Steel City Quartet, A. M. Beresh, first tenor; J. F. Nelson, second tenor; S. Jones, first bass; J. H. Thomas, second bass; A. L. Vetter, accompanist; KDKA Little Symphony Orchestra.
- KFAE, Pullman, Wash. (Pacific, 330), 7:30 p. m., "How to Prepare for One's Vocation," Dr. D. W. Hamilton; "Value of a Knowledge of the Sanitary Standpoint," Prof. A. B. Crane.
- KFI, Los Angeles, Calif. (Pacific, 469), 6:45-7:30 p. m., Detective stories, Nick Harris, detective; 10:00-11:00, Concert of instrumental numbers.
- KGW, Portland, Ore. (Pacific, 492), 3:30 p. m., Children's program, music by children and story by Aunt Nell; 8:00, Orchestra concert, auspices of Helen Harper; 9:00, Business talk, James Albert; 10:00, dance music, George Olsen's Metropolitan Orchestra.
- KHJ, Los Angeles, Calif. (Pacific, 395), 2:30-3:30 p. m., Matinee musicale; 6:45-7:30, Children's program; 8:00-10:00, De Luxe program, Harry Thompson, baritone; 10:00-12:00, Art Hickman's Orchestra.
- KPO, San Francisco, Calif. (Pacific, 423), 8:00-9:00 p. m., Gustave H. M. Schuitels, organist; 9:00-10:00, Dance music, E. Max Bradford's Orchestra.
- KSD, St. Louis, Mo. (Central, 546), 7:00 p. m., Aberg's Hotel Concert Ensemble, Arne Arnesen, violinist; 11:00, Hotel Stalter dance music.
- KYW, Chicago, Ill. (Central, 536), 6:50 p. m., Children's bedtime story; 8:00-8:58, Salvation Army Staff Band; Wendell W. Hall, KYW's Music Maker; Sallie Menkes, accompanist; 9:05-9:15, "Forest Fires Put the Wreck in Recreation," Field and Stream; 9:15, Reviews of the latest books, Llewellyn Jones.
- PWX, Havana, Cuba (Eastern, 400), 8:30 p. m., General Staff Band of the Cuban Army.
- WBAP, Fort Worth, Texas (Central, 476), 7:30-8:30 p. m., Sam S. Losh, baritone; 9:30-10:45, George Freeman's Sooner Sereaders.

Sonntag, violinist; Carl C. Schmidt, violinist; Herman Schmidt, Jr., mellophonist; Arthur R. Schultes, clarinetist; Edwards Congregational Male Quartet; Women's Chorus.

WOOD, Philadelphia, Pa. (Eastern, 509), 11:00 p. m., Organ recital, Mary E. Vogt; 12:00-1:00 p. m., Dinner music, Wanamaker Crystal Tea Room Orchestra; 5:15, Organ recital, Mary E. Vogt; 7:45, Dinner music, Adelphia Hotel Orchestra; 8:00, Monologue, Ralph Bingham; 8:30, Recital, WOO Orchestra; 10:30, Dance music, Adelphia Hotel Orchestra.

WTAM, Cleveland, Ohio (Eastern, 390), 8:00 p. m., Overture and orchestral numbers, WTAM Orchestra; Piano solos, Miss Clara Sharp; Harp solo, Miss Virginia Renter; Vocal numbers by "The Masked Singers"; piano by "The Masked Accompanist"; Violin solos, Mr. Ben Silverberg; Trumpet solo, Frank Hurby; Miss Clara Sharp, accompanist; Mrs. Dorothy Lenz, contralto; Clara Sharp, accompanist; Duet, Martha Broda, soprano, Mrs. Dorothy Lenz, contralto; Clara Sharp, accompanist; Martha Broda, soprano.

WWJ, Detroit, Mich. (Eastern, 517), 9:30 a. m., "Tonight's Dinner," Woman's Editor; 12:00 m., Joan Goldkette's Orchestra; 8:30, Detroit News Orchestra; Fred Moehring, pianist; Aileen T. Warner, soprano.

Thursday, December 20

- CKAC, Montreal, Can. (Eastern, 430), 7:00 p. m., Kiddies' stories in French and English; 7:30, Concert, Desrochers Trio; Paul Valade, soloist.
- KDKA, E. Pittsburgh, Pa. (Eastern, 326), 6:15 p. m., Grand Symphony Orchestra; 7:30, Weekly Chat with Farmers, Frank E. Mullen; 7:45, Uncle Remus has a story for the children; 8:30, Concert, South Side Presbyterian Church Choir; 11:30, late evening concert.
- KFI, Los Angeles, Calif. (Pacific, 469), 6:45-7:30 p. m., Concert, local Y. M. C. A., and opera story; 10:00-11:00 p. m., Concert program.
- KGW, Portland, Ore. (Pacific, 492), 3:30 p. m., Polly Fredmore Linden, interior decorator; 8:00, Dramatic program, Doris Smith; 10:00, Dance music, George Olsen's Metropolitan Orchestra.
- KHJ, Los Angeles, Calif. (Pacific, 395), 2:30-3:30 p. m., Matinee musicale; 6:45-7:30, Children's program; 8:00-10:00, Lincoln High School Chorus; 10:00-12:00, Art Hickman's Orchestra.
- KPO, San Francisco, Calif. (Pacific, 423), 6:00-7:00 p. m., "Night at the Theater" Orchestra; George Lipschultz, conductor; 8:00-9:00, Program, Mme. Gaillean, director; 9:00-10:00, Palace Hotel Orchestra.
- KSD, St. Louis, Mo. (Central, 546), 8:00 p. m., Choir of Westminster Presbyterian Church, W. M. Jenkins, director; Lewis H. Williamson, tenor.
- KYW, Chicago, Ill. (Central, 536), 6:50 p. m., Children's bedtime story; 7:45, "Hansel and Gretel," opera at the Auditorium Theater by Chicago Civic Opera Company, opera in English, music by Humperdinck, text by Adelheid Wette, three acts; cast: Hansel, Irene Parivaska; Gretel, Mary Fabian; The Witch, Maria Claessens; The Mother, Doria Fernanda; The Father, William Beck; Sandman, Beryl Brown; Dewman, Margery Maxwell; Conductor, Frank St. Leger.
- WBAP, Fort Worth, Texas (Central, 476), 7:30-8:30 p. m., Concert, group of Fort Worth artists; 9:30-10:45, Knights of Pythias Girls' Mandolin Club.
- WBZ, Springfield, Mass. (Eastern, 337), 7:30 p. m., Twilight tales for the kiddies; Letter from the New England Homestead; 8:00, Mrs. C. G. Simpson, conductor; Mary Steele, accompanist; 9:00, Bedtime story for grown-ups, Orison S. Marden.
- WDAR, Philadelphia, Pa. (Eastern, 395), 12:00 m., Organ recital, Stanley Theater; Piano recital, Edna Finestone; 2:00-3:00 p. m., Concert Arcadia Cafe Orchestra; 7:30-7:45, Bedtime stories, Dream Daddy.
- WEAF, New York, N. Y. (Eastern, 492), 11:00-11:25 a. m., Clarke E. Davis of National Biscuit Co.; 11:25-11:50, William Johns of Swift & Co.; 4:00-5:00, Landon's Serenaders; 5:00-5:30, Christmas program for children; 7:00-7:30, Midweek services N. Y. Federation of Churches; 7:30-7:40, Thornton Fisher's sport talk; 7:40-8:00, Dora Damon Pardee, cornetist; 8:00-8:10, Auction bridge talk; 8:50-9:00, Hearst's International Magazine; 9:00-11:00, Special

CHRISTMAS TALES
THE KIDDIES

THIS week Christmas tales are a special program for tots to tuck into at twilight which will bring their dream fuller if of Santa sugar plums wonderful Santa Claus himself be from KDKA many other tions, who assistant, speaks a spoken month from WEAF is a special mas pro every day.

In the of the min s came on mas Eve a outside th dows, s merry floated a cool, cr For many Christmas have been by only people her trehe, bu year Ch carols will at every y the air will brant with happy tho visible tun dial for W.D.A.P. WGY, WLW.

Dicken's mas Carol given b eastern s WLW w this Th night and on Christn WLW w give a Ch Eve play, Drum" a winning I

—THE PROGE

DOMINATES THIS WEEK ON THE AIR



In the center, to the left, is the Phil Ohman trio, consisting, in the order you find them, of Ohman, pianist, Sam Hermann, xylophonist, and Herb Finney, saxophonist. They are on the WFAA program for December 19. Immediately above is Irene Pavloska, who will be heard from KYW in Hånsel and Gretel Thursday, December 20, and at the right, Jack Hillman, baritone, who will broadcast Christmas carols from KPO on Christmas Eve

MAS FOR ODIES
s the before and ll sorts y pro- little e in to time t make is even possible Clause, ns and toys us will heard A and r stable his icicle, A has r a TOR. iving riving r a m
d days trel's Christ- sang e win- o that voices on the p air. years carols sung a few e and this istmas boat in ndow; be vi- a their igh in- s. Just KPO, WGR, IAZ or
Christ- will be y two tations. ll give ursday WYY, as Eve. ll also ristmas "The prize tadario.
AM LADY.

WHN, New York, N. Y. (Eastern, 360), 2:15-3:00 p. m., Fred Whitehouse Review; 3:45-4:45, Ideal Novelty Orchestra; 4:45-5:00, Ross Fowler, baritone; 9:00-9:45, Jimmy Clarke Entertainers.

WIP, Philadelphia, Pa. (Eastern, 509), 1:00 p. m., Karl Bonawitz, organist; 3:00, Ches West's orchestra; 6:05, Greenwich Village Follies Serenaders, direction Dave Martin; 7:00, Uncle Wip's bedtime stories; 8:00, Talk by a professor from Philadelphia College of Pharmacy and Science; 10:15, Charlie Kerr and his orchestra from St. James Hotel.

WJAZ, Chicago, Ill. (Central, 447.7), 10:00 p. m.-2:00 a. m., Mrs. Charles Ray, soprano; Mrs. George A. McGraw, contralto; Josephine Taylor, violinist; George Knutson, pianist; Oriole Orchestra.

WJZ, New York, N. Y. (Eastern, 455), 3:00 p. m., Wanda Norman, pianist; 4:00, Ted music; Hotel Belmont Stringed Ensemble; 5:00, Edna M. Scheller, soprano; 7:00, "Santa Claus Stories," Burr McIntosh; 7:30-8:00, Samuel Aronson, pianist; "Feeding Broadcast Receivers," Dr. Alfred N. Goldsmith; 8:15, Grand Charity Concert of the Liederkrantz Society.

WLW, Cincinnati, Ohio (Central, 309), 9:30 a. m., S. S. Services, auspices of the Editorial Staff of the Methodist Book Concern; 11:00, Church services, Church of the Covenant, Dr. Frank Stevenson, minister; 8:00 p. m., Cincinnati Commandery No. 3 of the Knight Templars Christmas service—Scottish Rite Cathedral.

WMAQ, Chicago, Ill. (Central, 447.5), 8:00 p. m., Christmas program; 9:00, Weekly revue from Balaban and Katz Chicago Theater.

WMC, Memphis, Tenn. (Central, 500), 8:30 p. m., Program, Burk's Orchestra.

WOC, Davenport, Iowa (Central, 484), 12:00 m., Chimes; 3:30 p. m., "The Products of Corn," C. C. Hall; 5:45, Chimes; 6:30, Sandman's visit; 9:00, P. S. C. Orchestra; V. B. Roche, baritone.

WTAM, Cleveland, Ohio (Eastern, 390), 9:00 p. m., Special Christmas dance program, WTAM Orchestra; Solos by Mrs. G. Madlung.

WWJ, Detroit, Mich. (Eastern, 517), 9:30 a. m., "Tonight's dinner," Woman's Editor; 3:00 p. m., Detroit News Orchestra.

Sunday, December 23

KFI, Los Angeles, Calif. (Pacific, 469), 10:00-10:45 a. m., L. A. Church Federation Service; 4:00-5:00 p. m., Federated Church Musicians; 6:45-7:30, Opera story and concert; 10:00-11:00, Theron Bennett Dance Orchestra.

KPO, San Francisco, Calif. (Pacific, 423), 11:00-12:00 m., Church services, undominational and non-sectarian; 8:30-10:00 p. m., Rudy Seiger and his orchestra.

KYW, Chicago, Ill. (Central, 536), 11:00 a. m., Central Church Service, Orchestra Hall, Dr. F. F. Shannon, pastor; 6:30 p. m., "Excerpts from the New Testament," William Ziegler Nurse; 7:00, Chicago Sunday Evening Club.

WBAP, Fort Worth, Texas (Central, 476), 11:00 a. m.-12:15 p. m., Church Services, First Methodist Church, Rev. J. W. Bergin; 4:00-5:00, Margaret Agnew White, organist; 5:00-6:00, Vesper concert.

WDAP, Chicago, Ill. (Central, 360), 9:15 p. m., Christmas Carols, Mrs. Jean McAlister Raegan, soprano; Mary Alice Dignam, accompanist; Mrs. Raegan will explain the origin and development of each carol; Drake Ensemble.

WDFR, Philadelphia, Pa. (Eastern, 395), 12:00 m., Organ recital, Stanley Theater; 2:00-3:00 p. m., Concert, Arcadia Cafe Concert Orchestra; 7:30, Bedtime stories; Dream Daddy; 7:45, Moving picture review, James Nassan; 10:10, Dance music, Howard Lanin's Arcadia Cafe Dance Orchestra.

WEAF, New York, N. Y. (Eastern, 492), 2:45-3:45 p. m., Program by the N. Y. Federation of Churches; 3:45-5:30, Dr. S. Parkes Cadman of the Bedford Branch, Brooklyn, organist and soloist; 7:00-9:00, Capital Theatre Symphony Orchestra and Star of Artists; 9:00-10:00, Skinner Organ Recital.

WFAA, Dallas, Texas (Central, 476), 6:00-7:00 p. m., Radio Bible Class, Dr. William M. Anderson, Jr.; 9:30-10:00, Chorists from Christ Church, Episcopal, Oak Cliff, Mrs. J. W. Oehl, director; 10:00-11:00, Jessie McKee's Orchestra.

WFI, Philadelphia, Pa. (Eastern, 395), 7:30 p. m., Church services, Arch Street Presbyterian Church.

WGY, Schenectady, N. Y. (Eastern, 380), 11:00 a. m., Church services, First Presbyterian Church, Rev. Robert Anthony, pastor; 3:30 p. m., Concert, WGY Symphony Orchestra; 7:30, Church services, First Presbyterian Church.

WHAS, Louisville, Ky. (Central, 400), 9:57 a. m., Organ music; 10:00, Church services, Second Presbyterian Church, Rev. Dr. E. B. Gowens, pastor; 4:00-5:00 p. m., Concert, Blanche Thorp, mezzo soprano; Mrs. J. Harry Trent, soprano; Mrs. Hazel Willinger, accompanist.

WHK, Cleveland, Ohio (Eastern, 283), 8:00 p. m., Program of favorite musical numbers by the WHK Trio; Vocal and instrumental offerings by popular artists; 9:30, Chapel service from the Cleveland Presbyterian Church, Rev. A. H. Limousin, pastor.

WHN, New York, N. Y. (Eastern, 360), 3:00-4:45 p. m., Christian Endeavor Union; 4:45-5:00, John D. Flynn of the National Security League; 5:00-5:30, W. H. N. Radio Five; 5:30-6:00, Lange's Hoosiers from the Cinderella.

WIP, Philadelphia, Pa. (Eastern, 509), 4:00 p. m., Direct broadcast from Germantown Theater of a meeting of the Germantown.

WJAZ, Chicago, Ill. (Central, 447.7), 6:00-9:00 p. m., Special Christmas program of Songs and Christmas Oriole Orchestra.

WWJ, Detroit, Mich. (Eastern, 517), 11:00 a. m., Services, St. Paul's Episcopal Cathedral; 5:00 p. m., Detroit News Orchestra.

Monday, December 24

KPO, San Francisco, Calif. (Pacific, 423), 6:00-6:30 p. m., Children's half hour; The Story of Christmas and Santa Claus, L. A. Tucker; Recitations for children by children; 8:00-10:00, Christmas carols, Pearl H. Whitcomb, director; Jack Hillman, baritone; Erwin Horton, tenor.

WBAP, Fort Worth, Texas (Central, 476), 7:30-8:30 p. m., Concert, group of Fort Worth artists; 9:30-10:45, W. B. Roche, organist.

WEAF, New York, N. Y. (Eastern, 492), 5:00-5:30 p. m., Christmas Program for Children; 7:30-7:40, Thornton Fisher's Sport Talk; 8:00-8:40, St. James Choir; 8:40-9:00, Charlotte Bergh, coloratura soprano; 9:00-9:15, Edna Soller, artist; 9:15-9:30, Charlotte Bergh; 9:30-9:45, Edna Soller; 9:45-11:15, Services and Chimes from Trinity Church.

WFI, Philadelphia, Pa. (Eastern, 395), 1:00 p. m., Meyer Davis Bellevue Stratford Orchestra; 3:00, Piano solos, Loretta Kerk; 6:30, Meyer Davis Bellevue Stratford Orchestra; 7:00, "Snowball" stories.

WGR, Buffalo, N. Y. (Eastern, 319), 12:30-1:00 p. m., George Albert Bouchard, organist; 4:00, Tea time music, Martha Gomph, harpist; Elise de Grood, violinist; 7:30, Vincent Lopez Hotel Statler Dance Orchestra; 7:30, Digest of the day's news; 9:00, Concert, Tokyo Dance Orchestra, featuring old time favorites, direction of the Niagara Battery Corporation.

WGY, Schenectady, N. Y. (Eastern, 380), 2:00 p. m., "The Right Kind of Moving Pictures," Mrs. William Mead; 6:30, Children's program; 7:45, Radio Comedy-drama, "Grumpy," WGY Players; 10:30, "Enoch Arden," with music, Clara Swanker, reader, Irene Cooley, pianist; WGY Orchestra.

WHAS, Louisville, Ky. (Central, 400), 4:00-5:00 p. m., Walnut Theater Orchestra; Selections, Strand Theater Orchestra; Alamo Theater organ; 7:30-9:00, Concert, Mu Iota Lambda Society; Reading, An Interesting Historical Episode.

WHK, Cleveland, Ohio (Eastern, 283), 9:00 p. m., Popular program arranged by the Cleveland Radio Dealers' Association.

WHN, New York, N. Y. (Eastern, 360), 2:15-3:30 p. m., Original Indiana Five; 3:30-4:15, Shapiro Bernstein Music Co.; 9:30-10:15, Rex Serenaders; 10:15-11:00, Fred Whitehouse Review; 11:00-11:30, Oriental Knights Novelty Orchestra.

WIP, Philadelphia, Pa. (Eastern, 509), 3:00 p. m., Popular program by Remick studio artists; 6:05, George Thomas and His Little Club Cafe Orchestra; 7:00, Uncle Wip's bedtime stories.

WJAZ, Chicago, Ill. (Central, 447.7), 10:00 p. m.-2 a. m., Esther Weiss, soprano; James Levinson, bass; Lawrence Preston, violinist; Oriole Orchestra.

WJZ, New York, N. Y. (Eastern, 455), 3:00 p. m., Leo Riggs, organist; 5:00, "The Larger Aspect of World Affairs," Frederick Dixon; 7:00, "Jack Rabbit Stories," David Cory; 7:30, Burr McIntosh the Cheerful Philosopher; 8:00, Xmas Carols, Plandome Singers; 9:00, Annual Forefathers Day Dinner of the New England Society of Orange, speeches, George Wickersham, pres. John Hibben of Princeton University; Joseph Freilinghausen, Hon. James V. Barry; Commander Bainbridge; Governor Selzer of N. J.

WLW, Cincinnati, Ohio (Central, 309), 4:00 p. m., Lecture Recital by Mildred Templeton Williams of the Cincinnati Conservatory of Music.

KFAE, Pullman, Wash. (Pacific, 330), "Automobile

Saturday, December 22

CKAC, Montreal, Can. (Eastern, 430), 7:00 p. m., Kiddies' stories in French and English; 7:30, Concert, Bagdad Cafe artists, Lino Monte, Jeanne Colliere, Elsie Thevenard, Jimmy Garrett's orchestra.

KDKA, Pittsburgh, Pa. (Eastern, 326), 6:15 p. m., Westinghouse Band; 4:45, The Worker in Sandal Wood—The Children's period; 8:30, Westinghouse Band.

KFI, Los Angeles, Calif. (Pacific, 469), 6:45-7:30 p. m., Vocal concert and bedtime story; 8:00-9:00, Instrumental concert; 10:00-11:00, Vocal and instrumental concert.

KGW, Portland, Ore. (Pacific, 492), 3:30 p. m., Children's program; Christmas story by Aunt Nell; 10:00, Dance music, George Olson's Metropolitan Orchestra.

KHJ, Los Angeles, Calif. (Pacific, 395), 12:30-1:15 p. m., Immanuel Male Quartet; 2:30-3:30, Matinee musicals, Immanuel Male Quartet; 6:45-7:30, "The Night Before Christmas," Children's program; 10:00-10:00, Immanuel Male Quartet; 10:00-12:00, Art Hickman's Orchestra.

KPO, San Francisco, Calif. (Pacific, 423), 8:00 p. m.-12:00 midnight, Art Waldner and his orchestra.

KSD, St. Louis, Mo. (Central, 546), 7:15 p. m., Orchestra concert, organ recital, vocal and instrumental specialties, Missouri Theater.

KYW, Chicago, Ill. (Central, 536), 6:50 p. m., Children's bedtime story; 8:00-8:20, Twenty Minutes of Good Reading, Rev. C. J. Perrin; 8:35-9:30, Louise Messerie, soprano; Charles H. Burch, baritone; Jessie Royce Landis, dramatic coach; Sallie Menkes, accompanist; Mrs. Harriet Miller, organist.

PWK, Havana, Cuba (Eastern, 400), Sr. Paula, blind violinist; Srta. Aurelia Inurmond, soprano; Sr. Fausto Alvarez, tenor; Prof. Sr. Carlos Fernandez, pianist.

WBAP, Fort Worth, Texas (Central, 476), 7:00-7:30 p. m., "The Universal Reign of Christ," Mrs. W. F. Barnum.

WBZ, Springfield, Mass. (Eastern, 337), 7:00 p. m., Hotel Kimball Trio; Jan Geerts, violinist; Angela G. Lonergan, cellist; Paul Lawrence, pianist; 7:30, Twilight tales for the Kiddies; 8:00, Stanley Fletcher, pianist; Mme. Van Mitzlaff, contralto; 9:00, Bedtime story for Grown-ups, Orison S. Marden.

WDAP, Chicago, Ill. (Central, 360), 10:00 p. m., Harmony Girls, Rob Brown and his Ukulele; Jerry Sullivan, Charlie Wellman, Margaret Shelley, Carlton Macklin, Fern Day, Laura Glen, Jack Chapman's Orchestra.

WDFR, Philadelphia, Pa. (Eastern, 395), 12:00 m., Organ recital, Stanley Theater; concert, Arcadia Cafe Concert Orchestra; 2:00 p. m., Piano recital, Edna Finestone; 7:30, Bedtime stories, Dream Daddy.

WEAF, New York, N. Y. (Eastern, 492), 4:00-5:00 p. m., Carolinians Orchestra; 5:00-5:30, Christmas Program for Children; 7:00-7:30, Laura Zelman, violinist; 7:30-8:00, Walter Hassler, pianist; 8:00-8:30, Sara Sharkey, dramatic mezzo-contralto; 8:30-9:00, Harold J. Brey, lyric tenor; 9:00-9:15, Title Guarantee & Trust Co.; 9:15-9:30, Columbia Graphophone Co.; 9:30-10:00, Rose A. Corelio, lyric soprano; 10:00-11:00, Lucky Strike Dance Orchestra; 11:00-12:00, Vincent Lopez Dance Orchestra.

WFAA, Dallas, Texas (Central, 476), 12:30-1:00 p. m., "Why Labor Must Organize," W. M. Reilly; 9:30-10:30, Music of the orchestra, Don Albert conducting; Emil Velasco, organist.

WGR, Buffalo, N. Y. (Eastern, 319), 12:30-1:00 p. m., George Albert Bouchard, organist; 4:00, Tea time music, Martha Gomph, harpist; Elise de Grood, violinist; 6:30, Vincent Lopez Hotel Statler Dance Orchestra.

WGY, Schenectady, N. Y. (Eastern, 380), 9:30 p. m., Jack Symonds' Orchestra.

WHAS, Louisville, Ky. (Central, 400), 4:00-5:00 p. m., Strand Theater Orchestra; Walnut Theater Orchestra; 7:30-9:00, Concert, auspices of Mrs. Fred Zahn; Carl Zahn, cellist; Fred Zahn, violinist; Reading: An Interesting Historical Episode.

Friday, December 21

KDKA, E. Pittsburgh, Pa. (Eastern, 326), 6:15 p. m., Lucile Hale, organist; 7:15, Radio Boy Scout Meeting, Richard Victor; 7:45, Santa Claus's visit to the Children; 8:15, "The Universal Reign of Christ," Dr. R. L. Lanning; 8:30, Fred E. Weber, baritone; George C. Muth, violinist.

KFAE, Pullman, Wash. (Pacific, 330), "Automobile

NEUTRODYNE

(Continued from page 9)

Much discussion has taken place covering the so-called superdyne circuit. This circuit illustrates quite clearly the idea of

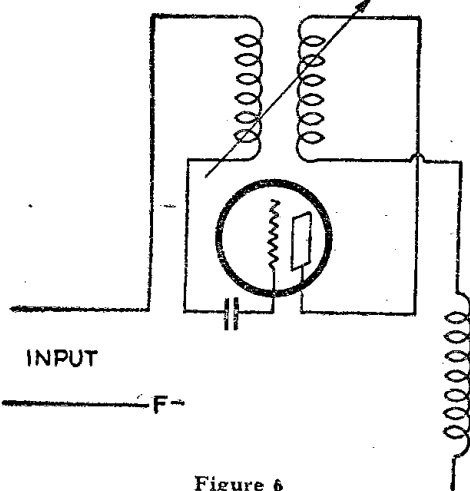

Figure 6

using an inductive reaction for neutralization. Inasmuch as the main difficulty is the leakage from grid to plate of the tube, we have the reverse inductance coupling in the grid and plate circuits, which is adjustable to exactly balance the leakage in the tube. This method has been used in various forms and manners before, especially in European circuits, but has not been given as much prominence in the past as it will no doubt receive in the future. (Figure 6.)

Balancing Operation

The instruction given with the Five-Tube Neutrodyne Receiving Circuit in the September 15 issue is here repeated for the convenience of those fans who have not as yet mastered the problem of balancing their circuits.

Light first four tubes and plug receivers in on first audio jack. Tune in for reception, but avoid any nearby local station where the volume is very great.

The reception should be clearly heard but not so loudly as to make it uncomfortable to the ears. Remove the second tube from the socket and insert a piece of paper under one of the filament contacts, then replace the tube in the socket. Although the rheostat is turned on, the filament naturally will not light. Don't turn off the rheostat; the real balancing should neutralize all capacity effects, even the filament battery leads; hence the method used.

With this tube inoperative, reception will still be heard faintly in the receiver due to the capacity coupling that exists and which is to be neutralized. If the dials are slightly readjusted, the volume can usually be increased a trifle. This step is now ready for balancing.

The adjustment is made on the second neutrodon. The screws are tuned in and out until the reception is entirely eliminated or reduced to minimum volume. If the volume of the reception is too great, it will be very difficult to judge this point. The dial adjustment should then be gone over to see if readjustment does not bring back the reception. If so, the balancing

operation will have to be repeated. After the adjustment is complete on this neutrodon the screws should be locked by means of the locknuts.

Take out the tube, remove the paper, then replace the tube and again retune the set. The procedure is then repeated with the first tube and the first neutrodon.

Simple Double Feedback Produces Good Results

F. H. Wetherald, an amateur, has devised what he call a double feedback circuit, and having very good results with it, feels that other amateurs might like to experiment with it. In reality the circuit is probably a modified super-regenerative one, which the inventor claims will operate satisfactorily with a ground, but better without one.

Referring to the diagram, the 300-ohm direct feedback resistance is made from an ordinary potentiometer of the same resistance. Without this device the tone of reception is inclined to be harsh and vibrant.

The rotor of the variocoupler is 3 inches in diameter, with 32 turns of number 22 wire.

The diameter of the stator is 3 1/2 inches, and it is wound with 100 turns of the same size wire with taps at the following points: 0, 10, 10, 10, 40, 10, 10, 10.

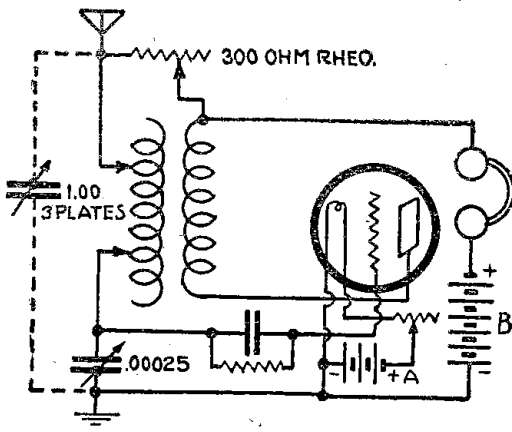

The 40 turns are at the center of the cylinder and are divided by the rotor shaft.

Two inductance switches are provided for, with four switch points to each. For the higher wave lengths additional windings are added symmetrically on each side

of the rotor and starter, so as to maintain the center of induction constant on all wave lengths.

There are thirteen plates to the variable condenser shown, with a vernier attachment for sharp tuning. Only a small part of the condenser is usually required for best results, as a maximum of turns is desired for given wave length. A variable grid leak from .5 to 5 megohms is necessary and at times permits separating two stations which are supposed to be on the same wave length. The grid condenser is the usual .00025 type.

A WD-11 tube works very well with this circuit. In tuning, the tickler is set for close coupling for weak signals and opened slightly for stronger ones. Set the 300-ohm feedback resistance about half-way to tune in a station. Carefully adjust the vernier on the variable tuning condenser to bring in the carrier wave of the broadcast stations. Should speech or music prove to be somewhat vibrant, this can usually be clarified by further adjustment of the vernier tuning condenser, filament rheostat, feedback resistance and tickler.

Multiple Headset Connector

In order that many members of the family may listen in with headsets, connect a closed circuit jack in series with the regular jack in the lead that goes to the plate of the last tube, or the lead



SPECIAL (IMPROVED MODEL) Direct From Manufacturer to Consumer LOUD SPEAKER

Genuine Wood Fiber Horn (With Unit and Cord) Entirely eliminates that annoying metallic sound. Positively the only WOOD FIBER HORN on the market today. 10-inch Bell with Standard Attachment; Complete. Height 24 inches. Colors, Black, Mahogany and Olive Green.

Price \$8.00

(For a limited time only.)

Delivered to any part of the United States and Canada

EMIL DECLYNE

15 Park Row, Room 2525, NEW YORK CITY Send M. O. or C. O. D. Dept. R. D., Barclay 6298

to the positive terminal of the B battery. I have two headsets tied on one plug and one to another. In this way, either one, two or three headsets can be used. For clearness and long distance, headsets surpass any loud speaker, especially if power amplification is necessary for the loud speaker, cost being considered.—J. B. Owen, Blair, Okla.

RADIO PANELS

Cut exactly to size and a guaranteed 12 hour shipment. 1/4" thick .0150 per square inch, 3/16" thick .0150. Made of the highest grade black fibre. This material possesses electrical strength of 200 volts per mil, is inexpensive, unbreakable, easy to work and takes a fine finish. We pay postage.

RADIO INSTRUMENT AND PANEL CO. 564 West Monroe Street Chicago, Illinois

The New METALECTRIC SOLDERING IRON

Operates on any electric current with the simplicity, ease and efficiency of a writing instrument.

An indestructible all-metal quality product with a worthwhile guarantee.

Accepted as the logical solution to radio soldering problems.

\$5.50

"worth it"



Ample Heat—Interchangeable Tips—Handle always cool

of your dealer or write

POST ELECTRIC CO., Mfrs. Dept. 509, 30 E. 42nd St. NEW YORK

TUBES \$5.43
Genuine R. C. A. Radiotrons
UV199, UV201A, WD11, WD12
Guaranteed Firsts in Original Packages

- Brandes "Superior" Phones.....\$4.78
- Brandes "Table Talker"..... 8.12
- Bremner Tully Vernier Tuner..... 3.96
- 3-Amp. Tungar Type Battery Charger..... 9.58
- "Erla" Reflex or Audio Transformers..... 3.96
- All American Transformers (All ratios)..... 3.82
- "Facent" New Style Phones..... 3.12
- "Como" Push-Pull Transformers (Dr.)..... 9.87
- 0 to 50 Pocket Volt-Meter..... 1.12
- "Gold Seal" Homecharger.....14.79
- Acme Audio Transformers..... 3.97
- 23-Plt. Vernier Condenser, Knob and Dial..... 2.13
- 23-Plt. Variable Condenser..... 1.14

Include postage.—Send for complete list.

SIMPLEX RADIO SALES CO.

1806 Lafayette Ave. St. Louis, Mo.

IF YOU CAN'T BUY THEM AT YOUR DEALER'S SEND DIRECT TO US

"Red-Heads" are guaranteed radio phones. You run no risk when you buy them. Money back if, after 7 days' trial, you're not satisfied that they're the best receivers on the market at the price. Why not act right now and get a pair? It'll mean getting the maximum from broadcasting from the day you put them into use.



RED-HEAD RADIO RECEIVERS

These remarkable head-sets are made by The Newman-Stern Co., one of the pioneer radio manufacturing houses in America.

JUST OUT

The new 1924 Model F

\$6.50 PER PAIR Complete

This is the standard 3,000 ohm "Red-Head." The 1924 Model F has eleven improved features. Sensitive and fine-tuned; aluminum case; famous brown-red ear caps; military headband; high-grade cord.

The new 1924 "Red-Head" Jr.

\$5.00 PER PAIR Complete

The Junior Model has most of the quality features of the standard Model F here described. The resistance is 2,000 ohms per set instead of 3,000 ohms. A remarkable value.

"Red-Heads" sent prepaid on receipt of price if you are unable to get them at your dealer's.

THE NEWMAN-STERN COMPANY
Dept. RD Newman-Stern Bldg. Cleveland

RADIO FANS

Tune in on station **W E A F** (New York)

every Thursday at 8.50 P. M. and listen to a story or article selected from

HEARST'S INTERNATIONAL

This is one of the most popular weekly features "on the air"

FREE

Write for Free Copy of the Latest Radio Reprint. It contains a complete story from Hearst's International Magazine. Address Radio Editor, Hearst's International Magazine, 119 West 40th Street, New York City.

Radio Circuits

The most popular American Radio Circuits

50 Diagrams and Illustrations
Price Only 50¢ each

Send Only Money Orders. No Checks or Stamps. Coins at Your Own Risk.

Radio Digest Publications
125 West Madison St. Chicago

Sterling
Portable Rectifier
\$16.00
Better Than Ever!
A Battery Charger Without a Weakness
In line with recent developments in the radio battery field a number of improvements have been made in the design of this useful device. A five-ampere maximum charging rate has been adopted. The number of contacts has been reduced to one, affording greater simplicity and ease of adjustment without loss in efficiency.
The quietness of operation, the almost total absence of sparking and the consequent free action and durability of the contact points mark a big advance in rectifier design.
AS EASY TO USE AS AN ELECTRIC IRON
No Danger of Wrong Connections to Ruin Plates
THE STERLING MFG. CO.
2829 Prospect Ave. Cleveland, Ohio

TRIGGER OF NEW YORK RADIO
EVERYTHING SOLD ON MONEY-BACK GUARANTEE. WE HANDLE NO BOOTLEG MERCHANDISE.

COCKADAY COMPLETE PARTS GUARANTEED \$12.50 ASSEMBLED \$17.50 Add \$2.50 to each for Cabinet	ERLA REFLEX 3 TUBE BEST OF PARTS \$45.00 ASSEMBLED \$67.50	COCKADAY 3 TUBE Unassembled \$32.50 INCLUDE CABINET ASSEMBLED \$42.50 DISTANCE VOLUME SELECTIVITY	LOUD SPEAKER Bristol 20.00 Atlas 18.00 Magnavox .. 30.00 Mercury 6.00 Music Master 26.00
---	---	---	---

Indoor Aerial\$1.75
Hydrometer50
Voltmeter, 50 Volts..... 1.85
Freshman Variable Grid and Leak..... .70
Remler Moulded Variometer..... 4.00
Freed-Eisemann 180° Coupler..... 2.00
Baldwin's Original\$8.50
Jefferson Transformer 2.75
American Transformer..... 5.50
Acme Transformer..... 4.25
Wave Trap 7.00
D. C. Charger..... 5.75

We carry a complete line—from screws to sets.
You can purchase with an absolute guarantee. We carry no factory seconds or salvage merchandise. Goods shipped immediately. Please be sure to include postage on orders under \$10.00.

TRIGGER OF NEW YORK
160 EAST 59TH STREET, NEAR THIRD AVENUE, NEW YORK CITY

Simple Explanation of Radio for Everybody

Chapter VII, Part II—Antennas and Grounds

By M. W. Thompson

THE following article is the thirteenth of a series for Radio beginners, written by Marvin W. Thompson, well known in air-phone circles for his understandable style of approaching his subject, and his ability as a Radio engineer. Mr. Thompson is now an associate editor on the staff of Radio Digest. A preliminary outline of the chapters to follow is:

- Chapter VII—Antennas and Grounds.
- Chapter VIII—Regeneration.
- Chapter IX—Audio Frequency Amplification.
- Chapter X—Loud Speakers.

The T-Antenna

THE T-type aerial is best suited for use where one's station is located midway between two high points. Figure 49 shows an aerial of this kind.

wires strung, the pole and spreaders would be unsightly and considered undesirable by the landlord, but a single thin wire attracts no attention and is noticed by no one.

The V-Antenna

The V-aerial is really a variety of the inverted L, yet should be considered a different type. Figure 51 illustrates the use of this aerial on a roof. One thing should be noted here. The distance from the little stair house at the far end to the flagpole at the left is not the same as the distance from stair house to chimney. The two wires, however, should be the same length, so that wire AB is cut the same length as wire BC, and a long support wire connects the insulator A to the flagpole. Insulators are inserted in each about 2 feet from pole B and a short lead connected to each close to these insulators. The two leads are then connected

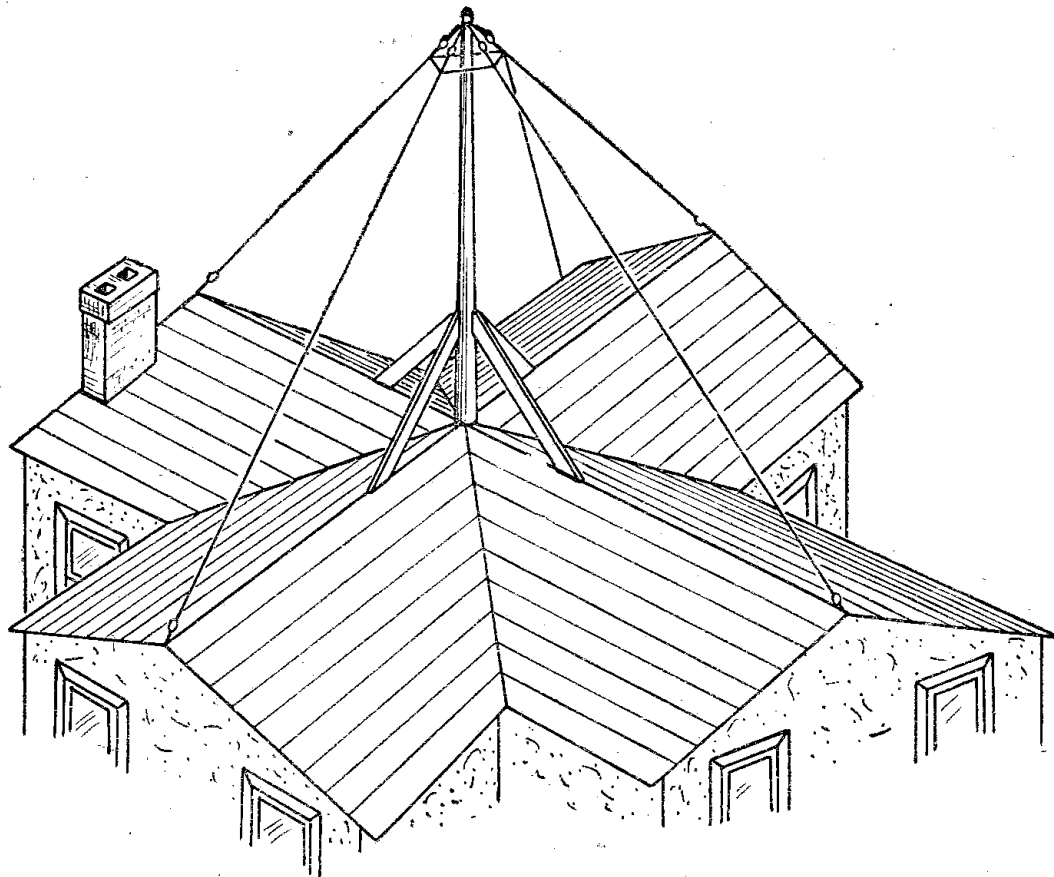

Figure 52—The umbrella aerial may be used where large horizontal area cannot be obtained

V-aerial has the advantage over the parallel-wire inverted L that each wire receives energy from a strong, unweakened part of the advancing wave, whereas in the latter type the wire reached first absorbs energy and the next wire does not receive as much unless they are 6 to 10 feet apart.

The Umbrella Aerial
The umbrella aerial is used when the horizontal area is very limited and there is no objection to a tall pole (see Figure 52). In this case the distance from one end of the house to the other is likely to be only 30 feet. By erecting a 30 to 10 feet apart.
(Continued on page 20)

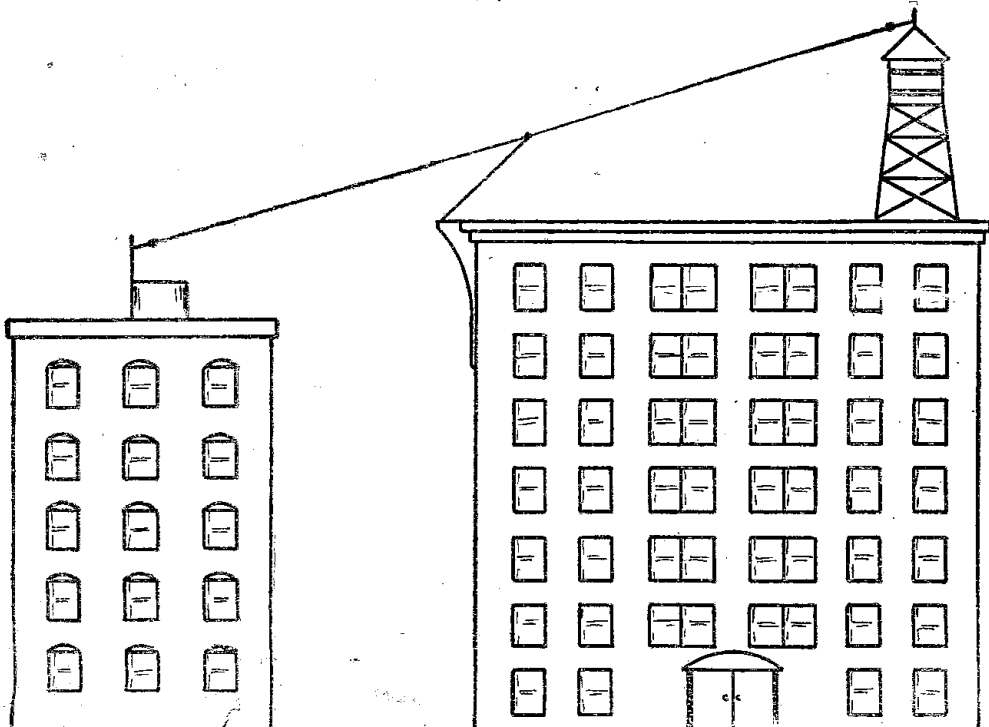

Figure 50—The single wire T, in this case, is less unsightly than a multi-wire inverted T would be. The natural period is equivalent to that of a four wire inverted L, one-half as long. Figure 50 illustrates a situation in which

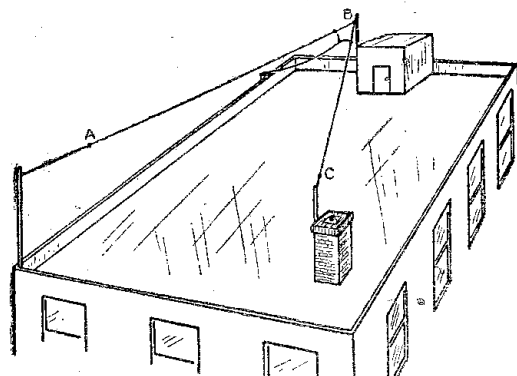

Figure 51—The arrangement of high points often makes a V-aerial possible

this aerial may be advantageously used. If a pole were to be erected at the left-hand edge of the taller building and two



(Patent Pending)
THE PERFECT SYNTHETIC CRYSTAL DETECTOR, SENSITIVE OVER ENTIRE SURFACE. No Hunting for "Spots." Loud and Clear. Endorsed by thousands of satisfied users. Sensitiveness Guaranteed. Price, Mounted..... **50c**
14 K. GOLD SUPERSENSITIVE RUSONITE CATWHISKER. Permanent. Will Not Oxidize. Price..... **25c**
RUSONITE REFLEX CRYSTAL. Manufactured Expressly for Reflex Circuits. Will Stand Up Under Heavy Plate Voltage. Guaranteed. Price, Mounted... **\$1.00**

Order from your dealer or direct from RUSONITE PRODUCTS CORP. 15 Park Row New York, N. Y.

B-METAL

LOUD TALKING CRYSTALS 50c

RADIO CRYSTAL

B-METAL TUBE DETECTORS

Have stood the test of time and are best by every test. **\$1.50**

At All Dealers and Jobbers
B-METAL REFINING CO.
 3134 Trumbull Ave., Detroit, Mich.
 Chicago Branch, 53 West Jackson Blvd.

REFLEX DETECTOR

Natural Re-PRODUCTION

Atlas AMPLITONE

LOUD SPEAKER

The radio sceptic, the repeatedly disappointed searcher after a real loud speaker, is I-N-S-T-A-N-T-L-Y convinced by the Atlas re-PRODUCTION. The patented "double diaphragm" responds to the full range of vibration cycles. Adjustable to your set and to receiving conditions. Ask your dealer for a Demonstration. **\$25**

Write for Booklet "R"
 What have you accomplished with your Atlas Amplitone? Tell us about it.

TRADE MARK

Multiple Electric Products Co. Inc.
 ORANGE ST. RADIO DIVISION NEWARK, N. J.

Clear as a Silver Bell

O-T SILVERTONE TUBES

(Registered)

In your radio set assure—sharp, clear, mellow tones—music with its delightful and thrilling modulations—speeches without distortion, audible down to a whisper—and all the other joys of Radio at their best

Three Models

O. T. 1A—2 to 4 volts, Battery Draw .15 amps. Price, \$6.00
 O. T. 9—2 to 4 volts, Battery Draw .06 amps. Price, \$6.50
 O. T. Power Tube—5 volts, Battery Draw .25 to .35 amps. Price, \$7.50

At your dealer or direct by mail. Write for complete literature.

Manufactured by DeForest Tel. & Tel. Co. Exclusively for the

O. & T. Electric Corporation
 1819 Broadway, New York
 High class representatives wanted.

The O-T is the only genuine Silvertone Tube. Fully guaranteed. Beware of imitations.

Radio Digest Illustrated

REG. U. S. PAT. OFF. AND DOM. OF CANADA

Published by the Radio Digest Publishing Company, Inc.
123 West Madison Street
Telephone: State 4843, 4844, 4845
Chicago, Illinois

E. C. RAYNER, Publisher

Chas. F. Smisor, Editor Evans E. Plummer, Managing Editor
H. J. Marx, Technical Editor M. W. Thompson, Associate Editor

Eastern Representative, Jacob Miller, Times Bldg., Times Square,
New York; Telephone Bryant 4909

Member of the Audit Bureau of Circulations



58
PUBLISHED WEEKLY

SUBSCRIPTION RATES

Yearly in U. S. and Possessions and Canada, \$5.00.
Foreign postage, \$1.00 additional. Single copies, 10 cents.

Vol. VII Chicago, Saturday, December 22, 1923 No. 11

Air Controlled Devices

Future Wars Will Be Prevented by the Use of Radio

RADIO-CONTROLLED mechanical devices, electrically operated, will exercise an influence difficult to foretell. Ten years and a new war will develop Radio and make its uses so far-reaching, in conjunction with chemicals and mechanics, that another world war will be impossible.

Christmas Spirit

A New Thing for Giving at the Forthcoming Holidays

A LOT of Radio receivers are going to be given for gifts this Christmas, as they stand at the top of the list of requests for Santa to fill, along with sleds, trains and dolls. However, the children are not the only ones that will receive them, for receiving sets have more interest for grown-ups.

This will create a demand for much advice. Scores are going to ask, "What kind shall I buy?" There are many standard sets now being sold that will give splendid service and can be recommended. The kind not to buy is the "\$2.98," etc., sold as the unknown mail order variety. Even the best sets sometimes are contrary, and if you have made a purchase of a reliable dealer you can get service in making it right.

Big values advertised seldom prove beneficial, you pay actual value for what you get, and you cannot expect to obtain the best quality for little money. It is easy to fool the uninitiated in Radio. It is best to buy a good single tube set, one that may be expanded as the purchaser desires when he knows more about the working of a set.

Women and Radio

Broadcasts Dispel Weariness and Entertains

WOMAN has the world by her elbow, thanks to Radio. No longer need the woman of leisure in the city wonder what to do with her spare time, nor kill time in the vain effort to dispel weariness. Radio, which has brought both entertainment and educational features to her drawing room, not alone for her but for her guests, is coming to be as fully appreciated by women as by the most ardent male Radiophan. One indication of this fact was seen in the surprisingly large number of women in attendance at the recent Radio shows, and in the alert and intelligent interest which they displayed in new circuits, equipment and recent improvements in the art.

But Radio is even more popular in the homes of women who reside on isolated farms and in small towns at a distance from the great urban centers of music, entertainment and general culture. To women thus situated, Radio is not merely a joy, it is rapidly becoming a necessity. Radio has a universal appeal to all classes of women. For every woman, housewife or lady of leisure, there is a program in the air somewhere which will appeal to her.

Furthermore, Radio lightens her burdens. For instance, instead of having to invent a story to tell the children at bedtime, she can turn to a station broadcasting a bedtime story, which, ten to one, is better than she could tell. Or instead of wondering what to cook for dinner, she can tune in on another station and obtain a menu—all by turning a knob. Each day, too, some of the largest stations broadcast information about fashions.

In fact, with the growth of women's interest in Radio it is rapidly assuming an indispensable place in every home. No longer is Radio a complicated maze of wires and controls, which confuse women and discourage their use of it. Circuits have been developed which require fewer operations and controls than ever before.

Then, too, many women are making their own sets nowadays. Women are taking Radio to their hearts, to their homes. This means that it has come into the American home to stay, and will be an increasingly important factor in promoting happiness, culture and good cheer in the humblest as well as the most pretentious home in the land.

RADIO INDI-GEST

Hello, England!

Hello, England, How-do-you-do?
Your old Yankee cousins have been thinking of you,
We've been wondering ever since the Radio came
If we both could converse and hear just the same
As we do in the States by this new fangled thing,
And whether you'd listen if we gave you a ring.
'Tis been along while since we've teased your John Bull
By giving the tail of his lion a pull,
Though once in a while when our jingoes all howl
We've heard the old lion give out a low growl.
We had a nice visit from the young Prince of Wales,
What he did here, no matter, we carry no tales,
And Lloyd George came to see us and minded his tongue,
But the old dog cut capers as though he were young;
Since the war we've been watching the trend of affairs
In your tight little isle with its trouble and cares,
Our papers are filled with the important news
That the Queen has a headache and the King has the blues.
Now, regarding the King, he's a jolly good sport,
And if you've got to have kings, why he's the right sort,
If ever his job as a monarch he'd shirk,
Send Georgie to us, we will put him to work!
Send your whole bally island to see us, by gum,
But bring us no more of your infernal rum,
Uncle Sam's on the wagon for good, you'll agree,
So please, please be careful upon the high sea;
Now England will say, "Are you there?" and "Hello,"
Don't be a-bit bashful, and please let us know
If our message came through, and how you all fare,
And accept our best wishes and regards on the air.

—CHARLES L. H. WAGNER.

We Stand Corrected. You Win

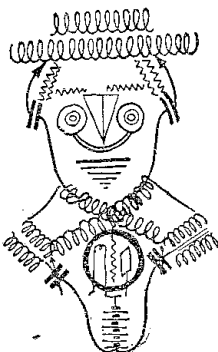

Dear Indi: I am enclosing a rough sketch of what I dreamed the Mystery Man of the Miloplex resembles, after laboring in vain till 3 A. M. to make a "Plexy" plex. As this was revealed to me while in the "arms of Morpheus" my subconscious surely must be correct. Your picture of the King doesn't agree with my psychic revelation. Did I dream right or wrong? ARKAHLO.

Vision of the Radio Man

(Part I, Part II will appear next week.)

Once there lived by the shore of the limitless sea
An ancient Radio man.
The far-flung song of his faithful spark
Was known to all his clan.
He worked by night and he slept by day
His phones upon his ears;
And had no other thought beside
Though he was gray with years.

On a night in Fall there came a call
That sounded out of space,
An S. O. S. distant, faint but clear,
That drew the blood from his face.
But the morning papers bore no news
Of disaster to any craft.
When he made so bold his tale to unfold
Friends shook their heads and laughed.

He labored early, he labored late
On a new transmitting set.
And every night as steady as fate
The far-away call he'd get
Till there came a day when the last coil set,
And the last dial put in place
He tuned her up to bridge the void
And with the elements race.

Again the call—an S. O. S.,
And from his fingers true,
Back rang his answer into space:
"S. O. S., who are you?"
Thrice he hurled his answer back
And the third time it was heard
For whispering back came the distant call
With its message word by word.

J. A. BYERS.

(To Be Concluded.)

A Martyr to Science

Here lies the body of "Old Man" Flack,
Who cured his ills without pill or quack;
He used his Radio—he was a Phan;
Mourned by his wife and daughter Nan.

H. K. C.

Apropos: It will be our privilege to give to the scientific world in the Indi-Gest column next week, a full account of the experiment by "Old Man" Flack in the new field of Radiotherapy, curing disease by high frequency Radio current.

Practice Watcha Broadcast—Quit @-ing Us

Deer Endy: A thing is funny wunce—& no more! In ref. to the endy-jest kinks dept. the notice appeared furst and wuz laffed @. When it came out the second time nine persinul friends uv mine laffed theyselves sick and three died uv ex-austium. Up tu date they haz been twenty seven persuns which haz passed away @ a youthful age acct. uv laffing two hard @ the dam thing. For gawdsaik take it out an forget it.

eZra hecht.

eZra: You forgot to include the usual challenge going something like this: "I dare you to print this, etc."

INDI.

To Contribs, Readers and Other Sufferers

At this jovial season of the year, Indi-Gest expresses his appreciation of all the fine things his followers have done for him, and in turn, desires that everybody have a merry Christmas, even to the extent of tuning in China.

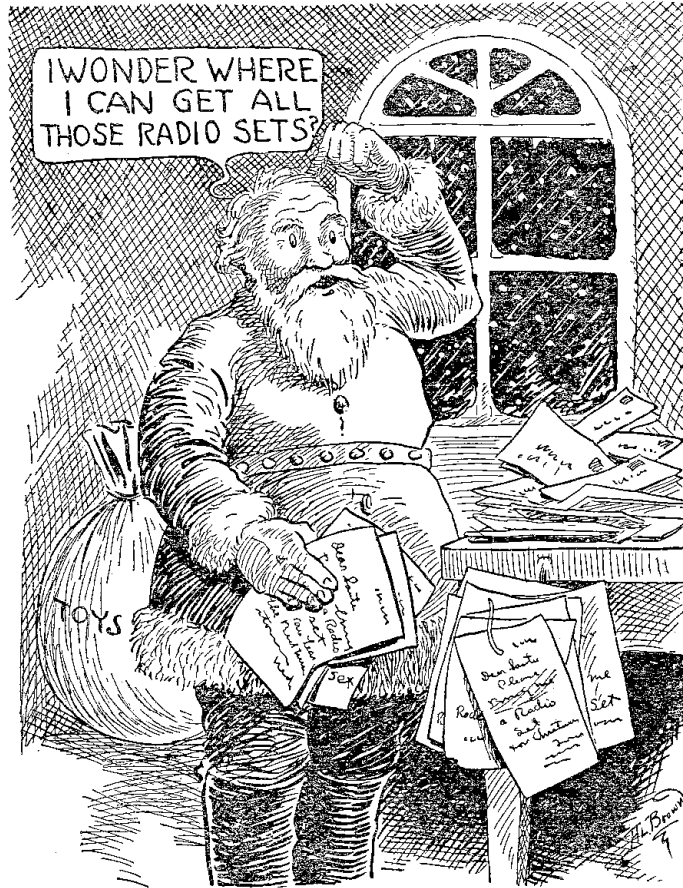

Condensed

By DIELECTRIC

To all fans desirous of hearing some excellent orchestra playing music of a high order I would commend the Fox theater programs, from Philadelphia, and broadcast through station WOO. Each Monday evening at 7:30 this splendidly trained organization comes on the air with selections to suit any taste. It is possible that others will come to see broadcasting from the same angle as Mr. Rapee, managing director, who believes in Radiophony as a box office feeder. On former occasions I have tried to impress upon the readers of this column the importance of acquainting broadcasting stations with their critical analysis of each feature. Let me do so again. Mr. Rapee assures me of his keen appreciation of your letters to him.

During the recent tests for trans-oceanic Radio reception it is doubtful if there was a single fan in this country whose set was not tuned to one of the several British stations at some time in the week. Even crystal set owners may have prayed for some miracle to happen whereby they would be able to catch the strains of music from across the sea, which to some of us was quite audible. Having heard two of the English stations on as many nights, I feel free to say that it is entirely unnecessary to tune England in order to hear some good musical numbers; it's fascinating, but we do nicely at home. The really significant thing is the vast field of educational potentialities opened up through our ability to reach one another by speech. It's a great age!

Like every other endeavor in which man is concerned, Radio has enthusiasts seeking to establish new records in speed of code transmission or distance covered. Usually we have not long to wait between the superseding by one record of another. In a recent case of Radio relaying the new long-distance speed record was made between Hartford, Conn., Avalon, Calif., and Etah, Greenland. Major Mott received the message for the McMillan party from Mr. Phelps and relayed the answer, consuming slightly more than five minutes in the entire transmission, which covered a total distance of about 12,000 miles. Another feather in the cap of Radio relaying. The Bowdoin is not without news, at least.

Radio as a means of linking up officers of the law in their search for criminals is rapidly finding its proper place among the various instrumentalities employed. More cities are coming to realize the great service rendered to law enforcement by establishing a system of Radio communication between headquarters and the officers on duty. One of the latest to make use of this modern device is New York City. There classes are formed to instruct the men in code and operation of Radiophony instruments, and as fast as the men qualify they are assigned to stations throughout the city until eventually a complete system of Radio communication will be established. Just here is where you listeners in could make yourselves more valuable citizens by learning the code and co-operating with the police in your own town.

You may not consider the life of a moving picture director a particularly hard one—maybe it isn't—deserving of sympathy and needing labor-saving devices. Whatever your attitude on the subject, they themselves consider any means of facilitating the work of running through a big picture something very much to be desired. Hence, Radio is resorted to as a substitute for a number of megaphones manned by as many subalterns scattered over the field of operations giving directions to the stars and lesser lights in an attempt to make a film that you and I would be willing to pay to see. Now, the directors speak to "Mike" and have him broadcast what instructions are needed. Very simple!

Latest Development in Grimes Inverse Duplex

Part V—Crystal Detectors and Extra Radio Amplification

By David Grimes

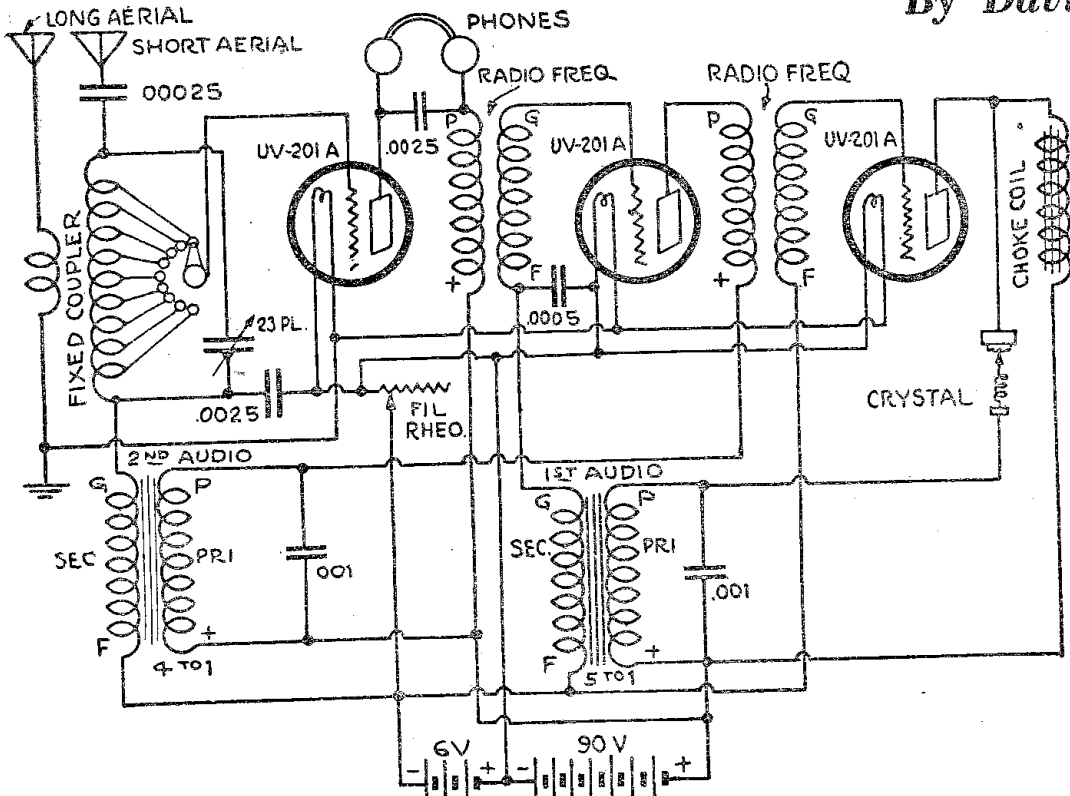

Figure 11—Grimes Inverse Duplex system, three Radio, crystal and two audio aerial operation

Third Stage of Radio Amplification
In order to simplify the problem, we will first discuss the addition of a third stage of Radio to the two tube Inverse Duplex crystal aerial set shown in Figure 8, Part IV.

Radio Reception under Difficulties

On December 1 I changed my hook-up to the Inverse Duplex shown on page 18 of Radio Digest of that date. I set all the parts on a large table and had no connections soldered, using three tubes and a variocoupler. Though there was a rain-storm causing much static trouble, I received programs from Detroit, Kansas City, Chicago, Louisville, Zion City, Ill., and Minneapolis very plainly. I used a Miller connection between my phone receiver and a large phonograph horn, and could hear music anywhere in the house. My experience may interest other fans. —Adrian J. Will, St. Cloud, Minn.

The natural question that arises when this problem presents itself is, where will the extra stage be added, before or after the duplex stages? Extensive experience has shown that it should be placed after the duplex stages and before the crystal detector. A little thought on the matter and several reasons will occur which confirm the practical work.

Location of Third Stage

One of the advantages of the Inverse Duplex System, as pointed out in an earlier article, was the reduction to a minimum of the possibility of overloading the duplexed tubes. Now, if the extra stage of Radio amplification is placed ahead of the duplex stages, the duplex tubes will be carrying the second and third degrees of Radio amplification. If (Continued on page 18)

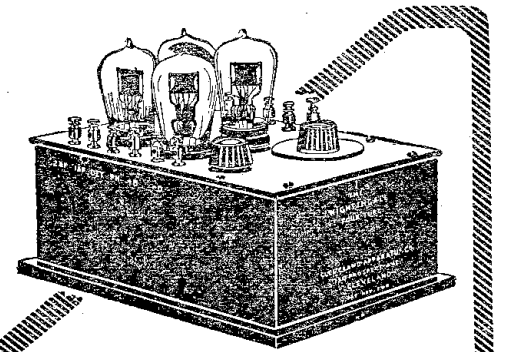

Radio Frequency Set for Only \$30

Send \$30 today and receive prepaid this fine non-regenerative Radio Frequency Set. Results guaranteed equal to sets costing three or four times as much. Four tube assembly—detector, 1 radio, 2 audio frequency. Only one simple adjustment for wide range of wave lengths. Perfect modulation. No howling or squeaking. Large, complete production in our own factory makes this wonderful value possible. Make draft or money order payable to CLEVELAND APPARATUS COMPANY, GRAFTON, OHIO.

The NIGHTINGALE

Super-Triplex Circuit Tuner to Radio Digest Specifications.....\$6.90

- Aerola Sr. Style Tuner Unit, 150-600 Meters
 - Push Pull Circuit Hi-Power Transformers
 - Neutralizing and Tuned R. F. Transformers
 - Reinartz Coils "New Static Reducing Winding"
 - Bureau Standards Style Resonance Wave Coils
 - Wavemeter and Wave Trap Combined, 150-600 Meter
 - Edison "Signal Corps" Batteries and Elements
 - New "Handy" Chargers, 2 to 24 Volt Batteries
 - 30 Henry Power Amplifier Chokes with 4 Values
 - Hi-Power Transformer with Variable Ratio
 - Nathaniel Baldwin New Loud Speakers and Phones
 - 200-300-400-600-800 Ohm Potentiometers
 - 6-10-30-50 Ohm and "Universal" Rheostats
 - Rheostat and Potentiometer Resistance Windings
 - Bishop "Phantom Super" Tuner Units
 - Quality Precision Var. Grid Leak, 0-10 Meg's
 - Outfits of Parts for Any Circuit You Desire
- SEND FOR NEW DEALERS' LIST
QUALITY RADIO SHOP, Richmond, Ind.

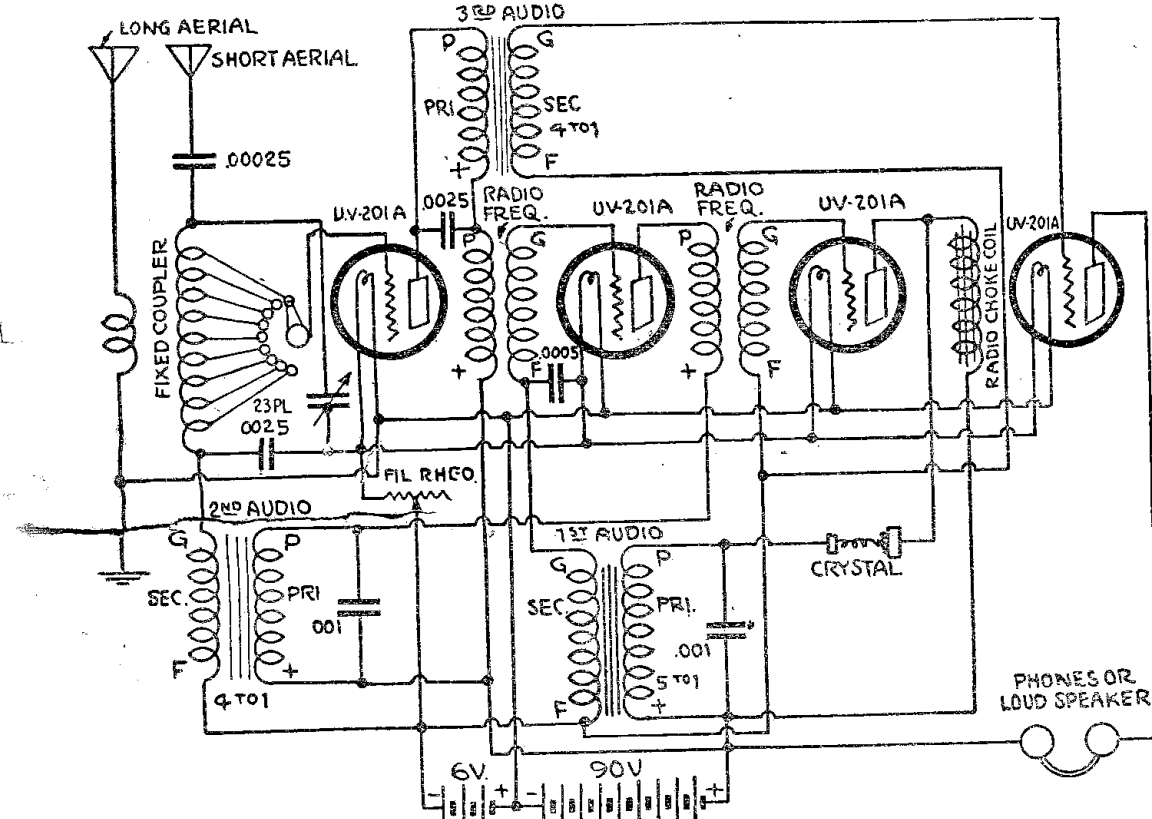

Figure 12—Grimes Inverse Duplex system, three Radio, three audio, crystal aerial operation

THE use of crystal detectors in connection with the Inverse Duplex was described in Part IV. The relative sensitivity of various types of tubes used as rectifiers was discussed and compared with crystals. It was suggested that, due to the decreased efficiency of crystal rectifiers, it would be necessary to add another stage of Radio frequency amplification or else operate the set entirely on an aerial. Even in some localities, on aerial operation, it would be advantageous to employ three stages of Radio frequency amplification when using a crystal detector. It is the purpose of this article to disclose information pertaining to this arrangement.

CAST COAST
E. MacDonald of Bangor, Me., received Wenatchee, Wash., on 1 tube Royal Portable Broadcast Receiver. One dial control. Takes all wave lengths. Complete parts, cabinet, instructions..... \$7.95
Royal Portable 1 tube set assembled..... 10.00
Phones, batteries, tube, aerial, etc., extra.... 9.75
Autoplex circuit complete Tube FREE..... 18.50
Cockaday-Reinartz—Ultra-Audion circuits, panel, complete parts—Tube Free with each 13.67
5 Tube ROYAL Neutrodyne (mounted)..... 49.47
ROYALTRON tubes, guaranteed. Standard base, 1 1/2 volt detector or amp. 6 V. amp. 3.95

Write for Catalog
ROYAL MANUFACTURING COMPANY
Dept. 50 World Building, New York City

Takes the Rattle Out of Radio

Morrison

"RENOWNED FOR SOUND"

The Loud Speaker you have been waiting for. Will fit any phonograph or horn. Sold on a money-back guarantee.

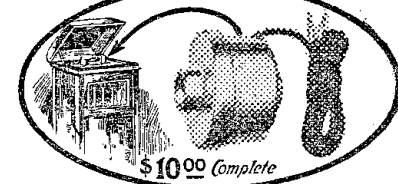

Loud Speaker \$10.00 Complete

The tone can be adjusted to suit any set or occasion.

LIST PRICE \$10.00

ASK YOUR DEALER FOR DEMONSTRATION,

Or upon receipt of \$10.00 we will send one prepaid

ON A ONE WEEK FREE TRIAL

MONEY-BACK GUARANTEE BASIS

Dealers Write for Sample and Special Discount Offer

PERFECTION RADIO CORPORATION

59 Cortland St., New York City

Six New York Retail Stores

Add Parcel Post

Do Not Send Stamps

208 page complete Radio catalogue free with orders of \$5.00 on request. Otherwise prepaid for 25 cents.



The FERBEND Wave Trap
STOPS INTERFERENCE

Unmounted Ready for Panel Mounting only \$6.00 Postpaid

Powerful amplification is of little value so long as local stations are "all over the dials." Here is the secret of the remarkable growth in popularity of the FERBEND WAVE TRAP. A St. Louis user (name on request) brought in Havana on his loud speaker while three St. Louis stations were broadcasting. You can make every night silent night too by using a Ferbend Wave Trap, the original wave filter. Order a Ferbend delivered at your home. Mounted on formica panel in mahogany finished cabinet 6x5x6, \$8.50; unmounted, ready for panel mounting, \$6.00.

SEND NO MONEY

You need not send a penny. Pay the postman on arrival while you test your Ferbend. Every Ferbend is guaranteed to tune out local stations or money back quick. You see, you take no risk, so mail your name and address today.

"The Original Wave Filter"

Ferbend Electric Company

Dept. 3 19 East South Water Street, Chicago



Mounted on formica panel in mahogany finished cabinet 6x5x6, \$8.50 postpaid.

WEIGHS ONLY 8 OZ

The Scientific

SEND NO MONEY!

20,000 TURNS EQUIVALENT TO 3,000 OHMS

Order TODAY by Postcard and Pay Postman on arrival

\$2.95

POST-PAID

LOUD SPEAKER UNIT \$1.95

We Guarantee The Scientific Headset to be the greatest value on the market. Try it for five days. If not satisfactory send it back and your money will be refunded immediately. Circular on request. Dealers wanted.

THE SCIENTIFIC ELECTRIC WORKS

98 Brookline Ave. DEPT. W. BOSTON, MASS.

Agents for New York and Vicinity—AMBASSADOR SALES CO., 74 Cortlandt St., Phone Cortlandt 6296

INVERSE DUPLEX

(Continued from page 17)

the extra Radio tube is placed after the duplex tubes, they will only be called upon to amplify the first and second stages of

Figure 8; so, except for the additional tube, the new circuit arrangement is quite inexpensive. Even with the cost of the tube, the results are well worth the money and, in fact, the additional equipment is necessary on loop reception. Ex-

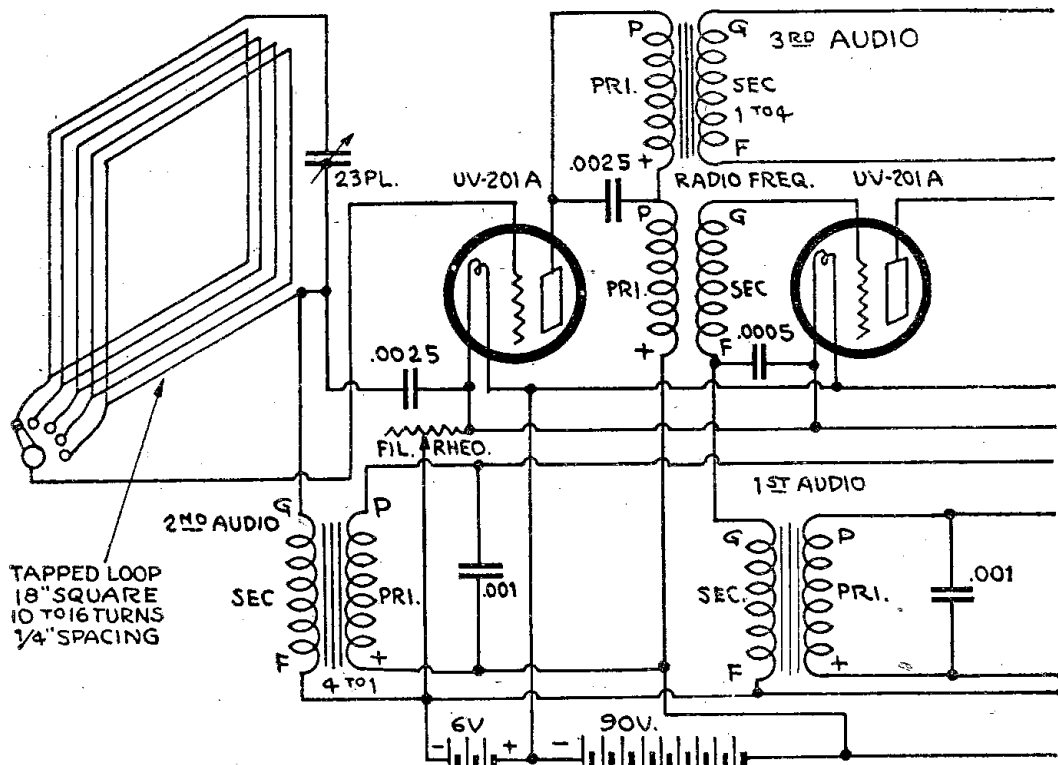

Figure 13—Grimes Inverse Duplex system, showing loop connections for Figure 12

Radio. This is obviously an easier task and will permit them to carry greater audio currents without being distorted from overloading. Another consideration enters into the problem. If a straight stage of pure Radio amplification is utilized without any precautions, it will tend to oscillate and interfere with proper operation of the set. Some means must be found to place a load or resistance on that free stage of Radio. If placed ahead of the duplex stages, the following tubes are not a sufficient load on the free stage of Radio to prevent oscillation. Something like placing a positive bias on the grid by means of a potentiometer would have to be employed and this would greatly broaden the tuning. In placing the free Radio tube in the other position, the crystal detector forms an excellent load or resistance on this amplifier tube, accomplishing the stabilizing effect without adding any detrimental factors.

Changes Made in Circuit

Referring to Figure 11, then, the reader will understand quite readily the changes which have been made in Figure 8 to accomplish the above outlined change. In order to add the third stage of Radio amplification, it is necessary to add another Radio transformer or Radio choke coil. Figure 11 shows the use of a choke coil as this method is as good as the transformer system and will be easier to make if the amateur so desires. The design and building of a satisfactory Radio transformer requires experience usually far beyond that possessed by the average experimenter. A Radio choke coil, on the other hand, is something even the beginner can build and use successfully. The choke coil shown may be made by winding about 100 turns of number 19 cc. wire on a 3-inch diameter insulated tube, such as fiber, cardboard, or the like. If one does not care to do this, it will be possible to use an ordinary Radio frequency transformer, as a choke with the primary and secondary windings in series. It will be necessary to make certain in this arrangement that the windings are not opposing one another. By merely reversing the connections on one of the windings and determining the proper connection for best results.

The other two Radio frequency transformers will be the same as employed in

treme care should be taken in selecting Radio transformers and the crystal detector. On these parts depend the success of the circuit. A chain is no stronger than its weakest link and it is unreasonable to expect satisfactory results from the Inverse Duplex system if you handicap it from the start by utilizing a poor Radio frequency circuit or a mediocre detector. Most of the audio transformers on the market are suitable, if they are of the proper ratio. The art of making audio transformers is more generally understood, but very few organizations at the present time understand anything about a Radio transformer.

Another Circuit

Figure 12 shows the addition of the extra stage of Radio frequency amplifica-

GENUINE EDISON ELEMENTS (new) for making "B" Batteries, obtained from U. S. Government. A positive and negative element—6c; glass tube—3c; all other parts at reasonable prices. Postage, etc., 50c extra per order. Free instructions. **TODD ELECTRIC COMPANY**, 109 West 23rd Street, New York.

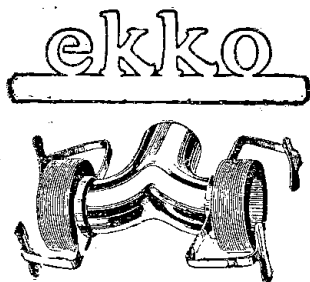

Listen to radio through your phonograph

Ekko adapter connects your head phones with the tone arm of your phonograph and turns the sound box into a loud speaker. The best loud speaker you can use—utilizes the scientific design of the phonograph sound box, producing a pure mellow tone. (Not adapted to crystal sets without amplification.)

For Double Head Phones . . . \$2.00 (Without Connectors)

For Single Head Phones . . . \$1.00 (Without Connectors)

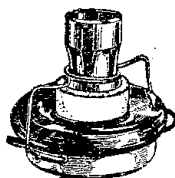

Ekko fits Victor, Silvertone, Sonora and other makes without connectors. Add 20c for connector for Pathé, Columbia, Vocalion; 25c for Edison; 30c for Brunswick. Or 75c for complete set.

Ekko Connectors at above prices also available separately to attach practically all loud speaker units to your phonograph.



For ground wire and battery terminal contacts. The Ekko Clamp bites through rust or corrosion and assures positive contact on all electrical connections. Also used to tap 2 and 4-volt current from a 6-volt battery.

Ekko Clamp 25c. Pair (for battery terminals) 50c Ekko Adapter and Ekko Clamp at your dealer's. Or order direct from us. Sent postpaid. Money back if not satisfied.

The Ekko Company
111 West Monroe Street Chicago, Ill.

tion to the circuit previously disclosed in Figure 9, Part 4. The free Radio stage is still placed between the duplex stages and the detector as in Figure 11, and for the same reasons. If you have understood the circuits in the preceding diagrams, this figure will not particularly annoy you. It is the most complicated so far, but with all that, it shows nothing which has not been described in the other sketches. Its intricacy lies mainly in combinations of easily understood arrangements. This circuit, when operating properly, should give greater distance reception than the other diagrams, greater ease of crystal adjustment, and somewhat greater volume of signal. The very fact that its receiving range has been increased will, however, increase the amount of static disturbance and telegraph interference. Any sensitive aerial set is subject to the same drawback. If audio howl is heard with three stages of audio, a change to a 4-to-1 transformer will usually remedy it.

Loop Operation

Loop operation has several distinct advantages over aerial operation. It is much more free from static effects and less interrupted by telegraph interference. And it also permits tuning stunts not possible on the aerial. If two stations are coming in to the receiver on nearly the same wave length, a whistling will occur which ruins both programs. This whistling phenomenon is called heterodyning. If two stations are thus close to the same wave length, it is impossible to tune one out and the other in on an aerial receiving set. It is often possible to do this on a loop by resorting to its directional effect. Very rarely are the two

Fifty assorted flathead solid brass machine screws, nuts, washers, copper lugs, 50c. Eight initialed binding posts, set, 60c. Twelve nickelled binding posts, 50c. All three items, \$1.50. **RADIO LIST** for stamp. All prepaid. Stamps accepted. **Kladag Radio Laboratories**, Kent, O.

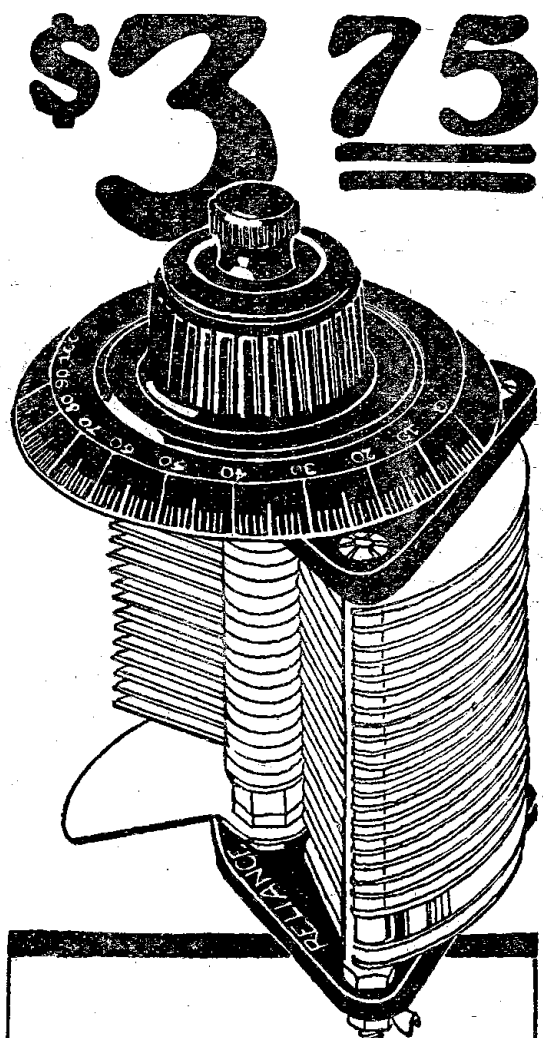

Reliance

23 Plate Bakelite Vernier Condenser

The RELIANCE 23 plate Bakelite Vernier Condenser is made and guaranteed by us to be mechanically and scientifically correct in every detail concerning construction and capacity.

The 23 plate RELIANCE comes complete with dial and knob—price \$3.75 F. O. B. Chicago. The 11 plate vernier is \$3.50 and the 43 plate \$4.00. Our products are sold exclusively thru jobbers and retailers but if your dealer can not supply you, write us direct.

We manufacture 20 other types of Vernier Condensers. Folder FREE on request

Manufactured and Guaranteed by
Reliance Die & Stamping Co.,
507 N. La Salle St.
Chicago, Ill.

annoying stations coming from the same direction, and the loop can be so placed that it will practically eliminate one of them and the program from the other can be enjoyed with some degree of pleasure.

Accordingly Figure 13 shows the connections necessary for adapting the last four tube crystal aerial set to loop work. The changes are self-explanatory. Upon trying this circuit out on the loop, don't be disappointed in the diminution of volume over that which you received on the aerial. Remember that a loop picks up only a very small fraction of the energy collected by an aerial. This energy is so small, in fact, that with most circuits it would be impossible to perform on a loop. But, you will have reduced your interfering noises much more than the signal you wish to receive, and this is the result for which you have been

(Continued on page 20)

TINY-TURN

A New and Superior Vernier Control

TINY TURN makes possible an exactness in tuning never before attained. It has a 30 to 1 gear ratio instead of only 4 or 5 to 1 as in the ordinary vernier. No lost motion! The vernier turns in the same direction as dial. It can be instantly disengaged, leaving dial free. TINY TURN provides a continuous vernier adjustment over

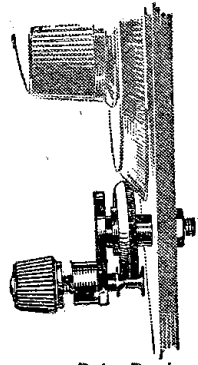

Pats. Pend. Side View showing friction drive against dial.

the entire range of the dial. When you desire, you can pass from one station to another by a continuous rotation of the vernier knob, without touching the dial at all. TINY TURN can be INSTALLED ON ANY SET IN 3 MINUTES. Handsome nickel and black finish. Packed in individual containers. We furnish counter display demonstrating boards.

PRICE 75 Cents

DUO-SPIRAL

The Leading Loop Aerial With New Dial and Handle

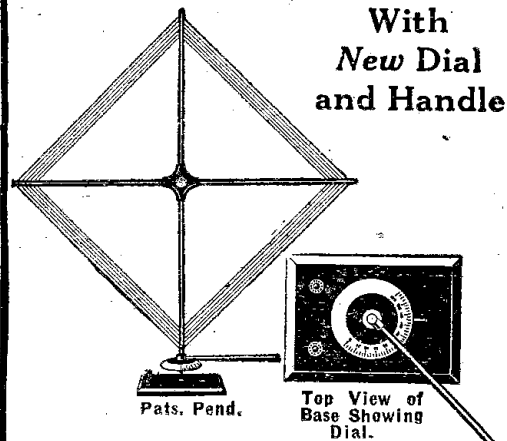

Pats. Pend. Top View of Base Showing Dial.

Careful tests of all available loop aerials by leading manufacturers and radio engineers has proved the superiority of the DUO-SPIRAL Loop. It is used exclusively by the largest manufacturers of radio frequency sets. It has many advantages over other forms of antenna for all radio frequency circuits, such as the Neutrodyne, the Reflex, the Super-Heterodyne, the transformer coupled circuits, etc. It is trim and neat in appearance and handsomely finished. It rotates freely on its base. Adjustment is made easy by handsome dial and a long handle which eliminates body capacity effects. The green double silk covered wire is kept always taut by hidden springs. The DUO-SPIRAL loop completely replaces roof antenna and ground and practically eliminates static.

24" Size \$8.50 - 12" Size \$7.50

(These prices include NEW Dial and Handle.)

The above products (folders on request) are sold through dealers and jobbers. If your dealer cannot supply you, write us direct.

RADIO UNITS INC
Suite 501 Webster Bldg., Chicago, Ill.

DEALERS
PROMPT SHIPMENTS
LIBERAL DISCOUNTS

COTO SPECIAL
Audio Frequency Transformer

\$2.50

COTO-COIL Distributors

Note!!
We are the largest exclusive Radio Jobbers in the Middle West

HUDSON-ROSS
123 W. Madison St. Chicago

Super-Triplex Selective Receiver Construction

Part III—Conclusion

By H. J. Marx

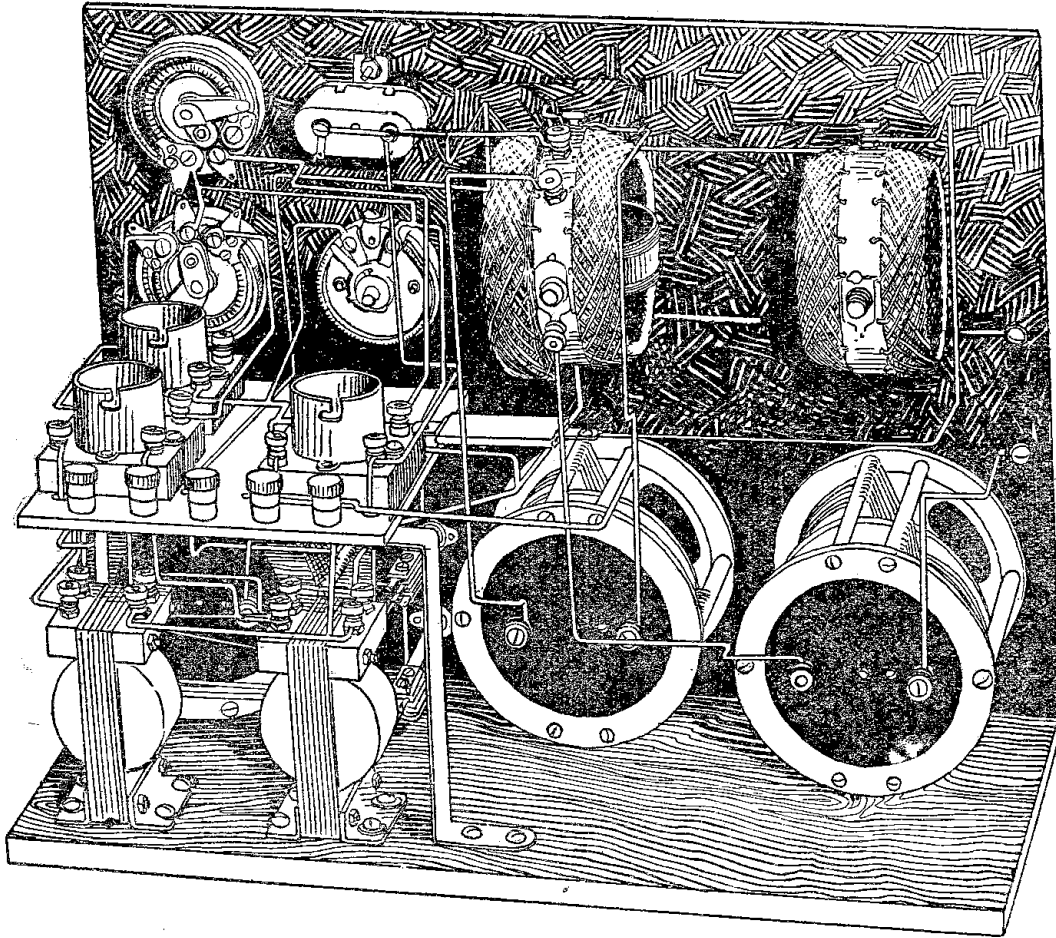

NO DOUBT a number of fans were at a loss to identify eight of the holes in the sub-panel. These were not added for mounting of apparatus but are used for the leads running from the upper to the lower side of the sub-panel. The rear view shows a number of these wires

shown in the rear view. The locations of the audio frequency transformers are also clearly shown in this view. The identification of the five binding posts is given in the plan view.

Wiring

The same precautions that have been

ever, does not mean that the set can be carelessly wired. Although the writer uses little or no spaghetti, it is recommended that the average fan cover wires wherever they run in close proximity. Careless handling may short the B battery leads to the filament of the tubes with disastrous results. Beware of long leads that have a tendency to sag against other wires below them. The writer has been consistently using 1/8-inch brass bus bar wire, which is quite stiff and not only has no tendency to sag but in itself helps stiffen up the general assembly of parts. In spite of repeated suggestions that close attention be paid to well soldered joints, sets are constantly brought in because of trouble, in which carelessly soldered joints can be pulled apart with no effort at all. Many a receiver has a peculiar throbbing reception owing to a poor connection somewhere in the circuit. A fair percentage of the difficulties encountered are wire troubles, and many of the remainder can be attributed to poor apparatus. Be careful to avoid splash soldering, especially when working around variable condensers. Hot solder when dropped on lattice windings burns through the insulation and often shorts out a considerable number of turns.

Battery Connections

The five binding posts for battery connections are the only terminals in the rear. When the set has been placed in a suitable cabinet, some means can be arranged that connections can be made directly to these binding posts through a small opening or a series of openings in the rear of the cabinet. The A battery voltage should suit the particular type of tubes to be used. Although a soft detector tube was used in the original set with two A tubes, yet three A tubes can be used as well. With the soft detector tube the detector plate voltage should be 22½. With an "A" tube in the detector stage it may be found necessary to increase this to approximately 45 volts, while 67½ volts on the plate of the amplifier tube is sufficient.

Tuning

Because of the number of controls the question of tuning may appear to be rather difficult. This, however, need by no means be the case. After all connections have been completed and the tubes inserted, adjust the rheostats. The potentiometer should be thrown over completely on the negative side. It is understood, of course, that, in wiring, the positive and negative terminals to the potentiometer were made to conform to the marking in front. The grid leak should be placed at about the halfway position. Set the coupling at halfway, that is, with the rotor at right angles to the fixed

windings. The antenna condenser is set at about three-fourths full capacity. The oscillating condenser at about one-fourth full capacity. The secondary condenser dial and antenna variometer dial should both be rotated in conjunction with one another. This rotation, especially of the secondary condenser, should be very slow, as the adjustment may be found some- (Continued on page 20)

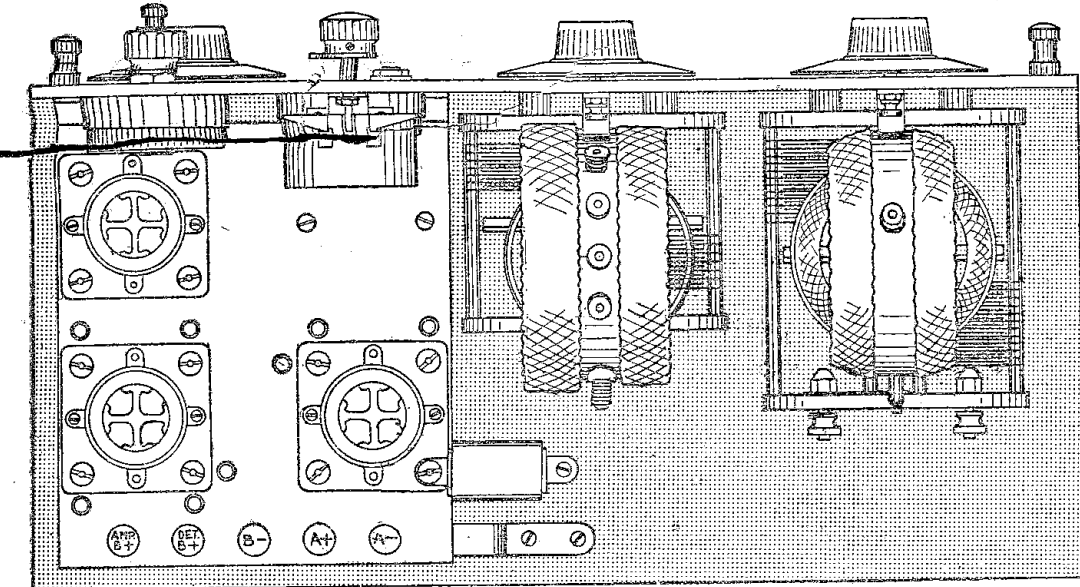

passing from top to bottom through these openings. Plan view shows the relative position of the apparatus as viewed from above. In reference to the arrangement of the tube sockets, the one shown on the left is the detector tube and the one alongside of it, on the right, is the first audio stage, and the one in front of that is the second audio tube.

In mounting the special three circuit coupler the 75 turn fixed coil should face to the right or sub-panel side. As previously explained the sub-panel is supported in front by means of the panel supports taken from two panel mount sockets. In the rear, a metal strip is bent up and fastened to the sub-panel and base as

emphasized before hold true in this set also. Naturally the leads should be kept as short and direct as possible. Inasmuch as there is no Radio frequency used, the constructor is not likely to run into interference difficulties. This, how-

YOU DON'T NEED TUBES

To hear concerts from distant cities. **YOUR CRYSTAL SET** will bring them in if you follow my instructions. You may already have all the parts you need and merely have it hooked up wrong. People using my plans hear programs clearly from stations **400 TO 1000 MILES AWAY**. No TUBES, Batteries or AMPLIFYING apparatus required. My COPYRIGHTED instructions selling for \$1.00 are written so anyone can understand. They show you exactly how to fix the set you have or make one like mine. Satisfaction Guaranteed or money refunded. Picture of my set and further particulars FREE. Write me today. **LEON LAMBERT** 561 So. Volusia St. Wichita, Kansas

Burned Out or Broken RADIO TUBES REPAIRED
All Tubes Guaranteed to Work Like New
Mail Orders Given Prompt Attention
24 HOUR SERVICE—All Tubes returned P.P. C.O.D.

RADIOTRONS	CUNNINGHAMS
WD-11 or 12.....\$3.50	C-11 or 12.....\$3.50
UV-209.....2.75	C-309.....2.75
UV-201.....3.00	C-301.....3.00
UV-202.....3.50	C-302.....3.50
UV-201A.....3.50	C-301A.....3.50
UV-199.....3.50	C-299.....3.50
DV-1 or 2.....3.50	DV-6 or 6A.....3.00

RADIO TUBE CORP.
76 Halsey St. Newark, N. J.
SEND TO NEAREST REPAIR BRANCHES
"RADIO TUBES" RADIO TUBE SPECIALISTS
39 West Adams St. Chicago, Ill. 137 Market St. Phila., Pa.
GLOBE ELECTRIC CO.
609 Chamber of Commerce Bldg., Pittsburgh, Pa.

KELLOGG VARIO-COUPLER



Very high inductance!

—low distributed capacity

Yes, boys! You are right! Our Vario-coupler is of the same staunch and true construction as the Kellogg Variometer. The Bakelite shells are of reinforced rib design. And, as with the Variometer, the air space between stator and rotor windings gives as high a maximum and minimum of inductance as is possible, with low distributed capacity—our special treatment of the Bakelite takes care of that.

Class is dismissed—wait!

It may or may not be of interest to you to know that we make a standard charge of \$9.00 for this piece of work but do not let that deter you. Results, boys, results! That is what we are looking for!

KELLOGG SWITCHBOARD & SUPPLY COMPANY

CHICAGO

Columbia Inside Coil Mounting
Newer, Neater, Better
Here is an inside coil mounting made for the radio owner who wishes to keep bulky coils out of sight. It is friction geared and fine "vernier" adjustments are possible. Nothing shows outside panel except knob and pointer. Only \$6.00 at all good dealers.
DEALERS—Responsible distributors all have Columbia Radio products. It pays to give your customers the best. No other radio products have this name—Insist on it.
Columbia Radio CORPORATION
155 N. UNION STREET, CHICAGO
It's Columbia—So It's Good!
GOOD JOBBERS HAVE IT

Build Your Own EASY

Full Details
Blue Prints
Reflex De Luxe
Miloplex
Neutrodyne

Price only **50¢** each

Send Only Money Orders. No Checks or Stamps. Come at Your Own Risk.

Radio Digest Publications
123 W. Madison St. Chicago

RADIO DIGEST PUBLICATIONS
123 W. Madison Street, Chicago, Illinois
Check Books Desired

REFLEX DeLUXE.....50c
 MILOPLEX.....50c
 NEUTRODYNE.....50c

I am enclosing M. O. for \$.....
Name.....
Address.....
City..... State.....

Review of Books

Radio First Aid. Illustrated with working drawings and complete data as to the necessary equipment and cost of constructing from the simplest to the most modern Radio outfits at home. Price, \$1.

The Armstrong Super-Regenerative Circuit. By George J. Eltz, Jr., E. E. This is a De Luxe edition of this famous circuit. Profusely illustrated and fully explained. Fifty-two pages. Price, \$1.

Vacuum Tube Receivers. By O. F. Heslar. A book that tells how to make a simple set. How to make the cabinet. It includes a 27 by 36-inch layout blueprint. Price, 75 cents.

Radio for the Amateur. By A. H. Packer and R. R. Haugh. The underlying principles of Radio thoroughly explained in simple language and understandable illustrations. This book will teach you how to construct and operate a receiving set successfully. Price, \$1.50.

Home Radio—How to Make It. By A. Hyatt Verrill. This book is particularly adapted for the amateur who desires to know how to make Radiophones. Twelve full page illustrations and diagrams. Price, 75 cents.

Elements of Radiotelegraphy. By Elery W. Stone. The text was written for the guidance and instruction of Radio students in the communication service of the Navy. It is an instruction book for Radio schools. Price, \$2.50.

How to Retail Radio. A new book telling of tested plans and methods and policies for the dealer in Radio. Financing, location, store equipment and arrangement. Price, \$2.00.

Radio Telephony. By Alfred N. Goldsmith, Ph. D. This book is intended for Radio engineers, operators and experimenters. Students and others who desire to be clearly informed concerning Radio need this book. It is written in a clear style, fully illustrated with wiring diagrams and photographs of Radio apparatus. Price, \$2.50.

The book department of the Radio Digest is prepared to send you any of the books on Radio published, whether listed in our Book Review or not. Let us know what book you want, send us your check and we will see that the book is mailed to you. Postage stamps in payment for books not accepted. Send money order or check. Radio Book Department, Radio Digest, 123 W. Madison St., Chicago, Ill.

INVERSE DUPLEX

(Continued from page 18)

striving. It is well worth the loss of volume, because, after all, it isn't very pleasant to have a station's program and call continually wiped out by booming static. Don't forget that a loop must be pointed toward the station which you wish to receive. Sometimes, if the A battery leads are rather long, one side of the loop pointed toward the station will receive better than when the other side is pointed toward that same station. A little experimenting will determine which side should be used for best results.

Tubes for Loop Reception

Some of the readers of this article will, no doubt, wish to use a soft detector tube on loop reception and have the benefit of three stages of audio for loud speaker results. This would be equivalent to adding an additional stage of audio amplification to the circuit shown in one of the early articles. This is entirely possible and is extremely satisfactory. It requires a storage battery to light the UV-200 tube and there are a few special precautions necessary to prevent howling when the audio is added in the last tube. The last and seventh article will go into details in regard to this arrangement. The next article, the sixth, will reveal, for the first time, all of the details for the successful use of tuned Radio with the Inverse Duplex.

Do YOU Understand

Wave Length Control
Reaction or Feedback Control
Filament Control?

BETTER TUNING

Better Tuning
B-7

Price 10c

Tells you why and shows you how. Sent on receipt of 10c or packed with each Bremer Tully Vernier Tuner.

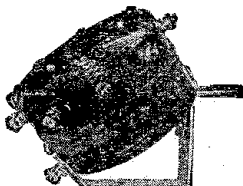

This instrument gives Greater Selectivity Longer Distance Clearer Signals than any yet devised.

BREMER TULLY MFG. CO.
532 South Canal Street CHICAGO

You probably have been thoroughly "sold" on the tuned Radio idea and don't mind the extra controls. You probably did not know that tuned Radio is the oldest form of Radio frequency amplification and that fixed transformer coupled Radio is considered an improvement in the art in that it produces satisfactory Radio amplification with fewer adjustments. Well, anyway, tuned Radio can be inverse-duplexed in first-class shape. The next article will tell how.

(TO BE CONTINUED.)

SUPER-TRIPLEX

(Continued from page 19)

what critical. Naturally, when the characteristic carrier wave whistle is heard, readjustments should be made for best reception on all controls.

The primary controls, variometer and condenser, will not be found very critical. The coupling control is a little more critical but by no means so bad as the secondary condenser. Its position is a

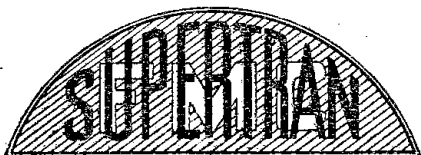

The Audio-Frequency Transformer that gives the highest possible amplification on all wave lengths without the slightest loss of tone quality and volume.

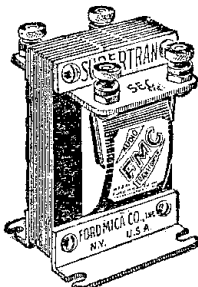

Can be used with any amplifying tube on the market today with excellent results.

Price \$6.00

At your dealers—or direct by mail on receipt of purchase price.

FORD MICA CO., INC.
14 Christopher St. NEW YORK

CARTER Jack Switch

\$1.00



knob operates springs.

The best radio switch yet devised—easily mounted on panel—a quarter turn of the heavy phosphor-bronze

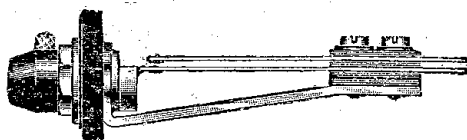

Furnished complete with "On and Off" name plate, knob and pointer.

Made in four spring combinations. Send for FREE wiring diagrams of various hook-ups; also complete catalog of other new improved Carter Radio Products.



Cold Winter Nights

Won't find you on the roof fixing the aerial—removing snow and sleet, exposing yourself to sickness, if you use

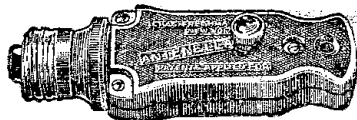

ANTENNELLA
(No aerial or antenna needed.)

A light socket plug that eliminates all outside wiring; lightning arresters and other inconveniences. Merely plug Antennella in any light socket and you can enjoy the best in radio in any room in the house.

NOW ONLY \$1.25

At your dealers—otherwise send purchase price and you will be supplied postpaid.

Chas. Freshman Co. Inc.
Radio Condenser Products
106 Seventh Ave., NEW YORK

factor of the strength of the incoming wave, that is to say, in order to eliminate interference from other stations, it is advisable to keep this adjustment as loose as possible, although with a weak signal, full strength of coupling is sometimes required.

This receiver does not feature an individual setting for a station. Readjustments of the controls for different positions will bring in a station sometimes better and sometimes worse than the original setting. The fan must find out for himself those adjustments which consistently give the best results. The usual tuning experience can best be gained by working with the strong local stations, gradually extending the field of operation until long distance work can be skillfully handled.

(THE END.)

An unusual demand for Radio receiving sets and parts throughout the Netherlands is expected to follow new broadcasting operations to be started soon.

ROOT for RADIO!!

Write for Our Bulletin

PHONES	PANELS (High Grade)
Baldwin-C \$8.25	7x10 \$.75
Brandes 5.25	7x18 1.35
Mercer 2.75	7x24 1.75

RADION DIALS, 3", 30c; 4" \$.40

TRANSFORMERS One Tube DX Set
All American \$4.00 SPECIAL FOR XMAS
Erla Reflex 4.25 ORDER
Acme, Audio 3.95 NOW \$15.00

BRANDES LOUD SPEAKER \$9.50

We carry a complete line of standard parts and sets.

ROOT RADIO CO., Inc.
Dept. D. 2525 Broadway, New York

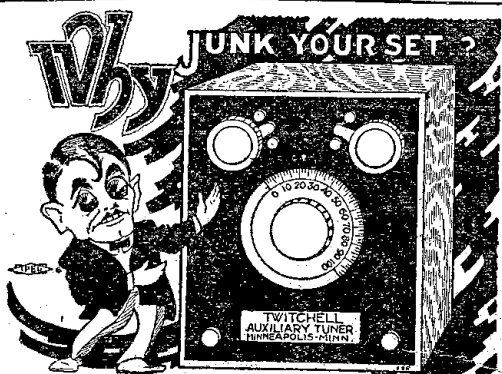

The new TWITCHELL AUXILIARY TUNER connected to your present set will enable you to bring in the long and short wave stations which your present set cannot get. It also cuts out all local stations so you may bring in distance any time without local interference. Copyrighted diagram of this tuner 50c, or with all parts \$9.00. Complete instrument in walnut cabinet, ready to use, \$15.00. Transportation prepaid.

MY HIGHLY IMPROVED REINARTZ brings in all important stations on this Continent loud, clear and without distortion. We dance to music from Atlanta and Los Angeles.

Build one of these wonderful 3 tube sets from my blueprint and specifications, price 50c, or with a complete and perfect double-wound spiderweb coil \$3.00 by mail. Picture of this set on a glass panel with every order. This copyrighted circuit is the most successful of any Reinartz modification yet produced, and is imitated the most. Thousands are in use.

My W. D. 41 Circuit is especially designed for use with the "Pickle" tube and brings out the full value of that little tube as no other circuit can. Stations 1000 miles away come in clearly on one tube. This set is small, complete, portable. For the man who wishes the highest efficiency, this is the set to build. Price of blueprint and specifications, 50c, or with complete and perfect windings, \$3.00. Photo of set with every order. Sets built from these copyrighted plans will receive all broadcasting stations operating under the new laws. Their wave length range is from 170 to 800 meters.

All goods prepaid. These instruments are easy to build, easy to operate. Everything clearly shown.

S. A. TWITCHELL
1925 Western Avenue Minneapolis, Minn.

IMITATIONS

Have Come and Gone

but the

FRESHMAN



Variable Resistance Leak

and Condenser combined, is considered the

STANDARD

throughout the world. It is the most efficient, most compact and the only leak that is entirely sealed and remains unaffected by climatic conditions.

Where the leak is not used as a tuning instrument we recommend the Base Type. In circuits where considerable adjustment is required, the Panel Type is preferable.

EITHER TYPE

Complete with either .00025 or .0005 Freshman Cond. \$1.00
Without Condenser75

At your dealers, otherwise send purchase price and you will be supplied postpaid.

Chas. Freshman Co. Inc.
Radio Condenser Products
106 Seventh Ave. NEW YORK

RADIO FOR EVERYBODY

(Continued from page 15)

40-foot pole in the center we can obtain sufficient distances from its top to the ends of the wings to erect very satisfactory aerial wires. The same idea can be applied to an apartment house roof when a watertank, chimney or other point of support projects upward from the center. As in the other types, insulators are inserted in each end of every wire. The individual wires are connected together at the upper ends and to a lead-in wire.

(TO BE CONTINUED.)

18 times more

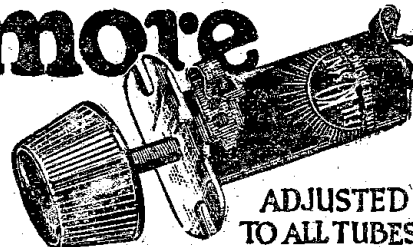

ADJUSTED TO ALL TUBES

FIL-KO-STAT has a fine adjustment area many times greater than any other rheostat. It is the only rheostat assuring minute control over the maximum audibility range of the vacuum tube; bringing in DX stations you never heard before and eliminating tube noises.

30 ohms full resistance. No adjustment to puzzle. No discs to break. No Carbon Powder.

\$2 AT ALL DEALERS

FIL-KO-STAT

Made and Guaranteed by
DX Instrument Co. Harrisburg, Pa.
Radio Stores Corp., 218 W. 34th St., New York
Sole International Distributors

FREE Your Choice

of one bound volume with each annual subscription

Limited Supply

Radio Digest
Illustrated
Volume 5

Greatest Collection of Radio Information Ever Published

Reinartz Long Distance Circuit
Ultra-Reinartz Circuit
Flewelling "Flivver" Circuit
Grimes "Inverse Duplex" Circuit
Single Tube Reflex Circuit
Armstrong "Super-Heterodyne" Circuit
Two, Three and Four Tube Reflex Circuits

A. B. C. Lessons for Radio Beginners

In addition to these features these volumes contain many instructive articles, receiving set diagrams, how to make articles, new apparatus, pictures and illustrations, hook-up diagrams, broadcasting stations, technical articles and book reviews.

65 Numbers

13 Numbers in the Bound Volume; 52 Numbers in Year's Subscription. Volumes 3, 4, 5 and 6 Now Ready.

Your choice of one Bound Volume is free and postpaid with your one year's subscription or renewal.

This offer good only in the U. S. and possessions. One dollar additional for Canadian or foreign countries.

Additional volumes are \$2.00 each, but are only available to annual subscribers. This on account of our limited supply.

Orders for these Bound Volumes must be mailed us direct with full remittance, as they can not be supplied on orders through subscription agencies or news dealers.

Remittance must be by check, money order or draft. (Stamps not accepted.)

COUPON

Radio Digest, 123 W. Madison, Chicago

CHECK OFFER DESIRED

1. One year's subscription and choice of one volume. Send Vol. Check or M. O. enclosed \$5.00

2. One year's subscription and choice of two volumes. Send Vols. Check or M. O. enclosed \$7.00

3. One year's subscription and additional Volumes—Nos.

Be sure to write plainly your name and address, giving city and state.

Inside Mounting for Honeycomb Coils

Coupling May Be Placed at Back Edge of Base

The illustration shows a mounting for honeycomb coils in the back of the cabinet with knob control on the panel. I am using this mounting on my Flewelling set. As only one coil moves on this set

WORKSHOP KINKS? EARN A DOLLAR—

THERE are many little kinks worked out at home that would aid your fellow Radio worker if only he knew about them. There are new hook-ups, new ways of making parts and various unique ways of operating sets that are discovered every day. Radio Digest is very much interested in obtaining such material. Send them in with full details, including stamped envelope, so rejected copy may be returned. The work must be entirely original, not copied.

RADIO KINKS DEPARTMENT,
Radio Digest,
123 W. Madison St., Chicago

it is mounted on a shaft which extends through the panel in front. Strips of brass are formed to fit over the shaft as bearings. These are attached to a wooden block which in turn is fastened to the base of the set.—Wm. Fernando, Cal.

Adjusting Phone Diaphragm

I purchased two phones recently of the same make. They were cheap phones and I did not expect very excellent results. However, one of them gave results that were surprising. The other, though of the same make, was not nearly so loud. By removing the diaphragm, I placed a card or straightedge across the ring and magnets and found the weak phone had the diaphragm placed about twice as far from the magnets as in the better set. By carefully filing the ring or shoulder on which the diaphragm rests, I made both phones of equal strength. This is a work

PANEL DIAL ROTATES THE SHAFT

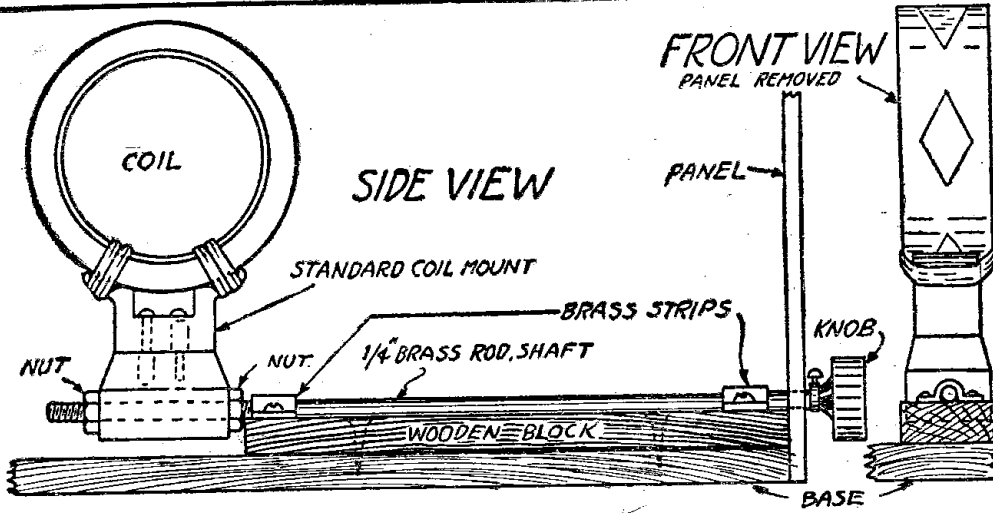

at which one must be very careful, however, as the diaphragm must not be bent and the shoulder on which it rests must be level.—J. B. Owen, Blair, Okla.

Eliminate Hazards in Radio

Do not permit wires to trail into thoroughfares or across high-power electric lines.

Support the antenna mast with guy wires to prevent its falling during a storm.

Lead-in and ground wires should be kept at least 5 inches away from the building. All joints should be soldered or made with approved types of clamps or splicing devices.

If fuses are used in circuits, they should be of approved types and not make-shift devices, such as copper wire or copper pennies. Small fuses should be placed on

a storage battery and connected in the storage battery leads to prevent short circuits. Keep fires and sparks away from storage batteries, especially after the batteries have been freshly charged, as the highly explosive hydrogen gas is expelled. Be careful no liquid is spilled out of the battery onto anything of value, as this fluid will ruin almost anything it touches.—Eric E. Leibner, St. Louis, Mo.

Lettering Panel with Draftsman's White Ink

To letter a bakelite panel, clean the surface with wood alcohol to remove any film of grease, and then print on the panel with a steel pen and draftsman's white ink.

When the writing is dry, cover it with a protective coat of transparent varnish, using a fine camel's-hair brush. If at any future time the lettering is to be removed, it may be done with a rag dampened in wood alcohol.—Eric E. Leibner, St. Louis, Mo.

Water Pipe Ground

I was having some trouble to get a good ground at a lake cottage which was not supplied with water pipes, and a rod driven into the ground gave very weak signals. I procured a piece of pipe, about 12 feet long, plugged the end to keep out the dirt, drilled a few holes above the plug and drove end into the ground. Using a funnel, water was poured in to make the soil wet at the bottom of the pipe. This made a good ground for the set.—Paul R. Boeringer, St. Paul, Minn.

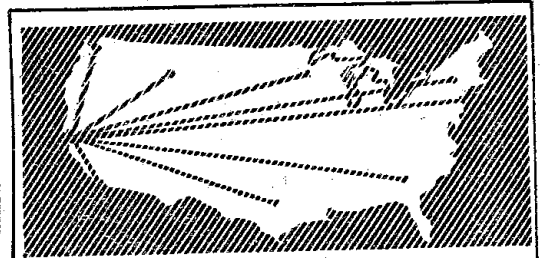

ON ONE TUBE

Broadcasting from Atlantic Coast, Mexico, Hawaii, Canada and Cuba heard in California by users of CROSS COUNTRY CIRCUIT. Range due to simplicity of set and only one tuning control. Easily and cheaply built by any novice. Dry cell tubes may be used. All instructions, blueprint panel layout, assembly photo, etc. Postpaid, 25c. Stamps accepted.

VESCO RADIO SHOP
OAKLAND, CALIF.

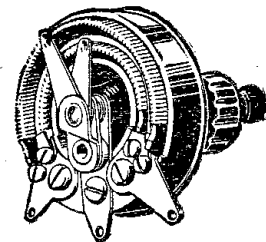

HERE IT IS!

Something New Different Better

PREMIER "DUOSTAT"

Trade Mark

Two Rheostats in One

For the first time you can have a high class rheostat that does the work of two ordinary rheostats for amplifier tube control. Windings independent of one another. Each operates one tube. Simplifies wiring. Base Bakelite moulder dial, silver etched, winding "NICHROME" wire. Made for all types of tubes. No. 12, two windings, each 7 ohms; No. 13, two windings, each 25 ohms; No. 14, two windings, each 40 ohms. Price, all types, \$3.00.

Greatly simplifies installation. Drill one hole, fasten to panel with nut supplied. And, Presto!—you have a finished job for any 2-stage amplifier.

You will surely want this wonderful "Duostat" for your next "hook-up." Ask your dealer. Send for our Free Bulletin No. 00.

Premier Electric Company
3310 Ravenswood Avenue CHICAGO

PRICE \$3.00

Complete with silver etched dial, knob, pointer, etc.

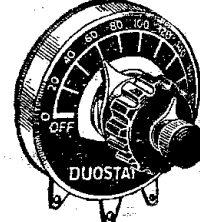

DUPONT PYRALIN SHELSTONE

Loud Speaker with Nath. Baldwin Head Set Type C Perfect Results

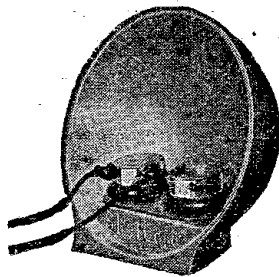

Shelstone is made of Dupont's Pyralin, is transparent and one of the most attractive Loud Speakers on the market.

It is built differently to take advantage of the most correct acoustic principles and reproduces music and speech with a clear tone.

Loud Speaker with phones .. \$15.00
Loud Speaker postpaid 3.00

Satisfaction guaranteed. C. O. D. or cash with order. Dealers write for discounts.

THE SHELSTONE COMPANY
185 Clinton Avenue NEWARK, N. J.

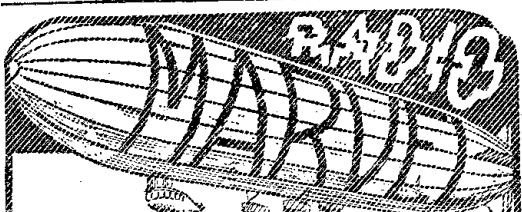

SPECIAL OFFERS

FADA NEUTRODYNE, All Parts for 5 Tube Set \$50.15

- B Batteries—Highest Quality
- \$ 1.75 22 1/2 V., small..... \$.70
- 3.00 22 1/2 V., large..... 1.20
- 4.75 45 V., medium..... 1.69
- 5.50 45 V., large..... 2.25
- 3.00 Soldering Iron, small tip, guaranteed..... 2.50
- 30.00 Music MASTER LOUD SPEAKER..... 24.50
- 18.50 Homecharger, "Gold Seal"..... 14.95
- 18.00 Westinghouse Reetigon Charger..... 14.63
- 7.00 Pioneer Moulded Bakelite Variometer..... 4.95
- 4.00 180 degree Variocoupler, 1200 meters..... 1.92
- 6.50 Pioneer Moulded Bakelite Variometer..... 4.85
- 5.00 Acme Audio Transformers..... 3.95
- 5.00 Acme Radio Transformers..... 3.95
- 12.50 Como Push Pull Transformers, per Pr..... 10.50
- 6.00 Brandes Superior Genuine Phones..... 2.50
- Nerco Phones, Guaranteed..... 2.50
- 13 plate Vernier Condensers, AMSCO..... 2.65
- 23 plate Vernier Condensers, AMSCO..... 3.50
- 43 plate Vernier Condensers, AMSCO..... 4.00
- 1.75 Potentiometer, 400 ohms, AMSCO..... .90
- 2.00 Potentiometer, with dial, 400 ohms, AMSCO..... 1.10

Remittances Must Include Postage. Send for free Monthly Price List. DEPARTMENT R. O.

MARVEL RADIO CO
132 NASSAU ST., NEW YORK

Perfect Connections

are always sure with

FAHNESTOCK PATENT WIRE TERMINAL

Grips Like a Vise Eliminates Vibrations
Easily Attached No Soldering
Best of All for RADIO OUTFITS

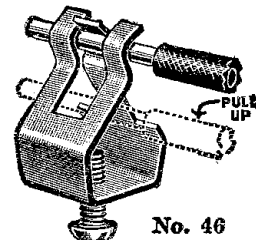

No. 46

Made in all Sizes and Shapes At Your Dealer's

Fahnestock Electric Co.
LONG ISLAND CITY, N. Y.

Dealers can obtain Fahnestock Products from following distributors:

- BOSTON—Wetmore-Savage Co.; F. D. Pitts Co.
- DETROIT—Detroit Electric Co.
- CHICAGO—Barawick Co.
- MILWAUKEE—Julius Andre & Sons Co.
- PHILADELPHIA—H. C. Roberts Elec. Sup. Co.
- PITTSBURGH—Ludwick, Hommel Co.
- WESTERN DISTRIBUTORS
Marshall & Co., Los Angeles, Cal.

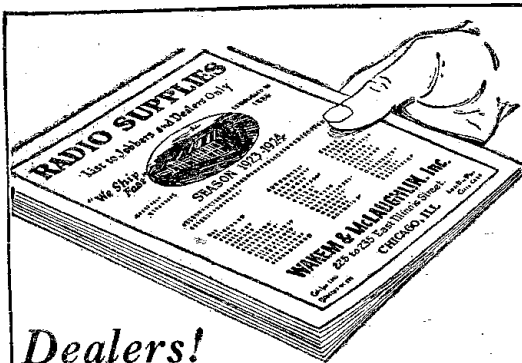

Dealers!

GET THIS BIG CATALOG

Write today for this big illustrated book. It's a storehouse of everything in radio—quality products of the foremost manufacturers—big stocks, liberal discounts, quick shipments.

Ask for Catalog A1001

WAKEM & McLAUGHLIN INC
223 E. ILLINOIS ST., CHICAGO

The Tube's the Thing!

Get Radio Reception Without Noise

MYERS RADIO VACUUM TUBES

Guarantee Perfect Clarity

Concerts, speeches, stories—hear them without noise or tube hiss with Myers Tubes. They give much greater amplification, are perfect detectors and oscillators. They add 50% to the efficiency of your set because they reduce interference.

Two Types: Myers Dry Battery Tube, 2 1/2 Volts, 1/4 Ampere. Myers Universal operates on either 3 Dry Cells or storage batteries. Ready for mounting. No sockets or extra equipment needed. \$5.00 each. See that you get the New Improved Myers Tubes. You will know them by the silver coating. Others are not guaranteed.

At your Dealer—otherwise send purchase price and you will be supplied postpaid

SOLE MANUFACTURERS

F. B. Myers Co. Ltd.
Radio Vacuum Tubes
240 Craig St. West, MONTREAL, CANADA

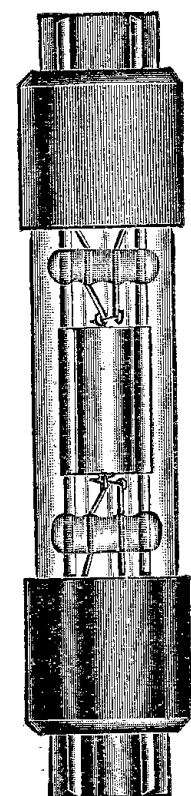

\$5.00 EACH

Questions and Answers

Transformer Trouble

(05880) AEM, Akron, Ohio.

In re my letter number 05496, your reply of October 16 stated that the action of the transformer described was without precedent in your records. I believe it

ULTRA AUDION QUESTION

Dear Sir:

In your very useful and highly appreciated publication I noticed in the Questions and Answers department a question answered, and I think that I am able to give you a little additional information on the matter discussed.

The question is number 5035, and appears in the issue of Oct. 13, 1923, which I have just received.

The set I used during reception was a home-made single tube ultra-audion receiver. I use a 90-degree variocoupler and a 23-plate condenser. The tube used at that time was a UV-200.

The ground was made by a connection to the conductor's train valve. I may state that there was absolutely no frictional electricity noticeable in this case.

The stations listened to, with the length of reception, were CJCA from 7:30 p. m. till 8 p. m.; 9CA from 8:00 p. m. till 8:30 p. m., and CJCA again from 8:30 p. m. till 10:00 p. m.

Both these stations are local ones and I should estimate that I was possibly eight miles from the station when they signed off and that I had traveled altogether about 20 miles during the 2½ hours I was listening in.

Yours very sincerely,

W. H. Croft, Edmonton, Canada.

then reassembled, using rubber cement to insulate the core laminations from each other, and is now working without a flaw, even better, I believe, than when it was purchased.

I am still using the Miloplex No. 1, and have made a few alterations in it which have proved of great benefit in keeping it quiet, and giving much finer tuning possibilities.

A.—We sincerely appreciate the interest evidenced in passing along your findings with reference to the source of difficulties explained in your previous inquiry. The condition uncovered was unusual and we are pleased to note that your troubles are removed.

Grimes Inverse

(05522) GCC, Chicago, Ill.

I am using the Grimes three tube Inverse Reflex hook-up with loop aerial. The Radio stages are transformer coupled, using a well-known make of transformer specially designed for reflex use.

Results with a loud speaker are very poor below 390 meters, and not much better above 480. Between these limits results are good, but I can get only one out-of-town station, even with the headphones. I am particularly anxious to get good reception on 536 meters.

A.—Noting limitations experienced in operation of Grimes circuit, we are advising that for consistent long range reception and flexibility of wave length it is our opinion that you will find it necessary to eliminate loop and substitute a variocoupler, employing an outdoor aerial. It must be admitted that as an antenna the merit of a loop is small except when em-

played in adequately amplified circuits. It is effective in your circuit on local reception and often at considerable distances; but not consistently perhaps.

Mr. Grimes' series of articles in Radio Digest will be of considerable assistance to you.

Reflex Circuits

(05961) OWP, Freeport, Pa.

Your advice in regard to Radio frequency transformers received and greatly appreciated, as well as your offer to help me.

I think I shall have to take advantage of that immediately.

Which has proved best, a three-tube Reflex with crystal detector with two A. F. and 3 R. F.; a three-tube Reflex with two A. F., two R. F., tube detector, or a three-tube standard honeycomb coil, two A. F. with good aerial and ground on each set,

all working 100 percent? Tuning coils are to be added to Reflex sets.

When local stations interfered last night I disconnected my ground and was astounded at the results. WSB, WDAP, WJAX and WGY came in fine. I was using single circuit honeycomb coil with one stage A. F. Is this considered exceptional?

A.—A three-tube Reflex circuit with crystal detector and two stages of audio and three of Radio frequency amplification is a highly efficient type of receiver, although varying conditions in operation of the several types of circuits in your inquiry make it difficult to make a conclusive statement as to consistently superior results in favor of either.

The reception record accomplished with disconnected antenna and ground is very good, although not exceptional.

RADIO BARGAINS

REAL VALUES and the best of Merchandise. OUR PRODUCTS ARE GUARANTEED. We enable you to keep the cost of the building and upkeep of your set at the lowest figures and offer you only the most scientific and reliable products.

SAVE ON RADIO

VARIOCOUPLER—180° Bakelite tubing, green silk wire	\$ 2.95
MOULDED VARIOMETER, green silk wire, special	3.45
VARIOCOUPLER—180° Jaco special	1.45
VARIOMETER—180° Jaco special	1.45
VERNIER CONDENSER, 23 plate	3.25
TRICOIL REFLEX TRANSFORMER (Specify tube used)	1.85
UNITED AUDIO FREQUENCY TRANSFORMER, 5 to 1 ratio	3.45
MAGNAVOX Loud Speaker	29.75
HEAD PHONES, Long Distance	4.95
22½ VOLT B BATTERY	1.45
PHONE PLUG, Special	.39
UV 199 SOCKETS	2.45
ELECTRIC SOLDERING IRON	.69
RHEOSTATS 6, 20 or 40 ohm special	.48
POTENTIOMETER, 2000 or 4000 ohm	.69

We offer this extraordinary opportunity to buy your radio supplies at unheard of prices. Take immediate advantage by ordering TODAY. Send money order, cash or check.

JACKSON RADIO COMPANY
Dept. 121D, 639 W. North Ave., Chicago, Ill.
For other bargains, write for our RADIO BULLETIN



Don't Waste Your Time

Looking for stations you already had. When you get a station simply copy the readings in a KASPER RADIO RECORD BOOK, then when you want it—IT'S THERE. This book can be used with any set and it is so arranged and printed that each day's broadcastings are kept separate; also contains full illustrations and instructions HOW TO RECORD STATIONS. 25 cents—or 6 for \$1.00, postage paid—don't send stamps.

Write Today
KASPER BROTHERS COMPANY
317 Lorain St. Bank Building
Cleveland, Ohio
Dealer or Agents Wanted Everywhere

For your information I am writing to tell you what I found the trouble to be, after taking down the transformer. The winding was carefully removed and then tested, but no trouble was located in that part. After separating the core into its laminations I found that each piece had become slightly magnetized. The laminations were heated red-hot and then cooled slowly, which made them very soft and pliable. The transformer was

Crosley "Harko Sr."

RECEIVING SETS

Non-regenerative type. Brand new, in original boxes. WERE SOLD FOR \$20

My Price
\$7.50

Prepaid While They Last
TWITCHELLS RADIO HOME
1925 Western Ave. Minneapolis, Minn.

FORMICA

A Laminated Phenolic Condensation Product
SHEETS TUBES RODS

RADIO PANELS

POLISHED BLACK FINISH

CUT PERFECTLY SQUARE TO ANY SIZE

1/32" THICK	1/2¢ PER SQ. INCH
1/16" THICK	3/4¢ PER SQ. INCH
3/32" THICK	1¢ PER SQ. INCH
1/8" THICK	1 1/2¢ PER SQ. INCH
3/16" THICK	2¢ PER SQ. INCH
1/4" THICK	2 1/2¢ PER SQ. INCH
3/8" THICK	4¢ PER SQ. INCH
1/2" THICK	5 1/2¢ PER SQ. INCH

SEND FOR COMPLETE PRICE LIST
PROMPT ATTENTION TO MAIL ORDERS
DEALERS PRICES ON APPLICATION

STARRETT MFG. CO.
519 SOUTH GREEN ST. CHICAGO

FADA

Instruments of Excellence

Langbein & Kaufman Variocouplers and Variometers
Malone-Lemmon Condensers and Control-o-Meters
Ballantine Tuned Radio Frequency Transformers and Units

Curcoids the supreme inductance by means of Precision Coupling Coils

Also in Stock
Amperites Meyers Hi-Mu Tubes

Literature sent on request



Rametra CORPORATION
23 Warren St.
New York City

514-Page RADIO Handbook Only \$1

Just off the press. The greatest book on Radio ever written. 514 pages. Compiled by Harry F. Dart, B.S.E.E., formerly with the Western Electric Co., and U. S. Army Instructor of Radio. Technically edited by F. H. Doane. Filled with sound, practical, tested information for every radio fan, from beginner to hard-boiled owl. Send \$1 to-day, and get this 514-page I. C. S. Radio Handbook before you spend another cent on parts. Money back if not satisfied.

Mail the Coupon To-day

INTERNATIONAL CORRESPONDENCE SCHOOLS
Box 8278D, Scranton, Penna.

I enclose One Dollar. Please send me—postpaid—the 514-page I. C. S. Radio Handbook. It is understood that if I am not entirely satisfied I may return this book within five days and you will refund my money.

Name.....
Address.....

MU-RAD DEALERS

are making money!

And they don't find it hard to do it either. Why? Because the Mu-Rad Receiver itself does practically all the selling. A careful check on the sales of one Chicago dealer, proved that Mu-Rads are sold in 8 out of 10 competitive demonstrations!

Write for Mu-Rad territory

Choice territory is still open to responsible, rated dealers. Kindly use your business stationery when writing for complete details.

Complete stock of parts
WESTERN ELECTRIC COMPANY
GENERAL RADIO COMPANY
Write for Details and Discounts

Chicago Radio Apparatus Co.
Jobbers of Good Radio Merchandise
General Offices: 407 South Dearborn Street
CHICAGO

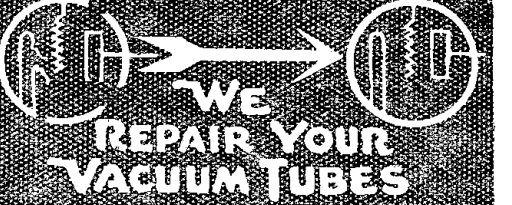

WE REPAIR YOUR VACUUM TUBES

WD-11-12, UV-199, UV-201-A	
C-301-A	\$3.50 each
UV-200, C-300	2.75 each
UV-201, C-301	3.09 each
DV-6, DV-6-A	3.50 each

All Work Fully Guaranteed
Quick Service—Repaired Tubes shipped C. O. D. unless accompanied by remittance plus postage.

NEW TUBES

A-399 (Type UV-199)	\$4.10 EACH
A-401-A (Type UV-201-A)	
A-12 (Type DW-12)	

All the above Tubes guaranteed amplifiers and detectors. Shipped C. O. D., postage prepaid.

To the Man Who Builds His Own: Write for Our Bulletin of Parts at Bargain Prices. Standard Merchandise Only.

ABALENE RADIO 416 Broadway
NEW YORK CITY



Worksman Radio Service
"THE ACCENT IS ON SERVICE"

14-16 Vesey St. NEW YORK

VARIOCOUPLERS

\$3.50 Workrite 180° Silk Wound	\$2.95
3.00 Mills 180° Silk Wound	1.95
3.50 Fisher, Large, 90°	2.25
2.75 Fisher, 180°	1.75

VARIOMETERS

\$3.50 Workrite	\$2.95
5.00 Pathé Moulded	2.25
3.50 Fisher, Large	2.65

CONDENSERS

\$2.00 R. C. 11 plate	\$1.05
2.35 R. C. 23 plate	1.35
2.75 R. C. 43 plate	1.65

VERNIER CONDENSERS

\$4.00 R. C. 23 pl.	\$2.25
5.00 R. C. 43 pl.	2.95

PHONES

\$18.00 DR. SEIBT IMPORTED "SUPER HEADSET" **\$5.90**

\$6.00 Brandes Superior	\$4.90
12.00 N. & K., Imported	5.50
5.00 Nerco	2.50
Ambassador	3.69
6.00 Potter Precision Headset	4.25
5.00 Diamond De Luxe Phones	3.50

Mail orders promptly attended to. All orders amounting to \$5.00 or more will be shipped prepaid. Will ship C. O. D. unless remittance accompanies order.

The above items are just a few of our numerous attractive priced articles, which are contained in our BULLETIN OF RADIO PARTS. Gladly sent to you upon request.

Positive Results

ARE ASSURED WITH

Eastern Coil Sets

for the COCKADAY CIRCUIT

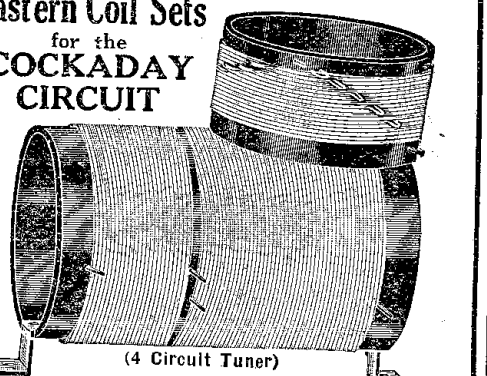

(4 Circuit Tuner)

Now a standard, and in universal use, due to their efficiency in this wonder circuit. Made as per specifications of Mr. Cockaday, using No. 18 wire with D coil bank-wound

Complete Assembled Set of B, C and D Coils **\$2.75**

Hook-up directions and material list furnished free with each set of coils.

Mail Orders Filled. Dealers Communicate
EASTERN RADIO MFG. CO.
22 Warren Street, Dept. R. D., NEW YORK, N. Y.

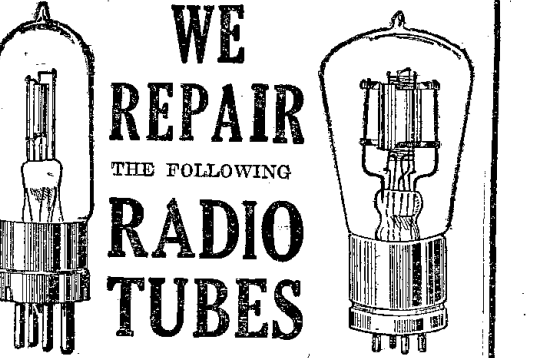

WE REPAIR THE FOLLOWING RADIO TUBES

Dealers and Agents write for Special Discount
Mail Orders Solicited and Promptly Attended to

WD-11	OUR SPECIALTIES	5 WATT TRANSMITTERS
WD-12		

UV-199	\$3.50	C-299	\$3.50
UV-200	2.75	C-300	2.75
UV-201	3.00	C-301	3.00
UV-201A	3.50	C-301A	3.50
WD-11	3.50	WD-12	3.50
DV-6	3.09	DV-6A	3.50
UV-202	4.09	C-302	4.00
UV-299	3.50		

H. & H. RADIO COMPANY
P. O. Box 22-A
Clinton Hill Station NEWARK, N. J.

Radiophone Broadcasting Stations

Corrected Every Week—Part III

CHALLENGE SUPPORTS LIST'S CORRECTNESS

ONE DOLLAR will be paid to every Radiophon reader of Radio Digest submitting the most errors in any one station's listing in the Directory of Radiophone Stations, which appears in four parts, serially continuously, on page 23. Letters must reach Radio Digest's office not later than one week from date of issue corrected. Readers are not limited to correcting one station. Turn in corrections for as many stations as you can find—if you can find errors! Use separate sheet of paper for each station submitted and place name and address on each sheet.

(Note.—The third part of the schedule list appears below. The fourth part consists of the remainder of the list and the complete state, city-station index and appear next week.)

WHD, Morgantown, W. Va. 360 meters. 250 watts. Va. University. Temporarily discontinued.
WHK, Cleveland, O. 283 meters. 100 watts. Warren R. Cox. Daily ex Sun, 12:30-1:30 pm, music; 6-6:30 pm, news, music. Fri, 9-11 pm. Dance program. Sun, 8-9:30 pm, concert; 9:30-10 pm, chapel service. Eastern.
WHN, New York, N. Y. 360 meters. 100 watts. Loew's State Broadcasting Station. Daily ex Sun, 9:30-11 am, 12-13:15, 3:45-5:30. Mon, Wed, Sat, 3:30-12 pm, Tues, Thurs, Fri, 9:30-12:00 pm, Sun, 3-6 pm, 9:30-12 pm, Eastern.
WHT, Rogers, Mich. 300-600-706 meters. Michigan Limestone & Chem. Co.
WIAB, Rockford, Ill. 252 meters. 50 watts. Joslyn Automobile Co. Mon, Fri, 8-9 pm, music. Central.
WIAC, Galveston, Tex. 360 meters. 100 watts. Galveston Sun Tribune. Daily ex Sun, 12:35 pm, reports. Tues, Sat, evening concert. Central.
WIAD, Philadelphia, Pa. 254 meters. 100 watts. Howard R. Miller.
WIAP, New Orleans, La. 234 meters. 10 watts. G. A. DeCortin. Tues, 8-9:30 pm, Sun, 10-11:30 am, Central.
WIAT, Newton, Ia. 258 meters. 10 watts. Continental Radio & Mfg. Co. Temporarily discontinued.
WIAT, Springfield, Mo. 252 meters. 20 watts. Heer Stores Co. Daily ex Sun, 10:30-11 am, reports, news, weather. Tues, 7:30-8:45 pm, Sat, 6:30-7:30 pm, music entertainment. Central.
WIAX, Neenah, Wis. 224 meters. 100 watts. Fox River Valley Radio Supply Co.
WIAC, Omaha, Neb. 275 meters. 200 watts. Daily Journal-Stockman. Daily ex Sun, 7:45 am, 9-10, 10:20-10 m, 1:30 pm, 3:50, markets, weather. Central.
WIAO, Milwaukee, Wis. 360 meters. 100 watts. School of Engineering of Milwaukee. Slogan, "In the Land of the Sky Blue Water." Mon, Tues, Thurs, Fri, 10-10:30 am, 11:30-12 m, music, news; 5-6 pm, music, news; 7-7:30 pm, speeches. Central.
WIAQ, Marion, Ind. 225 meters. 10 watts. Chronicle Pub. Co. Daily ex Sun, 4:30-5 pm, Tues, Thurs, Fri, 8-9 pm, Sun, 10-11:30 am, music. Home Slogan, "Burlington, On the Mississippi." Tues, Thurs, 8-9 pm, concert. Central.
WIAT, Tarkio, Mo. 360 meters. 15 watts. Leon T. Neel.
WIAU, Le Mars, Ia. 360 meters. 20 watts. Am. Trust & Savings Bank.
WIK, McKeesport, Pa. 234 meters. 500 watts. K & L Electric Co.
WIL, Washington, D. C. 360 meters. 10 watts. Continental Elec. Supply Co. Discontinued temporarily.
WIP, Philadelphia, Pa. 509 meters. 500 watts. Gimbel Bros. Slogan, "Watch His Progress." Daily ex Sun, 1-2 pm, 4:30, 6-6:45, music; 7-7:30 pm, bedtime stories. Tues, Thurs, 8-10 pm, concert. Tues, Sat, 10-10:12 pm, concert. Eastern.
WIAB, Lincoln, Neb. 275 meters. 500 watts. Am. Elec. Co. Mon, Thurs, 8-9 pm, music, special. Central.
WIAD, Waco, Tex. 360 meters. 150 watts. Jackson's Radio Engineering Lab. Daily ex Sun, 4-4:30 pm, news, music. Mon, Fri, 8-9, concert. Sun, 11-12 am, church service. Central.
WIAF, Muncie, Ind. 360 meters. 10 watts. Muncie Press and Smith Elec. Co. Daily ex Sun, 3:30-4 pm, news, music. Mon, Wed, Fri, 7-8 pm, Sat, 6-7 pm, music. Sun, 10-12 am, 2-3:30 pm, church services. Central.
WJAG, Norfolk, Nebr. 360 meters. 100 watts. Norfolk Daily News. Daily ex Sun, 12:15 pm, 5, 5:30, reports. Central.
WJAK, Greentown, Ind. 254 meters. 50 watts. Rev. Clifford L. White. Slogan, "The Radio Parson." Daily, 11:05 am, sacred music, sermonette. Thurs, 8 pm, music. Sat, 7 pm, music, Bible lesson. Central.
WJAM, Cedar Rapids, Ia. 268 meters. 20 watts. D. M. Perham. Slogan, "Central City of the World." Daily ex Sun, 10 am, 11:30, 1:30 pm, markets, reports. Tues, Wed, Fri, 7:15 pm, music. Sun, 2:45 pm, music. Central.
WJAN, Peoria, Ill. 280 meters. 100 watts. Peoria Star. Slogan, "The Grandview City of Illinois." Daily ex Sun, 9 am, 9:15, 11:30, 1:30 pm, markets, weather, diagrams. Tues, Thurs, 9:15-10:45 pm, concert. Sun, 11:30 am, 7:50 pm, church services. Central.
WJAO, Topeka, Kan. 360 meters. 50 watts. Capper Publications. Schedule not regular. Central.
WJAP, Providence, R. I. 360 meters. 500 watts. The Outlet Co. Slogan, "The Gateway of Southern New England." Daily ex Sun, 10-11 am. Housewives' talk, music. 1:05-2:15 pm, weather, reports, music; 7, weather. Tues, Wed, Fri, 7-8 pm, music. Wed, 10:30-12 midnight, dance. Fri, 8:15 pm, concert. Sun, 7:20-10:20 pm, concert. Eastern.
WJAS, Pittsburgh, Pa. 360 meters. 500 watts. Pittsburgh Radio Supply House. Daily ex Sun, 11:30-12 m, 2:30-3 pm, Mon, Wed, Fri, 7:45-9 pm, Eastern.
WJAT, Marshall, Mo. 360 meters. 20 watts. Kelley-Vawter Jewelry Co. Daily ex Sun, 5:15-5:45 pm, concert. Central.
WJAX, Cleveland, O. 360 meters. 500 watts. Union Trust Co. Slogan, "The Wave From Lake Erie." Daily ex Sat pm and Sun, 9-9:45 am, 10-10:45 am, 2-2:45 pm, 3-3:45 pm, music, financial reports, news. Tues, 7:30-9:30 pm; Thurs, 8-10:30 pm, entertainment. Eastern.
WJAZ, Chicago, Ill. 448 meters. 1,000 watts. Zenith-Edgewater Beach (Chicago Radio Lab.) Daily ex Sun and Mon, 10 pm-2 am, music, entertainment. Sun, 6-9 pm, concert. Central.
WJD, Granville, O. 229 meters. 50 watts. Denison Univ. Fri, Sat, 5-6 pm, music, educational lectures. Central.
WJH, Washington, D. C. 273 meters. 50 watts. Wm. P. Boyer Co. Daily ex Sun, 3, 4 pm, markets, reports, music. Tues, 7:45-10 pm, concert. Sun, 8 pm, church services. Eastern.
WJX, New York, N. Y. 360 meters. 500 watts. De Forest Radio Telephone & Telegraph Co.
WJY, New York City. 405 meters. 500 watts. R. C. A. Daily ex Sun, 4-6 pm, entertainment. Tues, Thurs, Fri, 7:30-11:30 pm, concert. Sun, 2:30-5 pm, 6-6:30 pm, Eastern.
WJZ, New York City. 455 meters. 500 watts. R. C. A. Daily ex Sun, 3-6 pm, entertainment; 7-11:30 pm, special program. Sun, 10:30 am-1 pm, church service. Eastern.
WJAA, Cedar Rapids, Ia. 268 meters. 100 watts. H. E. Paar. Daily ex Sun, 12:45 pm, reports; 5:30, reports, diagrams; 6-7, music. Thurs, 11-12 pm, music. Sun, 4-5 pm, church service. Central.
WKAD, East Providence, R. I. 240 meters. 10 watts. Charles Looff.
WKAF, Wichita Falls, Tex. 360 meters. 100 watts. W. S. Radio Supply Co.

WKAN, Montgomery, Ala. 226 meters. 20 watts. United Battery Service Co. Mon, Wed, Fri, 6:30-7 pm, music. Central.
WKAP, Cranston, R. I. 360 meters. 200 watts. Dutee Wilcox Flint.
WKAQ, San Juan, Porto Rico. 360 meters. 500 watts. Radio Corp. of Porto Rico. Slogan, "The Island of Enchantment, Where the World's Best Coffee Grows." Tues, Fri, 9-10:30 pm, Wed, 8-9, entertainment. Inter-colonial.
WKAR, East Lansing, Mich. 280 meters. 250 watts. Michigan Agri. College.
WKAV, Laconia, N. H. 254 meters. 50 watts. Laconia Radio Club.
WKAW, Beloit, Wis. 242 meters. 10 watts. Turner Cycle Co. Daily 12-12:15 pm, 7-7:30, concert. Central.
WKAY, Gainesville, Ga. 280 meters. 20 watts. Brenau College. No regular schedule. College activities. Thurs, 8:30 pm, concert. Eastern.
WKY, Oklahoma City, Okla. 360 meters. 100 watts. WKY Radio Shop. Daily 9 pm, weather. Mon, Wed, Fri, 9-10:30 pm, concert. Central.
WL2, Fairfield, O. 360 meters. U. S. Army.
WLAG, Minneapolis and St. Paul, Minn. 417 meters. 500 watts. Cutting & Wash. Radio Corp. Slogan, "The Twin City Station in the Land of Ten Thousand Lakes." Club, "Tooth Brush." Daily ex Sun, 9:30, 9:40, 10, 10:30, 10:45, 11:35 pm, 2, 2:30, 2:35, 4, 4:30, 5, 5:30, 6, 7:30, 9:15, reports, lectures, music; 5:30-6 pm, children's program; 9:30, music. Wed, Sat, 11-12:30 am, music. Sun, 10:30 am, 7:45 pm, church services; 3:30 music. Central.
WLAH, Syracuse, N. Y. 254 meters. 250 watts. Samuel Woodworth. No regular schedule.
WLAJ, Waco, Tex. 360 meters. 50 watts. Waco Elec. Supply Co. Daily ex Sun, 9:30 am, 10:30, 2:30 pm, music, reports. Tues, Thurs, 7:45-8:45 pm, music. Sun, 3 pm, church service. Central.
WLAK, Bellows Falls, Vt. 360 meters. 500 watts. Vermont Farm Machine Co.
WLAL, Tulsa, Okla. 360 meters. 100 watts. Naylor Elec. Co.
WLAN, Houlton, Me. 283 meters. 100 watts. Putnam Hdw. Co.
WLAP, Louisville, Ky. 360 meters. 15 watts. W. V. Jordan.
WLAQ, Kalamazoo, Mich. 283 meters. 10 watts. Arthur S. Schilling. No regular program. Central.
WLAV, Pensacola, Fla. 254 meters. 15 watts. Elec. Shop, Inc. Daily Mon, Tues, Fri, 8-9 pm, music, entertainment. Central.
WLAW, New York, N. Y. 360 meters. 500 watts. New York Police Dept.
WLAX, Greencastle, Ind. 231 meters. 10 watts. Greencastle Community Broadcasting Station. (Putnam Elec. Co.) Tues, 7:30 pm; Thurs, 7:30. Sun, 7:45 pm, church services. Central.
WLB, Minneapolis, Minn. 360 meters. U. of Minn. Dept. of Eng.
WLW, Cincinnati, O. 309 meters. 500 watts. Crosley Mfg. Co. Slogan, "WLW, In the Queen City of the West." Daily ex Sun, 10:30 am, 1:30 pm; daily ex Sat, Sun, 3, 4, reports. Mon, Wed, 8-10 pm, entertainment. Tues, Thurs, 10-12 pm, music. Sat, 2 pm, special. Sun, 9:30 am, S. S. services; 11, church services. Central.
WMAA, Canton, N. Y. 261 meters. 200 watts. C. B. Margdith. No definite schedule.
WMAF, Dartmouth, Mass. 360 meters. 500 watts. Round Hills Radio Corp. Slogan, "The Voice from 'Way Down East.'" Daily ex Sun, 5:30 pm, 7:30-10, Sun, 3:30-5:15 pm, 7:20-10, Eastern.
WMAH, Lincoln, Neb. 254 meters. 100 watts. General Supply Co. Slogan, "A Call from the Western Plains." Club, "Lions' Hot Oils." Daily, 2:15-3 pm, music; 8 pm, entertainment. Sun, 10 am, church services, 5:30-4:25, concert, 8, sermon. Central.
WMAJ, Kansas City, Mo. 275 meters. 250 watts. Kansas City Daily Drivers Telegram. Daily ex Sun, 8:15 am, 9:15, 10:15, 11:15, 12:15 pm, 1:15, 2:15, weather, markets, news.
WMAK, Lockport, N. Y. 360 meters. 50 watts. Norton Labs. Daily ex Sun, 11 am, weather, farm reports. Tues, 8-9 pm, music. Eastern.
WMAI, Trenton, N. J. 256 meters. 500 watts. Trenton Hdw. Co. Slogan, "The Home of Good Music." Mon, Thurs, 7:30-9 pm, music, lecture. Eastern.
WMAN, Columbus, O. 286 meters. 100 watts. First Baptist Church. Sun, 10:30-12 m, 7:30-9 pm, church services. Central.
WMAF, Easton, Pa. 246 meters. 250 watts. Utility Battery Service Co. Irregular schedule. Eastern.
WMAQ, Chicago, Ill. 448 meters. 500 watts. The Chicago Daily News. Daily ex Sun, Mon, 7-8 pm, 9:15-10. Daily ex Sat, Sun, 4:30-5 pm, Wed, 1-2 pm, Assn. of Commerce Luncheon. Sat, 1-5 pm, football. Central.
WMAW, Auburn, Ala. 250 meters. 250 watts. Ala. Polytechnic Institute. Daily ex Sun, 10 am, 12, weather, markets. Tues, Thurs, Sat, 7:30-8:30 pm, music.
WMAV, St. Louis, Mo. 280 meters. 100 watts. Kings-highway Presbyterian Church. Slogan, "May Every By-Way Hear King's Highway." Sun, 11 am, 8 pm, Fri, 7-8 pm, church services. Central.
WMAZ, Macon, Ga. 268 meters. 50 watts. Mercer University.
WMC, Memphis, Tenn. 500 meters. 500 watts. The Commercial Appeal. Slogan, "Station WMC, Memphis." "Down in Dixie." Club, "Midnight Frolic." Daily ex Sun, 9:30 am, 12 m, 3 pm, weather, markets. Mon, Tues, Thurs, Fri, 8:30 pm, program. Tues, Fri, 11 pm, Midnight Frolic. Sat, 8 pm, program. Central.
WMI, Washington, D. C. 261 meters. 100 watts. Doubleday-Hill Elec. Co. Daily, 4:30-5:30 pm, concert, sports. Thurs, 8-9, concert. Eastern.
WNAQ, Boston, Mass. 278 meters. 100 watts. Shepard Stores. Daily ex Sun, 4-5 pm, dance music. Mon, Wed, Fri, 6:30-7 pm, children's half hour. Tues, Thurs, Fri, 8:10 pm, Wed, Sat, 9-11 pm, Sun, 11-12 am, 3-4 pm, 6:45-8:30 pm, church services. Eastern.
WNAO, Norman, Okla. 360 meters. Univ. of Okla. Daily ex Sat, Sun, 10-10:30, news. Mon, Wed, Sun, 9-10 pm, program. Central.
WNAI, Omaha, Neb. 242 meters. 20 watts. R. J. Rockwell. Temporarily off air.
WNAJ, Syracuse, N. Y. 286 meters. Syracuse Radio Tel. Co. Mon, Wed, Sat, 7:30 pm, concert, agrigrams. Eastern.
WNAK, Springfield, O. 231 meters. Wittenberg College. No regular hour.
WNAQ, Charleston, S. C. 360 meters. 100 watts. Charleston Radio Elec. Co.
WNAH, Butler, Mo. 231 meters. 20 watts. C. C. Rhodes. Fri, 7:30 pm; Sun, 11 am, 7:30 pm, Central.
WNAS, Austin, Tex. Radio Corp. (Austin Statesman.)
WNAI, Philadelphia, Pa. 360 meters. 100 watts. Lenig Bros. Co. Irregular schedule. Eastern.
WNAV, Knoxville, Tenn. 238 meters. 500 watts. People's Tel & Telg Co. Mon, 7:30-8:30 pm, Tues, Thurs, Sat, 7:30-8:30, Wed, indefinite. Sat, 12:01-1:01, concert. Sun, 2:30-3:30 pm, Fri, silent. Central.
WNAW, Fortness Monroe, Va. 360 meters. 5 watts. Henry Kunzmann. Sun, 2-4 pm, 7-9, Eastern.
WNAZ, Yankton, S. D. 244 meters. 50 watts. Dakota Radio Apparatus Co. Daily, 11:30 am, reports; 4:30 pm, reports, music. Wed, Sat, 9-10 pm, music. Central.
WNI, Albany, N. Y. 360 meters. 55 watts. Shotton Radio Mfg. Co., Inc. Wed, 8:15 pm, concert. Eastern.
WQAA, Ardmore, Okla. 360 meters. 20 watts. Dr. Walter Hardy. Temporarily off the air.
WQAC, Lima, O. 266 meters. 50 watts. Matus Radio Co.
WQAD, Sigourney, Ia. 360 meters. 10 watts. Friday Battery & Elec. Corp.
WQAE, Fremont, Nebr. 360 meters. 20 watts. Medland College.
WQAF, Tyler, Tex. 360 meters. 10 watts. The Tyler Commercial College. Daily ex Sat & Sun, 12 m, weather, markets; 8 pm, weather, sports, codes; 10:15, U. S. Navy press. Sun, 11 am, 7:30 pm, church service. Central.
WQAG, Belvidere, Ill. 224 meters. 20 watts. Apollo Theater.
WQAH, Charleston, S. C. 360 meters. 100 watts. Palmetto Radio Corp. Mon, Thurs, Sat, Sun, 10 pm-11 am, music. Eastern.
WQAI, San Antonio, Tex. 385 meters. 500 watts. Southern Equip. Co. (Evening News-Express.) Daily

ex Sun, 10:30 am, 12:15 pm, 3, 6:15, news, markets. Tues, 9:30-10:30 pm, concert, Thurs, 7:30-8:30 pm, concert. Sun, 11 am, church services; 9:30-10:30 pm, concert. Central.
WQAJ, Parsons, Kans. 360 meters. 15 watts. C. E. Ervin. Slogan, "Queen City of the Plains." Temporarily discontinued.
WQAL, Webster Groves, Mo. 286 meters. 100 watts. W. E. Woods. Sun, 3-5 pm, Central.
WQAN, Lawrenceburg, Tenn. 360 meters. 150 watts. James D. Vaughan. Temporarily discontinued.
WQAO, Mishawaka, Ind. 360 meters. 50 watts. Lyradion Mfg. Co. Slogan, "The Biggest Little Town in Indiana." Daily ex Sun, 12:15-12:45 pm, music; 5:30-6:15, police reports, news. Tues, Thurs, 6:30-8 pm, program. Fri, 9:30-12:30 pm, "Rumhounds Hat Club." Sun, 10:45-12 m, church services. Central.
WQAP, Kalamazoo, Mich. 240 meters. 50 watts. Kalamazoo College. Mon, Wed, Fri, 6:30-7:00 pm, Central.
WQAR, Kenosha, Wis. 229 meters. H. P. Lundskov. Wed, 7 pm, Sun, 6 pm, Central.
WQAS, Wilmington, Del. 360 meters. 50 watts. Boyd Martell Hamps.
WQAV, Erie, Pa. 242 meters. 200 watts. Penna Nat'l Guard. Tues, 8:30-10 pm, music. Sun, 7:45 pm, church services. Eastern.
WQAW, Omaha, Neb. 526 meters. 500 watts. Woodmen of the World. Slogan, "Gateway to the West and to the East." Mon, Tues, Thurs, Sat, 6-7:30 pm, 9-11, concert. Fri, 6:30-8 pm, 9-11, Sun, 9-11 am, 9-11 pm, church services. Central.
WQAX, Trenton, N. J. 240 meters. 100 watts. F. J. Wolff. Intermittent schedule.
WOC, Davenport, Ia. 484 meters. 500 watts. Palmer School of Chiropractic. Slogan, "Where the West Begins and in the State Where the Tail Cuts the Groin." Daily ex Sun, Tues night, 10 am, organ recital; 4:30-5:30, talk; 5:45 chimes; ex Wed, 6, 6:30, Sandman, 6:50, scores, weather. Wed, 10 pm, concert. Sat, 9 pm, concert. Mon, Wed, Thurs, Fri, 8 pm, music. Sun, 9 am, chimes; 1:30 pm, orchestra; 7, concert. 7:30, sports; 8, church services; 9, concert. Tues, silent. Central.
WOL, Ames, Ia. 360 meters. 100 watts. Iowa State College. Daily ex Sun, 9:45, 10:15, market, weather, reports; 12:45 pm, markets, weather, educational talks; 9:30, weather, music. Central.
WOO, Philadelphia, Pa. 509 meters. 500 watts. John Wanamaker. Daily ex Sun, 11 am, organ recital; 11:30, weather; 11:55, time; 12-1 pm, concert; 4:45 pm, organ recital; 5, sports, police reports; 9:55, time; 10:02, weather. Mon, Wed, Fri, 7:30-11 pm, music, concert. Eastern.
WOP, Kansas City, Mo. 360 meters. 500 watts. Western Radio Co. Daily ex Sun, 9:50 am, markets; 10:30-11, music, time signals; 11:50 am-12:30 pm, markets; 2:45-3:15, music; 7-7:20 market. Mon, Wed, Fri, 7:30-8, music. Tues, Thurs, Sat, 8-9:30, music. Sun, 11 am-12:15 pm, 7-7:45, church services. Central.
WOR, Newark, N. J. 405 meters. 500 watts. L. Bamberg & Co. Daily ex Sun, 2:30-4 pm, 6:15-7:30, music, talks. Mon, Wed, Sat, 8-11 pm, music, entertainment, lectures. Eastern.
WOS, Jefferson City, Mo. 441 meters. 500 watts. Missouri State Marketing Bureau. Slogan, "Watch Our State." Daily ex Sun, first 15 min. of every hour from 8 am-2 pm, markets. Daily ex Sat, Sun, 5 pm, music, markets. Mon, Wed, Fri, 8-9:30 pm, concert. Central.
WPAB, State College, Pa. 283 meters. 500 watts. Pa. State College. Irregular schedule.
WPAC, Okmulgee, Okla. 360 meters. 200 watts. Donaldson Radio Co.
WPAH, Waupaca, Wis. 360 meters. 250 watts. Wisconsin Dept. of Markets. Daily ex Sun, 9:30 am, 10:30, 11:30, 12:30 pm, 2:30, 4:30, markets, weather, news, etc. Mon, 8-11 pm, music. Central.
WPAI, New Haven, Conn. 268 meters. 30 watts. Doolittle Radio Corp.
WPAK, Fargo, N. Dak. 360 meters. 250 watts. North Dakota Agricultural College. Daily, 10 am, weather. Mon, Wed, Fri, 7:30-8:15 pm, music, lecture, address. Central.
WPAL, Columbus, O. 286 meters. 100 watts. Superior Radio Tel. Equip. Co. Daily ex Sun, 3-4 pm, news; Wed, 7-9 pm, music; Sat, 12-1:30 am, "Yellow Dogs." Central.
WPAM, Topeka, Kans. 360 meters. 100 watts. Auerbach & Guettel. Daily ex Sun, 1 pm, markets; Wed, 9:30-10:30 pm; Sat, 8-9 pm, music. Central.
WPAQ, Frostburg, Md. 360 meters. 10 watts. General Sales & Engineering Co.
WPAR, Beloit, Kans. 283 meters. 10 watts. R. A. Ward. Fri, 8:30 pm, music. Sun, 3 pm, chapel service. Central.
WPAT, El Paso, Tex. 360 meters. 20 watts. Saint Patrick's Cathedral. Temporarily discontinued.
WPAU, Moorhead, Minn. 360 meters. 20 watts. Concordia College.
WPAZ, Charleston, W. Va. 273 meters. 20 watts. Dr. John B. Koch.
WPG, New Lebanon, O. 234 meters. 30 watts. Nushawg Poultry Farm. Slogan, "The Pulse of Miami Valley." Daily ex Sun, 12-12:15, news; 6-6:30 pm, markets. Mon, Fri, 8-9:45 pm, music, farm program. Central.
WQAA, Parkersburg, Pa. 360 meters. 500 watts. Horace A. Beale, Jr. Temporarily discontinued. Eastern.
WQAC, Amarillo, Tex. 360 meters. 100 watts. E. B. Doolittle.
WQAD, Waterbury, Conn. 242 meters. 50 watts. The Whitall Elec. Co. Mon, Wed, Fri, 5:30-6:45 pm, music, Boy Scout news. Eastern.
WQAE, Springfield, Vt. 275 meters. 150 watts. Moore Radio News Station. Slogan, "Among the Green Hills of Vermont." Daily, 7-7:30 pm. Sun, 2:30-4 pm, Eastern.
WQAF, Sandusky, O. 240 meters. 5 watts. Sandusky Register.
WQAH, Lexington, Ky. 254 meters. 10 watts. Brock-Anderson Elec. Eng. Co.
WQAL, Mattoon, Ill. 258 meters. 20 watts. Coles County Tel. & Telg. Co. Slogan, "The Buckle on the Corn Belt." Wed, Thurs, 9-10 pm, music, lecture; Sun afternoon, special program. Central.
WQAM, Miami, Fla. 360 meters. 100 watts. Electrical Equip. Co. Slogan, "Always June in Miami." Tues, Thurs, 8 pm, music. Sun, 9-11 pm, music. Eastern.
WQAN, Scranton, Pa. 280 meters. 100 watts. Scranton Times. Slogan, "The Voice of the Anthracite." Daily ex Sun, 12:30-1 pm, 4-4:30, 7:30-8, news, reports, music. Tues, Fri, 8 pm, entertainment. Eastern.
WQAO, New York City, N. Y. 360 meters. 100 watts. Calvary Baptist Church. Sun, 10:30 am, 7:45 pm, church services. Eastern.
WQAP, Abilene, Tex. 360 meters. 100 watts. West Texas Radio Co.-Abilene Daily Reporter. Slogan, "The Capital of West Texas." Tues, Thurs, Fri, 8-9 pm, Sun, am, pm, church services. Central.
WQAS, Lowell, Mass. 260 meters. 100 watts. Prince-Walter Co. Daily ex Sun, 10:45-11 am, 2:30-3 pm, music. Mon, Wed, Fri, 6-7 pm, news, concert. Thurs, silent. Eastern.
WQAV, Greenville, S. C. 258 meters. 15 watts. Huntington & Guerry, Inc. Slogan, "The Textile Center of the South." Tues, Thurs, 7:36-8:30 pm, music. Sat, 7:30-8 pm, music. Eastern.
WQAW, Washington, D. C. 236 meters. 5 watts. Dept. of Elec. Eng., Catholic University of America.
WQAX, Peoria, Ill. 360 meters. 10 watts. Radio Equipment Co. Mon, Wed, Fri, 7:15-8 pm, Central.
WRAA, Houston, Tex. 360 meters. 200 watts. Rice Institute. Mon, 8-9 pm, concert, college activities. Sun, 12:30 pm, extension lectures. All games broadcast. Central.
WRAD, Marion, Kan. 248 meters. 10 watts. Marion Radio Shop. Daily, 12:12:45 pm, 5:15-5:45, markets, weather. Mon, Thurs, 8 pm, concert. Sun, 5-6 pm, Central.
WRAF, La Porte, Ind. 224 meters. 10 watts. Radio Club, Inc. Wed, Thurs, 8 pm, talks, music. Sun, 2 pm, religious and musical program. Central.
WRAH, Providence, R. I. 231 meters. 10 watts. Stanley N. Reed.
WRAL, St. Croix Falls, Wis. 248 meters. 180 watts. Northern Star Power Co. Slogan, "The Dalles of the St. Croix Club. Royal Order of Interstate Knob Twisters." Wed, 10-11:30 pm, concert. Central.

WRAM, Galesburg, Ill. 244 meters. 250 watts. Lombard College.
WRAN, Waterloo, Iowa. 236 meters. 10 watts. Blackhawk Elec. Co. Slogan, "We Radiate all News." Daily ex Sun, 5-6 pm, Wed, 8-9:15 pm, Central.
WRAO, St. Louis, Mo. 360 meters. 20 watts. St. Louis Radio Service Co. Daily ex Sun, 4:15-5 pm, music, sports. Sun, 3:30-5 pm, music, sports. Central.
WRAV, Yellow Springs, O. 360 meters. 100 watts. Antioch College.
WRAW, Reading, Pa., 238 meters. 10 watts. Avenue Radio Shop. Thurs, 10 pm, Eastern.
WRAX, Gloucester City, N. J. 283 meters. 100 watts. Flexon's Garage. Mon, Wed, Fri evenings, program.
WRAY, Scranton, Pa. 280 meters. 100 watts. Radio Sales Corp. Mon, Wed, Sat, Sun, 8:30-10 pm, concert. Eastern.
WRAZ, Newark, N. J. 233 meters. 500 watts. Radio Shop of Newark. Irregular.
WRC, Washington, D. C. 469 meters. 500 watts. Radio Corp'n of America. Daily ex Sun, 10 am, reports; 5:15 pm, code practice; 6 pm, children's hour. Mon, Wed, Fri, 8-16 pm, music. Tues, Thurs, Sat, 3-4 pm, music. Eastern.
WRK, Hamilton, O. 360 meters. 50 watts. Doron Bros. Elec. Co. Slogan, "The Oldest Station in Existence." Fri, 8:15 pm, music, lecture. Sun, 2:15 pm, music. Central.
WRL, Schenectady, N. Y. 360 meters. 500 watts. Union College Radio Club.
WRM, Urbana, Ill. 360 meters. 500 watts. Univ. of Ill. Tues, 7-8 pm, music. Tues, Thurs, 8:30-9:00 pm, 9-9:30, Univ. news, talks, music. Central.
WRR, Dallas, Texas. 360 meters. 20 watts. City of Dallas. Daily ex Sun, 11:30-12:30 pm, weather; 2:45-3:30, sports, markets, news; music. Sun, 11 am, 3:30, church service. Central.
WRW, Torrington, N. Y. 273 meters. 150 watts. Tarrytown Radio Research Laboratory. Slogan, "Everything in Radio." Mon, Wed, Fri, 7:30-11:30 pm, music, lectures, entertainment. Sun, 8-9 pm, church services. Eastern.
WSAB, Cape Girardeau, Mo. 360 meters. 100 watts. Southeast Mo. State Teachers College. Mon, Wed, 3:30 pm, lecture, 9, concert. Central.
WSAC, Clemson College, S. C. 360 meters. 100 watts. Clemson Agri. College.
WSAD, Providence, R. I. 261 meters. 100 watts. J. A. Foster Co. Daily, 2:30-4 pm, Wed, 8:30 pm, music entertainment. Eastern.
WSAG, St. Petersburg, Fla. 244 meters. 10 watts. Lorin V. Davis.
WSAH, Chicago, Ill. 248 meters. 500 watts. A. G. Leonard, Jr. Daily ex Sun, 5:30-6:30 pm, Fri, 8:45-10, Central.
WSAI, Cincinnati, O. 309 meters. 500 watts. United States Playing Card Co. Tues, Thurs, 8-10 pm, Sat, 10-12 pm, Central.
WSAJ, Grove City, Pa. 360 meters. 100 watts. Grove City College. College activities. No definite schedule.
WSAL, Brookville, Ind. 246 meters. 10 watts. Frank-Han Elec. Co.
WSAN, Allentown, Pa. 229 meters. 10 watts. Allentown Radio Club.
WSAP, New York, N. Y. 263 meters. 250 watts. Seventh Day Adventist Church. Sat, 10:45-12:45 am, Sun, 7:30-9:30 pm, Eastern.
WSAR, Fall River, Mass. 254 meters. 10 watts. Doughty & Welch Elec. Co. Daily ex Sun, 12-1 pm, Tues, Thurs, Sat, 7:15-8:15 pm, Eastern.
WSAT, Plainview, Tex. 268 meters. Donohoo-Ware Hardware Co.
WSAU, Chesam, N. H. 229 meters. Camp Marienfield. Operates from July 3-Aug. 28.
WSAW, Canandaigua, N. Y. 275 meters. John J. Long, Jr.
WSAX, Chicago, Ill. 268 meters. Chicago Radio Laboratory.
WSAY, Portchester, N. Y. 233 meters. 100 watts. Irving Austin, Chamber of Commerce.
WSAZ, Pomeroy, Ohio. 258 meters. 50 watts. Chase Elec. Shop.
WSB, Atlanta, Ga. 429 meters. 500 watts. Atlanta Journal. Slogan, "The Voice of the South." Daily ex Sun, 12-1 pm, music, weather; 2:30, reports; 4-4:30, music; 5-6, news, sports; 8-9, concert (ex Wed); 10:45-12, concert. Sun, 10:54-12:15 pm, 5-6, 7:30-9:15, church services. Central.
WSL, Utica, N. Y. 273 meters. 100 watts. J. & M. Elec. Co. Daily ex Sat, Sun, 11-11:30 am, 5-6 pm, music, news. Mon, Wed, Sat, 8-9 pm, Sun, 10:30-12 m, 7:30-9 pm. Church services. Eastern.
WSY, Birmingham, Ala. 360 meters. 500 watts. Love-man, Joseph & Loeb. Daily ex Sun, 9:30 am, 3 pm, 3:30, news, weather. Mon, Wed, Fri, 8 pm, music. Sun, 11 am, 8 pm, church services. Central.
WTAB, Fall River, Mass. 248 meters. 100 watts. Fall River Daily Herald. Daily ex Sun, 7-8 pm, Eastern.
WTAC, Johnstown, Pa. 360 meters. 150 watts. Penn Traffic Co. Daily ex Sun, 4 pm, Sun, Thurs, 7:30 pm, Eastern.
WTAD, Carthage, Ill. 229 meters. 10 watts. Robt. E. Compton.
WTAF, New Orleans, La. 268 meters. Louis J. Gallo. Daily, 6:45-7 pm, police reports. Tues, Sat, 8-9:30 pm, music.
WTAG, Providence, R. I. 258 meters. 10 watts. Kern Music Co.
WTAH, Belvidere, Ill. 236 meters. Carmen Ferro. Tues, Fri, 7:30-8:30, Central.
WTAJ, Portland, Me. 236 meters. The Radio Shop. Wed, Sun, 7:45 pm, Eastern.
WTAL, Toledo, Ohio. 252 meters. 10 watts. Toledo Radio Elec. Co. Tues, Thurs, 8:45 pm, Sat, 8 pm, Eastern.
WTAM, Cleveland, Ohio. 360 meters. 1,000 watts. Willard Storage Battery Co. Slogan, "The Voice from the Storage Battery." Wed, 8-10:30 pm, concert. Sat, 9-11 pm, dance music. Eastern.
WTAN, Mattoon, Ill. 240 meters. 100 watts. Orndorff Radio Shop.
WTAP, Cambridge, Ill. 242 meters. 50 watts. Cambridge Radio & Elec. Co. Daily, 12:15-1:15 pm, 9:30-10:15, Central.
WTAQ, Osseo, Wis. 226 meters. 100 watts. S. H. Van Gordon & Son.
WTAR, Norfolk, Va. 230 meters. 100 watts. Reliance Electric Co. Daily ex Sun, 4-5 pm, Mon, Fri, 8:30-9:30 pm, music, weather reports, news, music. Eastern.
WTAS, Elgin, Ill. 275 meters. 500 watts. Chas. E. Erbstein. Daily ex Thurs, 7:30-9:30 pm, music. Central.
WTAT, Boston, Mass. 244 meters. 100 watts. Edison Elec. Illuminating Co. (Portable Station).
WTAU, Tecumseh, Neb. 360 meters. Ruzey Battery & Elec. Co.
WTAW, College Station, Tex. 280 meters. 200 mi. Agricultural and Mechanical College of Tex. Wed, Fri, 8-8:30 pm, music, talks. Sun, 11 am, church services. Central.
WTAX, Streator, Ill. 231 meters. 20 watts. Williams Hardware Co.
WTAZ, Oak Park, Ill. 226 meters. 15 watts. Oak Leaves.
WTAA, Lambertville, N. J. 283 meters. 15 watts. Thomas J. McGuire.
WTG, Manhattan, Kan. 360 meters. 75 mi. Kan. State Agri. College. Daily ex Sun, 9:55 am, weather (code). Central.
WWAB, Trenton, N. J. 226 meters. 20 watts. Hoenic, Swern & Co.
WWAC, Waco, Tex. 360 meters. 50 watts. Sanger Bros. Daily ex Sun, 11 am, weather; 1:30 pm, entertainment. Wed, Sat, 8 pm, music, entertainment. Central.
WWAD, Philadelphia, Pa. 360 meters. 50 watts. Wright & Wright, Inc.
WWAE, Joliet, Ill. 227 meters. 500 watts. Alamo Dance Hall. L. J. Crowley.
WWAF, Camden, N. J. 236 meters. 100 watts. Galveston Radio Supply Co.
WWAX, Laredo, Tex. 360 meters. 50 watts. Wormser Bros. Discontinued.
WWI, Dearborn, Mich. 273 meters. 50 watts. Ford Motor Co. Wed, 8-10 pm, music, lectures. Eastern.
(Note.—The fourth part of the directory will appear next week, consisting of the rest of the station schedule list and the state, city-station index.)

Radio Illustrated



Below is a complete crystal Radio set built as an integral part of an ordinary telephone receiver. It is made by a school boy and was exhibited at a recent show. Int. Photo

Novel loop, that works on the principle of a variometer, with its Radio amateur inventor, W. W. Obermiller. This makes it possible to tune in stations with the loop alone, eliminating controls on the Radio set. K. & H. Photo

Disorders in Germany are frequent and the Berlin "Schutzman" (police officer) has to carry this cumbersome Radio set for receiving orders from headquarters when a riot makes his presence elsewhere needed. K. & H. Photo



Dancing to Radio music from a set in the circuit of which the metal "dress" she is wearing forms a part, is pretty Virginia Beardsley, youthful member of the "Ziegfeld Follies" company. © Keystone



"Sport" Herman, director of the Chicago Radio Show, and his dog "Rowdy," who is his constant companion and an enthusiastic Radiophan. "Sport" claims "Rowdy" knows everything about Radio and is a music lover besides. Here he is getting an earful. Int. Photo