

Boff  
New Reinartz R.D.-104—Grimes—Miloplex

# Radio Digest

EVERY WEEK **Illustrated** TEN CENTS

REG. U. S. PAT. OFF. & DOM. OF CANADA

Vol. VII

Copyright, 1923  
R. D. P. Co. Inc.

SATURDAY, NOVEMBER 24, 1923

No. 7

## RADIO COLLECTS TAXES



### DRAFT OF FEDERAL RADIO QUIZ READY

Report to Go before Congress When It Convenes Early in December

WASHINGTON, D. C.—It is reported that the preliminary draft of the Radio trust investigation carried on by the Federal Trade Commission, will be laid before the commission in a few days. The field and all preliminary work has been completed and it only remains for the commissioners themselves to pass on the report. While officials of the commission refuse to discuss the investigation at present, it is understood that the findings will be submitted to Congress in December.

### "Aggies" of New Mexico Are Given New Station

STATE COLLEGE, N. M.—Through the efforts of Dean Goddard, the New Mexico College of Agriculture and Mechanic Arts has been presented with a new Radio station. The gift will include the equipment for constructing a 100-watt transmitter and the building to house it. The station will be utilized for experimental purposes and amateur relay work under the call 5XD. It will be separate and entirely distinct from the present studio and equipment which will be used solely for broadcasting service under its present call, KOB.

### AIRPHONE TALKS GET DELINQUENT EXCISES

Cities Find Dilatory Taxpayers Heed Broadcast Warnings and Pay Up—Method Saves Much Money

CHICAGO.—Of all the uses to which Radio, the eternal, universal element, has been put none is so close to the people, to their purses, as that to which the authorities of Cook County, of which county Chicago is the seat, recently applied it. And by the same token no use is likely to be so unpopular. For in Cook and in several other counties throughout the United States, Radio is used as a tax collector.

There are about 3,500,000 persons resident in Cook County. Most of them live in Chicago. The taxpayers of the county number about 2,000,000. They paid last year almost \$150,000,000. Fifteen per cent of the taxpayers were delinquent. (Turn to page 2)

### B'ARS AND WOLVES GET EAR OF JAZZ

BANGOR, ME.—It is reported that most hunting parties entering the Maine woods this fall for big game are equipped with receiving sets. Results obtained have been startling to some of the inhabitants who have experienced the sensation of hearing jazz and other forms of entertainment in the forest wilds for the first time.

Helen Eley, left, of the "Batling Butler" cast, now playing in New York, and recently broadcast from one of the large eastern stations. Jane Richardson, right, of the "Gingham Girl" cast, now playing in Chicago, and recently broadcast from Station WMAQ, the Chicago Daily News

### "Straight-from-the-Pulpit" Sermons Radioed by WBZ

SPRINGFIELD, MASS.—Church services direct from the church have been inaugurated by Westinghouse Station WBZ here, and will continue throughout the present season. The Rev. James Gordon Gilkey is pastor of the South Congregational Church of this city, which church has been wired direct to WBZ, located three miles distant.

### \$40,000 STATION IS ROTARIANS' DREAM

GRAND RAPIDS, MICH.—The Rotary Club of this city is planning to establish a high-power broadcasting station for entertainment purposes. A joint committee has found it would cost \$40,000 to install and operate for two years a station such as is desired. Offers to house the station have been made by several hotels and a church.

### WJZ Fans "Strong" for Visiting British Prince

Author Gives Views of Royal Edward as Rancher

NEW YORK.—America, the most democratic country in the world, must have a weakness for royalty, if the results of a recent talk from Station WJZ are taken as an indication. William H. Crawford, a journalist well known to WJZ audiences for his informal talks about great men he has met, gave a talk about "Ranching with the Prince" on a recent Sunday wherein he described the Prince of Wales as he saw him during a month's visit at the Prince's ranch in Canada. Mr. Crawford, wishing to determine how popular the royal Edward is in this country, offered to send an autographed snapshot of him to anybody who would write him in care of Station WJZ and enclose a stamped envelope for return. In three days over a thousand democratic Americans replied, all asking for the autographed photo.



# COLD WEATHER ENDS OFFER TO READERS

## NUMBER 26 IS LAST COUPON TO APPEAR

Readers Must Send Letters with Orders to Radio Digest Office by December 1

### SPECIAL REWARD OFFER

#### Coupon Number 26

This Special Reward Coupon is the last to appear in Radio Digest. When sent in, accompanied by necessary remittance, according to the rules governing same, apparatus can be secured. See rules of offer below.

Save Me—I Am Valuable

The Special Reward Offer is discontinued for the present season with the publication of Coupon Number 26 this issue. This action has been deemed necessary as a result of the increased rush in business coming with the colder (and more favorable for Radio) weather.

All Radiophans contemplating taking advantage of the special offer must do so before December 1. All letters containing coupons and remittances for parts must reach the office of Radio Digest on or before that date. Such letters arriving after December 1 will be returned to the sender.

Lack of space requires the omission of the list of Radio parts obtainable. See issue of October 27 or November 3 for this list. One change, however, is to be noted. Articles in Class H must be accompanied by sixteen consecutively numbered coupons and \$3.40, instead of \$3.00 as given previously in the list.

Readers contemplating taking advantage of the special offer must remember that the coupons turned in for any item must be numbered consecutively, as for example, 16, 17, 18 and 19, or 18, 19, 20, 21, 22 and 23. The number of coupons necessary and the cash remittance, of course, depend on the item sought by the reader. There is no limit to the number of series turned in by any one reader.

Another point to be remembered by readers taking advantage of the offer is that checks and money orders will be accepted, but no cash or postage stamps.

### 3 Stations Win Honor in "Mileage" Contest

#### KPO, KDKA, and CFCN Latest Aspirants to "DX" Crowns

CHICAGO.—The record's the thing. If recent reports from several broadcasting stations are to be taken as an indication, KPO, San Francisco, KDKA, E. Pittsburgh, and CFCN, Calgary, Alberta, are the three latest aspirants to "DX" crowns. All three have made very creditable records.

Calgary, Alberta's representative in the "mileage" contest, is W. W. Grant's station, CFCN, whose Sunday night church services were heard in England by H. W. Scase, of Darlington. The services were broadcast from the Grace Presbyterian Church in Calgary. This is believed to be the first acknowledged reception in England of any Canadian or American broadcasting station west of the Rocky Mountains. The distance traveled by CFCN's waves is well over 6,000 miles.

KPO, Hale Brothers, on the west coast, received a letter from Sydney, New South Wales, 8,200 miles across the Pacific Ocean, telling of the clear reception of the station.

Westinghouse's pioneer, KDKA, is receiving lots of letters from England. The last one was from T. E. Hamblett, of Lancaster, who has received KDKA's programs several times. The range covered measures 4,300 miles.

### Radio Marks Golden Wedding

SCHENECTADY, N. Y.—The Farmers' Night program of WGY, the General Electric station here, featuring the golden wedding anniversary of Josh Perkins and his wife Samantha, proved quite pat in the case of Mr. and Mrs. Charles H. Rice, of R. D. 2, Waterford, N. Y. Mr. Rice wrote WGY that the program was especially interesting to them for it came on their fiftieth wedding anniversary.

### Newark Show Ends

NEWARK, N. J.—Newark's third annual Radio show came recently to a successful conclusion. The exhibition was held at the Robert Treat Hotel.

### COLLECT TAXES BY AIR

(Continued from page 1)

Property was sold to pay \$3,500,000 in taxes in arrears.

Because of the large percentage of delinquent taxpayers, because of the expense and confusion attendant on such dereliction, the city administration of Chicago decided to use Radio to relieve the situation.

#### Tell People When Taxes Are Due

Shortly before the expiration of the legal limit of time in which to pay the current taxes those in charge of Station WBU, owned by the municipality and formerly operated by the department of gas and electricity under the supervision of John T. Miller, commissioner, arranged to broadcast to the people that their taxes were due.

So, during the days and nights prior to the time limit, Station WBU told the taxpayers what they should do as to payment of taxes and where to pay them.

The result, according to the county treasurer's office, was an almost immediate increase in the receipt of tax money. "There is no question," said Jacob Lindheimer, first assistant to the county treasurer, "that Radio is a great help in the collection of taxes. It is almost certain that it will be soon used generally for that purpose."

#### Other Cities Meet Same Success

The cities of Detroit, Dallas and New York already have successfully applied Radio to the collection of taxes, it was stated. There is likely to be soon an exchange of views by various county treasurers as to the practicability of Radio as a collector of taxes.

So efficient was Station WBU not only as a tax collector but as a means of informing the taxpayers as to the manner in which their taxes were spent, that it was determined to draw plans for increasing the Radio power of the plant. "Station WBU has been closed for the sea-

son," said Commissioner Miller, "but it may be reopened soon as a Class B station."

There are believed to be 250,000 receiving sets in Chicago. Their owners, hearing the sad news about "taxes due," tell their neighbors, friends and relatives. In that way a large if not the greater part of the population are apprised of their duty.

And thus does Radio emphasize the adage as to the inevitability of death—and taxes.

### GIVE SHOW TICKETS IN BOSTON CONTEST

#### Letters from Fans Tell How "Caroline Was Received"

BOSTON.—A prize contest was run by Station WNAC in connection with its recent broadcast of excerpts from the operetta "Caroline," for listeners in to the program. For the best letters from Radiophans, expressing their opinions of the clearness of the pronunciation and enunciation on the part of the artists in this broadcast, tickets to the opera were given; and for the best letter of analysis of the value to be derived by producers of musical plays in broadcasting selections, a similar prize was given.

The question was asked in this portion of the contest: "Do you stay at home and listen in to the music and thereby become satisfied with what the Radio has given you, or do you become so enthused as a result of the broadcast that you are attracted to the theater to see and hear the play in its entirety?" A third contest was for distance and the five listeners who reported hearing the Caroline broadcast from the greatest distance received signed photographs of J. Harold Murray and Miss Myrtle Schaff, the two stars of the production.

## CONTENTS

Radio Digest, Illustrated, Volume VII, Number 7, published Chicago, Illinois, November 24, 1923. Published weekly by Radio Digest Publishing Company, 123 West Madison Street, Chicago, Illinois. Subscription rates, yearly, Five Dollars; Foreign Postage One Dollar additional; single copies, Ten Cents. Entered as second-class matter at the postoffice at Chicago, Illinois, under the Act of March 3, 1879.

"All the Live News of Radio".....	1 to 9
An Evening at Home with the Listener In.....	9
Further Details of Miloplex Hook-Up.....	11
Advance Programs.....	12
New Reinartz R.D.-104; The Reader's View.....	14
Simple Explanation of Radio for Everybody, Chapter V, Part II—Condensers, Fixed and Variable, by M. W. Thompson.....	15
Editorials; Indi-gest; Condensed, by Dielectric.....	16
Latest Development in Grimes' Inverse Duplex, Part II—Overloading Prevention Circuits.....	17
How to Build a Three-Tube Miloplex Receiver, Part IV—Conclusion, by H. J. Marx.....	19
Questions and Answers.....	22
Broadcasting Stations, Part III—Station Schedules.....	23
Radio Illustrated, a Page of Pictures.....	24

## Looking Ahead

The Four-Circuit Tuner Gives Way before the Triple Circuit Coupler! It's a bear-cat! It beats them all! Never heard of a triple circuit coupler, have you? You think you know what it is? Impossible, as it's a brand new invention of H. J. Marx who uses it in his Super-Triple-Circuit. NEXT WEEK Mr. Marx will tell you how to build this coupler and will unfold a few of its thousand merits to you. All aboard for next week? Let's go!

David Grimes Isn't Worth Missing—so you'd better buy a copy of next issue if for that reason only. The "A" tubes didn't work just right in his Inverse Duplex, so Grimes worked till he located and corrected the trouble. The next article shows the results of his efforts and gives for the FIRST TIME, three new circuits!

Copyrighted Music, the A. S. of C. A. and P., and the Story of the National Broadcaster's Association—Beginning next issue, a serial exposé of the obstacles thrown in the way of but surmounted by the spunky stations who banded together and are now laughing at the "music trust" that threatened to throttle all popular song broadcasting.

Vacuum Tubes Aren't Such a Mystery—providing you study their action from the foundation up. Watch for M. W. Thompson's article on this subject.

That Stapleton Man Wrestled with Miloplex Till He Got RESULTS—Read the Mystery Man's story next issue.

R. D.-105, Next Week, the Green Circuit—M. P. Green's hook-up and it's excellent.

Coming—How to Make a Radio Frequency Transformer—Watch for this.

Newsstands Don't Always Have One Left

WHEN YOU WANT

# Radio Digest

YOU WANT IT!

BE SURE OF YOUR WEEKLY COPY BY SUBSCRIBING NOW

SEND IN THE BLANK TODAY

Publisher Radio Digest, 123 West Madison St., Chicago, Illinois.

Please find enclosed check M. O. for Five Dollars (Six Dollars for One Year's Subscription to Radio Digest, Illustrated.

Name .....

Address .....

City..... State.....

### 80% of demonstrations result in sales for MU-RAD dealers

When a complete check on the radio sales of one Chicago store reveals that Mu-Rads are sold in eight out of ten competitive demonstrations, there must be a reason.

There is! Mu-Rad is easy to operate, uses an inside 2-ft. loop aerial, and is highly selective. Mu-Rad is guaranteed to receive at least 1000 miles.

#### Dealers: Write for Mu-Rad Proposition

Inquiries are solicited from responsible dealers only.

In order to help us weed out curiosity seekers, please use your business stationery in requesting this information.

We also carry a complete stock of WESTERN ELECTRIC CO. GENERAL RADIO CO.

parts. Write for details and discounts Chicago Radio Apparatus Co.

Jobbers of Good Radio Merchandise General Offices: 407 South Dearborn Street CHICAGO

## FORMICA

Aluminum Phenolic Condenser Product SHEETS TUBES RODS

## RADIO PANELS

POLISHED BLACK FINISH

CUT PERFECTLY SQUARE TO ANY SIZE		
1/2" THICK	1/2°	PER SQ. INCH
1/16" THICK	3/4°	PER SQ. INCH
3/32" THICK	1°	PER SQ. INCH
1/8" THICK	1 1/2°	PER SQ. INCH
3/16" THICK	2°	PER SQ. INCH
1/4" THICK	2 1/2°	PER SQ. INCH
3/8" THICK	4°	PER SQ. INCH
1/2" THICK	5 1/4°	PER SQ. INCH

SEND FOR COMPLETE PRICE LIST PROMPT ATTENTION TO MAIL ORDERS DEALERS PRICES ON APPLICATION

STARRETT MFG. CO. 519 SOUTH GREEN ST. CHICAGO

## Morrison



### Loud Speaker

ONE of the nicest things about Morrison Loud Speaker is that you don't have to be an expert to attach and operate it. Anyone can get perfect reproduction from Morrison, there is only one adjustment—from soft to loud merely turn a dial.

Morrison attaches to any phonograph and to most horns — costs \$10.00 complete. Guaranteed absolutely. Send for catalog. Dealers who value their customers' good will are showing nice profits on Morrison Sales—easy to sell and stay sold.

Morrison Laboratories, Inc. 343 Jefferson Ave., East, DETROIT, MICH.

# CLAIMS FANS FAIL TO APPLAUD STARS

## WARNS OF GRAVE PERIL TO BROADCASTING

### Check-Up Shows Letters Praising Work of Artists Steadily Decreasing

Within the last few weeks, a man well known to Radio audiences throughout the country said, "Broadcasting is in a far more precarious condition than the three millions of listeners believe, due merely to one thing: the decrease in written applause mailed to artists after their appearance before the microphone."

"Last year and the year before that the appearance of a well-known artist at any one of the leading stations was a signal for a veritable flood of mail and telephone calls. Today an operatic star whose performance at a theater calls for the S. R. O. sign is fortunate if his Radio appearance draws a score of letters from appreciative Radio fans."

#### Need Spontaneous Letters

A check-up of this warning brings to light numerous facts that substantiate all the man said. Eventually this decrease in letter applause is certain to react on the quality of programs if it has not already done so. Whether or not there is a way to check the tendency is a problem now being studied by studio managers.

At any rate the simplest solution lies with the listener and his friends. No letter however carefully worded will "get over" with the artist unless it is spontaneous. The right kind of message of appreciation can be written on a postcard, while a full page letter written through a feeling of duty may be vacuous and deadening.

#### Public Appreciates Only What Costs

The sage who remarked that "the public will not appreciate what it does not pay for" has been referring directly to the Radio audience. It is probable that a tax on programs would cause features to be considered in their proper light. Too many fans take broadcasting for granted, as if the purchase of a set or the assembly of the parts carried with them the assurance of broadcasting organizations that programs would be continued.

If these fans would only consider for a moment that unless stations can assemble creditable artists the stations will be closed down, they would not be so chary with their applause but would let everyone know from artist to announcer that the efforts of all were sincerely appreciated.

Less public criticism and more private appreciation is the crying-need of broadcasting stations and the solution is up to the Radio enthusiasts who enjoy but do not applaud.

# SEEK VANISHED GIRLS IN "LOST KIN" PLEAS

## Motorist Finds Youngster After Description Is Broadcast

BUFFALO, N. Y.—Several cases have arisen recently in which WGR, station of the Federal Telephone & Telegraph Co., here, has been instrumental in locating lost persons. As a result of this success a systematic arrangement has been made between the Buffalo Enquirer and WGR for regularly broadcasting descriptions of lost persons.

One notable instance of such service on the part of WGR was the case of the description of a lost child being broadcast. A Radiophan who heard the broadcast happened to be driving along the road that evening and saw a child which tallied with the description. The youngster proved to be the lost child. He was a runaway and was restored to his parents.

Most of those for which descriptions are broadcast are girls. It is estimated that at least 200 girls disappear in Buffalo every year and very few are ever heard from again.

# CALLS THE KOPS AND NABS THE BURGLAR

DETROIT.—While Kelwin Kearney, 19 years old, of this city, was sending a Radio message to a friend in Richmond, Va., early one morning recently, he discovered a burglar breaking his way into the rear of a store back of his house. He broke off his message and called KOP, the Detroit police station. The burglar was captured before he could leave.

# UNCLE SAM'S FLIERS TALK THROUGH HAT

WASHINGTON, D. C.—Air mail pilots flying across the continent will soon be able to "talk through their hats" to their ground stations. A one-man Radiophone transmitter and receiver has been devised which provides the headset under the pilot's helmet and the microphone on his breast. One pilot recently talked with Postmaster-General New while flying over Washington.

# SHE SHOULD GET AN EARFUL



No human ears in evidence here—as usual—but we'll bet this captivating young Radiophan, Agnes Leonard, gets an earful. The mammoth telephone receiver, the largest ever made, was displayed at a recent Radio show. Int. Photo

# France Demands Vessels Have Radius of 150 Miles

PARIS.—The recent French Radio requirements for vessels, extending the minimum range of transmission fifty miles, now also affect all foreign ships touching at French ports. The decree, signed last spring, provides that all vessels of 2,000 gross tons, all ships licensed to carry fifty persons including the crew, and also all craft having as many as

twelve passengers aboard, must be equipped to send and receive Radio messages by day up to 150 nautical miles.

Merchant ships between 500 and 2,000 gross tons, licensed to carry less than fifty persons, or with less than fifteen passengers aboard, must be capable of receiving Radio signals up to 2,800 meters and preserve a watch for emergency calls.

Radio is being charged with the responsibility for a decrease in fiction reading during 1922.

# WILSON BREAKS HIS SILENCE BY RADIO

## EX-PRESIDENT ADDRESSES "LARGEST AUDIENCE"

### Ten Minute Talk on Armistice Day Advocates International Peace

WASHINGTON, D. C.—Breaking his silence of four years, Woodrow Wilson on Armistice Day eve made his first address to the American public through microphones installed in the library of his home here and connected with Stations WCAP of this city, and WEAJ of New York. Strangely enough, the address was heard by the largest audience the former president ever faced, even during the height of his career as leader of American affairs.

His speech, "The Significance of Armistice Day," was greatly appreciated by the million listeners in. His subject could have been handled better by no other man, as he, more than any other single individual, was responsible for the negotiations which brought about the declaration of the termination of the World War on November 11.

#### Advocates World Peace

Touching upon the present international situation, his speech lasting only a little more than ten minutes, was devoted largely to the subject closest to the ex-president's heart, American participation in the establishment of the peace of the world.

The extraordinary event of the broadcasting of the former president's address, following closely upon the recent dissemination through many stations of David Lloyd George's speeches, is hailed as a tribute to the importance and dignity of the Radio audience.

Mr. Wilson's speech was the first message he has given to the American public since September, 1919.

# LISTENERS IN RUN THIS BROADCASTER

## Station KFV, Formerly KFIQ, Owned and Operated by Invisible Audience

YAKIMA, WASH.—What is probably the first broadcasting station to be entirely supported and operated by its listeners in can be found in this city, the home of Station KFV. Since last Spring, when the Radio store owning Station KFIQ decided to abandon it, the outfit, a fifty-watt installation, has been operated entirely by the Yakima Valley Radio Broadcasting Association, an organization of listeners in formed for the purpose of keeping KFIQ on the air. KFV became the new call, however, when the change in ownership was made.

The Hotel Commercial of this city donates free studio and operating rooms, as well as the use of their roof for the antenna installation. The station is maintained purely as a community enterprise and service, and is supported by quarterly contributions from the members of the association. A number of business and professional members have volunteered as program directors, and the local Ladies' Musical Club has a standing Radio committee which presents several programs each month. Other musical organizations, business men's clubs, high school clubs and local orchestras also volunteer their services regularly to Station KFV.

Having kept the station on the air for over six months, the success of the enterprise is assured, and the experiment is indeed unique in that the station is operated and financed entirely by its own listeners in.

#### Yale-Army Game on WEAJ

NEW YORK.—"Bill" McNeary, well-known sport writer, broadcast from WEAJ here a running description of the recent Yale-Army game played at New Haven.

# THE ANTENNA BROTHERS

## Spir L. and Lew P.

# You Never Can Tell



# EXPOSE OF MUSIC TRUST PRINCIPLES

## SONG POPULARIZATION IS AIDED BY RADIO

How Broadcasters Association Is Developing Source of Support for Service

(The following article is one of a series which is being published with the express purpose of explaining to the Radio public the situation existing between the broadcasting stations and the American Society of Composers, Authors and Publishers. The series tells in detail the reasons why the National Association of Broadcasters was organized, and why certain popular songs the copyrights for which are controlled by the "music trust," are not being broadcast.—The Editor.)

### PART II

**B**UT BROADCASTERS believe, for many reasons, that Radio can do all this in a more thorough and expeditious manner. Among these reasons are: Music sent through the air is listened to by people in remote places as well as in cities. Ordinary song plugging methods do not reach millions of people, on the farms, in the villages, or even in small towns.

A repetition of the title before and after the rendition firmly fixes in the listener's mind the name of a musical number, a point frequently missed when hearing a composition sung from the stage or platform, and altogether absent when a melody is played by an orchestra or solo instrumentalist.

When a Radio listener likes a song, he naturally wants to hear it again, and when he wants to hear it. As far as he knows, it may never be broadcast again. This forces him to buy the music, phonograph record or player piano roll. Thus sales are directly linked with broadcasting—the results being surprising.

#### Form Bureau of Music Release

So the National Association of Broadcasters formed a Bureau of Music Release; employed a staff of experienced music men and invited publishers and song writers to send in their copyrighted music.

This invitation was widely spread through display advertisements placed in theatrical and musical papers; announcements by broadcasting station and cir-

## HALLOWEEN PRANKS BY AIR THE LATEST



Instead of looking into a mirror to see her future mate on Halloween, the modern miss hooks up the receiver and tries for her mate's voice coming in over DX. Here is pretty May West doing it. She wouldn't have had to wait long, if you had known, would she? Keystone View Photo

cular letters sent to every available name. The response was tremendous. Hundreds of compositions were sent in, and are continuing to come in every day. The Bureau of Music Release reviews these musical numbers and when one is found to be of good musical quality and clear lyrics, negotiations are opened with the owner of the copyright on this basis:

1. Standard compositions (as distinguished from popular and jazz) are broadcast without any financial return to the Broadcasters Association, on the theory that broadcasters want to do their part in fostering American musical genius.
2. Dance, jazz, blue and other types of

music described as "popular" are broadcast under special contracts whereby varying percentages of "mechanical royalties" are conveyed to the Association.

It is from this latter class of music therefore that this association is developing an income distributable to members upon an equitable basis and to be used by members for support of broadcasting.

**Earnings Aid Broadcasting**  
This is the first daylight on the much discussed question of where money is to come from to help support broadcasting. England tried to tax receiving sets. This could not be done in this country. Placing a tax on tubes has been suggested. For obvious reasons this is impracticable. Then (Continued on page 5)

# Thrills from Radio

No. 4 of a Series Featuring Experiences of "ALL-AMERICAN" Users

## Made Reflex Circuit Work Perfectly

By Harold M. Weinberger, Nashville, Tenn.

"I wish to congratulate you on the efficiency of your 'All-American' Radio Frequency Transformer.

"It is, in my opinion, one of if not the best transformers that have ever been made.

"I built a one tube Reflex Circuit for which another make of R. F. Transformer use was especially made.

"This transformer would not work at all, but when the 'All-American' was inserted the set worked to perfection."

Without distortion, "All-Americans" bring in distant and nearby stations with volume and tone-quality that mean real thrills.

They are the best known, most widely used transformers on the market. Standard equipment on the better sets. Why experiment?—over 300,000 radio enthusiasts, like Mr. Weinberger, have already proved "All-Americans" best.

### FREE!

All-American Book of tested hookups for getting new thrills out of your present radio outfit. Send 2c stamp for postage.



All-American Auto Frequency Transformer—comes in three ratios.

All the better dealers sell "ALL-AMERICAN"

**RAULAND MFG. CO., 200 N. Jefferson St., CHICAGO**  
PIONEERS IN THE INDUSTRY

AUDIO AND RADIO FREQUENCY



POWER AMPLIFYING INPUT AND OUTPUT

# ALL-AMERICAN AMPLIFYING TRANSFORMERS

Largest selling Transformers in the world



## REGENERATION and TUNED R. F.

find their first successful combination in the new

### GREBE

Broadcast Receiver



THIS instrument requires no outdoor wires. The beautiful walnut cabinet has compartments for all necessary batteries.

Write for "Grebe Radio in the Well-Appointed Home."

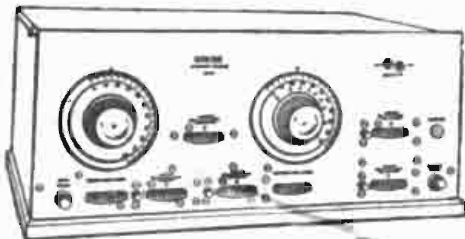

Licensed under Armstrong U. S. Pat. No. 1115149

**A. H. GREBE & CO., Inc.**  
Richmond Hill, N. Y.

Western Branch—451 East 3rd St., Los Angeles, Cal.

## THE AUDIOPHONE

Quality of reproduction such as only the original itself can equal. Speech that is so distinct that the voice heard is the actual voice of the speaker. Music that requires no tolerant imagination to be recognized as music of the finest type.



## Bristol's Single Stage Power Amplifier



gives additional VOLUME with any two stage amplifier. No C batteries required. It provides the additional volume necessary to bring in very distant stations on the loud speaker.

Write for bulletin and address of the nearest dealer handling our instruments

# THE BRISTOL COMPANY

WATERBURY, CONN.

Boston New York Philadelphia Pittsburgh Detroit Chicago St. Louis San Francisco

# CLAIMS FANS FAIL TO APPLAUD STARS

## WARNS OF GRAVE PERIL TO BROADCASTING

### Check-Up Shows Letters Praising Work of Artists Steadily Decreasing

Within the last few weeks, a man well known to Radio audiences throughout the country said, "Broadcasting is in a far more precarious condition than the three millions of listeners believe, due merely to one thing: the decrease in written applause mailed to artists after their appearance before the microphone."

"Last year and the year before that the appearance of a well-known artist at any one of the leading stations was a signal for a veritable flood of mail and telephone calls. Today an operatic star whose performance at a theater calls for the S. R. O. sign is fortunate if his Radio appearance draws a score of letters from appreciative Radio fans."

#### Need Spontaneous Letters

A check-up of this warning brings to light numerous facts that substantiate all the man said. Eventually this decrease in letter applause is certain to react on the quality of programs if it has not already done so. Whether or not there is a way to check the tendency is a problem now being studied by studio managers.

At any rate the simplest solution lies with the listener and his friends. No letter however carefully worded will "get over" with the artist unless it is spontaneous. The right kind of message of appreciation can be written on a postcard, while a full page letter written through a feeling of duty may be vacuous and deadening.

#### Public Appreciates Only What Costs

The sage who remarked that "the public will not appreciate what it does not pay for" has been referring directly to the Radio audience. It is probable that a tax on programs would cause features to be considered in their proper light. Too many fans take broadcasting for granted, as if the purchase of a set or the assembly of the parts carried with them the assurance of broadcasting organizations that programs would be continued.

If these fans would only consider for a moment that unless stations can assemble creditable artists the stations will be closed down, they would not be so chary with their applause but would let everyone know from artist to announcer that the efforts of all were sincerely appreciated.

Less public criticism and more private appreciation is the crying need of broadcasting stations and the solution is up to the Radio enthusiasts who enjoy but do not applaud.

# SEEK VANISHED GIRLS IN "LOST KIN" PLEAS

## Motorist Finds Youngster After Description Is Broadcast

BUFFALO, N. Y.—Several cases have arisen recently in which WGR, station of the Federal Telephone & Telegraph Co., here, has been instrumental in locating lost persons. As a result of this success a systematic arrangement has been made between the Buffalo Enquirer and WGR for regularly broadcasting descriptions of lost persons.

One notable instance of such service on the part of WGR was the case of the description of a lost child being broadcast. A Radiophan who heard the broadcast happened to be driving along the road that evening and saw a child which tallied with the description. The youngster proved to be the lost child. He was a runaway and was restored to his parents.

Most of those for which descriptions are broadcast are girls. It is estimated that at least 200 girls disappear in Buffalo every year and very few are ever heard from again.

# CALLS THE KOPS AND NABS THE BURGLAR

DETROIT.—While Kelwin Kearney, 19 years old, of this city, was sending a Radio message to a friend in Richmond, Va., early one morning recently, he discovered a burglar breaking his way into the rear of a store back of his house. He broke off his message and called KOP, the Detroit police station. The burglar was captured before he could leave.

# UNCLE SAM'S FLIERS TALK THROUGH HAT

WASHINGTON, D. C.—Air mail pilots flying across the continent will soon be able to "talk through their hats" to their ground stations. A one-man Radiophone transmitter and receiver has been devised which provides the headset under the pilot's helmet and the microphone on his breast. One pilot recently talked with Postmaster-General New while flying over Washington.

# SHE SHOULD GET AN EARFUL



No human ears in evidence here—as usual—but we'll bet this captivating young Radiophan, Agnes Leonard, gets an earful. The mammoth telephone receiver, the largest ever made, was displayed at a recent Radio show. Int. Photo

# France Demands Vessels Have Radius of 150 Miles

PARIS.—The recent French Radio requirements for vessels, extending the minimum range of transmission fifty miles, now also affect all foreign ships touching at French ports. The decree, signed last spring, provides that all vessels of 2,000 gross tons, all ships licensed to carry fifty persons including the crew, and also all craft having as many as

twelve passengers aboard, must be equipped to send and receive Radio messages by day up to 150 nautical miles.

Merchant ships between 500 and 2,000 gross tons, licensed to carry less than fifty persons, or with less than fifteen passengers aboard, must be capable of receiving Radio signals up to 2,800 meters and preserve a watch for emergency calls.

Radio is being charged with the responsibility for a decrease in fiction reading during 1922.

# WILSON BREAKS HIS SILENCE BY RADIO

## EX-PRESIDENT ADDRESSES "LARGEST AUDIENCE"

### Ten Minute Talk on Armistice Day Advocates International Peace

WASHINGTON, D. C.—Breaking his silence of four years, Woodrow Wilson on Armistice Day eve made his first address to the American public through microphones installed in the library of his home here and connected with Stations WCAP of this city, and WEAJ of New York. Strangely enough, the address was heard by the largest audience the former president ever faced, even during the height of his career as leader of American affairs.

His speech, "The Significance of Armistice Day," was greatly appreciated by the million listeners in. His subject could have been handled better by no other man, as he, more than any other single individual, was responsible for the negotiations which brought about the declaration of the termination of the World War on November 11.

#### Advocates World Peace

Touching upon the present international situation, his speech lasting only a little more than ten minutes, was devoted largely to the subject closest to the ex-president's heart, American participation in the establishment of the peace of the world.

The extraordinary event of the broadcasting of the former president's address, following closely upon the recent dissemination through many stations of David Lloyd George's speeches, is hailed as a tribute to the importance and dignity of the Radio audience.

Mr. Wilson's speech was the first message he has given to the American public since September, 1919.

# LISTENERS IN RUN THIS BROADCASTER

## Station KFV, Formerly KFIQ, Owned and Operated by Invisible Audience

YAKIMA, WASH.—What is probably the first broadcasting station to be entirely supported and operated by its listeners in can be found in this city, the home of Station KFV. Since last Spring, when the Radio store owning Station KFIQ decided to abandon it, the outfit, a fifty-watt installation, has been operated entirely by the Yakima Valley Radio Broadcasting Association, an organization of listeners in formed for the purpose of keeping KFIQ on the air. KFV became the new call, however, when the change in ownership was made.

The Hotel Commercial of this city donates free studio and operating rooms, as well as the use of their roof for the antenna installation. The station is maintained purely as a community enterprise and service, and is supported by quarterly contributions from the members of the association. A number of business and professional members have volunteered as program directors, and the local Ladies' Musical Club has a standing Radio committee which presents several programs each month. Other musical organizations, business men's clubs, high school clubs and local orchestras also volunteer their services regularly to Station KFV.

Having kept the station on the air for over six months, the success of the enterprise is assured, and the experiment is indeed unique in that the station is operated and financed entirely by its own listeners in.

#### Yale-Army Game on WEAJ

NEW YORK.—"Bill" McNeary, well-known sport writer, broadcast from WEAJ here a running description of the recent Yale-Army game played at New Haven.

# THE ANTENNA BROTHERS

## Spir L. and Lew P.

# You Never Can Tell





## ROMEO DOES HIS STUFF FROM KYW

GOUNOD'S OPERA TO GO ON AIR NOVEMBER 22

Synopsis of Action to Be Read between Scenes for Invisible Audience

CHICAGO.—Get out your works of Shakespeare, turn to "Romeo and Juliet" and review, for the next opera on the air will be Charles Gounod's popular love duet, based on the famous English dramatist's play. Announcement is made that "Romeo et Juliette" will be broadcast by Station KYW on the evening of November 22, direct from the Auditorium Theater where the Chicago Opera Company is holding away.

The three operas already broadcast this season from KYW, the Westinghouse station here, have proved very pleasing to the invisible audience of opera-Radiophans, as attested by thousands of letters received at the broadcasting studio.

### Mason and Hackett to Sing

Edith Mason, the famous American soprano, will sing the role of "Juliet," while Charles Hackett, tenor, another American, will make his first appearance this year, as a guest artist, in the rôle of "Romeo." Although at the time of writing the remainder of the cast was undecided, it was believed that Cesare Formichi, the Italian baritone, and Edouard Cotreuil, distinguished French basso, would sing in the tragic opera.

The opera, as was said, follows closely the action of Shakespeare's great love drama, except for the interruption of the balcony scene, and for the abbreviation of the cast in order to reduce the length of the drama when sung. As it is, there are five acts.

### Other Opera to Begin at 7:45

Following the precedent of the three operas already put on the air this season, A. W. "Sen" Kaney, KYW announcer, will begin the other production at 7:45 p. m., Central Standard time, with a short history of the opera and a synopsis of the first act.

Between acts, Mr. Kaney will explain the action to take place in the following act. His knowledge of operas and clear enunciation provide the missing link so necessary to visualize the beautiful love-drama for the unseeing listeners in.

Mrs. George B. Foster, well known in Chicago society, has prepared the synopses of the various acts, together with a short history of Gounod's composition.

### U. S. Has Job for Radio Man

WASHINGTON, D. C.—The United States Civil Service Commission has announced that a position is open in the army signal corps at Camp Alfred Vail, N. J., for a Radio laboratory aid, a Radio laboratorian and a junior Radio engineer. Certain specified education, training, and experience are required and competitors will be examined December 5. They will be rated as follows: General physics, twenty percent; mathematics through calculus, twenty-five percent; practical questions on Radio engineering, thirty percent; and education, training, and experience, twenty-five percent.

Col. Edward H. R. Green, son of Hetty Green, who operates Station WMAF at Round Hills, Mass., has a hobby for large loud speakers. While conducting some tests residents six miles away heard the music and spoken messages.

Charles Hackett, left, makes his first appearance this season with Chicago Civic Opera Company as guest artist in role of "Romeo"

Edith Mason as "Juliet" in "Romeo and Juliet," to be broadcast Thursday, November 22. Cesare Formichi, right, baritone, was announced as a probable member of the cast of the opera

## MUSIC TRUST SURVEY

(Continued from page 4)

there has been talk of a popular subscription from listeners. This has its defects. But here is a plan which places no additional burden on anyone and yet produces an income.

Now, what are these "mechanical royalties" heretofore mentioned and which are to yield support to broadcasting?

### Copyright Owners' Profits

The Copyright Act of 1909 provides that two cents cash royalty shall be paid for each phonograph record made of a copyrighted musical number whether song or instrumental. The phonograph record manufacturer puts this two cents in the price of the record. The public therefore unconsciously pays the royalty, and this two cents on each record goes to the owner of the copyright just as directly as does two cents paid for a postage stamp go to the U. S. Government. The yearly total of these royalties reaches a very large figure.

The Copyright Act of 1909 provides for two cents to be paid by the manufacturer on each player piano roll made of a copyrighted musical number. But the act failed to take into consideration rolls made, upon which are printed the words of a song. These so-called word rolls were unknown at the time the Copyright Act of 1909 was written, but at the present time represent 95 percent of all piano player rolls made. The publisher members of the American Society of Composers, Authors and Publishers, however, were not slow in sensing a fine opportunity for more profit. Through clever manipulation, and without the law giving them specific rights, they successfully collect ten percent of the retail price on each roll made, and the ultimate consumer pays this tax without knowing anything about it. Most good player piano rolls sell for \$1.25, which means a cash return of 12½ cents on each roll sold. The piano player roll industry therefore pays a tremendous sum yearly to musical copyright owners.

Then the copyright owner also has his profit from the actual sale of sheet music which in cases of "hits" is very substantial.

### "Plugging" Makes Popular Music

But phonograph and piano roll manufacturers only want to put out songs which have become popular. This popularizing of songs is the publishers' hardest job. Not only hard but costly. How does he accomplish "popularization"? How does he create enough of a demand for his song so that leading manufacturers such as the Victor Talking Machine Company and the Q. R. S. Piano Player Roll Company will seek him?

Why, by doing what he calls "plugging" his songs through every known channel. He employs an active professional department; influences prominent stage folk, orchestras and other performers to use his

song by frequently, if not usually, paying many good, round hard dollars to them; sends his staff singers around and forces them on programs wherever possible; pushes his song over music counters

privately owned; advertises in theatrical, musical and other mediums; sends out free many orchestral and "professional" copies of his song; provides elaborate and costly posters, window cards, movie films; circularizes music dealers, song shops, phonograph stores and various types of merchants; employs traveling men and in many ways "not apparent to the naked eye" does he plug his song.

(TO BE CONTINUED.)

## Canadian Boys Organize a League All Their Own

TORONTO, ONT.—A boys' Radio league is shortly to be organized in Toronto, Montreal, Winnipeg and Vancouver. The first meeting of the executive council was held here recently when preliminary plans were discussed. The object of the new association is to interest boys between the ages of ten and twenty years in Radio in all its branches.

**W**ELL worth listening to, those programs that are coming in by radio! Great music, lectures, news of the minute, stories—to make your home alive instead of dead. Use only De Forest Radiophones, and get the joys of radio at its best. Go see that De Forest agent today.

DE FOREST RADIO TEL. & TEL. CO.  
Dept. R. D. 3 JERSEY CITY, N. J.

If Located West of Pennsylvania, Address  
DE FOREST RADIO TEL. & TEL. CO.  
Western Sales Division  
Dept. R. D. 3 5680 12th St., DETROIT, MICH.



**MIKE DRESSES FOR HALLOWEEN PARTY**



One of the popular Class B stations staged a Halloween party recently and "Mike" (the microphone) was dressed up in this fashion. He ought to have scared witches away!

**Relay Boston Broadcasts to Station in Providence**

PROVIDENCE, R. I.—Broadcasts from Station WNC, the Shepard Stores, in Boston are now being relayed to WEAN, the Shepard Stores plant in this city, by a special telephone line and broadcast from the latter station simultaneously. This will give the Boston broadcasts a much larger area, as WEAN covers the southeastern part of New England. While the Providence station is low power, only 100 watts, and on a wave length below WNAC, it is covering the area around this city very well and by this new arrangement Rhode Island fans are assured much better programs.

**Concerts for Kids to Be Broadcast by WWJ**

Nine Detroit Programs Will Be Carried over Entire State

DETROIT.—It is announced that nine school concerts by the Detroit Symphony Orchestra will be broadcast this winter by WWJ, the Detroit News. The concerts are to be given for school children by the Symphony Society and will form a part of the state music memory contest. Through the broadcasting services by Station WWJ, the music as it is played in Orchestra Hall here will be given to all other schools in the state and country which possess receiving sets.

There will be five separate programs given on ten dates, that is, five of the concerts are repetitions of other programs. The concerts will be broadcast December 3, 10, Jan. 14 and 21, February 25, March 3 and 31 and April 7.

**OFFER PRIZES FOR HOMEMADE OUTFITS**

Boston Show to Give One Set Away Daily to Visitors

BOSTON.—Amateur set builders of New England will have an opportunity to enter their handiwork in the amateur set contest of the Boston Radio Show, which opens December 3 here in Horticultural Hall. There will be a class for boys and girls of ten years or younger, and one for all above that age. A \$25 prize in each class for the best workmanship and another of \$25 for greatest originality of design are offered in the contest.

Among the advertising features will be the free gift of a high-grade set to some one of the visitors each day by lot. Another feature will be the free sending of Radio messages to any part of the country. Sheldon Fairbanks, who managed the two previous shows, is the director of this year's show.

**WGY Controls Beach Lights**

SCHENECTADY, N. Y.—WGY here in directly controls the turning on and off of the street lights at Howard Beach, about twenty-five miles from New York. William L. Welling of that place reports that he depends on WGY for the correct time for the proper setting of the time clock which controls the operation of street lights in Howard Beach.

**YES! A RADIO FOR \$10.00**

Don't Pay More—First See the

**NATIONAL MONODYNE TUBE SET MODEL GT-1**

The Set with Only One Tuning Control

Operates on all wave lengths for local and long distance reception, clear and loud, without distortion.

So simple even a child can operate it.

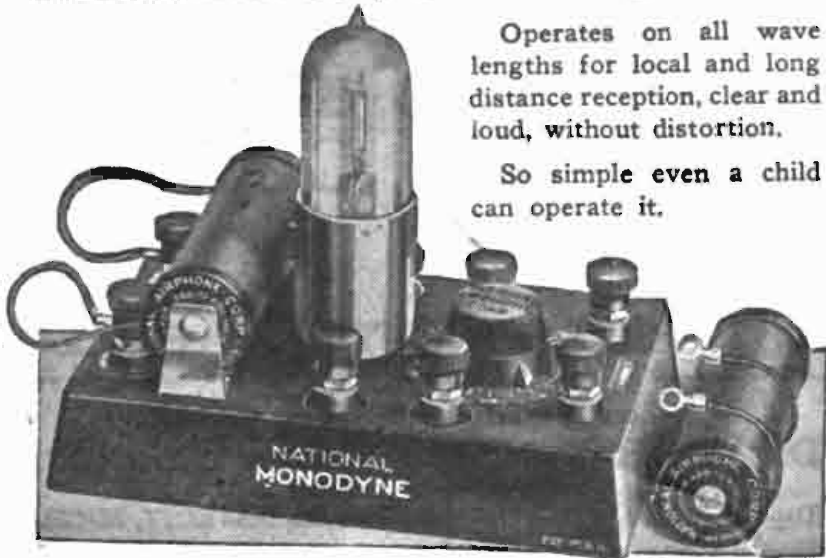

If your dealer cannot supply you, write direct to

**NATIONAL AIRPHONE CORPORATION**

16-22 Hudson Street NEW YORK CITY

**MAKE YOUR OWN SET CHEAPLY**

Selective Long Distance Receiver (See October 13, 1923, Radio Digest RD 100)		SPECIAL PRICE ITEMS	
3 Tube Sockets, Bakelite Bases	2.70	SPECIAL Tri-Coil Reflex Radio Frequency Transformer	
2 Radiometers, \$3.00 each	6.00	Our List Price	
1 .0005 Condenser, Variable Vernier	1.20	<b>PHONES</b>	
1 Honeycomb, 75 turn	1.20	Mico Double Phones "Sealed—Guaranteed" with Head Bands	
1 Single Coil Mounting	.50	Double Phone Cord	
1 Variable Grid Leak and Condenser	1.00	Genuine Master-Baldwin Type C Unit	
2 Transformers, Audio Frequency	8.00	Genuine Master-Baldwin Type C Doub.	
3 Rheostats	3.00	Loud Speaker Cord, 20 ft., 4 tips, our price	
1 .00025 Mfd. Fixed Mica Condenser	.40	<b>WIRE</b>	
1 .005 Mfd. Fixed Mica Condenser	.75	All kinds of wire put up in 1/2 pound spools. No. 18 to No. 28, silk, cotton and enamel, double or single	
1 Set Readem Binding Posts	.75	Same wire as above on 1/2 pound spools. 45 cents a spool	
12 feet of Bus Wire	.30	Hook-up Wire, No. 17 square brass, cut in 6 foot lengths	
2 Double Circuit Jacks	1.80	<b>RHEOSTATS AND SOCKETS</b>	
1 Open Circuit Jack	.75	MARVEL Rheostat, 6 ohms	
2 3" Dials	1.00	MARVEL Rheostat, 20, 25 and 30 ohms	
1 3 1/2" Dial	.75	MARVEL Rheostat, 40 ohms	
1 Panel, Bakelite, 9x14 1/2	2.50	MARVEL Rheostat, 50 ohms	
1 Baseboard, 9x14 1/2	.25	Potentiometer, 200 ohms	
1 Cabinet, 9x14x8, fine mahog. finish	6.50	Potentiometer, 400 ohms	
Including blue print with year 1923.	OUR PRICE	Potentiometer, 1,850 ohms, Federal Standard Sockets, bakelite base, \$1.25	
	\$39.75	No. Aid Sockets, 3 1/2", 3 ft.	
	TOTAL \$44.15	All-American Audio Transformers, 1-5 or 1-10	
		Webster Audio Transformers, 1-4 or 1-8	
		SPAGHETTI, black or yellow, 30"	
		<b>VARIOMETERS</b>	
		Moulded Variometer	
		Estru Split Variometer	
		Variometer, All Circuits	
		Readem Binding Posts, Set composed of 1 antenna, 1 ground, 1 A Battery + 1 A Battery + 2 tele-phones, 1 B Battery + 1 B Battery	
		OUR PRICE ONLY	
		TOTAL \$39.25	
		<b>Complete Parts for Miloplex Circuit—Cabinet Free</b>	
1 .0005 Variable Condenser, Vernier	\$6.00	3 3/4-inch Dials, each 75c	\$2.25
1 Estru Variometer	5.00	1 Potentiometer, 1850 ohm	2.20
1 .00025 Variable Condenser	2.00	1 Rheostat	1.00
1 Variable Grid Leak	.75	1 Socket Bakelite Base	.90
1 .00025 Mica Fixed Condenser	.40	1 Bakelite Panel 9x14 1/2	2.50
2 .002 Phone Condensers	.80	1 DeForest D.V. 6 Tube	6.50
		<b>TOTAL</b>	<b>\$33.70</b>
		<b>Our Price Only</b>	<b>\$28.50</b>
		<b>Blue print FREE only with order for complete parts</b>	

Complete Parts for One Tube Reflex		VARIABLE CONDENSERS	
1 Radiometer	\$3.00	Variable Condenser, .0005 (Same as 23 plate)	\$5.50 \$3.00
1 23 Plate Condenser	3.00	Variable Condenser with Vernier, .0005 (Same as 23 plate)	6.50 4.50
1 Tricoil Transformer	2.00	Variable Condenser, .001 (Same as 45 plate)	6.00 3.50
1 Audio Transformer	4.00	Walnut Variable Condenser, .00025	1.75
1 I99 Socket	.90	Bakelite, cut all sizes, 1/8" thickness	2c square inch
1 I99 Tube	6.50	<b>CABINETS</b>	
1 Baseboard, 7x9	.25	5x14x8, mahogany finish	\$3.25
1 7x9x 1/2 Bakelite Panel	1.25	7x 9x8, mahogany finish	2.75
1 Set Readem Binding Post	.75	7x21x8, mahogany finish	3.50
2 .002 Micon Fixed Condensers	.80	<b>MUST SEND POSTAGE</b>	
1 Type B. B. Metal Detector	1.50	H. C. Coil Mounting	\$5.00
1 Cabinet, 7x9x8	2.50		
<b>Complete OUR PRICE ONLY</b>	<b>\$22.45</b>	<b>TOTAL</b>	<b>\$28.45</b>

We Are Responsible Folks. Money Promptly and Cheerfully Refunded If You Are Not Satisfied. All Orders Mailed Promptly. Parcel Post Prepaid on \$5.00 or Over. No Stamps Accepted. Send Money Orders. Quality Merchandise at Low Prices. **Economical Radio House** 4600 Lincoln Avenue, Chicago

**RADIO TALKS**

If one is inexperienced and uncertain as to which is the preferable piece of apparatus to purchase for his set he will be moderately safe if he remembers that in a given wave-length class, the apparatus that covers the greatest range is liable to be of better design. Remember also that it takes a real piece of apparatus to operate satisfactorily below 200 meters. A tuning condenser that will work around 100 meters or less is a real condenser and the same applies for a tuning unit. Such apparatus is a guarantee of best results for broadest reception.

E. T. Flewelling

Visit our booth at the Radio Show, Coliseum, Chicago - Space 83.

**E. T. Flewelling Sockets**

This socket was designed by Mr. E. T. Flewelling to have the smallest possible amount of undesirable capacity effects between terminals—note how far apart they are. Spacing and shape of radio contact springs make this the ideal socket for radio frequency and reflex circuits and its use increases the efficiency of any radio set.

Tube cannot shake loose or break in your hand and will always have a positive connection at each terminal.

The design of this socket involved careful consideration of every detail, electrical and mechanical, to enable you to secure greatest efficiency in this vital part of your set.

**BUELL MANUFACTURING COMPANY**

2977 COTTAGE GROVE AVE. CHICAGO

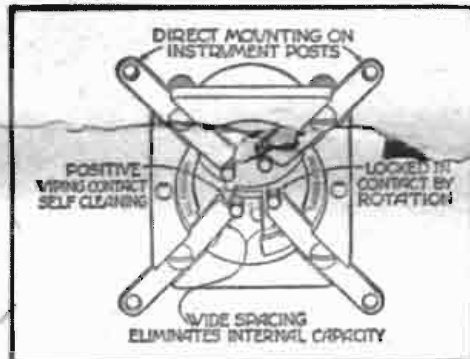

**\$1.00** At your dealers or post paid.



## ROMEO DOES HIS STUFF FROM KYW

GOUNOD'S OPERA TO GO ON AIR NOVEMBER 22

Synopsis of Action to Be Read between Scenes for Invisible Audience

CHICAGO.—Get out your works of Shakespeare, turn to "Romeo and Juliet" and review, for the next opera on the air will be Charles Gounod's popular love duet, based on the famous English dramatist's play. Announcement is made that "Romeo et Juliette" will be broadcast by Station KYW on the evening of November 22, direct from the Auditorium Theater where the Chicago Opera Company is holding sway.

The three operas already broadcast this season from KYW, the Westinghouse station here, have proved very pleasing to the invisible audience of opera-Radiophans, as attested by thousands of letters received at the broadcasting studio.

### Mason and Hackett to Sing

Edith Mason, the famous American soprano, will sing the role of "Juliet," while Charles Hackett, tenor, another American, will make his first appearance this year, as a guest artist, in the rôle of "Romeo." Although at the time of writing the remainder of the cast was undecided, it was believed that Cesare Formichi, the Italian baritone, and Edouard Cotreuil, distinguished French basso, would sing in the tragic opera.

The opera, as was said, follows closely the action of Shakespeare's great love drama, except for the interruption of the balcony scene, and for the abbreviation of the cast in order to reduce the length of the drama when sung. As it is, there are five acts.

### Ether Opera to Begin at 7:45

Following the precedent of the three operas already put on the air this season, A. W. "Sen" Kaney, KYW announcer, will begin the ether production at 7:45 p. m., Central Standard time, with a short history of the opera and a synopsis of the first act.

Between acts, Mr. Kaney will explain the action to take place in the following act. His knowledge of operas and clear enunciation provide the missing link so necessary to visualize the beautiful love-drama for the unseeing listeners in.

Mrs. George B. Foster, well known in Chicago society, has prepared the synopses of the various acts, together with a short history of Gounod's composition.

### U. S. Has Job for Radio Man

WASHINGTON, D. C.—The United States Civil Service Commission has announced that a position is open in the army signal corps at Camp Alfred Vail, N. J., for a Radio laboratory aid, a Radio laboratorian and a junior Radio engineer. Certain specified education, training, and experience are required and competitors will be examined December 5. They will be rated as follows: General physics, twenty percent; mathematics through calculus, twenty-five percent; practical questions on Radio engineering, thirty percent; and education, training, and experience, twenty-five percent.

Col. Edward H. R. Green, son of Hetty Green, who operates Station WMAF at Round Hills, Mass., has a hobby for large loud speakers. While conducting some tests residents six miles away heard the music and spoken messages.

Charles Hackett, left, makes his first appearance this season with Chicago Civic Opera Company as guest artist in role of "Romeo"

Edith Mason as "Juliet" in "Romeo and Juliet," to be broadcast Thursday, November 22. Cesare Formichi, right, baritone, was announced as a probable member of the cast of the opera

## MUSIC TRUST SURVEY

(Continued from page 4)

there has been talk of a popular subscription from listeners. This has its defects. But here is a plan which places no additional burden on anyone and yet produces an income.

Now, what are these "mechanical royalties" heretofore mentioned and which are to yield support to broadcasting?

### Copyright Owners' Profits

The Copyright Act of 1909 provides that two cents cash royalty shall be paid for each phonograph record made of a copyrighted musical number whether song or instrumental. The phonograph record manufacturer puts this two cents in the price of the record. The public therefore unconsciously pays the royalty, and this two cents on each record goes to the owner of the copyright just as directly as does two cents paid for a postage stamp go to the U. S. Government. The yearly total of these royalties reaches a very large figure.

The Copyright Act of 1909 provides for two cents to be paid by the manufacturer on each player piano roll made of a copyrighted musical number. But the act failed to take into consideration rolls made upon which are printed the words of a song. These so-called word rolls were unknown at the time the Copyright Act of 1909 was written, but at the present time represent 95 percent of all piano player rolls made. The publisher members of the American Society of Composers, Authors and Publishers, however, were not slow in sensing a fine opportunity for more profit. Through clever manipulation, and without the law giving them specific rights, they successfully collect ten percent of the retail price on each roll made, and the ultimate consumer pays this tax without knowing anything about it. Most good player piano rolls sell for \$1.25, which means a cash return of 12½ cents on each roll sold. The piano player roll industry therefore pays a tremendous sum yearly to musical copyright owners.

Then the copyright owner also has his profit from the actual sale of sheet music which in cases of "hits" is very substantial.

### "Plugging" Makes Popular Music

But phonograph and piano roll manufacturers only want to put out songs which have become popular. This popularizing of songs is the publishers' hardest job. Not only hard but costly. How does he accomplish "popularization"? How does he create enough of a demand for his song so that leading manufacturers such as the Victor Talking Machine Company and the Q. R. S. Piano Player Roll Company will seek him?

Why, by doing what he calls "plugging" his songs through every known channel. He employs an active professional department; influences prominent stage folk, orchestras and other performers to use his

song by frequently, if not usually, paying many good, round hard dollars to them; sends his staff singers around and forces them on programs wherever possible; pushes his song over music counters

privately owned; advertises in theatrical, musical and other mediums; sends out free many orchestral and "professional" copies of his song; provides elaborate and costly posters, window cards, movie films; circularizes music dealers, song shops, phonograph stores and various types of merchants; employs traveling men and in many ways "not apparent to the naked eye" does he plug his song.

(TO BE CONTINUED.)

### Canadian Boys Organize

#### a League All Their Own

TORONTO, ONT.—A boys' Radio league is shortly to be organized in Toronto, Montreal, Winnipeg and Vancouver. The first meeting of the executive council was held here recently when preliminary plans were discussed. The object of the new association is to interest boys between the ages of ten and twenty years in Radio in all its branches.

**W**ELL worth listening to, those programs that are coming in by radio! Great music, lectures, news of the minute, stories—to make your home alive instead of dead. Use only De Forest Radiophones, and get the joys of radio at its best. Go see that De Forest agent today.

DE FOREST RADIO TEL. & TEL. CO.  
Dept. R. D. 3 JERSEY CITY, N. J.

If Located West of Pennsylvania, Address  
DE FOREST RADIO TEL. & TEL. CO.  
Western Sales Division  
Dept. R. D. 3 5680 12th St., DETROIT, MICH.





# DIGEST GIVES RADIO DANCE INSTRUCTIONS

## FAMOUS MURRAY COURSE BEING BROADCAST

### Charts and Descriptions of First Two Lessons Herewith—Four More Lessons to Go on Air

Learn to dance by listening in! Radio Digest has perfected an arrangement with Arthur Murray, nationally known teacher of ballroom dancing, whereby Mr. Murray will broadcast dancing lessons from WOR, L. Bamberger and Company, Newark, N. J., and it is planned from a score of other prominent stations. Radio Digest exclusively will give the charts and instructions which apply to the lessons broadcast by Mr. Murray personally at WOR and by the other stations. The first two lessons with charts are given below. These may be used in conjunction with the broadcast lessons. The complete course will occupy six lessons, one of which will be given each week, following the first two which are given below. Save the lessons to use with the broadcasts.—The Editor.

## LESSON I—THE FOX TROT

By Arthur Murray  
How to Lead

**T**HE SECRET of being a good leader in dancing is to know exactly how to do each step—and then to dance in a decided manner. You must be sure of what you are doing. If you are uncertain as to how the steps are to be done, how is your partner to know?

If you know the steps and can do them well yourself, then guide your partner firmly with your right arm and hand, and she will follow if she knows anything about dancing.

There is a mistaken impression that the man must guide by pushing and pulling. This is unnecessary if your partner is a good dancer. The good dancer never thinks of how he is leading his partner; he simply does his own part well.

**How to Hold Right Hand**  
Hold your right hand firmly just below the lady's shoulder blade. You cannot lead if your hand is too low and if you hold your partner loosely.

You will need to do a bit of guiding sometimes with a partner who is not familiar with your steps. Then indicate to your partner with your right hand or arm. The left arm does not help very much in leading.

It is not best for the beginner to attempt to lead forcibly, as only advanced and intricate steps need forceful guiding. The beginner should learn his own part well. He will then find that his partner will follow without any help, even when she is only a fair dancer.

**Man Should Not Count**  
Don't count or tell your partner what to do next. By showing your partner that you really know what you are doing, you gain her confidence. She will follow you readily if she has faith in your ability.

Standing correctly and holding your partner in a comfortable position are of great help in leading successfully. Remember to stand erect. Be natural as well as comfortable and not too close to your partner, yet not too far away. At all times move easily and smoothly. The illustration shows the proper position of the head, arms, hands and body. The lady rests her hand lightly at the back of the man's right shoulder.

The man looks over the lady's right shoulder. The lady may face in the same direction, but it is advisable for her to

## FOOT-STEPS FOR DANCE LESSONS

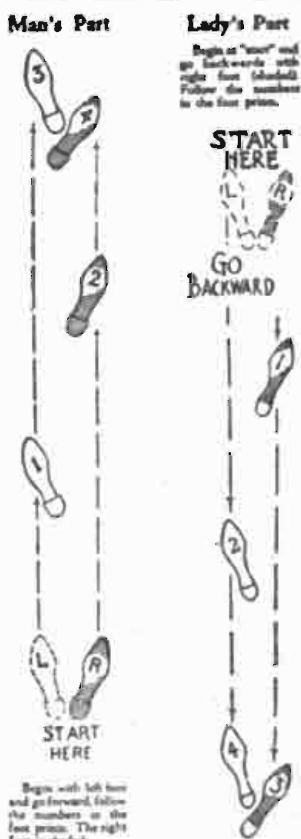

Figure 1 Figure 2

### THE TWO-STEP TO LEFT



Figure 3

### THE TWO-STEP TO RIGHT



Figure 4

look over her partner's right shoulder.

### Hold Firm; Stand Erect

The man holds his arms fairly high. He should hold his partner firmly, especially with the right arm and hand. Let the lady feel the pressure of your hand at her back (under the shoulder blade, above the waist line), and not have a "jelly fish" hold. The lady has more confidence in you if you hold firmly. The left arm is bent at the elbow. Dance on the toes and the balls of the feet. Do not let the heels touch the floor.

To look well while dancing, make yourself tall; hold your head up high, chin in, chest out. Dance as though your body were floating through the air. Keep your legs close together; do not spread them apart.

### Out Step or the Chassé—Man's Part

This step is one of the standard and most popular steps of the Fox Trot and One Step. It is sometimes referred to as the "Cut Step" because on the fourth step the man draws his right foot up to the left. Here is how the step is done:

At the "start" stand erect with your heels together. Then—1. Begin with the left foot and step directly forward, taking an ordinary walking step; 2. Walk for-

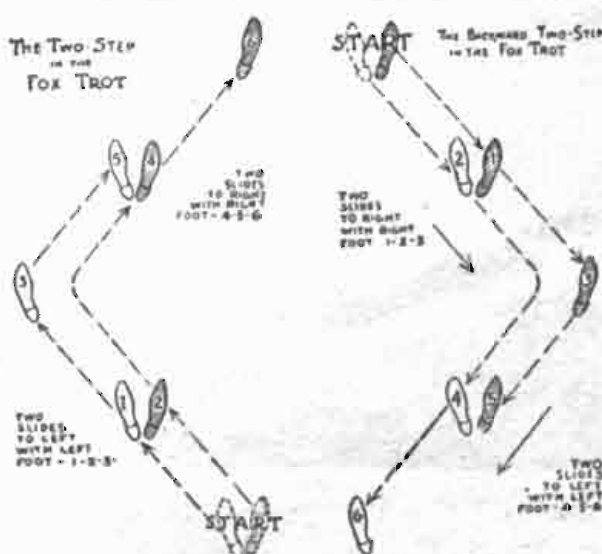

Figure 5 Figure 6

ward on right foot; 3. Walk forward on left foot; 4. Draw the right foot up to the left, placing weight on right foot. That's all.

Follow the numbers in the foot-steps shown in Figure 1.

If you want to repeat the step, begin with the left foot.

The Chassé may also be used in the One Step and the Waltz Canter. At first it is advisable to learn to dance the Chassé to Fox Trot music. After you learn it in the Fox Trot, you will have no difficulty in dancing it to One-Step or Waltz music.

The walking steps in the Fox Trot are long and slow. Each walking step takes a full second. The man generally walks forward so that he can see where to go. If the man dances backward he may collide with other couples.

### The Chassé—Lady's Part

The lady's part in the Chassé is just the opposite of the man's part. Start anywhere. Stand erect, with your heels together. Remember that the lady goes backward when the man goes forward.

1. Begin with right foot and step directly backward; 2. Walk backward on left foot; 3. Walk backward (long step) on right foot; 4. Draw the left foot up to the right, placing weight on left foot. That's all.

Follow the numbers in the foot-steps shown in Figure 2.

In the Chassé, as in other steps of the One Step and Fox Trot, the lady walks backward. To dance backwards may seem difficult at first, but with a little practice you will find it even easier than going forward.

Although the Chassé may also be used in the One Step and the Waltz Canter, it is most popular in the Fox Trot. Practice it going backward around the room, remembering to take long, slow steps. Each step is given a full second.

Remember to dance on the toes. Do not let your heels touch the floor.

## LESSON II—THE TWO-STEP In the Fox Trot

### What the Two-Step Is

Remember that a Two-Step is simply two sliding steps.

Beginning with the left foot, slide sideways two steps with the left foot. This you count:

1. Slide left foot directly to left; 2. Draw up right foot; 3. Slide left foot to left, weight on left. (Take right foot slightly off the floor.)

This completes a Two-Step to the right. See Figure 3.

The second part, two slides to right, is taken with the right foot:

1. Slide right foot to right; 2. Draw up left foot to right; 3. Slide right foot to right, weight on right. (Take left foot off the floor.)

(Continued on page 8)

## SAVE MONEY Radeco Safety Fuses

"The biggest little thing in radio"



Price 50 cents each postpaid

**R**ADIO experts recognize that some means of protecting the delicate filament of vacuum tubes is necessary. Thousands of tubes are needlessly burnt out each year. Radeco Safety Fuses have been developed to prevent this waste. They are endorsed by the leading radio publications. You can now absolutely protect the tubes of your set by slipping a Radeco Fuse on one of the filament terminals of each of your tubes.

Guaranteed not to interfere with the efficiency of your set. Save money by ordering today one fuse for each of your tubes. Mention type of tube.

Dept. 6

### RADIO EQUIPMENT COMPANY

20 Stuart Street, Boston, Mass.  
New England's Oldest Exclusive Radio House  
Distributors of many other successful radio specialties  
DEALERS: We are going to appoint live distributors  
Write for our proposition and full details

### READ WHAT ONE MAN SAYS

939 Dunlop Avenue  
Forest Park, Illinois  
Radio Equipment Company,  
Gentlemen: About last January I purchased some of your Radeco Safety Fuses. I have never had cause to regret this purchase, because I believe it has saved me many dollars. So I am writing to thank you and will recommend them to my Radio friends. The fuses have not interfered in any way with the operation of my set, and you are entirely at liberty to use this letter as an "ad" for your product, if you should so desire. Wishing you success in your present enterprise, I am,  
Yours truly,  
Mr. Harvey F. Reese.  
9/26/23

## New Coto Compact Moulded Variocoupler

Size is only 3/4x3x3 1/4. (Variometer to match 3/4x1 1/4x3 1/4.) Just what you have been looking for to make a beautiful, efficient and portable set. Eight taps for use with primary condenser. Pigtail connection to rotor. Range 200 to 600 meters.  
Type 9000.....\$5.50  
If your Dealer fails you write us at Once.

### COTO-COIL CO.

87 Willard Ave., Providence, R. I.

BRANCH OFFICES: Los Angeles, 329 Union League Bldg.; Minneapolis, Geo. F. Darling, 705 Plymouth Bldg.; Atlanta, C. P. Atkinson, Atlanta Tr. Co. Bldg.

## Natural Re-PRODUCTION

# Atlas AMPLITONE

## LOUD SPEAKER

The radio sceptic is I-N-S-T-A-N-T-L-Y convinced by the Atlas re-PRODUCTION. The patented "double diaphragm" responds to the full range of vibration cycles. Adjustable to your set and to receiving conditions. Hear the ATLAS Loud Speaker demonstrated at your dealer's. Write for Booklet.

Complete with Connecting Cord **\$25**

What have you accomplished with your Atlas Loud Speaker? Tell us about it.

TRADE MARK

### Multiple Electric Products Co. Inc.

ORANGE ST., RADIO DIVISION NEWARK, N. J.

### RADIO DANCE LESSONS

(Continued from page 7)

This completes a Two-Step to the right. See Figure 4.

To repeat, begin with the left foot and do the first part. Practice two slides to the left and two slides to right for thirty minutes.

#### The Forward Two-Step—Man's Part

In these instructions, "slide" indicates a sidewise movement. In the modern dances you do not actually slide or scrape the floor. Lift your feet slightly off the floor. The word slide will mean "step sidewise." Each step is about eighteen inches long.

The right and left two-step was explained first as merely a practice step and is not used in actual dancing.

The forward Two-Step is the easiest and most commonly used step in the Fox Trot. Once mastered, the turns and other steps are comparatively simple. The count is exactly the same as the right and left Two-Step given in the previous paragraphs.

Note that in the first Two-Step (count 1, 2, 3) you go toward the upper left corner. Then you Two-Step toward the upper right corner (count 4, 5, 6). In this way you advance forward instead of remaining on the same spot as in the Two-Step to the right and left, explained in the previous paragraph.

Start with the feet together as in Figure 5.

1. Slide left foot diagonally to left (toward upper left corner); 2. Draw right foot up to left; 3. Slide left foot again to the left, with weight on the left. This completes the first Two-Step; 4. Slide right foot to right; 5. Draw left foot up to right; 6. Slide right foot again to right, with weight on the right. This completes the second Two-Step.

Repeat the entire forward Two-Step of six counts and practice this step going around the room in the line of direction. Spend at least an hour.

#### The Backward Two-Step—Lady's Part

This movement is just the opposite of the forward Two-Step. It is the step the lady takes when the man goes forward. See Figure 6.

1. Slide the foot diagonally backward and to the right; 2. Draw left foot up to the right foot; 3. Slide right backward again, in the same direction as first step. This completes the first Two-Step. 4. Slide left foot diagonally backward to left; 5. Draw right foot up to left foot; 6. Slide left foot backward to left.

Study Figure 6 carefully and do each step slowly at first, then gradually faster

and faster until you can dance the backward Two-Step without counting.

Confidence is the very basis of achievement. There is a tremendous power in the conviction that you can do a thing.

You cannot build without a foundation. The forward and backward movements are the beginner's foundation for the Fox Trot. The steps to follow will be extremely simple if you know perfectly the steps described in the foregoing paragraphs.

Ask yourself: Do I know that a Two-Step is simply two slide steps taken sidewise? Do I know that the forward Two-Step consist of a Two-Step to the left and a Two-Step to the right. Do I know that the backward Two-Step is the counterpart of the forward Two-Step and that when the man does the forward Two-Step the lady does the backward Two-Step? Do I know that the lady always begins with her right foot?

#### Walking Steps and the Two-Step

We will now combine the walking steps with the Two-Step. The man will walk forward four steps, then take the forward Two Step, while the lady walks backward four steps and does the backward Two-Step.

Man's part: Begin with the left foot and walk forward four long, slow steps. Each walking step in the Fox Trot takes a full second.

(Continued on page 9)

### MID WEST RADIO TUBE EXCHANGE

We repair every type of tungsten wire filament tubes. Satisfaction assured.

UV 200- C 300	\$2.75
UV 201- C 301	3.00
UV 201a C 301a	3.50
DV 6	3.00
DV 6a	3.25

#### NEW TUBES

Clearon 3/4 amp. 6 volts detectors	\$2.50
Clearon 1/2 amp. 6 volts amplifiers	2.75

All the above tubes guaranteed detectors and amplifiers. Shipped C. O. D.

### MID WEST RADIO TUBE EXCHANGE

Congress Bldg., Room 613  
126-128 Congress Street West, Detroit, Mich.

## WALNART Variable Grid Resistance

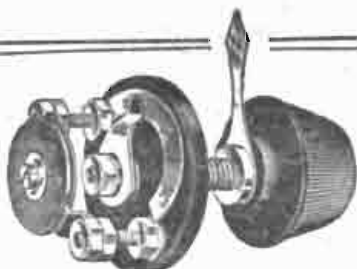

Complete with knob and pointer ..... **\$1.00**

Clears up signals.  
Gives longer life to batteries.  
Simple to operate and install.  
Will last indefinitely without deterioration or loss in efficiency.  
Can be used with or without a fixed condenser.  
The one Variable Grid Resistance that has given entire satisfaction.

We also manufacture variable condensers, plain and vernier, tube sockets, standard and UV. 199, vernier adjusters, inductance switches, etc., of highest quality. Ask to see them at your dealers.

**WALNART ELECTRIC MFG. CO.**

Dept. 410—1249 W. Van Buren St. CHICAGO

WRITE FOR FOLDER OF COMPLETE LINE OF WALNART RADIO PARTS



## WD-12

Radiotron WD-12 is the dry cell tube with the standard base—can be used in any set equipped with standard sockets.

It is one of the most popular of detector tubes, and gives most satisfactory volume as audio frequency amplifier—operating on a single 1 1/2 volt dry cell.

Price **\$6.50**

Radio Corporation of America

Sales Offices: Dept., 502  
233 Broadway, New York

10 So. La Salle Street,  
Chicago, Ill.

433 California Street,  
San Francisco, Cal.

Be sure that every tube you buy is marked **RADIO CORPORATION**

# Radiotrons

REG. U. S. PAT. OFF.



## Federal Radio Products Acclaimed by Experts the Whole World Over

—the result, obviously, of just one thing, their sturdy dependable efficiency—which means years of wonderful service and satisfaction.

More than 130 parts, from which any hook-up may be made, are manufactured and guaranteed by Federal.

Federal head sets, now endorsed the world over, are above all one of the Federal products that you should own.

Price  
2200 OHMS  
**\$7.00**

## Federal Standard RADIO Products



—WILLARD—  
WILLARD RADIO COMPANY  
291 BROADWAY,  
New York City  
"THE BEST FOR LESS"



### FLEWELLING CIRCUIT

EVERY PART COMPLETE  
2 honeycomb coils, 1 2-coil mounting, 2 coil bugs, 3 .002 condensers, 1 variable grid leak, 1 grid leak, 1 23-plate .0005 MFD. variable condenser, 1 Vernier rheostat, 1 tube socket, 8 binding posts, 20 feet bus bar wire, 1 3" dial and 1 high grade panel ALREADY DRILLED AS PER DIAGRAM in Booklet of instruction sent free. **\$11.95**  
Two-Stage Audio Frequency Amplifier—Parts complete in every detail for this Circuit—\$11.00  
Specify type of tubes you intend using

#### CONDENSERS

3 Plate Variable; value, \$1.75	\$1.05
11 Plate Variable; value, \$2.50	1.20
13 Plate Variable; value, \$2.50	1.20
17 Plate Variable; value, \$3.50	1.55
23 Plate Variable; value, \$3.50	1.35
43 Plate Variable; value, \$4.50	1.95
13 Plate VERNIER; value, \$5.50	\$3.75
23 Plate VERNIER; value, \$6.00	4.00
43 Plate VERNIER; value, \$6.50	4.25

Honeycomb Coils, 50 turns mounted	\$ .95
Honeycomb Coils, 75 turns mounted	1.00
Double Coil Mountings	2.45
Triple Coil Mountings	3.35
Reinartz Coils, increased wave-length and mounting	1.95

AUDIO FREQUENCY TRANSFORMER—  
Designed for use with W. D. 11  
Tubes, list, \$4.50; price..... **\$2.75**

BALL BEARING INDUCTANCE SWITCH—  
value, 75c; special..... \$ .25  
V. T. SOCKETS—Nickel, brass sleeve, composition base; value, \$1.00; special at..... .40  
EXTRA SPECIAL—Telephone 3000 Ohms Head-sets; \$9.00 value; reduced to..... 3.50  
Vernier Dial Adjuster. List, 35c; special..... .25

### REINARTZ CIRCUIT

EVERY PART COMPLETE  
1 Reinartz wound coil, 1 tube socket, 1 rheostat, 1 23-plate .0005 MFD. variable condenser, 1 15-plate .0025 MFD. variable condenser, 3 inductance switches, 23 switch points and nuts, 6 switch stops and nuts, 8 binding posts, 2 3" dials, 1 variable grid leak, 1 .002 MFD. phone condenser, 23 feet bus bar wire, 1 high-grade panel ALREADY DRILLED AS PER DIAGRAM and complete instructions..... **\$10.95**  
Two-Stage Audio Frequency Amplifier—Parts complete in every detail for this Circuit—\$11.00  
Specify type of tubes you intend using

BEST QUALITY JACKS, Single Circuit; value, 65c; special at..... \$ .30  
Double Circuit; value, 90c; special at..... .45  
MULTIPLE POINT INDUCTANCE SWITCH with Knob and Dial (15 Switch Points)..... \$1.25  
LIGHTNING ARRESTERS approved by underwriters..... .30  
THREE-INCH DIALS—Unbreakable—heat resisting composition—high finish; special..... .30

TWO-INCH DIALS—Same design—for rheostats and potentiometer; special at..... \$ .25  
Filament Rheostat, 6 ohm..... .65  
Filament Rheostat, 20 ohm..... .80  
Filament Rheostat, 50 ohm..... .90  
With 2" Dial, 15c extra.  
TELEPHONE PLUGS..... .60  
FRESHMAN VARIABLE RESISTANCE LEAK and MICA CONDENSER Combined. .75



Half the pleasure of Radio is in building your own sets. Many pleasurable and profitable hours can be passed in this way. Our service department will be glad to give you any information you need. Just drop us a line.



Every article advertised above is guaranteed by the manufacturer and by us—Mail orders filled immediately—transportation PREPAID on all orders of \$5.00 or over east of the Mississippi River. Send cash, check or money order—absolutely no goods sent C. O. D.

# HOME MADE CHART TELLS GRID GAMES

HELPS LISTENER TO VISUALIZE SCENES

Provides Means of Plotting Each Play As Announced by Broadcasting Station

BOSTON.—For the benefit of Radio-phans who listen in to the broadcast reports of the various football games, broadcast play-by-play, a chart has been devised by which plays can be plotted as they are announced and thus somewhat visualize the game.

First a field plan may be drawn on cardboard, wrapping paper or a large white sheet of paper, fifteen inches from end to end of field and twelve inches from sideline to sideline. A heavy line inside the end line marks the goal line, and then the sheet is ruled from end to end in spaces representing five yards each up to the fifty-yard line in the center, beginning with zero at each end, as on a regular football chart. Charting begins with the kickoff, and zigzags back and forth, following the plays as announced.

Small black circles represent one team and small white circles the opposing team. Crosses represent penalties; F. P., forward pass; black lines, rushes by the black team and short dashes rushes by their opponents. Zigzag lines with B above them represent black's kicks, and the same with W above them represent their opponents' kicks.

### Chart Good for Four Quarters

The chart is ruled in equal parts lengthwise of the field to represent the four quarters, the first period beginning at the top of the sheet, which would be placed the long way up, and the yard lines marked at top and bottom of the sheet. If one wants to keep a record of the number of downs, he puts a figure representing that number close to the circle representing the

### Audion Oscillation

Very little has been said about the oscillating point of the audion. Although two vacuum tubes may be of the same type, they will not always operate efficiently under the same conditions. Vacuum tubes vary in their characteristics; there are no two bulbs alike. The main trouble with nonoscillating V. T. circuits lies in the fact that too little is given the B battery potential. When trying out a new bulb use a variable plate voltage, as some tubes are very critical, necessitating careful adjustment.

Make \$128 Weekly in Spare Time—Sell what the public wants—long distance radio receiving sets. Two sales weekly pays \$120 profit. No big investment, no canvassing. Sharpe of Colorado made \$955 in one month. Representatives wanted at once. This plan is sweeping the country—write today, giving name of your county. Ozarka, 857 Washington Blvd., Chicago.

### RADIO WALL MAP 10c

Up to date, just off the press. Shows call letters, location, wave length, and kilocycles of all radio broadcasting stations; also American Relay divisions and radio districts. Complete with scale for measuring distances. Size 28x34 inches, printed in three colors. Postpaid for a dime. Ozarka, Inc., 854 Washington Blvd., Chicago

## Sweeping the Nation

1,000 MILE RECEPTION \$39 and Up



Electro Magnetic Loudspeaker Line of Remarkable Value \$35

The Lytton line of radio masterpieces is now being demonstrated by a number of unsolicited dealers. Mark us! When our broad campaign is announced in a short time, it will start a new era in radio. Also COAST-TO-COAST LOOP SET with the LYTTON 4-tube "Duplex" circuit. \$112.50 Write for descriptive catalog, specifying in which set you are interested.

WALTER LYTTON, INC. CHICAGO  
Lytton Building

## LLOYD GEORGE PONDER ON "MIKE"



Talking into "those-er-eh-Radio things" did not make a huge hit with David Lloyd George during his tour of the United States and Canada. "In the Flewelling circuit a push or amplifier tube is required and about 45 volts or more of B battery.

The variable condenser may be either a .00025 or a .0005-mfd. capacity. A vernier attachment will be found a valuable asset.

in the military and naval actions. He actually said that Radio would be the chief factor and stretch and the adjacent turns will be loose.

Radio set complete, batteries, phones, tubes, \$22.50, or parts separate. J. E. Lima, 4847 North Albany avenue, Chicago, Ill.

## RADIO DANCE LESSONS

(Continued from page 8)

Note: LF means left foot; RF means right foot.

Walk forward: 1 LF; 2 RF; 3 LF; 4 RF.

Then do the forward Two-Step of six counts. (See description of the forward Two-Step if you are not already familiar with it.) Repeat, beginning with walking steps.

Lady's part: Begin with the right foot and walk backward four long, slow steps. Each walking step takes a full second.

Walk backward: 1 RF; 2 LF; 3 RF; 4 LF.

Then do the backward Two-Step, beginning with right foot. (See description of the backward Two-Step if not already familiar with it.)

### How to Repeat

To repeat the four walking steps and the Two-Step, the man begins with the left foot and the lady begins with the right. At least an hour should be spent in practicing this step.

The Two-Step is made of three steps: slide, draw, slide. For convenience, we count it 1, 2, 3. Some teachers count a Two-Step as 1 and 2. Either way is correct. The word "and" is often confusing, therefore we will continue to count a Two-Step as 1, 2, 3.

Remember that there is a slight pause after you have taken the third step in the Two-Step; also after the sixth step.

Caution: Do not go any further until you are positive that you are thoroughly familiar with all the information in the foregoing lessons. Begin at the beginning and read carefully all information to be sure that you have not missed anything.

### Theatrical Reviews on WLW

CINCINNATI.—To give the Radio audience as wide a range in informative service as possible, Station WLW, the Crosley Manufacturing Company here, devotes a portion of its Monday schedule for theatrical and movie reviews. The movie reviews are given at 4:00 p. m., and the theatrical reviews at 9:30 p. m., Central time.

## FREE

Write for Free Copy of the Latest Radio Reprint. It contains a complete story from Hearst's International Magazine. Address Radio Editor, Hearst's International Magazine, 119 West 40th Street, New York City.

### WE PAY

You don't have to pay a cent of postage or shipping charges. We pay the postage for you.

# RADIO SHACK

58 DEY STREET

NEW YORK CITY

One of Six New York Stores

### C. O. D.

An extra convenience! You don't have to include a remittance with your order. Just pay the postman on delivery.

## Guaranteed Goods at "Lower-Than-New York" Prices!

### SAVE ON TUBES

Superiron, Type WD-12 (silvered). An exceptionally good guaranteed dry cell tube. Oscillates in all circuits. Very sensitive. 1½ volt..... \$2.98



### SHACKTON VARIABLES

Moulded endplates and a unique tension holding adjustment which keeps the plates in line.

43 Plate ..... \$1.35  
23 Plate ..... 1.15  
11 Plate ..... .95



### SWITCH LEVERS

Tapered knob and nicked blade. Bushing adjusts to any panel. 19c



### INSULATORS

Stop the leaks in your antenna. These moulded insulators will do it. Very strong..... 8c

### DIALS

De Forest type with brass bushing and clear, readable numbers.

4-inch ..... 45c  
3-inch ..... 23c  
2½-inch ..... 18c  
2-inch (rheostat) ..... 16c



### BRUNSWICK SPECIAL

¾ to 1 Audio

This transformer has a specially impregnated coil. The special construction makes distortion almost zero..... \$3.49



### BINDING POSTS

All nickel or composition with nicked shoulder. A good buy.

2 for 5c



4c Each



### PLUGS

Either the round or the flat type. Well made, sturdy brass parts that insure good contact..... 34c

### MOULDED SOCKETS

Made with a very heavy moulded base and nicked sleeve. Extra heavy spring contacts ..... 29c

### BRUNSWICK VERNIER

A precision vernier condenser. Strong moulded end plates and a moulded dial with vernier adjustment.

43 Plate ..... \$3.25  
23 Plate ..... 2.95  
11 Plate ..... 2.75



### SHACKTON RHEOSTATS

A very good all-moulded rheostat. In sizes for all tubes. Complete with knob.

30 ohm ..... 43c  
6 ohm ..... 32c



### JACKS



Single and double circuit. With a special insulator strip that prevents shorts. Two washers 34c

### BRUNSWICK D. L. COILS

Mounted on pure Bakelite De Forest type plugs. Correctly wound.

No. 35 ..... \$ .85  
No. 50 ..... .95  
No. 75 ..... 1.05  
No. 100 ..... 1.25



## A WRITTEN GUARANTEE!

A written guarantee is packed with each order. You must be satisfied before we consider the transaction closed.

ORDERS SHIPPED SAME DAY AS RECEIVED—WRITE FOR CATALOGUE

### THREE SPIDER WEB COIL HOOK-UP GIVES VOLUME

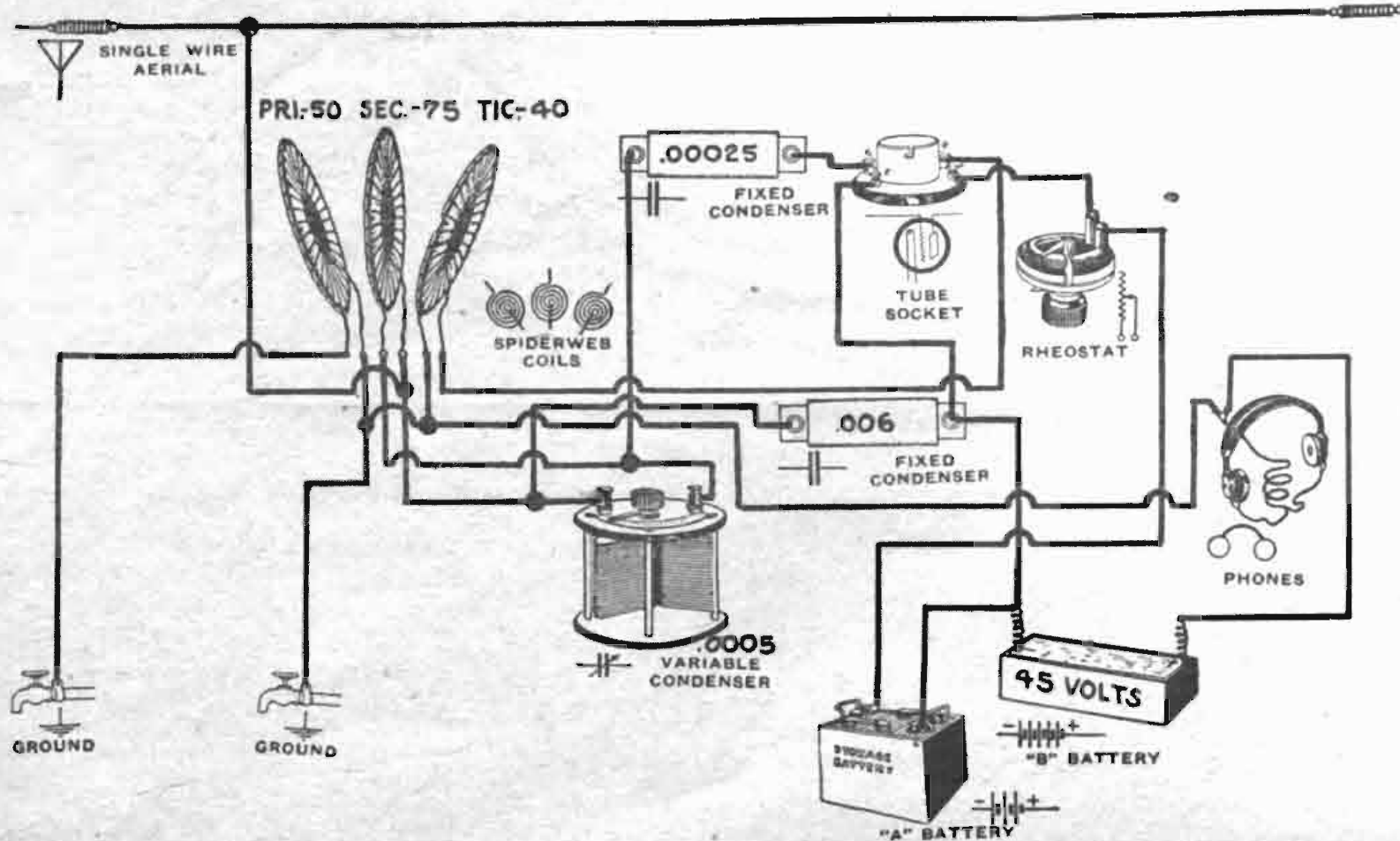

**M**R. H. G. BORGFELODT of Wilmette, Ill., submits to us his diagram of a hook-up using three spider web coils which has proved to give unusual volume. Because of this fact, he thought other fans might like to try it out. We

have reproduced his circuit in the form of a Simplex Diagram for the fans to construct.

He states frankly, it appears to be a form of Flewelling circuit, with some slight variations. The reception is unusual without distortion.

The number of turns in the spider web coils are indicated over each one.

#### Soldering Leads to Taps

When soldering leads to the loop taps do not pull on the lead more than is necessary. The wire on the winding form will then remain in its position.

side that gains the down... Lines showing the play... cross, but work gradually down... the space for each period to the bottom. Remember that the kickoff starts from the forty-yard line of the team kicking off. All goals from touchdown are kicked from the defending side's 20-yard line. It's as simple as A. B. C., and the listener in can keep a record of the game that will be as close as that of the newspaper in his city the next morning.

They are annoying, you know—I mean those—what do you call them—microphones? Mr. Lloyd George told a representative of Radio Digest in an exclusive interview. "One must keep his voice at an even keel, I understand, to make it sound well to the Radio listeners," he continued. "This fact alone, being constantly in the speaker's mind, is annoying to one who is not accustomed to talking into those strange little round affairs." Practically every speech made by the former English premier in the United States and Canada was broadcast. The little Welshman has great ideas for Radio. In a speech made in Toronto he declared that the next world war will be one fought from the air and that Radio will take the most important part

A short aerial gives a sharper tuning than a long one.

#### Hook-Up for Crystal Set

Very good results may be obtained with a crystal set if the variable condenser is placed in series with the aerial and

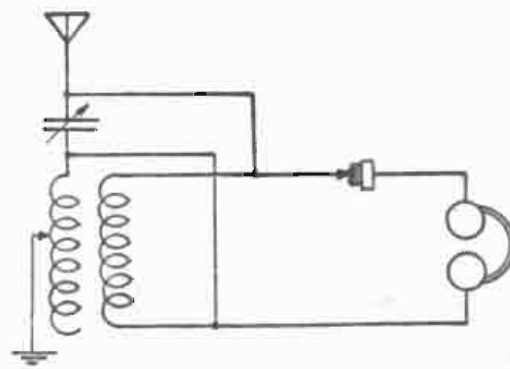

shunted across the secondary of the coupler.

With such a circuit I have no difficulty in receiving at least one or two of the stations, WEA, WGY, WBZ, KDKA and WHAZ, and occasionally CFCA, whereas only local stations could be heard before. Of course, it is only on quite clear nights that the stations referred to can be heard.

I may add that it may be necessary to use a lower tap on the primary coil, as it will be found that by putting the condenser in this position it will increase the primary inductance.—E. B. Mulkins, Ottawa, Canada.

Never use oilcloth, as this material holds static charges.

#### RADIO FANS

Tune in on station WEA F (New York)

every Thursday at 8.50 P. M. and listen to a story or article selected from

HEARST'S INTERNATIONAL

This is one of the most popular weekly features

#### Hearst Near Equator

CINCINNATI.—A message from Royal Sterling of the S. S. Hawaiian of the American-Hawaiian Line, recently informed Station WLW here that it had been heard about 120 miles off La Libertad Salvador.

In tuning in stations on a regenerative set it is necessary to pick up first the carrier note.

## How Lively Is Your "B" Battery?

THIS IS NUMBER THREE OF A SERIES Some people buy Eveready "B" Batteries oftener than other people. This is because each user has different tastes and desires in radio receiving. Those that demand maximum volume—and to get it use many tubes, forcing them to the limit with high voltages on the plates—are eager and frequent buyers of these batteries.

Others renew them less often. They are the ones that are content with smaller volume and employ fewer tubes at lower plate voltages. Furthermore, every radio user, regardless of the tubes he uses, has his own ideas as to when it is time to strengthen the signals with fresh "B" Batteries. Some will long enjoy concerts that others would not consider loud enough. Just what is "too weak" is purely a matter of personal opinion. These, then, are the things that determine how long you use your "B" Batteries—

1. The number and kind of tubes. The more tubes you use and the greater their power, the more current flows from the "B" Battery and the shorter is its life.
2. The "B" Battery voltage. The higher it is, the more current flows from the battery.
3. The amount of negative grid bias ("C" Battery voltage) on amplifiers. The greater the bias, the smaller the "B" Battery current.
4. The life put into the battery in the first place by the manufacturer, and the freshness of the battery when you buy it.
5. The signal strength you wish. The smaller the volume of sound you can enjoy, the longer you can use your "B" Batteries.

The life of any "B" Battery you can buy is affected by the above factors. Subsequent advertisements will set forth each factor in detail.

Eveready "B" Batteries predominate. There is more life in them—they last longer! Blocks of large cells, packed with energy, made especially for radio use, delivered fresh to your dealer, give you the most power for your money—power you can use loudly and swiftly, or softly and slowly as you wish—Eveready for Everybody!

#### "the life of your radio"



The Metal Case Eveready "B" Battery, No. 766. The popular 22½-volt Eveready Battery

in a new, handsome, durable, waterproof metal case. At all dealers, \$3.00.



Eveready "B" Battery No. 767. Contains 30 large size cells, as used in the popular No. 766. Voltage, 45. Made especially for sets using detector and one or more stages of amplification. The most economical "B" Battery where 45 volts are required. At all dealers, \$5.50.



Eveready Radio Battery No. 771. The Eveready "Three," the ideal "C" Battery. Voltage, 4½—three terminals permitting the use of 1½, 3, or 4½ volts. The correct use of this battery greatly prolongs the life of the "B" Battery. At all dealers, 70 cents.

Manufactured and guaranteed by

NATIONAL CARBON COMPANY, Inc. Long Island City, N. Y.

# EVEREADY Radio Batteries

—they last longer

Note: This is Number 3 of a series of informative advertisements, printed to enable users to know how to get the most out of their receivers and batteries. If you have any battery problem, write to G. C. Furness, Manager Radio Division, National Carbon Company, Inc., Thompson Ave. & Orton St., Long Island City, N. Y. Write for special booklets on "A," "B," and "C" Batteries.

### AN EVENING AT HOME WITH THE LISTENER IN (SEE INSTRUCTIONS FOR USE BELOW)

Station and City	Met	Monday	Tuesday	Wednesday	Thursday	Friday	Saturday	Sunday
CFCN, Calgary, Alta.	440	12:00-1:00		11:00-2:00			11:00-1:00	
CKAC, Montreal, Que.	430		6:00-8:30		6:00-8:30		6:00-8:30	3:30-4:30
KDKA, E. Pittsburgh, Pa.	320	5:00-9:00	4:00-8:00	5:00-9:00	5:00-9:00	5:00-9:00	5:00-9:00	6:30-7:30
KDZE, Seattle, Wash.	455	10:30-12:30		10:30-12:30		10:30-12:30		
KFAF, Denver, Colo.	300	9:00-10:00	9:00-10:00		8:30-9:00	9:00-10:00	9:00-10:00	
KFL, Los Angeles, Calif.	469	8:45-1:00	8:45-1:00	8:45-2:00	8:45-1:00	8:45-2:00	8:45-2:00	10:00-1:00
KGW, Portland, Ore.	492	10:00-12:30	10:00-1:00	10:00-1:00	10:00-1:00	10:00-1:30	10:00-1:30	8:00-10:00
KHI, Los Angeles, Calif.	305	8:45-12:00	8:45-12:00	8:45-12:00	8:45-12:00	8:45-12:00	8:45-12:00	10:00-12:00
KPO, San Francisco, Calif.	423	10:00-12:00	10:00-12:00		10:00-12:00		10:00-2:00	10:00-12:00
KSD, St. Louis, Mo.	546	8:00-10:00	8:00-1:00	8:00-1:00		8:00-10:00	8:00-10:00	
KYW, Chicago, Ill.	536	6:30-9:00	8:00-9:00	8:00-9:00	8:00-9:00	8:00-9:00	8:00-9:00	
NAA, Radio, Va.	435	6:45-7:20	6:05-7:20	6:25-7:40	5:45-7:40	7:05-7:40		
PWX, Havana, Cuba	400						7:30-10:00	
WBAP, Fort Worth, Texas	478	7:30-10:45	7:30-10:45	7:30-10:45	7:30-10:45	7:30-10:45	7:00-7:30	5:00-6:00
WBAP, Columbus, O.	390	8:00-10:00						
WBZ, Springfield, Mass.	337	5:00-8:00	6:30-8:00	5:00-11:00	6:30-8:00	5:00-11:00	6:30-8:00	5:45-8:30
WCAP, Washington, D. C.	469		6:30-7:30		9:00-11:00		6:30-11:00	6:20-7:20
WCBD, Zion, Ill.	345	8:00-10:00				8:00-10:00		2:30-5:30
WCX, Detroit, Mich.	517	7:30-9:00	7:30-11:00	7:30-9:00	7:30-9:00	7:30-9:00		6:15-7:15
WDAF, Kansas City, Mo.	411	8:00-1:00	11:45-1:00	8:00-1:00	11:45-1:00	8:00-1:00	11:45-1:00	
WDAF, Chicago, Ill.	360		7:00-1:00	7:00-1:00	7:00-1:00	7:00-1:00	7:00-1:00	9:15-11:15
WDAF, Philadelphia, Pa.	395	6:30-9:55	6:30-7:00	6:30-10:00	6:30-7:00	6:30-12:00	6:30-7:00	
WEAF, New York, N. Y.	492	6:30-9:00	6:30-9:00	6:30-9:00	6:30-9:00	6:30-9:00	6:30-10:00	6:30-9:00
WFAA, Dallas, Tex.	470	8:30-9:30	8:30-12:00		8:30-9:30	8:30-12:00	8:30-11:00	9:30-11:00
WFL, Philadelphia, Pa.	395	6:00-6:30	6:00-8:00	6:00-6:30	6:00-8:00	6:00-6:30	6:00-8:00	6:30-7:30
WGI, Medford, Mass.	360		6:00-7:30	6:00-7:30	6:00-7:30	6:00-8:00	6:30-10:00	7:30-10:00
WGR, Buffalo, N. Y.	319	5:30-11:00	5:30-7:45	5:30-11:00	5:30-7:45	5:30-11:00	5:30-7:45	2:00-3:00
WGY, Schenectady, N. Y.	380	6:45-9:00	6:45-9:00	6:45-9:00	6:45-9:00	6:45-10:30		5:30-6:30
WHA, Madison, Wis.	360	7:30-8:30		7:30-8:30		7:30-8:30		
WHAS, Louisville, Ky.	400		7:30-9:00	7:30-9:00	7:30-9:00	7:30-9:00	7:30-9:00	4:00-5:00
WHAZ, Troy, N. Y.	380	8:00-9:30						
WHB, Kansas City, Mo.	411		8:00-10:00		8:00-10:00			8:00-10:00
WHK, Cleveland, O.	283	5:00-5:30	5:00-5:30	5:00-5:30	5:00-5:30	5:00-8:00	5:00-5:30	7:00-8:30
WHN, New York, N. Y.	360	6:30-11:00	8:30-11:00	8:30-11:00	8:30-11:00	8:30-11:00	8:30-11:00	
WIP, Philadelphia, Pa.	509	5:00-6:30	5:00-11:00	5:00-6:30	5:00-10:00	5:00-6:30	5:00-11:00	
WJAR, Providence, R. I.	360		6:20-7:00	6:20-11:00		6:20-9:20		
WJAX, Cleveland, O.	390		6:30-8:30		7:00-9:30			
WJAZ, Chicago, Ill.	448		10:00-2:00	10:00-2:00	10:00-2:00	10:00-2:00	10:00-2:00	6:00-9:00
WJZ, New York, N. Y.	455	6:30-10:30	6:30-10:30	6:30-10:30	6:30-10:30	6:30-10:30	6:30-10:30	7:00-9:30
WKAQ, San Juan, P. R.	360		7:00-8:30	6:00-7:00				7:00-8:30
WLAC, Minneapolis, Minn.	417	7:30-10:00	7:30-10:00	7:30-12:30	7:30-10:00	7:30-10:00	7:30-12:30	7:45-8:45
WLW, Cincinnati, O.	309	8:00-10:00	10:00-12:00	8:00-10:00	10:00-12:00			
WMAO, Chicago, Ill.	448		7:00-10:00	7:00-10:00		7:00-10:00	7:00-10:00	
WMC, Memphis, Tenn.	500	8:30-9:30	8:30-12:00		8:30-9:30	8:30-12:00	8:30-9:30	
WNAO, Boston, Mass.	278		7:00-9:00	8:00-10:00		7:00-9:00	8:00-10:00	5:30-7:30
WOAI, San Antonio, Texas	385		9:30-10:30		7:30-8:30			9:30-10:30
WOAW, Omaha, Neb.	526	9:00-10:00	9:00-10:00		9:00-10:00	9:00-10:00	9:00-10:00	9:00-10:00
WOC, Davenport, Ia.	484	8:00-9:00		8:00-11:00	8:00-9:00	8:00-9:00	9:00-10:00	7:00-11:00
WOO, Philadelphia, Pa.	509	6:30-10:00		6:30-10:00		6:30-10:00		
WOR, Newark, N. J.	405	5:15-10:00	5:15-6:30	5:15-10:00	5:15-6:30	5:15-6:30	5:15-10:00	
WOS, Jefferson City, Mo.	441	8:00-9:30		8:00-9:30		8:00-9:30		
WRC, Washington, D. C.	469	7:00-9:00		7:00-9:00		7:00-9:00		
WSAL, Cincinnati, O.	309		8:00-10:00		8:00-10:00		10:00-12:00	
WSB, Atlanta, Ga.	429	8:00-12:00	8:00-12:00	10:45-12:00	8:00-12:00	8:00-12:00	8:00-12:00	7:30-9:15
WSY, Birmingham, Ala.	360	8:00-8:45		8:00-8:45		8:00-8:45		8:00-9:00
WTAM, Cleveland, Ohio	390			7:00-9:30			8:00-10:00	
WWJ, Detroit, Mich.	517	7:30-9:00	7:30-9:00	7:30-9:00	7:30-11:00	7:30-9:00		4:30-5:30

Instructions for Use.—All the hours above are given in Central Standard Time. If your city uses Eastern Time, add one hour to each of the periods stated; if your city uses Mountain Time, subtract one hour; if your city uses Pacific Time, subtract two hours. This table includes only the evening broadcasts, and on Sunday, the late afternoon program.

# Further Details of the Famous Miloplex Hook-Up

## Part VIII—On Aerials, Grounds and Condensers

By the Mystery Man

A GREAT big fellow in a Teeny-Weeny town in Florida writes: "If you're going to write on 'Troubles and How to Find Them,' start on 'Aerials and How to Build Them.'"

### THE MYSTERY MAN

Dear Sir:

In the September 29 issue of Radio Digest you gave a hook-up of the Miloplex circuit. I didn't pay any attention to it at the time, but when you came out with the October 6 article I sat up and took notice. Then I started to work and to say I got results is putting it rather mildly—but more about that later.

I used a fiber panel, a home-wound variometer, a B battery nine months old, and started in; couldn't get anything at first but a lot of humming and laid it to a 33,000-volt line across the street. After about 10 minutes of this I started looking around for trouble in the set, and I found out it will not work if the B— is connected to the A—. After this change it started to cut up something awful; don't know what it did, but it did anyway.

You can't make a "bug" quit, so I kept right on. Last night I put one stage of amplification with it and got—you say what! Oh, yes, the following: KSD, WFAA, WOAW, KYW, WDP, WOS, WLAG, WMAQ, WGY, WHB and Zion City, Ill., some of them so loud I could hear them 10 feet away.

What we need in the set is a tuner that is not so critical, the variometer works so fast I can't catch them fast enough to hold them. Now, Mr. Editor, please see that he does this, let's make him work. Respectfully,

J. W. Lickiss.

Very well, let's do, because some aerials are about as selective as a water sieve. So much really good aerial dope has been written—anything I may say may seem superfluous, yet it is true that too many—many too many—aerials, are usually too much aerial. Some time ago the thousands of real "hams," all members of the A. R. R. L., ran a bunch of experiments on aerials. While their interest was primarily in 200-meter work, yet most of their findings hold good for B. C. L. reception and I am believing two, yes three, prime essentials were established, viz.: The effective height should be close to 30 feet from earth; the effective length not exceeding 135 feet including lead-in; the ground—keep putting on more. And fourth (yes, there is a fourth), it should be a single wire. If you don't solder—well, you do or you lose.

What about counterpoise aerials? Well, when you want to get away from direct current, etc., it's a life-saver. I have a pet counterpoise, but it is not so good or nearly so easy for the everyday fan to build. Stick to the single wire.

Get a line of conversation with some local "brass pounder" and he will give you some real help on building a B. C. L. aerial. You know—that crack fellow static is the star B. C. L., especially in summer. Yet we plough through him and put up a DX battle that keeps him guessing; if he gets too important this coming summer, build your aerial so you can lower it to say 20 feet. The higher you go, the more he butts in, and the lower, the less he bothers. Of course, you can go so low you may lose too much signal strength. But wait a minute, if you happen to be living where you have room to look outdoors, why not slap in an underground aerial and fool (almost) Mr. Static?

Next summer—here's the law: Dig a trench about 8 inches deep and 200 feet long. In this bury a 200-foot length of number 14 rubber covered wire, connect one end to your receiver, making sure that the free end is thoroughly taped. Use your old ground as is, though sometimes with antennas of this type no ground is required, as the condenser capacity effect from the antenna through the rubber insulation to the ground reacts against an addition.

When is a ground not a ground? Answer: When it's a high resistance connection. In other words, so many radiator or water pipe grounds have to try and dodge around from 7 to 11 pipe connections and then run into and try to get out of a meter before it is safe, that it simply gets scared to death and decides to become only an effect. That's why I keep repeating "slap on more ground." I've got a 60-foot coil of number 14 copper dumped into the sewer manhole—it's a ground I'll say. You know now what I mean about grounds—the best is none too good.

And now a word about variometers—especially for the Miloplex, I, II or King. If you are using a wooden one, well, the King certainly won't do his best, and circuits one and two object. A wooden variometer works very well in many circuits wherein lowered efficiencies are not of prime importance. In the King distributed capacities and dielectric losses are simply not wanted; we must have some—the apparatus is not made which eliminates these two factors entirely—but we can purchase two or three makes which have little, if any moulded composition or wood in their fields. Buy them.

Many tell me that their set shows a persistent ground hum; and why? Here is the answer: Either your rheostat is too high you are burning your tube too bright or your timing is faulty—that's on a single tuber. If using amplifiers the two points mentioned are doubly important while the by-passing of your audio transformers is very essential.

Too many fans will not insist on holding the detector rheostat back as far as possible—not only on Plexy but on all circuits—yet every instruction book you ever read said: "Hold her down—just below."

Here and there a good fan writes in telling me that the variable condenser on the rotor is not effective—that the set works just the same without it.

No, Mercy, no! If this were true, variable condenser manufacturers would sure get the dickens; and I hear a few correspondents say, "But it ain't."

Seems to me I mentioned in one of my articles that those who are sending in destructive criticism usually write first and think afterwards. It still remains true—want me to prove it? All right, anything to oblige the fellows who have "trouble" and who have been good enough to tackle any of the Plexy family.

But before telling you the story, let me suggest that you pick up Radio Digest just a few weeks back and follow my good New York friend Thompson's articles now running. I don't know just why, but Thompson certainly has the knack of making Radio easily understandable, and I wish each of you would follow "his stuff" like a hawk—I'm reading every word and then re-reading. I mention Thompson's articles because just recently he had a "darb" of an article on "Inductance" with Indian's shooting arrows at the lines of force 'n' everything or with the lines of force, or how do you say Thompson? Anyway they're shooting, 'cause I saw the arrows.

With the rotor of my split variometer at right angles to the stator, it is opposed to the stator field. Hence, while the variable condenser is still operative, yet inasmuch as the rotor is entirely out of the primary's direction of field of magnetic flow, the rotor is not inductively coupled; no current is flowing in it from the primary and, by hek, the variable condenser has "nuttin" to work on.

Further, your variable condenser will appear as inactive until the rotor of the variometer is brought into the primary's inductance field to an absorption point exceeding the minimum capacity of the condenser; in other words, its absorption must equal or exceed the fundamental wave length of the rotor in conjunction with the variable condenser; so if your variable condenser isn't perking give it something to perk on and methinks it will operate on high or low gear.

Well, this then is aerials, grounds and something else, so supposing I close by telling you something of a surprise I have in store for you for next week. Remember in an early article I told you fellows to dig into the Plex because, while it was a "working fool," yet somebody, somewhere, some time would improve it?

Well, he has come to life and I'm saying he has turned a trick on the Plex that's a whiz. Yes, he's that brass pounder down in Stapleton, N. Y. His improvement on the Plex; just how and why is next week's story. No man in Radio work more roundly cussed me—the circuit and everything I said than this same fan, but he took my advice and stuck—with the result that he now has enough volume to

suit the neighbors, and, well, I tell you his story next week.

(TO BE CONTINUED.)

### Increasing Rheostat Resistance

Ordinary rheostats made for one ampere tubes can be quickly adapted to the new  $\frac{1}{4}$  ampere, WD-11, WD-12, UV-201A, or other tubes of low current consumption, by placing a small resistance in the circuit. The easiest resistance material to find is the ordinary lead pencil and a length about three-quarters of an inch long will give the required resistances for most rheostats for the new tubes.

The best way to make the resistance is to bare about  $\frac{1}{8}$  inch of the pencil on both ends and clamp or bind two lead wires in place. The resistance can then be placed somewhere in the feed-line from the battery to the tube. This resistance must be placed in the circuit and not across it, for the current that goes through the tube must also go through the rheostat and the resistance.

One can put this resistance in place as quick as he could change rheostats.—C. L. Smith, Jackson, Miss.

The navy Radio station in San Francisco, Calif., now receives messages direct from the navy station at Cavite, in Manila Bay, twice daily. The distance is 6,221 miles, and, as far as is known, is the longest one-way circuit in the world.

### Cockaday Coil Set \$2.50

Including full size blue prints of panel layout, complete picture hookup, and fully illustrated instructions for construction and operation.

Coils are fully assembled, made exactly as specified by Mr. Cockaday, D coil bank wound. Far more efficient than any home made coils.

Standard parts for this sensational circuit—panel, coils, condensers, variometer, variable resistance, vernier rheostat, socket, double jack, dials, switch, contact points, posts, busbar wire, spaghetti, etc. (no tubes or phones).

Complete for \$11.65

Postage additional on all shipments. Send No Money. PAY THE POSTMAN. All Goods Shipped Parcel Post C. O. D.

RADIO SURPLUS STORES  
HELENA, MONTANA

## Super Values

### Flewelling Circuit Complete

	List Price	Our Price
7 x 9 Radion Panel.....	\$ 1.15	\$ .90
23 Plate Var Condensers.....	3.00	1.50
3 .006 Mica Condensers.....	3.00	2.00
C. B. L. Var Grid Leak.....	1.85	1.30
Two Coil Honeycomb mount adjustable with knobs.....	4.00	2.55
50 Turn Honeycomb Coil.....	1.54	1.00
75 Turn Honeycomb Coil.....	1.54	1.00
(Mounted)		
One tube socket.....	1.00	.40
Klossner vernier rheostat with dial.....	1.50	1.00
One three inch Dial.....	1.00	.25
(Taper Knob)		
8 Binding Posts.....	.50	.40
Baseboard for mounting.....	.75	.40
Complete Instructions for Assembly and Wiring.....	.50	.50
Regular Price.....	\$21.63	

OUR PRICE \$13.20

### Reinartz Circuit Complete

	List Price	Our Price
Genuine Reinartz Coil endorsed by John L. Reinartz and bearing his signature. The only genuine coil for this circuit on the market. All others are imitations.....	2.50	\$ 2.00
One 7x10 Radion Panel.....	1.25	1.00
National Bakelite Socket.....	1.00	.40
Klossner Vernier Rheostat with dial.....	1.50	1.00
Two 23 Plate variable condensers at \$3.60 each.....	6.00	3.00
Switch Points and Nuts.....	.80	.40
Six Switch Stop Points and Nuts.....	.40	.20
Freshman Grid Leak and Condenser.....	1.00	.65
Seven Binding Posts.....	.70	.35
25 ft. Tinned Bus Bar.....	.50	.30
2 Switch Levers with knobs.....	.75	.35
One Baseboard for mounting.....	.75	.40
One Fixed Phone Condenser.....	.40	.25
One Single Jack.....	1.00	.25
Blue Prints with complete instructions for assembly and mounting.....	.50	.50
Regular Price.....	\$19.05	

OUR PRICE \$11.05

All the necessary screws, nuts and miscellaneous small parts which are necessary to complete the set are included in the above prices. Any part in either of these circuits may be purchased independently at the advertised out prices.

### FADA NEUTRODYNE

All parts for 5 Tube Set, complete (Genuine Fada Parts)..... \$50.15  
Solid Mahogany Cabinet, \$6.75 Extra

### COCKADAY

3 TUBE SET  
All Parts..... \$32.00  
Cabinet, \$5.00

### LOUD SPEAKERS

List Price	Our Price	List Price	Our Price
\$181.00 Western Electric 10-A.....	\$125.75	\$30.00 Music Master.....	\$24.50
55.00 Western Electric 10-D.....	44.00	25.00 Atlas Amplifier.....	19.50
60.00 Magnavox Type R-3.....	51.00	25.00 Trinity Type A-1.....	19.50
35.00 Magnavox Type R-2.....	29.50	22.50 Belcanto.....	18.00
		28.50 Dictagrand.....	23.50

### PHONES

List Price	Our Price
\$7.00 FEDERAL.....	\$5.50
\$8.00 BRANDES.....	\$5.25
\$8.00 N&K GERMAN.....	\$7.75

### TUBES

List Price	Our Price
\$5.00 RADIOTRON U. V. 200.....	\$3.95
5.00 CUNNINGHAM C. 300.....	3.95
6.50 RADIOTRON U. V. 201-A.....	5.75
6.50 CUNNINGHAM C. 301-A.....	5.75
6.50 RADIOTRON W. D. 11.....	5.75
6.50 CUNNINGHAM C. 11.....	5.75
6.50 RADIOTRON W. D. 12.....	5.75
6.50 CUNNINGHAM C. 12.....	5.75
6.50 RADIOTRON U. V. 199.....	5.75
6.50 CUNNINGHAM C. 299.....	5.75

### CONDENSERS

List Price	Our Price
\$1.80 3 PLATE VERNIER.....	\$ .90
3.00 23 PLATE VERNIER.....	2.50
3.50 43 PLATE VERNIER.....	2.75
3.00 23 PLATE PLAIN.....	1.50
2.80 43 PLATE PLAIN.....	1.80

### AUDIO TRANSFORMERS

List Price	Our Price
\$4.50 ALL AMERICAN, 3 to 1 Ratio.....	\$3.95
4.75 ALL AMERICAN, 5 to 1 Ratio.....	4.10
6.75 ALL AMERICAN, 10 to 1 Ratio.....	5.55
7.00 AMERTRON.....	5.55
7.00 FEDERAL No. 65.....	5.55

ALL Mail Orders Shipped Promptly Send Money Order, including Postage Write for Our Catalogue B

# HANES-ZENER



3 WEST 29TH STREET, NEW YORK CITY

## You Must Use



### VERNIER CONDENSERS

to get the best possible results from your set—no matter what type it is. They guarantee noticeable improvement in the reception obtained.

	13 Plate \$4.00
	23 Plate \$4.50
	43 Plate \$5.00

These Variable and Vernier Condensers will satisfy the most exacting. Perfect spacing, permanent adjustment, no iron used in construction. Whole white nickel finish. High maximum to minimum ratio.

At all good dealers—or direct on receipt of purchase price. Also write for our complete literature.

AMSCO PRODUCTS, INC.  
416 Broome Street NEW YORK



### PREMIER Audio-Frequency Transformer

HERE you have it—the smallest Audio-Transformer ever made, and yet the most efficient for volume and tone quality. Think of it! This "Little Wonder" (about the size of an English walnut) gives you maximum reproduction volume with minimum distortion. The secret is in its patented construction. It is 100% shielded against foreign noises. Mounts anywhere—saves space in assembly. Constructed of highest quality material. Made in tube socket types also. We guarantee it unconditionally. Try them in your next "hook-up." You'll be agreeably surprised and pleased.

Write now for Bulletin No. 90

### RATIOS

1 to 3, 1 to 4, 1 to 5..... \$3.50  
1 to 10..... 4.50

Premier Electric Company  
3510 Ravenswood Ave. CHICAGO

Ask for and insist on Premier at Your Dealers

# WRITE YOUR APPLAUSE TO THE ARTIST

## Let's Give Them Our Written Applause

HOW WOULD you like to do your best before the invisible audience and then get nothing in return for your effort? That's just what the artists whose names appear on these pages are doing. They don't expect financial remuneration. Broadcasting is too young for that. But they do like to get telegrams, letters, and even postcards from the listening Radiophans. Written applause! That's what makes the artist feel good, and makes him or her want to do their bit again. When you like their work, tell them!

—THE PROGRAM LADY.

### Tuesday, November 20

**CKAC, Montreal, Canada (Eastern, 430), 7:00 p. m.**, Kiddies' stories in French and English; 7:30, French compositions, heard for the first time in America, Raoul Venant.

**KDKA, E. Pittsburgh, Pa. (Eastern, 326), 6:15 p. m.**, Dinner concert, Grand Symphony Orchestra; 7:45, Children's period; 8:15, Lecture on recent European tour, Rev. John Ray Ewers; 8:30, Pupils of Amanda Werheller, Jean Woodford Wible, Bertha Gundelinger, Betty Bell, Hilda Gundelinger, Olive Nevin, William Hasselman, Blanchard Wheeler, Robertson Tilton, Carl Ruhe, Chauncey Parsons.

**KFI, Los Angeles, Calif. (Pacific, 469), 6:45-7:30 p. m.**, Concert, George J. Birkel Co.; 10:30-11:00, Concert, Sol Cohen, violinist.

**KGW, Portland, Ore. (Pacific, 492), 3:30 p. m.**, Talk, Jeanette P. Cramer; 8:30, Talk for farmers, Paul V. Maris; 10:30, Dance music, George Olsen's Metropolitan Orchestra.

**KHJ, Los Angeles, Calif. (Pacific, 395), 12:30-1:15 p. m.**, Ruth Thomas, pianist; 2:30-3:30, Matinee Musicale, Ruth Thomas; 6:45-7:30, Children's program, presenting "The Sandman"; 8:30-10:30, Führer String Orchestra; 11:00-11:30, Ethelwyn Conroy, Lucy Führer Genter and Nan Aylworth; 11:30-12:30, Swiss contralto, Constance Campbell, reader; 10:30-12:30, Art Hickman's Orchestra.

**KSD, St. Louis, Mo. (Central, 546), 8:00 p. m.**, Program; 11:00, Dance music, Silverman's Orchestra.

**KYW, Chicago, Ill. (Central, 536), 11:35 a. m.**, Table talk, Mrs. Anna J. Peterson of Peoples Gas Co.; 2:35 p. m., Studio program; 6:50, Children's bedtime story; 8:21-8:25, Program, American Farm Bureau Federation, "The Transportation Knot"; C. B. Hutchings; "The Nation's Food Supply"; R. C. Pollock; 9:30, Gladys F. Moore, soprano; Diana Tyson, contralto; Pauline Flak, pianist; One-act play, Jessie R. Landis; Herbie Mintz, pianist.

**WBAP, Fort Worth, Texas (Central, 476), 7:30-8:30 p. m.**, Concert, Hapuna Hawaiian Music School; 9:30-10:45, Monthly musical program, artists of the Fort Worth Harmony Club.

**WBZ, Springfield, Mass. (Eastern, 337), 7:00 p. m.**, "Love and Clocks and Suits"; Bruno Leasing from Hearst's International Magazine; 7:30, Twilight tales for the Kiddies; "Child Training and Family Behavior"; Agnes H. Craig; Eileen Kennedy, violinist; Katherine Gravelin, accompanist; Francis C. Doane, soprano.

**WOP, Chicago, Ill. (Central, 360), 1:30 p. m.**, Concert, Drake Concert Ensemble and Blackstone String Quintet; 7:00, Drake Concert Ensemble and Blackstone String Quintet; 10:30, Frederick W. Agard, tenor; Bob Cougle, pianist; Jack Chapman's Orchestra.

**WFAA, Dallas, Texas (Central, 476), 12:30-1:00 p. m.**, Address, DeWitt McMurray; 9:30-9:30, Elizabeth F. Crawford, director; Lucille Lechner, singer; Mrs. Cummings, pianist; 11:00-12:00, Mrs. O. Ledford, pianologist and readings.

**WFI, Philadelphia, Pa. (Eastern, 395), 1:00 p. m.**, Meyer Davis Bellevue Stratford Concert Orchestra; 3:00, Song recital; 6:30, Meyer Davis Bellevue Stratford Concert Orchestra; 7:00, Bedtime stories; 9:30, Radio play, WPI Players.

**WGI, Medford Hills, Mass. (Eastern, 360), 3:00 p. m.**, Amrad Women's Club Program; "Hospitality Talk"; Ida Bailey Allen Descriptions; musicals, arranged by Chickering & Sons Co.; 8:30, The Hayden, Max Quartette of Worcester; Arthur G. Harwood, first tenor; Carl G. Anderson, second tenor; Eric A. Anderson, first bass; Edward L. Davis, second bass.

**WGY, Schenectady, N. Y. (Eastern, 380), 2:00 p. m.**, "Early American Needlecraft and Weaving"; Mrs. F. R. Lord; 7:45, "The Moonlight Serenaders"; William La Barba, baritone; Airplane Passenger Travel in Europe; Charles M. Hiley.

**WHAS, Louisville, Ky. (Central, 400), 4:00-5:00 p. m.**, Selections, Strand Theater Orchestra; "Just Among Home Folks"; Selections, Risko Theater organ; 7:30-9:00, Ray Pfaff and his Orchestra; Reading: An Interesting Historical Episode.

**WHN, New York, N. Y. (Eastern, 360), 3:45-4:00 p. m.**, Frances Miller, soprano; 9:30-9:45, Julius Pokorn, violinist; 9:45-10:15, Charles Hathaway's Orchestra; 11:00-1:30, Shagiro Bernstein Music Company; 11:30-12:30, Broadway Musical Alpha.

**WJAX, Cleveland, Ohio (Eastern, 390), 11:30 a. m.**, 1:00 p. m., Special program for Community Fund Campaign; 7:30-10:30, Tuesday program, Cleveland News-Leader; 7:30-7:45, Bedtime story, E. G. Johnson; 7:45-9:00, The Singing Sherwoods in popular vocal selections, Gall Sherwood, director; 9:15, Edwin Arthur Kraft, organist.

**WJAZ, Chicago, Ill. (Central, 447.7), 10:00 p. m.**, 2:00 p. m., Florence K. White, soprano; J. Henry Welton, tenor; Helen Hawk, pianist; Helen Grein, pianist; Oriole Orchestra.

**WJZ, New York, N. Y. (Eastern, 455), 3:00 p. m.**, Gitta Gradova, pianist; 4:30-5:15, Maddalena Hauff, soprano; Josephine Kay, composer; Sarah Cass, pianist; Popular songs, Harry Cain; 6:30, "A Travelers Letters to Boys and Girls"; 8:30, "Broadcasting Broadway"; 8:15, Ruth Bodell, soprano; 8:50, "Etiquette"; Doubleday, Page talk; 9:30, Match, "Battling Siki"; French champion, and "Kid Norfolk"; American fighter; 10:30, Hotel Astor Grill Orchestra.

**WLW, Cincinnati, Ohio (Central, 309), 10:00 p. m.**, Program, arranged by Mable and Carew Mabley & Carew Glee Club; Soloists, W. Sanders, Clara Hartman, Ester Weschke, Charles Fischer; H. C. Smith, violinist; J. Zebelman, violinist; 11:00, Excerpts from "In the Garden of the Shah"; Aspects of the Ladies' Auxiliary of the Kishineu Grotto; Orchestra.

**WMAQ, Chicago, Ill. (Central, 447.5), 4:30 p. m.**, Glen Dillard Gunn School of Music; 7:30, Talk, Dr. Edwin L. Barnes; 7:30, Program, Chicago Consulate of Hungary; 9:00, Ensemble music, Hotel La Salle Orchestra; 9:15, Weekly musical program, Leon & Healy.

**WNAC, Boston, Mass. (Eastern, 278), 8:00-10:00 p. m.**, Y. D. Band of Malden, 30 pieces.

**WOC, Davenport, Iowa (Central, 484), 12:00 m.**, Chimes; 3:30 p. m., "Adenoids"; A. G. Hinrichs; 5:45, Chimes.

**WOO, Philadelphia, Pa. (Eastern, 509), 11:00-11:30 a. m.**, Organ recital, Mary E. Vogt; 12:00-12:54 p. m., Wanamaker Crystal Tea Room Orchestra; Robert E. Golden, director; 4:45-5:00, Organ recital, Mary E. Vogt.

**WOR, Newark, N. J. (Eastern, 405), 2:30-2:45 p. m.**, Anna M. Bolger, mezzo-soprano; 2:45-3:00, Lowell Sherman; 3:15-3:30, Talk for Women, Mando Hall of Pictorial Review; 6:30-6:45, Man in the Moon



The Detroit News String Quartet, a regular feature of the pioneer Detroit members are Maurice Warner, violinist, Goldstein, violinist, and Frederick Br... from the personnel of the News orchestra the big things in

Jud Landon, left, tells WGY listeners every Tuesday night how to cast to catch the trout. His talks are the apple of the eye to out-of-door enthusiasts. Rosemary Hughes, circle, is on WDAP Friday nights most every week

### Wednesday, November 21

**Stories; 7:00-7:30, Tobias and Breen, vaudeville team and composers.**

**WWJ, Detroit, Mich. (Eastern, 517), 9:30 a. m.**, "Tonight's Dinner"; Woman's Editor; 9:45, "Evening Day" program, Fred Shaw and Margery Richmond; 3:00 p. m., Detroit News Orchestra; 8:30, Detroit News Orchestra; G. Williams, bass-baritone; Mrs. T. Earl Guellette, soprano; Irene Mallicha, pianist.

**WJZ, New York, N. Y. (Eastern, 455), 3:00 p. m.**, Miltonella Beardsley, pianist; 3:45, Concert, Claudia Barr, mezzo-soprano; 4:30, Tea music, Hotel Commodore Orchestra; 6:50, "A Dog's Tale," a Shadowland Story, Florence Smith Vincent; 7:45, Manna Zuck, composer; Rex Stella, contralto; 9:00, Thanksgiving-Texas; Ann J. Fisher; 9:15, "A Merry Night"; 10:30, Paul Specht's Orchestra.

**WLW, Cincinnati, Ohio (Central, 309), 8:00 p. m.**, Pick-up program from Automobile Accessories and Radio Exposition; Esberger's Band of Cincinnati; Helen Hofer, soprano; Talk, Charles B. Hatter, pres. of the Cincinnati Trade Association; 8:45, Program, College of Music, Dorothy Martin, pianist; Francis Frazier, tenor; Mary Swainey, soprano; Yerna Cook, contralto; 8:30, Schima Kaufman, violinist; "Oh, What's the Use?"; Lillian Tart Maize, first prize Radium in the first contest of Radio plays (conducted by the "Writer's Digest"); Cast: Mrs. Bigsbee, pres. of the Club, Helen Rose; Mrs. Sommerville, Olive Vail; Mrs. Lowell, Katherine Hall; Mrs. Green, Dorothy Barlow; Linus Donoghue, Slick Barrett; Descriptionist, Alvin Richard Plough.

**WMAQ, Chicago, Ill. (Central, 447.5), 1:00 p. m.**, Speeches, Chicago Association of Commerce Luncheon; 4:30, Cosmopolitan School of Music and Dramatic Art; 7:00, Georgene Faulkner, the Story Lady; 7:30, Weekly lecture from Northwestern University; 9:00, Ensemble music, Hotel La Salle Orchestra; 9:15, Lyceum Arts Conservatory.

**WNAC, Boston, Mass. (Eastern, 278), 9:00-10:00 p. m.**, All-Elk Trans-continental Test. All night, Prizes, etc. offered. Program furnished by New England Lodges of Elks.

**WOC, Davenport, Iowa (Central, 484), 12:00 m.**, Chimes; 3:30 p. m., "Poisons"; Clyde G. Kern; 6:30, Sandman's visit; 7:00, "Boys' Club Week"; John Quist; 8:00, Temple Chorus of Rock Island, Ill.; J. W. Johnston, director; 10:00, Troy Laundry Machinery Co. Band; Margaret Patton, reader; Bernice Mason, soprano; Mrs. Harry Palmer, violinist.

**WOO, Philadelphia, Pa. (Eastern, 509), 11:00-11:30 a. m.**, Organ recital, Mary E. Vogt; 12:00-12:54 p. m., Wanamaker Tea Room Orchestra; Robert E. Golden, director; 4:45-5:00, Organ recital, Mary E. Vogt; 7:45, Adelphia Hotel Orchestra; 8:30, Monologue, Ralph Rincham; 10:10, Dance.

**WOR, Newark, N. J. (Eastern, 405), 2:30-2:45 p. m.**, Chester Sutta, violinist; 2:45-3:00, Meyer Prager, tenor; 3:00-3:15, Chester Sutta; 3:15-3:30, Edna Marie Scheller; 3:30-3:45, Chester Sutta; 3:45-4:00, Edna Marie Scheller; 6:15-6:30, Lella Brown, mezzo-soprano; 6:30-6:45, Albert E. Sonn, "Radio For the Layman"; 6:45-7:00 p. m., Lella Brown; 8:00-8:45 p. m., Dumont High School Orchestra; 8:45-9:15 p. m., Arthur Murray's weekly dancing lesson, assisted by Newark A. C. Orchestra; 9:15-9:45 p. m., Dumont High School Orchestra; 9:45-10:00 p. m., Helen Louise Althouse, contralto; 10:00-11:00 p. m., The Aladdin Orchestra.

**WOS, Jefferson City, Mo. (Central, 440.9), 8:00 p. m.**, "Taxation," Prof. S. D. Gruner; Old time "Brake Down"; or square dance, A. B. Williams of Jefferson City, director.

**WTAM, Cleveland, Ohio (Eastern, 390), 8:00 p. m.**, The Amphion Male Quartette; Mrs. T. G. Wilson, tenor; Robert Beam, tenor; H. C. Wialer, baritone; 2:30, Mercury, bass; the WTAM Orchestra, Max Schmitt.

**WWJ, Detroit, Mich. (Eastern, 517), 9:30 a. m.**, "Tonight's Dinner"; Women's Editor; 12:00 p. m., Jean Goldstein's Orchestra; 3:00 p. m., Detroit News Orchestra; 8:30, Detroit News Orchestra; Blanche Bliss Lyons, soprano, and her pupils.

### Thursday, November 22

**CKAC, Montreal, Canada (Eastern, 430), 7:00 p. m.**, Kiddies' stories in French and English; 7:30, Special transatlantic program for European amateurs, Orchestras of the S. S. Regina of the White Star Dominion Line.

**KDKA, E. Pittsburgh, Pa. (Eastern, 326), 6:15 p. m.**, Dinner concert, Grand Symphony Orchestra; 7:30, Weekly chat with the farmers, Frank E. Mullen; 7:45, Children's period; 8:15, Address of interest to the farmers; 8:30, Lyric Quartet, Sarah Peck, soprano; Jane Packham Alexander, contralto; Gilbert Morris, tenor; Almet B. Jenkinson; baritone; Agnes P. Schaffer, accompanist; Marian Dual McDevide, pianist; Charles Riley, violinist.

**KFI, Los Angeles, Calif. (Pacific, 469), 6:45-7:30 p. m.**, Features through courtesy of Y. M. C. A.; 10:00-11:00, Concert, Hollywood Girls Quartette.

**KGW, Portland, Ore. (Pacific, 492), 3:30 p. m.**, Woman's program on Child Training; 8:30, Dramatic program; 10:30, Dance music, George Olsen's Metropolitan Orchestra; Mary Anderson, pianist.

**KHJ, Los Angeles, Calif. (Pacific, 395), 12:30-1:15 p. m.**, Concert; 2:30-3:30 p. m., Matinee Musicale; 6:45-7:30, Children's program; 8:00-10:00, "Biology and Evolution"; Mabel Pearson, H. S. Head of Biological Science, Pasadena High School.

**KSD, St. Louis, Mo. (Central, 546), 8:00 p. m.**, St. Louis Symphony Orchestra; Carolina Lazzari, contralto.

**KYW, Chicago, Ill. (Central, 536), 11:35 a. m.**, Table talk, Mrs. Anna J. Peterson; 2:35 p. m., Studio program; 6:50, Children's bedtime story; 7:45, "Remee and Juliet"; opera at Auditorium Theater by Chicago Civic Opera Company, opera in French, music by Gounod, libretto after Shakespeare by Barbier and Carre, five acts and six scenes; Cast: Capulet, a Viennese noble, Alfredo Grandoff; Juliet, his daughter, Edith Mason; Tybalt, his nephew, Maxim Karolik; Romeo, a

Montague, Charles Hackett; Mercutio, friend of Romeo; Desire DeRose; Strepiano, page of Romeo; Irene Pavlovskas; Duke of Verona, William Beck; Friar Lawrence, Edouard Cotterill; Gertrude, Juliet's nurse, Maria Glassens; Ophelia, servant to Capulet, Glida Morelats; Incidental dances by Adolph Balm and Corps de Ballet; Conductor, Giorgio Polacco; Announcements of synopsis of action preceding each act by A. W. "Sen" Kaney, KYW announcer.

**WBAP, Fort Worth, Texas (Central, 476), 7:30-8:30 p. m.**, Dance concert, Tommie's Texans, Meadowmere Club Orchestra; 9:30-10:45, Organ concert, Will Foster.

**WBZ, Springfield, Mass. (Eastern, 337), 7:00 p. m.**, "Clubs, Spades and Wood"; an Outing story from Field and Stream; 7:30, Twilight tales for the Kiddies; "Settling the Story"; Dr. J. Berg Esenwein; Letter from the New England Homestead; 8:30, Concert, Y. M. C. A. Glee Club; 9:00, Story for Grown-ups, Orion S. Marden.

**WOP, Chicago, Ill. (Central, 360), 1:35 p. m.**, Drake Concert Ensemble and Blackstone String Quintet; 7:00, Drake Concert Ensemble and Blackstone String Quintet; 10:00, Program to be announced; Jack Chapman's Orchestra.

**WDAR, Philadelphia, Pa. (Eastern, 395), 12:30-12:54 p. m.**, Organ recital, Stanley Theater; Arcadia Cafe Concert Orchestra; Peri Sarkoz, director; 2:30-3:00, Arcadia Cafe Concert Orchestra; 4:30-5:55, Short talks, Musical; 7:30-8:00, Bedtime stories, Dream Daddy.

**WEAF, New York, N. Y. (Eastern, 492), 11:00-12:00 p. m.**, Special program for Women; 11:00-12:00, midnight, Vincent Lopez Dance Orchestra.

**WFAA, Dallas, Texas (Central, 476), 12:30-1:00 p. m.**, Music; 8:30-9:30, Elks' Band, from Dallas Lodge, No. 71.

**WFI, Philadelphia, Pa. (Eastern, 395), 1:00 p. m.**, Meyer Davis Bellevue Stratford Orchestra; 3:00, Song recital by WPI Strawschwigs and Chiller Quartet; 6:30, Dinner music, Meyer Davis Bellevue Stratford Orchestra; 7:00, Bedtime stories; 8:00, Boy Scouts Period; 10:10, Meyer Davis Bellevue Stratford Orchestra.

**WGI, Medford Hills, Mass. (Eastern, 360), 7:00 p. m.**, "Bits of Wisdom"; George B. Beal; Matinee Club Musicale; Mrs. Savage, director; Bedtime stories for Parents; Alfred F. Whitman, reader.

**WGR, Buffalo, N. Y. (Eastern, 319), 12:30-1:00 p. m.**, George Albert Boucard, organist; 4:00, Martha Gomph, harpist; Elsie de Grood, violinist; 6:30-7:30, Vincent Lopez Dance Orchestra; 7:30, Digest of the day's news; Boy Scout Radiogram, Story from "The American Boy" magazine.

**WGY, Schenectady, N. Y. (Eastern, 380), 2:00 p. m.**, "Literature Our Children Read"; Mrs. Hubert Hadlock; 7:45, A Night of Gilbert & Sullivan; "A Few Moments with New Books"; William F. Jarob; WGY Orchestra; Edith Ennis, soprano; WGY Ladies Light Opera Chorus; J. F. Quinlan, baritone; "Cement"; C. E. Cassidy; Dramatic Cantata; "Trial by Jury"; The Judge, Kolin Hager, baritone; The Plaintiff, Joseph Cuhane, tenor; The Defendant, Ass O Coggeshall, tenor; The Foreman of the Jury, J. F. Quinlan, baritone; The Usher, Maurice Summers, baritone; Bridemaids, Mae McCarty, soprano; Janice Brewer, soprano; Theresia Berberich, contralto; Gladys Robinson, contralto.

**WHAS, Louisville, Ky. (Central, 400), 4:00-5:00 p. m.**, Strand Theater Orchestra; "Just Among Home Folks"; Gus Edward's Orchestra; Barney Rapp's Orchestra; Alamo Theater organ, Mrs. Myrtle Fulks Zahn, Jr.; Walnut Theater Orchestra; 7:30-9:00, Constantine Thurethson, soprano; Mrs. Lauren English Evans, violinist; William E. Fitcher, accompanist; Frank R. Doblen, baritone; Four-minute digest of International Sunday-School lesson, Harry M. Lukins; Four-minute Radio Forum talk.

**WHN, New York, N. Y. (Eastern, 360), 2:15-3:00 p. m.**, Shapiro Bernstein Music Company; 9:30-10:15, Avon Society Orchestra; 10:15-10:30, Belle Bart, astrologist; 10:30-11:00, Fred Fisher Music Company; 11:00-12:00, Marshall Dance Orchestra, Marsh McCarty, leader.

**WIP, Philadelphia, Pa. (Eastern, 509), 3:00 p. m.**, Second of a series of programs of Women's interests, auspices of Ellen Foster Stone; 7:00, Bedtime stories, Uncle Wip; 8:00 p. m., Song recital.

**WJAX, Cleveland, Ohio (Eastern, 390), 11:30-1:00 p. m.**, Program for Community Fund Campaign; 8:00 p. m., Hotel Cleveland Orchestra; Harold B. Smith and his Hotel Orchestra.

**WJAZ, Chicago, Ill. (Central, 447.7), 10:00 p. m.**, 2:00

JUST LINE THIS  
Do all the air  
W T  
WJAX  
ever  
week  
hard t  
the  
Fund  
I am  
big fo  
as we  
darios  
The p  
Radari  
heard  
Wedne  
FO  
KID  
Da Te  
KY  
sin-C  
WG  
Yale-  
WH  
vania  
WJ  
Navy  
DRAN  
The  
one-a  
sire  
WEL  
WFL  
WLW  
from  
den-o  
W  
days  
What  
C. r  
darian  
Radari  
Player  
T  
WGY  
cant  
Jury  
Fri  
pla  
Green  
one-a  
Thre  
V  
ro I  
Cinc  
serva  
sic;  
Intim  
gera  
Playe  
"Ros  
Harle  
-The



Reinartz R. D. 104

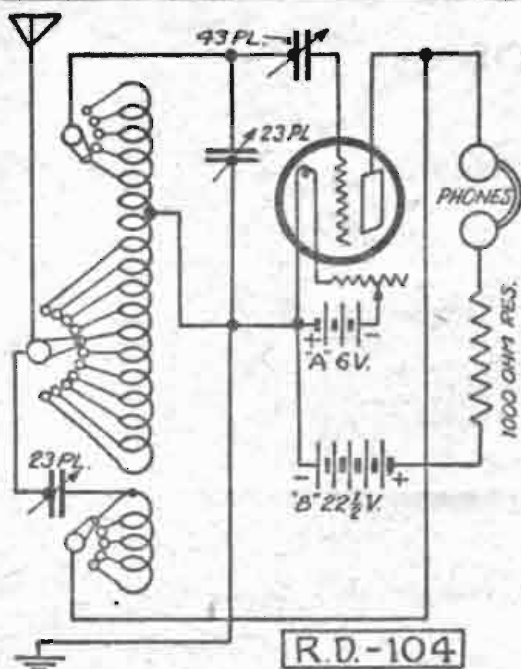

**T**HE diagram, RD-104, shows the latest hook-up using a Reinartz coil and is copyrighted by John L. Reinartz. It is a revised form of the old circuit covering the wide range of wave lengths at present used by the broadcasting stations. It will be noticed that three variable condensers are required, two of .0005-mfd. capacity and the third of .001-mfd. capacity.

The insertion of the 1,000-ohm resistance stabilizes the tube action and improves reception. Only 22½ volts are required in the plate circuit.

Spiderweb coils specially designed by Mr. Reinartz and bearing a facsimile of his signature are now being placed on the market.

Spacing Wires

The set builder should always remember that space is the best insulator for the high frequency currents used in Radio. Especially in a reflex set, the wires must be kept as far apart as possible. The success of such a set depends very largely on well spaced wiring, for the balance between the circuits is very delicate, and interference from one part may completely upset another.

Wave Length and Frequency  
Their Inter-Relation Explained

**T**HERE seems to be, among Radio beginners, considerable misunderstanding regarding the nature of wave motions and the relation existing between wave length and frequency. Some cannot understand what is meant by the wave motion produced by vibrating bodies or electrical discharges. Others cannot grasp the meaning of the terms wave length and frequency and the relation existing between them merely because they cannot form a mental picture of just exactly what takes place.

Wave Motion

Suppose, for the sake of illustration, that you hold an ordinary type of cardboard fan in your hand and move it back and forth at a constant rate, much as you would in fanning yourself. As the fan moves to the right, it creates an area of compression by forcing the air in its path toward the right. As it reaches the end of its travel to the right and is brought back toward the left again, it tends to create, on its right side, a partial vacuum. Now as it moves toward the right again it repeats the process of compressing the air on the right-hand side and on its return toward the left it again tends to create another area of low compression or partial vacuum. As the movement of the

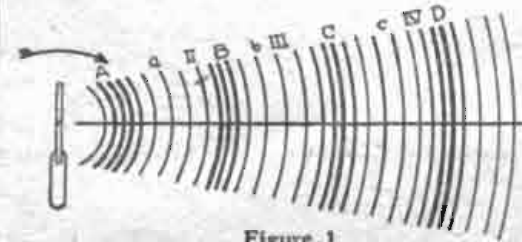

Figure 1

fan is transmitted toward the right, the air is made up of alternate portions of compressed and rarefied air. The portions vary from a point of highest compression to the point of lowest compression or partial vacuum.

This condition is shown diagrammatically in Figure 1. The portions where the heavy lines are shown close together represent the compression areas formed when the fan is traveling on the right-hand side of the middle point and the pressure is therefore above normal. The light lines spaced farther apart represent those portions of low compression when the fan

is traveling on the left-hand side of the normal or starting point of the fan.

What Is Known by Cycle

Any round of events, movements or operations in which a body or condition passes through a series of movements and then comes to its initial starting point for a repetition of the operation is termed a "cycle." As the fan moves from its verti-

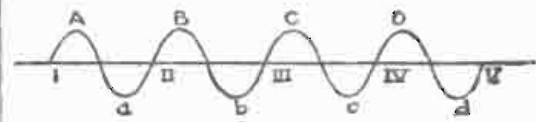

Figure 2

cal position or starting point, goes toward the extreme right, then to the extreme left and back to its starting point to go through the movement again, this movement from starting point to starting point is termed its cycle.

In moving through successive cycles the compressions and rarefactions follow closely upon each other. Since the conditions vary gradually from a normal point to a high compression point and then back to normal, down to the low compression point and up to normal again, the action can be represented diagrammatically as in Figure 2. The crests of the wave line, A, B, C, D, represent the points of high compression, A, B, C, D, in Figure 1; the points, I, II, III, IV, in both diagrams, represent the normal points and the troughs of the wave line, a, b, c, d, represent the points of low compression, a, b, c, d, in Figure 1.

Wave Lines

The compression and rarefaction action which takes place through the movement of the fan can therefore be thought of in terms of the wave line shown in Figure 2. In the same way we can think of sound, electricity, magnetism and other such phenomena in terms of the effects produced as represented by a graph similar to that of Figure 2, so that we can speak of sound waves, electric waves, etc., in describing these actions. The wave length of the waves shown in Figure 2 is the distance from any point on one wave to a similar point on an adjacent wave. In this case the distance from A to B, or from B to C, or from a to b is the same and is called the wave length of the wave produced by the fan. Whether the fan is

The Reader's View

Wants Call Letters Spoken Plainly

The writer, Radlophan, in the name of all the fans of the Island of Cuba, respectfully addresses to you this letter in order that, through your magazine, the attention of all the broadcasting stations in the United States may be called to the fact that it is next to impossible to understand the name or initial of the transmitting station, because the announcer in general speaks extremely fast, and this, added to atmospheric static, keeps us all from knowing who is transmitting.

During the past few months I have been experimenting in order to ascertain the distance I could reach with my receiving set and regularly every night hear Los Angeles, Fort Worth, Alabama, Davenport, Pittsburgh and others, receiving the concerts well, but am unable to identify the station until the second or third number for this very reason.

Undoubtedly you are aware that there are in the neighborhood of 25,000 or more Radio amateurs in Cuba, and also that we have several first-class broadcasting stations, first among them the Cuban Telephone (PWX), and I can assure you that their announcer can be easily heard and clearly understood in the States. Besides this, all the fans in Cuba are very much interested to get connections with the U. S. Oscar H. Sta. Cruz, Havana, Cuba.

Do not throw away the direction sheets or booklet that came with your set and with the tubes. Read all such material carefully now and then. If you have lost the direction sheets, write to the dealer or manufacturer for another. These sheets will answer most of the questions which have been puzzling you and preventing you from getting the best out of your set.

BUILD SETS THAT ARE SURE TO WORK

Here are the right parts at right prices

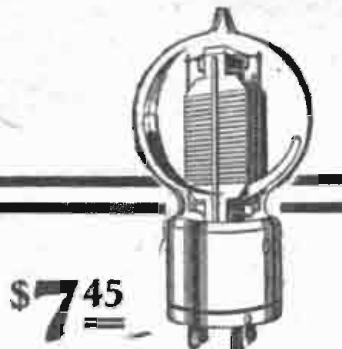

\$7.45  
**Western Electric VT-2 TUBES**

One of the big features of these brand new genuine Western Electric VT-2 Tubes that we bought from the U. S. Signal Corps is that they have a higher amplification factor than any other 5-watt tube made! And almost half of our purchase consisting of 10,000 tubes have been sold. Radio men know that a genuine VT-2 Tube for \$7.45 is an unusual opportunity—a real "find"! These tubes may be used for both RF and AF Amplification and for CW and phone transmitting. They are not Navy defects—have been sold only as a surplus.

Variable Condensers

- \$7.00 value, 43 Plate Vernier.....\$3.95
- \$6.00 value, 23 Plate Vernier..... 3.45
- \$5.00 value, 11 Plate Vernier..... 2.95
- \$1.75 value, 3 Plate Vernier..... 1.15
- \$4.30 value, 43 Plate, NOW..... 1.75
- \$3.70 value, 23 Plate, NOW..... 1.45
- \$3.30 value, 11 Plate, NOW..... 1.35
- \$2.25 value, 5 Plate, NOW..... 1.25
- Freshman Variable Grid Leak and Condenser, \$1.00 value..... 65c
- Double Phonograph Adapters..... 75c
- PATHE LOUD SPEAKER..... \$17.50
- 200 Ohm Potentiometers..... \$1.35



**Formica Sheets, Tubes, Rods**

We are prepared to furnish promptly and saw Formica panels of any dimensions. Cutting charge is included in the following prices:  
3/8" Formica, sq. in.....2c  
1/2" Formica, sq. in.....1 1/2c  
Tubing (up to 3 1/2" diameter), per running inch......10c

R. C. CABINETS—Genuine 5-ply Veneer Mahogany Cabinets—the same Cabinet used in the R. C. Radiola set. These Cabinets cost the Radio Corporation \$4.20 in thousand lots. Our Price..... \$2.95

Original Baldwin Phones

These are the Genuine Nathaniel Baldwin "Mica Diaphragm" Phones, complete with silk cord and headband. Special at..... \$9.95

Genuine Baldwin "Mica Diaphragm" Type "C" Loud Speaking Units. Special..... \$4.65



**Variometers Variocouplers**

Moulded..... \$3.65

Antenna—Use Electric Light Socket for Aerial..... \$1.15  
Dials—2, 3 and 3 1/2 inch..... 25c

COCKADAY COILS..... \$1.95  
BRANDES PHONES..... \$5.45

Western Electric No. 521W Loud Speaker..... \$21.00

Honeycomb Coils

- 1,500 Turns.....\$1.50
- 1,250 Turns..... 1.50
- 1,000 Turns..... 1.25
- 750 Turns..... 1.00
- 250 Turns..... .75
- 150 Turns..... .60
- 100 Turns..... .50
- 75 Turns..... .40
- 50 Turns..... .40
- 35 and 25 Turns..... .40

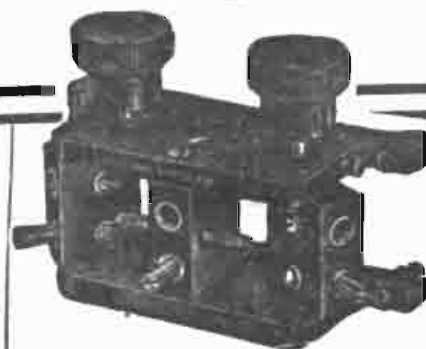

**2 and 3 Coil Mounting**

Completely moulded of bakelite in which all metal parts are moulded. Mounts on four screws threaded in back, nickel plated. Highly finished in black. Moulded, bakelite spaces the coil plugs. Silk flexible leads with provision for rear or base outlet. Spring contacts insure positive connection. Eliminates body capacity. Any standard plugs will fit. Size 3" deep, 2 1/2" high, 4" long.

2 COIL..... \$2.45  
3 "..... 3.45

Single Cords, Supersensitive Microphone Transmitter..... \$2.45

BRADLEYSTAT..... \$1.25  
GENUINE BALDWIN LOUD SPEAKER..... \$25.00  
U. S. A. Signal Corps, Aviation Type 194-W Western Electric Phones..... \$7.95



\$3.65  
**Automatic Electric LONG RANGE HEAD SETS**

Formerly sold by the Automatic Electric Co., makers of telephone exchanges, at \$10 each. We bought their entire stock—40,000 phones—paid spot cash and because of this unequalled buying power, we are able to offer you a \$10 headset for \$3.65. 30 years of experience have produced the Automatic headset. Coil is wound with about 6500 turns of No. 40 enamel coated copper wire. DC resistance 1600 ohms. Impedance, at average music and voice frequency (800 cycles) 21,000 ohms. (Effective impedance rather than DC resistance is the big factor in a good headset.)

**Electric Soldering Iron**

Specially adapted to Radio work. Simply attach to your light socket. Complete, with 6-foot cord and attaching plug. Lasts a lifetime for ordinary home or light shop work.

\$2.45

JOHN FIRTH SOCKETS:  
Single..... 35c  
Double..... 65c  
Triple..... 95c

"THE LARGEST RADIO STORE IN AMERICA"



ALL MDSE. GUARANTEED BY US TO BE OF FIRST QUALITY

ALL MAIL ORDERS, LARGE OR SMALL, SHIPPED TO YOU PROMPTLY

509 SOUTH STATE ST., Dept. RD, CHICAGO, ILL.



# Simple Explanation of Radio for Everybody

## Chapter V, Part II—Condensers—Fixed and Variable

By M. W. Thompson

THE following article is the ninth of a series for Radio beginners, written by Marvin W. Thompson, well known in air-phone circles for his understandable style of approaching his subject, and his ability as a Radio engineer. Mr. Thompson is now an associate editor on the staff of Radio Digest. A preliminary outline of the Chapters to follow is:

- Chapter VI—Vacuum Tubes.
- Chapter VII—Antennas and Grounds.
- Chapter VIII—Regeneration.
- Chapter IX—Audio Frequency Amplification.
- Chapter X—Loud Speakers.

TWO early forms of variable condensers are shown in Figures 37 and 38. The condenser shown in Figure 37 consisted of 4, 6 or 8 aluminum plates, set about 1/8 inch apart, between two wooden blocks, and another group of 3, 5 or 7

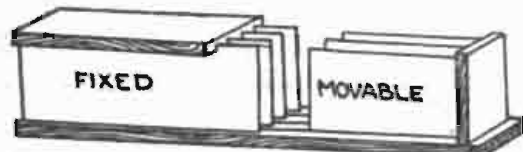

Figure 37—An early form of a variable condenser, bulky, mechanically bad and soon discarded

plates set 1/8 inch apart, which could be slid in and out of the first group, guided by slots cut in the baseboard. Fine adjustment was impossible, and this instrument took up a great deal of room. The device shown in Figure 38 consisted of two metal tubes, one fixed and one movable.

### Present Day Variables

The present method of making variable condensers is shown in Figure 39. The fixed plates are cut in half circles and supported about 1/16 inch apart by three pillars placed, one at each end of the semicircle of the outer edge and one at its center, opposite the center of the straight edge. The movable plates are also half circles but slightly smaller, and are supported 1/16 inch apart by washers placed on a shaft which is also used to

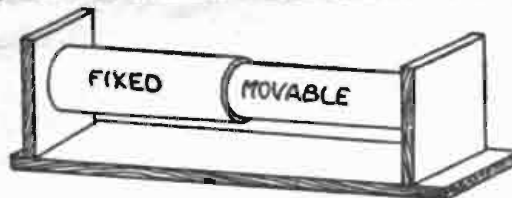

Figure 38—Another now extinct type of variable condenser

revolve them. Various types of bearings are used at the ends of this shaft to give smooth turning action yet not permit the movable plates to change their equidistant spacing between the fixed plates when within them.



## Unequaled Clearness Thru a New Magnetic Principle of Construction

Distant and local broadcasting reproduced without distortion. Endorsed by Radio Experts—Lieut. Commander Raison, U. S. Navy says: "I use your headset in preference to others in experimental work."

**Trial Offer** If your dealer is out of "Repeaters" send \$5.00 and dealer's name for complete set subject to refund in full within 10 days if not perfectly satisfactory.

**Moss-Schury Mfg. Co., Inc.**  
Radio Division  
2011-2015 Franklin Street, Detroit, U. S. A.  
Manufacturers of precision electrical devices

No matter what type of bearing is used, connection to the movable plates through the bearing is bad practice. In Figure 40 is shown what is known as a "pig-tail" connection. This takes the form of a thin, narrow metal strip or piece of braided

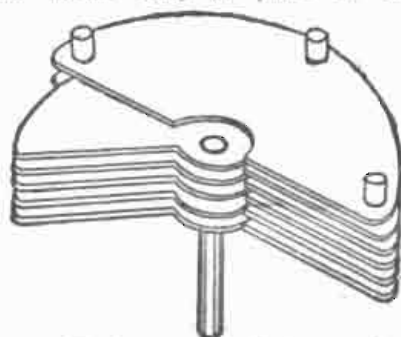

Figure 39—The better method of arranging plates in a variable condenser

wire, coiled like a watch spring, its inner end soldered to the shaft and its outer end anchored to the nonconductive end plates of the condenser. Connection is then made to the metal anchor. The coiled spring merely contracts or uncoils as the plates are turned and a positive, non-sliding connection is made at all times.

### Verniers

It was long ago found that the turning of the large group of movable plates did not permit sufficiently fine adjustments for accurate, close tuning, and the introduction of the vernier was the result. Figure 41 shows a simple, economical method of obtaining vernier control. A

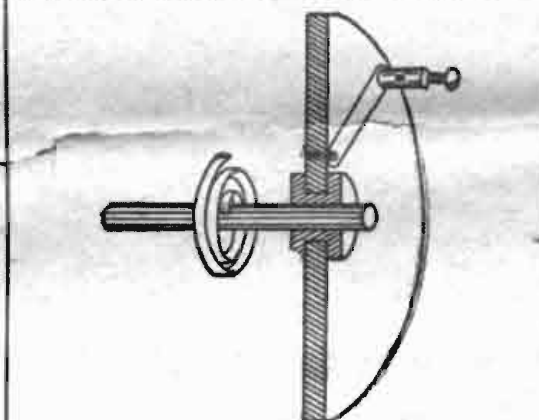

Figure 40—The pig-tail connection to the movable plates of a variable condenser

small rubber-tired wheel is mounted against the rim of the large 3 or 4-inch dial, and turning the circumference of the small wheel through an arc of 20°

Radio Call Cards printed to order. Red call, black printing, 100, \$1.75; 200, \$2.75, prepaid. Color changes, 35c extra. Government postals, 1c extra each card. Letterheads, 8 1/2 x 5 1/2, and envelopes, 100 each, \$2.25; 200 each, \$3.50. ARRL emblem used on cards or stationery if requested. Send today. Department 48 C. Radio Printers, Mendota, Illinois.

## IF YOU CAN'T BUY THEM AT YOUR DEALER'S SEND DIRECT TO US

"Red-Heads" are guaranteed radio phones. You run no risk when you buy them. Money back if, after 7 days' trial, you're not satisfied that they're the best receivers on the market at the price. Why not act right now and get a pair? It'll mean getting the maximum from broadcasting from the day you put them into use.

## RED-HEAD RADIO RECEIVERS

These remarkable head-sets are made by The Newman-Stern Co., one of the pioneer radio manufacturing houses in America.

### JUST OUT

The new 1924 Model F **\$6.50** PER PAIR Complete  
The new 1924 "Red-Head" Jr. **\$5.00** PER PAIR Complete

This is the standard 3,000 ohm "Red-Head." The 1924 Model F has eleven improved features. Sensitive and fine-toned; aluminum case; famous brown-red ear caps; military headband; high-grade cord.

"Red-Heads" sent prepaid on receipt of price if you are unable to get them at your dealer's.  
**THE NEWMAN-STERN COMPANY**  
Dept. RD Newman-Stern Bldg. Cleveland

turns the large wheel only 1 or 2°. It is possible to turn the small wheel but 2 or 3° and so move the large dial only a fraction of a degree. This means of getting vernier control is the most economical and is usually very satisfactory.

The experimenter who can afford to pay a little more for his condensers should buy the type shown by Figure 42. Condensers of this type cost more because of the greater complexity of their construction. A double shaft is necessary, consisting of an outer hollow shaft to which the group of movable plates is fastened, and a smaller, longer shaft to which a single movable plate is attached. This single plate can be revolved between two stationary plates or close to a single stationary plate.

### Grouping Capacities

Here is a rule for the experimenter to remember as utilizing it frequently saves time and money. If condensers are con-

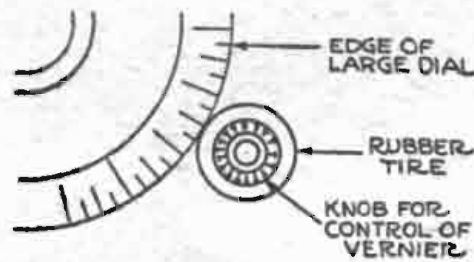

Figure 41—One method of obtaining vernier action

nected in parallel, the effective capacity is equal to the sum of the capacities of the individual units. If equal capacities are connected in series, the effective capacity is equal to the capacity of one divided by the number so connected. If a number of capacities of various values are connected

**Beautiful Hand-Colored Enlargement From Your Kodak Film, \$1.00**

A beautifully hand-colored photograph, enlarged to approximately 8 x 10 inches and ready for framing, can be made from any of your Kodak films at the very low price of \$1.00.

Enclose \$1.00 for each film to be enlarged and colored, together with the film and instructions for coloring.

**WELLER ART STUDIO**  
35 Evanston Avenue Dayton, Ohio

in series, this formula must be applied:

$$\frac{1}{\frac{1}{C_1} + \frac{1}{C_2} + \frac{1}{C_3}}$$

Let us see how these rules are of value

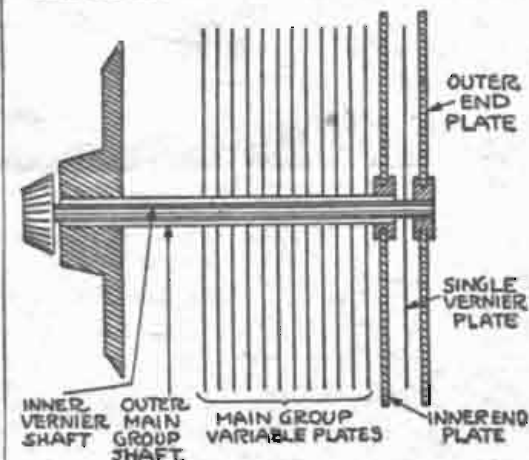

Figure 42—Another method of obtaining vernier control of capacity

in actual practice. Say, we have a variable condenser whose maximum is .001 mfd., a fixed condenser of .001 mfd. and (Continued on page 18)

**CHERRINGTON "NOISELESS" RHEOSTATS**  
Cherrington "Noiseless" Rheostats are manufactured with utmost care and precision. Comparison between the Cherrington and other rheostats will easily convince you of the superior quality of this instrument. The resistance elements used in Cherrington Rheostats are higher than the average, so as to take care of the different characteristics of the various tubes. If your dealer does not carry in stock, will send postpaid on receipt of purchase price.

7 ohm, 33 ohm, 43 ohm.....	\$1.00 each
52 ohm, 78 ohm.....	1.25 each
Cherrington Phonograph Adapter.....	.35 to .50 each
Neutralizing Condensers.....	.50 each

Dealers, Jobbers and Distributors who write at once will receive some very interesting information.  
**CHERRINGTON MFG. CO., Dept. 311, Waukegan, Ill.**  
CHICAGO OFFICE: 53 W. Jackson Blvd., Chicago

**RADIO AT N.Y. PRICES**  
**1/2 Daily Parcel Post**

The Prices Quoted Below Deliver Goods to Your Door

HOW TO ORDER—Write your order plainly; state number, description and price of items wanted. Send Post Office or Express Money Order, personal check or bank draft.

<p><b>Standard Brand Head Phones</b></p> <p>B134 Brandes Superior ..... \$5.25 B135 Dictograph ..... 6.75 B136 Baldwin Type "C" Double ..... 9.85 B137 Baldwin Type "C" Single ..... 4.95 B138 Western Electric ..... 10.50 B139 Dietzen 3000 ohms extra special.. 3.95</p>	<p><b>WOOD CABINETS</b> Highest grade Mahogany finish Cabinets. Hinged top. These cabinets are being sold at less than one-half regular value.</p> <p>B57 Wood Cabinet; panel size 7"x10". Each..... \$2.50 B58 Wood Cabinet; panel size 7"x12"..... 2.75 B59 Wood Cabinet; panel size 7"x14"..... 3.00 B60 Wood Cabinet; panel size 7"x18"..... 3.50 B61 Wood Cabinet; panel size 7"x21"..... 3.75 B62 Wood Cabinet; panel size 7"x24"..... 4.00</p>
<p><b>Amplifone Loud Speakers</b> This speaker will give efficient results when used with any pair of Head Phones; highly nickel plated; 18 inches high.</p> <p>B117 ..... \$3.95</p>	<p><b>1 1/2 VOLT DIETZEN TUBE</b> Two-element Fleming valve effect; operates on one dry cell with or without "B" Battery; wiring diagram free with each tube.</p> <p>B95 Dietzen Tube ..... \$1.00 B96 Socket for Dietzen Tube..... .40</p>
<p><b>Wave Trap</b> Simplifies tuning. Eliminates interfering stations, thereby improving the selectivity of your set. Selects between conflicting stations. Special white quantity lasts.</p> <p>B131 ..... \$4.95</p>	<p><b>Audio Frequency Transformers</b> The following transformers are guaranteed standard makes, and will produce very efficient results.</p> <p>B63 Dietzen 3 to 1 Ratio..... \$3.95 B64 Dietzen 5 to 1 Ratio..... 3.95 B65 Dietzen 10 to 1 Ratio..... 3.95 B66 Acme Audio..... 4.25 B67 Amertran..... 5.95 B68 U.V. 712 R.C.A..... 5.75 B69 U.V. 714 R.C.A..... 5.75</p>
<p><b>MISCELLANEOUS</b></p> <p>B163 Spaghetti Tubing per yd..... .09 B164 Synthetic Crystal ..... .30 B165 Ground Clamps ..... .17 B166 Black Rubber Binding Posts, 2 for..... .05 B167 Nickel Plated Binding Posts, 2 for..... .05 B168 No. 18 Annunciator Wire, half pound coil..... .39 B169 6 ft. Phone Cord with Tips..... .79 B170 20 ft. Extension Cord with Tips..... 1.95 B171 Wall Insulators, Porcelain..... .05 B172 Tubular Porcelain Lead-in Insulators, 6-in. .10 B173 Rehnartz Coil ..... 1.45 B174 Cockaday Coil ..... 2.42 B175 2 in. Dial and Knob..... .25 B176 3 in. Dial and Knob..... .35 B177 4 in. Dial and Knob..... .49</p>	<p><b>Loop Aerial</b></p> <p>B76. Can be assembled by anyone in five minutes; all wood parts, wire and binding posts included, complete..... .69c</p>
<p><b>Plate Circuit "B" Batteries</b> The highest grade of battery made at prices lower than they ever were sold before.</p> <p>B80—2 1/2 Volt Small..... \$1.15 B81—2 1/2 Volt Medium..... 1.45 B82—2 1/2 Volt Large..... 1.95 B83—4 1/2 Volt Medium..... 1.95</p> <p>B84—4 1/2 Volt Large..... 2.50 B85—4 1/2 Volt Extra Large..... 3.50 B86—360 Hour 1 1/2 Volt Twin Double Duty "A" Battery..... .75</p>	

**Modell's** ESTABLISHED 1910  
71 Cortlandt Street  
NEW YORK, N. Y.  
America's Greatest Radio Mail Order House  
ELEVEN NEW YORK STORES

# Radio Digest Illustrated

REG. U. S. PAT. OFF. AND DOM. OF CANADA

Published by the Radio Digest Publishing Company, Inc.  
123 West Madison Street  
Telephone: State 4843, 4844, 4845  
Chicago, Illinois

E. C. RAYNER, Publisher

Chas. F. Smiser, Editor Evans E. Plummer, Managing Editor  
H. J. Marx, Technical Editor M. W. Thompson, Associate Editor  
Eastern Representative, Jacob Miller, Times Bldg., Times Square,  
New York; Telephone Bryant 4909

Pacific Coast Representatives

E. J. Wood, 251 Kearney St., San Francisco  
Telephone Kearney 1472

H. M. Morris, 417 Western Mutual Life Building, Los Angeles  
Telephone 12011

Member of the Audit Bureau of Circulations



PUBLISHED WEEKLY

SUBSCRIPTION RATES

Yearly in U. S. and Possessions and Canada, \$5.00.  
Foreign postage, \$1.00 additional. Single copies, 10 cents.

Vol. VII Chicago, Saturday, November 24, 1924 No. 7

## Home Runs Count

Average Person Little Cares for the Why of a Thing  
POPULAR discussion of the moment concerns, to some extent, who is first in Radio. Whether Marconi, De Forest, Armstrong or who else is selected as the very first to make possible Radio reception, the fact remains that the forces employed came with the creation of this globe and its attendant gaseous (or atmospheric) envelope. An Einstein theory thrown in here and there cannot make any difference to the known or latent forces of the earth or the influences exerted upon it by the planetary system. Science advances on man's mental wings and mechanical fabrications enable the use of natural forces.

Radio sending and receiving take small toll of the average mind when it comes to the whys and wherefores of Radio operation—the busy brain of the American has, as a rule, little of the inquisitive; if results are secured, satisfaction reaches its pinnacle. Why a ball is propelled by a bat is of no consequence—the home run itself is all that counts.

## New Political Medium

Press to Take a Back Seat in Politics

RADIO will be the greatest political medium of the future. It will take the place of the press, to a large extent, in molding public opinion. It is not likely that broadcasting stations will take sides and cast their lot with certain party leaders. It is quite certain that every aspirant to public office will fight for an opportunity to broadcast the messages he knows must reach the voters.

What political leaders really are preparing to do is to take advantage of the non-partisan attitude of the Radio stations and to use these to the greatest advantage.

There is no man or woman who would not like to hear the voice of any candidate for the presidency, for a United States senatorship or for a governorship. There is no man or woman that would not be more impressed by hearing the voice of the candidate than by reading often distorted accounts of the speech in the partisan press. Broadcasting of vital political messages will bring them to the public without editorial comment.

The wise candidate is preparing even now the broadcast of addresses he knows he must make during the campaign.

## Two Kinds of Apparatus

Impulses from the Human Body Not Like Radio

WHILE it is true that something closely akin to the Radio impulses emanates from the human body and can be picked up, amplified and returned by an apparatus correctly assembled from some of the standard Radio parts, not all Radio apparatus will accomplish this result. An analogy would be the crude parts used in a harrow, a farm wagon, or a threshing machine. While it is true that a half-inch bolt is a half-inch bolt regardless of where you find it, it would never do to utilize bolts of the quality used to hold a farm wagon or stove together in the building of a fine automobile engine. The bolts would hold the engine together all right so long as it was at rest, but immediately it went into operation the stress would prove greater than the bolts would be able to withstand. So it is with the ordinary Radio apparatus as compared with the electronic apparatus.

Long ago it was found that the standard windings as used in Radio apparatus were absolutely unsuitable for electronic apparatus. Likewise standard condensers are absolutely useless in the electronic therapeutic apparatus for reasons which should be apparent to students of the deeper phases of high frequency phenomena.

A warning should be sounded in order that Radio enthusiasts the world over may be deterred from plunging blindly into the attempt to make therapeutic apparatus. Such apparatus would doubtless prove quite harmless, though ineffective. The damage would come from the raising of false hopes in the minds of afflicted persons which would cause them to defer consulting a competent practitioner until too late.

## RADIO INDI-GEST

### Interducing the Kink's Best

Ah, we never fail. We promised you last week that King Miloplex' Sheba would be right on deck. And here she is! She's no other than the better 4/5, alias Mrs. King Miloplex, alias Queen Miloplex, alias Maggie the cook. Yes, the Queen always smiles like this. Cam Era, Indi-Gest staff photographer, caught her expression at its best, when she was enjoying her favorite pastime. That is, she was on the well-known warpath for the King. (You can tell she's a queen. But with the hearts on her waist and the club in her hand, we don't know which suit she is queen of.)

The bloody stains on her apron are from the King's own life stream, deducted therefrom by bouncing the rolling pin on the crown of Miloplex.

Well, we've got a lot to say to get around this photograph so let's dig up some more dirt. Oh, yes, the Queen rules the throne.

Absolutely! We know, because we saw the big fur coat the King had to buy her for being late at all of her meals. Yes, that's straight, but don't tell a living soul.



### Exit One Fur Coat

We have a 'Phan in our town,  
Whose ways are wondrous wise.  
He carefully hides from wife dear,  
All the Radio things he buys.  
H. K. C.

### Our Own A. & Q. Dept.

Dear Indi: What do they mean by the word "broadcasting?" U. R. TOO.

Answer: Telling a secret to a woman.

Dear Indi: Does King Miloplex smoke Milo cigs?

Answer: No, but Maggie, his better nine-tenths, smokes Camels. I. M. NOE.

Dear Indi: What is a variometer?

Answer: A variometer is a cross between a variocoupler and a wavemeter. The second child in the generation (according to Darwin) would be a wavecoupler. Y. KNOT.

Dear Indi: Why does papa shut off the Radio church services just when the minister announces the offering?

Answer: Buttons cannot be sent by Radio. B. CAUSE.

Dear Indi: These here artikuls by the Mistury Man call for a split variometer. How can I make wun?

Answer: Words fail us. Far better 'twould be if we were but to illustrate. See picture below. AL. LITTERATE.



## A-B-C Lessons for Indigest Beginners Chapter XXIII—And WOAW, WHAM and KOP BY GOSH

**W** IS the letter  
For American stations alone,  
That's why WHO, and WHY and WEAR  
Make Uncle Sam's ether moan.

### Let Willie Do It

Willie had a crystal set—  
One he'd put together—  
He could hear the jazz, you bet.  
News and sports and weather.

Papa bought a Radio  
Cost him "feefty-dollar;"  
Couldn't get a thing and so  
He made an awful holler.

Papa cursed the blooming thing,  
Threw it in the cellar.  
Said ma'd give a better "sing"  
Than the Radio feller.

Willie found the set one day,  
Took it to the attic,  
Fussed 'with wires and battery  
So he'd bar out static.

When pop heard the music come  
Without crash or sputter—  
"Beats the dickens, sure, I vum,"  
He was heard to mutter.

L'ENVOI  
When the "blamed thing" won't go right,  
Not a thing comes through it;  
Ere you smash it up outright  
Best "let Willie do it."

—PITTSBURGH POST.

### Somebody Please Buy It

Dear Indi: Jack Nelson (of WDAP, of course) wants everybody to know that he's "Got a Song for Sale that His Sweetie Turned Down." Anyone feeling sorry for him and helping him out of his difficulty will please credit this advertisement. Goo Goo.

## Memories



## Condensed

By DIELECTRIC

SOS calls came rather thick and fast one night recently from vessels on the Pacific Ocean. Four ships were involved, and there was evidence of another having been wrecked when a ship's spar and part of a cargo of apples were cast up on Vancouver Island. The battleship New Mexico figured in a collision at the mouth of Los Angeles harbor, owing to a heavy tide driving an oil tanker into her side. Thanks to "QRT-SOS," Radio carries tidings of mishaps from ship to shore, or ship to ship, and aid is obtained in most cases. It makes one shudder to think back to the time when vessels were completely out of touch with the rest of the world and their fate unknown for long periods. Yet, Radio is a fad!!

I have heard of instances where blind men have been cheated or robbed outright, and that seems vicious enough, but an incident which took place on Long Island should make every listener in wish to assist in the capture of as miserable a set of thieves as I know of. Crippled children inmates of St. Giles home at Garden City were so fortunate as to possess a very fine Radio receiving set—until lately. While the youngsters were at dinner the set was stolen, and you can imagine the grief of these poor, little, afflicted ones when "bed-time stories" were due. Have you considered helping purchase a set for others in whose lives there is mostly suffering? Let's try it; dials turn easier, if we do.

David Lloyd George made his farewell speech in the Metropolitan Opera House, New York City, but his visible audience was no doubt small in comparison with the vast number who heard everything said both by him and other speakers. Station WEAF broadcast the entire proceedings and relayed it to WCAP and WJAR, so that the majority of listeners in the eastern section of our country were able to get it all. It really makes a difference whether a speech is heard or read, in most instances, as the voice inflections give subtle meanings. To those having receiving sets it is possible to hear many men and women of prominence though they be addressing groups in halls miles away.

There probably will be discussion of the advantages and failing of religious broadcasting indefinitely; that's quite natural. But what do the Radio audiences think about it? Well, if those who listen for Doctor Cadman's talk to the men at the Bedford Branch Y. M. C. A., Brooklyn, may be chosen as typical, then such broadcasting is decidedly attractive to thousands. One woman will forgo any other engagement in order to hear this Sunday afternoon address. A number of the stations broadcast regularly the Interdenominational Sunday School lessons. What reaction does this produce? A prayer service is held at WEAF's studio each Thursday evening. Ask Mr. Harkness what he hears from listeners in.

To lovers of good music inconveniently situated for attending orchestral performances, Radio is a wonderful boon. Even those who enjoy listening to a good dance orchestra, occasionally like to tune in a station featuring a classical program. The educational value of hearing such music as played by some of America's foremost orchestras is considerable and, I believe, tends to increase attendance. WJAX provided a treat when they broadcast the Cleveland symphony orchestra concert. WGY has a large audience on Sunday afternoons listening to the numbers played by their own company organization.

# Latest Development in Grimes' Inverse Duplex

## Part II—Overloading Prevention Circuits

By David Grimes

THE first article in this series concerning the Grimes Inverse Duplex System, written specially for the Radio Digest, introduced the reader to some of its advantages and also to the reflex field

transformers were all built to operate on the old wave lengths and the old tubes. Consequently, there weren't many of them on the market when the change came that were worth the box they were in, especially

freely. For the first time in any publication I will go into great detail in regard to all these points and will try to devote one article to each trouble or likely variation. The present article will discuss the change in circuit for controlling the Radio energy, necessitated by the above-mentioned changes in tubes and wave lengths.

You will notice in Figure 2 that there is shown, in the input circuit from the loop, a 400-ohm resistance or rheostat. This was put in the circuit to cut down or control the amount of Radio energy entering the first tube. This was necessary, particularly on local stations, to prevent what is called "overloading the tubes." In the ordinary Radio circuits, there is little or no trouble of this nature experienced. It is very likely to occur in reflex circuits, and steps must be taken to prevent it. In the straight reflex arrangements, it is much more likely to occur than in my inverse duplex. You will recall that one of the advantages of my circuit was that the Radio and audio loads in the tubes were balanced and that each tube in consequence carried its own share of the energy. In the ordinary reflex, the tube which handles both the strong Radio and strong audio is overloaded long before the others. This overloading causes poor action.

circuit is forced enough, the limits of the tubes will be reached. A vacuum tube will handle just so much amplification and no more. Hence, on local reception, it is sometimes necessary to cut down the incoming Radio energy. The 400 ohms were placed in the circuit for that purpose. To work properly this should be a pure resistance, containing neither inductance nor capacity. Most of the standard 400-ohm

(Continued on page 18)

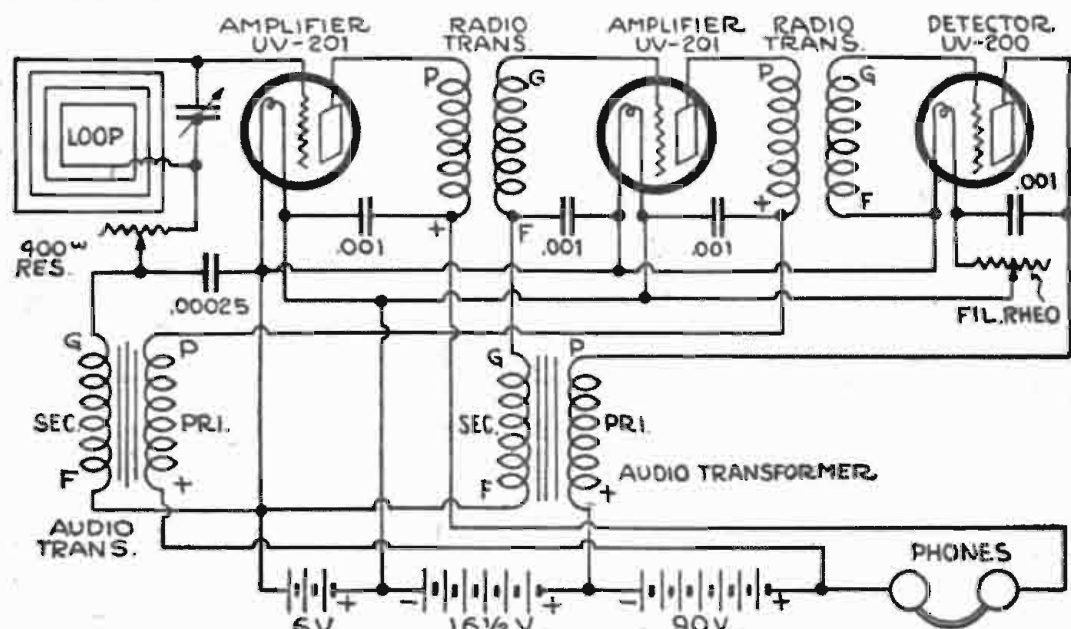

Figure 2

in general. It disclosed the prior art and showed just what relative position the circuit holds with respect to other Reflex developments. This second article will take up and discuss one of the serious defects which the original release on the inverse duplex contained. This defect was the inadequate means for controlling the amount of Radio energy entering the first tube. This was particularly troublesome when the listener was located very near to a powerful broadcasting station. It also caused difficulty with some types of Radio frequency transformers.

### The Original Circuit

In order to acquaint those who are not familiar with the earlier information pertaining to my circuit, I am duplicating the entire original circuit in Figure 2. In justice to this arrangement, let it be said that it was entirely satisfactory and gave excellent results with a minimum of tuning complications. However, it required certain definite apparatus with certain constants, and this equipment was not always available to the experimenter. As soon as he departed from the specifications in any particular, his troubles began.

Almost as soon as the information went out of my hands, the UV-201 tubes became obsolete. The circuit, as shown in Figure 2, was designed for use with these tubes. The new UV-201A tubes had certain characteristics which caused trouble in my circuit and sent many an enthusiast down to defeat. These new tubes were much better amplifiers and incidentally possessed somewhat different Radio frequency capacities. This later variation caused no end of trouble with the standard Radio frequency transformers then on the market. Of course, this was a source of annoyance to other Radio frequency circuits and finally forced the manufacturers of these parts to change their design to match the new tubes.

Fate, not satisfied with this damage, sought other channels in which to work trouble, and so the wave lengths were changed and the broadcasting band broadened. Now it doesn't take a great deal of thought to realize that the Radio frequency

for loop reception. And these were the conditions which existed in the field by the time my circuit information spread about. No wonder that some gave up in disgust. The only encouraging part of the experience was that most of the old amateurs and many of the new ones were able to ferret out the difficulty and to rectify it.

### Controlling the Radio Energy

Of course, I was anxious to send out the proper data immediately, but not until now have I, for several reasons, been permitted to discuss all of these things with you

At Last, Something You Have Been Looking For

## 2 in 1 Variable Grid Control

Can Never Wear Out—Always Gives Satisfaction—"A Combined Unit"

Variable Resistance Leak Variable Condenser

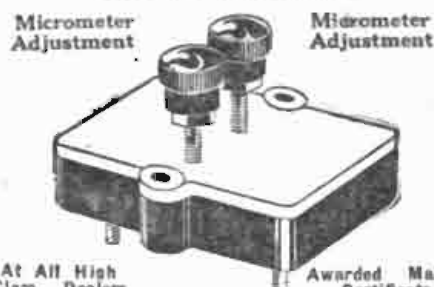

At All High Class Dealers Awarded Mail's Certificate

**\$2.00**

Panel Mounted 1-5 to 12 Megohms; No Sliding Contact; Dust Proof; Moisture Proof; Shielded; Best India Mira from .000002 to .0005 M. F.; No Sliding Contact; Shielded; Minimum Losses.

2 in 1 RADIO & ELECTRIC CO. 160 FIFTH AVE., Watkins 19277, New York

## Workman Radio Service

14-16 Vesey St. NEW YORK

- VARIOCOUPERS**  
 \$3.50 Workrite 180° Silk Wound.....\$2.95  
 3.00 Mills 180° Silk Wound..... 1.95  
 3.50 Fisher, Large, 99°..... 2.25  
 2.75 Fisher, 180°..... 1.75
- VARIOMETERS**  
 \$2.50 Workrite.....\$2.95  
 8.50 Remler, Molded..... 4.45  
 8.50 Fisher, Large..... 2.65
- CONDENSERS**  
 \$2.00 R. C. 11 plate.....\$1.05  
 2.25 R. C. 23 plate..... 1.35  
 2.75 R. C. 43 plate..... 1.65
- VERNIER CONDENSERS**  
 \$4.00 R. C. 23 pl.....\$2.25  
 5.00 R. C. 43 pl..... 2.95
- AUDIO TRANSFORMERS**  
 \$5.00 Acme.....\$3.95  
 5.50 Federal 226 W..... 4.35  
 7.00 Federal No. 65..... 5.75  
 7.00 Amertran..... 5.75
- PHONES**  
 \$6.00 Brandes Superior.....\$5.25  
 12.00 N. & K. Imported..... 5.50  
 5.00 Narco..... 2.50  
 Ambassador..... 3.89

### Complete Parts for Cockaday Sets

Including 7x14x2/16 panel. Standard tested apparatus furnished throughout.... \$12.75  
 Mail orders promptly attended to. All orders amounting to \$5.00 or more will be shipped prepaid. Will ship C. O. D. unless remittance accompanies order.  
 Write for our monthly bulletin of radio bargains at reduced prices.

## COLUMBIA ALL-CIRCUIT VARIOMETER



variometer can be used for MILOPLEX circuits.

**Price \$5.50**

Ask to see the nationally known Columbia line of licensed bakelite apparatus. Known satisfaction. A few more Columbia items:

- Moulded Bakelite Variocoupler.....\$6.00
- Geared Three Coil Mounting..... 3.00
- Geared Two Coil Mounting..... 3.50
- Inside Coil Mounting—"Vernier"..... 6.00
- All-Meter Variocoupler—150 to 2000 meters..... 7.00
- Mounted Coils, Coil Plugs, etc.

Write for our free literature

**COLUMBIA RADIO CORP.** 157 NORTH UNION STREET, CHICAGO



The new Twitchell Auxiliary Tuner connected to your present set will enable you to bring in the long or short wave stations which your present equipment cannot get.  
 Copyrighted Tuner diagram 50c. or with all parts \$9.00.

Complete instrument in walnut cabinet ready to use, \$15.00. Transportation prepaid.

My Highly Improved Reinartz brings in all important stations on this continent; loud, clear and without distortion. We dance to music from Atlanta and Los Angeles.

Build one of these wonderful 3-tube sets from my blueprint and specifications, price 50c. or with a perfect and complete double wound spiderweb coil, \$3.00 by mail. Picture of this set on a glass panel with every order.

This copyrighted circuit is the most successful of any Reinartz modification yet produced, and is imitated the most. Thousands are in use.

My W. D. II Circuit is especially designed for use with the "Pickie" tube and brings out the full value of that little tube as no other circuit can. Stations 1000 miles away come in clearly on one tube. This set is small, complete, portable. For the man who wishes the highest efficiency, this is the set to build. Price of blueprint and specifications, 50c. or with complete and perfect windings, \$3.00. Photo of set with every order.

These instruments are easy to build, easy to operate. Everything clearly shown.

Sets built from these copyrighted plans will receive all broadcasting stations operating under the new laws. Their wave length range is from 170 to 800 meters.

**S. A. TWITCHELL**

1925 Western Ave. Minneapolis, Minn.

## TINY-TURN

### A New Superior Vernier Control

TINY-TURN makes possible an exactness in tuning never before attained. It has a 30 to 1 gear ratio. No lost motion! The vernier turns in the same direction as dial; can be instantly disengaged, leaving dial free. **INSTALLED ON ANY SET IN 3 MINUTES.** Handsome nickel and black finish. We furnish counter display demonstrating boards.



Side View showing friction drive against dial.

**Price 75c**

## DUO-SPIRAL

The Leading Loop Aerial with New Dial and Handle

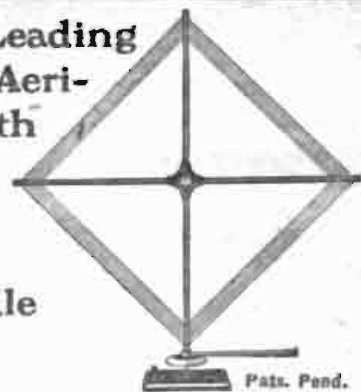

Top View of Base Showing Dial.

The DUO-SPIRAL loop reaches from coast to coast on the loud speaker. Careful tests by radio engineers have proved its superiority. Used exclusively by the largest manufacturers of radio frequency sets. It is trim and neat in appearance and handsomely finished. It rotates freely on its base. Adjustment is made easy by handsome dial and a long handle which eliminates all body capacity effects. The green double silk covered wire is kept always taut by hidden springs. The DUO-SPIRAL loop completely replaces roof antenna and ground and practically eliminates static.

**24" Size \$8.50 - 12" Size \$7.50**  
 (These prices include NEW Dial and Handle.)

## LOOX-RITE

### The Distinctive Binding Post

The handsome black and nickel finish and the beauty of design of LOOX-RITE Binding Posts add wonderfully to the appearance of your panel. LOOX-RITE is strong and sturdy thruout. Its concave metal base will stand tightening and prevents slipping. It fits any thickness of panel. Packed in cartons of fifty.

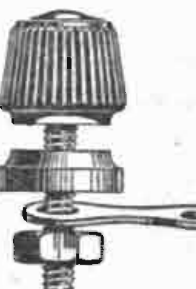

Pat. Pend.

**PRICE 10c EACH**

The above products (folders on request) are sold through dealers and jobbers. If your dealer cannot supply you, write us direct.

## RADIO UNITS INC

842 Webster Bldg., Chicago, Ill. Factory: Maywood, Ill.

## You Don't Need TUBES

to hear concerts from distant cities. **YOUR CRYSTAL SET** will bring them in if you buy my plans and follow them.

**PEOPLE USING MY METHODS** hear programs clearly from stations **400 TO 1000 MILES AWAY** No tubes, batteries or amplifying apparatus required. It may cost

**LESS THAN A DOLLAR** to perfect YOUR set. **EVERYTHING CLEARLY EXPLAINED**

in my copyrighted instructions selling for \$1.00. **SATISFACTION GUARANTEED.** Picture of my set and circular matter FREE. **WRITE ME TODAY.**

**LEON LAMBERT**

101 South Volusia Wichita, Kansas

### INVERSE DUPLEX

(Continued from page 17)

resistances contain capacity at Radio frequencies, and particularly on the new low wave length stations. Many amateurs used carbon rheostats and these were useless as they acted like condensers for the Radio frequency currents. It was only with considerable experience and knowledge, that the proper 400 ohms could be chosen. In order to make the circuit absolutely fool-proof, then, it was decided to drop this and use other means of control.

If a vacuum tube can only handle a certain amount of amplification—whether it

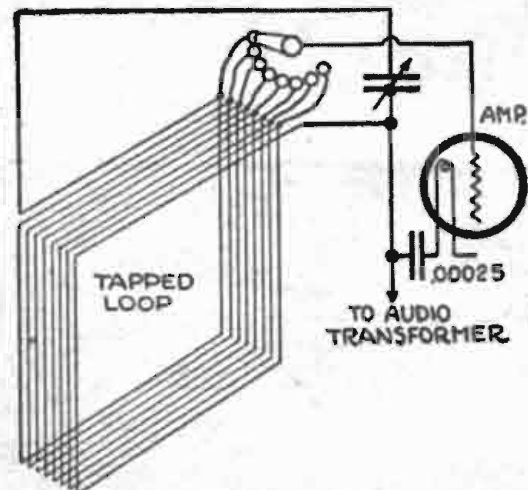

Figure 3

be all Radio, all audio, or a combination of both—then either the Radio or audio energy could be controlled to prevent overloading. But if the audio is cut down, there occurs a decided drop in volume of signal which is not desirable. If the Radio energy is diminished, usually no such drop in the signal strength is noticed. This is explained by the fact that the UV-200 detector tube will only effectively rectify or detect a certain maximum Radio current. If the Radio is stronger than this maximum, no increase in detection will take place. Thus, if the detector is already being overloaded, as is usually the case on local reception, then by dropping the incoming Radio energy, no cut in detection takes place and consequently no change in volume of signal strength is noticed. In dropping the Radio amplification through

the tubes, more room is left for the audio currents and a purer tone results.

### Controlling Radio Amplification

The Radio currents are to be controlled then, and not the audio energy. There are many ways to control this Radio amplification. In fact, there are as many ways as there are to control any electric current. A rheostat may be used or a potentiometer employed. A plus bias may be placed on the grids of the amplifying tubes or a shunting circuit used to cause a loss to the Radio currents. But anything we do to the circuit to effect the Radio must not alter the audio, or we are defeating our purpose. For this reason we can not use plus biases on the grids of the tubes and the resistance method, as before mentioned, is too critical. The solution is finally arrived at through the use of what is known as an auto-transformer circuit. By wiring the loop and connecting it as an auto-transformer, the strength of the Radio currents coming to the grid of the first tube may be varied as desired, and this will in no way effect the strength of the audio currents reaching this tube from the secondary of the second audio transformer.

### Improved Loop

Figure 3 shows a detailed drawing of such a loop. This illustration will bear close study, as it is probably different from any loop you have ever seen. It is not a tapped loop in the ordinary sense of the word. There have been tapped loops used in the past but the tappings have been for changes in wave length. This loop, which I have called the Grimes' autoloop, has three wires or leads coming from it. The two outside leads of this loop connect to the variable tuning condenser while the tapped connection goes to the grid terminal of the first tube. One outside terminal of the loop, which connects to the tuning condenser, also goes to the secondary of the second audio transformer and through a small fixed condenser to the filament of the first tube.

The variable contacts should preferably be made with a switch, care being taken to insure good contact. The size of this loop will be approximately 20 inches on a side, and it will have about 12 turns of wire, spaced about 1/4 inch apart. The tuning condenser should have about 23 plates. These condensers vary in capacity, so the

loop may have to be made a turn more or less in order to cover the entire wave length range with the one condenser. Experience will tell you whether you are running dangerously near one end or the other of your condenser in your effort to cover the entire range. If you are working with your condenser too far out, you will have to remove a turn from the loop, and vice versa.

The next article will show how the new tubes caused instability in my Inverse Duplex System and resultant howling. The full cause of this howling and its absolute guaranteed cure will be given. It requires a fundamental change in the circuit and this change will be shown in detail.

(TO BE CONTINUED.)

### RADIO FOR EVERYBODY

(Continued from page 15)

a fixed condenser of .0005 mfd. The circuit with which we are experimenting requires a variable capacity of .0015 mfd. We merely connect the .001 variable and the .0005 fixed in parallel (see Figure 43a). Another circuit requires a variable capacity of .0005 mfd.—we connect the .001 variable in series with the .001 fixed, and the effective maximum capacity is .0005 mfd. (Figure 43b). Should a circuit require .00025 mfd. capacity, we use all three in series (Figure 43c). Using our formula, and changing .001, .001 and .0005 to micromicrofarads, we have

$$\frac{1}{1000} + \frac{1}{1000} + \frac{1}{500}$$

and this gives us:

**GENUINE EDISON ELEMENTS (new)** for making "B" Batteries, obtained from U. S. Government. A positive and negative element—6c; glass tube—3c; all other parts at reasonable prices. Postage, etc., 50c extra per order. Free instructions. **TODD ELECTRIC COMPANY**, 109 West 23rd Street, New York.

### 2650 MILES

with ONE TUBE. Broadcasting from Atlantic Coast and Cuba heard in California by users of the CROSS COUNTRY CIRCUIT. This range is due to simplicity of set and operation as only one control is used for tuning. Easily and cheaply built. Dry cell tubes may be used. Complete instructions, with panel layout, assembly views, etc., postpaid for 25c. Or further information for red stamp. **VESCO RADIO SHOP**, Bx. 117, Oakland, Cal.

### What About It?

Isn't it about time to stop experimenting with multiple control circuits and build one that, combining ease of assembly and operation, loudness, clarity and selectivity of signals, as well as beautiful appearance, is excelled by none?

### THE ELGIN SUPER-REINARTZ RADIO RECEIVING SET

Embodies all the advantages of the well known Elgin Reinartz (the set which was largely responsible for the popularity of this wonderful circuit) and many others. It is much louder, more selective, requires no storage battery, and can be used with excellent results on a short or loop aerial. It has brought in California stations two thousand miles from Elgin, clearly and without interference on a loud speaker with only one tube, and that while our powerful local station was broadcasting three miles away. Could you ask for more? Write for circular giving one, two and three bulb hook-ups of this remarkable circuit. IT IS FREE.

**ELGIN RADIO SUPPLY CO.**  
207 East Chicago Street ELGIN, ILLINOIS

$$\frac{1}{.001 + .001 + .002} = \frac{1}{.004} = 250$$

That is 250 micromicrofarads, or put in

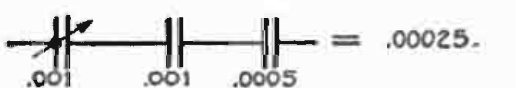
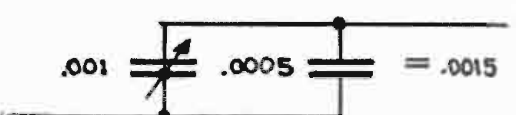

Figures 43a, b and c—Three ways of connecting condensers to obtain a capacity not provided by any individual unit

decimal form .00025 mfd. So, if at any time, you need a condenser of a particular value which you do not have in any one unit, see what you can do by grouping those you have.

(TO BE CONTINUED.)

**BUY DIRECT**  
SAVE DEALERS AND JOBBERS PROFITS

WD-11, WD-12, UV-199, UV-201A	\$5.43
Radiotron Vacuum Tubes	
Brandes "SUPERIOR" Phones	\$4.76
Battery Charger with "Tungar" Bulb	\$9.38

**VARIABLE "B" BATTERIES**

22 1/2 Volt	\$1.24	45 Volt	\$2.97
-------------	--------	---------	--------

**VARIABLE CONDENSERS**

11 Plate Regular	\$1.28	11 Plate Vernier	\$1.89
23 Plate Regular	1.44	23 Plate Vernier	2.19
43 Plate Regular	1.59	43 Plate Vernier	2.38

**AUDIO TRANSFORMERS**

All-American (All Ratios)	\$3.32
Jefferson "Star"	2.59
Eria-3 1/2 to 1 and 6 to 1	3.98
Duplex "Push Pull" Type	9.99

SEND FOR COMPLETE LIST  
Terms: Cash with Order or C. O. D.  
**SIMPLEX RADIO SUPPLY CO.**  
1806 Lafayette Avenue ST. LOUIS, MO.

"Service that is certain"



Langhelt & Kaufman Variometers and Variocouplers...\$6 ea. Finest instruments in the world. Myers Hi-Mu Tubes...\$4.35 Amperite-Automatic Filament, eliminates Rheostat...Unmounted, 70c; mounted, \$1.10 All merchandise absolutely guaranteed. Shipped immediately on receipt of purchase price.

**Radio & Mechanical Trade Corp.**  
23 Warren St. NEW YORK

**WE REPAIR THE FOLLOWING RADIO TUBES**

Dealers and Agents write for Special Discount Mail Orders Solicited and Promptly Attended to

WD-11	OUR SPECIALTIES	5 WATT	TRASMITTERS
UV-199	\$3.50	C-299	\$3.50
UV-200	2.75	C-300	2.75
UV-201	3.00	C-301	3.00
UV-201A	3.50	C-301A	3.50
WD-11	3.50	WD-12	3.50
DV-4	3.00	DV-6A	3.50
UV-292	4.00	C-302	4.00
UV-299	3.50		

**H. & H. RADIO COMPANY**  
P. O. Box 22-A  
Clinton Hill Station NEWARK, N. J.

### FREE with Every Purchase of \$10.00 and over, a small 22 1/2 V. B Battery

\$18.00 Westinghouse Rectigon Charger	\$14.63
\$9.00 Music Master Loud Speaker, Genuine	27.00
7.00 Pioneer Moulded Bakelite Variocoupler	4.75
100 Degree Variocoupler, 1200 Meters	1.92
100 Degree Variocoupler, Spider Web Rotor	3.50
6.50 Pioneer Moulded Bakelite Variometer	4.50

**ADVANCE B BATTERIES**

1.75 22 1/2 Volt, Small	.75
3.00 22 1/2 Volt, Large	1.45
4.75 45 Volt, Medium	2.00
5.50 45 Volt, Large	2.90

Bakelite Sockets, Base or Panel Mtg... .75  
Bakelite Sockets, Dble. Spring Contact... .45  
Contact Points, dozen... .10  
Freshman Variable Grid Leak... .50  
With Condenser... .65  
2.50 Brach Indoor Lightning Arresters... 2.10  
3.00 Brach Outdoor Lightning Arresters... 2.50  
Brandes Superior Phones, Genuine... 5.25  
10.00 Brunet French Phones, 4000 ohms... 6.50  
Thorlerson Transformers, High Ratio, Low Ratio... 3.75, 3.25  
12.50 Per Pair Comco Push and Pull Transformers... 10.50  
Aerial Insulators, each... .10  
2.00 Electric Soldering Iron, Small Tip... 2.50  
5.50 13 Plate AMSCO Condensers, Vernier... 2.65  
6.00 23 Plate AMSCO Condensers, Vernier... 3.50  
6.50 43 Plate AMSCO Condensers, Vernier... 4.00  
7 Strand Aerial Wire, 100 Ft. Coils... .60  
2" Composition Dials... .20  
3" Composition Dials... .25

**MARVEL RADIO SPECIALTY CO.**  
132 Nassau Street New York City, Dept. R. D.

### World's Biggest Battery Bargain

**FREE** **FREE**

**Hydrometer and "B" Battery FREE**

**READ THIS SPECIAL CHRISTMAS OFFER. THEN ACT!**

Thousands of Radio Digest Readers will profit by this amazing offer. They will buy the famous "B" battery FREE. And they get the best battery built. It is "World" quality that makes possible our 2-year ironclad guarantee. It is "World" quality that makes "World" owners "tell their friends." That's the best proof of performance any product can have.

**SEND NO MONEY**

You need not send a penny. Just clip this ad and attach your name and address. The battery will be shipped to you the day your order is received. When the battery arrives, inspect it—read our 2-year guarantee before you pay one penny. Confidence yourself you are protected from every angle—that the World battery price saves you 50%. Get the "B" battery and hydrometer FREE. Order today.

**COMPARE THESE PRICES:**  
Special 200-hour Rechargeable Storage Batteries

2 Volt for WD-11 and 12 Tubes	\$ 5.00
4 Volt for UV-199 Tubes	8.00
6 Volt 60 Amp	8.50
6 Volt 80 Amp	10.00
6 Volt 100 Amp	12.50
6 Volt 120 Amp	14.50
6 Volt 140 Amp	16.00

Mark the battery you want, clip this ad and save 50%

**World Battery Co., Dept. L, 60 E. Roosevelt Rd., Chicago, Ill.**

**World** Send your order today.

### DEALERS! Buy From a Reliable House

ESTABLISHED 1886

We can make immediate shipments of:  
CUNNINGHAM TUBES  
MORRISON LOUD SPEAKING UNITS  
CROSLLEY X. J. RECEIVING SETS  
"ACE" PRECISION SETS  
CUTTING AND WASHINGTON SETS  
ERLA REFLEX PARTS  
BREMER-TULLY NEUTRODYNE PARTS  
and hundreds of other well known high grade standard parts, etc.  
DEALERS: Write at once for our free catalogue A1001 and confidential discount sheet.

**WAKEM & McLAUGHLIN, Inc.**  
225-235 East Illinois Street  
CHICAGO, ILL.

# How to Build a Three-Tube Miloplex Receiver

## Part IV—Conclusion

By H. J. Marx

IT IS always easier to follow an illustration, than it is to conform to written descriptions, no matter how detailed. The last article covered the two alternative hook-ups and also the wiring. The rear view illustration helps considerably in making the main points in wiring clearly understood.

The wire used is  $\frac{1}{4}$ -inch square brass bus bar stock. It is very rigid and makes

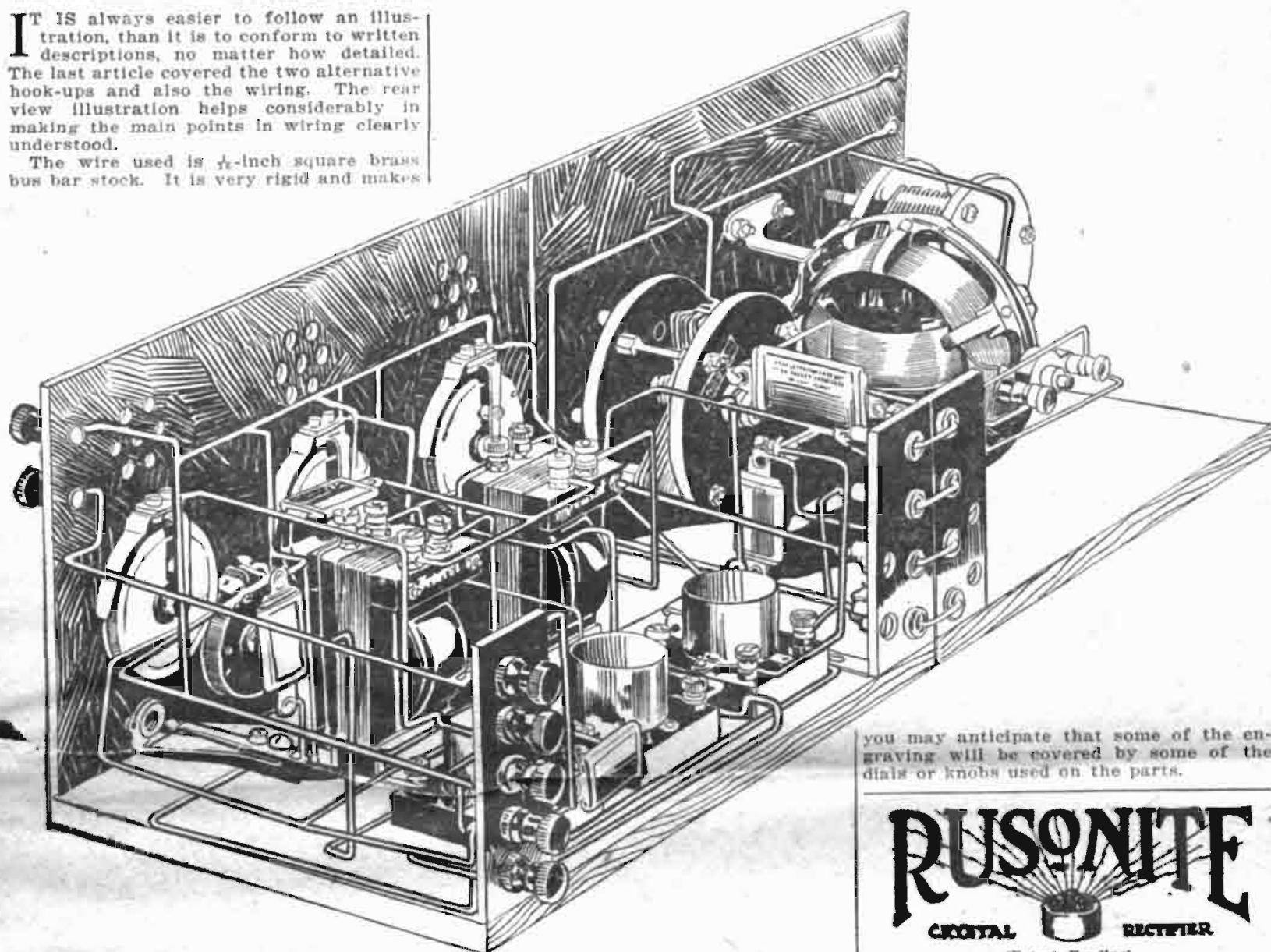

a decidedly neat-looking job. When the lengths are cleaned with some steel wool, it leaves a rich satin finish. It takes solder well and makes clean and firm joints.

It will be noticed that the potentiometer is marked for positive and negative side on the front of the panel. In assembly, set the slider in back at the halfway point, that is, in the exact center of the wire resistance winding, then put on the knob with its pointer vertical and tighten the setscrews or other locking means used.

Now turn the knob so the pointer is on the positive side. Then the terminal on the potentiometer which is nearest the slider must be connected to the positive A battery and the other terminal to the negative.

The by-pass condensers used in the amplifier circuit are conveniently placed as shown in the illustration. After all soldering has been completed, the circuit should be thoroughly checked and tested for any short circuits. This is often passed over and the fan wonders why it doesn't work.

**Front View**  
The view of the front of the two panels shows the abbreviations used in engraving. Engraving improves the appearance of the completed set, but because of its expense, it is advisable to reduce the number of letters and lines to a minimum. In furnishing a layout for an engraving, the locating dimensions for all names and symbols must be given. The engraver does not know what size dials and parts you intend using. If this is neglected,

**FREE RADIO VACUUM TUBE SET**

Receives 100 Miles or More  
Send name and address.  
Learn HOW you can get a Vacuum Tube Radio Set **ABSOLUTELY FREE**  
Write today for Free Radio Vint.  
**RELIABLE SALES CORP.**  
424 Broadway, N. Y. City, Dept. 598

you may anticipate that some of the engraving will be covered by some of the dials or knobs used on the parts.



**THE PERFECT SYNTHETIC CRYSTAL DETECTOR, SENSITIVE OVER ENTIRE SURFACE.** No Hunting for "Spots." Loud and Clear. Endorsed by thousands of satisfied users. Sensitiveness Guaranteed. Price, Mounted..... **50c**  
**14 K. GOLD SUPERSENSITIVE RUSONITE CATWHISKER.** Permanent. Will Not Oxidize. Price..... **25c**  
**RUSONITE REFLEX CRYSTAL.** Manufactured Expressly for Reflex Circuits. Will Stand Up Under Heavy Plate Voltage. Guaranteed. Price, Mounted..... **\$1.00**

Order from your dealer or direct from  
**RUSONITE PRODUCTS CORP.**  
15 Park Row New York, N. Y.

**METALECTRIC SOLDERING IRON**

*Indestructible All-Metal Quality Instrument—"GUARANTEED"*

Designed to meet the requirements of the discriminating assembler.

Interchangeable Tip  
**\$5.50**  
"WORTH IT"

Operates with the simplicity—comfort—ease and efficiency of a pen.

*Of your dealer or write*  
**Post Electric Co., Mfrs.**  
(Dept. 509) 30 East 42nd St.  
NEW YORK

**VERNI-TUNER**  
(Trade Mark)  
**3 in 1 Primary, Secondary and Variable Condenser**  
**NO TAPS NO INTERFERENCE**

No. 453 Price \$5.00

Indispensable for Construction of Radio Sets  
Just add a rheostat and socket and you have a complete regenerative set.  
**MOST SELECTIVE TUNER MADE**  
Saves Labor—Space—Money  
Serves as the main tuning device for all regenerative circuits, reflex circuits and the Horne "Combined tuned radio frequency and reflex" circuits.  
Other units for Reinartz, Cockaday, Flewelling and other circuits.  
Booklets of 14 circuits free with each device.  
At your dealer or postpaid on receipt of purchase price. Write for leaflet.

**HORNE ELECTRIC & MFG. CO.**  
Mercer & Colgate Sts. Jersey City, N. J.

**KELLOGG RECEIVERS**

**Very light!**  
*flexible and easily adjusted*

Mother, granny and little Willie who hangs on to his end until he is gently guided to bed by the car—even Dad himself stays until the furnace fire is low and the house is as silent as a morgue—they all appreciate this dandy little head set with wide receiving range and unusual sensitiveness because it is so light and easy on the ears. Not hard to take at all! Band is especially adaptable; receivers are instantly adjustable. Dispense with your "heavy artillery" and get this light, flexible, easily adjustable Kellogg head set. The price? Oh, \$10.00, but don't worry about that if you are after better results.

**Use—Is the Test**

**KELLOGG SWITCHBOARD & SUPPLY COMPANY**  
CHICAGO

The little vernier adjusters are added after the apparatus has been assembled, as their locations depend entirely upon the dials.

As shown in the rear view, the two units are connected by means of four straps in the adjacent sets of connection jacks.

The battery binding posts on the left side of the rear of the second panel are marked as follows, starting from the top: B + Amp.; B + Det.; B — ; A + ; and A — .

No details are given covering any cabinets. This size of panel is standard and cabinets can be purchased at very reasonable prices. When putting the set into the cabinet, the binding posts should project in the rear.

The connections from the one unit to the other can be made with flexible leads. The small single circuit plugs that can be purchased with the connection jacks will be found very convenient.

**Tuning**

There are three controls that work in conjunction with one another. These are the detector rheostat, the variable grid leak and the potentiometer. Never advance the detector rheostat to its maximum position unless the batteries are low.

(Continued on page 20)

**DUPONT PYRALIN SHELSTONE**

**Loud Speaker**  
With  
**Nath. Baldwin Head Set**  
Type C  
Perfect Results

Shelstone is made of Dupont's Pyralin, is transparent and one of the most attractive Loud Speakers on the market.  
It is built differently to take advantage of the most correct acoustic principles and reproduces music and speech with a clear tone.

**Loud Speaker with phones .. \$15.00**  
**Loud Speaker postpaid ..... 3.00**

Satisfaction guaranteed. C. O. D. or cash with order. Dealers write for discounts.  
**THE SHELSTONE COMPANY**  
185 Clinton Avenue NEWARK, N. J.

**The B-T Vernier \$5.00 Tuner (3-circuit coupler)**

has revolutionized many of the best circuits. Replaces coils on Reinartz Ultra Audion circuits, etc. Improves R. F. and Reflex circuits. Connections made to binding posts; easily changed to any circuit.

**Before Starting Your New Radio Set**

—read B-T's new booklet, "Better Tuning." It tells you why—the photo diagrams show you how. It is the result of thousands of inquiries we have had from both beginners and seasoned radio men. Sent on receipt of 10c or free with each Tuner.

**BREMER-TULLY MFG. CO.**  
532 S. Canal St. CHICAGO

**Better Tuning B-T**  
Price 10c

### THREE TUBE MILOPLEX

(Continued from page 19)

There is no necessity of using maximum current.

Set the detector rheostat about three-fourths of the way. Further experimenting with the set may even indicate that this much isn't necessary.

adjustment of the first three controls for improvement.

In tuning in for long-distance reception, the writer has found it advantageous to plug in on one stage of audio amplification. If tuning is done on the detector stage, the change from the phone impedance to the transformer primary im-

### Difficulties of Litz Wire

Litzendraht, usually called "litz," is recommended for winding coils, but only if the strands are perfect. The high frequency resistance of a coil wound with perfect litz is much less than for one wound with solid wire, but if some strands are broken or imperfect (and it is very

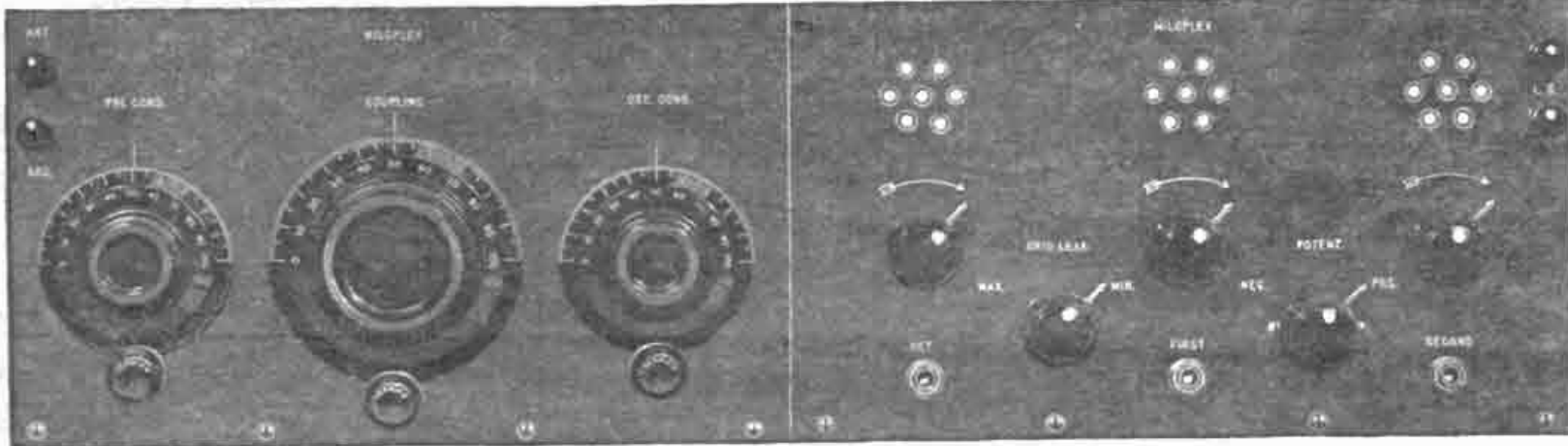

Set the grid leak about halfway and turn the potentiometer knob until the soft purring of a properly acting tube is heard. If a hum or roar is heard, readjust the grid leak until it is eliminated. The last two controls must be adjusted together until proper action of the tube is attained.

Now set the variometer dial at halfway; that is, with the rotating coils at right angles to the fixed coils. Set the OSC. COND. dial halfway, and very slowly turn the PRL COND. dial. It may be necessary to reset the coupling and OSC. COND. dials slightly.

When reception is heard, use the verniers for best adjustment of each of the last three controls. Then go over the

pedance unbalances the circuit, and the set must be retuned. Don't turn the amplifier rheostats any higher than necessary. The best point of operation is never maximum unless the batteries are low.

And, finally, don't worry about Radio frequency if your set is going good.

(THE END.)

### YELLOW TIP MICROMETER ADJUSTING CRYSTAL DETECTOR

Increases the Efficiency of Your Crystal Set



FINER tuning, clearest possible reception, constant adjustment until you wish to change, then—"A Twist of the Wrist—It's Set." Excellent for reflex and other circuits. Write for folder and name of your nearest dealer. \$2

Dealers and Jobbers—Write for Attractive Proposition  
**WHOLESALE RADIO EQUIPMENT CO.**  
Exclusive Factory Representatives  
35 William Street, NEWARK, N. J.

### Improved Ground Clamp

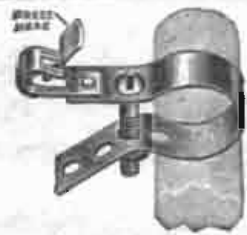

Equipped with Fahnestock Patent Wire Connectors  
Easily Attached  
No Soldering. For Radio Use Only  
At Your Dealers

**Fahnestock Electric Co.**  
Long Island City, N. Y.

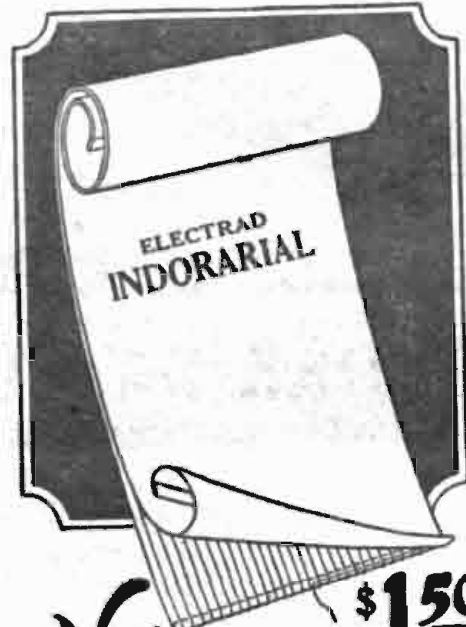

Now \$1.50  
A Practical Indoor Aerial

Ideal for sharp tuning. Reduces static to a minimum. Contains 600 feet of wire. Instantly collapsible and portable. Can be hung on door or placed under carpet. Noticeable directional effect. Particularly effective in large cities where several stations are broadcasting at the same time. One INDORARIAL used as antenna and another as ground gives interesting results.

At your dealer's, otherwise send purchase price and you will be supplied, postpaid.

**ELECTRAD, Inc., 423 L. Broadway, NEW YORK**  
**ELECTRAD INDORARIAL**

### LEAD-IN Troubles Gone

40¢

Electrad Lead-in fits right under closed window. Can be bent into any shape to fit ledges. Covered with fireproof insulating material which prevents grounding of circuits on wet window sills. Takes the place of ungainly porcelain tubes and holes in the window sash. Always presents a neat appearance. At your dealers, otherwise send purchase price and you will be supplied postpaid.

**ELECTRAD, Inc.**  
423-L BROADWAY  
NEW YORK

### SPECIAL (IMPROVED MODEL) Loud Speaker

Direct From Manufacturer to Consumer  
Genuine Wood Fiber Horn (With Unit and Cord)  
Entirely eliminates that annoying metallic sound. Positively the only WOOD FIBER HORN on the market today.  
10-inch Bell with Standard Attachment; Complete. Height 24 inches. Colors, Black, Mahogany and Olive Green.  
Price \$8.00 (For a limited time only.)  
Delivered to any part of the United States and Canada  
**EMIL DECLYNE**  
15 Park Row, Room 2525, NEW YORK CITY  
Send M. O. or C. O. D. Dept. R. D., Barclay 6298

### EASTERN COIL SETS

for the COCKADAY CIRCUIT

(4 Circuit Tuner)

are now a standard, and in universal use, due to their efficiency in this wonder circuit. Made as per specifications of Mr. Cockaday, using No. 18 wire with D coil bank-wound

Complete Assembled Set of B, C and D Coils..... \$2.75

Hook-up directions and material list furnished free with each set of coils.

Mail Orders Filled. Dealers Communicate  
**EASTERN RADIO MFG. CO.**  
22 Warren Street, Dept. R. D., NEW YORK, N. Y.

### EDSON Tone Tested Radio Headsets

\$3 POST PAID

2000 or 3000 OHMS

The lowest-priced first quality headset on the market today. Compare with headsets costing twice our price. Return ours if not satisfied. Our written guarantee protects you. Send \$3.00 by registered mail or money order. Buy direct of us and save the difference. We ship, postage prepaid, same day order is received. Ask for our Free Catalog of Radio Parts

**EDSON RADIO SALES CO.**  
6 Elmwood Providence, R. I.

### B-METAL RADIO CRYSTAL REFLEX DETECTOR

The Crystal That Brought Joy to 100,000 Radio Users Last Season.

Sent on approval. Pay us when you are satisfied. That's how sure we are that it will please you. Just pass the good news on to a dealer so others may enjoy B-Metals too. Just send us the name of dealer who hasn't heard of B-Metal when remitting. 50c

The B-Metal type C fixed detector for your reflex set—try one and know Gentlemen—Perhaps you would be interested to know that with the "B-Metal Crystal," which I purchased of you recently, I have received the past few days on an ordinary home made receiving set, without amplification of any kind, the following stations: WGY, Schenectady, N. Y.; KDKA, Pittsburgh, Pa.; WSW & WSAI of Cincinnati; WDAP, Chicago; WJAZ, Chicago; WOAW, Omaha, Neb.; WOS, Jefferson City, Mo. Williamsburg is 30 miles southeast of Cincinnati. This certainly speaks well for your crystal. Very truly yours, GILBERT BAZALL.

**B-METAL REFINING COMPANY**  
3134 Trumbull Avenue, Detroit, Mich.  
Chicago Branch, 53 West Jackson Blvd.

### PERFECTION MAKE PERFECTION YOUR SELECTION

DR. SEIBT PHONES Made in Germany. 6000 Ohms. The World's best Phones. \$18.00 List. Special.....	\$6.50	Atlas Loud Speaker—New Type. A loud speaker beyond compare. Adjustable tone. List \$25.00. Special.....	\$18.50
Brandes Phones. Superior.....	\$4.95	Amertran Transformers. List \$7.00. None better made.....	\$3.75
Reinartz. Complete parts for one tube set.....	\$10.50	Neutrodyne. Complete parts for 5 tube set. Exceptional value.....	\$32.50

**PERFECTION RADIO CORP.**  
Mail Order Dept. 59 CORTLAND ST., NEW YORK CITY Add Parcel Post  
Do Not Send Stamps  
N. Y. Retail Stores: 78 Cortland St., 119 West 23rd St., 128 Chambers  
208 page complete Radio catalogue free with order of \$5.00 on request. Otherwise prepaid for 25 cents

# R. F. Applied to Reinartz Receiving Set

## Amplification in Front of the Coil in the Set

I built a Reinartz three-tube set about a year ago and have had exceptionally good luck with it, having heard over 150 stations. I received 45 stations within 4 1/4 hours. I have tried all the new circuits including Flewelling, four-circuit and Neutrodyne, but I believe I have one now that is a good one. It is nothing

### WORKSHOP KINKS? EARN A DOLLAR—

THERE are many little kinks worked out at home that would aid your fellow Radio worker if only he knew about them. There are new hook-ups, new ways of making parts and various unique ways of operating sets that are discovered every day. Radio Digest is very much interested in obtaining such material. Send them in with full details, including stamped envelope, so rejected copy may be returned. The work must be entirely original, not copied.

RADIO KINKS DEPARTMENT,  
Radio Digest,  
123 W. Madison St., Chicago

more or less than the Reinartz circuit with a few changes and with one step of tuned Radio frequency ahead of the detector tube. This may not be new, but I have never seen it before. A diagram of it is shown herewith. It cuts out a great deal of static and certainly brings them in day and night.—R. J. Benante, Burlington, Vt.

### Two Super Circuits

Two super circuits are shown here which give pretty good results when they are adjusted right. The first seems to

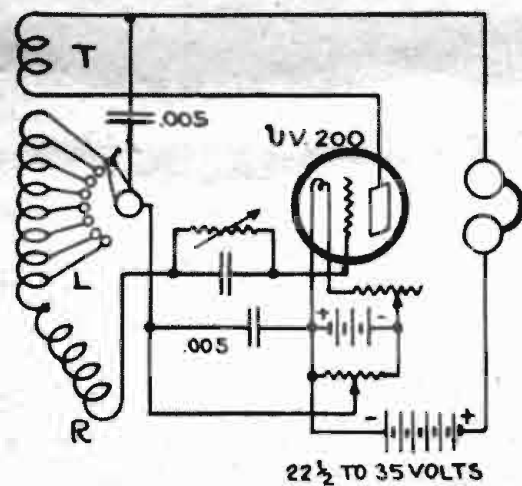

work best without antenna or ground; the second works with either, or both. In the second it does not seem to make any difference whether the plate variometer is in inductive relation to the grid variometer; nor does the grid leak seem critical.

If no ground is used, put a 23-plate condenser in the antenna line, as shown by the dotted lines. The value of T is 75 turns of number 22 dec. on the ball L.

## SEVENTY TURNS OF WIRE ON TUBE

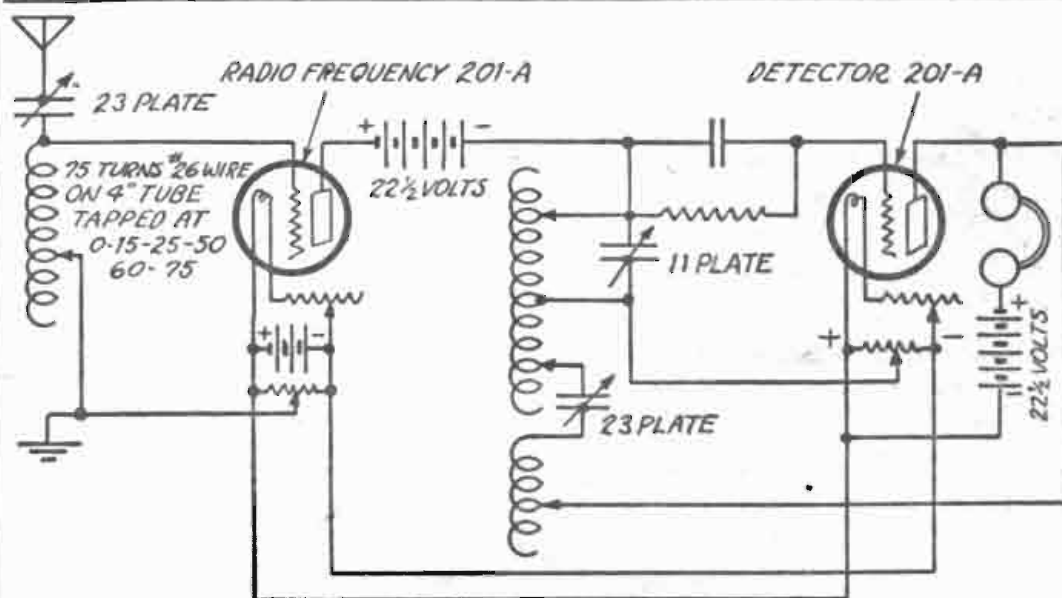

100 turns of 22 dec. on a 4 1/2-inch tube. Five taps are used at every 20 turns.

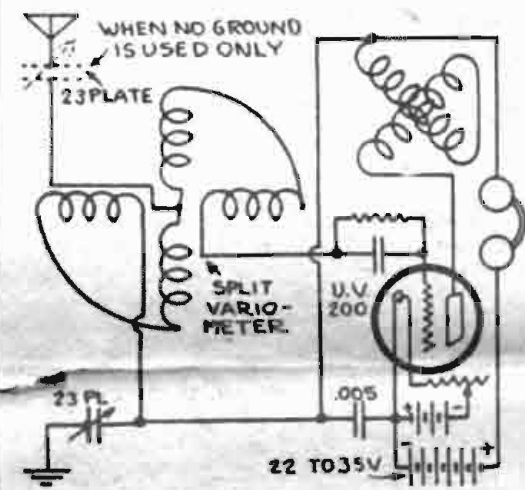

Twenty-five turns are used on R, the coupler ball.—T. R. Goldsborough, Washington, D. C.

### Insulate Lead-In

It is always good practice in bringing a lead-in into the house not to let it touch anything. If the lead-in touches any metal, some of the signal strength will be absorbed. In some cases where the lead-in touches wood there is not much difference in the signals; however, when it rains the wood has the same effect as a metal object.

WANTED—Radio Sales Engineers to call on highest grade jobbers and dealers for well known manufacturer, introducing new Grimes inverse Duplex Single Control Radio Receiving Set. Write for appointment for interview with District Manager. Address B-100, Radio Digest, Chicago.

**UNOTROL**  
\$ 11.90  \$ 11.90

## RECEIVER A Real One Tube Set

made of best material throughout. Mounted in high-grade mahogany-finished hinged-top Cabinet (as shown above). FULLY GUARANTEED Wonderful Distance reported by Enthusiastic Owners Will Ship C. O. D.; postage paid east of Rocky Mountains AGENTS WANTED To the Man Who Builds His Own: Write for our "BULLETIN OF RADIO PARTS AT BARGAIN PRICES." Standard Goods Only. Abalene Radio 105 Audubon Ave. New York, N. Y.

**WE REPAIR YOUR VACUUM TUBES**

WD-11-12, UV-199, UV-201-A \$3.50 each  
C-301-A  
UV-200, C-300 2.75 each  
UV-201, C-301 3.00 each  
DV-6, DV-6-A 3.50 each  
ALL WORK FULLY GUARANTEED  
Quick Service—Repaired Tubes shipped C. O. D.

**NEW TUBES**  
A-390 (Type UV-199) \$4.10  
A-491-A (Type UV-201-A) EACH  
A-12 (Type WD-12)  
All the above Tubes guaranteed amplifiers and detectors. Shipped C. O. D., postage prepaid.  
**Abalene Radio** 14 Vesey Street NEW YORK CITY

## Process of Tuning In Regenerative Circuits

In tuning a circuit of the regenerative type with tickler coil, the filament current should first be adjusted to a point below the normal filament brilliancy. The primary and secondary circuits are then adjusted to a condition of resonance with the incoming wave; the proper amount of regeneration is obtained by regulating the coupling between the tickler coil and the secondary. The filament current is next increased, by gradually reducing the amount of resistance in the circuit to the point where signals come in loudly and clearly without howling or distortion. Under this condition the local oscillations have the same frequency as the oscillations radiated from the broadcasting station. It is a condition known as "zero beat," due to the fact that there is no frequency difference, consequently no beat note.

If the tuning is slowly varied either way from this condition of synchronism, a high-pitched whistling note will be heard, gradually falling in pitch until it is replaced by the speech or music. Further change causes a low whistling note, gradually rising to a shrill whistling sound. It is thus apparent that the tuning adjustments in a regenerative circuit are so critical it will be found advisable to provide vernier condensers and vernier rheostats. These permit very small changes in the tuning of the circuit and in the regulation of filament current, so that the point of maximum signal amplification may be easily obtained and the sounds received will be free of distorting effects.—Peter J. M. Clute, Schenectady, N. Y.

A three-plate vernier condenser should be connected in shunt to a larger one and not in series.

### How to Prevent Howling

Shield the back of the panel with a thin sheet of tinfoil or metal, soldering a connection with it to the ground. Every joint in the wiring should be soldered. Make sure that the switch points and arms are not loose. Much unnecessary noise may be eliminated in this manner. Radio sets may sometimes be kept from howling by placing the plate and grid leak wires as far apart as possible. It is also advisable to plan the wiring so as to be sure that the smallest amount of wire is used in connecting the parts.

### Solder Flux for Taps

Never use acid paste as the flux for soldering taps to coils. When heated the paste will flow between the turns, penetrate the insulation and form a high frequency leak between the turns. In many cases it has short-circuited the turns. Use rosin core solder throughout.

## Another Scoop Miloplex

Genuine parts as recommended by the inventor including the now

### Famous SPLIT VARIOMETER

DEALERS ONLY  
Write for Dope

We are the largest exclusive radio jobbers in the middle west.

**HUDSON-ROSS**  
123 W. Madison St. Chicago

## DEALERS PROMPT SHIPMENTS LIBERAL DISCOUNTS

### COTO SPECIAL Audio Frequency Transformer

\$2.50



COTO-COIL Distributors

Note!! We are the largest exclusive Radio Jobbers in the Middle West

**HUDSON-ROSS**  
123 W. Madison St. Chicago

## TRIGGER OF NEW YORK RADIO

EVERYTHING SOLD ON MONEY-BACK GUARANTEE. WE HANDLE NO BOOTLEG MERCHANDISE.

<b>COCKADAY COMPLETE PARTS GUARANTEED \$12.50 ASSEMBLED \$17.50</b> Add \$2.50 to each for Cabinet	<b>ERLA REFLEX 3 TUBE BEST OF PARTS \$45.00 ASSEMBLED \$67.50</b>	<b>COCKADAY 3 TUBE Unassembled \$32.50 INCLUDE CABINET ASSEMBLED \$42.50</b> DISTANCE VOLUME SELECTIVITY	<b>LOUD SPEAKER</b> Bristol ..... 20.00 Atlas ..... 18.00 Magnavox . . . 30.00 Mercury .... 6.00 Music Master ..... 26.00
---	---	---	--

We carry a complete line—from screws to sets. You can purchase with an absolute guarantee. We carry no factory seconds or salvage merchandise. Goods shipped immediately. Please be sure to include postage on orders under \$10.00.

**TRIGGER OF NEW YORK**  
100 EAST 59TH STREET, NEAR THIRD AVENUE, NEW YORK CITY

## KEYSTONE RADIO LIGHTNING ARRESTERS

\$2.00  \$2.00

Should be on every aerial the year 'round. Provides highly efficient lightning and static protection for the home. Fully approved by Fire Underwriters. Can be installed outdoors. Has no vacuum to lose. Install one in your aerial lead now—be safe. This pioneer radio arrester is backed by 31 years' experience in lightning arrester design. For sale by Dealers everywhere, or sent postpaid for \$2.00. Write for circular.

**Electric Service Supplies Co.**  
17 & Cambria Sts. Philadelphia  
Monadnock Bldg., Chicago  
30 Church St., New York

# Questions and Answers

**Honeycomb Miloplex**  
(5672) WAW, Ottawa, Can.  
Please publish a Miloplex Number 3 hook-up, using two honeycomb coils, and give number of turns on each.

A.—The hook-up of the Miloplex using

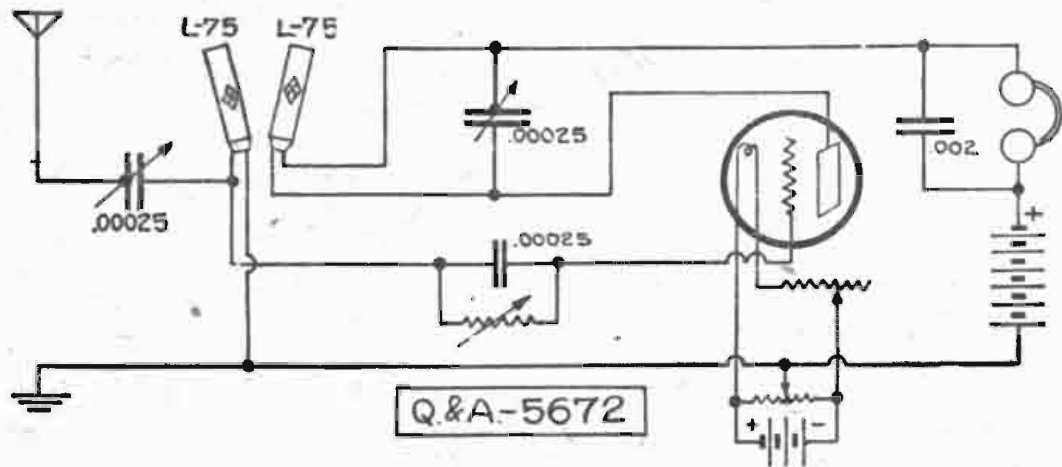

honeycomb coils is presented. Four coils, two of 50 turns and two of 75, should be kept on hand and interchanged for best results.

**Antenna**

(5090) FWS, Chicago, Ill.  
Will you kindly answer through Radio Digest if a loop type antenna of 125 feet

against the single strand wire being the presentation of loop faces to direction of current impact with resulting cutting out of local stuff when fishing for outside, on nights other than Monday. If yes—how far apart should the wires be spaced?

A.—Answering your inquiry we are advising that the antenna system of your description would not afford nearly so good long range reception as is possible with a single wire of 125 feet. However, it is admittedly advantageous where increased selectivity is desired. Spacing of wire at 1 inch will serve in constructing loop.

**Reflex Circuit**

(5207) EAS, Cincinnati, Ohio.  
I would like to ask you a few questions about the Reflex hook-up. Could I use a tube detector instead of a crystal? Also, could I use a 10 to 1 and 4 to 1 transformer for the audio frequency? Would a Crosley Radio frequency amplifying tuner be good for the Radio frequency?

At present I have a single circuit regenerative detector with two step audio frequency, and I want to make it more powerful for this winter. Would one step Radio and two audio give better results than my present set?

A.—Answering your inquiry with reference to Reflex circuit, we are advising that a tube may be substituted for crystal detector, although no material advantage will be gained. A diagram showing connections appears on page 11 of April 21 issue of Radio Digest.

Transformers of low ratio are indicated for Reflex circuits. Ten to one ratio is rather high. Those of 5 or 3 to 1 are recommended.

The addition of one stage of Radio frequency amplification to your regenerative circuit would not be of sufficient value to warrant the trouble.

Don't expect a Radio set to act like a phonograph, you can't push a button and get grand opera or jazz.

**RADIO TUBE CORPORATION**  
70 HALSEY ST., NEWARK, N. J.

## WD-11 and WD-12 Tubes Repaired

WD-11 or WD-12....	\$3.50
C-300 or UV-200....	2.75
C-301 or UV-201....	3.00
C-302 or UV-202....	3.50
C-301A or UV-201A.	3.50
Moorehead Detectors.	2.75
Moorehead Amplifiers.	3.00
DV-6 or DV-6A.....	3.00
UV-199 or C-299....	3.50

*All tubes guaranteed to work like new*  
**Mail Orders Given Prompt Attention**  
**"24 Hour Service"**  
Tubes Sent Parcel Post, C. O. D.

### AID FOR ABI

Gentlemen:  
Referring to Q. & A. department, Number 4832, October 20, ABI, Syracuse, N. Y., I will say that if he swaps the leads on his grid variometer he will lessen the body capacity to such an extent that it will not bother him. He may have to experiment with the plate variometer. However, if he changes the leads from the variometer to the same lead on the variocoupler and grounds the filament lead from the variocoupler, he will eliminate practically all body capacity.  
At least the foregoing filled the bill for me and my set was in the same predicament as ABI says his set was.  
Hoping this is worth something, as I want to try and repay as much as I can your kindness and courtesy in giving me some valuable help recently, I am,  
Yours very truly,  
H. B. Allen.

## CARTER

NEW 15 POINT

### Inductance Switch

\$2.00

Only one hole to drill; easy to install. Pigtail connection eliminates sliding contacts. Westinghouse "Mica-card" insulation prevents leakage. Solder terminal and contact one piece. New type dial knob eliminates panel numbering. Can be used as "B" Battery tap switch. Adjustable stop pin. Ask your dealer—Write for Catalog, complete line.

**Carter Radio Co.**  
102 S. STATE STREET  
CHICAGO

### MISSING WHAT YOU GET

**YOUR** set is probably bringing in DX stations you never hear because your rheostat cannot control your filament action. The Fil-Ko-Stat gives infinite adjustment and enables you to magnify the weak stations and bring them in strong and clear.

Full resistance 30 Ohms, adjusted to ALL TUBES. **\$2** At All Dealers in High Grade RADIO SUPPLIES

*"Avoid the use of inferior powdered carbon rheostats."*

## FIL-KO-STAT

Made and Guaranteed by  
Dix Instrument Co., Harrisburg, Pa.  
Sole International Distributors.  
Radio Stores Corp., 218 W. 34, N. Y. City

**I.C.S. RADIO HANDBOOK**  
**\$1**

## REINARTZ COILS

IMPROVED COILS MADE TO COVER NEW WAVE LENGTHS

21 tap coils.....	\$1.00
16 tap coils.....	.90

Above prices include coil mounting and also circuit diagram. Sent postpaid upon receipt of money order. Attractive discounts to dealers.  
**KINLEY RADIO CO.,** Box 185, Detroit, Mich.

## A NEW DISCOVERY!

EXTREME SUPER-REGENERATION is obtained without noises through

### FRESHMAN

*Variable Resistance Leaks*

by connecting between plate and Grid of the tube as disclosed by the sensational **New Kaufman Circuit No. 2**

Only the Knob Shows on the Panel

Panel Type

Absolutely No Pencil Markings

Base Type

Freshman Resistance Leaks are especially built for use as tuning instruments. Construction is such that they will withstand unusual usage. Freshman Leaks give an unbroken range of 180 degrees from 0 to 10 megohms. Absolutely guaranteed. Enables you to get stations you never heard before.

EITHER TYPE

Complete with either .00025 or .005 mfd. Mica Condenser..... **\$1.00**  
Without Condenser..... .75c  
At your dealers—otherwise send purchase price and you will be supplied postpaid.

Ask your dealer or write direct for free diagram showing how you can convert your single tube circuit into the new sensational Kaufman Circuit No. 2.

**Supertan**

An Audio Frequency Amplifying Transformer that does more than meet requirements.

Affords highest amplification on all wave lengths. Built to operate equally well with all modern types of tubes.

### PRICE \$6.00

At your dealer's or by mail on receipt of purchase price. Write for free literature.  
**FORD MICA CO., Inc.**  
14 Christopher Street New York

## Crosley Model X-J \$65

DISPEL dull care during the fall and winter evenings with a Crosley Model X-J radio receiver. Enjoy, nightly, the concerts, speeches and other amusements that are sent out from New York, Honolulu, Cuba, Cincinnati and hundreds of other places.

For bringing in distant stations clearly and distinctly, no set can excel a Crosley Model X-J. It is a 4 tube radio frequency set, combining one stage of tuned radio frequency amplification, detector and two stages of audio frequency amplification.

Actual tests have proven it the most remarkable radio receiver ever offered regardless of price. See this beautiful instrument at your dealers. Complete catalog describing the entire Crosley line of instruments and parts will be sent free upon request.

*Write for It Today.*

**Crosley Manufacturing Company**  
POWEL CROSLY, Jr., President  
11494 Alfred St., Cincinnati, Ohio

## Every Radio Fan Should Have This Book

**Price Only \$1**

514 pages Pocket Size

Compiled by HARRY F. DART B.S.E.E.  
Formerly with the Western Electric Co., and U.S. Army Instructor of Radio.

Technically edited by P. H. DOANE

Like a little radio encyclopedia, this I. C. S. Radio Handbook is packed with concise, sound information useful to everybody from beginner to veteran hard-boiled owl. It starts with simple explanations of radio phenomena and leads you along gently until you can understand the most technical diagram.

You may dip into it at random, or hunt up special information you want, or read it right through. Different types of receiving and sending hook-ups are explained; proposed insurance regulations; lists of broadcasting stations; radio compass stations; interesting experiments; definitions; codes and symbols; technical data and thousands of suggestions for getting more pleasure out of radio.

**A pocket course in radio!** Every page tells you something useful, and there are 514 pages; hundreds of illustrations and diagrams. It is the biggest dollar's worth in radio, and will save you from wasting money on things that don't work.

Send \$1 to-day and get this 514-page I. C. S. Radio Handbook before you spend another cent on parts. Money back if not satisfied.

--- TEAR OUT HERE ---

INTERNATIONAL CORRESPONDENCE SCHOOLS  
Box 4279-C, Scranton, Penna.

I enclose One Dollar. Please send me—post-paid—the 514-page I. C. S. Radio Handbook. It is understood that if I am not entirely satisfied I may return this book within five days and you will refund my money.

Name.....  
Address.....





# Radio Illustrated



... goes to the house top to catch all he can of the air messages. Left: Playing solitaire while listening to an evening concert, is she? Maybe, but she has the Queen of Hearts in her hand, and it is more likely she is wondering who is to be the king of her own heart. Left © Photonews Above, Int. Newsreel Photo

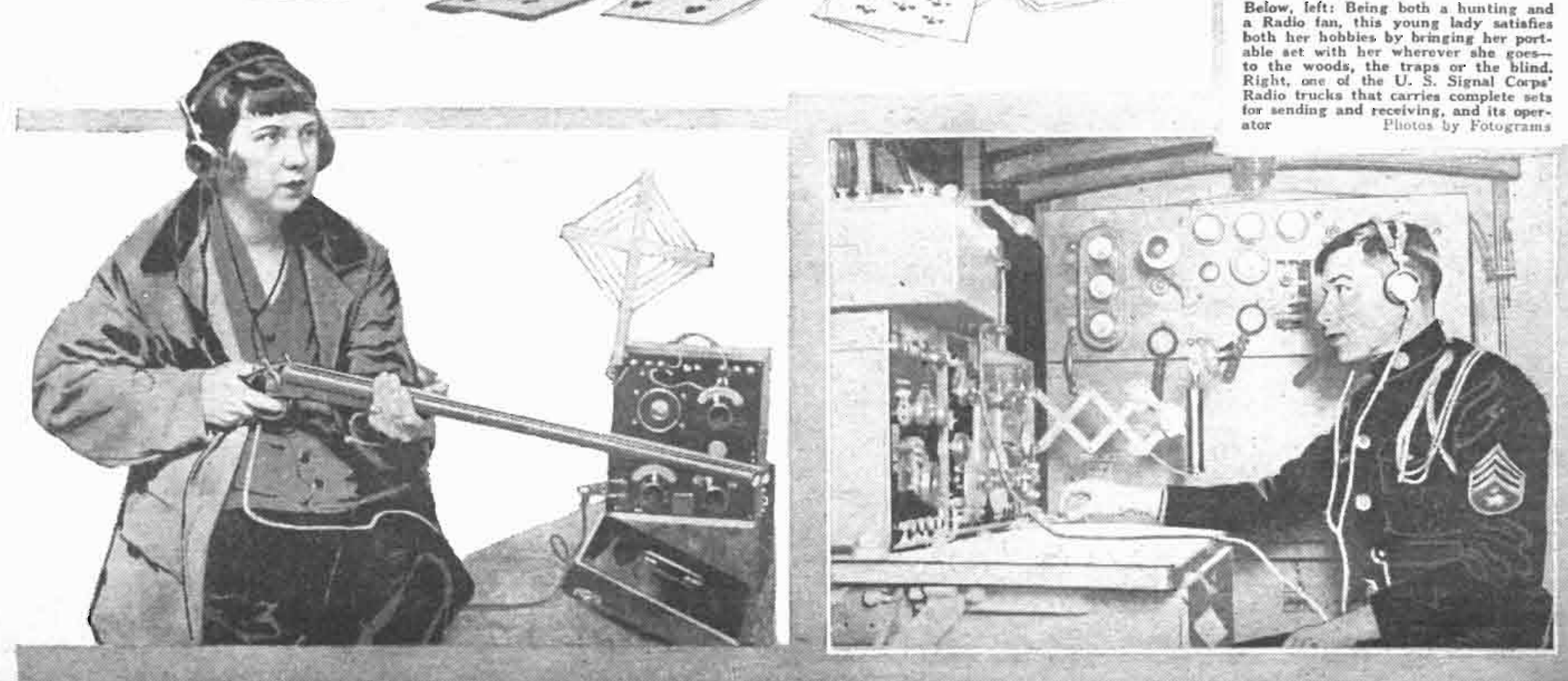

Below, left: Being both a hunting and a Radio fan, this young lady satisfies both her hobbies by bringing her portable set with her wherever she goes—to the woods, the traps or the blind. Right, one of the U. S. Signal Corps' Radio trucks that carries complete sets for sending and receiving, and its operator. Photos by Fotograms