

Radio Digest

EVERY WEEK

Illustrated

TEN CENTS

TRADE-MARK

Vol. III

Copyright, 1923
R. D. P. Co. Inc.

CHICAGO, ILL., SATURDAY, JANUARY 6, 1923

No. 13

FLEWELLING MAKES HIT

COMEDY CASTS PLAY FOR "RADIO OWLS"

CHICAGO.—One of the features of Westinghouse Station KYW's programs have been the midnight shows broadcasted every Friday from 11:30 to 12:30, Central Standard time. The casts of "Shuffle Along," "Greenwich Village Follies" and "Spice of 1922," now playing in Chicago theaters, were three recent groups of entertainers for the "Radio owls." The new venture is proving popular.

LISTENING IN WITH THE OPERA FANS



Mile. Galli-Curci, famous coloratura soprano heard in "Manon" broadcast last week by KYW, is here shown as Madama Butterfly in the opera of that name
fernand de Gueldre Photo

NEW CIRCUIT BIG WINNER ON RESULTS

Fans Find "Flivver" Fine

Thousands Interested—Meets Success without Ground or Aerial—Flewelling Contest Opens

Acting on the great burst of enthusiasm which has greeted the scoop RADIO DIGEST scored with the Flewelling "flivver" circuit, announcement is made of a prize contest to open at once. Eight prizes, a total of \$75.00, will be awarded to the most successful builders and describers of Flewelling type receiving sets. The contest will close at midnight January 27 and awards will be announced (Continued on page 2)



Edouard Cotreuil, distinguished French basso of the Chicago opera, in the role of Hunding in "The Valkyrie." He is often heard in operas which KYW broadcasts
Atwell Photo

BRITON BRINGS OUT NEW PHOTO DEVICE

Radio Photograph Transmitted Successfully One-Third Mile in Three Minutes

LONDON, ENG.—The Daily Mail has announced that an electrician, T. T. Baker, a pioneer in phototelegraphy, has completed a new process for Radio photography. It is said that he has found it possible to send by Radio, a photograph which is reproduced on a sensitive film some distance away from the sending set. The newspaper prints a picture which was transmitted by Mr. Baker's device, from one building to another building one-third mile away within three minutes. It adds that the process may be used before long for the transmission of pictures over unlimited distances.

Speaker Fools Audience by Using Recorded Voice

Starts Lecture in Person—Discovered Later Quite Silent

CHICAGO.—E. H. Colpitts, well-known Radio engineer, demonstrated some of the latest devices in the art of communication at a recent meeting here of the Western Society of Engineers. The film was shown depicting the internal troubles of "three electrode tube," accompanied by a running commentary by a lecturer. After a while the audience discovered that the lecturer was sitting silent among them, and it was then explained that he had delivered the lecture in New York several days before, his words being taken down on an electrical recording machine and then preserved on the ordinary phonograph record.



Miss Addie Rolf, with a pocket-book Radio receiving set exhibited at the American Radio Exposition, just held in Grand Central Palace, New York. The aerial wire is laid in the fold for the bills. The miniature set worked all right when tested
© Fotograms

FLEWELLING MAKES HIT

(Continued from page 1)
in the February 24 issue of this publication. A complete statement of the rules and the course to follow in entering the contest, appears on this page.

Circuit Declared a Winner

The unusual and unexpected results thousands of fans have attained by setting up the Flewelling circuit have caused it to be declared a winner. Chicago Radiophans have kept the telephone wires to the publication office busy with joyful proclamations of the circuit's abilities, requests for further information and back numbers. The first issues describing the circuit have been exhausted due to the heavy demand for them.

At the recent American Radio Exposition, held in New York, crowds of fans surrounded the RADIO DIGEST booth where a Flewelling set was on exhibit. All who had given it a trial spoke of its reaching power and strength of signals with great praise.

Uses No Aerial, Has Success

One Chicagoan, who had set up and tried the Flewelling "super-oscillator" circuit called the DIGEST only recently to tell of the success he was having without aerial or ground. He was using only one tube, and no amplification, but was able to hear WGM, Atlanta, Ga., WGY, Schenectady, N. Y., and WHB, Kansas City, Mo., as loudly as he could ever hear Station KYW, local, with aerial and ground on a one-tube regenerative set with one step of audio frequency amplification.

Hundreds of letters have arrived at the office of RADIO DIGEST, telling of results almost as unbelievable. Undoubtedly, the Flewelling set is the "flivver" of them all, if results are to be believed.

Reason for Contest

To perfect this circuit to the utmost, and make all details of the best construction and operation available to all, RADIO DIGEST announces the prize contest. Owing to the peculiarities involved in the action of the circuit, only those who have followed the directions given in the past issues of this paper, have had success. Improvements, however, are to be made in everything new, so that RADIO DIGEST believes the contest will unearth some interesting material.

National Guard Takes Over WEAF One Hour

71st Inf., N. Y. N. G. Gives Novel Entertainment—Recruits

NEW YORK.—A military night was the feature of the broadcasting program of WEAF recently. The 71st Infantry, N. Y. N. G., took over the station and provided entertainment for an hour. The first number of the regiment's program was a march by the thirty-five piece regimental band directed by Lieutenant Lambert L. Eben, which was followed by a bugler sounding adjutant's call.

Colonel J. Hollis Wells, commanding officer of the regiment, then gave his commands, which were received at the armory Radio station from WEAF and executed by the regiment.

Colonel Wells followed on the program with a short talk on the advantages of service in the National Guard and particularly in the 71st Infantry, now the strongest National Guard infantry regiment in New York State and the second largest in the United States.

Nine Navy Stations Closed; Not Needed Says Secretary

CHICAGO.—Nine Radio stations in the region of the great lakes were recently closed on orders from the secretary of the navy declaring that, since they did not contribute to the efficiency of the fleet, they should not be supported by the navy department. The Cleveland station was discontinued, except for air mail service purposes.

The stations shut down are at Mackinac Island, Manistique, Whitefish Point, Duluth, Eagle Harbor, Milwaukee, Alpena, Detroit and Buffalo. The first three were built primarily for Radio Compass work in directing ships through the fogs and storms of Lake Superior and the St. Mary river.

WRL to Cross "Pond" Regularly

SCHENECTADY, N. Y.—The Union College Radio station, WRL, located here, will make an earnest endeavor to become a pioneer in a new field, that of carrying on regular communication across the Atlantic Ocean. In preparation for the work, which began in December, the organization has built new apparatus. There are two tubes of 250 watts each.

Union College is famed as the introducer of the Radio baby carriage two years ago. That novelty received world-wide broadcast, via motion pictures. Likewise the station is remembered as one of the first in the country to have broadcast entertainments.

Arrangements have been made to connect the telephone of Lopez Island, one of the San Juan group, with the mainland by means of Radio.

FLEWELLING PRIZE CONTEST RULES

- Contest is open to all Radiophans, whether or not they are subscribers to Radio Digest, Illustrated. The contest is open now and will close January 27 at midnight. Awards will be announced in the February 24 issue of this publication.
- The object is to locate and award prizes on a competitive basis for the best Flewelling circuit receiving set entered.
- Prizes are: First, \$25.00; Second, \$15.00; Third, \$10.00; Fourth to Eighth (five prizes) inclusive, \$5.00 each.
- In event of a tie, equal prizes will be awarded both contestants.
- Judges will be the Technical Staff of Radio Digest, Illustrated.
- To enter the contest send working drawings and diagrams together with an article of from 1,500 to 2,500 words in length describing the making and operation of an actual Flewelling circuit receiving set. The contestant must build this set and test it before entering the contest. The article must tell: (a) how to make the set, (b) how to operate it, (c) helpful suggestions for getting maximum results, (d) actual airline broadcasting station receiving range using only one tube, first employing only an indoor aerial but no ground, second, using a ground but no aerial, and third, if available, using only a loop aerial. Other combinations and notations on the antenna system used will be considered in the award of prizes.
- In sending material for consideration in the contest, exclusive publication rights are automatically given to Radio Digest, Illustrated. All articles published, but not awarded prizes, will be paid for at regular space rates. Unused manuscripts will be returned to contestants.
- In deciding the winners of the contest the judges reserve the right to call for any set entered to be sent in for examination and test. Tubes, A and B batteries and phones will not be required in sets sent in for testing.
- Manuscripts will be judged from the standpoints of neatness, clarity of expression, completeness, and actual tried success of the set described.
- Originality in the use of various parts of apparatus other than shown by Radio Digest in the Flewelling circuit heretofore, is encouraged and even recommended. See Rule 6, however, for method to be used in determining the range.

X-Ray Machine Causes Grief

FREDONIA, KANS.—Radio enthusiasts here have been troubled for some time with interference which, while it seemed local, could not be located, despite every endeavor. At first it was thought to be the motors used for power but tests proved this untrue.

It was finally determined that the interference came from some electrical appliance. Accordingly Thomas Hudson, a

local fan, and several others recently made a thorough canvass of the offices near where the interference was at its worst and soon discovered the source of the trouble.

Dr. Roy Matthews who uses an X-ray machine, obligingly started and stopped his machine while observations were being made and has been declared the perpetrator of "Radio Rattle," a new disease that can be cured only by silencing the X-Rays.

CONTENTS

Radio Digest, Illustrated, Volume 3, Number 13, published Chicago, Illinois, January 6, 1923. Published weekly by Radio Digest Publishing Company, 123 West Madison Street, Chicago, Illinois. Subscription rates, yearly, Five Dollars; Foreign, Six Dollars; single copies, Ten Cents. Entered as second-class matter April 27, 1922, at the postoffice at Chicago, Illinois, under the Act of March 3, 1879.

"All the Live News of Radio".....	1 to 6
Flewelling Prize Contest Rules.....	2
You've Heard Them? Here They Are. Another of the Popular Announcer's Series.....	5
The Radiophonist's Mart.....	7
Radiophone Broadcasting Station Directory: Part I, Station Schedules from AG1 to WAAW..	8
Receiving Records Contest. Complete to Date.....	9
Editorials; Condensed by Dielectric; Indigest, Humor Column.....	10
A-B-C Lessons for Radio Beginners, by Arthur G. Mohaupt.....	11
Low Cost Set for the Novice to Make; Honeycomb Coil and Variometer Hook-Up; Four Workshop Kinks.....	12
Construction and Operation of Reflex Circuits, Part II, How to Build a Compact Single Tube Set, by Harry F. Marx.....	13
Radio Frequency and Audio Frequency Three-Coil Regenerator, R.D. Hook-Ups 68 and 69; The Reader's View.....	14
Questions and Answers.....	15
Radio Illustrated, a Page of Pictures.....	16

Looking Ahead

Reinartz Set in Photo Diagram Next Issue. Watch page 7 next week for the clear photographic-diagram method by which the Reinartz regenerative tuner will be explained. Working drawings with all dimensions and an explanation of all constructional details will be presented. This popular tuner has been the "old faithful" of distance working code amateurs for several years. Its ease of operation, selectivity and efficiency mark it as worth the novice's attention. Get this feature by purchasing the next issue of Radio Digest before your newsstand dealer says, "All sold out."

A—B—C Lessons for Radio Beginners, by Arthur G. Mohaupt, well-known author on electrical subjects, will continue in the next issue. Mr. Mohaupt gives clearly written explanations of electricity. Novices can well afford to read every installment. Turn to page 11 and begin now.

Reflex Circuits will be elaborated by Harry J. Marx in an early issue. The interesting consequences of doubling or tripling the work of a trade's tube is creating considerable furore among the ranks of the experimenters. The critical balance demanded by the constants in these "trick" circuits demands unusual care in experimental work. Watch for the reflex circuit data to appear.

Where the Stations Are, when you may hear them, who the owner is, what you can hear, ranges of the transmitters, and other desirable information is kept up-to-date weekly in the Radiophone Broadcasting Directory. See page 8. Part I is shown this week. During the two succeeding weeks, Parts II and III will appear. The three parts complete the directory and bring it up-to-date.

Pictures from the New York Show, just finished, will appear in next issue. Many novel features of interest to all Radiophans were exhibited at the exposition. Many of these will be shown in the January 13 issue.

Newsstands Don't Always Have One Left

WHEN YOU WANT

Radio Digest

YOU WANT IT!

BE SURE OF YOUR WEEKLY COPY BY SUBSCRIBING NOW

SEND IN THE BLANK TODAY

Publisher, Radio Digest, Illustrated, 123 West Madison St., Chicago, Illinois. 3-13

Please find enclosed check M. O. for Five Dollars (Six, Foreign) for One Year's Subscription to Radio Digest, Illustrated.

Name

Address

City State

SELFRIDGE COUPLES RADIO WITH PEACE

BELIEVES RADIOPHONY AID TO WORLD HARMONY

Son of Great Merchant Prince Makes Address at WJZ on International Aspect

NEWARK, N. J.—H. Gordon Selfridge, Jr., assistant manager of the merchandising division of the great London store, speaking from Station WJZ here recently, addressed the Radio audiences of England and America on the subject "International Aspect of Radio Telephony." A cable was sent to the amateurs in England notifying them of the time of the address.

Mr. Selfridge, in his Radio address, said in part:

"I believe that a great deal of the misunderstandings which exist between some of the nations of the world today, would not have existed had the past generation had this wonderful method of international communication we are enjoying tonight. Misunderstandings only exist because of the lack of knowledge the ordinary citizen has of the other fellow living in another country.

Sees Radio Aid to World Peace

"As the knowledge of Radio spreads and the possession of good instruments becomes more commonplace, I foresee the time when a service such as WJZ is giving daily will know no bounds, and we shall have the people in central Europe listening to an American singer in Newark, N. J., and the same song being applauded by Radio audiences in Australia and Japan.

"I believe I am correct in saying that the Radio audiences in any country are, and always will be, the better class of citizens, that is, those citizens who mould the great force known as public opinion, and this leads me to believe too, that the science of Radio, which has been brought to such a high state of efficiency by the engineers of this and other countries, will in the future be the most powerful means of world peace that this tired old Planet has ever had."

Doctor Hears on Phone by Aid of Garden Hose

Two Loud Speakers, Gardener and Friend Turn Trick

NEW YORK.—When the Radio returns of the World's Series baseball games were being broadcast, at least one unique turn was given this event, recent information indicates. Dr. Richard H. Hoffman of this city had been "listening in" on the Radio returns at his own home, but in the middle of a very exciting play, his storage battery became exhausted. In haste, he hurried to phone a friend to inquire what to do.

His friend, instead of continuing to listen in on one loud speaker connected a second in series. Then the gardener brought in a length of lawn hose, which saved the day. One end of the hose was stuffed down the throat of the loud speaker, and the other fastened to the mouth-piece of the land-telephone. "Central" set the connection to Dr. Hoffman's home telephone, and by listening to the receiver of his land-telephone, he was able to hear every play.

"Tree of Light" Gives Forth Santa's Voice to Children

NEW YORK.—Many thousands of children had their faith in Santa Claus renewed when they heard him speaking from a clump of trees in Madison Square on Christmas Eve and Christmas Day. The "Tree of Light" was again shown during Christmas week as it has been in many former years, but this time a noticeable departure from previous occasions was noticeable with the advent of Radiophony. A Radio receiver was installed on a small structure hidden among the branches of the huge tree. Connected to this receiver were several powerful voice projectors or loud speaker horns, also obscured from the view of the youngsters among the tree's branches. The aerial wire was stretched between two nearby structures and connected to the receiver so that the special Christmas programs from Station WJZ could be heard.

Curci and Chaliapin Sing

CHICAGO.—Amelita Galli-Curci, famous coloratura soprano, and Feodor Chaliapin, celebrated Russian basso, who took the place of Caruso as premier singer of the New York opera, were heard via Station KYW Thursday and Friday of last week. Chaliapin sang in "Mefistofele," Thursday evening, and Galli-Curci in "Manon," Friday night at the Auditorium Theater, from where their voices were carried to the KYW studio by wire.

NEW TRANSMITTER INSTALLED AT WJZ

CLEARNESS OF SOUNDS
STARTLES RADIOPHANS

Instrument Permits Listeners to Reduce
Amplification Set at Full
Before

NEWARK, N. J.—Radio listeners were recently startled by the great improvement in the power, clearness, and brilliancy of the voice of Station WJZ, located here. Many who have been accustomed to receive this station at the full power of their sets have been able to reduce their amplification materially since the sudden increase in power.

The explanation of this improvement is that WJZ has a new transmitter. Though the old one was generally regarded as one of the finest in the country, recent developments by Radio engineers rendered it obsolete, so that it has been removed and a new one, up-to-date in every respect, has been installed in its place.

Has Kilowatt Rating

The new transmitter is rated at double the power of its predecessor, or 1,000 watts, and is greatly superior in the details of its transmitting, modulating, and generating system. Hence it is about three times more effective than the old equipment. While listeners in with tube receivers all over the country have been quick to notice the change, it has been especially pleasing to local owners of either crystal detectors or loud speakers, who are now able to get unexpected results from their instruments.

WJZ now ranks very high among the broadcasting stations, but other improvements now being perfected by the engineers in charge, are in store for it, so that it is not yet at the end of its development.

Do Away with Motor Generation

The new WJZ transmitter includes a number of new features. Instead of using generators to develop the high voltage plate current as is the common practice now, a power rectifier has been installed, which was designed by D. G. Little, Westinghouse engineer, and is probably the last word in rectifiers as oscillograph pictures show no "ripple" in the current wave.

The new transmitter consists of four oscillators modulated by five modulator tubes of special design. A feature of this transmitter is that it has a meter which shows the percent of modulation at every instant. This enables the operators to keep a check on the performances of the transmitters. A new amplifier, to step up the energy received from the studio, has also been installed.

MIDNIGHT SPECIALS TO GO ON FOR WEST

Fans on Coast Hear Midwest
Concerts from WWJ at
Early Hour

DETROIT.—So successful have been the "Midnight Special" concerts broadcasted by WWJ, The Detroit News' powerful station, that hereafter the feature will be offered every other Thursday from 11 p. m. until midnight, Eastern time. The News makes this announcement after a trial "Midnight Special" brought thanks from listeners in Mexico City, Porto Rico, Saskatchewan, Nova Scotia, and on ships in the Caribbean Sea and the Gulf of Honduras.

The News tried out the "Midnight Special" after finding that, while Radio concerts at eight o'clock in the evening are all right for Middle Western and Eastern listeners, they were not at all convenient for Rocky Mountain and Pacific Coast fans. Eight o'clock at night in Detroit is five o'clock in the afternoon at Seattle. Very few families were in a position to listen to a Radio concert at that hour.

CHILD VIOLIN WIZARD PLAYS FROM NEWARK

NEWARK, N. J.—Maurice Kagan, 13-year-old violin virtuoso, played at Station WOR here, December 22. The young musician began his musical studies at the early age of 5 and when not quite 12 years old composed his first concert. He has studied under European and American masters, and rendered Fritz Kreisler's favorite number—"Viotte's Concerts."

"HOUSEWIFE'S HOUR" IS NEW KYW SERVICE

CHICAGO.—Westinghouse Station KYW announces a new daily service which began Monday, December 11. This service consists of a daily table talk by Anna J. Peterson, director of the home service department of the Peoples Gas Light and Coke Company. Mrs. Peterson is an authority on cooking and domestic science and will explain many delicious recipes.

IN OLDEN DAYS BEFORE RADIO



Dressed in a medieval costume for the role of Mistress Quickly in the opera "Falstaff," is Maria Claessens, contralto of the Chicago Civic Opera Company. Miss Claessens was born in Brussels, made her debut in Barcelona and sang three years in Buenos Aires before coming to America. She has been heard in several operas broadcast this season. Chicago Opera Photo

PICKS UP MUSIC IN INN CROSSES U. S.-EUROPE GAP

KYW Broadcasts Dance Tunes Gathered from Chicago Restaurant

CHICAGO.—A special wire has been installed to connect the College Inn with KYW, Westinghouse station here, so that the music of the Isham Jones dance orchestra may be broadcast directly from the Hotel Sherman as it is being played at the College Inn. The first program of this sort under the new arrangement was broadcast during one of the recent Friday midnight concerts of Station KYW.

R. C. Higgy, Columbus, Keeps Record of Similar Feats by "Bugs"

COLUMBUS, O.—R. C. Higgy, of Columbus, a member of the firm of Higgy-Avery, is keeping the record in Columbus of all amateurs who succeeded in bridging the gap between America and Europe. Mr. Higgy has developed a single receiving set capable of hearing the high-powered stations of Europe and America, the details of which he has given to the public through Columbus newspapers.

UNCLE SAM OFFERS EDUCATION BY RADIO

BROADCASTS TO BE MADE
TWICE WEEKLY

First Service of Kind in World to Come
from NOF, Navy
Station

WASHINGTON.—After a number of experiments in sending educational messages by Radio, the United States bureau of education, it was announced, by Commissioner John J. Tigert, will start operating on a regular schedule, sending out messages twice a week—Mondays and Thursdays, 6:45 to 7 p. m. Eastern time—through the Navy's station, NOF, in Anacostia. These broadcasts will be transmitted on a wave length of 430 meters.

This governmental Radio service by the bureau of education is the first instance in the world, so far as is known, where a national educational agency has broadcast messages on education.

Duty to Reach General Public

Commissioner Tigert said: "The bureau of education has started this service because it is the duty of the bureau to reach not only technical experts, but also the general public."

"In fact, the general public is one of the most fundamentally important audiences which we have to reach, since public education cannot progress any faster than the state of public opinion about education. This audience, however, has now grown too vast, the need for continuous education too great, and the necessity for sending out information quickly has become too pressing to be met any longer by the long-delayed, infrequent government bulletins."

Continuous Public Education Needed

"A new situation in education has arisen and a new method of reaching it must be found. I believe that Radio furnishes such a method. Radio is cheaper than printing; it reaches its audiences quicker; it reaches the mass of people who will not read printed articles; it is more effective because it has the intimate contact of speaker and audience, and above all it can be continuous in service, which is vitally important for us, since the only thing that educates the public is continuous education. Radio can be the means of such continuous education. I consider the inauguration of this service one of the most important pieces of work that the bureau has ever started."

MICHIGAN COLLEGE RIGS NEW STATION

WOAP, New Kalamazoo Broadcaster, Operates on 360 Meters
Wave Length

DETROIT.—Michigan has a new Radio station, the call being WOAP, located at Kalamazoo College, Kalamazoo. This station opened January 3, with a wave length of 360 meters. It will broadcast a program Mondays, Wednesdays and Fridays.

A license also has been obtained to enable the station to be used for experimental purposes by the college classes in Radio communication. Under the experimental call 8XP, the work of instruction and testing the set will be undertaken on a wave length of 375 or 500 meters.

To prevent conflict with the programs from Detroit and Chicago, the hour of broadcasting has been set at 6:30 p. m. For a few minutes before this time students of the Radio course will broadcast stock and crop reports of interest to farmers around Kalamazoo. The regular program will consist of orchestra music, vocal and instrumental selections with special numbers and educational features. From time to time additional numbers will be furnished by the Gaynor Club and the Glee Club.

The set has been designed and constructed by Prof. Leonard James Ashby, of the department of physics,

THE ANTENNA BROTHERS

Spir L. and Lew P.

Like the Janitor of Our Flat



DE FOREST PUT U. S. TO FRONT IN RADIO

PUT GRAND OPERA ON AIR IN 1908-09 SEASON

Wizard Takes Position of Foremost of Famous American Radio Pioneers

NEWARK, N. J.—Dr. Lee De Forest, inventor of the three-electrode vacuum tube around which is built the whole system of Radiophony as it exists today, recently broadcast "The Discovery of the Audion" from Station WOR, L. Bamberger and Company, located here. Many interesting facts were brought out in his talk.

Dr. Lee De Forest is perhaps more than any other one Radio pioneer an outstanding figure in Radiophony, largely through the fact that he himself began broadcasting Radio news and music as early as the spring and summer of 1907.

Broadcasts Yacht Race in 1907

In the summer of 1907 Dr. De Forest personally directed the broadcasting of yacht race reports on Lake Erie at Put-In-Bay. The ship station was on the Yacht Thelma, and the success of this experiment led to an investigation of the Radiophone by the United States Navy Department, and immediately afterward resulted in its installation on the fleet of the late Admiral Bob Evans for his now-famous world cruise.

Dr. De Forest broadcast grand opera from New York in the season of 1908-1909, developed the Radiophone for railroad use as early as 1913, and from that time until a year ago maintained a broadcasting station at the De Forest Laboratories at High Bridge, New York.

Put America to Front

The first system of Radio telegraphy developed by Dr. De Forest in the period of 1900-1902 quickly took the lead over all competitors, and although his great contribution to Radio is generally recognized as the three-element vacuum tube, his early work in the field of Radio telegraphy included many inventions which in those days put America far in the lead in the development of this art.

Dr. De Forest was born August 26, 1873 in Council Bluffs, Iowa, and spent part of his boyhood at Talladega, Alabama, where his father was president of Talladega College. In 1893 De Forest entered Sheffield Scientific School of Yale University, from which he was graduated in 1896.

The experiments which led to his discovery of the Audion "gas effect" took place in a two-dollar-a-week room in Chicago in the summer of 1900.

FANS HEAR DEBATE IN CONGRESS FIRST TIME

Representative Brennan of Michigan Is One of "Listeners In"

WASHINGTON.—Radiophans "listened in" on a debate in Congress recently, for the first time. The government station at Anacostia NOF, broadcast the debate in the House on the constitutional amendment abolishing tax-exempt securities.

Among the interested listeners in was Representative Vincent H. Brennan, of Michigan, who has fitted his office in the House office building with a Radio receiving set. Incidentally, Mr. Brennan has introduced a Radio resolution to equip all Capitol offices with Radiophone receivers. "It is my purpose," said Mr. Brennan, "to enable all members of Congress as well as the country at large, to listen in on the doings on the floor of the House."

Son of Scot Sod Broadcasts

NEWARK, N. J.—Wm. MacWilliams is from the old sod of Scotland and has been in America about 10 years. Recently he broadcast a program of Scotch songs. Those made famous by Sir Harry Lauder, from Station WOR, L. Bamberger and Company, located here. Assisting on the program was Pipe Major MacLeod, who rendered several bag pipe solos.

"ALL-AMERICAN" Amplifying Transformers

Two years of successful use all over the world guarantees permanent satisfaction. Radio and Audio Frequency. SEND FOR CIRCULARS. **RAULAND MANUFACTURING CO.** 35 South Dearborn Street Chicago

MYERS TUBES

Dealers: Write for Discounts Hudson-Ross, 123 W. Madison, Chicago

WEEK'S LICENSES GO TO 7 NEW STATIONS

CHICAGO.—During the past week seven new plants were licensed to broadcast public service. The new 360-meter stations are: WPAS, J. & M. Elec. Co., Amsterdam, N. Y.; WPAP, Theo. D. Phillips, Winchester, Ky.; WPAQ, Gen. Sales & Eng. Co., Frostburg, Md.; WPAU, Concordia College, Moorhead, Minn.; WWAD, Wright & Wright, Inc., Phila., Pa.; KFEP, Radio Equipment Co., Denver, Colo.; KFJH, Fallon Co., Santa Barbara, Calif.

"Variety Spice of Life," Motto Here

WGI Features, Among Other Things, Weekly "Boys' Hour," Motorist Service

BOSTON, MASS.—A number of novelties have been featured on recent broadcasting programs of WGI, Amrad Station at Medford Hillside. Once a week on Saturdays, a report is given out on the condition of Massachusetts highways, for the benefit of Sunday motorists. This is furnished by the Automobile Legal Association, which maintains a constant highway scouting service through a corps of motorcycle riders, who telephone in their reports daily of highway conditions.

WGI also instituted a "Boys' hour," starting at 8 p. m. on Saturdays, and conducted by the American Boy Magazine. They also have a "request night" occasionally, duly announced in advance, when request numbers are given as far as possible, and the program announced from the studio by Radio the same night.

Federated Church Service

A Federation Church service from some one of the churches in the Boston Federation of Churches is now broadcast every Sunday, with announcement in advance of the full church program of singing, the sermon, etc. The Christmas Sunday program was particularly fine, from the Centenary Methodist Episcopal church at Auburndale, Mass., about ten miles from the Amrad station. Microphones installed in the church reproduced the sounds over a special telephone wire to the broadcasting station at Medford Hillside, carrying the sermon, organ, choir-singing and congregational singing very clearly to thousands of Radiophans unable to attend church. In the evening a fine Christmas concert was given by the choir of this church in this same manner. Later in the evening a program of Christmas carols by the carol singers from Grace Church at Medford was broadcast from the studio.

Boston Is Musical Center

Boston being a great musical center, with many schools of music and great teachers, it is natural that some fine concerts should be given by Radio. A recent one was given by the New England Conservatory Orchestra, microphoned from Jordan Hall at the conservatory and broadcast by Radio. Another one was given by the choir of the College of Liberal Arts, Boston University. And for the first time in the history of the Salvation Army, some of its music was sent out by Radio from WGI recently, when the Salvation Army's Silver Staff Band of Boston gave a concert.

The United States Department of Agriculture Radio reports have been christened "Agriograms."

\$564,800 IN RADIO ABROAD IN OCTOBER

WASHINGTON.—In October American exporters sent \$564,803 worth of Radio equipment to foreign countries. The bulk of the shipments, 138,022 pounds, valued at \$463,239, went to Argentina where several transmitting stations are under construction. Approximately \$300,000 worth is in receiving sets, indicating that the Radio boom has spread to the southern republic as well as in the United States.

Radio Calls Bring Help to Marooned

Tugs Respond to Appeals from Wrecked Vessel and 23 Persons Are Rescued

SAULT STE. MARIE, MICH.—After being marooned for five days on barren Lizard Isle in Lake Superior, with the temperature below zero and apparently without food, twenty-three of twenty-seven missing persons from the tug Reliance were rescued recently by the tugs Gray and Favorite, as a result of a Radio distress call sent out by the Reliance.

The wrecking of the Reliance was the result of a gamble with fate on the part of those aboard the tug. After lying in a sheltered cove for three days in the hope of riding out the storm that was sweeping the lake, Capt. Williams found his supplies of food and fuel almost exhausted. The lake mariners elected to breast the blizzard rather than chance death from starvation.

Radio Calls for Aid

Four hours after the anchor had been hoisted the Reliance was dashed against the rocks and its wheel disabled. The craft filled rapidly. Just before the Radio apparatus was put out of commission the operator flashed a signal call for help. It was this call, received here, that instigated the rescue.

Navigation on the upper lakes usually closes December 1. This year it was decided to keep the waterways open until later.

At Eagle Harbor and Grand Marais, Whitefish Point and Detour, Alpena, Mackinac Island and Manistique, naval Radio operators are keeping a tireless vigil guiding the freighters through the night with Radio compass signals, and waiting for distress calls which may come.

Mexico Inaugurates New Service for Ships at Sea

MEXICO CITY.—The Mexican Government inaugurated a new broadcasting service for mariners recently. The service comprises the picking up and rebroadcasting of notices to mariners originating at Radio stations in America and Cuba, and vessels within their zone—six Mexican stations on both the Pacific and Gulf Coasts.

CARTER "HOLD-TITE" JACKS



1 to 5 springs; price 70c to \$1.10

New design; heavy phosphor-bronze springs; no spacer washers required. Write for Bulletin on these Jacks, "TU-WAY" Plugs and other Carter products.

CARTER RADIO CO., 209 S. State St., Chicago

WORLD FLIER TO LEARN FOG EFFECT

WILL DETERMINE ACTION ON RADIO WAVES

Col. Broome, British Airman, Says Full-est Information on Matter Is to Be Sought

MONTREAL, P. Q.—The effect of fog on Radio communication is one of the principal objects of investigation for which the round-the-world flight from England is planned next year, according to the noted English aviator, Colonel L. E. Broome, prior to his embarkation on the Canadian Pacific steamer "Melita" to return to Great Britain.

"A matter of particular importance, and one on which we are seeking the fullest possible information, is the effect of fog on Radio communication. It is generally understood that it will lessen the radius considerably, and if we can overcome that, or find apparatus that will do so, it will be most useful," said Col. Broome.

London to Japan, Then Canada

The aviators will set out next year from London, England, crossing first through France and following closely the route covered by Major Blake. In Japan it is planned to keep in close touch with all available land, flying by way of the Kuril Islands, Kamchatka Peninsula, Commander Island, some points on the Aleutians, reaching the mainland at Juneau, and following the Inner Passage to Vancouver. The route across Canada has not yet been planned.

The fogs offer the most severe obstacles to the success of the undertaking and special arrangements have been projected to overcome this. A steam trawler will precede the aircraft, and in addition to carrying food and provisions, will be provided with Radio to provide an easy means of communication between the steamer and the aircraft. The convoying ship will serve as a weather bureau for the airmen.

Enlarges Scheveningen Station

ROTTERDAM, HOLLAND.—The Government of the Netherlands is enlarging the present Radio station at Scheveningen, which will be ready for operation early this year. It is designed for communication with all parts of Europe and will be equipped for Radiophone broadcasting as well as Radio telegraph transmission.

HOW TO MAKE FLEWELLING RECEIVER

COMPLETE

Blue Prints

for the construction of a Flewelling Receiving Unit and two step amplifier.

Full Instructions FOR ASSEMBLY

Description of apparatus and accessories and details of tuning.

Cabinet Dimensions Panel Layout List of Parts

Only 50c

Send only money orders—no checks or stamps. Coins at your own risk.

Book Department

RADIO DIGEST
123 W. Madison Street
CHICAGO, ILL.

KING QUALITY

ALL THE NAME IMPLIES

IMPROVE your set in appearance and service. King Quality parts are the Best money can buy; cost no more than inferior made products. We use genuine Bakelite exclusively.

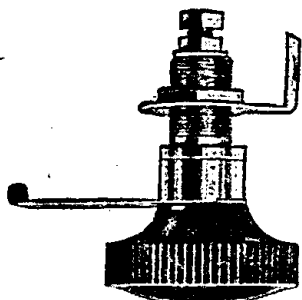

King Quality Vacuum Tube Socket

King Quality Vacuum Tube Socket

Base of genuine moulded Bakelite with mirror finish; tube and terminal binding posts of brass, nickel plated and highly polished. Black or mahogany finished Bakelite Base.

PRICES: Black or Mahogany Bakelite \$1.00

With perfect mechanical and electrical features. Mirror finish Bakelite knob with polished knurl that glows like a diamond. 3 sizes: 1 in., 1 1/4 in., 1 1/2 in.

Write today for bulletins containing complete lists of parts, prices, etc.

Radio Apparatus Division

KING SEWING MACHINE COMPANY, Buffalo, N. Y.

EVER HEARD THEM? HERE THEY ARE



BESIDES being a writer of magazine articles, O. E. McGillicuddy, shown at the extreme left, is announcer for CFCA, Toronto Star station. The Star's Radio editor says Mr. McGillicuddy has made thousands of friends over entire America by his work as announcer. The chief operator and chief announcer of WOO, Wanamaker's, in "Philly," is Joseph M. Nassau, sitting before the loud speaker in this group. He was one of the chief operators of the first experimental station to be licensed in the U. S. Next to Mr. Nassau is George S. Cruger, concert announcer of Wanamaker's. His promptness in making announcements has made a hit with fans. And—Ah, girls!—below is Cedric Elliott Hart, concert manager and announcer of KDYL, Salt Lake City, who admits himself that "he has been taken for Rodolfo Valentino many times." Mr. Hart is said to be considered somewhat of an opera singer.

WWJ CROSSES U. S. TO HAWAIIAN ISLES

POPULAR TUNE TRAVELS ABOUT 4,400 MILES

Detroit Plant Better Records Made by Pittsburgh and Newark Stations

DETROIT.—The Detroit News, WWJ, is believed to have established a long-distance record for Radio transmission. On the night of November 23, the Detroit News orchestra played "Three O'Clock in the Morning" in the studio of the News building here. This was about midnight. The news has just received information from Walluku, Hawaiian Islands, that the music was plainly heard there about 6:30 p. m., this being the difference of time between the two points. The postmaster, A. F. Costa, wrote: "It sure was some music." This report tallied with the log in the News station.

The distance between the two points is figured roughly about 4,400 miles. It would take the sound of a cannon five hours and 41 minutes to travel from Detroit to Hawaii without the aid of electricity, if it were possible to make a sound loud enough to travel that far.

Better Newark Plant Records

The previous record was between Pittsburgh and Iquique, Chili, 4,200 miles. New York City recently paid much attention to a Newark, N. J., station when it reported being heard in London, England, a distance of 3,100 miles.

The Detroit News states that it frequently hears from ships in the Pacific—notably the S. S. Easterner, which reports that while between Australia and Panama it heard the WWJ concert October 13, and greatly enjoyed it, at a distance of 3,500 nautical miles, which is 4,030 statute miles. The Easterner also reported that on the nights of October 11 and 12, while 2,500 nautical miles west of Panama, in latitude nine degrees south, longitude 112 degrees west, it plainly heard the Detroit News concerts.

John Martin, publisher of "John Martin's Book," a children's magazine, and well known by children, is now broadcasting to his youthful reading audience.

SHIP IN FRENCH DOCK PICKS UP U. S. MUSIC

SCHENECTADY, N. Y.—WGY, the General Electric Company's broadcasting station here, has successfully transmitted a musical program across the Atlantic Ocean, according to word received last week from Dr. W. R. Whitney, director of the company's research laboratory, who is traveling abroad. Dr. Whitney states that he talked with Chief Radio Operator Black of the S. S. America, who stated that while the ship was docked in Cherbourg, France, he picked up an entire evening's program from WGY and that the signals came in so clearly that when he laid the phones on his table, the music was audible in the Radio cabin.

INTERFERING AMATEURS MAY FACE INSPECTOR

Cleveland Expects Check on Violations of Transmission Rules

CLEVELAND, O.—Some few of the Radio amateurs who have interfered with the broadcasting in Cleveland stations may soon be called upon to face the United States Radio inspector if the interference is continued. Complaints have been made both to the Cleveland Radio Association by both amateur Radio transmitters themselves and others who belong to the big majority of listening-in fans.

The big majority of Cleveland amateurs who hold transmitting licenses has been abiding by the regulations, but a few others have failed to do so. The personnel of the inspector's office in this district has been increased and it is expected that a deputy inspector will be stationed in Cleveland soon to check up those stations violating the regulations.

WHAS Drops 400-Meter Wave

LOUISVILLE, KY.—After trying out the class B license on 400 meters for a short time, WHAS, Louisville Courier Journal, has returned to the 360-meter wave length. The station believes the 360-meter wave is better suited for their broadcasting, and more popular with the army of listeners in.



HEARINGS ON WHITE RADIO ISSUE START

Secretary Hoover, to Appear Before House, Reported Strongly in Favor of Passage

(Special to RADIO DIGEST)

WASHINGTON.—Announcement has been made by the Merchant Marine committee of the House that hearings would begin on January 2 on the so-called White Radio bill. It is not known at the time of this writing just how long the hearings will continue as these will be contingent upon the number of witnesses who appear, among whom will be Secretary of Commerce Hoover.

Secretary Hoover has had a preliminary conference with Representative White and, as is well known, Mr. Hoover is in thorough sympathy with the bill and has given it his official approval.

Hoover Wants Bill Passed

In discussing the Radio situation, Secretary Hoover says that there is no doubt but what the Radio receiving stations throughout the country are increasing by leaps and bounds and he believes that there are at least two million of them in the United States. The sending stations also are not only increasing, but are improving in their efficiency.

Secretary Hoover strongly advocates the passage of the White bill because the only Radio legislation effective now is twelve years old and he says that there is a "perfect pandemonium in the ether" at the present time and "we undoubtedly need new legislation as soon as possible."

Spokane, Washington, broadcasting stations have decided to suspend operations two nights a week so that owners of sets there may hear concerts from outside points.

HOOVER SILENT IN CHURCH "AIR FIGHT"

TO TAKE NO STAND IN MINISTERS' "BATTLE"

Sermons of Two Clergymen, Taking Air at Once, Run Amuck and Cause Trouble

WASHINGTON.—Secretary Hoover as "Czar of Radio" has no intention, for the present at least, of stepping in as an arbitrator in the Sabbath ministerial "air battles."

According to word passed out at the Department of Commerce, Mr. Hoover has decided to act merely as an interested listener in and let the Radio public determine what steps should be taken to preclude the sermons of Rev. Charles Wood at the Church of the Covenant and Rev. Earle Wilfley at the Vermont Avenue Christian Church from running amuck in the clouds, jumbling and tangling the ether waves.

For three successive Sunday nights the "air combats" have raged, because Stations WDM and WJH both "take the air" simultaneously on the same wave length to broadcast the services at the above-mentioned churches. Neither broadcasting station has made any effort to remedy the condition. The Church of the Covenant holds that it was first in the Radio field Sunday night and intends to continue. Dr. Wilfley maintains he will not discontinue broadcasting, because he is receiving many favorable contributions to the church by mail from Radiophans.

Fans May Appeal for Cure

What action the local Radio listeners in take, if any, to eliminate the interference in the clouds, remains to be seen. There have been rumors to the effect that Secretary Hoover would be formally appealed to by a delegation of Radio amateurs who want "peace in the air" on the Sabbath to put an end to the discordant Scriptures and sacred music that ring into their phones on Sunday night. In that event, it was intimated the "Radio Czar" may use his authority and designate different hours for the two churches to broadcast.

The question of changing the wave length in order that both stations could transmit in harmony, will meet a deaf ear if put up to Mr. Hoover, it was said. Such action, it is contended, would establish a precedent and let down the bars to 500 other Radio broadcasting stations in different sections of the country who desire to fill the air with religious services on Sunday.

Radio is now carrying a large part of the telegraph traffic between the United States and Europe and the Far East.

INVENTS AUTOMATIC OUTFIT FOR PLANES

BRITON'S DEVICE SENDS MESSAGES BY LEVER

Any of 62 Statements May Be Flashed Through Air at Aviator's Wish

LONDON, ENG.—An inventor here has devised an automatic Radio transmitter for use on airplanes. By pulling a lever the pilot of a machine can cause to be sent out from his craft any one of the sixty-two messages.

Samples of the messages are: "Forced to land," "Shall arrive late," etc. The messages are printed on the panel of the machine, and beside each message there is placed a jack similar to those now employed by Radio receivers. There are sixty-two jacks in all, one for each message. If the pilot, for instance, desired to send the message, "Forced to land," he would insert a plug in the jack opposite the message. This done, he would simply pull a little crank at the side of the machine and the transmitter would automatically send the message.

SOS Sent Automatically

In the case of an SOS this procedure would not be necessary. At one side of the machine there is a small lever protruding from a slot. To send an SOS it is only necessary to pull this lever down. The rest is done automatically. The transmitter then continues to send SOS, together with the identifying call of the airplane, until the operator stops it.

The big advantages accruing from the invention are that the pilot does not have to learn the code, and that he can send a message or distress signal without having his attention taken away from the control of the machine.

CURRENT KILLS BOY WORKING ON OUTFIT

Lad Is Found Lifeless Before His Instrument

CHATHAM, ONT., CAN.—Alfred Lambert, 17 years old, was electrocuted recently while working on his Radio outfit in the rear of his home.

The source of the current that killed him is not yet known. When found the youth had fallen lifeless from his chair before the Radio. Doctors said that death had been instantaneous and had been caused by the passing of an electric current through the boy's body. Burns on one hand showed where the current had entered.

A high tension wire from the city's public service station might have blown against the antenna strung from the roof of the boy's Radio shed, it was said.

Take Steps to Install Broadcasts in Brazil

WASHINGTON. — Preliminary steps have been taken for the introduction of Radio broadcasting in Brazil and indications point to a promising future market for receiving apparatus. Until recently Radio broadcasting was practically unknown, but the Centennial Celebration being held at Rio de Janeiro has served to stimulate interest in Radio and various

Book Reviews

Vacuum Tube Receivers. By O. F. Heslar. A book that tells how to make a simple set. How to make the cabinet. It includes a 27 by 36-inch layout blue print. Price, 75 cents.

The Armstrong Super-Regenerative Circuit. By George J. Eltz, Jr., E. E. This is a De Luxe edition of this famous circuit. Profusely illustrated and fully explained. Fifty-two pages. Price, \$1.00.

Radio Receivers for Beginners. By Snodgrass and Camp. Answers the universal question, "How can I receive Radio?" Price, \$1.00.

Elements of Radiotelegraphy. By Elery W. Stone. The text was written for the guidance and instruction of Radio students in the communication service of the Navy. It is an instruction book for Radio schools. Price, \$2.50.

Radio for the Amateur. By A. H. Packer and R. R. Haugh. The underlying principles of Radio thoroughly explained in simple language and understandable illustrations. This book will teach you how to construct and operate a receiving set successfully. Price, \$1.50.

Radio Communication. By John Mills. The fundamental principles and methods upon which recent developments are based are emphasized. The vacuum tube is treated in a simple, fundamental and up-to-date manner. Present methods and tendencies of the art are explained in a chapter which is non-mathematical. Price, \$2.00.

The A B C of Vacuum Tubes. By E. H. Lewis. Is a book for beginners who have no knowledge of either Radio or electricity and sets forth the elementary principles of theory and operation of the vacuum tube. No attempt has been made in this book to describe all the possible circuit arrangements, but those shown may serve as suggestions to experimenters who desire to evolve their own circuits. Price, \$1.00.

Experimental Wireless Stations. By S. E. Edelman. This book assumes that the reader has some knowledge of fundamental electricity and mathematics and is a readily understandable text for beginners in the art of Radio communication who desire to start with the elements. Earlier editions of this book were published during the war. The 1922 edition has been revised and enlarged so as to cover the progress made in the last few years. Price, \$3.00.

The book department of the Radio Digest is prepared to send you any of the books on Radio published, whether listed in our Book Review or not. Let us know what book you want, send us your check and we will see that the book is mailed to you. Postage stamps in payments for books not accepted. Send money order or check. Book Department, Radio Digest Illustrated, 123 W. Madison St., Chicago, Ill.

concerns in Brazil have been active in taking it up.

The Rio de Janeiro Light and Power Company recently finished a broadcasting station on the heights of Corcovada, using a wave length of 483 meters. Music from the Municipal Theater is sent to Corcovada summit by telephone and after amplification, is sent out by Radio. A studio near the summit also furnishes concerts and other entertainments which are heard locally. Additional broadcasting stations are now located at Monroe Palace (Congressional Building) and at the offices of the Marconi Wireless Telegraph Company. A number of receiving sets have been installed in the exposition buildings.

KHJ GIVES "TIPS" ON ROADS TO AUTOISTS

Also Broadcasts Information as to Cars Stolen, Hints for Driving

LOS ANGELES, CALIF.—On a recent evening, W. L. Valentine, president of the Automobile Club of Southern California, was presented in an address broadcast from Station KHJ, the Los Angeles Times, in a new feature on the program. Co-operating with the Automobile Club, who will furnish the data, the Times station will broadcast daily information of interest to the touring public.

The subjects that are to be presented in the educational broadcast scheduled by the Auto Club, are: Touring notes; local and transcontinental road conditions; stolen cars, giving the trade name, license number, engine number and report of cars

recovered; hints for safe driving; activities of the club's signposting department with all data relative to new routes.

A special feature is being prepared by the legal department of the Auto Club, which will tell what to do in the case of accidents, the liability of car owners to passengers, together with a brief discussion on these different subjects by members of the legal staff of the Auto Club. Seasonable news on the subjects of hunting, fishing and all outing information that is desired also will be included in the educational repertoire of the club in its broadcasting.

RADIO MAILING LISTS

12,400 Radio Dealers, covering U. S. by states	Per list \$ 7.50
2,614 Radio Mfrs., covering U. S. by states	Per list 15.00
2,757 Radio Supply Jobbers, covering U. S. by states	Per list 15.00
250 Radio Stations	Per list 4.00
257 Mfrs. who make and assemble complete Radio Sets	Per list 4.00
25,000 Radio Amateurs & Mfrs. of Radio Stations	Per list 7.50

Ask for price list covering Canada and England.
Send remittance with order.
Trade Circular Addressing Co., 166 W. Adams St., Chicago, Ill.

IMPROVED REINARTZ CIRCUIT

My highly improved circuit brings in all important stations on both coasts and the Mexican border without any distortion or other noises. We dance to music from Atlanta received on one loud Baldwin unit. Build one of these supersensitive sets from my blueprints and specifications. Price 50c or with a perfect and complete double wound spiderweb coil \$3.00 by mail. No other windings used. Photo of my set on a glass panel with every order. Everything clearly shown. Cheap and easy to build. Easy to operate. S. A. TWITCHELL, 1925 Western Av., Minneapolis, Minn.

THE ONLY KNOB and DIAL WITHOUT A SET SCREW

ASK YOUR DEALER
4 in., \$1.50 3 in., \$1.00

TAIT KNOB & DIAL CO., Inc.

11 East 42nd Street NEW YORK CITY

Wessco

W. E. SUPPLY AND SERVICE CORPORATION
18 MURRAY STREET, New York
2 Blocks South of Chambers, between Broadway and Church St.

OUR PRICES SPEAK LOUDER THAN WORDS

We Are Giving Away These Beautiful Crystal Sets

HAVE YOU RECEIVED YOURS?



FREE

This set will receive everything, broadcasted within a 25-mile radius of your home. Highly polished mahogany case with nickel-plated fittings.

Buy \$20.00 worth of Radio supplies and receive this beautiful Crystal Set absolutely FREE.

With each purchase of \$10.00 or more we are giving free of charge a \$1.75 B Battery.

Do you need Radio Supplies? Our prices speak louder than words. All Merchandise offered is Standard, Guaranteed, and is of perfect workmanship. Mail orders must include postage. TERMS—Money Orders with Orders—Checks not accepted.

Better Than The Best

PRICE AERIAL-A INCLUDING

Complete AERIAL-A PHONES, TUBES, AERIAL and BATTERIES

\$35 The Radio Tube Set That Made Good in a Night

\$25.00 MIRCLE CRYSTAL RECEIVING SET WITH 3000 OHM PHONES, 100 FT. AERIAL, 2 CLEATS AND POR. TUBES, \$7.95
U. V. 200 RADIOTRON Tubes.....\$ 3.75
U. V. 201 RADIOTRON Tubes..... 4.95
W. D. 11 Tubes..... 4.95
\$6.60 Wessco Variometer, highest quality guaranteed..... 3.25
\$5.00 Acme Transformer..... 3.40
\$24.00 A BATTERY, 100 AMP., 6 V..... 16.75
\$19.00 A BATTERY, 80 AMP., 6 V..... 11.45
\$14.50 A BATTERY, 60 AMP., 6 V..... 8.75
\$1.00 Rheostat..... .32
\$5.00 23-pl. Variable Condenser..... 1.65
\$5.50 43-pl. Variable Condenser..... 1.95
\$4.50 Variometer, guaranteed high quality..... 2.40
\$4.25 Variocoupler, guaranteed high quality..... 2.25
Contact Points, dozen..... .04
Bronze Bus Bar, tinned, ft..... .02
\$1.00 Sockets..... .35
\$3.00 BATTERY, 22 1/2 V. VARIABLE, HIGHEST QUALITY GUARANTEED, LARGE SIZE..... 1.45
\$1.75 B BATTERY, 22 1/2 V. VARIABLE, HIGHEST QUALITY GUARANTEED, SMALL SIZE..... .75
3-Plate Vernier Variable Condenser..... .70
Guaranteed Genuine Bakelite Panels—7x10, \$1.25; 7x18, \$1.35; 9x10, \$1.60; 5x5, 47c; 5x9, 95c; 6x12, \$1.25; 7x9, \$1.15; 12x14, \$3; 7x24..... 3.00
50c Mica Condenser..... .25
\$1.00 All Moulded V. T. Sockets..... .25
\$1.50 MICROSTATS..... .95
SPAGHETTI. Per length..... .07 1/2
\$8.00 Moulded Variocoupler, highest quality..... 4.50
\$6.50 Moulded Variometer, highest quality..... 3.50
\$18.00 Belclear Loud Speaker.....\$ 8.00
\$8.00 BRANDES PHONES..... 5.75
\$1.00 FRESHMAN VAR. GRID LEAK. .75
100 ft. coil No. 14 7 strand Pure Copper, Aerial Wire..... .50
\$16.00 ATWATER KENT Two-Step Amplifier..... 12.50
HOMECHARGER DE LUXE..... 13.25
\$4.50 Thordarson Transformers..... 2.35
Thordarson Grid Condensers..... .15
\$1.50 Thordarson Vernier Rheostat..... 1.10
Johns-Manville Bk. Com. Tubes, 3-in..... .25
75c Crystal Detector..... .35
\$1.50 Multi Jack..... 1.15
\$1.50 Twin Adapter..... 1.15
\$1.25 Universal Plug..... .75
\$18.00 WESTINGHOUSE BATTERY CHARGERS..... 13.75
\$19.50 WESTINGHOUSE BATTERY CHARGERS for A & B Batteries..... 16.00
\$5.00 Murdock Phones..... 3.55
70c Open Circuit Jack..... .60
85c Closed Circuit..... .65
\$1.00 2-Circuit Jack..... .50
40c K. D. Crystal Detector..... .16
Magnet Wire..... 20 per cent discount off list
\$3.00 Radio Frequency Transformers..... 1.65
75c Battery Hydrometer..... .35
Knife Switch, S. P. S. T..... .14
Knife Switch, S. P. D. T..... .22
Knife Switch, D. P. D. T..... .35
\$6.50 Wessco Audio Transformers, highest quality guaranteed..... 3.25
\$6.75 Westinghouse Storage Battery..... 4.75
\$5.00 Shamrock Variocoupler..... 2.50
\$8.00 Dreyfuss Phones..... 6.00
BLACK FIBER LOUD SPEAKER..... 6.00

"THE right path is near," said Men-cius, "yet men seek it afar."

The right receiver is here. See it at your dealer's and know.



A. H. GREBE & CO., Inc.
RICHMOND HILL, N. Y.



Licensed under Armstrong U. S. Pat. No. 1113149.

The Radiophonist's Mart

THE latest improvement in the condenser field is a combination variable grid leak and condenser. The grid leak consists of a piece of fiber, specially treated, upon which a bronze spring is rotated to vary the resistance in an unbroken range, from practically zero to five megohms. The condenser is a tested micron condenser of .00025 M.F. The whole is combined and sealed in a neat moulded body with nicked binding posts, and a pointer and knob to record the grid leak resistance.

Every tube requires a different grid leak resistance to operate at its maximum efficiency, especially when working on weak signals. It has been found in practice that it is possible to tune in distant stations by varying the grid leak resistance to the proper value.

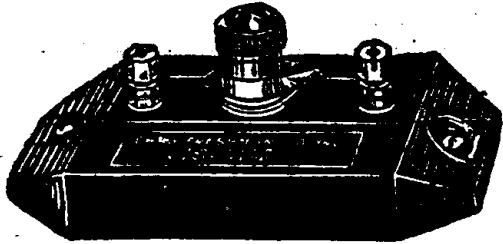

Variable Grid Leak with Condenser

The variable grid leak and condenser can be used in the parts of the circuit to eliminate noise and distortion. It has distinct advantage when placed across the phones in place of the condensers.

This device is manufactured by the Charles Freshman Company, Inc., New York City. It is especially interesting to readers of the RADIO DIGEST because it can be used in the Flewelling single-tube "super" circuit.

Judging Head Phones

One of the most delicate parts of the receiving set is the head set. Phones are what the amateur knows the least about, for he buys them already made. The price, of course, depends upon the make and type. Knowing little about the construction of the phones the novice takes what the Radio dealer advises and they are attached to the set to "do their damndest" to please. Very often the action of a pair of head phones leaves much to be desired.

Perhaps a few facts about the characteristics to look for in a pair of phones would enable the buyer to purchase more intelligently and thus through his phones get greater enjoyment from the Radiophone concerts.

For Radiophone receiving of the ordinary class, 2,000 to 3,000 ohms resistance will be satisfactory. However, there are a number of things to be taken into consideration besides the resistance in ohms that a head phone is rated at. It is a great mistake to rate phones entirely by their ohmage value. For instance, an exceedingly high resistance could be obtained in a pair of phones by winding the magnets with resistance iron. The resistance would be high, but the sensitivity would be practically nil.

In other words the 2,000-ohm or 3,000-ohm head phone is not good because it has high resistance, but because the resistance must be high to fulfill certain requirements. The greatest effect of the phone magnets comes when the greatest number of "ampere turns" are crowded into a given space. In order to get this large number of ampere turns around the small magnets used in phone construction, a very fine wire is used and the many turns of this fine wire are what causes the high resistance of the head phones. The phones would operate just as well without high resistance if it were possible to get the ampere turns without creating resistance. It is impossible to have one without the other. The fallacy of judging a pair of phones by the resistance rating is therefore apparent.

Good Contact in Variocoupler

In making a variocoupler I had some difficulty in procuring a good contact for my rotor. The rod that ran through the rotor was threaded and I used nuts taken from a dry cell battery to hold the rotor tightly against the stator. I secured some heavy brass spring wire and made two pieces as shown in the illustration. I fastened them to the base with brass

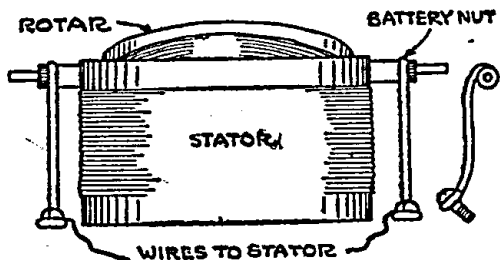

screws and then soldered my connections to the screws. The spring keeps a tension on the groove in the nut, thus making a good contact.—Dick H. Roberts, Miami, Okla.

Condenser for Fine Adjustments

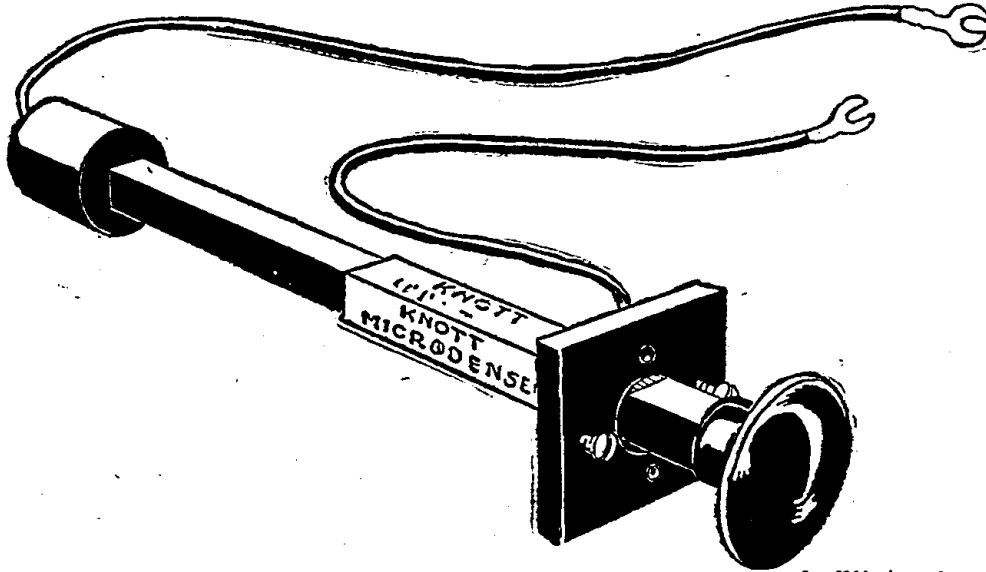

DIFFICULTY very often encountered where fine condenser adjustments are required, can be eliminated by the use of the Knott Microdenser, manufactured by the E. R. Knott Machine Company of South Boston, Mass. This instrument, as shown in the illustration, is mounted on the panel alongside of the usual variable plate condenser, and is connected in parallel with it. Flexible

leads are attached to facilitate easy connection. The variation is obtained by moving the knob in and out as required. When the knob is pulled out to its maximum distance the full capacity of the microdenser is utilized, whereas when the knob is all the way in, its capacity is practically zero. The adjustments obtainable by means of this instrument are very fine, and therefore permit greater selectivity in tuning.

Jack for Plugging in Two Phones

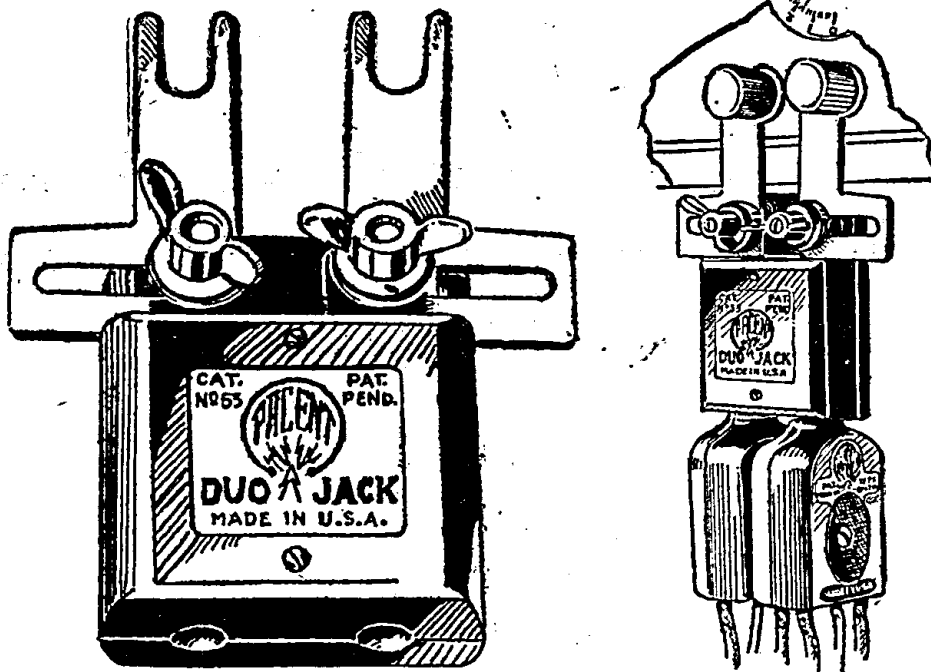

THE problem of the home Radio set has not always been a question of good reception, but an argument as to who has priority in using the head receivers. Oftentimes the expense of loud speakers precludes their use in many homes, or head sets may be preferred. For this reason, the Pacent Electric Company has developed what is called a Duo Jack for use in conjunction with two pairs of

receivers, both equipped with plugs. The terminals, used for connection to the binding posts on the receiving set, are adjustable so that the variations in distance between binding posts are compensated. The two thumb screws are loosened so that the tongue slots of the two arms are separated proper distance and fastened under the binding post. The thumb screws on the Duo Jack are then tightened up and the phones plugged in as desired.

Strength of Sets

A regenerative receiver employing a feed-back arrangement such as the "tuned plate circuit," "tickler coil circuit," or similar variations, is practically equivalent, in the reception of Radio signals, to a receiver using one stage of Radio-frequency amplification and a non-regenerative vacuum tube detector circuit. This is due to the fact that in the regenerative circuit the Radio frequency oscillations which pass through the detector without rectification and flow in the plate circuit are coupled back to the grid circuit and cause reinforced grid voltage variations, which result in greater variations in the plate current.

Set Not Always the Trouble

Usually the owner of a homemade set will say that perfect reception is not obtainable with the present-day equipment. This is true if taken in the sense of absolute perfection. Results can be obtained, however, so near to perfect that it would be extremely difficult for the ear to judge. In using audio frequency amplification it is necessary to have each individual tube operating on the proper point of its characteristic curve. This is usually the flat portion. To make this certain it is essential that the proper negative potential is kept on the grid of the tubes. The proper filament and plate battery adjustments are necessary to do this. This is accomplished by the use of an A battery potentiometer or a separate grid battery.

The great fault in the regenerative receiver is that of over-regeneration. This state is reached when the set is operated above the point where the oscillations start. The sacrifice of a little audibility corrects this. Poorly designed amplifying transformers are also a source of trouble and can be remedied only by replacing the troublesome units.

A frequent source of distortion is the use of too high a plate voltage. If it is necessary to use high plate voltages, and there is undoubtedly an advantage, the use of 5-watt power tubes is recommended.

Shielding with Tinfoil

One of the easiest ways of shielding a set is with tinfoil. To make a perfect protection proceed as follows: Drill the panel just as required, then coat the rear surface with a good grade of shellac. When this has dried for a few hours apply another coat to the panel and one to the tinfoil and allow them both to dry until the shellac becomes tacky. Press the tinfoil on the panel using care to avoid all wrinkles. Allow this to dry and then cut the tinfoil away from the holes and then apply another coat of shellac to the foil. Procure a piece of heavy brown paper and coat one side of it with the shellac. When these have set long enough to become tacky press the paper against the rear of the panel and burn the holes through with a hot iron. The paper prevents shorts.—Loren P. Hurd, Northfield, Minn.

THE grid leak and condenser shown is manufactured by the Howard Radio Company of Chicago. This condenser with leak is designed especially for use in connection with detector tubes now on the market. The time standard of the combination has been so chosen that the grid charge is neutralized at the proper rate to give maximum efficiency under normal operating conditions.

Ruby mica is used to separate the conducting plates of the condenser. The leak is clamped between the outside conductors and is well protected from mechanical injury. Because of its copper and mica con-

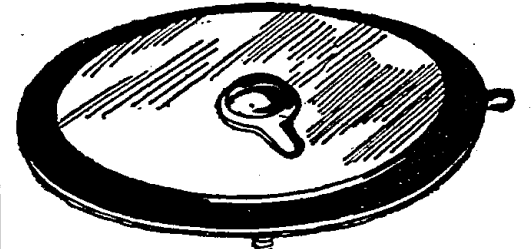

Disk Shaped Grid Leak and Condenser

struction and the elimination of the more common tinfoil and paper, the condenser-leak can be considered much more reliable in operation.

Single Wire Antenna Best

The Radio art suffers, as do all new arts, from "too many ways of doing the same thing," and in no feature does this appear more than in the type of antenna used. The unfortunate fact appears that practically every conductor there is on this earth can be used to receive signals, because the signal sent out from any transmitter sets up currents in every piece of metal it encounters, such as the metal structure of buildings and bridges, the rails of railroad tracks, and, of course, every electric light, telegram and telephone wire that hangs above ground and even below the ground. It is a problem not to find a conductor to pick up signals, but rather to choose a good one.

Fundamental laws governing the best form of receiving antenna have been worked out, particularly in popular form, by Dr. Austin of the United States Navy, and they are simple. Here they are, expressed in non-technical language:

1. The bigger the receiving antenna, the stronger the signal.
2. The "height" of an antenna is the distance above ground of its "middle point."
3. For any particular wave length, there is a best over-all length for the antenna.
4. The antenna should be as far away as possible from other wires, particularly grounded ones.
5. If it is necessary to cross other wires, run as nearly as possible at right angles to these, and as far as you can above them.

First of all, it is advised, use a single wire antenna. This is at least just as good as a four-wire antenna or cage antenna, and in many cases will prove to be a little bit better. The material of the wire does not matter much. It may be hard or insulated; it makes absolutely no difference which. Copper, phosphor bronze, brass, may be used; even galvanized iron can be used without much loss. Of course, it is advisable to use a good strong wire, such as phosphor bronze, so it will not break under strain, and it is recommended that this be used whenever possible. Every retail Radio store carries this stranded aerial wire so it is always easy to get.

Homemade Loud Speaker

The following described loud speaker may be easily made as shown in the illustration. First procure at a garage, a car repair shop or from the junk yard, the large front searchlight of an automobile. Remove all glass and fittings until only the metal bowl remains. In order to brighten the appearance of the bowl it should be carefully sandpapered and varnished. The hole in the center of the bowl may be covered with a piece of stout paper glued in place. Place the phones in the bowl with the diaphragm facing the center



of the bowl. A block of wood may be placed in the back for a support. This homemade loud speaker will give a remarkable clearness and a loud tone.—Morris Star, Chicago, Ill.

Radiophone Broadcasting Stations

Corrected Every Week—Part I

AGI, Presidio of San Francisco, Cal. 50 mi. Signal Corps, U. S. A. Sun, 7-9 pm, instruction. Pacific.

AG6, Canton, O. 425 only. 75 mi. Hdqrs. 185th F. Artillery O. N. G. Wed, Fri. music. Sun, church services. Eastern.

AS5, San Antonio, Tex. 480 only. U. S. Army, Camp Travis. Mon, 7:30-8:30 pm, Thurs, 9:30-10:30 pm, music. Central.

CFAC, Calgary, Alta., Can. 430 only. 400 mi. Western Radio Co., Ltd. Daily ex Sun, 3:30-4:30 pm, Daily, 7:45-8:45 pm. Mountain.

CFCA, Toronto, Ont., Can. 400 only. 500 mi. Toronto Star. Daily ex Sun, 12 m, weather; 2:30-3:30 pm, news, music; 5:30-6, news; 8-9, concert. Sun, 8:30-9:30 pm, concert. Eastern.

CFBC, Vancouver, B. C., Can. 440 only. 1,500 mi. Marconi Co. Daily ex Wed, Sun, 3:30-4:30 pm, Daily, 8:30-9:30 pm, reports, news, music. Pacific.

CFCE, Halifax, N. S., Can. 440 only. 150 mi. Marconi Co. Mon, Wed, Sun night, music, entertainment.

CFCF, Montreal, P. Q., Can. 440 only. 500 mi. Marconi Co. Daily ex Sun, 1-1:30 pm. Mon, Wed, Fri, 7:30-9 pm. Eastern.

CFCH, Iroquois Falls, Ont., Can. Abitibi Power & Paper Co., Ltd.

CFCL, Walkerville, Ont., Can. Motor Products Corp.

CFCN, Calgary, Alta., Can. 440 only. 300 mi. W. W. Grant Radio Ltd. Experimental station. Sat, Sun, after 11:30 pm. Mountain.

CFCL, London, Ont., Can. The London Advertiser.

CFCC, Fort Frances, Ont., Can. International Radio Develop. Co.

CFCT, Toronto, Ont., Can. The Bell Telephone Co.

CFYC, Vancouver, B. C., Can. Victor Wentworth Odlum.

CFZC, Montreal, Que., Can. Can. Westinghouse Co., Ltd.

CHBC, Calgary, Canada. 410 only. 1,000 mi. W. W. Grant Radio Ltd. (Morning Albertan.) Daily, 8:45-10 pm, news, stock quotations, music. Mountain.

CHCA, Vancouver, B. C., Can. Radio Corp. of Vancouver, Ltd.

CHCB, Toronto, Can. Marconi Co.

CHCC, Edmonton, Alta., Can. Can. Westinghouse Co., Ltd.

CHCF, Winnipeg, Man., Can. Radio Corp. of Winnipeg, Ltd.

CHCG, Calgary, Alta., Can. 400 only. 150 mi. Western Radio Co., Ltd. Daily ex Sun, 3:30-4:30 pm, Daily, 7:45-8:45 pm. Mountain.

CHCS, London, Ont., Can. London Radio Shoppe.

CHCX, Montreal, Que., Can. B. L. Silver.

CHCZ, Toronto, Ont., Can. Globe Printing Co.

CHCC, Vancouver, B. C., Can. Can. Westinghouse Co., Ltd.

CHVC, Toronto, Canada. 410 only. 200 mi. Metropolitan Motors Co. Daily ex Sat and Sun, 6-5:30 pm, news, concert. Eastern.

CHXC, Ottawa, Ont., Can. 400 only. 50 mi. J. R. Booth, Jr. Mon, Wed, Sat, 8:30-10 pm, music, entertainment. Eastern.

CHYC, Montreal, Que., Can. Northern Elec. Co.

CHBC, Montreal, Que., Can. 420 only. 75 mi. Dupuis-Freres. Wed, Fri, 9-10 pm, music. Eastern.

CJCA, Edmonton, Alta., Can. 450 only. 1,000 mi. Edmonton Journal, Ltd. Daily ex Sun, 12 m, reports, concert; 8:30-10 pm, concert. Western.

CJCB, Nelson, B. C., Can. 400 only. 100 mi. James Gordon Bennett. Daily, 8-9 pm, music, news, reports. Pacific.

CJCD, Toronto, Canada. 410 only. 200 mi. T. Eaton Co. Daily ex Sat and Sun, 4-4:30 pm, concert. Sat 12-12:30 pm, concert. Eastern.

CJCE, Vancouver, B. C., Can. 420 only. 150 mi. Vancouver Sun. Daily ex Sun, 12:30-1:30 pm, 3:30-5, 8-10, music, news. Pacific.

CJCF, Kitchener, Ont., Can. 420 only. 50 mi. The News Record. Sat, Thurs, 9-11 pm. Eastern.

CJCG, Winnipeg, Canada. 410 only. 1,000 mi. Manitoba Free Press. Daily ex Sun, 10-10:30 am, news; 12-1 pm, reports. Mon, Thurs, 8-10 pm, concert. Tues, 7-8 pm, music. Fri, 5:30-6:45 pm, music. Sun, 8 pm, every other week starting August 20. Central.

CJCH, Toronto, Ont., Can. United Farmers of Ontario.

CJCI, St. John, N. B., Can. 400 only. 75 mi. McLean, Holt & Co., Ltd. Daily, 8-9 pm, music, news, weather. Eastern.

CJCN, Toronto, Ont., Can. Simons, Agnew & Co.

CJCS, Halifax, N. S., Can. Eastern Telephone & Telegraph Co.

CJCY, Calgary, Alta., Can. Edmund Taylor.

CJGC, London, Ont., Can. 430 only. 75 mi. London Free Press. Daily ex Sun, 9:30-10 am; 12-1 pm, news; 3:30-6 pm, weather, news; 8-9, music, entertainment. Eastern.

CJNC, Winnipeg, Man., Can. 400 only. 1,000 mi. Tribune Newspaper Co. Daily ex Sun, 9:30-10 am, 1-2 pm. Mon, 5:30-6:45 pm. Tues, 8-10 pm, Fri, 7-8 pm. Sun, 3-4 pm. Central.

CJSC, Toronto, Ont., Can. Evening Telegram.

CKAC, Montreal, Can. 430 only. 1,000 mi. La Presse. Daily 2 pm reports, 3:30 markets, 4:45, musical teas, news, 5:30 specials, Tues, Thurs, Sat, 7 pm, kiddies' stories, 7:30-9:30, music, entertainment. Sun, 4 pm, sacred concert. Eastern.

CKCB, Winnipeg, Man., Can. T. Eaton Co., Ltd.

CKCD, Vancouver, B. C., Can. 410 only. 150 mi. Vancouver Daily Province. Daily ex Sun, 8:30-9:30 pm, music, entertainment, news. Pacific.

CKCE, Toronto, Ont., Can. Can. Ind. Telephone Co.

CKCK, Regina, Sask., Can. 420 only. 1,500 mi. Leader Pub. Co. Daily ex Sun, 10-10:30 am, news; 1:15-2 pm, markets, news, music. Mon, Wed, Thurs, 7:30-8:15 pm, sports, music. Tues, Fri, 7:30-9 pm, concert. Mountain.

CKCR, St. John, N. B., Can. 400 only. 75 mi. Jones Elec. Radio Co., Ltd. Daily 4-5 pm, concert, reports. Atlantic.

CKCS, Montreal, Que., Can. The Bell Telephone Co.

CKCZ, Toronto, Ont., Can. Westinghouse Co., Ltd.

CKKC, Toronto, Ont., Can. Radio Equipment & Supply Co., Ltd.

CKOC, Hamilton, Ont., Can. 410 only. 100 mi. Vertworth Radio Supply Co., Ltd. Mon, Wed, Fri, 8:30-9:30 pm, concert. Sun, church services. Eastern.

CKQC, London, Ont., Can. 410 only. 50 mi. Radio Supply Co. Mon, Wed, Fri, 7:30-8:30 pm, music, entertainment. Eastern.

CKZC, Winnipeg, Man., Can. Salton Radio Eng. Co.

DD5, Denver, Colo. 340 only. 200 mi. Fitzsimmons General Hospital. Daily ex Sun, 8:15 pm, weather, news, concert. Thurs, 8:15-9:30 pm, special concert, speech. Mountain.

DM4, San Antonio, Tex. 1,500 mi. U. S. Army, Kelly Field. No regular schedule.

DM5, San Antonio, Tex. 1,500 mi. U. S. Army, Brooks Field. No regular schedule.

DN4, Denver, Colo. 340 only. 200 mi. Colorado National Guard. Daily ex Sun, 8:15 pm, weather, news, concert. Thurs, 8:15-9:30 pm, special concert, speech. Mountain.

KDBZ, Bakersfield, Calif. 100 mi. Frank Siefert. Daily ex Sun, 7:30-8:15 pm, reports, music. Sun, sacred program, irregular. Pacific.

KDKA, E. Pittsburgh, Pa. 400 and 485 only. 2,000 mi. Westinghouse Elec. & Mfg. Co. Daily ex Sun, 10-10:15 am, 12:30-1 pm, music; 8:00, sports; 7:00-9, news, features, markets, entertainments; 9:55, concert; 9:55-10 pm, time, Sun, 10:45 am, church service; 2:45 pm, Bible story; 3 pm, 7:30, church service. Eastern.

KDN, San Francisco, Calif. 485, 510 also. 500 mi. Leo J. Meyberg Co. Daily, 1-2 pm, 8:30-9, 4:30-5:30, 7-7:15, music, reports, concert. Pacific.

KDOW, New York, N. Y. S. S. America. Home port is New York.

KDPM, Cleveland, O. Westinghouse Elec. & Mfg. Co.

KDPT, San Diego, Calif. 250 mi. Southern Elec. Co. Daily 7:30-9 pm, news, weather, concert, lecture. Pacific.

KDYL, Salt Lake City, Utah. 485 also. 500 mi. Salt Lake Telephone. Daily ex Sun, 7-8 pm, news, music, entertainment. Mountain.

KDYM, San Diego, Calif. Savoy Theater.

KDYO, San Diego, Calif. Carlson & Simpson.

KDYQ, Portland, Ore. Oregon Inst. of Technology.

KDYR, Pasadena, Calif. Pasadena Star-News Pub. Co.

KDVS, Great Falls, Mont. 485 also. 1,000 mi. Great Falls Tribune. Daily 12 m, weather, time. Daily ex Tues, 8-10 pm, concert etc. Sun, 4 pm, church services. Mountain.

KDVV, Salt Lake City, Utah. Cope & Cornwell Co. KDYV, Phoenix, Ariz. 100 mi. Smith Hughes & Co. Daily ex Sat, 7-7:30 pm. Mountain.

KDVX, Honolulu, T. H., Hawaii. 500 mi. Honolulu Star-Bulletin Co. Ltd. Daily ex Sun, 12:15-1:15 pm, reports; 6:30-7:30 pm, entertainment, music, talks. Sun, 11 am-12:15 pm, 5-6, church services. 120th Meridian.

KDZA, Tucson, Ariz. Arizona Daily Star.

KDZB, Bakersfield, Calif. Frank E. Siefert.

KDZE, Seattle, Wash. 500 mi. The Rhodes Co. Daily ex Sun, 10:30-11 am, 3:30-4:30 pm, news, music. Mon, Fri, 7-8 pm, concert. Wed, 8-9 pm, concert. Pacific.

KDZF, Los Angeles, Calif. Automobile Club of Southern California.

KDZG, San Francisco, Calif. Cyrus Pierce & Co. KDZM, Fresno, Calif. 485 also. 50 mi. The Herald-Examiner. Daily ex Sun, 8-8:15 am, 4-6 pm, news, reports. Daily ex Tues, Fri, 7-8 pm, reports, music. Tues, Fri, 8-9 pm. Pacific.

KDZI, Seattle, Wash. Seattle Radio Assn.

KDZK, Reno, Nev. 50 mi. Ner. Mchly. & Elec. Co. Wed, Fri, Sat, Sun, 8-9 pm, music, entertainment. Pacific.

KDZL, Ogden, Utah. Rocky Mountain Radio Corp.

KDZM, Centralia, Wash. 50 mi. Hollingsworth Hdwe. & Radio Supply Store. Daily ex Sat & Sun, 8-9 pm, music. Pacific.

KDZP, Los Angeles, Calif. Newberry Elec. Corp.

KDZQ, Denver, Colo. 500 mi. Wm. D. Pyle. Daily ex Sun, 6:45-7:15 pm, news, 9-10 pm, concert. Mountain.

KDZR, Bellingham, Wash. 200 mi. The Bellingham Pub. Co. Daily ex Sun, 7-8 pm, 8:30-9, music, news, codes, reports. Sun, 7-8 pm, music. Pacific.

KDZT, Seattle, Wash. Seattle Radio Assn.

KDZW, San Francisco, Calif. Claude W. Gerdes.

KDZZ, Everett, Wash. 50 mi. Kinney Bros. & Sapp. Daily ex Sun, 2:30-3:30 pm, 4:30-5:30, 8:15-9:15. Pacific.

KFCG, Wallace, Ida. 380 only. 100 mi. Auto Supply Co. Daily, 7:30-8:30. Pacific.

KFCD, Salem, Ore. 100 mi. F. S. Barton. Daily ex Sun, 12-1 pm, 8-9, music, news. Sun, 3-4 pm, church service. Pacific.

KFCF, Walla Walla, Wash. Frank A. Moore.

KFCB, Billings, Mont. 100 mi. Electric Service Station, Inc. Daily, 7:30-9 pm, music. Mountain.

KFCJ, Colorado Springs, Colo. Colorado Springs Radio Co.

KFCL, Los Angeles, Calif. Los Angeles Union Stock Yards.

KFCQ, Casper, Wyo. Motor Service Stn.

KFDA, Baker, Ore. Adler's Music Store.

KFDB, San Francisco, Calif. Mercantile Trust Co.

KFDC, Spokane, Wash. 25 mi. D. B. Crancy. Daily ex Sat, Sun, 6-7 pm, music. Sat, 8-10 pm. Sun, 4-5 pm. Pacific.

KFDD, Boise, Idaho. St. Michael's Cathedral. Sun, 11:15-12:30 pm, 8-9:15 church services. Mountain.

KFDF, Casper, Wyo. Wyo. Radio Corp.

KFDH, Tucson, Ariz. Univ. of Ariz.

KFDI, Corvallis, Ore. Oregon Agri. College.

KFDL, Denver, Colo. Knight-Campbell Music Co.

KFDS, San Francisco, Calif. John D. McKee.

KFEB, Taft, Calif. City of Taft.

KFEC, Portland, Ore. 25 mi. Meler & Frank Co., Inc. Daily ex Sun, 4-5 pm, music. Thurs, Sat, 9-10 pm, concert. Pacific.

KFED, Polytechnic Mont. 100 mi. Billings Polytechnic Institute. Mon, 8-9 pm, lectures. Mountain.

KFEI, Tacoma, Wash. Guy Grason.

KFFA, San Diego, Calif. Dr. R. C. Shelton.

KFFE, Pendleton, Ore. 100 mi. Eastern Oregon Radio Co. Daily, 7:30-8 pm, music. Pacific.

KFGG, Astoria, Ore. Astoria Budget.

KFGH, Stanford Univ., Calif. 500 mi. 300 and 410 also. Leland Stanford Junior University. No regular schedule.

KFI, Los Angeles, Calif. 500 mi. Earle C. Anthony, Inc. Daily ex Sun, 1-1:30 pm. Daily ex Mon & Fri, 7:40-8:20 pm. Tues, Sat, 2-3 pm. Sun, 10:45-11 am, 4-5 pm, 7:40-8:20. Pacific.

KFV, Yakima, Wash. 250 mi. Foster-Bradbury Radio

KMJ, Fresno, Calif. 200 mi. San Joaquin L. & P. Corp. Tues, Fri, 7-8 pm, music. Sun, 5-6 pm, music. Pacific.

KMO, Tacoma, Wash. 200 mi. Tacoma Times. (Love Electric Co.) Daily ex Sun, 11-1 pm, 6-7, 9:15-10, concert, news, lecture. Pacific.

KNJ, Eureka, Calif. T. W. Smith.

KNJ, Roswell, New Mex. 485 also. 750 mi. Roswell Public Service Co. Daily, 8 pm, news, reports, concert. Mountain.

KNN, Los Angeles, Calif. 100 mi. Bullock's. Mon, 2:30-3:30 pm. Wed, 2:15-3 pm. Thurs, 4-5 pm. Pacific.

KNT, Aberdeen, Wash. 400 mi. Grays Harbor Radio Co. Daily, 8-5:30 pm, 7:30-8:15, news, concert. Pacific.

KNV, Los Angeles, Calif. Radio Supply Co.

KOB, State College, N. M. 485 also. 500 mi. N. M. College Agri. & Mech. Arts. Daily ex Sun, 11:55-12 m, reports. Mon, Wed, Fri, 7:30-8:30 pm, concert. Mountain.

KOG, Los Angeles, Calif. 300 mi. Western Radio Elec. Co. Daily ex Sun, Wed, 5-5:30 pm, code, news. Mon, Fri, 7:40-8:20 pm, music. Wed, 4:30-5 pm, code, 8:20-9 pm, music. Pacific.

KON, San Diego, Calif. 200 mi. Holzwasser Inc. Daily ex Sun, 4-5 pm and 8:15-9, concert, news. Sun, 10-11 am, 4-5 pm and 8:15-9, church service. Pacific.

KOP, Detroit, Mich. Detroit Police Dept.

KPO, San Francisco, Calif. 300, 600 also. 500 mi. Hale Bros., Inc. Daily ex Sun, 11-12 m, 3:30-4:30 pm, concert. Wed, 7:30-8:15 pm, concert. Sun, 11-12:15 pm, church service. Pacific.

KPI, Berkeley, Calif. Univ. of Calif.

KPJ, Hood River, Ore. 350 only. 50 mi. Hood River News. Daily ex Sat, Sun, 7 pm, news. Tues, Fri, Sun, 8:30-9:30, entertainment. Pacific.

KQV, Pittsburgh, Pa. 300 mi. Doubleday-Hill Elec. Co. Daily ex Sun, 12-12:30 pm, 2:30-3, music, lectures. Mon, Wed, Fri, 10-11 pm, music, entertainment. Eastern.

KQW, San Jose, Calif. 345 also. 500 mi. Ches. D. Herrold. Daily ex Sun, 1-1:30 pm. Wed, 8:15-9 pm, concert. Pacific.

KQV, Portland, Ore. 200 mi. Stubbs Elec. Co. Daily, 1-2 pm, 6-7. Pacific.

KRE, Berkeley, Calif. 200 mi. Maxwell Elec. Co. Every other Sat, 8:15-9 pm. Sun, 1-2 pm, 6-7. Pacific.

KSD, St. Louis, Mo. 400 & 485 only. 1,500 mi. St. Louis Post-Dispatch. Daily ex Sun, 9:40 am, 10:40, 11:40, 12:40 pm, 1:40, 2:40, 4, 8, Sun, 8:15 pm. Central.

KSL, San Francisco, Cal. 50 mi. The Emporium. Daily ex Sun, 10-11 am, concert, news; 2-3 pm, concert, educational talk. Sun, 2-3 pm, concert and educational talk. Pacific.

KSS, Long Beach, Calif. Prest & Dean Radio Co. No regular schedule.

KTV, Seattle, Wash. 500 mi. First Presbyterian Church. Sun, 11-12:30 pm, 3-4:30, 7-9:30, church service. Pacific.

KUO, San Francisco, Calif. 485, 525 also. 1,500 mi. San Fran. Examiner. Daily ex Sun, 9-10 am, concert, chat to housewives; 11-12, reports; 3-3:30 pm, lecture, news; 5:30-6:45 pm, concert; 9 am, 12 m, 6:45 pm, weather report. Wed, 8:30 pm, health bulletins. Sun, 9-10 am, concert; 5-6 pm, concert, news. Pacific.

KUS, Los Angeles, Calif. City Dye Works & Laundry Co.

KUV, El Monte, Calif. 500 mi. Coast Radio Co. Daily ex Sun, Sat, 4-4:45 pm. Mon, Thu, 8:20-9 pm. Sat, 3-4 pm. Pacific.

KVQ, Sacramento, Calif. 300 mi. Sacramento Bee. Daily ex Sun, 6:30-7:30 pm, news, reports, music. Sun, 6-7 pm, reports, music. Pacific.

KWG, Stockton, Cal. 1,600 mi. Portable Wireless Telephone Co. Daily ex Sun, 4-5 pm, news, concert, markets. Tues and Fri, 8-9 pm, concert. Sun, 2-3 pm, concert. Pacific.

KWH, Los Angeles, Calif. 485 also. 250 mi. Examiner. Daily ex Sun, 1:30-1:40 pm, 5:30-6, 6-6:15, 8:20-9, reports, entertainment. Sun, 8:30-9 pm, church service. Pacific.

KXD, Modesto, Calif. Herald Pub. Co.

KXS, Los Angeles, Calif. Braun Corp.

KYF, San Diego, Calif. Theatre Music Co.

KYI, Bakersfield, Calif. Bakersfield Californian.

KYJ, Los Angeles, Cal. 485 also. 1,000 mi. Leo J. Meyberg Co. (Hamburgers). Daily ex Sun, 4-5 pm, concert, markets, weather, news. Mon, Thurs, Sat, 8-9 pm, same program. Pacific.

KYQ, Honolulu, Hawaii. Electric Shop. No definite schedule.

KYW, Chicago, Ill. 400 and 485 only. 2,000 mi. Westinghouse Elec. & Mfg. Co. Daily ex Sun, 9:25 am, 10, 1:20 pm, 2:15, 2:30, markets; 3 (8:30 ex Mon, Wed, Fri), 4, 4:15, 4:30, 5, news, sports, (6:30 Mon only, news, reports, sports), 6:50, bedtime stories, 8-9, music; 9, news, sports; 9:05 special. Sun, 3:30 pm, chapel. Central.

KZV, San Francisco, Calif. The Radio Telephone Shop.

KZC, Seattle, Wash. 100 mi. Public Market & Department Stores Co. Daily ex Sun, 6:45-7:15 pm, music, news, agriograms. Pacific.

KZM, Oakland, Calif. 200 mi. Western Radio Institute (Hotel Oakland). Daily ex Sun, 6:45-7 pm, news. Pacific.

KZN, Salt Lake City, Utah. 485 also. 1,000 mi. Deseret News. Daily ex Sun, 3-4 pm, reports, music, 8-9:30 pm, music, news, bedtime stories etc. Mountain.

KZV, Wenatchee, Wash. Wenatchee Battery & Motor Co.

KZY, San Francisco, Calif. Atlantic-Pacific Radio Supplies Co.

NOF, Anacostia, D. C. 412 only. 600 mi. U. S. Navy Dept. Mon, Tues, Thurs, 7:15-7:30 pm, lecture. Mon, Thurs, 6:45-7 pm, lecture. Tues, Thurs, 7:45-8 pm, health lecture. Wed, Fri, 8:30-9:45 pm, band concert. Eastern.

PWX, Havana, Cuba. Cuban Telephone Co.

WAI, Dayton, O. McCook Field, U. S. Army.

WAAB, New Orleans, La. Valdemar Jensen.

WAAC, New Orleans, La. Tulane Univ.

WAD, Cincinnati, O. 200 mi. Ohio Mechanics Inst. 2:30-4:30 pm, and Sat, 8:15-10:15 pm, Cincinnati Symphony, Orchestra concert. Central.

WAAF, Chicago, Ill. 485 only. 300 mi. Chi. Daily Drivers Journal. Daily ex Sat & Sun, 8:30 am, 10:30, 10:45, 12:30 pm, 3, 4:30, stock reports. Central.

WAAB, St. Paul, Minn. 500 mi. Commonwealth Elec. Co. Mon, Fri, 12:15-1 pm, pipe organ concert. Mon, 8:45-9:30 pm, entertainment. Tues, 8-9:30 pm, entertainment. Wed, 1:15-2 pm, pipe organ. Sun, 3:30-4:30 pm. Central.

WAJ, Boston, Mass. 50 mi. Eastern Radio Inst. Mon, Wed, Fri, 9-10 pm, music. Eastern.

WAAK, Milwaukee, Wis. 300 mi. Gimbel Bros. Daily ex Sun, 10 am, 11:10, 12:10 pm, 1:25, 3. Daily ex Wed and Sat, 7:15-7:30 pm. Central.

WAAM, Newark, N. J. 300 mi. I. B. Nelson Co. Daily ex Sun, 11-11:55 am, 3-4 pm, music. Wed, 8-9 pm, special program. Eastern.

WAAN, Columbia, Mo. Univ. of Mo.

WAAP, Charleston, W. Va. 40 mi. Radio Service Co. Daily ex Sun, 6:45-7:45 pm, music, news, weather, baseball. Eastern.

WAP, Wichita, Kan. 200 mi. United Elec. Co. Daily, 12-1:30 pm, music, news; 5, weather; 7:15-7:30, sports, markets; 9:45-12, talks, music, and code on C. W.; 10:30, weather. Tues, Fri, 8 pm on, concert. etc. Central.

WAQA, Greenwich, Conn. 600 mi. New England Motor Sales Co. Daily ex Sun, 9:30 am-5:30 pm, every half hr. Eastern.

WAAR, Huntington, W. Va. Groves-Thorton Hdwe. Co.

WAAS, Decatur, Ga. Georgia Radio Co.

WAB, Jersey City, N. J. 70 mi. Jersey Review. Wed, 7-8 pm, concert, lecture. Sun, 7-8, church service, concert. Eastern.

WAAP, Athens, Ga. 500 mi. Athens Radio Co. Daily, 7-9 pm, miscellaneous. Central.

WAAP, Omaha, Neb. 485 also. 500 Omaha Grain Exchange. Daily ex Sun, 9:45, 10:45, 11:45, 12:45, 1:20, 8 pm, market reports. 8:15-9 pm, music. Central.

(NOTE—The second part of the station schedule list will appear next week.)

Continued—

THE BROADCASTING station directory is the most complete and authentic list of Radiophone plants. Letters are being sent various stations every day for information. No other paper or source provides the data given here. The idea is original and a service which RADIO DIGEST has maintained from the start. Every public service broadcasting station is to be found now, not only in the location index, but in the schedule list. The latter, however is divided, one third appearing this week, the second third to appear next week, and the last part, together with the state, city, station index, to appear the week following.

The station schedules, given here, are listed alphabetically by call letters. Following the call is given the city and state, and the wave length (PROVIDING a wave length other than 360 meters is used), the miles range of the station, the owner of the station, the schedule of operating hours, and the kind of time used.

The state, city and call list appears with the last third of the station schedules and is merely an index. One wishing to find the calls of the stations in his vicinity, will find this index useful. Three successive issues of RADIO DIGEST will give one the most complete and accurate list of broadcasting stations obtainable.

KFAC, Glendale, Calif. 355 and 485. 250 mi. Daily Press. Daily ex Sun, 4:15-5:15 pm, news etc. Mon, Wed, Fri, 7-8 pm, concert. Pacific.

KFAD, Phoenix, Ariz. 485 also. 100 mi. Mon, Wed, Fri, 8-9:15 pm, concert, weather, stocks, markets. Sun, morning, church service. Mountain.

KFAE, Pullman, Wash. 200 mi. State College of Wash. Program irregular.

KFAF, Denver, Colo. 1,000 mi. Western Radio Corp. Daily ex Thurs & Sun, 8-9 pm, music, reports, news. Mountain.

KFAJ, Boulder, Colo. 250 mi. Univ. of Colo. No definite schedule. Univ. activities. Mountain.

KFAN, Moscow, Ida. 200 mi. The Electric Shop. Tues, Thurs, Sat, 7:30-8:30 pm, music, reports. Sun, church services.

KFAP, Butte, Mont. Standard Pub. Co.

KFAS, San Jose, Calif. City of San Jose.

KFAR, Hollywood, Calif. Studio Lighting Service Co.

KFAS, Reno, Nev. 300 mi. Reno Motor Supply Co. Mon, Tues, Thurs, 8-9 pm, music. Pacific.

KFAT, Eugene, Ore. 100 mi. Pac. Radio Co. Tues, Thurs, Sat, 7-8 pm, music. Sun, 8:45-9:15 pm, church service. Pacific.

KFAU, Boise, Ida. 485 also. 200 mi. Boise-H.S. Mon, Wed, Fri, 9:30-10 am, 2:30-3:00 pm, reports, news, 8:15-9 pm, concert. Tues, Thurs, Sat, 9:30-10 am, 2:30-3:00 pm, reports, news, 7:45-8:15 concert. Mountain.

KFAV, Yonico, Calif. 340 only. 50 mi. Abbot-Kinney Co. Mon, Tues, Wed, Fri, 8:30-9:30 pm, music. Pacific.

KFAW, Santa Ana, Calif. 485 also. 100 mi. Radio Den. Daily ex Sun, 4-4:30 pm, news, reports, music. Mon, Thurs, 8-9 pm, concert. Pacific.

KFAY, Medford, Ore. 485 also. 500 mi. Virgin Radio Service. Mon, Fri, 9-10 pm. Wed, 9-12 pm. Special programs other days. Pacific.

KFBA, Lewiston, Idaho. Ramey & Bryant Radio Co.

KFBB, Hays, Mont. 485 also. 150 mi. F. A. Butrey Co. Daily ex Sun, 9:30 am, agriograms, weather. Tues, Fri, 8-9:30 pm, music. Mountain.

KFBC, San Diego, Calif. 100 mi. W. K. Azbill. Thurs, Bible lesson for foll. Sun. Sat, lectures. KFBH, Hanford, Calif. 485 also. 200 mi. Clarence V. Welch. Mon, Wed, 3-4 pm, 7:30-8:30, news, music, agriograms. Tues, Thurs, Sat, 6-7 pm, music. Fri, 3-4 pm, 9-10, news, music. Sun, 7-8 pm, church services. Pacific.

KFBE, San Luis Obispo, Calif. 50 mi. R. H. Horn. Daily ex Sun, 4-5 pm, 7-8. Pacific.

KFBG, Tacoma, Wash. First Presbyterian Church.

KFBH, Marshallfield, Ore. Thomas Musical Co.

KFBI, Boise, Ida. 70 mi. Jenkins Furniture Co. Daily ex Sun, 8-9 pm. Mountain.

KFBK, Sacramento, Calif. 485 also. 300 mi. Kimball-Upton Co. Daily ex Sun, 3-4 pm, 6-6:30, concert, news. Sun, 8-9 pm, church service. Pacific.

KFBL, Everett, Wash. Leese Bros.

KFBM, Astoria, Ore. Cook & Foster Hdwe. Co.

KFBN, Oakland, Calif. Borch Radio Corp.

KFBP, Prescott, Ariz. Savage Elec. Co.

KFBS, Trinidad, Colo. Chronicle News & Gas & Elec. Supply Co.

KFBV, Laramie, Wyo. Bishop N. S. Thomas.

KFBW, Colorado Springs, Colo. Clarence O. Ford.

KFC, Seattle, Wash. 700 mi. Northern Radio & Electric Co. Daily, eight hours, miscellaneous. Pacific.

KFCB, Phoenix, Ariz. 500 mi. Nielsen Radio Supply Co. Mon, Wed, Fri, 8-9 pm, music. Tues, 8-10, sports. Mountain.

Store. Daily ex Sun, 3-4 pm. Mon, Wed, Fri, 8-9 pm. Pacific.

KFZ, Spokane, Wash. 300 mi. Doerr Mitchell Elec. Co. Tues, Wed, Fri, Sat, 7-8:30 pm, music etc. Pacific.

KGB, Tacoma, Wash. 200 mi. Tacoma Daily Ledger-William A. Mullins Elec. Co. Daily ex Sun, 7-9 pm. Sun, 5-7:30 pm. Entertainment, news, weather, tides, police reports. Pacific.

KGG, Portland, Ore. 500 mi. Hallock & Watson Radio Service. Daily ex Sun, 5-6 pm, music, entertainment, 7:30-8 pm, reports. Sun, 9-10, music. Pacific.

KGH, Portland, Ore. 100 mi. Northwestern Radio Mfg. Co. Irregular schedule.

KGO, Altadena, Calif. 350 only. 300 mi. Altadena Radio Lab. Mon, Wed, Fri, 5:15-6 pm, reports, code lessons, agriograms. Tues, Thurs, 7:40-8:20 pm, concert. Sat, 7:40-9 pm, concert. Sun, 2-3 pm, church service. Pacific.

KGU, Honolulu, Hawaii. 485 also. 150 mi. The Honolulu Advertiser. Daily, 7:30-9 pm. Tues, Thurs, Sat, special program, 150th meridian. (Three hours later than Pacific.)

KGW, Portland, Ore. 400 and 485 only. 1,000 mi. Shihl Owners Radio Service, Inc. (Daily Oregonian) Daily, 8:30-9:30 pm, news, etc. Mon, 7:30-8:30 pm, concert. Wed, 8-10 pm, concert. Fri, 8-9 pm, concert. Sun, 7-8 pm, church service. Pacific.

KGV, Lacey, Wash. 50 mi. St. Martins College. Tues, Fri, Sun, 8:30-9:30 pm, news, concert, bedtime story. Pacific.

KHD, Colorado Springs, Colo. 485 also. 50 mi. Daily ex Sun, 8:15 am, weather. Daily ex Sun, Mon, 7-7:30 pm, music. Mountain.

KHJ, Los Angeles, Calif. 400 and 485 only. 2,000 mi. Los Angeles Times. Daily ex Sun, 12:30-1:15 pm, 7-7:30, 8-9:30. Sun, 10-11 am. Pacific.

KHQ, Seattle, Wash. Louis Wasmer.

KJJ, Sunnyvale, Calif. 500 mi. Radio Shop. Tues, 8:15-9 pm, Fri, 7:30-8:15 pm. Pacific.

KJL, Stockton, Calif. C. O. Gould.

KJF, Seattle, Wash. 200 mi. Northwest Radio Service Co. Daily ex Sun, 8-9 pm, miscellaneous. Pacific.

KJS, Los Angeles, Calif. 100 mi. Bible Inst. of Los Angeles. Tues, Wed, 12-12:30 pm, sacred music, lecture. Sun, 11:30-12:30 pm, sacred music, sermon. Pacific.

KLB, Pasadena, Cal. 300 mi. J. J. Dunn Co. Mon and Fri, 7:30-8:15 pm, concert. Sun, 3-4 pm and 8-9, concert. Pacific.

KLD, Del Monte, Calif. Monterey Elec. Shop. Daily, 12-1 pm, weather, markets, news; 7-8 pm, concert. Pacific.

KLP, San Francisco, Calif. 500 mi. Colin B. Kennedy Corp. Mon, 7:30-8:30 pm. Thurs, 8:30-9 pm. Sun, 4-5 pm. Pacific.

KLS, San Francisco, Calif. 300 mi. Warner Bros. Radio Supply Co. Daily, 12-1 pm. Sat, 7:30-8:15 pm. Pacific.

KLX, Oakland, Calif. 500 mi. Oakland Tribune. Daily ex Sun, 7:15-7:30 pm, news, entertainment. Tues, 7:30-8:15 pm, Fri, 8:15-9 pm, and Sun, 3-4 pm, concert. Pacific.

KLZ, Denver, Colo. 485 also. 200 mi. Reynolds Radio Co. Daily ex Sun, 7:30 pm on, news, markets, bedtime story, concert. Sun, 8-9 pm, church service. Mountain.

KMC, Redley, Calif. 100 mi. W. W. Lindsay, Jr. Mon, Wed, Fri, 8:30-9 pm, concert. Pacific.

RECEIVING RECORD CONTEST

By the Contest Editor

TWO hundred and two receiving records are now to be found in the accompanying list of record holders. Some contestants have succeeded in making half a dozen or more station records while others are content with the holding of only one. There are still over four hundred stations in the "Broadcasting Station Directory" which have not been heard over 1,000 miles, if the contest is any indication.

Perhaps the usual flood of correspondence regarding the contest and following this issue will boost the number of successful contestants greatly. Every day the distances grow larger, and likewise, the contesting fans increase in number.

Rules to Remember

The rules to follow in the contest are but few and easily followed. They are:
1. Amateurs who are able to beat the records given, or who can claim with good evidence, distance receiving records of 1,000 statute miles or more for Radio-telephone broadcasting stations found in the "Broadcasting Station Directory," page 8, of three consecutive issues, may send in such records.

2. Distances must be measured AIR-LINE and expressed in statute miles. Disregard of this rule may cause amateurs to be declared ineligible.

3. Call signals of station heard, its location and the mileage, as defined in Rule 2, must be given in reporting record. Otherwise record will not be considered.

4. Distances are verified by the contest department of this publication, using a Geo. F. Cram Co. standard Radio map of the United States. Owing to much variance in maps, the distances are only given to the nearest 25 miles and are claimed accurate only within 50 miles.

5. There are no prizes awarded. The only compensation record holders receive is the distinction of recognition through the columns of RADIO DIGEST.

Station—Miles Away—Who Heard It

- CFAC—1275, A. W. Smallfield, Kansas City, Mo.
- CFCA—1850, C. C. Beery, Spokane, Wash.
- CFCE—1800, G. G. Ehrler, Chicago.
- CFCN—1450, V. B. Allen, Clinton, Ind.
- CHCB—2075, J. Kurtz, Brooklyn, N. Y.
- CHCQ—1225, M. L. Johnson, Atchison, Kans.
- CJCA—1300, A. G. Lewis, Topeka, Kans.
- CJCB—1300, V. Dennis, Oskaloosa, Kans.
- CJCE—2100, F. C. Woodford, Canton, O.
- CJCG—1250, W. D. Newcomb, Socorro, N. M.
- CKAC—1550, W. F. Macleod, Prince Albert, Sask., Can.
- CKCK—1100, C. Fruit, Fruit, Ill.
- CKCZ—1000, A. H. Jessup, Erie, Pa.
- DD5—1225, C. D. Mason, Cleveland, O.
- DN4—2100, W. E. Davison, Berwick, N. S., Can.
- KDJ—2450, C. Edge, Jr., Melbourne, Fla.
- KDKA—2150, Geo. Walker, Fresno, Calif.
- KDN—2175, F. C. Woodford, E. J. Poyser, Canton, O.
- KDPT—1800, C. Hackney, Fairmont, Ind.
- KDYL—1350, C. Hackney, Fairmont, Ind.
- KDYM—1100, R. L. Hartman, Hoisington, Kans.
- KDYQ—2550, C. M. Rice, Jr., Worcester, Mass.
- KDYS—1650, W. S. Rembert, New Orleans, La.
- KDYX—3900, Am. Radio Equip. Co., Minneapolis, Minn.
- KDYY—1100, P. Weisgerber, Jackson, Mich.
- KDZQ—1325, H. S. Rahiser, Pittsburgh, Pa.
- KFAD—1075, L. S. Icke, Holden, Mo.
- KFAF—1775, F. W. Foss, Boston, Mass.
- KFAM—1775, J. W. Hawes, Boston, Mass.
- KFAP—1575, C. D. Mason, Cleveland, O.
- KFAS—1900, F. Brumon, Urbana, O.
- KFAY—1550, C. N. Schwab, Grinnell, Ia.
- KFBK—1950, H. S. Juday, Eldorado, O.
- KFBM—2450, T. W. Zeigler, Charleston, S. C.
- KFC—1525, R. P. Wallace, Cedar Rapids, Ia.
- KFCB—1150, F. R. Parsons, Indianola, Ia.
- KFDB—1500, A. W. Smallfield, Kansas City, Mo.
- KFEB—1125, R. L. Hartman, Hoisington, Kans.
- KFI—1975, H. G. Peebles, Detroit, Mich.
- KFZ—1750, E. Stonton, Vicksburg, Miss.
- KGF—1350, S. M. Woodson, Jr., Liberty, Mo.
- KGG—1500, C. N. Schwab, Grinnell, Ia.
- KGK—1550, R. P. Wallace, Cedar Rapids, Ia.
- KGW—2150, J. O'Dell, Johnson City, Tenn.
- KGY—1500, E. Coston, Edmond, Okla.
- KHJ—2900, W. E. Davison, Berwick, N. S., Can.
- KHQ—2500, C. M. Rice, Jr., Worcester, Mass.
- KLP—2180, W. G. Mann, London, Ont., Can.
- KLX—2225, C. J. Lohman, McDonald, Pa.
- KLZ—2100, W. E. Davison, Berwick, N. S., Can.
- KMO—1200, A. Taylor, Winnipeg, Man., Can.
- KNI—1575, K. K. Kevill, Malden, Mo.
- KNJ—1350, N. M. Holmes, Chippewa Lake, O.
- KNT—2425, J. H. Wall, Rensselaer, N. Y.
- KOB—1975, C. M. Rice, Jr., Worcester, Mass.
- KOG—2125, A. H. Jessup, Erie, Pa.
- KQP—2100, G. A. Walter, McDonald, Pa.
- KQW—1900, C. Conrad, Logansport, Ind.
- KSD—1675, R. H. Strong, Bicknell, Calif.
- KUO—2675, C. M. Rice, Jr., Worcester, Mass.
- KUY—2100, Roland Smith, Hilo, Hawaii.
- KVQ—1125, G. D. Robarts, Edmonton, Alta., Can.
- KWG—2500, Mrs. A. S. Mawhinney, New York, N. Y.
- KWH—1925, F. Brumon, Urbana, O.
- KYF—1100, R. L. Hartman, Hoisington, Kans.
- KYG—2175, J. F. Means, Oil City, Pa.
- KYJ—1400, J. F. Harrison, Jr., Memphis, Tenn.

- KYW—1850, J. J. Beales, Jr., San Anselmo, Cal.
- KYY—1450, M. L. Johnson, Atchison, Kans.
- KZDQ—1250, F. C. Woodford, Canton, O.
- KZM—1325, F. E. Cox, Hutchinson, Kan.
- KZN—1650, E. K. Kitts, Bluefield, W. Va.
- KZY—1950, A. Galloway, Jr., Grand Rapids, Mich.
- NOF—1025, W. Loomis, Jr., Blencoe, Ia.
- PWX—2425, W. F. Macleod, Prince Albert, Sask., Can.
- WAAB—1050, H. Olson, St. Paul, Minn.
- WAAC—1775, W. F. Macleod, Prince Albert, Sask., Can.
- WAAG—1600, C. C. Beery, Spokane, Wash.
- WAJ—1600, R. & P. McDavid, Houston, Tex.
- WAAL—1150, C. C. Beery, Spokane, Wash.
- WAAM—1450, C. Sawyer, Liberal, Kans.
- WAAN—1400, H. Baird, River de Chute, N. B., Can.
- WAAP—1200, C. C. Beery, Spokane, Wash.
- WAAQ—1325, W. Douglass, Guthrie, Okla.
- WAAZ—1700, W. E. Davidson, Berwick, N. S., Can.
- WAP—1450, C. C. Beery, Spokane, Wash.
- WBAA—1575, C. C. Beery, Spokane, Wash.
- WBAD—1125, N. Theobald, Attleboro, Mass.
- WBAF—1250, M. Neuman, Guthrie, Okla.
- WBAH—1050, F. T. Wycoff, Springfield, Mass.
- WBAP—2550, C. Blanch, Amherst, N. S., Can.
- WBAY—2175, C. C. Beery, Spokane, Wash.
- WBL—1825, W. E. Davidson, Berwick, N. S., Can.
- WBT—1100, W. E. Davidson, Berwick, N. S., Can.
- WBZ—1400, C. Pearce, Hallis, Kan.
- WCAG—1325, K. McNeil, Ottawa, Ont., Can.
- WCAH—1000, A. Taylor, Winnipeg, Can.
- WCAK—1025, F. J. McKenny, New Prague, Minn.
- WCAL—1150, G. D. Robarts, Edmonton, Alta., Can.
- WCAR—1025, J. Dinkel, Charles City, Ia.
- WCAS—1125, G. D. Roberts, Edmonton, Alta., Can.
- WCM—1650, C. M. Rice, Jr., Worcester, Mass.
- WCN—1075, C. N. Schwab, Grinnell, Ia.
- WCX—1975, P. Brennehan, Fresno, Calif.
- WDAB—1225, J. Shamburg, Tekamah, Nebr.
- WDAF—1675, W. E. Davison, Berwick, N. S., Can.
- WDAH—1300, C. Hackney, Fairmont, Ind.
- WDAJ—2000, P. Bennehan, Fresno, Calif.
- WDAK—1200, R. Hastings, Atchison, Kans.
- WDAL—1125, M. M. Cardwell, Republic, Kan.
- WDAN—1375, W. H. Spencer, Montreal, Que., Can.
- WDAO—1500, M. J. Columbe, Plattsburg, N. Y.
- WDAP—1800, A. G. Hilton, Bicknell, Calif.
- WDAU—1250, A. L. Lewis, Stanberry, Mo.
- WDAV—1275, J. H. Wall, Rensselaer, N. Y.
- WDT—1125, R. Hastings, Atchison, Kan.
- WEAF—1125, W. Loomis, Jr., Blencoe, Ia.
- WEAH—1375, E. A. Howard, Watch Hill, R. I.
- WEAK—1100, J. H. Wall, Rensselaer, N. Y.
- WEAO—2100, Dobson & Tucker, Oakland, Cal.
- WEAP—1250, M. J. Columbe, Pittsburgh, N. Y.
- WEAT—1175, R. Luther, Jefferson, Ia.
- WEAV—1200, H. S. Rahiser, Pittsburgh, Pa.
- WEAY—1950, H. Gow, Seattle, Wash.
- WFAA—1925, W. E. Davison, Berwick, N. S., Can.
- WFAG—1375, R. L. Hartman, Hoisington, Kans.
- WFAT—1275, P. Bennehan, Fresno, Calif.
- WFAV—1175, E. E. Case, Beverly, N. J.
- WFAW—1250, J. H. Wall, Rensselaer, N. Y.
- WFI—1250, W. Douglass, Guthrie, Okla.
- WGAD—1950, F. Brinnon, Urbana, O.
- WGAN—1625, H. Lardner, Halifax, N. S., Can.
- WGAS—1250, W. E. Davison, Berwick, N. S., Can.
- WGAZ—2075, H. R. Anderson, Twin Falls, Idaho.
- WGI—1750, E. L. Dye, Plainview, Tex.
- WGL—2375, R. R. Martindale, Phila, Pa.
- WGM—2000, P. Brennehan, Fresno, Calif.
- WGR—1075, R. L. Hartman, Hoisington, Kans.
- WGY—2575, J. J. Beales, Jr., San Anselmo, Cal.
- WHA—1250, W. E. Davison, Berwick, N. S., Can.
- WHAB—1550, G. W. Perkins, Thomson, N. Y.
- WHAE—1050, H. Rawls, Phoenix, Ariz.
- WHAN—1250, K. McNeil, Ottawa, Ont., Can.
- WHAS—1425, W. F. Macleod, Prince Albert, Sask., Can.
- WHAZ—2075, H. R. Anderson, Twin Falls, Ida.
- WHB—1675, W. E. Davison, Berwick, N. S., Can.
- WHK—1550, L. W. Gushwa, Firth, Ida.
- WHX—1025, Mrs. A. S. Mawhinney, New York, N. Y.
- WIAC—1200, H. Meetze, Manassas, Va.
- WIAZ—1200, F. T. Wycoff, Springfield, Mass.
- WIP—1000, R. V. Hammer, Creston, Ia.
- WJAD—1100, F. A. Rose, Two Harbors, Minn.
- WJAJ—1000, D. J. Morris, Weir, Tex.
- WJX—1400, H. Simons, Ft. Worth, Tex.
- WJZ—2575, J. J. Beales, Jr., San Anselmo, Cal.
- WKAN—1100, C. M. North, Malden, Mass.
- WKAQ—2400, R. V. Hammer, Creston, Ia.
- WKC—1200, J. E. Latt, Fairfield, Tex.
- WKY—1125, H. Meetze, Manassas, Va.
- WLAB—1100, C. H. Vale, Providence, R. I.
- WLAC—1175, D. J. Morris, Weir, Tex.
- WLAD—1275, M. J. Columbe, Plattsburg, N. Y.
- WLAG—1500, P. Bennehan, Fresno, Calif.
- WLAH—1500, D. J. Morris, Weir, Tex.
- WLAJ—1450, J. H. Wall, Rensselaer, N. Y.

(Continued on page 14)

R-A-D-I-O

BUY HERE FOR LESS

Chicago Salvage Stock Store 509 South State Street, Chicago, Ill.

Radio Supplies purchased here are sold under a positive guarantee of satisfaction. We carry the largest new stock of first quality merchandise.

THRIFT NEWS for the SHREWD BUYER

\$8.50 Guaranteed 3,000 Ohm
HEAD PHONES \$3.65

COMPLETE PARTS FOR REGENERATIVE SETS

This includes 2 Variometers, 1 Coupler, 3 Dials, 1 Rheostat, 1 Cunningham Detector Tube, 1 Bakelite Socket, 1 Mahogany Cabinet, 7x18 Formica Panel, 6 Binding Posts, 1 Switch Lever, 12 Switch Points, 2 Stops and 1 Diagram to construct this set. Set is capable of receiving 1,000 miles if installed with outdoor aerial..... **\$17.95**

ORIGINAL TYPE "C" **BALDWIN UNITS \$4.95**

VARIABLE CONDENSERS

\$4.30 Value, 43 PLATE, now \$1.75 \$3.10 Value, 5 PLATE, now \$1.25
\$3.70 Value, 23 PLATE, now \$1.45 \$2.70 Value, 3 PLATE, now \$1.15
\$3.30 Value, 11 PLATE, now \$1.35

WD-11 TUBES, 1 1/2-Volt Dry Cell Lights Filament, \$5.95

U. S. A. Signal Corps Aviation Type 194-W Western Electric Phones, \$7.95

Each Phone Cap is covered with large soft rubber ear cushions, and an aviation leather helmet goes with each set! These are the only phones to pass the Government specifications for sensitiveness and loudness, the requirements called for in aircraft reception.

COMPLETE PARTS FOR FLEWELLING CIRCUIT

Includes 6x14 Formica Panel, 23 Plate Condenser, 3 Micon .006 Condensers, 1 Freshman Variable Grid Leak, 1 Remler Leak, 2 Coil Mount, 2 Honeycomb Coils, 2 Coil Plugs, 8 Binding Posts and 1 Diagram to Wire and Construct This Set. Complete..... **\$12.45**

MAGNAVOX, Loud Speaker, Type R3 \$34.95

U. S. Army Signal Corps, Type B. C. 14-A. Radio Sets, \$23.95

VARIOMETERS GENUINE MAHOGANY, \$5 VALUE, NOW \$1.95

VARIOCOUPERS, \$4.50 Value, Now \$1.75

HONEYCOMB COILS

1,500 Turns.....\$1.50	750 Turns.....\$1.00	75 Turns.....40c
1,250 Turns.....1.50	250 Turns.....75c	50 Turns.....40c
1,000 Turns.....1.25	150 Turns.....60c	35 and 25 Turns.....40c
	100 Turns.....50c	

COMPLETE PARTS FOR REINARTZ CIRCUIT

Includes 1 7x18 Formica Panel, 1 Bakelite Socket, 1 Howard Vernier Rheostat, 23 Plate Condenser, 11 Plate Condenser, 3 Switch Levers, 2 Dozen Switch Points, 1 Reinartz Wound Coil, 1 Variable Grid Leak, 8 Binding Posts, 25 Feet Tinned Wire, 1 Base for Coil, 1 Mounting Base Board, and 1 Diagram to Construct This Set. Complete..... **\$11.45**

High Grade RHEOSTATS 45c

Sponge Rubber EAR CAPS, Pair 50c

DIALS, 2, 3 and 3 1/2 in 25c

THORDARSON AMPLIFYING TRANSFORMERS \$4.50 VALUE, NOW \$2.95

GREWOL DETECTORS \$1.65

HEAD BANDS, now 50c

Signal Corps Super Sensitive Microphone Transmitters, \$2.45

Solid Copper Aerial Wire, 100 ft. 35c	2-Slide Tuning Coils, at \$1.95	Anti-Capacity Switches \$1.50
Spaghetti Tubing, yard 10c	3-Coil Honeycomb Mountings, with knobs \$4.20	Lightning Switches \$2.65
Cord Tip Plugs 60c	Phone Caps, for mostly all phones 25c	Hydrometers, now at 45c
Lightning Arresters 95c	Signal Corps Hot Wire Ammeters, at \$5.45	Radloite Crystal, at 35c

FORMICA PANEL, Square Inch 1 1/2c BLACK OR BROWN

WE GUARANTEE ALL MERCHANDISE PURCHASED OF US
Mail orders filled same day received

BUY HERE FOR LESS

CHICAGO SALVAGE STOCK STORE

509 South State Street, Chicago, Ill.

Radio Digest Illustrated

TRADE-MARK

Published by the Radio Digest Publishing Company, Inc.
123 West Madison Street
Telephone State 4844-4845
Chicago, Illinois

E. C. RAYNER, Publisher
Chas. F. Smisor, Editor Evans E. Plummer, Managing Editor
Harry J. Marx, Technical Editor

Eastern Representative, Jacob Miller, 2126 Broadway, New York
Telephone Columbus 2399

Pacific Coast Representatives
E. J. Wood, 251 Kearny St., San Francisco
Telephone Kearny 1472
H. M. Morris, 417 Western Mutual Life Building, Los Angeles
Telephone 12011

58

PUBLISHED WEEKLY

Subscription Rates
Yearly.....\$5.00 | Foreign.....\$6.00
Single Copies, 10 Cents

Vol. III Chicago, Saturday, January 6, 1923 No. 13

Radio Not a New Name

Name Has Been in Use Many Years

WITH almost every new development of great popular interest there comes an era of using the new name for practically anything and so many articles have been named "Radio." Some objects are aptly named, but many of them have nothing to do with the art of Radio telegraphy and telephony.

Twenty-four articles use the single word Radio as a trade mark, according to the Patent Office records, and more applications are on file. The first use appears to have been in connection with a chemical compound registered on August 23, 1904, about six years before the Navy adapted the word to the transmission of telegraph through the air.

In 1911 the word Radio was registered as a trade mark for a make of hot air fans, and also a brand of varnish and paint. The type and design of letters in the word, of course, were different, and sometimes the background varied. In 1913 and 1914, Radio was employed to designate certain forms of chemicals, medicines, insecticides, leather, threads of yarns, and furniture polish.

What was probably the first registration of this trade word for an electrical contrivance was taken out for electrical batteries and apparatus early in 1915. A little later came a type of Radio ball bearing, and in 1918 the Radio golf ball was trade-marked. A non-intoxicating beverage took on the name in 1918, and in the next two years it was used to designate certain flower and garden seeds, auto lenses, phonographs, tires, and a brand of canned fish. The last two years saw Radio applied to watch chains, writing paper, skirt braid, playing cards, cigarettes and dyes. It was March 14, 1922, before a piece of Radio apparatus was trade-marked with Radio, although before then it had been combined with other words to designate many things. Silks, pens, tonics, a magazine, and tea had been branded with the mystic letters. Recently Radio was the name given to a ship although it carries no Radio apparatus. Apparently Radio is a popular name but many of us would like to have it confined to matters, at least, within the art.

Poem Forecasts Radio Years Ago

Author Names Poem "There's Music in the Air"

"ALL poets aren't fools," some immortal once said. Evidently not, for some of them forecast the coming of Radio which will fill the air with music. In a Canadian town evidence has been found of some long dead, but anonymous, versifier, who composed three stanzas under title of, "There's music in the air."

He did this before Marconi had experimented with pebbles in an Italian pond, or Sir Oliver Lodge had learnedly expatiated on the fundamental principles of ether waves. Here is the verse of the poem:

"There's music in the air
When the noontide's sultry beam
Reflects a golden light
On the distant mountain stream.
When beneath some grateful shade
Sorrow's aching head is laid,
Sweetly to the spirit there
Comes the music in the air."

Cold Weather Favors Amateurs

Reception at Its Best During the Winter

RATHER than decreasing as Radio comes into more common usage, interest in the new science is growing. The winter with snow on the ground and cold winds blowing outside makes Radio the favorite pastime for thousands of families who sit around the fireside at home and enjoy an entertainment given in a distant city.

One thing which will serve to increase the Radio interest is the fact that interference from static conditions is reduced to a minimum in cold weather. This makes it possible to hear messages and broadcast programs at greater distances and much more distinctly than is the case in summer.

The amateur who is just learning to tune his Radio set will have much greater success now than he has had at any time during the summer season. Radio enthusiasts are taking more and more interest in the construction of their own sets.

Condensed

By DIELECTRIC

If these columns seem to carry more references to "silent periods" than perhaps to other matters of interest, it is because my detector is besieged with supplications for support of this particular thing. The other evening I listened to an address on the very topic, here discussed, from Station KDKA, and a fervent plea was made for co-operation among the various broadcasting stations in each city looking toward the adoption of specified periods of silence. When those who purchase receiving sets, and others who may, desire any particular feature, it behooves the broadcasters to give attention. Nothing would be lost to the local stations by acceding to this request. On the contrary, much would be gained.

It is possible that many of you were not listening in, or could not hear, when the proceedings at a meeting of Veterans of Foreign Wars was broadcast from a station in the East, not long ago. One resolution presented there is worthy of calling to your attention here. It referred to those who served in the World War and suffered serious disability thereby, going on to suggest that measures be taken to install Radio receiving sets in hospitals where such men are confined, so that they may reap the benefits which the rest of us enjoy. It occurs to me that Radio Clubs throughout the country could bring honor to themselves, and much joy to darkened lives, by boosting a movement of this kind. In fact, every fan should aid to the extent of spreading the idea in his community. Let's begin right away.

The movement, which is country-wide, to combat the great white plague has a powerful ally in Radiophony. The number of broadcasting stations from which information on this vital subject is disseminated, is increasing rapidly. In a great many cases the ravaging effects of carelessness on the part of unfortunate sufferers from this disease is learned of only through the instrumentality of this medium. How great a service it performs may not be known for some time.

Michael I. Pupin, professor and inventor, sees in the use of Radio a powerful factor in reaching that class of citizens who are employed all day long, and presenting them with educational ideas unobtainable otherwise. It is not plausible to expect the average mind to be content to concentrate on any given subject for long periods at a time, but when some lecturer lucidly sets forth a bit of scientific fact, literary compendium, or phase of musical appreciation, what he says will be more than likely retained by the listener. This is so because the mind may immediately relax again when a purely entertaining feature follows. As I have before stated in these columns, the universities and colleges will awaken to the vast field open to them in broadcasting educational addresses, thereby contributing to the progress of our civilization.

Men who are employed in logging camps in the forests of our country no longer feel themselves isolated from the outside world, for the daily news is brought to them as to you and me by the wonderful new agency—Radiophony. It is difficult, even now, to recall the time when the newspaper and telegraph office were looked to as the only sources of gaining information, where people were situated remote from any center of population. All that is changed now, and with the proper equipment, little that is transpiring in the world about us need be unknown. Lighthouse tenders are ordinarily thought of as human beings without social intercourse, except at long intervals. We need to revise that conception, also. True, they may not be able to "talk back," but with receiving sets (and the Government has provided many in this service with sets) they may hear the applause in some great hall; thrill to the tones of a violin; dubiously listen to the weather forecast; and contentedly listen to the announcement of enforced changes in fashions.

Wyoming was the last state to enter the union of broadcasters. However, it is adding to the number of stations, and Radio will become as important an adjunct to everyday life as it has been for a longer period in other parts of the country. Mississippi is not on the broadcast map any longer. How about it, Southerners?

There are no doubt many owning receiving sets who switch on their tubes at some hour of the day and hear "nothing but spark." Those dots and dashes are absolutely unintelligible to them and they are annoyed to have their receivers filled with such stuttering sounds. You know (they know, I should say) that lives at sea are sometimes dependent for safety upon those despised signals, and that some vital piece of news is communicated only in that manner. Why not, then, take advantage of the broadcasting stations kind enough to transmit code so slowly as to make it possible for anyone to learn it, and add to the wealth of musical and topical discourses the pleasure of understanding some of that "nothing but spark"?

We can jot down another important note on the progress of Radio in the world. The success with which Mr. Godley received messages in Scotland from amateurs in this country—and that was hailed as a great event—has been duplicated by amateur fans in France. This is the first time in the history of Radio that French amateurs have been able to copy successfully signals from American amateurs. We are progressing.

RADIO INDI-GEST

Zow! Bam! Another Pin Dropped

We thought that a flat wheel on a street car was about the limit, but now, by means of the Radio-microscope, we are to hear "the crashing of the petals of a rose as they fall." One of these days being deaf will have its advantages.

A Little Rectification

Dear Indi.—Do they train detectors on the police force as plain clothes men?
Algernon.—No, a cat's whisker is part of a Radio kit.

All Aboard, Toot, Toot



Someone said the Radio craze would dwindle with the years, That all the broadcasting and stunts would go—but it appears As though this prophet bold were wrong—the craze is far from gone. Radio is a "through train," folks, and everybody's on.

Letters from a Radio Engineer's Father to the R. E.

(Said Son Having Escaped Safely to School)

Dear Bill:

Well, I have shipped your Radio outfit to you as you asked, but of course in packing it up, I wanted to take a good look at it.

Well Bill, to say that I was surprised, is putting it rather mild.

They say a rhinoceros has a very thick hide, but Bill, you have a rind that would make one of them slink away blushing and hide.

I wondered at the time how it came that you developed such a fondness for coconuts, and ordered them at the grocery. Well, Bill, the shells made very good rotors anyhow, but Bill, I never knew what become of the knobs from our typewriter until I saw them on your panel. And then when your Ma's egg-beater went South, we never thought of blaming you, until I found the wheels in your Radio serving as miters for a vernier or something. Then I called Ma, and when she got down in your shop, the very first thing she set eyes on was a variable what-you-call-it, made out of her aluminum pie pans. Now, Bill, when you get home from school, you will be under suspicion right along, and one more act of piracy like this will be the signal for me to take you out in the woodshed, big as you are.—Your Daddy.

Osculatorially Speaking

Will: "It must be nice to get a Radiogram from a big ocean liner."
Lill: "A little smack would be better."

Then Electrocute Them

A newspaper heading reads: "Makes Footfall of Smallest Insect Sound Like a Roar of Thunder." Why not use Radio to track the nocturnal visitor which is so difficult to locate in the day-time?

Hearing Is Enough

A western paper describes an apparatus that makes sounds visible. A family quarrel ought to produce a veritable aurora borealis.

Wonder If She's a Dry Battery?

"Farmer up our way," writes J. D. Hawes, Ogdensburg, N. Y., "has named his pet cow 'B Battery.' Why?"



Discovered when milking her that her tail is full of switches."

This Is a Chestnut

Fan: "They say Radio has made a hit in Brazil."
Fanatic: "That means prospects for a large crop of Brazil nuts."

His Tickler Failed Him

"What's the matter, Charlie, out of sorts?"
"Out of sorts nothing—I'm just out of tune."

Wrong! It Usta Be Nickels

Teacher: "What is a conductor?"
Youth: "A medium through which nickels pass freely."

A. B. C. Lessons for Radio Beginners

By Arthur G. Mohaupt

THERE is nothing mysterious about Radio. The operation of all Radio apparatus is based upon a few common and elementary electrical principles, and once these few principles are clearly understood in their proper relation to each other, it will be readily seen how simple it all really is. It is merely that these underlying electrical facts are employed in a slightly different arrangement than most of us are accustomed to, that makes Radio appear as an entirely new science.

We will, therefore, first take up a discussion of the more common and important

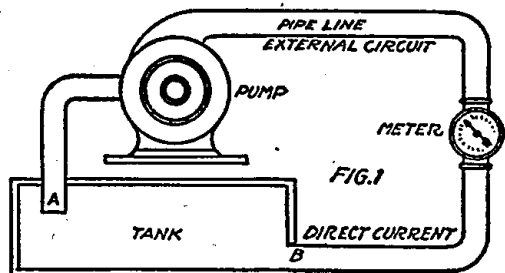

electrical principles with which every one must be acquainted who desires to gain a thorough knowledge of the entire Radio Art.

The Nature of Electricity

Electricity, as we know it today, exists in two forms or states known as static and dynamic electricity. The latter is more commonly known as current electricity, or merely as an electric current. Exactly what electricity is, however, no one at present knows. There are various theories as to its nature, but none has been definitely established as a fact thus far. But for our purpose we are more interested in how it can be produced and how it can be used to best advantage.

Static electricity is stationary electricity, or electricity at rest. It is generally produced by friction, by rubbing one object with another, and always remains at the same place on the object where it was produced. For example, if we rub our coat sleeve with a fountain pen, we are able to pick up small bits of paper with the pen. The pen is said to be electrified, and the condition existing on its surface due to which it is able to pick up the bits of paper is called electricity, or an electric charge. Although static electric-

passes successively is known as a cycle, called the frequency.

Analogy to Water in Pipe

The true nature of a direct and alternating current can be more easily understood by comparing the flow of electricity through a wire to the flow of water through a pipe. By means of this hydraulic analogy we compare the electric current with something with which we are all familiar, and hence we can see through the various properties more readily. Thus, in Figure 1, we have a centrifugal or rotary pump supplied with water from a tank, and feeding water to a pipe line in which a meter is inserted to measure the rate of flow. Water is thus constantly taken out of the tank at A, sent through the pipe line, and returned to the tank at B. The water is continually flowing at a uniform rate and in the same direction, and we thus have a direct current.

In Figure 2 we also have a tank in which a piston moves back and forth. The tank is also connected with a pipe line, but as the piston moves back and forth the water in the pipe flows first in one direction and then in the opposite direction. In other words, in this case we have an alternating current flowing through the line.

Graphic Diagram of Alternating Current

Graphically an alternating current is illustrated as is shown in Figure 3. Here the horizontal line OX is known as the reference line, above which are represented values of the alternating current as it flows in one direction and below values in the opposite direction. Values above the line are called positive, and values below the line negative. Two complete cycles are shown in the figure. The distance from the line to the top or bottom of the curves is known as the maximum value. Above the line it is known as the positive maximum, and below the line as the negative maximum.

Such alternating currents are used very extensively in Radio practice, but the currents are of very high frequencies—several thousand cycles per second and higher. Frequencies up to 10,000 cycles per second are known as audio frequencies, and frequencies above 10,000 cycles per second are known as Radio frequencies. Frequencies even as high as two million cycles per second are used in Radio practice.

Another form of current used exten-

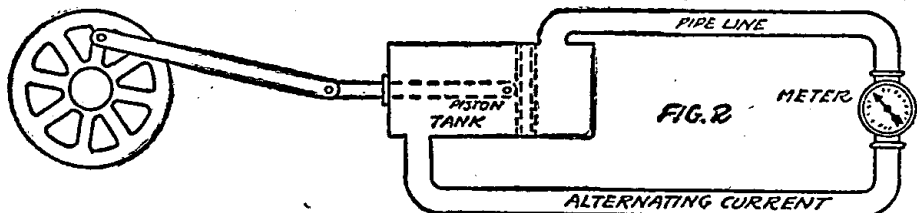

ity does not play an unimportant part in Radio operation, it is the electric current which we are more interested in at the present time.

The Electric Current

Whenever we see an electric light burning or an electric motor in operation, we say that these effects are caused by an electric current. However, if we were to try to explain what this current is, we would meet with considerable difficulty, for no one has thus far succeeded in doing so. Still, the suggestion that there is something moving or flowing in the wire is important and should constantly be kept in mind.

The same is true of our Radio receiving and transmitting sets. Although the set shows no difference in appearance when it is standing idle than when it is in use, still when we have the phones to our ears and we hear the signals, our imagination tells us that there is something moving through all these coiled wires inside of the cabinet.

Two Kinds of Current

Although all electric currents are essentially alike, still they differ in the way they flow through a wire or other conductor. There are thus two kinds of current in commercial use today, direct current and alternating current.

A direct current is one which constantly flows in the same direction and is always of the same strength. The currents furnished by dry cells and storage batteries are direct currents. In Radio practice direct currents are extensively used in vacuum tube circuits, which will be taken up later on.

An alternating current, however, differs from a direct current in that it does not constantly flow in the same direction and is continually changing in value, that is, it alternates in both directions and value. Thus, an alternating current starts at zero and flows in one direction until it reaches a certain maximum value, and then decreases back to zero. At the instant it reaches the zero value, it reverses in direction and increases to the same maximum value and then decreases back to zero again, when the entire process is repeated. Such a complete set of values through which an alternating current and the number of cycles per second is

sively in Radio practice is the so-called pulsating current. A pulsating current is one which constantly flows in the same direction, but in a jerky manner. Such currents are used in vacuum tube circuits. A pulsating current is illustrated graphically in Figure 4. Since it always flows in the same direction, the curve will lie on only the upper side of the reference line OX. It is somewhat like an alternating current which has the lower half of the current wave reversed and brought up above the line.

Electrical Pressure and Current Flow

An electric current is merely the movement or flow of electricity through a wire, just like a current of water is the flow of water through a pipe or channel. The strength of an electric current, that is, the rate at which the electricity flows through a wire, is measured in amperes. We thus say a current of 5 amperes is flowing through a wire, or that a storage battery is delivering 1½ amperes, etc. The amount of current (number of amperes) required in ordinary Radio work is very small, generally only a few thousandths of an ampere. The current required to heat the filament of a receiving vacuum tube averages 1 ampere, while in large trans-oceanic transmitting sta-

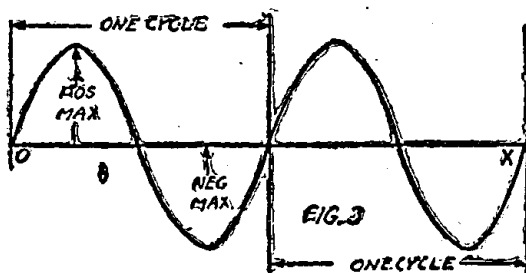

tions currents as strong as 300 amperes are supplied to the antenna.

In order that water can flow through a pipe, it is necessary that a certain amount of hydraulic pressure be exerted upon it by the pump at the pumping station. This might be called a hydromotive pressure, that is, a pressure causing the motion of water. Just so it is necessary to create an electrical pressure in order to cause a flow of electricity, or an electric current. Hydraulic pressure is measured in pounds per square inch, but electric pres-

sure is measured in volts. Thus we say that the current in a circuit is under a pressure of so many volts. The storage battery used for supplying current to the filament of a vacuum tube exerts a pressure of 6 volts, while the current which is fed to the antenna of a powerful broadcasting station is under a pressure of many thousand volts.

Resistance Like Mechanical Friction

As a current of water flows through a pipe, it experiences a certain amount of friction on the walls of the pipe. This tends to retard the current flow, and hence some of the pressure which was

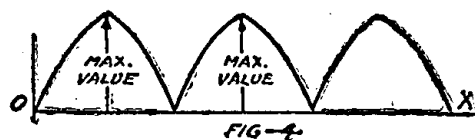

initially exerted upon the water is used up in overcoming this friction.

As an electric current flows through a wire, it also experiences a certain amount of electrical friction which is called resistance. The resistance of an electrical conductor depends upon the length of the conductor, its size, and the material of which it is made. The smaller the conductor, the greater is its resistance, for then the electric current has a smaller space to crowd through and hence it experiences more resistance.

Electrical resistance is measured in ohms. The resistance offered to the flow of current by the filament of a vacuum tube is about 6 ohms. The resistance offered by Radio telephone receivers ranges from 2,000 to 4,000 ohms. This high resistance is due to the large number of turns of fine wire that are used in building the receivers.

We now know that whenever an electric current flows through a conductor there are always three factors to be considered. The first of these is the amount of current flow which is measured in amperes, the second is the electrical pressure which is measured in volts, and the third is the electrical resistance which is measured in ohms. These three are very important, for upon a clear understanding of them will depend the ability to readily grasp the subject of electric circuits.

The Second Chapter

In the next chapter will be taken up a discussion of electric circuits and magnetism, both of which are very important subjects for every one who wishes to obtain a clear understanding of the entire Radio Art. To successfully use a Radio set requires that the interested person have a fairly good knowledge of most of the fundamental concepts of electricity. Although these may formerly have appeared forbiddingly difficult, this first chapter should show that they really form an interesting and fascinating study.

Gas Pipe Ground Poor

Rules issued by the National Board of Fire Underwriters forbid the use of gas pipes for ground connections. This is because in many cases there is no electrical connection available between the gas system and ground. The presence of a high potential surge would be very liable under these conditions, to result in a fire as the electrically insulated system would oppose the flow of current to the ground.

Marking Binding Posts

Binding posts with insulated knobs may be easily marked in the following manner: cut the first letter of the connection or wire on the knob with the point of a sharp knife blade. After all of the knobs have been marked procure some white lead and rub it on top of each knob with a clean rag wipe off the lead on the surface leaving the lead in the knife cuts.—Jesse J. Bonney, Franklin, Va.

ATWATER KENT

Immediate Delivery
Dealers: Write for Discounts
Hudson-Ross, 123 W. Madison, Chicago

To Yearly Subscribers Only

Limited Number of

BOUND VOLUME TWO

RADIO DIGEST

Volume Two

13 Numbers

July 15—October 7, 1922

Now Ready for Delivery. Parcel Post Prepaid, Only **\$2.00**

On account of the limited supply, the sale of these bound volumes No. 2 is limited strictly to those readers of the Radio Digest who have subscribed for a year.

TO NEW SUBSCRIBERS

One year subscription to Radio Digest and both bound volumes 1 and 2. **\$7.00**

By subscribing now for one year to the Radio Digest you get both BOUND VOLUMES 1 AND 2, 26 numbers, with one year's subscription for \$7.00.

or either volume 1 or 2, FREE with a year's subscription to Radio Digest. **\$5.00**

ALL ORDERS MUST BE SENT DIRECT—No orders on this offer will be accepted through subscription agencies, news dealers or other sources. Check, money or express orders (no stamps) must accompany all orders.

TEAR HERE—MAIL

Supply Limited—Better Hurry

COUPON

PUBLISHER, RADIO DIGEST ILLUSTRATED, 123 West Madison St., Chicago, Illinois, 3-11

I have already subscribed to the Radio Digest for one year, so please reserve me one bound volume Number Two for which I am enclosing check—M. O. for Two Dollars.

Please reserve me Bound Volume Number One and also Number Two and one year's subscription to the Radio Digest, Illustrated, for which I am enclosing check—M. O. for Seven Dollars.

Name

Address

City..... State.....

Low Cost Set for the Novice to Make

Beginner's Set Ideal For First Reception

The illustration shows a set that is ideal for the amateur exploring for the first time the mysteries of Radio. It is compact and portable and can be assembled

WORKSHOP KINKS? EARN A DOLLAR—

THERE are many little kinks worked out at home that would add your fellow Radio worker if he only knew about them. There are new hook-ups, new ways of making parts and various unique ways of operating sets that are discovered every day. RADIO DIGEST is very much interested in securing such material. Send them in with full details, including stamped envelope so rejected copy may be returned. The work must be entirely original, not copied.

RADIO KINKS DEPARTMENT,
RADIO DIGEST,
123 West Madison St., Chicago, Ill.

on a block of wood 6 by 6 inches. Any twelve-year old boy can construct it.

The tuning coil is made of 75 turns of No. 24 B & S gauge cotton covered wire. This wire is wound on a tube 3 inches in diameter and a tap is taken off every 15 turns to vary the coil. A tie clasp is soldered on the end of the aerial which clamps on any tap of the coil. The first end of the winding is not used, the last end is fastened to a water-pipe ground. Leads for the instruments are taken off as follows: One from the aerial to the

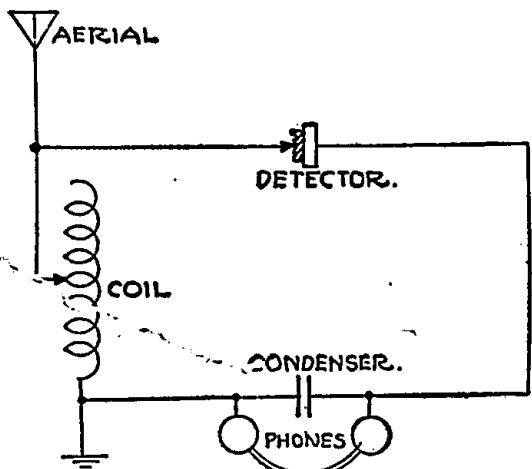

detector—and the other from the ground wire to the fixed condenser. Connect the instruments as shown in the diagram and you have a first class Radiophone good for from 5 to 10 miles reception range.

It is a good receiver and will work well. Nearby broadcasting stations will come in loud.

- Materials required:
- Murdock 1,000 ohm phone.
 - Buzzer.
 - Two tie clasps.
 - Battery for buzzer.
 - Galena metal.
 - Aerial wire.
 - Condenser.
 - Ground wire, junk shop.

Build one and you will be surprised at the results. The author was—for it works on dots and dashes, speech and music. To work with this set will give the boy a knowledge of Radio and may be make him a Radio electrician.—L. S. Hoover, Atlanta, Ga.

Homemade Vernier Rheostat

The form on which the wire is wound is made of wooden dowel. Dimensions are given in the illustration. Most rheostats do not have vernier adjustments. This one is just put in series with the filament circuit. Thermax wire can be bought

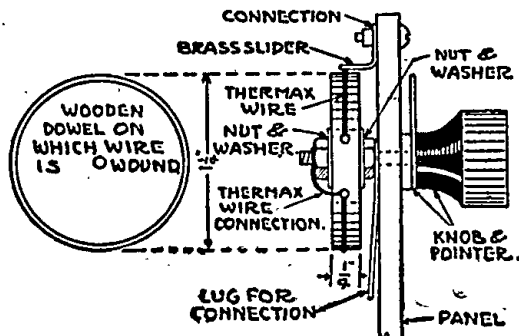

cheaply and it only requires a length of 4 1/2 inches for the rheostat. A small L-shaped piece of brass is used as the slider, which remains stationary. The form is the only turning part. The wire is held in place with two tacks. These tacks also serve the purpose of stops.—Richard Mahler, New York, N. Y.

SIMPLE CRYSTAL SET COMPLETE

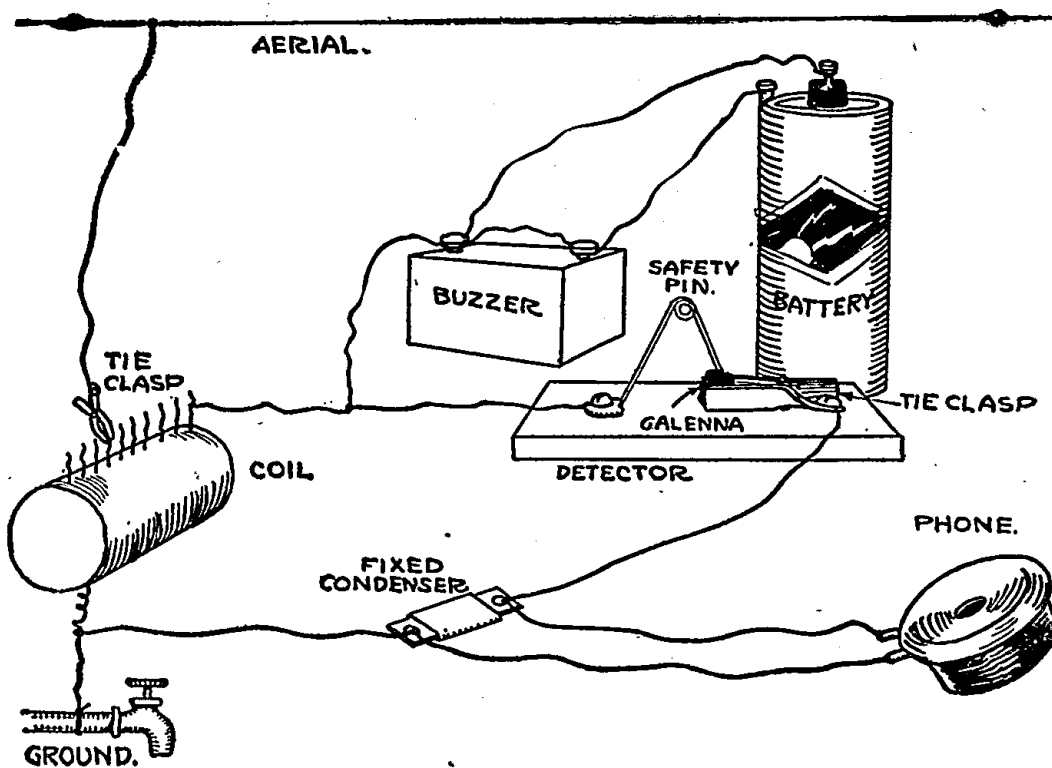

How to Make Mica Diaphragms

A pair of badly bent diaphragms in the receivers of my head set were substituted with mica and they worked better than a new set. A piece of mica was cut to the same size as the old diaphragm. A piece about the size of a dime was cut from the old diaphragm and this was stuck in the center of the mica diaphragm with shellac. The metal was placed on the side away from the coils in the receivers. At first they had a bad tone but after thinning the mica down and matching them in this manner I had as good a tone as in a new set.—Emel Retz, Omaha, Nebr.

Jack Used for Panel Mounting

A simple way to fasten horizontal panels to the vertical panels is to use jacks. One or two holes should be drilled and tapped in the contact supporting lever. Through corresponding holes in the horizontal panel, insert either round or flat head screws as desired. The jack is fastened in the usual way to the vertical panel. This assembly is strong enough to support all necessary mounting, and I have used this method throughout my set.

A regenerative receiver has 5 jacks used as supports, and the R. F. and A. F. amplifier set uses 7 jacks. No other means

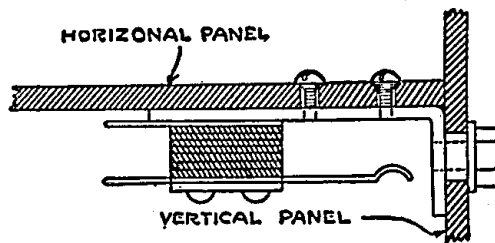

were found necessary for joining two panels at right angles.

The question probably arises, what is the use of all the jacks? I found that jacks made good switches for cutting in and out R. F. variometers, condensers, etc.—Peter S. Schott, Perth Amboy, N. J.

RADIO SUPPLIES STORES
Prompt Service—Quality Goods—Priced Right
Radio Division
TELEPHONE MAINTENANCE CO.
20 S. Wells St. Franklin 3986
5286 W. Madison, Austin 7041. 1122 E. 47th St.

SOMERVILLE TERMINAL TAGS 5c
READINGS
ANTENNA HI-VOLTAGE +
GROUND HI-VOLTAGE -
OUTPUT LO-VOLTAGE +
INPUT LO-VOLTAGE -
TICKLER MODULATION

"Slip under any Binding Post—Like Washers"
"The Original and Best" at Your Dealer or Direct
Somerville Radio Laboratory
43 CORNHILL, BOSTON, MASS.

Honeycomb Coil and Variometer Hook-up

I have tried out a great many hook-ups and the majority of them I have found wanting, but the one that I am describing has met all of my expectations and I think that it will do the same with those who try it out.

This hook-up is very simple and easy to wire. It consists of a variable condenser, a variometer, and a honeycomb coil. It allows sharp tuning and brings in the distant stations with usual loudness.

With this hook-up, using an 80-foot aerial and a gas pipe for a ground, I am able to bring in the following stations regularly: WDAO, WFAA, WRR, WPA,

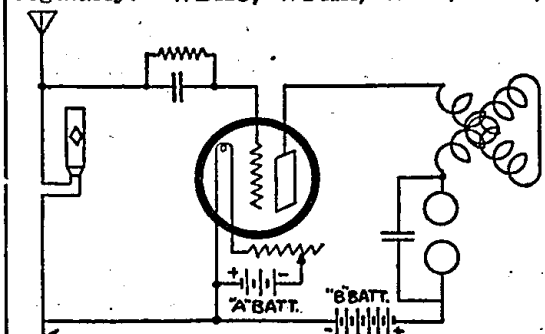

WBAP, WEAY, WLAG and WJAD. All of these are nearby stations. The distant stations heard are KSD, WDAF, WHB, WOS, WOC and KLZ. The greatest distance heard are WLAG and WGM. These stations were picked up during the time that my storage battery was run down and I am sure that after it is charged I will be able to get better results.—James Reilly, Dallas, Texas.

Phantom Tuner

\$19.75 will bring one of these marvelously sensitive instruments to your address, prepaid. No aerial, ground, loop or radio frequency used. All parts highest quality. Cutler Hammer, Remier, Dubelier, etc., mounted on genuine bakelite panel. Complete instructions furnished for wiring. No soldering necessary. Have music on strip of lamp cord one hour after set arrives. Our Phantom sets cover distance and is practical using detector only. Wind lamp cord in auto top and tune in music while driving. We've done it often. Send stamp for booklet and learn the Phantom story.
VESCO RADIO SHOP, Box D-704, Vacaville, Calif.

No. 57

\$98.00

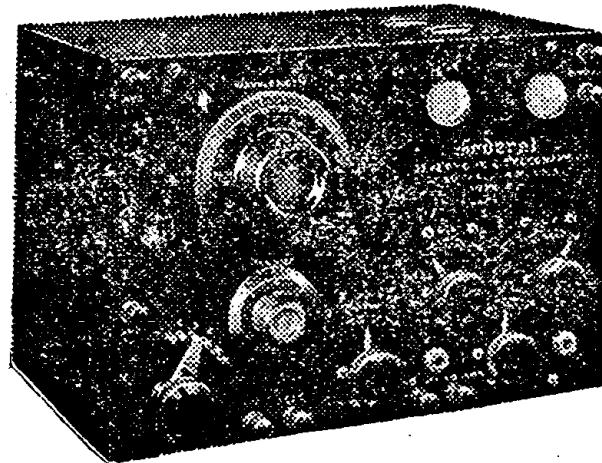

THE Federal -No. 57- Radio Frequency Receiver

GREATEST SELECTIVITY AND SENSITIVITY

of any Receiving Instrument yet made

Tune in the Station You Like Best

Write for Bulletin No. 119-W

Federal Telephone and Telegraph Company

BUFFALO, N. Y.

CHICAGO OFFICE: 805 STEGER BUILDING, CHICAGO, ILL.

Construction and Operation of Reflex Circuits

Part II—How to Build a Compact Single Tube Set

By H. J. Marx

IN PART I of the article on Reflex Circuits given in the December 30th issue of RADIO DIGEST, two reflex circuits were described. The one was a three-tube type, but the other was very simple in form, using but one tube and a crystal detector. This last one, in spite of its simplicity, is equivalent to one stage of Radio frequency amplification, detector and one stage of audio frequency amplification. It is reproduced in this article as Figure 3.

In tests with the set described in this article, good reception was obtained over a range of 1,000 miles and more using only a loop aerial with a variable condenser shunted across it for tuning. If an outdoor aerial is used, some other form of tuning apparatus is required. This can be a single or double slide tun-

Binding Post Connections
Of the three binding posts in the upper left corner of the panel, the one on the left is for the positive A battery connection; the center post for the negative terminals of both the A and B batteries, and the one on the right side is for the positive B battery connection.

The two binding posts in the lower left corner of the panel are for the input connections. If a loop aerial is used, a 23 or 43-plate variable condenser is shunted across it and the two terminals are connected to these two lower binding posts. If the outdoor antenna is used, a single or double slide tuning coil is connected between these two binding posts, and the antenna and ground attach to the coil and a slider.

The dimensions given need not be fol-

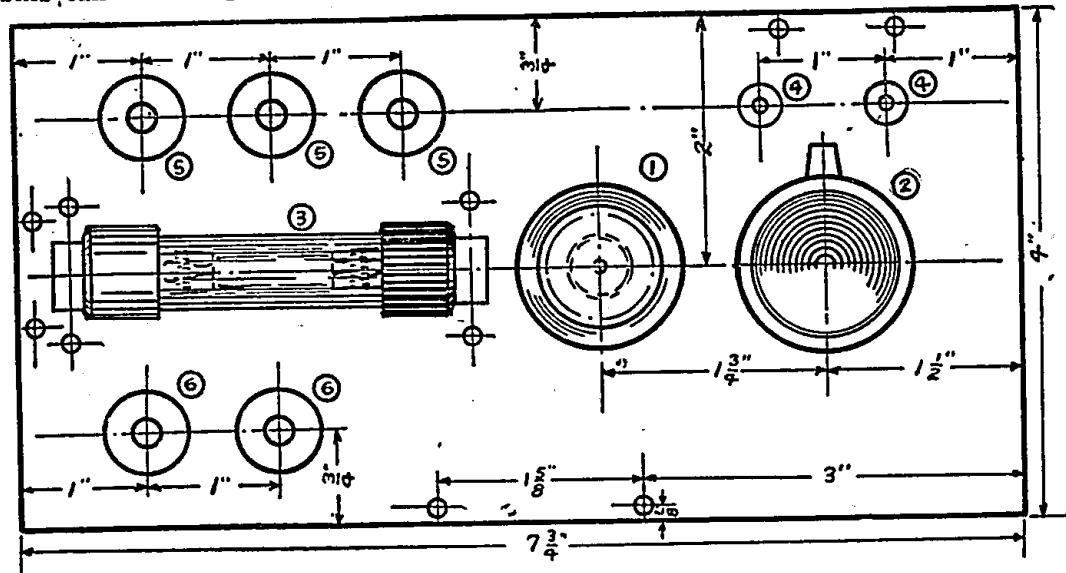

Figure 1

lowed, but can be altered to suit the cabinet or case to be used.

Surgical Instrument Case Used

The cabinet was an old surgical instrument case measuring about 4 3/4 by 4 3/4 by 8 1/2 inches outside dimensions. The walls were 1/4 inch thick. The cover itself is 1 1/2 inch deep. The panel was made up of 1/4 inch panel material, and the top of it is sunk 3/4 inches below the level of the lower half of the cabinet.

The layout of the panel is given in Figure 1. The various pieces of apparatus are numbered as follows:

- No. 1.—Crystal detector.
- No. 2.—Potentiometer, 200 to 400 ohms.
- No. 3.—Amplifying vacuum tube.
- No. 4.—Two phone tip jacks.
- No. 5.—Three binding posts for battery connections.
- No. 6.—Two binding posts for tuning connections.

Internal Parts Numbered

In the cross-section of the case shown in Figure 2, the same identification num-

bers are used with the following additions:

Tuning Operation

In tuning this circuit the condenser or tuning coil is used for wave length adjustment and the potentiometer is then set for the best operating potential of the grid circuit. The Myers tube shown in the illustration requires only four volts for the filament, and a fixed adjustment filament resistance can be inserted if necessary, but no rheostat is indicated.

Because of the compactness of the assembly, it is advisable to cover all leads with spaghetti tubing to avoid the possibility of short circuits. All connections should be soldered to insure perfect electrical contact.

In soldering leads to condensers, care must be taken to avoid heating the condenser so much that the mica dielectric begins to fuse, as this will kill the efficiency of the condenser and is apt to cause short circuiting. If paper condensers are

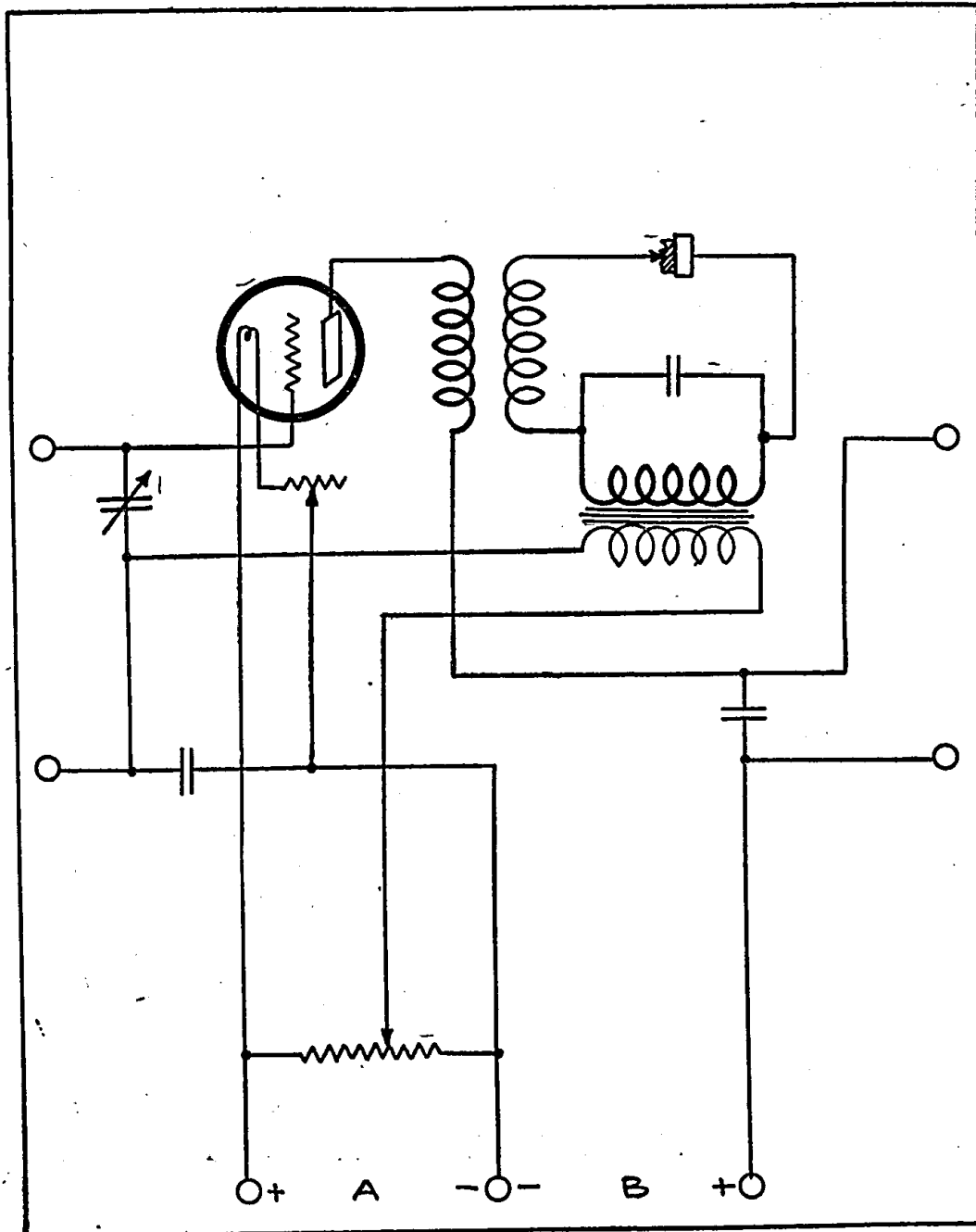

Figure 3

Must Use Values Given

The constant values of the apparatus indicated must not be altered, or the action of the hook-up cannot be depended on. The condenser capacities must be such as to fulfill certain conditions. When the values are changed they do not function as originally intended.

The circuit has been found to operate satisfactorily with a number of different types of transformers, so no recommendation is made for any particular make. Naturally those with known efficiency are better than unknown and unproven makes. The audio transformer however, should have a ratio of 3 1/2 or 4 to 1. The fastening in the case presents no great difficulty, and is left to the ingenuity and limitations of the individual fan.

Storage Battery Electrolyte

When mixing new electrolyte for any lead-acid type of storage battery to replace evaporated or spilled solution, precautions should always be taken to pour the acid into the water, and never do the reverse operation. This is due to the fact that the acid, being heavier than water, sinks to the bottom of the container and the heat of the chemical reaction which there takes place is conducted away by the water.—J. M. C.

Tell Us Your Radio Troubles

OUR ADVICE MAY HELP YOU

Give full particulars, make of instrument, local conditions, type and length of aerial. No circular letter proposition. Each case is individual.

Enclose 25c and addressed stamped envelope to

Radio Information Bureau
627 First Avenue North, MINNEAPOLIS, MINNESOTA

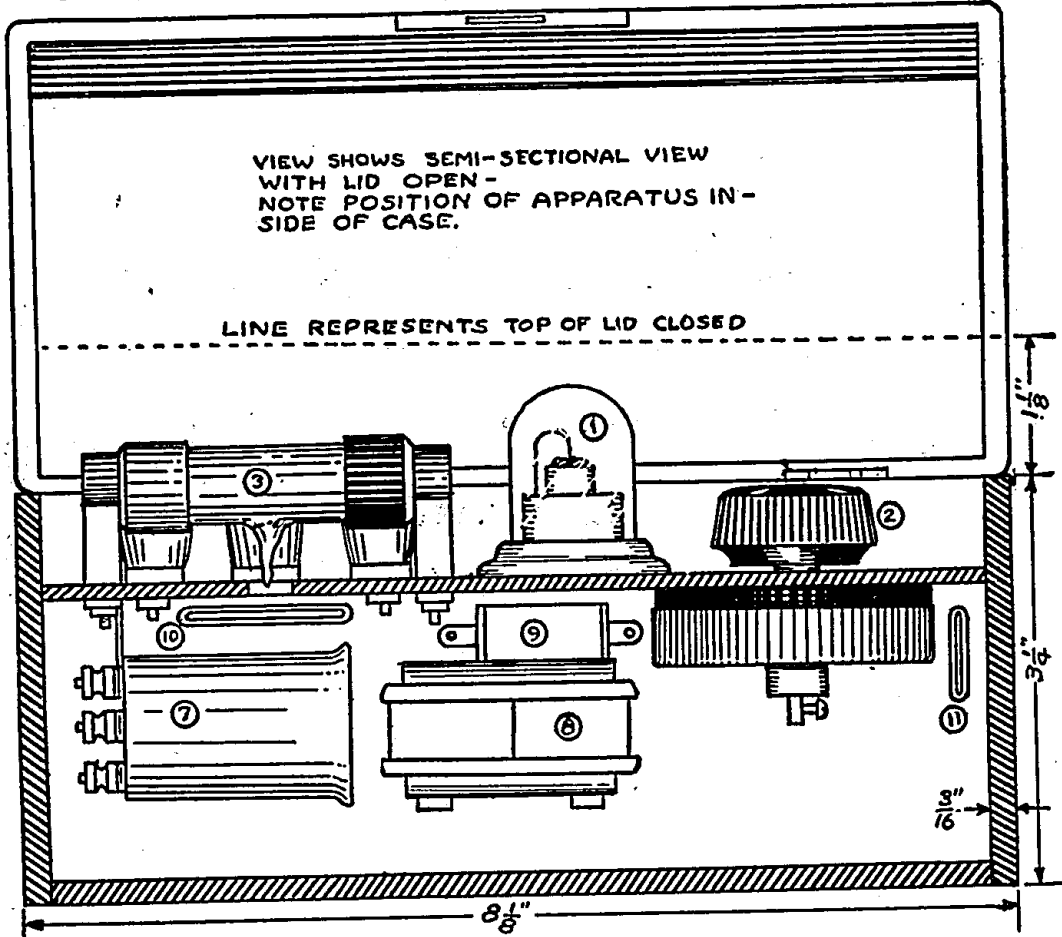

Figure 2

bers are used with the following additions:
No. 7.—Radio frequency transformer.
No. 8.—Audio frequency transformer.
No. 9.—.001 mfd. fixed condenser.
No. 10.—.002 mfd. fixed condenser.
No. 11.—.001 mfd. fixed condenser.
In order to avoid confusion the wiring is omitted. The circuit can be traced out from the diagram, Figure 3.

used, it pays to make sure that these are good. Many a good circuit has been condemned on account of a "weak link" in some of the apparatus.
Naturally a good piece of crystal is required so as to get good, clear rectification. Poor or dirty crystals will allow but weak currents to pass through, and the efficiency of the receiver is then destroyed.

Headquarters for
Radio Supplies and Equipment
Radio Department
COMMONWEALTH EDISON ELECTRIC SHOPS
72 West Adams Street
Chicago, Ill.

World Batteries
FOR
RADIO OR AUTOMOBILE
SAVE YOU 50%
Buy direct from factory. Get highest quality—lowest prices and 100% battery service.
WRITTEN TWO-YEAR GUARANTEE

AUTOMOBILE PRICES		RADIO PRICES	
6 Volt, 11 Plate.	\$12.50	6 Volt, 40 Amp.	\$8.50
Ford, Dort, Chev.		6 Volt, 60 Amp.	10.00
6 Volt, 13 Plate.	14.50	6 Volt, 80 Amp.	12.50
Overland, Buick.		6 Volt, 100 Amp.	14.50
12 Volt, 7 Plate.	18.00		
Maxwell, Dodge.			
Same 50% Saving on all cars. Give make car.			

Batteries shipped immediately express C. O. D. Thousands of satisfied users. Mail your order today!

World Battery Co., 60 East Roosevelt Road, Dept. L, CHICAGO, ILL.

Radio Reception
by
Marx
Only **\$2.00**
THIS BOOK
EXPLAINS RADIO
Sent by Insured Mail on receipt of Check or Money Order.
MAIL YOUR ORDER TODAY
HARRY J. MARX
900 WILSON AVE
CHICAGO

R.F. & A.F. THREE-COIL REGENERATOR

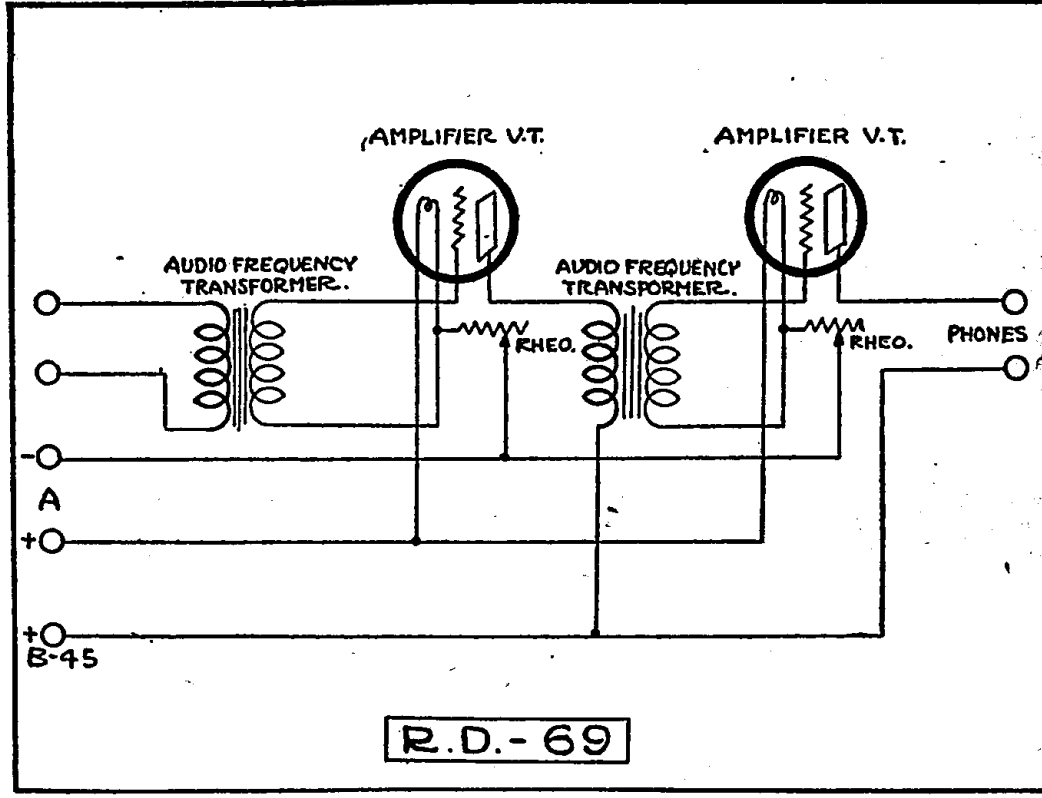
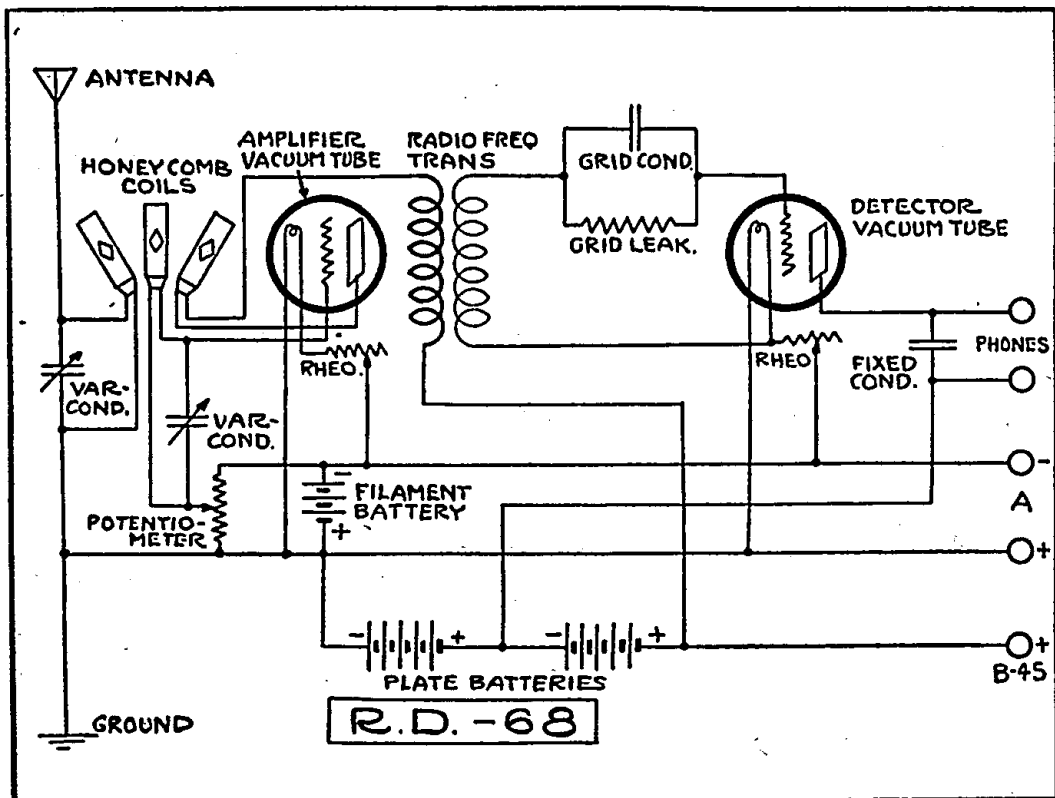

MANY requests have been received for hook-ups of the triple honeycomb coil type with the addition of Radio frequency and two stages of audio frequency. For this reason the circuit R.D.-68 is given and in addition a two step audio frequency amplifier, shown as R. D.-69, has been laid out. The three honeycomb coils for ordinary broadcasting range are primary 35 turns, secondary 50 turns and tickler 75 turns. The primary coil, however, may vary more or less with the construction and characteristics of the antenna circuit. A .001 mfd. variable condenser is shunted across the primary coil.

The variable condenser shunted across the secondary coil need not have more than a .0005 mfd. capacity. A potentiometer is shunted across the filament battery in order to control the grid potential of the first amplifying tube. The usual rheostat control is used for each vacuum tube, although the rheostat used on the detector tube should be preferably a vernier.

Any make of efficient Radio frequency transformer can be used. The grid leak and grid condenser unit should have the following characteristics; Grid leak resistance 1 megohm; grid condenser capacity, .0005 mfd.; fixed condenser shunted across

the phones, .001 mfd. The plate circuit of the detector tube is tapped in after the first of the 22½-volt batteries, whereas the plate circuit of the amplifier is tapped in following the second 22½-volt battery, giving it a plate potential of 45 volts.

R. D.-69 is the two-step audio frequency amplifier to be used in conjunction with R.D.-68. The binding posts on the right side of the hook-up diagram R.D.-68 corresponds to the binding posts on the left side of hook-up R.D.-69. The same batteries, A and B, are used for both panels. Two audio frequency transformers are required. Rheostat control is shown for

both tubes, although it would be possible to utilize one rheostat for both. This, however, is apt to overload the rheostat, which, in the end, may cost more than the expense of the extra rheostat. VT-2 or "E" tubes are used in the audio frequency stages. The B-45 post is not connected across, but the negative of another 45-volt B battery is connected to the B-45+ binding post on the R.D.-68 panel and the positive terminal is connected to the B-45+ binding post on the R.D.-69 panel. This will give a higher amplifier plate voltage and considerably increase the degree of amplification.

RECEIVING RECORDS

(Continued from page 9)

- WLAV—1775, A. B. Butter, Los Angeles, Calif.
- WLK—1150, W. E. Davison, Berwick, N. S., Can.
- WLW—1100, W. E. Davison, Berwick, N. S., Can.
- WMAB—1250, W. F. Macleod, Prince Albert, Sask., Can.
- WMAC—1075, C. Edge, Jr., Melbourne, Fla.
- WMAD—1150, H. J. Latshaw, Clearfield, Pa.
- WMC—1000, A. Taylor, Winnipeg, Man., Can.
- WMAF—1100, C. Edge, Jr., Melbourne, Fla.
- WNAC—1200, R. V. Hammer, Creston, Ia.
- WNAD—1300, W. F. Macleod, Prince Albert, Sask., Can.
- WNAF—1375, J. H. Wall, Rensselaer, N. Y.
- WNAK—1200, J. H. Wall, Rensselaer, N. Y.
- WNAT—1000, R. V. Hammer, Creston, Ia.
- WOAI—1675, W. F. Macleod, Prince Albert, Sask., Can.
- WOC—1675, H. S. Trost, San Jose, Calif.
- WOH—1150, W. E. Davison, Berwick, N. S., Can.
- WOI—1525, R. H. Strong, Bicknell, Calif.
- WOK—1150, H. Rawls, Phoenix, Ariz.
- WOO—1325, J. E. Lott, Fairfield, Tex.
- WOQ—1150, G. W. Perkins, Thompson, N. Y.
- WOR—1375, J. E. Lott, Fairfield, Tex.
- WOS—1200, W. F. Macleod, Prince Albert, Sask., Can.
- WPA—1140, C. Edge, Jr., Melbourne, Fla.
- WRP—1300, A. Taylor, Winnipeg, Can.
- WRR—1175, A. Taylor, Winnipeg, Can.
- WRW—1225, K. E. Gabbert, Clay Center, Kan.
- WSAS—1225, F. T. Wycoff, Springfield, Mass.
- WSB—2275, L. K. Poyntz, Victoria, B. C., Can.
- WSL—1175, L. Hull, Eureka, Kan.
- WVP—1000, A. C. Rothmund, St. Paul, Minn.
- WWJ—2200, F. W. Hill, Cristobal, C. Z.
- WWL—1275, G. W. Perkins, Thompson, N. Y.

The Reader's View

We Told You So

Not long ago I wrote to you, asking whether a crystal set consisting of a loose coupler, variable condenser, fixed condenser and a crystal detector would receive music.

Your answer was surely correct, for I am receiving Detroit News, St. Louis Post-Dispatch, Davenport, Chicago, Schenectady, New York, and Atlanta, Georgia. Every one of these places comes in very plain.

I would like to have this published to see if anyone else has ever received that far on a crystal set. Atlanta is more than 1,000 miles from Kankanna; Schenectady or the General Electric Company is nearly 1,000 miles.—George H. Cook, S. Kankanna, Wis.

Difference Between A. F. and R. F.

The essential difference between Radio and audio frequency amplification is that with Radio frequency, the very slight current produced in the receiving antenna system by passing waves from a transmitting system are caught and passed through amplifying devices designed to permit this current to oscillate, that is, to flow back and forth at the same frequency it passes

through the ether. However, with audio amplification the current from the detector tube is passed through successive stages of amplification, not at the natural frequency of the signal as it passes through the ether, but at a frequency very much lower, which is in the range of audibility. In the case of Radio frequency amplification, the incoming signals are amplified by means of a local source of energy before they reach the detector tube, while audio frequency amplification takes place after detection.

Detection requires a certain amount of energy for its proper functioning and it is obvious that several stages of audio frequency would be valueless where the strength of the incoming signal was insufficient to produce detection. It is here that Radio frequency is valuable for it builds up the infinitely weak signal to a point where proper detection may take

place, and from this point on it is possible to increase the signal audibility by the audio amplification method.

Care of Tubes

Every precaution should be taken for the care of the vacuum tube. This is the most expensive instrument in a Radio receiver, and is considered the most fragile. The most important part of the tube is the filament. The more the current is turned on the brighter the filament grows, and the life of the tube is shortened. To increase the brilliancy of the tube is of no value whatsoever, and is merely burning up the filament and current from the battery.

DON'T GUESS—USE A PREMIER "7-IN-1" VARIABLE GRID LEAK FOR EVERY TUBE SET



Price 50 Cents Each

Has seven carefully calibrated values of leak resistance of ¼ Megohm each between terminals. Bakelite discs protect "leaks," assuring permanency of resistance. Don't guess—a grid leak is a mighty important unit in securing the best results from all tube sets. A Premier Variable makes this sure and easy.

PREMIER UNIVERSAL RADIO PRODUCTS—Are all their name implies and will survive. We make a full line of Apparatus and Complete Sets. Why not begin STANDARDIZING NOW?

BULLETINS 102 and 203 SENT UPON REQUEST
PREMIER ELECTRIC COMPANY
 Manufacturers—Est. 1905
 3802-3810 RAVENSWOOD AVE., CHICAGO

INCREASE YOUR RANGE BY ADDING A PERFECTLY CONSTRUCTED VARIABLE CONDENSER TO YOUR SET

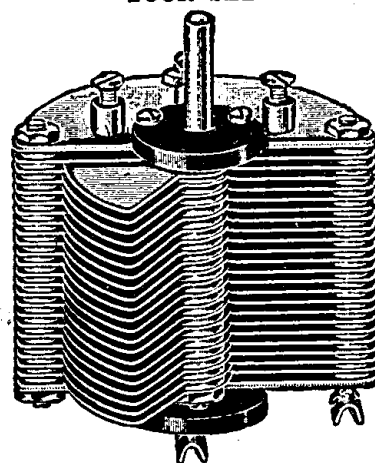

- 11 PLATE.....\$1.25
- 23 PLATE.....1.40
- 43 PLATE.....1.75

Mail Orders Filled Same Day
 Postage Extra No Personal Checks Accepted
B. K. Ford & Co. 4343 West Fifth Avenue
 CHICAGO, ILL.

ANTENELLA

(No Antenna or Aerial Needed)

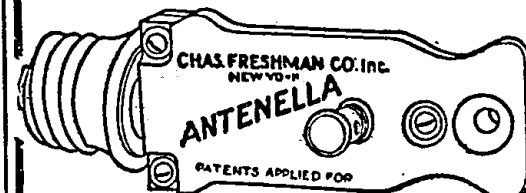

Does away entirely with antenna and all outside wiring, lightning arresters, switches and all other inconveniences.

ANTENELLA enables you to enjoy Radio pleasures in any room in your house. Place your receiving set anywhere and merely attach Antenella to any electric light socket. No current consumed.

At your dealer's—\$2.00

If he can't supply you send purchase price and you will be supplied promptly without further charge.

CHAS. FRESHMAN COMPANY, Inc.
 97 Beekman St., New York City

Government Radio Storage Batteries

All absolutely new Signal Corps Batteries. Edison 3 cell type BB-4 \$4.50; Willard 4 cell type SYR-12 \$4.25; Willard 2 volt 40 A. H. for WD-11 tubes \$4.75; 6 volts Edison \$7.75; Edison B Battery elements 4c each.

Flewelling .006 Condensers
 Bakelite mounted with binding posts. Set of three \$2.00.

Flewelling Variable Grid Leaks
 Give clearer music, louder signals on any circuit, 75c.

Reinartz Latest Spider Web Coils
 Double green silk winding on Bakelite spider, \$1.95.

Wonderful New Antenna
 Connects to light or phone wires. Beats condensers, \$2.95.

Vernier for Variable Condensers
 Fits any condenser. Requires no extra space, 95c.

Hi-Power Amplifying Transformers
 Best made. Louder signals. Cannot burn out. \$2.95. Call Book of all Canadian Stations, \$1.25. 3060 Meter long wave couplers, \$7.95. We save you money. Tell us what you need.

QUALITY RADIO SHOP, RICHMOND, IND.

Spirola BETTER LOUD SPEAKERS \$3.85 TRUE CABINET TYPE

Not just a common horn built into a cabinet. Beautiful—Compact—THE TONE OF FINE CABINET PHONOGRAPHS. Make your two-step set a HOME ENTERTAINER. All SPIROLAS are of the best construction, with fine, rubbed finishes and are absolutely guaranteed.

SPIROLA DUPLEX—uses any headset. Satin black (DB) finish \$3.85. Oak (DO) or mahogany (DM) finish \$4.85.

SPIROLA SIMPLEX—uses Baldwin or other unit. Black (SB), oak (SO), mahogany (SM) finish, same prices as DUPLEX.

SPIROLA CONCERT—complete with built-in unit and cord. Oak (CO) or mahogany (CM) finish \$12.50.

At dealers or postpaid (C. O. D. if preferred)

L. H. DONNELL MFG. CO., DEPT. D, BOX 70, ANN ARBOR, MICH.

Questions and Answers

Antenna Erection

(1203) WCS, Peru, Ind.
Having read your paper a good bit I want to ask you a few questions about erecting a new antenna. I am going to change my place of residence Monday and while the antenna I now have gives fair results I think it could be improved. The present antenna is only 93 ft. long and 25 ft. high. It is the same height as all the city electric lines, telephone and telegraph wires and on account of the way the many wires run through this part of town it is impossible to run my antenna at right angles. That is, when antenna is at right angles to one city wire, it is parallel to another. I believe a good bit of the unpleasant noises I hear on my set are caused by this.

Now if I should put my antenna 25 ft. higher and up above all the wires, do you think there would be less interference? The place I want to put up my new antenna gives me a space 132 ft. long and as high as I have money to make it. I thought I would make a 2 or 3 wire antenna 100 ft. long and 40 to 50 ft. high.

My set is a short wave regenerative set with one step of audio frequency amplification. I get as far south as Ft. Worth, Texas, north to Minneapolis, Minnesota, east to Atlanta, Ga., Schenectady, N. Y., and west to Kansas City.

What would be the best kind of antenna for this set? How long and how high? How many wires? I don't want to go over 100 ft. long. Do you think my set would be sensitive enough for a loop antenna? If so I would gladly pay for instructions to build it. I would also like to get instructions on how to install antenna and lead-in wires according to the Fire Underwriters' plans so I can get fire insurance on my house.

Could I use one or two steps of Radio frequency with my set? How many would I have to use to get San Francisco? How many for ships at sea, say 2,000 miles out?

Could I use a variocoupler and two variometers with my set for finer tuning? If so what would I need?

A.—In erecting an antenna with service lines close by running in all directions, it is necessary to get as high above them as possible, the higher you go, the less interference will be experienced from parallel lines. If you erect an aerial fifty feet in height, do not make your antenna over one hundred feet long as the length of the antenna system should not exceed one hundred and fifty feet, far end to ground. Two wires are the best construction, more will have no greater value for reception.

Page six, April 22nd issue, and page eleven, June 3rd issue of RADIO DIGEST give Fire Underwriters' regulations. They are liberal and easily complied with.

In preference to Radio frequency, the use of one or two steps of Audio frequency amplification is suggested. The loss of regeneration in adding Radio frequency equals about two stages of Radio frequency amplification.

Loop antennae are not designed for long distance reception and give little satisfaction. You are to be congratulated upon your present DX reception, and will find the above construction of outdoor antenna much more efficient.

Variocoupler and two variometers can be added to your present set. You probably already have them if your detector is now regenerative.

Honeycomb Coil Wave Lengths

(1224) HT, Lowell, Mass.
As I am a constant reader of your magazine, will you please tell me what honeycomb coils I have to use to get the Canadian stations that operate on 350, 400, 410 and 440 meters? Also Fort Wood station which operates on 1,450 meters?

I have a honeycomb set using coils of 35, 50 and 75 turns with which I receive as far as Pittsburgh. These coils are supposed to be good for wave lengths from 300 to 700 meters.

A.—Honeycomb coils L75, L50 and L35 would be advisable for reception on wave lengths of from 300 to 700 meters. You should be able to receive the stations desired. Failure to do so may be due to low power or directional effects of the transmitting station.

High Wave Honeycomb Coils

(1254) WFB, Nelsonville, O.
I have a short wave regenerative receiver consisting of a 23-plate condenser and a variocoupler, the coupler secondary being used as a tickler and having 20 turns on a three-inch core. I would like to know what sized coils I must use in the plate or tickler circuit and also in the inductance circuit to receive broadcasting on 1,500 and 2,500 meters.

A.—Honeycomb coils having a wave length of from fifteen hundred to twenty-five hundred meters are:

Primary, three hundred (300) turns; secondary, two hundred (200) turns; tickler, one hundred and fifty (150) turns.

However, the length of antenna is taken into consideration and may necessitate a change in primary and secondary coils. This can be determined by experimentation.

Amplifier for Flewelling Circuit

(1552) ETJ, Kansas City, Mo.
I am very much interested in the Flewelling super set, diagrams of which were published in the October 21 and November 4 issues. I have experimented with

Armstrong Super Regenerative

(1216) RPW, Overbrook, Pa.
Would like to take advantage of your department to ask a few questions with reference to the Armstrong super regenerative circuit shown in the cut, page 7.

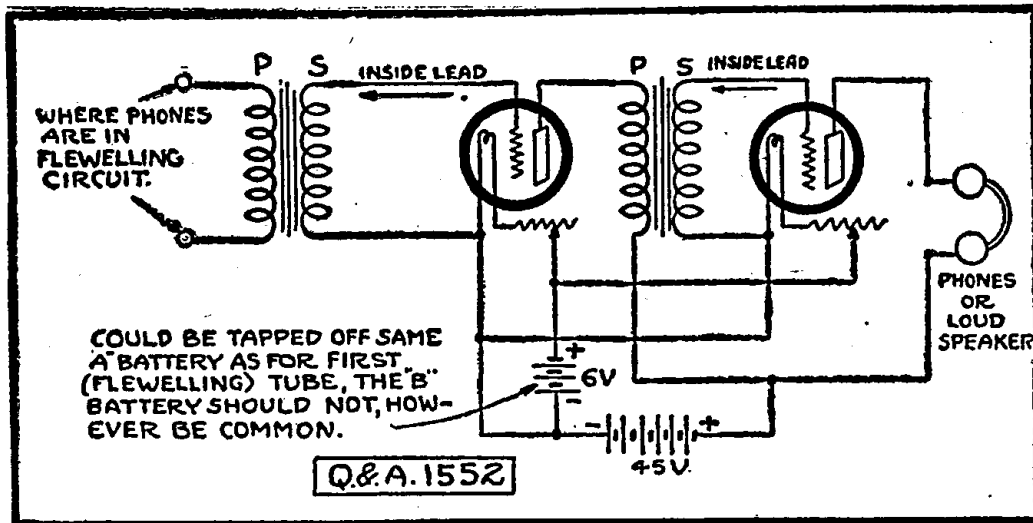

several hook-ups and find this set to be superior both from a serviceable and economical standpoint. I have received several distant stations very clearly with it. Could you give me a Radio frequency and audio frequency amplification hook-up that would be adapted to this set? I am a regular reader of your splendid magazine and I find lots of valuable information in it.

A.—The Flewelling circuit has not been tried with R. F. amplification. In fact, several complications would arise. If the first tube gets the signals at all, the two stages of A. F. should give you all the "noise" you want. Let us hear from you more on your Flewelling layout.

The diagram requested is shown herewith by Figure Q. & A. 1552.

Data on VT-1 Tube

(1234) FWS, Hartley, Ia.

1. What is the proper plate voltage to use with a VT-1 detector tube? What is correct value of grid condenser and grid leak?

2. Should a two stage audio amplifier and detector circuit be designed differently for different types of tuners?

A.—1. The proper plate voltage to use with a VT-1 is from 22½ to 45 volts. Correct value of grid condenser is .0005. Grid leak about 1½ megohm.

2. Any desired tuner may be used with the amplifier.



Magnavox Radio Completes Your Receiving Set

With the Magnavox you receive every program clearly and in volume for dances, parties and entertainment.

- R-2 Magnavox Radio with 18-inch horn; the utmost in amplifying power.....\$85.00
- R-3 Magnavox Radio with 14-inch horn; for homes, offices, etc.....\$45.00
- Model C Magnavox Power Amplifier; insures largest power input for the Magnavox Radio; 2 stage.....\$80.00; 3-stage.....\$110.00

At Good Dealers Everywhere
Unusual Illustrated Booklet on request

The Magnavox Co., Oakland, Cal.
New York Offices: 370 Seventh Avenue

MAGNAVOX
Radio
Sine Reproducer Supreme

of L1. In addition to going to grid and negative filament of first tube, the two primary leads will go to aerial and ground, or else to the two terminals of a loop aerial.

The loop should not have too great a natural period. Twelve turns on a thirty in. square will be plenty.

Bias batteries are not necessary in the circuit although they afford considerable additional stability and enable greater amplification.

The function of the filter system is that of smoothing out the removal of a whistle characteristic of super regenerative circuits.

What Holds Variometer Wires

(1231) FWC, Nebo, Ill.
What is used to hold wire on rotor and stator of variometers? What size wire is most efficient? Is silk covered better than cotton covered?

Would a variable grid condenser be better than a fixed one? If so, how many plates?

A.—Wind variometer with No. 20 or No. 22 wire, either silk or cotton covered, after which soak in banana oil to stiffen.

Variable grid condenser would be no more efficient than a fixed condenser.

Who Moves First?

(1255) RC, Englewood, Colo.
There is an electrotherapeutic physician right next door and his machine generates static when it is running. Would you please tell me how to overcome this?

A.—Noting your difficulties of interference from proximity of high frequency apparatus, we can say from personal experience that you are certainly "out of luck." There are several possibilities; have the doctor enclose his instruments in grounded screen or metal casing, or have him or yourself move. There is no other way.

BALDWIN

Master Type
Dealers: New Discounts
Hudson-Ross, 123 W. Madison, Chicago

Amateur Radio CALL BOOK AND MAP

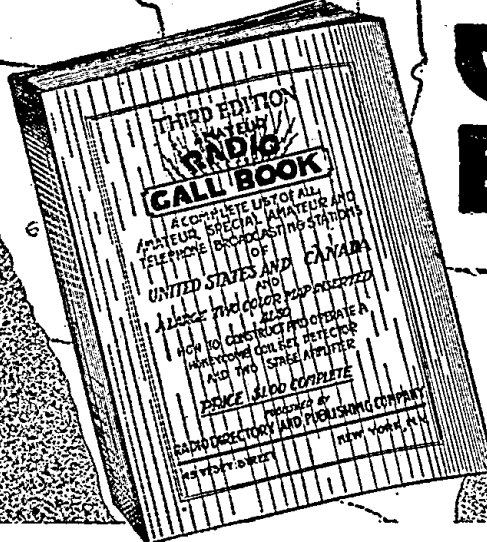

Your Step-by-Step
Complete Workbook

THE BOOK for RADIO FANS

THE New Edition of the AMATEUR RADIO CALL BOOK is the most complete directory of amateur stations published to date—listing Amateur, Special Amateur and Telephone Broadcasting Stations of the United States and Canada, also describes the Construction and Operation of a Honeycomb Coil Set, Detector and Two Stage Amplifier.

THE RADIO MAP

of the United States and Canada, size 2x3 feet, supplies an indispensable requisite of every radio station. The nine radio districts, broadcasting stations, standard time, areas, etc., etc., are clearly indicated.

Record Your DX Work

By pasting the map on heavy card board and using colored stick pins you can easily record your distant radio work.

At Your Dealer or Send Direct

PRICE book and map complete \$1.00
(DO NOT SEND STAMPS)

DEALERS WRITE FOR INFORMATION

RADIO DIRECTORY AND PUBLISHING CO.
45R VESEY STREET, NEW YORK, N. Y.

Radio Illustrated



Here is Adolph Bolm, Director of the Ballet for the Chicago Civic Opera Company. Six years ago Bolm made his first appearance in Chicago. One feature missed by Radiophans listening in to the opera via KYW, is the ability to see the dancing of Bolm, Premiere Danseuse Anna Ludmila and the Corps de Ballet. It is said that many ardent opera Radiophans have been lead to attend the opera more often just to see the finished work of the Ballet. Hutchinson Photo

Maria Claessens and Desire Defrere as they looked when heard in the opera "Snegourotchka" (The Snow Maiden), broadcast several times by KYW during the present season of the Chicago Civic Opera Company. The opera was one of the favorites with the Radiophans. Atwell Photo

If you happen to possess a loud speaker and a reflecting electric heater, both at the same time, you can throw the music from the loud speaker out into the room better by arranging the speaker at the right distance from the heater, as shown. © K. & H.

Miss Dorothy Knapp, recent winner of first prize as America's best formed and most beautiful girl, believes in the use of the Radiophone as an aid in keeping her fit. She is shown taking setting-up exercises as they come in over the ether from Station WGI, Medford Hillside, Mass. © K. & H.

