

Radio Digest

SELECTED RADIO TECHNICAL ARTICLES

OUR • EXPERIMENTAL
ENGINEERING • SERVICE
BY WAVE • TELEVISION
ELECTRONICS • COMMERCIAL
COMMUNICATION
BROADCAST OPERATING

(Another RADIO Publication)

HIGHLIGHTS FROM THIS ISSUE

A Consultant Talks about
Electronics —*Electronics*

A Low-Cost Single-Signal
Receiver —*QST*

Review of Vacuum-Tube Problems
—*RCA Review*

A Broadcast Type Modulation
Indicator —*RADIO*

A Mutual Conductance Meter
—*Communications*

NOVEMBER AND
DECEMBER, 1938

25¢
U.S.A. & CANADA

"Radio" for Christmas

AN IDEAL GIFT

RADIO's annual Christmas gift rates will be in effect from November 15th to January 15th. To radio amateurs with a "fellow ham" to remember, to radio employees with a radio-minded employer who must not be forgotten, and to radio manufacturers and distributors who want to remind a favored customer repeatedly through the year of their appreciation of his business, a RADIO subscription is an ideal (and effortless) solution of that puzzling Christmas shopping problem.

ONE SUBSCRIPTION (one year) - - - - -	\$2.50
TWO SUBSCRIPTIONS, each - - - - -	2.35
THREE or more SUBSCRIPTIONS, each - - - - -	2.25
SIX or more SUBSCRIPTIONS, each - - - - -	2.00
TWELVE or more SUBSCRIPTIONS, each - - - - -	1.75

Subscriptions at \$2.00 or less must be **cash with order.**

Above rates apply for U.S.A., Canada, Newfoundland, Cuba and Mexico. To Pan-American countries and Spain, add 50c per subscription. Elsewhere, add \$1.00 per subscription.

You May Enter or Renew Your Own Subscription at these Rates.

Rates for more than one subscription, as listed above, apply only on gift orders entered and paid for at one time by one individual or company. Unless otherwise requested, the subscriptions will be commenced with the January issue, which will be delivered as near Christmas as possible, together with an attractive card announcing the gift and the sender's greetings; those who are at present subscribers will automatically have subscriptions extended unless otherwise requested.



Announcing

the new
"Radio" Handbook

Just off the press with new receivers . . . new transmitters . . . antennas . . . charts . . . tables — More data than ever before. 21 chapters — 592 pages.
Get your copy now.

ONE DOLLAR, FIFTY CENTS

In Continental U.S.A.

Elsewhere. \$1.65 or 7s.

RADIO
LIMITED

TECHNICAL PUBLISHERS, 7460 BEVERLY BOULEVARD, LOS ANGELES, CALIF.

EUGENE M. RECTOR

RADIO DIGEST

● NUMBER 8

NOVEMBER - DECEMBER, 1938 ●

Best selections from the current world radio press
presented by the editors of "RADIO" Magazine.

A Consultant Talks About Electronics— <i>Electronics</i>	4
Radio-Operated Altimeter.....	9
Suppressor-Grid Modulation— <i>Bell Laboratories Record</i>	10
The Bridge-Stabilized Oscillator— <i>I.R.E. Proceedings</i>	14
Efficiency and High Fidelity— <i>Service</i>	24
By the Ton— <i>ATE Journal</i>	28
A Mutual Conductance Meter— <i>Communications</i>	29
Educational Broadcasts.....	33
Power Pack: Transformer Design— <i>Radio News</i>	34
A Low-Cost Single-Signal Receiver— <i>QST</i>	39
The Ham Maker— <i>Radio News</i>	50
Pictorial Section.....	51-54
A Broadcast-Type Modulation Indicator— <i>Radio</i>	55
Air Giant DC-4— <i>Pick-Ups</i>	63
An Electric Timing Device— <i>Electronics</i>	65
Amateur Auto Plates— <i>Radio</i>	69
The American System of Broadcasting— <i>RCA Review</i>	70
Strays.....	38, 64, 76, 91
Long Range DX Prediction— <i>Radio</i>	77
WWV Schedules— <i>QST</i>	82
Review of Vacuum-Tube Problems— <i>RCA Review</i>	83
Book Reviews.....	92
The Technical Field.....	93

RADIO DIGEST • No. 8 • M. M. Lloyd, Managing Editor

Editors: W. W. Smith, Ray L. Dawley, B. A. Ontiveros

25c per copy. By subscription: 12 issues, \$2.50 in U.S.A., Canada, Newfoundland, Spain, and all Pan-American countries; elsewhere, \$3.00 or 12s. 6d. (British postal orders accepted.)

Published every two months by Radio, Ltd., 7460 Beverly Blvd., Los Angeles., Calif. Entered as second-class matter November 20, 1937, at the post office at Los Angeles, California, under the Act of March 3, 1879. Copyright, 1938, by Radio, Ltd.

A Consultant Talks ABOUT ELECTRONICS

BY REX McDILL

ONE does not need to be a consultant in electronics very long before he discovers several things. In the first place, it is not one of the big-money businesses. Secondly, there is no other profession where the experimentally minded engineer can get more real enjoyment. Finally, one soon learns to classify prospects and clients in the following groups:

First, the fellow that wants you to come into his plant and design and build the apparatus to handle a particular job. Second, concerns that prefer to buy a machine or apparatus to do a particular thing. Third, the ones that employ you as a consultant and expect to pay you for it. Fourth, the engineers in various plants that expect you to tell them how to do it for the fun of doing it. This class is composed mostly of so-called research men who want to make a hit with the boss and from them the most inquiries are received. Fifth, the miscellaneous unprofitable inquiries, such as the letter cited below:

Gentlemen:

We have been informed that you manufacture a low-priced photocell that could be employed advantageously in a merchandise dispenser. The kind of cells we are mainly interested in are divided into two separate classes, namely, one that will detect one person from another by the slight difference in color, etc. After the dispensation of merchandise has been completed, there should be no repeat delivery to the same person for a considerable period, but another person who has not received any merchandise over a certain period can receive a full portion of it right after delivery has been completed to another person, without delay.

The second type of cell is one so arranged requiring the lapse of 10 or 15 seconds before another delivery can be made.

Trusting to hear from you by return mail, etc.

In the last five years I have received many letters of this type, most of them from small concerns. Such letters prove that there are still a lot of people who think that they can nail a photocell on a barn door and have the light from the lantern open it up at milking time. But when a large manufacturer writes in and states that it would be worth a couple of hundred dollars to devise a fully automatic means for keeping flies out of beverage bottles, you are getting into the money class and business is picking up.

- What Is Electronics?

Industrial electronics is really not a part of electrical engineering and much less a part of radio engineering. It is principally mechanical engineering and the electronic part is simply used where mechanical methods are not available. It is for that reason that radio engineers are not particularly fitted for industrial electronic work unless they can visualize a mechanical machine operated by electronic controls.

Many problems can be solved with standard equipment, that is, equipment already being manufactured. Inquiries on such problems should be referred to companies manufacturing the standard units. My experience shows that it is not practical to build in the laboratory everything that is used in an installation. Where standard units can be bought, these are purchased direct from the maker.

There are a number of large organizations and a few moderate sized ones that could well afford to hire an industrial electronics engineer as a consultant to work directly with their engineering and manufacturing departments. Even though he does not turn out for them any piece of work that is highly profitable, he can usually steer them clear of costly but impractical developments in the electronics field.

Industrial electronics is 97 per cent mechanics and 3 per cent electronics. The 3 per cent is as essential as a hundred miles of track in the center of a transcontinental railroad. A thorough knowledge of

the operation of telephone type relays and switches is probably as important to the industrial electronics engineer as a knowledge of what makes a vacuum tube act as a valve.

One of the reasons industrial electronics moves forward so slowly is the fact that there are not enough engineers who know electronic engineering to put the profession on an organized basis. In the present stage of the business most of the "consulting" consists of tinkering by mechanical, electrical and radio engineers. Five thousand competent engineers who know their stuff, and a realization by manufacturing concerns that the information they want must be paid for, would be a good start in a real electronics industry.

- How Much Is Electronic Equipment Worth?

This brings up the problem of compensation. Engineers in large manufacturing concerns who make electron tubes, amplifiers, photocells, etc., are being pestered constantly by engineers in various plants who have problems which they think can be solved by some mysterious hocus pocus called electronics. First thought is to call on these companies to solve their problems. "Please send blueprints and specifications."

The large companies cannot offend these boys because they buy lots of non-electronic material from the big companies every day. All the men in the control division can do is to try to help the fellow out and do it diplomatically. But they

are not fond of the job and feel they are being imposed upon. They send me hundreds of such problems every year and once in a while one turns into a job. Sometimes the same problem comes in from more than one company indicating that the originator of the problem has called on the engineering and development divisions of several of the largest organizations of that kind in the world with the expectation that these large companies should turn their whole staff loose on this one job. I have never got enough business out of the inquiries received from the big companies to pay for handling them although I have spent months in time working up proposals for machines. The big companies feel that they should do the engineering but that I should tell them how. Like every one else I have my weak moments and do tell them. Fully 20% of these problems that I get have an electronic solution and half of the 20% would be profitable to the user.

Unless a fellow has the backing of some financial angel he will miss a good many meals before he gets much business as a consultant in industrial electronics. In order to get business you must be prepared to deliver a complete apparatus to do the trick. This puts the engineer in the manufacturing business. Even then you are sunk unless you get an order or a contract setting forth exactly what the machine is to do and then get a 25% cash advance. Sometimes you can sell engineering services. Recently I did a job on an engineering basis which saved the

company \$11,000, over the cost of what they would have had to pay me if I built the machines on contract for them.

- Having Got a Job, How Much Should We Charge?

The ordinary manufacturer of a gadget, built for resale, figures that the final retail price must be from three to five times the actual production cost, based on direct labor and material. Often, costly engineering and experimental work are required to develop a machine to do a special job. It should not be exorbitant to charge ten times the cost of the actual labor and material that goes into the machine, but it is difficult to sell the purchaser on this idea. In one instance, I delivered a machine that saved the manufacturer \$100.00 every 24-hour day it operated and it replaced much needed help that was made available for another department. The price of the machine was \$3,000.00 and upon receipt of the order I was requested to deliver it at the earliest possible moment. The machine was designed from the ground up and the actual cost was \$600.00 in labor and material and delivered in six days. When it was delivered and put into operation everyone in the concern was highly pleased with its operation but when the day for payment came, the manager of the company said, "Surely you don't expect us to pay \$3,000.00 for a machine that took you only a week to build at a cost not exceeding \$500.00." I promptly told him that I was taking that machine away

that afternoon, that the deal was off, and that the machine was sold on what it did, not on what it cost me to build. (They had already spent several thousand dollars in trying to develop their own machine of this kind.) The superintendent was a listener-in and he came over and gave me a nudge, "Don't pay any attention to this fellow. We want another machine."

• Should We Give Free Advice?

I have built much automatic gauging equipment, mostly for measuring the diameters and lengths of straight rolls for roller bearings. The operation is simple in the extreme. You simply have your gauging part break a grid circuit to a vacuum tube which in turn causes the plate circuit to operate a relay and devise some mechanism for getting the piece out from under the micrometer and into the correct box. You, of course, have to compensate for temperature if your machine is to measure within a few millionths of an inch, synchronize the operations and feed the machine, make it variable in speed, design the spindles so they won't wear or get dirty and solve a number of other minor mechanical problems. Furthermore, it must operate a week or more without attention.

I had built a number of these machines and had them in operation when I saw an ad in one of the trade magazines reading something like—

"The Punky Sink Company manufactures its parts by the very latest known methods of inspection. There

is no question but what we have every known method of measurement and we are constantly applying it to our product. Nevertheless our doors are wide open to anyone who can show us better methods and we welcome with open arms anyone who can show us how to improve our product by gauging and inspection methods."

As the Punky Sink people are one of the biggest in the business and turn out millions of precision parts that should be measured automatically within tolerances of .0002, I thought here was a chance for some real business. So I wrote them and in about a week received a reply signed by an engineer. Although the plant was 600 miles from Cleveland I caught the first train and went forth.

I waited in the reception room about two hours (the engineer knew I was coming) and got a call to come back after lunch. Then another two-hour wait and I got in the office. I did not see the engineer, however, but his assistant who proceeded to spend about an hour telling me how good they were and that I should consider it a privilege to make a special trip to learn how well their engineering department functioned. At the end of the discourse I suggested that I might possibly be of use at some future time if they had something they couldn't do or felt that it was too simple for them to fool with. I walked down the four flights of stairs and I caught a train home.

There is a sequel, however. Later on, business had dwindled in the

gauging line so I sent out a circular letter to names got out of a trade register. One of the letters went to Punky Sink and I got another call from them. After the 600-mile train ride, this time I got in to see the enginner in about 20 minutes and found a new face. A pleasant sort of a chap and with him were two confederates. All of the gentlemen were armed with high speed centrifugal information pumps. It seemed as if they had just designed a trick assembly and were manufacturing it but unfortunately they admitted that their gauging method was not so hot. Would I please tell them how to gauge this assembly? No, I would not tell them how to gauge the assembly but would sell them an automatic gauge that I would guarantee to do the job at the rate of one hundred a minute.

The gauge was discussed at length when one of the bright boys spoke up and said they didn't want me to build an automatic gauge for their use. They could do it themselves. What they wanted to know was how to do it. I said sure I would tell them how and when could I start in? He said right now. I asked about an order to cover the engineering fee and when I gave him a very nominal figure for the job he nearly fainted.

He said, "You see we can't pay you to do that; we have engineers for that purpose."

One of my most happy experiences, however, has been with a large New England concern making

an enormous quantity of little gadgets. It took me two years to sell them since they were (as they called themselves) "hard headed Yankees." They never pumped me but gave me every help for the month I was in their factory. The chief engineer was a farmer-type of fellow who liked to tell stories but a gentleman from the word go and the smartest mechanical engineer I have ever met. This outfit is sorting over a million gadgets a day on my machine and are happy over the whole set-up. Incidentally, they are saving money. I might venture to say that ten times the cost of the machines would not buy them if they could not be replaced.

My experience with Punky Sink has been repeated several times with others, but I always keep coming back hoping that the next call will lead to a job and sometimes it does.

- Decide Whether to Take Credit or Cash

For example the High Class Mfg. Co. made a small part that went into a radio set. I had built testing machines for this part and sold a number of them. They did not cost much to build but saved the manufacturers of small parts a lot of money, and I sold them at a good profit. Nearly everybody that bought one was pleased with the machine but some objected to paying for it, after they saw it, because it was so simple. Even though they could pay for it out of 60 days' savings, they felt my price was unreasonable.

One of these companies had an engineer who had written monographs on how they tested these small parts and stated that his concern had an automatic machine based on his principles. After read-

ing his printed stories I surmised that they might be having difficulty with his circuit and dropped them a note. Eventually I sold them two units. The engineer got the credit and I got the business.

Radio-Operated Altimeter

AN INSTRUMENT which gives airplane pilots their height above the ground over which the plane is flying was recently demonstrated by the Western Electric Company and United Air Lines. Claimed to be the first successful altimeter showing terrain clearance, the new device operates by radio, using the shortest wave ever employed for aviation purposes, officials of the companies stated.

Following additional service tests which are planned for the near future the new altimeter will be installed on all United planes and will be made available to the industry generally.

Basically it involves the transmission of a radio signal from the airplane, the reception of the signal as reflected from the earth, the measurement of the elapsed time between the transmission and the reception, and the translation of this time interval into a direct reading of the plane's altitude in feet as shown on a meter. Because of its use of ultra-high frequency the new altimeter is entirely free from static interference.

Despite weather conditions or poor visibility, the pilot can read his height directly and accurately whether he is several thousand feet high or merely skimming a few feet above the earth. Thus, in effect, the flight personnel will be given a continuous line picture of the earth's surface over which the airplane is flying even though visibility is completely blotted out.

In addition to the regular meter, the device may also be equipped with a red signal light which will automatically flash a warning when the plane descends below a safe predetermined altitude.

So keen is the sensitivity of the new altimeter that, from an altitude of several hundred feet, the contour of the George Washington Bridge was flashed in sharp relief by the meter as the test ship flew down the Hudson River, far above the actual obstruction itself.

Extended flight tests of the new development are being made over regular airways by engineers of Bell Telephone Laboratories in a special Boeing twin-engined airliner assigned by United for service testing.

SUPPRESSOR-GRID MODULATION

BY C. B. GREEN

ALL radio-telephone transmission—and a rapidly increasing portion of long-distance wire-telephone transmission—is of the “carrier” type. A high-frequency current generated by an oscillator is varied in amplitude by audio frequencies, with the result that the transmitted signal is a varying high-frequency current conforming to an envelope that duplicates the audio-frequency wave. This process of modulation is usually accomplished by applying the carrier and audio frequencies to one or more electrodes of a vacuum-tube amplifier—the selection of the elements and the design of the tube being such that the carrier-frequency output will vary linearly with the audio-frequency input. Until recently there have been three major types of vacuum-tube modulation, which take their names from the tube element to which the voice-frequency is applied. More specifically they are grid modulation, plate modulation, and plate-and-screen modulation.

Each type has its own advantages and disadvantages. Both plate and plate-and-screen modulators are

characterized by a high degree of linearity and a very high plate-circuit efficiency, but they are under the disadvantage that much of the output energy is obtained from the voice-frequency input rather than from the d.c. power supply for the plate. As a result the audio-frequency power required is comparable to the modulated output, so that in these two cases large audio-frequency amplifiers are needed between the microphone and the modulator.

In grid modulation where the audio signal as well as the radio-frequency driving voltage is placed on the control grid, modulation is accomplished with much less audio power. This does not imply negligible audio-frequency driving power, since the potential of the control grid may be positive for a part of each radio-frequency cycle. The application of stabilized feedback to the grid modulator has resulted in linearity equal or superior to that obtained in plate or plate-and-screen modulators, and many modern transmitters, especially in

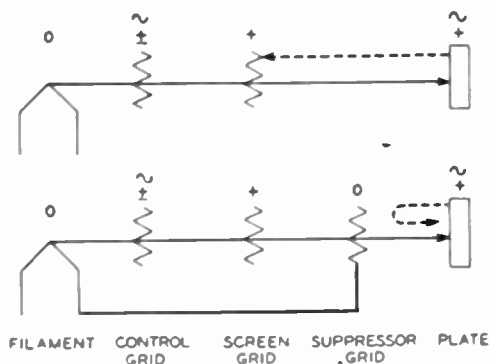

Figure 1. (Above) in a tetrode tube secondary electrons from the plate will be collected by the screen grid at low swings of the plate voltage; (Below) With a pentode, the zero bias of the suppressor grid turns back the secondary electrons.

the broadcast field, utilize grid modulation. A modulating system requiring neither stabilized feedback nor neutralization, and little or no audio-power amplification, would be a closer approach to the ideal, especially for use in mobile short-wave applications, where weight, size, and multi-frequency operation are complicating factors. A fourth form of modulation, which is nearer this latter ideal, can be employed by taking advantage of the output power on the potential of the suppressor grid in tubes which have three grids. These three-grid tubes, or pentodes as they are commonly called, have been used for several years as high-gain amplifiers, but only recently have they been especially designed for use as modulators. Their innermost grid serves as a control grid, as in a triode. The second, or screen, grid serves as a shield to lower coupling capacities and to accelerate the space current, as does the plate of a triode,

but its wires are made small so that this grid will collect as little current as possible. The third, or suppressor grid, is usually held at filament potential and is thus negative with respect to both the screen grid and the plate. Its function is to return to the plate the secondary electrons knocked from it by the electron stream coming through the screen. Without it, the secondary electrons would be collected by the screen during the negative peaks of the output voltage, when the plate potential drops below that of the screen. The loss of these secondary electrons from the plate would reduce the net plate current during part of each cycle and cause distortion and inefficiency.

In a screen-grid tube that has no suppressor grid, distortion and a loss in efficiency occur whenever the plate voltage swings too low. The arrangement of such a tube is indicated in the upper part of figure 1. The filament is considered to be

at zero, or reference, potential, and the screen grid, which is at a constant positive potential, accelerates the electrons toward the plate. The potential of the control grid varies with the carrier frequency, and may be positive during part of the cycle. Electrons accelerated by the screen pass through it and strike the plate, giving rise to secondary electrons. The potential of the plate, although biased more highly positive than the screen, varies with the signal, and if it swings below the screen bias these secondary electrons—indicated by the dotted arrow—will be drawn to the screen. With a suppressor grid, however, as shown in the lower part of figure 1, the secondary electrons are turned back by the effect of the zero bias, and distortion is avoided.

Hence, when a suppressor grid is used, the plate voltage may be allowed to swing lower with respect to the screen voltage. The losses in the plate circuit are proportional to the product of the instantaneous voltage and current, and since the maximum plate current occurs when its voltage is lowest, the losses are decreased by allowing the voltage to drop to lower values, which is another advantage of this type of tube. This lowering of the instantaneous plate voltage also permits an increase in the amplitude of the radio-frequency plate potential for a given d.c. plate voltage.

If the suppressor grid is disconnected from the filament and given a separate negative bias, it will be found that the plate current varies linearly with the suppressor bias

over a wide range of negative values. It is thus possible to use the suppressor grid as a modulating electrode. A new type of modulator is obtained in this way which retains the high plate efficiency of the pentode. It is possible to design such a tube so that approximately the maximum output is obtained with zero potential on the suppressor grid. Since no positive swing is required, no current is drawn by the suppressor grid, and negligible power is needed for modulation. This constitutes the principal superiority of suppressor-grid modulation over both plate and grid modulation. Since the suppressor can be driven on a voltage basis, without the expenditure of appreciable energy, it is not necessary to supply high amplification for the audio-frequency power.

The Western Electric 312A tube was designed for such use, and has the suppressor-grid characteristic shown in figure 2. The upper end is purposely saturated in the positive region very near zero bias, so as to obtain maximum power without driving the grid positive. The shape of the characteristic near its lower end is affected by the degree of screening furnished by the suppressor grid. At the negative peaks of audio modulation, practically all the electrons should be repelled, reducing the plate current to zero. If the suppressor grid does not shield the plate adequately, as at the end of the grid structure, a non-linear "toe" of the characteristic appears, and the plate current cannot be reduced to zero, which prevents

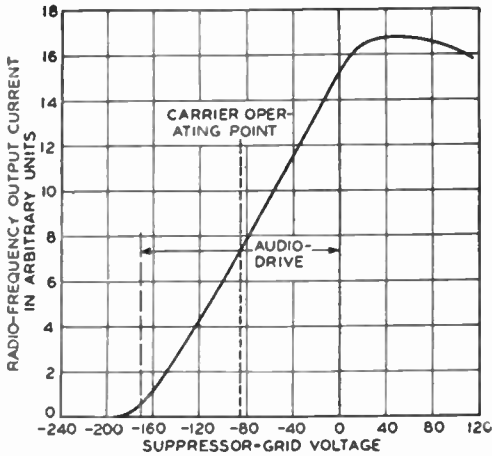

Figure 2. Dynamic suppressor-grid characteristic of the 312A tube.

attaining one hundred per cent modulation. In the 312A tube, metal shields are attached to the ends of the grid structure to reduce the "toe" of the characteristic to insignificant proportions.

In addition to this function, the suppressor end shielding assists the screen grid in reducing the grid-to-plate capacitance. If this capacitance is too high, there will be regenerative feedback from plate to grid and singing may occur. In tubes with a high grid-to-plate capacitance this effect is avoided by neutralization: the circuit is adjusted so that a voltage equal to the feedback but opposite in phase is also applied to the grid. Such neutralization requires additional apparatus, needs adjustment when

the carrier frequency is changed, and in addition is a source of distortion in broad-band transmission. In tubes with sufficiently small grid-to-plate capacitance, all these disadvantages are avoided. The 322A tube is a later development, and is capable of providing more than twice the output power of the 312A. It has the additional advantage of somewhat higher overall efficiency due to the relatively lower screen-grid current needed. This is secured by lining up the wires of the control grid and the screen grid so that the latter, while having normal electrostatic influence upon the space current, does not intercept as many electrons as it otherwise would.

The Bridge-Stabilized OSCILLATOR

BY L. A. MEACHAM
BELL TELEPHONE LABORATORIES, INC

THE problem of improving the stability of constant-frequency oscillators may be divided conveniently into two parts, one relating to the frequency-controlling resonant element or circuit, and the other to the means for supplying energy to sustain oscillations. The ideal control element would be a high-Q electrically resonant circuit, or a mechanical resonator such as a tuning fork or crystal, whose properties were exactly constant, unaffected by atmospheric conditions, jar, amplitude of oscillation, age or any other possible parameter. The ideal driving circuit would take full advantage of the resonator's constancy by causing it to oscillate at a stable amplitude and at a frequency determined completely by the resonator itself, regardless of power-supply variations, aging of vacuum tubes or other circuit elements, or the changing of any other operating condition.

This paper, concerning itself principally with the second part of the problem, describes an oscillator circuit which attains a very close approximation to the latter objective. The "bridge-stabilized oscillator" provides both frequency and amplitude stabilization, and as it operates with no tube overloading, it has had the added merit of delivering a very pure sinusoidal output.

• Oscillator Circuit

The bridge-stabilized oscillator circuit, shown schematically in figure 1, consists of an amplifier and a Wheatstone bridge. The amplifier output is impressed across one of the diagonals of the bridge, and the unbalanced potential, appearing across the conjugate diagonal, is applied to the amplifier input terminals. One of the four bridge arms, R_1 , is a thermally controlled resistance; two others, R_2 and R_3 , are

fixed resistances, and the fourth, $Z_4 = R_4 + jX_4$, is the frequency-controlling resonant element.

In this discussion Z_4 is assumed to represent a crystal suitable for operation at its low-impedance or series resonance. A coil and condenser in series could be substituted, and even a parallel-resonant control element might be used by exchanging its position in the bridge with R_2 or R_3 . Operating a crystal at series resonance has the advantage of minimizing effects of stray capacitance.

The bridge is kept as nearly in exact balance as possible. Assuming that R_1 , R_2 , and R_3 are pure resistances, we may write for exact reactive balance

$$X_4 = 0$$

and for exact resistive balance

$$\frac{R_1}{R_2} = \frac{R_3}{R_4}$$

In order that the circuit may oscillate, a slight unbalance is required. Accordingly R_1 must be given a value slightly smaller than $(R_2 R_3) / R_4$, so that the attenuation through the bridge is just equal to the gain of the amplifier.

It is evident that if all the bridge arms had fixed values of resistance, the attenuation of the bridge would be very critical with slight changes in any arm. This would obviously be undesirable, for the circuit would either fail to oscillate, or else build

up in amplitude until tube overloading occurred. The thermally controlled resistance R_1 eliminates this difficulty. This arm has a large positive temperature coefficient of resistance, and is so designed that the portion of the amplifier output which reaches it in the bridge circuit is great enough to raise its temperature and increase its resistance materially. A small tungsten-filament lamp of low wattage rating has been found suitable. Its functions as follows:

When a battery is first applied to the amplifier, the lamp R_1 is cold and its resistance is considerably smaller than the balance value. Thus the attenuation of the bridge is relatively small, and oscillation builds up rapidly. As the lamp filament warms, its resistance approaches the value for which the loss through the bridge equals the gain of the amplifier. If for some reason R_1 acquires too large a resistance, the unbalance potential e becomes too small or possibly even inverted in phase, so that the amplitude decreases until the proper equilibrium is reached.

This automatic adjustment stabilizes the amplitude, for the amount of power needed to give R_1 a value closely approaching $(R_2 R_3) / R_4$ is always very nearly the same. A change in the amplifier gain would cause a readjustment of the bridge balance, but the resulting variation in R_1 or in the amplifier output would be extremely small. The operating temperature of the lamp filament is made high enough so that

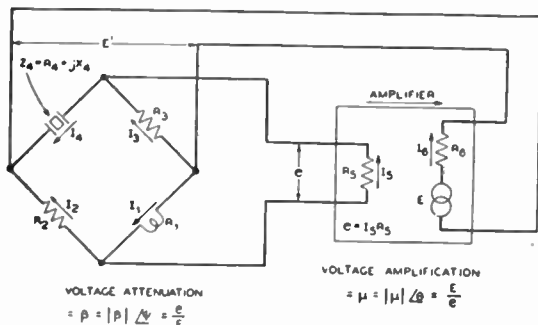

Figure 1. Schematic circuit diagram of a bridge-stabilized oscillator.

variations in the ambient temperature do not affect the adjustment appreciably.

No overloading occurs in the amplifier, which operates on a strictly class A basis, nor is any nonlinearity necessary in the system other than the thermal nonlinearity of R_1 . As the lamp resistance does not vary appreciably during a high-frequency cycle, it is not a source of harmonics (or of their intermodulation, which Llewellyn¹ has shown to be one of the factors contributing to frequency instability).

In contrast to the lamp, an ordinary nonlinear resistance, of copper oxide for example, would not be suitable for R_1 . A resistance of the thermally controlled type having a negative temperature coefficient could be used by merely exchanging its position in the bridge with R_2 or R_3 .

The frequency control exerted by the crystal depends upon the fact that the phase shift of the amplifier must be equal and opposite to that through the bridge. In the

notation of Black,² applied to the circuit of figure 1,

$$\mu = \frac{E}{e} = | \mu | \angle \vartheta,$$

and

$$\beta = \frac{e}{E} = | \beta | \angle \Psi,$$

The condition for oscillation is

$$\mu\beta = 1 \angle 0,$$

which implies that $| \mu\beta | = 1$ and $\vartheta = -\Psi$.

When ϑ , the amplifier phase shift, equals zero, changes in $| \mu |$ do not affect the crystal operating phase, but for any other small value of ϑ , gain variations cause slight readjustments of the angles between

1F. B. Llewellyn, "Constant frequency oscillators," *Proc. I.R.E.*, vol. 19, pp. 2063-2094; December, (1931).

2H. S. Black, "Stabilized feedback amplifiers," *Bell. Sys. Tech. Jour.*, vol. 13, pp. 1-18; January, (1934).

vectors. The amplifier should accordingly be designed for zero phase shift, and also, of course, should have as much phase stability as possible.

In this discussion the input and output impedances of the amplifier, R_5 and R_6 , are assumed to be constant pure resistances. Actually, changes in the tube parameters or in certain circuit elements are likely to affect both the magnitude and the phase of these impedances. It may be shown, however, that such changes have the same effect upon the bridge and upon the frequency as do changes of about the same percentage in $|\mu|$ or θ ; therefore all variations in the driving circuit external to the bridge may be assumed for convenience to be represented by variations in its gain and phase.

This leniency with regard to R_5 and R_6 does not apply to the other bridge resistances, however. R_1 , R_2 , and R_3 are directly responsible for the crystal's operating phase and amplitude; they should be made as stable and as free from stray reactance as possible.

The effect of the bridge upon

harmonics of the oscillation frequency is of interest. Harmonics, being far from the resonant frequency of the crystal, are passed through the bridge with little attenuation but with a phase reversal approximating 180 degrees. Thus if the amplifier were designed to cover a band broad enough to include one or more harmonics and if care were taken to avoid singing at some unwanted frequency, a considerable amount of negative feedback could be applied to the suppression of the harmonics in question.

One of the significant differences between the bridge oscillator and other oscillator circuits is the fact that its frequency stability is roughly proportional to $|\mu|$. This relationship holds at least for amounts of gain that can be dealt with conveniently. Although increased gain is generally accompanied by larger variations in phase, the two are not necessarily proportional. For example, if greater stability were required for some precision application than could be achieved with a single-tube bridge oscillator, and if the constancy of the crystal itself

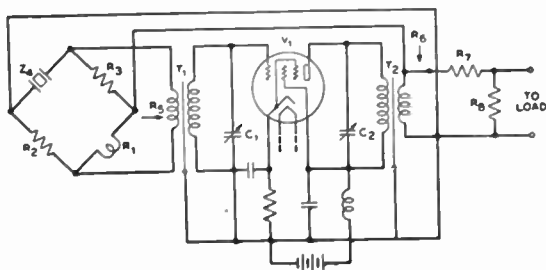

Figure 2. Circuit of an experimental bridge oscillator.

warranted further circuit stabilization, it could be obtained by adding another stage. The phase fluctuations in the amplifier might possibly be doubled, but the value of $|\mu|$ would be multiplied by the amplification of the added tube, giving an overall improvement.

• Experiment

The circuit diagram of an experimental bridge-stabilized oscillator is shown in figure 2. The amplifier unit consists of a single high- μ tube V_1 with tuned input and output transformers T_1 and T_2 and the usual power supply and biasing arrangements. The crystal is mounted in a cylindrical container at the left end of the panel and has a very low temperature coefficient of frequency at ordinary ambient temperatures. A high Q is obtained by clamping the crystal firmly at the center of its aluminum-coated major faces between small metal electrodes ground to fit, and

by evacuating the container.

Some of the circuit parameters are listed below.

- $R_1 =$ tungsten-filament lamp
- $R_2 = 100$ ohms
- $R_3 = 150$ ohms
- $Z_4 = 100$ -kilocycle crystal
- $R_4 = 114$ ohms
- $X_L = X_C = 11,900,000$
ohms (at resonance)
- $Q = 104,000$
- $R_5 = R_6 = 150$ ohms
(approximately)
- $R_7 = 500$ ohms
- $R_8 = 200$ ohms
- $|\mu| = 422$ (52.5-decibel
voltage gain from e
to E)

Figure 3 shows the resistance of the lamp R_1 plotted against the power dissipated in its filament. The large rise in resistance for small amounts of power is due to the effective thermal insulation provided by the vacuum surrounding the filament and to low heat loss by radia-

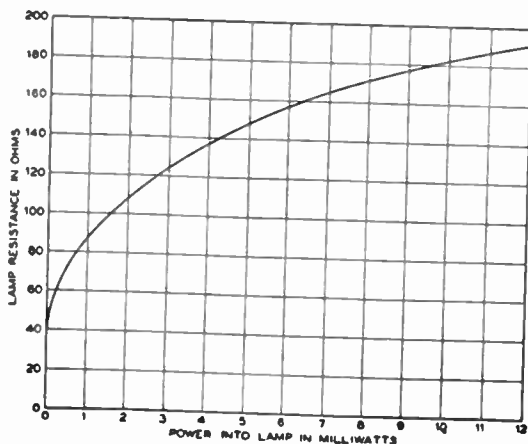

Figure 3. Characteristic of the lamp used for R_1 .

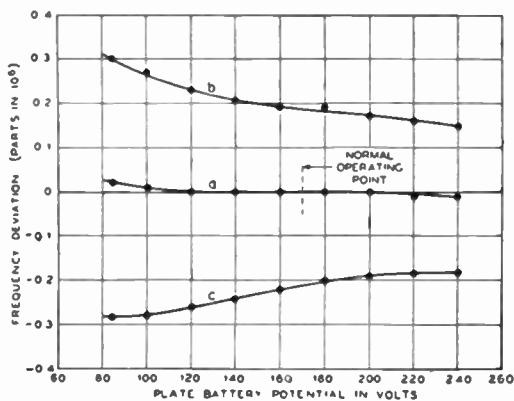

Figure 4. Oscillator frequency versus plate-battery potential.

- a— C_1 and C_2 tuned for maximum amplifier gain.
- b— C_1 and C_2 decreased 5 per cent.
- c— C_1 and C_2 increased 5 per cent.

tion. The lamp operates at temperatures below its glow point, assuring an extremely long life for the filament.

The particular value assumed by R_1 in the circuit of figure 2 is approximately $(R_2 R_3)/R_4 = [(100)(150)]/114 = 131.6$ ohms, and hence from figure 4 it follows that the power supplied to the lamp is about 3.7 milliwatts. The root-mean-square voltage across the lamp is computed to be 0.70 volt, and across the entire bridge, 1.23 volts. The power supplied to a load of 150 ohms through the pad composed of R_7 and R_8 is accordingly 0.22 milliwatt, or 6.6 decibels below 1 milliwatt, which is in agreement with measurements shown in figures 6 and 7, described below. These quantities are given to illustrate the fact that currents and voltages in this type of oscillator may be calculated readily from the values of the circuit elements, and without reference to the power-supply volt-

ages or the tube characteristics except to assume that they give the amplifier sufficient gain to operate the bridge near balance, and that tube overloading does not occur at the operating level.

Experimental performance curves for the circuit of figure 2 are presented in figures 3 to 8 inclusive. Figure 4 shows frequency deviation plotted against plate-battery voltage for several settings of the grid- and plate-tuning condensers. For curve *a* the amplifier was adjusted at maximum gain, corresponding approximately to zero shift as well. Here the frequency varied not more than one part in one hundred million for a voltage range from 120 to 240 volts. Curve *b* was taken with the two tuning capacitances C_1 and C_2 decreased 5 per cent from their optimum settings, and curve *c* with both capacitances increased 5 per cent. These detunings introduced phase shifts of about ± 40 degrees (± 0.70 radian), decreased $|\mu|$ by

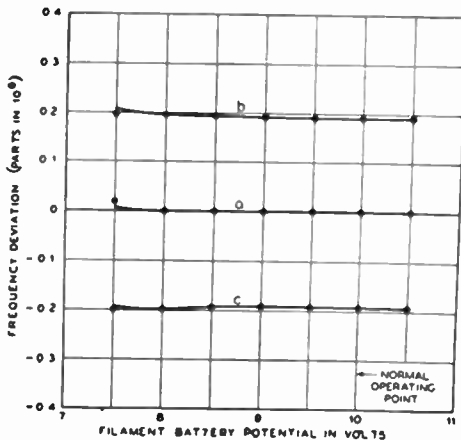

Figure 5. Oscillator frequency versus filament-battery potential.

- a— C_1 and C_2 tuned for maximum amplifier gain.
- b— C_1 and C_2 decreased 5 per cent.
- c— C_1 and C_2 increased 5 per cent.

0.8 decibel and changed the frequency, as shown in figure 4, approximately ± 2 parts in ten million. Although the analysis should not be expected to apply accurately for such large phase shifts, calculation of the frequency deviations gives ± 1.4 parts in ten million—in fair agreement with the experimental results. As might be expected, curves *b* and *c* show somewhat less stability with battery-voltage changes than does curve *a*.

Figure 5 presents a similar set of curves for variations of filament voltage. Here, for the "maximum-gain" tuning adjustment, a drop from 10 volts, the normal value, to 8 volts caused less than one part in one hundred million change of frequency, as shown in curve *a*.

In figure 6, the gain of the amplifier and the output level of the oscillator are plotted against plate-battery voltage, while in figure 7 the same quantities are related to

the filament potential. These curves show that although power-supply variations change the amplifier gain, they have but slight effect upon the amplitude of oscillation. This stabilization is produced, as explained heretofore, by the action of the lamp.

The oscillator was designed to work into a load of 150 ohms, its output impedance approximately matching this value. It might be expected that variations in the magnitude or phase angle of the load would affect the frequency materially even though a certain amount of isolation is provided by R_7 and R_8 . However, measurements made with (1) a series of load impedances having a constant absolute magnitude of 150 ohms but with phase angles varying between -90 degrees and $+90$ degrees and (2) a series of resistive loads varying between 30 ohms and open circuit, showed less than one part in a

hundred million frequency variation. Graphs of these results have not been included, since they practically coincide with the axis of zero frequency deviation.

The tuned transformers T_1 and T_2 in this experimental model precluded the suppression of harmonics by negative feedback, $|\mu|$ being small at the harmonic frequencies. The tuning itself provided suppression, however, so that the measured levels of the second and third harmonics in the output current were, respectively, 67 and 80 decibels below that of the fundamental. This purity of wave form is of course largely dependent upon the absence of overloading.

To correct any small initial frequency error of the crystal and to allow for subsequent aging, a small reactance connected directly in series with the crystal provides a convenient means of adjusting the frequency as precisely as it is known.

This added reactance may be considered as modifying either of the reactances in the equivalent series-resonant circuit of the crystal. Figure 8 shows that for a small range of frequencies the change introduced in this manner is accurately proportional to the added reactance. Series inductance, of course, lowers the frequency, while series capacitance raises it. The stability requirement imposed on the adjusting reactance is only moderate, for its total effect upon the frequency should not be more than a few parts in a million.

The frequency measurements here presented were obtained using apparatus similar in principle to the frequency-comparison equipment of the National Bureau of Standards.³ Frequency differences between the oscillator under test and a reference bridge oscillator were read upon a linear scale calibrated directly in terms of frequency deviation.

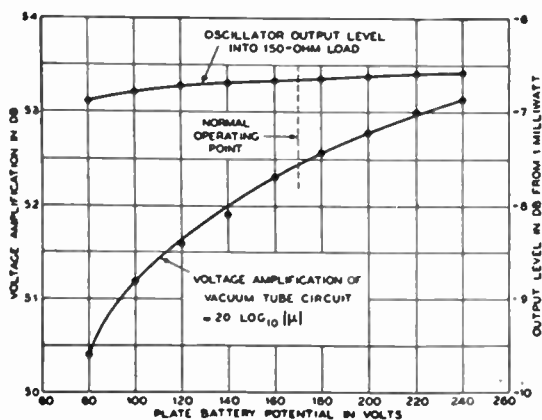

Figure 6. Amplifier gain and oscillator output level versus plate-battery potential.

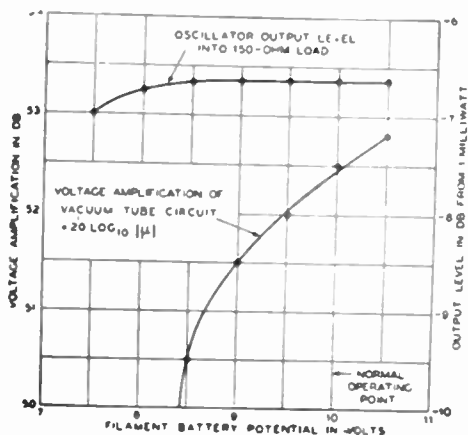

Figure 7. Amplifier gain and oscillator output level versus filament-battery potential.

tion. Full scale could be made one part in 10^4 , 10^5 , 10^6 , or 10^7 by means of a simple switching operation. For most of the measurements in this paper the full-scale reading was one part in a million, and the resolution about ± 0.005 part in a million.

By using a recording meter with this measuring set, continuous frequency comparisons between two independent bridge oscillators were obtained over a period of several months. It showed the short-time variations of both oscillators plus a small amount of scattering caused by the measuring equipment itself. The crystals were temperature controlled in separate ovens, and the power was supplied from separate sets of laboratory batteries controlled to

about ± 2 per cent in voltage. Shielding was ample to avoid any tendency to lock in step.

In addition to these small short-time variations, the oscillators exhibited a very slow upward drift in frequency, attributed to aging of the mounted crystals. This aging decreased in a regular manner with time, the mean drift of one of the crystals being less than one part in ten million per month after three months of continuous operation, and about a third of this amount after seven months. In most applications, gradual frequency drift is not objectionable even though the required accuracy is very high, for readjustment is merely a matter of setting a calibrated dial.

• Application

The bridge-stabilized oscillator promises to become a useful tool in many commercial fields as well as in certain purely scientific problems,

³E. G. Lapham, "A harmonic method of intercomparing the oscillators of the national standard of radio frequency," *Nat. Bur. Stand. Jour. Res.*, vol. 17, pp. 491-496; October, (1936); *Proc. I.R.E.*, vol. 24, pp. 1495-1500; November, (1936).

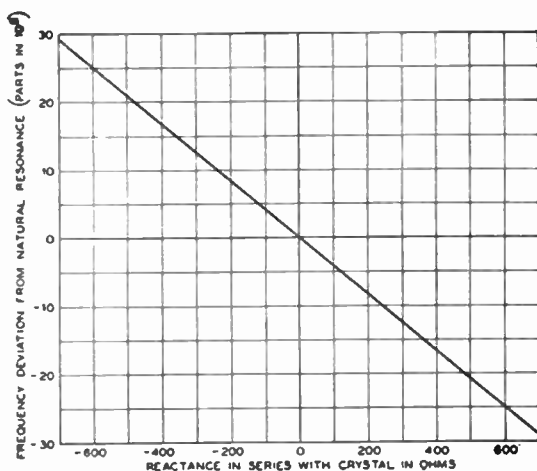

Figure 8. Frequency of oscillator versus adjusting reactance.

such as time determination and physical and astronomical measurement. It may be used either to increase the frequency precision in applications where operating conditions are accurately controlled, or else to make such control unnecessary, affording high stability in spite of unfavorable conditions.

An interesting application in the field of geophysics has already been made in the form of a "crystal chronometer." This chronometer consists of a single-tube bridge oscillator, a frequency-dividing circuit, and a synchronous timing motor. It was recently loaned by the Bell Telephone Laboratories to the Ameri-

can Geophysical Union and was used with the Meinesz gravity-measuring equipment on a submarine gravity-survey expedition in the West Indies. Although operating under somewhat adverse conditions of power supply, temperature, and vibration, it was reported^{4,5} to be more stable than any timing device previously available, errors in the gravity measurements introduced by the chronometer being negligibly small.

⁴M. Ewing, "Gravity measurements on the U. S. S. *Barracuda*," *Trans. Amer. Geophys. Union*, part 1, pp. 66-69, (1937).

⁵A. J. Hoskinson, "Crystal chronometer time in gravity surveys," *Trans. Amer. Geophys. Union*, part 1, pp. 77-79, (1937).

EFFICIENCY *and* HIGH FIDELITY

BY MAURICE APSTEIN
MORLEN ELECTRIC CO.

THE average serviceman is vaguely aware that a wide frequency range is not necessary for the proper reproduction of speech. To a great degree, however, he does not realize that a broader response than absolutely necessary may actually impair the results obtained from any given system. Stated in another way, by properly curtailing the frequency response or by choosing components having just the right response, a considerable increase in efficiency and power handling capacity of any given system may be obtained, providing the installation is meant for the reproduction of speech at high intensities. Since most high power *outdoor p.a. systems* are primarily used for this purpose, a study of the necessary requirements should prove extremely useful in enabling the installer to obtain the highest speech intensity per electrical watt output.

• Wide Response Reduces Efficiency

It is generally known that the broader the response of any given electro-mechanical system, the lower its efficiency. This is so because such a system is most efficient at or near its resonance frequencies, and in order to broaden out the response, it must be operated in a region far removed from resonance, or else the resonances must be damped out so that they will not cause irregularities in the response. Either mode of operation results in a very low operating efficiency. The above line of reasoning applies to speakers and microphones as well as any other electro-acoustic or electro-mechanical device. It explains in general why high-fidelity microphones have lower output levels, and high-fidelity speakers have lower efficiencies than their corresponding types with less broad fre-

quency range. It can be readily appreciated that, if under certain circumstances efficiency is important, it may be advantageous to sacrifice fidelity in its favor. In fact a broader response than absolutely necessary can very often become a drawback.

- Restriction Saves Power

Figure 1 is a curve showing the distribution of power and "articulation" in normal speech sounds. Articulation may be defined as the capability of a system to reproduce the original speech; in other words it is roughly a measure of the understandability or intelligibility of speech reproduction. The curves show the variation in articulation for voice sounds as one end of the frequency spectrum is cut out, together with the fraction of the original sound power remaining after the frequency band has been restricted.

It can be seen from a casual inspection that by far the greatest amount of intelligibility lies in the middle and upper frequency regions and that these frequencies contain only a small fraction of the power represented by the whole spectrum. Similarly, the lower frequencies contribute very little to the intelligibility but require large amounts of power to reproduce. By cutting out the low-frequency end of the response range, a given voice can be maintained at approximately the same intensity as before with only a small fraction of the power handling capacity previously required.

Specifically, by cutting off the low-

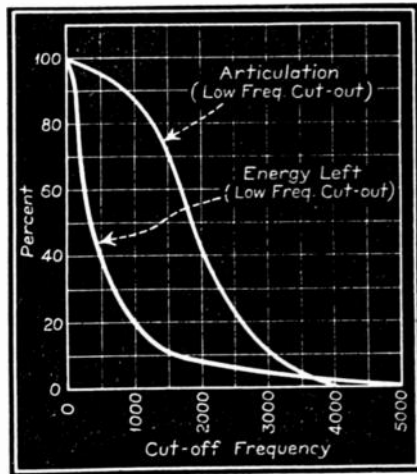

Figure 1. Variation of intelligibility or articulation for voice as the low end of the frequency spectrum is cut out, together with the fraction of the original sound power removed after the frequency band has been restricted.

frequency end at 500 cycles, only three per cent of the intelligibility is lost in spite of the fact that the power output has been reduced 60 per cent. With a given amplifier and speaker system, the amplifier gain control could then be advanced until the restricted response output equalled the previous broad-band output. The result would be that even though the actual power output was the same in both cases, the useful power, and therefore the speech intensity would be two and one half times as great in the restricted band case as in the wide range condition.

To take a definite example: Assume a 20-watt amplifier of high-fidelity characteristics and a speaker

of the same response. By driving the speaker at 20 watts input, a certain speech intensity is set up at a given distance from it. If all frequencies below 500 cycles are cut off in the amplifier, the power output will drop to 8 watts but the speech intensity will remain practically the same at the reference point, leaving two methods of further procedure. The 20-watt amplifier can be replaced with an 8-watt amplifier of restricted response with practically no loss in speech intelligibility, or the gain of the 20-watt amplifier can be increased so that with the low frequencies cut out its output will still be 20 watts. The latter condition will result in a speech intensity of $2\frac{1}{2}$ times that of the high fidelity adjustment at the reference point, even though in both cases the actual power being fed to the speaker is 20 watts.

- **Increases Speaker Life**

Another aspect of the situation tends to increase the desirability of curtailing the low-frequency response. The amplitude of sound waves varies inversely with frequency. This means that in order to reproduce low frequencies a speaker cone or diaphragm must move further than is necessary for the reproduction of high frequencies. Many speakers overload mechanically at low frequencies long before they reach their electrical power handling capacities. If the low frequencies are attenuated such speakers can be made to handle considerably more power without rattling and with increased life since

their mechanical suspensions are thus prevented from being strained to the limit of movement.

- **Efficiencies**

It has been previously noted in the remarks above concerning resonances in electro-mechanical and electro-acoustic devices, high-fidelity speakers as a rule have lower efficiency than those of restricted range. A recent comparison of two widely used 12-inch permanent magnet dynamic speakers, one of high-fidelity type, and the other of the so-called public address, speech, or high-efficiency type, showed that with the same input, the high-efficiency cone actually delivered three times the sound output delivered by the high-fidelity cone; this in spite of the fact that both speakers had the same magnet structure, were sold at the same price, and were made by the same manufacturer. The difference was simply a matter of design, in which in order to get the high-fidelity response, the overall efficiency of the speaker had to be lowered.

Similarly, exponential horns with either cone or diaphragm type units have considerably higher efficiencies than straight cone speakers, but due to the horn dimensions have a very sharp low-frequency cutoff, usually in the neighborhood of 200 to 250 cycles in the public-address type horn. Below this frequency the air column no longer loads the diaphragm properly with the result that lower frequencies tend to overload the unit. Such speakers should be operated with amplifiers having

attenuated low-frequency response to prevent damage to the speaker and when so operated will deliver reliable output at surprising efficiencies.

A tabulation of the relative efficiencies in the speech range of the different types of reproducers follows:

Hi-Fi cone.....	2% to 4%
Hi-Efficiency cone....	4% to 10%
Hi-Efficiency cone with air column—	10% to 18%
Specially designed cone unit with air column up to.....	25%
Diaphragm type dy- namic unit with exponential horn..	25% to 40%

In one special case where the response has been restricted to between 400 and 4000 cycles, a high-efficiency dynamic unit working into a reflex horn has been built which actually handles 500 watts at 50 per cent efficiency. Care has been taken, however, to insure that no low frequencies are fed to this unit unless at greatly reduced power; otherwise, the diaphragm and suspension would rattle apart under the high amplitudes.

• High Fidelity Has Its Place

The above information should not be misconstrued to mean that there is no point to high-fidelity reproduction of music, and certain types of speech. It merely indicates that for many outdoor installations, especially the types used for announcing or high-power paging, certain facts concerning efficiency

should not be neglected in the scramble for wide-range reproduction.

On the other hand, the serviceman should not feel that the fact that the system has poor bass response means that speech will sound tinny or highly distorted. Although reproduced speech in a restricted response system does not sound as natural in the sense that a given person's voice is not as easily recognized, at the same time restricting the frequency response often makes the speech actually clear and more crisp, due to the fact that low-frequency tones have a tendency to mask the upper frequencies of speech sounds.

It is true that talking of a p.a. system which has poor response below 250 or 300 cycles evokes a mental picture of the type of sound that used to emanate from the speaker of fifteen years ago. This is far from the type of results to be expected from a modern system in which the response is knowingly controlled. Every serviceman is familiar with the fact that midget a.c., d.c. sets of the very compact type reproduce speech and announcements with particularly good clarity, although their reproduction of music leaves much to be desired. These sets very rarely have appreciable response below 250 cycles. They usually depend on the reproduction of the harmonics of bass notes to give a semblance of bass response in the reproduction of music.

With that fact in mind, the serviceman should appreciate that the

advocation of narrow-band response for public-address work is not by any means a step backward. On the contrary, properly applied, such treatment results in extremely beneficial results in terms of performance, reliability and economy.

These principles are not new. They are very widely used in telephone transmission, in speech amplifiers and modulators for voice transmission in radio transmitters,

and in certain types of properly engineered commercial speech address systems; in short, wherever it is required to generate the maximum amount of intelligibility with a minimum amount of power. The judicious application of a similar line of thought to the selection of components for speech address systems in general should result in improved efficiency and greater reliability at reduced cost.

By the Ton

IF YOU plan to launch a radio network you'll probably be doing a lot of talking about "the air," but if you are wise you'll give a thought to more material things—copper wire, for instance.

Let's say that you figure on something like the NBC studios at Radio City as the key point of your network. You first get some 10,000,000 assorted lengths of wire. Then, with your soldering iron, you'll go round making 20,000,000 connections, each one with the chance of a "bug" included, free of charge. ("Bug" equals an error not readily apparent to the eye. Terrible things, these radio "bugs.")

About 250 microphone outlets in 27 studios would require some 1,250 miles of wire. The total mileage of cable, some with 40 strands, some with 20, and others with 10, would be about 89 miles. All in all, you'll need about 110 tons of copper cable and wire.

Then, when you have all this installed, you think of something else. Your master control desk, if you decide on one like that devised by O. B. Hanson, NBC vice-president and chief engineer, will mount about 3,700 lamps and keys.

Finally, you'll need a few more tons of copper for transmitter equipment, and will have to top it off with 145 miles of copper ribbon in the ground system of your antenna—that is, if you want one like WJZ, the key station of the NBC-Blue Network. Add 153 stations all over the country, connect them up with 23,750 miles of special radio conductors and you have the equivalent of the present NBC networks. Of course, you'll have to have special lines, but they seldom run over 75,000 miles a year.—ATE Journal.

A Mutual CONDUCTANCE METER

BY C. B. AIKEN AND J. F. BELL

THERE are many circuits for measuring the mutual conductance of small high-vacuum thermionic tubes, ranging from complicated and expensive bridges down to simple tube checkers that merely indicate "good" or "bad." The cost and complexity of the former make them unsuited for certain applications, while many of the latter are not accurate enough for laboratory use. A mutual conductance meter has been developed for service in the communication laboratories at Purdue that is reasonably simple and is capable of making accurate measurements of the mutual conductance of all the standard thermionic receiver tubes.

• The Fundamental Circuit

The simplified schematic circuit is shown in figure 1. Alternating current is impressed, through blocking condensers, upon the input of the triode under test, and the variable resistance R_a is adjusted until the signal heard in the head tele-

phones is reduced to zero. This condition of balance is obtained when

$$g_m = 1/R_a \dots\dots\dots (1)$$

The balance is independent of the impedance in the plate circuit of the tube and only one calibrated element is required, namely R_a . These points are of great advantage in testing a wide variety of tubes, since no special provision must be made for tubes of very high or very low plate resistance. Furthermore, the telephones can be shunted with a low-resistance choke coil so that troubles caused by direct-current voltage drop in the plate circuit are reduced to a minimum. This is an important consideration when testing tubes that draw large amounts of current. Multi-electrode tubes can, of course, be measured with the same fundamental circuit, it being necessary merely to supply the proper voltages to the dynamically inactive electrodes.

The equivalent circuit of figure

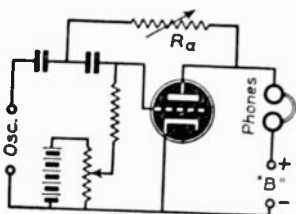

Fig. 1

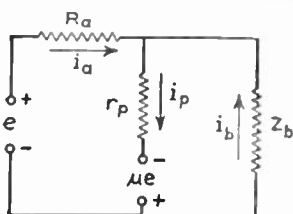

Fig. 2

1 is shown in figure 2 with only the alternating-current quantities indicated. The equations of this circuit are:

$$e = Z_a i_a - Z_b i_b \dots\dots\dots (2)$$

$$\mu e = r_p i_p + Z_b i_b \dots\dots\dots (3)$$

$$i_p = i_a + i_b \dots\dots\dots (4)$$

The solution of these equations for i_b , the current through the load impedance, gives.

$$i_b = \frac{e(\mu Z_a - r_p)}{Z_a r_p + Z_a Z_b + Z_b r_p} \dots\dots (5)$$

from which it follows that the balance condition is that specified by (1), since

$$g_m = \mu / r_p$$

If we solve for i_a and divide the result into the driving voltage e , there results the effective input impedance of the device, exclusive of the grid leak. This turns out to be

$$Z_{i_n} = \frac{Z_a + Z_{pb}}{1 + g_m Z_{pb}} \dots\dots\dots (6)$$

in which Z_{pb} is the alternating-current impedance of r_p and Z_p in parallel. It is evident from this expression that the input impedance may be rather low. Thus in the case of a type 2A3 tube, the plate re-

sistance is normally 800 ohms, and if high-impedance headphones or a buffer amplifier is used, Z_{pb} will be about this value. If $g_m = 0.005$ mhos, the input impedance calculated from (6) is 200 ohms. This is about as low an input impedance as is likely to be encountered and the oscillator should be designed to deliver several volts into this impedance.

• Circuit Details of the Measuring Device

Figure 3 shows the circuit diagram of the instrument which has been used in the Purdue laboratories. The oscillator and input buffer amplifier employ a single dual-purpose tube. The circuits of this portion of the apparatus have not been shown, since they may be of any conventional type or they may be entirely omitted and a signal supplied from a suitable external audio-frequency oscillator of reasonably good wave form.

In order to reduce to a minimum the inevitable complexity resulting from the great variety of tubes that must be handled, the screen volt-

age is held constant at 90 volts by a type 874 gas regulator tube.

A single milliammeter is used to give plate-current ranges of 10 and 100 milliamperes full scale and a plate-voltage range of 0-250 volts. The grid bias may be measured externally if desired by connecting a high-resistance voltmeter to the terminals provided on the pin jack panel. Ordinarily, however, the desired operating condition may be secured by observing plate voltage and plate current.

Although the balance is independent of the load impedance, there is an optimum value determined by a compromise between high sensitivity and apparent sharpness of balance. If a tube having a high plate resistance is being tested, and a high load impedance is used, a slight amount of stray pickup from the oscillator may occur in the high-impedance plate circuit that will obscure the balance. Experiments showed that 1000 ohms was a good value for the apparatus which has been constructed. With an external oscillator a higher value might be used.

The output of the tube under test is fed to an output buffer amplifier, in the grid of which is a parallel resonant circuit tuned to 700 cycles, the oscillator frequency. In the plate mesh of the buffer amplifier is a series-resonant circuit tuned to 1400 cycles. These two filters greatly reduce the harmonic content of the signal supplied to the headphones and make it possible to obtain a sharp balance since

harmonics generated in the tube do not balance.

Some trouble was experienced with rhythmic fluctuations in the power-supply voltage caused by hunting of synchronous machinery. Since mutual conductance varies with the electrode voltages, there is a tendency for a fluttering signal to appear at balance. This effect was greatly reduced by employing 40 μ f. of electrolytic condensers in the plate return of the tube under test. This large capacitance in conjunction with the series impedance of the power-supply circuit exerted a marked smoothing action on the power-line voltage fluctuations.

The model which has been built for the laboratory uses a 3-dial decade conductance, adjustable in steps of 1000, 100, and 10 micromhos, respectively. Thus the range of the balance extends from 10 to 11,000 micromhos. A tapered potentiometer can be used,

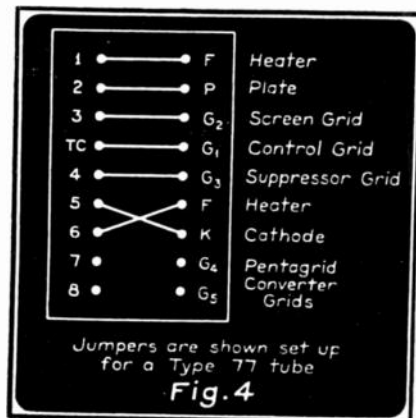

but if excessive scale crowding is to be avoided the available range of g_m will be limited. However, if a 1000-ohm tapered potentiometer is used in series with a 250-ohm fixed resistance, it is possible to cover a range from 4000 down to 800 micromhos without serious crowding of the scale in any part of the dial. A much wider range can be covered by using two tapered resistances of suitable values ganged together on the same shaft. In this case a double scale would, of course, be necessary.

Provision for measuring a wide variety of tubes is made by using only enough sockets to take care of

the different prong arrangements and furnishing a set of pin jacks on which connections can be set up for connecting any electrode to any one of the nine points in the measuring circuit. The arrangement of the jacks is indicated in figure 4. Each jack in the left-hand row is numbered and connected to all of the socket contacts designated by a corresponding number in the RMA tube-socket numbering system. The jacks in the right-hand row are marked with the conventional symbols for the tube elements and connected to the appropriate points in the measuring circuit.

Educational Broadcasts

THE FIRST of a series of four weekly broadcasts designed to provide foreign listeners with an accurate portrayal of American educational practices, as carried out in the primary, secondary and collegiate institutions of this country, was launched by General Electric's international short-wave radio stations W2XAD and W2XAF, November 1.

Working in conjunction with Dr. Frank Graves, Commissioner of Education of the State of New York, and Superintendent of Schools Howard W. Pillsbury, the series mark an advent from the lecture type of radio broadcast by giving foreign listeners an insight into the social, economic and historical background of the American school system. The broadcasts are participated in by students and parents as well as teachers, professors, college presidents and governmental officials. The programs are broadcast in English, Spanish and Portuguese.

Power Pack:

TRANSFORMER DESIGN

BY L. J. GABALONE AND D. R. KAFFRY
STANDARD ELECTRIC COMPANY

The authors discuss the necessities of transformer design and how a good unit is engineered. There are a great number of amateurs and semi-professionals who wish their own to whom this article will be of value.

THE main elements in a power pack are the transformer, the rectifier, the filter, and the voltage divider. This article deals with the power transformer of the power supply.

It might be well at this time to explain the action of a power transformer. It is a device containing a primary, one or more secondaries, and an iron core. The design of a power transformer having high efficiency requires elaborate calculations and takes into account the d.c. flowing in a transformer secondary when the full wave or half wave rectifier is used. However, in a bridge rectifier, the d.c. does not flow in the secondary of the transformer.

The transformers used in power packs take in three sizes: miniature, medium and large. The small and medium are by far the most popular because of the greater number of applications for these types. In the design of transformers, economy is secured when the windings are enclosed in a magnetic core area with a minimum of wire and the shortest possible magnetic path.

The core form used in these transformers with the greatest overall economy is one which employs lamination which is called "waste less," i.e. the opening of the E pieces are equal to the opening of the I pieces. In this way two E pieces and two I pieces are stamped in one operation utilizing the greatest per-

© 1958 STANDARD ELECTRIC COMPANY

Whereas: I_p equals primary current. W_p equals primary watts. E_p equals primary voltage. W_s equals watts per second.

- (2) The current of the windings being known from our previous calculations, and using a current density of 1 ampere for 1000 cir. mils., the copper wire is determined (d^2). One mil equals 0.001.

Therefore, the following are typical examples:

No. 20 wire has a diameter of .0319 inch. This value squared will give 1022 cir. mils. Another example: No. 30 wire has a diameter of .01003 and has 100.5 cir. mils. Using no. 10 wire, it is found that the diameter is .1019 inch. This squared is 10,380 cir. mils. These values are for bare wire at a temperature of 68° F. or 20° C. This is the temperature to which all measurements are converted.

With this information, it is possible to determine the current carrying capacity of windings on a transformer where the specifications have been lost or misplaced. However, in the design of a new transformer, it is easier to obtain this information from a wire chart.

An example of using a current density of 1 ampere for 1000 cir. mils. is no. 20 wire, which has a diameter of .03196 inch, and 1022 c.m. The closest wire size to this is either 1288 c.m. for no. 19, or 810 c.m. for no. 21.

- (3) Iron or Core Consideration.

The following may be used as an example. For no. 26 RT iron, 40 watts should have 1 square inch of core area; 70 watts $1\frac{1}{2}$ square inches, and 120 watts 2 square inches. The core area is determined by the size of the center leg of the "E" piece multiplied by the stack of this iron. Assuming the center leg of the "E" piece to be 1", this stacked 1" would give a square area of 1". The same stacked $1\frac{1}{2}$ " would give a square core area of $1\frac{1}{2}$ ".

The above is gross core area which must be multiplied by 0.9 because there is a loss of approximately 10% in the net area from gross stacking area. This core area is needed before the turns per volt may be determined. See chart.

- (4) Induction and Core Losses.

Assuming 65,000 lines to be the flux density used with no. 26 (RT) gauge Armco radio grade lamination, it is found, by referring to the chart, that the core loss is approximately 0.6 watts per pound of iron. The flux density at which the core will be determined the iron or core loss. The various grades of laminations have different losses per pound, which may be plotted against a flux density in kilolines

per square inch. A value of 65 kilolines is used as an average value of induction per square inch of core material. However, with various grades of steel it is not uncommon to find flux densities ranging from 15 kilolines to 95 kilolines. This will be determined not only by the quality of the steel but also by the thickness of the laminations. The thicker laminations must necessarily be used with lower flux densities than the thinner laminations because of the greater loss set up by the mass in the thicker laminations. The formula for flux density is:

$$B \text{ equals } \frac{E 10^8}{4.44 ANf}$$

Whereas: B equals flux density. 4.44 equals A factor also. E equals primary voltage. A equals the gross area. 10^8 equals A factor. N equals the number of primary turns. F equals frequency.

- (5) Induced voltage equation, turns per volt.

The definition that 10^8 magnetic lines cut per second will induce 1 volt pressure is the basis for the following equation:

$$E \text{ equals } \frac{BANf}{10^8} \times 4.44$$

Where E is the voltage, A the area of the core, B the flux density for A, f the frequency in the cycles per second, and N the number of turns it is found, by the substitution, that this formula may be changed to:

$$N \text{ equals } \frac{E 10^8}{4.44 ABf}$$

By working out this formula for 115 volts primary at 60 cycles, the following is a simplified formula.

$$N \text{ equals } \frac{4.84}{AB}$$

- (6) Number of turns for each winding.

With a B of 65,000 lines, N equals 870 turns on the primary; therefore, the turns per volt will be 7.65. It is then a matter of obtaining the voltage ratios and multiplying this by the number of turns per volt to obtain the desired number of turns in the secondary winding.

- (7) Winding space required.

From the total turns for each winding and the wire size, the total area of winding space is calculated. Most transformers used in power packs and radios employ enameled wire. By using a wire chart, the diameter of the wire is found. The steps in calculating the build of a transformer are as follows:

Power Pack:

TRANSFORMER DESIGN

BY L. J. GAMACHE AND H. H. KREFFT
STANDARD TRANSFORMER CORP.

The authors discuss the necessities of transformer design and how a good unit is engineered. There are still a great number of amateurs and servicemen who wind their own to whom this article will be of value.

THE main elements in a power pack are the transformer, the rectifier, the filter, and the voltage divider. This article deals with the power transformer of the power supply.

It might be well at this time to explain the action of a power transformer. It is a device containing a primary, one or more secondaries, and an iron core. The design of a power transformer having high efficiency requires elaborate calculations and takes into account the d.c. flowing in a transformer secondary, when the full-wave or half-wave rectifier is used. However, in a bridge rectifier, the d.c. does not flow in the secondary of the transformer.

The transformers used in power packs range in three sizes: small, medium, and large. The small and medium are by far the most popular because of the greater number of applications for these types. In the design of transformers, economy is secured when the windings are enclosed in a magnetic core area, with a minimum of wire and the shortest possible magnetic path.

The core form used in these transformers with the greatest overall economy is one which employs lamination which is called "wasteless," i.e., the opening of the "E" pieces are equal to the "I" pieces. In this way, two "E" pieces and two "I" pieces are stamped in one operation, utilizing the greatest per-

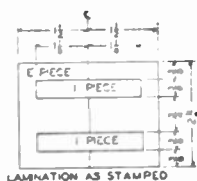

Figure 1

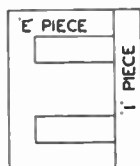

Figure 2

centage of metal and wasting very little steel (figure 1). After the stamping, or blanking as it might be called, the iron is annealed. This is a complicated procedure and cannot be described fully at this time. During this process, each lamination is coated with a metallic oxide which acts to insulate it electrically. When this iron is stacked in the core, each lamination acts as a separate piece of iron and reduces the mass in a unit. Should this insulation between laminations be broken by stamping or otherwise, this would cause the unit to generate a great amount of heat, resulting in a burn-out. From this will be seen that insulation of laminations plays a vital part in transformer design.

Permeability is the ratio between the magnetic induction and the field strength. In air this ratio is unity. In paramagnetic material, the permeability is greater than unity. In ferromagnetic material, it may have a value of several thousand, and in diamagnetic material, it is a value of less than unity.

The unit of magnetic pole strength is a magnetic pole of such

a value that when placed one centimeter from a like pole, a force of repulsion of 1 dyne will exist between them. The magnetic pole strength of any pole is measured in terms of this unit, the dyne.

The following steps are used in designing a power transformer:

- (1) Determine the voltage and amperes in each secondary.
 - (a) To find the total wattage of all of the secondary windings, multiply the load voltage by the load current of each of the windings and add the results.
 - (b) Assuming that the small transformer will have approximately 90% efficiency, divide the wattage found in A by 0.9, which will give the approximate primary wattage.
 - (c) To find the primary current:

$$I_p \text{ equals } \frac{W_p}{E_p \times 0.9} \text{ equals } \frac{W_s}{9.81 E_p}$$

Whereas: I_p equals primary current. W_p equals primary watts. E_p equals primary voltage. W_s equals watts per second.

- (2) The current of the windings being known from our previous calculations, and using a current density of 1 ampere for 1000 cir. mils., the copper wire is determined (d^2). One mil equals 0.001.

Therefore, the following are typical examples:

No. 20 wire has a diameter of .0319 inch. This value squared will give 1022 cir. mils. Another example: No. 30 wire has a diameter of .01003 and has 100.5 cir. mils. Using no. 10 wire, it is found that the diameter is .1019 inch. This squared is 10,380 cir. mils. These values are for bare wire at a temperature of 68° F. or 20° C. This is the temperature to which all measurements are converted.

With this information, it is possible to determine the current carrying capacity of windings on a transformer where the specifications have been lost or misplaced. However, in the design of a new transformer, it is easier to obtain this information from a wire chart.

An example of using a current density of 1 ampere for 1000 cir. mils. is no. 20 wire, which has a diameter of .03196 inch, and 1022 c.m. The closest wire size to this is either 1288 c.m. for no. 19, or 810 c.m. for no. 21.

- (3) Iron or Core Consideration.

The following may be used as an example. For no. 26 RT iron, 40 watts should have 1 square inch of core area; 70 watts $1\frac{1}{2}$ square inches, and 120 watts 2 square inches. The core area is determined by the size of the center leg of the "E" piece multiplied by the stack of this iron. Assuming the center leg of the "E" piece to be 1", this stacked 1" would give a square area of 1". The same stacked $1\frac{1}{2}$ " would give a square core area of $1\frac{1}{2}$ ".

The above is gross core area which must be multiplied by 0.9 because there is a loss of approximately 10% in the net area from gross stacking area. This core area is needed before the turns per volt may be determined. See chart.

- (4) Induction and Core Losses.

Assuming 65,000 lines to be the flux density used with no. 26 (RT) gauge Armco radio grade lamination, it is found, by referring to the chart, that the core loss is approximately 0.6 watts per pound of iron. The flux density at which the core will be determines the iron or core loss. The various grades of laminations have different losses per pound, which may be plotted against a flux density in kilolines

per square inch. A value of 65 kilolines is used as an average value of induction per square inch of core material. However, with various grades of steel it is not uncommon to find flux densities ranging from 15 kilolines to 95 kilolines. This will be determined not only by the quality of the steel but also by the thickness of the laminations. The thicker laminations must necessarily be used with lower flux densities than the thinner laminations because of the greater loss set up by the mass in the thicker laminations. The formula for flux density is:

$$B \text{ equals } \frac{E 10^8}{4.44 ANf}$$

Whereas: B equals flux density. 4.44 equals A factor also. E equals primary voltage. A equals the gross area. 10^8 equals A factor. N equals the number of primary turns. F equals frequency.

- (5) Induced voltage equation, turns per volt.

The definition that 10^8 magnetic lines cut per second will induce 1 volt pressure is the basis for the following equation:

$$E \text{ equals } \frac{BANf}{10^8} \times 4.44$$

Where E is the voltage, A the area of the core, B the flux density for A, f the frequency in the cycles per second, and N the number of turns it is found, by the substitution, that this formula may be changed to:

$$N \text{ equals } \frac{E 10^8}{4.44 ABf}$$

By working out this formula for 115 volts primary at 60 cycles, the following is a simplified formula.

$$N \text{ equals } \frac{4.84}{AB}$$

- (6) Number of turns for each winding.

With a B of 65,000 lines, N equals 870 turns on the primary; therefore, the turns per volt will be 7.65. It is then a matter of obtaining the voltage ratios and multiplying this by the number of turns per volt to obtain the desired number of turns in the secondary winding.

- (7) Winding space required.

From the total turns for each winding and the wire size, the total area of winding space is calculated. Most transformers used in power packs and radios employ enameled wire. By using a wire chart, the diameter of the wire is found. The steps in calculating the build of a transformer are as follows:

- (a) The size of the tube or the winding form.
- (b) The diameter of the wire for the primary, the number of turns which may be wound on one layer and the insulation between each layer. This, multiplied by the number of layers required for the primary is the area required for the primary. To this, add a winding insulation. Then proceed with the wire size of the secondary, number of turns, etc., as above.

If more than one secondary is used, repeat this until the primary steps and secondary steps have been totaled and then divide this by the window area.

It is impractical to wind a transformer with more than 85 or 90% build.

The photographs illustrate a complete pin game power pack, a coil for a transformer, a small transformer for a pack and a larger transformer used in a theatre power pack.

(See page 51 for photographs.)

TESTS, adjustments and modifications on the two megacycle coaxial cable installation between New York and Princeton have been under way during the past few months by Bell Telephone Laboratories. Equalizers and power separation filters in all repeaters were modified to obtain improved characteristics. Transmission-vs-frequency characteristics were measured both before and after these modifications. Further study directed toward obtaining greater precision of equalization and regulation is in progress.

Satisfactory test conversations were held over a circuit 2100 miles in length, built up by looping back and forth through the coaxial system a total of 20 times. This circuit consisted of four voice-frequency links in tandem. The conversation passed through sixty-four steps of modulation in each direction, using channels located in different parts of the frequency band between 100 and 1900 kilocycles, and passed twenty times through each amplifier, giving the equivalent of 420 amplifiers in each direction.—Bell Laboratories Record.

A Low-Cost Single SIGNAL RECEIVER

BY GEORGE GRAMMER

THERE is no doubt that with amateur activity at its present height something considerably better than the t.r.f. receiver is not only desirable but essential. But recognition of that self-evident fact does not give material aid to the fellow with a t.r.f. pocketbook. Something more concrete than sympathy is needed—to wit, suggestions for what to do about it.

We propose to offer some herein, in the form of a description of a superhet which will do a real single-signal job, but which costs little if any more than the average t.r.f. set—maybe less. Figures prove the case, and we rest ours on the fact that the receiver pictured here can be built for \$21, plus approximately \$4.50 for the six tubes used in it. It is a ham-band outfit, using plug-in coils adjusted so that each band is spread over practically the whole dial range. What you get out of it depends to some ex-

tent on how intelligently you use it—but then, that is also true of high-priced receivers. It is quite easy to build and put into operation, with only one original adjustment which requires more than ordinary care.

The circuit, shown in figure 1, will not be hard to follow by anyone having an understanding of the operation of a superhet receiver. The mixer, a 6L7, is coupled to the antenna. To reduce image response and provide additional gain, this stage is made regenerative. The oscillator is a 6J5 triode, one of the most satisfactory types for this purpose. There is a single i.f. stage, using a 6K7 and iron-core transformers. The second detector is a 6C5 operated as a plate rectifier to handle large signals and to provide good headphone output; this type of operation, incidentally, does not load the i.f. transformer and hence better overall selectivity results than when a diode detector is used. The

**Journal of the American Radio Relay League, Inc., West Hartford, Conn.*

© 1938, A. R. R. L.

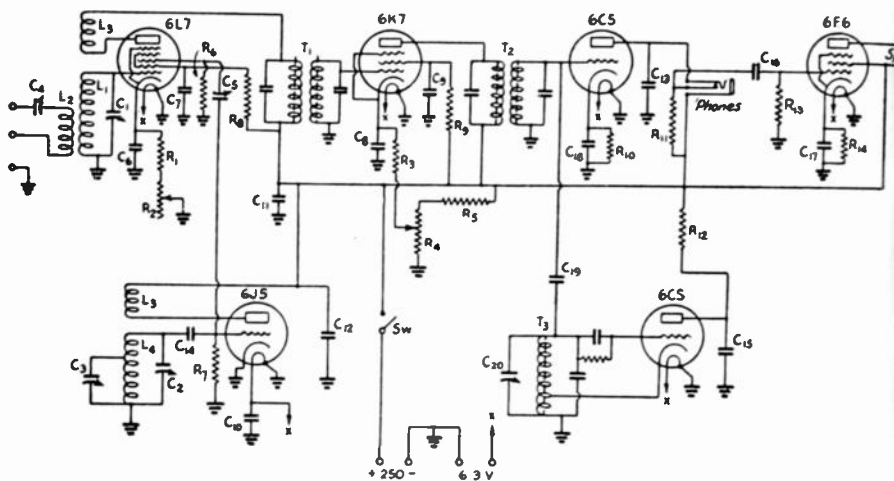

FIGURE 1. CIRCUIT DIAGRAM OF THE REGENERATIVE S.S. RECEIVER

- | | | |
|---|---|--|
| C_1, C_2 —50- μ fd. variable | trolytic | R_7 —150,000 ohms, 1/2-watt |
| C_3 —35- μ fd. variable | C_{15} —5- μ fd. 25-volt electro- | R_8 —12,000 ohms, 1-watt |
| C_4 —70- μ fd. mica trimmer | lytic | $R_9, R_{10}, R_{11}, R_{12}$ —50,000 |
| C_5 —30- μ fd. isolantite-in- | C_{17} —See text | ohms, 1/2-watt |
| insulated mica trimmer | C_{20} —25- μ fd. variable | R_{13} —0.5 megohm, 1/2-watt |
| $C_6, C_{10}, \text{inc.}$ —0.1- μ fd. paper, | R_1 —300 ohms, 1/2-watt (see | R_{14} —450 ohms, 1-watt |
| 400-volt | text) | T_1, T_2 —455-kc. interstage |
| C_{11} —0.2- μ fd. paper, 400- | R_2 —500-ohm variable, wire- | type i.f. transformers |
| volt (or larger) | wound | T_3 —455-kc. beat oscillator |
| C_{12}, C_{13} —0.005- μ fd. mica | R_3 —300 ohms, 1/2-watt | transformer, with grid |
| C_{14} —100- μ fd. mica | R_4 —25,000-ohm value con- | condenser and leak |
| C_{15}, C_{16} —0.01- μ fd. paper, | trol | $L_1-L_5, \text{inc.}$ —See coil table |
| 400-volt | R_5 —50,000 ohms, 2-watt | Jack—Double-circuit type |
| C_{17} —10- μ fd. 25-volt elec- | R_6 —50,000 ohms, 1/2-watt | Sw—S.p.s.t. toggle |

audio output tube is a 6F6. A 6C5 beat oscillator completes the tube complement.

Metal tubes were used throughout because they are self-shielding and thus eliminate the need for extra tube shields. Although not indicated on the circuit diagram, the i.f. amplifier is made regenerative by a very simple method to give the single-signal effect.

Taking the circuit features individually, the mixer stage uses the familiar tickler circuit to obtain regeneration. This method was used in preference to the popular cathode tap arrangement for three reasons: First, it is much easier to change the number of turns on a separate coil in making preliminary adjustments than it is to move a tap; second, the possibility of hum

always likely to be present in regenerative circuits using 6-volt tubes, is lessened by having the cathode at ground potential for r.f.; third, with the cathode grounded it is less likely that any oscillator voltage will appear in the mixer grid circuit. The appearance of oscillator voltage on the no. 1 grid of the mixer is not only undesirable from the standpoint of tube performance, but also, since in this case the mixer works directly from the antenna, is likely to bring in unwanted signals. This is particularly so on the lower-frequency bands, where high-frequency commercial signals can be picked up on oscillator harmonics.

To avoid constructional complications, the mixer tuning is not ganged with the oscillator. Although this might seem a disadvantage, in that the two circuits must be tuned separately, in practice it has not turned out to be so. In fact, the mixer tuning condenser, C_1 , makes a quite effective volume control and for c.w. reception in particular its use in this fashion is quite advantageous. The regeneration control is a variable resistor, R_2 , in series with the 6L7 cathode resistor.

In the high-frequency oscillator the tickler circuit again is used, the reason being to keep the cathode at ground potential to reduce hum. Our previous experience with 6-volt oscillators using the cathode-tap circuit has been none too good—all of them were only too prone to turn

"r.a.c." on 14 Mc. and practically refused under any circumstances to be "d.c." on 28 Mc. Results so far with this receiver have justified grounding the cathode. Bandspread is by the usual tap method, C_3 being the tuning condenser and C_2 the band-setting trimmer. The oscillator grid is coupled to the no. 3 grid of the 6L7 through a small trimmer condenser, C_5 .

The i.f. stage as shown in the diagram is quite conventional. Its gain is controlled by R_4 , which varies the control-grid bias. The stage is made regenerative by simply running a short length of insulated wire from the control grid of the 6K7 through a hole in the shield can of i.f. transformer T_2 , so that a small amount of energy is coupled back to the grid from the plate. When this is done R_4 serves as a regeneration control and is more effective in varying the selectivity than gain. If the high selectivity afforded by regeneration is not wanted, the regenerative coupling may be omitted and the set becomes a straight super insofar as the i.f. is concerned.

The second detector, beat oscillator and power amplifier need no special comment. The head-phones plug into the plate circuit of the second detector; the signal level is quite high here and no additional audio amplification is needed. For simplicity, no audio gain control is incorporated in the set, since the various r.f. controls afford quite a range in volume.

- Layout

The various photographs show the layout, both top and bottom, quite plainly. The chassis is a standard item measuring 11 by 7 by 2 inches. The bandspread tuning condenser, C_3 , is at the front center, operated by the vernier dial. At the left is C_1 , the mixer tuning condenser, and at the right, C_2 , the oscillator band-setting condenser. The oscillator tube is directly behind C_3 , with the mixer tube to the left on the other side of a baffle shield which separates the two r.f. sections. This shield, measuring $3\frac{3}{4}$ by $4\frac{3}{4}$ inches, is quite effective in preventing unwanted coupling between oscillator and mixer. The mixer coil socket is at the left edge of the chassis behind C_1 ; the oscillator coil socket is between C_2 and C_3 .

The i.f. and audio sections are along the rear edge of the chassis. The transformer in the rear left corner is T_1 ; next to it is the i.f. tube, then T_2 . The transformers are mounted so that the adjusting screws project to the rear where they are easily accessible. With the particular type of transformer used this requires drilling a new hole in the shield of T_1 so that the grid lead to the 6K7 can be brought out the proper side. In T_2 , the grid lead should be pulled through the side of the can and brought out the bottom with the other leads, since the grid of the 6C5 second detector comes through the base.

The transformer at the rear right

is for the beat oscillator. The 6C5 second detector is directly in front of it and the beat oscillator tube is about midway along the right chassis edge. The 6F6 output tube is in the rear right-hand corner.

Power cord, headphone jack (insulated from the chassis) and a tip jack for the speaker are on the rear edge of the chassis. The antenna input terminals are on the left edge, near the mixer coil socket.

The controls along the bottom edge of the panel are, from left to right, the mixer regeneration control, R_2 , the on-off switch, Sw, the i.f. gain or regeneration control, R_1 , and the beat-oscillator vernier condenser, C_{20} . The latter has the corner of one rotary plate bent over so that when the condenser plates are fully interleaved the condenser is short-circuited, thus stopping oscillation.

- Wiring Pointers

Study of the bottom view will show how the various resistors and by-passes are wired in. The tube sockets are bakelite except that for the high-frequency oscillator, which is isolantite. The coil sockets also are isolantite, a six-prong socket being used for the mixer coil and a five-prong unit for the oscillator. In most cases the various components can be mounted by their wire leads, but one or two insulated lugs will be needed for "B" connections.

As shown in figure 1, one side of the heater circuit is grounded, so that only one filament wire need be

run from tube to tube. The more conventional method of running heater current through a twisted pair can be used if preferred. The method indicated has proved to be quite satisfactory, however, in that it does not seem to introduce any particular hum. On each tube socket the shield prong and adjacent heater prong are tied together and grounded.

In making ground connections the practice of bringing all by-pass condenser returns for each individual stage to a single point has been followed when possible, the cathode ground (through the by-pass condenser, when used) being the focal point. In some cases, where long return leads would have been necessary, separate grounds are used on the same stage. If desired, such grounds can be tied together with heavy wire, but since no instability resulted without them they were not used in this case. In any event, it seems desirable to make the r.f. path from cathode to chassis as short as possible, as a fundamental requirement.

The oscillator-mixer condenser, C_5 , is mounted from one of its connection tabs on a small ceramic pillar (furnished with one of the tube sockets) between the oscillator and mixer tube sockets. The antenna series condenser, C_4 , also visible in the bottom view, is mounted between one terminal on the antenna strip and one of the mixer coil-socket prongs. These condensers do not require readjustment in normal operation, hence are screw-

driver adjusted from the bottom.

The i.f. plate by-pass condenser, C_{11} , actually consists of two 0.1- μ f.d. units in parallel. A minimum of 0.2 μ f.d. was found necessary to prevent i.f. instability, but any convenient larger value can be used, or a single unit of the proper capacity may be substituted.

In doing the actual wiring, it will be found convenient to start with the filaments and follow with all the by-passes and resistors, leaving the r.f. until last. This method makes it possible to find room for the larger parts first and thus avoids any re-wiring if things don't fit right toward the end of the job. It also keeps the condensers close to the chassis and leaves the r.f. wiring out in the open.

The grid and plate leads from T_2 are covered with shield braid to help prevent coupling back to T_1 . This precaution probably is not necessary, but may mean avoiding unwanted i.f. oscillation.

The b.o. coupling condenser, C_{10} , is not an actual condenser unit but is simply the capacity existing between the grid prong on the 6C5 socket and the adjacent prong on the side away from the plate. This prong, ordinarily unused, is connected to the b.o. as shown; more conveniently, it may be connected directly to the grid of the b.o. tube with identical results. This coupling puts a rather strong beat voltage at the grid of the second detector; sufficient coupling was used so that strong signals give loud audio response. If a weaker beat

signal is wanted, the coupling should be from the cathode on the b.o. tube.

R_1 , the fixed cathode resistor in the 6L7 circuit, is an adjustable unit furnished with R_2 . It was set to 300 ohms before installation.

- Coils

The method of winding coils is shown in figure 2, and complete specifications are given in the table. All windings are in the same direction. With connections brought out as shown, reversing L_3 with respect to L_1 , or L_5 with respect to L_4 , will prevent oscillation.

In figure 1 the ticklers, L_3 and L_5 , have been shown coupled to the grid ends of L_1 and L_4 , respectively. This was done purely to make the diagram less awkward; the actual method of construction is given in figure 2, with the ticklers coupled to the grounded ends of the grid coils.

The specifications given should be followed rather closely in the case of L_4 , if complete bandspread is to be obtained in each band. The tickler, L_5 , is not so critical; use

enough so that the tube oscillates readily with fairly low plate current, but not so much as to cause blocking. There is a good deal of leeway in the case of L_1 , since the tuning condenser has sufficient range to compensate for moderate changes in the inductance of this coil. The tickler coil L_3 , however, is another story, and it may be necessary to "tailor" it to fit the antenna. It must be large enough to make the mixer circuit oscillate readily, but yet not so large that oscillation continues over the whole range of R_2 . The desirable condition is that of having the circuit go into oscillation when the optimum bias, approximately six volts, is applied to the 6L7. The number of turns on L_3 , or the coupling between L_1 and L_3 , should be adjusted so that the mixer goes into oscillation with R_2 set at about half scale. The antenna coupling condenser, C_4 , affords some compensation for the antenna loading effect, and is particularly useful on the higher frequencies where the number of turns is small and the adjustment therefore more critical.

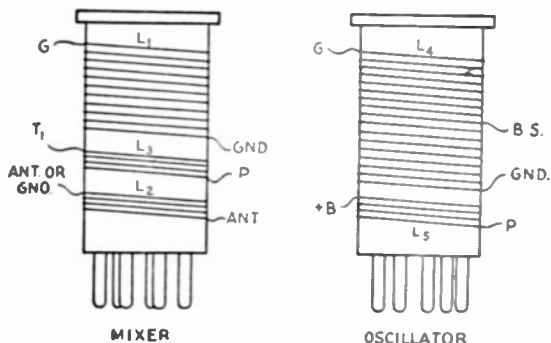

Figure 2. This drawing shows the method of winding the mixer and oscillator coils. All coils are wound in the same direction.

COIL DATA

Band	Coil	Wire Size	Turns	Lengths	Tap
1.75 Mc.....	L ₁	24	70	Close-wound	—
	L ₂	24	10	"	—
	L ₃	24	3.5	"	—
	L ₄	22	42	"	Top
	L ₅	22	8	"	—
3.5 Mc.....	L ₁	22	35	"	—
	L ₂	22	7	"	—
	L ₃	22	2.5	"	—
	L ₄	22	25	1 inch	17
	L ₅	22	5	Close-wound	—
7 Mc.....	L ₁	18	20	1 inch	—
	L ₂	22	4	Close-wound	—
	L ₃	22	2	"	—
	L ₄	18	13	1 inch	6
	L ₅	22	3	Close-wound	—
14 Mc.....	L ₁	18	11	1 inch	—
	L ₂	22	4	Close-wound	—
	L ₃	22	2.5	"	—
	L ₄	18	7	1 inch	2.4
	L ₅	22	2	Close-wound	—
28 Mc.....	L ₁	18	5	1 inch	—
	L ₂	22	3	Close-wound	—
	L ₃	22	2.5	"	—
	L ₄	18	3.6	1 inch	1.3
	L ₅	22	1.4	Close-wound	—

All coils $1\frac{1}{2}$ " in diameter. Spacing between coils on same form approximately $\frac{1}{8}$ ". Bandsread taps are measured from bottom (ground) end of L₄. All coils are wound with enamelled wire.

Where spaced windings are called for, the turns may be spaced by hand or by winding small wire or thread between them. After the windings are finished they may be held permanently in place by Duco cement spread along the coil-form ridges. After soldering the coil ends in the pins, be sure to clean off any rosin which may have formed a thin film over the contact surfaces.

Any convenient pin-connection arrangement may be used. Make the connections so that the shortest leads between coil socket and circuit points result.

• I.F. Alignment

The i.f. alignment procedure is an oft-told story and probably does

not need too detailed treatment here. Undoubtedly the most difficult feature is that of securing proper equipment for the job, but a serviceman friend or the local parts store may be able to help out. A test oscillator and 0-1 milliammeter make a suitable combination. The i.f. should be aligned without the regenerative connection and with the h.f. oscillator coil out of its socket. A mixer coil may be in place in order to complete the 6L7 plate connection; without the coil it is necessary to connect a jumper across the L₃ prongs on the coil socket. Incidentally, if no speaker is used either the speaker terminals must be short-circuited to prevent damage to the 6F6, or else the tube must be out of its socket.

Connect the test oscillator output between the 6L7 grid and chassis, with the normal grid connection to C₁ removed. Hook the milliammeter to a phone plug and insert plug in the head-phone jack. Set the oscillator to 455 kc. and adjust the trimmers on T₁ and T₂ to give maximum meter reading, with R₄ set for maximum gain or slightly below. The beat oscillator should be off. Without signal the second detector plate current should be between 0.1 and 0.2 ma.; adjust the test oscillator output so that the reading with signal is about 0.4 or 0.5 ma. As the circuits come into line, reduce the signal input to keep the reading about the same. Line up the circuit as accurately as possible, since correct alignment helps

both gain and selectivity. If the i.f. is unstable, the meter will not show a smooth rise and fall through maximum as a circuit is adjusted but will be jumpy, probably to full scale or more if oscillations start. There should be no trouble on this account if adequate by-passing and reasonable circuit isolation are employed.

If no 0-1 milliammeter is at hand a fair alignment job can be done by ear. Using a modulated test oscillator, peak all the trimmers for maximum audio output, using a fairly weak input signal for the final adjustment. With a little practice an equally good result can be obtained even without modulation on the oscillator, careful attention being paid to the change in character of the hiss as the circuit is tuned through resonance.

If no regular test oscillator is available, the beat oscillator can be used as a substitute, preferably set up temporarily in a separate unit. The output can be taken, in many cases, without formal coupling, the oscillator simply being on the same table as the receiver. A resistor of several thousand ohms should be connected between the 6L7 grid and ground to complete the d.c. grid circuit and give some impedance for the i.f. The beat oscillator can be set to the correct frequency by coupling it to a broadcast receiver and adjusting the tuning so that its 2nd and 3rd harmonics fall on broadcast carriers of the proper frequency, i.e., 910 and 1360 kc., in round numbers. The i.f. does not

have to be exact; anything between 450 and 460 will be satisfactory. With the beat oscillator serving as a test oscillator, the alignment procedure will be the same as before, but adjustment of signal level will not be so convenient.

- Adjusting R.F. Circuits

After the i.f. is aligned, the next step is to get the r.f. end working. No special equipment is needed for this purpose. Plug in a set of coils for some band on which there is a good deal of activity—7 Mc. in the evening, for instance. Set the oscillator padding condenser, C_2 , at approximately the right capacity; with the coil specifications given, the proportion of total C_2 capacity on each band will be about as follows: 1.75 Mc., 80 per cent; 3.5 Mc., 75 per cent; 7 Mc., 95 per cent; 14 Mc., 90 per cent; 28 Mc. 45 per cent. Now set the mixer regeneration control, R_2 , for minimum regeneration—all the resistance in circuit. Connect an antenna and set C_4 at maximum capacity. Switch the beat oscillator on by turning C_{20} out of the maximum position, and adjust the screw on T_3 until the characteristic beat-oscillator hiss is heard.

Now tune C_1 slowly over its scale, starting from maximum capacity. Using the 7-Mc. coils as an example, when C_1 is at about half scale there should be a definite increase in noise, and in the strength of the signals which no doubt by this time have already been heard. Continue on past this point until a

second peak is reached on C_1 ; at this peak the input circuit is tuned to the frequency which represents an image in normal reception. The oscillator in the receiver is designed to work on the high-frequency side of the incoming signal, so that C_1 always should be tuned to the peak which occurs with most capacity. On the higher-frequency bands the two peaks will be closer together on C_1 because of the greater tuning range; the reverse is true on the lower frequencies, and on 160 meters the two peaks will be found at opposite ends of the tuning range.

After the signal peak on C_1 has been identified, tune C_3 over its whole range, following with C_1 to keep the mixer circuit in tune, to see how the band fits the dial. With C_2 properly set, the band edges should fall the same number of main dial divisions from 0 and 100; if the band runs off the low-frequency edge, less capacity is needed at C_2 , while the converse is true if the band runs off the high edge. Once the band is properly centered on the dial, the panel may be marked at the appropriate point so that C_2 may be reset readily when changing bands. Incidentally, if the type of knob shown in the photograph is used it will be helpful to scratch a thin line on the edge of the knob opposite the pointer arrow so that the scratch may be lined up with the mark on the panel. The scratch may be filled in with white ink or paint for easy visibility.

• Mixer Regeneration

At this point it is time to become familiar with the operation of the mixer when regeneration is introduced. Tune in a signal and adjust C_1 for maximum response. Advance R_2 slowly, simultaneously swinging C_1 back and forth through resonance. As regeneration is increased signals and noise both will become louder and C_1 will tune more sharply, until finally the mixer circuit will break into oscillation when, with C_1 right at resonance, a loud carrier will be heard, since the oscillations generated will go through the receiver in exactly the same way as a signal. Always work the mixer somewhat below the critical regeneration point and never permit it to oscillate in practical operation.

The procedure described above should be followed through for all coil sets. Barring mistakes in wiring or changes in circuit constants, particularly coil dimensions and tuning capacities, the only feature likely to give trouble is the regeneration. If the antenna happens to be nearly resonant in the band, it may not be possible to make the mixer oscillate; on the other hand if the antenna loading is negligible the circuit may oscillate continuously regardless of the setting of the regeneration control. The former condition can be cured by reducing the capacity of C_4 or by increasing the number of turns on L_3 . If the mixer oscillates continuously, the opposite remedies are required. The

latter condition easily can be recognized by a series of beats and chirps as C_1 is tuned over its range. Normally, only signals tuned in by the oscillator circuit will be heard, with C_1 having no effect except to control volume. Since the antenna loading changes with frequency, there may be cases where the mixer will go into oscillation at frequencies somewhat removed from the actual signal frequency, but operate normally at the latter. In general, it is not necessary to "push" the regeneration for the sake of signal strength. It is there chiefly to increase the signal-to-image ratio, which it does by the process of building up the desired signal. Peak regeneration is needed only when a desired signal is being QRM'd by an image, which happens a surprisingly small number of times in practice.

It is a good plan to spend some time operating the set without attempting to add regeneration to the i.f. stage, in order to attain complete familiarity with the method of handling mixer tuning and regeneration. As a straight super the receiver is, of course, considerably more selective than a t.r.f. receiver, especially to strong off-channel signals. Learn to keep C_1 always at resonance or on the low-frequency side of resonance with the incoming signal. Keeping exactly in line naturally requires "two-handed" tuning, but in practice it will be found that C_1 need not be touched when tuning over the portion of the band normally covered near the transmitter frequency. This conden-

ser may, in fact, be used as a volume control, in which case it is advisable to keep it on the high-capacity side of resonance so that it will be as far as possible from resonance with the image frequency. Its tuning will not be too critical so long as the regeneration is kept to a moderate value; at peak regeneration, however, the tuning is quite sharp. For operating convenience, be sure to pick out an easy-running condenser for C_1 —there's no band-spread on this circuit.

The oscillator-mixer coupling condenser, C_s , should be adjusted so that pulling of the oscillator frequency at 14 Mc. is negligible as C_1 is tuned through resonance with the incoming signal. The setting generally will be with the plates rather far apart. There will always be considerable pulling if C_1 is tuned to the oscillator frequency, even on the low-frequency bands. This, however, does not represent an actual operating condition. On 7 Mc. and lower there should be no detectable change in beat note as C_1 goes through the signal peak. A few hundred cycles change is typical of 14 Mc.

• I.F. Regeneration

When the operation of the receiver is completely familiar, the i.f. regeneration may be added. The method has already been mentioned; it remains only to describe the operation. The amount of feedback will be determined by the length of wire inserted in the can containing T_2 . Optimum selectiv-

ity usually will be secured when the regenerative coupling is adjusted so that the 6K7 goes into oscillation with the gain control, R_4 , fairly well "down"—far enough so that it is well below maximum gain and in the region where, without regeneration, its effect on gain is not great. There are two reasons for operation in this way rather than with the feedback adjusted so that oscillation takes place when the gain is near maximum. In the first place, the normal tube gain is not needed—the volume will be too great with both regeneration and high tube gain. Second, the selectivity will be considerably greater if the signals are kept at a low level and built up to a peak almost solely through the use of regeneration. Aim to balance gain and regeneration so that the average signal level, at resonance with peak regeneration, is about the same as with normal i.f. gain without regeneration. The off-resonance signals will then be rather far down, giving greater effective selectivity. With the conditions recommended, the i.f. regeneration gives a voltage gain of about 40 on a moderately strong signal; that is, the signal is 40 times as strong with regeneration as without it at the same i.f. gain-control setting.

For single-signal c.w. reception, set the beat oscillator so that when R_4 is advanced to make the i.f. just go into oscillation the resulting tone is the desired beat-note frequency. Then back off on R_4 to give the desired selectivity. Maximum selectivity, of course, will be secured

with the i.f. just below the oscillating point; noise and miscellaneous clicks and impulses will make a "ringing" sound at this point and the signal must be tuned carefully to be set right on the peak. At the peak the signal strength will build up to a large value as compared with a frequency slightly off resonance. With regeneration reduced slightly the ringing will disappear and the signal peak will not be quite so marked, although the selectivity still will be high. The "other side of zero beat" will be very much weaker than the desired side. A typical measurement, using a 1000-cycle beat note, gave a ratio of 35 db between the desired signal and the a.f. image, or 1000-cycle beat note on the "other side." The ratio will depend somewhat on the accuracy of i.f. tuning; the best method found is to peak all i.f. circuits as accurately as possible without regeneration, then to introduce the regeneration without further adjustment of the i.f. trimmers.

Since the i.f. amplifier works out of the mixer, it is to be expected that the latter will have some effect on the i.f. regeneration, and such is the case if the regeneration is worked too near the critical point. For example, if C_1 is slightly on the low-frequency side of resonance and R_4 is advanced to critical regeneration, tuning the mixer input to the high-frequency side may cause the i.f. amplifier just to go into oscillation. To overcome this, R_4 may be set so that the i.f. does not oscillate at any setting of C_1 ; this will give

somewhat less than maximum selectivity, but there is still plenty. Another method is to detune slightly the i.f. circuit in the plate of the 6L7, which will "decouple" the circuits sufficiently to make the i.f. regeneration independent of the setting of C_1 . This, however, has an adverse effect on the selectivity be-

cause of the staggered tuning.

A regenerative i.f. stage has a quite sharp peak when operated as outlined above. On phone, the sidebands are drastically cut, but it becomes possible to copy signals which otherwise would be completely drowned out by near-by carriers.

(See pages 52 and 53 for photographs)

THE HAM MAKER—

BY J. W. LATTIG

THE Ham Maker consists of groups of letters, numbers, and abbreviations arranged in groups of five; in other words, code words.

There are fourteen horizontal rows of these code words, each row containing fourteen groups. They are arranged in rows vertically and horizontally so that they can be read down or across.

This sheet was evolved after a long search for some economical, sure-fire way of giving code practice to aspiring hams. I have tried sending from newspapers but the fault there is that only common letters appear while z, x, j, q, and numbers seldom appear. Also there is no way of estimating your speed when sending this way.

All these faults are done away with in the Ham Maker. Every letter and number is included at least once in each line. Abbreviations

commonly in use appear often. Furthermore the sender, by glancing along the top of the page as he sends and keeping his eye on the watch, can keep a very accurate check on his speed. Suppose he finishes group two at the end of 15 seconds, his speed is 8 words per minute.

Some hams and would-be hams have attempted to solve the problem by making up sentences containing all the letters. This is a difficult task, and the code student unconsciously memorizes the sentences.

This is merely for practice after the beginner can recognize the characters. Vary this frequently with lots of copy from newspapers as it becomes very monotonous. Anyone who can copy 12 to 13 w.p.m. from the Ham Maker can easily copy 16-17 w.p.m. from newspaper copy.—RADIO NEWS for November.

The Ham Maker

	1	2	3	4	5	6	7	8	9	10	11	12	13	14
1	zaqws	xcedr	fvf	gbyhn	mju.	ikolp	22q	32s	poiuy	trewq	98k	75m	lkjhg	66b
2	ghikl	rfdsa	trqfb	bnvxs	mlk7	78f	qwaae	43g	bvexz	ployg	74o	m96	42m	gtrwq
3	qplfg	hgkjp	92r	r65	74d	sslpq	inoet	35c	x01	23m	msqzm	kdlpw	hydra	90k
4	w4dk	fua2	ipjl	sedki	mmbxc	vsdfg	hdsja	k83	24y	cantk	leaky	quick	doggy	slipk
5	crook	swigq	s7sq	frtyu	kyrwq	awpia	12y	kra9	w98	pinky	boppq	scram	zincx	xer.
6	whose	ink8	mqs7	35m	kitty	sweet	kiddo	nlkjw	w3dg	hurry	w6tg	wzk7	clunk	tac.
7	meete	bendj	moq.	x-hi	ill?	xenia	pjm.	62m	as7m	dew2	wait.	break	sox6	wheng
8	eqdew	7hot	bgbjk	.7j	frogs	soopy	piqky	io199	atf.	8vu	sqvak	7-k	xx6	yucyi
9	aqsew	dteef	frvgt	hby8	97j	nkm4	29i	lop.	90t	soq.	dew2	tht4	5e5	h55
10	d57	49g	ripto	bit3	73k	fpikj	awrgq	mkptg	.v.	lmcfg	ivjse	tinko	blabs	w9gt
11	cqcd	ew9q	jrkkf	hisis	w9qj	r.ga	kpsck	rat4	82r	st.s	qrtps	compe	etaxo	b73
12	urnix	s92	7sqp	grhkm	cadkf	.r.	frank	poppy	w60	46v	cantl	eak7	58f	oru9
13	gak?	sw15	34b	qlsfr	ipltd	?s	yuhxs	wdjna	isu5	lijp	twitt	steep	sleet	ar-a
14	pl.o	kmijn	ubb7	ygx6	5tfc	rdx4	3esa	waq2	8,x	7arh	SOS,1	dew5	taxob	73a

Power Pack: TRANSFORMER DESIGN

[As described on pages 34-38]

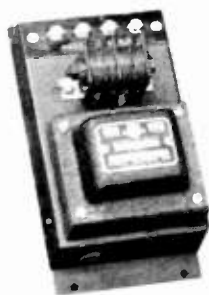

Illustrating the various steps from the coil to the finished transformer. A d.c. power pack which uses one of this type of transformers is shown to the left.

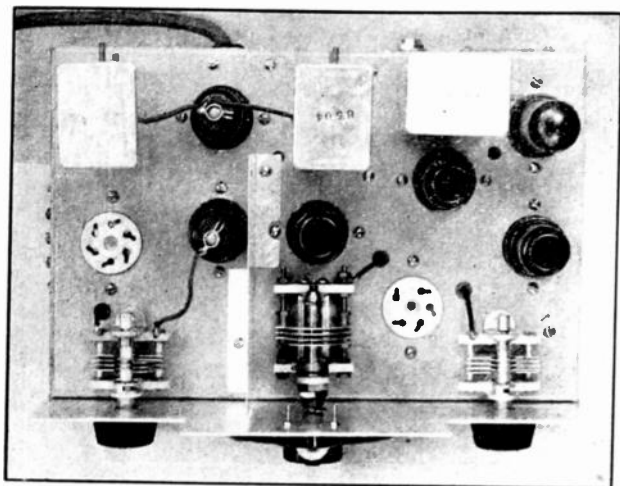

• The tubes and most R.F. components are plainly shown in this plan view. The location of various ports is discussed in the text. The i.f. transformers are permeability-tuned, with high-stability fixed mica condensers. Any type of air-tuned iron-core transformer may be used instead.

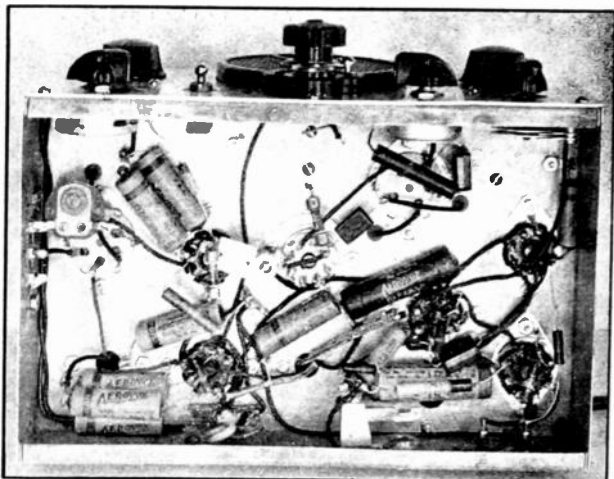

• Left—Below chassis. Chiefly by-pass condensers and resistors.

A Low-Cost SINGLE-SIGNAL RECEIVER

[As described on pages 39-48]

[Cuts courtesy QST]

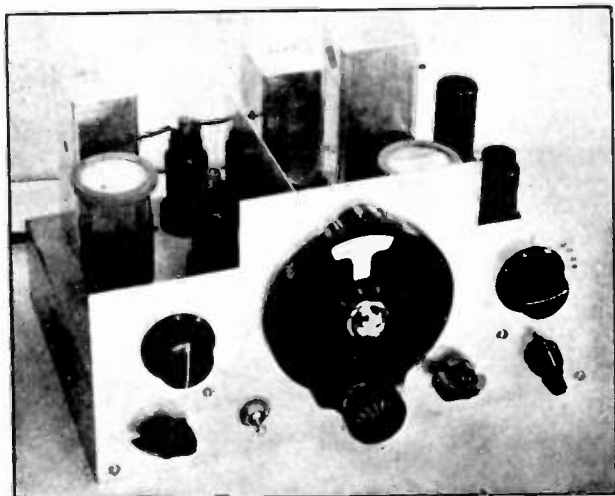

• This six-tube S.S. receiver can be built for about twenty-five dollars, with tubes. A regenerative i.f. stage gives single-signal selectivity; a regenerative mixer is used to provide good signal-to-image ratio. Power supply requirements are 2.1 amperes at 0.3 volts, and 60 milliamperes d.c. at 200-250 volts, for loud-speaker operation.

A Broadcast Type MODULATION INDICATOR



Figure 1. Panel view of the rock-mounting type modulation indicator.

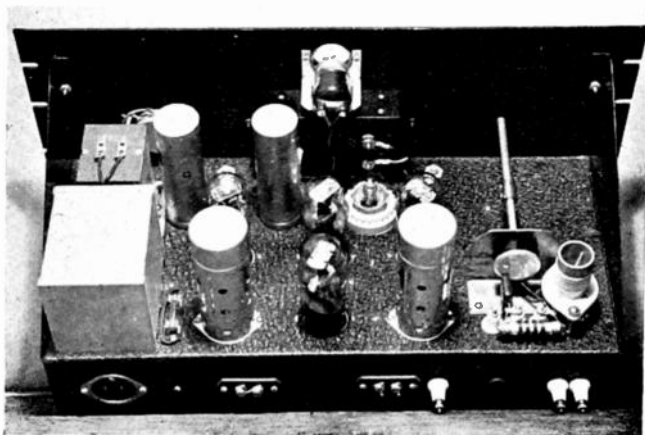

Figure 2. Rear view showing the shielded input circuit on the right, the various other components in the center and the special power transformer and choke alongside the left edge of the chassis.

A Broadcast Type

MODULATION INDICATOR

BY HENRY G. JONES

IN this day of frequent air checks by F.C.C. monitoring stations, it is quite essential that amateur stations be operated correctly—unless, of course, the amateur has the short-lived hobby of collecting pink and green tickets. Good modulation indicating equipment is excellent insurance on the life of the amateur phone station, and will relieve the phone man of a lot of worry when the rig is being operated.

Most modulation indicating devices commonly used by amateurs are lacking in the ability to register accurately the type of modulation peaks of short pulse duration that result from the varying, complex wave forms of speech sounds. Some are so highly damped in order to avoid overswing of the indicating instrument that they miss speech peaks entirely, and others are so fast that they go far beyond the actual modulation percentage. In both cases, definite and reliable in-

dication of actual peaks is usually lacking. Oscilloscopes are fine business for initial adjustments and tuning up, but critical to handle for the continuous monitoring necessary nowadays. They also lack definite peak indication, for which reason the F.C.C. does not approve them for broadcast use.

If you are satisfied with the usual run of ham-station measuring devices, do not visit a first-class broadcast station as the writer of this article did, or you will start figuring on some new equipment immediately. The broadcast types of modulation indicators provide good measuring. Ease of adjustment, a percentage-calibrated instrument that has a rapid upswing but does not go too far on the peaks, (the same instrument having a slow return to keep from bouncing), and a means for instantaneous indication of peaks over any desired modulation percentage are their common fea-

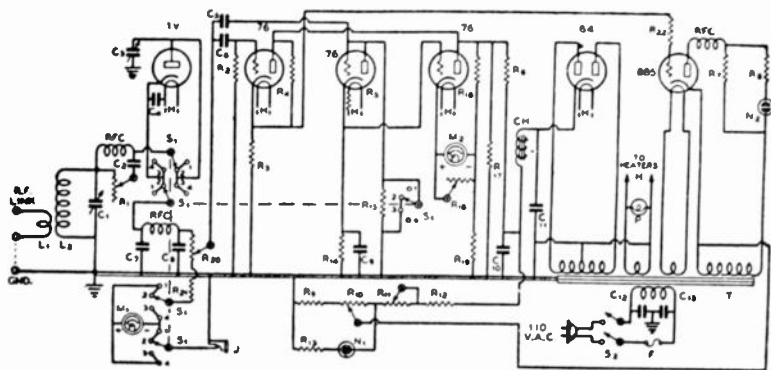

FIGURE 3. SCHEMATIC DIAGRAM

C ₁ —50- μ fd. midget variable	R ₃ —70,000 ohms, 1/2 watt	R ₁₅ —15,000 ohms, 1 watt	RFC—2 1/2-mh., 125-mo. r.f. chokes
C ₂ —0.0001- μ fd. mica	R ₄ —700,000 ohms, 1/2 watt	R ₁₆ —40 megohms, $\pm 5\%$ (see text)	M ₁ —0.5 d.c. milli-ammeter
C ₃ —35- μ fd. ultra midget var.	R ₅ —10 ohms, 10 watts	R ₁₇ —560,000 ohms (1/2- and .06-meg. 1/2 watt in series)	M ₂ —0.5 d.c. milli-ammeter
C ₄ —0.0001- μ fd. mica	R ₆ —56,000 ohms (50,000, 2 watt and 6000, 1/2 watt in series)	R ₁₈ —700,000 ohms, 1 watt	S ₁ —5-pole, 4-throw tap switch
C ₅ , C ₆ —0.25- μ fd. 400-volt paper, can type	R ₇ —10,000 ohms, 10 watts	R ₁₉ —27,000 ohms, 1 watt	S ₂ —D.p.s.t. a.c. line switch
C ₇ , C ₈ —0.0025- μ fd. mica	R ₈ —1,000 ohms, 1 watt	R ₂₀ —1000 ohms, 10 watts, semi-fixed	N ₁ , N ₂ —1-watt neon glow lamps
C ₉ —0.07- μ fd. mica $\pm 10\%$ type	R ₉ —15,000 ohms, 1 watt	R ₂₁ —70,000 ohms, 1/2 watt	T—Special power trans. See text
C ₁₀ , C ₁₁ —8- μ fd. 450-volt elect.	R ₁₀ —15,000-ohm pot.	R ₂₂ —3000-ohm pot.	CH—40-hy., 1500-ohm, 10-ma. choke
C ₁₂ , C ₁₃ —0.5- μ fd. 400-v. tubular	R ₁₁ —30,000-ohm pot.	R ₂₂ —8000 ohms, 2 watts	L ₁ , L ₂ —Tuning coil (see text)
R ₁ —500-ohm pot.	R ₁₂ —40,000 ohms, 2 watts		
R ₂ —560,000 ohms (1/2- and .06-meg. 1/2-watt in series)			

tures. These are the requirements we desired in our modulation meter. We obtained them by constructing one similar to those commercially available to broadcast stations.

• General Operation

The r.f. signal to be monitored is fed into the meter through a low

impedance link circuit L₁ to a tuned circuit comprised of L₂ and C₁. The amount of r.f. input is controlled by R₁, which is isolated from the d.c. circuit by condenser C₂ and RFC. This r.f. is rectified by the first diode, a 1-V, and the signal is filtered out by C₇-RFC-C₈ allowing a pulsating direct current to flow in

the first diode load resistor R_{20} - R_{21} . The carrier meter M_1 reads the average value of this direct current, which is proportional to the average carrier input voltage. The average component of the voltage across this load resistor excites two indicating devices—one an instrument, M_2 , calibrated directly in modulation percentage, the other a flasher circuit for providing warning when a certain degree of modulation is exceeded.

The modulation indicating instrument operates as follows: The audio component previously referred to is rectified by the second diode detector, a 76, and charges a condenser C_9 . Since this condenser has only a 40-megohm load, R_{14} , across it, appreciable time is required for it to be discharged. The voltage across this condenser is impressed across the grid circuit of a voltmeter tube (another 76) which has the modulation meter M_2 in its cathode circuit. This voltmeter tube circuit is indifferent to plate voltage changes. The resistor-condenser combination R_{14} - C_9 gives the modulation meter the characteristic of rapid increases and slow decreases in indication, which makes for better reading and also reads peaks of short duration much more accurately.

For the flasher circuit, the same audio component is impressed across the grid circuit of a triode detector (a 76). The output of this detector appears across the cathode resistor R_3 and is impressed upon the grid circuit of an 885 discharge tube. The bias on the 885 is con-

trolled from the front panel, this control being calibrated from 50 to 130, representing per cent modulation. The 885 is normally biased to cutoff and when the audio voltage exceeds a value determined by the peak-level control R_{10} the tube passes current and operates the neon lamp N_2 in its plate circuit.

• Construction

As shown in the photographs, the unit is designed to fit in a standard 19-inch rack; in our case it is mounted with the transmitter speech equipment on the operating desk. The panel is standard $\frac{1}{8}$ " steel $8\frac{3}{4}$ " x 19", to which is fastened an 8" x 17" x 3" chassis. The parts are arranged for symmetry, short leads where needed, and r.f. isolation; nearly all of the wiring is subpanel. The input circuit components L_1 , L_2 , RFC, R_1 , and C_2 are mounted on the top left-hand side of the chassis to the rear. A shaft extension is run back to R_1 to permit short leads. C_1 is mounted below the chassis directly under these parts, the leads running to it using small feed-through insulators.

In line to the rear of the chassis are mounted the 1-V first diode (shielded), 76 triode detector, 885 discharge tube (shielded), fuse and power transformer. In the middle row are located the 76 second diode detector, the 76 voltmeter tube and the 84 rectifier. N_1 the neon-lamp voltage stabilizer, is mounted toward the front of the chassis in a standard sign receptacle lined with C_{10} , C_{11} and the filter choke. The audio calibration control R_{20} and

the flasher calibration control R_{11} are mounted below the chassis near the front, R_{20} to the left and R_{11} to the right. These are standard potentiometers with their shafts cut off and slotted for screwdriver adjustment.

The peak indicator tube N_2 is located in the top center of the panel, utilizing an Amphenol eye assembly and a molded bakelite lamp socket for mounting purposes. The twin instrument can be seen in the center with the r.f. input control R_1 to the left and the peak level control R_{10} to the right. Along the bottom from left to right are lined up the input tuning control, C_1 balancing condenser control, C_3 , the polarity switch control, S_1 , pilot lamp, monitor jack and power switch.

Below the chassis, C_3 and S_1 are mounted toward the rear by using shaft extensions. Since many resistors are required, neat wiring was obtained by mounting most of them on two thin bakelite cards. On the card in the center are R_2 , R_3 , R_{22} , R_{14} , C_9 and R_{15} . The other card has R_{18} , R_4 , R_7 , R_6 , R_{17} , R_{16} , R_8 , and R_9 mounted on it. This leaves a few additional components, which are mounted directly on the parts with which they are associated. Filament leads are twisted, and cabled with power supply leads, but r.f. and audio leads are run directly and as short as possible.

The a.c. input is run in the back of the chassis through a recessed male receptacle, and r.f. and ground through small feed-in insulators which extend out from a dust cover. Two terminal strips are shown in

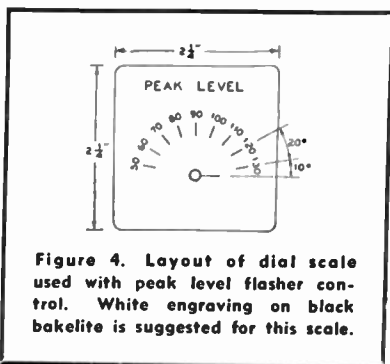

Figure 4. Layout of dial scale used with peak level flasher control. White engraving on black bakelite is suggested for this scale.

the photograph but they are not ordinarily used. One of them was intended to bring out leads so that additional percentage modulation meters could be placed in the circuit for remote operation and also calibration; the other for placing a 4-ohm shunt across the carrier meter, changing the range. This may be used when utilizing the modulation reading meter as an output meter in reading small levels.

• Parts

In some cases, to get the proper value of condensers and resistors, several stock sizes had to be connected in series or parallel as the case demanded. For example: To get the plus or minus 10% .007 μf . required for C_9 , standard tolerance .005- μf . and .002- μf . mica condensers were paralleled and checked on a capacity bridge. R_{14} , the 40-megohm plus-or-minus 5% resistor, was ordered special from the S. S. White Co. Several companies lately have started marketing high-resistance accurately calibrated

resistors, so that it should not be very difficult to obtain one. However, if access is had to a high-range accurate ohmmeter, this value may be obtained by checking two 20-megohm stock resistors and using them in series.

The polarity switch connections look rather foolish at first glance, but are necessary to prevent the meters from banging their pointers against the pins when switching from positive to negative peaks while in operation. A three-section six-pole four-throw nonshorting switch, a stock item, was employed; one pole of it is not used.

N_1 and N_2 are standard GE screw-base one-watt neon lamps with a little work done on them. These lamps have a series resistor of fairly high value in the base, which must be removed. Use the old and tried tube-base removal method: heat the bulb in boiling water, unsolder the leads, remove the base and clip out the resistor. Replace the base on the bulb while still hot and resolder the leads; usually no additional cement will be required to hold them together.

The high-voltage power supply requirement is very low; the direct current required for the entire unit is around 10 milliamperes at 350 volts. The power transformer used as shown in the photographs is an RCA replacement part number 16766 which can be ordered through your local jobber. The use of this particular transformer insures having correct voltages on the various components and makes it

possible to get all the required voltages in one compact unit. However, should it be desired to use a standard replacement type transformer, the following ratings will be necessary: one 2½-volt 1.4-amp. winding for the 885, one 6.3-volt 1.7-amp. winding for the 1-V, 76's and 84, a high-voltage winding to put out 350 volts d.c. at 15 milliamperes (approximately 600 volts a.c. center tapped with condenser input will do this), and a winding having 160 volts a.c. for the flasher circuit. It will probably be difficult to find a small transformer with both a 2½-volt and 6.3-volt winding, in which case an 884 can be substituted for the 885, the only difference being the 6.3-volt filament of the 884. All tubes can then be run on a single 6-volt winding. The real catch in substituting transformers comes in getting the 160-volt winding. This would best be obtained by using a separate transformer which could very easily be constructed by the amateur. Small wire can be used in this winding as the current demand for the flasher circuit is quite low. Some of the early types of sets have windings which from center tap to one side of the high voltage will give close to the value needed, and perhaps one of these can be found in the overworked junk box.

The filter choke used, an RCA part number RT331, was ordered with the transformer. This choke has an inductance of 40 henries and a d.c. resistance of approximately 1500 ohms. Substitution here is

easy as the choke has to carry only about 10 milliamperes. One such as Thordarson T74C30 should be quite satisfactory. In making voltage checks on the complete unit, 350 volts should be measured from the filter choke to ground, 115 volts from plate to ground on the flasher amplifier, and 115 volts from plate to ground on the voltmeter amplifier.

- Choice of Resistors

In the choice of variable resistors, it is a good idea to use wirewound ones since they will maintain calibration where bleeder current is running through them. An exception to this is the r.f. input control R_1 , where a non-inductive type should be used since r.f. is being handled. R_{10} is a Yaxley M15MP 4-watt wirewound linear-taper potentiometer.

- Choosing the Instruments

Care should be taken in the choice of the percentage modulation meter, as the unit to be used should have a high-speed movement with a minimum of overthrow. Quite a few different types were tried before a satisfactory one in the reasonably low-price class was found. Weston makes a meter for this purpose that is really marvelous to watch in operation, seeming nearly as fast as an oscilloscope picture and yet overswinging very little. This meter would be ideal but is really too high priced for the average amateur, since it sells for around \$35. In testing different types of

500-microampere meters, we fortunately tried the d.c. movement of a 1200A Triplett tester and found it to be just what we were looking for. This meter is quite fast and has good action, due partly to having a light knife-edge pointer which reduces the momentum and also gives an air damping effect on the peaks of rapid swings. This type of pointer travels through the air broadside, creating enough air resistance when moving rapidly to give the required retarding effect on peaks.

The carrier meter M_1 is a standard d.c. milliammeter having a range of 0 to 5 milliamperes. In ordering the meters special the twin instrument type was decided upon for appearance and convenience. These can be furnished in any combination desired. Specify the meter as follows: left side to be 0.5 milliamperes marked carrier; right side to be 0.500 microamperes, same type movement as in 1200A tester, knife-edge pointer, scale divisions marked 0-120, and labeled per cent modulation. Submit a drawing of the scale desired.

This meter is later shunted to the required 0.600 microamperes by the semi-variable resistor R_{18} . To do this put the shunted meter in series with an accurate 0.1 milliammeter, battery and variable resistor. Adjust the current flow to 0.6 ma. on the 1-ma. meter, and set the shunt to give full scale deflection on the percentage meter. For convenience, a line should be made on the M_1 meter scale at the 3.8-ma. carrier reference point.

The peak-level dial scale shown was made of a good grade of dull black poster cardboard with white drawing ink lettering. Three or four coats of thin clear varnish give a nice finish and provide protection for the lettering. This of course could be made to order by a bakelite engraving company if so desired. The dimensions are given in the drawing.

- Coils

The plug-in r.f. input coil L_1 - L_2 is wound on a one-inch coil form. L_2 is wound to hit the desired frequency, and L_1 to give sufficient coupling, depending on the line impedance and the amount of r.f. available from the transmitter. The number of turns in L_2 is quite critical and is affected by the coupling to L_1 , so some cutting and trying will probably be necessary. For the 80-meter band, L_2 has 35 turns of no. 28 d.c.c. wound 60 turns per inch; for 20 meters, $7\frac{3}{4}$ turns of no. 22 d.c.c. wire spaced to $\frac{5}{8}$ inch; for 10 meters, 4 turns of no. 22 d.c.c. spaced to $\frac{3}{4}$ inch. A two-turn link interwound at the cold end should be sufficient in most cases. After the coils have been wound and tested to hit frequency and coupling, give them a good coat of coil dope.

- Adjustments

Set meters M_1 and M_2 to read zero with the power on but with no r.f. being fed in. An r.f. link circuit with a twisted-pair line should be run either to the final

tank circuit or to the antenna tank if one is used. The amount of coupling necessary will of course vary with the amount of power being run in the transmitter. Ordinarily, very loose couplings can be employed as normally only about a quarter of a watt of r.f. is needed to operate the meter. With the polarity switch set in the negative position and the r.f. input control R_1 at maximum (minimum resistance), feed in r.f., tune C_1 to give maximum reading on the carrier meter M_1 and adjust the coupling link at the transmitter to increase this reading to approximately full scale. Now reduce this to the 3.8-milliampere carrier reference value with input control R_1 and throw the polarity switch to positive. If the carrier meter does not read the same, adjust balancing control C_3 to compensate for asymmetry of the r.f. voltage so that with the same r.f. input the meter reads the same with the polarity switch thrown in both positions. This does not affect the calibration of the modulation meter or peak indicator.

- Calibrating for Modulation Percentage

To calibrate the modulation percentage meter, set the polarity switch to negative and feed sufficient signal to the transmitter (constant-frequency modulation) to cause over 100% modulation. Adjust r.f. input to the 3.8 reference value and vary the audio calibration control R_{20} until the modulation

meter reads 100%. This calibration depends upon the transmitter's working properly so that negative peaks reach 100% on over-modulation. If possible, an oscilloscope should be used in conjunction with this calibration to see that the transmitter is modulating properly.

To set the control tube, have sufficient carrier and modulation to give a reading of 100% on the modulation meter, turn the peak level control knob until the neon lamp just flashes and note position of pointer. Reduce the modulation meter reading to 50% by either reducing the r.f. input or reducing the transmitter per cent modulation, and again rotate the peak level control knob until the neon lamp just flashes. Measure the distance between the positions at 100% and 50% modulation, which should be the same as 100% to 50% on the pointer scale. If not, it will be necessary to change the position of the calibration control R_{11} until this condition results. When this condition has been satisfied, loosen the nut holding the peak-level control on the panel and rotate the control itself until the neon lamp just breaks down with the pointer on 50, with the modulation meter still reading 50%. Check back on 100% modulation and see that the neon lamp just flashes when the

control is set at 100. These adjustments sound quite complicated, but once they are learned they can be done quite rapidly.

With the arrangement shown for aural monitoring, calibration will be disturbed when the headset is plugged in. This could be remedied by reducing R_{21} by an amount equal to the resistance of the headset, and switching in another resistor of this value with the mounting jack. However, this was not deemed necessary since these checks are infrequent and only of short duration.

In addition to the general monitoring for which the meter was intended, amplitude and frequency characteristics of the transmitter may be taken if a suitable audio source is available. An overall amplitude characteristic may be taken by using the modulation meter as an output meter and impressing measured audio voltage on the input of the speech amplifier.

The phone man constructing such a unit will have a valuable addition to his station, and will be fully repaid for his effort and outlay by the performance and security to be derived from a broadcast-type modulation indicator. That trip to the broadcast station will put you to work.

(See page 54 for photographs.)

AIR GIANT DC-4

WHEN the giant new Douglas airliner DC-4, now undergoing tests at Santa Monica, California, roars into the sky with 42 passengers and three tons of air express, she will carry the most powerful and comprehensive radio telephone system yet developed for commercial air transport service.

The 250-watt transmitter installed aboard the DC-4 is five times more powerful than conventional airplane equipment and includes many unique features. For the first time, a flight crew is equipped to make simultaneous observations of the beacon, weather and marker signals while holding two-way communication with the landing field. During flight the pilot may talk over any one of ten different frequency bands, and a special direction finding loop enables him instantly to check the ship's position with respect to ground stations.

All major components of the system are assembled to form a panel installed on the "bridge" immedi-

ately behind the co-pilot's position. This unit, operated remotely from a master control column which rises between the pilot and co-pilot, is entirely self-contained and is comprised of the transmitter; communication, beacon, auxiliary and marker receivers; and the intercommunicating system amplifier.

As the ship passes from one radio zone into the next, the transmitter and communications receiver to which it is geared are shifted progressively through five pairs of "day" and "night" frequencies by means of a rotary dial on the transmitter panel. Instantaneous shift from day to night frequency is effected by a push-pull lever located on the master control column. Quartz-plate oscillators of new and improved design hold the several frequencies within required limits and a forced draft ventilation system cools the transmitter with filtered air.

The communications receiver, too, is crystal controlled and is of the superheterodyne type. It is adjusted

to maximum sensitivity from the master control column and thereafter is regulated automatically by a special vacuum tube circuit.

The beacon receiver is basically similar to the communications receiver but different in its purpose and in several minor features of mechanical design. Provision is made for reception on either a conventional single wire antenna located beneath the ship's fuselage, or from the shielded direction finding loop enclosed within the ship's plastic nose. The receiver can be tuned to any frequency between the limits of 195 and 415 kilocycles by means of an illuminated dial on the control column, on which is also mounted the sensitivity control knob and an indexed dial showing the loop position.

An auxiliary receiver, which may be operated from battery supply in event of power failure, covers all of the frequencies to which the pilot

would normally have occasion to listen. It is tuned remotely from the control column by flexible shafting.

Marker zones are indicated by a series of colored signal lights which appear in the cockpit and which may be augmented by an audio signal to the headset. The crystal controlled superheterodyne receiver operating these devices requires no operating attention during flight.

Performance specifications for the new equipment were compiled by four leading airlines: United Airlines Transport Corporation; Transcontinental and Western Air, Inc.; American Airlines, Inc., and Eastern Airlines, Inc. The system was designed by Bell Telephone Laboratories, and more than two years were required to perfect and complete the initial model. It is the first complete commercial aviation radio system ever built for operation from 800 cycle power supply.

●

A SURVEY by the Marketing Department of De Paul University shows that approximately 20% of all radio receivers in operation are over 5 years old. 14.7% are between 4 and 5 years old; 18.7% are between 3 and 4 years old; 20.3% between 2 and 3 years old and 20.6% between 1 and 2 years old.—Ohmite News.

An Electric Timing Device

BY ROBERT W. CARLSON
WBNY, BUFFALO

Simple timing device, using synchronous clock mechanism, phototube, and amplifier is described. May be used to transmit timing impulses or control time sequence operations. Low in cost; simple in construction.

AN accurate, inexpensive electric timing device operated by means of a synchronous electric clock mechanism in conjunction with a phototube and its accessory amplifier may be made to perform a wide variety of timing operations. At WBNY a simple timing device built along these lines has proven useful in transmitting time impulses or chimes every half hour, although the system to be described lends itself readily to the production of timing impulses at other time intervals if this is desired. The device is simple both in operation and construction, and the precision of operation is dependent for all

practical purposes, only upon the accuracy of the mean frequency of the a.c. power supply line and the time operating characteristics of the relays in the control circuit. The frequency of regulated power supply lines from which clocks may be operated is usually maintained much more accurately than is ordinarily required. With proper care and attention, the time characteristics of the relay may be made quite uniform over a long period of time. Consequently the overall precision of the device is satisfactory for all ordinary purposes. In practice the timing device has been found to be accurate to within one sixtieth of a second.

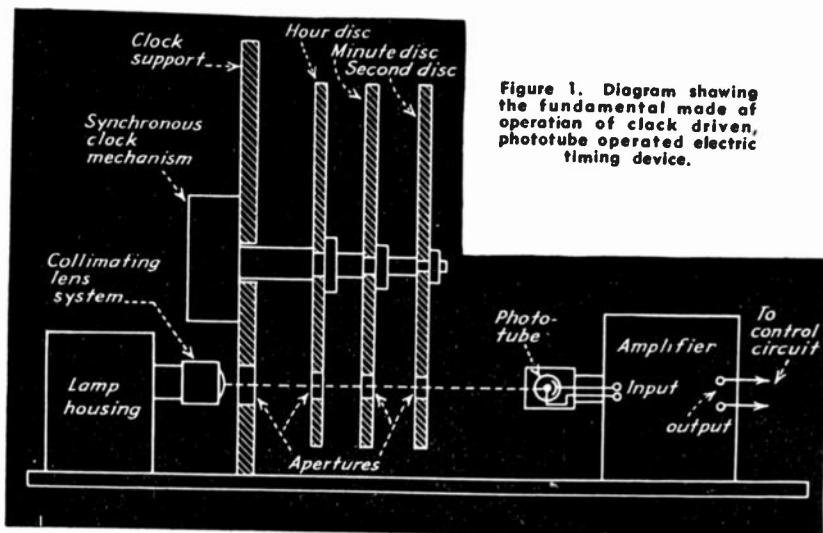

Figure 1. Diagram showing the fundamental made of operation of clock driven, phototube operated electric timing device.

The fundamental method of operation is indicated in figure 1. The essential elements of the system include a synchronous clock mechanism having the usual clock hands replaced with opaque discs having suitable apertures, a light source, and a phototube, together with its associated amplifier and control circuit. The hour, minute, and second hands rotate, respectively, once every twelve hours, once every minute, and once every minute, in accordance with the motion of the hands they replace. The discs are provided with one aperture each near their periphery, and by means of adjustable collars by which the discs are attached to their proper shafts, the apertures may be made to become aligned at any desired time, with the light source and

phototube. The apertures, which are slightly wedge shape, are cut so as to subtend an arc of 6° .

When the apertures are aligned with the light source and the phototube, the light impulse acting on the phototube may be converted into an electric current impulse which may be made to operate any circuit in the output of the amplifier. The duration of the impulse is one second after which the light is cut off by the opaque disc of the second hand. When the aperture of the second hand returns to the position of original alignment with the lamp and phototube, the minute hand has moved 6° and cuts off the light so that no signal impulse is possible. With this method of operation, an impulse may be transmitted once every twelve hours.

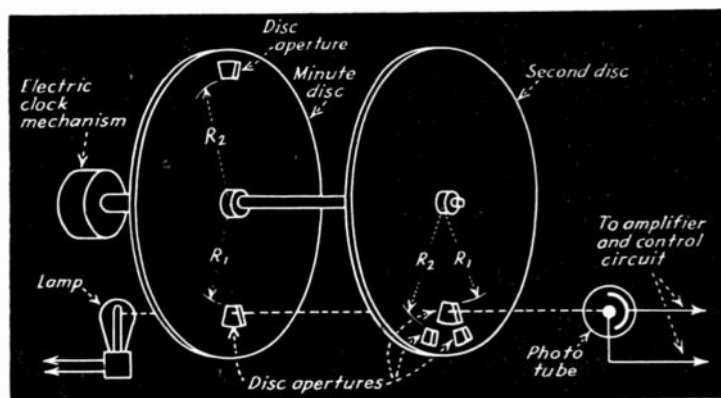

Figure 2. Simplified and improved form of electric timer producing one pulse on the hour and two pulses every half hour.

Although only one lamp and phototube are shown in figure 1, it is possible to extend the fundamental method so that, through the use of a plurality of lamps and phototubes, impulses may be transmitted at several equally spaced time intervals throughout the day. Because such a system does not permit impulses to occur at convenient time intervals, another system was developed which operates every half hour.

An improved version of the fundamental system of operation, designed to transmit a single impulse every hour and two short pulses on the half hour is shown in figure 2. The apertures on the minute disc are 180° apart and are cut for two different radii, R_1 and R_2 . One aperture on the second disc has a radius of R_1 and two adjacent apertures on this same disc have radii R_2 . All of the apertures

on the second disc are symmetrical placed along one radius vector rather than being displaced 180° as in the case with the minute disc.

Every hour on the hour the apertures on the two discs which have radius R_1 become aligned and a light impulse is permitted to flow to the phototube, actuating the control once. Hourly on the half hour, the apertures having radius R_2 become aligned with the lamp and phototube, and two short impulses actuate the control circuit through the intermediary of the amplifier and the phototube circuits.

With this arrangement, which was designed primarily to provide a time signal for use in broadcasting, a service highly appreciated by the listener, it can be seen how a tone or chime can be controlled by the relay circuit in the phototube amplifier.

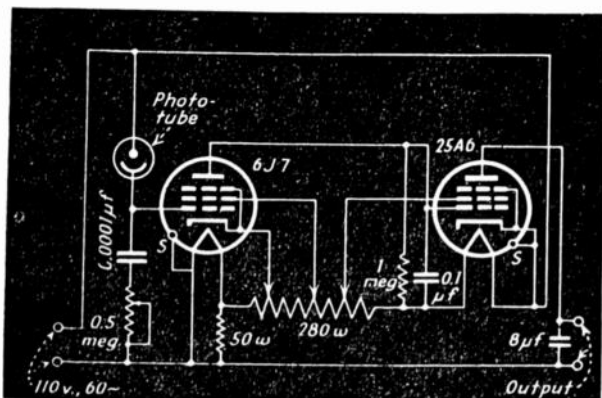

Figure 3. A simple two stage a.c. operated phototube circuit and amplifier functioning in a negative direction on the received light.

It is important to select a type of phototube, amplifier, and relay whose operation is dependable and whose time lag is small or at least very constant. It has been the author's experience that the emission type of photoelectric device performs most satisfactorily. The selenium or resistance type of photosensitive device was found unsatisfactory because of its lack of sta-

bility. The generating or barrier layer type of cell proved unstable with the heat developed by the voltage dropping resistors which were used in the amplifier.

A wide variety of amplifier circuits is available for amplifying the phototube current. Two circuits which have been found useful at WBNY are illustrated in figure 3 and figure 4, both of which oper-

Figure 4. Another simple a.c. operated phototube control circuit operating in a positive direction on the light received by the phototube.

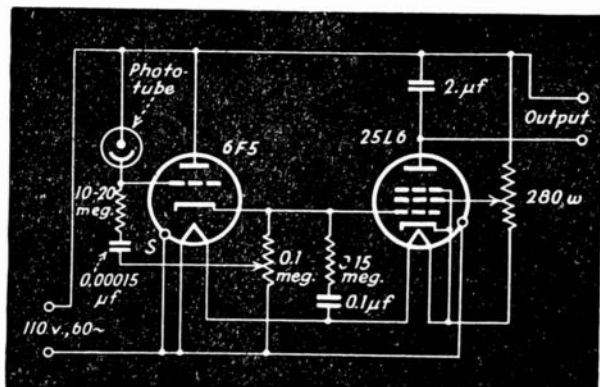

ate directly from the 110-volt a.c. line. The circuit shown in figure 3 operates in the absence of light, whereas that of figure 4 operates by virtue of the presence of a light beam.

Since the resistance of the phototube is likely to be much larger than the resistance in series with it, the major portion of the applied voltage will appear across the phototube. The peak instantaneous voltage across the phototube may

be as much as 150 volts when the line voltage is 110 volts r.m.s. This voltage is in excess of the ionization potential of most gas phototubes. A vacuum type of phototube is recommended for use rather than a gas phototube which would ionize over a considerable portion of the positive half of the cycle.

As in all phototube circuits, careful attention must be given to the matter of insulation resistance if the circuit is to operate most satisfactorily.

Amateur Auto Plates

MICHIGAN ham taurists in 1939 easily may be identified on the highways by their license plates which will bear their call letters, according to members of the Detroit Section of the Central Division Radiophone Association. Michigan is the first state to recognize the amateur by issuing to him a special automobile license plate bearing his federally-assigned station call letters. Others, no doubt, will follow suit in the near future.

In order to secure these special tags, amateurs throughout the state must make application for them at an early date. The Radiophone Association, with headquarters at 3-523 General Motors Building, Detroit, is compiling a list of those desiring them which it will forward to the secretary of state's office in the near future. When these plates are ready, they will be delivered to the nearest branch office along with the regular ones for assignment to the general public. There will be no additional charge for this service.—Radio.

The American System OF BROADCASTING

• BY DAVID SARNOFF
PRESIDENT, RADIO CORPORATION OF AMERICA

IT HAS been my privilege to be associated with radio for more than thirty years. At an age when the average boy is still wearing a football headguard or a catcher's mask, I was proud to wear a radio telegrapher's headset. The radio telephone was nothing but a dream, and radio broadcasting was not even that.

There were only a handful of us in those days, but during the intervening years thousands of able men and women have joined our ranks. A vast radio industry has grown up. No other industry ever grew so fast. The years and days and hours have been crowded with a never-ending procession of new discoveries, new developments, new services.

The pagan conception of Mercury serving the gods on Mount Olym-

pus never approached the present-day reality of radio, the modern messenger that travels with the speed of light, encircling the globe seven times in a single second. Radio carries messages between all nations. Oceans, mountain ranges, and man-made boundaries alike are powerless to hold it back. It safeguards the passage of ships at sea and in the air. It has given mankind the greatest means of mass communication ever devised. It brings the voice and the music of civilization—and some day will also bring its living image—into the most isolated home.

Nature yields her secrets slowly and reluctantly. It has been a hard, exciting struggle to take these ether waves, that have filled the atmosphere since the beginning of time, and in a single generation harness them to serve mankind.

Although my subject concerns broadcasting, I am not speaking as a broadcaster. I am speaking as one of the pioneers of a new art, of which broadcasting, however significant, is only a part. I speak as one who has watched that art develop from the beginning. I am concerned with the opposition to which all new arts are exposed, and with the forces which tend to shackle their freedom and curtail their development. I speak to preserve broadcasting as one of the free institutions of our democracy.

- What Is Broadcasting?

Broadcasting consists of more than wavelengths, more than towers outside and equipment inside a radio station. It is a service of entertainment, culture, and information. The greatest significance of broadcasting is in the directness of its appeal, not merely in the speed and spread of its message. Many of its programs originate in a single local station, and are heard only in a single listening area. Here radio performs an important community service.

The national services of the American system of broadcasting, however, depend upon more ambitious programs, nationally distributed. In the broadcasting systems of other countries there is nothing comparable to the great transcontinental networks across the United States. These are voluntary associations of independent stations, each an important economic and social factor in its own community.

During a portion of the time, each station broadcasts national instead of local programs. During the remaining time, stations associated with the National Broadcasting Company, for example, may choose whether they will broadcast national or local programs.

Without this linking of broadcasting facilities there would be no national service of broadcasting. Without networks the vast majority of the American people would never have the opportunity to hear the voice of their President, or the music of Toscanini, or the debates of the Town Meeting of the Air. Tapping the talent sources of the world, American network broadcasters have made a radio receiving set infinitely more valuable in the United States than it is anywhere else in the world.

- Broadcasting a Young Art

When we talk about the American System of Broadcasting we are talking about something barely eleven years old. The first nationwide broadcasting network was created by the National Broadcasting Company in November, 1926. And because it is young, the American system is still developing, subject to constant experiment and change.

In its present state, there is only one certainty about the technical development of radio, and that is the certainty of change. Its greatest achievements still lie in the future. The public services of radio sight will soon be added to those of sound. Radio facsimile, which makes

it possible to deliver a radio newspaper into the home, may supplement the regular services of the press. Television will bring us the faces and gestures of speakers and artists, as well as their voices, and will enable us actually to see news in the making. As new inventions create new channels in the ether, not only in short waves but in waves measured in centimeters and millimeters, the day will come when there will be more wavelengths than broadcasting stations to use them.

Whatever controls over broadcasting are necessary at the present time, it is important that they should be kept as flexible, as free from rigidity, as the art itself. Otherwise there is danger of tying up the future usefulness of radio in a strait-jacket. We should not try to regulate something as yet unborn; and we should not free an expanding art in any rigid code.

- Relation of Radio to Government

If wavelengths were now available for an unlimited number of broadcasters, there would be no more need for special government regulation over broadcasting than over the printing of newspapers.

It is the allocation of station frequencies, which for the moment are limited in number, that creates a difficult task for the Federal Communications Commission. The Commission deserves great credit for having helped broadcasters to make the present American System of Broadcasting what its name says

it is: something that is both systematic and American.

The law empowers the Commission to license broadcasting stations for periods not exceeding three years. In practice, however, the Commission grants licenses for only six months, on the theory that it is easier to reject an application for renewal than, for any reason, to cancel an unexpired license. When its license comes up for renewal, if the station has operated with technical efficiency, and if, in the opinion of the Commission, it has served "the public interest, convenience, and necessity," it gets another six months' lease of life. Twice a year, therefore, the substantial investment which the licensee has made in his business is placed in jeopardy.

- Censorship

The broadcasting controls established by law are intended primarily to regulate physical facilities, not programs. The law specifically withholds from the Commission the power of program censorship. Section 326 of the Radio Law of 1934 states:

"Nothing in this Act shall be understood or construed to give the Commission the power of censorship over the radio communications or signals transmitted by any radio station, and no regulation or condition shall be promulgated or fixed by the Commission which shall interfere with the right of free speech by means of radio communication."

While direct Government censorship over radio programs is thus forbidden by law, the terms of the Government licenses leave the door open for an indirect—and more insidious—censorship. Any attempt to impose the ordinary "blue-pencil" censorship is little to be feared, because, being a conspicuous violation of the right of free speech, it would arouse a storm of public protest. But what is not conspicuous—and is therefore dangerous—is the effect on the mind of the broadcaster, resulting from attitudes that may be taken by the government toward stations on matters outside the regulation of facilities.

Fear of disapproval can blue-pencil a dozen programs for every one that an official censor might object to. While practically nobody advocates a pre-program blue-pencil in the hands of government, few realize that post-program discipline by the government can be a form of censorship that is all the more severe because it is undefined.

Another aspect of government supervision over broadcasting, which is in effect a form of censorship, is the attitude in some quarters of the government toward the profits earned by broadcasters.

The grant of broadcasting licenses is only one of the many responsibilities of the Federal Communications Commission. It has supervision over all forms of wire and radio communication. In the field of two-way telephone and telegraph communication, control over rates is one of its most important

functions. Here questions of investment value and profits are material.

But broadcasting is a one-way, not a two-way, medium. It is not a common carrier which the public hires to perform a fixed service. It is a medium of artistic and intellectual expression, free to the listening public. Its financial structure does not impinge upon the public interest, convenience or necessity.

While stations and networks represent substantial investments, broadcasting is essentially a personal service business. The earnings of stations cannot be judged on the basis of their investment, any more than those of a lawyer, doctor, theatrical producer or publisher. Income results, not from studios and transmitters, but from programs.

It is a strange assumption that the less money a broadcasting company makes, the better the public will be served. This attitude is contrary to all sound business principles and experience. In what way is it conceivable that the public will be given better programs if the broadcaster is deprived of both the incentive and the means to improve his facilities and service?

Adequate profits mean the continuance of private investment, and increased enterprise. Losses mean poorer programs, and, when private resources fail, government ownership. If government regulation of the economics of broadcasting results in a no-profit industry, investors may prefer to exchange their broadcasting equities for government securities. Then we shall have

government ownership and 100 per cent control of broadcasting. Any further discussion of censorship would then be purely academic. We would have broadcasting of the government, by the government, and for the government.

We have but to look to the autocracies of Europe to see what such governmental control of broadcasting may mean.

- Broadcasting In European Autocracies

Broadcasting in those autocracies serves the interest, convenience and necessity, not of the public, but of totalitarian government. It is allowed to present only one side of public issues. Its so-called news services are services of propaganda. When the dictator stands before the microphone, the citizens are regimented before the loudspeaker. At the same time, the public may be forbidden, under penalty of imprisonment to listen to programs presenting any point of view contrary to that of the party in power.

It is no coincidence that in an autocracy where freedom of broadcasting does not exist, neither is there a free economy to which it might look for support. It is no coincidence that where freedom of thought and of speech are denied on the air, they are equally denied on the platform, in the university, and in the church. It is no coincidence that where you find broadcasting enslaved, you also find a slavish press.

- Broadcasting Under the American System

Our American system of broadcasting is what it is because it operates in the American democracy. It is a free system because this is a free country. It is privately owned because private ownership is one of our national doctrines. It is privately supported, through commercial sponsorship of a portion of its program hours, and at no cost to the listener, because ours is a free economic system. No special laws had to be passed to bring these things about. They were already implicit in the American system, ready and waiting for broadcasting when it came.

Broadcasting did not take on the American system. The American system took on broadcasting.

In recent years we have witnessed a steady enlargement of the economic power of federal government. That very enlargement has put upon the defenders of democracy the need for greater vigilance. That is where radio and the press assume a new importance. In the European countries that have been lost to democracy, the dictators who accomplished that revolution did so through their control of radio and the press. Nor were they satisfied with that. Their next step was to use the same governmental power to destroy the freedom of religion and of education.

Every increase in the economic power of a government makes more precious and more important

the vigilant maintenance of the freedom of thought, and the courageous, unflinching defense of the freedom of all forms of its expression.

- Radio and the Press

In its functions, its freedoms, and its responsibilities, broadcasting is essentially analogous to the press. It provides a forum for the spoken word, just as the press provides a forum for the written word.

The broadcasting networks perform for their affiliated stations the same service that the great press associations perform for their member newspapers. They assemble news and talent from the four corners of the earth, and deliver it swiftly and economically to local stations. And just as a press association franchise is a coveted asset for a local newspaper, so a major network connection is a principal factor in determining the importance and quality of service of a local broadcasting station.

The broadcasting station and the newspaper both have editorial functions, one in the selection of programs, and the other, of reading matter. Both also have commercial functions. Both are supported by advertising revenue. The income and influence of both depend upon circulation figures; of listeners in one case, readers in the other. Both have a legitimate investment asset of goodwill in the circulation they have built up.

The broadcaster decides upon the relative interest to his audience of

each program, and proportions his broadcasting hours accordingly. In so doing, he performs an editorial function similar to that of the newspaper in making up its pages or selecting its features. The care exercised by the broadcaster to present all sides of controversial public issues is in itself an editorial function of great importance.

There may be occasional abuses both on the air and in the press, but in a democracy it is the power of public opinion, rather than a government tribunal, which enforces standards of public expression.

This public censorship is in keeping with democratic principles. And it is a very real power, because it is exercised by direct control over the profits of the broadcaster. Broadcasters are competing every moment of the day for the listeners' interest. Program approval by listeners spells circulation and profits; disapproval spells losses and disaster.

If freedom means anything it means freedom to make mistakes as well as to do the right thing. Broadcasters have made mistakes, plenty of them. That is the way they learned to be broadcasters. I want them left free to make more mistakes. That is the way they will learn to be better broadcasters.

- Summary

Let me summarize the four beliefs about broadcasting concerning which I have tried to give you the groundwork of my thinking:

First, The extent and value of the

services of American broadcasting depend upon its freedom to develop and to operate with a minimum of regulation by the Government. Until and unless the radio art can provide as many wavelengths as there are broadcasters to use them, centralized regulation of technical facilities is essential. But the spirit of such regulation and its enforcement should differentiate clearly between technical operations and program services.

Second, While broadcasting should remain subject to all the laws that apply to other industries serving the public, it should be made morally as well as legally certain of its freedom from program censorship, other than the legitimate censorship of public opinion. There should be no censorship by intimidation or economic pressure. The station license should carry a longer term than six months. It should be revocable only for cause, and these causes should be clearly defined in advance.

Third, The progress of the American system of broadcasting, and the improvement of its program services, depend upon continued network development. Only by such development can we provide a finer national service, free to the public.

Fourth, and finally, Freedom of the air is inseparable from the freedom of thought, of speech, of worship, of education and of the press. These are the cornerstones of our American democracy. What helps one helps all; what injures one is an encroachment upon all; what destroys one destroys all, and thereby destroys democracy itself.

A free system of broadcasting can survive only under a democratic form of government, but it is no less true that democratic government itself will survive only if broadcasting is kept free.

American broadcasting asks no special privileges. It deserves none. It needs none. All it asks is the preservation of the American spirit of freedom.

Old Stuff

PHILCO has conducted a nation-wide survey of electrified farms to determine the farm market for radio sets. Two hundred thousand farms were surveyed, to discover that 93.7 per cent of such farms had one or more radio receivers. But of these, almost one-third were over six years old. More than half were over three years old.—
Electronics.

Long Range DX

Prediction

• BY E. H. CONKLIN

IT MIGHT be said that there are two general methods of predicting the future — omitting such things as crystal balls—a close study of variations of the data being studied with a view to extending the variations and, secondly, a study of other factors which may have a similar movement or a causal (not casual) relationship to the thing in which we are interested. An example of the first is the "dx cycle" from which conditions a few months ahead have been predicted with fair accuracy; and of the second, attempts to show what is going to happen to our bands based on the change in sunspot activity.

Amateurs appear to have given but little thought to the comparison of radio conditions with other data such as variations in the earth's magnetic field and sunspots, although a few isolated workers have made a study of these things. There has been almost a complete absence of any quantitative record of radio conditions in amateur publications, going back a few years. However, acknowledging that the layers of the

ionosphere are very important to radio, we can turn to a paper written by Elbert B. Judson,¹ W3AFU-W3GBI, in 1936 and extend the study to the present time. By determining the ionosphere layer that is supporting transmission at a given frequency, predictions become possible if changes in the layer can be predicted.

• Layer Height

Of the more important layers, the E and F₂ are of most interest to us. Ordinarily, the E layer which has a virtual height of about 100 to 120 kilometers (varying around 70 miles), is the medium for transmission on our lowest frequency bands only, although occasionally strong sporadic reflections take place from it permitting it to con-

¹E. B. Judson, "Comparison of Data on the Ionosphere, Sunspots, and Terrestrial Magnetism," *Nat. Bur. Stand. Jour. Res.*, vol. 17, pp. 323-330; September, 1936. Also, the same paper will be found in *Proc. I.R.E.*, vol. 25, p. 38; January, 1937.

trol transmission even down to five meters. Of most interest is the F_2 region, about 200 to 500 kilometers (124-310 miles) in virtual height, depending on the time of day and the season, and the F layer which is generally formed at night by the combination of the F_1 and F_2 layers.

From ionosphere measurements, two important types of data are obtained:² the virtual height of the layers, and the penetration frequency or critical frequency above which reflections will not return the signal directly downward.

- Zurich Sunspot Numbers

Mr. Judson used the Zürich provisional sunspot numbers in comparison with the magnetic character number for each day as reported by the Cheltenham Magnetic Observatory of the U.S. Coast and Geodetic Survey. The ionosphere data of the National Bureau of Standards for noon, Eastern time, was used because the majority of observations during 1930, 1931 and 1932 were taken around that time, although the noon values are not necessarily the daily maximum points.

Critical frequencies from 1934 through 1937 were generally increasing, as were sunspot numbers and magnetic activity. An examination of individual days in 1934 and 1935 showed no consistent agreement between the curves for

critical frequency and those for the cosmic data.

- Critical Frequency

Monthly averages are plotted in figure 1. The critical frequency and virtual height curves show the marked seasonal variation repeating each year and usually having high daytime critical frequencies around February and November, with much lower values in the summer. It is this seasonal factor which appears to govern 28-Mc. transmission across the Atlantic. It is interesting to note that the virtual height is generally low when the critical frequency is high, a condition which also has been found to hold for individual days. The curve of magnetic disturbances follows fairly well the seasonal curve of virtual heights, but beyond the seasonal factor the correlation does not appear great. A comparison of the sunspot curve with that for critical frequency shows no certain correlation for corresponding months, even if the seasonal factor is eliminated from the ionosphere data, but there is some similarity between the general long-term trends.

Annual averages of sunspot and critical frequency data are next considered. Here there is a marked similarity, as seen in figure 2, suggesting the possibility of forecasting on an annual basis, for various parts of the sunspot cycle, if the effects of changing F_2 layer critical frequencies are well understood. The maximum frequency which would return to earth would be approxi-

²E. H. Conklin, "New Ionosphere Broadcasts," RADIO, October, 1937, p. 26.

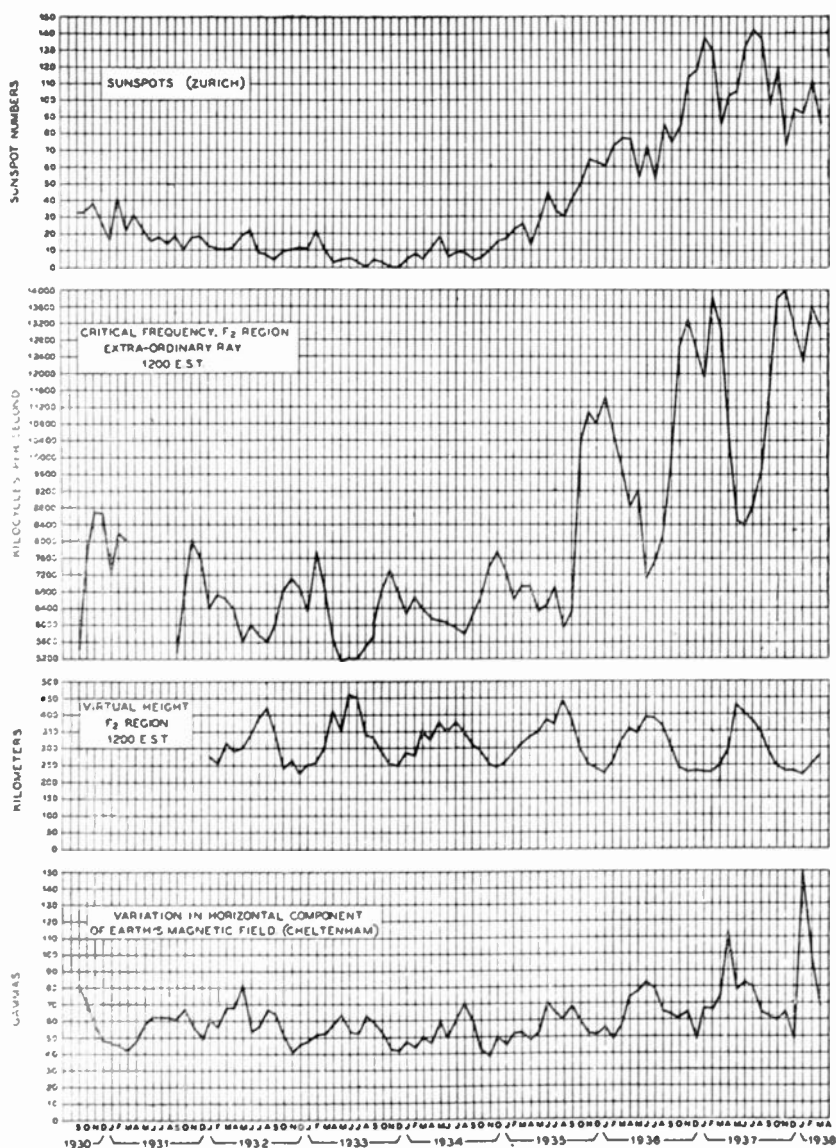

FIGURE 1.

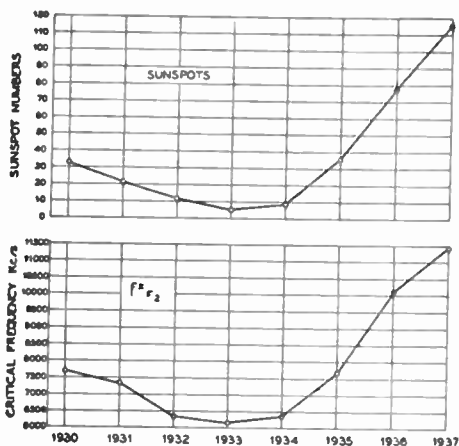

FIGURE 2.

mately the value of the critical frequency (at vertical incidence as given) multiplied by the secant of the angle at which the waves strike the layer, for the lowest possible angle of radiation. For the F_2 region, this would mean multiplying by 3 or 4, depending upon the height of the region above ground.

- Checking Conditions Against Past Data

Let us compare radio conditions with the F_2 layer curve. It is known that 56-Mc. transatlantic signals have been reported during the last year or two, but not previously since 1927,³ but a somewhat more detailed comparison can be made on lower frequencies.

On 28 Mc., some data is available covering a series of years, in

³E. H. Conklin, "5 Meters On Parade," *R/9*, October, 1935, p. 40.

past issues of *R/9*, *RADIO* and *QST*. When the band was opened up early in 1928, little time was lost in making some good long-distance contacts which lasted through the winter of 1930. Following that summer, when dx went through its seasonal slump, few stations were active. There was one transatlantic report in each of 1932 and 1933. OK1AW was heard over here in June of 1934, a Canadian was heard in Australia in August, and by the end of the year, W9TJ and ON4AU were making fairly regular contacts, including a 1935 contest number exchange, though other stations did not seem to get in on the fairly good conditions. Australians got through well for a few weeks in the spring of 1935, following which there were two isolated transatlantic contacts in the summer, together with quite a bit of South American work. By the fall of 1935, things

opened up for all continents, continuing to date except for the seasonal slump in summer.

On 14 Mc., in 1933 and 1934, the band used to pass out at 5 p.m. in Illinois, not to open again until after sunrise. Europeans, without any interfering U.S.A. signals, were heard on 7 Mc. after seven or eight o'clock in the evening.

• Sunspot Lag or Lead

A very important consideration in making predictions will be whether radio conditions precede or lag behind sunspots. One paper⁴ suggested that the magnetic activity follows sunspots on the way up but lags nearly two years on the way down, but the F_2 layer data on an annual basis looks like a high correlation, though the decline in 28-Mc. conditions may have preceded the change in sunspots and the F_2 layer. This is possibly attributable to a general discouragement in the 28-Mc. ranks, which was quickly overcome when things began to pick up. The writer is inclined to believe that the F_2 layer curve will give the more accurate indication.

Before making any long-range predictions, we point out that averages are simply averages—they permit wide variations from day to day. Thus, in the monthly data, there may have been quite a few days around November, 1932; Feb-

ruary and November, 1934; and December, 1935, when the ionosphere measurements indicated 28-Mc. dx to be possible. At the recent high levels of critical frequencies, the *average* value itself was sufficient to support 28-Mc. transmission, so that there have been but few winter days in the past several years when the band failed to open for dx, other than when severe magnetic storms occurred, making very high frequency work impossible as a rule.

Another factor worthy of mention is that the best signal strength may occur on a frequency that is nearly the highest that will support communication. Thus, foreign 7- and 3.5-Mc. signals may be somewhat weaker now than during a period when the 28- and even 14-Mc. bands are useless.

Without more knowledge of a possible lag in radio conditions behind the sunspot cycle and of the exact peak of sunspots—which may have been last winter or may yet come in the next year or so, it cannot be said definitely that we are soon to enter the downward phase of the cycle. We *can* say that conditions are unlikely to change markedly in the next year, and comment on how things will be by 1944. At that time, presumably, solar activity will again be around its low, and 28-Mc. winter dx will be very scarce. 14 Mc., in the winter, is likely to go dead for U.S.A. work much below 2200 miles in the early evening; the Europeans who have

⁴A. L. Durkee, "Forecasting Sunspots and Radio Communications Conditions," *Radio Digest*, January and February, 1938, p. 3; from Bell Laboratories Record, December, 1937.

been coming through most of the night are likely to pass out in mid-afternoon; and in the late evening the band is likely to sound completely dead, not to open up until just before sunrise. 7 Mc. may also pass out for U.S.A. work at short distances by eight o'clock in the evening, but stay open for dx at distances beyond about 1500 miles.

There is some reason to look to transmitter, receiver, and antenna design that will permit reasonably rapid change of band, including the use of "80," for a late evening rag-chew in 1944.

One very hopeful result of a long-range study of conditions is that the 28-Mc. band, out of every ten or eleven years, may be open for winter dx from as few as five years (of which three have already passed), to as many as eight years with somewhat more spotty conditions at the beginning and end of that period. This is based on what has happened since 1933, and assumes that conditions will not change for the worse much more rapidly than they improved following the last sunspot minimum.

WWV Schedules

EACH Tuesday, Wednesday and Friday (except legal holidays), the National Bureau of Standards stations, WWV, transmits with a power of 20 kw. on three carrier frequencies as follows: 10:00 to 11:30 a.m., E.S.T., on 5000 kc.; noon to 1:30 p.m., E.S.T., on 10,000 kc.; 2:00 to 3:30 p.m., E.S.T., on 20,000 kc. The Tuesday and Friday transmissions are unmodulated c.w. except for 1-second standard-time intervals consisting of short pulses with 1000-cycle modulation. On the Wednesday transmissions, the carrier is modulated 30% with a standard audio frequency of 1000 c.p.s. The standard musical pitch A=M440 c.p.s. is also transmitted from 4:00 p.m. to 2:00 a.m., E.S.T., daily except Saturday and Sundays, on a carrier frequency of 5000 kc., power 1 kw., 100% modulation. The accuracy of the frequencies of the WWV transmissions is better than 1 part in 5,000,000.—QST.

Review of

VACUUM-TUBE PROBLEMS

BY B. J. THOMPSON

THE intensive use of all longer wavelengths by established services has forced new services and expansions of the old into the shorter wavelength portion of the radio spectrum. Fortunately, it has been found that these shorter wavelengths have advantages over the longer for many applications. In fact, the known or expected advantages of the very short wavelengths have brought about the use, or proposed use, of wavelengths from 7 meters to 10 centimeters, even though the spectrum of longer wavelengths is not saturated. Among these advantages are limited transmission range, making possible the multiple use of one wavelength for providing secrecy; wide available band width for a single channel, necessary for television; high directivity attainable with small antenna systems, including the possibility of using "wave guides"; and high resolving power of the waves, making pos-

sible, for example, navigational aids for ships and airplanes.

As shorter and shorter wavelengths have been used, it has been found that the vacuum tubes of the transmitters and receivers place a serious limitation on the attainable performance. Ultimately, improved performance can only be attained by radical improvements in vacuum-tube design or by radical departures from conventional modes of vacuum-tube operation. It may be said that the problem of the development of satisfactory apparatus for the ultra-short wavelengths, on which depends the development of this promising field, is identical with the problem of designing better vacuum tubes for ultra-high-frequency operation.

In recent years very considerable advancements have been made in the design of vacuum tubes for high-frequency use. Most noteworthy has been the trend toward

the use of conventional modes of operation at frequencies where formerly such operation was not considered feasible. This has been the result of improved design based on increased theoretical knowledge of the limitations to high-frequency tube performance and on the development of new manufacturing techniques. Noteworthy advances have also been made in the performance of some of the unconventional types of vacuum tubes. These advances naturally focus attention on the question of what may be expected in the future.

Foretelling the future is a dangerous though fascinating game. We shall be on surer ground if we confine ourselves to an attempt to understand the nature of the limitations which restrict the design and operation of present ultra-high-frequency tubes. Such an understanding should indicate the directions in which progress may be expected.

• Fundamental Considerations

At low frequencies any effects of electron transit time or electrode leads are usually ignored. At the higher frequencies which we are discussing, this may no longer be done. The limitations imposed on the performance of high-frequency tubes are so largely the result of lead and transit-time effects that we must consider these in some detail.

The current flowing to an electrode in a vacuum tube is frequently viewed as resulting from the arrival of electrons at the electrode

and as being, therefore, proportional to the instantaneous rate of arrival. This viewpoint is fairly satisfactory at frequencies where the electron transit time is a vanishingly small part of the period, but it is completely misleading at higher frequencies where the transit time becomes appreciable.

A useful and satisfactory viewpoint is to consider the current flow to an electrode the result of the motion of charges in the space between electrodes. Consider two infinite parallel-plane electrodes as in figure 1 with the voltage E applied between them. The electric field F

between the electrodes is simply $\frac{E}{d}$

where d is the distance between electrodes. If a small positive electric charge q is placed between the plates very close to the positive plate there will be an increase in the charge of the positive plate of amount $-q$ and no increase in the charge of the negative plate. There will be a force acting on the charge of magnitude Fq tending to move it toward the negative plate. If the charge is allowed to move, the work done on it by the field is equal to Fqx where x is the distance the charge has moved. Now, the work done on the charge is supplied from the battery. The work done by the battery is equal to the product of its voltage E and the change in charge induced on one of the plates. If q_n represents the charge induced on the negative plate, we may write

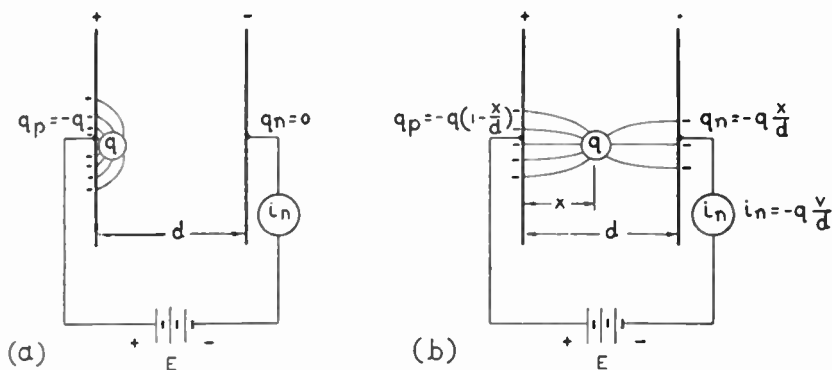

Figure 1. Distribution of induced charge and current flow between parallel planes as a charge q moves between the planes. (a) illustrates the condition where the charge is on infinitesimal distance from the positive plane. (b) represents the condition where the charge has moved a distance x away from the positive plane and is moving at a velocity v .

$$-Eq_n = Fqx$$

$$= \frac{Eqx}{d}$$

or

$$q_n = -q \frac{x}{d}$$

In other words, the charge induced on the negative plate is proportional to the charge in the space and to the fraction of the total distance between plates which the charge has covered. Of course, the charge q_p induced on the positive plate is equal to the difference between the space charge and the charge induced on the negative plate, since the total charge induced on the two plates is always equal in magnitude and opposite in sign to the space charge.

The current flowing to the negative plate as a result of the motion of the charge q is equal to the rate of change of the charge q_n . This is simply

$$i_n = \frac{dq_n}{dt} = -\frac{q}{d} \frac{dx}{dt} = -q \frac{v}{d}$$

In other words, the current flowing as a result of the motion of a charge between two plates is equal to the product of the charge times its velocity divided by the distance between the plates. Of course, the current flow to the positive plate is always instantaneously equal in magnitude to the current to the negative plate.

The important conclusion which we may draw from this simple analysis is that in a vacuum tube the

current produced by the passage of an electron does not flow simply at the instant the electron reaches the electrode, but flows continuously in all adjacent electrodes while the electron is in motion. If the electron moves between parallel plates, the current flow does not depend on the position of the electron, but only on its velocity.

The total current flowing to an electrode may be determined by adding up all the minute currents produced by individual electrons, or more analytically by integrating the currents produced by infinitesimal strips of space charge.

In a steady-state condition, the current flow determined by such integration (or measured value) is exactly equal to the rate of arrival of electrons at the electrodes. When the current is varying with time—as in the case of an amplifier tube with an alternating voltage applied to the grid—the rate of arrival of electrons at the electrode may be greater or less than the actual current flowing because of the finite transit time of the electrons. If the current is momentarily increasing, the rate of arrival of electrons is less at any instant than corresponds to the flow of electrons in the space.

These considerations show that the current flowing to an electrode may be different from the rate of arrival of electrons at the electrode. It is also possible to have a current flowing to an electrode at which no electrons arrive, if the number or velocity of the electrons approaching the electrode is instantaneously

different from the number or velocity of those receding from it.

From these elementary considerations we may understand qualitatively the various transit-time effects which are observed in high-frequency vacuum tubes.

The transit-time effects in the grid circuit are of most interest to us because they are the only effects in that circuit when no electrons or ions reach the grid. Because of the instantaneous difference between the rates at which electrons approach the grid and recede from it, there is an alternating current flowing to the grid which is proportional to the transconductance, to the alternating grid voltage, to the frequency, and to the electron transit time. This current leads the alternating grid voltage by 90 degrees. Hence, one may say that there is an electronic component of grid capacitance which is proportional to the transconductance and to the transit time. This capacitance is the well-known increase in "hot" capacitance over "cold" capacitance. While it is a transit-time effect, the equivalent capacitance does not vary appreciably with frequency, though, of course, the capacity current is proportional to the frequency.

Because of the electron transit time, there is a shift in the originally 90-degree phase relation between grid voltage and grid current with increasing frequency. This phase shift results in an equivalent shunt resistance between grid and cathode which is inversely propor-

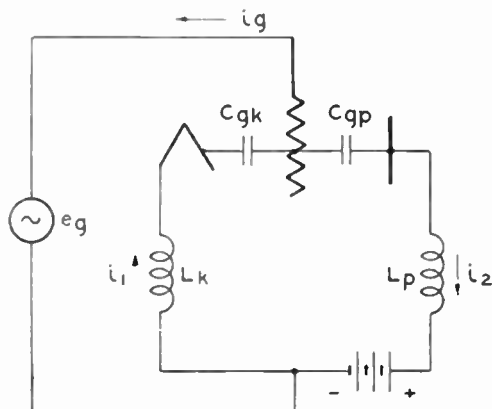

Figure 2. Schematic diagram of triode without plate-load impedance. L_k and L_p represent the self-inductances of the cathode and plate leads.

tional to the transconductance and to the square of the frequency and of the transit time. This resistance, which is normally very high at frequencies of the order of 1 megacycles, may become as low as several thousand ohms at a frequency of 50 megacycles in conventional receiving tubes.

There are also transit-time effects in the plate circuit. First, there is a phase lag between plate current and grid voltage which is proportional to the frequency and to the transit time. The relation between plate current and grid voltage is normally expressed as the transconductance. Of course, properly speaking, conductance can refer only to the component of alternating plate current which is in phase with the grid voltage. The quotient of the total alternating plate current divided by the alternating

grid voltage is therefore called the transadmittance.

Second, the magnitude of the transadmittance decreases somewhat as the frequency is increased. This effect is normally quite small at the maximum frequency at which a given tube may be used.

Third, there is a decrease in the internal plate resistance of the tube as the frequency is increased. This is also usually quite small.

These are the principal transit-time effects. Lead effects are also of importance.

Consider the simple triode shown in figure 2 with inductance in the cathode and plate leads and with capacitance between grid and cathode and grid and plate. The plate has no external load and the frequency of the voltage applied to the grid is well below that at which resonance between lead inductances

and interelectrode capacitances occurs. If L_k is equal to L_p , C_{gk} to C_{gp} , and i_1 to i_2 , it can readily be seen that i_g is not influenced by the lead inductances, for the triode is then a bridge in perfect balance. But if any one of these qualities is upset (more exactly, if $i_1 L_k C_{gk}$ is not equal to $i_2 L_p C_{gp}$), there appears a conductive component in the grid current i_g . If $i_1 L_k C_{gk}$ is greater than $i_2 L_p C_{gp}$, this component is positive and represents an input loading in addition to the electronic loading. It is most interesting to observe that the effective resistance shunted between grid and cathode which corresponds to this lead-effect loading is inversely proportional to the transconductance and to the square of the frequency, exactly as was the case for electronic loading.

Normally it is not feasible to balance out the two lead effects. Especially is this true in screen-grid tubes where the screen-grid current is a small fraction of the cathode current. Therefore, the lead-effect loading is often very important.

• Receiving Tubes

For almost any application of ultra-short waves, both transmitting and receiving apparatus are required. While it may seem that transmission logically comes first, the problems of receiving tubes are such that the discussion of them will serve as background for the discussion of transmitting tubes.

It is conventional practice at lower frequencies to amplify the received signal at the radio frequency,

then to convert it to a lower intermediate frequency at which additional amplification takes place, and finally to detect the signal, or to omit the intermediate frequency and detect the radio-frequency signal directly. Where intermediate-frequency amplification is used, radio-frequency amplification is desirable to prevent radiation at the local-oscillator frequency from the receiving antenna, to reduce the response to the unwanted frequency which differs from the local-oscillator frequency by the same amount as the wanted frequency, and to increase the signal-to-noise ratio for weak signals. Where intermediate-frequency amplification is not used, radio-frequency amplification is required to achieve selectivity and sensitivity with high signal-to-noise ratio. While special applications of ultra-short waves may not impose such severe requirements on the receiver, it is reasonable to suppose that equivalent performance will be desired in other applications. We shall, therefore, wish to discuss all pertinent limitations of receiving tubes.

The maximum voltage amplification per stage which may be obtained from a vacuum-tube amplifier depends on the magnitudes of the transadmittance, the internal grid conductance, the internal plate resistance, the grid and plate capacitances to ground, and the band width to be passed by the amplifier. The phase angle of the transadmittance is unimportant in an amplifier. There is ordinarily no serious

problem in obtaining suitable external circuits at even the highest frequencies. Where ordinary lumped circuits may not be used, distributed circuits, such as concentric transmission lines, are suitable.

As was stated earlier, the reduction in magnitude of transmittance with increasing frequency is usually not serious. The internal plate resistance may or may not be importantly reduced at high frequencies. When it is, the trouble is not usually fundamental, but is likely to be a matter of bulb effects such as electron bombardment or surface film resistance. Such effects may be hard to isolate and to eliminate, but they will certainly not be an ultimate limitation.

For wide-band amplification, the interelectrode capacitances may be a limiting factor in determining the maximum attainable amplification at moderately high frequencies. However, as the frequency is increased, the input conductance becomes rapidly larger until the effective impedance of the circuit connected to the grid becomes lower, in general, than the value required for wide-band amplification. The problem of increasing the frequency at which some voltage amplification may be obtained is, therefore, the problem of increasing the ratio of transmittance to input conductance.

Because for given spacings and operating voltages the ratio of transmittance to input conductance at a definite frequency is fixed, increase in this ratio may be at-

tained in a straightforward manner only by reducing spacings or increasing voltages. As the latter method is usually impractical, reduced spacings is the obvious alternative. This is the method followed in the design of acorn tubes. There are possibilities of more or less radically new kinds of amplifying tubes which may give better performance without smaller structures. Speculation as to the nature of such tubes is beyond the scope of the present paper; one may be sure, however, that the improvement will be in the ratio of transmittance to input conductance.

Satisfactory performance at higher frequencies than those at which vacuum-tube amplifiers will give a voltage gain appears to be possible only if one is satisfied to do without radio-frequency amplification. Detectors will operate at much higher frequencies than present amplifiers or oscillators. Superheterodyne operation at as high as 3,000 megacycles does not seem impossible with the use of a harmonic of a lower-frequency local oscillator.

• Transmitting Tubes

The performance requirements for transmitting tubes for ultra-high-frequency operation are substantially the same as those for lower frequencies. Only where such requirements cannot be met will inferior performance be accepted. These requirements stated briefly are: oscillators having good frequency stability; efficient power amplifiers which have good modulation char-

acteristics; and as much power output as can be attained. It appears that the requirements of power amplification and good modulation characteristics may not readily be met by such tubes as magnetrons and Barkhausen-Kurz oscillators. It is not surprising, therefore, that the trend has been toward conventional negative-grid tubes at all frequencies much below 3,000 megacycles.

The fundamental electronic theory of the operation of negative-grid transmitting tubes at high frequencies is, naturally, the same as that of receiving tubes. If power output were not a consideration, transmitting tubes would not differ from receiving tubes. The demand for large power outputs with low interelectrode capacitance and close spacings, three requirements mutually in opposition, naturally requires a compromise in design about which one might not be optimistic. Actually, however, the situation is not so bad as it might appear at first. Because transmitting tubes are normally operated with much higher voltages than receiving tubes and, further, because the grid usually swings quite positive over a portion of the cycle to cause the current to flow for a half-cycle or less, the electron velocity is much higher and therefore the spacings may be greater than in the case of receiving tubes. The fact that current flows for only part of a cycle causes the average grid conductance over the cycle to be lower.

Oscillators have one important advantage over power amplifiers.

Lead-inductance effects are not serious because the feedback from cathode to grid may be more than compensated by feedback from plate to grid. They also have a disadvantage in that the phase angle of the transconductance is of importance in the simple feed-back circuits which are more convenient to use. The net result is that properly designed power amplifiers may be expected ultimately to equal or to exceed the performance of oscillators with respect to obtainable power output at a given frequency.

The limitation in power output at a given frequency of either oscillators or power amplifiers is set by the limitation in cathode-emission density and in anode and grid-dissipating ability which are properties of the materials used or of the methods of cooling. If unlimited emission could be obtained in a small space and the resultant unlimited-power dissipation accommodated, the problem would become simply one of handling the output power in the plate lead.

The limitation in frequency for a given power output is set by the transit times which result from the operating voltages, anode area, and spacings determined by the permissible anode dissipation per unit area and interelectrode capacitance.

The limitation in highest operating frequency without regard for power output is set by how small and how closely spaced it is considered feasible to make tubes, exactly the same limitation as for receiving tubes.

Improvements in both power output and maximum frequency may be expected from further refinements of design and construction. Greater improvements may be expected to result if new anode, grid, and cathode materials are found which will withstand greater dissipation density and afford greater emission density. As it is not to be expected that very great improvements may be attained in this direction, it appears that other means of generation may be found if power out-

puts as great as will be demanded are to be obtained.

The substantial progress which has been made in ultra-high-frequency vacuum-tube performance in the past few years is very encouraging. It will be interesting to watch the developments in the next few years. The requirements are definite and the demands pressing; the limitations are great and well recognized. Engineering and scientific ingenuity seem to be most active under such circumstances.

Strays

Phone QRM

MANY an amateur who has had no QRM difficulties whatever while operating on c.w., finds that when he tries phone, interference is caused in nearby broadcast receivers. Such complaints come, in many instances, from the owners of up-to-date modern receivers, and therefore, according to regulations, it behooves the amateur to aid in removing the interference. In most instances, a wave trap or other complicated tuning device is unnecessary and a simple method for eliminating this trouble is to place a 2.5 millihenry r.f. choke in series with the antenna lead to the broadcast receiver.—Radio News.

Special Receivers

RADIO receiver manufacturers might possibly find an additional outlet for their receivers if they were to build sets with special period and modernistic cabinets to be retailed exclusively by furniture stores. These models would have considerable sales appeal since they would be designed to go with specific sets of furniture, and sold at list price they would afford very little competition to regular dealers.—Communications.

BOOK REVIEWS

BOOKS submitted to the Review Editor will be carefully considered for review in these columns, but without obligation. Those considered suitable to its field will also be reviewed in RADIO.

THE Newton Institute of Applied Science, Newark, New Jersey, has issued a catalog of their home-study courses on college engineering subjects. This booklet is available on application and lists complete information on both their three and four year courses on the following subjects: Civil Engineering, Electrical Engineering, Mechanical Engineering, and Radio Engineering. The entrance requirements, textbooks, and study hours required are given for each of the courses. If desired, only special subjects from the courses may be taken for study.

CATALOG no. 161 of the Cornell-Dubilier Electric Corporation, South Plainfield, New Jersey, has been announced. The catalog, like its predecessors, is distributed free of charge to interested parties. It comprises 40 pages and each item is illustrated with a large half-tone clearly depicting the physical characteristics of the capacitor unit being described. Physical dimensions are shown in a reverse blueprint beneath each photographic illustration. A complete listing and description is on the right-hand page facing the illustration. Much thought and time has been given to the assembly of a catalog that would be easy to read and in which it would be an easy matter to find the item required.

Because of the tremendous strides recently made in capacitor development, many of the types illustrated are new. A copy of this new and complete catalog may be had from your local Cornell-Dubilier distributor or by writing direct to the manufacturer.

The new catalog of the United Transformer Corporation is now available, either from your local jobber or direct from the manufacturer at 72 Spring Street, New York, N. Y. A complete listing of the entire line of the manufacturer is included in the new catalog. The new Ouncer Series, Varitran Voltage Control Units, and new transmitter and amplifier kits are featured. Also listed are their well-known lines for broadcast, aircraft, industrial, amateur, and replacement service.

A NEW catalog featuring all RCA parts, test equipment and antennas has been prepared by the RCA Parts Division for distribution to amateurs, dealers and servicemen through its parts distributors. The 16-page catalog lists more than 100 items, many of them appearing for the first time in this catalog.

Two of the new instruments being announced in the catalog are the 2-inch cathode-ray oscilloscope and the new beat-frequency audio oscillator. The catalog is available gratis from any RCA parts distributor.

THE TECHNICAL FIELD

in Quick Review

RADIO DIGEST briefly summarizes for its readers the contents of leading radio articles in current technical publications, some of which may appear later in RADIO DIGEST.

EXPONENTIAL TRANSMISSION LINE, by *C. R. Burroughs*.—A discussion of the theory and operating characteristics of the transmission line in which the spacing of the conductors (or their diameters) varies exponentially throughout the length of line under question. The impedance transforming characteristics of the line are discussed along with its operation with respect to the ratio of cut-off frequency to transmission frequency.

COUPLING NETWORKS, by *W. L. Everitt*.—Part II of a series covering the design of coupling networks for various circuit applications. Many design formulas and charts are given, and as an example of the procedure employed in



Bryan Davis Pub. Co., Inc.
19 E. 47 St., N.Y.C.
25c a copy—\$2.00 yearly

OCTOBER, 1938

the design, a network is shown which will couple two transmitters on different frequencies within the broadcast band into the same radiator.

A D'ARSONVAL REPRODUCER, by *George W. Downs and William Miller*.—A discussion of the design of a d'Arsonval reproducer for lateral recordings which has greatly improved characteristics over the conventional types in common usage.

MYSTERY CONTROL, by *Robert G. Herzog*.—An article covering the operation of both the remote unit and the stepping circuits within the receiver as used in the new Philco receivers employing "Mystery Control."

to cover all the aspects of coupling networks with regard to the modern requirements of such systems. Many illustrative charts are given.

PORTABLE FIELD INTENSITY METER, by *J. V. Cosman*.—A new-type portable field-intensity meter has been made available recently. The meter is of the recording type, has a sensitivity of 20 microvolts to approximately 8 volts, weighs only 28 pounds and is self-contained.

THEORY AND DESIGN OF PROGRESSIVE UNIVERSAL COILS, by *A. A. Joyner and V. D. Landon*.—A theoretical analysis and practical discussion of a new system of winding high-Q coils for use in tuning circuits of receivers. Many examples and winding charts are given for the coils which are claimed to have considerably improved characteristics over conventional designs.

COUPLING NETWORKS, PART I, by *W. L. Everitt*.—The first article of a series

SEPTEMBER, 1938

AUGUST, 1938

REDIFFUSION IN GREAT BRITAIN, by *Paul Adorjan*.—A description of the distributing system employed to serve approximately 6100 subscribers to the remote wire-line broadcast system. The control and amplifying systems are covered as to their general features.

ON SYNTHETIC REVERBERATION, by *Dr. S. J. Begun and S. K. Wolf*.—Synthetic reverberation may be obtained in a large number of different manners but the authors have found that the most satisfactory method and the one allowing the greatest flexibility is the use of a magnetic tape recorder and a number of pickup heads displaced with respect to time along the recorded ribbon.

HIGH-FREQUENCY CORRECTION IN RESISTANCE-COUPLED AMPLIFIERS, by *E. W.*

Herold.—Resistance-coupled amplifiers for certain uses such as television must have a uniform transmission characteristic over a wide frequency range, frequently extending to 100 kc. or higher. By employing reactances of the proper value between the amplifier stages it is possible to obtain the desired characteristic. An analysis of the determination of the values for these reactances is given.

AUTOMATIC EQUALIZATION & DISC RECORDING, by *George J. Saliba*.—An equalizer with an attenuator whose insertion loss is varied by the distance of the recording head from the outside of the disc allows a substantially flat response characteristic to be obtained from the inside to the outside of the recording.

LAMINATED PLASTICS FOR RADIO, by *T. J. McDonough*.—Laminated plastics have had considerable growth in the radio industry because of light weight, easy machining, high resistivity, and freedom from moisture absorption. Some of the more important properties of laminated plastics, and their use in electronic circuit applications are given in this article.

HALF-WAVE GAS RECTIFIER CIRCUITS, by *C. M. Wallis*.—Current and voltage waveforms for half-wave rectifier circuits having various types of plate loading and employing gaseous conduction tubes. A method of operational calculus is given which provides a rigorous analysis.

A LABORATORY TELEVISION RECEIVER—IV, by *Donald G. Fink*.—In this fourth installment describing *Electronics'* equipment, the u.h.f., converter, and

audio portion of the super-heterodyne receiver are described, completing the sound channel from antenna to loudspeaker and the picture channel from antenna to i.f. amplifiers.

A SHIELDED LOOP FOR NOISE REDUCTION IN BROADCAST RECEPTION, by

Stanley Goldman.—An analytical discussion of the theory and operation of the shielded loop antenna and the application of this information to the design and manufacture of the internal antenna as used in the new General Electric receivers.

PARASITIC CIRCUITS, by *Philip A. Ekstrand*.—Parasitic oscillations are a source of erratic operation and reduced output in transmitters. Most troublesome cases occur when parasitics are at fundamental frequency. This article describes remedies that have been found to be effective in practice.



50c a copy—\$5.00 yearly
McGraw-Hill Pub. Co., Inc.
330 W. 42 St., N.Y.C.

OCTOBER, 1938

SEPTEMBER, 1938

A SOUND ILLUSION PRE-AMPLIFIER, by *C. F. Sheaffer*.—An analysis of the theory and of the practical construction of a special pre-amplifier designed to be able to produce unusual frequency discriminations or resonating effects for the production of special sound effects. An extremely large number of variations are made possible with the amplifier described.

A FEEDBACK D. C. METER, by *J. M. Brumbaugh and A. W. Vance*.—A portable, electronic, multi-purpose d.c. instrument having a resistance of 50 megohms per volt at greatest sensitivity, full-scale current sensitivity of 0.02 microamperes, capable of measuring resistances of the order of 200,000 megohms.

COLOR MATCHING IN THE PAPER INDUSTRY, by *E. L. Deeter*.—A discussion of a bridge d.c. amplifier color matching comparator employing two phototubes and a 38 amplifier stage. Due to the bridge connection of the two phototubes a very small difference in the transmission characteristics of the two paper samples will produce a comparatively large change in the plate current of the amplifier tube; it is thus possible to match two samples quite accurately.

A LABORATORY TELEVISION RECEIVER, by *Donald G. Fink*.—The vertical scanning generator, methods of testing the characteristics of the scanning pattern,

and the details of the synchronizing circuits are described in this third installment of *Electronics'* construction series.

SINGLE-ENDED R. F. PENTODES, by *R. L. Kelley and J. F. Miller*.—A discussion of the history of development of the single-ended r.f. pentode and an exposition of the operating characteristics and advantages of this type over the previous double-ended types. Practical comparisons between the two types in various circuit applications are discussed.

MAGNETIC RECORDING, by *S. J. Begun*.—A survey of the distinguishing characteristics of recording on magnetic material, such as steel tape or wire, with a description of a modern machine of this type, with suggestions for its application.

ELECTRONIC VOLTMETER USING FEEDBACK, by *Stuart Ballantine*.—This instrument comprises essentially a multistage amplifier, diode rectifier and a special d.c. meter in which the deflection is proportional to the logarithm of the current. In addition a feedback circuit has been provided whereby some of the rectified current is brought back to the input circuit of the amplifier. High sensitivity and excellent characteristics over a wide operating range of frequency are the results obtained with the instrument.

AUGUST, 1938

WHAT'S NEW IN RADIO SETS.—As in former years the manufacturers have announced their new models as having new features. This article deals with all that the writers have been able to find out from the manufacturers plus what data can be picked up here and there from unofficial sources of information. Great interest is shown in the "beamscope" antenna which, it is claimed, eliminates the need for an outdoor antenna. It consists essentially of a rotatable loop inside of the speaker cabinet. Around the loop is an electrostatic

screen and in operation the loop is turned sufficiently to eliminate or decrease interference which is picked up. Another of the new developments is "time-tuning," by which any one 15-minute period from five different stations can be preselected for 24 hours in advance. Other subjects commented upon are audio compensation, pushbutton tuning, newly improved speakers and automatic record changers.

TELEVISION V. F. CIRCUITS, by *E. W. Engstrom and R. S. Holmes*.—The third of a series of articles dealing with the

general problems of television receiver design. Antenna, r.f. selector, oscillator, first detector and i.f. amplifiers have been covered. This paper deals with v.f. detector and amplifier and a.v.c. for picture.

PRACTICAL REMOTE AMPLIFIERS, by *Robert W. Carlson*.—Useful to the radio station where enough pickups are made outside to make a sufficient number of portable high-quality amplifiers an item of considerable expense, the amplifiers described in the article are highly satisfactory. Designed for battery operation, the filament current is 0.9 amperes and the "B" drain is 25 milliamperes. The tubes are: 6J7's as pentodes in the first two stages, and a 6F6 in the output stage operated as a triode. The frequency response is plus or minus 1 db

from 40 to 10,000 c.p.s. The overall gain is about 105 db including mixers and output pad.

A LABORATORY TELEVISION RECEIVER, by *Donald C. Fink*.—The second in the series of articles describing *Electronics'* television equipment, designed for professional use. Details of the construction of the cathode-ray tube mount, bleeder circuits, and horizontal scanning current generator.

EQUIVALENT RESISTANCE CHART, by *Alfred E. Teachman*.—A full-page chart for computing equivalent parallel resistance in circuits containing reactance and series resistance. Applicable also for determining the impedance of tuned circuits at resonance and the Q values of reactive elements.

JULY, 1938

A LABORATORY TELEVISION RECEIVER, by *Donald C. Fink*.—The first of a series of articles describing a vision receiver designed and constructed in *Electronics'* Laboratory, intended to serve as a flexible and comprehensive piece of laboratory equipment. Details of power supply are treated in this, the first installment. Two purposes are in mind: first, to accumulate information at first hand on standard television practice and, second, to produce a design which would be of interest, and possibly of direct use to the readers of *Electronics*.

AN ELECTRONIC DEVICE FOR MEASURING MAGNETIC FIELDS, by *Albert Rose*.—A description of the use of a special cathode-ray tube for the quick estimation of the distribution of magnetic fields. Present methods such as the use of search coils are subject to certain limitations which cause a good deal of work not necessary by the use of the tube described in this article. A detailed sketch of the construction of the tube is shown and the rest of the article is given to the methods used in determining the various measurements such as the direction of the field and its magnitude and variation.

VOLUME INDICATOR-ATTENUATOR, by *S. G. Carter*.—Descriptive of the con-

struction of this useful device for measurements on high-gain amplifiers and transmitters, this article by a broadcast engineer gives much data useful to a public address engineer as well. The variable attenuator has a range of 75 db, and the level indicator measures as low as minus 40 db. The device has proven valuable for making frequency runs on high-gain amplifiers and pre-amplifiers, for checking the overall response of transmitters and for checking the noise and hum level below 100 per cent modulation. The article is illustrated by several circuit diagrams and charts as well as a sample scale as employed for the volume indicator.

MEASURING FOUR-POLE NETWORKS, by *J. L. Clarke*.—Much has been written about the theory of 4-pole networks but very little information has been published about the method of checking these calculations by measurements. In this article is given a practical method of measuring the phase-shift, current and voltage ratios of any four-terminal circuit, when terminated in any impedance, useful for checking calculations and improving performance. The article is supplemented by a full page *Electronics* reference sheet for making four-terminal impedance measurements.

A VISIT TO W1AW, by *F. E. Handy*.—An article discussing the equipment, personnel, and operating schedule of the Maxim Memorial Station, W1AW.

A SIX-BAND ONE-KILO-WATT TRANSMITTER, by *J. E. Jennings*.—A compact four-stage outfit for c.w. or phone employing some excellent design principles that may well be applied to lower-powered transmitter design.

CHARACTERISTICS OF SKY-WAVE TRANSMISSION, by *Harner Selvidge*.—A discussion of some high-frequency transmission effects of practical interest to the user of the ultra-high-frequency bands.

RADIO CONTROL OF POWERED MODELS, by *Clinton B. DeSoto*.—Through the use of miniature thyratrons in the receivers,



25c a copy—\$2.50 yearly
American Radio Relay League
West Hartford, Conn.

OCTOBER, 1938

midget circuit control relays, and small motors to actuate the various control surfaces of the model airplane, satisfactory control of gas models has been obtained.

A COMPACT 100-WATT TRANSMITTER, by *Thomas Sue Chow*.—Six-band-cover

age with quick band coverage; a description of a transmitter designed for use in the sweepstakes contest which succeeded in establishing new records for this competition.

LOW Z FOR LINEARITY, by *M. A. Brown and J. N. A. Hawkins*.—The authors make out a good case for 6A5G output tubes in the design of a 35-watt class-A amplifier that is excellently suited for use as a driver for a high-powered modulator or for use as a public-address amplifier.

SEPTEMBER, 1938

NORFOLK AMATEURS PREPARE FOR EMERGENCIES, by *Fenton Priest and Laurie Turner*.—The Norfolk group has standardized on 30-watt phone, 40-watt c.w. transmitters designed to operate either from 110-volts a.c. when available or from a 6-volt storage battery when a.c. is not available. The transmitters are self-contained in small carrying cases as are the revamped all-wave broadcast receivers.

PRESELECTION SIMPLIFIED, by *T. M. Ferrill, Jr.*—A description of a simple one-tube preselector r.f. amplifier with coil switching for five wave-bands. Either a 58, a 6K7, or one of the newer 1851 tubes may be used.

A FIVE-BAND SWITCHING EXCITER WITH 807 OUTPUT, by *T. P. Kinn*.—A description of an 18-watt exciter with any one of five bands available by a switch and any frequency within these bands available by turning the knob on an electron-coupled oscillator. Optional crystal control, with crystal selection, is also available on all the bands.

INTERPRETING 1938's 56-Mc. Dx, by

J. A. Pierce.—An article covering a series of ionosphere deductions based on long-distance amateur work on five meters. Charts showing numbers of reports plotted against distance and a chart showing probable ionization density within the ionosphere are given.

A DE-LUXE ROTARY ANTENNA STRUCTURE, by *Byron Trowbridge*.—A description of a supporting assembly for stacked multi-element directional antennas. Practical constructional details are given in complete form.

GRID-BIAS POWER PACKS, by *N. M. Patterson*.—An analysis of their operation and a number of practical pointers are given to assist in taking the guesswork out of the design of satisfactory grid-bias power supplies.

AN AUXILIARY TRANSMITTER FOR 1.7 AND 3.5 Mc. WORK, by *Don H. Mix*.—A description of a self-contained unit with ganged tuning and quick frequency change. An 89 electron-coupled oscillator is used to excite an 807 final; the unit includes a self-contained power supply.

AUGUST, 1938

A THREE-TUBE SUPER FOR PORTABLE OR EMERGENCY WORK, by *George Grammer*.—Designed for better performance than the well-known regenerative receiver, but with equivalent light weight and cost this version of a small three-tube superhet uses a 6K8 for combined mixer and h.f. oscillator, a 6K7 for i.f. stage and a 6C8G for second detector and c.w. beat oscillator. Constructional data for making the chassis is given as well as a circuit diagram and value of components.

A 250-WATT OUTPUT CRYSTAL-CONTROLLED 28- AND 56-Mc. TRANSMITTER, by *Abe Hass*.—A description of a transmitter for putting out a heftier signal on the two above-mentioned bands with crystal control. The circuit and arrangement is much the same as trans-

mitters designed for lower frequency bands with the exception of the particular arrangements which are necessary for working on these higher frequencies. The tube lineup is as follows: 6V6G crystal oscillator, RK49 doubler or quadrupler, 809 doubler, 809's push-pull, and the final stage is a pair of HF100's in push-pull. A chart gives the various current readings of all the tubes when used on 56 megacycles—also the readings on 28 megacycles.

WHICH DIRECTIVE SYSTEM, by *Hugo Romander*.—"Choosing an antenna system is something like choosing a tube line-up for a new transmitter—there's an embarrassment of riches. The author here discusses some pertinent points in connection with simpler directive arrays."

A NOVEL 600-WATT TRANSMITTER, by *Frank C. Jones*.—A novel crystal-buffer arrangement is described in this 600-watt phone and 800-watt c.w. rig that should be a delight to the high-power amateur.

ELECTRICITY WRITES ITS OWN STORY, by *Austin C. Lescarbourea*.—The cathode-ray tube is not new, experiments on it being started in 1897 by J. J. Thompson. The author describes the tremendous strides that have been made in this type of tube since that time.



25c a copy—\$2.50 yearly
Ziff-Davis Pub. Co.
608 S. Dearborn St., Chicago

OCTOBER, 1938

MOTOR-DRIVEN ANTENNA, by *Rowland J. Long*.—

The amateurs are finally awakening to the fact that most of the signal power comes from a properly designed antenna system. With the directive system described here a power gain of 4 db may be expected.

W9XZK PROTECTS CHICAGO, as told by *Sgt. James Flavin*.—Using the bands originally developed by the amateur, the Chicago Park District Police covers a great city with "prowl" cars that are equipped with 15-watt transmitters and a headquarters 100-watt station located a half-mile from radio control.

SEPTEMBER, 1938

THE NERVE CENTER OF A BROADCAST NETWORK, by *Jack Ryan*.—A non-technical description of the routing and other handling of the numerous programs in the NBC network in Chicago. How two men and 547 push-buttons control one of the greatest switchboards of the nation. Besides the several photographs illustrating the article, several block diagrams and a map show the studio-network switching, the lines fed throughout the nation, and the engineering department organization of the central division of the NBC.

MARINE MANNERS FOR SEAGOING OPS, by *Lee Scupper*.—The mere holding of that commercial operator's ticket is not all that makes the marine radioman. He needs to know the "code of the sea."

AUGUST, 1938

THE MARINE-HAM LOOP RECEIVER, by *Raymond P. Adams*.—A constructional article on a receiver designed for the greatest usefulness to the average small-boat owner. It is basically an all-wave radio receiver, 6- or 12-volt powered, providing either for headphone or loud-speaker reception, tuning from 40 megacycles to 140 kc. A direction finding circuit is incorporated electrically and physically into the design in such a way that it may be eliminated where finder facilities are not specifically desired. This article deals with the receiver proper and a succeeding article describes the construction of the loop and the installation and use of the receiver in its completed form.

MIKES, MIXERS, AND MONITORS, by *Oliver T. Read*.—A detailed description on how to choose the right mike, use the proper mixer circuit, and employ the correct monitor. The first portion deals with the numerous types in general use, gives their relative output and discusses the meaning of the db ratings,

The author, who "stood" many a watch in a blow, advises you what it is.

RADIO-CONTROLLED LIGHTSHIP, by *C. S. Van Dresser*.—From sounding a fog horn at the right time, to turning on, and sending out the proper radio beacon, and lighting the all-important light—all is done by radio signals. The author describes this interesting and unique ship which protects sailors.

HOW ELECTRICAL TRANSCRIPTIONS ARE MADE, by *Edward Reynolds*.—Electrical transcriptions have become a tremendous business requiring specialized equipment and an entirely different type of radio engineer to operate. The author describes the care and difficulties encountered in making the recording on wax.

along with the advantages and disadvantages of the several types in various kinds of work. Mixing problems are discussed and several diagrams of suitable mixer circuits are shown. The article is concluded with illustrations of visual and aural monitoring circuits and their diagrams.

THE PHOTOCELL AT WORK, by *Elmore B. Lyford*.—A short article dealing with the simpler forms of circuits to be used with photocells. Some common uses of the "go-no-go" circuits, "quantity" and "quality" circuits are listed and also circuit diagrams of the resistance coupled and capacity coupled types of amplifiers are shown for use with the vacuum or gas-filled photocells.

COLUMBIA'S KNX, by *Jerry Goldby*.—"With the fanfare over, KNX settles down to being just one of Columbia's regular studios. The author tells of the newest equipment installed there which makes it one of the world's finest and first class broadcast stations."

CHATHAM RADIO GUARDS THE SEA, by *John N. Meissner*.—Here is described in the popular style, one of the busier commercial radiotelegraph stations working with the marine service. Schedules and mode of operation with vessels are described and a good part of the article is composed of anecdotes of rescues and aid extended in emergency cases in which this station has figured.

RADIO LANDS THE PLANE, by *Harry Wilkin Perry*.—A general description of a blind landing system as developed by the U. S. Air Corps. Photographs of various units installed in the plane and a sketch showing the path followed by the plane in making a blind landing

illustrate the article. Although no technical data is given the general procedure followed by the pilot in preparing for a landing is outlined.

RADIO WEATHERMAN, by *C. S. Van Dresser*.—A valuable adjunct to the forecasting of weather are small radio transmitters which are sent aloft by means of small hydrogen-filled balloons. The units transmit automatically impulses which are received at the ground station and can be translated in terms of temperature, humidity and atmospheric pressure. This article deals in a general way with the equipment used in this work and with its value to weather forecasting.

THE THREE-ELEMENT ROTARY, by *Peter Gioga and Ray L. Dawley*.—The increasingly popular three-element rotary antenna is here described in detail. Several photographs of typical amateur installations give a wide variety of constructional possibilities to the prospective builder. Complete design data for a ten-meter array is given in one easily used chart.

POUNDRING BRASS FOR UNCLE SAM, by *Kenneth Lum King and E. H. Bryan, Jr.*—A narrative of the experiences of Mr. King, whom amateurs will remember as K6BAZ—K6XJ1, while with the government colonization parties on Howland, Baker and Jarvis Islands.

5- TO 160-METER PHONE, by *Frank C. Jones*.—A description of a versatile transmitter supplying 100 watts of output on 5 and 160 meters and 250 watts on the intermediate bands. Two HK54's are used in the final amplifier. Another pair of HK54's serve as modulators.

AN IMPROVED RECEIVER FOR 10 METERS, by *Raymond P. Adams*.—The receiver described in this article is one

RADIO

30c a copy—\$2.50 yearly
RADIO, Ltd.
7460 Beverly, Los Angeles

NOVEMBER, 1938

evolved from the author's original 10-meter phone receiver, which was described in detail in the October, 1937, issue of RADIO. The receiver is built on two chassis, one containing the "front end," and the other the i.f. and the audio section. Fifteen tubes provide maximum performance on the ten-meter band.

EMERGENCY PRIMARY POWER, by *Lawrence B. Robbins*.—With a view toward possible emergency work, a complete listing of the various sources of emergency power is given. A complete discussion of the advantages and disadvantages of each type of supply also is given.

KITES AS ANTENNA SUPPORTS, by *B. P. Hansen*.—A constructional article describing the construction of high efficiency kites, which make good supports for experimental antennas. The type of kite design described is one which has been in use for many years by various weather observation groups.

FIVE-METER DX, by *E. H. Conklin*.—Mr. Conklin has compiled and corre-

lated a great number of reports from amateur stations who participated in the recent 5-meter DX spree. From these reports he arrives at conclusions concerning the causes of such unusual conditions and the possibilities of their recurrence.

SINGLE CONTROL BANDSPREAD, by *Ver-non C. Starr*.—The problem of combin-

ing stability and bandsread in a single control receiver has always been a puzzling one. A system of tapped coils is described which allows the use of a high capacity oscillator tank and at the same time allows highly efficient tank circuits to be used in the r. f. and detector stages.

OCTOBER, 1938

AMATEUR RADIO AND THE HUGHES FLIGHT, by *R. P. Turner*.—The story of amateur radio participation in the epochal, record-breaking Hughes around-the-world flight. Amateur stations W2UK, W2GOQ and W6CUH maintained communication with the plane throughout the flight, relaying vital weather and ground condition reports at times when commercial stations were unable to get through.

A DIRECTION INDICATOR FOR ROTARY ANTENNAS, by *L. C. Waller*.—Another system for determining the direction in which a rotatable antenna is pointed. A potentiometer, instead of the usual rheostat, is used at the antenna end. An ordinary 0-1 ma. d.c. milliammeter serves as an indicator on the operating desk. Stable voltage is provided by use of an OA4-G as a voltage regulator.

THE RELAXATION OSCILLATOR, by *A. W. Friend*.—In this article a low cost, simple audio oscillator suitable for code practice (and other applications where wave form is not important) is described. The author finds argon lamps more satisfactory for this type of service than the more usual neon bulbs. One diagram shows the method of connecting an argon tube in the output stage of a receiver, thus allowing code practice to be given to large groups.

INDUCTIVE TUNING, by *Frank S. McCullough*.—With the advent of vacuum condensers in final-amplifier tank circuits, inductive tuning returns to the radio picture. By means of vector diagrams, the author shows that, in inductively tuned circuits, maximum im-

pedance and resonance do not necessarily occur at the same time. He recommends tuning for maximum circulating current.

DIAL PHONE REMOTE CONTROL, by *George M. Grening*.—Telephone dial selector practice is herein applied to transmitter control circuits. One diagram shows a complete transmitter control system, which allows simultaneous voice and control impulses over a single pair of wires.

A 100-WATT BANDSWITCHING EXCITER, by *Charles W. Hunter*.—This exciter allows instantaneous bandswitching as well as frequency change within the five bands which it covers. Pretuned, extremely low-C tank circuits provide the flexibility within bands while a simple switching system allows quick band change.

REMOTE FREQUENCY CONTROL, by *Frank C. Jones*.—A description of a simple unit designed to allow quick frequency change from the operating desk. A 6C5G as a Pierce oscillator is followed by a 6J5G doubler to supply about one watt of 7-Mc. output, which is sufficient to drive most small buffer or doubler stages. Three variable eighty-meter crystals allow a wide choice of operating frequency.

THE NEWCOMER'S SPECIAL, by *Jack Rothman*.—This two stage transmitter solves the transmitter problem for newcomers who have but little money to invest in their first radio equipment. Using a 42 crystal oscillator and a 6A6 amplifier or doubler, the transmitter is about the ultimate in simplicity.

VISUAL INDICATOR TUBES, by *R. Lorenzen*.—A discussion and chart showing the uses and a comparison of the various types of "magic eye" type indicator tubes. The operation of the various types is shown.



25c a copy—\$3.00 yearly
 Bryan Davis Pub. Co., Inc.
 19 E. 47 St., N.Y.C.

OCTOBER, 1938

SEPTEMBER, 1938

PRACTICAL SUGGESTIONS.—It is often possible to correct an abnormal characteristic in a defective receiver by making a few simple changes in the receiver circuit. This material contains information on the characteristics of tubes and circuits and definite sugges-

tions for correcting peculiar behaviors in receivers in for service.

SELLING SERVICE, by *Lucius S. Flint*.—Practical suggestions in sales psychology to increase the sales-to-prospects ratio, and to increase customer satisfaction on repair and service jobs.

SERIES MODULATION, by *E. B. Vass*.—A discussion of a method of modulation whereby the high voltage supply to the r.f. amplifier is obtained through a modulation tube in series. The varying impedance of the modulator tube brought about by the audio frequencies of modulation applied to its grid alters the effective high voltage applied to the r.f. amplifier tube, so causing modulation of the carrier. The theory of the system is thoroughly discussed and illustrated by circuit diagrams and mathematical formulas; a circuit diagram of a complete transmitter using British tubes is shown.

THE SINGLE WIRE MATCHED IMPEDANCE FEED AERIAL, by *C. F. Turner*.—In this article the writer shows a method whereby the above-mentioned antenna, also known as the Windom,



1/6 a copy
 Radio Society of Gt. Brit.
 53, Victoria St., London
 JULY, 1938

can be tapped by the single-wire feeder in such a manner as to improve greatly its operation in harmonics. Although the theory discussed is not new to many users, a point of interest is brought out in his mention of the fact that with the new tapping

point the terminating impedance would be higher and that this higher impedance can be met by using a smaller feeder wire than is usual.

BAND SPREAD AND CREEP, by *R. H. Hammans*.—The band spread of a superhet receiver depends entirely on the frequency coverage of the oscillator tuned circuit and the L/C ratio should be kept low for several reasons. In this article the writer discusses the relationship between methods of band spreading and the cause of frequency drift, with illustration of the points involved by several charts and circuit diagrams.

Enthusiasm

for the "new" Radio Magazine has spread like wildfire.

Have you seen it?

Get a copy of the latest issue at your favorite dealer's, or send 30c for sample.

\$1.00 brings you a trial subscription of five issues if you live in U.S.A.

Radio, Ltd.

7460 Beverly Blvd.

Los Angeles, Calif.

Oh Yes.....
Your Subscription
to 'Radio Digest'



Radio Digest
7460 Beverly Blvd.,
Los Angeles, Calif.



I want 12 issues of 'Radio Digest'.
Here is my \$2.50.

Name _____

Street _____

City _____

