

RADIO CRAFT

CHICAGO
PARTS SHOW
NUMBER

HUGO GERNSBACK, *Editor*

KENOTRON
TUBE TESTS
SEE PAGE 22

In this issue—

An Economy Transmitter
Quick A. C.-D. C. Repairs
R. F. Power Supplies

RADIO-ELECTRONICS IN ALL ITS PHASES

MAY

1947

25¢

CANADA 30¢

Going places
(AGAIN)

hallicrafters

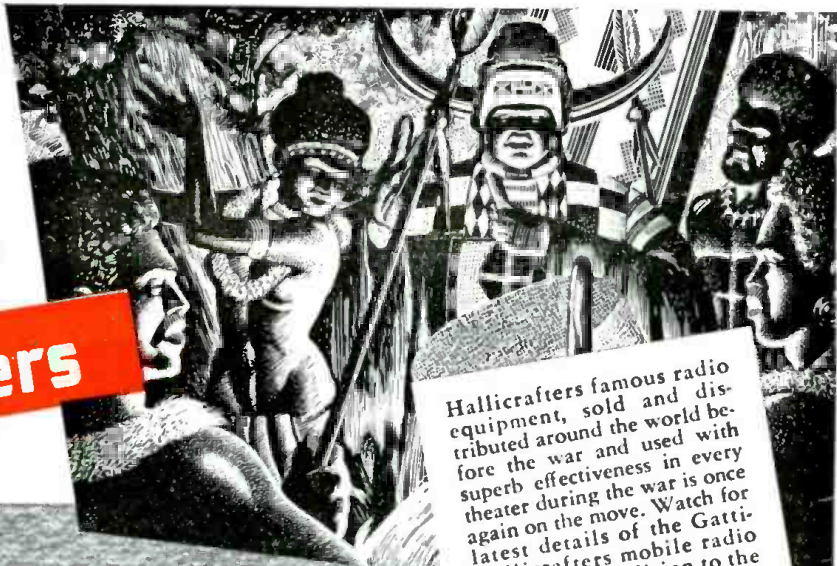

Hallicrafters famous radio equipment, sold and distributed around the world before the war and used with superb effectiveness in every theater during the war is once again on the move. Watch for latest details of the Gattilatest expedition to the Moon in deepest Africa—a new and exciting test for the ingenuity of hams and the performance of Hallicrafters equipment.

3 GREAT RECEIVERS designed and priced for hams who are going places, too



Model SX-42 Described by hams who have operated it as "the first real postwar receiver." One of the finest CW receivers yet developed. Greatest continuous frequency coverage of any communications receiver—from 540 kc to 110 Mc, in six bands. FM-AM-CW. 15 tubes. Matching speakers available. **\$27500**



Model S-40A Function, beauty, unusual radio performance and reasonable price are all combined in this fine receiver. Overall frequency range from 540 kc to 43 Mc, in four bands. Nine tubes. Built-in dynamic speaker. Many circuit refinements never before available in medium price class. **\$8950**



Model S-38 Overall frequency range from 540 kc to 32 Mc, in four bands. Self contained speaker. Compact and rugged, high performance at a low price. Makes an ideal standby receiver for hams. CW pitch control is adjustable from front panel. Automatic noise limiter. **\$4758**

Prices slightly higher in zone 2

BUILDERS OF *Skyphone* AVIATION RADIO TELEPHONE



hallicrafters RADIO
THE HALLICRAFTERS CO., MANUFACTURERS OF RADIO AND ELECTRONIC EQUIPMENT, CHICAGO 16, U. S. A.
Sole Hallicrafters Representatives in Canada:
Rogers Majestic Limited, Toronto-Montreal



J. E. SMITH
PRESIDENT
National Radio
Institute
33rd Year of
Training Men
for Success
in Radio.

I WILL TRAIN YOU TO START A SPARE TIME OR FULL TIME RADIO SERVICE BUSINESS WITHOUT CAPITAL

You Build These and Many Other Radio Circuits with Big Kits of Parts I Supply

By the time you've conducted 60 sets of Experiments with Radio Parts I supply, made hundreds of measurements and adjustments, you'll have valuable PRACTICAL Radio experience for a good full or part-time Radio job!

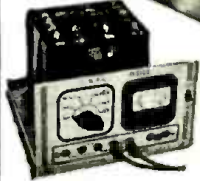
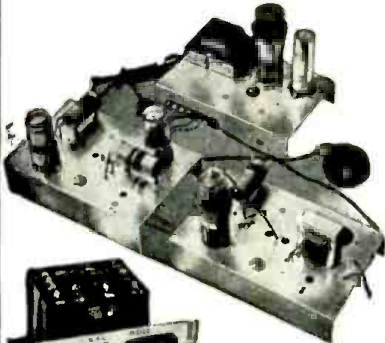

You build MEASURING INSTRUMENT above early in Course, useful for Radio work to pick up EXTRA spare time money. It is a vacuum tube multimeter, measures A.C., D.C., R.F. volts, D.C. currents, resistance, receiver output.

You build the SUPERHETERODYNE CIRCUIT above containing a preselector oscillator-mixer-first detector, i.f. stage, diode-detector-a.v.c. stage and audio stage. It will bring in local and distant stations. Get the thrill of learning at home evenings in spare time while you put the set through fascinating tests!

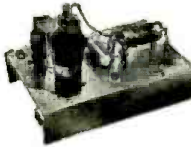

Building the A. M. SIGNAL GENERATOR at right will give you valuable experience. Provides amplitude-modulated signals for test and experimental purposes.

The men at the right are just a few of many I have trained, at home in their spare time, to be Radio Technicians. They are now operating their own successful spare-time or full-time Radio businesses. Hundreds of other men I trained hold good jobs in practically every branch of Radio. Doesn't this PROVE my "50-50 method" of home training can give you BOTH a thorough knowledge of Radio principles and the PRACTICAL experience you need to help you make more money in the fast-growing Radio industry?

Many Beginners Soon Make Extra Money in Spare Time While Learning

The day you enroll I start sending EXTRA MONEY JOB SHEETS. You LEARN Radio principles from my easy-to-understand, illustrated lessons—PRACTICE what you learn by building, testing and experimenting with parts I send—USE your knowledge to make EXTRA money fixing neighbors' Radios in spare time while still learning! From here it's a short step to your own full-time Radio Shop or a good Radio job!

VETERANS

You can get this training right in your own home under G. I. Bill. Mail coupon for full details.

Future for Trained Men Is Bright in Radio, Television, Electronics

It's probably easier to get started in Radio now than ever before, because the Radio Repair Business is booming. Trained Radio Technicians also find profitable opportunities in Police, Aviation, Marine Radio, Broadcasting, Radio Manufacturing, Public Address work. Think of even greater opportunities as Television, FM, and many new, war-developed Electronic devices become available to the public! Soon, there will be more Radio equipment to install, operate, maintain and repair than ever before in all history! Get the facts on all these opportunities. Send for FREE books now!

Find Out What NRI Can Do For You

Mail Coupon for Sample Lesson, "Getting Acquainted with Receiver Servicing," and my FREE 64-page book. It's packed with facts about Radio's opportunities for you. Read the details about my Course. Read letters from men I trained, telling what they are doing, earning. See how quickly, easily you can get started. No obligation! Just MAIL COUPON NOW in an envelope or paste it on a penny postal. J. E. SMITH, President, Dept. 7EX, National Radio Institute, Pioneer Home Study Radio School, Washington 9, D. C.

I Trained These Men

SPARE TIME RADIO BUSINESS



MINISTER MAKES \$10-\$20 WEEKLY, SPARE TIME
"I am a Minister. I am in a county seat church, also trying to keep the people in my playing. I have been making from \$10 to \$20 per week in spare time."—L. H. SMITH, Benton, Tenn.

DOING GOOD SPARE TIME BUSINESS
"I have been getting receivers to repair right along lately, and by using the methods taught me in the NRI Course, I don't have to spend much time on any of them."—STANLEY N. STRICKLAND, 191 Dale Homes, Portsmouth, Va.



MADE \$812, IN 12 MONTHS, SPARE TIME
"Soon after I finished my experimental lessons I tackled my first Radio cooperative job. The neighbors were very cooperative. I soon had all the repair jobs I could handle in spare time. I am making \$812 in the past 12 months in spare time."—J. W. CLARK, Wilmington, N. C.

I Trained These Men

FULL TIME RADIO BUSINESS



FULL TIME JOB BEFORE FINISHING COURSE
"After completing about two-thirds of my Course I entered a Radio Repair shop. Later I branched out for myself and opened a shop in my own home. I am much pleased with the work I have done. My first year of business, I had during my spare time."—A. N. AYERS, Washington 10, D. C.

MADE \$1800 WHILE LEARNING
"By the time I finished my NRI training I had made \$1800. When I started the Course I did not know a resistor from a condenser. I have bought my home. My income from Radio work, etc., is about \$3,000 a year."—WILLIAM THOMAS, Baldwin, Miss.



AVERAGES BETTER THAN \$3,000 A YEAR
"I now have a shop and am doing fine. I average better than \$3,000 per year, and certainly give NRI much of the credit."—RAYMOND F. DAVIS, Ashburn, Ga.

SAMPLE LESSON FREE

I will send you a FREE Lesson, "Getting Acquainted with Receiver Servicing," to show you how practical it is to train for Radio at home in spare time. It's a valuable lesson. Study it—keep it—use it—without obligation! Tells how Superheterodyne Circuits work, gives hints on Receiver Servicing, Locating Defects, Repair of Loudspeaker, I. F. Transformer, Gang Tuning, Condenser, etc., 31 illustrations.



My Radio Course Includes TELEVISION • ELECTRONICS FREQUENCY MODULATION

GOOD FOR BOTH 64 PAGE BOOK SAMPLE LESSON FREE

J. E. SMITH, President, Dept. 7EX
National Radio Institute, Washington 9, D. C.

Without obligating me, mail your Sample Lesson and 64-page book FREE. I am particularly interested in the branch of Radio checked below. (No salesman will call. Please write plainly.)

- | | |
|---|---|
| <input type="checkbox"/> My own Radio Service Business | <input type="checkbox"/> Operating Broadcasting Station |
| <input type="checkbox"/> Spare Time Radio Servicing | <input type="checkbox"/> Industrial Electronics |
| <input type="checkbox"/> Service Technician for Radio Stores or Factory | <input type="checkbox"/> Public Address Systems |
| <input type="checkbox"/> Aviation Radio | <input type="checkbox"/> Ship, Harbor, Gov't., Military Radio |

(If you have not decided which branch you prefer—mail coupon for facts to help you decide.)

Name Age

Address

City Zone State

Approved for Training Under GI Bill



SENSATIONAL



Model 15D-NC

NEW

Noise Canceling Microphone by **TURNER**

Transmits only when spoken to at close range

A new Turner development . . . Now factories, machine shops, engine rooms, trains, aircraft, etc., can have sharp, clear communications. Turner engineers have solved the problem of effective speech transmission under adverse noise conditions. The Turner Model 15D-NC is so expertly designed and balanced it amplifies only sound originating close to its specially engineered diaphragm. Random sound (noise) arriving from a distance strikes both sides of the diaphragm simultaneously and is canceled out. This new microphone transmits only when spoken to at close range from the front.

The LOUDER the noise—the BETTER the results
By speaking directly into the front side of the Turner Model 15D-NC clear cut results are achieved at ordinary levels of conversation. The din, clatter, and clang of machinery and other disturbances are canceled out. In fact, the higher the noise level, the more effective will be the results observed.

Designed for Convenience

The Model 15D-NC is a rugged dynamic built to stand severe operating conditions. It is housed in an attractive hand held case of light, tough alloy. When not in use, it may be hung on a hook. If desired, a "push-to-talk" thumb switch is built into the handle for on-off operation or relay work. Available in 50, 200, 500 ohms, or high impedance.

SPECIFICATIONS Turner Model 15D-NC

EFFECTIVE OUTPUT LEVEL: 56 db below 1 volt/dyne/sq cm.
FREQUENCY RESPONSE: 50 to 5000 c. p. s.
OUTPUT IMPEDANCE: 50, 200, 500 ohms, or high impedance.
DIRECTIONAL CHARACTERISTICS: Close talking only.
DIAPHRAGM: High quality corrosive resistant aluminum.
MAGNETIC CIRCUIT: High energy magnetic circuit with moving voice coil. Both sides of diaphragm exposed to balance out random sound.

CASE: Smooth, die cast alloy.
FINISH: Gray gunmetal enamel.
MOUNTING: Hand held. Hole provided at top of case for hanging on hook.
CABLE: 7 foot attached, single conductor, shielded.
DIMENSIONS: 7" long x 2 3/8" wide x 1 1/2" deep.
WEIGHT: Approximately 24 ounces.
OPTIONAL: "Push-to-talk" thumb switch for on-off or relay operation.

Also available as Model 15D semi-directional dynamic without noise canceling feature. Level: 56 db below 1 volt/dyne/sq cm. Response: 40 to 7500 c. p. s.

*Visit the
Turner Exhibit at the
Parts Show Booth 49—
Stevens Hotel,
Chicago, May 13, 14, 15*

THE TURNER COMPANY

902 17th Street N. E., Cedar Rapids, Iowa

TURN TO TURNER FOR SOUND PERFORMANCE

Microphones licensed under U. S. patents of the American Telephone and Telegraph Company, and Western Electric Company, Incorporated. Crystals licensed under patents of the Brush Development Company



\$400,000 WORTH OF RADIO SERVICE DATA

A Continuous Service for less than 9¢ a day in

PHOTOFACT^{*} FOLDERS



VOLUME 1, containing first ten sets of PHOTOFACT FOLDERS in deluxe binder, \$18.39. Individual sets Nos. 1 to 10, \$1.50 each. De Luxe Binder alone, \$3.39.

COMPLETE

Everything you need in one handy, unified form—large schematics, pictorials keyed to parts lists and alignment data complete listings of parts values and replacements, alignment, stage gain, circuit voltage and resistance analysis, coil resistances, dial cord stringing, disassembly instructions, record changer analysis and repair.

ACCURATE

All sets are taken apart and analyzed by experts in the Sams Laboratories. Every part is measured, tested and triple-checked for accuracy. All data is original. This means the data you get is *right*.

CORRECT

PHOTOFACT FOLDERS are issued twice monthly as the new receivers come off production lines. You don't have to wait for information. As receiver changes are made, you get correction and addition sheets for your files. Your data is always up to the minute.

EASY TO USE

All diagrams and pictures are coded to numbered parts lists. Everything is positively identified for fast work. All folders are set up in uniform, easy-to-follow style: big type, big illustrations—no hunting, guessing or eye strain—no more loss of time and temper.



CHECKING OVERALL PERFORMANCE

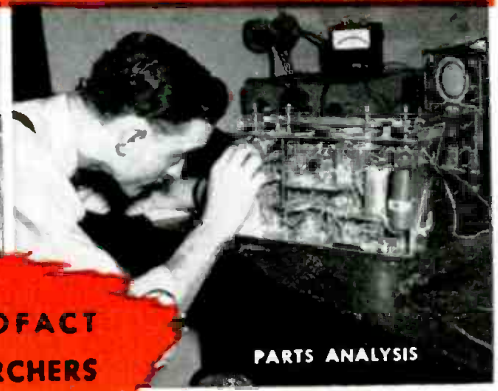

PARTS ANALYSIS



CODING PICTORIAL VIEW

**PHOTOFACT
RESEARCHERS
AT WORK
FOR YOU**

\$403,531.05†—that's what it actually cost us to create, print and distribute Volume 1 of Sams PHOTOFACT FOLDERS. Every penny of that money has been spent to bring the industry the most accurate, complete, up-to-the-minute data ever produced for radio servicemen. And this continuing service, designed to help you make up to *twice as many repairs daily*, actually costs you less than 9 cents a day.

PHOTOFACT FOLDERS could not be produced without the support of America's leading replacement parts manufacturers—without the support, too, of thousands of enthusiastic PHOTOFACT subscribers. With their cooperation, we will continue to place in your hands ALL the information you need to do a better job—facts, figures, photographs, full-page schematics—*information compiled from actual first-hand analysis of all*

* Trade Mark Reg.

new instruments. PHOTOFACT FOLDERS cover *all* radios, phonographs, record changers, recorders, communications systems and power amplifiers—and are *timed to reach you as these instruments are released.* The cost is only \$1.50 per set of 30 to 50 folders and includes membership in the Howard W. Sams Institute.

Set No. 17 will be ready for mailing April 10th. Set No. 18 on April 25th. Sets Nos. 11 to 16 inclusive, also priced at \$1.50 each, are available for immediate order.

Start using PHOTOFACTS to make more profits. Remember, PHOTOFACT FOLDERS actually cost you nothing: *they pay for themselves over and over!* See your replacement parts distributor—or write us direct. In Canada, address A. C. Simmonds & Sons, 301 King Street East, Toronto, Ontario. Canadian price, \$1.75.

†C.P.A. Statement Available

HOWARD W. **SAMS** & CO., INC.

2924 EAST WASHINGTON STREET, INDIANAPOLIS 6, INDIANA

PHOTOFACT SERVICE

"The service that pays for itself over and over again"

SYLVANIA NEWS

RADIO SERVICE EDITION

MAY

Prepared by SYLVANIA ELECTRIC PRODUCTS INC., Emporium, Pa.

1947

BRAND NEW SYLVANIA TECHNICAL MANUAL NOW AVAILABLE TO RADIO SERVICEMEN!

Handy Volume Describes Over 500 Receiving Tubes— Is Full Of Helpful, Essential Data



Here's the new, handy volume of valuable radio tube information radio servicemen everywhere have been waiting for. This bigger, better-than-ever latest Sylvania Technical Manual—listing over 500 radio tube types (old and new)—has been made available as a result of the solution of extensive and elaborate tube engineering problems.

IMPORTANT INFORMATION

You'll surely welcome this handy reference manual, with its important features including: Fundamental Properties of Vacuum Tubes; The Characteristic Curves; General Tube and Circuit Information; Resistance Coupled Amplifier Data—and many more.

AVAILABLE NOW

We urge you to get your copy right away—because we know you'll find this volume chock-full of invaluable information—facts that will be helpful to you day in and day out.

See Your Sylvania Distributor or order from Radio Tube Division, Emporium, Pa.

SYLVANIA ELECTRIC

MAKERS OF RADIO TUBES • CATHODE RAY TUBES • ELECTRONIC DEVICES • FLUORESCENT LAMPS • X-RAY TUBES • WIRING DEVICES • ELECTRIC LIGHT BULBS

RADIO-CRAFT for MAY, 1947

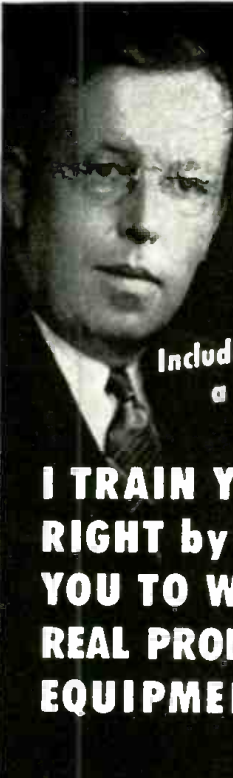

NOW! An Amazing Opportunity to LEARN RADIO AT HOME

I SEND YOU 8 BIG KITS OF RADIO PARTS Including a COMPLETE 6 TUBE SUPER-HETERODYNE RECEIVER

I TRAIN YOU RIGHT by PUTTING YOU TO WORK with REAL PROFESSIONAL EQUIPMENT!

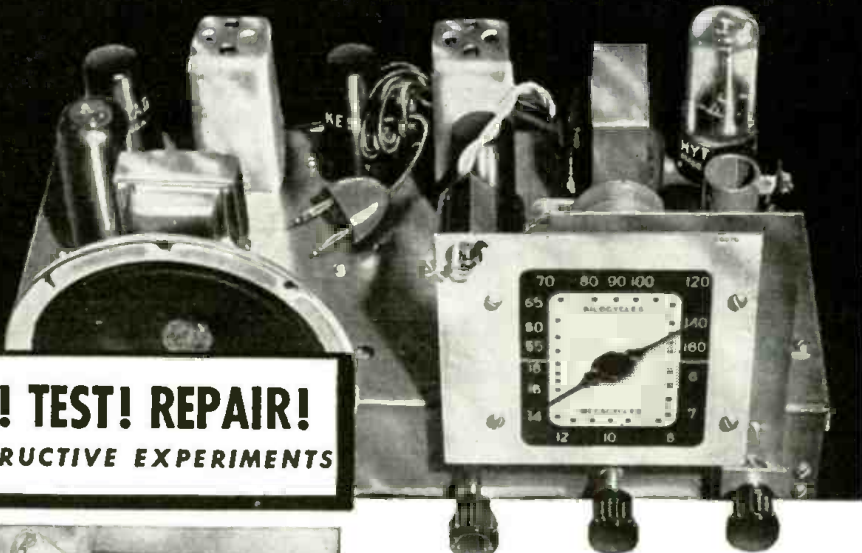

LEARN HOW TO BUILD CIRCUITS! TEST! REPAIR!
YOU DO OVER 175 INSTRUCTIVE EXPERIMENTS



HERE'S THE EASIEST, MOST PRACTICAL WAY OF ALL TO PREPARE FOR GOOD PAY in RADIO ELECTRONICS and TELEVISION!

I train your mind by putting you to work with your hands on a big 6-Tube Superheterodyne Receiver. And, believe me, when you get busy with real Radio Parts — 8 big Kits of them — you really LEARN Radio and learn it RIGHT! You get the practical stuff you need to be useful in Radio, and that's what it takes to make money. You don't have to worry about what to do with these 8 Kits of Parts. Step by step, I show you how to build circuits, test, experiment, trouble-shoot. And you don't need any previous experience. The Sprayberry Course starts right at the beginning of Radio! You can't get lost! Simplified lessons, coupled with real "Shop" practice, makes every subject plain and easy to understand and remember. Soon after you begin Sprayberry Training, I'll send you my sensational BUSINESS BUILDERS.

A BUSINESS OF YOUR OWN . . . OR A GOOD RADIO JOB
You'll find out how to get and do neighborhood Radio repair jobs for nice profits and rich experience while learning. This sort of work can easily pave the way for a Radio Service business of your own. But with Sprayberry Training, you're not limited. You can swing into any one of the swiftly expanding branches of Radio-Electronics INCLUDING Radio, Television, FM, Radar, Industrial Electronics. Be wise! Decide now to become a fully qualified RADIO-ELECTRONICIAN. Get full details about my Training at once! Mail coupon below for my 2 big FREE Books.

YOU BUILD THIS USEFUL TEST EQUIPMENT!

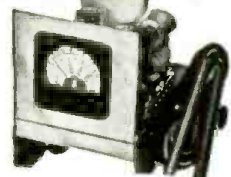

I give you a fine, moving-coil type Meter Instrument on Jewel Bearings — with parts for a complete Analyzer Circuit Continuity Tester. You learn how to check and correct Receiver defects with professional accuracy and speed.

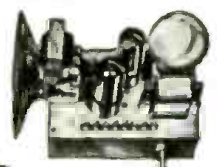

Soldering, wiring, connecting Radio parts . . . building circuits — you can't beat this method of learning. When you construct this Rectifier and Filter, Resistor and Condenser Tester, etc., you get a really practical slant on Radio.

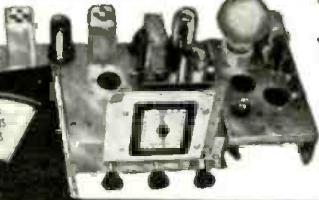

You'll get valuable experience and practice building this Signal Generator and multi-purpose Tester. Makes a breeze out of fixing Radios and you don't have to spend money on outside, ready-made equipment.



RUSH COUPON!

SPRAYBERRY ACADEMY OF RADIO
F. L. Sprayberry, President, Room 2057, Pueblo, Colorado
Please rush my FREE copies of "How to MAKE MONEY in RADIO, ELECTRONICS and TELEVISION," and "HOW to READ RADIO DIAGRAMS and SYMBOLS."

Name Age
Address
City State
(Mail in envelope or paste on penny postcard)

GET THESE VALUABLE FREE BOOKS
"How to Read Radio Diagrams and Symbols"
Here's a valuable and wonderfully complete new book which explains in simple English how to read and understand any Radio Set Diagram. Includes translation of all Radio symbols. Send for this volume at once. It's free! Along with it, I will send you another Big Free book describing in detail my Radio-Electronic Training.

GET YOUR PROFIT-MAKING FEDERAL SELENIUM RECTIFIERS FROM THESE JOBBERS!

There's an authorized jobber near you who can supply your Federal Miniature Rectifiers — and give you free selling-aids that will help you cash in on the big market for this new component that replaces the rectifier tube

in AC-DC, Portable, Table, and Console radio receivers.

It's the modern way to give better service, improve set performance, get instant starting and longer life. . . . Get in touch with your nearest jobber today.



ALABAMA
Mobile—Radio Labs

ARIZONA
Phoenix—Southwest Wholesale Radio & Appliance Co.

ARKANSAS
Ft. Smith—Wise Radio Supply

CALIFORNIA
Long Beach—Fred S. Dean Co.
Los Angeles—U. S. Grant Supply Co.
Radio Equipment Distributors
Radio Products Sales Co.
Radio Specialties Company
United Radio Supply Co.
Sacramento—Sacramento Electric Supply
San Diego—Electronic Distributors Radio Parts Co.
San Francisco—Leo J. Meyberg Co., Inc.
Schuyler-Wilson Co.
Zack-Radio Supply Co.
Santa Ana—Radio & Television Equipment Co.

COLORADO
Denver—Inter-State Radio & Supply Co.
Radio Products Sales Co.

CONNECTICUT
Bridgeport—R. G. Scell & Co.
Hartford—R. G. Scell & Co.
New Britain—United Radio Supply

DELAWARE
Wilmington—Radio Electric Service Co. of Pennsylvania

DISTRICT OF COLUMBIA
Washington—Capitol Radio Wholesalers
Emerson Radio of Washington

FLORIDA
Miami—Herman Radio Supply Co.
Thurou Distributors, Inc.
Jacksonville—Thurou Distributors, Inc.
Orlando—Thurou Distributors, Inc.
St. Petersburg—Welch Radio Supply
Tallahassee—Thurou Distributors, Inc.
Tampa—Thurou Distributors, Inc.
W. Palm Beach—Goddard Distributors
Thurou Distributors, Inc.

GEORGIA
Atlanta—Concord Radio Corp.
Augusta—Prestwood Electronics Co.

IDAH0
Boise—Craddock's Radio Supply

ILLINOIS
Chicago—Allied Radio Corporation
The Lukko Sales Corp.
Walker-Jimieson, Inc.

INDIANA
Anderson—Seybert's Radio Supply Co.
Evansville—Wesco Radio Parts
Indianapolis—Kiefer-Stewart Co.
Radio Distributing Company
Rodefeld Co.
Van Sickle Radio Supply Co.
Muncie—Standard Radio Parts
South Bend—Collfax Co., Inc.
Terre Haute—Terre Haute Radio

KANSAS
Wichita—Radio Supply Company

KENTUCKY
Louisville—P. I. Burks & Co.
Universal Radio Supply Co.
Owensboro—General Electronic Supply

LOUISIANA
New Orleans—Radio Parts, Inc.
Shuler Supply Co.
Southern Radio Supply Co.
Walther Bros. Company

MAINE
Auburn—Radio Supply Co., Inc.
Bangor—Radio Service Laboratory of New Hampshire & Maine
Portland—Radio Service Laboratory of New Hampshire & Maine

MARYLAND
Baltimore—Kann-Ellert Electronics, Inc.
Wholesale Radio Parts Co., Inc.
Cumberland—Radio Wholesaler

MASSACHUSETTS
Boston—De Mambro Radio Supply Co.
Louis M. Herman Company
Hub Cycle and Radio Co., Inc.
Radio Shack Corporation
Cambridge—Electrical Supply Corp.
The Eastern Company
Fall River—Flint Radio Co.
Roxbury—Gerber Radio Supply Co.
Worcester—De Mambro Radio Supply Co.

MICHIGAN
Detroit—Ingram Distributing Co.
Grand Rapids—Milton Bursma

MINNESOTA
Minneapolis—Lew Bonn Co.

MISSOURI
Kansas City—Potter Radio Company
St. Louis—Radonics

NEBRASKA
Omaha—General Appliance Co.

NEW HAMPSHIRE
Manchester—De Mambro Radio Supply Co.
Radio Service Laboratory

NEW JERSEY
Camden—General Radio Supply Co.
Radio Electric Service Co. of Pennsylvania
Newark—T. A. O'Loughlin & Co.
Variety Electric Company
Perth Amboy—Bennett's Radio Supplies
Phillipsburg—Carl B. Williams

NEW MEXICO
Albuquerque—Radio Equipment Co.

NEW YORK
Albany—Hudson Valley Asbestos Corp.
E. E. Taylor Co.
Binghamton—Broome Distributing Co.
Federal Radio Supply
Morris Distributing Co., Inc.
Buffalo—Generee Radio & Parts Co.
Radio Equipment Corp.
Standard Electronics Co.
Elmira—Fred C. Harrison Co.
Le Valley-McLeod-Kincaid Co.
Glens Falls—Ray Distributing Co.
Hempstead—Standard Parts Corp.
New York—Bronx—Slate and Company
Brooklyn—Penray Distributing Co.
Electronic Equipment Company, Inc.
Green Radio Distributors
Hornbeam Distributing Co.

Manhattan—H. L. Dalls, Inc.
Federated Purchaser Inc.
Harvey Radio Company, Inc.
Milo Radio & Electronics Corp.
Newark Electric Co. Inc.
Radio Wire Television Inc.
Radionic Equipment Co.
Stan-Burn Radio & Electronics Co.
Terminal Radio Corporation
Queens—Peerless Radio Distributors

Rochester—Hunter Electronics
Masline Radio & Electronic Equipment Co.
Rochester Radio Supply Co.
Schenectady—M. Schwartz & Son
Syracuse—Broome Distributing Co.
W. E. Ferndt
Morris Distributing Co.
Syracuse Radio Supply Co.
Troy—Trojan Radio Co., Inc.
Utica—Beacon Electronics, Inc.
Electronic Lab's & Supply Co.
Vaeth Electric Co.
White Plains—Sound Products Co.
Westchester Electronics Supply Co.

NORTH CAROLINA
Charlotte—Radiotronic Distributors, Inc.
Raleigh—Supreme Radio Suppliers

OHIO
Akron—Brighton Sportline Goods Corp.
Cincinnati—Herrlinger Distributing Co.
Holub & Hogg
Cleveland—Goldhammer, Inc.
Columbus—Hughes-Peters, Inc.
Thompson Radio Supplies
Dayton—Hughes-Peters, Inc.
Standard Radio & Electronics Products Co.
Toledo—Lifetime Sound Equipment Co.
Warren Radio Company

OKLAHOMA
Lawton—Reynolds Radio Supply

OREGON
Portland—Lou Johnson Company
Tracy & Company, Inc.

PENNSYLVANIA
Allentown—Radio Electric Service Co. of Pennsylvania
Ardmore—O. K. Griffith Radio
Erie—Warren Radio Company
Harrisburg—Radio Distributing Co.
Lancaster—Geo. D. Barbey Co.
Mt. Carmel—Big Boys Auto Parts Co.

Philadelphia—Almo Radio Co.
Emerson Radio of Pennsylvania
Electronic Research Laboratories
Radio Electric Service Co. of Pennsylvania

Pittsburgh—Cameradio Co.
Tydings Company
Reading—Geo. D. Barbey Co.
Scranton—Fred P. Pursell
Sunbury—Big Boys Auto Parts Co.
Wilkes-Barre—General Radio & Electronic Co.
York—J. R. S. Distributors

RHODE ISLAND
Providence—Wm. Dandreta & Co.
De Mambro Radio Supply Co. (Branch)
W. H. Edwards Co.

SOUTH DAKOTA
Rapid City—Giraud Supply Co., Inc.

TENNESSEE
Memphis—Bluff City Distributor Co.
Nashville—Currey's, 109 16th Ave.

TEXAS
Dallas—Crabtree's Wholesale Radio
Huey & Philip Hardware Co.
Wilkinson Brothers
Ft. Worth—Fort Worth Radio Supply Co.
Houston—Sterling Radio Products Co.
San Antonio—Mission Radio, Inc.

UTAH
Salt Lake City—S. R. Ross

VERMONT
Burlington—Vermont Hardware Co.
Rutland—Rutland Radio Center

VIRGINIA
Norfolk—Radio Parts Distributing Co.
Radio Supply Company
Roanoke—Leonard Electronic Supply
Staunton—Southern Electric Co.

WASHINGTON
Seattle—Seattle Radio Supply, Inc.
Herb E. Zobrist Co.
Yakima—Lay & Nord

WISCONSIN
Milwaukee—Radio Parts Co., Inc.

OUTSIDE THE UNITED STATES

HAWAII
Hilo—Photo Radio Products, Ltd.
Honolulu—Radio Wholesale & Supply Co.

GET THESE FREE SALES HELPS



SELF-SERVICE COUNTER DISPLAY
Holds 12 individually boxed units.



SERVICE MANUALS
Show how to apply and install Federal's Miniature Rectifiers.

ALSO — a 17-by-22 inch 3-color window poster, that gives all sales points at a glance. Available from your nearest jobber!

Federal Telephone and Radio Corporation

In Canada — Federal Electric Manufacturing Company, Ltd., Montreal.
Export Distributors — International Standard Electric Corp. 67 Broad St., N. Y.



100 Kingsland Road,
Clifton, New Jersey

Grasp the **NEW OPPORTUNITIES** in

RADIO ELECTRONICS AND TELEVISION NOW!



Modern Radio — FM Broadcast and Reception — Television — Industrial Electronics; Power, Control, Communications — new equipment and methods demand new technical ability and experience. Keep up to date with the latest.

**MODERN RADIO
EQUIPMENT FOR YOU
TO USE AND KEEP**

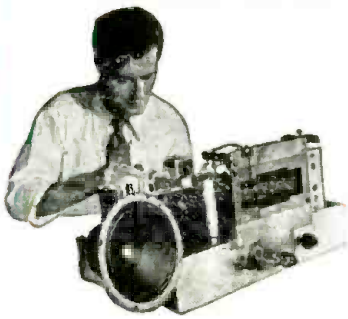

The very essence of National Shop Method Home Training is **EXPERIENCE**. You get actual experience by working with modern Radio and Electronic equipment—building many types of circuits. You may build a fine, long distance **MODERN SUPERHETERODYNE**, signal generator, miniature radio transmitter, audio oscillator, etc.—many other standard actual operating pieces of equipment—cathode ray and other experiments. This practical work advances with your training—**YOU LEARN BY DOING!**

Shop Method Home Training

By a Real Established Resident School with its own FM Studios, Shops and Laboratories.

TRAIN WITH ADVANCED TECHNIQUE

The good jobs in Radio Electronics now go to the men who are equipped to handle them. It takes training and experience. National Schools, one of the oldest and largest trade schools in the country, makes it possible for you to get this training right in your own home **IN YOUR SPARE TIME**.

National maintains modern resident training Studios, Shops and Laboratories where instructors and engineers are working constantly to improve training methods. **SHOP METHOD HOME TRAINING** is a logical extension of this practical system.

A **FREE** lesson that shows you how practical and systematic this new training method is will be sent you without obligation. You may keep and use this lesson to prove to yourself just how practical National Training really is.

Get one of the many **NEW JOBS** that demand new techniques and methods in Modern Radio. Get your share of the **NEW BUSINESS** that servicing the new sets and equipment demands. Experts agree that Radio, Television and Electronics present opportunities

much greater than ever before! Radio is expanding with far-reaching improvements in reception. No one knows yet how great the Television market will be. Electronics will touch almost every walk of life—in industry and in the home.

TURN YOUR INTEREST IN RADIO INTO A CAREER THAT WILL ASSURE YOU SUCCESS AND SECURITY.

FIND OUT WHAT NATIONAL TRAINING CAN DO FOR YOU

Where do you stand today in modern industrial progress? What does the future hold for you? You owe it to yourself to investigate this opportunity. With National Training **YOU GET AHEAD FAST**—you may step into a good position or start a business of your own, with little capital, even before you complete your National Course.

Fit yourself for a career of independence, good earnings, success and security in one of the fastest growing fields in industry. For full information, just send your name and address on the coupon and mail it **TODAY**.

**FREE
LESSON**



Get This Book FREE

This big book presents the facts about the field of Electronics and your opportunities in it together with full information about the advanced National Training. Read it and make up your own mind that National Training will equip you for a great future. No salesman will call on you from National. The book is **FREE** with your sample lesson. Clip and mail the coupon **TODAY!**



NATIONAL SCHOOLS
LOS ANGELES 37, CALIFORNIA EST. 1905

MAIL OPPORTUNITY COUPON FOR QUICK ACTION

NATIONAL SCHOOLS, DEPT. 5-RC
4000 South Figueroa Street, Los Angeles 37, California

(Mail in envelope or paste on penny post card)

Mail me **FREE** the two books mentioned in your ad including a sample lesson of your course. I understand no salesman will call on me.

NAME AGE

ADDRESS

CITY STATE

Include your zone number

Check here if veteran of World War II

See What National Training Has Done For These Men

National Shop Method Home Training wins good jobs, independence and security. Take the word of National men who have established records in their favorite Radio, Television, or other branches of Electronics.



From O. K. Ivey, Washington, D. C., comes this endorsement: "I believe National offers the best course to be had. Keep up the good work."

Here's a statement from R. R. Wright, Blackfoot, Idaho: "Due to my training at National I was selected to instruct in the laboratory work of Navy and Marines."



Clifford Hannah, Portage la Prairie, Manitoba, Canada, writes: "My training has brought results as I'm in line for another raise thanks to National's encouragement and thorough training."

Joseph Michel, Jr., Granite City, Illinois, writes:

"I am enthused with National training. I am now earning \$225 a month as a radio operator and technician and \$20 a week more in my shop at home."



Read what other enthusiastic students have written about National Training in the big 40 page book we will send you.

"Communications"

HOUSE OF MICROWAVES



Magnetrons! Type 2J32 (Jan.) just released. The 2J32 is designed for 10 cm. operation. Rated at 300 kw peak pulse power. Complete information supplied. Listed at \$200. Our Price New \$25.00 3J31's. One cm. magnetron listed at \$95. OUR PRICE...\$20.00 720 Magnetron. Value \$200. Special...\$20.00

2J38 (\$245-3263 mcs) Complete with magnet...\$37.50
2J42 (3 cm) complete with magnet...\$37.50
2J26 (10 cm)\$25.00
Magnets for Magnetrons\$12.00

Klystrons! 2K25/723AB (3 cm) new; with data listed at \$38. Our price\$7.75
707B. Limited quantity\$15.00
External Cavity for 707B\$3.50

715B Pulse Power Tube.....\$9.50
30 mc oscillator-amplifier with 2 6AC7's. Uses 723ab. Wave guide input, xtal detector. With 6AC7's\$10.00
With 6AC7's and 723ab. IN24\$16.50
Thermistor Beads (D-170896), for use with UHF and Micro-Wave equipment (List \$3.00). In separate sealed containers\$5

WAVE GUIDE PLUMBING 3 centimeters

T Section with choke terminations.....\$5.00
3 cm TR Box (cavity) silvered for 721A TR tube\$2.50
2 1/2 foot silver plated with 180° bend (2" radius)\$4.50
150° bend with 90° twist 3 1/2" radius with pressurizing nipple and coax coupler...\$3.95
2 1/2 foot 3 cm wave guide choke to cover fitting\$4.50
5 foot 3 cm wave guide section. Per foot...\$1.95
Slotted Dipole Antenna 3 cm\$4.00
90° bend in wave guide 15"\$4.00
Silver Plated Directional Couplers with a 20 DB drop with:
A. Wave guide 90° bend 15" long.....\$4.00
B. 15° bend in wave guide 15"\$4.40
C. 30° bend in wave guide 10" long.....\$3.95
D. 90° bend in wave guide 15" long also 90° bend in coupler\$5.00
Choke flange for 3 cm. 1"x1 1/2". 2 for\$1.15

1.25 Centimeters

Flexible section 1" long, choke to choke...\$3.00
Mitted elbow and "S" section, cover to choke\$3.50
T-section, choke to cover\$4.50
Section—1" long, cover to cover\$2.00

10 Centimeters

Wave Guide per ft.\$2.00
16 foot lengths
Coax Coupler 9/16" to 3/4" coax\$2.50
Coax Rotary Joint with mounting plate.. \$8.00

SO RADAR

Transmitter unit (10 CM) includes 2J26 magnetron, TR-ATR section, pulse transformer, McNally Klystron, 1F strip all tubes, blower motor. Used but in good condition\$150.00
SO Radar antenna assembly (10 Cm) dipole, parabolic reflector 24 in. diameter. Drive and selayn motors, wave guide couplings, rotary joint. Masking dome, 30x30x40". Used and in good condition\$45.00
New\$90.00
SO Radar 10 cm echo boxes\$15.00
SO Radar indicator unit, with CR tube, focusing and deflection coils, azimuth scale, all controls. tubes and components used and in good condition\$100.00
SO Radar accessory range unit, with AC voltmeter on front of cabinet\$35.00
In fact we have the complete SO Radar. New and used. Ask us for quotations.

APS-10 Modulator assembly: Includes 2J42 magnetron, 2-3B24s, 3C45, relays, blower motor.
Together with Low Voltage power supply assembly for APS-10. Chokes, condensers, transformer.
Both units, a buy for\$50.00

Signal Generator, 2700 to 8000 MC. Regulated power supply, 115V/60C. Contains output meter. Made by Western Electric. Value \$400. Our price\$75.00

NEW ARC-5 SUPERHET RECEIVERS—NEW!

Tubes (included) 3—12SK7; 1—12K8; 1—12SR7; 1—12A6. Freq. range: A different receiver for each of these bands: 1.5 to 3 Mc; 3 to 6 Mc; 6 to 9.1 Mc. Any one receiver; specify frequency. Tubes and schematic are included\$12.00



Extra to go with ARC-5
Dynamotor\$2.25
Control Box\$1.00
Drive Cable\$2.50
Mounts\$1.00

(SCR-274-N) Transmitters

ARC-5 Transmitters; 25 watts CW; 15 watts phone. Tubes: 2—1625; 1—1629; 1—1626; 1 crystal. Range (specify frequency desired); .5-.8 Mc; .8-1.3 Mc; 1.3-2.1 Mc; 4-5.3 Mc; 5.3-7 Mc; Power: 24-28 VDC. Less dynamotor\$12.00
Dynamotor for Transmitter\$14.00
Modulator unit (with tubes) 1—1625\$14.50
1—VR150; 1—1215\$14.50

These units are BRAND NEW!!!

SONAR SOUND DETECTION UNIT

Ideal for detecting underwater sounds, such as fish swimming in schools, within a 15 mile area. Using a Rochelle salt crystal, which is about 1000 times more sensitive than quartz, as the active unit the sound is transmitted up a 60 ft. length of cable. It is completely enclosed in a solid rubber sheath. This sound detector was originally used in harbor defense. Coupled to an audio amplifier, this can be found to have many valuable applications. Ask for SD-1\$6.95



New US Navy Model RAK-7 Ship Receiver



15 kc to 600 kc, 6-tube receiver with: AVC-Band pass filter-Audio filter-Noise limiter—Precision tuning with a Vernier dial—Voltage regulated power supply, with three tubes, for 60 cycle, 115 volts. Can be battery operated. Complete with spare parts box weighing 73 lbs.. tubes and instruction book\$69.95

RA-58-A HI-VOLTAGE POWER SUPPLY

Ideal for breakdown insulation testing, or as a source of power for a pulse transmitter. This unit supplies continuously variable voltages between 500 and 15,000 volts DC at 35 ma. A voltage Doubler circuit using two 705a rectifiers and two 1 mf condensers is employed. RMS ripple voltage at maximum power is 6%. THIS UNIT OPERATES FROM 115v/60c. Variable voltage is obtained by means of a Variac in the primary circuit of the high voltage transformer. Size is 21"x17 1/2"x29" deep. Net weight 314 lbs. This unit sells for the low price of\$116

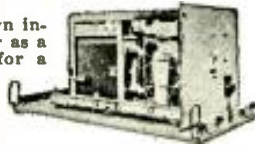

We have unbelievable bargains in 400 cycle transformers. Ideal for pulse work. At this price you can figure out your uses for them. Most sizes at 50 cents each. Send us your voltage requirements.

Values in All Frequencies SPECIALS FOR THIS MONTH

Visors for 5-inch scopes\$.75
Tube shields for 2AP1\$.98
Broadcast band push-button tuning units inductive types\$1.98
Mushroom rubber earphone cushions for lightweight set—2 pairs for\$.89
Oscilloscope chassis, completely punched for use with a 2-inch tube. Octal sockets included 15"x11"x9"\$1.50
Microphone element T-30-K for throat mike selling 2 for\$.50
Microphone unit MC-419 for lip microphone\$.98
140 mmf split stator variable midget condenser\$1.49
Silver button mica condensers, 175-185 mmf, each\$.05
Lots of 100\$4.50
Silver button mica condensers: 500 mmf, each\$.10
Lots of 100\$9.50
Whip antenna—2 sections fasten together—Ideal for 10 meters\$1.25
B-29 computer amplifier contains 8-6SN7s, 5 neons, 8 relays completely wired, new...\$9.95
115 volt 60 cycle transformers for plate and filament 570 V CT. 60 MA-5 and 6.3 V\$1.89
6 Hy Choke 60 MA. to match above\$.65
I-F Crystal filter for BC-312, BC-342 Resonant at 470 kc. Crystal included..\$6.95

Oil Filled Condensers

1 mf 300 vdc ..\$.25	2 mf 600 vdc ..\$.40
2 mf 800 vdc ..\$.30	1 mf 1000 vdc ..\$.85
4 mf 800 vdc ..\$.35	2 mf 1000 vdc ..\$.98
4 mf 400 vdc ..\$.55	1 mf 1500 vdc ..\$1.05
5.5 mf 400 vdc ..\$1.15	4 mf 1500 vdc ..\$.20
2 mf 550 vdc ..\$.30	2 mf 660 ac/1000 ..\$.95
.25 mf 600 vdc ..\$.25	4 mf 1500 vdc ..\$1.30
.85 mf 600 vdc ..\$.30	1 mf 2000 vdc ..\$1.10
1 mf 600 vdc ..\$.35	1-1 mf 7000 vdc GE, Pyr\$2.00
	10-10-10 mf synchro cap 90v/60c\$2.50

Hi-Volt Mica Condensers

F3L .0003 mfd 8000V list \$29.00\$3.75
Solar type SX .0015 mf 3000V list \$9.95 ..\$.75
Sangamo G-3 .006 mf 10 kv list \$87.50 ..\$17.50
.0008 mf 5000 vdc C-D No. 599-6H\$.80
.0002 mf 5000 vdc Aerovox\$.75

Tube Special

Tube Type	Approx. List	Your Cost	Tube Type	Approx. List	Your Cost
2AP1	\$12.00	\$3.75	837	\$2.80	\$1.35
3BP1	15.00	3.95	872A	7.50	2.45
3FP7	27.00	3.50	3B24	12.00	3.95
5BP1	20.00	4.95	705A	22.50	6.75
5BP4	29.00	7.95	241-B-WE	85.00	40.00
5CP1	45.00	4.95	861	155.00	50.00
5FP7	32.00	4.25	304 TL		8.00

Sockets for 5CP1, 5BP1, 3BP1, 705A, 829 \$95 ea.

Hi Volt Transformers

2 KVA Transformer and choke—115 V. 50 to 70 cycle input, single phase. Output 17,000 V. @ 144 Ma; choke 4,000 H @ 0 current, DCR 4500 ohms. Dimensions 26"x29"W. x13"D. Amertran\$94.50
3200 volts, AC 150 M.A. 115 volt, primary, 60 cycles. Designed for half wave operation with 150 M.A. output each, two transformers hooked up with secondaries in series and primaries in parallel will give 3,000 volts, output at 300 M.A. from a full wave rectifier. These are conservative, continuous commercial ratings \$7.25

Relays

SPST Latching relay made by Kurman. Make coil 115v/60c; DCR 1500 ohms. Break coil 115 vdc 10 ma; DCR 5000 ohms\$2.95
DPST Telephone type; 2 p. 1 cl; 1 open cont. rating 5a at 50v. coil rating 3.5 ma (at 12K ohms), 1000 vac.\$1.05
Edison-Sealed Tube Type Thermal Relays—45 to 60 second delay. Normally open. \$10. value. Our special price\$3.45
24 Volt Relay Grab Bag Bargains: SPST, ea..\$.50; DPDT, ea., \$.60; TPPT, ea., \$.70.

All merchandise guaranteed. Mail orders promptly filled. All prices F.O.B. New York City. Send Money Order or Check. Shipping charges sent C.O.D. Send for Flyers.

COMMUNICATIONS EQUIPMENT CO.

131-C LIBERTY ST., NEW YORK 7, N. Y. TELEPHONE WH 4-7658

RADIO ELECTRONICS

DeFOREST'S TRAINING, INC. CHICAGO, ILLINOIS

IT IS THE **WELL TRAINED** MAN WHO **WINS**

In the prize ring, as in the bigger contest of making a livelihood for ourselves and families, *training* makes the champion... brings the real **PAY OFF!**

You can prepare for bigger winnings, too, by training for one of America's great championship fields—**RADIO and ELECTRONICS**—the billion dollar opportunity-packed industry that is *on the march*.

Mail coupon below right now, for late facts about the exciting events in F.M. Radio, Broadcast Radio, Motion Picture Sound, Electronics, Sound Recording, the future developments in Television, Radar and other branches. See, too, how you may score a *knockout* against low pay, uninteresting work, an uneventful future.

You don't have to know a thing about Radio and Electronics at present. Over a period of 15 years, DeFOREST'S TRAINING, INC. has perfected a championship method of home training that **GETS RESULTS QUICKLY!**

We provide you, for use in your own home, with a **BIG FOUR** training method that includes

(1) commercial type Radio-Electronic parts and assemblies for valuable "LEARN-BY-DOING" experience, (2) a 16 mm. Motion Picture Projector and 12 reels of action-packed "LEARN-BY-SEEING" instructive movies to speed your understanding of important principles, (3) many easy-to-read loose-leaf lessons illustrated with handy fold-out diagrams, and (4) an effective **EMPLOYMENT SERVICE** to help you get started toward a good Radio Job when trained—or to assist you in starting your own Radio Business where you can be your own boss.

This championship method has started many men toward Real Pay, Fascinating Work, and a Grand Future—see **HOW** it may do the same for you. Mail coupon today for big free book that shows you the way.

**DeForest's Training, Inc. Wins
Coveted "Certificate of Merit".**

DeForest's Training, Inc. is the first school of its kind in the country to win the "Certificate of Merit" of the New York Museum of Science and Industry. This award is granted "in recognition of outstanding achievements in the pioneering, development and use of home study and laboratory courses to train men for the fields of Radio and Electronics."

YOU CAN BUILD 133 FASCINATING EXPERIMENTS

You use 8 Big Kits of Radio-Electronic parts and assemblies. Build and operate **SEVEN** different Radio Receiver Circuits, Electric Eye Devices, Radio Telephone, Wireless Microphone and dozens of other fascinating projects.

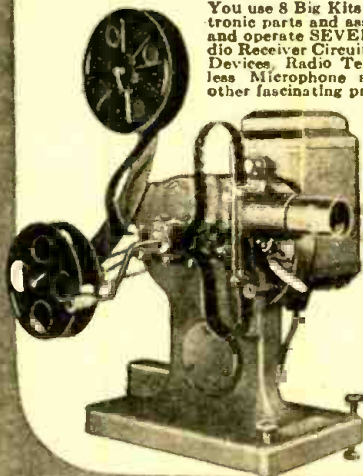

YOU USE A 16 MM. MOTION PICTURE PROJECTOR with 12 reels of instructive movies to help you grasp important fundamentals faster, easier. You enjoy one of today's most modern, effective training aids, right in your own home.



LEARN FASTER AT HOME WITH MOVIES

Without obligation, send for our valuable, information-packed book, "**VICTORY FOR YOU**"

MAIL COUPON TODAY!

DeFOREST'S TRAINING, INC.
2533-41 N. Ashland Ave., Dept. R.C.-D5
Chicago 14, Illinois, U. S. A.

Send me both your big book "**VICTORY FOR YOU**" and Kit Supplement, showing how I may make my start in Radio-Electronics with your modern home training plan. No obligation.

Name..... Age.....
Address..... Apt.....
City..... Zone..... State.....
 If under 16, check here for special information.
 If a discharged veteran of World War II, check here.



VETERANS!!!

Both the Home Study and Chicago Laboratory courses of DeForest's Training, Inc. are approved for your training. If you qualify under the "G. I. Law", you can obtain this training without cost.

CHICAGO PARTS SHOW SECTION

Editorial: 400 Million U. S. Radios?	by Hugo Gernsback	17
Radio-Electronics Monthly Review		18, 19
Canberra's Mobile Radios		34
New French Radio Parts	by E. Aisberg	40
Radio 35 Years Ago		91

Electronics

King of Tube Checkers (Cover Story)		22
Multivibrators	by O. B. Mitchell	25
Antenna Principles, Part VI—Directive Arrays with Metal Screen Reflectors	by Jordan McQuay	29
Television for Today, Part XII—High- and Low-Voltage Power Supplies	by Milton S. Kiver	32
High Voltage Power Supply		52

Amateur Radio

An Economy Transmitter	by R. F. Scott, W2PWG	20
A 300-Ohm Folded Dipole		54

Servicing

Speedy A.C.-D.C. Servicing	by John Bowles	28
Radio Data Sheet 346 (General Electric Farm Radio Model 28U)		36
Install a Wave Trap!	by Oliver Parsons	86

Sound

Home-Built Sound Effects		26
A Small Recording Studio, Part III—Cutters, Volume Level Indicators and Compensation Circuits	by J. C. Hoadley	31
Multi-Station Intercoms, Part III—Intercom Installation and Maintenance	by Richard H. Dorf	33

Test Instruments

Efficient Test and Repair Bench	by C. A. Brown	22
Easy-To-Build Oscilloscope	by B. W. Southwell	23

Construction

Code Oscillator	by Bernd Falk	82
-----------------------	---------------	----

Departments

World-Wide Station List	by Elmer R. Fuller	35
Transatlantic News	by Major Ralph Hallows	38
Technotes		56, 76
New Radio-Electronic Patents		60
The Question Box		62
New Radio-Electronic Devices		64
Radio-Electronic Circuits		70
Try This One!		72
Communications		92
Book Reviews		95



- HUGO GERNSBACK**
Editor-in-Chief
- FRED SHUNAMAN**
Managing Editor
- M. HARVEY GERNSBACK**
Consulting Editor
- ROBERT F. SCOTT, W2PWG**
Technical Editor
- I. QUEEN, W2OUX**
Editorial Associate
- ELMER FULLER**
Shortwave Editor
- ANGIE PASCALE**
Production Manager
- G. ALIQUO**
Circulation Manager
- JOHN J. LAMSON**
Advertising Director
- ALFRED STERN**
Promotion Manager

On THE COVER:



A giant tube tester used for testing the kenotrons used for uranium concentration in atomic processes.
Chromatone by Alex Schomburg from General Electric Photo



RADCRAFT PUBLICATIONS, INC. Hugo Gernsback, President; M. Harvey Gernsback, Vice President; G. Aliquo, Secretary

Contents Copyright, 1947, by Radcraft Publications, Inc. Text and illustrations must not be reproduced without permission of Copyright owners.
RADCRAFT PUBLICATIONS, INC. • PUBLICATION OFFICE 29 Worthington Street, Springfield 3, Mass. • EDITORIAL AND ADVERTISING OFFICES 25 West Broadway, New York 7, N. Y. Telephone REctor 2-9690.

BRANCH ADVERTISING OFFICES: Chicago: 308 W. Washington Street, Suite 1413, Chicago 6, Ill. Tel. Randolph 7363. Cleveland: Burdette Phillips, Manager, 405 Erie Bldg., Cleveland, Ohio. Tel. Main 9645. Detroit: Frank Holstein, Manager, 307-B Boulevard Bldg., Detroit, Mich. Los Angeles: Ralph W. Harker, Manager, 606 South Hill St., Los Angeles 14, Calif. Tel. Tucker 1793. San Francisco: Ralph W. Harker, Manager, 582 Market St., San Francisco 4, Calif. Tel. Garfield 2481.

RADIO-CRAFT, May, 1947, Volume XVIII, No. 8. Published Monthly on 28th of month preceding date of issue. Allow one month for change of address. When ordering a change, please furnish an address stencil impression from a recent wrapper. All communications about subscriptions should be addressed to the Circulation Manager, Radio-Craft, 25 West Broadway, New York 7, N. Y.

SUBSCRIPTION RATES: United States and possessions, Mexico, Central and South American countries, \$2.50 a year; \$4.00 for two years; \$6.00 for three years. Canada, \$3.00 a year; \$5.00 for two years; \$7.50 for three years. All other foreign countries, \$3.25 a year \$5.50 for two years; \$8.25 for three years. Special rates for members of the Armed Forces in U.S., or those addressed by A.P.O. or F.P.O. mail, \$2.00. Entered at Post Office, Springfield, Mass., as second-class matter under the Act of March 3, 1879.

FOREIGN AGENTS: Great Britain: Atlas Publishing and Distributing Co., Ltd., 18 Bride Lane, Fleet St., London E.C.4. Australia: McGill's Agency, 179 Elizabeth Street, Melbourne. France: Brentano's, 37 Avenue de l'Opera, Paris 2e. Holland: Technisch Bureau Van Baerle, Bemelms & Co., Heemstedsche, Dreef 124, Heemstede. Greece: International Book & News Agency, 17 Amerikis Street, Athens. So. Africa: Central News Agency, Ltd., Cor. Rissik & Commissioner Sts. Johannesburg; 112 Long Street, Capetown; 369 Smith Street, Durban, Natal. Universal Book Agency, 70 Harrison Street, Johannesburg. Middle East: Steimatzy Middle East Agency, Jaffa Road, Jerusalem. India: Magazines Distributors, 5 Bombay Mutual Annexe, Gunbow Street, Fort, Bombay 1.

Prepare **NOW** for a Better Job *in the Field of Radio!*



**Don't Delay—
Write Today!**

Greater Knowledge means Greater Opportunities!

Yes, Mr. Radioman, there are innumerable more and better jobs in the Field of Radio as a result of war-developed techniques—Mobile Communication Systems for Automobiles, Busses, Trains, many Industrial Applications, Micro-Wave Relay Systems, FM Broadcasting, Television—these are just a few of the many new opportunities open to you who are alert—and are qualified!

Let Cleveland Institute Take Over Your Personal Up-Grading Problem! Qualified, competent instructors, ample, personalized instructional aids, orderly, progressively arranged study assignments in recognized, approved technical texts—these are only a few of the many superior advantages of CIRE'S plan of personalized spare-time home study training for professional self-improvement.

CLEVELAND INSTITUTE COURSES OFFER COMPLETE TECHNICAL TRAINING RANGING FROM LOW-LEVEL TO COLLEGE-LEVEL.

- A. Master Course in Radio Communication. Covers complete preparation for broadcast station employment including Preparation for FCC License Examinations.
- B. Advanced Course in Radio Communication Engineering. A college-level Radio Engineering Course.
- C. Specialized Television Engineering. Including post-war Television Techniques.

All Courses Include

The Remarkable Workbooks of Instructional Aids, prepared by the instructing staff of Cleveland Institute.

Choose the course best suited to your needs—Start with the section you are qualified to enter—Use the economical CIRE "Pay-As-You-Go-Plan."

CLEVELAND INSTITUTE OF RADIO ELECTRONICS

Contractors to the Canadian Broadcasting Corporation

**RC-5 Terminal Tower
CLEVELAND 13, OHIO**

Approved for Training under "G-I Bill of Rights"

ENROLL FOR INDIVIDUAL SECTIONS OF COURSES, IF YOU PREFER

If you need only highly specialized training, you can study one or more of the following sections instead of a complete course.

1. Mathematics of Radio.
2. Fundamentals of DC and AC Theory.
3. Essentials of Radio Communication.
4. Communication Networks.
5. Advanced Radio Telephony for the Broadcast Operator.
6. Audio and Radio Components and Systems (Design of Receiver and Transmitter Equipment).

(MAIL THIS COUPON)

Cleveland Institute of Radio Electronics, RC-5, Terminal Tower, Cleveland 13, Ohio.

Gentlemen: Please send information about your home courses in Radio Electronics.

NAME
ADDRESS
CITY
ZONE STATE

I desire training in A B C
I have had experience in broadcasting servicing
operating mfg. CAA Army-Navy
amateur other I am a
High School Grad. College Degree
 Check here for Veteran Enrollment Information.

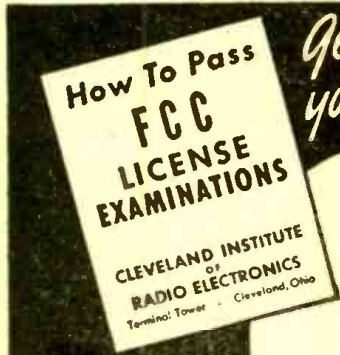

Get your

FCC Commercial Radio Operators' LICENSE NOW!

**Don't Delay—
Write Today!**

Approved for Veteran Training under "G-I Bill of Rights"

CLEVELAND INSTITUTE OF RADIO ELECTRONICS

Contractors to the Canadian Broadcasting Corporation

**RC-5 Terminal Tower
CLEVELAND 13, OHIO**

IT'S EASY IF YOU FOLLOW OUR PLAN!

Thousands of new jobs are opening up—FM, TELEVISION, MOBILE COMMUNICATIONS SYSTEMS, are only a few of the radio fields which require licensed operators.

TIME IS IMPORTANT TO YOU!

You can get your License quickly with **NILSON'S MASTER COURSE in RADIO COMMUNICATION** and exclusive CIRE Workbooks of Instructional Aids. Saves you many hours of random, undirected study.

Assures a MINIMUM of time in getting your ticket.

FREE BOOKLET tells you the Government Requirements for all classes of commercial licenses—Sent immediately upon receipt of coupon.

MAIL THIS COUPON

CLEVELAND INSTITUTE OF RADIO ELECTRONICS
RC-5 Terminal Tower, Cleveland 13, Ohio

Gentlemen: Please send information about your Home Study Course for preparation for FCC Commercial License Examinations. (Does not cover Amateur License Examinations.)

Name
Address
City Zone State

If a Veteran check here



ESSE Specials!



C-1 AUTO PILOT AMPLIFIER

Used to control the operation of the Servo Units causing them to move the control surfaces of the airplane in one direction or the other in response to the signals received. The complete amp. includes one rect. 7Y4, three 7F7's for amplification and control, three 7N7's for signal discrimination, one power transformer, six relays, four control pots, chokes, condensers etc. Convert for use on radio controlled models, doors etc. Operates from 24 V. DC. Size 9 1/4" x 6 1/2" x 7 3/4". Complete with tubes as described.

Price.....\$9.95

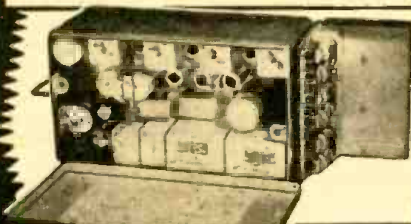

R-89/ARN 5A GLIDE PATH RECEIVER

Formerly used for blind landing but adaptable to many other uses such as receiver for new police or citizen's band. Band of operation 326-335 mc. on any of three pre-determined crystal controlled frequencies. Contains eleven tubes, 6 relays and other valuable parts. For 24 V. DC operation. Size 13 3/4" x 5 1/4" x 6 5/8"

Price, complete as shown.....\$12.45



LOCALIZER RECEIVER BC-733-D

A part of aircraft blind landing equipment manufactured by WE. Operates on any six of its predetermined crystal controlled frequencies in the range of 108-120 mc. Contains 10 tubes, three of which are WE 717-A's — and crystals. Ideal receiver for conversion to 144 mc. ham band or mobile telephone bands. For 24 V. DC operation. Size 14 1/2" x 7" x 4 3/8". Complete with tubes.

Price, complete with dynamotor.....\$12.45

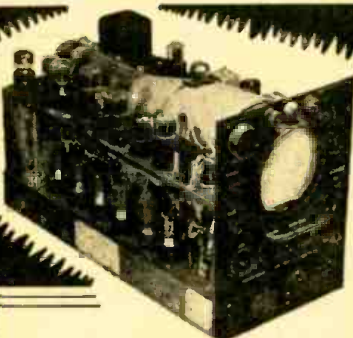

APN-4 RADAR SCOPE

Ideal for conversion to service scope or salvage for parts. Contains 27 tubes such as 6SN7GT, 6H6GT, 6SL7GT, 6SJ7GT and 5CP1 scope tube. 22 pots, switches, condensers, transformers etc. In aluminum case, approx. size 9" x 12" x 18".

Price.....\$17.95 ea.

SOLD OUT



AIRCRAFT RADIO RANGE FILTER FL-8-A

For helpful reduction of QRM on crowded CW bands. When attached to output of any communications receiver:
1 — Will pass signal of 1020 CPS, eliminating others.
2 — Will pass voice frequencies and eliminate 1020 CPS code signal.

Compact, light weight, with switch. Size 2 1/4" x 2 1/4" x 3 3/4".
Price.....\$2.25 ea.

Unless otherwise noted this merchandise was removed from surplus aircraft and is sold as used.

MARKER BEACON RECEIVER

Ideal for controlling remote circuits for model aircraft, boats, etc. Operates from 75 mc. Signal easily altered to 2 meter band. Tubes used and included: 1—6SH7, 1—6SL7GT, 1—12SN7GT. Also sensitive relay. Circuit diagram included inside case. Size 5 3/8" x 3 3/8" x 5 1/4". For 24 V. DC operation. Complete as shown.

Price.....\$3.95

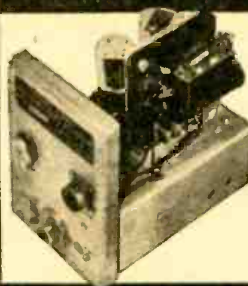

RECTIFIER UNIT RA-63-A

Charges 12V. batteries at 5 amp. rate hi charge or 2 amp. trickle. Easily converted to use as 6V. charger or battery eliminator for auto radio servicing in your shop. Sturdily built dry plate rectifier protected by overload circuit breaker. These units removed from famous SCR-299. Used but in good condition.

Price.....\$14.85 ea.

INTERVALOMETER

Electronic timing device for releasing bombs at preset intervals. Ideal for dark room timer, model train controller etc. Contains relays, switches, pilot light, resistors, knobs, etc. Approximate weight, 7 lbs.

Price.....\$3.95 ea

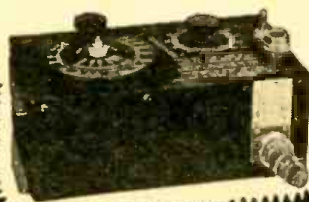

TERMS:
CASH with ORDER
or 25%
BALANCE C.O.D.
All Items
Shipped Collect

On orders less than \$10.00 allow additional charge of 25% to cover handling.



Radio Company
130 W. New York St. - Indianapolis 4, Ind.

ESSE Specials!

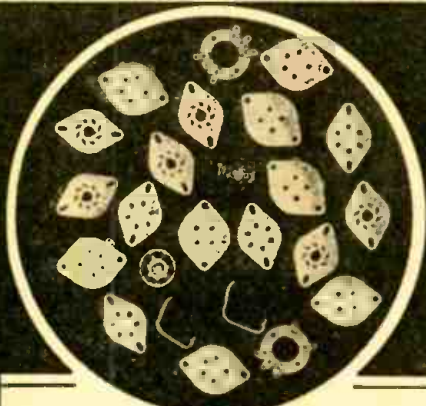

KIT — 24 TUBE SOCKETS

Containing the following new Ceramic 10-loss sockets: 2-Acorn, 6 octal Amphenol, 4-6 prong Millen, 4-5 prong waler, 4-4 prong waler, 2 molded bakelite, 2 octal female plugs and 2-7 prong tube tester sockets with center socket for checking pilot lamps.

Price, complete kit\$1.95

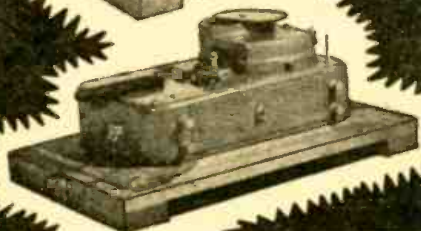

MC ELROY CODE EQUIPMENT BRAND NEW

A proud addition to any Ham Shack. Use it to ink paper tape for high speed sending or receiving, or convert to other uses. Original price several times this low price. Shipped as shown in individual wood carrying case. Tubes used: 1-111726; 2-1177—not included.

Price for both New\$50.00
Used\$35.00



SIGNAL CORPS TIME INTERVAL UNIT ML-138

This unit is housed in a sturdy metal case, 7½"x6"x5¼" with hinged top. Includes necessary adjustment tools. Powerful clock mechanism runs several days. Audio Tone, controlled by relay, is emitted for several seconds once every few minutes. Two flashlight cells needed. Has many possibilities for Radiomen or Model Makers. Parts alone are worth more than our price.

Price\$4.95 ea.

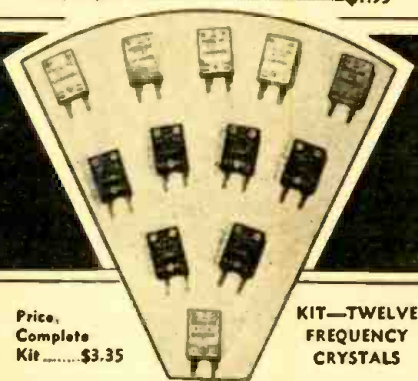

KIT—TWELVE FREQUENCY CRYSTALS

Price,
Complete
Kit\$3.35

Contains assorted frequencies between 3,000 Kc. and 8,000 Kc. in FT 243 crystal holders. We pick at random from mixed supply and cannot select frequencies.

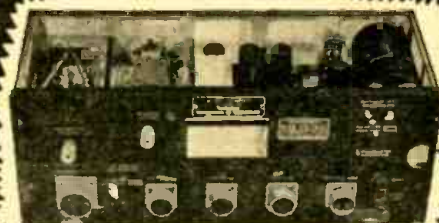

RADIO ALTIMETER APN/1

A complete 460 mc. radio receiver and transmitter which can be converted for ham or commercial use. Tubes used and included: 4-12SH7, 3-12SJ7, 2-6HG, 1-VR150, 2-955, 2-9004. Other components such as relays, 24V. dynamotor, transformers, pots, condensers, etc. make this a buy on which you can not go wrong. Complete as shown in aluminum case 18"x7"x7¼".

Price\$14.95



INTERPHONE AMPLIFIER AM-26/AIC

Convert to high fidelity phone amp. or speech amp. Case size 9¼"x4¼"x5½". Tubes used and included: 2-12SJ5GT, 2-12A6. Complete with dynamotor as shown, for 24 V. DC operation.

Price\$4.85 ea.



BC-348 POWER SUPPLY

To convert the BC-348 receiver for 110 V. AC operation. Constructed especially for the Esse Radio Company by a leading transformer company.

These power supplies have gained great popularity due to quality, price and simplicity in conversion. Filament supply 24V. Rectifier tube used: 6X5 (not included).

Price\$8.95 ea.

Unless otherwise noted this merchandise was removed from surplus aircraft and is sold as used.

On orders less than \$10.00 allow additional charge of 25¢ to cover handling

ESSE

Radio Company
130 W. New York St. · Indianapolis 4, Ind.



ESSE Specials!

Attention Prospectors, Miners, Oil Companies, Plumbers, etc.
The finest metal detecting mine detector ever built.

SCR-625 MINE DETECTOR — BRAND NEW Metallic Objects Only

Used by the Army to detect buried metallic mines. Its private use suggests the location of underground or underwater pipes, cables and ore bearing rock, the location of metallic fragments in scrap materials, logs, etc. and the screening of personnel in plants for carrying of metallic objects.

The unit consists of a balanced inductance bridge, a two-tube amp. and a 1,000 cycle oscillator. The presence of metal disturbs the bridge balance, resulting in a volume change of the 1,000 cycle tone. The tubes used are low battery drain types such as 1G6 and 1N5. The circuit may be modified for control of warning signals, stopping of machinery etc. when metal is detected. Operates from two flash light batteries and 103 V. "B". However, a power supply operating from 110 V. may be used. Comes complete with spare tubes, spare resonator and instruction manual — in wooden chest 8 1/4" x 28 1/4" x 16". Weight in operation is 15 lbs. New, complete in original overseas packing container. Originally sold by War Assets for \$166.00.

The U. S. Forestry Service has recommended procedure for using the SCR-625 Mine Detector to find concealed metal in tree logs and other timber products.

Price \$79.50 ea.



GASOLINE GENERATOR— 27.5 V. DC — 70 AMP.

Electrical starting when connected to 24 V. battery. Ideal for power for emergency, cabins, aircraft, welding etc. These units were used for auxiliary power on bombers.

Price (used) \$72.50

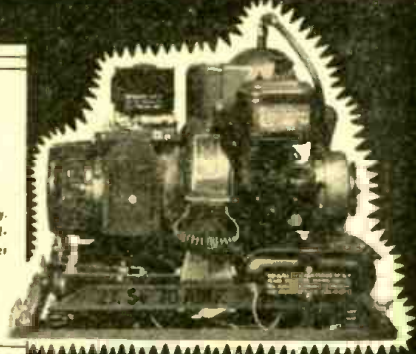

MOTOROLA POLICE TRANSMITTER AND RECEIVER—AM

An ideal unit to convert from its original 9 meter freq. to the 10 meter amateur band for mobile work. Complete with antenna relay, high voltage vibrator supply for both receiver and transmitter and most all tubes. These units were used by Army Military Police and are sold as received. Condition is good except for occasional missing tubes.

Price. Complete as shown (used) \$65.00

LINK FM POLICE TRANSMITTER AND RECEIVER (Not Shown)

Received in same purchase as above equipment. For 27-38 mc. operation. Complete ready to operate.

Price per set (used) \$65.00



MINE DETECTOR AN/PRS-1 BRAND NEW

For detection of metallic and non-metallic objects. Used to locate buried pipe, cables, sewer tile etc. The unit is a UHF transmitter and indicates objects by deflection of the microammeter either to left or right depending upon whether metallic or non-metallic. Audio indication is also given by a change in volume of 1,000 cycle tone. Ready to operate with addition of 1-6 V. and 3-45 V. batteries. Comes complete with spare tubes, antennae, reflectors and instruction book — in wooden chest 9 1/2" x 28 1/4" x 15 1/2". Weight, in operation 22 lbs. Shipped new in original overseas moisture proof container.

Price \$14.95 ea.



TERMS:
CASH with ORDER
or 25%
BALANCE C.O.D.
All Items
Shipped Collect



Radio Company

130 W. New York St. • Indianapolis 4, Ind.

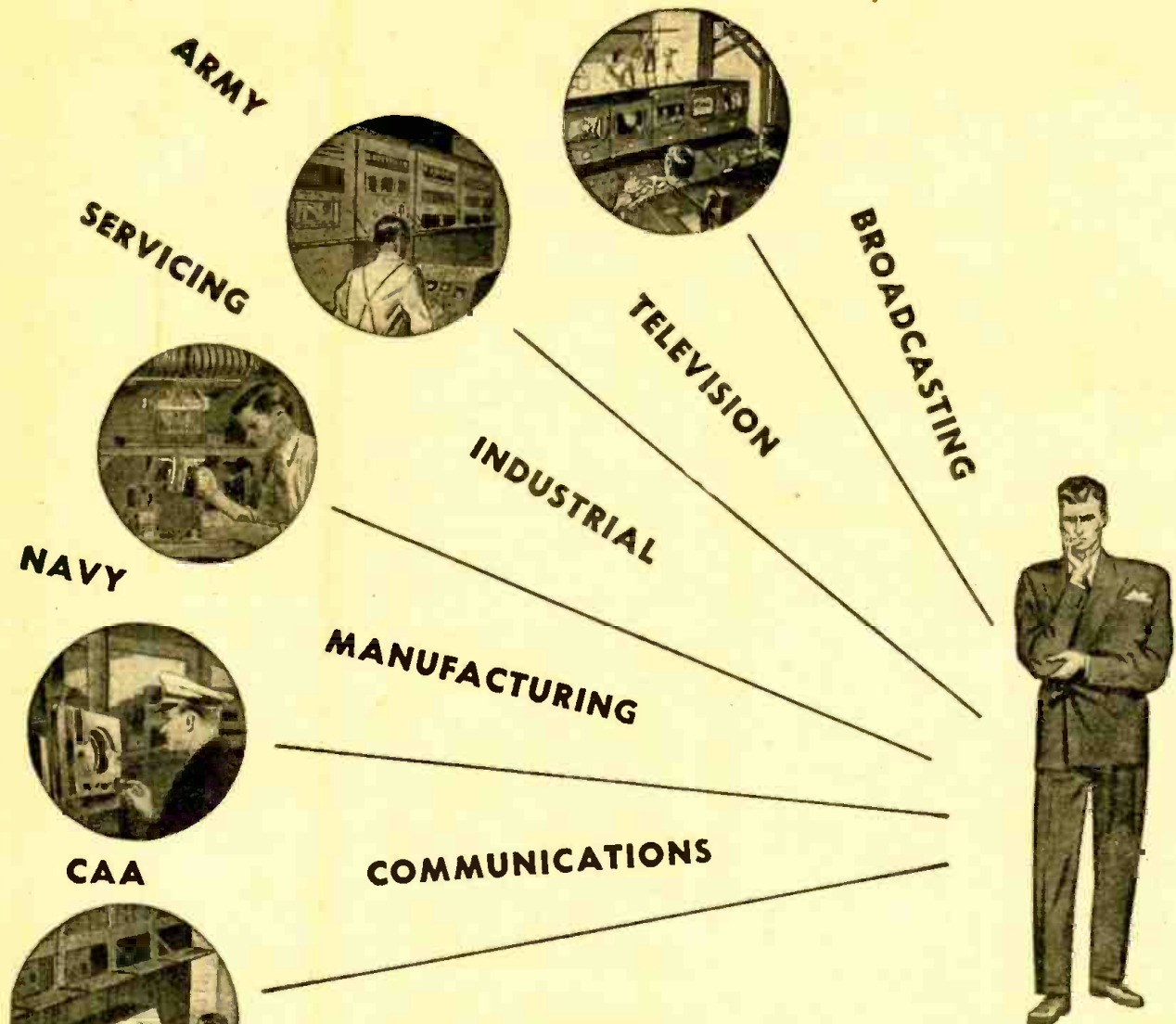

Where Do YOU Go From Here?

CREI Streamlined, spare time training is the DIRECT COURSE to that Secure, GOOD-PAYING JOB You Want

NEVER was there such widespread opportunity as exists today in every field of radio-electronics. Not only are there countless new jobs . . . but *more* jobs with good salaries. The demand, however, is far beyond the number of radiomen *qualified* to fill these positions.

You may have "gotten by" up to this point. But if you want to progress with the industry . . . if you want an important, good-paying position and the security that goes with it—you must acquire up-to-date technical training.

No matter if your interest lies in broadcasting, aviation, manufacturing, television or radio service, or in any of the many other radio-electronics applications that are

open today . . . you can enroll with CREI confident that this high-calibre, professional, practical radio-electronics engineering training will give you proper and sound qualifications for the field of your choice.

Decide today "where YOU will go from here". You can assure your future security . . . end the threat of competition challenging you for your job. CREI is prepared to train you for a better place in this new world of electronics. Mail the coupon today for details of the CREI self-improvement program. Yes, a 3c stamp can result in more security . . . a better job . . . happiness. Write *now*.

If you have had professional or amateur radio experience and want to make more money, let us prove to you we have the training you need to qualify for a radio job. To help us intelligently answer your inquiry—PLEASE STATE BRIEFLY YOUR BACKGROUND OF EXPERIENCE, EDUCATION AND PRESENT POSITION.



VETERANS! CREI TRAINING AVAILABLE UNDER THE "G. I." BILL!

Capitol Radio Engineering Institute

An Accredited Technical Institute

DEPT RC-5, 16TH AND PARK ROAD, N. W., WASHINGTON 10, D. C.

Branch Offices: New York (7): 170 Broadway • San Francisco (2): 760 Market St.

RADIO-CRAFT for MAY, 1947

Mail Coupon for FREE BOOKLET

CAPITOL RADIO ENGINEERING INSTITUTE
 16th & Park Rd., N. W., Dept. RC-5, Washington 10, D.C.
 Gentlemen: Please send me your free booklet, "CREI Training for Your Better Job in RADIO-ELECTRONICS", together with full details of your home study training. I am attaching a brief resume of my experience, education and present position.

CHECK PRACTICAL RADIO ENGINEERING COURSE PRACTICAL TELEVISION ENGINEERING

NAME.....
 STREET.....
 CITY..... ZONE..... STATE.....
 I am entitled to training under the G.I. Bill.

SPRAGUE TRADING POST

SWAP-BUY OR SELL

FOR SALE—National SW-3 short wave receiver with power supply, three sets band spread coils for 20, 40, 80 meter bands, one general coil for 20 meters. Good condition. \$20 as is. George Kerzhentzin, 1100 Albany Ave., Hartford 5, Conn.

FOR SALE—RME-69 with re-aligned speaker, \$95.00 F.O.B. Radio WHW, Lykesland, S. C.

FOR SALE—Hallerafters S-20-R in good condition. R.F. and I.F. stages "soud up" with hi-zain tubes. Want to buy SX-28A. A. J. Elsen, 410 Thurston, Ithaca, N. Y.

FOR SALE—Telrad 18-A standard frequency. Brand new in original carton with extra tubes, \$20. Samuel Straus, 94-06 31th Road, Flushing, N. Y.

FOR SALE—2-meter Transmitter-receiver "193" osc., 20 watts, 955. Receiver 6C5-6L6, common audio. Switch for fixed or mobile. Black crackle case. Meter, 27 p.m. speaker; plus power supply. \$45. J. R. Lowe, 1230 2/3 North Flores St., Hollywood, Calif.

FOR SALE—Hallerafters SX-32 receiver and speaker, Masco 35-watt amplifier and Turner 83X mike. Thordarson TSM22 modulation transformer; Thordarson 1000V d-c power supply; Kenyon 1000V d-c power supply; Millen Ntal control exciter with coils for all bands. M. W. Shellhammer, 224 Pitt St., Tamaqua, Pa.

FOR SALE—New BC-375 transmitter, 20 to 160 meters converted for 110V, a-c operation with a-c power supply. Complete with tubes, key, mike and tuning units. Less a-c power supply. Arthur Buck, 413 N. Second St., Wornaleysburg, Pa.

FOR SALE—Brand new, McMurdo Silver Model 900 Tontax, \$49; Model 905 Spark, \$47; Model 901 Bridge, \$44. All three to one person for \$125. S. R. Bernstein, 819 19th St., Brooklyn, N. Y.

FOR SALE—New Abbott TR-4 transmitter and receiver; new Abbott DK-3 portable transmitter complete; instruction graph with ten new tapes and oscillator. Want 8-19-B or Howard 430 in good working condition. Wm. H. Lorimer, P.O. Box 361, Williamsport, Pa.

FOR SALE—Hallerafters receiver SX-32 modified with SX-28A panel and new cabinet. John Lim, P.O. Box 2307, San Francisco, Calif.

FOR SALE—American code reader with 110V, 60cy. motor, key attachment with 12 learner's tapes, 3-tri-signal beklmer's units, earphones, T17H, TUB8 tuner units, QST's 1923 to date. H. E. Leigh, Sr., 197 N. 14th, San Jose, Calif.

FOR SALE—Gardner model "S" code reader; Speedex key; 117 rathode ray tube with socket and leads. Supreme multi-meter. Write for information on other equipment. Edwin W. Ozellus, 977 Warren Ave., Brockton, Mass.

WHAT'S THIS ABOUT MIDGET TUBULARS?

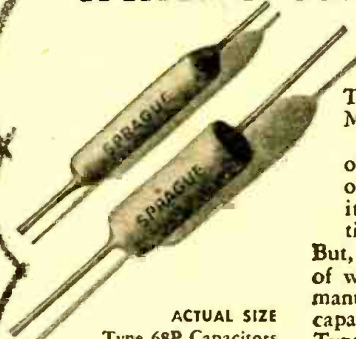

ACTUAL SIZE
Type 68P Capacitors
Ranges from
.001 mfd. 400V to
0.5 mfd. 100V.

There's more about the new line of Sprague Type 68P Midget Tubular Capacitors than appears on the surface:

They're the smallest, most dependable midgets yet offered for normal applications. They're the direct result of Sprague engineering experience in developing capacitors for the famous VT fuse and other miniature war-time electronic assemblies. . . .

But, even more important, they offer concrete evidence of what you can expect from Sprague in the future. No manufacturer was called upon to engineer as many unique capacitor types for war equipment as was Sprague. The Type 68P Midgets are the first of these to be converted for everyday service and amateur radio use. Many more are coming.

Look to Sprague for the newest—and the best!

See Us in BOOTH 89 at the Chicago Show!

FOR SALE—Hallerafters Sky Ranger S-39 in good condition, \$70. Robert Goron, Montecello Hotel, Boulder, Colo.

FOR SALE—Webster phono with model 50 changer, plays up to 12 records, fast changing, 8" speaker, 3-tube amplifier, leatherette cabinet, 24" x 17". Bargain at \$65 complete. David Ehart, 2219 Sunset Ave., Utica 4, N. Y.

WANTED—Solar CE or VTVM. Have new Superior signal generator for trade. Larson, 14 E. 30th St., New York 16, N. Y.

FOR SALE—New Precision 200 signal tracer, \$25; Simpson 315 signal generator new, \$66; Simpson 260 Volt-ohmmeter, \$35; New Precision set tester; Used equipment: 535 Simpson scope, \$30; HCA 156 Tube Tester, \$35. Hamilton Radio Clinic, What Cheer, Iowa.

SELL OR SWAP—Western Electric six, generator, 50-100 MC \$35; 804 voltage reg. transformer, 300 watt, \$20, 500 watt, \$35. G. E. 6V battery charger, 1 to 12 batteries, \$45; QST's 1927-1932; IRE's 1927-1937. A. J. Gerel, 278 E. Columbia St., Hempstead, N. Y.

FOR SALE—Supreme 400R Diagonmeter in case. A-C cord missing, otherwise complete; 3 fine Jewell meters A-C, D-C. Ma. Radionic Engineering Co., 620 North and South Rd., University City 5, Mo.

SELL OR SWAP—Transmitter, receiver 2-9 mc; 235 mc transceiver, same cabinet; VFO phone/cw/mcw 25 watts; headphones; mike; variometer; Intercoms; Antennas; co-axes; dynamotor. Robert Bonnick, 35-63 88th St., Jackson Heights, L. I., N. Y.

FOR SALE—Pellers sig. tracing analyzer TS-2, slightly used, good as new, \$25; Chicago Instrument VOM 371, new, \$2.50; Meissner 3-tube midget radio, wired, complete with tubes and 5 coils, \$10; Hallerafters S-28 receiver, \$45. Garland Bowman, Star Route, Rockymount, Va.

WANTED—Used six, generator in good condition; condenser tester (cap. resistor or bridge). Pay cash or trade. What do you need? Your Radio Doctor, 337 Melrose St., Brooklyn, N. Y.

WANTED—Instruction manual, wiring diagrams, parts list, other data pertaining to Hilekoc tube tester 51X. James W. Hoskins, 212 Middlefield Rd., Palo Alto, Calif.

FOR SALE—Motorola portable radio 41D, good condition, uses 11E, 1N5, 1A7, 1Q5 tubes, \$20; good P.A. and instrument amplifier 15 watt; and Turner 1X mike, \$50. J. E. Decker, Chattanooga, Okla.

WANTED—One original Nathaniel Baldwin phone unit in good condition, type C or G, condition of case unimportant. Write E. L. Neill, Box 33, Cleburne, Texas.

WANTED—Hilekoc tube tester 510 or 532, common or portable type, in good condition. Also Rider's manuals 2, 3, 4, 5. Cash. Leonard Peak, 1920 N. Spaulding, Chicago 47, Ill.

SELL OR SWAP—10,000 V, 23MA transformer taken from oil burner. Good condition, suitable for experimental work. Geo. Wechsler, 1729 E. 17th St., Brooklyn 29, N. Y.

SELL OR SWAP—Portable single play phono, with 3-tube amplifier, tuning, tone controls, 5" speaker, lightweight pick-up, \$25 or equal in trade. H. Kanter, 1301 E. 57th St., Brooklyn, N. Y.

FOR SALE—Write for surplus list containing brand new Westinghouse meters and many other items. Alfred C. Denison, 38 Park Place, Rockville, Conn.

SELL OR SWAP—Dumont 5" scope 274; Supreme combination tester 599a; RCP sig generator 650; de Forest's 1946 radio course, All perfect condition. Need communications receiver, typewriter, automatic 22 rifle or target pistol. John E. Kapos, Jr., 167 Washington St., Fall River, Mass.

SELL OR SWAP—Philco auto radio for 1933-37 Ford; Pilot 0-100-0-100; Kurz-Kash 0-100 and 0-180. Used var. condensers; I.F. coils; R.F. coils. Many other items. List free. Smajd Radio, 724 Meadow Ave., Joliet, Ill.

SELL OR SWAP—Teleplex telegraph waedno A-1. John Zudell, 1968 E. 34th St., Lorain, Ohio.

FOR SALE—Lead-acid surplus aircraft batteries, new, dry charged for long storage life, 12V 34AH, \$10.50; 12V 17AH, \$8.50; 24V 11AH, \$15. Special prices for orders for more than two. R. N. Eseneault, 229 N. E. 70th St., Miami 38, Fla.

FOR SALE—T.T.I. television chassis with 7" tube in fair working condition with schematic, less than parts cost \$75. Cash or C.O.D. J. I. Frieman, 5025 Arch St., Philadelphia 39, Pa.

FOR SALE—Brand new 1 KW motor-generator from army tank, 24 V., 75 Amp. D-C motor and 230 V., 4.5 Amp. D-C generator. Rewind two coils for heavy duty welding, \$42. H. Balerlein, Box 415, Camden, N. J.

SWAP—RCP electronic multi-tester 660, used 30 days. In good condition. Want late model signal tracer. Chas. C. Butler, 616 E. 15th, Cherryvale, Kan.

SELL OR SWAP—Vomax VTVM in A-1 shape, used 3 months, calibration perfect. Need portable tester like Supreme 592. Ray F. Knoepfer, 1059 Rockman Pl., Rock Hill 19, Mo.

SELL OR SWAP—Small kleig lights; speakers; tubes' gift items; unusec U.S. postage; Want 8mm projector, record player, small vacuum cleaner, G. Zambokofsky, 527 Bedford Pl., Brooklyn, N. Y.

WANTED—Used volt-ohmmeter; Precision or Supreme tube checker; H. Wager, 211 Tulip Ave., Franklin Sq., L. I., N. Y. State price and details.

SWAP—21 jewel Elgin pocket watch and 14 k white gold chain for tube tester or vacuum tube volt-ohmmeter. Robert R. Hurd, 1713 W. 15th St., Topeka, Kans.

YOUR OWN AD RUN HERE FREE

The Sprague Trading Post is a free advertising service for the benefit of our radio friends. Providing only that it fits in with the spirit of this service, we'll gladly run your own ad in the first available issue of one of the six radio magazines in which this feature appears. Write CAREFULLY or print. Hold it to 40 words or less. Confine

it to radio subjects. Make sure your meaning is clear. No commercial advertising or the offering of merchandise to the highest bidder is acceptable. Sprague, of course, assumes no responsibility in connection with merchandise bought or sold through these columns or for the resulting transactions.

Send your ad to Dept. RC-57

SPRAGUE PRODUCTS COMPANY
North Adams, Mass.

(Jobbing distributing organization for products of the Sprague Electric Co.)

ASK FOR SPRAGUE CAPACITORS and *KOOLOHM RESISTORS by name!

*Trademark Reg. U.S. Pat. Off.

400 MILLION U.S. RADIOS?

Radio saturation is not in sight

By HUGO GERNSBACK

EVERY few years, unimaginative radio people—who really should know better—begin to have grave doubts about the future of radio. This hoary, old depresser has been paraded before the radio world ever since the boom of 1922. It continues to pop up with irritating regularity.

To show how foolish and completely without merit these dark forebodings are, let us look at the record.

From the best available estimates there are now at least 35 million homes equipped with radios. This leaves out automobile radios, radio sets in factories, commercial institutions, and others. The total number of radio receiving sets in the United States in 1946 was computed to be somewhat above 60 million.

If we look at the curve of radio sets in use in the United States we will observe that ever since 1922, when radio broadcasting started, the curve has been one of practically uninterrupted ascent. This curve will not change appreciably in this country for a long time to come, for the following simple reasons:

There was the time when radio sets were used strictly for receiving purposes; news, entertainment, music, etc. Times have now changed. In the future there will be many new and different types of radio sets aside from the ones now in vogue. Take, for instance, the rise of radio amateur sets, which now run into the hundreds of thousands.

In the late 20's we started to install radio sets in cars purely for entertainment purposes, like the radio in the home. Already the radio telephone set, for communication purposes, has been added and is now expanding at an extraordinary rate. With some 26 million passenger automobiles in the United States today the time is not far distant when a very large percentage of automobiles will be equipped with these two-way telephone radios, plus a radio set for entertainment and news, etc., which means that soon there will be *two* radio sets in an automobile.

How many millions of the two different types of car radios there will be during the next ten years is a guess today. At least every business man who owns a car will want to have a communication radio set in his automobile. The limit is apparently only the ability of the telephone companies to manufacture these sets fast enough and install them.

Originally we started out with one radio receiver in the home. Now a very large percentage already has two and three sets; one in the living room, one in the bedroom and children's room, and in the servants' rooms—even an appreciable percentage is in the bathroom.

Where this tendency will stop no one knows, but the chances are that *three radio sets in the home* will certainly be the average before very long.

We next come to a type of radio which was not on the

horizon even a few years ago. That is *Citizen's Radio*—the type with which a person can communicate directly with another, by means of ultra-short waves. How many of these radios will come into use during the next decade is difficult of computation, but there certainly will be millions of them.

Next on the list we have the *facsimile radio*. Already newspapers are broadcasting the printed word over facsimile sets in a number of cities in the United States so that with your breakfast in the morning you have spot news on a sheet of paper issuing from your radio set! This is a comparatively new type of radio set on the market, and although it has been known experimentally for several decades, no practical set has been turned out in quantity until recently.

Another type of specialized radio set which is about to make its appearance is the small receiver, the size of a cigarette pack. This will be kept either in your pocket or on your desk at home or in the office and will be designed for only one purpose—time and brief news announcements. You pick up the tiny set any time during the day or night and you will have the time, weather reports and other news shorts. Only a single station will be received with such sets. It is conceivable that anywhere between 30 to 50 million of such receivers will be sold during the next few decades, for the important reason that they are really a necessity in this country.

Still another type of radio—now already beginning to emerge—is the pocket type broadcast receiver. This small type of miniature set—forecast in these pages for several years—is now a reality. When we speak of pocket sets we really mean the type of radio receivers small enough to fit into the vest pocket—a set not much bigger than a pack of cigarettes. There is an enormous demand for such novelty sets. Whenever news appears that someone is bringing out such a receiver the manufacturer is immediately swamped with mail. It probably will be another five years before these radios have been perfected so that they will stand up under *all* conditions and that the reception will be entirely satisfactory to the public. That over 50 million such sets will be sold in this country within an appreciable time is a foregone conclusion.

Add to this the utility sets, such as are used in factories, offices, restaurants, and other commercial houses.

In factories where there is tedious work, radio has been found to enhance the morale of the workers. It speeds their work and improves general conditions. In many plants, where there is much noise, the ordinary type of public address system is often not feasible and in smaller factories individual sets are used right alongside the workers.

If we add up all these different types of radio sets it becomes apparent that

(Continued on page 91)

CALLING - CARD RADIOS were demonstrated by Dr. Cleo Brunetti at the annual meeting of the Institute of Radio Engineers early in March. Not only did he operate a receiver printed on a card 3 inches long and 2 inches wide, but he operated it with a transmitter small enough to be kept in an old lipstick



A complete "calling-card" radio receiver.

case! Dr. Brunetti spoke into a lapel microphone as he walked about the stage, his words being picked up by the calling-card receiver and further amplified through a standard amplifier to fill the large ballroom in which the meeting was held.

The radios are all constructed by the "printed-circuit" technique first de-



"Lipstick" transmitter used by Dr. Brunetti.

scribed in **RADIO-CRAFT** in April and June, 1946. The lipstick-size transmitter actually has the coils painted on the glass of the tube itself. A flat disc-shaped condenser, less than a quarter inch across, and a painted resistor complete the circuit. Battery and microphone complete the equipment.

The little radios, of which Dr. Brunetti had nearly a dozen on hand, were built by a group of Bureau of Standards scientists working under his direction.

RADIO-ELECTRONICS

Items Interesting to

TWO FM RADIO STATIONS in New York City were asked last month by the FCC to adopt new frequencies to avoid interference with aircraft instrument landing systems. The interference is due to technical shortcomings in the aircraft receivers—designed before FM moved to its present frequencies—and the use of new frequencies is to continue only until March 1, 1948, by which time it is expected that all aircraft can be equipped with apparatus of modern design.

Since the users of ILS equipment concede that FM broadcasters are technically blameless for the flying hazard created by their transmissions and that the aviation industry simply has been caught in the unfortunate position of equipping itself with war-time receivers which did not have to contend with the problem of FM interference, they are endeavoring to work out a method whereby they can defray the cost of the FM operators' temporary frequency shift.

RADIO TECHNICIANS of San Francisco last month embarked on a plan of study designed to prepare them for the new world of frequency modulation. Seventy members of Radio Division No. 1245 of the Brotherhood of Electrical Workers registered for night school courses at Radio KALW in the Samuel Gompers Trade School, San Francisco.

The courses are being handled under a three-cornered co-operative arrangement between the Board of Education, the union and the manufacturers of FM equipment. Courses are being taught under the direction of Kenneth Nielsen, chief engineer of KALW. Various manufacturers have pledged their assistance in making the studies effective, and the General Electric Co. has supplied each student their FM instruction booklet, as well as service notes applying to current G-E FM receivers.

COMMERCIAL MICROWAVE relay circuits are being installed for the first time, officials of Raytheon Manufacturing Co. announced last month.

The microwave links, which will represent the first commercial use of such relay circuits, will operate between the Canadian Marconi Montreal office and two other points, Yamacaiche, about 35 miles away, and Drummondville, 100 miles distant.

Installation of the new circuit follows experimental work by Raytheon on its New York-Boston microwave circuit. The company is carrying on extensive propagation studies, looking toward the elimination of noise through use of high-power magnetron units.

FCC'S LATEST MEMBER is Commodore Edward Mount Webster, who was formerly in charge of Safety and Special Services for the Commission.

Commodore Webster has been in the communications field from the time of his graduation from Coast Guard Academy in 1909 to the present. He served as assistant chief engineer of the FCC from 1938. Like his former chief, Ewell K. Jett, now also a Commissioner, he is an independent in politics, and has never voted.

VLADIMIR K. ZWORYKIN, leading American television engineer, received two signal honors during the past two months. The first, award of the Potts medal of the Franklin Institute, occurred March 3. On March 7, RCA's president David Sarnoff announced that Zworykin had been elected Vice President and technical consultant of the RCA Laboratories, where he has done much of his important work.

Besides his achievements in the field of television and the electron microscope, Dr. Zworykin has been interested in other branches of the electronic art, and during the war directed research in the development of aircraft fire control, infra-red tubes for the sniperscope and snooperscope, television guided missiles and improvement of radar systems. He is now directing work on an electronic calculator which he believes may make possible accurate meteorological predictions and ultimate control of weather.

IGNITION INTERFERENCE in television and high-frequency radio receivers can be eliminated, a joint committee of the Radio Manufacturers Association and the Society of Automotive Engineers reported last month. The committee made four recommendations:

1. Locate the high-tension coil to permit an 8-inch or shorter lead from coil to distributor.
2. Keep primary electrical wiring metal rods and conductive tubing as far from high-tension wiring as possible.
3. Use a 10,000-ohm suppressor in the distributor-to-coil high-tension lead.
4. Use a 10,000-ohm suppressor at each spark plug.

The Automobile Manufacturers Association has adopted the recommendation in principle, and has asked all bus, truck and car manufacturers to begin immediately to prepare their vehicles to meet the recommended tolerable interference limits by Jan. 1, 1948, but asked that installation of resistors be deferred until tests now under way have been completed.

MONTHLY REVIEW

the Radio Technician

TAXATION ON TELEVISION in public places will not be levied, the Bureau of Internal Revenue announced last month, putting an end to earlier rumors.

Under the law, the tax applies to all establishments which provide entertainment "other than instrumental or mechanical music." An answer by the Bureau to an inquiry by a New Jersey collection official made it appear that television was therefore considered taxable, but the Bureau later formally stated that television is not "live" entertainment and therefore not subject to tax.

MAGNETIC WIRE RECORDERS plus radio-phonograph combinations were placed on the market for the first time last month by a Chicago department store and mail-order house. Price of the combination, described as a low-cost item, is in the order of \$170, and comprises a straight record player (without record changer) a superheterodyne radio and the magnetic recorder.

MICROWAVE DIATHERMY equipment was released for the first time to the medical profession last month, a Raytheon report states. The apparatus operates at 2,450 mc, almost 100 times higher than the present 27-mc diathermy band.

Diathermy investigators, including Dr. de Forest, have suggested that extremely high-frequency treatments might be especially valuable, but have been hampered by lack of suitable equipment.

The new *Microtherm* u.h.f. waves are directed at the patient like a beam of light, eliminating electrodes or "pads" which have to be strapped on. Due to its faster absorption than lower frequencies, less power is required, and a small portable unit can be used.

The FCC has made available the frequency band of 2400 to 2500 megacycles for industrial and medical applications. Use of the magnetron oscillator at these frequencies will not give rise to the objectionable radio interference which has been so common with the older type of diathermy.

ELECTRICAL UNIT CHANGES will be introduced January 1, 1948, the Bureau of Standards announces. The electrical units of the "international" system will be superseded by those of the "absolute" system derived from the fundamental mechanical units of length, mass and time.

The changes will not be great enough to be noticeable in most practical measurements, but will affect those of high precision. The new values as compared with those now recognized by the United States are:

1 international ohm	=	1.000495	absolute ohms
1 international volt	=	1.00033	absolute volts
1 international ampere	=	0.999835	absolute ampere
1 international coulomb	=	0.999835	absolute coulomb
1 international henry	=	1.000495	absolute henries
1 international farad	=	0.999505	absolute farad
1 international watt	=	1.000165	absolute watts
1 international joule	=	1.000165	absolute joules

New units for the measurement of light will be introduced at the same time, according to the Bureau of Standards.

FIRST ALL-RADAR airway will be installed in Alaska, the Army Air Forces announced last month.

The AAF will use "racon" type radar navigational beacons at Shemya, Adak, Anchorage, Ladd Field (Fairbanks) Nome, Fort Randall and Point Barrow, providing radar coverage over the entire Alaskan airways system.

AUSTIN C. LESCARBOURA, one of the earliest editorial associates of the Gernsback publications, last month received from the Republic of France the order of *Officier de l'Instruction Publique*. The honor is in recognition of technical and literary services rendered for many years past.

Mr. Lescarboura was one of the first



managing editors of the original Gernsback magazine, *MODERN ELECTRICS*, and was later managing editor of *Scientific American* and editor of *Popular Science Monthly*. He has written and edited a number of books on radio subjects, and is a frequent contributor to technical publications both in the English and French languages. As correspondent for the Physics Department of the University of Lyons, he has kept that faculty in touch with the progress of radio-electronic science in America. More recently he has acted as consultant for visiting members of the French Mission for Industrial Production. He holds a second French decoration, *Officier d'Académie*, awarded for services to France and the Allies during World War I.

COLOR TELEVISION is not yet ready for commercial exploitation, the Federal Communications Commission decided last month. The FCC decision came after several hearings in which Columbia Broadcasting System led the proponents of immediate color television and RCA spoke for those who believe color is not yet ready for the public. Both sides backed their arguments with showings of color television.

"The commission cannot escape the conclusion," the FCC said in a fourteen-page decision, "that many of the fundamentals of a color-television system have not been adequately field-tested, and that need exists for further experimentation."

Television broadcasters and manufacturers interpreted the ruling as giving a green light to black-and-white television and some predicted that greatly expanded production would result almost immediately.



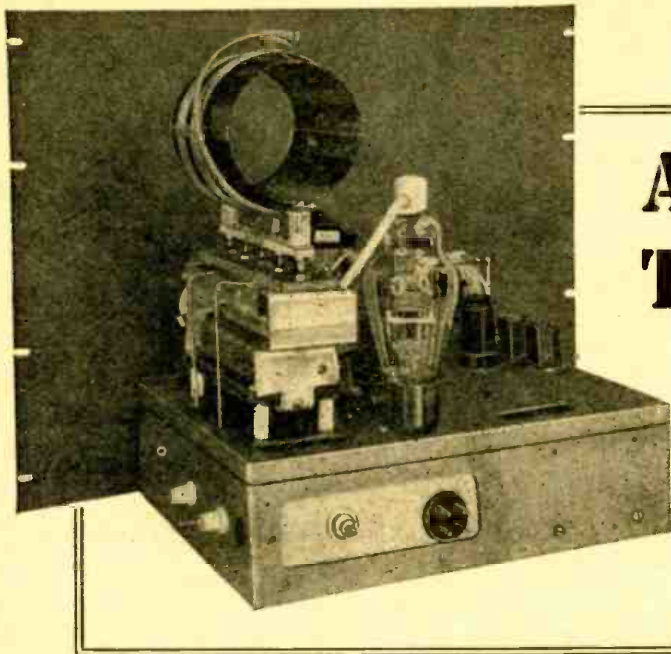

AN ECONOMY TRANSMITTER

This 225-watt transmitter can be built for only \$16

By R. F. SCOTT, W2PWG

A STAND-BY transmitter was needed to keep W2PWG on the air while rebuilding the regular rig. A little thought, plus careful selection of parts and use of those already on hand, produced this 225-watt c.w. transmitter at a cost of a little more than 7 cents a watt.

The panel and the coil turret were purchased at amateur net cost. Four crystals, an 811, three 500-watt tank coils, and the tank tuning condenser—purchased at bargain prices from government surplus stocks—brought the total cost to slightly over \$16.00. All other parts were resurrected from the junk box.

Three stages are used in the transmitter. A 6C5 Pierce oscillator simplifies operation by eliminating both tuning in the oscillator circuit and neutralization of the buffer-multiplier stage. Any one of four crystals may be switched into the oscillator circuit from the front panel. A 50- μ f mica condenser across the grid leak provides sufficient regeneration to give trouble-free

oscillator operation even with the most sluggish crystals.

The buffer stage

The 6L6 buffer-multiplier is capacity-coupled to the oscillator. Parasitic suppressors, Rsp, in the grid and screen grid leads consist of 6 to 8 turns of No. 16 enamel wire wound around a 50-ohm, 1-watt resistor. The plate of the 6L6 is series fed through a Barker & Williamson Type 2A band-switching turret. This stage is tuned by a 140- μ f receiving type variable condenser controlled by a knob on the front panel. The knob on this control should be a good electrical insulator with its setscrew well removed from possibility of physical contact with the operator. The turret permits the 6L6 to work as a buffer when working "straight-through" and as a multiplier on 40, 20, 15, or 10 meters. With this arrangement and a suitable crystal, W2PWG hopes to be one of the first signals on the proposed 15-meter ham band when it is officially opened.

Final amplifier stage

The 811 was chosen as a final amplifier because it has a reasonably high plate dissipation factor (55 watts), can be driven by the 6L6—even when quadrupling—and its high- μ characteristics permit operation without fixed bias although preceding stages are keyed. Other triodes, such as the HK54, T55, T40, TZ40, and 812, can be used with minor changes in voltages and circuit constants. The 811 draws 35 ma grid current through its 3,200-ohm grid leak to produce 112 volts of operating bias with 1,500 volts on the plate. If the plate voltage is reduced to 1,250 or 1,000 volts, the grid leak R1 should be replaced with a 2,500-ohm, 10-watt unit.

A series-fed, plate-neutralized tank circuit is used. The rotor and stator of the tuning condenser are connected to the high-voltage lead and the r.f. is bypassed to ground through a 0.002- μ f, 5,000-volt condenser. The tuning condenser was originally a 160- μ f, single section unit with 3,500-volt spacing between its plates. The present connection reduces the required condenser spacing by about 50 percent. It was salvaged from a Type A-27 phantom antenna unit formerly used with Army radio sets SCR-193 and SCR-506, and converted to split-stator connection by removing the center stator plate and cutting a 3/8-inch gap in the center of each stator connecting bar. It is mounted on 1/2-inch standoff insulators to insulate it from the chassis.

The tank coils used in this rig are available at most radio surplus stores. They are fitted with special terminal blocks which will not fit standard jack bars. Substitute bars may be made by drilling properly spaced holes in 1/4-inch bakelite or mycalex strips and mounting shallow banana jacks in the holes. The assembly is then mounted on the frame of the condenser with L-shaped brackets.

The neutralizing condenser NC has its rotor connected to the grid of the 811

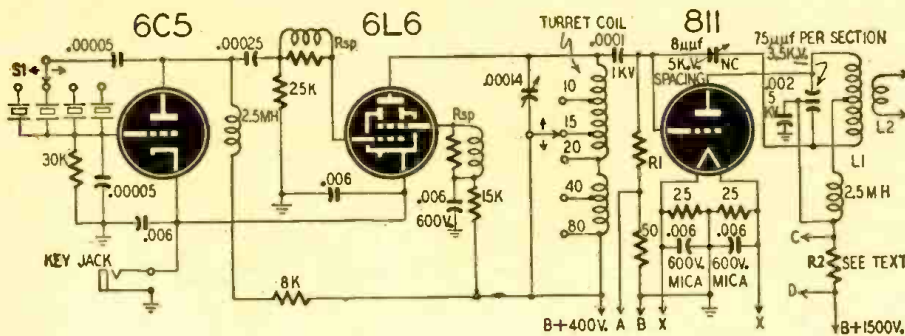
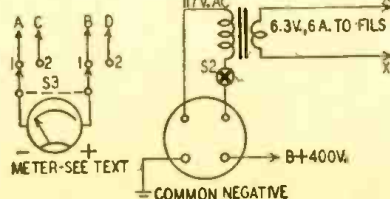

Fig. 1—Schematic of the economy transmitter. Bandswitching is used on the buffer and plug-in coils on the output tank. The 4-prong socket is a male receptacle for the a.c. line supply to the filament transformer, also the low-voltage leads from the pack. The 1,500-volt lead is brought in separately.



and its stator to the bottom end of the tank coil to prevent the operator from coming in contact with high voltage. An insulated knob is used to avoid r.f. burns.

Special construction features

The 9 x 12 x 3-inch chassis permits all parts to be mounted without crowding. Four sockets are mounted in the left front corner. Two of these are for oscillator and buffer, the other two for crystals. Each octal socket will hold two crystals if they are mounted in the new type holders—most surplus stock crystals are. Five symmetrically spaced holes are drilled in the front skirt of

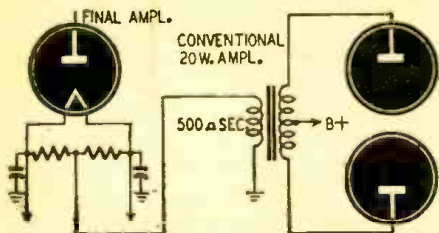

Fig. 2—A simple cathode modulation hookup.

the chassis for mounting the key jack and the crystal, and the band-changing, meter and filament switches.

A 4-prong socket in the rear skirt is the input terminal for a.c. leads to the filament transformer and the common ground and low-voltage connections. The positive high-voltage line enters the chassis through a ceramic feed-through insulator.

The internal shunt was removed from an old 3-ampere meter, which was then found to have an 8-ma movement. A shunt was wound to give a 90-ma full-scale deflection. When the meter switch, S-3, is in position 1, it is connected across a 50-ohm, 1-watt resistor in the 811 grid return, making it possible to read the grid current without opening the circuit. To read plate current, the meter is switched across R2, a shunt wound to give 300-ma deflection. With the meter used, the shunt consisted of about 2 feet of No. 22 enameled wire.

Almost any available meter may be used if shunts are wound to provide the required range or ranges.

Tuning and tuning coils

The transmitter is connected to a 400-volt, 100-ma. power supply for the oscillator and buffer stages and to 1,500 volts for the final amplifier. The filaments are allowed to preheat for a few seconds and plate voltage is applied to the oscillator. A key in the cathode circuits of the low-power stages is closed and the final amplifier neutralized by conventional methods with the grid current meter indicating neutralization.

After neutralization, high voltage is applied to the final amplifier and the antenna coupling is adjusted to draw 150 ma of plate current. Under these conditions, the grid current is between 30 and 35 ma and the power output approximately 170 watts. When operating straight through, it may be necessary to detune the buffer to avoid overdriving the final grid. With active crystals and a high-C buffer tank circuit, it is often possible to excite fully the final grid on 10 meters with the oscillator operating on 80. For 15-meter operation, the 6L6 may be used as a tripler with 40-meter crystals in the oscillator.

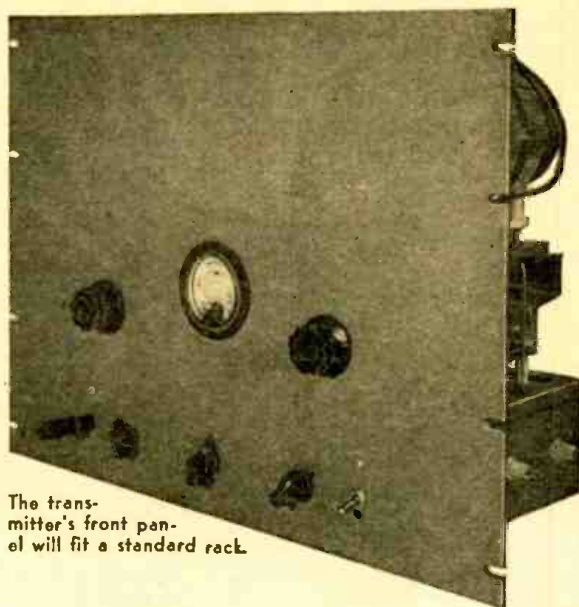

The transmitter's front panel will fit a standard rack.

If manufactured coils are undesired or unavailable, coils may be wound from data given in the table below. In this event separate plug-in coils are wound for the buffer stage.

BUFFER COIL TABLE

BAND	TURNS	WIRE SIZE	WINDING SPACE
80	30	No. 22 en.	1 1/2 inch
40	15	No. 22 en.	1 3/4 inch
20	8	No. 16 en.	1 3/4 inch
15	5 1/2	No. 14 en.	1 1/2 inch
10	3	No. 12 en.	Spaced to hit band with low C.

The 10-meter coil is air-wound and self-supporting. The others are wound (Continued on page 73)

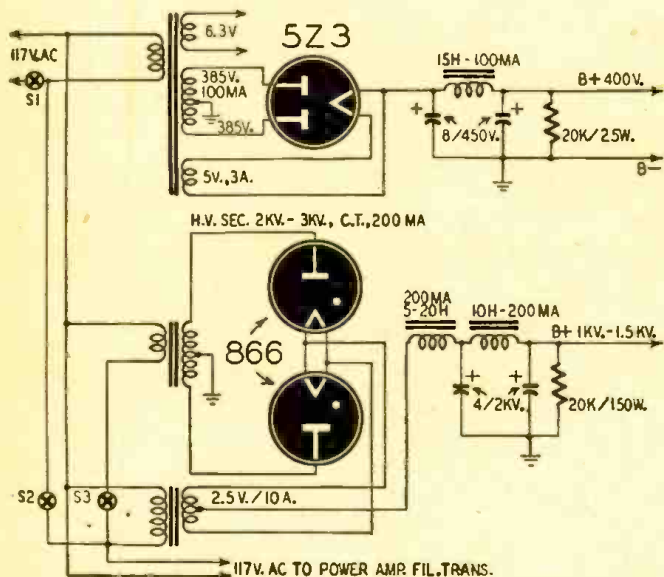
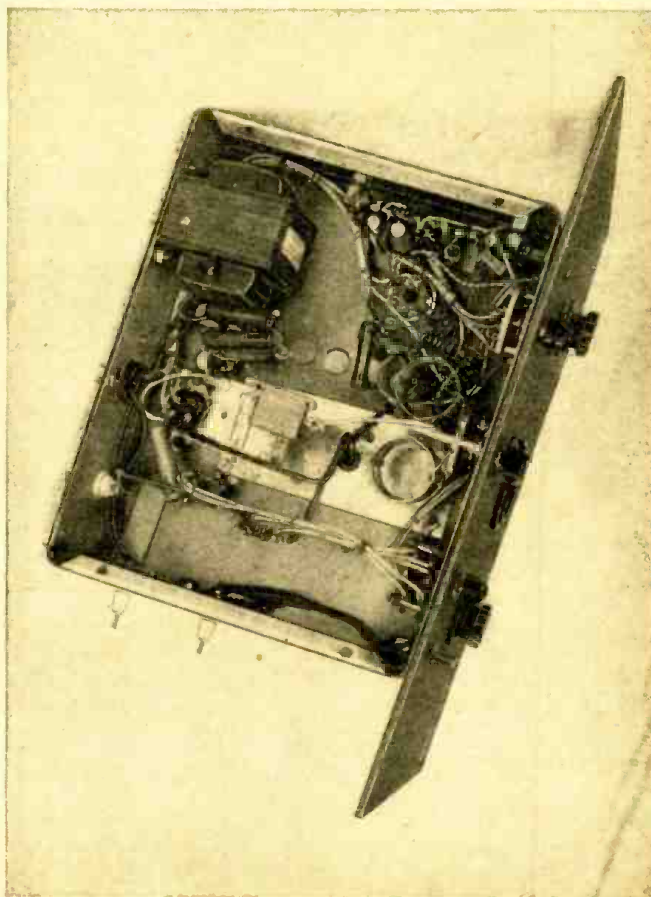

Fig. 3, above—The power supply used for the standby transmitter. Right—Underchassis view shows filament transformer, buffer coils.



Efficient Test And Repair Bench

By C. A. BROWN*

THE radio service bench has always been the object of many discussions, arguments and opinions. Scores of articles have been published on what should constitute a radio service bench. We built up several experimental benches and installed them in a radio service shop. The reactions of radio technicians and customers alike were carefully noted, and those ideas which did not meet with their approval, were weeded out. We came to the following conclusions:

1. A radio service bench must be more than just a bench. It must be a place to test any electronic device efficiently. The test equipment must be permanently mounted to do away with dangling wires, cumbersome connections, and other haphazard devices. Instruments must be placed so they can be easily read, either standing or sitting. Lighting must be glare-free.

A slightly tilted panel, with a satin white finish, made of a nonconducting material, which is strong but easily cut and drilled, was found most suitable. At the top of this panel a fluorescent light is mounted.

*Berrelux Mfg. Co., Grand Rapids, Michigan



2. One must have a place to perform any operation the radio or other electronic device needs. The space must be

large enough to accommodate several radios at once, or a large multiple-unit job, and still have ample room to maneuver. The surface must be smooth, easily kept clean, and nonconducting. Battleship linoleum was chosen as the ultimate in top surfaces.

3. The problem of where to keep tools. Certainly not just anywhere, especially not on the working surface where they are always under the thing you are working on. That goes also for those bottles of speaker cement, solvent, contact cleaner, etc. A tool and chemical rack has been incorporated in the instrument panel, in a smooth hasic design, not tacked on. It is an integral part of the equipment. The parts storage problem has been licked too. Two large, deep cabinets of drawers form the supports for the working surface and the instrument panel. These drawers are of varying depths and are compartmented. There is a drawer for special tools, those not used in every job, but very important when needed. Besides being compartmented these drawers are labeled as to specific values and form a perpetual inventory of parts. Two tray drawers in the front edge of the working surface receive parts removed from radios, such as bolts, nuts, knobs, dial glasses and pointers.

4. Here are two problems very often overlooked: The radio service unit must be at least semi-portable and should be constructed so instruments can be easily connected to the power line and easily serviced.

The instrument panel can be cut and drilled for any instrument, and power outlets for instruments are provided in

(Continued on page 74)

King of Tube Checkers

THE increasing use of kenotrons has increased in

turn the need for equipment with which they may be tested. The kenotron is a high-vacuum rectifier, especially built for high voltages. Ratings are from 40,000 to 150,000 volts, with outputs from 100 ma to ¼ ampere. One of the most important uses of kenotrons is for the concentration of uranium for development of atomic energy.

They are used in the electromagnetic plant at Oak Ridge, Tennessee, one of the largest units of the atomic project.

Power supplies for this uranium-concentration equipment were especially designed, and special tubes had to be developed for them.

Naturally a checker to test and measure the characteristics of these tubes became a necessity. The instrument on our cover is that tester.

This equipment, developed by the General Electric Co. to check their high-voltage kenotrons, subjects the tube under test to a continuous

COVER FEATURE

series of impulses of various duration and magnitude.

The operating cycle of the equipment is completed in 60 seconds, and consists of 6 5-second intervals, 3 seconds of 60-cycle impulses, followed by 2 seconds of continuous voltage application; a 17-second rest period, followed by 2 seconds of 800- to 1500-cycle impulses, with the remaining 6 seconds as a rest period. This cycle is repeated automatically for the specified test time and for the conditions of voltage and current required.

During this test a tube which is normally rated at 20,000 watts plate dissipation receives impulses of a maximum of 50 kilovolts and 75,000 watts. The tube must withstand these impulses without change in the tube current and without excessive arc-backs.

The test cycle is automatically controlled by the timing switch mounted on the inside test panel. The operating controls and meters are all mounted on this control panel which is located so that the operator can observe the tube during the test period.

The high voltage required for the test is obtained from two 6-tube rectifier units mounted in the back of the test cage. These rectifiers may be placed in series or in parallel, depending upon the conditions required for test. These

(Continued on page 74)

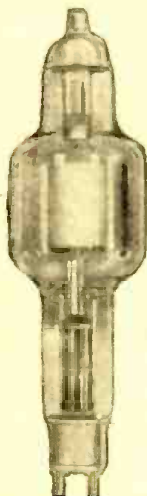

G-E kenotron GL-411, a 150,000-volt tube.

Easy-To-Build Oscilloscope

By B. W. SOUTHWELL

THE 3-inch oscilloscope diagrammed in Fig. 1 uses a single-stage 6J7 in the horizontal and the vertical amplifier. This single tube provides ample amplification for a cathode-ray tube of the size used. The gain of the horizontal and vertical amplifiers is in the order of 30.

The cathode-ray tube, together with its amplifiers and gas-triode horizontal sweep generator, is built on a 12 x 17 x 3 inch chassis. The front panel is 12 x 19½ x ½-inch steel. The power supply was originally built on the right side of the scope chassis, but it was later rebuilt on a separate 7 x 15 x 3-inch chassis because the transformers' magnetic field was strong enough to influence the electron beam between the deflection plates and the fluorescent screen. This magnetic interference was very bothersome and interfered with interpretation of patterns on the screen. Magnetic fields cause deposition, relative tilting of the deflection axes, and other spurious deflections, and can magnetize the cathode-ray tube electrodes.

Looking at the front-panel view, the controls are: top left, intensity control; directly below it, vertical positioning; top right, focus control; below it, horizontal positioning. Below the vertical position control and going from left to right are the sweep-frequency selector switch, synchronization and frequency controls. The bottom row contains the vertical (Y-axis) gain, toggle switch (not connected, for future use), sync selector switch (3-pole, single-throw for internal, 60-cycle, and external), single-pole, double-throw toggle switch for horizontal sweep (internal or external), and horizontal (X-axis) gain. To the left of the intensity control is external sync binding post. Below it are the vertical input binding posts. Horizontal input binding posts are on the right-hand side of panel.

The 3AP1 cathode-ray tube is located in a horizontal position midway between the intensity and focusing controls. The tube is enclosed in a stovepipe shield of 3-inch diameter which extends to its base. The pipe shield is supported at the panel end by insertion into a snug-fit hole in the panel and by a piece of 5/16-inch brass rod, drilled and tapped and fastened to the pipe and chassis at the tube base end. The cathode-ray tube measures 3-1/16 inches in diameter across the face and hence will not fit into the shield at the front. The shield should be lined with a strip of sponge rubber ½ inch wide and 3/16 inch thick at the front-panel end to form a shock-absorbing mount for the 3AP1. A flange

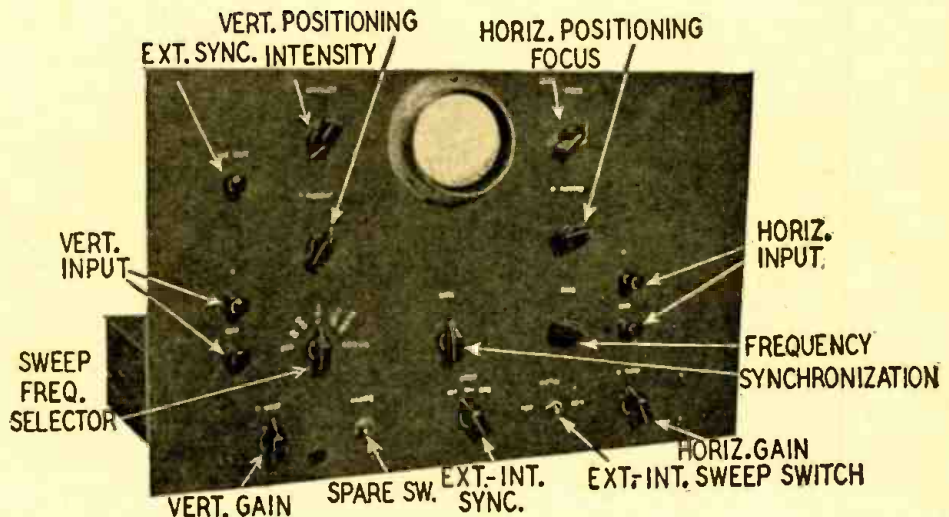

All controls and input and output connections are clearly marked in the photograph above.

3½ inches in diameter and 1 inch deep projects in front of the panel over the protruding tube, and serves both as a protection and as a light shield. For details of construction of shield see Fig. 2.

Fig. 3 is the dimensional diagram of the support for the 3AP1 tube socket. The bakelite panel for making direct connections to vertical or horizontal deflection plates is a great convenience when working with d.c. or high-frequency applications. The tube socket support itself is constructed of 16-gauge galvanized sheet metal.

Amplifiers and sweep circuits

All wiring in deflection amplifiers together with the filament supply of the 3AP1 are run through shielded wire to

minimize a.c. pickup. An extra tube socket was installed for the incorporation of an external Z-axis (blanking) amplifier at a later date. A portion of the signal on the plate of the 884 gas triode is fed through a 50-μmf condenser (1,000 volts working) to the intensity grid to blank out the return trace of the beam during its tracing of a pattern. This is internal blanking. This signal is opposite in polarity to that at the plate of the horizontal amplifier. Peaking coils containing 55 turns of No. 34 enameled wire, wound on a ½-inch bakelite form, are inserted in the plate circuits of the horizontal and vertical amplifiers to prevent loss of the high frequencies. Peaking inductances are used to compensate for the decrease

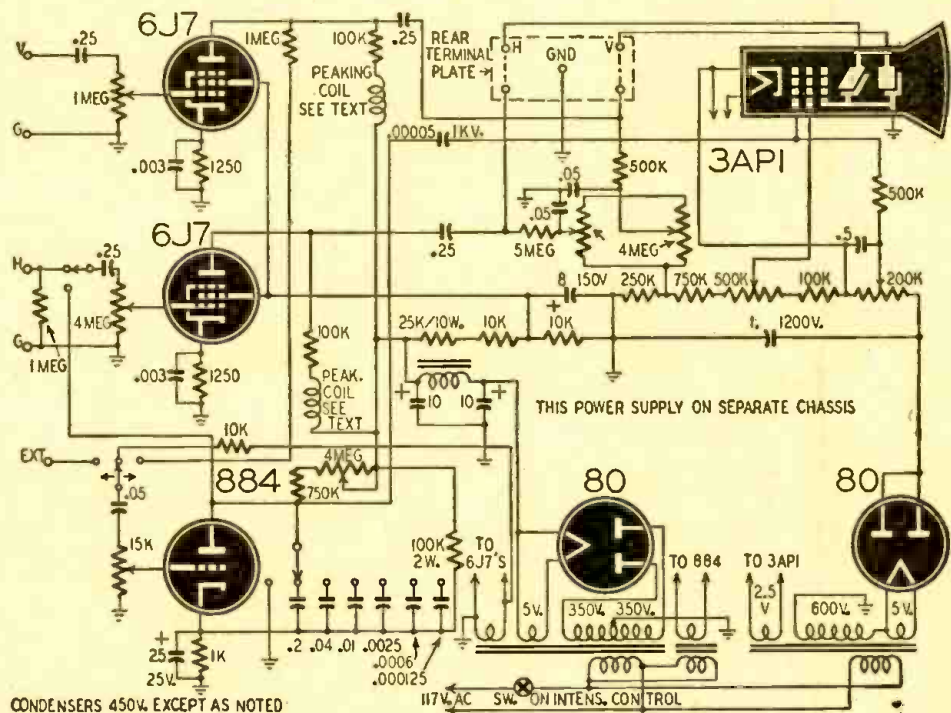

Fig. 1—This efficient oscilloscope circuit is simply designed and uses a minimum of tubes.

in plate-load impedance with frequency. Too large an inductance for a given resistance will cause nonuniform gain as a result of peaking in the network response at some frequencies. Too small an inductance will not give maximum band width for uniform response.

The vertical or Y-axis amplifier should reproduce faithfully square waves from 10 to at least 100,000 cycles/sec. For perfect square-wave reproduction an infinitely wide band of frequencies must be passed without at-

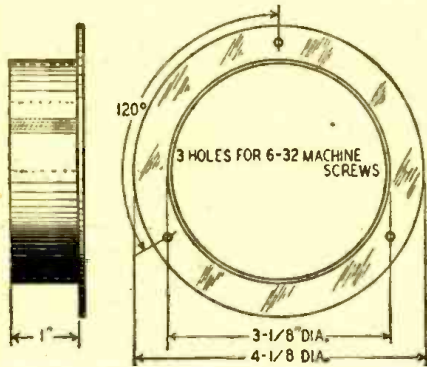

Fig. 2—How the light shield is constructed.

tenuation or relative phase shift. A square wave is analyzed in terms of its harmonic content, taking the repetition rate as fundamental. The horizontal or X-axis amplifier should be capable of reproducing a linear sweep of saw-tooth voltage up to 100,000 cycles/sec. A wave form resulting from a nonlinear sweep

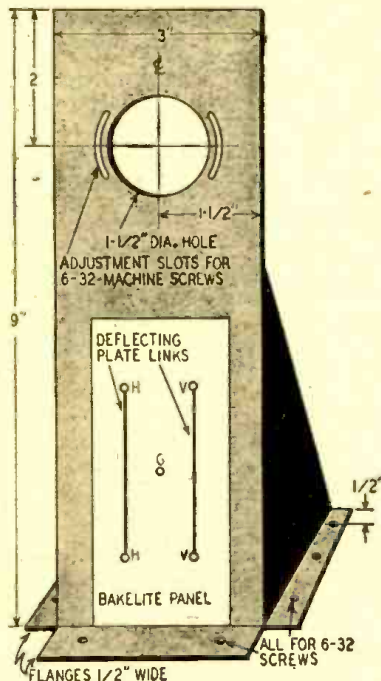

Fig. 3—Rear support of the cathode-ray tube.

is shown in Fig. 4. Pattern is bunched together at one end. A saw-tooth sweep gives a deflection linearly proportional to time. A sinusoidal sweep is used for phase and frequency determination. The horizontal and vertical amplifiers should have phase characteristics of identical nature.

The horizontal amplifier may be switched to amplify either the linear

time-base signal from the 884 sweep oscillator or any externally provided signal.

The linear time-base horizontal sweep has 7 changes of frequency in rough steps. These are approximately:

- Position 1—Sweep off
- Position 2—20 to 70 cycles
- Position 3—60 to 250 cycles
- Position 4—220 to 950 cycles
- Position 5—900 to 3,200 cycles
- Position 6—3,000 to 11,500 cycles
- Position 7—10,000 to 33,000 cycles.

In series with the switch arm controlling these steps is a 4-megohm potentiometer which permits a fine frequency adjustment over each frequency position range of the 7-position rotary switch. The sweep circuit proper utilizes a grid-controlled 884 gas-triode tube in a synchronized relaxation oscillator. The sweep condensers are connected from plate to cathode of the 884 separately by a rotary selector switch for the determination of sweep frequency desired. The condenser is allowed to charge up to a potential determined by the breakdown potential of the tube. This voltage output, which consists of saw-tooth waves (see Fig. 5) from the

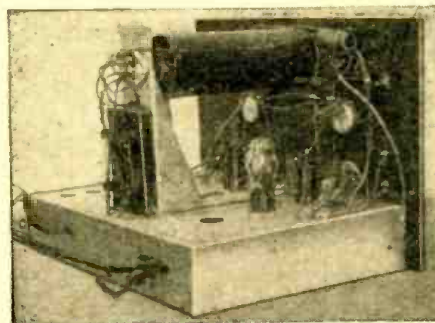

How the tube looks in its stove-pipe shield.

plate of the 884, is coupled to the grid of the horizontal amplifier to be amplified before reaching the horizontal plates of the 3AP1.

Synchronization and positioning

A portion of the output of the 6J7 vertical amplifier tube is coupled to the grid of the sweep tube to provide synchronization to maintain a stationary pattern on the screen of the cathode-ray tube. Synchronization provides for 180-degree phase shift. Oversynchronization (sync-control potentiometer advanced too far) results in a poor wave form. Figs. 6 and 7 show properly synchronized and over synchronized patterns.

A single-pole, 3-throw switch on the panel provides for internal synchronization in position 1. Position 2 switches in 60-cycle or line frequency through a 10,000-ohm, 1/2-watt resistor connected to the ungrounded side of the filament leads. A separate filament transformer is required for the 884 tube as the filament is not grounded on one side. Position 3 connects the grid of the 884 discharge tube to the external sync binding post on the front panel.

Horizontal and vertical positioning of the pattern is obtained through a voltage divider circuit using two 4-megohm potentiometers. These potentiometers

apply a positive or negative voltage to the free deflection plate of each pair. As the electron beam in a cathode-ray tube consists of negative charges of electricity, it can be readily seen that, by applying a positive or negative voltage to either deflecting plate, the spot position on the screen can be controlled. The intensity control controls the brilliancy of the pattern by applying to the control grid of the 3AP1 a greater or lesser negative voltage.

The power supplies are conventional. One 80 operates as a full-wave rectifier supplying 250 volts. The other 80 operates with plates tied together as a half-wave rectifier. The output voltage of this half-wave supply is 850-900 volts.

Scope applications and patterns are too numerous to cover completely in this article, so a brief resumé of some of the more commonly encountered wave forms

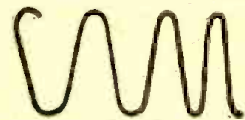

Fig. 4

Wave form caused by non-linear sweep.



Fig. 5

The correct saw-tooth sweep wave form.



Figs. 6 and 7

Good and bad synchronization.

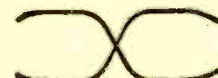

Fig. 8

Vertical to horizontal frequency 1:2.

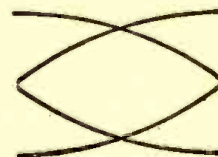

Fig. 9

Vertical to horizontal frequency 1:4.

will be given. It is general practice when observing wave forms to use several waves on frequencies of 1,000 cycles and above.

Some oscilloscope applications

Fig. 8 shows the pattern obtained when vertical frequency is half the horizontal sweep frequency. For example, a signal of 60 cycles is applied to the vertical plates and a saw-tooth wave of 120 cycles to the horizontal plates. Fig. 9 shows a pattern with vertical frequency one quarter that of the sweep frequency. When the vertical signal frequency is 3 times the sweep frequency, 3 complete wave forms will appear.

By switching the horizontal amplifier
(Continued on page 90)

MULTIVIBRATORS

By O. B. MITCHELL

THE multivibrator offers more possibilities for practical application in the field of electronics than possibly any other circuit, so it is desirable that we make its acquaintance. This simple circuit played an important role in the design of radar and other war-time electronic devices.

Let us consider the basic multivibrator schematic of Fig. 1. The circuit con-

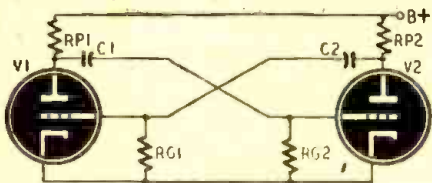

Fig. 1—The standard multivibrator circuit, consists of a 2-stage amplifier with the output of V2 fed back into the grid of V1. Due to the phase reversal of 180 degrees in each stage, the feedback voltage is in phase with the original impulse on V1 grid. Thus, the circuit satisfies the conditions necessary for oscillation—amplification with positive feedback.

If we examine the multivibrator



Fig. 2—Form of multivibrator plate current.

plate-current wave form of Fig. 2, we will better appreciate its possibilities. The current makes rapid excursions from one stable condition to a second stable condition. These rapid excursions produce a highly distorted output wave, which makes possible the many applications of the circuit.

To many radiomen, the multivibrator is primarily a useful means of generating harmonics for frequency measurements. It is the most practical means

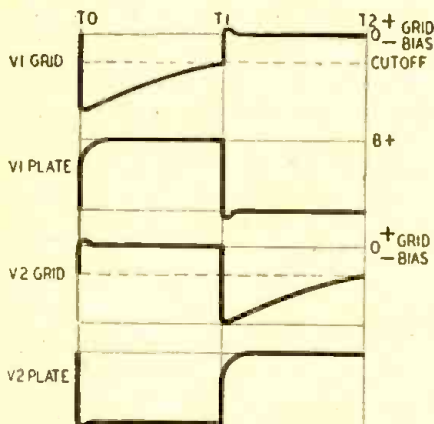

Fig. 3—Analysis of voltage over one cycle.

of generating 10-kilocycle calibration points. This technique has been adequately covered in technical radio publications and will be touched on but briefly in this article.

In Fig. 3 the circuit operation is graphically illustrated by a time-plot analysis. If what is taking place on the grid and plate of V1 or V2 were observed with a cathode-ray oscilloscope, the oscillogram would be similar to the wave of Fig. 3. The vertical lines T0, T1, and T2 are time designations, and intersect points on each of the waveforms occurring simultaneously.

Analyzing the multivibrator

Assume that at a given instant T0 the grid of V1 goes slightly negative, causing a positive increase in the plate voltage of V1. The positive increase is applied to V2's grid through C1, causing its plate voltage to drop. V1 grid is now driven far below cut-off by the negative pulse fed back from V2's plate through C2. All of the preceding action takes place instantaneously at T0.

The grid of V1 is held below cut-off by the negative charge of C2, which must leak off through RG1. During the interval from T0 to T1, the discharge of C2 takes place, and the circuit remains stable. The actual length in seconds of this time is approximately the product of $RG1 \times C2$. This portion of the cycle ending at T1 is known as the *slow-phase* action.

Another action occurring during the first half-cycle of operation is known as the *rapid phase*. At T0, when the grid of V1 is driven below cut-off, the plate voltage of V1 would ordinarily be expected to rise immediately to the B-plus value. As seen from Fig. 3, this is not the case, since the plate voltage tapers off exponentially as it rises. This phenomenon is caused by the charging of C1 through the grid circuit of V2. The charging path of C1 consists of RG2 in parallel with the internal grid-cathode impedance of V2. At the time V2 grid is in the positive region, this impedance is low in comparison to RG2. Therefore, C1 charges rapidly as the grid is driven positive. This charging phenomenon of C1, during the first half-cycle, is called the *rapid-phase* part of the operation.

When the voltage on the grid of V1 rises above the point of cutoff (T1), the first half-cycle of the multivibrator operation is completed. V1 now begins to conduct, and the plate voltage drops, driving the grid of V2 below cut-off. The remainder of the second half-cycle is identical to the first half, with V1

and V2 exchanging places, so to speak. From T1 to T2 the grid of V2 is below cut-off and is held there by the charge on C1. RG2 now provides the discharge path for the second slow phase. Note that since V2 is now cut off, the internal grid-cathode impedance is extremely high and doesn't affect the discharge time of C1. V1 grid goes through the rapid phase on this half-cycle since this grid is positive at T1.

The grid of V2 reaches its cut-off point at time T2, as determined by $RG2 \times C1$. At this time, the original half-cycle will repeat itself, and oscillation will continue as long as power is applied to the circuit.

One complete cycle of oscillation takes place during the time from T0 to T1. The total length of this time, or the period of one cycle of operation, is equal to the sum of the two slow phases of operation. These in turn are determined by the RC constant of the grid circuits of V1 and V2. The frequency of the self-oscillatory multivibrator is determined by the equation f equals $1/t$, where f



Fig. 4—Synchronized multivibrator circuit.

equals frequency in cycles per second and t equals time or period of one cycle. In our case t approximately equals $(RG1 \times C2) + (RG2 \times C1)$. Actually, other factors are involved, but the above method is satisfactory for approximation.

Controlled multivibrators

If the circuit of Fig. 1 is triggered by an external impulse approximately equal, or harmonically related, to the natural frequency of the multivibrator, the circuit will oscillate in synchronism with the applied frequency. When this circuit is triggered, the frequency output of the multivibrator may be very accurately controlled by the exciting frequency. Either harmonics or subharmonics of an exciting frequency may be generated in this manner.

It is common practice to employ a 100-kilocycle crystal oscillator as the exciting frequency for a 10-kilocycle multivibrator harmonic generator. Such a combination, as shown in Fig. 4, provides accurate calibration points every 100 kilocycles throughout practically the entire useful radio spectrum.

In many electronic applications, it may be desirable to employ a multivibrator that will not oscillate unless it

(Continued on page 58)

Home-built Sound Effects

Simple equipment makes realistic sounds

“ WAS alone’ whispers a husky voice from the radio. ‘It was late at night. Through the fog came the faint swish of small waves, and a distant vessel hooted mysteriously. I slipped cautiously into an

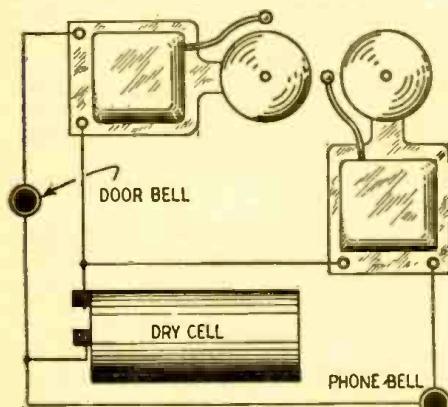

Fig. 1—Bell board produces several effects.

alleyway.’ The voice ceases. Lapping water and a foghorn blend with the tinkling of a channel buoy. Footsteps ring sharply against the stones . . .”

So commences a recent book* which tells how to make the sound effects for home recordings, excerpts from which are printed in this article. In the studio, the authors explain, an ingenious sound effects technician has flipped his fingers

* *How to Create Sound Effects for Home Recordings*, by Ed Ludes and Hallock B. Hoffman. The Castle Press, Pasadena, Calif.

in a pan of water, blown a wooden whistle, struck a metal plate with a tack hammer, and marched along in a single spot, getting nowhere. Amplification and suggestion have converted the sounds to a waterfront scene.

Sound effects are to radio what seasoning is to food—without them it would sink into meaningless monotone, and many types of presentations would become impossible. Many of these effects are achieved very simply, and with apparatus which can be constructed by the home recorder or the small experimental studio operator.

Bells are among the commonest sound effects. A bell board is shown in Fig. 1. These two bells will serve you well as telephone bells, doorbells, riveting machines, buzzers, and rattlesnakes. Mount the bells on the board so the clapper of one will strike both gongs when that bell is rung. It becomes a telephone. The other can be used for doorbells.

All sorts of other bells, such as clock bells, dinner gongs, and school bells can be made with bowls and cake tins to be found around the house. A useful pair of bells appears in Fig. 2. One of these is a ¼ x 6 x 10-inch metal plate. The other is a piece of small pipe bent into a U-shape. Both are hung from a bar with leather thongs (never with wire).

The U-shaped bell is particularly useful where a quick clang is needed. The plate can be used for a variety of effects, depending on how it is struck and with what. Strikers can be bought from

a music store, and are referred to as xylophone mallets, chime hammers, soft-hard mallets, and felt mallets. All are useful, and can be supplemented by a tack hammer and an ordinary pencil with an eraser.

Carry the eraser-tipped pencil around the house and strike flower vases, brass bowls, ash trays, and other objects. Every house is full of bells and chimes and gongs! If not enough are available, short lengths of brass or iron pipe may be hung by thongs with the two bells already described. By cutting pipes to various lengths, any desired pitch can be obtained.

A good ear and a little imagination will help to audition household objects for sound effects. The microphone gives

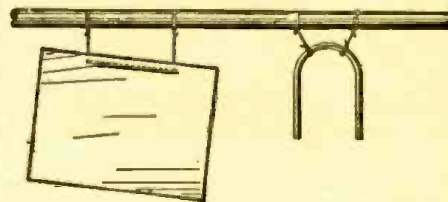

Fig. 2—Two of the most useful bell effects.

them their realism; unamplified they may not display their real character. All the effects depend on the mike, and in many cases on special placement of the mike. Once the ideal effect is produced, do not depend on getting exactly the same layout of mike and instrument, the same technique and the same amplification, at a future date when you may need it. *Record your effects*—then you will have them when you need them.

Squawks, squeaks, and gripes

Time was when the first sound heard when you turned on your radio was the opening or closing of a “screechy door.”

Produced by the squeak board illustrated in Fig. 3 and one of the photographs, this equipment can be used also to imitate the creaking of a ship’s timbers, rusty hinges, and other sounds. To build it, you need one board, ½ x 8 x 14 inches (plywood is best); one board, 1 x 2 x 20 inches; one piece of stock, 1 x 1 x 16 inches; one ½-inch dowel, 12 inches long; one 8/32 machine screw, 1½ inches long, with washer and screw to fit.

The drawing explains the construction. The trick is to drill the hole in C so the dowel fits tightly, and to drill the hole in D so it fits loosely. A nail is used to hold the dowel firm in C. Piece F is put on the dowel and turned till the saw-cut is up. The cut is filled with powdered rosin, and the board A rotated till the rosin is worked well into the dowel and its socket in F. Then the

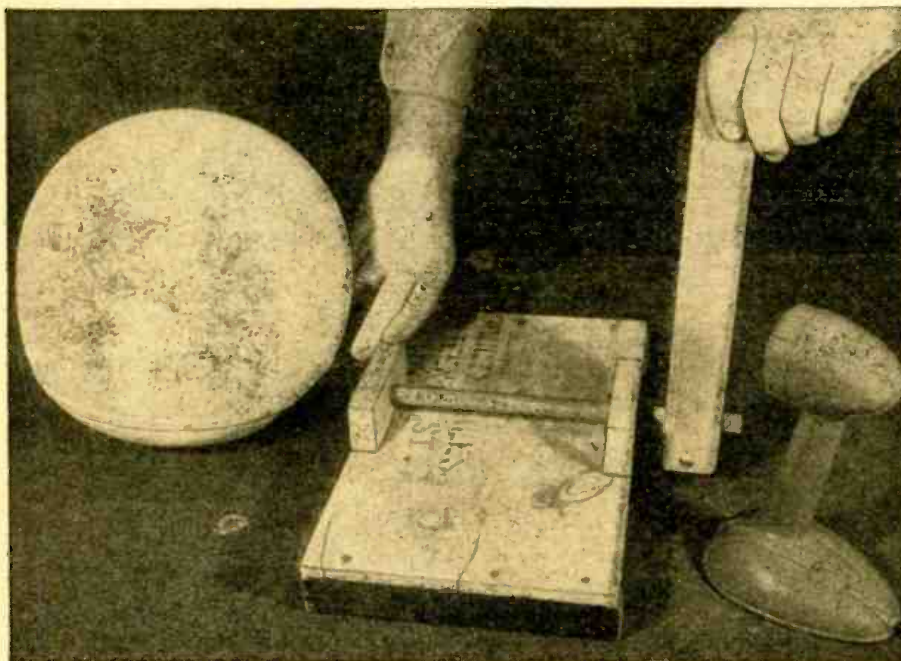

At left is the “thunder ball,” used also for explosions. The squeak board is seen at right.

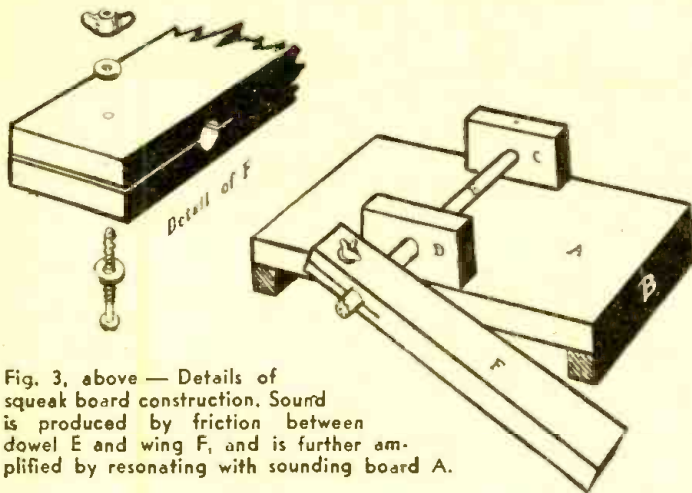

Fig. 3, above — Details of squeak board construction. Sound is produced by friction between dowel E and wing F, and is further amplified by resonating with sounding board A.

screw is adjusted for the desired range of notes.

An ear-splitting squeal can be made with the simple device shown in Fig. 4. The points of the nails should be bent forward *ever so slightly*—toward the point of the triangle. Put the block on a piece of glass at least 8 inches square, held off the table by a couple of strips under its edges. (The squeal-block can be used also on a window.) Try running

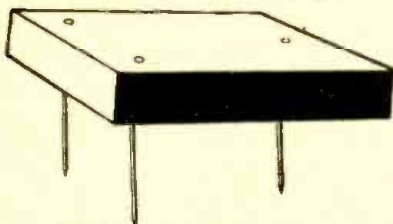

Fig. 4—This block can make unearthly squeals.

it over a smooth, unpainted piece of metal, for the squeal of automobile braked-skidding.

The twang or squeal box

The box of the instrument is 4 x 8 x 10 inches. The top is made of 1/4-inch plywood; the remainder may be made of 1/2-inch wood or plywood. The neck is of 1/4 or 3/16-inch plywood, 2 inches wide and 2 1/2 feet long. The string is No. 8 piano wire. Fig. 5 explains all construction details.

To make squeaks, the string is bowed with a violin bow. The pitch is varied by pressing down on the end of the neck. Twangs are made by plucking the wire, tuning the string with the eyebolt at the end of the neck to produce a medium sound. For best results, the box should be secured to the table with a C clamp, which will leave both hands free to produce sound.

The twang box is well shown in the photo. Note especially the position of the mike, which is very important. With all sound effects, great variations can be produced by slightly changing the mike position. Experiment!

Other sound machines may be made very easily. Wind is produced with an electric fan motor and a block with 4 dowels inserted and firmly fastened into it. See Fig. 6.

To produce thunder or an explosion, use a half-teaspoon of BB-shot in a basket-ball bladder. This is shown in the photo of the squawk board. Hold the

bladder between the hands and snap wrists sharply, so the shot is thrown from the bottom and then falls back on it. For an explosion, one snap will usually be enough. For thunder, snap, then roll the shot gently around the inside by tilting the bladder.

A rattlesnake also is imitated with BB-shot. Put about half a teaspoonful of shot in the cellophane wrapper of a cigarette package. Attach to the clapper of a doorbell (with the gong removed), and push the button.

A small chamois-skin sack of cornstarch is used to make footsteps in the snow. Hold the bag in both hands, near the microphone, and squeeze it with the thumbs, alternately, in walking rhythm. The effect is extremely realistic.

Rain is produced with a large piece of tissue paper, some scotch tape, a supply of salt or sugar, and two cardboard boxes. The drawing (Fig. 7) is completely self-explanatory. By making the tissue-paper slide flatter or steeper, the rain may be made hard or gentle. The steeper the slide, the faster the salt moves and the harder the rain seems.

For a railway locomotive, two blocks of wood, about 3 x 4 inches each, the surface of each covered with rough

sandpaper, are used. Rubbing the faces together, close to the microphone, will produce a convincing train.

Fire is produced by twisting a piece of cellophane before the mike. Water, or waves, can be produced with another handful of BB-shot in a thin oval cardboard box such as a man's hat box. Hold the box at the ends and tilt it slowly so the shot rolls around on the bottom, near the outside edge.

Things are what they seem

An early sound-effects story tells of the attempts of one studio to imitate the sound of water being poured from a pitcher into a glass. The BB-shot could not produce a convincing sound. Crumpling a newspaper was no good. Everything in the sound-man's repertoire was tried without effect. Finally someone suggested pouring water from a pitcher into a glass . . . !

Here is a lesson for the amateur sound-effects man! Hammer a piece of board with an ordinary hammer, and you are carpentering. For sawing, use

(Continued on page 88)

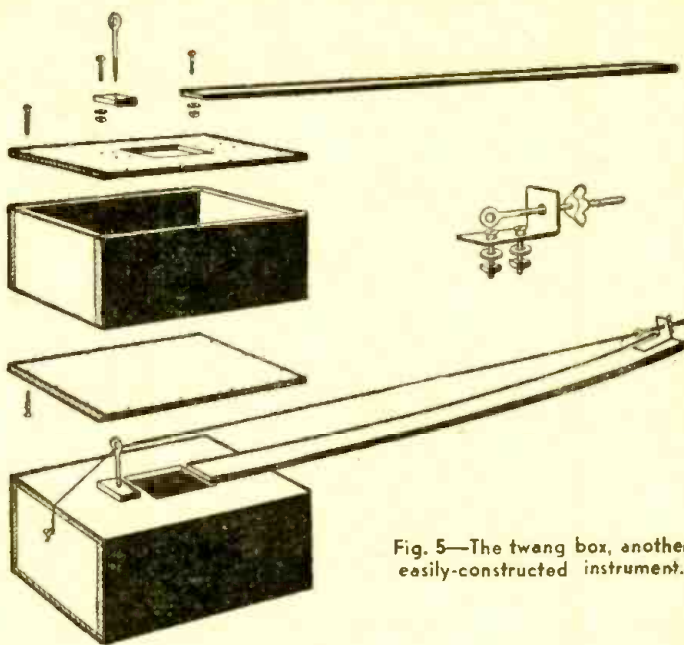
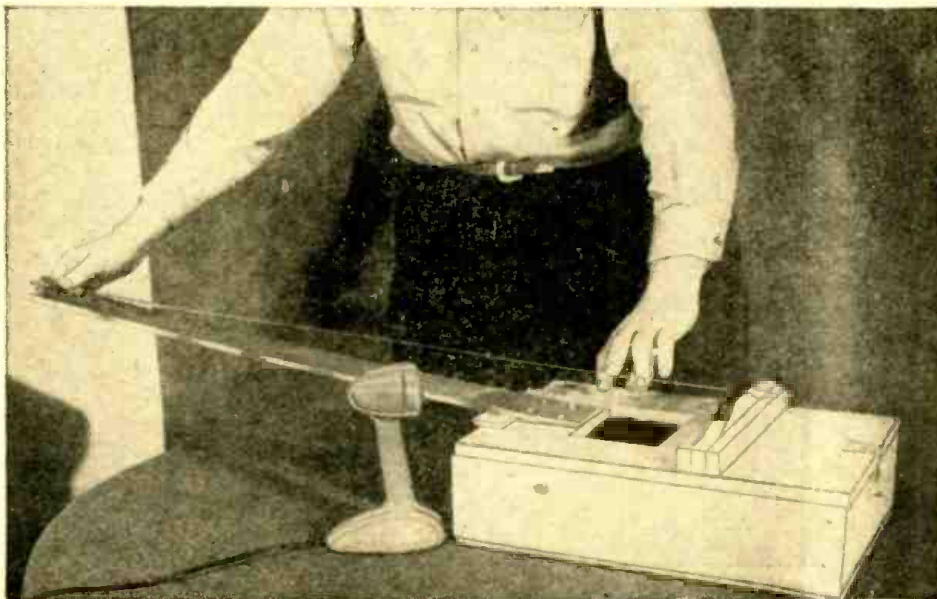

Fig. 5—The twang box, another easily-constructed instrument.



Construction and use of the twang box can be easily understood from the photograph above.

SPEEDY A. C. - D. C. SERVICING

A few short-cuts in midget radio repair

By JOHN BOWLES

This same test may be used for open ballasts or series line resistors.

In some cases the rectifier tube fails

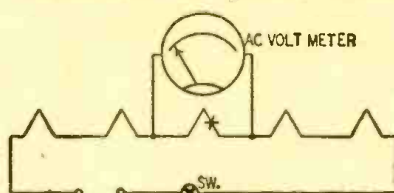

Fig. 1—A quick way to find an open filament.

without the filament opening. Often this can be determined just by looking at the tube. A bluish or pinkish glow between the elements indicates a shorted filter condenser or an overload due to some other cause. Usually this has already damaged the tube.

Microphonic or noisy tubes can be found by tapping them lightly or they may be moved around slightly. If a blast of noise or a squeal is produced, it is best to replace with a new tube. Repeat the tapping or movement with the new tube. This tells the story quickly.

Filter condenser troubles

Faulty filter condensers come second in causing a.c.-d.c. set failures. Open condensers occur as frequently as shorted ones. If the set has a bad hum, chances are that one or more of the

filters are open. The quickest way to check is to connect another condenser across the circuit. You know this method, of course. You also know that it is tedious. It is extremely hard to touch the correct points with the leads. They slip off, causing shock, or perhaps a disastrous short. This difficulty can be overcome by making a filter condenser test box. Five 8- μ f. condensers are connected as shown in Fig. 2. A test cord is brought out with polarized markings. The capacities are additive by throwing the toggle switches, in steps of 8 μ f.

Test first across the input filter. If the hum does not stop and the volume increase, try it across each of the other filters in turn.

If one part of a multisection condenser block is bad, it is always wise to replace the entire pack.

The quickest way to find a shorted filter condenser is to take an ohmmeter reading between the cathode of the rectifier tube and the chassis. A reading of less than 1,000 ohms would indicate that the filters were shorted. In some a.c.-

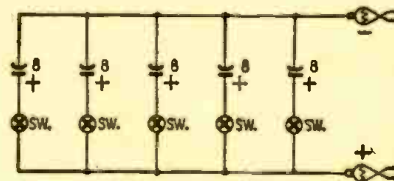

Fig. 2—Substitution box for filter tests.

d.c. sets the speaker field across the rectified voltage supply has a resistance as low as 1,000 ohms. For these sets this reading may be expected. The quickest way to find out which condenser is causing the trouble is to cut the positive leads, one at a time, until the ohmmeter reading increases.

Faulty paper condensers

By-pass condensers are another source of trouble in a.c.-d.c. sets. Placing another condenser across the suspected one, or across each one in the set, is slow. The job can be speeded up by using a by-pass condenser check box. Five condensers, with a selective switch and a pair of leads mounted in a small box can test the usual sizes. The capacities are .0001, .00025, .01, 0.1, and 0.5 μ f. A rotary switch with at least 5 contacts is needed. The leads may be brought out to test prods or alligator clips. Refer to Fig. 3 for details.

This test box may be used to check capacities other than those contained in it. If a 0.25- μ f condenser is to be checked, the 0.1- or 0.5- μ f test condenser can be used. Results may not be perfect, but you can determine whether or not the condenser is open.

(Continued on page 77)

THE a.c.-d.c. radio is the most frequent visitor to the service shop. Not only is it the commonest type of radio, but many parts are often weakened by heat in the smaller and less well-ventilated a.c.-d.c. midgets.

The first cost of these sets is so low that the customer is unwilling to pay a great deal to have them repaired. The question then is: how can the serviceman make any money servicing these receivers?

The answer is—turn out more sets per day! Perhaps you are already turning out all you possibly can. But by using a few good short cuts, these small sets can really be serviced much faster.

The larger part of the time used in servicing a set is spent finding the trouble. Therefore the main concern is to locate the fault as quickly as possible. Then the job can be completed quickly.

Defective tubes cause the majority of a.c.-d.c. set failures. Burned-out filaments cause the most trouble. To find them—remove the chassis from the cabinet. Usually little can be done without this. Turn the bottom of the chassis up to get at the tube bases. Plug in the set and switch it on. The leads of an a.c. voltmeter capable of reading the full line voltage are placed across each tube filament in turn. (See Fig. 1.) When the voltmeter reads approximately full line voltage, it is across the open filament. Replace the tube.



Test panel and service bench constructed by pupils of the Electric Shop, Dover (N.H.) High School. Power panel supplies 117 volts, 6 volts for farm and rural sets, and 2 volts.

ANTENNA PRINCIPLES

Part VI—Directive arrays with metal-screen reflectors

By JORDAN McQUAY

THE reflector elements considered in our previous article on the subject were single pieces of rod or tubing, dipole-like in construction and slightly longer than the radiating dipole.

A prominent characteristic of u.h.f. waves is that they are reflected by almost any type of metal screen, object, or surface. The metal functions much as an ordinary mirror when light waves impinge on it.

Thus, when desired, the dipole-like reflector element can be replaced by a metal screen or surface of suitable area, properly spaced behind the radiating dipole. Length of the metal screen or surface should be such that the reflector extends about a half wavelength beyond the extremities of the radiating

case of rod or tube reflectors.

Typical uses of metal-screen, wire, or mesh reflectors are shown in Fig. 1, and photos A, B and C.

Phased arrays

The simple horizontal arrays previously described provide various amounts of directivity of the field intensity pattern in the horizontal plane. The vertical plane also is unidirectional, but the pattern of radiation is extremely wide and not too useful.

Such arrays are adequate for low-power or limited-range applications, where extreme directivity in both horizontal and vertical planes is not required.

But for high-power operation, extreme directivity in both planes, and general increased efficiency—upright and much larger arrays (consisting of many radiating dipoles) are used for the transmission and reception of u.h.f. waves.

Included in this group of important microwave antennas are: The broad-side array, the colinear array, the billboard array. Differences in the arrays are primarily those of arrangement and number of radiating dipoles.

In general, the half-wave dipoles are constructed of conventional metal rod or tubing. They may be center-fed or end-fed, but all dipoles must be fed in phase—by suitable spacing and arrangement of feed or transmission lines.

The dipoles are arranged within the same plane with respect to the earth. They may be stacked parallel, or mounted end-to-end. The position of all dipoles within that plane determines the polarization of the u.h.f. waves being transmitted or received. Horizontal polarization—used in most u.h.f. applications—is obtained by mounting the dipoles in a horizontal position. For vertical polarization, the dipoles are mounted vertically.

For unidirectional operation, individual and separate reflector elements can be used behind each radiating dipole.

It is more practical and efficient to

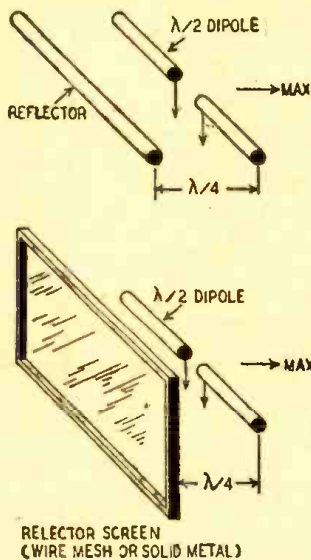
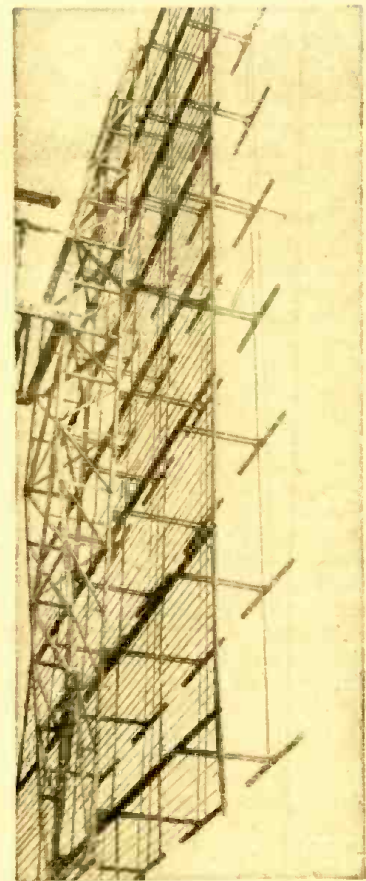

Fig. 1—The reflector may be a flat screen.

dipole. Height of the metal screen or surface is not critical, but should be at least half the length of the reflector. See Fig. 1.

At u.h.f. operating wavelengths of less than 1 meter, the metal reflector need not be a solid surface. It may be perforated with holes no larger than $\lambda/8$. Or the reflector may employ a screen of wire mesh, again providing that openings are no larger than $\lambda/8$. Many types of ordinary fencing material are satisfactory for the construction of reflectors for arrays.

Metal-screen reflectors are spaced in the same manner as the dipole-like reflectors. The reflectors are not connected to the electrical circuit, since their operation is parasitic in nature, as in the



Photos by U.S. Army Signal Corps

Photo A—Billboard antenna's screen reflector. use a reflector screen, particularly if there are a large number of dipoles. Such a nonresonant reflector is easier and cheaper to construct, and provides a better broad-band response than a resonant reflector.

The wire mesh of the reflector is often made the main support of the entire array by mounting the radiating dipoles on quarter-wave metallic insulators which are short-circuited at the reflector screen. This rigidity of construction permits use of larger, heavier radiating dipoles—in turn providing oper-



Photo B—A simple horizontal four-element colinear array with a wire-screen reflector.



Photo C—High-elevation 32-element billboard.

ation over a broader band of frequencies.

Directors are seldom used with large, phased arrays. This is mainly because of mechanical difficulties of construction. Any added benefit of directivity can be equaled—if not surpassed—by careful design and arrangement, spacing, and phasing of dipoles.

Broadside array

When any number of half-wave dipoles (or pairs of half-wave dipoles) are stacked one above the other in parallel, the result is known as a *broadside array*. It is essentially an arrangement in *height*, and may consist of two or more dipoles.

Vertical spacing between parallel dipoles should be close to a half-wave length. To preserve phase relationships without unnecessary lengths of transmission line, polarity is reversed between alternate dipoles as shown by antennas A and B in Fig. 2. Thus the array is fed with equal currents in the same phase.

The broadside array is used to obtain extreme directivity in the *vertical* field. Sharpness of the radiation pattern in the vertical plane is primarily a function of the number of stacked dipoles. The greater the number of dipoles, the greater the directivity in the vertical plane with no regard for the horizontal plane.

This relation is illustrated by antennas A and B and their relative radiation patterns in the *vertical* field, where antenna A provides greater directivity and greater power gain. This is an outstanding characteristic of the broadside array.

Colinear array

When any number of half-wave dipoles are placed end-to-end along a horizontal line, the result is known as a *colinear array*. It is essentially an arrangement in *width*, and provides extreme directivity in the *horizontal* field. Typical example of the colinear array is shown in Fig. 2.

Quarter-wave stubs are used between adjacent dipoles. Thus current is in phase in each radiating section of the array.

Sharpness of the radiation pattern is primarily a function of the number of half-wave radiating dipoles arranged in a horizontal line. The greater the number of dipoles, the greater the horizontal directivity—with no regard for the vertical directivity pattern.

This relation is shown in Fig. 2 by antennas C and D with their relative radiation patterns plotted in the horizontal plane, where antenna C provides greater directivity and consequent increase in power gain.

This is the outstanding characteristic of the colinear array.

Billboard array

When a considerable number of half-wave dipoles are arranged geometrically both in *height* and *width*, the result—a combination of the broadside and colinear types—is known as a *billboard array*.

It may consist of 4 or multiples of 4 dipoles. Some months ago when radar contact was made with the moon, Signal Corps engineers used a billboard array consisting of 64 half-wave dipoles. Another arrangement is shown in Photo B. In general, the greater number of dipoles in a billboard array, the greater the power gain and directivity.

Vertical spacing between parallel dipoles is about a half wavelength, and feed points along the transmission line

(Fig. 2) are chosen to place the dipoles a half-wave apart. By reversing connections on alternate dipoles, they are effectively fed in phase.

The billboard array exhibits many directional characteristics of both the colinear and broadside arrays. It combines the directivity and power gain of antennas A and C—resulting in an extremely narrow, directional beam in the horizontal field of intensity. It also exhibits similar high directivity in the vertical plane. But, except for radar and certain types of navigational equipment, the horizontal field of intensity is of prime importance.

Feeder systems

Maximum efficiency of the u.h.f. antenna system requires a low-loss, non-radiating feeder system between the output of the transmitter and the actual antenna array and between the array and the input of the u.h.f. receiving equipment.

At fairly low frequencies in the u.h.f. band—from 300 to 600 megacycles—it is possible to use rigid, spaced, open-wire transmission line. Such feeder lines consist of metal tubing. They must be nonresonant, otherwise leakage current will damage the insulators.

Polystyrene can be used for all insulators, attached to the feeder line at voltage nodes. However, a much more satisfactory insulator is the metal stub support, or metallic insulator, which also helps keep the feeder line rigid. A stub support is a quarter-wave section of line, short-circuited at one end by any kind of metal frame or surface. The opposite end—connected to the line—represents a very high impedance. Thus no energy is lost through use of such an insulator at ultra-high frequencies.

The feeder line is matched to both antenna array and the transmitter output, with matching stubs placed anywhere along the feeder line.

The principal disadvantage of the open-wire feed line is a sporadic tendency to radiate because of the spacing between conductors. U.h.f. feeder lines must be nonresonant. The best remedy is to employ a concentric line or coaxial cable.

The concentric line may contain ceramic or polystyrene insulators between inner and outer conductors. Often the line is sealed shut after injecting an inert gas. This prevents collection of moisture inside the concentric line and thus raises the breakdown voltage.

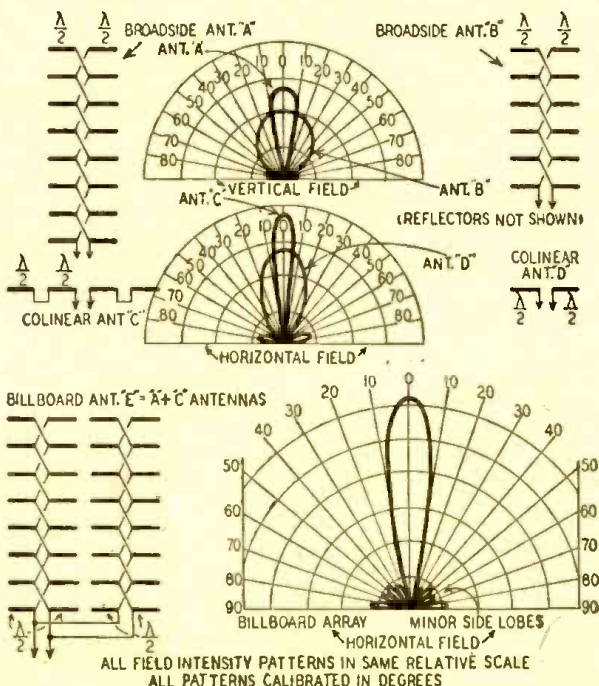

Fig. 2—Showing how characteristics of broadside and colinear arrays are combined in the billboard to give excellent sharpness and gain.

A SMALL RECORDING STUDIO

Part III—Cutters, volume level indicators and compensation circuits

By J. C. HOADLEY

WITH the equipment described in Part I of this article on hand, it is necessary to connect the different units in such a way that a maximum of fidelity and utility may be obtained.

Fig. 1 is a block diagram of a typical recording layout. This is a basic setup which may be added to from time to time. It consists of several studio microphones, a recording amplifier with level indicator and monitor speaker (or phones), dual recording tables with playback pickups, a high-quality playback speaker, receiver, and switches to perform the switching operations required for maximum usefulness.

The most important considerations are to connect the cutters to the amplifier properly and to connect—between the cutters and the amplifier—suitable networks which control the cutter's characteristics in order to provide the best possible recording.

First, it is necessary to match the impedance of the cutter so frequency response will be smooth and distortion low. There are several types of recording heads and their connections vary. If you have chosen a crystal type, you can connect it to the amplifier in various ways. We will assume the use of a push-pull recording amplifier, as it is markedly better than a single-ended one for recording and not much more expensive. We will further assume the use of either triodes or beam tetrodes with sufficient negative feedback as output tubes.

Connecting the cutter

Fig. 2 shows two methods of connecting a crystal cutter. For a constant-amplitude recording characteristic, we omit R_x or R_y , because the crystal cutter has a uniform stylus displacement with constant applied input voltage within its frequency range. It is necessary, with a conventional crystal cutter

such as the Brush RC-20, to reflect not over 4,000 ohms to the cutter. It is desirable to reflect a lower impedance, of the order 2,500 to 3,000 ohms. This

constant-velocity recording characteristic with a turnover frequency of 500 cps, the transformer should have a secondary impedance of 22,000 ohms

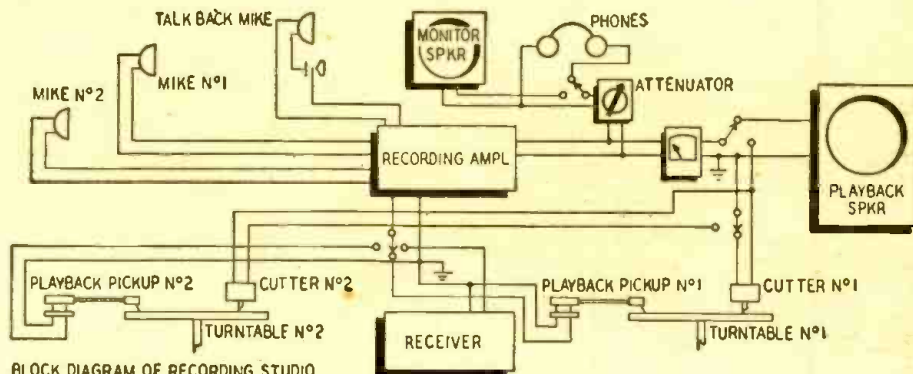

BLOCK DIAGRAM OF RECORDING STUDIO

Fig. 1—Block diagram of a recording studio with sufficient equipment for professional work.

happens to be the plate-to-plate output impedance of push-pull 2A3's, so we do not need a special output transformer for these tubes. We can connect the cutter as shown in Fig. 2-a.

To cut commercial modified constant-velocity recordings (similar to shellac pressings), we must insert R_x in Fig. 2-a. As the crystal presents a capacitive impedance, this constitutes an RC network. Voltage across the crystal will decrease with frequency above a certain turnover frequency. This frequency will be determined by R_x and the crystal's capacity. The RC-20 crystal's internal capacity is 0.007 μf at 100 cycles. Therefore, for this type crystal to provide a turnover frequency of 500 cps, in Fig. 2-a R_x would equal 44,000 ohms. For other turnover frequencies, consult the Brush technical bulletin No. 291 which is supplied with this cutter.

In Fig. 2-b, the transformer T2 matches the crystal to a 500-ohm line, and for constant amplitude recording should have a secondary impedance of 3,000 to 4,000 ohms. For a commercial

and R_y also should have a value of 22,000 ohms.

These recording characteristics may

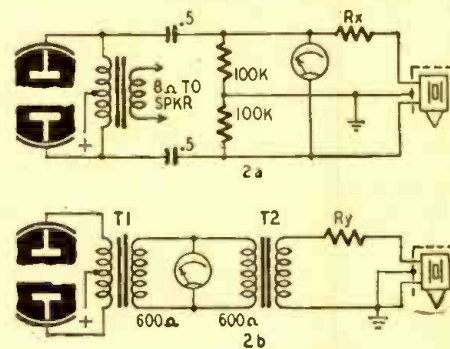

Fig. 2—How crystal cutter may be connected.

be modified for special purposes by varying the frequency response of the recording amplifier with frequency controls or external equalizers. It is conventional to emphasize the high-frequency response in constant-velocity recording. The high frequencies are

(Continued on page 83)



Typical specimens of high-quality recording and playback apparatus.



TELEVISION FOR TODAY

Part XII - High and low-voltage power supplies

By MILTON S. KIVER

A TELEVISION receiver, because of its construction, requires two types of power supplies. All the tubes, with the exception of the cathode-ray tube, are low-voltage units. Hence, all of these circuits can be bunched together and supplied from the same source. This is generally a conventional power supply capable of supplying the required current. A commercial unit is shown in Fig. 1.

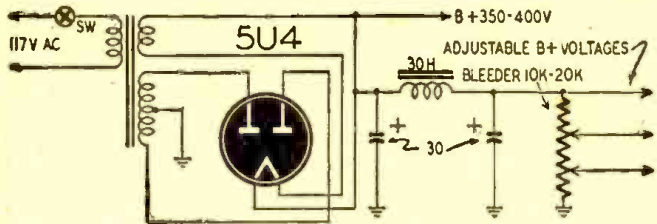

Fig. 1—A conventional power supply suited to low-voltage circuits.

The high-voltage unit must be capable of supplying 5,000 to 7,500 volts. However, the current drain is extremely small—generally not more than 750 microamperes. This permits modification of the component values in the high-voltage unit to result in a relatively small and compact assembly. Fortunately, the small current drain permits the use of half-wave rectification with very little filter difficulty.

Filtering is accomplished by a "brute force" unit (one with large series elements and relatively small shunt condensers). When the voltage reaches the values called for in television, extreme care must be exercised that the energy in the filter condensers does not exceed 1 joule, since this is sufficient to kill most people on contact. Energy storage varies directly with capacitance; consequently, the smaller the capacity, the better. The smaller capacitance is also economical. However, filtering ability of a condenser decreases directly with de-

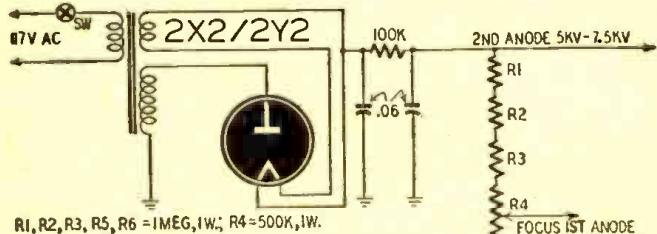

Fig. 2—High-voltage cathode-ray tube supply.

creasing capacity. Hence, a compromise value is used. A typical high-voltage circuit is shown in Fig. 2.

A bleeder resistor is placed across the high-voltage power supply terminals for two reasons. First, it permits tap-

ping off voltages for the focusing (first anode and the accelerating electrode. Second, it discharges the condensers when the set is turned off. Since the voltage is high and the current low, the bleeder resistance must be high. Values between 4 and 10 megohms are normal. The low current drain permits the use of 1-watt resistors, at 1 and 2.2 megohms. The resistors are series-connected, as in Fig. 2, and taps or suitable

potentiometers are inserted at the appropriate voltage points.

The only difference between a high-voltage supply designed for electrostatic deflection tubes and that used for electromagnetic deflection is in the centering system which must be provided for the deflection plates. The necessary circuit was shown in the preceding article of this series. These controls are placed as close to the second anode potential as possible, since the deflection plates are physically located near the second anode in the cathode-ray tube. A large difference in voltage between the deflection plates and the second anode would slow down the electrons in the beam and distort the image.

The centering controls provide a method of varying the d.c. voltage between the two plates of each set. The electron beam, in passing between the plates, is subjected to the electric field caused by the voltage difference and shifted accordingly. If the electron beam does not require this additional shifting in order to reach the center of the screen, the centering voltage can be reduced to zero volts difference between the plates. Note that the centering is accomplished by the voltage difference between each set of plates and not by the polarity or value of this voltage with respect to the cathode.

In electromagnetic deflection, the centering controls receive their voltages from the low-voltage power supply. By controlling the amount and direction of the current through the coils, we can alter

the position of the beam as it appears on the screen.

One final word about the power supply of Fig. 2. Many manufacturers connect the negative end of the high-voltage supply to some positive point on the low-voltage unit, instead of directly to ground. As a result of this connection, every point on the high-voltage unit is raised by an amount equal to the potential at the point of attachment. Why this is done can be understood best by reference to Fig. 3.

In Fig. 3-a, the control grid of the cathode-ray tube is directly connected to

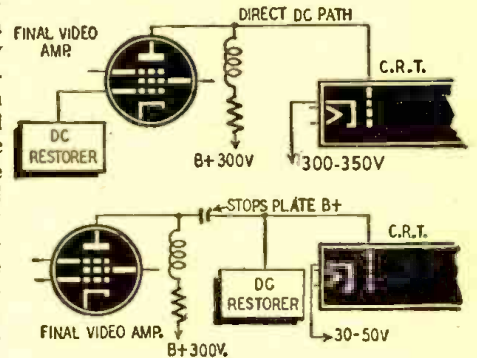

Figs. 3-a and 3-b—How voltage may be gained attaching to positive of low-voltage supply.

the plate of the final video amplifier. This places a high positive voltage on the grid of the cathode-ray tube and necessitates an even greater positive voltage on the cathode. The positive voltage on the control grid comes from the low-voltage power supply. The required positive voltage for the cathode can come either from the low-voltage supply, or by tapping up on the high-voltage bleeder chain. If we tap up on the high-voltage bleeder chain, we decrease the positive potential of each of the other elements in the cathode-ray tube. The effective voltage of these other elements is measured from the cathode of the tube, not ground. Hence, in this latter method, two hundred to three hundred volts of the high-voltage supply is used only to counteract the positive control-grid voltage and not for accelerating the electron beam.

If we connect the negative end of the high-voltage unit to the B-plus of the low-voltage supply, then the cathode can be placed at the lowest point in the high-voltage bleeder chain, or even at some lower positive voltage in the low-voltage unit. This permits complete utilization of the high voltage.

If the control grid is not subjected to the d.c. potential of the preceding video (Continued on page 50)

Multi-Station Intercoms

Part III—Intercom installation and maintenance

By RICHARD H. DORF

IN the last two articles we discussed the construction of two types of intercommunication master stations and three types of switching systems. This part will deal with the problems of installing and maintaining intercom networks.

Whether custom-built units or factory-built commercial jobs are to be used, the initial step is to appraise the requirements of the particular installation. Each user's needs should be carefully tabulated.

The principal question is whether to use a master-to-master or a master-to-remote system. In installations which consist of only two stations, this problem answers itself, since it would be foolish to use two masters. In other cases there is always the consideration of cost versus utility.

In a home, for example, where a person in any room may want to call a person in any other room, the master-to-master system is almost obligatory. If the user wants communication only between each of several master bedrooms and the kitchen, however, the less expensive master-to-remote setup can be used, with the master in the kitchen.

In a typical factory installation, the production manager may want to be able to call each of several assembly rooms; that would permit use of the cheaper intercom system. But if communication were needed among several executives, master-to-master would be indicated.

Where master-to-master is decided upon, a choice must be made—where the custom-built units are used—of either the 3-tube or the 1-tube master. Either will perform very satisfactorily, and in operation there is no difference. However, with the 1-tube masters, failure of any station amplifier will incapacitate that station entirely. With the 3-tube amplifier the station will still be able to hear calls, even though its amplifier is dead. In this case, the choice is one of price versus reliability.

It is always necessary to confer with the buyer of the system, to explain all these factors, and then to base the final choice upon his informed decision.

The next consideration is the physical layout of the area to be covered. Fig. 1 shows block diagrams of an installation with five stations. Examination will show that Fig. 1-a obviously uses less connecting cable. The installation shown in Fig. 1-b would be justified only if some barrier such as a stone wall, body of water, etc., prevented the more economical cabling route.

The usual method of connecting each station to the cable is through a junction box. A standard black-crackle finish steel box, 4 x 4 x 2 inches, was conveniently made into such a junction box (see drawing). A terminal strip with the required number of lugs (1 more than the total number of stations) is fastened to the inside of the box. The holes required for entry and exit of the cable are made, and the box is screwed to the baseboard as near as possible to the location of the station unit.

In the box pictured, a standard 8-contact tube socket is mounted in the upper wall. Under the chassis of the station unit is a 6-lug terminal strip, to which one end of a 6-wire cable is soldered. The other end is soldered to an 8-prong plug, which fits into the junction-box socket. The socket is wired to the junction-box terminal strip, as is the cable which runs between stations. With this arrangement, the station unit can be removed for cleaning or repair by simply pulling out the a.c. plug and the cable plug. No unsoldering or tampering is necessary.

Another factor which makes the use of junction boxes almost imperative is the difficulty of cutting into or splicing multiwire cables. A junction box should be used at any place in the system where the cable must be tapped. It is entirely practical—as an alternative—to mount a socket on the rear apron of the amplifier chassis and plug a cable from the

junction box into that. The difficulty is that the plug will usually jut out unpleasantly from the rear of the cabinet.

Richard H. Dorf was born in New York City in 1921. Being thrown several feet after inserting a hairpin in the a.c. wall socket at the age of 5 started his interest in electricity. Progressed through model train control systems and model stage set lighting setups to audio amplifier construction. Has been announcing and handling programs at New York radio stations since the age of 17. Spent 3½ years in the Air Forces as communications officer, teaching radio and maintaining airborne v.h.f. equipment. Now is programming FM station WMGM.

About eight hours a day are spent on his hobbies, audio, radio, and good music. Specializes in the design and construction of audio equipment, including recording systems, but creates a bit of r.f., too, now and then, with the call W2QMI.

Several manufacturers make intercom cable with almost any desired number of conductors. This cable is color-coded

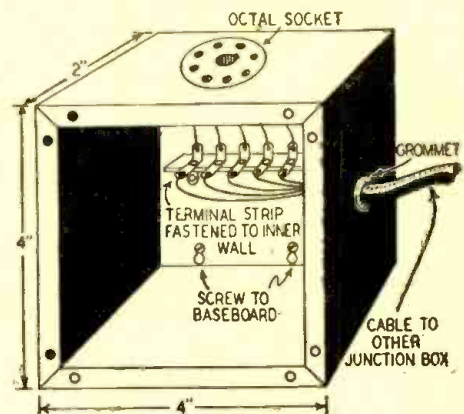

Junction boxes simplify maintenance problems.

(a necessity) and usually cloth-insulated. It is very satisfactory for all indoor installations, but actually any (Continued on page 80)

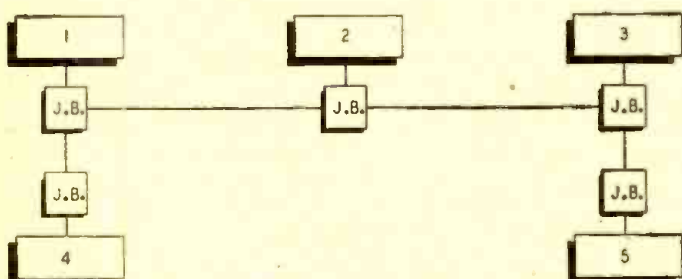

Fig. 1-a—Economically-wired intercom system.

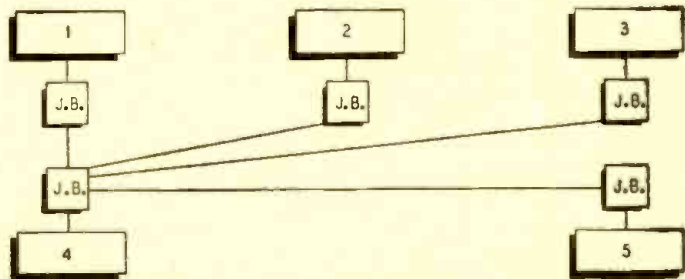

Fig. 1-b—Wiring system due to blocking walls.

Canberra's Mobile Radios

Firemen and plumbers respond to radio calls



Central control station of Canberra's municipal mobile radio net.

SOMETHING has gone wrong with the main fuses in your house. You report to the electricity people by 'phone, and almost before you've had time to put the instrument down, there's a ring at the door, and a man has come to do the job.

It sounds like a housewife's dream, doesn't it? But in Canberra, Australia's planned capital, it often happens. And not only with the electricians, but with the plumber and the ambulance, the police and the men who repair refrigerators and other mechanical appliances.

The Government department that is landlord of most of Canberra's houses and which provides all the normal serv-

ices, uses radio communication with its service vehicles just as police departments do in other cities. An electrician, for instance, who has just finished a job, doesn't go straight back to his base. He tunes his radio to find out if there's another job in the immediate neighborhood. The department has been astonished to find how often there is.

Readymade sets lacked power

R. G. Fowler, radio engineer to the department, fitted up a few cars with small imported commercial sets, and the problem was solved. There was only one difficulty. The little sets had a short range and the patrols worked over wide areas, so cars were often out of range of the base station. Because of war demands, no further units were obtainable. Fowler set about designing and making his own.

The result was even better than he had expected. His sets, although worked off car batteries with vibrator units, and not much bigger than a car radio, had a range

that far exceeded anything that could have been bought. Forest patrols often speak to each other across forty-mile skyline distances, over thickly-wooded hilly country, unfavorable for radio communication.

Shortly after the successful trials of the first sets, the department realized that radio control could be usefully applied to all the ordinary services. After the road and bridge maintenance cars had been fitted, Fowler turned to the water and sewerage services, and the electrical and mechanical fitters.

Now the police, fire brigade and ambulance services are having their turn, and soon every emergency that can happen to Canberra people will be dealt with swiftly and efficiently by radio. Incidentally, the department has found that by being able to go straight to his next job, the average serviceman saves as much as forty miles of driving each day.

Ordinary citizens have also had reason to be glad of the service. Recently some hikers were lost for days in the densely wooded country outside the capital. When they were eventually found by airplane, the pilot radioed messages that were relayed to forestry cars working in the vicinity. The wanderers were soon picked up. Had it not been for speedy radio service, help might have arrived too late.

Radio electrician's helper

Some weeks earlier, an electrical maintenance man, installing a wind-powered battery charger up on the Bag Range, damaged some of his essential equipment in an accident.

Bag Range is a wild place, almost inaccessible, and to reach it, he'd been obliged to transfer all his gear, including the radio, on to a mule-drawn sledge, and drag it for miles. The sledge capsized and all his equipment rolled down

(Continued on page 75)

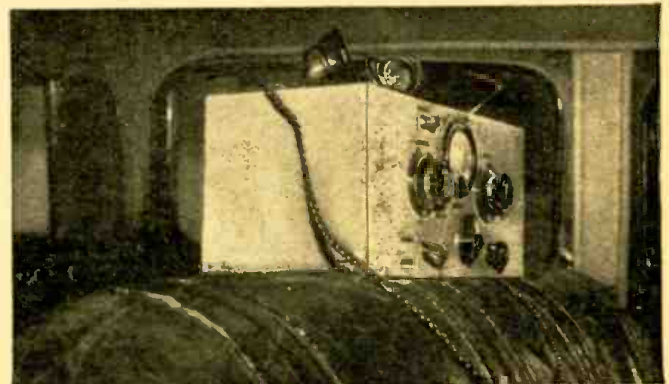
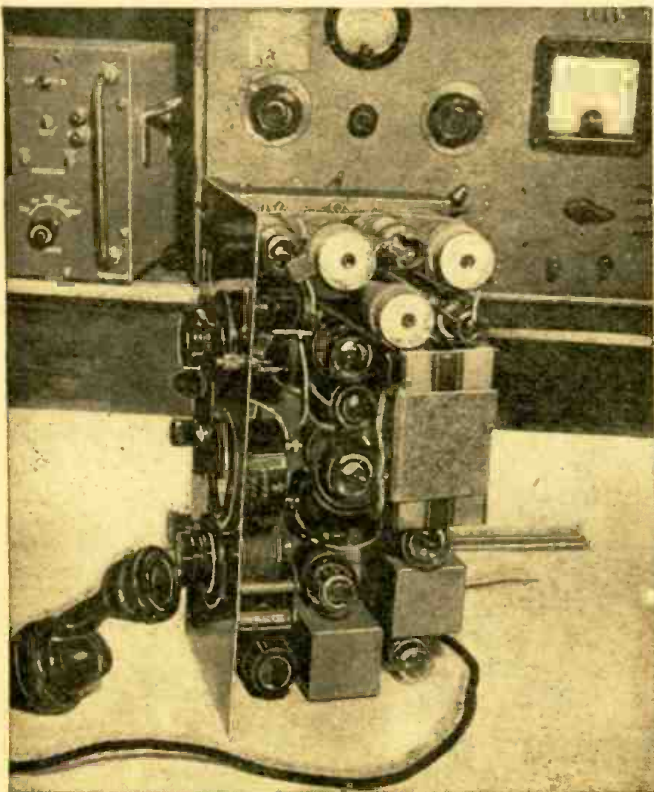

Above—The large transceivers are conveniently installed as shown. Left—Top view of transceiver unit. The B-battery is inside the case.

WORLD-WIDE STATION LIST

Edited by **ELMER R. FULLER**

CONDITIONS have been improving in the past few months and perhaps some good dx will be heard one of these days. Sun spots have been bothering at times, but there have been a few good days. The Australians have been heard very fine business on 15.200 mc from 0200 to 0400 hours EST; and in foreign-language broadcast on 15.230 mc and 15.310 mc from 0230 to 0345 hours. Ponta del Gada in the Azores is being heard from 1700 to 1900 hours on 4.845 mc and puts in a very good signal, on this new frequency. PGD in the Netherlands gives the news in English at 2300 hours except Saturday on 6.020 mc. Ceylon is still being heard Sundays from 1330 to 1530 hours to

England on 7.190 mc, coming in at a very convenient time. Dx on the ham bands has also been very good at times. Several countries have been heard on 10 and 20 meters including G6WT in England, as well as G2MF, G2BB, G3BK, G3IY and G8JB. From Scotland GM8MN and GM4AN. Denmark was heard via OA6PX. Several hams have been heard from Germany on 10 but notably D4ACD, who seems to be on most of the time. PAHS has also been heard several times from the Netherlands as was LA4FB from Norway. D4ARN is also heard often from Germany. On 20 meters we have numerous reports of the following: G6BY and G6AY from England; XE1A

and XE1CK from Mexico; EI6G from Ireland; VO2AF from Newfoundland; YV5ADX and YV5AE from Venezuela; HK3BF from Colombia.

Listening Post Certificates will be in the mails by the time that you have read this, but more observers' services could be used. We never can have too many reports. The more we have, the better picture of conditions we can print. Send your requests for further information to the Shortwave Editor, c/o RADIO-CRAFT, 25 West Broadway, New York 7, New York. We would especially like to hear from oms, yls, and xyls from overseas. So until next month, best of luck and lots of fb dx. All time is given in 24-hours EST.

Location	Station	Freq.	Schedule	Location	Station	Freq.	Schedule	Location	Station	Freq.	Schedule
ALASKA	WXFD	12.250	1800 to 0100	Montreal	CFMX	6.000	0700 to 2315	Barranquilla	HJAB	4.780	1700 to 2255
ALBANIA	ZAA	7.850	1400 to 1800	Montreal	CBFW	6.090	0730 to 1945; 2000 to 2400	Bogota	HJCA	4.850	1900 to 2200
ALGERIA				Montreal	CKLO	9.630	1800 to 1800	Bogota	HJCH	4.890	1800 to 2200
Algiers		6.040	1230 to 1800	Montreal	CKNC	15.190	0800 to 1200	Bogota	HJCW	4.910	0645 to 1115; 1600 to 2315
Algiers		9.540	1230 to 1700	Toronto	CFRX	6.070	0800 to 2345	Bogota	HJCU	4.950	1600 to 1400; 1700 to 2300
Algiers		11.830	0630 to 0300; 1200 to 1800	Vancouver	CFKX	6.080	0930 to 0300	Bogota	HJCV	6.020	0700 to 0800; 1400 to 2315
ANDORRA		5.980	0500 to 1900	Vancouver	CBRR	6.160	0900 to 0200	Bogota	HJCD	6.140	0700 to 0800; 1600 to 2330
ANGOLA				Winnipeg	CHRD	6.150	2200 to 0300	Bogota	HJCT	6.200	1000 to 1400; 1800 to 2315
Benguela	CR6RB	9.160	1330 to 1430	Winnipeg	CKRX	11.720	1000 to 2000	Bogota	HJCF	6.210	1700 to 2360
Louanda	CR6RA	9.470	0115 to 0230; 0630 to 0745; 1400 to 1530	CANAL ZONE		2.390	0530 to 0700; 1000 to 2305	Cartagena	HJAP	4.920	0600 to 1300; 1700 to 2300
ARGENTINA				Quarry Heights				Cartagena	HJAE	4.960	1600 to 2230
Buenos Aires	LRSI	5.980	1800 to 2300	CANARY ISLANDS		7.570	0630 to 0800; 1100 to 1240; 1230 to 1800	Call	HJED	4.820	1900 to 2300
Buenos Aires	LRYI	6.090	0545 to 0715; 1800 to 2100	Santa Cruz	EAI43			Cucuta	HJBB	4.810	1700 to 2280
Buenos Aires	LRYI	9.080	1600 to 1830					Medellin	HJDE	6.140	1100 to 2300
Rosario	LRR	11.880	0600 to 1800	CEYLON		3.390	0600 to 1200	CEYLON			
AUSTRALIA				Colombo		6.070	0715 to 1200; 1930 to 0545				
Brisbane	VLQ2	7.210	0230 to 0830	CHILE		11.740	1700 to 2400	San Jose	TIRH	6.150	2130 to 2400
Brisbane	VLQ	7.240	1500 to 1900	Santiago	CEI174		0600 to 0800; 1600 to 2300	San Jose	TIPG	9.610	0700 to 2330
Melbourne	VLQ	9.580	1100 to 1200	Santiago	CEI180			CUBA			
Melbourne	VLG3	11.710	0100 to 0145; 0230 to 0345	CHINA		11.650	0400 to 0915	Camaguey	COJK	8.720	2000 to 0030
Melbourne	VLA4	11.770	1100 to 1200; 1330 to 1830; 2345 to 0045	Canton	XTPA	7.150	0630 to 1130	Havana	CDBZ	6.040	0600 to 2300
Melbourne	VLG6	15.230	2100 to 2300	Chungking	XGOY	9.650	0630 to 1030	Havana	COCD	6.130	0700 to 2400
Perth	VLW7	9.520	0530 to 1030; 1700 to 2015	Chungking	XG0A	9.730	0900 to 1030	Havana	COCW	6.330	0600 to 2400
Shepparton	VLG8	7.280	1015 to 1045	Chungking	XG0Y	11.900	0500 to 0630; 1045 to 1145	Havana	COCQ	8.700	0700 to 2330
Shepparton	CLR	9.540	1620 to 1900; 2045 to 0220	Chungking	XGOL	10.000	0400 to 1000	Havana	COBZ	9.030	0700 to 0100
Shepparton	VLG6	9.610	0830 to 1200	Goochow	XPSA	7.010	2330 to 0030; 0430 to 0900	Havana	COBQ	9.230	0800 to 1200; 2000 to 2300
Shepparton	VLB2	9.680	0900 to 1100	Kwelyang	XGRS	11.690	0300 to 0930; 1830 to 2400	Havana	COCX	9.270	0700 to 0030
Shepparton	VLG7	11.840	0800 to 0915	Shanghai				Havana	COBC	9.380	0700 to 2100
Shepparton	VLG4	15.310	N. American beam, 2045 to 2145; 0010 to 1145; Asiatic beam, 1730 to 1800; Philippine beam, 1900 to 1915	COLOMBIA		4.880	0600 to 2200	Havana	COBL	9.830	0715 to 0045
AUSTRIA				Armenia	HJFH			Havana	COCY	11.740	0630 to 0100
Vienna		7.160	0600 to 0200; 0400 to 0800; 1000 to 2030								
Vienna		9.820	2345 to 2030								
Vienna		12.210	1145 to 2030								
AZORES											
Ponta del Gada		4.040	1700 to 1900								
Ponta del Gada		11.090	1500 to 1600								
BELGIAN CONGO											
Leopoldville	OTC	9.380	0000 to 0200; 1045 to 1600								
Leopoldville	OTC	9.740	1300 to 2015								
Leopoldville	OTC	11.720	0530 to 0730								
Leopoldville	OTC	17.770	0500 to 0930; 1130 to 1215								
BOLIVIA											
Cochabamba	CP40	6.510	1930 to 2200								
Lopaz	CP49	6.770	0700 to 0900; 1100 to 1200; 1730 to 2100								
BORNEO											
Balikpapan		9.130	0700 to 0935								
BRAZIL											
Belém	PRC5	4.860	0600 to 1100; 1530 to 2000								
Fortaleza	PRE9	6.100	1530 to 2100								
Rio de Janeiro	ZYC8	9.610	1500 to 2200								
Rio de Janeiro	PRL7	9.720	0430 to 0600; 1415 to 1445; 1500 to 2100								
Rio de Janeiro	PSH	10.220	1700 to 1800								
Rio de Janeiro	PRL8	11.720	heard at 0500								
Sao Paulo	ZYB7	6.090	1600 to 1950								
BRITISH GUIANA											
Georgetown	ZFY	6.000	0545 to 0745; 0945 to 1145; 1415 to 1945								
BRITISH SOMALILAND											
Hargelsba		7.130	0800 to 1030; 1200 to 1300								
BURMA											
Rangoon		6.040	0030 to 0230; 0645 to 0830; 2100 to 2145								
CANADA											
Calgary	CFYP	6.030	0730 to 0100								
Edmonton	CJCA	9.540	0815 to 0200								

(Continued on page 79)

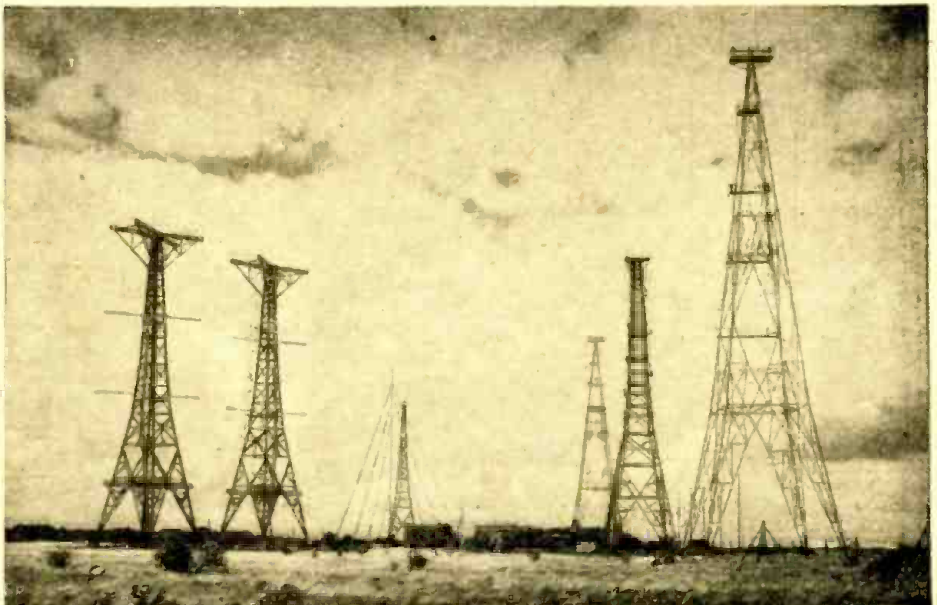

PCJ. "The Happy Station" at Huizen, Holland, covers the earth with this array of antennas.

RADIO DATA SHEET 346



GENERAL ELECTRIC FARM RADIO

MODEL 280

SPECIFICATIONS

OPERATING FREQUENCIES:

Broadcast Band 540-1710 kc.
Shortwave Band 5.8-18.3 mc.
I.f. Amplifier 455 kc.

POWER OUTPUT:

Undistorted 0.15 watt
Maximum 0.27 watt

R.F. STAGE GAINS:

Antenna post to IN5-GT r.f. grid 3 at 1000 kc.
IN5GT r.f. grid to IR5 10 at 1000 kc.
IR5 grid to IN5-GT i.f. grid 46 at 1000 kc.
IR5 grid to IN5-GT i.f. grid60 at 455 kc.
IN5-GT grid to IH5-GT i.f. diode plates 80 at 455 kc.

ALIGNMENT CHART

Step	Connect Test Oscillator To	Test Oscillator Setting	Pointer Setting On Radio	Adjust For Max. Output
1	IN5GT r.f. grid in series with .05 mfd.	455 kc	"BC" Band 550 kc	1st i.f. transformer trimmers
2	IR5 conv. grid in series with .05 mfd.	455 kc	"BC" Band 550 kc	2nd i.f. transformer trimmers
3	IN5GT r.f. grid in series with .05 mfd.	1710 kc	H.f. End	C18 (osc.)
4	IN5GT r.f. grid in series with .05 mfd.	1500 kc	1500 kc	C11 (conv.)
5	IN5GT r.f. grid in series with .05 mfd.	600 kc	600 kc	*C16 (osc. padder)
6	Antenna Post in series with 200 mmf.	1500 kc	1500 kc	C4 (r.f.)
7	IN5GT r.f. grid in series with .05 mfd.	18.3 mc	H.f. End	C21 (osc.)
8	Antenna post in series with 400 ohms	16.0 mc	16.0 mc	*C12 and C5 (Conv. and r.f.)

*Rock gang condenser when making alignment.
**Repeat steps 3 and 4 for best results.

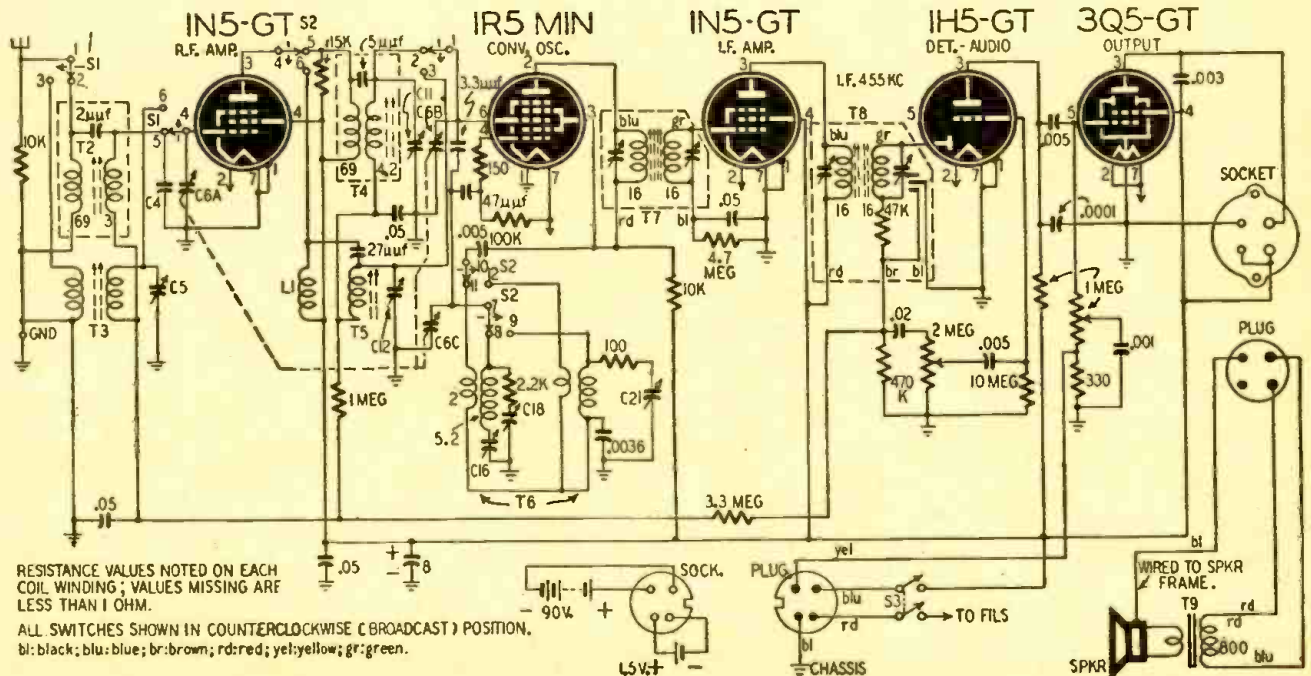
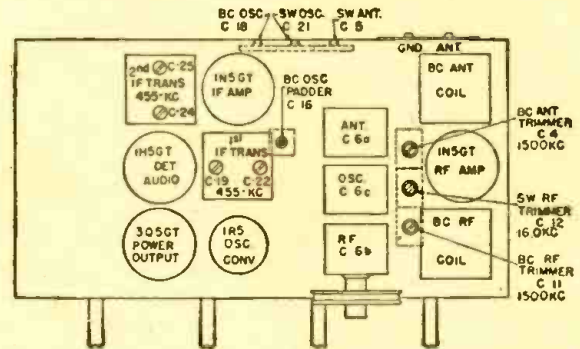
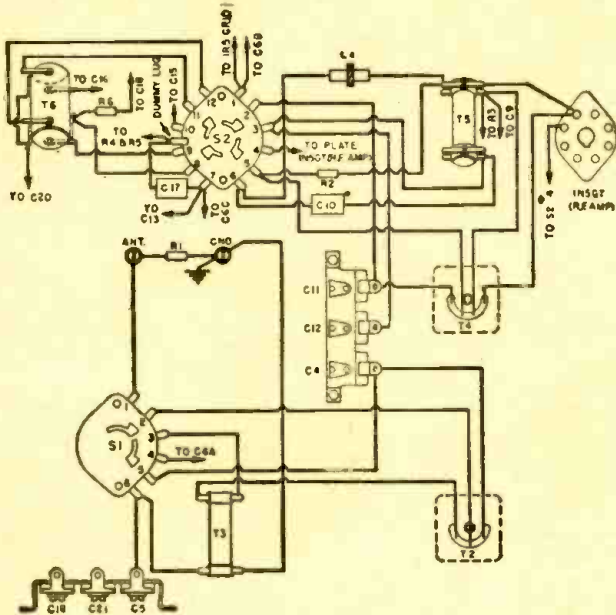

RESISTANCE VALUES NOTED ON EACH COIL WINDING; VALUES MISSING ARE LESS THAN 1 OHM.

ALL SWITCHES SHOWN IN COUNTERCLOCKWISE (BROADCAST) POSITION.
bl:black; blu:blue; br:brown; rd:red; yet:yellow; gr:green.

Start Your Own RADIO SERVICE SHOP

Choose one of these
3 GREAT NEW DEALS

\$99⁵⁰

\$179⁵⁰

\$350⁰⁰

Includes TEST EQUIPMENT, TUBES, PARTS, TOOLS

3 complete going-in-business packages. (If necessary they can be changed to suit your needs.)

There never was a better opportunity than now to start a profitable business of your own. No fuss, no worry. Here's everything you need. Details upon request. Write, wire or phone!



Featherweight Miniature

TEST INSTRUMENTS

Compact — Accurate — Priced Right!

- Jeweled Meter • Range Selector Switch
- All multipliers bridge tested for 1% accuracy
- Zero adjustment—built in batteries
- Molded bakelite case only 3-15/16" x 2-7/8" x 2"



MODEL 450A

Volt—Ohm—
Milliammeter

A fine instrument having a sensitivity of 1000 ohms per volt.

Ranges: Volts DC, 0-5/10/50/500/1000;
Mills DC, 0-1;
Ohms full scale, 0-5000/50,000/500,000;
Ohms center scale, 30/300/3000.

NET complete with batteries **10.90**

MODEL 451A

AC-DC
Volt—Ohm—
Milliammeter

A dependable instrument of wide utility—sensitivity 1000 ohms per volt.

Ranges: Volts AC, DC, and Output Ranges, 0-10/50/100/500/1000;
Ohms full scale, 500,000;
Ohms center scale, 7200.



NET complete with batteries. **14.90**

MODEL 451B

Same instrument as above but has 2500 ohms per volt sensitivity.

NET complete with batteries. **16.60**



MODEL 452A

Volt—Ohmmeter

A superb instrument—100 microampere meter gives 10000 ohms per volt sensitivity.

Ranges: Volts DC, 0-10/50/100/500/1000;
Ohms full scale, 0-2000/20,000/200,000/2 MΩ;
Ohms center scale, 30/300/3000/30,000.

NET complete with batteries. **14.90**



MODEL 312

Volt—Ohm—
Milliammeter

An economy pocket meter featuring a 2" moving vane meter.

Reads: AC-DC volts, 0-25/50/125/250;
Mills AC-DC, 0-50;
Ohms, 100,000;
mfd. .05-15.
Jacks provide range selection.

NET Complete with cord and plug. **6.75**

TEST LEADS (Removable Needle Points) **.59**
Excellent for above instruments.

TURNTABLE STAND



\$3⁹¹

FREE

With each stand we send a stroboscope free.

All steel—adjustable—holds turntable 15" above bench—tilts to any position—speeds work—saves time—prevents damage to parts—pays for itself on first job—you need several at this low price.

PHILCO BEAM OF LIGHT

Selenium cell only, no holder, postpaid... **\$1.80**
(Puts new life into Philco Changers)

Sapphire needle only, no-mirror, postpaid **\$1.20**

SHORT WAVE RECEIVERS



Hallierasters S-38 **\$47.50**
S-40 (Replaces S-20R) **89.50**
SX-42 (Replaces SX-28A) **275.00**

SELENIUM RECTIFIERS

Direct permanent replacement for 11726—11723 etc. No filament—no socket—no trouble.

1 to 5 **1.08** net 6 to 49 **98c** net 50 or more **90c** net

SLIDE RULE DIALS



Crowe No. 534—direct ratio drive—antique bronze escutcheon 2 1/4" x 4"—pointer travel 3 3/4".
NET with pilot lamp bracket... **\$1.74**

V. M. AUTOMATIC CHANGER



A Two Post Changer with well-made mechanism—plays 10" or 12" records intermixed. Low pressure crystal pickup. Size 14" x 14". Packed two to a factory-sealed carton, factory guaranteed.

SPECIAL EACH **15⁹⁵** CARTON OF TWO **29⁹⁵**

TRANSVISION

Television Kit

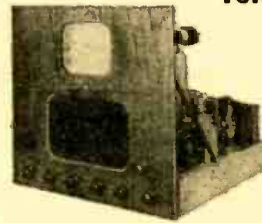

Proven Circuit
7" Picture Tube
Pre-tuned RF
Special Antenna
100% Complete

Famous Television Kit as advertised by Transvision, Inc. complete with all tubes, panel, everything—now available from our stock. Another Radio Supply "First"..... **\$159.50**

When ordering, specify station channels needed.

JEWELLED PILOT LIGHT ASSEMBLIES



- Candelabra screw base for 110 volt lamp.
- Mount in 1" hole.
- Lamps removable from front of panel.
- Available marked 1-2-3 or 4 on back of lens.

YOUR CHOICE net **19c**

Include full remittance with orders of \$3.00 or less. Include 25% deposit with all C.O.D. orders of \$3.00 or more. Prices subject to change without notice.

SEND FOR FREE CATALOG

RADIO

SUPPLY & ENGINEERING CO., Inc.

125 SELDEN AVE.

DETROIT 1, MICH.

Transatlantic News

From our European Correspondent, Major Ralph Hallows



MUSA stands for multiple-unit steerable antenna. The system was installed at a site in Kent by the British

General Post Office to ensure at all times and all seasons distortion-free and fading-free reception of telephonic transmissions from the United States. The quality of these, as relayed to all parts of Britain by the BBC, is now excellent.

The principle of Musa is theoretically quite simple. With a high-frequency transmission, the vertical angle of arrival of the wave trains at the receiving antenna varies constantly owing to rapid changes in the under surface of the F-layer. At any instant there is a particular vertical angle at which incoming signals are at their strongest. But wave trains may be (and probably are) arriving simultaneously at other angles. Fading occurs when there is a phase difference between wave trains arriving at different angles after traversing paths of different lengths. A fruitful source of distortion is the more or less rapid change of polarization of a transmission which may occur during reflection by the F-layer. By making use of superdiversity reception, Musa responds at every instant (A) to the signal, whatever its arrival angle, which has the greatest amplitude, and (B) to the signal that has undergone the smallest change in polarization.

This is accomplished by what amounts to making the narrow major lobe of the receiving antenna's vertical polar diagram sweep rapidly and continually through a wide arc. The receiver accepts only the best signal at any instant, rejecting all others.

Our Musa station works with the transmitter at Lawrenceville, N. J. Frequencies of the order of 19.82, 14.59, 9.87, 7.55, and 5.08 mc are used, the particular one in operation at the moment depending on the optimum for the state of the sunspot cycle, season of year, and time of day.

The Musa receiving equipment consists of 16 rhombic antennas, spaced at regular intervals over a distance of two miles on the great-circle path to Lawrenceville. These antennas are connected to the receiving apparatus by 16 co-axial transmission lines, the lengths of which depend on the distance between individual antenna systems and

the receiving set. The 16 signals are combined after introduction of appropriate phase shifts. These phase shifts cause the major lobe of the vertical polar diagram of the whole antenna system to swing up and down, constantly changing the angle of elevation.

The system is equipped with calibrated cathode-ray tube display units to measure accurately both the optimum wave-angle and the field strength. Records of these have been made at quarter-hourly and hourly intervals ever since the station opened in July, 1942, and are available to both radio engineers and ionospheric physicists.

Russian radio and television

At the moment the USSR claims that big advances in both radio and television have been achieved by Russian scientists. Large-scale plans to extend broadcast services of both kinds are also under way. Twenty-five television stations, it is announced, shortly will be in operation, 21 in European Russia and the rest in Siberia. It is known that work on color television has been going forward for some time, and the latest report is that a color transmitter working in Moscow has a service area with a 75-mile radius. Much attention is being paid to both land-line and radio links between main television and v.h.f sound transmitters and relays sited at considerable distances away. FM has been adopted to a large extent, particularly for the coverage of big cities, where man-made static due to electrical machinery presents almost insuperable problems with AM. How much of all this is fact and how much wishful thinking it is impossible to say. One must however, bear in mind that Russia is the home of many first-rate radio physicists and radio engineers and that almost unlimited funds are available for research and development on approved lines.

FM in Britain

As I have already reported, our BBC has been making experimental FM transmissions on 45 and 90 mc for some time. The conclusions reached as a result of extensive trials are (1) that

FM is superior to AM for v.h.f. relays in the quality obtainable and in freedom from interference; (2) that it has also advantages over any form of pulse modulation; (3) that horizontal polarization is very much better than vertical for suppressing the effects of interference. The BBC has now decided to start regular FM broadcasts from a full sized transmitter as soon as it can obtain delivery of the apparatus. A 25-kw transmitter has been ordered from the Marconi Wireless Company. Where it will be erected is still a secret. My guess is that the selected site will be on high ground in one of our midland districts.

Meteors and radio

I was much interested to see a reference to this subject in the February number of RADIO-CRAFT because some very important and interesting work has been done on it. One of the most puzzling problems in radio is the continued existence after dark of the ionized E-layer. If the recombination rate of its atoms is calculated, this should be complete and the reflecting properties of the layer brought to an end very soon after sundown unless something happened to prevent deionization. During the showers of meteors last October from the Giacobini-Zinner stream it was established that each left a trail of ionized air from which radar echoes could be obtained. Recent work by four separate teams of physicists, working under the direction of Sir Edward Appleton and using a variety of methods,

(Continued on page 73)



Franz BEAVER

Suggested by Grego Bانشuck, New York City

"There must be a fire in the television studio."

RADIO-CRAFT for MAY, 1947

SERVICEMEN

Check This Column for Lowest Prices on Quality Parts

TUBES: A warehouse full, including the new miniatures. Order all types you need. We'll try to supply you completely. Special this month: Sylvania 6V6gt-3 for \$2.00; RK-75 or 307 Transmuting tubes only \$2.50 each; 6L6G-89c; 6SD7 (replaces 6SK7)-59c.

POWER TRANSFORMERS—Half-shell type, 110V, 60 cy. Centertapped HV winding. Specify either 2.5 or 6.3V filament when ordering.

For 4-5 tube sets—650V, 40MA, 5V & 2.5 or 6.3V.....\$1.49
 For 5-6 tube sets—650V, 45MA, 5V & 2.5 or 6.3V.....1.75
 For 6-7 tube sets—675V, 50MA, 5V & 2.5 or 6.3V.....1.90
 For 7-8 tube sets—700V, 70MA, 5V & 6.3 or two 2.5.....2.35
 For 9-11 tube sets 700V, 100MA, 5V & 6.3 or two 2.5V...2.85
 For 9-15 tube sets—600V, 150MA, 5V & 6.3V.....2.95

TRANSFORMERS—All types in stock. **AUTO-TRANSFORMERS:** Steps up 110v to 220v, or steps down 220v to 110v—\$1.95. **FIL. TRANS.:** 6.3v, 8 Amps—\$1.98; 5v, 10 Amps—\$1.98.

Universal Output Trans. 8 Watt—89c; 18 Watt—\$1.29; 30 Watt \$1.69. **AUDIO TRANSFORMERS:** S. Plate to S. Grid. 3:1—79c; S. Plate to P.P. Grids—79c; Heavy Duty Class AB or B. P.P. Inputs—\$1.49; Midset Output for AC-DC sets—69c.

MIKE TRANSFORMER for T-17 Shure microphone, similar to UTC oncer type—\$2.00.

CONDENSERS—**PAPER TUBULAR** 600 WV—001, 002, 005—8c; .01, .05—9c; 1—10c; .25—23c; 5—36c. **ELECTROLYTICS:** 8mfd 200v—20c; 10mfd 35v—20c; 20mfd 150v—23c; 20/20mfd 150v—35c; 30/20 250v—46c; 50mfd 150v—43c; 8mfd 475v—34c; 10mfd 350v—65c. **OIL CONDENSERS:** 4mfd 600v 49c. **BATH TUB TYPE CONDENSERS:** 8X1mfd—20c. **RESISTORS:** All types in stock at the lowest prices; Resistor Kits: 100 2 watt resistors—\$1.95.

FILTER CHOKES—300, 400, 500 ohm light duty—59c; 200 or 300 ohm heavy duty—89c; 250 ma 35 ohm, made for U.S. Navy, fully shielded—\$1.95; 75 ohm 125 ma—25c or 25 for \$4.25; "Melssner type" tapped filter chokes—25c; 8 amp. iron core A filter—25c; Choke-condenser combination. Ideal to replace any size speaker field when installing PM speakers—79c.

110 V. CIRCUIT BREAKERS of Magnetite type: Following Current Ratings in Stock; 1.25, 3, 4, 8 Amps. Please specify. \$1.95.

SEVEN ASSORTED I.F. TRANSFORMERS—\$1.98; Five Ass't. Oscillator Coils—89c.

PERMEABILITY TUNERS—Attractive slide-rule dial, compactly replaces dial, tuning condensers, oscillator and antenna coils in broadcast band receivers. Special \$3.43.

WILLARD rechargeable 3 volt storage batteries for G.E. portable radios \$2.95.

SPEAKERS—PM dynamic type—4"—\$1.55; 5"—\$1.55; 6"—\$1.95; 8"—\$3.95; 10"—\$5.95; 12"—\$7.50.

CRYSTAL PICK-UPS—Two nationally known makes, one \$1.90, the other at \$2.29.

PHONO-MOTORS—110V, 80 Cycle, with turntable—\$4.25.

HEADPHONES—Highest quality Signal Corps headsets with sponge rubber ear cushions, 12' cord and plug \$1.00. 5' rubber covered patchcords with phone plug and socket—25c.

RELAYS—Guardian SPST 12-24v, has heavy duty 15 Amp. Contacts—\$1.25; Guardian 12 to 24v D.C. triple make, single break relay, 5 for \$3.75; Sigma super-sensitive 2000 ohm D.C. SPDT Relay. (May be adjusted to operate on less than 1 milliamperes)—\$2.50.

6 POLE, DOUBLE THROW, Telephone Type 2000 ohm Relays. Super sensitive, \$2.50 each, or two for \$4.50.

SELENIUM RECTIFIERS—Dry disc type 1 1/2" by 1", 1.2 Amp. maximum, suitable for converting DC relays to AC, for supplying filament source in portable radios, convertink DC meters to AC applications, and also may be used in low current chargers—90c.

METER RECTIFIERS—Full wave, may be used for replacements or in construction of all types of test equipment—\$1.25. Half Wave—90c.

FILTER CHOKES—200, 300, 400, 500 ohm light duty—59c; 200 ohm hvy. duty—99c; 250 MA, 35 ohms DC res. Made for U. S. Navy. Fully shielded—\$1.95.

LINE FILTERS—110V—each unit contains two 2 mfd. oil filled condensers and a 15 amp. iron core choke. This filter has innumerable uses such as oil burner line filter, etc. A ten dollar value for 98c.

PHONO AMPLIFIERS—A real AC, 110V, 60 Cycle, 6 Watt Amplifier suitable for PA systems and phonographs; with a husky power transformer. Complete with tubes—\$12.95.

PUBLIC ADDRESS AMPLIFIERS—25 Watts peak output, 5 tubes, separate controls for Microphone and Phono Inputs. \$65.00 value for only \$32.00.

WIRE—No. 18 POSJ 2 conductor parallel Alncord, brown. 250' spools—\$5.25. 500' spools—\$9.95. No. 18 PO brown rayon covered parallel lampcord. 500' spools—\$12.25. No. 18 SV round rubber covered double wire for wash machines, vacuum cleaners, etc. 250' spools—\$6.95. Rubber covered mike cable. 250' spools—\$15.00. All kinds hook-up wire 10 per ft., transmission line. 50 ohm Impedance RG8U, cut to any length, 8c per ft. Single stranded conductor shielded lead with brown rubber over shield, super special, \$1.20 per 100 ft., \$10.00 per 1000 ft.

MICROPHONES—All national and known brands. Bullet crystal—\$5.45; Bullet Dynamic—\$7.45; Mike Jr.—60c; Handy Mike—90c; Lapel Mike—93c; SHURE T-17 MIKES, with push to talk switch—89c.

20 **ASS'D COIL FORMS**, including 11 ceramic, 9 polystyrene, and 6 fiber, all useful sizes—50c.

VARIABLE CONDENSERS: 350 MMFD, 5 gang—\$1.95; 4 gang—\$1.49; 3 gang—83c; 2 gang—79c; 7.5 to 20 MMFD, 1750v spacing, extra long shaft Hammarlund—69c; miniature variables, 25 MMFD—39c; 50 MMFD—49c; 75 MMFD—59c; 100 MMFD—69c; 140 MMFD—79c.

TRANSMITTING RF CHOKES, 4 PIE, 350 Ma.—25c or 4 for \$1.00.

INTERRUPTION FREQUENCY COILS for super-regenerative receivers or the tremendously popular FM adapters for standard broadcast sets. Iron core with a resonant frequency of 50 KC—39c; Air Core, 100 KC—29c.

30 MC IF TRANSFORMERS, double slug tuned—25c.

VIDEO AMPLIFIER PLATE COILS—Slug tuned—25c.

REMOTE CONTROL UNIT: Aluminum case 4x3x2" containing 2 potentiometers, triple pole switch, 4 knobs, gear mechanism counter and phone jacks—99c.

MODULATION TRANSFORMERS: 10 watt, metal case—98c; 30 watt, open type—\$1.95; 40 watt, cast aluminum case—\$2.95.

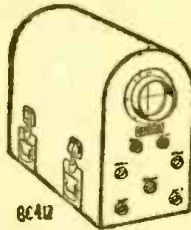

5" Receiver Indicator Oscilloscope with 31 Tubes

This unit, sold by Western Electric for \$2500.00, includes a 13 tube receiver with 7 IF stages; 2 tube multivibrator sweep generator; 2 tube sweep amplifier; video amplifier; pedestal impulse and sweep generator; and 115 V, 60 cycle supply with 2X2 for high voltage. Makes a wonderful laboratory instrument, or can be more easily converted to a complete home television receiver than any other war surplus item. Only \$69.95

13 Tube BC412 Radar Oscilloscope—Easily converted to a superb laboratory oscilloscope by just a little work. Already 110V, 60 cycle \$59.95

RADAR OSCILLOSCOPE APN4. Complete with 27 tubes including 5" cathode ray tube, 18"x9"x12". Shipping Weight 60 lbs. .. \$39.95

BC-947 3000 MC ULTRA HIGH FREQUENCY TRANSMITTER

This unit contains amplifier tubes and rectifier tubes, 115 V, 60 cycle power supply, 6 meters including 250 MA, 50 MA, 1 Amp thermo, for input modulating current, 150 V AC, and 1500 V for plate & screen at 1000 ohms per volt. Interior temperature controlled by heater resistances and blower. Plate supply automatically cut off if blower fails. Western Electric charged \$1500 for this unit. Your cost only\$69.95

BC 221 FREQUENCY METERS with calibrating Crystal and calibration charts. A precision frequency standard that is useful for innumerable applications for laboratory technician, service man, amateur, and experimenter, at the give away price of only \$39.95

5BP4 CATHODE RAY TUBE, 5" tube at the lowest price ever offered \$3.95

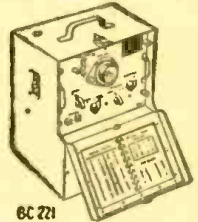

GENERAL ELECTRIC RT-1248 15-TUBE TRANSMITTER-RECEIVER

TERRIFIC POWER—(20 watts) on any two instantly selected, easily pre-adjusted frequencies from 435 to 500 Mc. Transmitter uses 5 tubes including a Western Electric 316 A as final. Receiver uses 10 tubes including 955's, as first detector and oscillator, and 3-7H7's as IF's, with 4 slug-tuned 40 Mc. IF transformers, plus a 7H7, 7E6's and 7F7's. In addition unit contains 8 relays designed to operate any sort of external equipment when actuated by a received signal from a similar set elsewhere. Originally designed for 12 volt operation, power supply is not included, as it is a cinch for any amateur to connect this unit for 110V AC, using any supply capable of 400V DC at 185 MA. The ideal unit for use in mobile or stationary service in the Citizen's Radio Telephone Band where no license is necessary. Instructions and diagrams supplied for running the RT-1248 transmitter on either code or voice, in AM or FM transmission or reception, for use as a mobile public address system, as an 80 to 110 Mc. FM broadcast receiver, as a Facsimile transmitter or receiver, as an amateur television transmitter or receiver, for remote control relay hook-ups, for Geiger-Mueller counter applications, and it sells for only \$29.95 or 2 for \$53.90. If desired for marine or mobile use, the dynamotor which will work on either 12 or 24V DC and supply all power for the set, is only \$15.00 additional.

GENERAL ELECTRIC 150 WATT TRANSMITTER

Cost the Government \$1800.00
 Now only \$44.50!

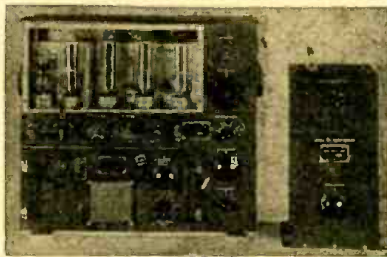

This is the famous transmitter used in U.S. Army bombers and ground stations, during the war. Its design and construction have been proved in service, under all kinds of conditions, all over the world. The entire frequency range is covered by means of plug-in tuning units which are included. Each tuning unit has its own oscillator and power amplifier coils and condensers, and antenna tuning circuits—all designed to operate at top efficiency within its particular frequency range. Transmitter and accessories are finished in black crackle, and the milliammeter, voltmeter, and RF ammeter are mounted on the front panel. Here are the specifications: **FREQUENCY RANGE:** 200 to 500 KC and 1500 to 12,500 KC. (Will operate on 10 and 20 meter band with slight modification). **OSCILLATOR:** Self-excited, thermo compensated, and hand calibrated. **POWER AMPLIFIER:** Neutralized class "C" stage, using 211 tube, and equipped with antenna coupling circuit which matches practically any length antenna. **MODULATOR:** Class "B"—uses two 211 tubes. **POWER SUPPLY:** Supplied complete with dynamotor which furnishes 1000V at 850 MA. Complete instructions are furnished to operate set from 110V AC. **SIZE:** 21 1/2 x 23 x 9 1/4 inches. Total shipping weight 200 lbs., complete with all tubes, dynamotor power supply, tuning units, antenna tuning unit and the essential plugs. These transmitters are priced to move fast: Order today and be the proud owner of one of the finest rigs obtainable.

BENDIX SCR 522—Very High Frequency Voice Transmitter-Receiver—100 to 156 MC. This job was good enough for the Joint Command to make it standard equipment in everything that flew, even though each set cost the Gov't. \$2500.00. Crystal Controlled and Amplitude Modulated—**HIGH TRANSMITTER OUTPUT** and 3 Microvolt Receiver Sensitivity gave good communication up to 180 miles at high altitudes. Receiver has ten tubes and transmitter has seven tubes, including two 832's. Furnished complete with 17 tubes, remote control unit, dynamotor and Ant. \$37.95. We include complete instructions for conversion to 110v A.C.

SCR-274 N COMMAND SETS, including 3 separate 6 tube superhet receivers, 2 separate transmitters, each with 40 watts output, modulator and DC power supply. Bargain price for all 6 pieces complete with tubes\$39.95

300 MILLIAMPERE METERS—G.E. or Westinghouse, 3 1/2 inch diameter, flush mounting. Priced at \$2.25 each, or 5 for \$10.00

AIR CRAFT MARKER BEACON—Complete with 3 tubes and sensitive relay to control external circuits from received signals. Just the receiver you have been waiting for to control models, open doors from a distance, etc. Priced at only.....\$ 4.95

AIRPLANE INTERCOM AMPLIFIER—with 4 tubes in aluminum case—

BC-654 TRANSMITTER-RECEIVER—Complete with 17 tubes and 200 Kc. calibrating crystal..... \$39.95

NEW FRENCH RADIO PARTS

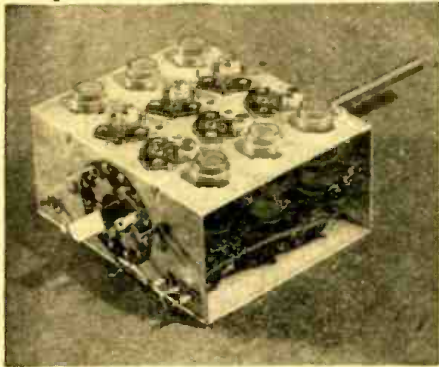

THE Frenchman is essentially an individualist—that is why France is an artisan's country. The radio industry proves this rule. There are about 50 big radio manufacturers and approximately 200 medium-sized ones. Besides these, one counts literally thousands of small constructors who compete—often successfully—with the big brands.

These small firms occupy themselves largely with assembling receivers from standard components found readymade in commerce. Their artisans do not actually manufacture any of the elements which go into the set. Yet from these readymade parts they design a great variety of receiver models.

From this one understands the great importance of the parts manufacturer to the French radio industry. The post-war shortages, particularly in tubes and all components that require copper, has had a very serious effect on the small constructors. They have had to buy everything they could find—without being too particular about quality. The black market therefore naturally flourishes in the radio field, as it does, alas, in many others, for official allotments give the manufacturers only a small part of the material they need.

What is remarkable under such conditions is that the parts manufacturers have made real efforts to better the quality of their material, even though they know in advance that anything will sell. This is an encouraging sign which proves that the moral stability of the French has not been broken by the trials of the war years.

All this was proved at the recent *Exposition Professionnelle des Pièces Detachées* (Professional Radio Parts Show) held at Paris in February, 1947. Not many technical novelties were featured there. The Show was rather characterized by a better quality of material and also that the material was more readily available. We did see, however, a few original items which pre-empt the new tendencies of the day.

In the domain of high-frequency

coils, the specialists have presented superheterodyne "blocks" (1) which contain all the tuning and oscillator coils with trimmers, padding condensers, etc., grouped around the switch. These blocks—which are very compact—facilitate construction of the receivers. Most of them have the three usual frequencies: long waves 1,000 to 2,000 meters, medium waves 200 to 600 meters, short waves 10 to 50 meters. Nevertheless, one sees also blocks with higher frequencies. These are generally in the short-wave bands which are again divided into two or three sub-bands. One also finds blocks having a number of spread-bands in the 20, 25, 30, 40, and 50-meter bands.

The variable condenser scales are becoming longer and longer. The style usually shows a horizontal dial, more or less slanted backward, placed at the lower part of the receiver.

One constructor exhibited a dial composed of a luminous tube which carries a number of scales (2). Change of ranges is effected by turning the luminous tube around its axis so that the listener always sees the scale of the corresponding frequency band. The pointer is a ring encircling the tube, which is moved along as the set is tuned.

An interesting novelty is presented by an oscillating quartz crystal (3) whose frequency remains rigorously stable in spite of temperature variations. The support of the quartz has a bi-metal (thermostatic metal) armature which flexes more or less, depending on the temperature. The displacement of this armature with the temperature variation modifies the thickness of the air space of the quartz mounting. Thus variations of frequency which would otherwise have been caused by temperature changes, are compensated by variation of the air space.

An amusing economizer of electric current for a soldering iron (4) was another item which drew attention.

(Continued on page 68)

(1)

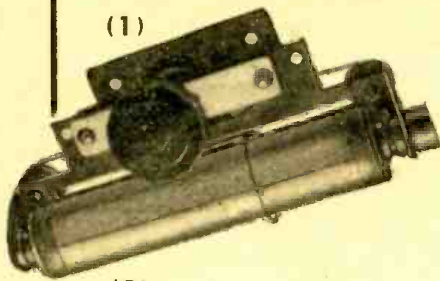

(2)



(3)

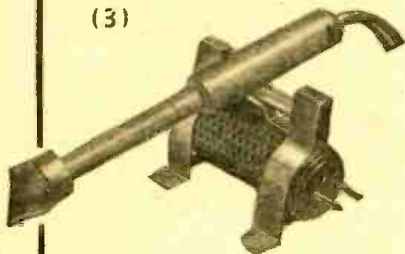

(4)

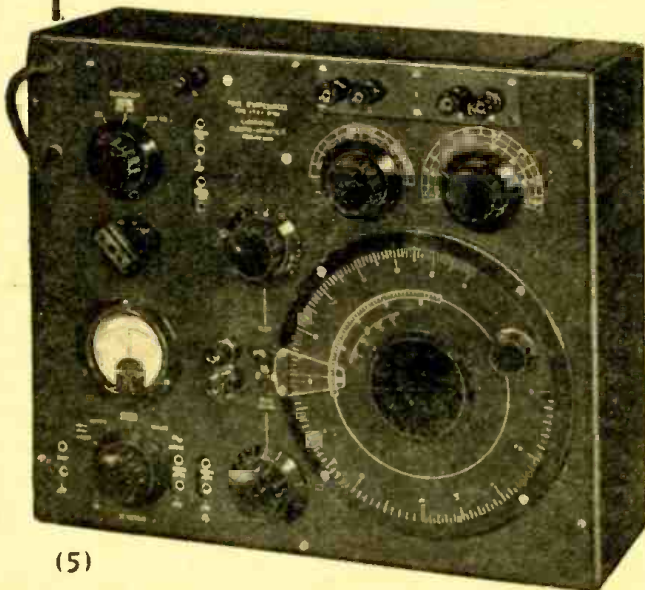

(5)

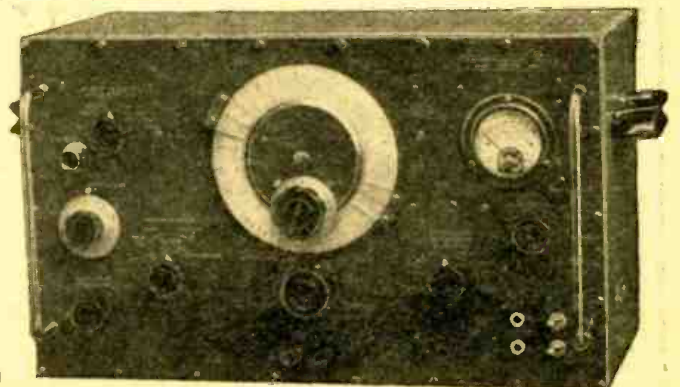

(6)

Chicago Parts Show



The 1947 Radio Parts Show at the Hotel Stevens in Chicago chalked up the unprecedented advance registration of 2054. This marks it definitely as predestined to be the most successful parts show held. Of the 2,054 registrants, 885 are member exhibitors, 39 are guest exhibitors, and 489 are members of the National Electronic Distributors Association (NEDA).



The new operating plan of the show, used this year for the first time, confines attendance during the first four days to distributors, exhibitors, and manufacturers who operate through distributors. On Friday, May 16, the show is being thrown open to radio servicemen, amateurs, engineers, and the general public. Exhibitors have been requested to have attendants on hand Friday who can be particularly helpful to these groups.

Program for the show:

SATURDAY AND SUNDAY, May 10 and 11—Organization meetings and sales meetings.

MONDAY, May 12—NEDA Day—No sales meetings to be allowed.

Breakfast sponsored by NEDA for member exhibitors and NEDA members.

12:00 noon—Luncheon meeting of members of sponsoring groups of the show corporation.

7:00 p.m.—Keynote dinner for entire industry, featuring Bill Cunningham, noted sports writer and radio commentator, as guest speaker.

TUESDAY, WEDNESDAY, AND THURSDAY, May 13, 14, and 15—No sales meetings to be allowed on these days. Attendance in Exhibition Hall to be confined to members of sponsoring manufacturers, their booth attendants, and their sales representatives and distributors.

Exhibition Hall open from 10:00 a.m. to 6:00 p.m.

FRIDAY, May 16—Open House Day—Radio servicemen, amateurs, engineers, and the general public will be admitted to the Exhibition Hall without registration. Exhibition Hall open from 10:00 a.m. to 6:00 p.m.

NEDA Day, Monday, May 12, will feature a breakfast for manufacturer guests of National Electronic Distributors Association members and a luncheon for sponsoring organizations (Radio Manufacturers Association, Sales Managers Club Eastern Division, Association of Electronic Parts and Equipment Manufacturers, and National Electronic Distributors Association).

The products displayed cover the whole gamut of radio components, sound equipment, and special types of radio systems. Home and auto receivers, home phonographs, hearing aids, and health and diathermy equipment not regularly handled by radio parts and electronic equipment distributors are not exhibited at the show. However, intercommunicators, special and communications receivers, PA amplifiers, and record changers designed for use in commercial sound systems are shown.



LIST OF EXHIBITORS

Company	Booth
Advance Electric & Relay Company...	47
Aerovox Corporation	85
Alliance Manufacturing Company	123
Alpha Metals, Inc.	144
Alpha Wire Corporation	125
American Coil & Engineering Co.	116
American Condenser Company	41A
American Microphone Company	4
American Phenolic Corporation	65
American Radio Hardware Co., Inc.	75
Amperex Electronic Corp.	67
Amperite Company	60
The Astatic Corporation	95
Atlas Sound Corporation	23
Audio Devices, Inc.	148
Barker & Williamson	77
Belden Manufacturing Company	128
Bell Sound Systems, Inc.	66
Biley Electric Company	78
Boland & Boyce, Inc.	154 1/2
David Bogen Co., Inc.	40
William Brand & Company	13
British Industries Sales Corp.	112
Bruno Tools	76
Brush Development Company	118
Bud Radio, Inc.	39
Burgess Battery Company	34
Burlington Instrument Co.	22
Caldwell-Clements, Inc.	20 1/2
Camburn, Inc.	143
Allen D. Cardwell Mfg. Corp.	134
Carron Manufacturing Company	57
Centralab	68
Chicago Transformer Division	11
Cinaudagraph Speakers, Inc.	3
Clarostat Mfg. Co., Inc.	124
Condenser Products Company	153
Continental Carbon, Inc.	150
Cornish Wire Company, Inc.	48
Cowan Publishing Corp.	130 1/2
Croname, Incorporated	84
Dial Light Co. of America, Inc.	109
Drake Electric Works, Inc.	61
Dumont Electric Corporation	12
Duotone Company, Inc.	20
Eastern Electronics Corp.	111
Eckstein Radio & Television Co.	29
Eitel-McCullough, Inc.	14
Electric Soldering Iron Co.	58
Electronic Engineering Co.	62
Electronic Laboratories, Inc.	56
Electro Products Laboratories	81
Electro-Voice, Inc.	15
Electrovox Company, Inc.	122
The Erwood Company	105
Federal Telephone & Radio Corp.	64
Freed Transformer Corp.	113
General Cement Mfg. Co.	96
General Electric Company	32
General Industries Company	110
General Transformer Corp.	63
Guardian Electric Mfg. Co.	51
The Hallderson Company	37
The Hallicrafters Company	86
Hammarlund Manufacturing Company	90
Hardwick, Hindle, Inc.	36
Herlec Corporation	9
Hickok Electrical Instrument Co.	142
Hytron Radio & Electronics	91
Indiana Steel Products Co.	38
Industrial Condenser Corp.	141
Insuline Corp. of America	114
International Resistance Company	88A
Jackson Electrical Instrument Co.	98
Jackson Industries, Inc.	156
J-B-T Instruments, Inc.	5
Jensen Manufacturing Co.	44
J. F. D. Manufacturing Co.	117
E. F. Johnson Company	73
Kenyon Transformer Corp. Inc.	6
Kings Electronics Company	94
Lectrohm, Incorporated	132
Lenz Electric Manufacturing Co.	104
P. R. Mallory & Company	106

"1947 Radio Parts and Conference and

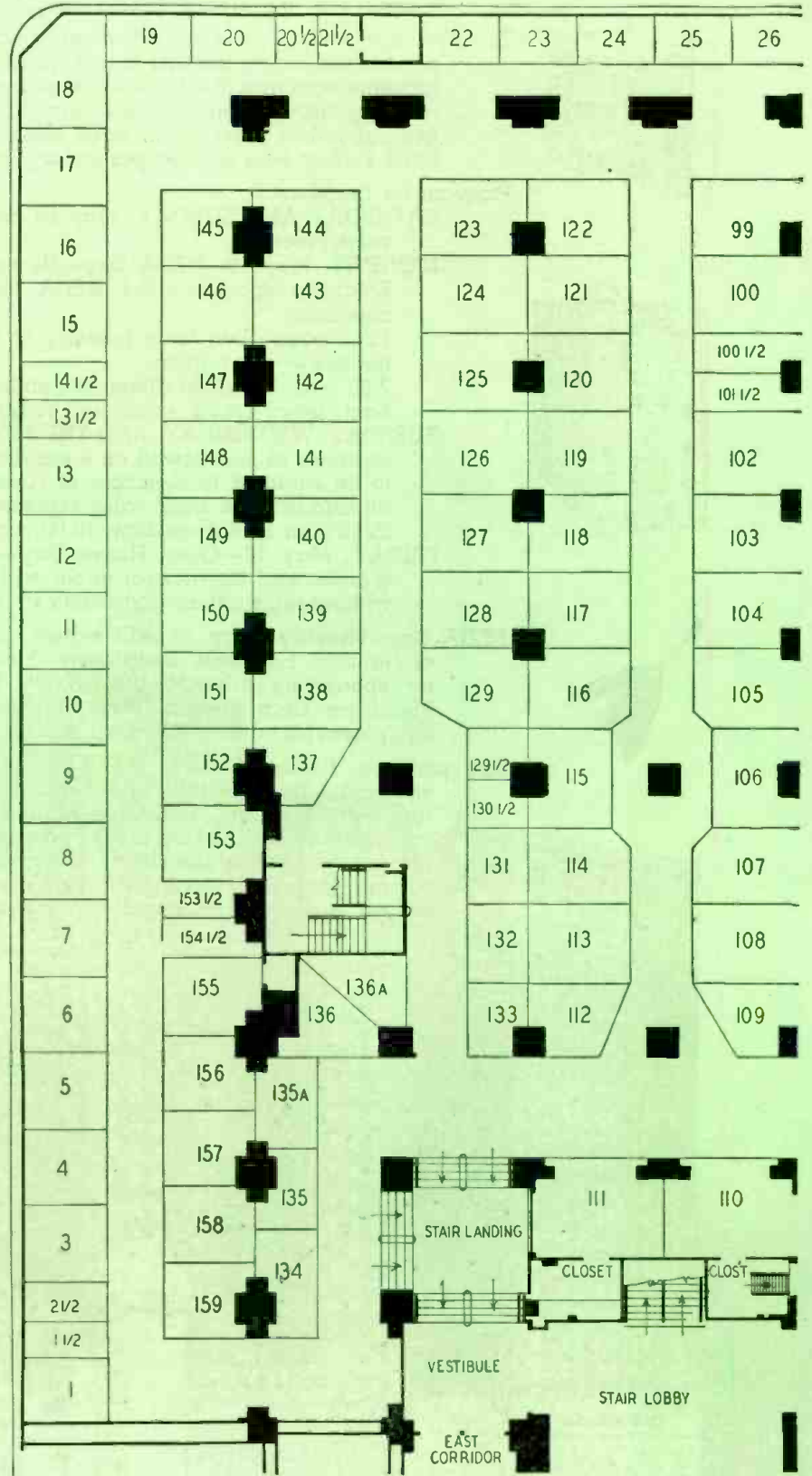

Electronic Equipment Show" Floor-Plan

LIST OF EXHIBITORS

Company	Booth
John Meck Industries, Inc.	133
Meissner Manufacturing Co.	93
Merit Coil & Transformer Corp.	52
James Millen Mfg. Co., Inc.	33
Milwaukee Stamping Company	136A
National Company, Inc.	147
National Union Radio Corp.	10
Newcomb Audio Products Co.	7
Ohio Tool Company	135
Ohmite Manufacturing Co.	74
Operadio Manufacturing Co.	139
Oxford Radio Corporation	59
Panoramic Radio Corp.	115
Park Metalware Co., Inc.	136
Par-Metal Products Corp.	24
The Parts Jobber, Inc.	28 1/2
Permo, Incorporated	41
Philmore Manufacturing Co.	119
Potter & Brumfield Mfg. Co.	53
Precision Apparatus Co., Inc.	152
Premax Products Division	18
Price Electric Corporation	145
Pyramid Electric Company	157
Quam-Nichols Company	140
Racon Electric Company, Inc.	158
Rad-El-Co. Manufacturing Co.	87A
Radiart Corporation	79
Radio City Products Co., Inc.	8
Radio Corporation of America	135A
Radio-Craft	21 1/2
The Radio Craftsmen, Inc.	25
Radio & Electronic Jobber News	45 1/2
Radio Essentials, Inc.	99
Radio & Television Weekly	129 1/2
The Rauland Corporation	83
The Recordisc Corporation	27
Recoton Corporation	26
Reiner Electronics Co., Inc.	35
Rek-O-Kut Company	55
Resistors, Incorporated	70
John F. Rider, Publisher, Inc.	120
Howard W. Sams & Co., Inc.	31
Walter L. Schott Company	71
Shur-Antenna-Mount, Inc.	42
Shure Brothers	87
McMurdo Silver Company	138
Simpson Electric Company	149
Mark Simpson Mfg. Co., Inc.	46
SNC Manufacturing Co., Inc.	72
Snyder Manufacturing Corp.	30
Solar Manufacturing Corp.	92
Special Products Company	103
Spirling Products Company	159
Sprague Products Company	89
Standard Transformer Corp.	88
Stromberg-Carlson Company	108
Supreme Instruments Corp.	102
Sylvania Electric Products	50
Talk-A-Phone Company	151
Technical Appliance Corp.	19
Telex, Incorporated	131
Thordarson Electric Co.	126
Trimm, Incorporated	100
Triplet Electrical Instrument	121
Tung-Sol Lamp Works, Inc.	107
The Turner Company	49
United Catalog Publishers	27 1/2
United Transformer Corp.	1
University Loudspeakers	16
Utah Radio Products Div.	97
Vaco Products Company	82
Vertrod Corporation	69
Ward Leonard Electric Co.	127
Ward Products Corporation	80
Waterman Products Company	101
Webster-Chicago Corporation	155
Webster Electric Company	137
Weller Manufacturing Company	43
Westinghouse Electric Corp.	17
Weston Electrical Instrument	54
Wirt Company	146
Workshop Associates, Inc.	129
Ziff-Davis Publishing Co.	44 1/2

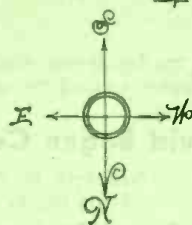
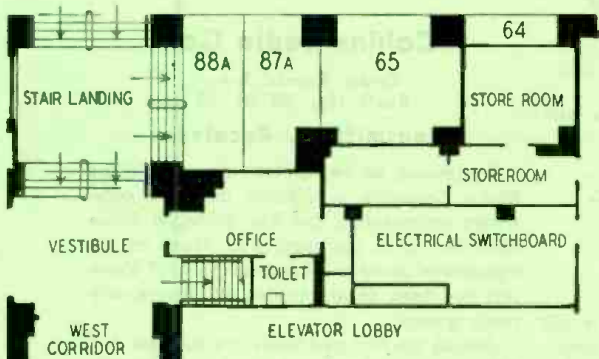
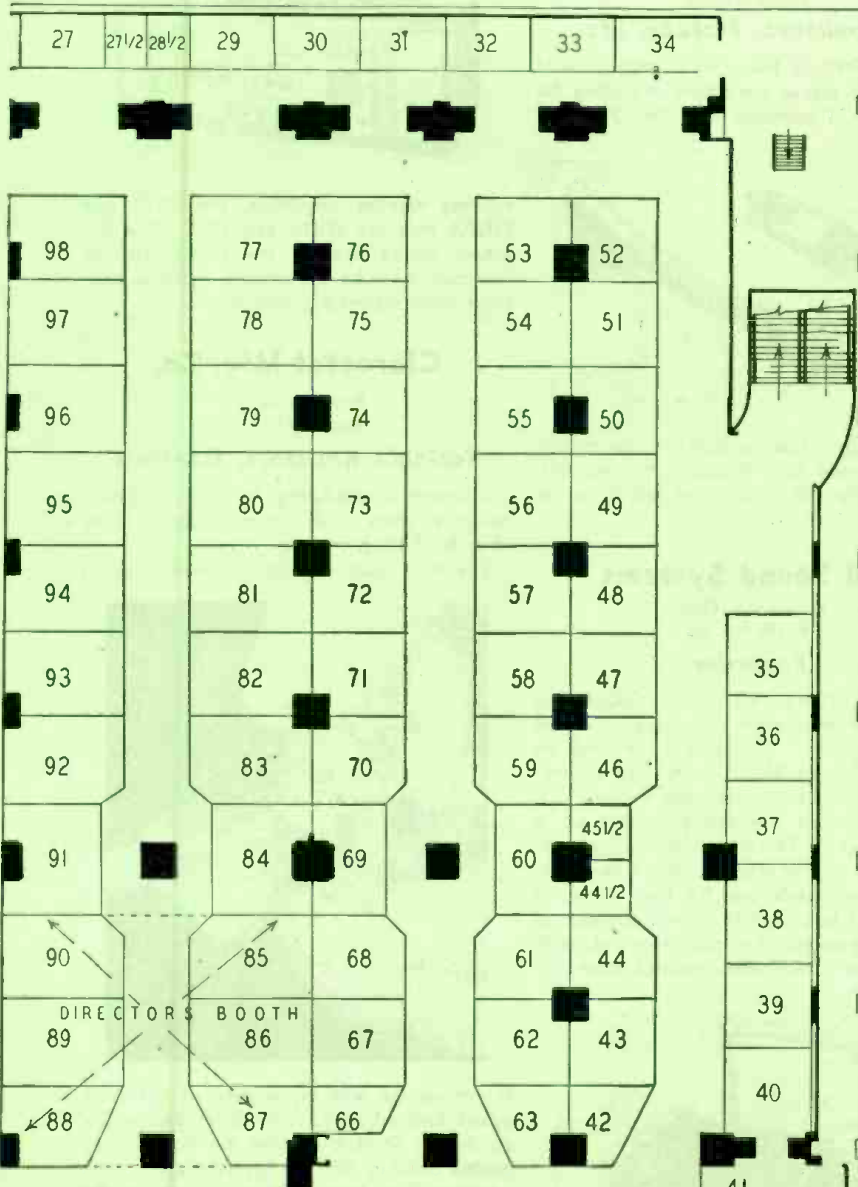

Radio Items on Exhibition

Alpha Metals, Inc.

Brooklyn, N. Y.
Booth No. 144

Tri-Core Solder

Tri-Core, a solder with three independently filled cores of pure rosin flux, is the chief exhibit of Alpha Metals.

A continuous supply of high-grade non-corrosive rosin flux is always present in Tri-Core solder, since the three cores are completely independent of each other. With these three cores, occurrence of "dry" sections in more than one core at a given point is mathematically unlikely, making Tri-Core more efficient and less wasteful than the usual single-core solder.

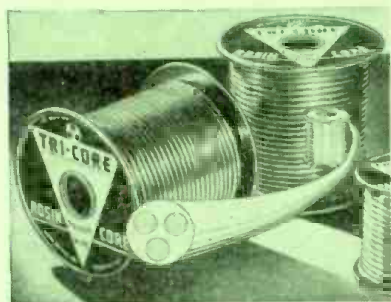

American Coil & Engineering Co.

Chicago, Illinois
Booth No. 116

Transformers, Reactors, Etc.

American Coil and Engineering Co. is exhibiting a line which includes all types of small and medium transformers, reactors, chokes, and autoformers, as well as r.f. coils and transformers.

American Condenser Co.

Chicago, Illinois
Booth No. 41A

Plastic Capacitors

American Condenser Co. announces its small Amcon plastic capacitor. Measuring only 2 1/2 inches high and with a diameter of only 1 3/8 inches, this new unit is specifically intended for top chassis mounting, where space is extremely limited. Self-insulating because of its molded plastic case, the unit resists high temperatures and has a wide climatic range.



Working voltage of these capacitors is 600, they are tested at 1800 volts. Other Amcon capacitors include tubular and metal-cased (bath-tub) units and 1600-volt vibrator capacitors.

The Astatic Corporation

Conneaut, Ohio
Booth No. 95

Microphones, Pickups, Etc.

Astatic Corp. is featuring a large line of pickups and pickup cartridges, including the new Nylon I-J cartridge and the QT (quiet

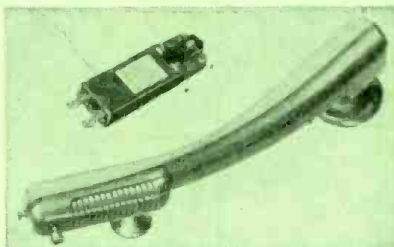

talk) cartridge. Phonograph pickups include Models 400 and 508. A line of microphones, featuring the 600-, 820-, and 840-S, is on exhibition.

Bell Sound Systems

Columbus, Ohio
Booth No. 66

Recorder

The Bell Model RC-47 RE-CORD-O-*tone* provides for permanent recording of sound from any source. It records 12 minutes on a 10-inch disc at 33-1/3 r.p.m. (the equivalent to four 12-inch commercial records). It copies a 12-inch commercial record on a 10-inch blank at 78 r.p.m. One central control permits instant selection of all functions: recording, playback and PA use. Plugging in a pair of headphones allows operator to judge every setup. The unit is entirely self-contained in a two-piece, portable case cov-



ered with tan leatherette which blends with the rich brown tone of the unit

David Bogen Co., Inc.

New York, N. Y.
Booth No. 40

Sound Equipment

The David Bogen Co. is exhibiting a full line of sound systems, intercoms and amplifiers. Featured among the amplifiers are the G050 and G0125 boosters—to be used with



existing smaller amplifiers, the PU10 and PU20A and the GX50 and G50. The SM school sound system, the LC-LA DeLux intercom, and the SA paging systems comprise other interesting exhibits.

Clarostat Mfg. Co.

Brooklyn, N. Y.
Booth No. 124

Variable Resistors, Controls

Clarostat is exhibiting its line of variable resistors, pads, and controls, featuring the new Ad-A-Shaft system.

The Ad-A-Shaft controls are being stocked



in conjunction with an assortment of flatted, round, knurled, and double-flatted shafts. The tip of the shaft slips into the hole in the control bushing until the keyway is engaged, whereupon a sharp blow on the end of the shaft, or hitting the shaft on a hard surface, drives the shaft securely into place.

Collins Radio Co.

Cedar Rapids, Iowa
Booth Nos. 80, 89, 90

Transmitters, Receivers

Equipment to be shown by the Collins Radio Company is divided into five categories representing the five principal fields of endeavor of the company. Much of the equipment being exhibited in the 1947 show has not been shown previously before any radio group.

Among the featured items are the new 20T AM broadcast transmitter (1,000 or 500 watts), the 3-kw FM broadcast transmitter, the 30K

and 32V ham transmitters, the 75A amateur receiver, and the 188 aircraft transmitter-receiver. Speech input consoles, turntables,

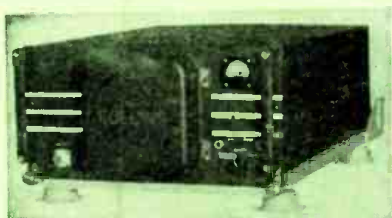

railroad entertainment systems, and amateur equipment occupy important places in the exhibit.

Electronic Laboratories, Inc.

Indianapolis, Ind.
Booth No. 56

Intercommunicators, Etc.

Electronic Laboratories exhibits a line of both war and postwar developments. Among the items featured is a combination radio and intercommunicator. The master unit is a 6-tube radio as well as intercom, and slave stations may be added up to the num-



ber of four. Other Utiliphone intercommunicators will be exhibited.

Federal Telephone & Radio Corporation

Newark, New Jersey
Booth No. 64

Selenium Rectifiers, Etc.

Leading the list of Federal's products is the miniature selenium rectifier, which replaces all conventional receiver rectifier tubes, and represents one of the first real advancements made in home radios since the end of the war. Its improved features are longer life, more immediate rectification,



improved efficiency, higher current rating, smaller size, and elimination of the power transformer in some circuits. This miniature type selenium rectifier offers manufacturers and servicemen a new source of profit and makes available to the amateur a component that will both improve the performance of his equipment and cut down his costs.

Wire and cable for television and FM, battery chargers, and d.c. power supplies are other exhibits at the Federal booth.

Indiana Steel Products Co.

Chicago, Illinois
Booth No. 38

Magnetic Recorder

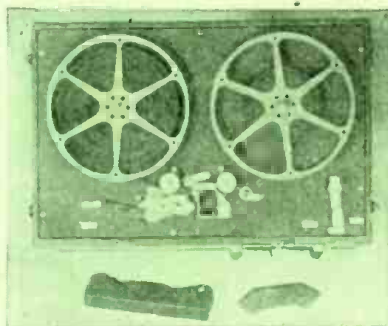

Indiana Steel Products is featuring the Hyflux magnetic tape recorder. Hyflux is a finely divided magnetic material with qualities that compare favorably with those of Alnico. Tests now being made with the recorder indicate that besides being a high-fidelity musical recorder, it may be adapted to the following uses: recording audio signals or pulses of any duration or wave length; seismograph investigation; memory record for electronic calculating machines; retention of telegraph signals; multiple single-tone reception (as in electronic organs); control signals for industrial machinery; and continuous advertising or announcing equipment.

Kings Electronics Co.

Brooklyn, N. Y.
Booth No. 94

Roto-Beam Antenna

Kings Electronics announce its Roto-Beam antenna for television reception.

The antenna covers all the television bands and rotates either clockwise or counterclockwise through 360 degrees, giving optimum reception from stations in any direction. It is operated by a rugged 24-volt motor, which is controlled by a d.p.d.t. spring-loaded switch located in the control box at

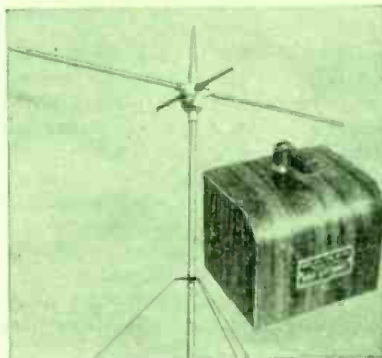

the set. Neither snow, sleet, nor rain affect the operation and efficiency of the antenna, as it is completely weatherproofed, with a neoprene de-icing skirt completely surrounding the head.

J. F. D. Manufacturing Co.

Brooklyn, N. Y.
Booth No. 117

210-110-Volt Ballasts

The J.F.D. Co. is featuring a new step-down resistor ballast, designed to enable operation of 110-volt radios on 220-volt circuits, common in foreign countries.

These ballasts come with American, British and Continental male plugs; the female sockets are American. They may be used with radios, electric razors, fluorescent fixtures, phono-radio combinations,

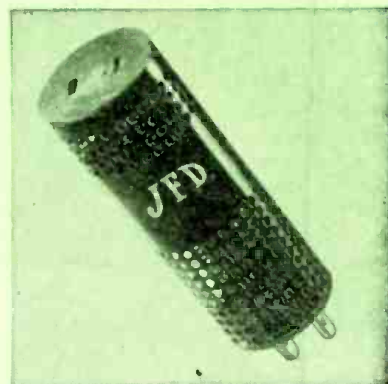

electric clocks, electric blankets and other electrical appliances.

The National Co.

Malden, Mass.
Booth No. 147

Communications Receiver

A new post-war communications receiver for amateur use, the NC-173, is exhibited by the National Company.

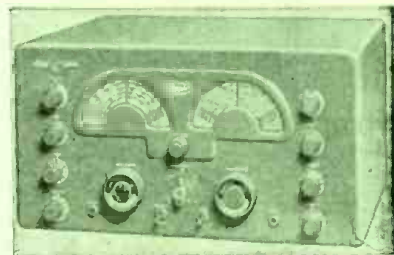

The new NC-173 is a 13-tube superheterodyne model with a calibrated band spread covering the 6, 10-11, 20, 40 and 80 meter amateur bands. Its frequency range extends from 540 to 31,000 and from 48,000 to 56,000 kilocycles for both amplitude-modulated phone reception.

Outstanding among the special features of the new National receiver is the automatic volume control, which is operative for both phone and c.w. reception. In addition the S-meter on the NC-173 will also work on both phone and c.w.

Voltage regulated circuits give the NC-173 a minimum of drift and the pitch of code characters does not change appreciably over extended periods of listening time. An additional feature is a new adjustable threshold noise limiter.

Pyramid Electric Co.

Jersey City, N. J.
Booth No. 157
Capacitors

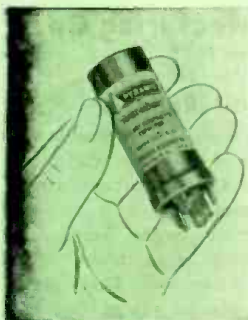

Pyramid's main display is the "Twist-Mount" Capacitor, an ultra-compact, metal-sealed, easy-to-mount dry electrolytic unit. Each of these units is supplied with metal and bakelite mounting plates.

Rad-El-Co Mfg. Co.

Cleveland, Ohio
Booth No. 87AA
Auto Aerials

Rad-El-Co is exhibiting a new concealed type of automobile aerial in two models. The FM-3 is a 3-section aerial extending to 55 inches; the FM-4 a 4-section aerial which extends to 72 inches. The antenna in the center of the photo is the FM-4; it is flanked by other antennas made by the same manufacturer.

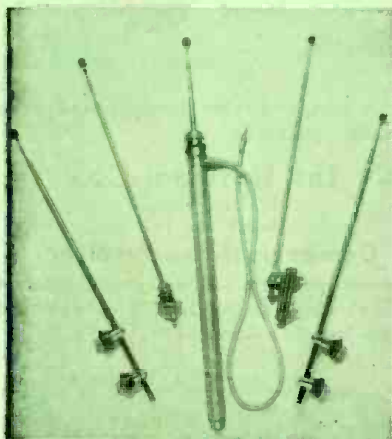

Stromberg-Carlson Co.

Rochester, N. Y.
Booth No. 108

Sound Systems, Etc.

Stromberg-Carlson is displaying at the show its new standard sound systems, three new centralized systems for schools, new amplified intercommunicating systems, new intercommunicating telephone designs, a new line of reproducers and reproducer housings, as well as its complete line of universal am-



plifiers, record amplifiers, power amplifiers, pre-amplifiers, Alnico V cone speakers, and microphones.

Among the featured items are the Model 750 and Model 1200 sound systems (the latter for schools), the Model 33 amplifier, and the Stromberg-Carlson intercommunicating system.

Sylvania Electric Products

New York, N. Y.
Booth No. 50

Test Equipment



Three new additions to Sylvania's line of test equipment are exhibited for the first time at the Chicago Radio Paris Show.

The 7-inch oscilloscope type 132, the audio oscillator type 145, and the signal generator type 150 are shown in handmade models. Announcement of the availability dates on these new pieces of test equipment also is being made at the show.

The new 7-inch oscilloscope is designed for general purpose use by laboratories and radio service dealers. The new audio oscillator and signal generator has unusual stability, wide coverage, and a high degree of accuracy. The signal generator also possesses several novel calibration features.

Telex, Incorporated

Minneapolis, Minn.
Booth No. 131

Headset, Pillow Speaker



The Telex Monoset is designed to reduce head fatigue and ear pressure for operators who wear headsets for long periods. Weighing only 1.2 ounces, it uses two stethoscope-like tubes that end in clear plastic ear tips, and a single magnetic unit.

The standard unit has an impedance of 128 ohms per receiver and a sensitivity of 18 dynes per square centimeter for 10 microwatt input per receiver. The miniature plug-in cord attachment and the durable plastic insulated tinsel cord are made of the finest materials.

The Telex pillow speaker is a flat plastic electromagnetic sound generating unit designed to reproduce sound normally when placed under a pillow or cushion, giving the listener a private loudspeaker. It is a low-impedance unit designed to work from the secondary of the output transformer, and is supplied with a closed-circuit jack, permitting it to be hooked up in the output circuit so that the regular speaker is cut out when the pillow speaker is plugged in.

The Turner Co.

Cedar Rapids, Iowa
Booth No. 49

Noise-Cancelling Microphone

A new hand microphone, designed for use in factories, machine shops, railroad yards, aircraft, and other places where background noise prevents intelligible communication with standard equipment, is being exhibited by The Turner Company. The Model 15D-NC cancels out background noise, permitting only close talking speech to be transmitted. It is a hand-held dynamic microphone, housed in a tough, lightweight alloy case finished in gunmetal enamel. The 15D-NC is available in 50, 300, 500 ohms or high impedance.



Webster-Chicago Corp.

Chicago, Illinois
Booth No. 155

Recorder, Record Changers

Webster's leading exhibits are its Model 80 wire recorder and Model 70 record changer. Model 80 wire recorder is an all-purpose, self-contained portable magnetic wire recorder and player. It consists of a simple, efficient wire-transporting mechanism, recording amplifier, playback amplifier, and 5/4-inch speaker built into a compact carrying case. Furnished complete, ready to play with microphone, power cord, and a supply spool of wire.

The Model 70 is a single-post, cushioned spindle intermix record changer. Simple in operation, it provides automatic or manual playing of both 10- and 12-inch records intermixed or in full stacks of either size, or individually. Home recordings, children's records, or "inside out" records up to the 12-inch size may be played manually.

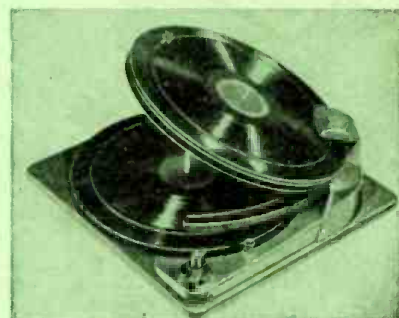

JOBBER AND DEALERS DIRECTORY

FOR READERS OF RADIO-CRAFT

This list of Radio Jobbers and Dealers has been compiled as a service to RADIO-CRAFT readers. The magazine is sold by the stores listed below where they are displayed on counters and shelves for your convenience. At these stores you will also be able to buy standard parts, sets and every other product of the radio and electronic industry.

- ALABAMA**
- Decatur*
Radio & Tel. Sup. Co.
717 Bank St.
- Dothan*
Hand Wholesale Radio
& Refrig.
707 S. Oates St.
- Tuscaloosa*
Allen & Jemison Co.
- ARIZONA**
- Phoenix*
Radio Specialties
& Appl.
401 W. Jackson
- Fort Smith*
Packard Radio Co.
205 Garrison Ave.
- Texarkana*
Lavender Radio Sup. Co.
Ash at 4th Sts.
- CALIFORNIA**
- Fresno*
Jack C. Arbuckle
1427 Broadway
- Hollywood*
Hollywood Radio Sup., Inc.
5521 Hollywood Blvd.
Yale Radio Electric Co.
6616 Sunset Blvd.
- Long Beach*
Fred S. Dean Co.
969 American Ave.
Scott Radio Supply
226 Alamitos Ave.
- Los Angeles*
General News Agency
326 W. 5th St.
Papal Bros.
2639 E. 4th St.
Radio Tel. Sup. Co.
1509 So. Figueroa St.
Electric Supply Co.
149 - 12th St.
- Sacramento*
E. M. Kemp Co.
115 R. St.
Sacramento Elec. Sup. Co.
711 Capitol Ave.
- San Bernardino*
George D. Bagley Co.
1216 D St.
- San Diego*
Harold W. Burt
Radio-Electronic
4162-64 Park Blvd.
Electronic Equip. Distr.
1228 2nd Ave.
Western Radio & Elec. Co.
1415 India St.
- San Francisco*
Associated Radio Dist.
1251 Folsom St.
San Francisco Radio
& Supply Co.
1284 Market St.
- San Jose*
Frank Queument Wholesale
Radio
156 W. San Francisco St.
- Santa Ana*
Radio & Tel. Equip. Co.
207 Oak St.
- Oakland*
Electric Supply Co.
149 - 12 St.
- COLORADO**
- Denver*
McGee Radio & Elec. Co.
1350 Broadway
Radio Products Sales Co.
1237 16th St.
Western Electronic
Lab. Co.
913 18th St.
- Grand Junction*
Radio & Electronics
Supply Co.
418 South 7th St.
Variety Electric Co.
601 Broad St.
- CONNECTICUT**
- Bridgeport*
Coastal Radio Service Co.
1559 Stratford Ave.
R. C. Scell & Co., Inc.
84 Elm St.
L. N. Waldhaus
1132 Norman St.
- Hartford*
R. G. Scell & Co.
317 Asylum St.
- New Britain*
United Radio Supply
53 E. Main St.
- New Haven*
Congress Radio
& Battery Co.
207 Congress Ave.
- Rockwell*
Alfred C. Denson
38 Park Place
- DELAWARE**
- Wilmington*
Radio Electric Service Co.
4th and Tatnal Sts.
- DISTRICT OF COLUMBIA**
- Washington*
Capitol Radio
Wholesalers
2120 14 St. N. W.
Intercommunications Co.
2027 Nichols Ave. S.E.
Kenyon Radio Supply Co.
2214 14th St. N.W.
Sun Radio
938 N.W. F St.
- FLORIDA**
- Jacksonville*
Radio Parts Co.
712 Main St.
Thurow Distr. Inc.
15-17 E. Church St.
- Miami*
Thurow Distr. Inc.
420 S.W. 8th Ave.
- Orlando*
Thurow Distr. Inc.
131 South Court St.
- St. Petersburg*
Welch Radio Supply
408 9th St. So.
- Tallahassee*
Thurow Distr. Inc.
213 E. Teecsee St.
- Tampa*
Thurow Distr. Inc.
134 S. Tampa St.
- West Palm Beach*
Thurow Distr. Inc.
308-310 So. Olive Ave.
- GEORGIA**
- Augusta*
Preswood Electronics Co.
727-29 Reynolds St.
- Columbia*
Radio Sales & Svce. Co.
1326 First Ave.
- Macon*
Guy White Radio
654 Mulberry St.
- ILLINOIS**
- Benton*
Lamprey Radio Co.
812 N. McLeansboro St.
- Danville*
Allen Electric Co., Radio
Supply
109 N. Hazel St.
- Deatur*
York Radio Distr. Co.
801-805 N. Broadway St.
- Chicago*
Allied Radio Corp.
833 W. Jackson Blvd.
American Parts, Inc.
610 W. Randolph St.
Concord Radio Corp.
901 W. Jackson Blvd.
Electronic Distributors
620 W. Randolph St.
Lake Radio Sales Co.
615 W. Randolph St.
Radio Shack
630 W. Randolph St.
- Radolek Co.*
601 W. Randolph St.
Schuh Radio Parts
1253 Loyola Ave.
- East Moline*
C. L. Swanson Radio
Laboratory
933 15th Ave.
- Goreville*
Century Supply Co.
Main St.
- Rockford*
H. & H. Electronic Supply
510 Kishwaukee St.
Mid-West Associates
506 Walnut St.
- Springfield*
Harold Bruce
303 E. Monroe
Wilson Supply Co.
108 Jefferson St.
- W. Frankfort*
Radio Hospital
1107 E. Main St.
- INDIANA**
- Anderson*
Seybert's Radio Supply
19 E. 12th St.
- Evansville*
Castrup's Radio Sup.
1014 W. Franklin St.
Montoux Auto
& Machine Co.
517 Locust St.
- Gary*
Cosmopolitan Radio Co.
524 Washington St.
- Hammond*
Stanton Radio Supply
521 State St.
- Indianapolis*
Rodefco Co.
614 N. Capitol
- Ri hmond*
Rinehart Inc.
511-513 Main St.
- South Bend*
Commercial Sound
& Radio Co.
334 E. Colfax Ave.
- Terre Haute*
Terre Haute Radio
501 Ohio St.
- IOWA**
- Council Bluffs*
World Radio Labs
- Des Moines*
G. W. Onthank Co.
11th & Cherry
- Luque*
Boe Distributing Co.
498 N. Grandview
- Fort Dodge*
Ken-Elis Radio Sup. Co.
111 So. 12th St.
- Six City*
Dukes Radio Co.
114 W. 4th St.
- Power City*
Power City Radio Co.
13 7th St.
- Sioux City*
Sioux City Radio
& Appliance Co.
313 Fifth Street
- Waterloo*
Ray-Mac Radio Supply
224 W. 4th St.
- KANSAS**
- Pittsburg*
Pittsburg Radio Sup. Co.
103 N. Broadway
- Topeka*
Acme Radio Supply
516 Quincy St.
- Wichita*
Instate Distr. Inc.
1236 E. Douglas
Radio Supply Inc.
1125-27 E. Douglas
- KENTUCKY**
- Lexington*
Kentucky Radio Supply Co.
619 Georgetown St.
- Louisville*
Peerless Electronic
Equip. Co.
912-914 So. Second St.
- Newport*
Apex Distributing Co.
506 York St.
- Owensboro*
Central Electronics Supply
203 W. 4th St.
- LOUISIANA**
- Lafayette*
Radio-Electronic Sup.
1419-21 Cameron St.
- Monroe*
Male & McNeill
381 Pine St.
- New Orleans*
Wm. B. Allen Supply Co.
916-918 W. Claiborne Ave.
Radio Parts Inc.
807 Howard Ave.
- Shreveport*
Koelemay Sales Co.
327 Market
Radio Supplies Inc.
2408 Line Ave.
- Radio Electronic Supply*
1112 Warren West
Radio Specialties
456 Charlotte St.
Radio Supply Co.
6724 Michigan Ave.
Radio Supply & Eng. Co.
129 Selden Ave.
Westside Radio Supply
6724 Michigan Ave.
- Flint*
Radio Tube Mfg. Co.
508 Clifford
Sheldon Radio & Appliance
2914 N. Saginaw St.
- Jackson*
Fulton Radio Supply Co.
707 S. Blackstone St.
- Lansing*
Electric Products Sales Co.
427 E. Michigan Ave.
- Muskegon*
Industrial Electric
Supply
1839 Pack St.
- Saginaw*
Orem Distributing Co.
801 E. Genesee Ave.
Radio Par. Co.
234 S. Second St.
- MAINE**
- Bangor*
Radio Service Lab.
45 Haymarket Sq.
- Portland*
Maine Electronic
Supply Corp.
13 Deer St.
Radio Service Lab.
45 A Free St.
- MARYLAND**
- Baltimore*
Henry O. Berman Co., Inc.
12 E. Lombard St.
D. & H. Dist. Co.
31 E. Lee St.
Royal Radio
941 Penna. Ave.
Wholesale Radio Parts
Co. Inc.
311 W. Baltimore St.
- Cumberland*
Cumberland Radio
Wholesalers
143 N. Centre St.
- MASSACHUSETTS**
- Boston*
Hub Cycle & Radio Co., Inc.
596 Commonwealth Ave.
Sager Electrica. Sup. Co.
201 Congress St.
- Lawrence*
Harty & Young of Mass.
Inc.
639 Essex St.
- Melrose*
Melrose Sales Co.
407 Franklin St.
- New Bedford*
C. E. Beckman Co.
Commercial St.
- Springfield*
Springfield Radio Co., Inc.
406 Dwight St.
Springfield Bond Co.
141 Dwight St.
- Worcester*
Radio Maintenance Supply
19-25 Central St.
- MICHIGAN**
- Ann Arbor*
Purchase Radio &
Camera Shop
605 Church St.
- Beikley*
Tie J. M. Morel Co.
1949 Woodward Ave.
- Detroit*
M. N. Duffy & Co.
2040 Grand River Ave.
Electronics Inst. Inc.
21 Henry at Woodward
Radio Center
2-30 East Davidson
- Mississippi*
Low Bonn Co.
228 E. Superior St.
Northwest Radio
109 E. First St.
- Minneapolis*
Low Bonn Co.
1211 LaSalle Ave. So.
Northern Radio Lab.
3927 East Lake St.
Radio Electric Supply
2451 Nicollet Ave.
Ron's Radio Supply
4001 Bryant Ave., So.
- MISSISSIPPI**
- Jackson*
Cabell Electric Co.
- Meriden*
Radio Supply Co.
- MISSOURI**
- Cape Girardeau*
Sundakum Electronio
Supply Co.
902 S. Spring St.
- St. Joseph*
Harry Reed Radio Supply
110 N. 9th St.
- St. Louis*
Napper Radio Co.
3117 Washington
- Springfield*
Harry Reed Radio &
Supply Co.
833-37 Boonville Ave.
- MONTANA**
- Butte*
Geo. Steel & Co.
126 W. Broadway
- Great Falls*
Geo. Lindgren Co.
109 Central Ave.
- NEBRASKA**
- Lincoln*
Hicks Radio Co.
1422 "O" St.
- Omaha*
Alco Radio Inc.
4011 Cumling St.
A.I-State Distr. Co.
2857 Farnum St.
H. C. Neil Co.
226 Harney St.
Omaha Appliance Co.
18th & St. Mary's
Radio Equipment Co.
2820-22 Farnum St.

See Other Side For Additional Listings

(Continued)

NEW JERSEY

Bridgeton
Joe's Radio Shop
67-69 S. Pearl

Camden
Radio Electric Service Co.
513 Cooper St.

Hackensack
Trade Radio Service Co.
10 1/2 Morris St.

Newark
Continental Sales Co.
195-197 Central Ave.
Radio Wire Telev. Inc.
24 Central Ave.

Phillipsburg
Carl B. Williams Co.
154 South Main St.

Red Bank
Bradleys Radio Service
Newman Springs Rd.

Trenton
Allen & Hurley
25 South Warren St.

NEW YORK

Albany
E. T. Taylor Co.
465 Central Ave.

Binghamton
Broome Dist. Co.
221 Washington St.

Brooklyn
Electronic Equipment
Co. Inc.
1460 Bushwick Ave.
Green Radio Dist.
482 Sutter Ave.
Hornbeam Distributing Co.
1639 Bedford Ave.

Buffalo
Buffalo Radio Supply
219 E. Genesee St.
Dymac Inc.
2329-31 Main St.
Scheller Radio Co.
269 Oak St.
Standard Electronics
Dist. Co. Inc.
1497-1501 Main St.

Cortland
C. A. Winchell
37 Central Ave.

Croton-on-Hudson
WRO Radio Laboratory
6 Hamilton Ave.

Elmira
Fred C. Harrison Co.
108 W. Church St.

Hempstead
Standard Parts Corp.
235 Main St.

Jamaica
Harrison Radio Corp.
172-31 Hillside Ave.
Norman Radio Dist.
94-29 Merrick Rd.
Peerless Radio Dist. Co.
92-32 Merrick Rd.

Jamestown
Johnson Radio &
Electronic Equip.
48-50 Harrison Ave.

Mount Vernon
Davis Radio Dist. Co.
66-70 E. 3rd St.

New York City
Adson Radio
221 Fulton St.
Arrow Radio
82 Cortlandt St.
Beam Radio
165 Nag's Ave.
Bronx Wholesale Radio
470 E. Fordham Rd.
Blair Radio
64 Dey St.
Douglas Radio Supply Co.
128 Greenwich St.
Eagle Radio
84 Cortlandt St.
Electronic Marketers Inc.
120 Greenwich St.
Federated Purchaser Inc.
80 Park Place
Grand Central Radio
124 E. 44th St.
Harrison Radio Corp.
12 W. Broadway
Harvey Radio Co.
105 W. 43rd St.
Highridge Radio
Television & Adpl.
340 Canal St.
B. Lar
210 Greenwich
Milo Radio & Electronics
200 Greenwich St.
National Radio Dist.
899 Southern Blvd.
Niagara Radio Sup. Corp.
160 Greenwich St.

Newark Electric Co.
224 Fulton St.
Newark Electric Co. Inc.
250 W. 5th St.
North Radio Co. Inc.
172 Washington St.
Radio Wire Telev. Inc.
100 Sixth Ave.
Radioic Equipment Co.
170 Nassau St.
Risco Electronics
22 Warren St.
Sun Radio
122 Duane
Wilco Radio Dist.
383 E. 138th St.

Olean
Wanamaker & Redstone
413 Third Ave.

Poughkeepsie
Chief Electronics
104 Main St.

Rochester
Hunter Electronics
255 East Ave.
Masline Radio &
Electric Equip.
192-196 Clinton Ave. N.
Rochester Radio Sup. Co.
114-118 St. Paul St.

Syracuse
Broome Dist. Co.
912 Erie Blvd. E.
Stewart W. Smith Inc.
325 E. Water St.
Syracuse Radio Supply
238-40 W. Willow St.

White Plains
Weschester Electronic
Sup. Co.
333 Manaroneck Ave.

NORTH CAROLINA

Charlotte
Henry V. Dick & Co. Inc.
311 E. 5th St.

Goldboro
Signal Radio Supply
124 S. James St.

Raleigh
Supreme Radio Suppliers
103 W. Hargett St.

Winston-Salem
Dalton-Hedge Radio Sup.
Co.
340 Brookstown Ave.

NORTH DAKOTA

Fargo
Fargo Radio Service
511-515 Third Ave. N.
Radio Equipment Co.
624 2nd Ave. N.

OHIO

Ashkum
Morrison's Radio Supply
331 Centre St.

Akron
Brighton Sporting
Goods Corp.
110 E. Market St.

Cincinnati
Chambers Radio Supply
1104 Broadway
Herrlinger Dist. Co.
15th & Vine St.
Holub & Hogg
500 Reading Rd.

Cleveland
Northern Ohio Labs.
2073 W. 85th St.
Radio Surplus Co.
648 Prospect Ave.
Strong, Carlisle &
Hammond Co.
2801 St. Clair Ave.
Winteradio Inc.
1468 W. 25th St.

Columbus
Electronic Supply Corp.
219 N. 4th St.
Whitenead Radio Co.
120 East Long St.

Warren
Radio Specialties
135 S. Pine St.

Dayton
Standard Radio &
Elect. Prod.
135 E. 2nd St.

Kent
Kladag Radio Labs.
105 W. Erie St.
Ferguson Radio Inc.
1453-51 Madison Ave.

Marion
Bell Radio Supply
527 N. Main St.

Steubenville
D & R Radio Supply
156 S. 3rd St.
210 Cherokee St.

Hausfeld Radio Supply
230 N. 4th St.
Toledo
Lifetime Sound Equip. Co.
911-913 Jefferson

OKLAHOMA

Lawton
Reynolds Radio Supply
909 1/2 C Ave.

Oklahoma City
Electronic Supply Co.
212 N. W. 10th St.
Radio Supply Inc.
724 N. Hudson, Box 597

OREGON

Portland
Appliance Wholesalers
of Oregon
609 N. W. 14th Ave.
Harper-Meggee
1506 N.W. Irving

PENNSYLVANIA

Allentown
Radio Electric Service Co.
1042 Hamilton St.

Altoona
Hollenback's Radio Supply
2221 8th Ave.
Kennedy Radio Supply
1500 Fifth Ave.

Beaver Falls
Reliable Motor Parts Co.
1700 7th Ave.

Easton
Radio Electric Service Co.
916 Northampton St.

Erie
Jordan Electronic Co.
201 W. 4th St.
Warren Radio
12 & State Sts.

Harrisburg
D. & H. Distributing
Co., Inc.
311 S. Cameron St.

Lancaster
Eshelman Supply Co.
110 N. Water St.

Philadelphia
A. G. Radio Parts Co.
3515 N. 17th St.
Almo Radio
509 Arch St.
Flanagan Radio Corp.
N.E. Cor. 7th & Chesnut
Herbach & Rademan Co.
522 Market St.
M. & H. Sporting Goods
Co.
512 Market St.
Radio Electric Service Co.
7th & Arch Sts.
3145 North Broad St.
5133 Market St.
Warner Radio Co.
631 Market St.

Pittsburgh
Tydings Co.
632 Grant St.

Scranton
Broome Dist. Co.
26 Lackawanna Ave.
Fred P. Pursell
550 Wyoming Ave.

Sharon
Helges Bros. Inc.
1344 E. State St.

York
J.R.S. Distributors
656 W. Market St.

RHODE ISLAND

Providence
William Dandreta & Co.
Regent Ave.

SOUTH CAROLINA

Charleston
Radio Laboratories
215 King St.

Greenville
Arthur Rixon & Son
209 W. Washington

TENNESSEE

Chattanooga
Curle Radio Supply
825 Cherry St.

Kingsport
Radio Electric Sup. Co.
210 Cherokee St.

Knoxville
Bomar Appliance Co. Inc.
520 Western Ave.

Memphis
Bluff City Dist. Co.
905 Union Ave.
McGregor's Inc.
1071 Union Ave.
Radio & Electronic
Supply Co.
1002 Jackson Ave.
Shobe Inc.
1117 Union Ave.

Nashville
Frost Electric Inc.
1922 West End Ave.

TEXAS

Amarillo
Tom Thomas Sound Sales
& Service
410 S. Jackson

Beaumont
R. C. & L. F. Hall Co.
961 Pearl St.

Dallas
All-State Dist. Co.
2405-07 Ross Ave.
R. C. & L. F. Hall Inc.
2123 Cedar Springs
Southwest Radio Sup.
1820 N. Harwood

Fort Worth
Ft. Worth Radio Sup. Co.
1201 Commerce
The Electronic Equip. Co.
301 E. 5th St.

Galveston
R. C. & L. F. Hall Inc.
1803 Tremont

Houston
R. C. & L. F. Hall Inc.
1306 Clay St.
Sarlino Radio Prod. Co.
1602 McKinney

Laredo
Radio & Electronics
Supply Co.
12-9 Lincoln St.

Lubbock
P. & R. Supply Co. Inc.
706 Main St.

Port Arthur
Lapham Radio Co.
309 1/2 Proctor St.

San Antonio
Mission Radio Inc.
814 So. Presa St.
Tom Hopkins Radio
324 Nacogdoches St.
R. L. Ross Co.
118 7th St.
South Texas Radio
Supply Co.
445 E. Commerce

Tyler
Radio Service Supply Co.
111 University Place

Waco
The Hargis Co., Inc.
1303 Austin Ave.

UTAH

Ogden
Ballard & Carter Co.
203 24th St.

Salt Lake City
O Laughlin's Radio
Supply Co.
113 E. Broadway
Radio Supply Co.
45 E. 4 South

VIRGINIA

Norfolk
Ashman Distributing Co.
807 Granby St.
Radio Parts Dist. Co.
128 W. Olney Rd.
Radio Supply Co.
711 Granby St.

Richmond
Johnston Gasser Co.
1402 E. Main St.

Roanoke
H. C. Baker Sales Co.
19 W. Franklin Rd.
Leonard Electronic
Supply Co.
106 Second St. S.W.

Salem
Richie Radio Supply
306 E. Main St.

Staunton
Southern Electric Corp.
14 E. Johnson St.

WASHINGTON

Bellingham
Waltkus Supply Co.
110 Grand Ave.

Seattle
Harger-Meggee
960 Republican St.
Western Electronic
Supply Co.
2609 First Ave.

Spokane
Columbia Electric
& Wfg. Co.
P. O. Box 1441 S.

Tacoma
C. & G. Radio Sup. Co.
123 Wall St.
714 St. Helens Ave.
A. T. Stewart Co.
743 Broadway
Wible Radio Supply
909 Tacoma Ave.

WEST VIRGINIA

Clarksburg
Tronton Radio Co.
791-93 W. Pike St.

East Charleston
Hicks Radio Supply
10 Virginia St.

Parkersburg
John A. Cox Radio
Supplies
554 7th St.

Wheeling
General Distributors
21 10th St.

WISCONSIN

Appleton
Valley Radio Dist.
518 N. Appleton St.

Chippewa Falls
Sarlino Radio Prod. Co.
Bushland Radio Spec.

Green Bay
Nesio Electronic Dist.
312 N. Chesnut

Hudson
J. H. Larson Co.
109 Walnut St.

LaCrosse
Stark Radio Supply Co.
131 S. 6th St.

Madison
Satterfield Radio
Supply Inc.
326 W. Gorham St.

Manitowish
Harris' Radio Company
115 No. 10th St.

Milwaukee
Acme Radio Supply Corp.
510 N. State St.
Acme Radio Supply
310 W. State St.
Central Radio Parts Co.
1723 W. Fond du Lac Ave.
Electro-Plance Dist. Inc.
2458 W. Lisbon Ave.
Electronic Supply Corp.
436 W. State St.
Taylor Electric Co.
112 N. Broadway

Racine
Standard Radio Parts Co.
1244 State St.

WYOMING

Casper
Golden Power Oil &
Supply Co.
260 S. Center

Cheyenne
Hough Radio & Supply Co.
2008 Carey Ave.

CANADA

Radio Supply Co. Ltd.
Grd. Floor McLeod Bldg.
Edmonton, Alberta

Western Radio Supply Co.
328-330 King St. E.
Hamilton, Ontario

Detroit Sales Ltd.
203 Rideau St.
Ottawa, Ont.

Electronic Supply Co.
(Ottawa Ltd.)
244 Slater St.
Ottawa, Ont.

Electro-Voice Sound
Systems
141 Dundas St. West
Toronto, Ont.

Hygrade Radio Ltd.
673 Homer St.
Vancouver, B.C.

DEALERS: If you are not receiving RADIO-CRAFT, please ask for our Special Consignment Proposition



Amazing Bargain Offer in Diagram Manuals

ALL NEW 1947 CIRCUITS | SERVICE DATA YOU NEED TO GET AHEAD

Be prepared to repair quickly all new 1947 sets. In this big single volume you have clearly printed, large schematics, needed alignment data, replacement parts lists, voltage values, and information on stage gain, location of trimmers, and dial stringing, for almost all sets released between June 1, 1946, and March 1947. A worthy companion to the six previous volumes used by over 100,000 shrewd radio servicemen. There is no need to spend large sums for bulky, space-wasting manuals or to buy additional drawings every few weeks—get this low-priced new SUPREME PUBLICATIONS manual and you have all service information on popular 1947 sets. Covers 327 models of 52 different manufacturers. Large size: 8½ x 11 in., 192 pages + index. Manual style binding. **\$2.00**

Speed up and simplify all radio repairs with the inexpensive SUPREME Manuals. Service radios faster, better, easier, save money and time, use these most-often-needed diagram manuals to get ahead and earn more per hour. At unbelievable low cost (only \$2 for most volumes) you are assured of having in your shop and on the job, needed diagrams and other essential repair data on 4 out of 5 sets you will ever service. Every popular radio of every make, from old-timers to new 1947 sets, is included. Clearly printed circuits, parts lists, alignment data, and helpful service hints are the facts you need to improve your servicing ability. Save hours each day, every day, let these seven volumes furnish diagrams for 80% of all sets. See pictures of these attractive manuals above. Each volume has between 192 and 240 pages, large size 8½ x 11 inches. Manual style binding. Send coupon today. Complete satisfaction guaranteed.

Most Popular Models Made by:

R.C.A., Zenith, Philco, Sears, Fada, Emerson, Belmont, Detrola Radio, United Motors, G.E., Westinghouse, Arvin, Majestic, Stewart-Warner, Admiral, Delco, Stromberg-Carlson, Western Auto, Sparton, Motorola, Wards, Gamble, and many others.



Compiled by M. N. Beitman, radio engineer, teacher, author, & serviceman.

Post-War Automatic 1945-1947 Record Changers
Service expertly all new (1945-1947) record changers. Follow simplified factory instructions to make needed adjustments and repairs. Hundreds of photographs and exploded views; thousands of test hints; service instructions for all popular makes. Large size: 8½ x 11", 144 fact-filled pages. At your jobber or post-paid, only **\$1.50**

Pre-War Record Players, Changers, & Recorders
Just what you need to repair quickly thousands of pre-war automatic record changers, manual units, pick-ups, wireless oscillators, recorders, and combinations. Hundreds of mechanical and electrical diagrams. Instructions for adjustments and repairs. Most popular units of all makes. 128 large pages. 8½ x 11 inches. Price, only **\$1.50**

NO RISK TRIAL ORDER COUPON

SUPREME PUBLICATIONS, 9 S. Kedzie Ave., Chicago 12, ILL.
Ship the following manuals: (Money back guaranteed)

1947 1946 1942 1941 1940 1939 1926-1938

Price each volume only \$2.00, postpaid \$2.50

Post-War Automatic Record Changers, \$1.50.

Pre-War Record Players, Changers, & Recorders, \$1.50.

I am enclosing \$..... send postpaid.

Send C.O.D. I am enclosing \$..... deposit.

Name:

Address:

Supreme Publications
PUBLISHERS OF RADIO BOOKS, MANUALS, AND DIAGRAMS
9 S. KEDZIE AVE. CHICAGO 12, ILL.

OHMITE

Little Devil

INSULATED
COMPOSITION RESISTORS

RESISTANCE AND
WATTAGE MARKED
ON EVERY
UNIT!



(Actual Size)

TINY but DEPENDABLE

You never have to guess about the resistance and wattage of any Little Devil resistor. Every unit is not only color-coded, but individually marked for quick, positive identification. Millions of these Little Devils have proved their ruggedness and reliability in critical war equipment. Available from stock, in standard RMA values from 10 ohms to 22 megohms. Tolerance $\pm 10\%$.

Available only from OHMITE Distributors

See them at the
RADIO and ELECTRONICS SHOW
Stevens Hotel
Chicago, May 13-16... Booth No. 74

Send Now for
Bulletin No. 127

Gives complete data and list
of RMA values. Includes dimen-
sional drawings and handy
color codes.



OHMITE MANUFACTURING CO.
4896 Flournoy Street Chicago, Ill.



Be Right with...

OHMITE

RHEOSTATS • RESISTORS • TAP SWITCHES

TELEVISION FOR TODAY

(Continued from page 32)

amplifier plate (as in Fig. 3-b) the cathode needs only 30 to 50 volts. Under these circumstances, the end of the high-voltage unit may be grounded directly, since the 30 to 50 volts bias needed is negligible in comparison to the remainder of the voltage.

volts necessary to drive the 6Y6-G oscillator tube. The oscillator itself is a conventional tuned plate, untuned grid tickler coil arrangement. The secondary coil L2 contains more turns than the tuned primary, and steps up the oscillator voltage to approximately 10 kv. Voltage

step-up is set at half maximum obtainable to provide high efficiency and good voltage regulation.

The feedback coil L1 is coupled to L2 instead of L3 directly, for greater stability. See Fig. 5. The oscillator tube is biased for Class C operation, resulting in relatively low plate loss and greater efficiency. The 6Y6 (or 6L6) beam power tube can

develop 15 watts of power with 80 per cent efficiency at 350 volts. The screen-grid voltage is made self-regulating by a series resistor, and during operation varies from approximately 65 volts at no load to 120 volts at full load.

The high-voltage rectifier is a half-wave unit employing an especially designed 8016 tube. Standard high-voltage rectifiers, such as the 2X2 and 2V3-G, require considerable heater power (3.1 watts for the 2X2 and 12.5 watts for the 2V3-G). The 8016, however, takes only 0.25 watt. This can be supplied directly from the oscillator. At the relatively high frequency of the oscillator, approximately 300 kc, a 500- μ f condenser and a 100,000-ohm resistor provide filtering.

The second high-frequency power supply is based on an idea conceived by P. T. Farnsworth about 1930. Only recently, however, has a good practical model been evolved. The voltage induced in any inductance is governed by the relationship

$$e_i = L \frac{di}{dt}$$

As the time interval dt is made smaller, e_i becomes greater. In the horizontal deflection coils, the retrace interval dt is quite small and a large pulse of voltage is produced. By rectifying the pulse, voltages to 30 kv can be obtained.

A circuit schematic of an "inductive kick" power supply is shown in Fig. 6. The horizontal-sweep amplifier, an 807, is driven by the saw-tooth voltages which are developed in the preceding sweep oscillator. The saw-tooth plate current of the 807, flowing through a portion of the transformer T1, develops a large inductive pulse during the retrace period. Two 8016 rectifier tubes are connected in cascade across the full primary. These tubes rectify the pulses

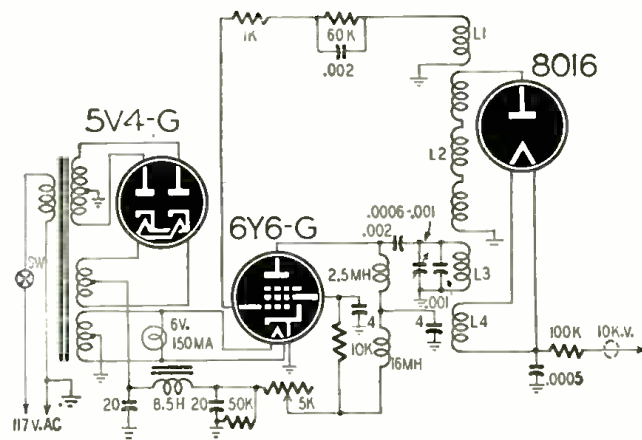

Fig. 4—An r.f. power supply. The filament also operates on r.f.

R. F. power supplies

As we increase the voltages of the high-voltage supply, the cost and the bulkiness of the unit also increases, but at a much greater rate. Projection tubes, which require voltages as high as 27,000, would—if the previous conventional design were followed—lead to a unit far out of proportion to the rest of the set. Two types of power supplies promise at least partial relief from the cost and bulkiness of the conventional supply. Both units develop high-frequency voltages, which are rectified to obtain the d.c. high voltage. The formation of the voltages, however, differs considerably in each system.

The first type of r.f. power supply is shown schematically in Fig. 4. A 5V4-G full-wave rectifier operating from the 60-cycle line supplies the 300 to 350

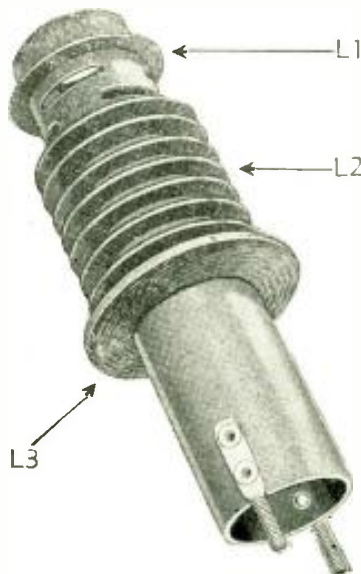

Fig. 5—The high-voltage step-up transformer.

(Continued on page 69)



TELEVISION-

*Does it Hold
A Future
For You?*



SPECIAL INVITATION TO WAR VETERANS

With extensive new training facilities under the personal supervision of the famed inventor of the radio vacuum tube, Dr. Lee de Forest, we are able to accept additional applications from Veterans for Television training under the G.I. Bill of Rights. For qualified men who are seriously considering entering a residence school, we have a limited number of Home Study Courses which are available free of charge. Your success with this course will not only help you to decide your own future in Television but will also aid us greatly in qualifying you for residence training.

Send your name and address for your Eligibility Questionnaire. If you qualify under the simple rules, you may start your Home Study Television Course at once and entirely without cost or obligation to you.

American Television Laboratories, Inc.

5050 BROADWAY • CHICAGO 40, ILLINOIS

LEARN ELECTRIC MOTOR REPAIR!



**A PROFITABLE
ADDITION TO
ANY RADIO SERVICE
BUSINESS**

This big book shows you how—every step of the way—
only \$5

IT PAYS TO SPECIALIZE IN SOMETHING DIFFERENT

There's good money in electric motor repair! The field is not crowded—and what could be a finer more profitable addition to your already established radio service business? Every home you visit on radio work has many motor-driven appliances. Be the man who can repair them!

ELECTRIC MOTOR REPAIR, the unique new book by the publishers of the famous Ghirardi Radio-Electronic books, teaches you the work from the very beginning. Explains every detail of motor trouble diagnosing, repair and rewinding. Covers a-c and d-c motors, synchronous motors and generators and mechanical and electrical control systems.



A "BENCH" BOOK

Based on what you can learn from this big book alone, you can train for prompt, profitable motor service. Quick reference guides for use right at the bench show exactly how to handle specific jobs. Invaluable for beginners or for daily reference in busy shops. Unique Duo-Spiral Binding divides book into 2 sections permitting text and the more than 900 diagrams and illustrations to be seen AT THE SAME TIME.

"BORROW" IT FOR 5 FULL DAYS!

Send coupon now! Practice from **ELECTRIC MOTOR REPAIR** for 5 days. If not more than satisfied, return book and every cent will be cheerfully refunded.



NO RISK COUPON mail today

Dept. RC-57, Murray Hill Books, Inc.
232 Madison Ave., New York 16, N. Y.

Enclosed is \$5 (\$5.50 foreign) for a copy of **ELECTRIC MOTOR REPAIR** Book; or I send C.O.D. for \$5 plus postage (no foreign C.O.D.'s). In either event, if not satisfied, it is understood I may return book in 5 days for complete refund of my money.

Name

Address

City & Dist. No. State

HIGH VOLTAGE POWER SUPPLY

A 2,000-volt r.f. low-current unit

THE high-voltage, low current power supplies required for operation of cathode-ray tubes in large oscilloscopes and in television receivers are costly. High-voltage insulation in power transformers and filter condensers adds to the bulk and weight of the supply. An r.f. power supply is less cumbersome and

The core of the coils is a polystyrene rod $\frac{3}{4}$ inch in diameter and about $1\frac{1}{2}$ inches long. The secondary winding consists of a total of 500 turns of No. 9/44 Litz wire wound in three pies to prevent high-voltage breakdown between turns. The feedback and plate windings, each consisting of 60 turns, are pie-wound on opposite ends of L2. All dimensions are given in the figure.

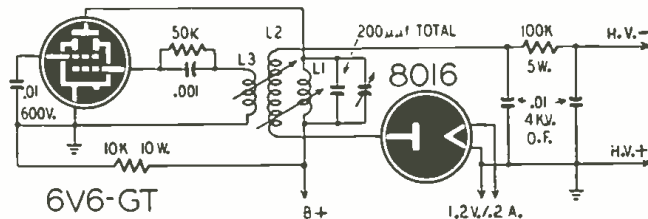

Circuit of the r.f. high voltage supply. Coil system is shown below.

more economical. This advantage increases in proportion to the output voltage. An interesting r.f. power supply was designed experimentally by the Amalgamated Wireless Valve Co. (Australia). This circuit uses a 6V6-GT in a self-excited tuned-plate oscillator circuit operating at a frequency of approximately 1 megacycle. The frequency

The coils should be shielded with a coil shield that will allow at least $\frac{1}{2}$ -inch spacing from the nearest conductor. All leads should be kept as short as possible and sharp bends in the high-voltage wiring should be avoided to prevent power losses through corona discharges.

The high-voltage output of the unit may be adjusted roughly by varying the screen-grid voltage of the oscillator tube. Precise adjustments are made with the tuning condensers across L1.

The positive output of this circuit is grounded. If grounded negative is required, 4,000-volt insulation should be used on the filament transformer, or a battery, well insulated from ground, may be employed.

This circuit appeared in the January-February, 1946, issue of *Radiotronics Technical Bulletin*, published in Australia.

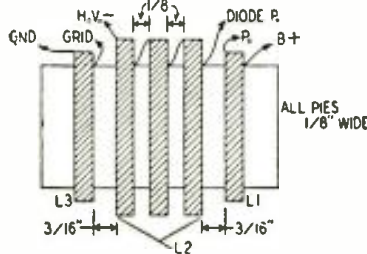

Dimensions of the high-voltage transformer.

of operation is determined by the inductance of the output coil L2, tuned by its distributed capacity and the stray capacity of the circuit wiring. The plate circuit is resonated to the operating frequency by L1 tuned by parallel fixed and variable capacities totaling 200 μ mf. The grid coil L3 provides sufficient feedback voltage to the grid to sustain oscillations.

The r.f. voltage in the plate coil is transferred to L2 with a step-up ratio of 8.3 to 1. This produces about 2000 volts which is applied to the high-voltage rectifier. This voltage is rectified in a half-wave circuit and filtered in an RC filter consisting of a 100,000-ohm resistor and two 0.01- μ f 4,000-volt oil-filled condensers. Although an 8016 rectifier is shown, an 879, 2Y2, or a 2X2 may be used with changes in the filament transformer.

After the coil has been wound, it closely resembles the harmless oscillator coil of a broadcast receiver. This appearance should not be deceiving because the high voltages across L2 are sufficient to cause serious injury or DEATH.

RADIO TERM ILLUSTRATED



Signal Generator
Suggested by: W. H. Althouse, Bainbridge, Ohio



Servicemen...



Mail coupon
NOW — so your
 subscription
 will start at once

Here's one of the greatest "no strings attached" offers ever made to professional servicemen. All you have to do is mail the coupon below—and we'll put you on the subscription list for "The Capacitor"—the magazine published by C-D to help you with tough servicing problems—and to provide you with a steady flow of money-making ideas. That's all there is to it. No cost. No obligation. This is C-D's way of repaying servicemen everywhere for their loyalty to C-D Capacitors.

Don't wait. Be the first in your territory to receive this valuable magazine — every month — absolutely FREE.

MAIL COUPON TODAY! Cornell-Dubilier Electric Corp., Dept. RC-5, South Plainfield, New Jersey.

this magazine
 is published
 just for you
 and it's yours
 • absolutely **FREE**

READ WHAT THESE SUCCESSFUL SERVICEMEN SAY ABOUT "THE CAPACITOR"—*"Your magazine carries much of interest to the serviceman. Keep up the good work."* From a Maine serviceman.

"The C-D Capacitor is a Fine Paper. My apprentice uses it to good advantage." From a Philadelphia service shop.

HELPS TO SPEED UP SERVICING PROCEDURES—BUILD BUSINESS—Every issue of "The Capacitor" brings you the kind of professional "Know-how" that speeds up servicing procedures—and builds profitable business. Also contains up-to-the-minute data on test instruments, scientific circuit analysis and trouble-shooting, parts repair and substitution, information on new-type tubes. *Clip coupon now.*

1910  1947

CORNELL-DUBILIER
 WORLD'S LARGEST MANUFACTURER OF
CAPACITORS

MICA • DYKANOL
 PAPER • ELECTROLYTIC

Cornell-Dubilier Electric Corporation Dept. RC-5
 South Plainfield, New Jersey

Please start my FREE subscription to "The Capacitor" at once.

Name.....

Address.....

City..... Zone..... State.....

SILVER

EXPERTS CHOOSE



"VOMAX" is the overwhelming choice of experts because it's the finest, perfected v.t.v.m. . . . because greatest demand makes greatest production and lowest cost to you.

"VOMAX" gives you a total of 51 ranges to directly measure d.c., a.c., o.f., i.f. and r.f. volts up through hundreds of megacycles, six resistance ranges covering 2 10ths ohms through 2,000 megohms, three output meter-decibel ranges from -10 through +50 db., six direct current ranges measuring from 50 microamperes through 12 amperes. Most important is the absolute stability, complete freedom from usual grid current errors . . . and its astronomical input resistance . . . on honest 6.6 megohms upon a.c., o.f., i.f. and r.f.; 51 and 126 megohms upon d.c. Voltage ranges measure from .1 through 3000 volts d.c., .1 through 1200 volts a.c.

If you want to guard your meter dollar investment . . . to make it only once for many years to come . . . then "VOMAX" at its present low \$59.85 net price is your logical choice . . . as thousands more wise technicians like yourself have proved to their profit.

Let's look at this matter of what meter you buy seriously . . . for your choice of this, the service technicians basic instrument, can spell either peace and profit . . . or annoyance and loss to you. You must have the best meter to meet "smart" competition. And "smart" competition overwhelmingly uses "VOMAX." The reason is simple. Other manufacturers have had to copy "VOMAX" inventions to try to satisfy your demand for a modern, post-war, obsolescence-proof universal meter. Yet, "VOMAX," the perfected v.t.v.m., stands head and shoulders above all other meters. This is proved by its heavy purchase and use by the Bureau of Standards in Washington, by Western Electric, G. E., Westinghouse, university after university, by top-ranking industrial laboratories, F.C.C., C.A.A., Veterans Administrations, schools, colleges . . .

NEW IMPROVED "SPARX"



Thousands of technicians today rely on "SPARX" dynamic signal tracer to save time . . . increase efficiency . . . cut their costs. It lets you hear and see signals . . . traces signal right on thru every receiver circuit from antenna thru voice-coil . . . is shop test speaker, too. Continuous laboratory research has now improved "SPARX" immensely . . . created the Improved Model . . . tremendously increased sensitivity . . . greatly expanded general usefulness. And the SILVER policy of protecting your dollar investment pays out handsomely . . . a free bulletin tells every user how to convert his "SPARX" into the new, Improved Model in a jiffy . . . goes to prove that for the really serious, profit-conscious technician there's no substitute for SILVER, that "SPARX" costing you only \$39.90 is outstandingly the world's best signal tracer. "SPARX" will earn you, too, more profits in less time than any other instrument you can buy.

906

Thanks for your patience. Model 906 Signal Generator is now flowing to your favorite jobber. And what an instrument . . . 90 kc. through 170 mc. on fundamentals . . . 8 air-trimmed bands . . . variable % 400 ~ amplitude modulation . . . built-in variable electronic FM sweep . . . laboratory triply adjustable attenuator . . . metered microvolts . . . output 1/2 microvolt to over 1 volt . . . multiply shielded . . . strays lower than \$500.00 laboratory generators! Yet all this costs you only \$89.90 net. Better order your 906 now for demand far exceeds production capacity on this precision instrument for months to come.

Send Post Card for Catalog of new measuring equipment, communication receivers, transmitters, kits, parts. See them at your favorite Jobber.

OVER 36 YEARS OF RADIO ENGINEERING ACHIEVEMENT

McMurdo Silver Co., Inc.

1249 MAIN ST., HARTFORD 3, CONNECTICUT

A 300-OHM FOLDED DIPOLE

The folded-dipole antenna has definite advantages over the straight dipole. It covers a wider frequency range and its impedance is increased to 300 ohms so that it can be connected directly to standard 300-ohm transmission line. However, it is a more elaborate antenna than the straight dipole, and is more difficult to make.

The construction of a folded dipole may be considerably simplified without sacrifice of efficiency by using a length of 300-ohm line for the antenna itself. Many amateurs are using such an antenna for receiving and transmitting on high-frequency bands, and the same design makes a very effective FM or television receiving antenna. Only about 5 feet of line is necessary for the new FM band which is now being incorporated in many receiver models. Reception is at least as good as with a straight dipole, and it is often much more convenient to match to the 300-ohm line.

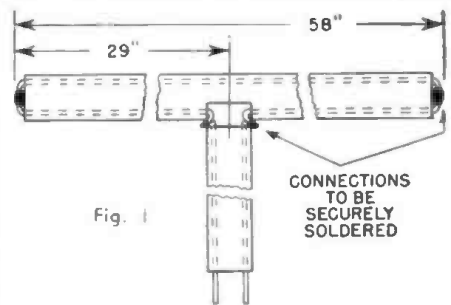

Fig. 1 shows how the antenna is made. The 300-ohm twin-lead transmission line may be type K-1046 (Federal Telephone and Radio) which is especially suitable because of its flexibility, weather-resistance, and very low loss. A 58-inch length of line is shorted at both ends after stripping the insulation as shown. The ends are twisted and soldered. Then one of the conductors

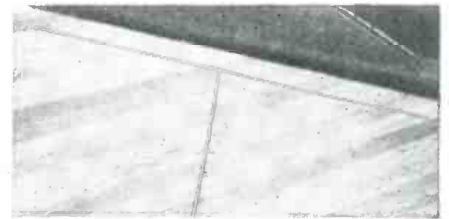



Photo courtesy Federal Telephone and Radio Corp. Dipole is installed on the floor under a rug.

is cut at its center and the insulation stripped to expose the two ends which are soldered to the transmission line. The distance between the two ends is equal to the distance between conductors of the twin lead. All connections should be lacquered after soldering.

The folded dipole should be erected as high as possible and away from obstructions. It is mounted to any suitable insulator such as wood and is supported at the two shorted ends. In some cases sufficient signal strength may be available to use an indoor antenna. The folded dipole then can be placed under a rug or behind furniture, as shown in the photo.

new

 **PYRAMID**
"twist-mount"
ELECTROLYTIC
CAPACITORS

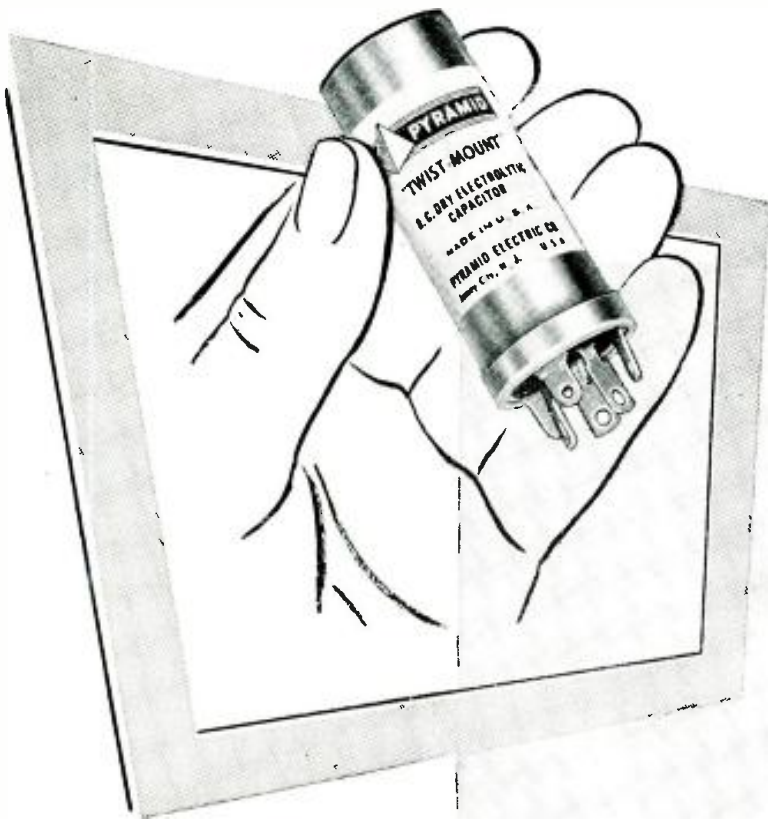

Here's the latest addition to
the Pyramid family—an
ultra-compact, high quality,
metal-sealed, easy-to-mount capacitor!
Pyramid Type TM units are
available in a wide range
of capacity and voltage ratings,
for every application.
And, like all other Pyramid
capacitors, they're modestly priced!

W R I T E F O R L I T E R A T U R E

P Y R A M I D
ELECTRIC COMPANY

JERSEY CITY 6, N. J.



Lick any **RADIO REPAIR JOB** ... in **LESS TIME** ... with **LESS WORK!**



Written by Alfred A. Ghirardi, servicing expert and author of the most widely used books in radio training history.

and a lot **MORE PROFITABLY!**

Ghirardi's **RADIO TROUBLESHOOTER'S HANDBOOK** quickly helps you diagnose and repair common troubles in over 4800 receiver models and automatic record changers of 202 manufacturers.

4 radio repair jobs out of every 5 can be handled as easily as falling off a log—without tedious testing. Try this servicing short cut that really works—the one that pays for itself in time saved on the very first job! There's no magic about it. Just common sense. In this big, 4 lb., 744-page manual-size **TROUBLESHOOTER'S HANDBOOK**, Ghirardi supplies you with a carefully tabulated and indexed compilation of the common Troubles (and their Remedies) that occur in over 4800 models of home radios, auto radios and automatic record changers of 202 manufacturers—the sets that account for well over 90% of all service work today! Clear instructions tell you exactly **WHAT** the trouble is likely to be—exactly **HOW** to fix it. No guessing or lost time!

NO OTHER SERVICING HANDBOOK LIKE IT

This priceless Trouble Case History section of the **HANDBOOK** eliminates the need for all trouble-shooting and laborious testing on 4 jobs out of 5. Tells you **HOW** to make the necessary repairs **QUICKLY**, **SIMPLY**, **DIRECTLY!** Ghirardi passes on to you the priceless experience from thousands of hours of tedious troubleshooting so you can save **MORE THAN HALF** your precious time and do your work **Easier, Faster, more Profitably.**

NOT A STUDY BOOK!

Over 300 additional pages contain parts repair data, diagrams, tube charts, tuning alignment and i.f. transformer data for more than 20,000 receivers, complete ITMA color codes, and dozens of graphs, diagrams and other service data, all designed to help you repair **ANY RADIO EVER MADE** easier and twice as fast! You get all this for only \$5 complete!

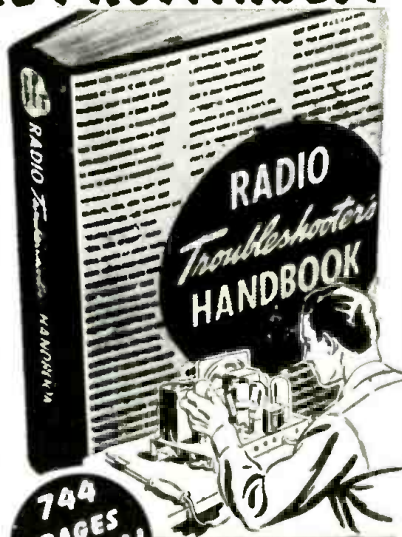

744 PAGES MANUAL SIZE

GOODBYE TO TEDIOUS TESTING ON FOUR JOBS OUT OF 5

Trouble Case History repair instructions on over 4800 models of all these makes:

- | | |
|----------------|-----------------|
| Admiral | Howard |
| Airline | Majestic |
| Arvin | Motorola |
| Belmont | Philco |
| Brunswick | Pilot |
| Capehart | RCA |
| Chevrolet | Silver-Marshall |
| Clarion | Silvertone |
| Colonial | Sonora |
| Crosley | Spartan |
| Emerson | Stewart Warner |
| Fada | Strom-Carlson |
| Farnsworth | Westinghouse |
| G.E. | Wilcox-Gay |
| General Motors | Zenith |

... and 172 more!

Don't BE A HACK!

Learn Professional Servicing by **MODERN, SCIENTIFIC Methods**

MODERN RADIO SERVICING is A. A. Ghirardi's famous illustrated and simplified course in professional radio-electronic service work. 32 big chapters, 1300 pages and over 700 illustrations complete in 1 vol. — sold for only \$5! It explains the construction and operation of all types of test instruments — and how to use each one. Shows how to analyze circuits scientifically; how to test, repair and replace components; how to do every phase of home and auto-radio repair work from A to Z by most expert, time-saving **MODERN methods**. Worth its weight in gold in giving you a real, honest-to-goodness complete course in the **KNOW HOW** of radio - electronic service work!

1300 pages
706 illus.
only

\$5

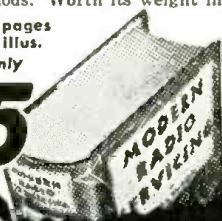

HAVE A LOOK AT THEM—NOW!

DEPT. RC-57, MURRAY HILL BOOKS, INC.
232 Madison Ave., New York 16, N. Y., U. S. A.

Enclosed find \$..... for books checked; or send C.O.D. (in U.S.A. only) for this amount plus postage. If not fully satisfied, I may return either or both books within 5 days for full refund of my money.

- RADIO TROUBLESHOOTER'S HANDBOOK** \$5 (\$5.50 foreign)
 MODERN RADIO SERVICING \$5 (\$5.50 foreign)

MONEY-SAVING COMBINATION OFFER:

Both big books—over 2040 pages total—only \$9.50 for the two (\$10.50 foreign).

Name.....
Address.....
City & Zone..... State.....

... SPARTON MODEL 667

When the full-wave output i.f. transformer opens or burns out it is almost impossible to get replacements. I use a standard 456-kc i.f. transformer with its secondary loaded with two 1-megohm resistors in series. A tap at the junction of the resistors provides a source of a.v.c. voltage. The resistors load the transformer sufficiently enough to permit it to be tuned to 345 kc.

GEORGE E. BROWN,
Lonaconing, Md.

... ZENITH 6DO30E

On this set, the tuning condenser is insulated from the chassis by mounting it on the dial. The dial sometimes permits the condenser to sag and make contact with the chassis at the rear, causing the set to stop playing. This may be cured by cementing a piece of sponge rubber to the chassis just under the rear of the tuning condenser.

HAROLD L. BLISS,
Francesville, Ind.

... AIRLINE 04BR511A AND 04BR512A

Persistent audio oscillation and feedback that does not respond to ordinary methods can be cured by replacing the 12SQ7 tube. Try several tubes. It will not be necessary to discard the offending tube, as it will usually work well in other sets.

ARTHUR L. JOHNSON,
Hutchinson, Kansas

... SMALL COMBINATIONS

Cabinets of many table model combinations are constructed so that needles and other trash can slide between the player panel and the cabinet wall and fall into the speaker assembly, lodging between the voice coil and the pole piece. This often causes a loss in volume and distortion. After cleaning the speaker, make a cover of light cloth and place it around the speaker. This protects the speaker from dust and other foreign matter. (A speaker cover of this type is standard equipment on many European sets.)

MCCLESKEY RADIO CO.,
Baton Rouge, La.

... SPEAKER REPAIRS

When replacing speaker cones, it is often difficult to remove dirt and filings from around the pole piece. I find it helpful to take a piece of scotch tape and probe around the pole piece. Foreign matter will adhere to the sticky side of the tape, leaving the air gap nice and clean.

JEROME COOPERMAN,
New York, N. Y.

... EMERSON 1940-1941 MODELS

Many of these models use 25AC5 output tubes which are difficult to replace. I tie the No. 3 and No. 4 pins together at the socket and use a 25A6. No other changes are necessary since the filament voltages and currents are identical.

CHESTER T. MARTOWICZ,
New York, N. Y.

MONEY-SAVING COMBINATION OFFER!

Let the **HANDBOOK** save you time on common service jobs. Let **MODERN RADIO SERVICING** train you for truly professional work. Get **BOTH** big books at special Money-Saving Combination price of only \$9.50 for the two by mailing coupon today.

new

CONCORD

Radio

Catalog



**RADIO PARTS • RADIO SETS
RECORD CHANGERS • PLAYERS
HAM GEAR • AMPLIFIERS • TESTERS**

It's here—ready for you now—the new, comprehensive, 1947 Concord Catalog displaying a vast, complete selection of everything in Radio and Electronics. Send for your copy now. Select your needs from value-packed pages showing thousands of items available for IMMEDIATE SHIPMENT—hundreds of them now available for the first time—featuring new, latest 1947 prices. See the new LOWER prices on finest-quality RADIO SETS, PHONO-RADIOS, RECORD CHANGERS, RECORD PLAYERS, PORTABLES, AMPLIFIERS, COMPLETE SOUND SYSTEMS, TESTERS. See complete latest listings of all the well-known, standard, dependable lines of radio parts and equipment—tubes, condensers, transformers, relays, resistors, switches, speakers—all available for IMMEDIATE SHIPMENT from huge stocks in CHICAGO and ATLANTA. Whatever your needs in Radio and Electronic Parts, Supplies and Equipment—before you buy—SEE THIS GREAT NEW CONCORD CATALOG. Mail coupon for your FREE copy now.

CONCORD
RADIO CORPORATION
LAFAYETTE RADIO CORPORATION
CHICAGO 7, ILL. ATLANTA 3, GA.
901 W. Jackson Blvd. 265 Peachtree St.

free

Radio Hams • Service Men • Engineers
Sound Men • Maintenance Men
Schools • Institutions • Manufacturers

THIS CATALOG IS FOR YOU!

Mail **COUPON TODAY!**

Concord Radio Corporation, Dept. RC-57
901 W. Jackson Blvd., Chicago 7, Ill.

Yes, rush FREE COPY of the comprehensive new Concord Radio Catalog.

Name

Address

City State

SAVE AT RESCO!

Farm and Home BATTERY CHARGERS

- Insure Engine Starting
- Improve Lighting
- Prolong Battery Life
- Save Money
- Improve Auto Radio Reception

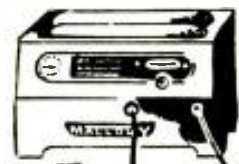

MODEL 6A C4
6-volt, 4-amp. For the average car whose battery needs occasional boost.

797

MODEL 6A C6
6-volt, 6-amp. For cars and trucks subjected to greater-than-average loads.



1063

MODEL 6A C10
6-volt, 10-amp. For servicing several batteries regularly.

MODEL 12A C5
12-volt, 5-amp. For 12-volt batteries.

1330

1863

BATTERY ELIMINATORS

For Demonstrating, Testing and Servicing Auto Radios

Can't be beat as a power supply for radio sets, aircraft instruments, relays, motors, and other electrical equipment. In the laboratory for supplying various low D.C. voltages by simply using a rheostat on one side of the A.C. cord. Will eliminate radio interference and hum. Plug into any standard 115 volt A.C. cycle for D.C. power.

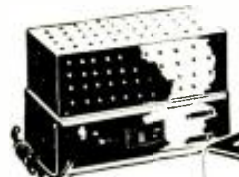

ATR Model 120C
D.C. output, 6.3 volts, 14-amps or 14 volts, 7-amps.

3720

E-L Model 976
D.C. output, 6.3 volts, 7-amp.

2097



SCHAUER Model AR-1
D.C. output, 6-volts, 15-amp

3750

Write for Big, Value-Packed Bulletin Include Postage with Cash Orders

Radio Electric SERVICE CO. OF PENNA., INC.

7TH AND ARCH STREETS, PHILA 6, PENNA.
Branches: 5133 Market St. and 3145 N. Broad St. in Phila.
Also in Wilmington, Del., Easton, Pa., Allentown, Pa., Camden, N. J.

MULTIVIBRATORS

(Continued from page 25)

is triggered externally. The previously described circuit may be "locked in" by an external source, but will continue to function when the excitation is removed. Fig. 5 illustrates a single-ended or one-kick multivibrator. The name is derived from the fact that such a circuit will complete one cycle of operation with each triggering pulse. When the triggering pulse is removed, the oscillation ceases.

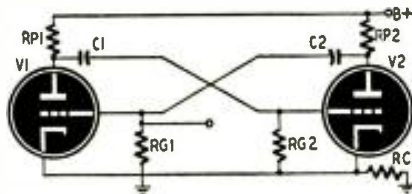

Fig. 5—Circuit of a one-kick multivibrator.

Fig. 5 is similar to Fig. 1, with one exception. In Fig. 5, V1 is normally cut off while in Fig. 1 both tubes are normally at zero grid bias. In the latter circuit, bias for V1 is provided by the voltage drop across RC caused by V2 current. V2 is conducting because the grid is connected directly to the cathode through RG2. Due to this bias, V1 will remain cut off whenever V2 is conducting and oscillation will stop.

The one-kick multivibrator

Fig. 6 is a time-plot analysis of one-kick multivibrator operation. The resting potential on the plate and grid of each tube is indicated on each oscillo-

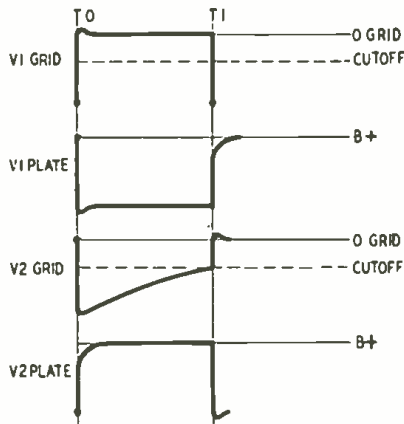

Fig. 6—Analysis of one-kick vibrator action.

gram by a dot. A positive pulse is applied to the grid of V1, which is normally below cut-off. The following operation is almost identical to the second half-cycle of the circuit in Fig. 1. V2 grid is driven below cut-off by the multivibrator action and the cathode bias on V1 disappears, since V2 is no longer conducting. The charge on C1 leaks off through RG2, and, at T1, V2 begins to conduct, once again completing the cycle. Current flows through RC and the resulting voltage drop biases V1 grid below cut-off as before. The circuit will remain in this original con-

dition until another positive triggering pulse is applied to V1 grid.

From Fig. 5 it is seen that only one slow phase is present in the one-kick-multivibrator operating cycle. This slow phase is determined by the RC grid constants of the tube that is cut off during the cycle.

The one-kick multivibrator provides, among other uses, a method of producing pulses of a definite frequency and time duration. For example, in a certain electronic application it is desired to operate a pair of thyatron mercury-vapor rectifier tubes for 500 microseconds and have them inoperative for 1,000 microseconds. Such regulation is easily accomplished by the one-kick multivibrator. The positive pulse from the plate of V2, as shown in Fig. 5, is applied to the thyatron grids, causing the tubes to conduct for length of time from T0 to T1. This time is limited to

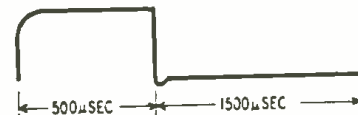

Fig. 7—The multivibrator as pulse generator.

the required 500 microseconds by adjusting RG2 and C1. The necessary wave form is shown in Fig. 7. The total length of the pulse would be 2,000 microseconds, since the negative portion would be 1,500 microseconds. By again referring to formula: f equals $1/t$, we find f must equal 500 pulses per second for our purpose. This will be the frequency of the triggering pulse applied to the multivibrator.

The preceding example illustrates only one of the many possible applications of the multivibrator to electronic circuits. Additional similar applications for industrial and other uses should suggest themselves.

From a more conventional point of view, the multivibrator, as employed in cathode-ray sweep circuits, is of practical interest. This circuit provides one of the better means of producing a high-speed sweep. Such a sweep voltage is required in the television receiver. Fig. 8 illustrates a variation of a multivibrator-type sweep generator that is suitable for extremely high-speed sweep applications. This circuit operates like that of Fig. 5.

Between triggering pulses, while V2 is cut off by the voltage drop across RC, sweep condenser C charges to B-plus

(Continued on page 96)

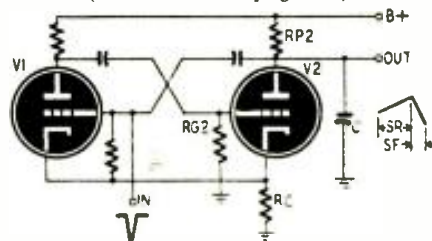

Fig. 8—Adaption to high-speed sweep circuit.

Never so much radio for so little money —

\$10⁹⁵

Including Tubes
Postpaid in U. S. A.

**SUPER-HETERODYNE
FOUR TUBES and
SELENIUM RECTIFIER
110 Volt AC-DC KITS**

**direct from factory
to you —**

Never before has BELLTONE packed so much quality and value in a \$10.95 complete package. This four tube and selenium rectifier super-het kit of parts (chassis 10½"x5½"x7") has proven its selectivity, sensitivity and high quality radio reproduction in tens and tens of thousands of receivers sold during the past months. Today you can have this same chassis with all

post-war improvements

at virtually cost of component parts, drawings, instructions, packing and mailing costs —complete except for cabinet, wire and solder.

**three big assembly and
hook-up prints and
ABC detailed instructions
supplied**

including schematic circuit, picture wiring diagram, top chassis layout, dial cord instructions and cabinet layout suggestion—makes assembly, wiring and final adjustments easy, instructive and foolproof.

**direct from factory to you
only — no sales to jobbers,
dealers or surplus outlets**

no cabinet, wire or solder supplied



circuit improvements and parts include —

1. **SELENIUM RECTIFIER** — eliminates troublesome rectifier tube—it's unbreakable—lasts the lifetime of your set—starts instantly—increases sensitivity.
2. **PROTECTIVE FILAMENT RESISTOR**—prevents current surge through filaments—eliminates tube burn-outs and increases tube life.
3. **ALNICO PM SPEAKER**—1.47 ounce 5 inch speaker for high quality voice and music reception.
4. **GRIP-STRAIN RELIEF**—securely anchors power line cord to chassis—preventing short circuits.
5. **TUBES SUPPLIED**—one each 12SA7 - 12SK7 - 12SQ7 and 50L6.

**ORDER YOUR BELLTONE
SUPER-HET CHASSIS KIT--TODAY
SHIPPED BY RETURN MAIL**

BELLTONE RADIO and TELEVISION CORP.
583 Ave. of the Americas, New York 11, N. Y.

Yes, I want..... BELLTONE chassis kits. Enclosed find

money order check for \$

SHIP TO

STREET CITY..... STATE.....



P.A. SOUND EQUIPMENT FOR ALL REQUIREMENTS



MASCO DE LUXE 35 WATT AMPLIFIER RECORD CHANGER TOP EQUIPMENT

AMPLIFIER SPECIFICATIONS FOR MODEL MA-35 RC

- Power output: 35 watts
- Gain: Microphone, 125 DB. Phono, 78 DB
- Controls—Five: Two microphones, Phono, Dual-Tone
- Separate on-off switch
- Input—Three: Two Microphones, Phono
- Tubes: 2-7C7, 1-7B1, 1-7F7, 1-6V6GT, 2-6L6GA, 1-5U4G
- Output: Tapped—2-4-8-15-500 Ohms
- Power Consumption: 130 Watts
- Hum Level: Below zero level—20 DB
- Frequency Response: 50 to 10,000 cycles
- Astatic LP-6 Low Pressure Cartridge with Permanent Sapphire Stylus
- Changer Plays—10-12" or 12-10" records
- Dimensions: 15" x 12" x 9"

Complete with tubes **\$179.00** List

MASCO 25 WATT 6 AND 110 VOLT AMPLIFIER



\$147.25 List

- Phono operation on both 6 volts D.C. and 110 volts A.C.
- Two Mike Inputs
- Outputs: 2-4-8-15-500 Ohm
- Extra Heavy Duty Vibrator
- A truly universal amplifier for sound car, outdoor or indoor use. Complete with tubes.

WIRELESS PHONOGRAPH WITH AUTOMATIC RECORD CHANGER



No wires to connect. Just plug in and play through radio. 45 minutes of uninterrupted plays of 10 or 12 inch records without reloading. For 110 V.-60 cycle operation. Complete with open type cabinet.

\$28.50

IMMEDIATE DELIVERY FROM STOCK



509 Arch St., Philadelphia 6, Pa.
LOmbard 3.9225

New Radio-Electronic Patents

By I. QUEEN

TELEGRAPH REPEATER

William E. Simpson, S. Ozone Park, N. Y.
Patent No. 2,404,754

It is often necessary to receive high-speed telegraph signals on one channel and transmit them on a different channel. This may be done electronically with the circuit shown.

Assume first that no signals are coming in. The triode and thyatron grids are at ground potential, so both tubes conduct. When an in-

coming signal appears, the output of the full-wave rectifier is applied to the grids as a negative voltage, cutting off both tubes. The triode

allows the thyatron to de-ionize rapidly because both tubes are in series.

During the time that the thyatron is cut off, the voltage drop across potentiometer P is higher than during conducting periods, due to the ab-

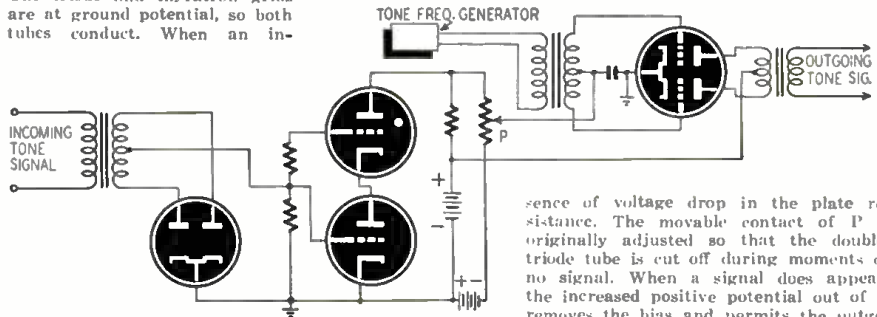

sence of voltage drop in the plate resistance. The movable contact of P is originally adjusted so that the double-triode tube is cut off during moments of no signal. When a signal does appear, the increased positive potential out of P removes the bias and permits the outgoing tone signal to be transmitted. This system allows keying of the local generator rapidly and in accordance with the incoming telegraph signal.

RADIOTELEGRAPH A.G.C.

R. Lee Hollingsworth, Riverhead, N. Y.
Patent No. 2,404,712

The requirements for automatic gain control circuits are different for code reception than for "phone." In the former case a sudden burst of static or increased signal strength may block the receiver and cause the loss of the first few characters of a high-speed code transmission. Also, the charge on the condensers of an a.g.c. system leaks off during spaces between signals so that the gain of the receiver varies.

The difficulties are eliminated in the circuit shown. The signal is heterodyned, amplified and rectified in a conventional three-stage circuit. Note, however, that the amplifier grids are isolated unless either tube A or B conducts. These tubes have special functions.

The detector output flows through B and develops an a.g.c. voltage at point P. B conducts only when a signal is received, and may be ad-

justed for delayed a.g.c. Tube A is adjusted to be cut off without signal input. It conducts only when a powerful signal or surge of static appears. During these intervals the tube bypasses current and prevents the receiver from blocking. Due to amplifier grid isolation, this receiver maintains its sensitivity without regard to the length of spaces between signals.

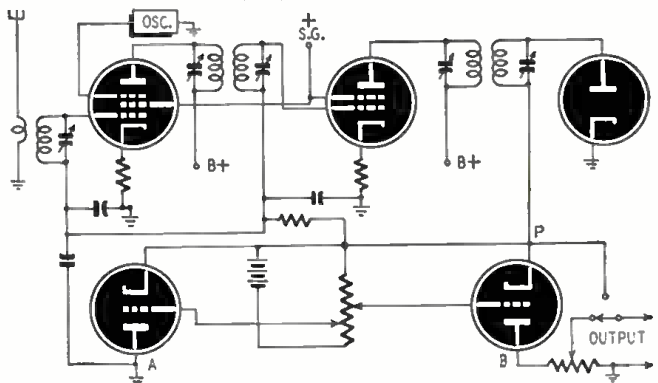

TIME-INTERVAL MEASUREMENT

William S. Wilson
(Assigned to Radio Corp. of America)
Patent No. 2,412,111

This circuit greatly simplifies the equipment needed to measure short time intervals between pulses. It may be required, for example, to measure the interval between a transmitted pulse from an aircraft and that of the echo received from ground (as used in altimeters to determine the height of the airplane above ground).

Two triodes are used in a multivibrator circuit. They may be in separate envelopes or a single unit such as a 6J6. Transmitted pulses are applied to the first grid as negative potentials through a coupling condenser. Such a pulse cuts off plate current and causes the voltage to rise sharply. The abrupt change produces a positive voltage on the second grid and therefore increases the plate current of the second tube and causes a sudden decrease of plate voltage. This negative pulse is fed back to the first grid through a voltage-dividing network, charging the condenser C and thus maintaining the tube at cut-off.

The echo pulse is applied to the second grid. It causes plate cut-off and produces a positive pulse which also affects the first grid. The first tube then returns to its normal conducting state and is ready to receive the next pulse.

A d.c. voltmeter measures the plate voltage of

the first tube. It assumes an average indication and therefore measures the time during which the first tube is cut off. The shorter the time between transmitted and reflected pulses, the shorter the interval during which there is a high plate voltage, and therefore the lower the average voltage reading. Note that no condenser is used in the plate circuit of the first tube. The second grid is affected by the weak reflected pulse and not by a charge left on a condenser.

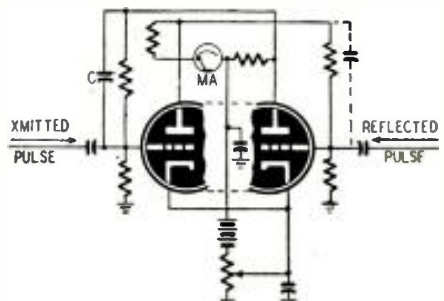

Long-distance Television is twenty years old



At the 1927 demonstration, Dr. Herbert E. Ives explained the television system developed in Bell Telephone Laboratories.

APRIL 7 is a notable day in communication history, for on that day in 1927 was the first demonstration of television over long distances. Large-scale images were flashed from Washington, D.C., by wire and from Whippany, N.J., by radio to a public demonstration in New York City. "It was," said a newspaper, "as if a photograph had suddenly come to life and begun to smile, talk, nod its head and look this way and that."

That was the first of many public demonstrations, each to mark an advance in the television art. In 1929 came color television, and in 1930 a two-way system between the headquarters buildings of A. T. & T. and Bell Laboratories. When the first coaxial cable was installed

in 1937, television signals for 240-line pictures were transmitted between Philadelphia and New York and three years later 441-line signals were transmitted. By May, 1941, successful experiments had been made on an 800-mile circuit.

End of the war brought a heightened tempo of development. Early in 1946 began the regular experimental use of coaxial cable for television between New York and Washington, and a few months later a microwave system for television transmission was demonstrated in California.

Transmission facilities will keep pace as a great art advances to wide public usefulness.

BELL TELEPHONE LABORATORIES



EXPLORING AND INVENTING, DEVISING AND PERFECTING, FOR CONTINUED IMPROVEMENTS AND ECONOMIES IN TELEPHONE SERVICE
RADIO-CRAFT for MAY, 1947



Question Box queries will be answered by mail and those of general interest will be printed in the magazine. A fee of 50c will be charged for simple questions requiring no schematics. Write for estimate on questions that may require diagrams or considerable research.

MIXER CIRCUIT

I would like to replace the 6A7 oscillator-mixer in my receiver with the single-ended 6SA7. Will you kindly draw a circuit showing how this tube may be used without electron-coupled oscillator coils? — O.G.F., Oakland, Calif.

A. The 6SA7 may be used with your present oscillator coil. Connections are shown in the drawing.

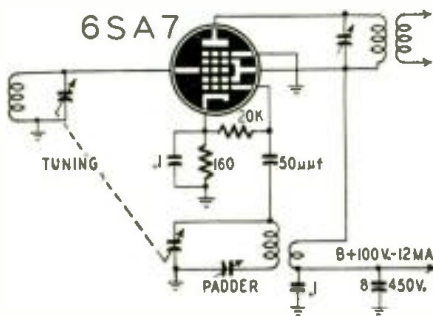

COIL DATA

I would like to have coil-winding data for a superhet receiver tuning from 18 to 42 mc. I am using a 6SK7 r.f. stage, and a 6SA7 oscillator-mixer. I have some 3/8-inch low-loss forms that I would like to use.—J.W., Tripp, S. Dak.

A. Here is the coil data that you desire. It is designed to cover the range you require when using 450- μ f condensers and a 456-kc i.f. stage.

The secondary of the antenna coil consists of 3 1/2 turns of No. 14 enamel wire spaced to cover about 3/4 inch. The primary is 1 turn of No. 28 d.c.c. wire interwound with the secondary. The detector coil secondary is identical with that of the antenna coil. The primary of this coil consists of 2 turns of No. 28 d.c.c. interwound with the ground end of the secondary. The secondary of the oscillator coil consists of 3 1/2 turns of No. 14 enamel spaced to 3/4 inch with a

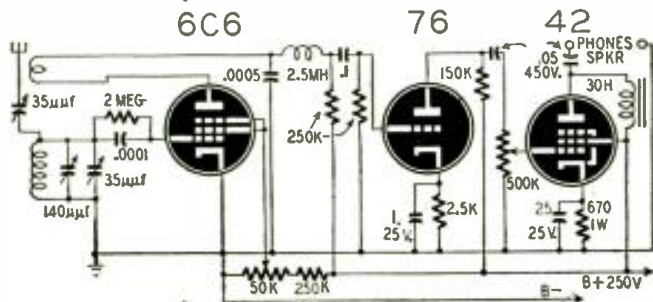

4-turn plate winding of No. 36 s.s.c. interwound.

It is not an easy task to wind and track three stages over this band. It will be necessary to experiment with the spacing of the grid windings to get good tracking throughout the range.

RADIO-THERAPY CIRCUIT

Please print a diagram of a diathermy or radio-therapy machine such as the one described by Dr. Lee de Forrest in the August 1943 issue. This should be powerful enough to produce artificial fever and the frequency should be variable between 5 and 18 meters.—J.J.S., Sharon, Pa.

A. A radio-therapy circuit is shown to the right. When properly adjusted, the power will be approximately 300 watts.

As in the case of most circuits of this nature, some experimenting is necessary to obtain the best results. The grid and cathode resistors and the grid excitation taps should be adjusted for optimum performance.

L1 consists of 15 turns wound on a 2 1/2-inch form spaced to 4 inches. L2 is wound with 4 turns spaced to 1 1/4-inch long. This coil should be well insulated and placed on the inside of L1. Both coils are wound with 1/8-inch copper tubing.

THREE-TUBE RADIO

Kindly print a circuit of a three-tube regenerative receiver using a 6C6 detector, 76 first audio, and 42 or 6F6 output stage. I have standard plug-in coils for use with a 140- μ f tuning condenser, a small magnetic speaker, and a 250-volt power supply.—L.J.S., Donora, Penn.

A. Here is a circuit that should meet your specifications. Regeneration is controlled in the screen-grid circuit of the detector and the 6C6 screen grid circuit. If band spread is desired, a 35- μ f trimmer may be connected across the main tuning condenser as shown.

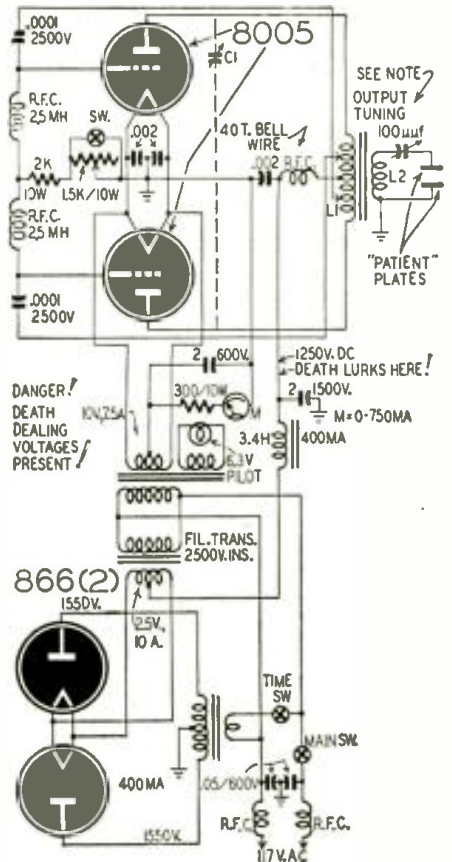

SET FOR 2-VOLT TUBES

Please print a circuit of a small receiver using a t.r.f. amplifier, a regenerative detector, and a power amplifier stage. I have a 32, a 33 and a 34. —G.A.S., St. Michael, B. W. I.

A. This circuit uses the tubes you specify. Regeneration is controlled in the screen-grid circuit of the detector and the r.f. gain in the grid return on the 34. Standard four-prong coils are used in the r.f. stage and six-prong in the detector circuit.

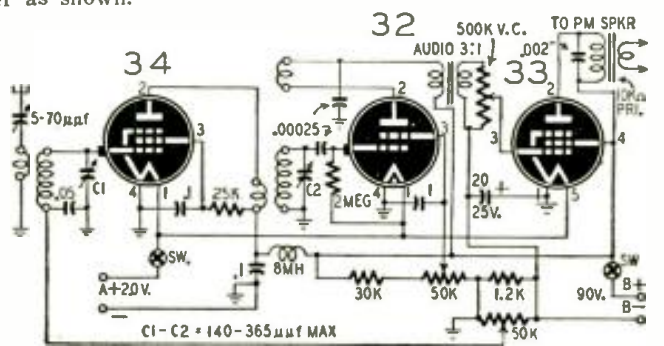

HERSHEL *Offers* BETTER BARGAINS . . . BIGGER BUYS

CONDENSERS

Cat. No.	Cap. MFD.	Working Volts	Your Cost
C110	1	3000 Oil	\$3.95
C111	3	4000 Oil	\$4.95
C112	1	1000 Oil	44c
C114	8	600 Oil	95c
C115	2	600 Oil	49c
Westinghouse 1 MFD 6000 volts WVDC			\$7.95
Westinghouse 1 MFD 10,000 volts WVDC			\$12.95

CHOKES

Thoradson 8 HY 150M choke, Cat. No. FC-201	95c
Thoradson 8 HY 175M choke, Cat. No. FC-202	\$1.49
Thoradson 12 HY 25M choke, Cat. No. FC-203	39c
Thoradson 8 HY 350M choke, Cat. No. FC-204	\$4.95

FILAMENT TRANSFORMERS

Thoradson 6.3 V-4 amps., 6.3 V-4.5 amps., 9.7 V-3 amp., pri. 110 V AC 25 or 60 cy.—Cat. No. FT-11	\$1.95
Thoradson pri. 110 V 60 cy.—sec. 6.3 V 6 A, CT—Cat. No. FT-12	\$1.49
Thoradson 110 V 60 cy. pri., sec. #1-2.5 V, 10 A Ct, 3000 V Int., sec. #2 10 V 3.25 A, Two 5 V 3 A; 6.3 V 1 A—Cat. No. FT-13	\$4.95

MICA CAPACITOR

.002 MFD 3000V VDC, Cat. No. RT-101

IF TRANSFORMER

Mounted in aluminum shield can 1500 KC, with air trimmer, impedance coupled type, Cat. No. T-19

30MC IF TRANSFORMER

In square aluminum can, silver slug tuned, Cat. No. T-20

RECEIVER AND TRANSMITTER

SCR-522, 100-156 MC receiver and transmitter. Used in good condition. Cat. No. RT-10

HALLICRAFTER RECEIVER

R45/ARR7—contains xtal filter, variable I.F. selectivity A.V.C. and A.M.L. B.F.O. patented after 5K28A Hallicrafter, voltage regulator complete with tubes and power supply components for 110V operation. Catalog No. 5K28A

SELSYN MOTORS

The ideal way of indicating the position of rotary beams, wind indicator, etc. (400 cycle). Line cord and instructions for 110 VAC operation furnished.—Cat. No. SM-100

R44/ARR-5 HIGH FREQUENCY

receiver. Patterned after S-36A by Hallicrafters. Receives FM and AM signals in the spectrum between 28 and 145 megacycles. Circuit has 14 tubes including voltage regulator for high frequency oscillator. Has two position selectivity control. Contains no internal power supply. Has acorn tubes RF, Osc., and Mixer. Complete with components for power supply including transformer, choke, filter condensers, and rectifier tube.

ALL ORDERS F.O.B. DETROIT

MINIMUM ORDER — \$2.00

Mich. Sales add 3% Sales Tax

Write for **FREE** Bulletin



NEW BC 223 AX TRANSMITTER

801 Oscillator and 801 Power Amplifiers, 2-44 Modulators and 1-44 Speech Amplifier 4 Xtal Frequencies and Master Oscillator on selector switch. 10 to 30 watts output. Tone Voice or C. W. Mod. Ideal for 80 meter band. Comes with 3 coils TU 17A 2000-3000 Kc. TU 18 3000-4500 Kc. TU 23 3500-5250 Kc. Black wrinkle case. Includes 2 separate cases to store extra coils. Frequencies chart and tubes included. Packed in original cases, less crystals at this low price.

\$29.95



BC 654 TRANSMITTER & RECEIVER

Frequencies range 3800-5800 Kc.—calibration every 10 Kc.—with crystal oscillator checked every 200 Kc.—power output 17 watts, voice or CW. Less tubes

\$7.95

1 KW MODULATION TRANSFORMER

\$14.95 BUY NOW AND SAVE

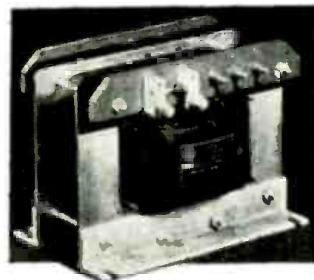

RCA modulation transformer is conservatively rated at 550 Watt audio to modulate that new KW rig.

Really rugged construction with protective flashover gaps, which are adjustable. Terminals and gaps are mounted on a "Mylolac" terminal board. The laminations that make up this transformer are of high audio quality and are extremely thin, making it impossible for the core to "chatter or talk."

Audio Watts—550 Sec. #1—450 Mils Sec. #2—80 Mils Turns Ratio—Pri. Sec. # 1-1:1 Pri. Sec. #2-5:1 Pri. Sec. #2 Tap—25:1

Impedance Ratio—Pri. #1-1:1 Sec. Pri. Sec. #2-23:1 Pri. Sec. #2 Tap—625:1

DC Resistance—Pri: 135 ohms Sec: #1, 112 ohms; Sec. #2, 99 ohms.

Transformers insulation tested: Pri. 8000V; Sec. #1-11-000V; Sec. #2-2000V. to the rest of the coils and core. Primary center-tapped for Class "B" modulators. Secondary #2 will carry 80 Mils to modulate screens of beam power or screen grid tubes.

Primary will match any Class "B" tubes up to 10,000 ohms plate to plate, such as 810's, 75T's, 800S's, ZB120's, 203's, HV512's, 211's, 813's, 828's, 805's, 203Z's.

Size 9 1/2" wide, 7 1/2" deep, 7 1/4" high. Heavy channel iron mounting brackets.

Weight approx. 40 lbs. Catalog number MT-100.

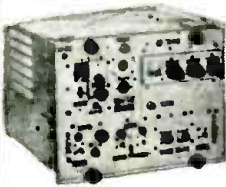

BN IFF

Transmitter & Receiver

Transmitter and receiver. The famous boat anchor, widely used on 144 MC band. Shipping weight 100 lbs. Your price, less tubes and power transformer.

\$14.95

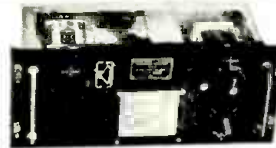

TUNING UNIT

Turning Unit DC 375. Approx. 65 M.M.F.D. cond., coils, RF chokes

dials, ext'd. mica condensers

2500 WVDC, over \$50.00 in parts. Cat. No. TU-101

\$37.50



BUTTERFLY CONDENSERS

Type B—frequency range 300 to 1000 megacycles to be used with 361A5 door knob tube. Cat. No. BC-2

95c ea.

DYNAMOTOR

Power supply—inputs 6 or 12 V, output 300 VDC at 160 MA. mounted on base with circuit breakers, relays, interference filter and two 10 ft. cables. U. S. Govt. surplus. Cat. No. DM-101

\$9.95



TUBES

813	5.45
RK60	1.25
VT127	2.95
VR150	.69
829	2.45
872	1.95
211	1.45
368AS	4.95

IT4
3S4
IS5
6SL7
3Q4
IR5
6SN7
6SA7

59¢ each

HOT SPOT SPECIALS

Ass't resistors 1/2 watt fully insulated, in popular ohmages. Cat. No. R-5—per 100

Ass't mica condensers, Cat. No. C-12—per 100

Water sockets, 4-5-6-7 and 8 prong. Cat. No. WF-4—per 100

12" Utah P. M. Speaker, Alnico J5 with 66 output transformer. Cat. No. ST-100

Ass't knobs push on wood and plastic. Cat. No. KP-100—per 100

6J4 . . . \$1.50 6J6 . . . 95c

Johnson sockets #210-25W. Cat. No. JS-210

955-9004 tubes. Cat. No. T-99

Sockets for acorn tubes. Cat. No. AT-10

8-8 MFD 350 WVDC, 20 MFD 150 WVDC, round can. Cat. No. RC-88

Hallicrafter volume knobs—SX 28 . . . 15c

Pots—screw driver shaft, 2 meg., 1 meg., 150M, 50M, 25M, 5M, 2M, 200 ohm—ea.

A 144 MC Radar Osc., uses 15 E or Hy 75. Enclosed silver plated tank with variable coupling. Complete less tube

Jacks PL 55, PL 68 . . . 15c

Powdered iron slug with Isolonite coil form to match. Ideal for broad tuning E.C.O.

Powdered iron 3/4 slug . . . 10c

1 Meg. Shalcross Acra—Oam wire wound resistors

±1W 89¢

HERSHEL RADIO CO.

5249 GRAND RIVER

DETROIT 8, MICHIGAN

20% DEPOSIT REQUIRED ON ALL C. O. D. ORDERS

NEW

RADIO-ELECTRONIC DEVICES

FLAW DETECTOR

General Electric Co.
Schenectady, N. Y.

The new GE flaw detector can continuously detect and count holes, weak spots, and conducting paths in thin materials, such as paper, sheet rubber, sheet mica, varnished cloth, plastic materials, and enamel films on wire during manufacturing processes. It can be applied to sheet materials up to 0.025 inch thick moving as fast as 450 feet



per minute and to wire moving up to 100 feet per minute.

It consists of an electrode assembly through which an adjustable voltage is applied to the material undergoing test, and an electronic circuit which indicates the flow of current through the material when a flaw passes under the electrode.

The detector can be made to sound an alarm, operate a recorder, or shut down the manufacturing process when flaws are encountered, and can be arranged to indicate when flaws exceed a given total.—RADIO-CRAFT

HIGH-FREQUENCY PROBE

Alfred W. Barber Laboratories
Flushing, N. Y.

The Model 29 high-frequency probe is designed with an input capacity of 1/2 to 1 µmf, which extends its useful range to 500 mc.

It is designed to replace the standard

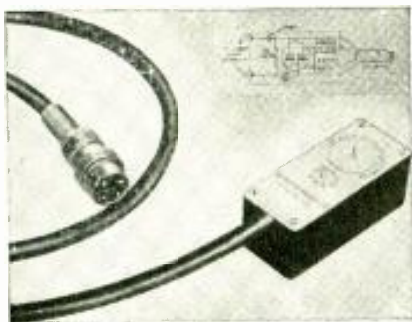

probe used with the Model VM-27 v. t. v. m. It has one-tenth the sensitivity of the standard probe. Consequently, all measured voltages are ten times the indicated values. With the new probe, the Model VM-27 voltmeter has full-scale ranges of 10, 30, 100, 300 and 1000 volts.—RADIO-CRAFT

D.C. RELAYS

Leach Relay Co.
Los Angeles, Calif.

The new Type 7064-534 relay is a light-weight solenoid d.c. type.

Designed for feeder type planes and small personal aircraft. It is capable of operating at altitudes up to 50,000 feet and at temperatures between minus 54 C and plus 71 degrees C.

Designated Type 7064-534, this relay is supplied with intermittent duty coils for motor starting applications. Type 7064-534-C has duty coils for battery switching, motor control, aircraft and marine radio switching and lighting.

Contacts are made of special silver alloy, are 3/8 inches diameter, and rated at 100 amperes at 12 volts d.c. or 75 amperes at 24 volts d.c. Contact arrangement is s.p.s.t., double break, normally open. Dependent upon the voltage and operating requirements, the coils have a resistance of from 9.5 ohms to 110 ohms. On intermittent duty, coils consume approximately 15.12 watts and 5.23 watts for continuous duty. Each relay weighs approximately 8 1/2 ounces.—RADIO-CRAFT



SIGNAL TRACER

Feiler Engineering Co.
Chicago, Illinois

The TS-2 and TS-3 are battery and a.c.-operated signal tracers, respectively, with jacks for attaching phones, r.f.



or audio output meters. The TS-2 uses two 1T4 and one 3Q4 tubes; the TS-3, two 1T4, one 6K6-GT and one 6X5-GT.

Speaker is a 5-inch PM dynamic (for both models). The probe is 1 inch in diameter, 4 3/8 inches long, made of aluminum. It houses the miniature tube, isolating network and associated circuits for the special detector-amplifier. Cable is 3 feet long, heavy rubber-covered.

Size of both models, 8 x 11 x 6 inches. Weight of TS-2 with batteries, 5 1/2 lbs.; of TS-3, 10 1/2 lbs. Case is steel in brown iridescent finish, with beige control panel.—RADIO-CRAFT

CHASSIS RACKS

Aetna Radio Service
Chicago, Ill.

The *Changerak* and *Chasirak* are chassis racks for record changers and small radios respectively.

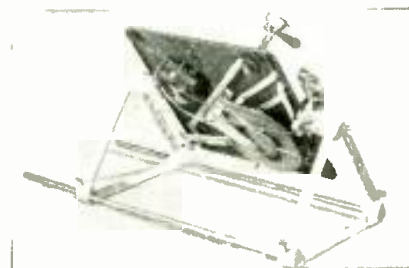

The *Changerak* is quickly adjustable to any size record changer, locks positively in any position, and permits normal operation of the unit while in the rack. The changer may be left in the rack till final delivery, which will prevent damage or change in adjustments.

The *Chasirak* is a small sheet-metal device into which a midget chassis can be clamped quickly. Large radios may be handled by using two *Chasiraks*.

—RADIO-CRAFT



SIGNAL GENERATOR

Premier Electronic Laboratories
New York, N. Y.

The Model 570 Signal Generator puts out modulated or unmodulated r.f. on fundamental frequencies from 75 kc to 50 mc, and up to 150 mc on harmonics. The 6J5 oscillator, with air trimmers, feeds into one section of a 6SN7 which is used as a buffer amplifier. The a.f.



oscillator, using the remaining half of the 6SN7, provides 400-cycle modulation with less than 5-percent distortion. Provision is made for applying external audio modulation to the r.f. signal. The power supply operating from a 117-volt a.c. line, uses a 6X5 rectifier.

The dial is direct-reading with a knife-blade pointer driven by a spring-loaded vernier knob. A smaller dial, geared to the main pointer, helps to provide reset calibration accuracy up to 0.5 percent to 1,600 kc and 1 percent on higher frequencies.—RADIO-CRAFT

MARKED RESISTORS

Ohmite Manufacturing Co.
Chicago, Ill.

In addition to RMA color coding, these insulated fixed resistors are now individually marked with resistance and wattage for quick, positive identification.

Little Devils are small—size of the 1/8-watt is only 3/8-inches long by 9-64th-inch diameter—the 1-watt, only 9-16-inch long by 7-32-inch diameter—the 2-watt, 11-16-inch long by 5-16-inch diameter.—RADIO-CRAFT

ELECTRONICS KIT

Deer & Taylor Co.
Berkeley, California

The Magi-Klips experimenter's kit consists of a chassis on which is mounted a 4-inch PM speaker with output



RADIO-CRAFT for MAY, 1947

TOP BUYS!

U.S. GOVERNMENT SURPLUS ELECTRON TUBES

Type	Your Cost	Type	Your Cost	Type	Your Cost	Type	Your Cost
3AP1	\$2.95	12DP7	\$6.95	5Y3	.43	6SF5	59c
3BP1	2.95	829B	3.50	50L6	.69	6V6GT	69c
5BP1	3.95	6Y6G	.59	6AG7	.69	12SQ7	59c
5CP1	3.95	6AK5	.95	2X2	.79	89	49c
5FP7	3.95	5U4	.59	6SJ7	.49	77	49c
7BP7	4.95	78	.49	12SH7	.49	39-44	49c
9LP7	5.95	12A6	.69	6SS7	.49	2B7	49c
304TH	7.95	6K7	.49	7S7	.49		

RADIO RECEIVERS

BC-454-A; 3-6 mc	\$6.95
BC-433-A; 100-550 kc	\$8.95
BC-455-A; 0-9.1 mc	\$6.95

RADIO TRANSMITTERS

BC-357-A; 4-5.3 mc	\$7.95
BC-458-A; 5.3-7 mc	\$7.95

MODULATOR UNIT

BC-456-A	\$6.95
----------	--------

REMOTE CONTROL BOX

BC-450-A	\$2.95
----------	--------

ARMY AIRCRAFT RECEIVER

Model BC-946-B

Broadcast band from 520 to 1500 Kc. Tube complement: 3-12SK7, 1-12SR7, 1-12A6, 1-12K8. Designed for dynamotor operation, but is easily converted to 110 or 32 volt operation. Has two I.F. stages and three gain condensers. Comes packed in sealed carton complete with tubes and instruction manual, but less dynamotor. **\$12.95**

IFF RADIO RECEIVERS

Signal Corps, complete with 13 tubes. Model IC-946-A—only **\$9.95**

MARKER BEACON RECEIVER—AIRCRAFT

Complete with 2 tubes and sensitive relay to control external circuits from received signals. The receiver to control models, open doors from a distance, etc. Special **\$4.95**

COMPLETE 4-TUBE INTERPHONE AMPLIFIER

Comes in an aluminum cabinet, 9 1/4 x 4 1/2 x 5 1/2 inches with two 12J5GT and two 12A6 tubes; also Electric Dynamotor 28DC Volt input and 250 V DC output at 80 MA. Yours for only **\$7.95**

ALL SHIPMENTS F.O.B. CHICAGO. 20% DEPOSIT REQUIRED ON ALL ORDERS

RADIO TRANSMITTER AND RECEIVER APS-13

Light weight air-borne radar system, radio transmitter and receiver APS-13; tube complement: 5-6J6; 9-8AG5; 1-VR105; 2-D21; unit is brand new, complete with tubes, the tubes alone are worth **\$15.00** more than this LOW PRICE OF ONLY **\$15.00**

GLIDE PATH RECEIVER R-89/ARN-5

Glide Path Receiver used in the Instrument Landing System covering the frequency range 332 to 335 mc; complete with the following tubes: 7-6AJ5; 1-12SR7; 2-12SN7; 1-2ND7 and including three crystals 6497KC; 6522KC; 6547KC—units are in **\$6.95** A-1 condition for only

ARMY SURPLUS, principal components of radio set SCR-274-N; includes 2 transmitters, 3 receivers, 1 modulator, 4 dynamotors, control box, etc.—original cost over \$600.00. **\$34.95** NOW—complete

SCR-522 TRANSMITTER AND RECEIVER

The standard very-high frequency airborne receiver-transmitter, 100 to 156 megacycles, 4 crystal-controlled channels selected from remote control box. In excellent condition—ONLY **\$19.95**

SETCHELL CARLSON RADIO RECEIVER

BC-1206-C

Designed to receive A-N beam signals, 21-23 vdc, 21.6 watts. Tube complement: 14H7 or 14A7, RF amplifier; 14H7 or 14J7, mixer; 14A7 or 14H7, IF amplifier; 14H7, detector and 1st audio amplifier; 28D7, output amplifier, 195 to 420 Kc. 4" high x 4" wide x 6 1/2" long—wt. 3 lbs. 14 ozs. Used—A-1 condition **\$4.95**

BRAND NEW in original carton. Complete with tubes **\$7.95**

DYNAMOTOR DM 32A \$1.95

Each

RADAR OSCILLOSCOPE

Complete with 27 tubes including 5" Cathode Ray Tube—used—each **\$24.95**

RADAR OSCILLOSCOPE

Complete with 29 tubes including 3" Cathode Ray tube—used—each **\$24.95**

ARROW SALES, INC.

59 WEST HUBBARD STREET • CHICAGO 10, ILLINOIS

Telephone: SUPERIOR 5575

transformer, a 50L6 power amplifier tube, a 35Z5 rectifier tube, a plate circuit relay, a 2-gang tuning condenser, a 12SL7 twin-triode tube and a tuning coil socket. A number of extra resistors and condensers are supplied, as well as two plug-in coils.

Leads from the components are run out to 24 Fahnestock clips, making a large number of combinations possible. Among the circuits which can be made

up are a regenerative receiver, home broadcaster, code practice oscillator, photoelectric relay, signal tracer, and remote control relay.—RADIO-CRAFT

TUBE TESTER

Triplett Electrical Instrument Co.
Bluffton, Ohio

The Model 2425 tube tester provides transconductance readings through a simple measurement directly proportional to Gm and a properly calibrated measuring instrument. No possibility of grid overloading. Short and open tests of every tube element. Gas tests of all tubes.

Metal case, 10 x 10 x 5 1/2 inches with tan hammered enamel finish, brown trim. Removable cover.—RADIO-CRAFT

SPECIALS



**REDUCE
C.W.
QRM!**

X-315 AIRCRAFT RADIO BEAM FILTER
Filter tuned to 1020 cps. and can be used to eliminate interfering C.W. signals. Used with aircraft receivers, to fly radio marker beam, or receive voice signals from marker beam stations.

BRAND NEW \$4.50

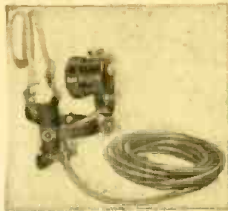

**M-110 WESTERN
ELECTRIC SOUND
POWERED
MICROPHONES.**
Complete with chest-plate & 20 ft. of high grade mlko cable, \$8.50. With 50 ft. length of cable \$7.50.

BRAND NEW

SPECIAL ASSORTMENT OF FIFTY RESISTORS

Containing: 5 watt w.w., 5-100 ohm, 4-200 ohm, 6-400 ohm, 1-800 ohm, 4-500 ohm; 10 watt w.w., 10-10,000 ohm, 2-400 ohm, Tap, 50 ohm, 1-40 ohm, Tap, 10 ohm; Cartridge w.w., 1-4000 ohm, 20 w., 1-400 ohm, 1w.; 15 Assorted Carbon Resistors.

COMPLETE ASSORTMENT for ONLY \$4.00

ALTEC LANSING SPEAKERS, AMPLIFIERS & TRANSFORMERS. MAGNETIC WIRE & TAPE RECORDERS... SOUND EQUIPMENT

SEND for our BARGAIN FLYER

30% Deposit with COD's. Min. Order \$3.00. Many other items & specialties. Quality sound & recording equipment.

CLARION SOUND ENGINEERING CO.
963 Victory Boulevard, Staten Island 1, N. Y.
Phone: Gibraltar 7-8975

RECORDING AMPLIFIER

In perusing my article: "Small Recording Studio, Part I" I find the resistor values in the 6SN7 voltage amplifier are incorrect as printed. I am enclosing a correct circuit diagram for the amplifier, together with an additional feedback resistor for use if a builder encounters oscillation in the tone control circuit. Rx1 and Rx2 should be from 20 to 30 thousand ohms each.

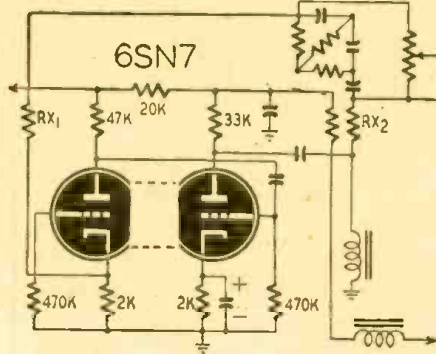

Good results will follow installation of Rx2 whether there is oscillation in the circuit or not. It should then be about 25,000 ohms.

J. C. HOADLEY,
West Newton, Mass.

If a television receiver refuses to work well, ten to one the fault is a poor antenna installation, say television service experts.



Hard-to-Find and Special Purpose

TUBES

991	\$.27	6AL5	\$.89
1629	.27	2051	.89
6AK5	.89	6SU7	.98
5R4GY	.79	6L7	1.19
		6AK6	1.59

CORNING PYREX INSULATOR #67017

7 1/2" OVERALL **89c** ea.
Your cost..... List \$2.25

4 mfd. 600 volt
TRANSMITTING CONDENSERS
G.E. PYRANOL **79c** ea.
Your cost.....

MALLORY VIBRATOR 534C
Same as Radiart 5605 **\$2.29** ea.
Your cost..... List \$7.65

Synchronous Vibrator. Adjusted to handle high output voltage. Used in Mallory and Radiart Vibrapacks.

7-Prong, 2 Volt
GE-TYPE VIBRATOR **\$1.97** ea.
Used in GE self-charging portables. Special

PEERLESS RADIO DISTRIBUTORS, INC.
#92-32 JERICHO RD., JAMAICA 3, N. Y.
Branch: #71, MURRAY STREET, NEW YORK 7, N. Y.

Take your choice of these FREE GIFTS from OLSON

100 POPULAR CIGARETTES

Free

with your purchase of \$15 or more in Radio Parts. Lucky Strikes, Camels or Chesterfields — smoke 'em or give 'em away! Make up an order and use the coupon TODAY.



Vacuum-Packed Tin of Planters Peanuts

Free

with your purchase of \$10 in Radio Parts; a \$20 purchase brings you TWO tins, etc. Big 1/2 lb. can of fresh, delicious Salted Jumbo Peanuts of famous quality! Use the coupon TODAY.



NEW, 200-PAGE HANDBOOK

Free

with your purchase of \$10 or more in Radio Parts. A practical guide to help you operate a shop or store successfully. Packed with valuable information! Use the coupon today.



Help yourself to a gift from Olson Radio Warehouse, and get a square deal in Radio Parts too! These gifts are free to our customers — proving that you get MORE for your money when you buy from OLSON. Try it and see!

Here's how to get your Free Gift: Look through our

catalog (you should have one) and make up an order in the amount specified for the gift you want. Mail this order to us and enclose the coupon below. Do it NOW!

IF YOU DON'T HAVE A COPY OF OUR LATEST CATALOG, SEND FOR IT. NO CHARGE, OF COURSE.



Mail us an order today,
and attach this coupon →
for your Free Gift!
OLSON RADIO WAREHOUSE, Inc.

73 E. MILL ST., DEPT. 79, AKRON, OHIO

OLSON RADIO WAREHOUSE 73 E. MILL ST., AKRON, OHIO
I enclose an order totalling \$..... Send me FREE the gift checked below.

100 CIGARETTES (Luckies Camels Chesterfields)
 PLANTERS JUMBO PEANUTS 200-PAGE HANDBOOK

NAME _____

ADDRESS _____

CITY _____ STATE _____ 79

Sensational Value!

BUILD YOUR OWN VOLT-OHM MILLIAMMETER!!

The model KT 20 kit provides *all* components, including meter, panel, cabinet, resistors, condensers, tip jacks, control, selector switch, copper oxide rectifier, pre-cut wires—in fact every component and part needed to complete the unit.

THE KIT COMES COMPLETELY ASSEMBLED. Can be wired in 15 minutes. Components and circuit guaranteed to meet the following specifications:

- 4 A.C. VOLTAGE RANGES: 0-15/75/300/1500 volts.
- 4 D.C. VOLTAGE RANGES: 0-15/75/300/1500 volts.
- 2 A.C. CURRENT RANGES: 0-15/150 MA.
- 2 RESISTANCE RANGES: 0-10,000 ohms; 0-1 Megohm.

Complete kit including all parts assembled and ready for wiring, circuit diagram, easy-to-follow instructions and detailed operating data for the completed instrument.

Only
\$9⁵⁰



The New Model B-45 SIGNAL GENERATOR

Self-modulated—provides a highly stable signal. RF frequencies from 150 Kc. to 12.5 Mc. on Fundamentals and from 11 Mc. to 50 Mc. on Harmonics. Modulation is accomplished by gridlocking action—equally effective for alignment of amplitude and frequency modulation as well as for television receivers. Self-contained batteries. All calibrations are etched on the front panel.

Complete, ready to operate **\$27⁷⁵**

The New Model 670 SUPER-METER

A Combination VOLT-OHM-MILLIAMMETER plus CAPACITY REACTANCE INDUCTANCE and DECIBEL MEASUREMENTS.

- D.C. VOLTS: 0 to 7.5/15/75/150/750/1500/7500 Volts
- A.C. VOLTS: 0 to 15/30/150/300/1500/3000 Volts.
- OUTPUT VOLTS: 0 to 15/30/150/300/1500/3000 Volts.
- D.C. CURRENT: 0 to 1.5/15/150 Ma; 0 to 1.5 Amperes.
- RESISTANCE: 0 to 500/100,000 ohms; 0 to 10 Megohms.
- CAPACITY: .001 to .2 Mfd. .1 to 4 Mfd. (Quality test for electrolytics).

- REACTANCE: 700 to 27,000 Ohms; 13,000 Ohms to 3 Megohms.
- INDUCTANCE: 1.75 to 70 Henries; .35 to 8,000 Henrys.
- DECIBELS: -10 to +18, 10 to +38, +30 to +58.

The Model 670 comes housed in a rugged, crackle-finished steel cabinet complete with test leads and operating instructions. Size 5 1/4" x 7 1/4" x 3".



\$28⁴⁰



The New Model CA-11 SIGNAL TRACER

Simple to operate . . . because signal intensity readings are indicated directly on the meter!

- ★ SIMPLE TO OPERATE—only 1 connecting cable—NO TUNING CONTROLS.
- ★ HIGHLY SENSITIVE—uses an improved Vacuum Tube Voltmeter circuit.
- ★ Tube and resistor-capacity network are built into the Detector Probe.
- ★ COMPLETELY PORTABLE—weighs 5 lbs. and measures 5" x 6" x 7".
- ★ Comparative Signal Intensity readings are indicated directly on the meter as the

Detector Probe is moved to follow the Signal from Antenna to Speaker.

★ Provision is made for insertion of phones. The Model CA-11 comes housed in a beautiful hand-rubbed wooden cabinet. Complete with Probe, test leads and instructions

\$18⁷⁵

The New Model 450 TUBE TESTER

Speedy operation—assured by newly designed rotary selector switch which replaces the usual snap, toggle, or lever action switches.

SPECIFICATIONS:

- ★ Tests all tubes up to 117 volts. ★ Tests shorts and leakages up to 3 Megohms in all tubes. ★ Tests both plates in rectifiers. ★ New type line voltage adjuster. ★ Tests individual sections such as diodes, triodes, pentodes, etc., in multi-purpose tubes. ★ Noise-Test—detects microphonic tubes or noise due to faulty elements and loose internal connections. ★ Uses a 4 1/2" square rugged meter. ★ Works on 90 to 125 volts 60 cycles A.C.

EXTRA SERVICE—May be used as an extremely sensitive condenser Leakage Checker. A relaxation type oscillator incorporated in this model will detect leakages even when the frequency is one per minute

\$39⁵⁰

- OUR POLICY**
- We do not advertise any unit which is not available for immediate shipment from stock.
 - Less flowery adjectives, more detailed specifications.
 - All units are sold subject to one year guarantee except when components are damaged through misuse.

- We do not solicit orders for any unit that does not meet our requirements for accuracy and honest value. Any item purchased from us is sold with the understanding that it may be returned for full refund after a 10-day trial.

**20% DEPOSIT REQUIRED
ON ALL C.O.D. ORDERS**

GENERAL ELECTRONIC DISTRIBUTING COMPANY
98 PARK PLACE, Dept. R. C. 5 NEW YORK 7, N. Y.

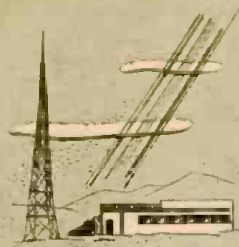

RADIO STATION STANDBY



MOBILE RADIO UNITS



GEOPHYSICAL SURVEY



MUNICIPAL SIGNAL STANDBY



RAILROAD RADIO

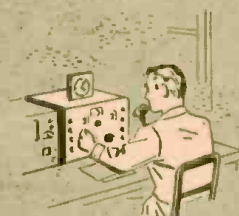

AMATEUR RADIO



"SPOT" RECORDING

A.C. OR D.C. POWER

PORTABLE, STANDBY OR STATIONARY for Electronics Uses

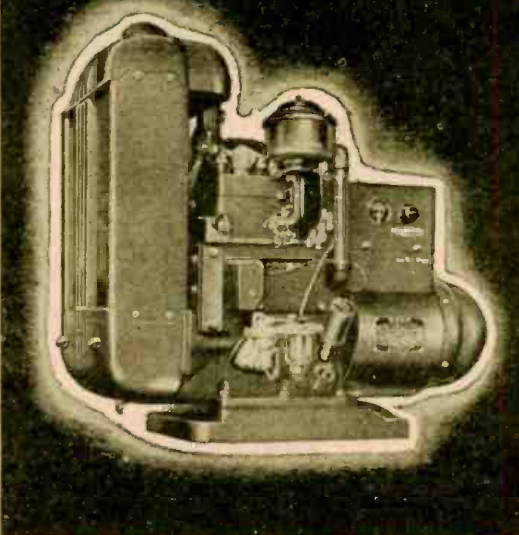

Onan Electric Plants are completely self-contained, dependable power units built in a wide range of sizes and standard voltages.

Lightweight, one or two-cylinder, air-cooled models offer the maximum in portability for many applications. Portable A.C. models—350 to 3,000 watts; portable D.C. models—600 to 5,000 watts.

Although widely used for intermittent service as standby units, Onan two, four, and six-cylinder water-cooled plants are built for continuous heavy-duty operation . . . stationary or mobile. A.C. models—3 KW to 35 KW; D. C. models—3.5 KW to 10 KW.

WRITE FOR FOLDER

ONAN Electric Plants are available in many sizes and models. ALTERNATING CURRENT: 350 to 35,000 watts in all standard voltages and frequencies. DIRECT CURRENT: 600 to 10,000 watts, 115 and 230 volts. BATTERY CHARGERS: 500 to 3,500 watts; 6, 12, 24 and 32 volts.

D. W. ONAN & SONS INC.

2437 Royalston Ave.

Minneapolis 5, Minn.



NEW FRENCH RADIO PARTS

(Continued from page 40)

When you put the iron on its support a contact opens which puts an open-wound resistor in series with the heating element. The current decreases, remaining just sufficient to maintain the temperature of the iron.

Measuring apparatus

Contrary to the practice of previous years, measuring apparatus and test equipment was exhibited at the Parts Show. Before the war France was much



The 7 1/2-inch potentiometer described below.

behind in this domain. But the technicians have done a very fine job in this field, and the measuring apparatus now presented compares well with foreign production. We particularly noted an impedance bridge—(5) on page 40—which permits the measuring of all the inductors and capacities over a very large range. The leading feature of the instrument is a potentiometer of which the diameter is 7 1/2 inches and which makes it possible to obtain precision results.

Another highly interesting apparatus is a universal generator—(6) on page 40—which covers radio frequencies 50 kc to 50 mc with an output variable from 1 μ v to 1 v, six different modulation frequencies and the possibility of functioning as a multivibrator to facilitate alignment of receivers.

To sum up, the French Radio Industry, despite all difficulties, is developing favorably.

ANOTHER SPECIALIST

Specialization in radio has reached such a level that even radio thieves are specializing, if a last month's report emanating from Britain is to be believed.

According to a story in the *Scottish Radio Trade Digest*, an unemployed truck driver, Robert A. Fisher of Norwich, stole a receiver from one radio shop and sold it to another dealer. Returning a couple of days later, he sold the dealer an electric iron, then on leaving left the door open so the bell would not ring. Returning a few minutes later, while the dealer was busy in the back of the shop, he re-stole the radio and decamped.

Specialization in crime does not go unrewarded. The brand-conscious thief was captured and sentenced to 12 months in jail. The cell is *not* to be radio-equipped.

NOW AVAILABLE FOR IMMEDIATE DELIVERY FROM STOCK!

THE NEW MODEL 670

SUPER-METER



**A Combination VOLT-OHM-MILLIAMMETER
plus CAPACITY REACTANCE INDUCTANCE
and DECIBEL MEASUREMENTS.**

Added Feature: The Model 670 includes a special GOOD-BAD scale for checking the quality of electrolytic condensers at a test potential of 150 Volts.

Specifications

- D.C. VOLTS: 0 to 7.5/15/75/150/750/1,500/7,500 Volts.
 - A.C. VOLTS: 0 to 15/30/150/300/1,500/3,000 Volts.
 - OUTPUT VOLTS: 0 to 15/30/150/300/1,500/3,000 Volts.
 - D.C. CURRENT: 0 to 1.5/15/150 Ma.; 0 to 1.5 Amperes.
 - RESISTANCE: 0 to 500/100,000 ohms; 0 to 10 Megohms.
 - CAPACITY: .001 to .2 Mfd., .1 to 4 Mfd. (Quality test for electrolytics.)
 - REACTANCE: 700 to 27,000 Ohms; 13,000 Ohms to 3 Megohms.
 - INDUCTANCE: 1.75 to 70 Henries; 35 to 8,000 Henries.
 - DECIBELS: -10 to +18, +10 to +38, +30 to +58.
- Housed in a rugged, crackle-finish steel cabinet complete with test leads and operating instructions. Size 5½" x 7¼" x 3".

\$28⁴⁰

PLEASE PLACE YOUR ORDER WITH YOUR REGULAR RADIO PARTS JOBBER. IF YOUR LOCAL JOBBER CANNOT SUPPLY YOU, KINDLY WRITE FOR A LIST OF JOBBERS IN YOUR STATE WHO DO DISTRIBUTE OUR INSTRUMENTS OR SEND YOUR ORDER DIRECTLY TO US.

SUPERIOR INSTRUMENT CO., 227 Fulton St., Dept. RC-5, New York 7, N. Y.

and convert them into the necessary high voltage. A pair of parallel tubes are placed across the deflecting coils to damp out any oscillations after the retrace period. A centering control is contained in the same circuit. It functions as previously described.

Note that this power supply does not depend upon oscillations in the transformer (since none occur), but only on the high voltage which is developed during the retrace interval. In 1 second, 15,750 of these peaks occur. The problem of filtering these from the final d.c. output voltage can be readily solved by the addition of a 500- μ f condenser and a bleeder resistor.

A voltage doubler circuit

Cascading rectifier tubes to obtain the desired high voltage is not usually attempted in conventional units. In the circuit of Fig. 6, the 8016 tubes are connected so that their plates receive the same potential, at the same time, from the primary of T1. If we trace the flow of current through the first 8016, we find that the electrons flow down through the primary, through the low-voltage power supply to ground, and then up through C1 to the cathode of the 8016. In this way, C1 becomes charged to essentially the peak voltage of the retrace pulse appearing across the primary of T1. The polarity of the voltage across C1 is as indicated, with the ground end negative and the other plate positive. Let us assume that this peak voltage is 5,000 volts. Actually it

TELEVISION FOR TODAY

(Continued from page 50)

may be higher, depending upon the design of T1.

The plate of the second 8016 also receives the same pulse potential. Under the impetus of this force, electrons flow through the tube, down through the resistor R1, through C2, and back to the tube. Current flows until the condenser C2 is charged to the peak applied voltage. Note the polarity of the charge across C2. If a connection is made to the cathode end of C2, the voltage existing between this point and ground is the sum of the peak voltages of C1 and C2. Since they are series aiding, 10,000 volts is available between point A and ground. A bleeder resistor chain from point A to ground will make available additional voltages for the focusing and accelerating electrodes of the cathode-ray tube. Separate filament windings for the 8016 tubes are necessary because of the different d.c.

potentials on each. In this instance, under the conditions assumed, each differs by 5,000 volts from the other.

For projection tubes, it is customary to design T1 for a peak pulse voltage of 7,500 volts. Then, four 8016's are connected in cascade, and the output potential is 4 x 7,500, or 30 kv.

Typical voltage regulation curves for the two types of high-frequency power supply are shown in Figs. 7 and 8. According to the standards of conventional low-voltage 60-cycle units, the regulation of the high-voltage supplies is not good. However, the current requirements of the cathode-ray tube are small and the variation in current during op-

(Continued on page 78)

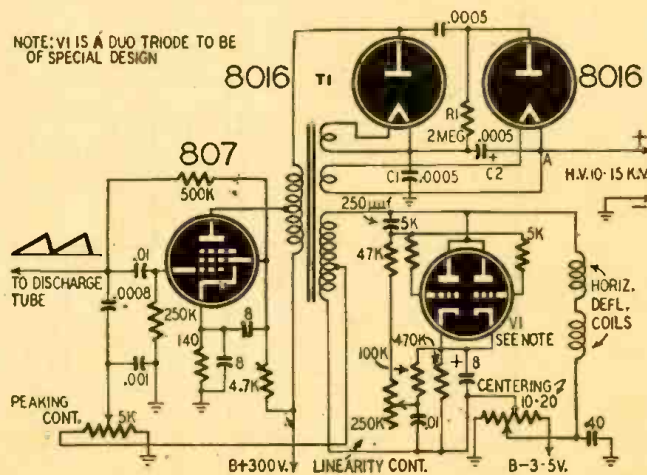

Fig. 6—An "inductive-kick" type of voltage-doubling power supply.

METROPOLITAN'S 4 GREAT VALUES!



The New Model 111 AC-DC QUALITY MULTITESTER

A new pocket-size volt-ohm-milliammeter with features never before available in an instrument of this size and price.

D.C. Voltmeter: 0-5-50-250-500-2500 volts. A.C. Voltmeter: 0-10-100-500-1000 volts. Output Voltmeter: 0-10-100-500-1000 volts. D.C. Milliammeter: 0-1-10-100 milliammeters. D.C. Amperes: 0-1-10 amperes. Ohmmeter: 0-500-100,000 ohms; 0-1 megohm. Decibel Meter: -3 to +55 db. The scale is calibrated for line

of 500 ohms impedance. For other impedances correction charts are supplied.

Model 111P, in portable case (not illustrated) including testing leads and complete instructions **\$19.85**

Model 111A, open face, as shown, complete with instructions **\$16.85**

The New Model B-45

Battery
Operated

SIGNAL
GENERATOR

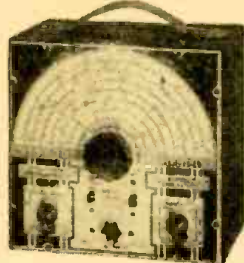

for servicing AM, FM and Television Receivers. R.F. frequencies from 150 Kilocycles to 50 Mcycles (150 Kc. to 12.5 Mc. on Fundamentals and from 11 Mc. to 50 Mc. on Harmonics). Complete with shielded test lead, self-contained batteries and instructions.

Net **\$27.75**

The New Model 200 MUTUAL CONDUCTANCE TUBE TESTER



A tube tester with complete flexibility. Unfailing accuracy in classifying tubes under test on the REJECT-GOOD scale. Absolutely NO DANGER of BAD tubes reading "good" and GOOD tubes reading "bad." Tests all tubes from .75 volts to 117 filament volts.

- 3" Meter in sloping counter case **\$49.85**
- 3" Meter in hand-rubbed carrying case **\$3.85**
- 4 1/2" Meter in sloping counter case **\$2.85**
- 4 1/2" Meter in hand-rubbed carrying case **\$6.85**

VM Automatic CHANGER

with Built-in Amplifier

One of the finest automatic changer units at a price that permits a substantial resale profit. Usually sells for \$39.75. Powerful 3-tube amplifier with 5" Alnico 5 speaker. Precision automatic record changer—sensitive pickup—excellent tone quality—superb performance.



- VM record changer only **\$16.85**
- Base for above **3.95**
- Complete unit with amplifier **29.85**
- Lots of 6 or more **28.75**

ORDERS FILLED SAME DAY RECEIVED!
Terms: 25% Deposit, Balance C.O.D. or full payment with order.

Write for FREE New 1947 Catalog

**METROPOLITAN
ELECTRONIC & INSTRUMENT CO.**
6 MURRAY ST., Dept. CS NEW YORK 7, N.Y.

RADIO-ELECTRONIC CIRCUITS

LOW-VOLTAGE RECEIVER

Here is a circuit of a low-voltage receiver that I find to be sensitive and selective. I have applied a positive voltage to the control and screen grids and use

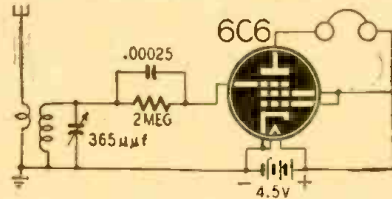

the suppressor as the control grid. In this way, the set works with only 4.5 volts on the various elements.

EMMITT A. BARNES, *Gulfport, Miss.*

(This is a type of space-charge detector. Performance may be improved by using a 6-volt battery.—*Editor*)

CARRIER TRANSCIEVER

I get good results with the following 4-tube carrier-current transceiver. The transmitter is a 6SJ7, suppressor-modulated by a 25L6. For receiving, a 6SJ7 regenerative detector works into the 25L6, which has a pair of headphones switched into its plate circuit. A 50-mh r.f. choke and a pair of 500-µmf condensers prevent r.f. voltages from entering the a.f. amplifier and power supply.

The transmitting coil consists of 160 turns of No. 28 enamel wire on a 1 1/2-inch form with a tap taken off at 50 turns from the bottom end. All of the receiver coils are wound on a common 1 1/2-inch form with No. 32 enamel wire. The grid coil L2 is wound with 300 turns and covered with a thin layer of tape or waxed paper. L4 has 100 turns wound over the grid end of L2,

and the tickler L3 has 75 turns wound close to the ground end of L2.

Bias for the suppressor grid is supplied through a 220,000-ohm resistor and a bias battery. The battery voltage may be adjusted by listening to the signal on another transceiver and adjusting for highest modulation strength with least distortion.

H. O. NORTHERN, *Chattanooga, Tenn.*

A.C.-D.C. V.T.V.M.

Here is a circuit of a vacuum-tube-voltmeter that I have found useful for measuring a.c. and d.c. voltages up to 500 volts. A 6SN7, a 6AG5, and a 1-watt neon lamp are used in a voltage-regulated power supply, and a 6SQ7 acts as meter amplifier and rectifier.

The 6SN7 is connected as a grid-controlled rectifier with its grid voltage derived from the output of the supply. Any changes in the output voltage are neutralized by changes in the internal resistance of the rectifier. A 6AG5 was used as the voltage regulator, but a 6J7, 6K7, and similar tubes can be used with equal results. The bias on these tubes is critical and should be adjusted to give 250 volts between A and B.

When the ranges are changed, the meter should be brought to zero by adjusting the 1,000-ohm control with the leads shorted together.

LEON MEDLER, *Bronx, N. Y.*

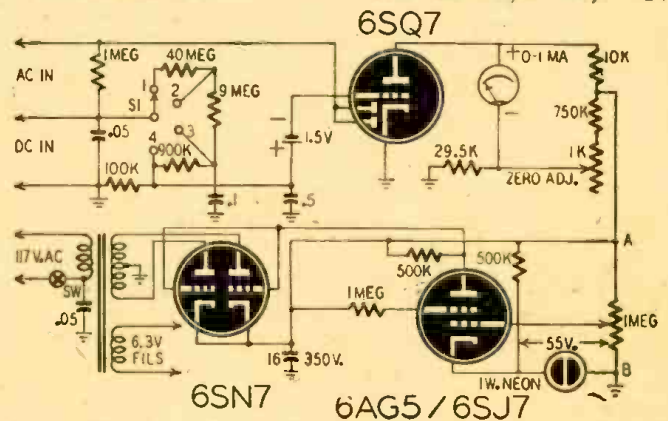

Above—The v.t.v.m. Ranges are—from points 1 to 4—500 volts, 100 volts, 10 volts and 1 volt. Below—Carrier-current transceiver.

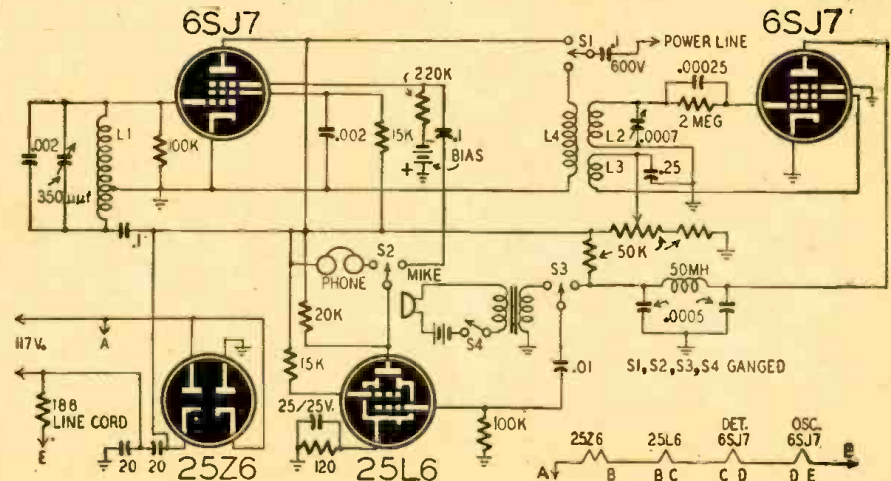

ADDING A PHONO PICKUP

Many commercial radios are fitted with phono input jacks that connect directly to the grid of the first a.f. stage without a volume control. These sets are rewired as shown. R1 (50,000 to 500,000 ohms) decreases the phono input to approximately the same level as the output of the detector and the 0.00025- μ f r.f. filter condenser between the arm of the volume control and ground serves as a high-frequency scratch filter.

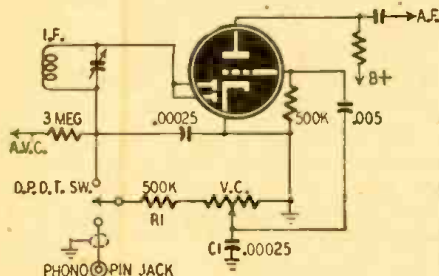

In some sets, the volume control is the entire detector load. In this instance, a 500,000-ohm resistor may be connected in the hot lead of the phono input circuit.

FRED W. RODEY,
Berwyn, Ill.

SAFETY POWER SUPPLY

Here is a system that I use to obtain d.c. voltages from an a.c. line without using a transformer or having one side of the line connected directly to the chassis—undesirable in many applications. It is useful in supplying fixed bias for amplifiers and transmitters and other applications where up to 120 volts is required.



The filter constants will depend on the amount of filtering required.

In the circuit shown, the chassis is positive. The polarity may be reversed by reversing the connections to each diode section. Any double diode such as a 25Z6, 50Y6, or 117Z6 may be used as long as the correct heater voltage is applied. The 6H6 may take its heater voltage from the 6.3-volt line of an amplifier or transmitter and will work well in circuits where its current ratings are not exceeded.

JOHN A. DEWAR,
Bancroft, Ont., Canada

CLEANING CONDENSER PLATES

Condenser plates of the present-day radio are so closely spaced that we can no longer use the old stand-by (a pipe cleaner) for cleaning them.

Wash between the plates with white gasoline, using a soft-bristled brush. A good absorbent photographic blotting paper, cut into strips about 1/2 inch wide, is then passed between each pair of condenser plates. This absorbs the unevaporated gasoline along with any dirt which may be present.

C. J. WHITTON,
Denison, Texas

FREE send for it now!

VALUE-
PACKED

ALLIED'S NEW RADIO CATALOG



EVERYTHING IN RADIO FOR EVERYONE IN RADIO!

Send for your FREE copy of the handiest, most complete Buying Guide for Everything in Radio! Packed with the latest, finest values in radio and electronic supplies . . . parts, tubes, test instruments, communications receivers, Ham gear, Public Address equipment, home radios, tools, books . . . more than 10,000 items of nationally known, guaranteed quality . . . the world's largest and most complete stocks. For fastest service, expert help, lowest prices, depend on ALLIED! Send for FREE Catalog now . . .

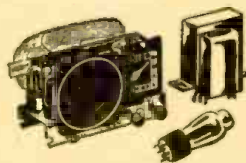

MORE THAN 10,000 ITEMS. Everything in radio and electronic supplies to serve the needs of engineers, servicemen, dealers, soundmen, amateurs, and builders. Complete stocks of all the leading makes. Guaranteed quality. Lowest prices. Get everything you need from one dependable source—ALLIED—Radio's Leading Supply House for everyone in Radio!



HAM GEAR

Earliest delivery on latest communications receivers, transmitters and Amateur station equipment. Time payment plan; trade-ins accepted. Expert Amateur Service.

HOME SETS

New 1947 radios and radio-phonos. Radios for radio men! Handsome styles. Wonderful performance. Outstanding complete line of radio values!



NEW P. A. EQUIPMENT. Entirely new line of complete Packaged Sound Systems for every public address requirement. New styling, new design features. Everything in amplifiers, speakers, microphones, accessories. New intercom systems. New professional-type sound apparatus. Everything for the Soundman!



HANDY RADIO BOOKS

Radio Formulas and Data . . . 10c
Dictionary of Radio Terms . . . 15c
Radio Circuit Handbook . . . 25c
Radio Builders' Handbook . . . 15c
Simplified Radio Servicing . . . 10c
Radio Data Handbook . . . 25c
ALL 6 BOOKS No. 37-799 . . . \$1.00

HELPFUL CALCULATORS

These radio reference-aids provide valuable data quickly:
Parallel Resistance and Series Capacitance Calculator, No. 37-960 . . . 25c
R-F Resonance and Coil Winding Calculator, No. 37-955 . . . 25c

- ALLIED RADIO CORP.
- 833 W. Jackson Blvd., Dept. 2-E-7
- Chicago 7, Illinois
- Send FREE 1947 RADIO CATALOG
- Send Books checked above
- Send 6 Books No. 37-799
- Send Calculators checked above

FREE



Name.....
Address.....
City..... Zone..... State.....

ALLIED RADIO

Everything in Radio
and Electronics

TRY THIS ONE

NOVEL CIRCLE CUTTER

An efficient circle cutter for light metal and wood can be made from a pulley from an old Atwater Kent radio. These pulleys were used to gang two or more variable condensers mounted on the panel.

A 1/4-inch twist drill is inserted in the center hole and the set screws tight-

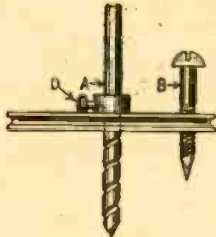

ened to hold it in position. A small bolt, selected to make a tight fit in one of the holes near the outer rim of the pulley, is ground to a triangular point for cutting. One nut is run up on the bolt before it is inserted in the hole and another is run up from the bottom to hold the bolt in place. The length of the bolt can be adjusted by changing the position of the two nuts. If a larger pulley is available, the bolt may be

placed in holes drilled at different distances from the center so that several sizes of holes may be drilled.

JOHN HAYNES,
Doe Run, Missouri.

BATTERY TESTER

I have constructed a convenient load for testing dry batteries. It consists of a 10,000-ohm potentiometer housed in a small box fitted with pin terminals or phone tips along its bottom edge. The tips are spaced so that they will fit into the voltage jacks of the tester. Pin jacks, for test leads, are mounted in the top of the box. The dial of the potentiometer is calibrated directly in standard battery voltages. Resistance values are shown in figure below.

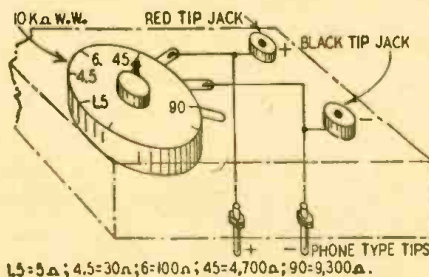

Standard Voltage	Resistance Ohms	Current Ma	Min. Service Voltage
1.5	5	300.0	1.2
4.5	30	150.0	3.6
6.0	100	60.0	4.8
45.0	4,700	9.6	36.0
90.0	9,300	9.7	72.0

The table also gives the normal current that is drawn from batteries under load and the minimum service voltage. This voltage is 80 percent of the normal value, and is the discard point.

WILLIAM B. THORNE
St. John, N.B., Canada

REPLACEMENT TRANSFORMERS

Replacement power transformers with 6.3-volt filaments are often hard to find. Distributors sometimes have a large stock of power transformers with 2.5-volt filament windings. These may be used instead by connecting one side and the center tap of the 2.5-volt winding in series—aiding with the 5-volt rectifier winding to give 6.25 volts. Other transformers are designed for use with 1.5-volt tubes. These can be made to give the necessary filament voltage by connecting the 1.5-volt and 5-volt windings in series. In either case, the rectifier tube may be replaced with a 6X5 or similar tube.

CARL G. BLANYER,
Houston, Texas

PROTECTING DRAWINGS

When constructing a piece of apparatus from a schematic drawing which you do not want marred and wish to save, it will help if you cover the diagram with a sheet of tracing paper tacked to your workbench or held on a clip board. In this way connections may be crossed off on the tracing paper as they are wired and the drawing will remain clean. This is especially helpful when building several copies of the same circuit, as the paper can be changed easily and always may be checked against the original schematic.

PAT CLEMENS,
Columbus, Ohio

NEW SIGHT FOR MAGIC EYE

Life can be restored to electron-ray indicator tubes such as 6U5, 6G5, and 6E5, provided the filament is in good condition. Rotate the tube slowly over the flame of a candle for about 3 minutes and allow it to cool slowly in an area free from cold drafts. The tube will glow more brightly, though not as brightly as a new tube.

Other types of tubes can be given a new lease on life in the same manner.

JOHN POTTER,
Lebanon, Conn.

3 WAYS TO BE AHEAD in Buying Test Equipment



Model 599-A Tube and Set Tester

SPECIFICATIONS
DC Volts — 3 ranges 0/6/15/150/600/1500 volts, 1000 ohms per volt.
AC Volts — 3 ranges 0/15/150/600 volts.
DC Current — 3 ranges 0/6/60/600 millamps.
Output volts — 0/15/150/600 volts.
Ohmmeter — 4 ranges 0/200/20,000 ohms and 0/2/20 megohms.

Condenser Checker — Ohmmeter provides fast method of checking leakage of both paper and electrolytic condensers.
Battery Tester — Tests most commonly used dry portable batteries of 1.5/4.5/6.0/45/90 volts. English reading "Re-Place-Good" scale.



WRITE FOR NEW CATALOG

SUPREME INSTRUMENTS CORP., Greenwood, Miss., U.S.A.

Export Department: THE AMERICAN STEEL EXPORT CO., Inc., 347 Madison Ave., New York 17, N. Y., U.S.A.

- 1 BUY ACCURACY
- 2 BUY DEPENDABILITY
- 3 BUY SUPREME-ACY

Ask your nearest SUPREME jobber for a demonstration of Model 599-A Tube and Set Tester (above), Model 561-AF & RF Oscillator, Model 546-A Oscilloscope, Model 592 Speed Tester. Ask to see the complete line of SUPREME equipment.

SUPREME

Tube Testing — Circuit incorporates proven and modernized emission circuit. Checks for short, leakage, and noise tests between elements.
Power Supply — 100-133 volts — 50/60 cycles. Special voltages and frequencies on request.

AN ECONOMY TRANSMITTER

(Continued from page 21)

on 1½-inch, low-loss forms. The 10-meter coil is 1½-inch in diameter and may be mounted on an old tube base.

AMPLIFIER COIL TABLE

BAND	TURNS	WIRE SIZE	WINDING SPACE
80	30	No. 16 en.	4 inch
40	20	No. 12 tin.	3½ inch
20	10	No. 12 tin.	3½ inch
15	8	No. 12 tin.	3 inch
10	6	No. 10 tin.	3 inch

These coils are center tapped and wound on ceramic forms 2½ inches in diameter. The link coils L2 are wound with well-insulated wire around the center of L1. The number of turns is adjusted to load the final amplifier fully with a low-impedance line attached.

Phone operation

If low- or medium-mu tubes are used in this circuit, they may be cathode-modulated with only 20 watts of audio power. Any conventional amplifier supplying this power may be used if its output transformer has a 500-ohm secondary. This is connected in series with the filament center tap and ground as shown in Fig. 2. If the audio quality is mushy, the filament by-pass condensers should be reduced to .003 or .002 µf.

Any power supply capable of giving the correct voltages with good regulation may be used. Fig. 3 shows the one actually employed with this transmitter. Switch S-1 is the exciter switch, S-2 filament switch for high-voltage rectifiers and S-3 the plate power switch. The switches are interlocked so that high voltage cannot be applied to the 866's till the filaments are hot.

With a little ingenuity and a well-stocked junk box, the average ham can duplicate the performance of this rig at similar or perhaps lower cost.

TRANSATLANTIC NEWS

(Continued from page 38)

has shown that the ionization of the E-layer—on which nighttime long-distance medium-wave reception depends—is maintained by the arrival of meteors and meteoric dust in the upper atmosphere. Analysis of the radar echoes shows that meteors and meteoric dust would produce exactly the effects observed. The work done also clears up another point which had up to now never been satisfactorily explained. Every dx fan knows by experience that the behaviour of the E-layer is much less liable to eccentricities in the latter part of the night. This is because, wherever he may be, an observer is after midnight on the forward side of the earth as it moves along its orbit. When you walk fast through rain your face becomes wetter than your back because it is driving into the stream of raindrops. Similarly the forward side of the earth receives more meteors and meteoric dust than the other and the E-layer covering it is more strongly affected by their arrival.



Just 3 JFD

ADJUSTABLE BALLASTS

Replace Over 3000 Exact Duplicate AC-DC Resistance Tubes!

New features!

- ✓ 1. Air-Cooled Perforated Shell
- ✓ 2. Larger Insulating Surface
- ✓ 3. Longer Life, Heavier Resistance Wire
- ✓ 4. Exact Adjustments made

List Price \$1.50 each

USE JFD BALLASTS	TO REPLACE AC-DC RESISTANCE TUBES		
	Beginning with	With Numbers	Ending with
"A" Ballasts	K, L, M, BK, BL, or BM	6 through 42	A, B, C, D, F, G, or H
"B" Ballasts	K, L, M, BK, BL, or BM	45 through 105	A, B, C, D, F, G, H, S1, S2, S3
"C" Ballasts	All 4 prongs	80 through 350	R, R4, R8, L, L4, L8

J.F.D. Manufacturing Co.
4111 Ft. Hamilton Parkway Brooklyn 19, N. Y.

LOOK! COMPARE! BUY!

SPEAKERS

5" P.M. Alnico 5 Magnet, each \$1.25
6 for \$7.00

6" P.M. Alnico 5 Magnet, each \$1.79
6 for \$10.00

All other sizes in stock, at money-saving prices.

Volume Controls

½ MEG. volume control with switch and long shaft, ea. \$9c
6 for \$3.25

15 ASSORTED VOLUME AND TONE CONTROLS (less switches) \$1.95

CONDENSERS

Tubular Paper (600 V. Test)

Mfg.	Price Ea.	Per 100
.01	.08	\$ 6.50
.02	.08	6.50
.05	.10	8.00
.1	.12	9.00
.25	.17	13.50
.001	.08	6.50
.002	.08	6.50
.005	.08	6.50
.006	.08	6.50
.5	.26	22.50

***Illinois** Electrolytics

Mfg.	Vdc	Price
10	25v	.25
100	25v	.55
12	50v	.38
16	150v	.35
20	150v	.38
24	150v	.38
30	150v	.40
50	150v	.50
8	450v	.38
10	450v	.43
16	450v	.55
20	450v	.60
40	450v	.88
100	15v	.49

***Illinois** Duals

16-16	150v	.58
20-20	150v	.65
30-30	150v	.70
40-20	150v	.70
50-30	150v	.76
8-8	450v	.65
10-10	450v	.70
20-20-20	150v	.99

10% discount on all electrolytics if purchased in lots of 10 or more. Mica Condensers, all sizes, 8c each.

AUTO RADIO SUPPLIES

4 PRONG Universal non-sync. VIBRATORS \$1.39
Minimum order, 6

OZ4 TUBES, each \$1.07
Minimum order, 6

SPARK Plug SUPPRESSORS \$1.11
See our Catalog for full line of auto aeriels.

Money KITS Saving

100 Insulated Resistors, ½, 1 & 2 Watt \$1.95

20 Assorted Wire Wound resistors... 1.95

50 Popular Assorted Mica Condensers... 2.50

20 Assorted Tube Sockets... 1.00

20 Assorted Trimmers... 1.00

I.F.'s 455 KC... .45

PHONO SUPPLIES

Phono Motor & Turntable... \$3.39

Crystal Pickup Arms... 2.49

Webster No. 50 Changer... 21.47

Webster No. 56 Changer... 26.66

Webster No. 70 Changer... 43.20

Free \$2.50 permanent needle with each changer.

WIRE

400 ft. (approx.) of wire in assorted colors and gauges, solid & stranded in 2 to 4 feet lengths, per pkg. 99c

TEST EQUIPMENT

Model 670 Superior Voltohmmeter... \$28.40

Model 905 McMurdy Silver "SPARX" Signal Tracer... 39.90

Model 900 Vomax... 59.85

Model 450 Superior Tube Tester... 39.50

Minimum Order \$3.00—20% with Order.

12lbs. SURPLUS RADIO PARTS \$2.00

A gold mine of parts for repairmen, amateurs, and experimenters... sockets, condensers, resistors, transformers, coils, hardware, wire, etc. etc. An outstanding bargain in usable parts! Send \$2.00 cash, check or M.O. today! (Pay small express charges on receipt.)

Balance C.O.D.—WRITE FOR CATALOG.

ELECTRONIC PARTS, Inc.

Dept. C5 622 W. Randolph St., Chicago 6, Ill.

NEWARK HAS MORE RADIO BARGAINS THAN EVER BEFORE

OAK RECORD CHANGER



2-Post Model — Plays 10" and 12" records. A sturdy, dependable record changer at a remarkably low price that means bigger profits for servicemen. 110 volts AC. Limited Quantity. A wonderful buy **\$17.95** at ONLY.....

DUAL CONTROL BOXES

2-Channel box for intercom. PA, Ham work. Parts alone worth many times the price! 3-12 deck, 12 pt. rotary switches, 1-double deck, 2-triple light, socket and bulb with translucent red cover, 1/4 watt resistor, 3 pointer knobs, 3-3 ft. cables, 5 pt. female terminals. All in dual metal box 10 x 4 x 2". A hot buy for only..... **49¢**

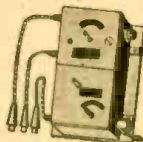

SINGLE CONTROL BOXES

5 x 4 x 2". Two 3-deck, 12 pt. rotary switches, pilot light, 2-12 pt. recessed male connectors, 3 ft. 5-wire cable. With 2 bakelite knobs. Great Value! Only..... **39¢**



SINGLE BOX, as above, but with one rotary switch, 2-3 ft. 5-wire cables. Only..... **39¢**

SINGLE BOX — Push Button, high frequency buzzer, 2-3 ft. 5-wire connectors and several terminal strips. Parts alone worth twice as much. Only..... **39¢**



WAR SURPLUS TRANSMITTING and SPECIAL PURPOSE TUBES

1C21	\$.75	4J4	\$1.50	250TH	\$9.00	808	\$3.00	8308	\$5.25	872A/872	2.25	958A	\$.75
1N21A	.20	10Y	1.50	304TH	12.00	809	1.50	832A	4.05	884	.75	959	.75
1N23	.20	35TG	1.95	304TL	3.75	810	2.63	836	1.50	921	.75	1616	3.00
2AP1	2.25	75TL	2.25	715C	33.00	811	1.95	837	3.38	922	.73	1619	.75
2C40	2.63	VR90	.75	800	2.25	813	6.75	838	3.75	923	.45	1624	.90
2C44	1.50	100TH	4.13	801A	1.73	814	4.50	843	.75	927	1.05	1625	.75
2D21	.60	VR105	.75	802	1.58	815	2.25	845W	3.75	931A	1.88	1626	.60
2X2/879	.90	VR150	.75	803	9.00	816	.60	860	3.00	954	.75	1629	.27
3AP1	3.00	204A	60.00	804	6.75	826	2.25	861	90.00	955	.75	2051	.90
5AP1	9.00	211	1.13	805	3.75	828	9.00	864	.60	956	.75	8005	3.15
6AK5	.90	217C	7.50	807	1.05	829B	3.00	865	1.50	957	.75	8016	.53

PHONE and MICROPHONE ASSEMBLY

Dynamic type, adaptable for code practice sets, mobile equipment, PA systems, home recording, etc. Mike handset with 50-ohms Impedance. Mike and Phones terminate in 5-wire male plug, 3 ft. cord with female receptacle facilitates disconnection. Special Value **\$1.95** at Only.....



CRYSTAL PICK-UP

A rare bargain! Brand New, High Fidelity, Famous Make crystal pickup. Featherweight, Tangent Head, 7" mounting center. While they last, only..... **\$1.99**

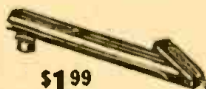

- MAIL ORDERS FILLED FROM EITHER NEW YORK CITY OR CHICAGO
- Write: 242-F W. 55th St., N.Y.C. OR 323-F W. Madison St., Chicago

Receivers Now Available!

HALLICRAFTERS	
S-38 complete....	\$47.50
S-40 complete....	\$9.50
SX-42	275.00
NATIONAL	
HRO-5Tol complete	306.71
NC-240D with speaker	241.44
NC-46 with tubes, less speaker and power supply ..	67.50
HAMMARLUND	
HQ-129X complete.	173.25
SP-400X complete.	342.00
RME-45 complete..	198.70
RME-84 complete..	98.70
Panadaptor	99.50
Supreme Transmitter	450.00

KING OF TUBE CHECKERS

(Continued from page 22)

units are designed to provide a maximum of 100,000 volts and 1 ampere.

In switching such high voltages, it was necessary to develop a special means of applying and disconnecting the power to the tube under test. This unit consists of a double-sphere gap. The spheres are adjustable to obtain the desired voltage breakdown value. The triggering voltage for this sphere-gap switch is obtained from a separate rectifier unit which provides approximately 50 kilovolts to the center sphere to initiate the arc discharge.

During the operating cycle the arc is turned on and off at 60-cycle and approximately 1000-cycle rates. After the arc is initiated by the triggering gap, it will continue as long as voltage is applied. To stop the arc discharge and remove voltage from the tube, a stream of high-pressure air is directed at the sphere gap by an automatic switch at the instant it is desired to remove voltage.

All these high-power arcs of course develop an excessive din. To reduce the noise as much as possible, a special soundproof box is mounted around the sphere gap. The high-voltage supply to this test equipment has a solid metal enclosure installed to protect the operating personnel from harmful X rays originating from the rectifier tubes. The maximum number of safety devices must be installed for the protection of the operator.

EFFICIENT TEST AND REPAIR BENCH

(Continued from page 22)

the rear. Four duplex receptacles in the base of the instrument panel have been placed in the most logical positions. The soldering iron plugs into an outlet under the working surface so the iron can be used anywhere on the unit without dragging the cord under or over obstacles. Outlets in the rear of the panel for instruments bring up the total to eight. All wiring is shielded and can be grounded.

5. Last but by far the least of our problems is to incorporate all of these ideas into an attractive piece of equipment. The Ser-V-Lux is a smooth, streamlined, custom-built unit, finished in a soft white duco set off with satin finished aluminum trim and hardware.

We have used two of these units for eighteen months in an actual radio service business, and the results are beyond expectation. Business has increased and the comments of customers are highly satisfying.

More than 300,000,000 phonograph records were manufactured in 1946, according to Wm. C. Speed of Audio Devices, Inc. This figure, Mr. Speed says, triples the pre-war output. He predicts a larger output for 1947.

A WATER WATTMETER

Accurate microwave measurement with a high-frequency water calorimeter, which indicates r.f. power in terms of temperature rise of water through which v.h.f. waves are passed, is revealed by the Polytechnic Institute of Brooklyn.

The newly-invented device is important with the increasing use of very high frequency radiation in airplane approach-control, television, radar, and frequency modulation broadcasting.

It will enable engineers to improve the design of high-frequency equipment for specific distances because it accurately measures the power of the radiation.

ATTENTION Amateurs-Experimenters-Inventors

Cut your cost on radio supplies and equipment in half. Clip coupon today. Hundreds of "hard to get" war surplus items along with the best in standard brand equipment—all at great savings to You. Let us know your particular requirements. IMMEDIATE DELIVERY.

SEND THIS COUPON TO

NIAGARA RADIO SUPPLY CORP.
180 Greenwich St.,
New York 6, N. Y.

Name

Address

City

State

Call. No.



PROMPT SERVICE ON ALL
SPEAKER AND PHONO PICK-
UP REPAIRS

MAY LEOTONE SPECIALS

- DEFLECTION YOKE for 5" cathode ray tube. Fully shielded. 1 1/2" I.D., 8" sq. 2.49
- DYNAMOTORS (Navy Dy-9) DC input: 26V. DC output: 360V @ 150MA or 310V @ 215MA. Black crackle finish, with mtg. base 6 1/2" x 3 1/2". 3.95
- Co-axial Cable, RG-13/U. 74 ohm. double copper braid, outside vinyl jacket. 420' O.D. with 2 connectors. 20 ft. lengths 1.69
- PHONO MOTORS—110V. A.C. Quiet rim-drive motor and 8" socked turntable 2.95
- 12" Turntable Felts, Brown/Green 2.23
- Brand new RCA UX-200 tubes in sealed cartons. Ideal triode detector. 8 for 1.00
- TUBES: Perfect condition. But not in sealed cartons. Guaranteed for 90 days. 26, 27 or 35 .29
- #24, 42, 45, 75, 77, 78, 80, 83, 810, or 8K7 .39
- #8A8, 6C5, 6F5, 6J7, 6SA7, 6SK7 or 12SA7 .49
- #1A7, 6A3, 6G5/6U5 or 50 .59
- SPEAKER GRILLES, 5 1/2" sq. Flocked musical design on gilt perforated metal .19
- Speaker Grille cloth, gold or silver weave, sq. ft. 3.75
- SELVYN SYNCHRO-TRANSMITTERS, 115V, 60 cycle. Used in pairs as trans. & follower. 3 1/2" x 9" ca. 1.00
- SELVYN Continents (22J1G1) 57.5 .39
- 57.5V, 400 cycle. 2 1/2" x 4" 1.00
- Wall Toggle Switch (C-10, S.P.D.T., 3A/125V) .39
- RADIOMAN'S HARDWARE TREASURE. APPROX. 1000 screws, nuts, washers, etc. (0157) .49
- Clear ACETATE for dials, windows, etc. (0157) .39
- 3" x 3" - 10 7" x 7" - 45 12" x 12" - 98
- 5 1/2" x 6 1/2" sheet 2000 - 2.99
- EXPERIMENTAL TUBES .20 assd. sizes & base types for testing, research, etc. P.N. tested. 1.00
- Vicor Transformer for models R-32, 45, 57 or 75. Unshielded 5.95

ALNICO MAGNETS

- 
- #1-Bar. 1/4" x 1/4" Max length 4" Per inch .5-1.2
 - #2-Face 1 1/2" x 1 1/2" x 3/4" high .98
 - #3-Heavy duty bar. 2 1/2" x 1 1/2" x 5/16" .98
 - #4-Face 3/4" x 1 1/2" x 3/4" high .39
 - #5-Polished. 1 1/2" x 9/16" x 3/4" high .35
 - #6-Polished bar. 2" x 1 1/2" x 1/4". 20 for 1.00
 - #7-Face 1 1/2" x 1 1/2" x 3/4" high .10
 - #8-ALNICO V.h. shoe, poles 3/8" sq. 1 1/4" high .7-
 - #9-ALNICO V.h. shoe, poles 9/16" sq. 1 1/4" high .98
 - #10-ALNICO V.h. shoe, poles 1 1/2" x 1 1/2" x 3/4" high 5.95
 - #11-Horseshoe ex. pole 1 1/2" x 1 1/2" x 3/4" high 1.29
 - #12-(Similar to 25) 3/4" x 3/4" x 7/16" .39
 - #14-Polished heavy duty bar. 3" x 1 1/2" x 3/4" (magnetized lengthwise, wide or narrow ideal) 1.29
 - #15-Polished Block. 3" x 2 3/4" x 1 1/2" Magnetized wide or narrow sides. (wt. 3 lbs.) 2.49
 - Unmagnetized .195
 - #16-Flat Bar. 1 1/2" x 1 1/2" x 5/16" thick. 1/4" groove each end .49

SERVICEMEN'S KITS



- #1-R.F. Antenna and Osc. coils. 10 ass'd .98
- #2-Speaker Coils: 12 ass'd. 4" to 12" moulded and free-edge (magnetic incl) Less voice coils. 2.00
- #3-BAKELITE MICA CONDENSERS: 50 ass'd. .00001 to .2mf. 200-600V.V. clearly marked .95
- #4-Tubular By-Pass Condensers: 50 ass'd. .001 to .25mf. 200-600V.V. Standard brands 2.49
- #5-Dial Scales: 25 ass'd. airplane and slide-rule (acetate and glass included) .298
- #6-Escutcheon Plates: 25 ass'd. airplane and slide-rule and full-vision types .295
- #7-Knobs: 25 ass'd. wood and bakelite. Incl. push-on, setscrew and push-button types 1.00
- #8-Wafer Sockets: 12 ass'd. 4 to 7 Prong 1.95
- #9-Voltage Dividers: 10 ass'd. standard, multi-tapped. Hi-wattages included. 1.00
- #10-Shield Cans: 15 ass'd. for coils, tubes, transformers, etc. .60
- #11-Mica Padders and Trimmers: 15 ass'd. Incl. multiple and ceramic base types .49
- #12-Volume and Tone Controls: 10 ass'd. wire-wound and carbon. Less switches. 1.40
- #13-Wire-wound Resistor: 15 ass'd. ohmage, 5 to 20 watts; Incl. enameled and candohms .98
- #14-I F Coils: 6 ass'd. including shielded and slug-tuned. Peaks unmarked. 1.20
- #15-Dial Windows: 12 ass'd. sizes. Incl. flat and moulded acetate and convex glass .98
- #16-Bakelite Coil Forms: 18 ass'd. popular sizes up to 3" diam. .49
- #17-High Resistance Units: 25 ass'd. carbon, ferrule-ended. 25000 to 5 megohms. 2.49
- #18-SPEAKER REPAIR KIT. A real money and time saver. Contains: 20 ass'd. paper rings. 10 paper-wound, multi-sections; 200 400WV .98
- #19-Metal Cased By-Pass Condensers: 20 ass'd. paper-wound, multi-sections; 200 400WV .98
- #20-Resistor Assortment: 20 carbon and wire-wound. 1/3 to 3 watts. .49

Minimum Order \$2.00—20% Deposit Required on all orders. Please Add Sufficient Postage. WRITE DEPT. RC-5.

- Filter Choke, 15 Henry, 1200 ohms DC, 50ma. 2" x 1 1/2" x 1 1/2" .49
- 4 TUBE AMPLIFIER (2-7C5, 7F7, 7Y4). Used as electronic supercharger control. 110V, 400 cycle. Black crackle finish case & slide-in chassis. Contains: power trans. 7 mica & oil cond. 7 resistors, 4 local sockets plus other components worth several times the price. 8 3/4" x 4 1/2" x 3 1/4". Less tubes 1.49
- "Ouncer" INPUT Transformers (1/2" x 1 3/16") = 50: Carbon miko to grid; = 50—Dynamic miko or low impedance pick-up to grid; either 12 for 5.00
- ALUMINUM PANELS (10 1/2" x 8" x 6") .39
- 8" x 8" .49
- 59" 8" x 10" .79
- BAKELITE PANELS: 79" glossy brown. 7" x 10" .59
- 7" x 14" .69
- 7" x 11" .79
- 7" x 14" .85
- 1/2" Linen Bakelite Strips. 1 1/2" x 1 1/2" - 3 for .25
- PRECISION RESISTORS: plus/or/minus 1%, wire-wound. Ohmage: 2.35, 11, 24.5, 100, 840, 7800 30K, 60K or 400K .35
- Frequency Meter tech. manual (Navy) Theory & operations. 39 illust., diagrams. 58pp .15
- "FM" Tech. Manual (Army) Theory, maintenance, operation. 80 illust., 49 diagrams. 240pp .39
- HEADBANDS (HS-33) with PL-54 plug & cord .39
- PL-54 plug & 13" tipped double phone cord. .19
- JK-26 ext. jack for PL-54 Bakelite shell .23
- HEADPHONES — Army HS-33, 2000 ohms. Leather covered, adj. forks. With PL-54 plug 1.25
- Rubber phone cushions for above, per pair .20

LEOTONE RADIO CO.

MAKERS OF CONES AND FIELD COILS
65-67 DEY STREET, NEW YORK 7, N.Y.
WORTH 2-0284-5
12,000 SQ. FT. OF RADIO PARTS

a hillside. The idea of making the whole laborious journey again was heart-breaking. He decided to ask for help through his radio, which had come through unscathed. He contacted headquarters, and planes were sent to biscuit-bomb him with supplies, with which he was able to finish the job.

There are two control stations. At Mount Stromlo, the Commonwealth Solar Observatory, is a small 50-watt transmitter, keeping constant touch with the widely-spread forest patrols. A 500-watt station in Canberra controls Mount Stromlo and also keeps in touch with the engineers maintaining roads and bridges and with all the vehicles that work about the town itself.

The main control station

The network call sign is VJA6, and control is carried on from the Canberra power station, some hundreds of yards from the main transmitter, to which it is connected by remote control. The main transmitter is a crystal-controlled unit, operating on 2.86 megacycles, and consists of a 6L6 oscillator, link-coupled to two 805's, link-coupled to tuned feeders, current feeding a full-wave antenna approximately 120 feet in height.

The 805's are operating under 1,580-volt plate-modulated conditions, and have no difficulty in putting a 500-watt signal on the air. Filaments are in "stand-by" at all times, permitting immediate operation by remote control at the power station. The modulated output is obtained from two 805's in class-

CANBERRA'S MOBILE RADIOS (Continued from page 34)

B, working in 1250-volt conditions. Power supply is from the mains.

The main receiver has a crystal-controlled oscillator frequency and uses the transmitter antenna. The output can be switched from the speaker to a T-filter network (1000 cycles), operating an electric relay and bell-call system. This power supply also comes from the mains.

Cars carry a transceiver unit, whose transmitter sections consist of an 1F5 crystal oscillator (2.86 megacycles), capacity-coupled to a plate-modulated, shunt-neutralized twin triode, 1J5G, used as a single triode. There are approximately 200 volts at the plates, and the output is approximately 2 watts.

The modulator section consists of a carbon microphone feeding a 1F5, and transformer-coupled to a 1J6G in class-B, working at about 160 volts. A 1,000-cycle generator is incorporated, to permit transmission of the call note.

The receiver section is crystal-controlled and has a reflexed i.f. stage and grid-leak detector, with a 1F5 operating at around 150 volts, driving a midget speaker. The power supply of the whole transceiver is from a 6-volt storage battery and a vibrator.

The cars have fishing-rod aerials for general use. These give satisfaction up to approximately twelve miles, after which it is necessary to use the sectionalized thirty-foot pole provided, which permits operation over a distance of fifty miles.

CODE OSCILLATOR

Presented herewith is a circuit of a code-practice oscillator that can be used with a speaker or several pairs of headphones. It uses the amplifier section of a 117N7 as a Hartley oscillator, using a push-pull output transformer as the inductance. A 1-megohm variable grid leak provides variable tone control. No volume control is used on the speaker, but one may be added if desired. Jacks are provided for several pairs of phones, which are connected in parallel. A volume control in the output circuit sets the volume level to the phones.

CALVIN SMITH,
North Troy, N. Y.

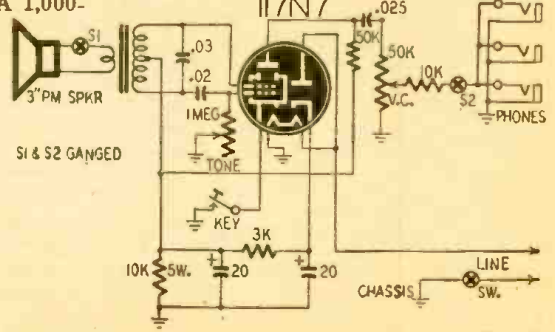

HARRISON HAS IT! HARRISON HAS IT!

A WHOLE NEW BUILDING—

so we may serve you even more efficiently!

Yep!—we've just added an entire five story building to enlarge our present facilities. More space to display all the fine lines we distribute—more room in which you can shop in comfort—a sparkling new Harrison Select Surplus section—a real Ham Shack where you can meet with the gang—a bigger and better Bargain Counter—larger and more complete stockrooms.

A streamlined Order Department that will get us back to our pre-war speed of 4 Hour Mail Order Shipments—A special Export Department to expeditiously handle the orders from our good friends in other parts of the world—

And many more new features—all designed to better enable us to give the friendly service and superior value that have made Harrison's the Ham Headquarters—Since 1925!

Business going on as (or even better than) usual during alterations. Drop in now and you'll pick up some exceptional bargains during our E-X-P-A-N-S-I-O-N SALE!

73
Bil Harrison, W2AVA

HARRISON SELECT SURPLUS SIGNAL CORPS EQUIPMENT

Here are some exceptional bargains in AAF gear that are easily adapted to efficient Ham use.

There are lots of these used units around, but we believe we have been discriminating enough to be able to offer you the very best ones! Carefully reconditioned, checked, and crated to come to you in almost new condition—yet our prices are no higher! Order yours from Harrison—in a hurry—and you'll be happy.

- SCR-522 VHF Transmitter-Receiver. Complete with 17 tubes, control box, dynamotor, crystals, etc. . . . \$39.95
- SCR-274-N. THREE Receivers. TWO Transmitters, controls, antenna unit, dynamotors, 29 tubes, etc. . . \$39.00
- BC-375-E Transmitters. Complete with tubes, tuning units, antenna tuner, dynamotor, etc. \$35.00
- BC-348 Receivers. Complete with tubes, crystal filter, dynamotor, etc., less speaker \$49.50
- BC-221 Frequency Standard. Complete with original crystal and calibration chart, and tubes, in cabinet. \$39.50

RG-8/U COAXIAL CABLE

52 ohm. FB for feeding beams, etc. Handle a KW. New, perfect cables 110 feet long with two PL-259 coaxial plugs. Total list price is \$39.28. HSS \$4.98 Special!

DYNAMOTOR

Delivers 500 volts at 100 MA from 6 or 12 DC. From PE-103 Pack. Brand new! \$5.75

KW MODULATION TRANSFORMER

Here's the one they're all talking about! RCA broadcast quality. 550 Watt conservative audio rating. 1 to 1 ratio will match most any tubes. Screen winding. Safety flash-over gaps. 38½ lbs. \$14.75

Get ready for SUMMER FUN ON 2

Abbott TR-4B, Transmitter-Receiver. Complete with tubes—\$56.78. Abbott 110 V AC, power pack—\$22.50. EL 6 Volt Vibrator, pack—\$14.97. EL Combination 110, AC/6 V DC Input. Delivers 300 Volts DC at 100 Ma. 6.3 at 4.75 A—\$27.00. Abbott 5 element high gain beam. All aluminum. Complete, ready for easy assembly—\$14.10

HAMMARLUND FS-135-C

Crystal controlled frequency standard. Easily connected—zero beat with WWV—and your receiver is an FB Freq. Meter! Complete unit with crystal, \$14.25 tube, and simple instructions

MILLEN R-9'ER

Hop up your receiver with this new antenna matching pre-amplifier! 27-32 Mc. \$24.75



- 48-55 Mc plug-in inductor \$3.15
- 13-15 Mc plug-in inductor \$4.15
- 6AK5 Tube \$3.38

New! SONAR VFX-680 NBFM, ECO, "Rubber Xtal." Exciter Unit. \$87.45 Harrison Has It!

1947 MEISSNER Signal Shifter. Complete for all band operation \$120

SERVICEMEN HAMS!

Earn money for that new FR by selling Intercommunication Systems, Talk-A-Phone and Bogen in stock!

As Distributors of COLLINS RECEIVERS and TRANSMITTERS

we are now entering orders for earliest delivery. Literature upon request.

MEISSNER RECEIVER KIT

Build your own 6 tube AC-DC two band BC receiver with this famous 10-1199 kit! Complete with speaker and antenna, less only tubes and cabinet. \$19.75

MECK T-60 TRANSMITTER

Compact! 15" x 11" x 9" metal cabinet contains complete 60 watt input phone-CW Xmitter; 110 Volt AC. With all tubes and 10 meter coils, less only \$150 microphone and crystal

COMMUNICATION RECEIVERS. AMATEUR TRANSMITTERS. TEST EQUIPMENT—All Makes. All Models. Harrison has the biggest and most complete stock! Lowest Prices! Top Trade-In allowances!

TECHNOTES

(Continued from page 56)

... GE LB530
 If the battery charges too slowly or refuses to take a charge, check the control switch for high-resistance contacts in the a.c. or charge positions. Poor contacts here will hamper charging action. Replace the switch or clean and tighten its contacts.

OTTO WOOLLEY
 Colo. Springs, Colo.

... STROMBERG 65 and 66
 In these and other Stromberg-Carlson models using wired remote-tuning systems, the armature of the on-off relay on the main chassis sometimes sticks because of residual magnetism in the cores. To restore operation, remove the coils and file down the cores so that there will be a 1/32-to 1/16-inch air gap between them and the armature, which will then rest on the insulating washers. File the faces at an angle so that they will be parallel to the armature. This will not shorten the core too much.

WILLIAM FORD, JR.,
 Chicago, Illinois

(If troubled with residual magnetism, why not demagnetize the core in an a.c. field?—Editor)

... G.E. MODEL TC-3 TUBE TESTER
 In the January 1947 issue of RADIO-CRAFT there was a Technote regarding the tube short indications given on the Model TC-3 and TC-3P tube testers. This is a situation which has arisen with the development of newer tubes having a high plate-to-cathode capacity.

The model TC-3 tube checker was originally engineered for high sensitivity on the four short test positions. Because of this high sensitivity, tubes with very slight base or interelectrode leakage will, at times, indicate a direct "shorted" condition. For all practical purposes, however, these same tubes will perform satisfactorily in the average radio receiver.

If it is desired to reduce the sensitivity of the short test in the Model TC-3, the following modification may be made:

Withdraw the equipment from the case by removing the twelve nickel-plated screws from the edges of the panel. Solder a 1-megohm, ½-watt resistor directly across the tubular paper condenser which is wired to the test switch. The capacity of this condenser varies in different production models from .01 to .005 µf but it should be easily located since it is the only tubular condenser on the test switch. Replace the equipment in the case.

This modification will cause the "short" indicator to glow with a resistance of approximately 250,000 ohms or less present in tested tubes. Key positions and index settings will not be affected by this modification.

R. H. RUDOLPH,
 General Electric Co.



HARRISON RADIO CORPORATION
 9 WEST BROADWAY • NEW YORK CITY 7
 PHONE—BArclay 7-9854 • EXPORT DEPT.—CABEE—"HARRISONRAD"
 [JAMAICA BRANCH—172-31 Hillside Ave.—REpublic 9-4102]

The BUY of a LIFETIME

U.S. SIGNAL CORPS **5 Meter** ONLY \$3.49
 SHORT WAVE XMTRS. (72.2 Mc)
 XMTR and Tube Only Less mks, Batteries and Antenna

One 1½ volt dry cell and 87½ volts of B operates it. Just attach dipole, key or mike, connect the batteries and it's ready to use. Signal Corps spec wired with silvered wire, mica condensers, and precision resistors. Highly stable circuit with Lo-Loss silvered inductance. (Adjustable paddler.) Schematic supplied. Converts to walkie-talkie and Ham bands. Weighs less than a pound. Shipped by express only. No C.O.D.'s. No Parcel Post. A sacrifice at only \$3.49. Postal or express money order or certified check.

NEWARK SURPLUS MATERIALS CO.
 324 Plane St., Dept. C. Newark 2, N.J.
 SEND STAMP FOR GIANT CATALOG!

AMPLIFIER
 For Call System or Phono. Amplifier
\$2.95

- Complete with tubes
- Compact—wired
- Ready to Operate
- Uses 35Z5—50L6.

N. J. INDUSTRIAL CO.
 309 ELM ST. NEWARK 5, N. J.



Coast-to-coast television will become a reality before the end of 1948, say Bell Telephone engineers, who report that nearly three-quarters of their transcontinental co-axial cable is "under ground."

SPEEDY A.C.-D.C. SERVICING

(Continued from page 28)

Leaky or noisy by-pass condensers can be found by moving them around while the set is operating. This may be best done with an orange stick or insulated rod. (A screw driver might slip off and cause a short.) Any condenser

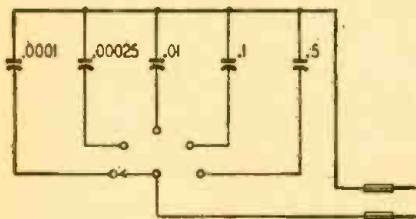

Fig. 3—Substitution box for r.f. capacities.

that causes the slightest noise should be replaced.

Checking the volume control

Volume control trouble is one of the easiest faults to find. Move the knob up and down. If the control is faulty, there will be a noisy burst from the speaker. Turn the knob slowly, from minimum to maximum position. Scratching noise, or points where the set cuts out completely, may be noticed.

If you think that the control is the cause of the set being completely dead, connect "hot" and center lugs. If the set begins to play when the control is shunted, you know that it is open. This test works for most circuits, but fails for some.

Quick resistor tests

Someone has said, "There is only one simple way of testing a resistor—with a multirange ohmmeter." Here is another quick, very effective, method of testing the small resistors in a set. The set is turned on and a station tuned in. The leads of a multimeter, turned to the highest d.c. voltage range, are put across the suspected resistor. The voltage selector switch is turned down the scale, stopping at each position to note



Fig. 4—A quick check method for r.f. coils.

if there is any improvement in the set's performance. Of course the meter is watched to see that it is not driven off scale.

This test is the same as the substitution method. The various resistors of the multimeter are shunted across the resistor in question.

Open or shorted coils

Much time is used up checking r.f., a.f., and i.f. coils for continuity or winding resistance with an ohmmeter.

Here is a faster way of finding the trouble, one that actually shows the working condition of the coil instantly.

PREMIER SIGNAL GENERATOR



NEW! EXCLUSIVE! BAND SPREAD DIAL. AWAY OUT IN FRONT AND UP ON TOP—this brand-new PREMIER SIGNAL GENERATOR is in demand from COAST TO COAST.

CHOCK-FULL of super-features usually found only in the most expensive units, PREMIER is an outstanding value.

NO OTHER low priced signal generator has the famous MICROMASTER BAND SPREAD DIAL. Total scale length approximately 60 inches. Spring loaded drive eliminates all backlash, and result is split-cycle tuning.

BANDS: 75 Kc to 50 Mc on FUNDAMENTALS. 45 to 150 Mc on powerful 3rd harmonic.

400 CYCLE Pure sine wave Audio Signal. **FOUR STEP**, ladder type, accurately calibrated Attenuator.

COMPLETE LINE FILTER.

TRIPLE SHIELDING throughout. Leakage is reduced to the absolute minimum.

ACCURACY. Better than 1%.

In stock now for immediate delivery.

complete with coaxial cable. **\$54.50** NET

Manufactured by Premier Electronic Laboratories

RADIONIC

EQUIPMENT COMPANY

TRIBUNE THEATRE ENTRANCE
Dept. 105-170 NASSAU ST., NEW YORK 7, N. Y.
PHONE WO 2-0421—CABLE "CHANSLOR"

Your finger serves as the test instrument. Be very careful not to touch more than one part of the circuit at a time. It is especially important to watch the other hand. It should not contact the chassis or any other part of the set. There is danger of shock. Touch the moistened finger to the grid of the tube following the coil under test. If the circuit is working properly between that point and the speaker, a loud, clear click will be heard. Next touch the primary terminal of the coil, the one connected to the plate of the preceding tube. A loud, clear click here indicates that the coil is working perfectly. Refer to Fig. 4 for the points to be touched.

In a.c.-d.c. midsets with dynamic speakers an open field coil often causes

Free Radionic Catalog



Radionic Equipment Co. Dept. 1058C
170 Nassau Street
New York 7, N. Y.

Please send me a FREE copy of your 1947 Catalog. I understand it has thousands of items illustrated, described and priced and will be a great help to me in my search for "hard-to-find" radio equipment, CHANCELLOR Portable and Phono Radios.

Name

Address

City State

AMATEUR & EXPERIMENTER SUPPLIES
RADIOS—PARTS & ACCESSORIES
PUBLIC ADDRESS
RECORD CHANGERS
TEST INSTRUMENTS—TUBES

RADIONIC

EQUIPMENT COMPANY

TRIBUNE THEATRE ENTRANCE
Dept. 105-170 NASSAU ST., NEW YORK 7, N. Y.
PHONE WO 2-0421—CABLE "CHANSLOR"

trouble. It is an easy matter to check the field strength. Hold a small screw driver in front of the cone, within about 1/4 inch of the pole piece. If the screw driver is strongly attracted, the field coil is O.K.

One of the best ways to check a magnetic speaker is to have a small test speaker with long flexible leads mounted on the service bench. If small alligator clips are provided on the leads, the test speaker can be connected quickly in parallel with the one in the set. The set speaker cone can be held in tightly with the hand to prevent it from operating.

Common sense is the greatest aid to speedy servicing. Note symptoms and make first the tests which seem most likely to apply in the particular case.

TELEVISION FOR TODAY

(Continued from page 69)

eration is limited. In a sense, the relatively poor regulation is advantageous, since it decreases the possibility of fatal injury to anyone accidentally touching the high-voltage terminals. For the serviceman, it is suggested that the following be committed to memory:

All high voltages must be turned off before any work is done on a television receiver. High-voltage terminals do not have to be touched to prove fatal; the voltage can span small distances. The only safe method of repairing a high-voltage unit is by substituting components or by resistance measurements.

NEW PIEZO CRYSTAL

In past years the use of quartz and Rochelle salt crystals has been well established and is now well-known. A new crystal known as ADP (ammonium dihydrogen phosphate) has been used in some war-time electronic devices.

The new crystal is free from non-linear response and hysteresis effects and is unusually stable with temperature, often a weakness of piezoelectric crystals. Furthermore, it cannot dehydrate like Rochelle salt.

ADP is stable at temperatures as high as 100°C as contrasted with the limit of 55°C for Rochelle salt. It is also effective at low temperatures, although it shatters at the extreme low of -125°C. In the normal range, ADP has a larger electromechanical coupling than other crystals, a measure of its effectiveness.

Now Ready

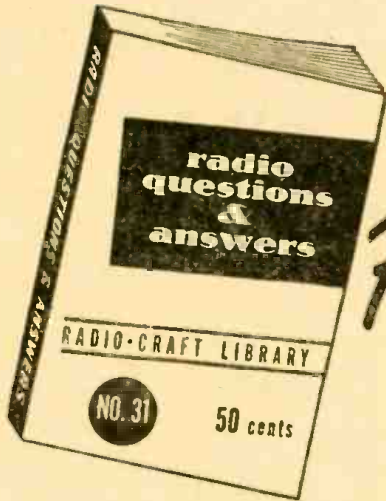

The Two Latest Titles in the
RADIO CRAFT NEW LIBRARY SERIES
 50¢ each
 Nine Recent Titles

- # 29 HANDY KINKS AND SHORT CUTS
- # 30 UNUSUAL PATENTED CIRCUITS 1944-1946
- # 31 RADIO QUESTIONS AND ANSWERS
- # 32 ADVANCED SERVICE TECHNIQUE
- # 33 AMPLIFIER BUILDER'S GUIDE
- # 35 AMATEUR RADIO BUILDER'S GUIDE
- # 36 RADIO TEST INSTRUMENTS
- # 37 ELEMENTARY RADIO SERVICING
- # 38 HOW TO BUILD RADIO RECEIVERS

Two more titles in this popular new series are rolling off the press. The two latest—described below—like the others, give you the most recent, reliable technical information and are as modern in appearance as 1947 radios and cars. The type is fresh, clear-cut, easy to read. The books are bound in flexible covers, smartly designed. In short, everything connected with these volumes is up-to-the-minute and practical to the nth degree. You'll find them constructive helps in building up your knowledge of radio.

NO. 31 RADIO QUESTIONS AND ANSWERS

Here are the answers to questions most frequently asked of the "Question Box" editor of RADIO-CRAFT. The material selected is well diversified and chosen for practical application to workaday problems. Circuit diagrams are supplied with the answers.

NO. 35 AMATEUR RADIO BUILDER'S GUIDE

A book for the amateur operator who builds his own. Practical and down-to-earth, it tells you how to build transmitters, receivers, and other ham gear. Construction data on a 430-mc transmitter, an HK-24G c.w. transmitter, a miniature communications receiver, an acorn-tube preamplifier, and many others. Whether you're an amateur now, or just studying for your ticket, you'll want this book.

SEE YOUR DEALER IF HE CAN'T SUPPLY YOU. USE COUPON

ELECTRICIANS! RADIOMEN!
 Here's the Answer
 Book to Bigger Pay!

ELECTRICAL & RADIO TROUBLE SHOOTING MANUAL



Yours for 7 Days FREE

EARN MORE
 by quickly spotting troubles! This great book tells you where to look—how to find—what to do! 312 pages—9 1/2" x 11"—really 4 books in one: (1) New Step-by-Step Trouble Shooting, (2) 500 Shop Prints, (3) Electrical and Radio Dictionary, (4) Spare Time "Fill In" Jobs. Take it with you on every job—let it take you into the higher money bracket—put you in demand as "doctor" for troubles. Written by the Coyne School—an Approved Veteran Training Institution—and backed by 48 years shop experience. **SEND NO MONEY** Coyne wants you to see for yourself how others have increased their earnings through this book. Read our **FREE TRIAL OFFER COUPON** below, and rush it to us today.

A BIG Book
 with more than 500 large, 8 1/2" x 11" Electrical and Radio Shop Prints!

7-DAY FREE TRIAL COUPON

COYNE ELECTRICAL SCHOOL, Dept. 57-T2
 Educational Book Div., 500 S. Paulina St., Chicago 12, Ill.

Send postage prepaid, your new Coyne Electrical and Radio Trouble Shooting Manual. After 7 days Free Trial, I'll either return it and owe nothing, or send \$3 and pay balance of \$4.50 in 2 months. Or I'll pay \$6.96 cash price in 7 days. (Price now reduced on new large edition—thousands sold at \$9.00.)

NAME _____
 ADDRESS _____
 CITY _____ ZONE _____ STATE _____

Check here if you want Manual sent C.O.D.—You pay postman \$6.96 plus small C.O.D. fee. Money back guarantee.

RADCRAFT PUBLICATIONS, Dept. 47
 25 West Broadway, New York 7, N. Y.
 Send me the volumes (50c each, postpaid) checked. My dealer is unable to supply.

I enclose \$.....
 Your Name (Print Clearly)
 Address
 Dealer's Name
 Address

() ALL NINE BOOKS

- 29 35
- 30 36
- 31 37
- 32 38

I'll Train You Quickly—in at Home—in Your Spare Time —to Make More Money in the Fastest Growing Industry in the World!



WHO SAID IT COSTS A LOT OF MONEY TO LEARN RADIO ELECTRONICS?



Ghirardi's Famous RADIO PHYSICS COURSE costs you only \$5 complete... and it is complete! 36 BIG COURSES IN ONE!

FOR BEGINNERS!

No previous experience needed

Send coupon today! Examine Ghirardi's big, 972-page RADIO PHYSICS COURSE for five full days. See how this one giant book at ONLY \$5 can give you complete, basic training to pave the way for a brilliant future in Television, Radio, Frequency Modulation, Facsimile, Broadcasting, Communication, Servicing, Industrial Electronics, etc. Prove to yourself that training doesn't need to be expensive to be really good!

9 OUT OF 10 RADIO MEN CAN'T BE WRONG!

Actually, this famous book has given more people their start in Radio-Electronics than any other book or course ever published. On an actual survey among 817 men already in radio, 724 of them—9 OUT OF 10—answered that Ghirardi's RADIO PHYSICS COURSE is their choice as the finest, easiest to understand training on the market—and far better than any other book or course they have ever seen!

LEARN FAST! LEARN RIGHT!

... as fast as you can read!

You'll be pleasantly surprised how RADIO PHYSICS COURSE helps you master subjects that other courses make seem very complicated. Starting with Basic Electricity—over 300 pages—it takes you through the entire Radio-Electronics field. Everything is made crystal clear. Nothing is omitted or condensed. You buy it for only \$5 complete—ON OUR MONEY-BACK GUARANTEE. You progress as fast as spare reading time permits. Many students have completed it in a few weeks. 972 pages, 508 illustrations and 856 self-test review questions make study doubly easy. Rush coupon. You cannot lose!



'BORROW' IT FOR 5 FULL DAYS!

MAIL ORDER—Rush Coupon

Dept. RC-57, Murray Hill Books, Inc., 232 Madison Ave., New York 16, N. Y.

Enclosed find \$5 (\$5.50 foreign) for Ghirardi's 972-page RADIO PHYSICS COURSE book; or I send C.O.D. for \$5 plus postage (no foreign C.O.D.'s). In either event, if not satisfied, it is understood I may return book in 5 days for complete refund of my money.

Name
Address
City & Zone State

MONEY-BACK GUARANTEE

MULTI-STATION INTERCOMS

(Continued from page 33)

cable with the required number of conductors will do just as well. Twisting of the wires is unnecessary and shielding is an added expense that yields no advantage. (Other sound men may dispute that statement.—Editor)

For outdoors, the cloth-covered cable is not usable. Ideally, weatherproofed wire such as that used by the telephone company would be best, but, so far, the author has never seen any multiwire cable of that type. Practically the only type available and feasible is rubber-covered. Use the best grade, in which each conductor is covered with color-coded rubber, with a heavy over-all live-rubber sheath. If there is a shield beneath the sheath, use it as the common lead, but if possible, save money by getting unshielded cable with the proper number of conductors.

Cable should be kept off the ground as much as possible, since soil is chemically bad for rubber. It can be suspended between trees, but, if there is any tendency for the tree to sway in the wind, be sure to leave plenty of slack. If it can be fastened along the top of a high fence, that is ideal. Outdoor installation is tedious, and hazardous if not done right, so run cable as much as possible indoors.

Indoors, running the cable is just a matter of keeping it out of sight and possibility of damage as much as possible. If feasible, running it along mouldings is better than on baseboards. Vacuum cleaners, carpet sweepers, and other such instruments are lethal to cable if they tangle with it.

Methods of going through doors and windows are varied. A hole right through the window frame or doorjamb in an inconspicuous spot will often suffice. One good tip is to find the telephone cable, if possible, and follow it. Usually, if the telephone cable is at all large, the holes through which it travels are large enough to allow the intercom cable to be squeezed through too. If it is necessary to enlarge any of these holes slightly, use the utmost care, as most telephone companies are singularly unfriendly toward anyone who damages their cable.

After the cable has been laid, it must be connected to the junction boxes. Make a tabulation of the code colors and assign each a number. Connect each color to the correspondingly numbered box terminal. If the same type of cable is used to connect each station to the junction box, the color code will be complete for the whole installation.

Servicing intercoms is very easy. If a station fails to operate, the first thing

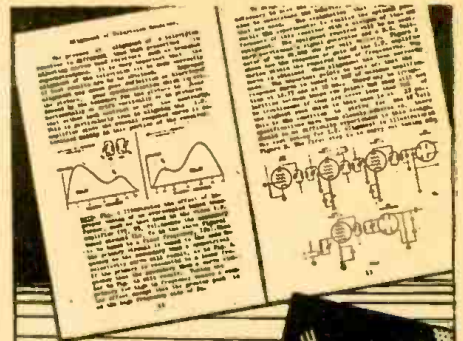

Television 1947!



Amateurs, Experimenters, Radio Servicemen...

Now you have access to the secrets of post-war television. Vision Research Laboratories now brings you in its new series of television booklets complete and detailed plans for the construction of a 5- or 7-inch television-FM receiver! The plans in these books incorporate all of the latest design features plus a detailed parts list. There is no need to wade through textbooks to get this necessary information. These booklets furnish you with all of the information needed for the construction of television receivers, sweep alignment generator, etc.

NOW AVAILABLE At a new low price demand "Design and Construction of a Modern 5- or 7-inch TELEVISION RECEIVER" and "Design and Construction of a Visual-Alignment SWEEP SIGNAL GENERATOR."

Each booklet contains: Many pages of theory and practical design information. Detailed sketches, layout photographs and schematic diagrams. In addition, each booklet is furnished with an 11 x 17 inch wall chart working diagram.

C O I L S SPECIAL TELEVISION COIL KIT Including 10 matched coils for above Television Receiver. Complete line of TELEVISION AND FM COILS—Write for particulars!



P.O. BOX #52, Kew Gardens 15, N. Y.

Enclosed is \$..... (Check or Money Order):
Quantity:
..... Television Receiver Booklet at \$1.75 ea.
..... Sweep Generator Booklet at \$1.75 ea.
..... Television Coil Kit \$4.95 ea.
Name
Address
City Zone
State C5

Order direct or through your local distributor!

ROTA-BASE

NEW HANDY LAB. DIAL actually gives a "prong" picture of radio tube connections. Simply turn the dial to the tube number desired on the ROTA-BASE and complete correct connections are instantly indicated on the "prong" diagram. No more valuable time lost thumbing pages or on lengthy readings, Filament, grid, plate, cathode, etc. to MORE THAN 300 tube types are given. PRICE NOW ONLY \$1.00 postpaid or sent C.O.D. plus postage. Order NOW, money refunded if you are not delightfully pleased.
REED MFG. CO. 411 S. Main St., Los Angeles 13, Calif.

RADIOMEN! Here's the Way to Bigger Pay

A Complete Practical Set of RADIO Home Study and Reference Books for Only \$9.75 CASH PRICE



Yours FREE To Try 7 Days

NOW — a new 1947 set of practical, "down to earth" books for the man who wants to get ahead in RADIO and realizes he must know modern radio and television to handle a bigger job. "Applied Practical Radio" gives the radio worker the information he needs to advance in his job or radio business. Yet, this great set is written simple enough

for the beginner. This is the only set of its kind in America today.

APPLIED PRACTICAL RADIO Tells All in 3 Handy Volumes

Here is practical, working knowledge of RADIO as it is used TODAY—from basic-principles to latest advances in Television. The facts are boiled down, including the "know how" to construct, install and service all types of Radio and Television apparatus. Unique picture instruction method takes a key equipment apart to show what makes it work and how to keep it going.

FREE!
1 year of Consultation Service & Tech Bulletins included

Everything New in Radio Made Easy

The hundreds of interesting up-to-the-minute subjects covered include Frequency Modulation, Television, Auto Radio, Public Address Systems, Multi-Band Receivers, High Frequency and Short Wave—everything in radio today from A to Z. Almost 1000 pages with 600 illustrations and new diagrams.

10 to 1 GUARANTEE
Set must earn 10 times its cost or, Coyne sends money back on its return at end of 1 year.

Send No Money—See Books Free

But don't take our word for what these great books can do for you—see them yourself. Just fill in coupon below and mail it today. Coyne sends you "APPLIED PRACTICAL RADIO" to look over 7 days FREE. If you feel set isn't everything we say AND MOIRE, just return it at our expense and you owe nothing. If you keep the set you need pay only \$3 after 7 days and \$3 per month (see coupon). You can't lose on this offer, so don't delay—send that coupon NOW.

Backed by Coyne School's 20 years of Radio shop experience



COYNE ELECTRICAL SCHOOL
Radio Division, Dept 57-71
CHICAGO 12, ILL.

FREE TRIAL COUPON

EDUCATIONAL BOOK PUBLISHING DIVISION,
COYNE ELECTRICAL & RADIO SCHOOL, Dept. 57-71
500 S. Paulina St., Chicago 12, Ill.

Send me Coyne's new 8-Volume Set, "APPLIED PRACTICAL RADIO" for FREE examination. After 7 days I'll either return it and owe nothing, or pay \$3 and \$3 a month to total \$10.75. Or I'll pay \$9.75 cash price in 7 days. Include 1 yr. FREE Consultation Service, Technical Bulletins and 10 to 1 Guarantee.

NAME AGE

ADDRESS

TOWN ZONE STATE

Send C.O.D. I'll pay postman \$9.75 plus C.O.D. fee. Same money back guarantee after 7-day trial.

is to check whether the cable has been damaged, or the amplifier is bad. If the tubes light, take a station from another location and substitute it for the suspected one. If it fails to work, the cable must be gone over.

To check the cable electrically, remove the plugs of all stations from their junction boxes, and check terminals with an ohmmeter for shorts. To find opens quickly, short any two conductors at one location and see if an ohmmeter across the corresponding terminals of another station shows the short. Repeat this until the trouble is located.

The amplifiers are much less complicated than ordinary radios, and servicing them is therefore a simpler problem. Since there are very few components in any of them, the most trouble will be found in tubes and filter condensers. Always check the outgoing cable connections in each amplifier unit. If possible, a miniature cable clamp should have been used in assembling them to keep the cable and a.c. cord from being pulled.

A final touch, which will add a professional air and inspire trust, is the preparation of a small instruction manual. Two pages or so will suffice. Manipulation of the controls should be explained clearly and inclusion of information about the privacy and versatility of the system is good advertising. If the person who makes and installs the system does not intend to service it, a paragraph or two headed "For the Serviceman" will help him understand the units. A schematic of the amplifiers and remotes should always be included, together with cabling information.

Speaking of advertising, it is always a good idea to install a cable with enough conductors to accommodate the maximum number of stations allowable with a particular system, even though that number may not be in use. Invariably, purchasers are highly pleased with intercoms after they become accustomed to using them, and often they decide to add more stations. If the cable is already large enough, it need only be tapped or extended to add units, but if not, entirely new cable will be needed.

CORRECTION

On the Question Box page of the February 1947 issue the values of C1, C2 and C3, in the intruder alarm, were not shown. C1 is a 1- μ f paper condenser with a working voltage of at least 450. C2 and C3 are identical units connected in a voltage dividing network. Each is made by connecting a 500- μ mf mica condenser in parallel with a 500- μ mf variable trimmer. A 2-gang variable of large capacity might be used for each of these.

We thank Mr. Lewis P. Lane, of Ojia, Calif., for calling our attention to the omitted values.

RADIO SERVICEMEN: SPECIALS

- TUBES—50L6, 35Z5, 12SQ7, 12SA7, Etc. 50% ON
 - TREBOR SPEAKERS 6 inch PM, Alnico 5... \$ 2.39
 - TREBOR SPEAKERS 4" or 5" PM, Alnico 5... 1.89
 - BY P55 COND. 600 v.-60S, 01, 02 mfd... .07
 - FILTER COND. 20-20 mfd. 150v. (Special) 10 for 4.40
 - MALLORY 10-10 450v. 20 25v. F.P. Cond... .85
 - MALLORY 40-20 MFD. 150v. F.P. Cond... .69
 - SPEAKER GRILLE CLOTH—6 Ass'd 6"x8"... .49
 - DIAL CORD KIT—100 Ft. Ass'd 4 & 6 Springs... 1.35
 - KNOB KIT—20 Ass'd Bot. Screw & Spr. Types... .99
 - PHONO AMPLIFIER—3 Tube (Less Tubes)... 3.25
 - RADIO'S—5 Tube Super 147 Model... Net 18.95
- Write Today for Bargain Bulletin
RADIO DISTRIBUTING CO., Pasadena 18, Cal.

In New Jersey... ..it's VARIETY

VARIETY'S SPECIALS FOR THIS MONTH

Limited quantities for immediate shipment. All guaranteed and will be sent in order received while stock lasts.

- ASTATIC Phono Pickups complete with L70 crystal & Hardware... \$1.98
- 5-INCH PM SPEAKER complete with mounted transformer for 50L6 or 35L6 tubes, 10 for \$23.00... \$2.49 ea.
- I.F. INPUT & OUTPUT transformers, 10 for \$5.40... .59 ea.
- PHONO KIT (Contains motor, turntable, pickup arm complete)... \$5.95
- PLASTIC KNOBS (White, Red, Red Mahogany and Tan) (in lots of 100 \$4.25) Slip-on type 1 1/8 in. with 1/4 in. shaft... .05 ea.
- ANTENNA LOOPS 8x5 1/2 Primary and Secondary (10 for \$3.60)... .39 ea.
- PUNCHED RADIO CHASSIS (for 6 or less tubes) 10 x 3 1/4 x 1 1/2, 10 for \$4.20... .45 ea.

VARIABLE CONDENSERS—2-gang, front section cutplate 162 mmf, rear section 420 mmf—2 trimmers long side rotor shaft extension 3/4" dia. x 5/8" long-knurled, 10 for \$12.50... \$1.45 ea.

R.C.A. CABINETS—Beautiful inlaid veneer with grill cloth. Inside measurements 13 x 11 1/2 x 8 1/2 deep. Speaker baffle for 5" speaker. Rubber feet \$4.95 ea. 3 for \$14.00

Guaranteed Volume Controls

- Less Switch... 48c 10 for... \$4.45
 - With Switch... 59c 10 for... \$5.45
- 500,000, 100,000, 50,000, 25,000 ohms; 1/2 meg, 1 meg, 2 megs.

FEDERAL SELENIUM RECTIFIER, 6 or more... 99c
Less than 6... \$1.09 ea.

RESISTOR & CABINETS. All wood construction, 6 drawers, 24 compartments... \$3.89
Complete with 100 assorted 1/2 W and 1 W resistors... \$7.95

Bargain! Guaranteed!

100 Assorted Bypass Condensers, 600 V Value... \$11.00
Special \$6.95

50L6 OUTPUT TRANSFORMERS, 10 for \$4.95... .53 ea.

SUPERIOR Model 670 Super-Meter

A Combination Volt-Ohm Milliammeter plus Capacity Reactance Inductance and Decibel Measurements.



Complete with test leads and instructions... \$28.40

Write Dept. C-5, for our FLYER. 20% Deposit with order required. Please add sufficient postage. Excess will be refunded.

Variety ELECTRIC CO., Inc.
601 Broad St., Newark 2, N. J.

JOBBERS-DEALERS

AND SERVICEMEN!

IF YOU NEED TUBES— WE'VE GOT 'EM!

Send us a trial order. This will convince you we merit your patronage, based on low prices, quick delivery and FULLY GUARANTEED TUBES. The following is a sample of our bargains always in stock:

Type	Lots of 10		Type	Lots of 10	
	Each	Each		Each	Each
1H5GT	65c	55c	7B7	50c	40c
1U5	39	35	7C6	50	40
1V	60	50	7Y4	50	35
5U4G	50	40	7X7	50	40
5W4GT	50	45	7AF7	45	40
5Y3GT	40	37	XXL	50	40
5Y4GT	45	37	12A8GT	60	49
6A7	62	50	12J7GT	50	42
6A8GT	62	44	12Q7GT	53	45
6AB7	69	65	12SA7GT	50	39
6AC7	69	65	12SQ7GT	50	39
6C6	50	42	12SK7GT	50	40
6BA6	75	50	24A	50	39
6F6GT	45	40	25L6GT	68	50
6H6	48	44	25Z5	63	50
6J5GT	63	50	25Z6GT	62	51
6K6GT	59	39	27	42	38
6K7	60	50	35L6GT	60	50
6K7GT	60	44	35Z3	65	60
6K8	60	54	35Z5GT	65	42
6L5G	65	40	43	90	60
6SA7GT	50	45	45	66	50
6SF7	65	56	47	92	55
6SJ7	50	49	50L6GT	65	50
6SK7	55	48	56	51	45
6SK7GT	60	38	75	67	44
6SL7GT	60	52	77	45	39
6SQ7	50	45	80	40	38
6SQ7GT	50	45	84/6Z4	58	45
6U7G	60	48	117Z3	85	60
6V6GT	83	50	12AT6	75	45
6X5GT	55	45	12BA6	75	45
7A4	69	40	12BE6	75	45
7B6	50	40	50B5	54	42
			32L7GT	90	80

(ALL TUBES FULLY GUARANTEED)

Get Our SPECIAL PRICE LIST on TRANSMITTING TUBES!

XTRA SPECIAL BUYS!

- Complete Assembled and Tested 2-Tube Wireless. Phono Oscillator
Less Tubes Special **\$3.95**
- 1825 TRANSMITTING Beam Power, Amplifier. Same as 807 except 12.6 volt filament medium
7 pin base **19c ea.**
- 1629 Tuning Indicator—Tri.
(Magic Eye) tube **29c ea.**
- 829 Push Pull twin-unit.
Beam power amplifier tube **\$2.25 ea.**
- Buss H.C.M.
fuse holder **15c ea.**
- Western Electric Thermistor
No. D-163903 **50c ea.**
- Standard make—20 MFD—20 volt
FP plug in type condenser.... **15c ea.**
- Standard make 6 Volt 4 prong.
Auto Vibrator **\$1.19 ea.**

WRITE, WIRE OR PHONE FOR OUR SPECIAL QUANTITY PRICES

25% deposit on all orders, balance C.O.D., F.O.B. New York

SENCO RADIO, Inc.

96 WARREN ST., N. Y. 7, N. Y.
TEL. CORTLANDT 7-6065

CODE OSCILLATOR

Upon reading about Mr. Gaessin's very unique code practice oscillator in the June, 1943, issue of RADIO-CRAFT, I was determined to discover if such a hookup would work on the radio frequencies as well as the audio. The result of this experimenting is a midget signal generator for i.f. and r.f., covering from approximately 450 to 1800 kc.

Many diagrams of signal generators were studied before any attempt was made to make this one. A small yet efficient oscillator was desired. The smaller signal generators were all a.c.-d.c., and this type of unit was undesirable as there is always the possibility of shorting out the line in aligning another a.c.-d.c. set. Other designs used a bulky power transformer to avoid this setup. This again was undesirable because of the space a power transformer would require. The only way out seemed to be by the use of 6 volts on the plates of the various tubes.

First, an audio oscillator similar to the one in RADIO-CRAFT was constructed. A 6SN7 was used in this part of the circuit. After this section was completed and tested, construction of the r.f. end was started. The r.f. oscillator consists of a 6F5 triode, hooked up similarly to an electron-coupled oscillator.

The set is tuned by means of a midget condenser with its two sections connected in parallel. This was done to give greater frequency range. A double-pole double-throw switch changes the oscillator from high to low frequency. The 500-ohm potentiometer gives adequate attenuation. A phone jack provides for the feeding of the output to a shielded greater frequency range. A double-pole cable. The i.f. coil has 150 turns of No. 30 enamel wire and the broadcast coil 90 turns of No. 28 enamel. Both are close-wound on 1½-inch forms and tapped one-third the distance from the bottom.

The entire unit was built into a cigar box measuring 5½ x 9 x 2½. The a.f. part was put in the bottom of the box, leaving the top for the r.f. section. By careful planning, the components can easily be made to fit in a cigar box of average size. This signal generator has been used for quite some time and has never given the least bit of trouble during the whole period.—Bernd Falk

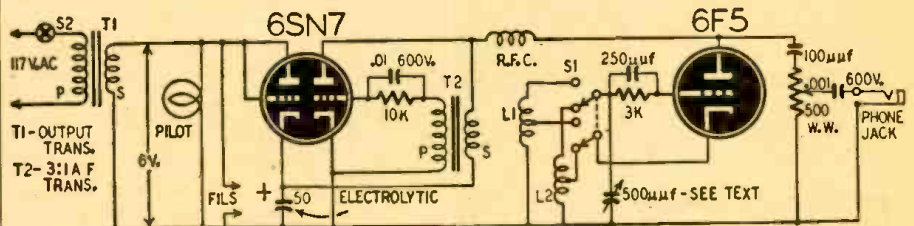

- 5" Dynamic Speaker 350 ohm with Output Transformer **\$1.95**
 - Volume Controls ½ Meg or 50,000 ohms with switch **.39**
 - Volume Controls 1 Meg without switch **.24**
 - 2 Gang Variable Condensers 420/162 MMFD **.78**
 - 5" PM Speaker Alnico #5 Magnet **1.22**
 - Tubular Condensers .01-600V. (per hundred) **3.95**
 - 6' Line Cords, 18 Gauge with finest plug **.14**
- ALSO TUBES, OUTPUT TRANSFORMERS, COAXIAL WIRE, ETC. SEND FOR LIST
- BROOKS RADIO DISTRIBUTING CORP. 80 Vesey St., New York (7), N. Y.**

AMSCO MAY SPECIAL

Klystron Osc. Tube
2K25/723AB, oper-
ates on 3 cm. New
in cartons,
each **\$5.75**

Microphone
Carbon—T-24
Push to talk
Button **\$1.29**

Microampere
Meter
0-200
Beede
2¾" **\$3.29**

Air Trimmers
12 Ass't **\$1.19**

Mica Cond.
25 Ass't **.98**

Vibrators
2 Volt, 7 Prong Syro
For GE
Portable **\$1.69**

Neon Panel
Lights
Two for **98c**

20 Henry
300 Ma Chokes
Two for **\$3.95**

Electrolytic
Capacitors
40-40 mfd., 150 V
Five for **\$1.95**

Parabolic Reflectors,
15 inch, spun Alum.
Alzak Fin. Ideal for
1200 MC and up.
\$2.19 ea.
\$3.95 pr.

Mike Buttons
T-30—Contact Type
1" Round
Three for **\$1.19**

Meter Rectifiers
Full Wave **98c**
Half Wave **69c**

Resistors
½ and 1 watt
500 Ass't **\$7.95**

Knobs
25 Ass't **\$1.95**

Hardware Ass't
2 lbs.
Nuts, Bolts, Springs,
Lugs, Wash-
ers, etc. **\$1.49**

Panel Type Fuse
Holders 4AG
Ten for **.98**

Plate Trans-
former
110V.-60 cy Sec-
ondary 1500 V.C.T.
250 Ma **\$6.95**

Volume Controls
½ Meg. with Switch
Two for **\$1.29**

WRITE FOR CIRCULAR
FEATURING RADIO COMPONENTS
AT BARGAIN PRICES
AMERICAN SALES CO.
1811 W. 47th St. Chicago 9, Ill.

★ PUT YOUR EXTRA MONEY ★
★ INTO ★
★ U.S. SAVINGS BONDS ★

RISCO HAS IT The PARTS AT THE PRICES



V. M. MIXER CHANGER

PLAYS 10" and 12" Records at the same time.
WALNUT BASE, \$4
SEEBURG RECORD CHANGERS, \$22.50
DETROLA RECORD CHANGERS, \$14.50
OAK CHANGERS, \$20.00
MAGUIRE 2-POST CHANGERS, \$12.95

\$16.50

Above Easily Attached to Any Radio



RISCO RECORD PLAYER

Plays 10" and 12" records. Easily attaches to any radio, heavy duty motor, crystal pickup - high output walnut finish

\$9.95

with built in amplifier and tubes \$16.95

ALLIANCE PHONO MOTORS, 9" TURNTABLES

\$2.95

6 TO A BOX

ASTATIC L-70 Cartridges, \$1.45

ASTATIC L-70 SHURE CRYSTAL PICKUPS

\$1.95

Nylon Cartridges, \$3.25

Phono Amplifier

3 TUBE AC-DC
Wired Vol. & Tone Control **\$2.95**
Uses 12SQ7, 501A, 35Z5.
Complete with 3 tubes and 5 inch speaker in kit form. \$7.50
Wired and Tested ...\$8.00



OXFORD 12" 6.8 ALNICO V	\$8.95	6" PM	\$1.95
Clarnatal Vol C W/BW any size	Electrolytic Condenser Specials
CD-10-10-450V59c	CD-20-20-150V49c
CD-20-40-150V55c	CD-30-50-150V55c
Military 10-250V23c	Military 30-30-150V49c
Springe 8-500V.FP43c	Springe 40-450V.FP59c
Aerovox 6-8-450V52c	Aerovox 16-450V49c
Mercury 20-90-150V39c	Pyramid 30-30-150V44c

45% discounts on all radio tubes—FREE CATALOG
25% on C.O.D. orders to unrated acct's

ORDER DIRECT FROM THIS AD

RISCO ELECTRONICS
WHOLESALE DISTRIBUTORS
22 Warren St., New York 7, N. Y.

A SMALL RECORDING STUDIO

(Continued from page 31)

boosted on the recording and de-emphasized when the disc is played back. The de-emphasis reduces the scratch, resulting in a quieter recording.

Volume level indicators

With a crystal cutter of the type described, the signal voltage required in Fig. 2-a is 50 r.m.s. volts and in Fig. 2-b, 150 r.m.s. volts. This voltage is read with an a.c. voltmeter across the amplifier output. This voltmeter should have a flat frequency characteristic over the audio range and should not materially load the output circuit. If the meter is connected across a 600-ohm line, as in Fig. 2-b, it may be a commercial db or v.u. meter, calibrated in decibels or volume units, respectively. (Zero db equals 600 milli-watts from a 600-ohm circuit.) The v.u. meter is calibrated in volume units and is carefully designed to follow the average audio level. It is also calibrated in some cases, in db.

In the interest of economy, an output level indicator may be made by connecting a d.c. milliammeter and a rectifier. The rectifier may be a copper-oxide or a vacuum-tube diode, or a 1N34 germanium crystal diode may be used. To make the meter follow the average level, a capacitor may be connected across the rectifier load, or a sensitive meter used

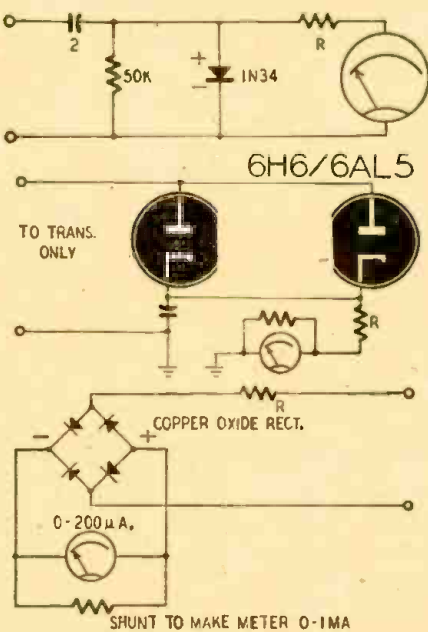
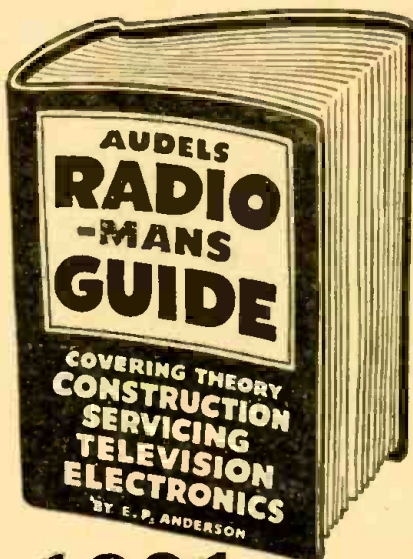

Fig. 3—Output meter rectifiers, three types. with a heavy shunt, or both. Fig. 3 shows several output meter circuits. Figs. 2 and 4 show their proper connection. (Continued on page 84)

RED-HOT P A SPECIAL !!!

50 Watt RCA Power Amplifier, Type 4288J, 4-8-15-60-250 ohm output, highest quality de luxe RCA brand new units; uses 4-6L6's complete with tubes sells for \$142.00
Only One — BC-937A Receiver Indicator from SCR-547 with diagrams, sells for \$155.00 \$99.95
Only One — 947-A Magnetron Transmitter from SCR-547 with diagrams, less meters, as-is \$25.00
Both SCR-547 Units, as-is, over 40 tubes \$110.00
Cash or Money Order. Sent F.O.B. Washington, D. C.
EDWARD ERSLER, 1615 Que St., N.W., Wash. 9, D. C.

7 DAYS FREE EXAMINATION



1001 RADIO FACTS AND FIGURES

AUDEL'S RADIOMANS GUIDE—914 Pages, 633 Illustrations, Photos, Wiring Diagrams, 38 Big Chapters, covering Radio Theory, Construction, Servicing, including Important Data on Developments in Television, Electronics and Frequency Modulation, Review, Questions and Answers, Calculations & Testing. Highly Endorsed—Indispensable for Ready Reference and Home Study.

\$4 COMPLETE • PAY ONLY \$1 A MONTH
Step up your own skill with the facts and figures of your trade. Audels Mechanics Guides contain Practical Inside Trade Information in a handy form, Fully Illustrated and Easy to Understand. Highly Endorsed. Check the book you want for 7 days' Free Examination.

Send No Money. Nothing to pay postman.

CUT HERE MAIL ORDER

AUDEL, Publishers, 49 W. 23 St., NEW YORK 10, N. Y.

Please send me postpaid for FREE EXAMINATION books marked (x) below. If I decide to keep them I agree to mail \$1 in 7 Days on each book ordered and further mail \$1 monthly on each book until I have paid price. Otherwise, I will return them.

- RADIOMANS GUIDE, 914 Pages \$4.
- ELECTRICIANS EXAMINATIONS, 250 Pages 1.
- WIRING DIAGRAMS, 210 Pages 1.
- ELECTRICAL DICTIONARY, 9000 Terms 2.
- ELECTRICAL POWER CALCULATIONS, 425 Pgs. 2.
- HANDY BOOK OF ELECTRICITY, 1340 Pages 4.
- ELECTRONIC DEVICES, 216 Pages 2.
- ELECTRIC LIBRARY, 12 vol., 7000 Pgs., \$1.50 vol. 2.
- OIL BURNER GUIDE, 384 Pages 1.
- REFRIGERATION & Air Conditioning, 1280 Pgs. 4.
- POWER PLANT ENGINEERS Guide, 1500 Pages. 4.
- PUMPS, Hydraulics & Air Compressors, 1658 Pgs. 4.
- WELDERS GUIDE, 400 Pages 1.
- BLUE PRINT READING, 416 Pages 2.
- SHEET METAL WORKERS Handy Book, 388 Pgs. 1.
- SHEET METAL PATTERN LAYOUTS, 1100 Pgs. 4.
- AIRCRAFT WORKER, 240 Pages 1.
- MATHEMATICS & CALCULATIONS, 700 Pgs. 2.
- MACHINISTS Handy Book, 1600 Pages 4.
- MECHANICAL Dictionary, 968 Pages 4.
- AUTOMOBILE GUIDE, 1540 Pages 4.
- DIESEL ENGINE MANUAL, 400 Pages 2.
- MARINE ENGINEERS Handy Book, 1280 Pages 4.
- SHIPFITTERS Handy Book, 272 Pages 1.
- MECHANICAL DRAWING COURSE, 160 Pages 1.
- MECHANICAL DRAWING & DESIGN, 480 Pgs. 2.
- MILLWRIGHTS & Mechanics Guide, 1200 Pgs. 4.
- CARPENTERS & Builders Guides (4 vols.) 6.
- PLUMBERS & Steamfitters Guides (4 vols.) 6.
- MASONS & Builders Guides (4 vols.) 6.
- MASTER PAINTER & DECORATOR, 320 Pgs. 2.
- GARDENERS & GROWERS GUIDES (4 vols.) 6.
- ENGINEERS and Mechanics Guides 12.
- Nos. 1, 2, 3, 4, 5, 6, 7 and 8 complete 12.
- Answers on Practical ENGINEERING 1.
- ENGINEERS & FIREMANS EXAMINATIONS 1.

Name _____
Address _____
Occupation _____
Employed by _____ R.C.F.

MAY SPECIALS SCARCE TUBES

All types—40% to 80% off
All Popular Brands—New—Guaranteed—Sealed Cartons
024, 1L4G, 1LN5, 1P5, 2A3, 5Z4, 6AB, 2A6, 6E5, 6F5, 6J8, 6K5, 6K8, 6P5, 6Q7, 7A8, 7B4, 7B8, 7B5, 7B7, 7C5, 7F8, 7Q7, 12A8, 12F5, 12J7, 12K7, 12Z3, 14Q7, 14R7, 25A7, 25L8, 25Y3, 28Z5, 29Z6, 30, 32L7, 33, 38, 39A8, 39V4, 35Z3, 43, 45, 47, 50A5, 50V6, 55, 57, 58, 70L7, 71A, 84, 117L7, 117M7, 117N7, 117P7, 117Z3, 117Z6, 108, XXL ... and many others.

11 SPECIALS 11

- 1—Five tube "All American" Kit: 501A, 35Z5, 12BA7, 12SK7, 12SQ7 \$3.25 per kit
- 2—Five tube "Miniature" Kit: 50B5, 35W4, 12AT6, 12BA6, 12BE6 \$3.25 per kit
- 3—25Y3 (Same as 25Z5) List Price, \$3.20. Your cost 69c each
- 4—6AK5 89c each
- 5—6AH6 69c each
- 6—6J5GT 59c each
- 7—1R5, 1S5, 1T4, 394 49c each
- 8—ACORN TUBES: Nos. 954, 955, 956, 957 49c each
- 9—HEARING AID TUBES: Nos. 501X to 509AX 49c each
- 10—717A Transmitting Tubes 69c each
- 11—Transmitting Tubes: RK-39 and VT-127 98c each

CONDENSERS

At a Price You Can't Beat. Fully Guaranteed for one year. "The American Radio Repairman's 1st Choice in a Condenser."
20/20 MFD @ 150 volts \$4.45
10 MFD @ 450 volts32
10 MFD @ 450 volts45
20 MFD @ 150 volts32

BYPASS

400 Volts	600 Volts	400 Volts	600 Volts
.001	.12c	.03	12c
.003	.12c	.05	12c
.005	.12c	.1	14c
.01	.12c	.25	24c

Special Discounts On All Large Orders
Minimum Tube Order—1 doz.
Minimum Condenser Order—1 doz.
20% deposit required on all orders
We ship anywhere—Write for catalog



COMMERCIAL RADIO
36 BRATTLE ST., BOSTON 8, MASS.

Only "FERRET"

CAN OFFER YOU
THESE REAL HIGH GRADE
PRECISION INSTRUMENTS
AT POPULAR PRICES!

All Metal Cases — Black Wrinkle Finish



Wt. 12 lbs.

Model 600—SIGNAL GENERATOR: 110-120 volts, 50-60 cycles. RANGE: 165 K.C. to 56 M.C. in 5 bands. AUDIO: 400 cycles, sine wave, 10 volts output. R.F. OSCILLATOR: Electron coupled for stability. Ceramic, no drift, coupling condenser. .3 volt R.F. output. **\$49.95**

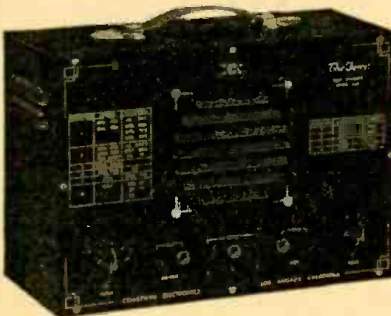

Model 620—TEST SPEAKER. FIELD IMPEDANCE: 500, 1000, 1500, and 2500 ohms. INPUT: Match any single tube or tubes in push-pull. SIZE: 12" long, 6½" wide, 9" high. WEIGHT: 6 lbs. packed. **\$19.95**



Model 610—AUDIO OSCILLATOR: 110-120 volts, 50-60 cycles. RANGE: 20-24,000 cycles. OUTPUT: Low impedance, 25 volts. DIAL: 3 to 1 vernier, multi-colored, red and white scale, easy to read. OVER-ALL DIMENSIONS: 12" long, 6½" wide, and 9" high. WEIGHT: 10 lbs. **\$69.95**

SEND FOR DESCRIPTIVE LITERATURE ON COMPLETE LINE

IMMEDIATE DELIVERY — Terms: 20% with Order, Balance C.O.D. Satisfaction Guaranteed or Money Refunded.

AUDIO

SALES COMPANY

11 Warren St., New York 7, N. Y.

nection in the circuit. The resistor R should be great enough to prevent damage to the 1-ma meters. For Fig. 2-a, 150,000 ohms and, for 2-b, 50,000 ohms, would be a safe first approximation. Transformers used in coupling the amplifier to a cutter or speaker must be of the highest quality in order to reduce distortion to a minimum and to provide a wide frequency response. This is particularly true when the output tubes are beam tetrodes with or without negative feedback. A high order of negative feedback cannot be applied around a poorly designed transformer.

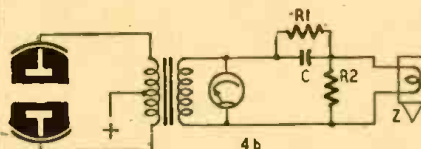
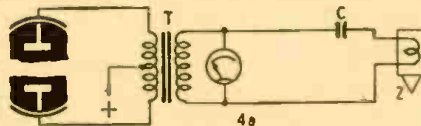

CUTTER IMPEDANCE	8Ω	500Ω
VALUE C	MOD. CONSTANT VELOCITY 40μf	6μf (10,000 cps)
VALUE C	CONSTANT AMPLITUDE 2μf	2μf (10,000 cps)

4c

Fig. 4—Compensating network considerations.

One of the photos shows a collection of high-quality transformers capable of the highest fidelity.

Compensating networks

When the cutter is of the magnetic type, the connection may be as seen in Fig. 4.

A magnetic or dynamic cutter has a natural constant-velocity characteristic—the stylus amplitude varies inversely with frequency. If the output is adjusted for the correct stylus amplitude at 1,000 cycles, the resultant amplitude at 50 c.p.s. would be so great as to cut into the next groove, and so it is conventional to limit the amplitude of the stylus motion. This is done by connecting a network between the amplifier and the magnetic cutter to impart a constant-amplitude characteristic below a certain turnover frequency. This frequency is usually near 500 c.p.s.

The network consists, in its simplest form, of a series-connected capacitor as shown in Fig. 4-a. The impedance of the transformer is chosen to match the impedance of the cutter. With C connected as shown, its reactance at a very high frequency will be so low as to constitute, effectively, a short circuit and cease to exist electrically. At some frequency, its reactance will increase to a point

SERVICE MEN!

- RCA Radiotron
- Tungsol
- Raytheon
- Tubes, Parts & Equipment
- Sylvania
- New Astatic QT-J
- Nylon Crystal

\$5-24 each

Write for our latest bulletin, Dept. C2
Distributors of RADIO EQUIPMENT

CHIEF ELECTRONICS

104 MAIN STREET, POUGHKEEPSIE, N. Y.
The Square Deal Supply House

RESISTORS

IS
OUR
BUSINESS

½ WATT - 1 WATT - 2 WATT
ANY QUANTITIES
ANY TOLERANCES

Immediate Delivery

RESISTORS KIT

\$2.05 each

(Assorted and Not Mixed 100 pcs.)
(60 pcs. ½ watt and 40 pcs. 1 watt)

ELECTRONIC PARTS
AND COMPONENTS

LEGRI COMPANY, Inc.

848 - 850 Amsterdam Avenue
New York 25, N. Y.

Supplying Every
Electronic Need

- FOR THE—
- RADIO SERVICE MAN
 - AMATEUR
 - STUDENT
 - EXPERIMENTER
 - INDUSTRIAL

WRITE FOR ILLUSTRATED PRICE LIST
GRABREE'S
WHOLESALE RADIO

DALLAS 2508 ROSS AVE. TEXAS

The Unpublished Facts of Life

There are some things that cannot be generally told... things you ought to know... amazing discoveries of the hidden processes of man's mind and the mastery of life's problems. Write today to: Scribe V.Z.N.
The ROSICRUCIANS (AMORC) San Jose - California

BARGAIN PRICE LIST!

Competition is increasing. Write for catalogue for low price, quality Parts, Test Equipment, Radio Kits, and Radio Receivers.

RADIO DEALERS SUPPLY COMPANY
135 Liberty St., N. Y. 6, N. Y.

Name

Address

City Zone... State.....

where it is equal to the impedance of the cutter. At this point the voltage across the cutter will be reduced by a factor of 2 (6 db). As the frequency decreases, less and less voltage is impressed across the cutter and more and more across the capacitor C.

The slope of this decrease in cutter voltage with frequency will be approximately 6 db per octave, which is correct to impart a constant-amplitude characteristic to the cutter stylus.

The value of C determines the point at which the transition from constant velocity to constant amplitude takes place. If a very high frequency is chosen for the turnover point—10,000 e.p.s., for example—the cutter becomes a constant-amplitude device below that frequency and will record in the same manner as a crystal. The value of C will be found in the table in Fig. 4-c.

It is possible to vary the effect of this series condenser by shunting it with a resistance of the proper value. For instance, the value of R1 may be selected so that in the circuit in Fig. 4-b, the cutter becomes a constant amplitude device down to some predetermined low frequency, and then becomes constant-velocity again. This would result in a bass-boost cutting characteristic which would be effective if a record is to be played on a turntable with appreciable rumble, as the playback amplifier can be adjusted to reduce its low-frequency response and this would in turn reduce the playback turntable rumble.

If the cutter has serious peaks in its response curve, it might be feasible to reduce this effect by shunting the cutter with a resistor such as R2 in Fig. 4-b. This would have the effect of damping the peaks in the cutter's response and also reducing the effects of these changes being reflected back into the network and the output tubes. Of course, the impedance of the cutter for calculating C is the parallel combination of R2 and the cutter. The impedance of the cutter at some frequency is usually supplied by the manufacturer.

In low-impedance output circuits, it may be necessary to use electrolytic capacitors for C, due to the impractical size of the large values. There is no d.c. polarization voltage, so two electrolytic condensers of twice the necessary capacity can be connected in series opposing; that is, the plus terminal of one connected to the plus terminal of the other, and the two negative terminals used to connect the resultant capacitor in the circuit.

Power limitations

It is worth while noting that too much bass boost, with a magnetic cutter, may result in the driven reed hitting the pole pieces. Also, the travel on a magnetic cutter becomes nonlinear with extreme stylus motion. It is therefore unwise to exceed the manufacturer's rated input level.

The crystal cutter can be ruined by the application of too high a voltage. If there is danger of the application of too high voltage to a crystal, a protec-

(Continued on page 89)



Musical Distinction
WITH
**ABSOLUTE FIDELITY
AMPLIFICATION**
DESIGNED BY A. C. SHANEY

A new amplifier development now enables you to clearly identify all the instruments in a full orchestra! After 20 years of audio research and development, we can now place in your hands a new means to make the most fascinating, uplifting, and enjoyable journey into the realm of perfect sound reproduction—through the medium of the most satisfying musical amplifier the world has ever known.

If you are one of those discriminating persons for whom anything less than the best is a disappointment, you are one for whom the ACA-100DC Amplifier was designed. Send for literature.

AMPLIFIER CORP. of AMERICA

398 BROADWAY, NEW YORK 13, N. Y.

Send 3c stamp for A. C. Shaney's new booklet "20 STEPS TO AMPLIFIER PERFECTION"
A. C. SHANEY'S FM-AM AMPLIFIER MANUAL IS STILL AVAILABLE AT 25c

VERIFIED SPEAKERS

"They speak for themselves"

Distributors Enjoy Selling Them
Because they make friends and build business

The **VERIFIED GUARANTEE** enables the Distributor to immediately Replace any defective Speaker with a new one.

Saves Time And Money For The
RADIO SERVICE MAN

WRIGHT

Inc.

2232 University Avenue

St. Paul 4, Minnesota

Get Started in Radio



10 "HOW-TO-DO-IT" BOOKS

Get a solid foundation in radio by means of these 10c timely text books. Each clearly written, profusely illustrated, contains over 15,000 words. You'll be amazed at the wealth of information packed into these handy books. Excellent for reference—ideal for technical library. Your money back if not satisfied.

5 BOOKS for 50c

10 BOOKS for \$1.00

Sent to You Postpaid

- | | |
|--|-------------------------------------|
| No. 1—How To Make Four Doerle Short Wave Sets | No. 6—How To Have Fun With Radio |
| No. 2—How To Make The Most Popular All-Wave 1 and 2 Tube Receivers | No. 7—How To Read Radio Diagrams |
| No. 3—Alternating Current for Beginners | No. 8—Radio for Beginners |
| No. 4—All About Aerials | No. 9—Simple Electrical Experiments |
| No. 5—Beginners' Radio Dictionary (Leading Terms) | No. 10—Television |
- Remit by check or money order—register letter if you send cash or stamps.
RADIO PUBLICATIONS, 25A West B'way, New York (7)

NEWS ABOUT

THE LATEST IN RADIO PARTS—EQUIPMENT—ELECTRICAL DEVICES—brought to you in our monthly bulletins. **ABSOLUTELY FREE!** No obligation.

WRITE TO
MANUFACTURING DIVISION
HERBACH & RADEMAN, INC.
ELECTRONICS SPECIALISTS
522 MARKET ST., PHILA. 6, PA. • DEPT. B

GET THIS FREE CATALOG NOW



ALL THE BEST
BUYS IN RADIO,
HAM EQUIPMENT
AND P. A.
SYSTEMS.

SEND FOR YOUR COPY

of this new free book designed to save you money. Select the new Lafayette radio or famous-make ham equipment you want — at thrifty, low Lafayette prices. Do as thousands today are doing — make the big FREE Lafayette Catalog your buying guide. You save valuable time when you "shop" by mail. And you save real money on everything you buy. Every item in the great Lafayette Catalog is value-priced! Don't be without this book another day. It's FREE — just mail the coupon for your own copy. See what you get!

YEAR'S BEST P.A. BUY
Lafayette 8-watt Indoor System
Here's Lafayette's value-leader in the low-power field. If you sell P.A. — this system will go like hotcakes. If you use P.A. — it's your chance to save a lot of money.
MODEL 7015 — Complete unit includes: Model 708 8-watt amplifier, complete with tubes. Amplifier has separate mike and phono inputs, output impedances of 8, 15 and 500 ohms. Ten-inch PM speaker. Fabrikoild wall baffle. Crystal mike and stand with 7 1/2-foot cable with end connector. Twenty-five-foot speaker cable. Operates on 110-120 V. A. C., 60 cycles, 65 W.
COMPLETE READY TO OPERATE
—Your Cost Only \$44.60

LAFAYETTE Radio
RADIO WIRE TELEVISION INC.
100 SIXTH AVENUE, NEW YORK 13, N. Y.

110 Federal St., Boston 10 ★ 24 Central Ave., Newark 2, N. J.

LAFAYETTE RADIO, Dept. JE7
100 Sixth Avenue, New York 13, N. Y.
Please RUSH big free radio catalog.
Enclosed is Check Money Order for PA System
Name _____
Address _____
City _____ Zone _____ State _____

INSTALL A WAVE TRAP!

By OLIVER PARSONS

A VERY annoying and frequent trouble is encountered in almost all low-priced commercial receivers, especially since the advent of multitude of radio range transmitters located along the constantly expanding airways systems in this country. On tuning in stations, especially near the low-frequency end of the dial, we encounter squeals, whistles and "da-dit, da-dit," or "dit-da, dit-da," in an unending stream, sometimes so strong that the received station's music or speech is completely garbled, or its entertainment value destroyed.

This type of interference is recognized by every good service man as the signal put out by the nearest airways beacon transmitter leaking through the mixer stage into the i.f. amplifier, which is probably peaked on the beacon's frequency.

One way to get rid of it, the oldest and easiest way when it works, is to detune the i.f. stages from the original frequency and peak them at least ten kilocycles away from the interfering signal. That's fine if the oscillator circuit of the set has a low-frequency pad-der that will allow for re-tracking. But remember that it is sometimes necessary to remove the i.f. much farther than ten kilocycles, to get rid of the unwanted interference. Many cheap sets, however, are designed to track with a specially cut oscillator tuning condenser section at the i.f. recommended by the manufacturer. Throwing the i.f. off this frequency, therefore, causes the set to function poorly or—in many cases—not at all.

The most logical and most efficient method of eliminating this interference is to insert a wave trap in the antenna circuit of the receiver or in the grid circuit of the mixer stage. The old way of doing this was to simply disconnect the aerial lead where it joined the set antenna post and connect a coil and condenser in a parallel-tuned circuit in series with the antenna and the set.

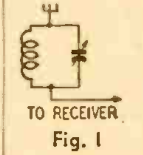

(Fig. 1) This left exposed leads—including the antenna coil which was generally unshielded — which picked up sufficient signal to make the hookup practically worthless. On the other hand there is generally little room left in the average set to install a wave trap on the chassis where the leads may be short and the installation shielded sufficiently to get maximum results.

This calls for some ingenuity on the part of the radio man. Many small sets have the antenna coil mounted on top of the chassis near one corner with quite a bit of space above the coil and the top of the cabinet. In these cases inductive coupling may be used without the necessity of even making an electrical connection. Simple wave traps are constructed of one coil of an old i.f. transformer with a suitable trimmer con-

MORE SMASH BUYS at National Radio Distributors

Famous National Radio Kits

NOW—Immediate Delivery from stock
COMPONENT PARTS MOUNTED ON CHASSIS FOR EASY WIRING
All Radio Kits complete, including beautiful plastic cabinet, built-in loop antenna, new Alnico speaker, and full instructions for assembly. For 110-125 volts AC/DC.
White Plastic Cabinets now available. \$1.00 additional.
MODEL N.R.-7-5 TUBE SUPERHETERODYNE. uses 12SA7, 12SK7, 12SQ7, 50L6 & 3B25 tubes. Your net \$11.95
Kit of 5 Matched tubes Your net 4.50
MODEL N.R.-5-5 TUBE "TWO BAND" SUPERHETERODYNE. uses Tubes as above. Band 1—550/1600 K.C. Band 2—8/16 Mcracycles Your net \$13.95
Kit of 5 Matched tubes Your net 4.50
MODEL N.R.-6-6 TUBE SUPERHETERODYNE. uses 2-12SK7, 12SA7, 12SQ7, 95L6 & 3525 tubes. Your net \$13.75
Kit of 6 Matched tubes Your net 5.50
MODEL N.R.-4 TUBE T.R.F.. uses 12SK7, 12SQ7, 50L6 & 3525 tubes. Your net \$19.95
Kit of 4 Matched tubes Your net 3.50



NOW! IMMEDIATE DELIVERY! THE NEW TRANSVISION TELEVISION KIT

If you can use a soldering iron you can assemble this kit. Step by step instructions include wiring, schematic and pictorial diagrams. Finished set is guaranteed to operate satisfactorily if directions are followed exactly.
This kit is complete including 17 tubes, 7" picture tube, finished front panel, pre-tuned RF unit, solder, wire, 60' of low loss lead-in and specially designed Television antenna. THERE IS NOTHING ELSE TO BUY. Provisions for six television channels. Price Complete \$159.50

Please include 25% with order. We will ship balance C.O.D. Write for New Free Catalog. Just Out.
Tivoli 2-6015 Cable address: ENARDEE

National Radio Distributors

899 r Southern Blvd., New York 59, N. Y.

Ruf-Koat Inspection Lite
Dial Belt Kit - Hardware Laboratory
G-C RUF-KOAT
G-C INSPECTION LITE
Ideal for servicing. Lights up hard-to-see corners. Perfect for repairs, experiments, etc. 110-20 AC/DC No. 705. List \$1.50
G-C SERVICEMEN'S DIAL BELT KITS
Fine woven replacement for all sets. Easy to install. Supplied in kits of various quantities, with steel box. No. G-25-kit of 25 belts List \$6.70
G-C HARDWARE LABORATORY
20 clear glass jars of over 1000 essential electronic hardware items; ideal for servicemen, etc. No. 6601. List \$12.00
At leading jobbers Write for complete catalog today!
SEE OUR EXHIBIT—BOOTH # 96
1947 RADIO PARTS CONFERENCE
Stevens Hotel, Chicago * May 13-16
RADIO DIVISION DEPT. D
GENERAL CEMENT Mfg. Co., Rockford, Ill., U. S. A.
Manufacturers of over 3,000 products
Sales offices in principal cities

S.S.S.

"Servicing by Signal Substitution"

Learn about this modern dynamic approach to radio servicing with ONLY BASIC TEST EQUIPMENT.
 ... Fully described in a 120 page book available from your Precision Distributor or factory at 35¢.
 ... Schools are invited to inquire regarding quantity orders from our Educational Division.

PRECISION APPARATUS COMPANY INC.
 ELMHURST 4, N. Y.

Manufacturers of Fine Test Equipment
 RADIO • TELEVISION • ELECTRICAL • LABORATORY

SUPER DRILL GRINDER ONLY \$2.95
 At Your Dealers or Postpaid
 Order Today!

Sharpens round shank drills from 3/32" to 1-1/16" in diameter, up to 11" long. Grinds old drills like new in 4 different point angles, using hand or power grinding wheels.

MONEY-BACK GUARANTEE
A. D. Mc BURNEY
 Dept. R-5, 939 W. 6th St. Los Angeles 14, Calif.

RADIO TUBES

Most Critical Types in Stock 50L6, 1A7, 35Z5, etc.
 Brand New, in Sealed Cartons
 100% GUARANTEED
 Repairs men and Dealers. Write For Available List at Trade Discounts

RADIO-EXPERTS
 178 E. 33rd St., Dept. C. Paterson 4, N. J.

OPPORTUNITY AD-LETS

Advertisements in this section cost 20 cents a word for each insertion. Name, address and initials must be included at the above rate. Cash should accompany all classified advertisements unless placed by an accredited advertising agency. No advertisement for less than ten words accepted. Ten percent discount six issues, twenty percent for twelve issues. Objectionable or misleading advertisements not accepted. Advertisements for June, 1947, issue must reach us not later than April 28, 1947.
 Radio-Craft • 25 W. B'way • New York 7, N. Y.

CORRESPONDENCE COURSES AND SELF-INSTRUCTION books slightly used. Sold, Rented, Exchanged. All subjects. Satisfaction guaranteed. Cash paid for used courses. Complete information and 100-page illustrated bargain catalog Free! Write—Neison Co., Dept. 39, Chicago 3, Ill.

WE REPAIR ALL TYPES OF ELECTRICAL INSTRUMENTS, tube checkers and analyzers, Hazelon Instrument Co. (Electric Meter Laboratory), 140 Liberty Street, New York, N. Y. Telephone—BARclay 7-4239.

MAGAZINES (BACK DATED)—FOREIGN, DOMESTIC, arts, books, booklets, subscriptions, pln-usa, etc. Catalog 10c (refunded). Cicerone's, 863 First Ave., New York 17, N. Y.

AMATEUR RADIO LICENSES, COMPLETE CODE and theory preparation for passing amateur radio examinations. Home study and resident courses. American Radio Institute, 101 West 63rd Street, New York City. See our ad on page 96.

FREE WHOLESALE BULLETIN, TUBES, PARTS, Bargain prices. Henshaw Radio Supply, 3313 Delaware City, Kansas City, Kansas.

AGENTS WANTED—MALE—POWER MOWERS, Special deal—sample. ROTACUT, M-2133. Ex. Springs, Mo.

RADIO MEN—LOWEST PRICES IN AMERICA, BIG Stock. Write for latest Catalogue. McGee Radio—1330 Broadway, Denver, Colorado.

FRESH MAILING LISTS, TRAIL 1000 RADIO-SERV- ice-men-Dealers \$10.00; 600 Radio EQUIP. MFERS. \$8.00; 55 RADIO AMPLIFIERS MFERS. \$3.00; 49 RADIO TUBE MFERS. \$3.00. HOUSE OF BUTTE 60 E. 42nd St., New York 17, N. Y.

BUILD RADIO, PHONOGRAPH, COMBINATIONS, complete kits; catalog. Radion. 6922C, 21st Ave., Brooklyn 4, N. Y.

A GREAT MONEY SAVER, COMPLETE KIT WITH Tubes \$10.95. Details Radio, 9418 Ave. A., Brooklyn, New York.

UNIVERSAL MIDGET RADIO TOOLS, DANDY SIX- teen piece set, Midget Pliers, Diagonal Cutters, Four Midget End Wrenches, Needle-nose Pliers, Screwdriver, Six Punches & Chisel, Round File, Midget Crescent Wrench, \$14.85. Remit today. New Catalog Free. **UNIVERSAL TOOL COMPANY HAS IT.** 1527 Grand, RC, Kansas City, Missouri.

25 YEARS EXPERIENCE IN RADIO REPAIRING AT your fingertips for \$1.00. I've repaired 4500 radios and have perfected system you can follow step by step. My methods are far simpler than any other course published. Requires no calculations. Total price \$1.00 postpaid or C.O.D. Money-back guarantee. Ross Radio Company, 14615-J Grand River, Detroit 27, Michigan.

denser across it and mounted as close to the grid end of the coil as possible and cemented in place with coil cement freely applied. (Fig. 2). Being duo-

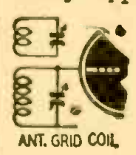

Fig. 2

lateral wound, they take up little space and will fit the end of most solenoid-wound antenna coils. The i.f. coil should be from an old transformer of the same frequency as that of the set in which it is used.

If the antenna coil of your set is in an inaccessible place or is a duo-lateral coil wound on a wooden core, it may be impossible to couple the wave trap inductively to it. The next best bet is to wire the wave trap in series with the grid circuit of the antenna stage. Break the connection between the grid coil and condenser and the grid prong of the mixer tube or the r.f. tube (whichever is the antenna stage in the set) and connect the wave trap in series, as shown in Fig. 3.

If fairly heavy tinned copper wire is used and the leads kept short and direct, no trouble should be experienced with extra wiring capacity in the circuit.

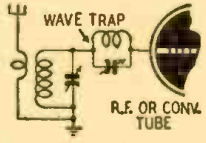

Fig. 3

To adjust the wave trap for maximum efficiency, connect a standard signal generator to the antenna and ground connections of the set, set it to the frequency of the interfering signal, which will usually be the intermediate frequency of the set. Adjust the output of the signal generator to a value high enough to be heard clearly in the set speaker or cause a good deflection on an output meter across the secondary of the speaker output transformer. Adjust the trimmer condenser on the wave trap until a MINIMUM of sound is heard in the speaker or a MINIMUM deflection is obtained on the meter.

This adjustment should be fairly critical or sharp and should reduce the signal from the generator to a very low value, sometimes causing it to disappear at the original signal level from the generator. In this case turn up the generator level control until a reading is obtained and continue to adjust for MINIMUM response.

To get sufficient rejection of the unwanted signal and to trap a frequency band only as wide as the unwanted signal, the wave trap circuit must have a high Q. The trimmer condenser should have good quality mica and good insulation at its terminals. Also the ratio of capacity of the trimmer to the inductance of the coil must be high enough to get good circulating currents in the trap circuit at the frequency of the unwanted signal. The usual i.f. coil has a good enough set of characteristics to pass the requirements for the coil but the Q of the trap circuit can generally be raised by removing a few turns from it and using a 15-75 µf condenser to tune it, thus raising the Q of the entire trap circuit.

(Continued on page 96)

ARMY RADIO PHONES
They're Weather—Water and Shock Proof

When we say they are made to Army specifications, that's enough assurance they must be of best quality. These Army Radio Phones are perfect and were O.K.'d by Signal Corps Inspectors. These Dynamic Mikes and Receivers, were used on aircraft and tank inter-communication systems. Use them for recording, for batteryless phone, for pocket size set loud speaker or talk through your radio set. We bought a good many of these Radio Phones, they are brand new, and cost a great deal more than you can get them for. A complete dynamic hand mike, 2 earphones, headband, cord set. **\$3.45**

A wonderful buy for only

The New NATIONAL NC-173 RECEIVER

A 3 tube Superhet 540 KC to 58 Mc; voltage regulated circuit with AVC amplifier, X'tal filter, noise limiter, General coverage plus bandspread, 8 meter adjustable for phone or CW. Completely modern in a streamlined grey finish cabinet with smooth surface and round corners. 110-120V or 220-240V 50-60 cycles. Phonograph, mike pick-up or headphones can be plugged into special jack.

NC-173 T Receiver **\$179.50**
 NC-173 TS Speaker **\$10.00**

450 MC BC-645 A 15 TUBE I.F.F.

Easily converted to a voice-CW-transmitter-receiver; 15 tubes including W.E. 316A door knob. These units are brand new and can be converted for use on the 420-450 Mc ham band; 460-470 Mc citizens radio; 450-460 Mc fixed and mobile and 470-500 Mc television. Supplied complete with tubes and conversion diagram; less power supply. **\$14.95**

RELAYS

SIGMA 2000 ohm SPDT plug-in. Hermetically sealed; will operate 1 to 4 MA **95c**

AUTOMATIC VOLTAGE STABILIZER

Raytheon 60 watt regulator. Delivers 115 VAC from any line between 95-130 volts, ±1%. An exceptionally good buy. Brand new **\$10.95**

SCHWEIN Free and Hato Gyro. Operates from 24 V. DC. Complete in metal case ready for use \$5.00

METERS

G.E. 3" type D0-41 round bakelite case 0-1 MA black face with white lettering **\$3.50**
 GRUEN 2" round bakelite case 0-3 MA with scale **\$1.95**

TRIPLETT Model 625-N Volt-Ohm-Milliammeter

DC voltage ranges with dual sensitivity (10,000 and 20,000 ohms/volt) provide for double the number of full scale readings. AC voltage ranges at 10,000 ohms/volt permit checking many audio and high impedance AC circuits. Ideal for checking television circuits. Ranges DC Volts 0-1.25/5/25/125/500/2500, 20,000 ohms/volt; 0-2.5/10/50/250/1000/5000, 10,000 ohms/volt; AC Volts 0-2.5/10/50/250/1000/5000 at 10,000 ohms/volt; DC Microamps 0-50; DC Ma 0-1/10/100/1000; DC Amps 0-10; 0-400 ohms; 0-50,000 ohms; 0-10 megohms. Capacity check of paper condensers is possible by following data in instruction book. 50" banana plug, test leads included. Long readable 5" scale arc. Compact, molded insulated case. 6x5 1/2 x 2 1/2". Shpg. wt. 4 lbs. **\$44.10**
 Your Cost **\$5.15**

Model 629—Carrying Case for Model 625N K21505—Complete **\$5.15**

If not rated 25% with order, balance C.O.D. All prices F.O.B. our warehouse New York. No order under \$2.00
 We ship to any part of the globe

LEEDS RADIO CO.
 75 Vesey St., Dept. RCM
 COrtland 7-2612 New York City 7

HIGHBRIDGE'S BEST BUY NEW DYNAMIC TELEVISION KIT

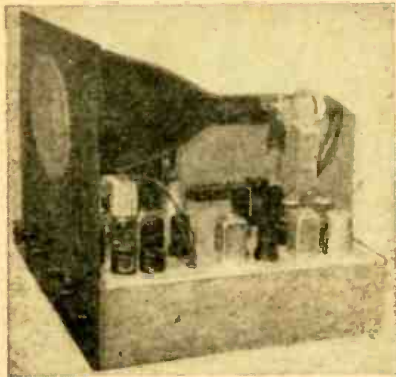

COMPLETE **\$159.50**
With Tubes—Parts—Cabinet

Exclusive Mail Distributors

Check These Outstanding Features:

- Three stages of video L.F. amplification—3.5 MC bandwidth.
- Receiver may be aligned easily without use of signal generator.
- Complete resistance and voltage analysis chart for easy trouble shooting supplied with each kit.
- If transformers are slug tuned for high gain and maximum efficiency.
- Safety interlock switch supplied with each unit.
- Simplicity of operation—only 5 controls on front panel.
- Schematic diagrams are broken down into simple circuits for ease in wiring.
- Picture is very stable—does not jump or tear out even under unusual receiving conditions.
- 3 Channels—provisions for six.
- Seventeen tubes including large picture tube.
- Picture tube is seven inches in diameter and gives a picture 26 square inches in size.
- All parts are unconditionally guaranteed to be electrically and mechanically perfect.

Set comes complete with all necessary information sheets, parts, drilled and punched chassis, beautifully finished front panel and modernistic cabinet. Hardware and other necessary items are also included. **NOTHING ELSE TO BUY.**

SONAR SOUND DETECTION UNIT

In Original Overseas Packing

Ideal for detecting underwater sounds within an area of 15 miles. Using a Rochelle salt crystal as the active unit the sound is transmitted up a 60 ft. cable. Completely enclosed in a solid rubber sheath. Originally used in harbor defense. Coupled with audio amplifier it has many valuable uses. **\$7.95**

SELETRON SELENIUM RECTIFIERS

50 to 99	.85
6 to 49	.90
1 to 5	.99

Quotations on larger quantities furnished upon request

USEFUL FOR: ★ AC-DC Portables ★ Intercom Power Supplies ★ Console Radios ★ Replaces 29 Types of Rect. Tubes

Gives Instant Reception—Requires No "Warm Up" Replaces Tube & Socket—Prolongs Life of Set Requires Less Space—Increases Sensitivity Made to Last The Life of the Set



NEW BATTERY BOOSTER

Powerful—Efficient—Economical

A compact, lightweight, automatic, constant voltage battery charger which is especially designed to help car, truck or tractor owners keep 6 volt storage batteries fully charged. 4"x4"x5" Weighs 4 lbs. packed. Operates on 105-120 v AC 60 Cy. DC 6 v 4-2 amp. Complete with 6 ft. AC cord with molded rubber plug and 6 ft. DC cord with alligator clips. **\$9.27**

NEW No. 631P1/SNA Glass Strobotron tubes. Each \$3.25
100 By-Pass Condensers, 10 Varieties, Special \$4.95

Vision Research Laboratory design and construction of modern 5 or 7 inch television receiver Instruction Book and complete set of coils. Special \$6.95.

All Prices FOB New York City, N. Y.

HIGHBRIDGE RADIO - TELEVISION & APPLIANCE CO.

340 CANAL
343 CANAL

NEW YORK 13,
NEW YORK

HOME-BUILT SOUND EFFECTS

(Continued from page 27)

a saw. Any noisy tool will record well, and the sound can be bigger than life if amplified.

To turn on the lights, use an electric switch. Taking the telephone receiver

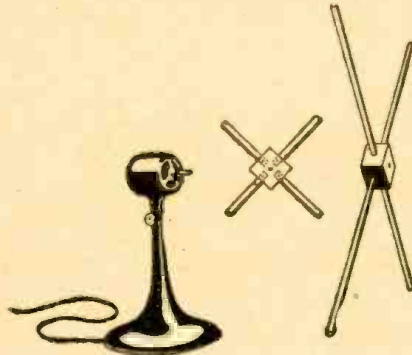

Fig. 6—A fan motor and dowels make wind.

off the hook and replacing it is very convincing if done close to the mike. To strike a match, a special trick increases the effect. Strike the match about 4 inches from the mike, then quickly move it very close to catch the flaming noise as the head burns.

Making our noises work

For the radio workshop or the "home-broadcaster," what to do with the various noises he has recorded presents no problem. Others may be embarrassed with a wealth of canned sounds. As a

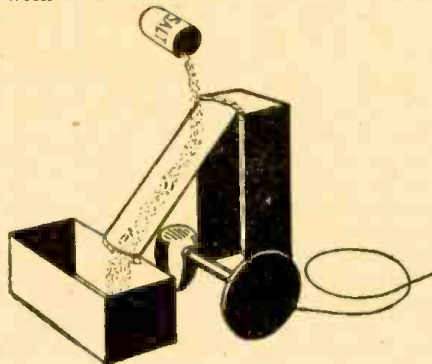
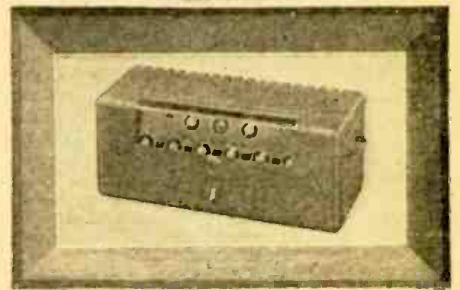

Fig. 7—Rainmaking is easy with this machine.

suggestion, amateur plays may be improved by properly used sound, amplified or recorded. The modern "radio script" type of play can be immensely heightened in interest if genuine radio-type sound effects are used. Enthusiastic sound-effects recorders have even used the sounds as a subject for an evening's entertainment, making a guessing game with prizes for participants naming the greatest number of effects correctly. It is surprising indeed how many sounds may be misinterpreted if the listener's mind is not directed by the contextual material.

Airlines are testing a "block signal" method which will light a red or green light on the pilot's instrument board, telling him whether or not he may enter the next "section" of the airway.

AMERICA'S TOP QUALITY AMPLIFIER



Deluxe K Series

A reputation for quality is our most priceless asset. The performance and operation of the Newcomb Deluxe K-Series of amplifiers form outstanding proof of the reason for that reputation.

Incorporated in every K-Series model is a combination of features never before offered in any amplifier . . . features that spell top quality in sound reproduction.

A glance at Newcomb specifications will convince the man who knows—and cares.

Write for literature

Newcomb
AUDIO PRODUCTS CO.
Dept. C, 6824 Lexington Avenue
Hollywood 38 California

RADIO PARTS SOUND SYSTEMS ELECTRONIC APPARATUS

Depend on RADOLEK

Radolek's big Free Profit Guide Catalog and Profit Bulletin supplements keep you abreast of the rapidly changing radio situation. Buying from Radolek means greater values, better service and more profits. Make Radolek your buying headquarters.



FREE
CATALOG

Large Stocks
Fast Service

SEND TODAY!

RADOLEK CO., Dept. C-117
601 W. Randolph St., Chicago 6, Ill.
Please send your FREE Profit Guide Catalog.

Name

Address

SAVE AT RADOLEK

SMALL RECORDING STUDIO

(Continued from page 85)

tive circuit should be provided. Neon bulbs connected in series can be placed across the crystal so that, in the presence of too much voltage, the bulbs will fire and their resultant low resistance will protect the crystal cutter. The small ¼-watt neon bulbs have a firing voltage of approximately 70 volts. It is essential that the bulbs do not fire during the application of normal cutter driving voltage, or distortion will result.

In the final analysis, what is really expected of a cutter is a recording which, when played back, sounds as like the original material as possible. Each recording setup requires individual attention to obtain the best results of which it is capable. Each set of requirements and conditions is different; it rests on the user to take maximum advantage of the equipment he has so that he may produce good recordings.

VIBRATOR AMPLIFIER

This six-volt battery-powered amplifier is very compact and is easily constructed on a 7¼x5¼x2¼-inch chassis.

It uses a pair of push-pull 6V6 beam-power pentodes driven by a cascade connected 6SC7. A push-to-talk switch on the microphone reduces the drain on the storage battery when the amplifier is on stand-by operation.

The 6SC7 is connected in a standard cascade circuit with a fader-mixer in the grid circuit of the second half of the tube. This permits gradual switching from microphone to phono pickup.

A novel phase inverter is used. A 2000-ohm loading resistor is inserted in the screen grid lead to one of the 6V6's. This grid is capacity-coupled to the control grid of the other 6V6. With 250 volts on the screen grids of Class AB1 6V6's, the screen current for each tube swings from 2.5 ma at no signal to 6.5 ma at maximum signal. This variation in screen current is converted to variable voltage drop across the 2000-ohm resistor. The grid of the second 6V6 gets its excitation from the variable screen voltage. This phase inversion system makes it possible to take full advantage of the 6SC7's amplification.

The power supply uses a synchronous vibrator feeding into a resistance-capacity filter. A push-to-talk switch closes the low-voltage circuit through the coils of a relay, made from an old vibrator.

—Edgar Dunn, Johannesburg, South Africa

(This amplifier is worth trying without the vibrator feature, as an ordinary a.c. or a.c.-d.c. amplifier.—Editor)

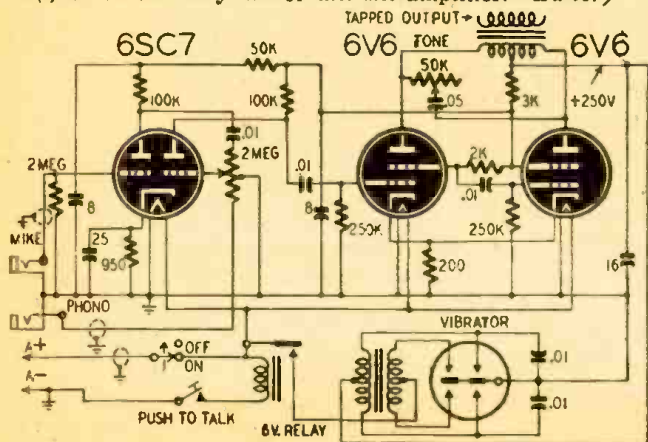

Nationally Known AUTOMOBILE ANTENNAS

Side Cowl—3 Section 66"
Sturdy Rust Proof

\$4.75 LIST \$2.13 NET

Deluxe Side Cowl—4 Section 100"
Sturdy Rust Proof

\$7.75 LIST \$3.36 NET

Top Cowl (Fender Mount)
3 Section 56"

\$5.95 LIST \$2.58 NET

Universal Cowl or Fender
Mount 3 Section 68"

\$5.95 LIST \$2.58 NET

All are complete, ready for installation
All are chrome plated

THREE TUBE PHONO AMPLIFIERS

Complete with tubes 1LA4—1LE3—
and 117Z6GT. **\$4.49 ea.**

CONDENSERS

.005 mfd. 1200 V DC Buffer Condensers
19 CENTS EACH 10 FOR \$1.50
100 FOR \$12.50 1000 FOR \$100.00

PORTABLE PHONO CABINETS

Beautifully covered in leatherette.
Dimensions 13" x 15¾" x 7¼"

\$4.95 ea.

STREAMLINED ELECTRIC IRONS

List for 7.90 reduced to the sensationally low price in lots of 6 for **\$2.98 ea.**

5" UTICA OR CHANELLOCK DIAGONAL CUTTERS \$1.12 ea.

A COMPLETE LINE OF TUBES ARE NOW AVAILABLE

Write for our latest Catalogue

RADIO PARTS COMPANY

612 W. Randolph, Dept. "C"

Chicago 6, Illinois

QUIK-LABELS CODE CARD SYSTEM

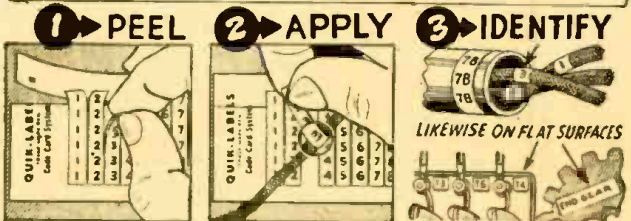

QUIK-LABELS code Wires, Leads, Circuits, Relays, Parts, etc., faster and cheaper. • Pre-cut to exact size, QUIK-LABELS come on handy cards. • Ready to use, they stick-quick without moistening, replace slow and costly string tags, roll tapes, decals, stencils, metal tabs, etc. • Resist dirt, grease, oil, abrasion. • *Self Starter Strip automatically exposes ends of Labels for you to grasp instantly—no more finger-picking.

W. H. BRADY COMPANY Established 1914

Manufacturers of Self-Sticking Tape Products
802 N. 3rd STREET, MILWAUKEE 3, WISCONSIN

I'm interested. Send me all the facts on QUIK-LABELS.

Name Title
PLEASE ATTACH TO YOUR COMPANY LETTERHEAD

In a British form of "printed radio" the circuits are deposited in grooves on plastic plates. The inventor claims that 180 sets per hour can be made by the process.

10 METER CONVERTER

27 to 30 MEGACYCLES

Designed for Army surplus receivers such as the BC 342, BC 348, BC 312, etc. Uses a single 6SA7 fixed oscillator at 16 megs. Adjust plate output and grid input signal for maximum. Calibrate and tune the entire band on your receiver. The power for the converter comes from the receiver. Our special adapter secures the power from the receiver by a plug-in arrangement. When this is not possible instructions will indicate the correct tapping point. In ordering be sure to mention the model receiver.

Complete In-
structions and
plans

\$1.00

Kit of parts
and plans for
complete oper-
ation

\$12.00



Complete unit
wired and
tested.

\$18.00

BROADCAST BAND CONVERTER

100 KC to 1550 KC

A valuable unit for owners of Army-Navy surplus receivers. Uses a single 6SA7 which secures its power from the receiver with which it is used. The special adapter to secure power is supplied with the unit. An improved feature incorporates an aperiodic tuned antenna circuit for low noise level. Also tune in the long wave band to hear aircraft beacon and weather reports.

"BE SURE TO SEND RECEIVER MODEL NUMBER."
Tried and tested with BC-312, 342, NC 100-ASD, BC-348, and others.

Cash, Check or M.O. Write Dept. CM

THOR ELECTRONICS

5051 N. Clark St., Chicago 40, Ill.

\$15.00



EASY-TO-BUILD OSCILLOSCOPE

(Continued from page 24)

to external sweep and applying a sinusoidal signal to the horizontal binding posts on the front panel and another voltage of different frequency to the vertical amplifier, various patterns called *Lissajou figures* will be obtained. These figures are helpful for frequency calibration or comparison.

To obtain a trapezoidal pattern for determining the percentage of modulation of an amateur transmitter, the connections to the rear panel should be made as shown in Fig. 10. Fig. 11 shows

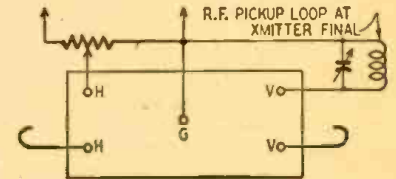

Fig. 10—Connections for modulation tests.

some trapezoidal patterns.

In Fig. 11-a we have the standard pattern for 100 percent modulation. Fig. 11-b shows overmodulation and 11-c a condition of less than 100 percent modulation. Patterns similar to 11-d are due to phase shift in the speech amplifier.

The value of an oscilloscope in servicing receivers was shown fully in two articles (*The Scope—A Repair Tool*, January and March RADIO-CRAFT).

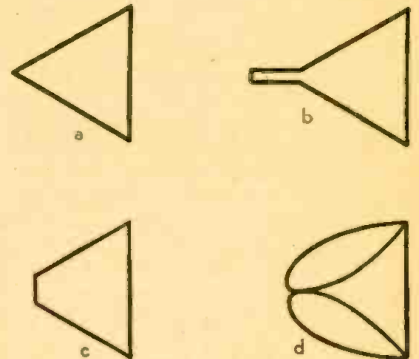

Fig. 11—A few more common Lissajou figures.

After having built and become familiar with the operation of a scope and its capabilities as an instrument, anyone having one will discover new uses for it daily.

POWDERED IRON CORES

Make your own high "Q" I.F.-R.F. or Antenna coils! Range 100 kc to 50 mc.
KIT No. 1—18 Pieces, 3 Types....\$2.00 pp
Also, perm. tuning cores—1700 kc to 535 kc
KIT No. 2—12 Pieces, 3 Types....\$3.25 pp
MAGNA-METAL PRODUCTS CO.
70 E. 45th St. New York 17, N. Y.

Learn RADIO

Train at home, in spare time, for a good pay job or start a business of your own without capital—under our proven 2-Way method; you receive Lessons plus Home Shop Practice including 9 kits of radio parts to make hundreds of tests. Many students earn money in spare time while learning. Write for FREE book "Your Opportunities in Radio" to

Hollywood Radio & Television Institute,
(Established 1929)
Dept. F2, 810 W. 6th St. Los Angeles 14, Calif.

The HOUSE OF A MILLION RADIO PARTS

SPECIAL TIME and MONEY SAVERS for SERVICEMEN!

No. 100 C—Kit of 100 By-pass and Buffer Condensers. \$20.00 Value \$5.82
No. 101 R—Kit of 100 1/4-Watt Resistors 1.95
No. 102 K—Kit of 100 Assorted radio knobs—plastic and wood—set screw—pushons 5.91
No. 103 T—Kit of 50 assorted Trimmer and Padder condensers—A real Buy 3.93

Thousands of radio and sound equipment parts and supplies. Tubes, Record Changers, Amplifiers, Speakers, etc. Write for Catalog No. 29.

Lifetime SOUND EQUIPMENT Co.
911-913 Jefferson Ave., TOLEDO 2, OHIO

Headset Headquarters

GUARANTEE CANNON-BALL

Phones to give absolute satisfaction. Unusually sensitive. Noted for fidelity and clarity of tone. Folder R-5 illustrates Complete Cannon-Ball line. Write

Scientifically Built
Heavy bar magnets greatly increase their efficiency.

C. F. CANNON COMPANY
SPRINGWATER, N. Y.

FMT ★ FM Tuner Permeability Type

A complete fully assembled, tested oscillator-mixer that tunes in the 88 to 108 MC FM broadcasts. Enjoy noise free high fidelity radio reception. FMT output feeds into usual FM I.F. amplifier which you can easily build, or into the older FM-45 receivers (I.F.) to change them to the new FM band. All parts, including a standard metal tube, are combined into a single compact unit measuring only 2 1/4" x 1 1/2" on chassis, to which you connect aerial wire and three voltage wires. It works right every time. It will save you headaches and lots of work, as compared with trying to make a VHF oscillator-mixer with usual clumsy parts available. The FMT is calibrated to feed into 10.7 MC and other I.F. Introductory Price \$6.50 (less tube) postpaid. State I.F. used. Complete directions and drawing with each unit.

Est. 1922
ORDER TODAY

J-M-P Mfg. Co.
Milwaukee 10, Wis.

BE YOUR OWN BOSS!

MAKE MORE MONEY

In "CASH IN" you now get THE real money-makers—dozens of profitable tested mail order plans, confidential business secrets, dozens of practical tested formulas, successful tested schemes—actual experiences of men who have started on a shoestring—with less than \$10 capital. 25¢ a copy postpaid. Send U. S. stamps, money order, or coin.

25¢

40,000 WORDS IN TEXT

NO ADS ALL "MEAT!"

Money Back Guarantee

NATIONAL PLANS COMPANY
Box 26RA, Ansonia Station New York 23, N. Y.

PEN-OSCIL-LITE

Extremely convenient test oscillator for all radio servicing alignment. • Small as a pen • self powered • Range from 700 cycles audio to over 600 megacycles u.f. • Output from zero to 125 v. • Low in cost • Used by Signal Corps • Write for information.

GENERAL TEST EQUIPMENT
38 Argyle Ave. Buffalo 9, N. Y.

● TEST OSCILLATOR KIT ●

Supplies I.F. and broadcast frequencies modulated or unmodulated complete with tubes, chassis and metal cabinet punched and all parts mounted ready to wire. RTO-100C \$14.75.
Wired and tested \$20.25

RECEIVER SPECIAL, Wilcox type F3 fixed tuned superheterodyne, ideal for use with a high frequency converter. Complete with coils, tubes, 110 volt 60 cycle power supply and complete instructions \$14.50

PHONO PLAYER KITS, Table Model, dual tube amp. five inch speaker, light weight crystal pick-up, attractive two tone cabinet and quiet rim drive motor. Model RCP4, complete \$15.95

Wireless Phono Player, tune it in on any radio. Model RC5W, complete \$14.35
Phonograph Attachment, plays through any radio. Model RC5A, complete \$9.85

Tubes are supplied with all the above kits.
AMPLIFIER KITS—3 tube RC3, \$3.80; 2 tube RC2, \$2.60; 1 tube RC1, \$2.10; phono oscillator kit RC1W, \$2.90. Tubes extra.

RADIO TUNER KIT, complete with tubes. HRT 150C \$7.45

TUBE SPECIALS, 12AT6 \$6.65; 12SA7 \$6.65; 25Z5 \$6.65; 32L7 \$1.35; 35L6 \$6.65; 35W4 \$6.60; 60B5 \$8.50; 60L6 \$7.00; 117N7 \$1.45.
Terms—Cash with Order or C.O.D. with 20% Deposit.
Add Postage.

Send for special bargain list.

HALLMARK ELECTRONIC CORP.

592 Communipaw Ave. Jersey City 4, N. J.

GOVERNMENT SURPLUS

If you cannot get to the Government Sales of War Surplus Radio Equipment, the next best thing to do is to buy our **SPECIAL \$25.00 GOVERNMENT RADIO SURPLUS ASSORTMENT**. We buy large quantities all over the country, divide those items we don't have in large quantities into choice assortments for which we know you would gladly pay \$25.00 if you could see them.

On a deposit of \$5.00 we will ship you C.O.D. (balance \$20.00) freight collect, a large quantity of Government Surplus Radio Items subject to your inspection. If, after inspecting, you are not more than satisfied, return to us, freight charges collect and all it will have cost you will be freight charges. You should be able to dispose of a few of the items that you may not need for the entire cost. This is the cheapest way we can sell you War Surplus Radio Material. Our warehouse are filled with thousands of choice Government Surplus Radio Items. Lot of them we do not have in sufficient quantity to advertise nationally and the cost of inventorying, itemizing, corresponding, etc., would only increase their cost to you; therefore we make this offer. If you wish to mention a few items you desire, we will endeavor to include them in this assortment. State whether you wish "Ham" or Commercial assortment.

THE ABELL DISTRIBUTING CO.

5 E. Biddle Street, Baltimore 2, Maryland

PREPARED ASSORTMENTS GUARANTEED FIRST QUALITY

100	1/3 Watt Resistors All Insulated	\$2.98
100	1/2 Watt Resistors All Insulated	3.98
100	1 Watt Resistors All Insulated	4.45
50	2 Watt Resistors All Insulated	3.98
50	200 Volt Paper Condensers	2.48
50	Mica Condensers	2.98
20	Dry Electrolytic Filter Condensers	6.75
10	25 ft. Rolls Hookup Wire—Ass't'd colors	1.98
10	Volume and Tone Controls—No Switches	1.98
100	ft. Spaghetti and Nylon	3.98
10	Coils I.F., P. Ant. and Oae.	1.98
20	Wafer and Ceramic Band Switches	3.98
20	Auto Suppressors	2.98
50	Electrical Wiring Devices—Plugs, Taps, Bases, Elements, Fuses, etc.	5.00

SEND FOR TRUTONE COMPLETE RADIO AND ELECTRICAL LIST

Terms: 25% deposit required with order. Balance C.O.D. Merchandise sent prepaid if full remittance accompanies order.

TRUTONE PRODUCTS CO.

303 W. 42nd St. Dept. CA New York 18, N. Y.

EASY TO LEARN CODE

It is easy to learn or increase speed with an Instructograph Code Teacher. Affords the quickest and most practical method yet developed. For beginners or advanced students. Available to a D o a from beginner's alphabet to typical messages on all subjects. Speed range 5 to 40 WPM. Always ready—no QRM.



ENDORSED BY THOUSANDS!

The Instructograph Code Teacher literally takes the place of an operator-instructor and enables anyone to learn and master code without further assistance. Thousands of successful operators have "acquired the code" with the Instructograph System. Write today for convenient rental and purchase plans.

INSTRUCTOGRAPH COMPANY

4701 Sheridan Rd., Dept. RC, Chicago 40, Ill.

Radio Thirty-Five Years Ago

In Gernsback Publications

HUGO GERNSBACK

Founder

Modern Electrics	1908
Electrical Experimenter	1913
Radio News	1919
Science & Invention	1920
Radio-Craft	1929
Short-Wave Craft	1930
Wireless Association of America	1908

Some of the larger libraries in the country still have copies of **ELECTRICAL EXPERIMENTER** on file for interested readers.
Interesting Radio Articles in the May, 1913 issue of the **ELECTRICAL EXPERIMENTER**.

A Treatise on Wireless Telegraphy, by *Hugo Gernsback*.

The Quenched Spark Gap, by *H. Winfield Secor*.

Building Large Spark Coils, by *Hugo Gernsback*.

The Vacuum Detector, by *H. Winfield Secor*.

How to Make a Loud-Speaking Telephone.

The Tuft's College Wireless Society.

35-mile Transmission with Half-Inch Spark Coil.

400 MILLION U.S. RADIOS?

(Continued from page 17)

during the next decade we can confidently look forward to a future in which there will be between 400 and 500 million radio sets of various types in this country. Even this will not be final saturation; because by the end of 10 years several new types of radio receivers—for instance television combined with radio sound sets, and many others—will have made their appearance.

Add to that replacements of obsolete radios and even the most pessimistic radio man must admit that saturation in this country is—for practical purposes—distant and unreal.

Six American railroads were using either carrier or high-frequency radio by the middle of the past summer. Most frequent use has been in freight service.

TELEVISION "ORGAN"



Suggested by Grego Banahuck, New York City

Radio & Electronic Government Surplus

MINE DETECTORS



\$9.95

MODEL AN-PRS-1

F.O.B. DETROIT

Brand new army mine detectors; portable, will detect metallic and non-metallic objects; very sensitive; using 955 tube in detecting head; two tube amplifier using two IN5GT; headset; or microphone. Also 150 micro meter; power supply, 3-45V, one 6-V or two 3-V batteries. Complete with instrument less batteries. Packed in original cases. Shipping weight 108 lbs.

THIS MONTH'S RADIO BARGAINS

INTERPHONE AMPLIFIERS complete with tubes and Dynamotor	\$2.50
WIRE—14, 16, 18, 20, 22 gauge up to 50 ft. lengths. Per lb.	.20
AUTO ANTENNA—3 section 64" side cowl mount—2 insulators	1.50
125 MFD. CONDENSERS at 350 Volts C.D.	.25
500 MFD. CONDENSERS at 10 Volts	.25
.5 MFD. OIL FILLED CONDENSERS, 400 Volts	.05
BY-PASS CONDENSERS, ASSORTED SIZES—per hundred.	1.50
BUFFER CONDENSERS .01 1600 Volts per hundred C.D.	12.00

No order under \$5.00—please send check or money order. Orders shipped C.O.D. subject to 20% advance deposit.

Write us about your needs

RADIO CENTER

Radio & Electronic Surplus

2530 E. DAVISON AVENUE
DETROIT 12, MICHIGAN

COMMUNICATIONS

AN INSTRUCTOR LOOKS AT RADIO-CRAFT

DEALERS! SERVICEMEN!

These VALUES mean PROFITS for YOU!

All merchandise offered below is BRAND NEW, and FULLY GUARANTEED. Our enormous stocks and facilities enable us to give you IMMEDIATE DELIVERIES on all merchandise listed.

TERRIFIC BUY FOR P.A. MEN!

Astatic R-3 Crystal Handmk. with 6 ft. R.C. Mike Cable \$4.50



WILLARD 2-VOLT STORAGE BATTERY

Exact replacement for GE portable — brand new each \$2.75

Willard 6-volt (3-cell) storage battery, brand new \$7.95

Magnetic Pickup \$2.20
 Shure Magnetic Cutting Head, Special \$1.95
 Telegraph Key Sig. Code J-35 99c
 7-prong 2-volt Vibrator for Portable & Farm Sets. Replacement for GE LB-530 \$1.65

LOOK AT THESE PM SPEAKER VALUES!

Ainco 5 4" PM \$1.30
 Ainco 5 5" PM 1.43
 Ainco 5 6" PM 1.95
 Ainco 5 8" PM 3.25
 450 ohm 4" Dynamic 1.59

MAGNAVOX "FP" FILTER CONDENSERS

8 mfd 500 volts 45c
 18 mfd 500 volts 65c
 8-8 mfd 500 volts 70c
 40-20-20 mfd 150/150/25 V 40c

METER SPECIAL!

3" Square AC Milliammeter 0-1000 mils \$1.95

BRAND NEW 6-TUBE SIG. CORPS RECVRs BC-453-B series. SEASON'S BEST BUY!

Tubes alone worth total cost! All Aluminum Aircraft receivers. 5"x8"x12 1/2". Weight 6 1/2 lbs. Black wrinkle enamel finish. Tuning range: 3 to 8 Mc. Tubes: 3-12SK7, 12KB, 12SR7, and 12AB. Power required: 250V @ 50 Ma and 25.2V @ .48A for heaters (heaters revolved for 12.0V @ .9A. Hi and Low impedance output). Voice, MCW and CW reception. EACH SET COMPLETE WITH ALL TUBES \$5.95
 1M SOCKETS, less dynamotor \$5.95
 Same as above, but tuning range: 6 to 9.1 Megacycles \$5.95

VOLUME CONTROLS

25M ohm Your Cost, Any Type
 50M ohm
 100M ohm
 250M ohm
 500 ohm
 1 Megohm
 2 Megohm
 With Switch 40c
 Less Switch 28c

MIDGET TUNING CONDENSERS .00014 mfd, Isolantite insulation, long shank 39c
 1-MFD 1000 Volt OIL-FILLED FILTER CONDENSER in metal case, with porcelain insulators 51c
 3-CIRCUIT PANEL JACK, fits PL68 plug and standard mike plugs 14c
 50 MIMFD TUNING CONDENSER, Isolantite insulation 75c
 22 1/2 VOLT "4B" BATTERIES with leads 35c
 MIDGET VISE-SPECIAL \$3.19
 PLEASE INCLUDE: 25% deposit with order—Balance C.O.D. All above subject to prior sale.

G&G GENUINE MAJESTIC
RADIO PARTS SERVICE
 53 VESEY STREET - NEW YORK 7, N.Y.

"More than 10,000 satisfied Radio Dealers and Servicemen since 1940"

ELECTRONIC VOLT-OHMMETER

\$1185 110 VOLTS AC 20 RANGES
 0/5/10/50/100/500/1000/5000 volts DC and AC. 0-1,000,000,000 ohms in six overlapping ranges. Sensitivity: over MILLION OHMS per VOLT on 5 volt range.
 POSTPAID

Complete kit includes all component parts, tubes, punched and drilled chassis and beautifully enameled panel. Easily assembled and wired.

Special slideback circuit developed during war by scientist at the California Institute of Technology gives amazing sensitivity and flexibility while completely eliminating necessity of batteries and expensive meter. Each instrument is individually calibrated. Dial scale over nine inches long!

In addition to performing the usual volt-ohm functions, this instrument easily measures these voltages: SUPER-HIGH OSCILLATOR, AVC, AFC, TRUE GRID BIAS AT THE GRID, BIAS CELLS without affecting the circuit. Measures the exact leakage resistance of INSULATION, TUBES, CONDENSERS. It can be used with a signal generator for SIGNAL TRACING.

STERLING ELECTRONIC COMPANY

166 N. Sierra Bonita Ave., Dept. 2, Pasadena 4, Calif.

Do you need BINDING POSTS?



The XL PUSH POST with its Spring Action assures Constant Contact and Quick connection. Manufactured in All Aluminum Type M at 12c each. Aluminum Body, Bakelite Top Type B1 at 15c each. Types CP or NP ALL BRASS-STAIN-LESS STEEL SPRING & PIN. PROVEN by 240 HB. SALT SPRAY TEST as NON-CORROSIVE at 28c each. Manufacturers and Dealers Liberal Discounts

X. L. RADIO LABORATORIES.
 420 West Chicago Ave., Chicago 10, Ill.

Dear Editor:

Why do I buy RADIO-CRAFT? It cannot be because it is "too darned technical" for my pocketbook knows that I prefer the technical magazines. Having been in the radio field as an engineer for well over forty years I would have no interest in a magazine that catered too much to the screwdriver and plier type of serviceman.

My interest in RADIO-CRAFT is solely that of a teacher interested in seeing how others attempt to inform, and to instruct, the mixed audience of RADIO-CRAFT. When some of the instructors "talk down" to their audience they are sloppy and careless, but most of them give us something very well worth reading, and prepare their material with great care.

Your policy seems sound when I think of where your magazine fits into the

present picture. During the war I thought you were a bit short of proof-readers; and that you were compelled to fill space with articles that were thrown together without care, but as things return to normal you should be able to select material with more discrimination. In general, sketches thrown together with parts missing or not properly identified are very provoking, even when one has no intention of using the material; they must be still more annoying to those who would build what is imperfectly shown and described in the article.

RADIO-CRAFT does not go to extremes. It very obviously keeps the rank beginner in mind at times, but its policy indicates to me that it believes that the beginner wants to grow.

THOMAS J. MACKAVANAGH,
 Washington, D. C.

MILD DEFENSE OF AMERICAN RECEIVERS

Dear Editor:

Stavríde's letter from Greece in the January issue was very interesting. Distance and the outsider's viewpoint lends a novel, discerning and honest air to the criticisms. However, there is usually more than one side to any problem in this cockeyed world of ours.

1. What is meant by the "best" American prewar sets? Does Mr. Stavrides include \$1,200 Scotts or \$600 Philcos or \$700 Spartons in his "best" category? I would very much like to hear a "good" European set with better frequency response than those receivers.

2. Degenerative feedback must not be regarded as a magic cure-all. How is a resistance-capacity loop or degeneration in a cathode leg to compensate for non-linear phase-shift, audio frequency-modulation, transient and complex intermodulation distortion in audio systems? Real quality is obtained not by phony "bass boost" or high-frequency cut-off and phase shifting "tone-controls" but by using low-mu triodes in push-pull; video-circuit type low- and high-frequency peaking circuits; direct coupling; \$100 to \$200 loudspeakers, flat from 30 to 15,000 cycles; and \$30 to \$50 laboratory standard output transformers flat from 20 cycles to 20 kilocycles. Such circuits are really wide-band and high-fidelity, but cost money—real money—and cannot be attained with a dollar's worth of condensers and resistors.

3. American receivers must use higher intermediate frequencies of necessity. This reduces various cross-modulation, harmonic, and difference-frequency interference effects from other American communication bands. Lower i.f.'s might improve gain but are impractical in the United States.

4. Cost and psychological factors are as important here as in Greece. Labor

and material difficulties—real or imaginary—present a serious problem to American design engineers. It's a sad aftermath of a still sadder war and is to a large extent inevitable.

TED POWELL,
 Maspeth, New York

THE GUITAR WORKS WELL

Dear Editor:

I have had such good luck with the Electric Guitar I made from instructions in your (1946) *Radio Electronics Reference Annual* that I am enclosing a photo of the complete project.

"EL" GRIMSHAW,
 North Andover, Mass.

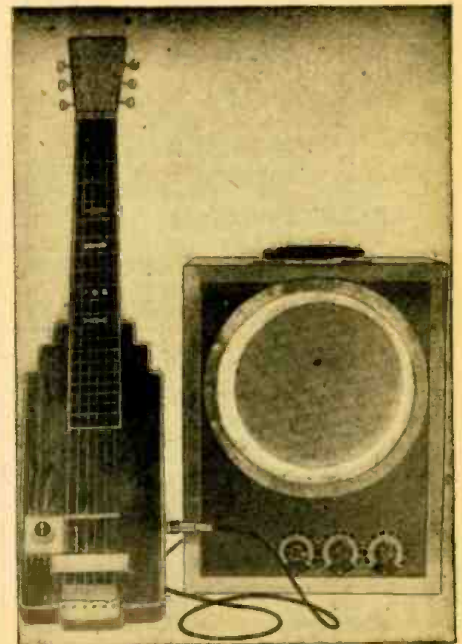

**Anyone Can Build Our
NEW MODEL S-5C RADIO**

Our model S-5C uses the universally accepted super-heterodyne circuit containing the following tubes: 12SA7, 12SK7, 12SQ7, 50L6, 35Z5 and tubes from 550 Kc. to 1600 Kc. Model S-5C . . . complete kit less tubes. With Bakelite cabinet and brand new illustrated instruction sheet, showing simple, detailed, step-by-step diagrams.

OUR INSTRUCTION SHEET COVERS EVERYTHING

• Pictorial Diagram • Schematic Diagram • Photographs • Step-by-Step wiring instructions.

Available at your local distributor or write to us for catalog M
Other Models Available

RADIO KITS COMPANY

127 Cedar Street New York 6, N. Y.

AMAZING NEW RADIO!
Pocket or Purse size
SMALL AS A PACK OF CIGARETTES! Weighs only a few ounces—Beautiful black chrome plastic case. Uses new crystal diode, Hi-Q slide dial. No tubes, batteries or electric "plug-ins" required! Receives local broadcasts and

GUARANTEED TO PLAY when used according to instructions sent with each radio! You can use it at home, in many offices, hotels, cabins, in bed, etc.—lots of fun—real entertainment!

Send Only \$100 (cash, money order, check) and pay postman \$2.99 plus delivery fees on arrival or send \$3.99 for postpaid delivery. Complete as shown ready to play with self contained personal phone. For Girls—children will love it—grown-ups too! An exceptional value—order yours and enjoy the many good radio programs coming! Don't be without your Pa-Kette Radio another day! (All foreign orders \$5.00 U.S. cash.)
Pa-Kette Electric Co. Dept. RC-5 Kearney, Nebraska

\$3.00 FOR CARTOON IDEAS
RADIO-CRAFT prints several radio cartoons every month. Readers are invited to contribute humorous radio ideas which can be used in cartoon form. It is not necessary that you draw a sketch, unless you wish. **IDEAS NOT WANTED:** No electrical or radio definitions wanted. Some of these were published in the past, but the subject is about exhausted. Payment is made on publication.
Address RADIO CARTOONS, RADIO-CRAFT, 25 West Broadway, New York 7, N. Y.

Come to the Great SHOPS OF COYNE
where you learn by doing
RADIO ELECTRONICS-TELEVISION
in a Few Short Weeks
Prepare For A Good Job Now With A Lifetime Future!
Trained Radio men needed now. Get Radio training and be ready for a real future. Learn on actual equipment at Coyne. Free employment service to graduates. Many earn while learning. If you are short of money, ask about Student Finance Plan. Now added training in Electric Refrigeration. We are also equipped to train those who qualify under G. I. Bill. Men with Physical Disabilities may qualify for training at no cost to them for tuition and subsistence.
SEND COUPON FOR FULL DETAILS
B. W. COOKE, Director, Radio Division
COYNE ELECTRICAL SCHOOL
500 S. Paulina St., Dept. 37-8H, Chicago 12, Ill.
Send Big Free Book; also details about Coyne Part-Time Employment and Student Finance Plan.
 Send G. I. Bulletin Physical Disability

NAME.....AGE.....
ADDRESS.....
CITY.....STATE.....

Wire so fine that 1,000 feet of it reeled on a spool is invisible to the naked eye is reported by the Westinghouse Lamp Division. The wire was ordered by the Bell Telephone Laboratories for a new amplifier tube.

RADIO-CRAFT for MAY, 1947

CONSIGNMENT COMING?

Dear Editor:

We are expecting some of the radio tube manufacturers to begin consigning tube stocks to radio shops, as was the practice before the war.

This will be a direct blow to all the better radio shops throughout the country, who have had to purchase their tubes outright during the war, many of them at black-market prices. It will also greatly stimulate the backyard mechanic and the number of new shops opening up over the country. It will also increase the price of tubes and parts to us all, for the manufacturer and jobber will naturally lose money on many of these consignment accounts, which must be made good by those that are able to keep going.

It would be well for the shop owners to fight such a plan by any manufacturer or jobber and voice their objections to their respective jobbers.

We will not use a tube that is being distributed on the consignment plan, and we will not do business with a jobber who is consigning tubes, if there is one we can find who does not.

G. E. RENFROE,
Southern Radio Service,
Thomasville, Ga.

BRICKBATS AND BOUQUETS

Dear Editor:

I have read your magazine for many years, but gradually it is becoming worse and worse as far as the amateur radioman, experimenter or set builder is concerned. Its only interest is to the serviceman or technician. Therefore you are just out one more subscriber.

G. L. RUIZ,
(No address)

Dear Editor:

I have the following bouquets and brickbats for your magazine.

I find the Question Box, Radio Electronic Circuits, and Try This One! departments very interesting. I feel, however, that you publish too many audio amplifier circuits in this department. Very satisfactory amplifiers can be designed by the experimenter from readily available information (tube manuals, books, etc.).

JOSEPH E. STEMBEL,
Keniland, Indiana

(We have felt there is not enough available material on sound and amplifiers. What do other readers think?—Editor)

Dear Editor:

I think your paper is swell but let's have a little more on how to build radio equipment and a little less on the subject of commercial and war radio equipment and the like. Thanks.

PETER MERRICK,
Hollyburn, B. C.

WIRELESS PHONO OSCILLATOR

Transmits recordings from phono pickup or voice from mike to radio without use of wires up to 500 ft. Neatly designed.
Complete kit, less tubes \$3.49
Above kit assembled and tested 4.49
Tubes for above kit (12BA7, 35Z5) 1.49

IMMEDIATE DELIVERY

Jobbers, Write for Quantity Discounts on Amplifiers and Oscillators.

CONSTANT ELECTRIC, Dept. C

112 Cornelia Street Brooklyn 21, N. Y.

Thousands of Satisfied Users!

TRANSVISION

TELEVISION KIT...A HIGH QUALITY TELEVISION RECEIVER

ready for Easy, Rapid Assembly

ENGINEERED BY TELEVISION SPECIALISTS



Easy-to-Assemble: No knowledge of television required. COMPLETE easy-to-follow INSTRUCTION SHEET gives you all the knowledge you need.

This Kit INCLUDES SOUND, all component parts, and the following:—

1. Specially designed Television Antenna.
2. A \$30.00 Brilliant Lectrovision seven-inch Picture Tube . . . plus ALL other tubes.
3. Pre-tuned R-F unit.
4. Finished front panel.
5. All solder, wire and 60 feet of low loss lead-in cable.

Operates on 110V.; 50-60 cycles A.C.

Price: complete with ALL tubes, \$159.50. Shipment will be made immediately after receipt of order. \$25.00 deposit required on all orders, balance C.O.D.

We believe that the comparative quality of this set is superior to other available sets. It has been acclaimed by major television schools throughout the country.

DEALERS: You can cash in on this kit. For full information write to:

TRANSVISION, INC. DEPT. R. C.

385 North Ave. New Rochelle, N. Y.

Enclosed find \$..... deposit. Please ship..... Transvision Television Kits C.O.D. to

Name.....

Address.....

City & State.....

BOOK REVIEWS

RADIO OPERATING QUESTIONS AND ANSWERS, by Arthur R. Nilson and J. L. Hornung, Eighth Edition. Published by McGraw-Hill Book Co. Stiff cloth covers, 5 x 8 inches, 434 pages. Price \$3.50.

The new edition of this standard work supplies specimen answers to questions asked in U. S. Government radio operator examinations, as did the former editions. There are three appendices, covering radio abbreviations, radio regulations, radio laws, and—a new feature in this issue—the American Standards Association's authorized graphical symbols for radio and electronic equipment. All schematics in the book have been redrawn to conform to the new A.S.A. radio-electronic symbols.

ATOM SMASHERS, A Story of Discovery, by Raymond Francis Yates. Published by Didier. Stiff cloth covers, 5½ x 8½ inches, 182 pages. Price \$2.00.

A story of man's exploration of the atom, written in the most popular style, this narrative begins with Democritus and continues to the experiment at Los Alamos.

The style is one that will be appreciated by juvenile readers as well as adults. Several highly scientific pieces of apparatus, such as the Wilson cloud chamber and the cyclotron, are so easily described that the reader not only understands them, but fails to realize that the subject is difficult.

The book is illustrated with numbers of good photographs and drawings, well placed to explain the subject.

ESTABLISHING AND OPERATING AN ELECTRICAL APPLIANCE AND RADIO SHOP. Prepared by Donald S. Parris and Associates, under the direction of H. B. McCoy, United States Department of Commerce. Published by the Superintendent of Documents, Govern-

ment Printing Office. Paper covers, 6 x 9 inches, 199 pages. Price 35 cents.

This is one of a series of small business manuals prepared for the use of veterans and former employees of wartime civilian organizations. It assumes that the reader is already a skilled radioman and does not concern itself with purely technical features of maintenance and servicing. The 19 chapters range from selecting a location to credit management and the special problems of expansion. Coverage of all angles of the small radio business is so complete that the established as well as the beginning radio dealer or serviceman might well make use of the book, with profit to himself.

SELECTING AND OPERATING A BUSINESS OF YOUR OWN, by Gustav E. Larson, Robert H. Johnson, and Walter Magnus Teller. Published by Prentice-Hall, Inc. Stiff cloth covers, 6 x 8½ inches, 364 pages. Price \$3.00.

While only 9 pages of the book directly concern the man who plans to start an electrical appliance and radio repair shop, the radio repairman or would-be radio repairman may well find interesting the three chapters on small business in general. It is also interesting to compare the prospects and problems of other small businesses with those of radio repairing.

The space given to starting an electrical and radio business is so small that the treatment is necessarily rather general, but some specific cost estimates are given. The bibliography is interesting, as it must have been made up by compiling the books on the author's desk at the moment. Three magazines are mentioned, but all are largely concerned with appliances rather than radio servicing.

(Continued on page 96)



Suggested by Grego Banshuck, New York City

"I want 100,000 radios to give away on our radio show—
If you can build them for 50c each."

ATTENTION at last

A 25 Watt
"High Fidelity" Public Address Amplifier



Model PH 25
NET \$49.95
List \$110.00
Incl. Tubes

Manufactured by
Atomite Electronic & Radio Corp.
IMMEDIATE DELIVERY
SPECIFICATIONS
Tubes—2-6SC7, 2-6L6, 1-6N7, 1-6U4G
Channels—(3) 2-Mic High Gain 125DB 1-Phone 87DB
Response—40-12000 cycles plus or minus 1 db
Output Imp.—2-4-8-15-500 ohms at both "Speaker
Terminals," "Strip or sockets. Handles 2 Micro-
phones
Output Power—25 Watts 3% Dist. 35 Watts peak.
Hum level 57DB below output
Duty—Continuous—Protection—Fused 2 amp slow
blow.
Case—Steel two tone black and silver crackle. Blue
panel—white letters.
Capacitors—Oil coupling condensers & hermetically
sealed electrolytic filter condensers.
Sockets—Output and rectifier sockets standard.
Dimensions—8" x 10" x 14½ inches.
Power Input—110-125 Volts, 60 cycles.
Available with Phono Top and Tubes— **\$64.95**
List \$145.00

TERMS: 10% DEPOSIT WITH ORDER—
BALANCE C.O.D. F.O.B. NEW YORK

AERCO SALES CO.
387 Bushwick Ave. Brooklyn 6, N.Y.



B.A. made a lucky buy.
Genuine U. S. Signal
Corps head phones.
Highly sensitive, 8000
ohms impedance. Only
20c per magnet.
\$2.49 a pair plus
postage and pkg. chgs.
Retail value \$13.50.
Order No. 17A37.

FREE Catalog

GET THIS
catalog, latest devel-
opments in radio and
electronic parts and de-
vices, newest ham gear,
gadgets and bargains.

BURSTEIN-APPLEBEE CO.
1012 McGee St., Kansas City 6, Mo.
Send me your new FREE catalog.
Send me _____ pairs of phones at
\$2.49 plus 20c pair postage. I enclose
\$ _____ in payment. RC

NAME _____
ADDRESS _____
TOWN _____ STATE _____

Specializing in the design and Assembly of
Physics Demonstration Apparatus, Electronic
Equipment and Special Test Equipment. Con-
sulting Service on Applied Physics and Elec-
tronics.
CARLOCK LABORATORIES
of
Applied Physics and Electronics
CLINTON MISSISSIPPI

RADIO SCHOOL DIRECTORY

PREPARE NOW FOR SKILLED JOBS IN RADIO AND ELECTRONICS

CAREERS in RADIO

INTENSIVE COURSES—Thorough, technical education for progressive men and women.

1. **RADIO TECHNICIAN**—The MRI General Course. Includes F.M. & Television. Prepares For FCC Broadcast Licenses.
2. **RADIO & TELEVISION SERVICING**—Prepares for employment as Repairman on Standard Broadcast, F.M. & Television Receivers.
3. **RADIO COMMUNICATIONS**—Prepares for FCC Operators' License. Leads to position as Merchant Marine or Flight Radio Officer, Commercial Operator.
4. **FUNDAMENTAL RADIO MATHEMATICS**—The MRI Preparatory Course. Required pre-training for students lacking a basic mathematical background.

MELVILLE RADIO INSTITUTE
45 W. 45th St., N. Y. 19, BR 9-5080
"The Radio School Managed By Radio Men"

Licensed by the State of New York

MELVILLE RADIO INSTITUTE
45 West 45th St., New York 19, N. Y.

GENTLEMEN: RC
Send me FREE information about your school.

Name

Address

MAIL THIS COUPON NOW

RADIO-TELEVISION TECHNICIAN'S COURSE

- New Classes starting every 5 weeks.
- Women Students invited.
- Approved for veterans—Public Law No. 346 and No. 16.

Write for Free Bulletin on Courses

HOLLYWOOD SOUND INSTITUTE, Inc.

1040 N. Kenmore Ave., Los Angeles

Dept. B

MO 1-2345

RADIO ENGINEERING!

Complete Radio Engineering Course. Bachelor of Science Degree. Courses also in Civil, Electrical, Mechanical, Chemical, Aeronautical Engineering; Business Administration, Accounting, Secretarial Science. 63rd year. Enter June, Sept., Jan., Mar. School now filled to capacity. No applications can be accepted until further notice.

DEGREE IN 27 MONTHS

TRI-STATE COLLEGE 2487 College Ave. ANGOLA INDIANA

RADIO

TECHNICIAN and RADIO SERVICE COURSES

FM and TELEVISION

AMERICAN RADIO INSTITUTE

101 West 63rd St., New York 23, New York

Approved Under GI Bill of Rights

Licensed by New York State

COMMERCIAL RADIO INSTITUTE

A radio training center for twenty-six years.

RESIDENT COURSES ONLY

Broadcast, Service, Aeronautical, Television and Marine telegraphy classes; Preparatory Course now forming. Literature upon request. Veteran training. Classes now forming for July 1st.

Dept. C, 38 West Biddle St., Baltimore 1, Md.

CODE SENDING RECEIVING SPEED

Be a "key" man. Learn how to send and receive messages in code by telegraph and radio. Commerce needs thousands of men for jobs. Good pay, adventure, interesting work. Learn at home quickly through famous Candler System. Write for FREE BOOK.

CANDLER SYSTEM CO.
Dept. 3-E, Box 928, Denver 1, Colo., U.S.A.

RADIO COURSES

Servicing, Broadcast Engineering, Commercial Operating, Television

INDIVIDUAL LABORATORY WORK!—LEARN BY DOING! DAY AND EVENING CLASSES

Approved by the Maryland State Department of Education and the Veterans Administration

FREE TO VETS—TEXTBOOKS, TOOLS, TEST SET

Write for Bulletin

BALTIMORE TECHNICAL INSTITUTE

1425 Eutaw Place—Dept. C. Baltimore 17, Maryland

PRACTICAL TECHNICAL TRAINING FOR YOU

Specialize in Electronics, Radio, Electricity, Refrigeration, Heating and Air Conditioning, or Welding. Prepare in one year for position as Technician, or in two additional years secure your B. S. Degree in ELECTRICAL ENGINEERING with major in Machinery or Electronics.

Write for booklet "Career Building"

MILWAUKEE SCHOOL OF ENGINEERING
"A TECHNICAL INSTITUTE"

RC-547 N. Broadway and E. State, Milwaukee, Wis.

SOUND RECORDING SCHOOL

A practical 9 months' course in Sound Fundamentals, Recording, and Sound Transmission measurements; in a laboratory containing transmission sets, oscillators, square wave generator and Intermodulation analyzer, and other equipment.

Two complete recording studios assimilating broadcast, motion picture and commercial sound recording, under the direction of H. M. Tremaine.

Approved for Veterans

DON MARTIN SCHOOL OF RADID ARTS
1655 Cherokee St., Hollywood, Calif.

CORRESPONDENCE COURSES IN RADIO and ELECTRICAL ENGINEERING

ELECTRICAL ENGINEERING Get good job, or wide electrical field. Prepare yourself at Low Cost, for secure future. Modern course. So simplified anyone can understand quickly.

RADIO ENGINEERING Extra fine course in radio. public address, photo-electric work. Trains you to be super-service man, real vacuum-tube technician. Servicemen needed badly. Diploma on completion. Many graduates earning big pay.

Send postcard for Free Copies of school catalog, full details, all about deferred payment plan, experimental kits, etc. \$25 Course
Lincoln Engineering School, Box 931C-99, Lincoln 2, Nebr.

RCA INSTITUTES, Inc.

Offer thorough training courses in all technical phases of **Radio and Television**

DAY-EVENING WEEKLY RATES

VETERANS: RCA Institutes is approved under G. I. Bill of Rights

For Free Catalog Write Dept. RC-47

RCA INSTITUTES, Inc.

A Service of Radio Corporation of America
75 VARICK STREET NEW YORK 13, N. Y.

MULTIVIBRATORS

(Continued from page 58)

through RP2. At the instant V1 is triggered by a negative pulse, V2 grid is driven positive. V2, of course, conducts heavily, and C discharges through the low-impedance plate-cathode path of V2. This voltage change occurs rapidly, depending on C and V2's plate impedance.

There are numerous other practical applications to which the multivibrator circuit may be adapted. No attempt has been made to describe all of them.

BOOK REVIEWS

(Continued from page 95)

MOST-OFTEN-NEEDED 1946 RADIO DIAGRAMS and Servicing Information, by M. N. Beitman. Published by Supreme Publications. Heavy paper covers, 8 x 10½ inches, 192 pages. Price \$2.00.

More than 300 schematics of 1946 model receivers are printed in this book. Many of the diagrams are accompanied by complete service and alignment data. In some cases parts lists and replacement data are given, and there is also a certain amount of information on record changers.

The book is carefully compiled, and in spite of the large amount of material, excellent utilization of available space has made it possible to print all the diagrams large enough to be easily read in practically all cases.

INSTALL A WAVE TRAP!

(Continued from page 87)

R.d.f. beacon signals leaking through the i.f. of the set are not the only headaches encountered in the way of interference of this type in sets with no preselection before the mixer stage. In the "good old days" of ham radio operation on the 160-meter band, some owners of small, and not-so-small, radios got very wrathful with the unfortunate amateur whose signals the second harmonic of his receiver local oscillator were converting to the i.f. of his set, with the result that several favorite programs were completely spoiled by strong "Ham chatter." Now that the 160-meter band and adjacent frequencies are being used for LORAN and local police radio services, the interference in most localities hasn't let up much.

This type of interference calls for almost the same treatment as the i.f. leak-through type. The only difference is that this new interference is of a higher frequency and calls for a wave trap tuned to that frequency and efficient enough to reduce the unwanted incoming signal to a level that will not be amplified by the i.f. amplifier of the set. In addition, see that the grid circuit of the mixer stage from the wave trap to the grid of the tube is sufficiently shielded.

NEXT MONTH IN RADIO MAINTENANCE

June Issue



Test Equipment Maintenance

The first of a series of three big articles on maintaining your own test equipment. Every Serviceman knows the importance of keeping his test instruments properly calibrated and in good condition—and this series of articles will help you do just that. Read about preventive maintenance on Tube Testers, VTVM, Oscillographs, Multimeters, Signal Generators, etc. . . . How often they should be calibrated . . . How to service them and the equipment needed for best results . . . A discussion of laboratory techniques of fine adjustments . . . Hints and kinks . . . meter peculiarities . . . Replacement parts, etc. Your test instruments can mean the difference between success and failure of your business . . . This series of articles will be a valuable reference for your service library!

Television Receivers

Part of a series by Mortan Scheraga, Television Editor for RADIO MAINTENANCE. Mr. Scheraga describes completely each of the sections in a television receiver and its component parts . . . Alignment, Maintenance and Repair are thoroughly covered . . . In Metropolitan areas, television receivers are already in wide use and smaller communities will soon have them. The public will demand competent repair and maintenance of these new sets, and the Serviceman who knows his television is assured a successful career. Follow television in RADIO MAINTENANCE and be prepared!

When the customer isn't right!

What to do to keep good customer relations. Have you ever had a customer say that your price is too high compared to others? Or that this repair job should be free because you fixed the same radio only a month previously? Find out how some of the leading servicemen in the country handle these difficult situations brought on by some customers. The most frequently encountered problems of customer relations were boiled down into ten questions and each is answered by a different service organization. Read these answers in the June issue, and they will help you meet awkward problems with tact and assurance, and keep all of your customers happy!

And in addition you'll find

- THE RADIO SERVICE BENCH
- SERVICE MEN'S ACTIVITIES
- ELECTRONICALLY SPEAKING
- REVIEW OF TRADE LITERATURE
- THE LATEST THING IN RADIO

**THE MAGAZINE
WITH EVERYTHING YOU NEED**

Start your Subscription with the

June Issue

SUBSCRIBE TODAY

RADIO MAINTENANCE is not sold on the newsstands.

You'll feel this way too!

Although I am a comparative neeconer to the radio servicing field, I felt, as many other servicemen must have, that what our trade needed was a publisher who would devote a magazine entirely to the radio serviceman. After receiving only one copy, I am more than pleased with RADIO MAINTENANCE and wish to thank your organization in all sincerity for doing a great job.

J. M.
Chicago, Ill.

This is my first subscription to your magazine and as long as it continues to have such fine articles, you can count on me as a subscriber. It is the answer to a technician's prayer, and any one who misses your magazine is missing valuable material.

W. L. B.
Berkeley, Calif.

RADIO MAINTENANCE MAGAZINE

460 Bloomfield Avenue, Montclair, N. J.

Please send me RADIO MAINTENANCE magazine every month for

1 year at \$2.50 2 years at \$4.00

Name

Address

City-State

*Occupation

Title (Service Mgr., etc.)

Employed by

*Business or professional classifications are required to serve you better. Each subscriber will profit by writing one of the following classifications in space indicated.

**INDEPENDENT SERVICEMAN—DEALER SERVICEMAN—SERVICE
MANAGER—DEALER—DISTRIBUTOR—JOBBER**

State your trade or occupation if not listed

Here's the world's first VIBRATOR DATA BOOK

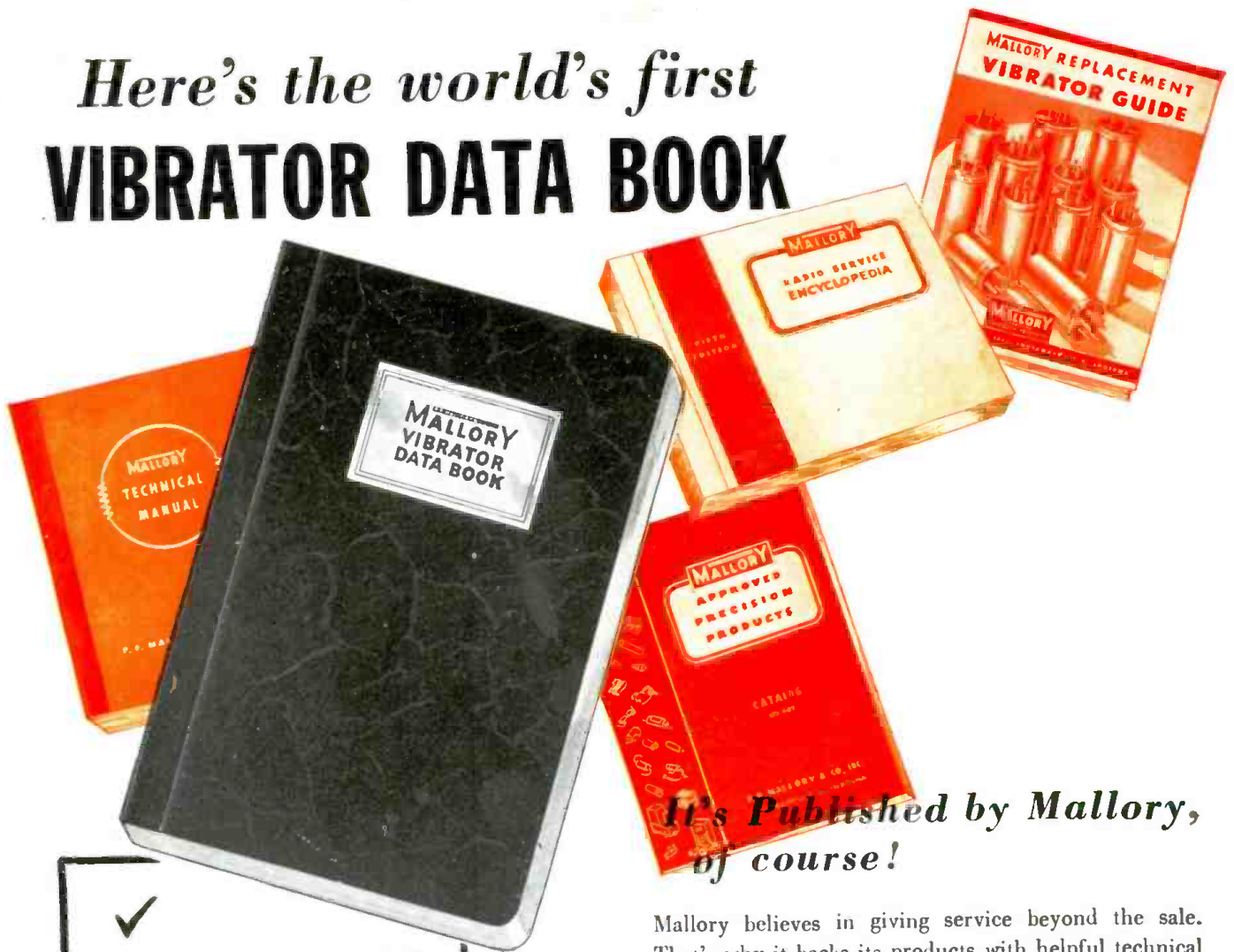

*It's Published by Mallory,
of course!*

✓
CHECK THIS LIST OF CONTENTS

Basic Vibrator Structures
Mallory Standard Vibrator
Types
Selection of Correct Vibrator
Power Transformer
Characteristics
Typical Vibrator Characteristic
Data Sheets
Power Transformer Design
General Procedure in Designing
Transformers
Examples of Transformer
Design
Design Considerations for Other
Applications
High Frequency Vibrator Power
Supply
Timing Capacitor
Considerations
Design Practices and Methods
of Interference Elimination
Vibrator Power Supply Circuits
Vibrator Inspection Procedures

Mallory believes in giving service beyond the sale. That's why it backs its products with helpful technical literature—outstanding books like the Mallory Technical Manual, the Radio Service Encyclopedia and others.

Now comes another important Mallory publication: the first of its kind in the world. It's the Vibrator Data Book, a comprehensive manual that tells you everything about vibrator power supply systems that Mallory has learned in sixteen years of building better vibrators and vibrator power supplies. Does your shop service auto radios? The Vibrator Data Book is an absolute *must* for you. Do you handle other types of equipment powered from a DC source? This volume very definitely belongs on your work bench.

The price? Only \$1.00. The supply? Limited at present. Better order now from your Mallory Distributor before the first edition runs out.

*See Your Mallory Distributor for a free copy of the
1947 Replacement Vibrator Guide*

P. R. MALLORY & CO. Inc.
MALLORY

VIBRATORS . . . VIBRAPACKS* . . . CAPACITORS . . .
VOLUME CONTROLS . . . SWITCHES . . . RESISTORS
. . . FILTERS . . . RECTIFIERS . . . POWER SUPPLIES.

* Reg. U. S. Pat. Off.

APPROVED PRECISION PRODUCTS

P. R. MALLORY & CO., Inc., INDIANAPOLIS 6, INDIANA