

RADIO CRAFT

HUGO GERNSBACK, Editor

LAT. 40° 40' 15" N.
LONG. 73° 45' 30" W.

W2IXY
ON THE AIR

AMATEUR RADIO
STATION W2IXY
SEE PAGE 20

In this issue

- Supersonic Applications
- Cinematic Analysis
- Antenna Principles

RADIO-ELECTRONICS IN ALL ITS PHASES

DEC
1946

25¢
CANADA 30¢

SPRAGUE TRADING POST

is coming Back!

Your Own Swap, Buy or Sell Advertisement Run FREE—Send it in today!

Have you any parts or equipment you'd like to trade or sell to some other radio man who could put them to good use?

Are there any hard-to-get items you'd like to buy?
Want to get a radio job — or to hire a helper?

If so, write up your advertisement in brief form, rush it to Sprague. We'll run it **ABSOLUTELY FREE OF CHARGE** in the famous Sprague Trading Post that will start again next month in seven leading radio publications: **RADIO NEWS, RADIO CRAFT, QST, SERVICE, RADIO SERVICE DEALER, RADIO MAINTENANCE** and **RADIO & TELEVISION RETAILING.**

This famous Sprague service needs no introduction. During the war over 12,000 individual free classified advertisements were run for our friends. Everything, from parts and equipment to complete radio shops, was bought, sold and exchanged as a result.

In discontinuing The Sprague Trading Post at the close of the war, we thought there was no longer any need for it. But we were wrong! Hundreds of letters flooding in from all parts of the country tell us so. "*We need this sort of thing now as much as we ever did!*" is the gist of what our service and amateur friends say, "*Start it going again!*"

And so we're doing it! Send in your swap, buy or sell advertisement today!

Sincerely yours,



Harry Kalker
Sales Manager

**THIS IS THE WAY YOUR
FREE AD WILL LOOK.**

FOR SALE — Standard model all-wave signal generator, \$25; modern tube tester with adapters, \$27.50; popular phono motor, \$15; power transformers and other parts. Write for list. **YOUR NAME and ADDRESS HERE.**

WANTED — Input 1-t transformer and oscillator coil assembly for Model 15 Majestic. Will pay cash or trade. What do you need? **YOUR NAME and ADDRESS HERE.**

HELP WANTED — Need radio service man for busy dealer store in small Mid-western city. Well equipped shop. Write giving full details of experience. **YOUR NAME and ADDRESS HERE.**

INSTRUCTIONS: Print or type your advertisement **CLEARLY**. Hold it to 40 words or less including name and address. Confine it to radio subjects only. **MAKE IT EASILY UNDERSTANDABLE!** No commercial advertisements are acceptable. Sprague reserves the right to reject any copy that, in our opinion, does not fit in with the spirit of this free service. Your advertisement will be run in the first possible issue of at least one of the seven magazines on our list.

Write it now. Mail it to
Dept. RC-126
SPRAGUE PRODUCTS COMPANY
North Adams, Mass.



CAPACITORS AND *KOOLOHM RESISTORS FOR EVERY RADIO SERVICE AND AMATEUR NEED

*Trademark Reg. U. S. Pat. Office



I Will Show You How to Learn RADIO by Practicing in Spare Time

**I Send You
6 Big Kits
of Radio Parts**



KIT 1

I send you Soldering Equipment and Radio parts; show you how to do Radio soldering; how to mount and connect Radio parts; give you practical experience.



KIT 2

Early in my course I show you how to build this N.R.I. Tester with parts I send. It soon helps you fix neighborhood Radios and earn EXTRA money in spare time.

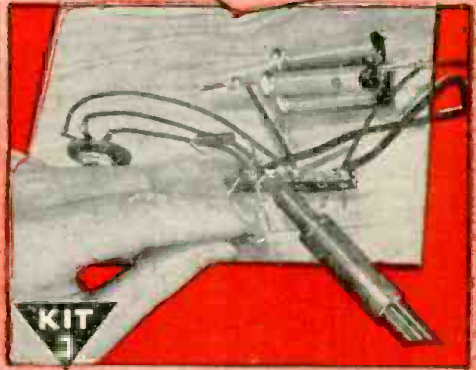

KIT 3

You get parts to build Radio Circuits; then test them; see how they work—learn how to design special circuits; how to locate and repair circuit defects.

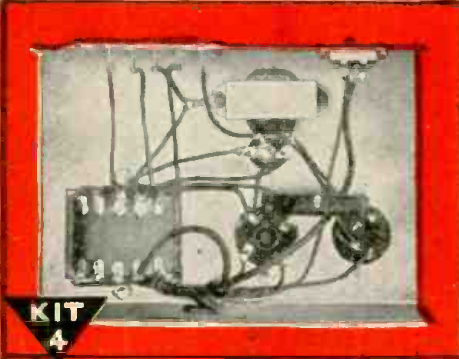

KIT 4

You get parts to build this Vacuum Tube Power Pack; make changes which give you experience with packs of many kinds; learn to correct power pack troubles.



KIT 5

Building this A. M. Signal Generator gives you more valuable experience. It provides amplitude-modulated signals for many tests and experiments.

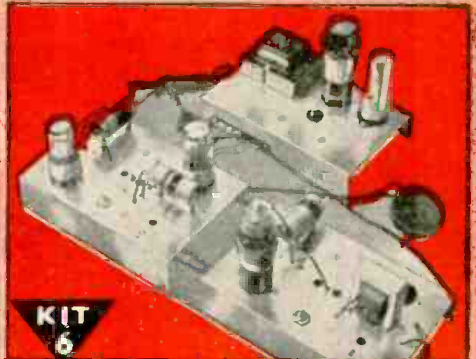

KIT 6

You build this Superheterodyne Receiver which brings in local and distant stations—and gives you more experience to help you win success in Radio.

I Will Train You at Home - SAMPLE LESSON FREE

Do you want a good-pay job in Radio — or your own money-making Radio Shop? Mail Coupon for a FREE Sample Lesson and my FREE 64-page book, "Win Rich Rewards in Radio." See how N.R.I. gives you practical Radio experience at home—building, testing, repairing Radios with 6 BIG KITS OF PARTS I send!

Many Beginners Soon Make Good Extra Money in Spare Time While Learning

The day you enroll I start sending EXTRA MONEY JOB SHEETS. You LEARN Radio principles from my easy-to-grasp, illustrated lessons—PRACTICE what you learn with parts I send—USE your knowledge to make EXTRA money fixing neighbors' Radios in spare time while still learning! From

here it's a short step to your own full-time Radio Shop or a good Radio job!

Future for Trained Men Is Bright in Radio, Television, Electronics

It's probably easier to get started in Radio now than ever before because the Radio Repair business is booming. Trained Radio Technicians also find profitable opportunities in Police, Aviation, Marine Radio, Broadcasting, Radio Manufacturing, Public Address work. Think of even greater opportunities as Television and Electronics be-

Our 32nd Year of Training Men for Success in Radio

come available to the public! Send for free books now!

Find Out What N.R.I. Can Do for You

Mail Coupon for Sample Lesson and my 64-page book. Read the details about my Course. Read letters from men I trained, telling what they are doing, earning. See how quickly, easily you can get started. No obligation! Just MAIL COUPON NOW in an envelope or paste it on a penny postal. J. E. SMITH, President, Dept. 6NX National Radio Institute, Pioneer Home Study Radio School, Washington 9, D. C.

**My Radio Course Includes
TELEVISION • ELECTRONICS
FREQUENCY MODULATION**

Good for Both—FREE

Mr. J. E. SMITH, President, Dept. 6NX
National Radio Institute, Washington 9, D. C.
Mail me FREE, without obligation, Sample Lesson and 64-page book about how to win success in Radio and Television—Electronics. (No salesman will call. Please write plainly.)

Age

Name

Address

City State

(Please include Post Office zone number)



APPROVED FOR TRAINING UNDER GI BILL

WHATEVER YOU NEED IN RADIO OR ELECTRONICS

PARTS...SETS...KITS
TESTING EQUIPMENT...TOOLS
PUBLIC ADDRESS EQUIPMENT
TRANSMITTERS

YOU CAN GET IT AT NEWARK!



SERVICEMEN

Three big stores, each carrying tremendous stocks, are ready to serve you with tools, replacement parts, test equipment, sets or anything else you need. Wire, write or telephone if you can't visit one of our stores. If you can visit with us you'll find our trained staff of tremendous help to you.

SERVICE

Mail orders are shipped the same day they are received. You don't have to wait when you buy from Newark. On special inquiries, we give you full information, prices and delivery dates promptly. Newark will give you service that will help you serve your customers better.



PUBLIC ADDRESS SYSTEMS FOR EVERY NEED AND PURPOSE

No matter what your public address needs may be, Newark has the outfit that will do the job for you. All the well known, standard makes are carried in stock. Delivery is fast and dependable . . . in New York and Chicago we maintain our own delivery system . . . for out-of-town customers we ship orders the same day they are received.

All our stores are staffed by trained men who know public address needs and can help you select the outfit that will best serve your purpose. If your needs are unusual, they know how to make up special combinations to satisfy them efficiently.

If you can, visit one of our stores. If you can't come to see us, write, phone or telegraph and your inquiry will be answered promptly and fully. Newark has the stock, Newark has the 'know how', Newark can help you.

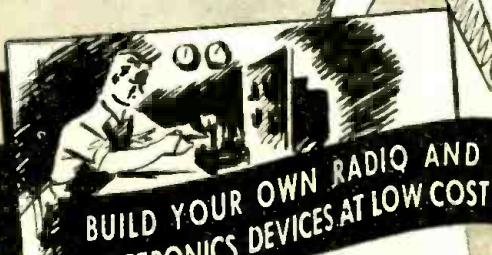

BUILD YOUR OWN RADIO AND ELECTRONICS DEVICES AT LOW COST

With Newark's kits and parts you can easily build radio receivers, transmitters, amplifiers, and other exciting radio and electronics devices.

Make a good radio receiver for yourself or a fine record player with automatic changer at tremendous savings. You can construct these and many other radio and electronics devices easily. Our men know how to make them and will gladly show you if you can visit one of our stores—or will explain clearly by mail.

FOR GOOD BUYS AND A GOOD TIME VISIT OUR BIG BARGAIN COUNTERS

These big bargain counters in all our stores, are loaded down with special items available in quantities too small to advertise. Marvelous war-time sets, new small gadgets you can have fun with . . . all sorts of new parts and special things you'll want to see. Come in, look around and ask all the questions you wish. Come in often you'll have a wonderful time.

WRITE FOR OUR BIG BARGAIN BULLETIN LISTING THE LATEST AVAILABLE EQUIPMENT

Magazines are printed months before you read them, stocks change, new things are developed and made, so we give you the very latest news about the very newest things in radio and electronics in our Big Bargain Bulletin. Send for your copy today and know all about the latest equipment first. When writing address Dept. F-2



N.Y.C. Stores: 115 W. 45th St. & 212 Fulton St. Offices & Warehouse: 242 W. 55th St. N.Y. 19

NOW SPRAYBERRY RADIO TRAINING

GIVES YOU 8 BIG KITS OF RADIO EQUIPMENT

WITH A COMPLETE 6 TUBE SUPER-HETERODYNE RECEIVER

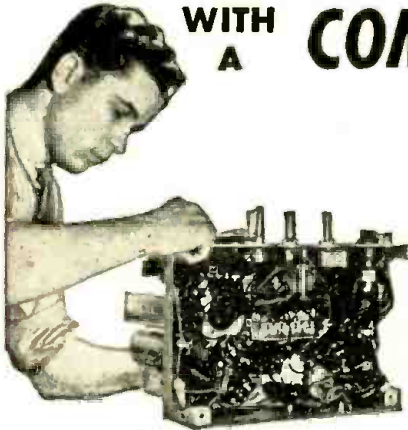

YOU LEARN RADIO SERVICING THROUGH INTENSIVE "SHOP-BENCH" PRACTICE

YOU DO EXPERIMENTS, CONSTRUCTION, TROUBLE-SHOOTING

I'll show you how to perform over 175 instructive Experiments—how to build countless Radio Circuits. You'll learn a new, fast way to test Radio Sets without mfg. Equipment.



I give you a fine, moving-coil type Meter Instrument on Jewel Bearings—with parts for a complete Analyzer Circuit Continuity Tester. You learn how to check and correct Receiver defects with professional accuracy and speed.

You'll get valuable experience and practice building this Signal Generator and multi-purpose Tester. Makes a breeze out of fixing Radios and you don't have to spend money on outside, ready-made equipment.



Soldering, wiring, connecting Radio parts . . . building circuits with your own hands—you can't beat this method of learning. When you construct this Rectifier and Filter, Resistor and Condenser Tester, etc., you get a really practical slant on Radio that leads to a money-making future.



HERE'S THE LATEST, SIMPLEST WAY TO TRAIN at HOME for a GOOD LIVING in RADIO-ELECTRONICS & TELEVISION

I train your mind by putting you to work with your hands on a big 6-Tube Superheterodyne Receiver. And, believe me, when you get busy with real Radio Parts—8 big Kits of them—you really LEARN Radio and learn it RIGHT! You get the practical stuff you need to be useful in Radio, and that's what it takes to make money. You don't have to worry about what to do with these 8 Kits of Parts. Step by step, I show you how to build circuits, test, experiment, trouble-shoot. And you don't need any previous experience. The Sprayberry Course starts right at the beginning of Radio! You can't get lost! Simplified lessons, coupled

with real "Shop" practice, makes every subject plain and easy to understand and remember.

A BUSINESS OF YOUR OWN . . . OR A GOOD RADIO JOB

Soon after you begin Sprayberry Training, I'll send you my sensational BUSINESS BUILDERS. You'll find out how to get and do neighborhood Radio repair jobs for nice profits and rich experience while learning. This sort of work can easily pave the way for a Radio Service business of your own. But with Sprayberry Training, you're not limited. You can swing into any one of the swiftly expanding branches of Radio-Electronics INCLUDING Radio, Television, FM, Radar, Industrial Electronics. Be wise! Decide now to become a fully qualified RADIO-ELECTRONICIAN. Get full details about my Training at once! Mail coupon below for my 2 big FREE Books.

SEND FOR THESE FREE BOOKS



"How to Read Radio Diagrams and Symbols"

Here's a valuable and wonderfully complete new book which explains in simple English how to read and understand any Radio Set Diagram. Includes translation of all Radio symbols. Send for this volume at once! It's free! Along with it, I will send you another Big Free book describing in detail my Radio-Electronic Training.

SPRAYBERRY ACADEMY OF RADIO

F. L. Sprayberry, President, Room 20126, Pueblo, Colorado

Please rush my FREE copies of "How to MAKE MONEY in RADIO, ELECTRONICS and TELEVISION," and "HOW to READ RADIO DIAGRAMS and SYMBOLS."

Name Age

Address

City State

(Mail in envelope or paste on penny postcard)

MAIL COUPON TODAY!

NEW!

WESTON Mutual Conductance Tubechecker and Circuit Analyzer

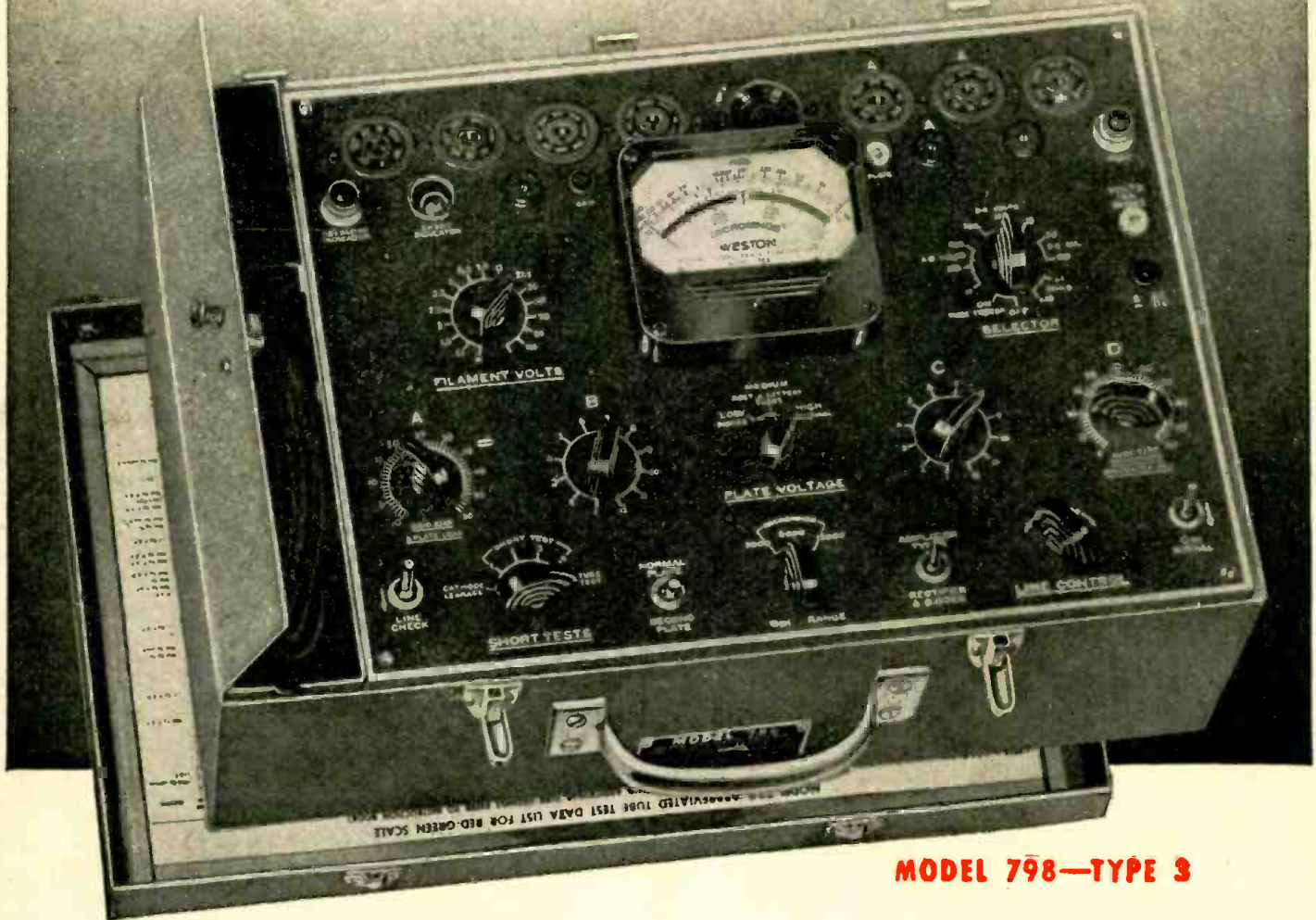
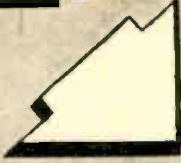

MODEL 798—TYPE 3

Outstanding Features

- ✓ Direct-reading mutual conductance tests, and "Good-Bad" indications.
- ✓ New patented high frequency tube testing circuit.
- ✓ AC-DC volt-ohm-milliampere ranges.
- ✓ Tests 4, 5, 6, 7 prong octal, loctal, miniature, and acorn tubes... spare octal and miniature sockets.
- ✓ Hot neon leakage test between any two tube elements... neon short check.
- ✓ Adjustable plate, screen, grid bias, and signal voltages.
- ✓ Flexibility in switching simplifies testing present and future tubes.
- ✓ Durable heavy-gauge, light-weight aluminum case.

Model 798 combines broad utility, ruggedness, and dependable accuracy for maintenance of sound and electronic equipment. Detailed bulletin available. Weston Electrical Instrument Corporation, 599 Frelinghuysen Avenue, Newark 5, New Jersey.

Weston Instruments

ALBANY • ATLANTA • BOSTON • BUFFALO • CHARLOTTE • CHICAGO • CINCINNATI • CLEVELAND • DALLAS • DENVER • DETROIT • JACKSONVILLE • KNOXVILLE • LOS ANGELES • MERIDEN • MINNEAPOLIS • NEWARK
NEW ORLEANS • NEW YORK • PHILADELPHIA • PHOENIX • PITTSBURGH • ROCHESTER • SAN FRANCISCO • SEATTLE • ST LOUIS • SYRACUSE • IN CANADA, NORTHERN ELECTRIC CO., LTD., POWERLITE DEVICES, LTD.

RADIO-CRAFT for DECEMBER, 1946

Now IN YOUR OWN HOME Learn

RADIO ELECTRONICS

The Practical
"HOME-TESTED"
Modern "A-B-C" Way



YOU USE ALL OF THESE RADIO PARTS
TO BUILD
AND OPERATE
7
DIFFERENT RADIO
RECEIVING CIRCUITS

WITH THE HELP OF

A EIGHT Big Kits of Actual "Learn-by-Doing" Radio Parts and Assemblies with which you make 133 fascinating SHOP METHOD EXPERIMENTS in your own home! Imagine building 7 different Radio Receivers that operate!

B A 16 mm Home Movie Projector and Twelve Reels of "Learn-by-Seeing" Home Movie Films . . . for picture-clear, fast understanding of Radio Fundamentals!

C Modern, well-illustrated, Loose-leaf Lessons, prepared in clear, simple, understandable language . . . to guide you throughout your training!

NO PREVIOUS RADIO OR ELECTRICAL EXPERIENCE NECESSARY

DeForest's Training, Inc. provides every major home study aid to help you learn Radio-Electronics rapidly and thoroughly . . . to give you the experience and confidence needed for a responsible, Good-Pay Job, or to Start a Business of Your Own! Here is a REAL opportunity field for YOU . . . when you are a trained Radio-Electronics man! Just think of the tremendously exciting future ahead of FM Radio, Aviation and Broadcast Radio, Sound Motion Picture Equipment, Servicing and Sales of Radio Equipment, etc. Put yourself in this picture . . . See how you can benefit from a PRACTICAL training in this fascinating work! Think, too, of the coming possibilities ahead of Radar, Facsimile and Television. Send TODAY for the interesting, opportunity-revealing book, "Victory for You!" See how others probably no more talented or ambitious than you, have advanced in earning power after this training . . . how YOU can do it too! Mail the coupon NOW!

INCLUDING:

1. Simple Receiver
2. Two Tube Receiver
3. Tuned Radio-Frequency Receiver
4. Short Wave Receiver
5. Aviation Band Receiver
6. 4-Tube Superheterodyne
7. 5-Tube Superheterodyne with Magic Tuning Eye

PLUS SCORES OF OTHER FASCINATING, INSTRUCTIVE RADIO-ELECTRONIC EXPERIMENTS

THEN GET THE HELP OF OUR EFFECTIVE EMPLOYMENT SERVICE

16 MM MOVIE PROJECTOR
YOU USE "LEARN-BY-SEEING" MOVIES



DEFOREST'S TRAINING, INC. INCLUDES INSTRUCTION IN MOTION PICTURE SOUND EQUIPMENT, FM RADIO AND TELEVISION . . . RESIDENTIAL TRAINING IN OUR MODERN CHICAGO LABORATORIES ALSO AVAILABLE—ASK US FOR INFORMATION!

VETERANS!

Big things are happening at DeForest's Training, Inc. for veterans! See how you can prepare yourself WITHOUT COST for a GOOD JOB or a BUSINESS OF YOUR OWN in the vast Radio-Electronic opportunity field.

DeFOREST'S TRAINING, INC.
CHICAGO 14, ILLINOIS

E. B. DEVRY, President
DeFOREST'S TRAINING, INC.
2535-41 North Ashland Ave., Dept. RC-C12
Chicago 14, Illinois, U.S.A.

Send FREE "VICTORY FOR YOU!" BOOK, showing how I may make my start in Radio Electronics.

Name _____ Age _____

Address _____ Apt. _____

City _____ Zone _____ State _____

If under 16, check here for special information.

If a discharged Veteran of World War II, check here.



RADIO CRAFT

AND POPULAR ELECTRONICS

Incorporating
SHORT WAVE CRAFT TELEVISION NEWS
RADIO & TELEVISION



HUGO GERNSBACK, *Editor-in-Chief*
FRED SHUNAMAN, *Managing Editor*
M. H. GERNSBACK, *Consulting Editor*
R. F. SCOTT, W2PWG, *Technical Editor*
I. QUEEN, W2OUX, *Editorial Associate*
ELMER FULLER, *Shortwave Editor*
A. PASCALE, *Production Manager*
G. ALIQUO, *Circulation Manager*
JOHN J. LAMSON, *Advertising Director*
ALFRED STERN, *Promotion Manager*

Published by Radcraft Publications, Inc.
Publication Office: 29 Worthington Street,
Springfield 3, Mass.
Editorial and Advertising Offices: 25 West
Broadway, Tel. RE 2-9690, New York 7, N. Y.
Chicago Advertising Office: Radio-Craft, 308
W. Washington Street, Suite 1413, Chicago 6,
Ill. Tel. Randolph 7363.

Cleveland Advertising Office: 405 Erie Bldg.,
Cleveland, Ohio. Burdette Phillips, Manager.
Tel. Main 9645.

Detroit Advertising Office: 307-8 Boulevard
Bldg., Detroit, Mich. C. Frank Holstein, Man-
ager.

Los Angeles Advertising Office: 606 South
Hill Street, Los Angeles 14, Calif. Ralph W.
Harker, Manager. Tel. Tucker 1793.

San Francisco Advertising Office: 582 Market
St., San Francisco 4, Calif. Ralph W. Harker,
Manager. Tel. Garfield 2481.

RADIO-CRAFT is published monthly on the
25th of the month preceding that of date.
Subscription rates: United States and pos-
sessions, Mexico, Central and South American
countries, \$2.50 a year, \$4.00 for two years,
\$6.00 for three years. Canada, \$3.00 a year,
\$5.00 for two years, \$7.50 for three years.
All other foreign countries, \$3.25 a year,
\$5.50 for two years, \$8.25 for three years.
Special rates for members of the Armed
Forces in U. S., or those addressed by A.P.O.
or F.P.O. mail, \$2.00. Entered at the post
office at Springfield as second-class matter
under the Act of March 3, 1879. All com-
munications about subscriptions should be
addressed to: Circulation Manager, Radio-
Craft, 25 West Broadway, New York 7, N. Y.

Notice of CHANGE of ADDRESS should
reach us at least one month in advance. When
ordering a change, please furnish an address
stencil impression from a recent wrapper if
you can. Address changes cannot be made
without the old address as well as the new.

Foreign Agents

London—Atlas Publishing and Distributing
Co., Ltd., 18 Bride Lane, Fleet St., London,
E.C. 4.

Melbourne—McGill's Agency, 179 Elizabeth
St., Australia.

Text and illustrations of this magazine are
copyright and must not be reproduced without
permission of the copyright owners.
Copyright, 1946, Radcraft Publications, Inc.

RAD-CRAFT PUBLICATIONS, INC.:

Hugo Gernsback, *President*
M. Harvey Gernsback, *Vice Pres.*
G. Aliquo, *Secretary*

Contents December, 1946 Volume XVIII, No. 3

Editorial: Servicemen—Wake Up!.....	by Hugo Gernsback	13
Radio-Electronics Monthly Review.....		14

ELECTRONICS

Private Aircraft Radio.....	by R. F. Scott, W2PWG	22
Antenna Principles, Part I—Dipole Antennas and Feeders.....	by I. Queen	23
Wave and Pulse Counter.....	by Richard Blitzer	25
Electronic Mathematicians.....	by Robert W. Ehrlich	26
Police Radio Maintenance.....		28
Television for Today, Part VII—Video Detector Circuits.....	by Milton S. Kiver	29
Names for Wavebands.....	by E. Aisberg	63

AMATEUR RADIO

Amateur Radio W2IXY.....	by Dorothy D. Hall	20
Folded Dipole Antenna.....	by Leon S. Wecker	43

SERVICING

Servicing Movie Sound, Part II—Lamp Supplies and Amplifier Equipment.....	by Hubert W. Watkins	30
Radio Data Sheet 342 (Howard Radio Model 901).....		35

SOUND

Supersonic Applications.....	by T. F. LoGiudice	16
Adding a Crystal Pickup.....	by George Duff	32

CONSTRUCTION

Miniature 3-Tube Receiver.....	by Edwin Bohr	37
A Modern Crystal Set.....	by W. J. E. Spain	48

TEST INSTRUMENTS

The Cinematic Analyzer.....	by E. Aisberg	18
-----------------------------	---------------	----

DEPARTMENTS

Transatlantic News.....	by Major Ralph Hallows	31
World-Wide Station List.....	by Elmer R. Fuller	33
New Radio-Electronic Devices.....		34
Radio-Electronic Circuits.....		36
Try This One.....		42
The Question Box.....		44
Available Radio-Electronic Literature.....		50
Communications.....		68
Book Reviews.....		71



ON THE COVER

Radiophone W2IXY, outstanding amateur
station of Dorothy D. Hall, Springfield, N. Y.,
is the subject of our cover. W2IXY has won
fame as a consistent 20-meter DX station,
and has become known to our soldiers abroad
and to dwellers in remote corners of the earth.

JANUARY ISSUE—DE FOREST 40TH ANNIVERSARY

Our next issue will be a special double-size anniversary number honoring Dr. Lee de Forest on the fortieth anniversary of his invention of the vacuum tube which makes all modern radio possible. It will contain special stories by de Forest and others, as well as a brilliant selection of articles in the usual RADIO-CRAFT style, featuring construction of a television receiver, light-beam transmitter and electronic organ, as well as selected articles on sound, servicing and electronics, and circuits for the skilled experimenter and technician.

Grasp the **NEW OPPORTUNITIES** in

RADIO ELECTRONICS AND TELEVISION *NOW!*



Modern Radio — FM Broadcast and Reception — Television — Industrial Electronics; Power, Control, Communications — new equipment and methods demand new technical ability and experience. Keep up to date with the latest.

**MODERN RADIO
EQUIPMENT FOR YOU
TO USE AND KEEP**



The very essence of National Shop Method Home Training is **EXPERIENCE**. You get actual experience by working with modern Radio and Electronic equipment—building many types of circuits. You may build a fine, long distance **MODERN SUPERHETERODYNE**, signal generator, miniature radio transmitter, audio oscillator, etc.—many other standard actual operating pieces of equipment—conduct cathode ray and other experiments. This practical work advances with your training—**YOU LEARN BY DOING!**

Shop Method Home Training

By a Real Established Resident School with its own FM Studios, Shops and Laboratories.

TRAIN WITH ADVANCED TECHNIQUE

The good jobs in Radio Electronics now go to the men who are equipped to handle them. It takes training and experience. National Schools, one of the oldest and largest trade schools in the country, makes it possible for you to get this training right in your own home **IN YOUR SPARE TIME**.

National maintains modern resident training Studios, Shops and Laboratories where instructors and engineers are working constantly to improve training methods. **SHOP METHOD HOME TRAINING** is a logical extension of this Practical system.

A **FREE** lesson that shows you how practical and systematic this new training method is will be sent you without obligation. You may keep and use this lesson to prove to yourself just how practical National Training really is.

Get one of the many **NEW JOBS** that demand new techniques and methods in Modern Radio. Get your share of the **NEW BUSINESS** that servicing the new sets and equipment demands. Experts agree that Radio, Television and Electronics Present opportunities

much greater than ever before! Radio is expanding with far-reaching improvements in reception. No one knows yet how great the Television market will be. Electronics will touch almost every walk of life—in industry and in the home.

TURN YOUR INTEREST IN RADIO INTO A CAREER THAT WILL ASSURE YOU SUCCESS AND SECURITY.

FIND OUT WHAT NATIONAL TRAINING CAN DO FOR YOU

Where do you stand today in modern industrial progress? What does the future hold for you? You owe it to yourself to investigate this opportunity. With National Training **YOU GET AHEAD FAST**—you may step into a good position or start a business of your own, with little capital, even before you complete your National Course.

Fit yourself for a career of independence, good earnings, success and security in one of the fastest growing fields in industry. For full information, just send your name and address on the coupon and mail it **TODAY**.

FREE LESSON



Get This Book FREE

This big book presents the facts about the field of Electronics and your opportunities in it together with full information about the advanced National Training. Read it and make up your own mind that National Training will equip you for a great future. No salesman will call on you from National. The book is **FREE** with your sample lesson. Clip and mail the coupon **TODAY!**



See What National Training Has Done For These Men

National Shop Method Home Training wins good jobs, independence and security. Take the word of National men who have established records in their favorite Radio, Television, or other branches of Electronics.



Clifford Hannah, Portage La Prairie, Manitoba, Canada, writes: "My training has brought results as I'm in line for another raise thanks to National's encouragement and thorough training."



From O. K. Ivey, Washington, D. C., comes this endorsement: "I believe National offers the best course to be had ... Keep up the good work."



Joseph Michel, Jr., Granite City, Illinois, writes: "I am enthused with National training. I am now earning \$225 a month as a radio operator and technician and \$20 a week more in my shop at home."



Here's a statement from B. E. Wright, Blackfoot, Idaho: "Due to my training at National I was selected to instruct in the laboratory work of Navy and Marines."



Read what other enthusiastic students have written about National Training in the big 40 page book we will send you.

NATIONAL SCHOOLS

LOS ANGELES 37, CALIFORNIA EST 1905



MAIL OPPORTUNITY COUPON FOR QUICK ACTION

National Schools, Dept. RC-12
4000 South Figueroa Street, Los Angeles 37, California

(Mail in envelope or paste on penny post card)

Mail me **FREE** the two books mentioned in your ad including a sample lesson of your course. I understand no salesman will call on me.

NAME AGE

ADDRESS

CITY STATE

Include your zone number

Check here if veteran of World War II



NEW HIGHER PAY FOR THE ARMY

GRADE	MONTHLY PAY (Service in U. S.)	MONTHLY PAY (Service Overseas)
Private	\$75 to \$112.50	\$90 to \$135
Private, First Class	80 to 120.00	96 to 144
Corporal or Technician, 5th Grade	90 to 135.00	108 to 162
Sergeant or Technician, 4th Grade	100 to 150.00	120 to 180
Staff Sergeant or Technician, 3d Grade	115 to 172.50	138 to 207
Technical Sergeant	135 to 202.50	162 to 243
Master Sergeant or First Sergeant	165 to 247.50	198 to 297

Family allowances for the duration of the present emergency and six months thereafter are provided under current laws.

**A GOOD JOB FOR YOU
U. S. Army
CHOOSE THIS
FINE PROFESSION NOW!**

ENLIST NOW



"SERVICE" MAG. PHOTO

**CREI Home Study Training in New Techniques is a \$ and Sense Investment in Your Future
PREPARE NOW FOR NEW MONEY-MAKING SERVICING OPPORTUNITIES**

Foresighted radio servicemen are looking ahead to the future. A future that has unlimited opportunities and real profits for those who have the "Know-How" to SERVICE television, FM, industrial electronic equipment, and the many other new radio developments.

Join the many professional servicemen who are studying at home the new developments, the new techniques with CREI . . . protecting their future jobs, their businesses by acquiring the new "Know-How" NOW!

CREI's reputation for home study training

VETERANS! CREI IS APPROVED FOR "G. I." TRAINING!

Capitol Radio Engineering Institute

Dept. RC-12, 16th and Park Road, N. W., Washington 10, D. C.

NEW YORK (7): 170 BROADWAY

Branch Offices:

SAN FRANCISCO (2): 760 MARKET ST.



If you have had professional or amateur radio experience and want to make more money, let us prove to you we have the training you need to qualify for a better radio job. To help us intelligently answer your inquiry—PLEASE STATE BRIEFLY YOUR BACKGROUND OF EXPERIENCE, EDUCATION AND PRESENT POSITION.

**MAIL
COUPON
FOR FREE
36-PAGE
BOOKLET**

has been proved over 19 years. Important new developments have been included in our present course. Trained instructors give you personalized attention and guidance *all the way*.

Find out for yourself how CREI can help you to greater security and prosperity. Send in the coupon now! Actually see what CREI has to offer.

RESISTANCE

—To New Ideas Has Cost Many A Man a Great Future. We all know the classic stories of the people who scoffed at Edison, Ford, de Forest. It was the scoffers who lost out when the rewards poured in. Now with radio-electronics entering a great, new era, when it may well emerge in greatly magnified form, you fellows who are in on the ground floor and don't prepare now for the future fall in the same class as those early scoffers.

E. N. Pfeiffer
President of CREI

CAPITOL RADIO ENGINEERING INSTITUTE RC-12
16th and Park Road, N.W., Washington 10, D.C.

Gentlemen: Please send me your free booklet, "Your Opportunity in the New World of Electronics," together with full details of your home study training. I am attaching a brief resume of my experience, education and present position.

NAME

STREET

CITY ZONE STATE

CHECK PRACTICAL RADIO ENGINEERING COURSE PRACTICAL TELEVISION ENGINEERING

I am entitled to training under the G. I. Bill.

MORE SUPER-SPECIAL BUYS!!!

RECEIVERS — TRANSMITTERS — COMPONENTS MAGNETRONS — KLYSTRONS

NEW USN NAVY MODEL RAK-7 SHIP RECEIVER

15 kc to 600 kc. 6-tube receiver with: AVC—Band pass filter—Audio filter—Noise limiter—Precision tuning with a Vernier dial—Voltage regulated power supply, with three tubes, for 60 cycle, 115 volts. Can be battery operated. Complete with spare parts box weighing 73 lbs., spare tubes and inst. **\$69.50**



AMERTRAN PLATE TRANSFORMER, 115 v. 60-cycle primary, 6200 volt-ct. 700 mill secondary. Size 11"x14"x 10" **\$39.95**

6HY 700 M. A. CHOKES
can be used with Amer-
tran
Transformers **\$7.95**

HI-VOLT TRANSFORMER

1/2 WAVE RECTIFICATION 115v-60c/3200v @ 150
mils.
MADE BY KENYON **\$9.95**

Power supply transformer. Pri. 115/60 cps Sec. 1:
750v-113a; Sec. 2: 6.3v-5a; Sec. 3: 5v-3a. 2500TV
specially priced at \$5.95.

RELAYS

DPDT 10a contacts, 115v/60
cps coil—Leach, Allied, **\$1.69**
SPST 5a, ac; 1a dc; 115v
cont. 115v/60 cps. **1.25**
SPDT contacts: 5a 50v
coil rated 115v/60c. **1.39**
DPDT 115v/60c. cont. rating 5a @ 50v **1.69**
DPST Telephone type: 2p, 1 cl; 1 open; cont.
rating, 5a @ 50v, coil rating 3.5 ma (@
12K ohms) 1000 vac **1.05**



JUST A FEW LEFT

NEW COMPLETE TRANSMIT- TING AND RECEIVING SETS **\$68.50**

No. 19—Mark I-II-III Tank, made by Zenith &
Emerson, lend-lease Russia. Trans. 6 tubes 807 final,
grid mod. tel. 2 to 8 meg. cont. var. Includes 80
& 40 m. bands. Receiver 6-tube Super-Het. Also
included intercom, 8v. 3 control boxes, 3 Comb. head
phones & mikes; power supply, dynamotor, 12-volts.
Ideal for mobile or marine. Also includes ant.
variometer. Shipping weight in crates 300 lbs. (&
spare set of tubes).

THESE UNITS ARE NOT KNOCK-DOWN
SETS. THEY ARE COMPLETELY AS-
SEMBLED AND READY TO OPERATE!
MANY SPARE PARTS INCLUDED.

AUDIO TRANSFORMER, MODULATORS, ETC.

Modulation xfmr: typical for 211's cl. 450W. **\$1.35**
Modulation xfmr: 897 to pr 807's **1.65**
Modulation xfmr: pr 811's to 818 **5.00**
Line Coupling trsf. 150 ohm, 250 ohm, 600
ohm c.t. and 4000 ohm windings. **1.25**
Chl. transformer: P.P. Mod. & Driver 6L6's
per pr. **3.30**

BRAND NEW C.R. TUBES

Made by No. American Philips

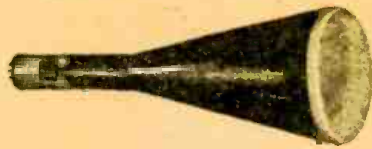

Tube Type	Approx. List	Your Cost
3BP1	15.00	3.95
3FP7	27.00	5.35
5BP1	20.00	4.95
5BP4	27.00	5.95
5CP1	45.00	4.95
5CP7	48.00	6.00
5FP7	32.00	4.95
5JP2	48.00	13.50
837	2.80	1.50
872A	7.50	3.50
705A	22.50	7.50
241B-WE	85.00	50.00
861	155.00	95.00

Sockets for 5CPI; 3BP1, and similar types
of tubes **\$.95**

PULSE AMPLIFIER



Signal cups type
BC409. Designed for
115 volts. AC 60
cycles. Component
parts worth several
times the price of this
unit. Slightly used.
Following are a few
of the items that
make up the unit.
1—304TL (Eimac). 3—2 mfd. 4,000 V.V.xGE
Pyranol condensers. 1—3200 volt 150 MA power
transformer. 1—Variac 5 amps. General Radio type
CU 200. 1—3 volt 28 amp. fl. transformer (for 304
TL). 1—2.5 volt 10 amp. fl. transformer (3000
volt insulation). 1—1 mfd. 1000 volt GE Pyranol
1—2 mfd. 1000 volt GE
Pyranol. **\$59.50**

TRANSMITTING CONDENSERS

A.V.H.F. dual section
variable 15-60 mmf;
3/4" air gap; 11 rotor
plates; feedback provision. Designed to oper-
ate in a tuned grid, tuned filament cir-
cuit. List at \$98.00. **\$14.95**
OUR LOW PRICE
B. Split stator Cardwell PK-200-QD; 30-200
mmf per section. Special Hi-Volt. **\$9.95**
Listed at \$65
C. Johnson type 500D85. Maximum cap.
500 mmf. min 35 mmf. .08" spacing. **\$4.75**
3500v. Listed at \$11.75. Lowered to.



NEW POWER SUPPLY for LM-18 freq.
meter. Output: 290 v. @ 20 ma; 13 v. @ 600
ma. Input: 105-125 v. @ 60 cps; 260 ma;
27.6 W. type 84 rectifier tube; shock mount-
ed. Complete with input and out-
put cables, tube included **\$14.75**



MAGNETRON 811
Westinghouse type
2J32 (JAN) just re-
leased. This is the
first large lot of
MAGNETRONS to
flow into the civilian
market! The 2J32 is
designed for 10 cm.
operation. Rated at
300 kw. peak pulse
power. Complete in-
formation supplied.
Brand New, packed in
individual protective cartons. The 2J32 is listed at
\$200. OUR PRICE **\$25.00**
3J31 Magnetrons also in stock **\$20.00**

KLYSTRON oscillator
tubes 2K25/723-ab.
designed for 3 cm.
operation. New Pack-
ed Individually. List-
ed at \$38.00.
OUR PRICE **\$7.75**



OIL, AND OIL IMPREGNATED CONDENSERS

8 mfd 600vdc **\$.15**
2. mfd 600vdc **.69**
2. mfd 220vac, 600 vdc **.40**
5. mfd 600vdc **1.00**
10. mfd 600vdc **1.49**
2. mfd 1000vdc **1.29**
4. mfd 1500vdc **.20**
2. mfd 1500vdc **1.50**
1. mfd 2000vdc pyranol **1.50**
4. mfd 600vdc **2.95**
15. mfd 220vac or 600vdc **1.95**
2. mfd 4000 vdc **5.95**
4000 mfd at 30 vdc. **2.75**



SANGAMO MICA CONDENSERS

F3L .0003 mfd 8000v list \$29 **\$3.75**
F3L .0015 mfd 8000v list **\$31 4.00**
F3L .002 mfd 8000v list **\$32 4.00**
F3L .005 mfd 8000v list **\$40 4.75**
F2L .001 mfd 6000v list **\$14 1.95**
Solar type SX .0015 mf 3000v list **\$9.95 .75**

Sangamo G-4 .004 mf 20 kv
(list \$110) **\$25.50**
Sangamo G-3 .006 mf, 10 kv
(list \$87.50) **\$19.50**



I-F Crystal filter for
BC-312, BC-342. Res-
onant at 470 kc.
Crystal
included **\$6.95**

NEW ARC-5 SUPERHET RECEIVERS.

Tubes (included) 3—12SK7; 1—12K8; 1—
12SR7; 1—12A6. Range (specify freq. de-
sired); 190-550 Kc; 1.5-3 mc; 3-6 mc; 6-9.1
mc. Power: 24-28 VDC. Remote control unit
and Dynamotor and tubes **\$25.50**

WHEN IN N. Y.
CITY — You're
welcome—
Browse around,
thousands of
different parts—
no obligation.

SERVICE MEN ATTENTION
Send for Philco Auto replacement parts list, also standard
resistors, condensers, and miscellaneous parts, etc.

All merchandise guaranteed. Mail orders promptly filled. All prices F.O.B. New York City.
Send Money Order or Check. Shipping charges sent C. O. D. Send for Flyers.

COMMUNICATIONS EQUIPMENT CO.

131-C LIBERTY ST., NEW YORK CITY 7, N. Y.
TELEPHONE WH 4-7658

SILVER BUTTON
MICA CONDENSERS
stud. mtg. (Erie/Cen-
tralab.) 175-180-185-
245 - 335 - 360 -
370 mmfd 400 vdc
each **\$.05**
lots of 100 **4.50**
lots of 1000 **37.50**
minimum order \$1.00



Guarantee
 All manuals sent on 10-day trial basis. You must be entirely satisfied or your money will be refunded.
The Radio Shack
 630 West Randolph St.
 Chicago 6, Ill.

"The Radio Shack" OFFERS SUPREME PUBLICATIONS DIAGRAM MANUALS

Most Popular Models Made by:
 R.C.A., Zenith, Philco, Sears, Fada, Emerson, Belmont, Detrola Radio, United Motors, G.E., Westinghouse, Arvin, Majestic, Stewart-Warner, Admiral, Delco, Stromberg-Carlson, Western Auto, Sparton, Motorola, Wards, Gamble, and many others.

- 1946
- 1942
- 1941
- 1940
- 1939

This large, new, and inexpensive diagram manual has the circuit for almost every 1946 radio set made since V-J day. Large manual, 8 1/2 x 11 inches, 192 pages of circuits and repair data.

Clearly printed circuits, alignment data, parts lists, service hints. Includes 351 models of 40 largest manufacturers. 192 fact packed pages. Large size, 8 1/2 x 11 in. Manual style binding. Well printed.

This volume covers 1941 models, with alignment data, I.F. peaks, and replacement parts lists. Compiled by M. N. Beitman, radio serviceman for many years, author, and teacher. Be an expert in radio servicing; simplify your work. 192 pages 8 1/2 x 11 inches.

Let this important manual give you over 80% of all 1940 circuits you will ever need, acquaint you with new developments. Data on portables, recorders, FM, etc. 417 models of 43 manufacturers. 208 pages.

Circuit data, hints and information are time-savers and money-makers for you. Let these diagram manuals guide you to easier service work. Use this volume with 192 pages of diagrams of 39 makes.

1926-1938

The most popular volume of the series. Will pay for itself with the time saved during the first day of use. Includes all the popular old timers. Save hours on every job. 427 diagrams of the most serviced radios of this period, with parts lists and alignment information. 240 pages, 8 1/2 x 11 inches. Sold with a money back guarantee. Price, postpaid, **\$2.50**

PRICED AT ONLY \$2 EACH
 Send your order today!
 Save hours on every job

The Radio Shack Inc.
 630 W. RANDOLPH STREET CHICAGO 6, ILL.

Other Practical Radio Manuals



RADIO SERVICING COURSE-BOOK

Let this complete 22-lesson radio course help you get ahead in radio servicing. Learn new speed-tricks of radio fault finding, case histories of common troubles, servicing short-cuts, extra profit ideas. Servicemen use this low-price radio training to brush-up and study new servicing methods. Reprinted in 1946, with latest facts. Complete 22 lessons, with self testing questions, index. Large size: 8 1/2 x 11 in. **\$2.50**
 A bargain in radio training. Price only

SIMPLIFIED RADIO SERVICING BY COMPARISON



New, revolutionary different Comparison technique permits you to do expert work on all radio sets. Most repairs can be made without test equipment or with only a simple meter. Many point-to-point, cross-reference circuit suggestions locate faults instantly. Covers every radio set—new and old. This new servicing method presented in manual form, size 8 1/2 x 11 inches, 84 pages. Over 1,000 practical hints. 24 large trouble-shooting blue-prints. Charts for circuit analysis. 114 tests using a 5c resistor. Price, only **\$1.50**

- ★ ★ STEWART-WARNER MANUAL . . . 50c
 - ★ ★ ARVIN DIAGRAM MANUAL . . . 50c
 - ★ ★ GENERAL-ELECTRIC MANUAL . . . 50c
- 64 pages of popular circuits. Size: 5 1/2 x 8 1/2 inches

RECORD PLAYERS & RECORDERS MANUAL
 Just what you need to repair quickly thousands of automatic record changers, manual players, phono pick-ups, wireless oscillators, recorders and combinations. Hundreds of mechanical and electrical diagrams. Instructions for adjustment and repair. Most popular units of all makes, 128 large pages, 8 1/2 x 11 in. Price, postpaid, only **\$1.50**

FREE! Ask for our new catalog. Write today!

RADIO-CRAFT for DECEMBER, 1946



NO RISK TRIAL ORDER COUPON

THE RADIO SHACK, 630 West Randolph Street, Chicago 6, Illinois
 Ship the following manuals: (Satisfaction guaranteed or money back)

- | | | |
|---|-----------------------------------|--|
| <input type="checkbox"/> 1946 | PRICED AT ONLY \$2.00 EACH | <input type="checkbox"/> Radio Servicing Course @ \$2.50 |
| <input type="checkbox"/> 1942 | | <input type="checkbox"/> Simplified Radio Servicing @ 1.50 |
| <input type="checkbox"/> 1941 | | <input type="checkbox"/> Stewart-Warner Manual @ .50 |
| <input type="checkbox"/> 1940 | | <input type="checkbox"/> Arvin Diagram Manual @ .50 |
| <input type="checkbox"/> 1939 | | <input type="checkbox"/> General-Electric Manual @ .50 |
| <input type="checkbox"/> 1926-1938 @ \$2.50 | | <input type="checkbox"/> Record Players and Recorders 1.50 |
- I am enclosing \$..... send postpaid.
 Send C.O.D. I am enclosing \$..... deposit.

Name:
 Address:

SILVER

"VOMAX"

Top Ranking Choice

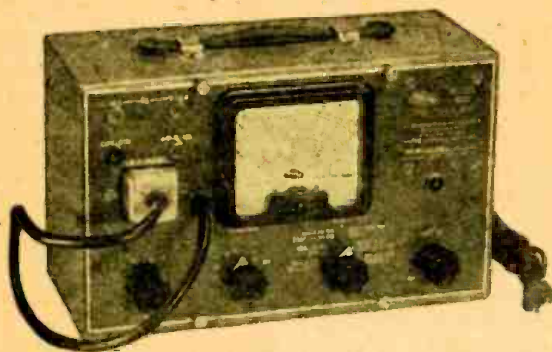

Thousands upon thousands of "VOMAX", the truly universal vacuum-tube volt-ohm-milliammeter In service today in ranking laboratories ranging from the U. S. Bureau of Standards on through the roster of radio's elect bought by Veterans Administration and other school training programs consistently selected by America's top-profit service organizations conclusively prove it is the best. "VOMAX" is also the cheapest not only because the best is always cheapest in the long run but in first cost, too! Increasing production in response to increasing demand enables us despite continually increasing material costs to hold its price down.

"VOMAX" alone gives you the profit-priceless ability to measure every voltage in radio servicing of meter resistance so astronomically high it does not upset measured circuits 24 d.c. voltage ranges 0 through 3000 volts at 51 and 126 megohms input resistance 6 ranges 0-1200 volts a.c., a.f., i.f., r.f. to over 100 megacycles at 6.6 megohms honest input resistance decibels from -10 through +50 resistance from .2 ohms through 2,000 megohms direct current from 50 microamperes through 12 amperes. No other instrument at any price gives you all that "VOMAX" does. Its value is unequalled it's the standard of comparison the overwhelming choice of those "in the know" is radio's outstanding buy at only \$59.85.

"SPARX" DYNAMIC SIGNAL TRACER

Next to the universal volt-ohm-milliammeter "VOMAX" is the ideal universal d.c. through u.h.f. meter what the radio service profession most needs is a good dynamic signal tracer. Ability to trace the signal through every successive receiver circuit reduces "trouble-shooting" to basic fundamentals banishes forever the hard-to-service "toughies" turns loss jobs into quick profits. Designed by radio's only International Grand Prize winner, "SPARX" is the aural-visual signal tracer you have been clamoring for. Not only does "SPARX" trace r.f., i.f., a.f. signals from 20 cycles to over 200 megacycles it is your shop test-speaker as well. It also tests microphones, phono pickups, P.A. amplifiers, speakers registers presence or absence of d.c. and a.c. operating voltages, too. With new radar crystal diode probe, 3-stage 65 db. gain a.f. amplifier, ground-insulating transformer power supply and PM dynamic speaker, it's the instrument you've dreamed of like all SILVER instruments will earn its cost in no time at all. Yet "SPARX" costs you only \$39.90.



"904" LABORATORY CAPACITANCE RESISTANCE BRIDGE

Not only does Model 904 C-R Bridge cover the tremendous range of $\frac{1}{4}$ mmfd./ohm up through 1000 mfd./megohms give you truly laboratory accuracy in measurement of capacitors and resistors provide 0-500 volts continuously variable built-in d.c. polarizing voltage for electrolytic and other capacitors give power factors measurement 0-50% but it brings something quite new to radio measurements. With Model 904 C-R Bridge you can at last measure capacitance of any type of condenser air, paper, oil, electrolytic, ceramic with d.c. operating voltage applied during measurement! Think what this means in increasing your efficiency in finding those "Intermittents" which cause so much trouble in speeding your work and increasing your profits. Measuring capacitors and resistors to $\pm 3\%$ laboratory accuracy matching "VOMAX" and "SPARX" in size, post-war style, top quality components and construction it's the same amazing bargain at only \$49.90 net as "VOMAX" value which has forced 500% expansion in our plant facilities in less than one year.

And

See these "must" instruments and new SILVER amateur transmitters, receivers, kits, parts which were sensations at the 1946 Trade Show at your favorite jobber. Act fast demand continues far in excess of supply for SILVER products are the profit tools used by your smart competitors. Send postcard for new post-war catalog.

SEND FOR FREE CATALOG of what's
new in post war Receivers, Transmitters,
factory built, or Kits and Parts

OVER 35 YEARS OF RADIO ENGINEERING ACHIEVEMENT

McMurdo Silver Co., Inc.

1249 MAIN STREET • HARTFORD 3 • CONNECTICUT

SERVICEMEN—WAKE UP!

Seven Suggestions for Successful Servicing

Editor RADIO-CRAFT:

I HAVE READ in your recent publication how unfair the manufacturers and distributors of radio sets have been to the returning service men, also your editorial on this subject.

As an old hand at this game (started in 1916, and have made a living out of it all these years) I notice that almost every one is complaining about not being able to get new sets. Question: Why does a radio man want to sell sets?

My experience is that the biggest job in the radio business is to sell himself, have an up-to-date repair bench and keep up with the new sets and circuits so that he can give the customer a repair job that looks as if it came out of the factory.

It really looks as if the drug and hardware stores are taking over the selling end of the business. Just the other day I talked to a distributor of a well-known radio and he admitted that *he would rather sell to a filling station than to a radio service shop.*

The only way out for most of us in the radio business is to better ourselves in the repairing end, so that when that new set that we couldn't sell goes dead, they will bring it into our shop for a good repair job.

Don't get me wrong, from 1916 to 1930 I was with a large manufacturer making radio sets.

Ray Charleston

1124 New York Ave.

St. Cloud, Florida

We are glad to print Mr. Charleston's letter in full. It is a representative sample of similar ones which have reached us from time to time, ever since we voiced our views of the servicing business in our May, 1946 issue.

But let us also hasten to state here that we have noticed a great deal of improvement in the business methods of the servicing industry as a whole. We constantly see this in the improved tone of the thousands of letters that reach us. Yes, the scribbled, penciled letters are distinctly on the way out—the neat business-like letters on good quality letterheads are in the ascendancy. And letters written with battered old typewriters and moth-eaten ribbons are rare nowadays.

This brings us back to our correspondent's letter. Let us now analyze why radio set manufacturers "would rather sell to a filling station than to a radio service shop."

To begin with, like so many other glib statements, this one too must be taken with a large pinch of salt. It is only partly true—less than one half, to be exact. We made it our business to contact a number of set manu-

facturers and ascertained that practically all of them do sell to radio service shops, and *they sell an increasing amount of their product to them.* But they also admit that they are choosy—they sell only to those service shops who have a reputation and who are known for their integrity. It is as simple as that. Yes, they don't even sell "for cash on the line" to shops who have no standing in their community. The manufacturers emphatically state that they don't single out any particular trade, whether it be radio service shops, filling stations, drug stores, or general stores—the same principle prevails: *deserving* stores get the agency. All this seems elementary, but is often lost sight of.

How does a newcomer fare in this set-up? Unless he can show a good cash balance in the bank, he is out in the cold. It is true that very many manufacturers gave returned service men a raw deal and often gave them the proverbial run-around. But we believe this too is more or less a temporary situation.

Said one manufacturer to us: "What would you do in a like situation? Here we have thousands of applications from ex-servicemen, for agencies for our product. We don't know these men, know nothing of their ability, integrity, experience, or their knowledge of the trade. How do we know they will succeed? Why should we put them in competition against our old established customers in the same town, who made money for us for years? Yes, we *do* want to help the ex-servicemen, but they must first prove themselves."

Is all this cynical and heartless? It is. It's the old story of trade following along established lines—newcomers must show their ability to survive first. That's the kind of world in which we live.

As for the question: "Why does a radio serviceman want to sell sets," we think there are some good answers to this. A shop may start out as a 100 percent service establishment and remain that way for years. The business may grow, however, and, depending on the location, the customers may insist on getting new sets from the shop they trust and believe in. Against their best convictions, many shops have found it necessary to change their methods. It happens all the time. Progressiveness of the owner also counts. Look around your town and note how many little stores in various trades started on a shoe-string while today they own large establishments. Frequently they did it in a few short years too.

But you may be sure of two things: They gave Service with a capital "S" and they were business men who knew their trade backward and forward.

It is just not enough to know radio. You must know how to merchandise. In other (Continued on page 40)

"THE VOICE OF AMERICA," a super-power shortwave broadcast station, was advocated by General David Sarnoff, president of the Radio Corporation of America, on the occasion of Princeton University's bicentennial celebration.

Such a station, said General Sarnoff, might cost \$20,000,000 a year, which is less than that spent by large European powers, notably Great Britain and the U.S.S.R.

According to the plan, radio companies would co-operate to make the station a success. "Only the government," said General Sarnoff, "can make known to the world the nation's foreign policy, or provide the financial means commensurate with the task. On the other hand, private industry is needed to lend its initiative, ingenuity and experience to make this exposition effective."

The station, he suggested, would also be the agency to establish direct relationships with the other international broadcasting organizations of the world, and would thus provide facilities for interchange of programs from different countries, to be relayed and broadcast through local-station tie-ins.

SUICIDE PLANES guided by radar instead of a locked-in aviator were demonstrated by the Navy last month.

The Bat, latest naval guided missile, is no longer an experiment. It is ready for active combat use. It is now standard equipment. Navy officials are confident that it will give a good account of itself, if another war is fought.

With a ten-foot wingspread and a body length of about 16 feet, the Bat looks like a small airplane without engine or propeller. Radar equipment in its nose keeps the missile, after its release from its mother-plane, headed directly on the target, which may be an enemy ship or land installation. The Bat's radar equipment is focussed on the target before its release. An operator on the mother-plane spots the enemy by radar if necessary.

The mother-plane carries the Bat under its belly or under its wings. The release is made from four to seven miles away, and preferably from an altitude from several thousand to 12,000 feet. The Bat then sweeps downward and forward in a long glide to approach its prey at a low angle. Once the Bat is launched, the mother-plane flies off to safety.

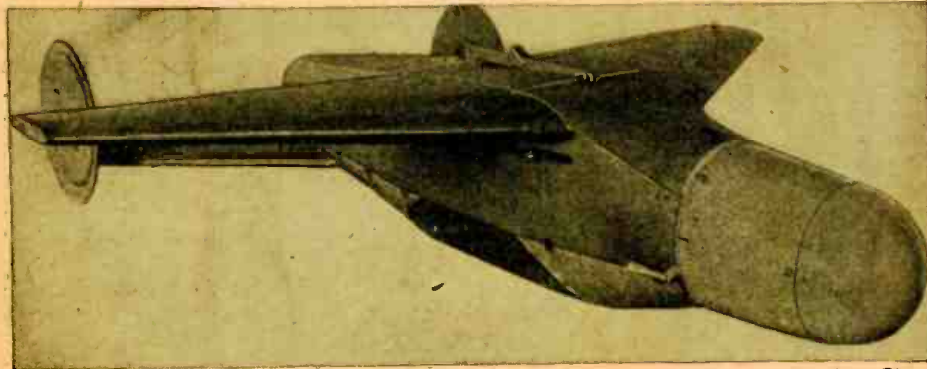

The radar mechanism by which the Bat is guided is concealed in the blunt nose of the glider.

RADIO-ELECTRONICS

Items Interesting

RADARANGE, latest peacetime application of war-developed techniques, made its debut at a demonstration in New York last month. Electronic hot dogs, cooked in ten seconds, hamburgers, and even gingerbread were served to the press representatives present.

Automatic timing made burning the food impossible. Each item, wrapped in paper or (as in the case of the gingerbread batter) in a paper cup, was inserted in a little metal-grill box and slipped into place under the "burner,"

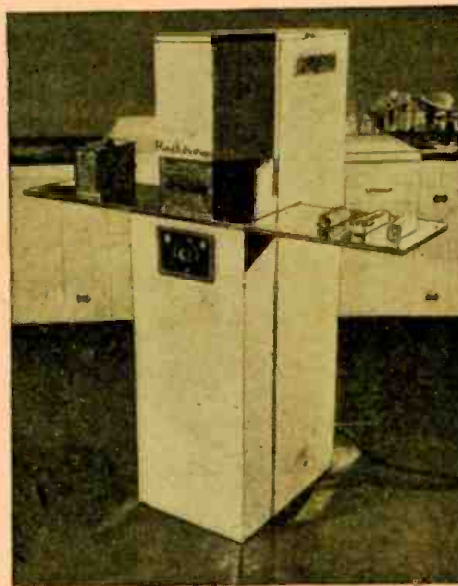

Courtesy Raytheon Mfg. Corp.

The Radarange, as designed for airplane use.

closing a switch as it was put in place. Ten seconds later (or at a time preset for the object being cooked) the switch snapped open automatically and the food was ready to eat.

The name *Radarange* is justified not only because of the magnetron tube which generates the high-frequency heat but by the system of propagating the microwaves. Instead of being placed between two plates of a condenser, as in some older forms of electronic food-

cooking devices, the object to be cooked is placed on a metal plate (bottom of the box) at the mouth of a horn-shaped radiator. Waves come down the horn, go through the food, and are reflected back into the horn again. The cycle is repeated over and over, the waves passing through the food in both directions till their energy is spent in heating the edibles.

The unit weighs about 100 pounds and requires 5 kilowatts of power. The tube is a water-cooled magnetron. While the model demonstrated was intended for use on airlines, a modified design, suitable for use on railroads, ships or other commercial installations, was also on display.

BROADCAST STATION 1,000 was licensed by the FCC on September 25. The license was granted to the Indian River Broadcasting Co. for Radio WIRA, to be operated on 1400 kc at Ft. Pierce, Florida.

The thousandth license drew a special salute from FCC chairman Charles Denny, who, commenting on the rapidly increasing number of broadcast stations, said in part:

"These stations have great opportunities to provide the means for local expression and to stimulate local participation in the solution of the difficult community, national and international problems in this transition era.

"Every additional radio station provides the American people with a new instrument for vitalizing our democracy and for access to wholesome entertainment and education."

BROADCASTING ABUSES were scored by William S. Paley, head of the Columbia Broadcasting System, speaking before the National Association of Broadcasters at their recent convention. Asserting that the industry had been guilty of advertising excesses, he called for a new code of program standards by which the business could discipline itself and meet "a growing volume of criticism of American broadcasting."

In his address, which was entitled "Radio and Its Critics," Mr. Paley defended professional criticism in newspapers and magazines as a desirable stimulus to better programing.

Charles Denny, acting chairman of the Federal Communications Commission, also affirmed that the FCC would continue its much-assailed plan to assure a better balance between advertising and non-advertising matter on the air. He charged that the N.A.B. was raising a "red herring" by contending that the FCC's new rules on program balance might jeopardize freedom of speech.

MONTHLY REVIEW

to the Technician

ELECTRONIC READING MACHINES with the aid of which blind persons can read ordinary print were demonstrated last month by Vladimir K. Zworykin, RCA's director of electronic research.

To read with the electronic device, the blind person scans the printed or typewritten page with a stylus that looks like a large black fountain pen. A small beam of light in the "point" of the stylus moves up and down on each letter, reflecting to a phototube that operates an amplifier tube.

A combination of five different sounds is produced for each letter as the stylus moves over the printed matter. The reader hears the sounds through a hearing-aid-like ear attachment. Total weight of the electronic unit is only five and one-quarter pounds.

Work is now under way on an instrument using the same principles to form the actual sound of each letter. This would spell out each word for the blind person as he scanned print with the stylus.

Flashing the beam of light vertically up and down each letter, the stylus reflects the black area of the letter as distinguished from the white page. A frequency-modulated audio oscillator uses the reflected light from the printed letter to produce high-frequency "pips" at the top of the letter and low-frequency ones for the bottom. These create the blind reader's sound picture of the letter.

The electronic reading aid requires the reader to learn a code of sounds for each letter. Blind persons in several laboratories are now being taught the new system experimentally, Dr. Zworykin reported, adding that the device is not yet being produced commercially.

STRATOSPHERE ROCKETS are tracked throughout their flight by radio, no matter how fast or how far they go, it was disclosed at the Army Ordnance Society's field day held at Aberdeen, Maryland, last month.

The method is more convenient and sure than radar for test rockets in which a radio transmitter can be installed. As the rocket is launched, a very-high-frequency station starts sending waves of 38.5 mc frequency. These are picked up by the radio set carried in the rocket and rebroadcast at double frequency (70 mc).

The returning waves are set "off beat" by the rocket's increasing distance from the starting point in what physicists know as the Doppler effect. By measuring this, observers can tell where their giant missile is, to as close as six feet.

HIGHEST TELEVISION ANTENNA, atop the Empire State Building in New York City, has been redesigned. The photo released last month by the National Broadcasting Company was



The Empire State Building has a new antenna.

made just before construction was finished and shows all the features of the new skypiece.

The television antenna is a four-stack turnstile, with sixteen elements designed for broad-band picture transmission. This antenna delivers from the WNBT transmitter the maximum power authorized by the FCC for metropolitan television stations. It is equivalent to 50 kw at an antenna height of 500 feet. Because of the 1300-foot elevation and the power gain of the antenna itself, the maximum authorized power for the actual transmitter is approximately 2.5 kw.

Immediately above the four turnstile elements are two triangular arrays, one above the other. These antennas transmit the programs of WNBC - FM. At the very top of the

structure a third group of elements constitutes a two-stack turnstile built in the RCA Laboratories to test wide-band television on 288 mc. The tests were immediately commenced with a 5000-watt transmitter developed and built for the purpose.

In all, four separate transmitters feed four sets of signals into antennas mounted on this 62-foot structure which surmounts the highest building in the world. Television receiver owners within a range of about 70 miles have reported excellent reception of programs put on the air at this point.

A SUPER TUBE-CHECKER, the size of an average small service shop, has just been completed, General Electric announced last month. The giant tube tester will simulate actual operating conditions for all the larger tubes under most transmitting and industrial applications.

Believed to be the first and only set of its type in existence, the new tester now under construction—about the size of a giant 100-kw transmitter—is expected to facilitate the development and design of new and improved tubes for FM, television and microwave equipment in addition to industrial tube types.

New circuits can be simply designed to test all tubes up to a rating of 500 kilowatts (the largest transmitting tube now in general use is rated at 100 kilowatts) thus assuring accurate performance ratings before tubes are shipped to customers.

Another test device of the same concern is a "tube icebox" capable of testing tubes from 100 degrees below to 175 degrees above zero Fahrenheit. The purpose is to simulate conditions at high altitudes.



The operator works inside this new transmitting-tube checker.

SUPERSONIC APPLICATIONS

"Inaudible Sound" Is Making Rapid Progress in Industry

TWO types of sounds can be generated by electro-mechanical means: those which can be heard by the human ear and those above the audible range. Inaudible sounds are known as ultrasonics or supersonics. Audible sounds have a frequency range of 10 to about 15,000 cycles per second. In general, the upper frequency limit is lowered as a person's age increases, so that high-frequency sounds become inaudible to older people.¹ The range of supersonics is from 15,000 to at least 100,000 cycles per second, and they cannot be detected by the human ear.

To detect the presence of sounds in that frequency range, the mechanical

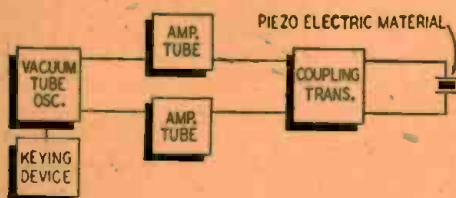

Fig. 1—One way of exciting transducer.

sound energy must be converted into electrical energy. Conversely supersonic energy is generated by converting electrical energy into mechanical sound energy.

Two methods of generating supersonics are common. The first uses piezo-electric properties of crystals; the other

depends upon the magnetostrictive properties of certain metals. Both convert electrical to mechanical energy and vice versa. When a strain is produced in a piezo-electric material², an electromotive force is induced and a voltage appears between any two surfaces of the material. Conversely, when a voltage is impressed upon two surfaces of a piezo-electric material, a stress appears. These effects have been observed in quartz, tourmaline, and Rochelle salt crystals. If an alternating voltage of super-sonic frequency is impressed upon one of these crystals, the vibration set up by it will result in a super-sonic wave. Magnetostrictive materials are nickel, monel metal, stainless steel and invar.³ If a rod of any of these materials is placed in a coil of wire carrying current, magnetization will cause it to increase or decrease in length. Conversely, as in the case of the crystal, a change in the length of the rod will result in a current being induced in the coil of wire surrounding the rod.

Photo A shows a magnetostriction oscillator or transducer pack being used in an underwater sound depth finder.

ELECTRONIC EXCITATION

Electron tubes are used to excite crystal transducers. A typical arrangement consists of a vacuum tube oscillator—whose frequency is fixed and determined

by the circuit constants—and vacuum tube amplifiers to increase the strength of the signal. The frequency of the oscillator is made to lie between 15,000 and 100,000 cycles per second depending on the use to which the energy is to be put. For underwater sound applications the frequencies used are between 15,000 and 25,000 cycles.

The outgoing signal waveshape can be compared to an ICW signal. The vacuum tube amplifiers are usually transformer-coupled to the crystal. Fig. 1 shows such a system.

In exciting the magnetostrictive type of super-sonic transducer, two methods are in use.⁴ The first is essentially the same as the system shown in Fig. 1. A more popular system used with magnetostriction transducers is the *condenser discharge* method of excitation. This is shown in Fig. 2 and Photo B.

The condenser C1 is allowed to charge fully through the resistance R1 and through the winding of the magnetostriction transducer. As soon as C1 is fully charged, the keying relay closes. Condenser C1 is immediately discharged through the generator winding and the rod vibrates at a frequency dependent upon its physical dimensions. These are made so the frequency will be in the super-sonic range. The oscillation is of the nature of a damped wave having an *exponential* decay.

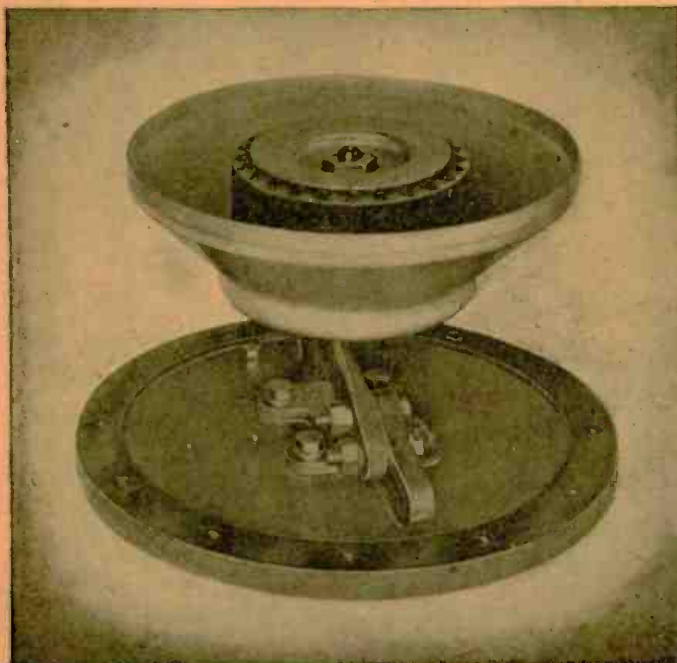

Photo A—Magnetostriction transducer used in underwater equipment.

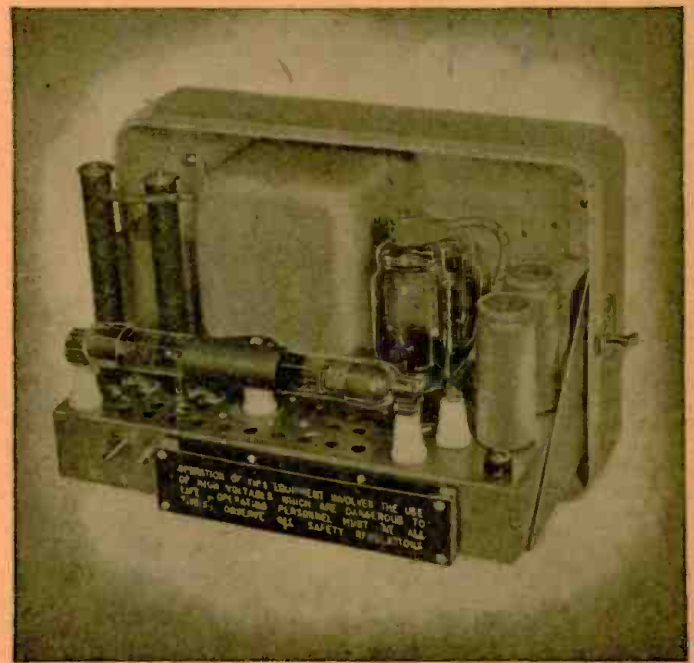

Photo B—A condenser-discharge type of supersonic signal generator.

At one time keying relays consisted simply of a pair of silver contacts. Since then an electronic keying relay having a much longer life and greater efficiency than the contacts has been developed. This electronic relay uses the strobtron tube and its associated circuits.

APPLICATION TO DEPTH FINDING

Supersonics, like audible sounds, are reflected or refracted when they meet a medium of different density than the

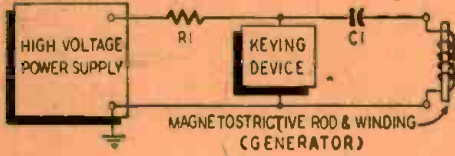

Fig. 2—Another transducer-excitation system.

one in which they are being conducted. This property of sound waves has made possible their extensive use in detecting objects in a sound-conducting medium. The largest application of super-sonic waves is in the field of underwater sound. Equipment to measure the absolute depth of water beneath the keel of a ship has been extremely useful and almost essential, in some cases, to navigation. A typical depth finding equipment is shown in Fig. 3. It consists

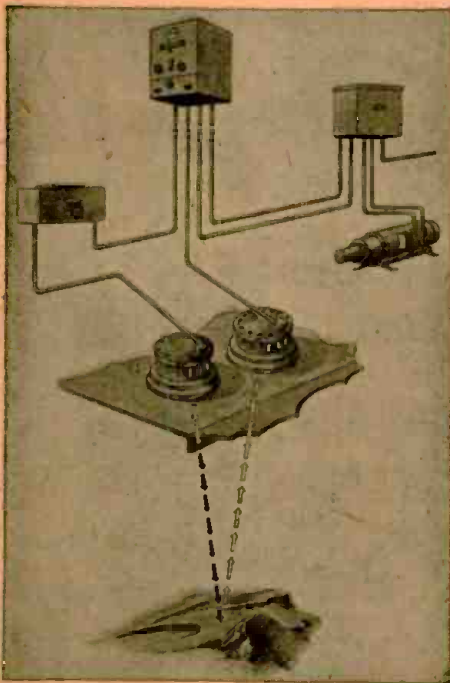

Fig. 3—Equipment of standard echo sounder.

of two magnetostriction oscillator packs, one for receiving and one for transmitting, and the associated equipment needed to generate and detect the super-sonic waves. The signal is generated by a condenser-discharge apparatus and has a frequency of about 20,000 cycles per second. The receiving oscillator pack is connected to the input of a high-gain vacuum tube amplifier which is tuned to the frequency of the outgoing signal. The depth of the water is read directly on a calibrated rotating disc located in the indicator. Since the velocity of sound in water is known to be approximately 4,800 feet per second, the depth can be most easily found by the equation

$$S = \frac{v \times t}{2} \quad (\text{Equation 1})$$

where S is the distance from the hull of the ship to the bed of the ocean, v is the velocity of propagation and t is the time required for the super-sonic signal to travel from the transmitter to the reflecting surface and back to the receiver. The velocity is dependent upon such factors as temperature, pressure and salinity, and for very accurate soundings these must be known. Equation (1) reduces to $S = 2,400 \times t$ in water. Therefore the depth is determined by multiplying a constant by the time in seconds. Photo C is a depth indicator using a fixed light source to illuminate a rotating calibrated disc. The light source consists of a strobtron tube whose light discharge is very intense and whose light duration is in the order of a few microseconds. The rotating disc is driven by a synchronous motor at a known constant speed. If the disc were travelling at an angular speed of 48 revolutions per second and the velocity of sound in water assumed to be 4,800 feet per second, then one revolution of the disc would represent 100 feet of sound travel in water, or 50 feet of actual depth. In this manner, the disc can be calibrated around its periphery from zero to the maximum depth to be measured. (See "The Sonicator" in RADIO-CRAFT, August, 1946.) If the signal is sent out at the moment the zero figure passes the indicator window and the returning echo is made to operate the light source upon its arrival, the figure that is illuminated on the disc will measure the depth of the water. A fixed scale and moving light source (Photo D) can also be used to indicate depth. Both systems work equally well.

Other Applications

Supersonic equipment played a major role in submarine warfare during World War II. It has been responsible for the detection of enemy submarines and underwater objects, making possible the accurate dropping of depth charges. Naval underwater sound, known as sonar, is quite similar to the depth indicating system already described except that the super-sonic signal is directed in a horizontal plane rather than toward the sea bed.

Supersonics has also found application in the field of metal inspection

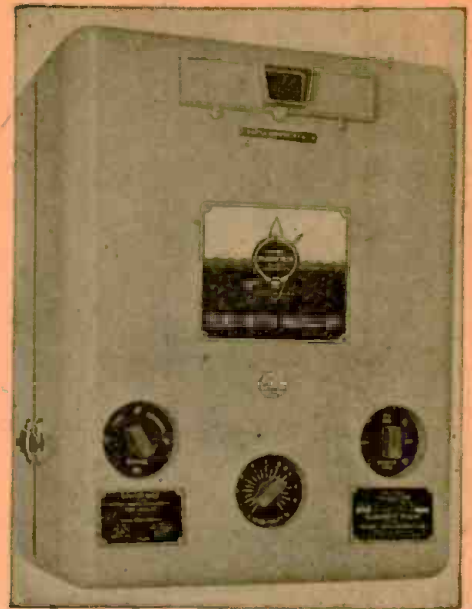

Photo C—A depth indicator with moving scale.

for flaws.⁸ A method has been devised whereby super-sonic detectors may, in certain instances, replace costly and

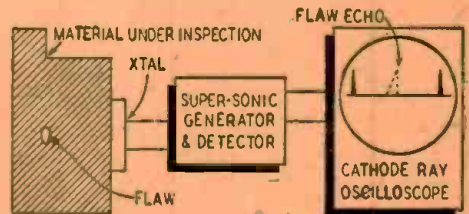

Fig. 4—Supersonic casting inspection hookup.

large X-ray equipment to inspect objects such as steel castings for imperfections. (Continued on page 67)

Photos courtesy Bidwarth Marine

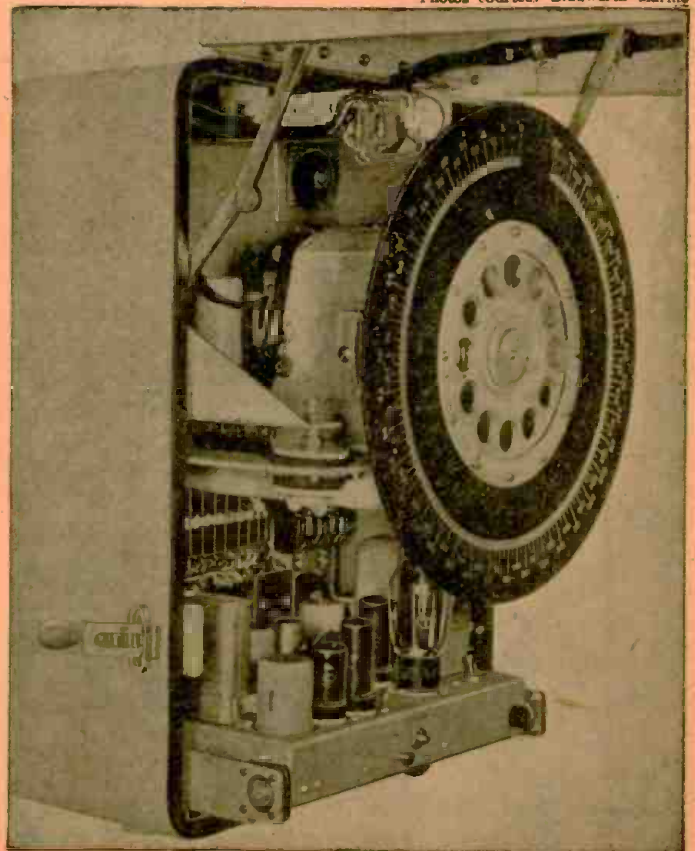

Photo D—This type of indicator has a fixed scale and moving light.

FOR THE
FIRST TIME
IN ANY
RADIO
PUBLICATION

THE CINEMATIC ANALYZER

New French Instrument Shoots Trouble and Measures Both Gain and Frequency at Signal-Tracer Speed

THE new method that we are happy to explain here for the first time in the American radio press, was devised to permit the receiver repair technician to work *faster and better*. Compared with existing methods—including signal tracing—it is distinguished by the precision and rapidity of the measures effected. Having an unparalleled flexibility, it is applicable to all the operations of repair, alignment and analysis of the essential characteristics of radio receivers. It offers the following advantages:

1. Visualization of the signal in all stages of the receiver.
2. Simultaneous readings of the signal's frequency and amplitude.
3. Study of the receiver's actual functioning.
4. Possibility of calculating the effective gain of each stage.
5. Alignment according to resonance curves.

This new method requires only one

piece of apparatus, the cinematic analyzer. It is composed of two parts, the amplifier-modulator and the cathode-ray oscilloscope.

The analyzer may also be used as a panoramic receiver. It then permits visualization of all transmissions "on the air" at a given moment over a band of 100 kc in any part of the spectrum, showing the relative intensities of the signals, fluctuations caused by fading and their exact frequencies.

THE INDUCTION WOBBLER

In introducing the cinematic analyzer, a brief description of one of its essential elements should be given. This is the Bernhardt induction-varying device. It is an electromagnetic vibrator, the reed of which supports at its end a short-circuited turn (Fig. 1). This turn moves in the field of a coil which forms part of the oscillator tuned circuit.

The currents induced in the single turn re-induce currents in the coil, thereby modifying its self-induction. This modification

occurs at the vibration frequency of the ring. By so varying the inductance of the winding, the frequency of which it forms a part is also varied. Thus we obtain true frequency modulation, without the use of electronic methods. (It is of course understood that the mechanical vibrator in the cinematic analyzer may be replaced by an ordinary reactance tube and circuit.)

ANALYZER ANALYZED

The analyzer is composed of the following elements (Fig. 2):

- a. Wide-band amplifier tuned to 460 kc.
- b. Converter stage in which the signals from the amplifier are mixed with those from the oscillator.
- c. Oscillator tuned to 877 kc, frequency-modulated over a range of plus and minus 50 kc by the mechanical frequency wobbler described above.
- d. Highly-selective amplifier, tuned to the converter's intermediate frequency of 417 kc ($877-460=417$).
- e. Cathode-ray tube with its own power pack and the usual brightness, focussing and vertical and horizontal positioning controls.

The output of the last amplifier is applied to the vertical deflection plates of the cathode-ray tube. Its sweep is effected by a 60-cycle voltage synchronized with that which determines the modulation frequency of the oscillator.

Besides these elements, which compose the analyzer proper, the apparatus includes, before the input of the 460-kc amplifier, all the high-frequency portion of an ordinary receiver (r.f. tuning section, converter stage and i.f. transformer tuned to 460 kc). This section, represented within the dotted lines in Fig 2, serves to receive radio signals which are subsequently visualized on the cathode-ray tube screen (panoramic reception).

OPERATING PRINCIPLES

Let us apply a 460-kc signal to the input marked R.F. The 877-kc oscillator with its ± 50 -kc modulation, produces a beat frequency of 417 kc, always modulated by ± 50 kc. In other words, we obtain a variable frequency, which twice in each 1/60-second period of modulation, passes through the mean value of 417 kc to which the following selective amplifier is tuned.

As the signal passes 417 kc each time, it enters the selective amplifier, is there amplified and causes a vertical elongation of the spot on the cathode-ray tube screen. This elongation occurs always at the instant the spot—in the

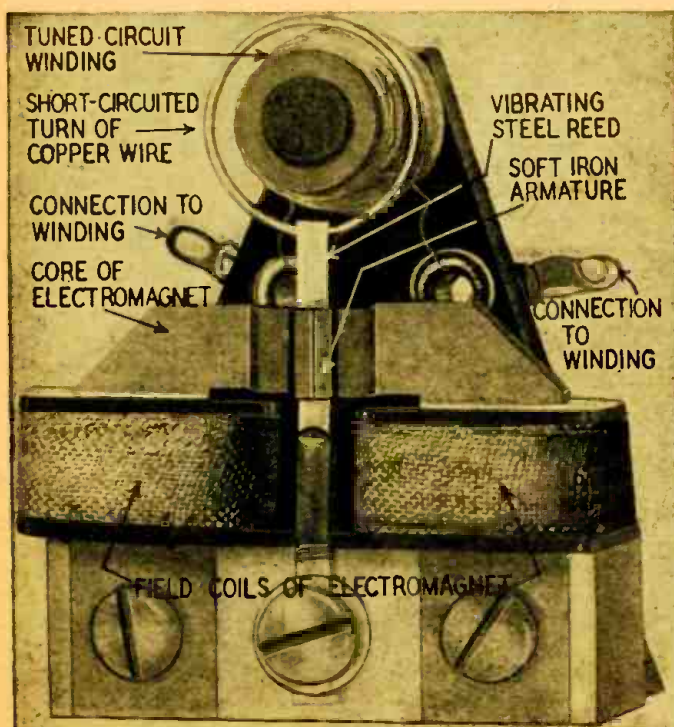

The heart of the instrument is this mechanical frequency modulator.

Photo A shows the device. Note that the vibrating reed moves between the pole-pieces of the electro-magnet without touching them. The electro-magnet is excited by 60-cycle a.c.,

course of its horizontal sweep—finds itself at the center of the screen. In effect, the analyzer must be rigidly calibrated once for all so that the image is centered when a frequency of 460 kc is applied to the input R.F. The figure traced out by the spot is shown at A in Fig. 3. Its envelope represents the resonance curve of the 417-kc amplifier, symmetrically folded over the screen's horizontal axis.

(In the practical cinematic analyzer, the signals are detected by a diode before being applied to the screen, so the image appears only *above* the horizontal diameter and traces only the outline of the curve.)

Now, instead of 460 kc, let us apply at the input marked R.F. a frequency of 410 kc. This produces an i.f. of 417 kc only at the instants when the oscillator reaches the lower limits of its modulation, equal to $877-50=827$ kc ($827-410=417$ kc). Elongation of the

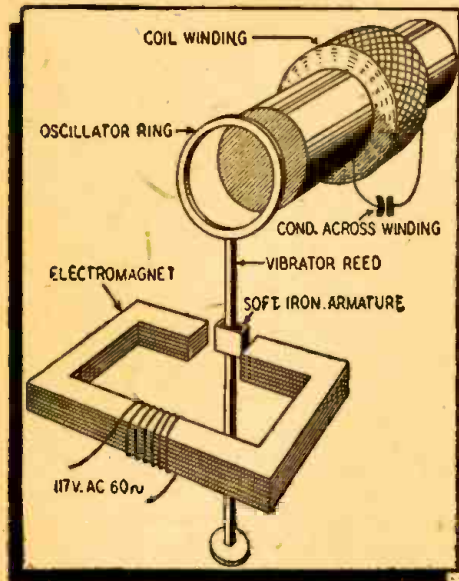

Fig. 1—Components of frequency wobbler.

spot therefore occurs at B in Fig. 3, that is, at the extreme left end of the horizontal sweep.

Equally, if a frequency of 510 kc is applied at R.F., the intermediate frequency of 417 kc is obtained only at the instants when the oscillator passes through its highest frequency, 927 kc. The resulting image, displaced in time over one-half cycle of the modulation, appears at C (Fig. 3).

Thus, for every frequency between 410 and 510 kc, an image will be produced which will occupy a position on the screen between B and C. The horizontal axis of the tube may therefore be calibrated in frequency; and the analyzer itself becomes a frequency meter.

The band of frequencies from 410 to 510 kc was chosen because it contains all the values to which superheterodyne i.f.'s are ordinarily tuned. Upon applying the intermediate frequency of a receiver to the input one may read its frequency immediately. At the same time, the height of the image indicates the amplitude of the signal. Thus the apparatus serves equally as a voltmeter of high sensitivity.

It is this double role of *frequency meter-voltmeter* which is put to profitable use in the innumerable applications of the cinematic method, of which the following are among the most characteristic:

PANORAMIC RECEPTION

The receiver which forms a part of the analyzer has a very broadly-tuned input circuit. For the rest, it converts the frequency of stations received to the i.f. of 460 kc.

Connecting an antenna and ground to our receiver, we get a 460-kc signal at the analyzer input whenever the receiver is tuned to a station. This gives us, consequently, an image A at the center of the screen.

At the same time, the input also admits signals on neighboring wavelengths. Suppose, for example, the receiver is tuned to 10,000 kc (30 meters). The local oscillator is therefore tuned to 9,540 kc, giving an i.f. of 460 kc. But if the antenna intercepts a signal of 10,025 kc, this signal also reaches the converter, and superimposed on the 9540 kc of the oscillator, produces a beat frequency of $10,025-9,540=485$ kc.

This new frequency causes an image to appear between A and C on the cathode-ray tube screen. It is displaced 25 kc with regard to 460 kc, just as the original signal frequency is displaced 25 kc with regard to the frequency to which the receiver is tuned.

Obviously, all transmissions removed less than 50 kc from the tuned frequency of the receiver will appear as images along the horizontal axis of the screen. Their position along this axis depends on the frequency. The height of these images depends in part on the original signal strength and in part on the attenuation caused by the input circuit (on off-tune signals).

Panoramic reception may also be obtained without the "receiver" section of the analyzer. It is necessary only to connect the input R.F. to the plate of the converter tube of any superheterodyne to get the same result.

STUDY OF RECEIVER R.F. SECTION

To study that part of a receiver between the antenna and the i.f. input, connect it in place of the analyzer's "receiver." The converter plate is simply connected to the input (R.F.) of the analyzer, as indicated in Fig. 4. By tuning the receiver to a signal, either from a broadcast station or a signal generator, we should see an image appear at A. Its absence proves the existence of a defect in the r.f. end of the receiver.

By applying a signal directly to the converter grid, the input r.f. circuits are eliminated. If the image appears, the input circuit is at fault. If not, the oscillator must be blamed.

A signal at the desired alignment frequency (say 1400 kc) is applied to

the aerial and ground posts and the pointer set at that frequency on the dial of the receiver. If the image obtained does not appear at the point on the screen corresponding to the i.f. of the receiver, the appropriate element of the oscillator circuit is adjusted (trimmer for the high end of a band, padder or magnetic core for the low-frequency end) till the image is moved to the correct place. The r.f. input circuits

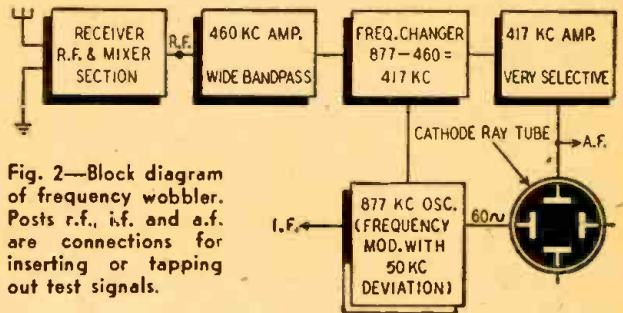

Fig. 2—Block diagram of frequency wobbler. Posts r.f., i.f. and a.f. are connections for inserting or tapping out test signals.

are then adjusted by their trimmers to obtain maximum height of the image.

SELECTIVITY CURVE

After having tuned the receiver to a frequency supplied by the generator, and without touching any of the receiver controls, the generator frequency is varied above and below that to which the receiver is tuned. Height of the images produced to the right and left of the point corresponding to exact resonance is diminished more or less, according to the degree of mistuning. The curve traced by the tips of these images constitutes the selectivity curve of the receiver's r.f. section.

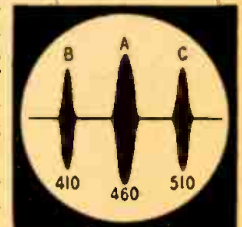

Fig 3—The indicator.

according to the degree of mistuning. The curve traced by the tips of these images constitutes the selectivity curve of the receiver's r.f. section.

Note also that the analyzer permits measurement of rejection of image-frequency signals. As the tuning of the receiver is varied, elongations produced by frequency-images move along the screen in the opposite direction to those made by normal signals.

STUDY OF I.F. CIRCUITS

Trouble shooting: By connecting the input r.f. successively to various cir-

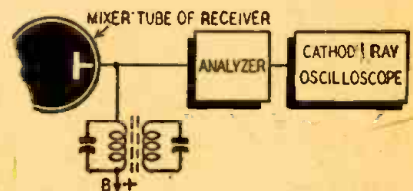

Fig. 4—Receiver mixer analysis connection.

cuits in the i.f. amplifier, the defective element is located by elimination.

Alignment: Is accomplished by increasing to a maximum the height of the images formed on the screen.

Resonance Curves: It is understood, that, to obtain resonance curves, it is necessary to use a frequency-modulated generator. Such a generator exists, in
(Continued on page 66)

AMATEUR RADIO W2IXY

AMATEUR radio station W2IXY has available four transmitters. They are one: one kilowatt commercially built by Erco Company of Long Island; the r.f. tube lineup is an RK39 into an Eimac 100TH into a pair of Eimac 250TH. This crystal-controlled transmitter is used on the 14 and 28 mc phone. The second transmitter is a commercially-built 60-watt input rig, utilizing a pair of T20's in the final stage. The third "baby" runs at 40 watts input with an 815 in the final. Last but not least is the 100-watt job—home grown—using an 807 into a pair of 809's in the final stage. All rigs are crystal controlled—no electron-coupled oscillator is used on any rig and none is found to be necessary.

Eleven receivers, ranging from the most modern in design to the garden variety, are scattered around the shack. Four National's; three RCA; one General Electric; one Federal; one Pilot; and one hand made. The two HRO's are used exclusively for communication purposes—but band-spreading them has not been found to be necessary, and operating them "straight" has been found very effective, as after a CQ, a quick check of the entire band is possible and several DX calls can be answered simultaneously.

The recording equipment consists of one high-fidelity recorder which uses

sixteen-inch embossed discs. Three other recorders are also used, mainly for speech and amateur c.w. signals. Since

Perhaps the most outstanding Y.L. in the United States is Radio Amateur Dorothy Hall. Starting in radio in 1929, she is known in radio amateur circles all over the world as America's No. 1 female radio ham.

Amateurs from all countries, when in America, want to see her in person.

On a busy day her station handles messages throughout the world.

At one time a chief operator for the Telephone Company, she now runs the two-way radio department in the Alarm Bureau of the New York Fire Department.

1938 W2IXY has made hundreds of recordings of amateurs and played back their transmissions—indisputably accurate reports can be given to stations which are contacted by radiophone.

The radiating system in use at W2IXY is possibly the most important feature of the station. Considerable work, time and study were necessary before it reached the stage of perfection. There is absolutely no "haywire" in the station and the antennas are a thing of beauty. A detailed description has never appeared in print but now we shall break down and give full details.

Dorothy was engaged in a QSO with a British station at the instant this photo was snapped. Captain Horace Hall, her husband, is seen logging a few notes on the transmission. Note setup for indicating the moon's phases.

The latitude and longitude of W2IXY is: 40 degrees—40 minutes—15 seconds north; 73 degrees—45 minutes—30 seconds west. There are two steel towers, 66 feet, 6 inches high and 85 feet apart. The true bearing from tower to tower is north 10 degrees 30 minutes west. The antennas between these towers—for the 14 mc band—is four half-waves in phase, which is broadside with a bearing from the center: north 78 degrees thirty minutes east and south 78 degrees thirty minutes west. The antenna has world-wide coverage—proof of its consistency of performance were the schedules maintained between W2IXY and McGregor Arctic Expedition; Byrd Expedition; VU2CQ, Bombay, India; Gatti Expedition to the Congo; and the historical schedules with VR6AY, Pitcairn Island. There is no reflector or directors. It is not a beam and it does not rotate. The vital part of the radiator is the feed line. It is an open line 34 feet 5 inches long, of No. 14 wire with 6-inch spacers (625-ohm) between the upper and lower portion of the antenna. From the lower section the feeders are 17 feet (625-ohm) into two aluminum half-inch bars 17 feet long—spaced one and a half inches. From these bars to the transmitter there are two copper bars half inch in diameter three feet long. The copper bars are used to tune up the antenna by squeezing them in or widening them and tuning the antenna for the lowest reading on the antenna meter.

There is a second antenna—a simple rotary—no reflectors or directors—35 feet above ground, 625-ohm feed line. This antenna is used for local and United States contacts.

ORIENTING THE ANTENNA

The antenna is clearly explained in Fig. 1. It should be so erected that its best transmission is in the desired direction. Do not try to line up your antenna by a compass, as any old salt will tell you that you must have some special knowledge of this instrument. No compass points to the true north. All compasses in and around the New York area have an error of twelve degrees to the west, for example. This is known as compass variation. We recommend that the average amateur line up his antenna by locating the North Star, then locating south, east and west.

It is not likely that a station on the same meridian of latitude as you is due east or west. If it is any distance away, it certainly is not! For example, if it is half-way around the earth it is due north of you. If you want to work a certain area of the earth use a big globe and a piece of string to ascertain its true bearing—or ask a navigator.



On November 15, 1946, when some of the amateur frequencies were released—28 mc in particular—W2IXY went on this band. The antenna used was six half waves in phase—stacked two over two—and then another two—said antenna was erected between the steel towers. Schedules were maintained with the GIs overseas. W2NVD and W2NBH (themselves ex-GIs) ably assisted the station to maintain regular schedules. It was found that from 8 am to 2 pm consistent transatlantic contacts could be established and maintained over a period of hours with this radiating system. The 20-meter simple rotary was also used at off times for contacts with the States and local rag-chewing.

Since the ban was lifted on the amateur bands, W2IXY has operated 100 percent phone on 10 and 20 meters. As GI schedules are maintained on both bands not too much time or effort has been given to pulling in or working rare ones, but WAC (worked all continents) has been accomplished many times over.

In April 1941 the station's receivers and antenna system "went to war"—acting as official monitoring station for the Australian government shortwave broadcasts. This work is still being carried on very successfully by Captain Hall and considerable data relating to short wave transmissions and reception has been compiled over a long period of time. Before the British Broadcasting Corporation had completed arrangements for their own monitoring setup the work was also done with the receiving equipment of this station.

WHO IS DOROTHY?

As to the operator, possibly someone else should tell that story, but here is an outline of the main facts:

Became interested in shortwave radio in the late '20's, due to activities of the OM, who, while never an amateur, was always an enthusiastic shortwave listener and writer (column in *New York Sun*). Heard first foreign stations on the old Pilot Wasp. Attended hamfest in 1934, sitting at table where every other woman held a license, and resolved to become an amateur as well. Studied code and took the examination within the year, receiving Class-B license. Broke in on 160 meters, and exactly one year later received Class-A, starting on 20-meter phone immediately and remaining mostly on that band ever since.

Other radio activities include teaching code to pre-inductees for New York University, and working eight hours daily for the last three years for the New York Fire Department, No. 40 at WNYF.

Listed is a brief outline of various contacts made by the station:

October 9, 1935: Station received Class B license; handled Johnstown Flood Traffic (A.R.R.L. commendation.)

November 4, 1936: Station received Class A license.

January, 1937: Located Captain Loch's Expedition which was reported lost in the Andes.

January, 1937: Received first W.A.C. on phone issued in Second District.

February, 1937: Carried daily schedules with Baffin Bay Expedition.

March, 1937: Received first W.B.E. (Worked

British Empire) certificate on phone for a woman in the entire world.
 October, 1937: McGregor Expedition scheduled for traffic handling.
 November, 1937: North West River Expedition scheduled—traffic handling.
 February, 1938: Rebroadcast W2DKJ who was flying 10,000 feet in an airplane over Long Island and working on 5 meters—100 per cent

from ARRL for Pitcairn work.
 November, 1938: Received A1 operators certificate from ARRL.
 April, 1939: Russian fliers located for WOR.
 May, 1939: Handled Sarabia flight—commendation from Mexican government.
 July, 1939: Handled Commander Gatti's traffic from Africa.
 September, 1939: Represented amateurs on De-

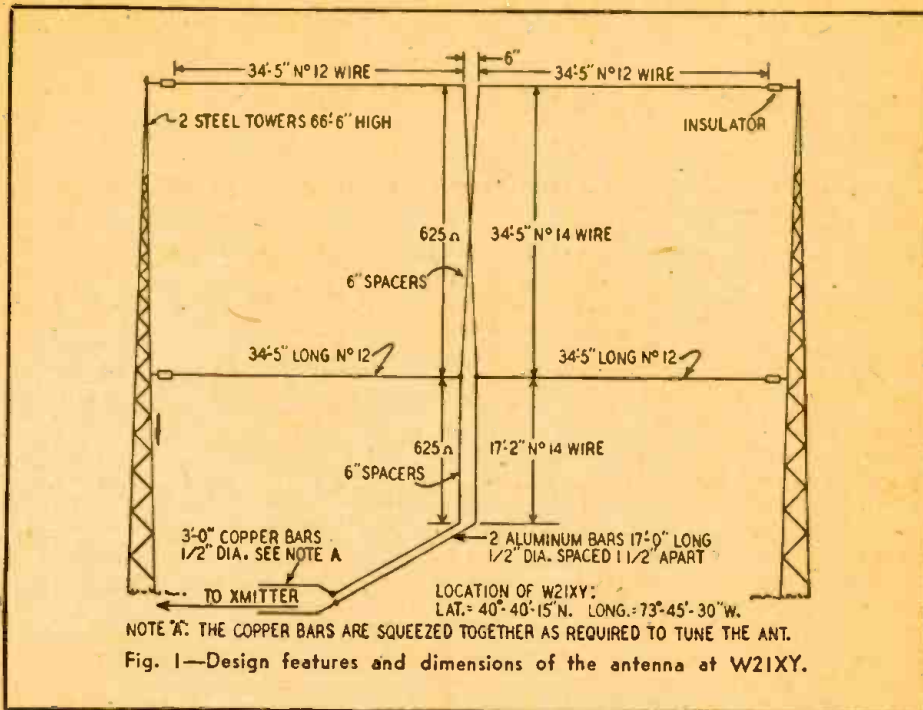

QSO with London, England.
 March, 1938: Established first contact with Pitcairn Island.
 March, 1938: Retransmitted W2GNJ (who was operating on 5 meters) to five capitals of Europe.
 March, 1938: Emily McCoy spoke to her family on Pitcairn Island for the first time in 42 years.
 July, 1938: Pitcairn Island SOS handled; NBC broadcast from W2IXY over coast-to-coast and short wave direct contact with Pitcairn.
 August, 1938: Received Public Service certificate

Forest Day at the New York World's Fair. Requested by the Pioneers Wireless Operators Association.
 February, 1940: Byrd Expedition.
 April, 1940: Handled messages between Col. William Donovan and his wife who was aboard the "Yankee" in the South Pacific.
 June, 1940: Received "Worked All States" certificate.
 June, 1940: Cocos Island Expedition.
 April 15, 1941: Station receiving equipment went to war for the Australian government—official monitoring post.

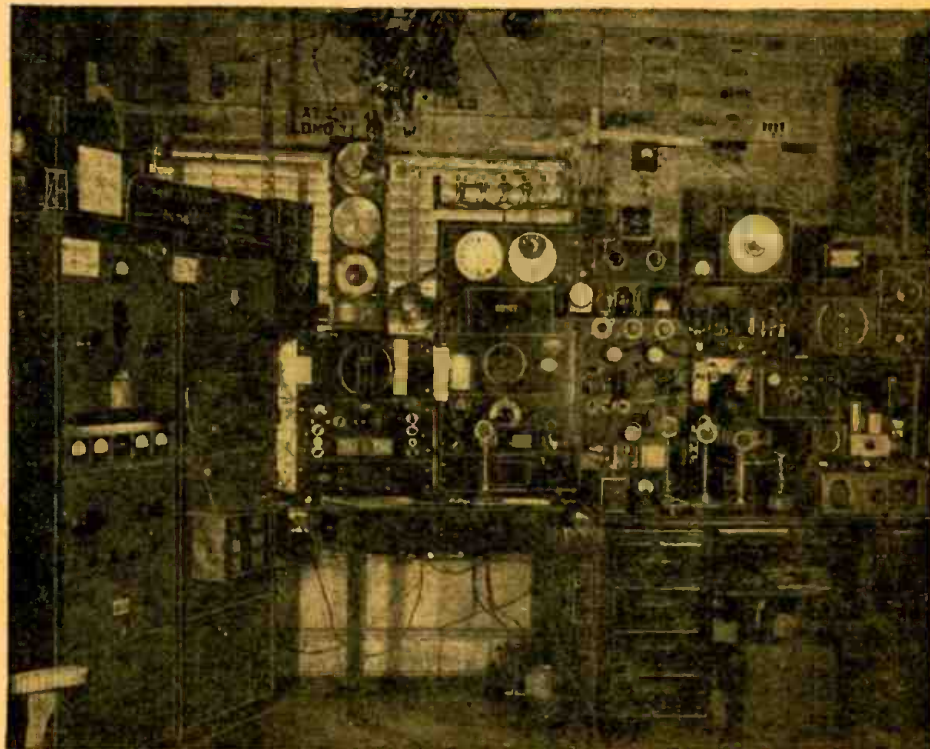

Not all the equipment in this amateur's dream of Paradise could be got into the photograph. There is another transmitter at the desk's right and a recorder at the other side of the room.

PRIVATE AIRCRAFT RADIO

Miniature Equipment Increases Small Aircraft Flying Safety

A PRIVATE aircraft radio with all the features of radios previously used only on large commercial planes at a fraction of the cost is the claim made for the new Motorola "Navigator" Radio by its designer, Donald H. Mitchell, of Galvin Mfg. Corp.

The "Navigator" is a single, self-contained, transmitter and receiver incorporating features which are very important to the itinerant flyer using the Radio Aids to Navigation as provided

by the United States Government. These are Beacon-Broadcast-Tower reception with automatic tuning, Marker Beacon, Radio Compass and loud speaker reception. The range of the transmitter is approximately 25 to 30 miles, depending upon altitude and atmospheric conditions. The receiver range is equal to or better than the best commercial receivers used by airlines and transports.

Among other features of the Motorola "Navigator" are: beam reception by push button, with six push buttons that can be instantly and easily reset while in flight without the use of tools; 75-megacycle marker reception; and automatic reeling antenna. Upon reaching cruising speed, the antenna automatically reels out, and on return to gliding speed, automatically retracts and retunes the transmitter.

Three-band reception — beacon band (200-400 kc), broadcast band (535-1620 kc), and 75-megacycle marker band is available. Both Fan and "Z" markers can be heard concurrently with the beam or other signals being received. The teardrop loop

is statically shielded and remotely controlled with control and azimuth indicator on radio set panel.

Interphone communication between pilot and passengers can be carried on while receiving radio signals. Passengers use the same type headset assembly as pilot. A switch is located in back of the set to disconnect passenger's microphones. These are automatically disconnected when the press-to-talk button on the transmitter is operated.

The transmitter has a 25 to 35 mile range, 10 watts of power. A lip microphone is attached to a light-weight head-set.

The transmitter, receiver and power supply are in one compact unit, size 4¾ x 6 x 9½ inches deep. Weight 12 pounds. (The entire radio equipment weighs only 21.34 pounds.)

A Range-Talk switch applies automatic volume control to the receiver, making it unnecessary to adjust volume control when taxiing or circling the control tower.

The apparatus is pictured in Photo A. In this small housing is contained the entire radio equipment, except antenna, headphones and loud-speaker. In the central lower portion of the panel are located the six push-buttons that can be reset to a new station instantly. Complete reset can be made in flight with one hand, no tools being required. The call letters on each push-button can be changed at the same time of resetting merely by rotating discs which contain the entire alphabet.

The manual tuning knob is located in the lower right corner with the tuning dial indicator above it. The band selector switch is above the tuning indicator.

In the lower left corner is the loop control knob with the radio compass dial indicator for loop azimuth above it. Calibration is in degrees bearing, to right or left.

The 75-megacycle switch is located in the center just above the push-buttons. By throwing this switch to "ON" position, the modulated tone of both Fan and "Z" markers are heard concurrently with the beam or other signal being received. The dial light is located just below the volume control knob. It is accessible from the front and can be dimmed by merely rotating the cover to right or left to complete cut-off.

Above the volume control is the loud speaker-headphone switch. When in "Speaker" position, this switch turns on

(Continued on page 57)



Photo A—Front view of Navigator, showing all operational controls.

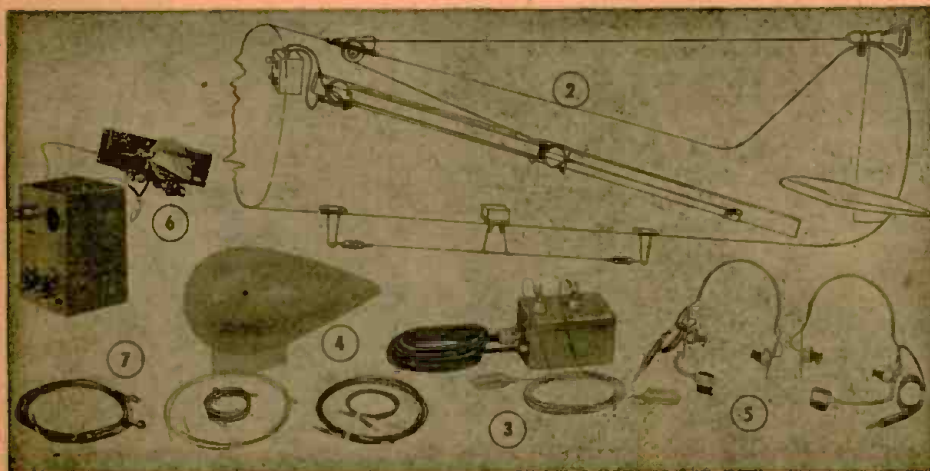

Fig. 1—Accessories for the equipment. Installation of the trailing antenna is shown above.

ANTENNA PRINCIPLES

Part I—Simple Dipole Antennas and Transmission Lines

NOT many years ago, any conductor strung outdoors for the transmission or reception of radio signals was an antenna. All of them looked practically alike and the dimensions of most receiving antennas were determined by the distance between convenient supports for their ends. All this changed with the general migration to short waves and the introduction of FM and television. The urgent necessities of war and the increasing use of microwaves produced types of antennas hitherto never seen.

Today, each antenna is designed for the particular type of transmission or reception with which it is to be used. An antenna which is satisfactory for narrow-band broadcasting is not good for broad-band FM or television. Highly directional systems are used in the horrible QRM of the amateur bands to bring in distant stations that would be otherwise inaudible.

Feeder systems have been vastly improved. High-powered stations use efficient feeder methods to eliminate appreciable losses of power, while low-powered stations have been enabled to make better use of the limited energy at their disposal.

HALF-WAVE ANTENNA

The half-wave antenna (Fig. 1) is the most common, both for transmission and reception. Its popularity is well deserved—it is the shortest and simplest

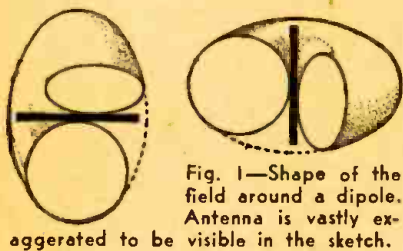

Fig. 1—Shape of the field around a dipole. Antenna is vastly exaggerated to be visible in the sketch.

antenna which can give excellent results. It is also directional to some extent.

The actual construction of a short-wave antenna of this type is shown in Fig. 2. It is designed for 10- and 11-meter operation. The aluminum sections can be telescoped to some extent to tune the antenna to the correct length for reception of any frequency within its range. Table I includes a length-vs.-frequency chart for the 10-meter band.

When the antenna is excited by an r.f. voltage, electrons flow alternately in one direction, then the other, as shown by the arrows in Fig. 3-a, at the

frequency of the alternating current. As the current from the source starts to flow in one direction, electrons are forced up one of the feeders and along one half of the antenna toward the end. At the same time electrons are drawn down the other feeder and away from the other end of the antenna. As the alternating voltage reaches its maximum, large numbers of electrons are piled

up at one end of the wire, resulting in a high negative charge, while the other end is equally positive. This is at the time when the largest amount of current is flowing up the feeders and into the center of the antenna. As the current has no place to go, it decreases gradually toward the ends of the dipole, while the voltage rises correspondingly. Current fluctuations may be visualized with the help of a rubber band fastened between two supports, as shown at Fig. 3-b. The points A, B, C, and D represent the current on successive portions of the antenna when no current is supplied from the feeder; A, F, G and H when maximum current is supplied. The various other lines show the amount of current at each point on the antenna at different parts of the cycle.

Since no current can flow at the ends of the antenna (because it has no place to go) the piling up of electrons creates high voltages. Voltage distribution on the antenna may also be illustrated simply by a strip of spring steel clamped at the center and set into vibration (Fig. 3-c). There can be little voltage difference at points near the center of the antenna, since at these points current would flow to equalize any difference. At the ends, the amplitude is great, as may be seen by comparing the points A, B and C with the same points E, F and G when maximum current is moving into the antenna. Fig. 3-d shows (maximum) voltage and current distribution along a half-wave antenna, and is a figure often used.

ELECTROMAGNETIC FIELD

The oscillating r.f. current is surrounded by a magnetic and electric

field which increases and decreases in strength as do the voltages and currents which set it up. This field travels away from the antenna at the speed of light. The maximum electromagnetic field is radiated from current-loop points (points of greatest current) such as the center of a half-wave antenna. As a result the greatest power is sent out at right angles to the antenna. Of course, it can receive best from the same direction. A radiation or reception pattern looks like a doughnut with the antenna passing through the hole (Fig. 1).

A vertical half-wave antenna is best to communicate in every horizontal direction because its doughnut-shaped pattern is a horizontal one, and little power is lost by upward or downward radiation. When using a horizontal antenna the doughnut is vertical and is more effective in two opposite directions.

When used with a low-impedance feeder the connection must be made at the center of the antenna. Therefore the system is actually two wires insulated from each other to allow for feeder con-

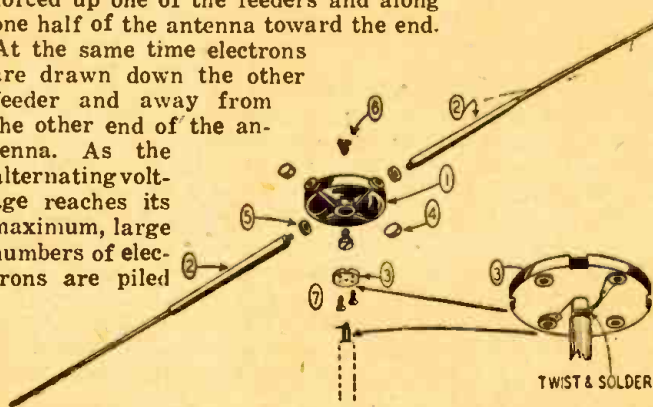

Fig. 2—A commercial dipole for short waves.

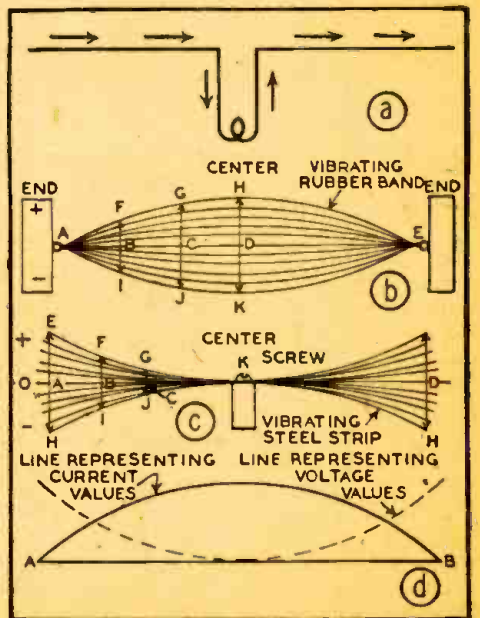

Fig. 3—Distribution of current and voltage.

nection. This gives it the popular name *dipole*.

Up to this point it has been considered that the antenna radiation pattern is always an ideal doughnut shape. This is not exactly true. The earth is a

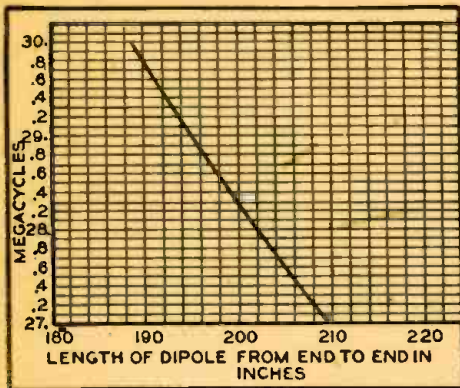

Table I—Dipole lengths for 10-meter band.

very good mirror for radio energy and if the antenna is not as high as it should be, there are actually *two* sources of power, the antenna and the reflection from the ground. The resultant pattern is the sum of these two. Therefore a vertical antenna no longer has a horizontal pattern. Instead, the end of the doughnut tends to be deflected upward because of the reflections. This means that power is lost and the effective energy is decreased. In general, the antenna should be constructed at least one wavelength (and preferably more) above the earth.

ANTENNA FEEDER SYSTEMS

To properly supply (or absorb) energy from the antenna, the feeder must be of the correct impedance to match it. Circuit theory shows that a low im-

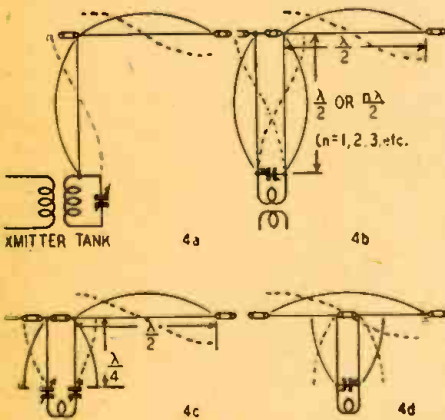

Fig. 4—Different types of transmission lines.

pedance exists across the ends of a series-tuned circuit and that a parallel-tuned circuit has a high impedance across its terminals. Therefore such tuned circuits may be used to supply power with the correct impedance depending upon whether we wish to feed the antenna at an end or excite it at the center.

A voltage-feed system is one which connects to the antenna at a voltage loop (usually the end of the antenna). A current-feed is one which connects at the center of the wire. The first requires a high-impedance feeder, and the second

needs a low impedance. The circuits shown in Fig. 4 operate at maximum efficiency because the impedances are correctly matched. Unfortunately, we cannot construct the antenna high above ground and still feed it directly. Most transmitters are located near the earth. Antenna and transmitter must be connected by a *feeder*.

Feeders may be of various types, depending on the height of the antenna from the ground and a number of other factors. If an antenna is a half-wavelength high (approximately) another half-wavelength may be dropped from one end and the tank coil connected to directly or through a coupled circuit, as in Fig. 4-a. Since the end of the feeder will be a voltage loop, or high-impedance point, a parallel-tuned circuit is used. This tuned circuit may also be used to compensate for differences from a half-wave in the feeder length, as by varying the tuning, the feeder can be made to "look" a little longer or shorter to the transmitter.

A feeder of this type is actually part of the antenna, and radiates with it. Since we often wish to have all the radiation from the antenna itself, a

	25 MC	60 MC	100 MC	200 MC
75 Ω	1.7	3.4	5.0	8.3
150 Ω	.9	1.8	2.7	4.7
300 Ω	.77	1.45	2.1	3.6

Table II—Characteristics of twin-lead cable.

feeder wire parallel to the first is used, as in Fig. 4-b. This makes our feeder a second dipole, folded on itself. Because the wires are so close together, the field set up at any point on one wire is neutralized by that set up at the same point on the other one, and the feeder does not radiate.

If the antenna is a quarter-wave high, more or less, the current-fed feeder of Fig. 4-c may be used. The tuning arrangement again compensates for slight differences in feeder length. Current-fed antennas work well with the same type of feeders, as shown in Fig. 4-d, which represent a line a quarter-wave long. Since the ends of the feeders are at voltage loops, parallel tuning is used. If the feed-line were approximately a half-wave-length long, a series-tuned circuit like that of Fig. 4-c would be used.

Note that a voltage loop may appear somewhere along the feeders. Such a point requires especial care to decrease loss of energy due to leakage. It is best not to use spacers at this point but to introduce them some distance away.

Actually, these feeders are an extension of the antenna proper along which the alternate loops and nodes (standing waves) can be passed on.

The above systems are called *resonant feeders*. They are simple and require only resonating the tuned circuit to the frequency being used. No thought need be given to actual impedance values so long as the connection is made at the

proper node or loop. The disadvantage is the high voltage which may appear at certain points along the feeder. Therefore, resonant feeders are of the open type, that is, spaced wires proper-

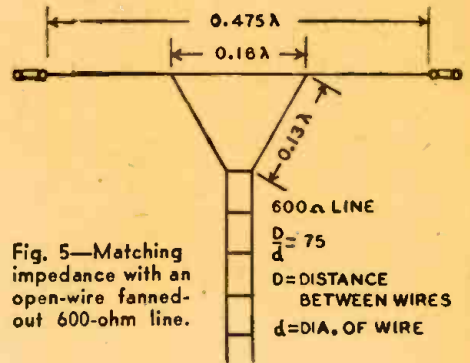

Fig. 5—Matching impedance with an open-wire fanned-out 600-ohm line.

ly insulated and kept away from other structures. The use of two leads prevents radiation because the field due to one wire is opposite to that of the other. The current in each feeder must be equal. Thermocouple meters or other indicators may be used for this purpose. Generally two are used, one in each lead, although one may be switched into one lead or the other. Flashlight bulbs may also be used in the leads to indicate balanced currents. They may be shunted across equal lengths of feeder, and when they indicate equal brilliance the adjustment is correct.

The tuned or resonant feeder attaches to an antenna at the center or end—at a point of zero or infinite impedance. By attaching to the antenna at an intermediate point whose impedance matches that of the transmission line, tuning may be dispensed with. The standing waves (fixed voltage and current nodes and loops) no longer appear on the line, which may be of any convenient length.

The *characteristic impedance* of a line depends on a number of factors, chief of which is spacing between conductors and their diameter. A common



Fig. 6—Two types of popular co-axial cable.

impedance is 600 ohms, the lines being spaced 75 times their diameters, commonly four to five inches apart. To connect this line to an antenna, the method shown in Fig. 5 is used. The gradual "fanning" out of the 600-ohm line to a point on the antenna where a 600-ohm impedance is found is to prevent reflections which would be caused by sudden mismatch. All dimensions are given in the figure. Note that a "half-wave" antenna is actually cut slightly shorter than a half-wave long, to compensate for effects due to capacity to earth and to the wire thickness. (An infinitesimal-

(Continued on page 64)

WAVE AND PULSE COUNTER

A Direct-Reading Device for All Waveforms

THE FREQUENCY of pulses and square waves can be measured by the use of a simple electronic circuit. Radar and television equipment make extensive use of these pulses and square waves of voltage.

The method is one in which a charged condenser is caused to discharge by the input pulses to be measured. The average condenser current, as read on a meter, is converted into pulse repetition frequency.

To measure the frequency of wave forms at various amplitudes, they must first be amplified sufficiently, and then

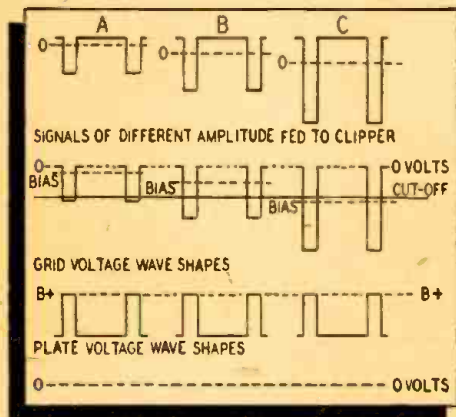

Fig. 1—The clipping circuit reduces waves of widely different amplitudes to one level.

clipped or limited to uniform amplitude when fed to the counter. A series of pulses having an amplitude of, say, two volts will be amplified sufficiently to cut off a tube operating at zero bias. This will produce a certain amount of plate voltage swing.

If series of pulses having an amplitude of 20 volts were also amplified, they would also drive the zero-biased stage to cut-off, and produce the identical amount of plate voltage swing as did the two-volt pulses.

Fig. 1 represents three pulses of different amplitudes, pulses A, B and C, applied to the grid of the clipper stage at different times. This stage is zero biased, which means that the grid and the cathode are at the same potential with no input signal being applied. When a pulse which is actually d.c., but varying in potential, such as may be developed on the plate of a tube, is put through a coupling condenser to the grid of the next stage, the pulse then becomes a.c., since it fluctuates above and below the zero voltage axis.

When the first positive alternation hits the grid, the grid-cathode resistance is reduced, the grid current quickly

charges the grid condenser to a voltage practically equal to the peak of the positive input. The condenser voltage then acts as a bias, shoves the operating point from zero into the negative portion of the eg-ip curve. The signal has to swing about this new operating point. Thus the gain of the stage is reduced, and only the peak of the positive input can drive the grid positive (just a trifle above zero). If the input voltage is increased, the condenser voltage increases, the bias increases, and the signal now varies about the greater bias. See Fig. 1.

This action is called *grid clipping*. The clipping for pulses of various amplitudes takes place always at approximately zero.

In Fig. 1 pulses A, B and C each drive the grid above zero (positive), and below (negative), beyond plate current cut-off. Due to the grid clipping of each pulse at approximately zero, and the tube being cut off, only the shaded portion of each pulse (Fig. 1, grid voltage waveshape) will affect the plate current and therefore, plate voltage. Note that these shaded portions of each pulse all have the same amplitude even though the original pulses were of different amplitudes. Therefore, the plate voltage waveshapes will all be of the same amplitude regardless of input signal strength, provided that the minimum signal input is large enough to bring the stage to cut-off. This is assured by a previous amplifier.

Referring to the block diagram of Fig. 2, we see that either a small positive pulse or a larger one will be amplified by the first stage which is operating class A.

The output voltage waveshape from



Fig. 2—Incoming wave is first amplified, then clipped and reduced to a sharp pulse.

this class A amplifier will be similar to that of the input, but reversed in phase unless the input is great enough to overdrive the stage. If this happens, grid clipping will occur.

It is this amplifier's output pulse that is fed to the grid of the clipper. The clipper's output will be of uniform amplitude.

The output of the clipper is put through a differentiating circuit which peaks the square-topped pulses. Refer to Fig. 3, where condenser C1 and re-

sistor R1 make up the short time-constant circuit needed for differentiating.

These very narrow peaked waves are applied to the grid of the thyatron tube. Due to the d.c. negative biasing voltage, the tube remains nonconductive. The positive half of the differentiated signal applied to the grid of the thyatron will trigger the tube and cause it to conduct.

During the time that the tube is nonconductive, condenser C2, which is in parallel with the tube, will charge up to the value of the B+. The charging path of C2 will be through resistor R2 and the meter.

When the narrow differentiated waves trigger the tube, its conductivity permits condenser C2 to discharge through the tube. When C2 has discharged sufficiently, the difference of potential between the thyatron's plate and cathode (which is actually the potential across C2) will be reduced to the extinction voltage of the tube. As soon as the tube ceases to conduct, C2 will commence charging up again through resistor R2 and the meter. This action produces a saw-tooth voltage waveshape on the thyatron plate.

The repetition frequency of the pulses applied to the grid of the thyatron will determine the frequency at which condenser C2 charges and discharges. The more often C2 charges, the higher will be the reading on the meter.

To determine the repetition rate or frequency the meter can be calibrated by one or two methods. If a square wave generator or a variable pulse generator is available, the meter may be calibrated by noting the meter readings for various known input pulse or square wave frequencies. An audio oscillator can

also be used to calibrate the p.r.f. meter since the audio sine waves will be clipped off and square waves would result.

If no generator is available, the meter may be calibrated approximately by the following method:

$$F = I/C (V1 - V2)$$

Where:

V1 is the ignition voltage (maximum voltage of C).

(Continued on page 49)

ELECTRONIC MATHEMATICIANS

Differentiators and Integrators Are Much Used in Radio

TELEVISION, radar, pulse modulation systems, many of the newer branches of the growing electronic science, make use of a.c. signal waveforms that were seldom used or heard of only five or ten years ago. Now the good radio man finds that he can't go very far in a discussion of these new developments without talking of the newborn twins of radio: *integration* and *differentiation circuits*. Their names are ponderous, reminiscent of calculus and other forms of higher mathematics, yet their actual functioning is a relatively simple matter that should become part of the basic working knowledge of the modern radioman.

To start with, let's get down to the basic meaning of integration and differentiation and strip these words of their frightening aspect. The *differential* of any quantity, voltage or current for example, is just the *rate of change* of that quantity. An everyday application of the principles of differentiation is found in the speedometer unit of an automobile. This instrument usually indicates both distance travelled and speed, which is the *rate of change of distance*. The speed hand, then, is an indicator of the differential of the distance covered. *Acceleration* is felt by the occupants of a car when its *speed is changing*. If some device were installed to measure acceleration it would really indicate the *differential of the speed*.

Fig. 1 shows how the three factors, *distance*, *speed* and *acceleration*, vary as a car makes an idealized trip during

the period from time (0) to time (3). During the acceleration period from (0) to (1), the *distance* covered per unit of time is increasing, as shown by the gradual increase in slope of the distance-time curve; the *speed* is increasing at a constant rate as shown by the straight upward slope of the speed-time curve; and the *acceleration* is constantly positive (forward) represented on the chart by a straight line of positive value.

During the cruising period from (1) to (2), the *distance* covered increases at a uniform rate as represented by the steady upward slope of the distance curve; the *speed* is a constant unchanging value; and the *acceleration* is zero because the car is neither increasing nor decreasing in speed.

Finally, during the stopping period, the *distance* levels off to a permanent fixed value; the speed *decreases* uniformly as indicated by the downward slope of the speed curve, and the *acceleration* is a constant negative value because the speed is decreasing *uniformly*.

There are two important points to be noted from these curves. The first is that the differential of a quantity can be negative even though the quantity itself is positive. For instance, let us examine the speed and acceleration curves between times (2) and (3). Here the speed is positive (forward), but the differential of that speed (acceleration) is negative because the speed is changing in a downward direction.

The other important point to notice is that a differential of any curve has

at all times a value representative of the *slope* of that curve. The speed curve indicates the slope of the distance curve, and the acceleration curve shows the slope of the speed curve. Therefore, drawing the differential curve is simply a matter of drawing a curve that represents the slope of the original curve. This fact becomes of importance when it becomes necessary to find the differential of some curve of voltage or current in an electrical circuit.

Integration is most easily defined as being the opposite of differentiation. If A is the differential of B, then B must be the integral of A. In the automobile analogy, speed becomes the integral of acceleration, and distance becomes the integral of speed. The two processes, differentiation and integration, always work hand in hand.

The next question to be answered is, "Where do differentiation and integration fit into practical radio circuits? Why worry about this rate-of-change proposition?" To answer that, let's look at a few very common a.c. waveforms in Fig. 2. Curve a is a triangular wave, used in some oscilloscope circuits and frequency measuring apparatus. Curve b is the familiar square wave, useful in testing amplifiers for frequency and phase response. Curve c is sharp pulses; and what radar set, television set, or pulse-modulated transmitter doesn't use pulsed circuits? Now, looking closely at the square wave of b, we find that it expresses the *rate of change* of curve a; that is, where the triangular wave is *increasing in a positive direction*, the

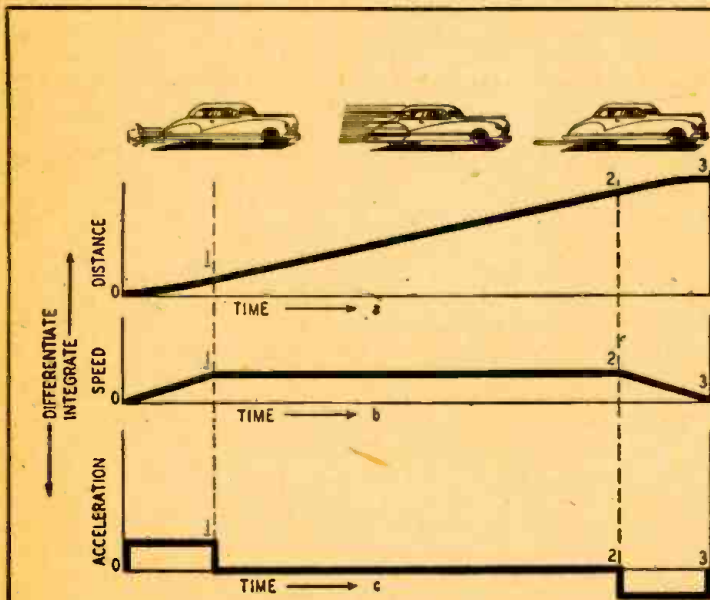

Fig. 1—Distance, speed and acceleration reproduced in graph form.

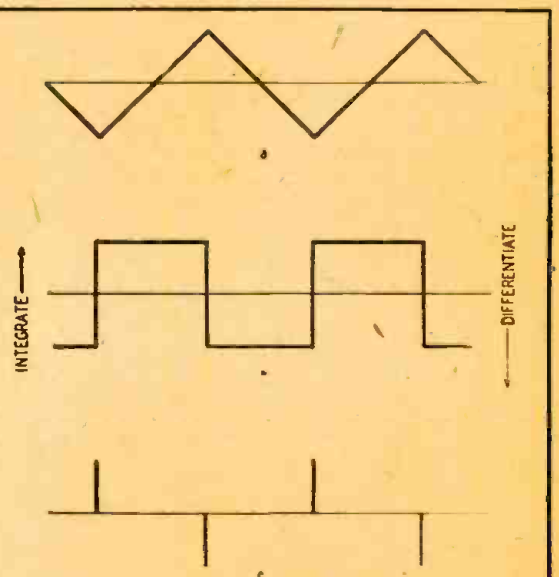

Fig. 2—Differentiation and integration in actual radio circuits.

square wave shows a *constant positive* value, and where the triangular wave is *decreasing* (increasing in a negative direction), the square wave has a constant *negative* value. On the same basis, the pulses of curve c represent the *rate of change* of the amplitude of the square wave. As the square wave increases in a positive direction, a very sharp positive pulse is produced and, conversely,

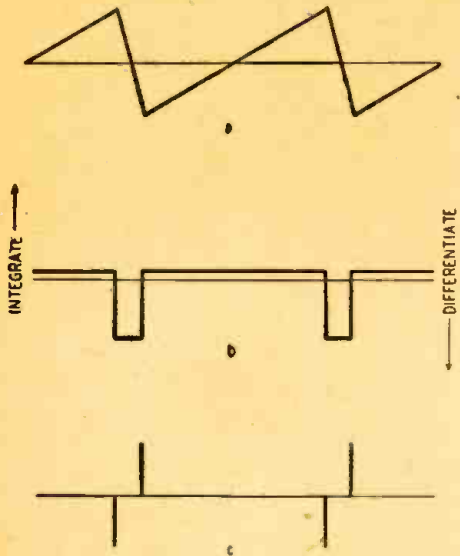

Fig. 3—Differentiation of a sawtooth wave.

as the square wave decreases in a negative direction, a very sharp negative pulse is the result. Differentiate a and the result is b, differentiate b and the result is c; conversely, integrate c to arrive at b, and integrate b to arrive at a. Here, then is a means of arriving at any one of several desirable waveforms by proper application of differentiation and integration. Figs. 3 and 4 show how it is possible, in a similar manner, to obtain several other interesting waveforms.

Through intelligent application of the most fundamental properties of capacitors, inductors, and resistors the two processes of differentiation and integration are obtained in electronic circuits. Consultation of any textbook will show that: (a), the *current* through a capacitor is proportional to the *rate of change* of voltage across that capacitor, and (b), the *rate of change of current* through an inductor is proportional to the *voltage* across its terminals. Here are two rules which involve *rate of change*, and they lead toward solution of the problem.

A *capacitor* is a device that stores electric charge. The amount of such charge is at any instant proportional to the voltage across the capacitor terminals ($Q = CE$) where Q is the charge, C the capacity and E the applied volt-

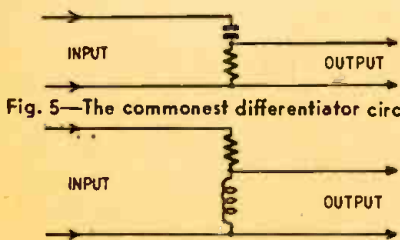

Fig. 5—The commonest differentiator circuit.

age. Any change in voltage impressed across the capacitor causes a corresponding change in charge. Now, current is simply movement of charge; therefore, *change in voltage* causes a flow of *current*. This *current* is thus representative of the *differential of voltage* applied.

To make the differential appear as a voltage rather than a current, a small resistor is inserted in series with the capacitor, as indicated in Fig. 5. Any change of voltage at the input side will cause a current to flow. This current will develop a voltage across the output resistor.

Turning now to the inductor as a differentiating device, we must remember that an inductor tries to maintain a constant flow of current through itself. It would require no voltage to maintain any *constant* current through a perfect inductance. Forcing a change in current will cause a corresponding change in the magnetic field around the inductor, and the changing magnetic field will, in turn, induce a voltage in the inductor windings. We find, this time, that the *voltage* appearing across the inductor terminals is the *differential of the current* through it.

Fig. 6 shows how the inductor is applied in a practical differentiation circuit. The resistor in series with the inductor is made large, so that the current in the circuit will be—as nearly as possible—directly proportional to the voltage applied to the input and independent of small voltages that will appear across the inductor.

It should be pointed out that either the capacitance-resistance circuit of Fig. 5 or the resistance-inductance circuit of Fig. 6 can be used for differentiation. In actual practice the former is used more often. A small capacitor is usually cheaper than an inductor, and, in addition, the series capacitor will block off any d.c. component of the input voltage which, after all, is of no concern when only *changes* are being considered.

Integration is accomplished by direct reversal of the circuits of Figs. 5 and 6. A capacitor can be used in integration because its current is the differential of the voltage applied, hence the voltage across the capacitor must be the integral of the current. Similarly, the inductor integrates by virtue of the fact that the terminal voltage is the differential of the current, hence the current will be the integral of voltage. Integration circuits are shown in Figs. 7 and 8.

Integration can be accomplished with either a capacitor or an inductor, but again the capacitor type is more popular. When using the capacitive circuit

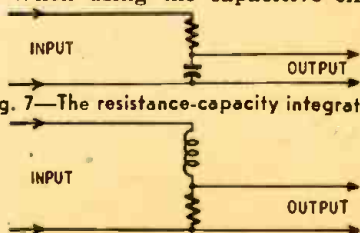

Fig. 7—The resistance-capacity integrator.

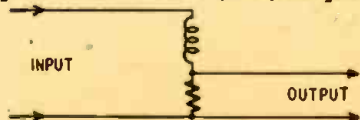

Fig. 8—This integrator employs an inductor.

of Fig. 7, it is necessary to remember that when the circuit feeds into the grid of an amplifying tube, a high resistance should be shunted across the capacitor to provide a d.c. return for the grid.

The designer of a practical differ-

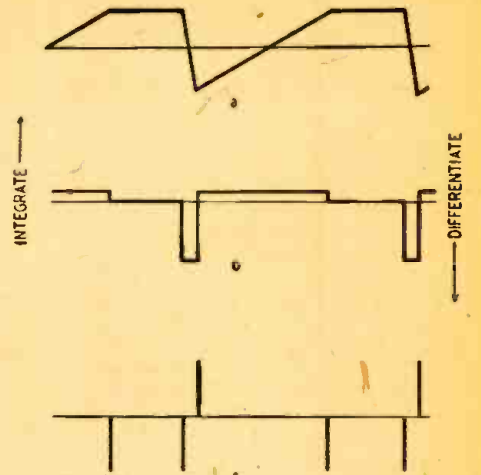

Fig. 4—A special-shaped wave differentiated.

entiation or integration circuit must take into account the imperfections in its action due to the presence of the series resistor (Figs. 5, 6, 7 and 8). For example, Fig. 9 shows a step voltage (part of a square wave) applied to the capacitance-resistance differentiation circuit of Fig. 5. Ideally, the differential of an instantaneous change in voltage is a sharp pulse, of infinite height and zero duration. The actual curve obtained is not of infinite height but, measured in volts, is equal to the step voltage. Moreover, the resistor introduces a time lag in the charging action of the capacitor, so the pulse drops off gradually.

The time required for the output pulse to return most of the way to zero (specifically, to 36.8 percent of the peak voltage) is easily found by multiplying the resistance, in ohms, by the capacitance, in farads. This time, in seconds, is known as the "time constant" of the circuit. A one-microfarad capacitor and a one-megohm resistor have a time constant of one second, while a 500-microfarad capacitor and a 100,000-ohm resistor have a time constant of only .00005 seconds, or 50 microseconds.

The time constant of an inductive circuit is calculated just as easily by dividing the inductance, in henries, by the resistance, in ohms. The time constant obtained with one millihenry of inductance and 100 ohms resistance is .00001 second, or 10 microseconds.

The actual time constant employed will, of course, depend on the sharpness of pulses desired and the frequency with which the applied voltage repeats itself. If, for instance, the step voltage shown in Fig. 9 lasted only .001 second, the time constant required for the differentiation circuit would be on the order of .0002 or .0001 second. Returning to the applications indicated in Figs. 2, 3, and 4, good differentiation would require that the time constants be kept below 1/5 to 1/10 of the period of the wave to be differentiated.

Many combinations of R and C or R
(Continued on page 59)

POLICE RADIO MAINTENANCE

FAULTLESS radio communication is one of the basic requirements in keeping the New York City Police Department at its peak of efficiency. Reliable inter-unit communication demands that the radio equipment operate efficiently at all times under all climatic conditions. To this end, the police department has developed a very efficient radio servicing system.

Twenty-four hour service is performed by a staff of approximately 15 men who are divided into three eight-hour shifts. Major radio repairs are made in five repair shops. The main shop is located in Manhattan and branch shops are located in each of the other four boroughs. Three men are employed on each shift at the main shop and each branch shop is manned by one man per shift.

The men are responsible for maintenance of the radio equipment in over 800 mobile units. All of these units are equipped with single frequency receivers tuned to the police frequency, 2450 kc. A number of these cars, some of the emergency trucks and the police launches are also equipped with two-way AM radio operating in the 30 to 40 mc band. Recently two-way FM equipment has been installed in the borough of Richmond and has added to the problems of the servicemen.

When a radio car, police launch or

other unit has trouble with its radio equipment, the condition is immediately reported to a dispatcher at headquarters who marks the unit "out of service" and immediately notifies the radio serviceman at the police repair shop nearest the point-of-call. The serviceman drives to the scene of the trouble in a small panel-type truck equipped to carry spare radio equipment, parts, tubes and tools. A precision single-frequency signal generator, multimeter and output meter are carried in the truck for making tests and aligning receivers in the field. If the trouble may be cured by replacing a tube, realigning the receiver or tuning the transmitter, the repair is made on the spot. In other instances the defective receiver or power supply is quickly removed from the vehicle and replaced with one of the spare units from the truck. The defec-



Photos from Three Lions

Police PA trucks are invaluable wherever huge crowds assemble.

tive unit is then taken to the shop for repair and general overhaul. Preventive maintenance is practiced by replacing all defective or questionable parts.

The main shop is equipped with oscilloscopes, signal generators, multimeters and other radio test equipment necessary for quick and efficient radio servicing. A drill press, lathe, punch press, grinder and other machine tools are on hand for making special parts when required and for making repairs on some types of power supplies.

PERIODIC INSPECTIONS

In addition to the necessary servicing work, the servicemen are also required to make periodic inspections on all radio equipment. All equipment that has been in service for a specific period is replaced and taken to the shop for thorough overhaul.

Servicemen are constantly on the alert to detect sources of outside interference that may impair the efficiency of communication. The thousands of overhead wires, neon signs, industrial machines and medical apparatus are a potential source of interference at all times. The servicemen analyze the characteristics of the noise and are able to determine the type of noisemaker and track the trouble to its source. Corrective measures are then undertaken to eliminate the trouble entirely.

TESTS AND STANDARDIZATION

The radio equipment used by the de-
(Continued on page 62)

The excellent instruments make work on the mobile equipment easier and more rapid.



TELEVISION FOR TODAY

Part VII—Video Detector Circuits

VIDEO signals are detected by the same method as employed for audio signals. Some modification is necessary because of the differences associated with video voltages. The detector must not only remove the video modulation and eliminate the carrier but also possess characteristics which will enable the full 0-4-mc video signals to pass. The detected video signal polarity must be observed, as it governs the number of video amplifiers that may be used between the detector output and the control grid of the cathode-ray tube.

A diode detector for a television receiver (generally half of a 6H6) is shown in Fig. 1. Conventional value of R_L would be 250,000 ohms, and C_1 would be 100 μ f. The purpose of C_1 is to bypass all of the i.f. voltage, leaving the video and rectified d.c. to appear across R_L . However, since the highest video voltage extends to 4 mc, we find that these conditions are not completely fulfilled. At 4 mc, the impedance of C_1 is only about 400 ohms. The result, then, of employing a 250,000-ohm load resistor bypassed with a 100- μ f condenser is to shunt the higher video frequencies away from the load resistor.

To minimize the shunting effect of the bypass condenser, the value of the load resistor is decreased, usually to some point near 5,000 ohms. A much lower value would produce a better frequency response, but the ratio of the output to input voltage would decrease. Remember that the load resistor is in

series with the diode tube, and this latter component itself has considerable resistance, often about 2,500 ohms. Hence, with a 5,000-ohm load resistor, we lose approximately 1/3 the total available detected voltage. This necessitates increased amplification, an additional stage or two either before or after the detector. The efficiency of such a circuit is far lower than we obtain with audio broadcast receivers where the ratio of R_L to r_p is between 100 and 200 to 1.

Efficiency of the detector action may also be aided by decreasing the value of the bypass condenser. This increases the impedance of the bypass path and forces more of the video frequencies into the load resistor. Danger in this procedure lies in the relative proximity of the highest video frequency (4 mc) and the intermediate frequency (25.75 mc). If we decrease the value of the condenser to the point where even the i.f. voltages are impeded in their passage through the bypass, then we find that they reach the following video stages and perhaps overload them to produce distortion.

The best solution—for the conditions that we find in television receivers—is a load resistor with a value close to 5,000 ohms and a low-pass filter to prevent any i.f. voltages from reaching the video amplifiers. In Fig. 2 we have a diode circuit widely used in commercial receivers. One half of a 6H6 tube functions as the detector, feeding the rectified signal into a low-pass filter.

The load resistor, at the far end of the filter, is 5,000 ohms. The low-pass filter consists of a 22- μ f input condenser, a small choke and the input capacitance of the first video amplifier. Fig. 3 shows practically the same circuit (as employed in GE models) except that one half of a 6F8-G is connected to act as a diode.

PEAKING COIL FILTERS

In Fig. 4 we have a low-pass filter with a series peaking coil. The purpose of the peaking coil is to extend the frequency response characteristics of the filter to permit the full 4 mc to pass.

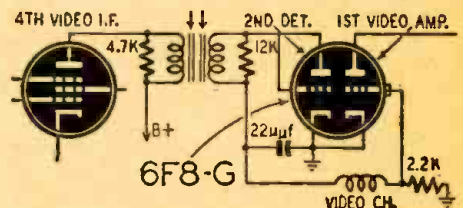

Fig. 3—Modification used in G.E. receivers.

The use of peaking coils (both series and shunt) will be encountered again in video amplifiers. The 75,000-ohm resistor across the peaking coil is designed to prevent the coil from excessively raising amplification of these higher frequencies. The coils serve the purpose of resonating with the ever-present stray capacity of the circuit to minimize their shunting effect on the higher video frequencies. A resonant circuit is formed with the inserted coils and the stray capacity, the latter being determined by measuring or experiment. This combination then tends to maintain the frequency response to the point chosen by the designer.

With full-wave or balanced detection (See Fig. 5) the output across the load resistor contains only the rectified d.c. and the video voltages. Theoretically no i.f. carrier voltage appears across the load resistor, eliminating the need for a bypass condenser or a low-pass filter. Actually, it is difficult to obtain an exact balance between each diode. As a precautionary measure some manufacturers add a bypass condenser, although of reduced value. Due to this change in conditions, it becomes possible to increase the value of the load resistor and with this, the detector efficiency. The limit on the value of R_L is set by the stray capacitance always present in the circuit. It is usually safe to assume the stray capacitance is 10 μ f. This

(Continued on page 54)

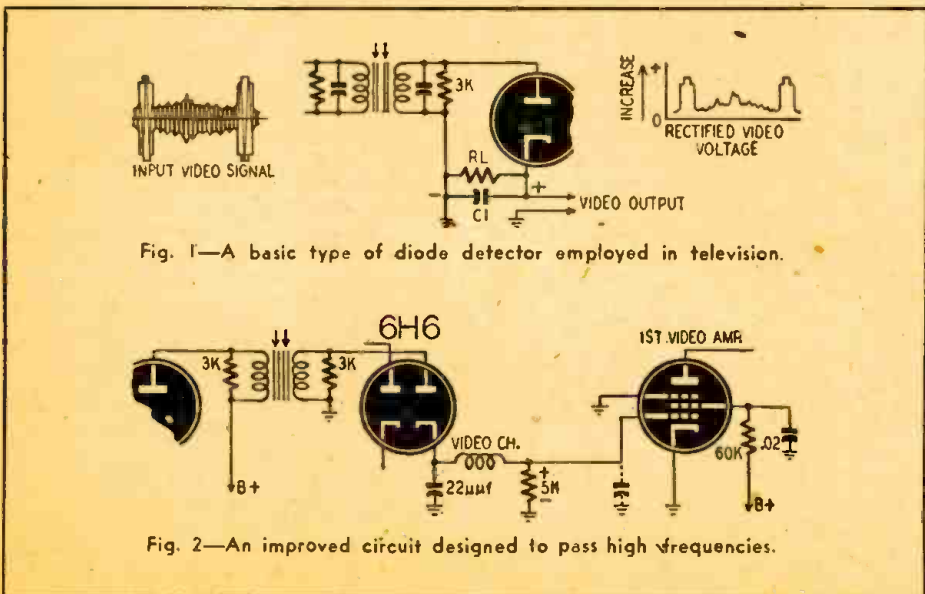

Fig. 1—A basic type of diode detector employed in television.

Fig. 2—An improved circuit designed to pass high frequencies.

SERVICING MOVIE SOUND

Part II—Lamp Supplies and Amplifier Equipment

EXCITER lamps may be operated on direct or alternating current. Lamps designed for operation on a.c. have much heavier filaments and consequently a higher thermal inertia than those designed for d.c. operation. This is to prevent appreciable cooling of the filament between cycles, which would result in hum. Although there are a number of lamps with different ratings, those in general use are 7½ amperes at 10 volts for a.c. and 4 amperes at 9 volts for d.c.

Most exciter lamp power units supply a low pre-heat voltage to the lamp in the stand-by machine. This is so there will be no appreciable lag while the exciter lamp reaches normal operating temperature when changing from one machine to the other.

A flickering exciter lamp often indicates a defective rectifier tube in the exciter lamp power supply. The defective tube should be replaced with a new one.

The power unit may be adjusted by connecting an ammeter in series with the exciter lamps and adjusting the variable resistor provided for this purpose until the current is correct for the type lamps used. The current and voltage ratings are printed on top of the exciter lamp bulb.

Circuits of two typical exciter lamp power units are shown in Fig. 1.

Fig. 2 shows the circuit of a typical

An increase in output voltage will show when the bad tube is replaced.

VOLTAGE AMPLIFIERS

The system may include a separate voltage amplifier for each sound head or one amplifier may be used for both. It usually has two resistance-capacity coupled stages. Its plate and filament currents are drawn from the main amplifier power supply, housed in a small metal cabinet mounted on the wall near

If the output of one head is considerably lower than that of the other and cannot be equalized by adjusting P1, condensers at ends of P1 should be checked for leakage. Any leakage here will result in lowered polarizing voltage and an unbalanced condition. The voltage applied to the cells should read approximately 80 (using a v.t.v.m.) which is the actual voltage. Readings made with a 1000-ohm-per-volt meter will be lower (about 60 volts) due to

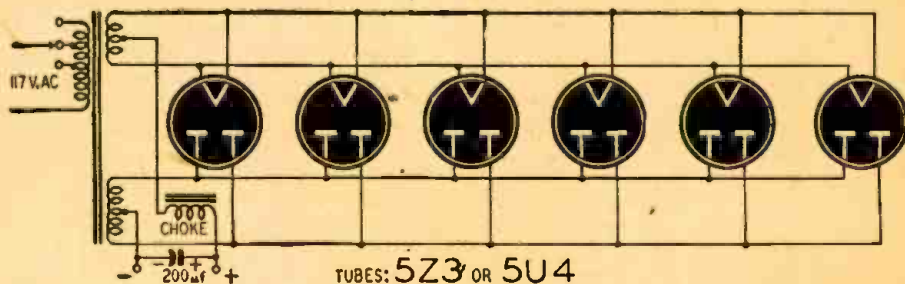

Fig. 2—A large bank of rectifiers excites the fields of several loudspeakers in parallel.

the projectors. In some cases it is located on the chassis with the power amplifier.

Since it is very unlikely that the output of two sound heads would be exactly equal, some means of balancing the output of the two heads must be provided so there will be no noticeable change in volume when a change-over is made. This is done by varying the d.c. voltage applied to the photo cells. As the arm on potentiometer P1 (Fig. 3) is moved either way it reduces the voltage applied to one cell and simultaneously increases the voltage applied to the other one. This decreases the output of one sound head while increasing the output of the other.

The output of the two heads may be equalized by turning the volume

the additional meter drain.

POWER AMPLIFIERS

The circuit of a typical power amplifier for a sound system designed for use in theatres up to 800 seats is shown in Fig. 4. It has a gain of 47 db and an output of approximately 12 watts.

The circuit uses one 6J7 tube as driver, one 6J7 as phase inverter, two 6L6's in push-pull and one 5Z3 rectifier. Provision is made to supply filament and plate current to the photo cell amplifier, on a separate chassis.

The circuit is extremely simple, with no trick or unusual features. This is characteristic of all theatre amplifiers, dependability, simplicity and good frequency response being the desirable qualities.

LOUDSPEAKER SYSTEMS

Although a few systems use one speaker for full-range reproduction, by far the greater number use one or more low-frequency units and one or more high-frequency units with a suitable cross-over network.

The speakers are located directly behind the screen, the low-frequency units in cabinets and the high-frequency horns mounted on top of these cabinets.

If any of the leads to the speakers are disconnected, during tests, it is extremely important that they be marked and—when the tests are finished—reconnected exactly as they were originally.

Repairs are easily made on the low-
(Continued on page 56)

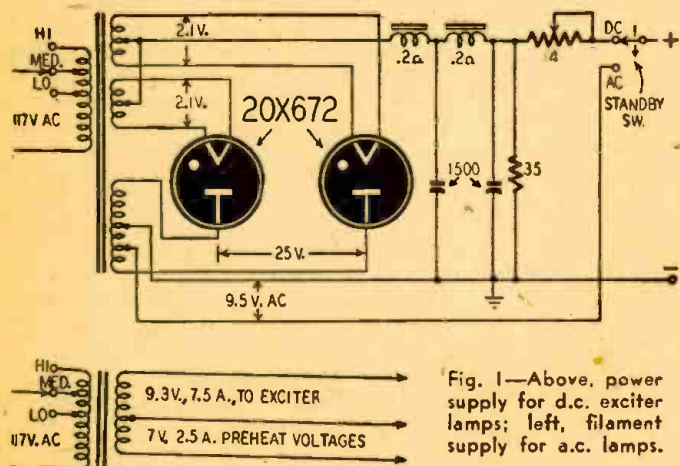

Fig. 1—Above, power supply for d.c. exciter lamps; left, filament supply for a.c. lamps.

speaker field power supply, capable of energizing the fields of four to six speakers. It will supply a maximum of 1.4 amperes at 110 volts d.c. The output voltage should be checked periodically and if found to be low the tubes should be checked, or replaced one at a time until the defective one is located.

control up to a point where the photo-cell hiss is audible, and while operating the sound change-over switch. Adjust P1 until the hiss from both cells is equal. A better method is to make the adjustments while running two loops of identical test film, one in each machine.

TRANSATLANTIC NEWS

From our European Correspondent, Major Ralph Hallows



ABOUT 15 years ago radio fans first noticed a peculiar hissing noise which sometimes occurred during reception on frequencies in the neighborhood of 60 megacycles. Though never very loud, the hiss was often strong enough to cause an unwelcome background to reception. It was suggested then and has since been confirmed that the noise might be due to radiation originating in the Milky Way.

Shortly before the war another type of hiss, sometimes strong enough to interfere considerably with radio reception, was first observed in Britain. This came about in a rather interesting way. Our first gun-laying radar equipment, developed sometime before the evolution of the cavity magnetron, used frequencies between 50 and 70 mc. Azimuth measurements were made by means of a directional aerial array, the cabin containing the radar set being rotated until the cathode-ray tube indicator showed that it was pointing straight at the target.

Operators began to complain that the time-base traces on their tubes were sometimes cluttered up by a peculiar kind of interference. When this interference was in evidence it was found that if the output of the radar was fed to headphones or a loudspeaker a loud hissing noise was heard. Both the noise and the clutter on the time base were found to occur only when two conditions were fulfilled: it must be a period of sunspot activity and the radar set must be so turned that its azimuth aeri-als were pointing in the direction of the sun. It was accepted that the hiss was probably due to some kind of solar radiation; but during the war there was no opportunity to investigate the matter very closely.

"ATMOSPHERICS" FROM THE SUN

Once the war was over a team of physicists was assigned the task of looking into the matter thoroughly. They are still at work, but they have already produced some very interesting results.

It has been established beyond any possibility of a doubt that hiss and shortwave radio blackouts are directly due to one form of solar activity. In February, July and September of this year shortwave blackouts occurred. On

each occasion the hiss was strong during the blackout and faded away as the blackout ended. But that was not all. The times when blackouts and hiss occurred coincided exactly with those of particularly violent outbursts of solar activity, when flares from great sunspots were observed by astronomers at Greenwich Observatory.

A flare is a gigantic column of incandescent gases, thousands of miles in height, shot out from a sunspot. Since hiss and blackouts began at the instant when activity resulting in a flare was observed through the telescope they must be caused by radiation travelling at the speed of light. That radiation was found to have its peak value in the neighbourhood of 60 mc. Such radiation has an effect on the reflecting surface of the F-layer which has been described as being like that of breathing on a mirror.

About one day after a solar outburst, radio communication on the short waves

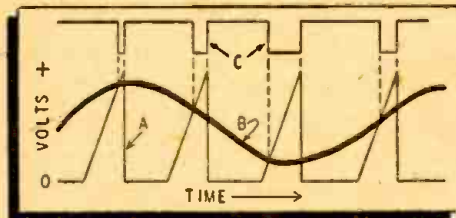

Diagram to illustrate pulse-width modulation.

is again affected and often the Aurora Borealis is seen. These are also due to the activity causing the flare, but as they do not happen until so many hours after the start of this activity they cannot be caused by electro-magnetic radiation travelling at the speed of light. They are in fact brought about by a bombardment of the upper atmosphere by actual atoms ejected from the flare. Travelling at less than one hundredth the speed of light these take many hours to journey from the sun to our world.

A controversy about Milky Way hiss is raging in the advanced scientific magazines. One group of physicists maintains that it is due to spots and flares on the surfaces of distant stars; another believes that the activity of atoms and electrons in the vast interstellar spaces is the cause.

The investigations of both kinds of hiss will undoubtedly lead to much new knowledge about the reflecting layers of our upper atmosphere and may have far-reaching effects on the future of long-distance radio communications.

BAT RADAR APPLICATIONS

As long ago as 1920 Professor Hart-ridge of London suggested that bats were able to avoid obstacles when flying in the dark at full speed by means of

a special development of their hearing system. Dr. Griffin of Harvard has recently examined and recorded the noises produced by bats and has found that they do in fact emit pulses of sound waves. In Britain the system of bat radar has been investigated scientifically and the results have led to some interesting articles in our magazine *Nature*. RADIO-CRAFT printed an article on the subject in 1945.

It has been found that the range at which a bat receives a "danger ahead" warning is about four feet. Allowing

1
for a reaction time of — second, this
10

enables the avoiding maneuver to begin at two feet from an obstacle and to be completed with still a foot to go.

Some highly ingenious outfits for demonstrating the principles of radar by means of sound waves have been made up and exhibited. One that I have seen emits high-pitched sound pulses from a miniature loudspeaker provided with a narrow horn to produce a directional effect. When an assistant walks about the lecture room his position is constantly indicated by "breaks" on the azimuth and range cathode-ray tubes of the device. Readers may spend an interesting time in devising apparatus on these lines for themselves. The velocity of sound waves in air, by the way, is $33,170 + 54t$ cm/sec, where t is the air temperature measured in degrees Centigrade.

PULSE MODULATION

The possibilities of pulse-width, pulse-height and pulse-position modulation are attracting a great deal of attention in this country. All have their advantages and drawbacks. At the moment the pulse-width system seems to be giving the most promising results. Some details have just been released of a remarkable radio equipment employing pulse-width modulation—PWM for short—developed by the British Army. This apparatus enables one v.h.f. carrier to be modulated by eight separate sets of signals. Each receiver picks out its own set of pulses and rejects the others. Space does not permit me to give any detailed description of the apparatus, which resembles very much the pulse-position modulation described in RADIO-CRAFT last February. All that I can indicate here is this. Every synchronizing pulse is followed by eight "channel pulses," each of which carries the modulation of a particular channel. The first pulse following the sync is always modulated by No. 1 channel, the second by No. 2 channel and so on. In the receiver a "gate tube," kept in step by the sync pulses, is opened only during

(Continued on page 47)

ADDING A CRYSTAL PICKUP

Several Methods of Hooking Record Players to Old Sets

IN CONNECTING record players to radio sets, particularly older circuits which make no provision for such connection, the following suggestions may be of benefit to servicemen and record dealers. Since the crystal pickup has practically superseded other types in

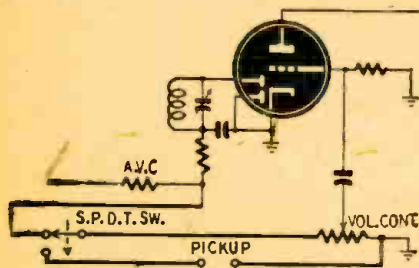

Fig. 1—Attachment to modern radio receiver.

the easily-obtainable replacement field, only this type will be discussed.

Little information on the subject has been printed, the last extensive article in RADIO-CRAFT being published no later than January, 1943. True, the problem is not difficult, but there are several wrong ways of doing the job, and more

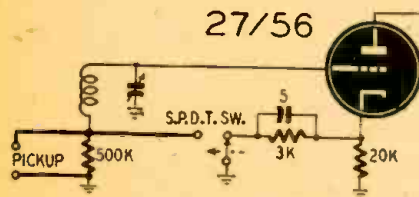

Fig. 2—Simple connection to power detector.

than one special circuit which can cause even the skilled serviceman to wonder which is the best and quickest method of hooking up a record player.

The modern set with a.v.c. and high-gain audio amplifier offers few problems. The circuit of Fig. 1 is satisfactory. This allows the volume and tone control in the set to be used with no interference from broadcast signals.

In older type sets, either a biased

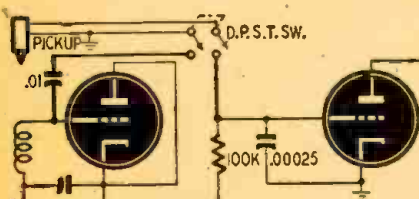

Fig. 3—Connection to sets like Philco III.

detector fed directly to a pentode output or a type 27 bias detector fed into a 27 audio amplifier and then to pushpull 45's were often used. In either case the

detector is needed as an audio amplifier to get sufficient gain for a crystal pickup. A commonly used connection is to the detector grid, but this is unsatisfactory because of detuning the detector circuit. Unless the leads are very short this circuit may also result in oscillation. A much simpler and better method is to disconnect the return end of the coil and connect a .5 meg resistor between it and ground. The high side of the phono jack goes to the junction of coil and resistor, the low side to ground.

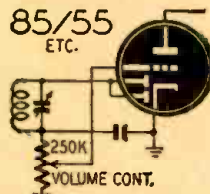

Fig. 4-a—Diode-biased detector-audio stage. Lack of bias on phonograph poses a problem.

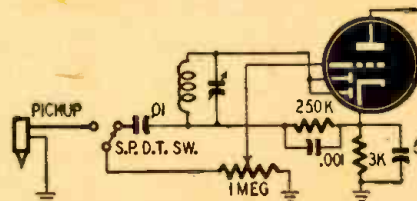

Fig. 4-b—Circuit is changed to cathode bias with pickup connected across volume control.

In order to bias the detector as an amplifier a resistor and by-pass condenser of suitable size for the tube and conditions is connected from cathode to one side of a s.p.d.t. switch. The other side of the switch is connected to the high side of the phono jack, the common terminal to ground or chassis. Fig. 2 will make the connections clear. Values may vary with different tubes and sets, but those shown will work well.

In one switch position the set will operate in its original state, the other position connects the pickup. Leads may be as long as required, without affecting set operation. Turning the volume control—which in these radios usually biases the r.f. tubes—to minimum position will eliminate broadcast interference. If it persists, a d.p.d.t. switch may be hooked up instead of the s.p.d.t. shown, and the second section used to open a cathode circuit.

In addition to these basic circuits, there are a few special cases that may offer some difficulty. Among these are hookups like the Philco type numbers 111, 112, etc.

The connections are shown in Fig. 3, but leads must be as short as possible.

The phono jack and switch should be mounted in the rear right hand corner of the chassis close to the audio amplifier tubes.

Sets using diode-biased triodes as audio amplifiers, such as 55, 85, 6R7 (and sometimes separate tubes as detector and amplifier) may also offer some difficulty. With no r.f. applied, there is no bias and consequently high distortion. Fig. 4-a gives the original circuit; Fig. 4-b, the pickup connection. The tube is biased by a cathode resistor, with the coil returned to cathode and not to ground. The volume control is connected through a coupling capacitor and s.p.d.t. switch. The volume control should be several times higher in value than the diode load, one megohm or greater. There may be a slight increase in distortion due to the change in volume control circuit but it will not be noticeable to the average listener. If a perfect circuit is required a d.p.d.t. switch may be used to combine the functions of Figs. 1 and 2, switching the volume control from radio to pickup and inserting a cathode resistor.

The Majestic M-25 employs a little-used detector circuit. When connected as shown in Fig. 5, the twin detector tubes operate in parallel when using the phonograph pickup. The cathodes are biased by a resistor on phono and grounded directly on radio. To kill broadcast signals, a lead is taken from the antenna terminal to one terminal of the d.p.d.t. switch.

Some special problems—or rather opportunities—may be found in battery sets. A switch may be inserted to cut off the filament supply to those tubes which are not used on phonograph, thus

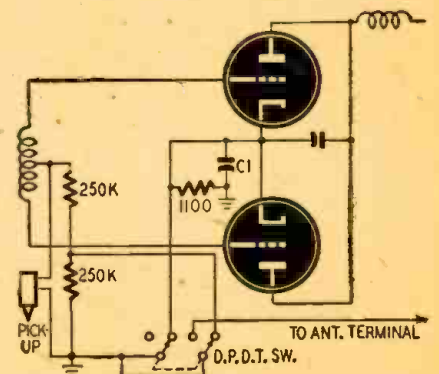

Fig. 5—Attachment to another special circuit.

economizing. The smallest battery sets (portables) often have not enough output to give good performance, though some listeners are well satisfied with them as record players.

WORLD-WIDE STATION LIST

"Merry Christmas" to you, and may good old Santa bring you a new receiver, a Panadaptor, a super-duper antenna kit, or whatever you are wishing and hoping for at this time of the year. Also, we sure hope the old gent will remember to bring us some good dx this winter. It sure seems like a long time since any real good dx has been heard, at least in this section of the world.

The BBC has changed its schedules to 11.800 from 5 am to 6 am and 4:15 to 9:45 pm; 15.310 from 6 to 8:15 am; 4:15 to 6:45 pm; 18.130 from 8 to 11:15 am; and 11:30 am to 4:15 pm; 9.625 from 4:15 to 11 pm; 9.825 from 5 to 11 pm; and 6.110 from 7 to 11 pm. The 11.800 and 9.625 frequencies are beamed to the west coast of North America, while the others are beamed to the east coast, the North Caribbean, and Mexico.

HOXA in Panama City, Panama is

heard on 15.100 megacycles from noon to 9 pm; and HOXE is heard on 11.810 megacycles from 9 to 11 pm. They use the name of "Radio Central America" and are very well received most of the time. These are new transmitters, and have only been on a short time. They would like reports on reception, which may be sent to HOXA, Radio Central America, Panama City, Panama.

Keep one eye open for the Aussies, as they are again being heard very well on the east coast, and we would like to have your reports on them. We haven't a schedule of them at present, but we will try to have one for the next issue. Moscow is also being heard quite well on the east coast on several of their regularly used frequencies.

The International Service of the CBC in Montreal is now being heard with CKNC on 17.820 mc 4 to 8 pm; CKLK on 15.090 mc 4 to 9 pm; CKCS on 15.320

mc 5 to 11 pm; CHOL on 11.720 mc 3:15 to 11 pm; CKRA on 11.760 mc 6:20 to 7:30 pm.

The 20 and 75 meter amateur phone bands are very active these days, and some good dx is heard now and then on the 20 meter band. Several ham stations are being operated by U. S. Army personnel while they are stationed in foreign countries. Heard quite often is W7ELL on Iwo Jima, W6OCA from Japan, W2LFI from French West Africa, and W8QEN (a Navy man) from the Azores. Nearly all countries and continents are being heard on 20 meters. Let's have a few more reports on activities on this band. Best of luck, and lots of fb dx during the coming year. Send all reports and correspondence to Short Wave Editor, c/o Radio-Craft, 25 West Broadway, New York City, 7.

All schedules in Eastern Standard Time

Freq.	Station	Location and Schedule	Freq.	Station	Location and Schedule	Freq.	Station	Location and Schedule
7.230	GSW	LONDON, ENGLAND; Indian beam, 9 to 11 pm; Southwestern Pacific beam, 1 to 4 am.	9.125	HAT4	BUDAPEST, HUNGARY.	9.165	CR6RB	BENGUELA, ANGOLA; 3:30 to 4:30 pm; 8:30 to 9 pm.
7.230	KWID	SAN FRANCISCO, CALIF.; Oriental beam, 6:45 to 11 am.	9.130	H12G	CIUDAD TRUJILLO, DOMINICAN REPUBLIC; heard at 9 pm.	9.185	HEF4	BERNE, SWITZERLAND; North American beam, 7:15 to 8 am.
7.250	KGEX	SAN FRANCISCO, CALIF.; Philippine beam, 5 am to noon.	9.140	KU5Q	GUAM; heard at 7 am.	9.235	COBQ	HAVANA, CUBA; 9 am to noon; 8 to 10 pm.
7.250	PJCI	WILLEMSTAD, CURACAO; 11:45 am to 12:15 pm; 3 to 4:30 pm.				9.270	COCX	HAVANA, CUBA; heard at 12 am.
7.250	GW1	LONDON, ENGLAND.				9.300	MACEIO	MACEIO, BRAZIL; 6 to 7 pm.
7.260	GSU	LONDON, ENGLAND; North American beam, 7 to 11 pm.				9.330	KU5Q	GUAM; 8 am.
7.260	JVW	TOKYO, JAPAN; Home service, 3 pm to 8:30 am.				9.330	PY	ANDORRA; noon to 7 pm.
7.265		MUNICH, GERMANY; 11 pm to 2 am; noon to 4 pm.				9.305	PJY9	MANILA, PHILIPPINES; 5 to 7 am; 11 to 11:30 pm.
7.275	VUD3	DELHI, INDIA; 8 to 7 am; 11:15 am to 1:15 pm; 6:30 to 7:15 pm; 9 to 10 pm.				9.340	HBL	WILLEMSTAD, CURACAO.
7.280	VLC8	SHEPPARTON, AUSTRALIA; 10:15 to 10:45 am.				9.345		GENEVA, SWITZERLAND; 1 to 3 pm.
7.285	JLG	TOKYO, JAPAN; Home service, 4 to 8 am.				9.350		VIENNA, AUSTRIA; heard at 4:30 pm.
7.290	VUD3	DELHI, INDIA; 7:30 to 10:30 am; 9 to 10 pm.				9.350	CBFX	SOPIA, BULGARIA; on at 11 pm.
7.295	ZOY	ACCRA, GOLD COAST; off at 1 pm.				9.360		MONTREAL, CANADA; 6:30 am to 10:30 pm.
7.300		MOSCOW, U.S.S.R.; noon to 5 pm; 6:15 to 11:30 pm.				9.360	EAQ	CETINJE, YUGOSLAVIA; 1:30 to 3 pm.
7.315	Y8N	SAN SALVADOR, EL SALVADOR; 1 to 3 pm; 7 to 11 pm.				9.370	COBC	MADRID, SPAIN; 2 to 3 am; 7 to 9 am; 10 am to 5 pm; 6:30 to 9 pm.
7.320	GRJ	LONDON, ENGLAND; Northwestern Pacific beam, 11 pm to 12:30 am; Italian beam, 11 pm to 12:30 am; Far Eastern beam, 11 pm to 12:30 am; South American beam, 6 to 10:15 pm; Near East beam, 11 pm to 12:30 am.				9.385	OTC	HAVANA, CUBA; heard at 5:30 pm.
7.380	NCN	U.S. NAVY at Guam.				9.420	FZI	LEOPOLOVILLE, BELGIUM CONGO; 5:30 to 7:30 am.
7.380	HEK3	BERNE, SWITZERLAND; 8:10 to 8:30 pm; 6:30 to 8 pm.				9.440		BELGRADE, YUGOSLAVIA; midnight to 2 am; 10 to 10:45 am.
7.565	KNBA	SAN FRANCISCO, CALIF.; Oriental beam, 4 to 9:45 am.				9.440		BRAZZAVILLE, FRENCH EQUATORIAL AFRICA; 11 am to 8:20 pm.
7.565	WNRE	NEW YORK CITY; European beam, midnight to 3:15 am; 4:30 to 6 pm.				9.465	TAP	ANKARA, TURKEY; 11 am to 4:45 pm.
7.570	EAJ43	SANTA CRUZ, CANARY ISLANDS; 11 am to noon; 5 to 6:15 pm.				9.470	CR6RA	LOUANDA, ANGOLA; heard signing off at 4:30 pm.
7.575	KCBA	SAN FRANCISCO, CALIF.; East Indies beam, 4 to 9:45 am.				9.480	WCBX	MOSCOW, U.S.S.R.; 6 to 8 am; 11 to 11:30 am; midnight to 1 am.
7.805	KNBX	SAN FRANCISCO, CALIF.; Oriental beam, 5 to 11 am.				9.490	KNBI	NEW YORK CITY; Brazilian beam, 4 to 10:30 pm.
7.805	WOOC	NEW YORK CITY; European beam, midnight to 3:15 am; 3:30 to 5:45 pm.				9.490	KNBX	SAN FRANCISCO, CALIF.; Oriental beam, midnight to 3:45 am; Hawaiian beam, 4 to 9:45 am.
7.850	ZAA	TIRANA, ALBANIA; 2 to 6 pm.				9.490	GNB	SAN FRANCISCO, CALIF.; Oriental beam, 11:15 am to 3:30 pm.
7.860	SUX	CAIRO, EGYPT; 5 to 5:30 pm.				9.490	GW	LONDON, ENGLAND.
7.950		ALICANTE, SPAIN; off at 6 pm.				9.495	ZBW	VICTORIA, HONG KONG; 4:30 to 8:30 am.
8.000		DAMASCUS, SYRIA; 11 pm to midnight.				9.500	XEW	MEXICO CITY, MEXICO; 8 am to 2 am.
8.030	FXE	BEIRUT, LEBANON; 11 pm to 5:30 am.				9.502	OIX2	LAWYI, FINLAND; 11 to 4 pm.
8.565	AFN	MUNICH, GERMANY; 4 am to 12:15 pm.				9.510	TAP	ANKARA, TURKEY; 1 to 2 pm.
8.685	COJK	CAMAGUEY, CUBA; 8 pm to 12:30 am.				9.510	GSB	LONDON, ENGLAND; Near East beam, 11 pm to 12:30 am; 12:15 to 4 pm; South American beam, 4:15 to 10:15 pm; Indian beam, 11 pm to 12:30 am; Ceylon beam, 9 to 11 pm; Middle East beam, 11 pm to 1 am; Italian beam, midnight to 4 am; 12:15 to 4 pm; Southwest Pacific beam, 1 to 4 am.
8.696	COCO	HAVANA, CUBA; 7 am to 11:30 pm.				9.520		PARIS, FRANCE; North American beam, 12:30 to 12:45 am; 1 to 1:15 am.
8.830	COCQ	HAVANA, CUBA; 4:30 am to 12:30 am.				9.520	VLW7	PERTH, AUSTRALIA; 5:30 to 10:30 am.
8.840		DAKAR, FRENCH WEST AFRICA; afternoons till 4:30 pm.				9.520	ZRG	JOHANNESBURG, SOUTH AFRICA; 2 to 7 am.
8.950	COKG	SANTIAGO, CUBA; 6:30 am to 10 pm.				9.530	WGEO	SCHENECTADY, NEW YORK; South American beam, 5 to 11 pm.
8.985	COKW	HAVANA, CUBA; evenings.				9.535	JZI	TOKYO, JAPAN; 7 to 8:15 am.
9.030	COBZ	HAVANA, CUBA; 7 am to 11 pm.				9.535	SBU	STOCKHOLM, SWEDEN; 1:30 to 5 pm; 8 to 9 pm; Sundays only, 5 to 9 am.
9.062	CNR3	RABAT, MOROCCO; 2 to 5 pm; midnight to 3 am.						
9.120		BALIKPAPAN, BORNEO; heard 5 to 6 pm.						

RADIO TERM ILLUSTRATED



Suggested by: J. Durnett, Vancouver, B.C., Canada
Volume Control

(Continued on page 52)

NEW

RADIO-ELECTRONIC DEVICES

TELEVISOR KIT

Transvision, Inc.
New Rochelle, N. Y.

This Television Kit includes, in addition to all the components and the necessary solder and wire, complete assembly directions.



The picture tube included in the kit is a seven-inch electrostatic type. There are 18 tubes, three i.f. picture stages, 3.5-megacycle bandwidth in the picture circuit, newly designed sweep circuit, 3000 volts second anode supply, giving sufficient brilliance to allow daylight viewing.

There are three television channels which will be adjusted to give reception for each individual location. The sensitivity is good enough to allow reception within approximately a 50-mile radius of the television station.—**RADIO-CRAFT**

PLASTIC CAPACITORS

Condenser Products Co.
Chicago, Ill.

Two complete lines of Plasticon Glassmikes, types ASG and AOG, are now available. These condensers use a plastic film dielectric and are hermetically sealed in metallized glass tubes.

Type ASG is silicone-filled with an operating range of minus 60 degrees to plus 125 degrees Centigrade. Type AOG is filled with mineral oil and is efficient at temperatures ranging from minus 40 to plus 105 degrees Centigrade.



These condensers are made with a tolerance of 1 percent with working voltages from 600 to over 30,000. Insulation resistance is 20,000 megohms per μf .—**RADIO-CRAFT**

ADD-A-UNIT AMPLIFIER

Concord Radio Corp.
Chicago, Ill.

The new Multiamp Add-A-Unit basic amplifiers are available for 30 or 45 watts output. Simple plug-in units may be used to increase the flexibility of the

amplifiers by increasing the number of input circuits, and boosting the power output up to 60, 75 or 90 watts. A screwdriver is the only equipment necessary for adding any unit to the basic amplifier.

The basic amplifiers are equipped with dual tone controls, two 100,000-ohm microphone input circuits at 122 db and two high impedance phono inputs at 83 db. The tops of the cabinets are removable and are replaceable with record player or automatic changer tops.

A plug-in input stage provides two additional input and control circuits for microphones. A plug-in output meter uses two neon lamps, one marked NORMAL and the other OVERLOAD. A calibrated dial permits the operator to set the amplifier to work at any percentage of its full output and when the pre-set level is reached, the "normal"

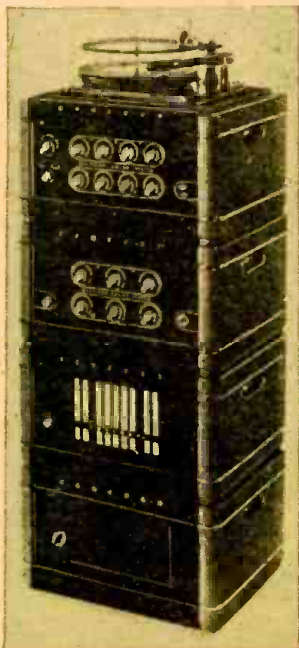

lamp lights. If the level is exceeded, the "overload" lamp lights.

Blank cabinets are available for housing additional power boosters and associated power supplies to give audio outputs up to 270 watts.—**RADIO-CRAFT**

ELECTRON TRACER

Electronic Instrument Co.
Brooklyn, N. Y.

The Model 113 Electron Tracer combines, in one compact unit, all equipment necessary for rapid trouble shooting in broadcast, shortwave, FM and television receivers. The instrument consists of an audible signal tracer and an a.c.-d.c. electronic volt-ohmmeter.

The signal tracer uses a 6F5 probe feeding into a 6SJ7 high gain amplifier. This tube drives the 6V6 output stage for the 4-inch built-in speaker. The tracer is sensitive enough to trace a signal from the antenna post of a

receiver to the speaker. The frequency range of the probe is from 20 cycles to over 100 mc.

The d.c. v.t.v.m. uses a 6SN7 in a grounded grid bridge circuit to drive



a meter. The a.c. v.t.v.m. circuit uses a 6SQ7 to amplify and rectify a.c. voltages and apply them to the d.c. section. The electronic ohmmeter uses the d.c. voltmeter bridge and a 1.5-volt battery to measure resistances.

The meter functions are as follows: d.c. voltmeter, 0 to 5, 10, 100, 500, 1000 volts with input resistance of 26 megohms. The same voltage ranges are available for a.c. measurements at nearly 1 megohm input impedance. Five electronic ohmmeter ranges: 0-1000 ohms with 9.5 ohms C.S.; 0-10,000 ohms with 95 ohms C.S.; 0-100,000 ohms with 950 ohms C.S.; 0-1 megohm with 95,000 ohm C.S.; 0-1000 megohms with 9.5 megohm C.S.

This tester is useful in measuring voltages in inverse feedback circuits, FM and a.f.c. discriminators and in the video circuits of television receivers.

All ranges of the meter are protected against overload. A bridge circuit provides constant accuracy despite line voltage variations.—**RADIO-CRAFT**

AUDIO FREQUENCY METER

General Electric Co.
Schenectady, N. Y.

The unit has been designed for use in FM and AM transmitter monitoring, in the manufacture of all types of electronic devices, and in many industrial operations.

The meter gives a direct indication of the frequency of an audio voltage applied to its input over a range extending from very low pulses up to 50,000 cycles per second. A range switch is provided, permitting maximum accuracy on any one of eleven ranges within the above limits. Over a power-line range of 105 to 125 volts, variation in the frequency reading will not vary more than 1 percent.—**RADIO-CRAFT**

RADIO DATA SHEET 342

HOWARD RADIO

MODEL 901

TUNING RANGE 540-1600 kc
 I.F. 450 kc
 Type Iron-core tuned
 Power Output (Max.) 1.25 w
 SPEAKER 5-in. Electrodynamic
 V.C. Imp (400 cps), 3.2 Ohms

TUBES:
 12SA7 Mixer
 12SK7 i.f. Amp
 12SQ7 Diode, 1st a.f.
 50L6GT Output
 35Z5GT Rectifier



The Howard 901-I is a one-band receiver in an ivory plastic cabinet; Model 901-M, the same receiver in a walnut plastic cabinet.

ALIGNMENT INFORMATION

Each 455 kc i.f. coil has an iron core adjustment protruding from the top and the bottom of the i.f. can. Look beneath the chassis to reach the lower i.f. adjustments. Repeat the i.f. alignment operation several times to insure accuracy of adjustment.

Add or remove resistance in the cathode circuit of the 12SK7 tube as the i.f. gain indicates.

The wire lead running from the loop aerial between the i.f. coils and the condenser gang is important in its placement. Dress this wire tightly to the chassis.

Set dial at 1400 kc and adjust oscillator trimmer which is located on back section of variable condenser, then peak antenna stage trimmer on front section of variable

condenser to 1400 kc. No adjustment is required at the low frequency end of the dial.

The filter condenser has a common negative, but note it does not return to ground and is insulated from the chassis.

a 20,000 ohm-per-volt d.c. meter and the line voltage fixed at 117 volts a.c.



Replacement Parts List

- Condensers (Tuning):
 Filter, 30-30-30-mfd, 200 v.
 Filter, 30-20-mfd, 150 v. or
 Filter, 30-30-mfd, 150 v.
 Filter, 25-mfd, 25 v.

Coil Assemblies:

- Antenna loop
- Oscillator coil
- 1st i.f. assembly, complete
- Diode i.f. assembly, complete

SOCKET VOLTAGE READINGS					
TUBE	FUNCTION	CATHODE	SCR. GRID	PLATE	OSC. PLATE
12SA7	MIXER		92	92	92
12SK7	I.F. AMP	3	92	92	
12SQ7	DETECTOR			44	
50L6-GT	OUTPUT	5,8	92	85	

All voltages taken from the back of the a.c. switch to the socket contacts with

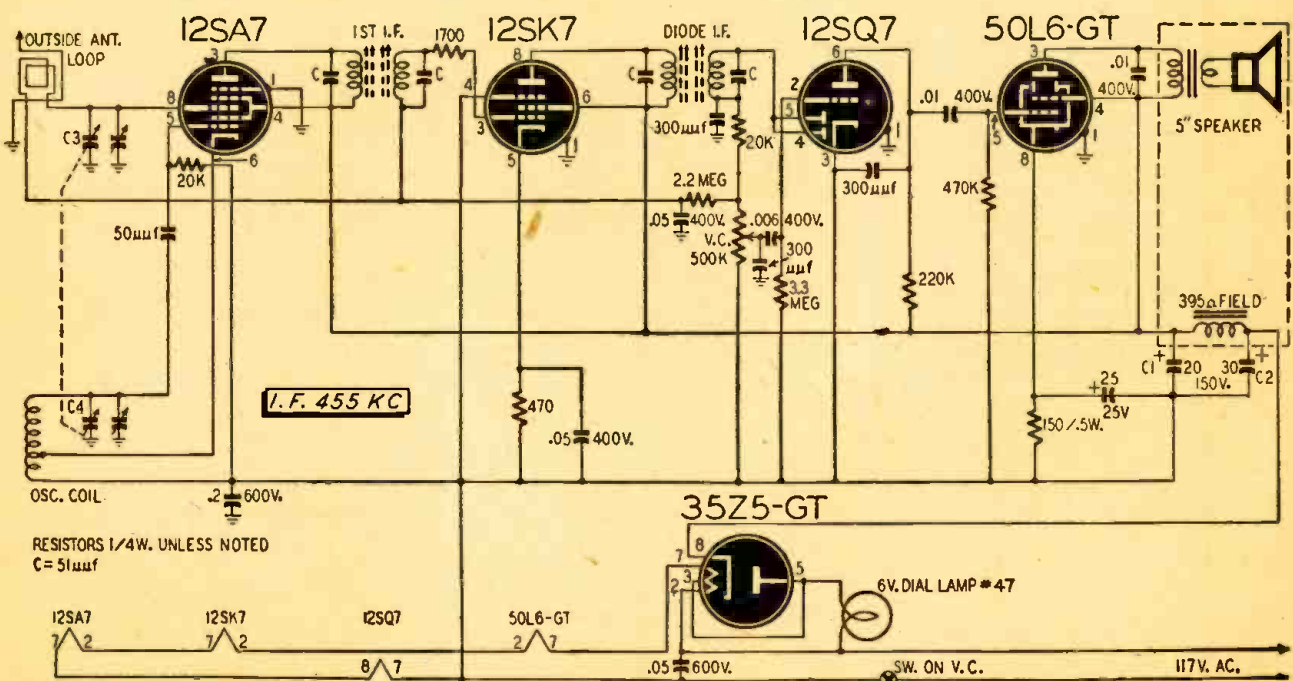

RADIO-ELECTRONIC CIRCUITS

SPEECH AMPLIFIER

This speech amplifier was designed as a driver for the modulator of an amateur transmitter. The circuit uses a 6L7 resistance-capacity coupled to a 6J5 phase inverter for push-pull 6J5's. Provisions are made in the 6L7 circuit for the injection of automatic modulation control voltage to the No. 3 grid.

The phase inverter is a modification of the Australian Kangaroo circuit. Grid excitation for one 6J5 is taken from the plate of the inverter tube. In the Kangaroo circuit, the input signal to the inverter appears between the grid and ground and the overall gain is limited to less than 2.

In this circuit, the input signal appears between the grid and cathode of the inverter. In this way, the degenerative effects of the Kangaroo are avoided and the gain is increased to about 15. This gain is possible because the cathode feedback voltage, which would normally be in series with the grid return, is isolated from the grid circuit by C1, R3, and C2 which effectively bypass the feedback voltage to ground. R2 and R3 are in parallel, with respect to a.f. voltage, and the effective impedance of R2 is equal to R3 making the audio voltage drop across each of the load resistors equal. Voltage for the other 6J5 is taken from the junction of R1 and R2.

WILSON FINLEY,
Canton, Ohio

(Note: In this circuit, the input is floating and the inverter will probably suffer from hum from its cathode. This may be cured by applying a potential equal to the cathode voltage to the heater return.—Editor)

MULTI-STATION TUNING

The following scheme will be a great convenience for the amateur who likes round-table operation or for the s.w.l. who has a favorite station. By adding a small ganged tuning condenser with

appropriate trimmers, and switching between this and the regular tuning condenser it is possible for the ham to set up two stations at once and change from one to the other merely by throwing a switch (d.p.d.t. for two gang, t.p.d.t. for three gang circuits) thus eliminating the usual scramble and delay of tuning across the band to find the other net station. By using a small capacity tuner (with shunt trimmers to bring it into the band) no vernier will

DE FOREST 40TH ANNIVERSARY NUMBER

What's so special about the January issue of RADIO-CRAFT? It will have twice the number of pages and will be of historical import. It will contain articles by Dr. Lee de Forest and other prominent figures of the radio world. January marks the 40th Anniversary of the birth of the vacuum tube. Reserve your copy NOW!

be necessary, its spread being approximately equal to its fraction of the regular condenser's capacity.

For the s.w.l., who regularly listens to any of several stations, a mica pad-

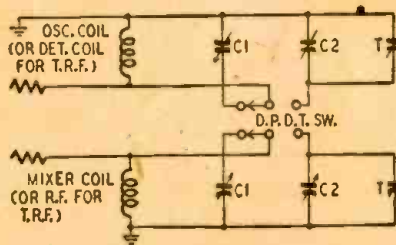

ding set pre-tuned to each station may be used. The stations are selected with a multiple-throw rotary switch. Tune the condensers to the station (little or no realignment of the main condenser will be necessary) and the station is ready merely by flopping the switch.

J. O'CONNELL,
Wilmington, Calif.

VARIABLE D.C. SUPPLY

This circuit is useful in supplying low-current d.c. voltages up to 110 volts for powering ohmmeters and other devices having similar requirements.

The transformer, wound on the core of an old audio transformer, has a high voltage secondary producing between 85 and 110 volts, and a filament winding to supply the tube used.

Voltage output variation is obtained by varying the position of the potentiom-

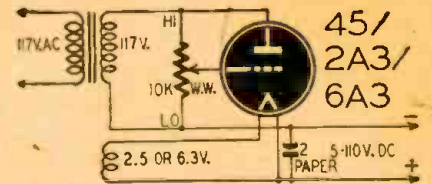

eter across the high voltage winding. Maximum output is obtained when the grid potential is equal to that of the plate.

MERLE GIER,
Wichita, Kansas

HIGH FIDELITY TUNER

Here is the circuit of a simple high fidelity tuner. It can be attached to any public address system with excellent results. It uses a 6K7 r.f. stage and a 76 detector. The coils and tuning condensers were salvaged from an old t.r.f.

In localities where there are strong local stations, it may be necessary to use a small condenser between the grid of the 6K7 and the antenna to provide the proper ratio between selectivity and sensitivity.

SAUL SHERMAN, W2MPL
New York City

(It might be better to refer to the circuit as a medium-fidelity tuner, as its quality of output is intermediate between that of an average superheterodyne and the special r.f. tuners with broadened tuning characteristics.—Editor)

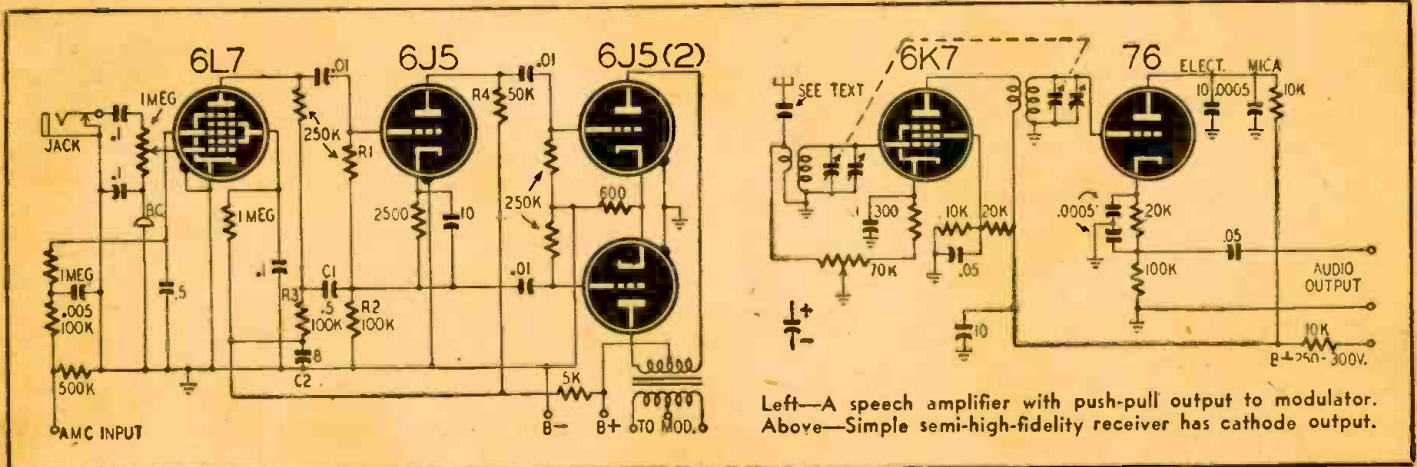

Left—A speech amplifier with push-pull output to modulator. Above—Simple semi-high-fidelity receiver has cathode output.

MINIATURE 3-TUBE RECEIVER

All Batteries Are Included In This Diminutive Radio



QUITE a few vest pocket radio receivers have been described in past issues of magazines, but unfortunately these sets required external battery packs or were

otherwise bulky. The recent development of extremely small batteries, tubes, and other components should make possible the design of radios no larger than a package of cigarettes, which will easily slip into a vest pocket. Some experiments in this direction led to a radio which contains an orthodox circuit consisting of regenerative detector followed by two stages of audio amplification; the only deviation from standard set construction being use of very small parts and crowded wiring.

The entire set and cabinet was built around a diminutive 22½-volt B battery which measures approximately 2½ x ¾ x 1¼ inches while the outside case dimensions of the radio are 3¼ inches high by 2½ inches wide by 1½ inches deep, excluding the height of the knob extending above the case. All parts were mounted upon the front panel, to which the top of the cabinet was also attached. The two controls, tuning trimmer and slide switch, were also mounted on the top section.

Even the very smallest tuning condensers were much too large to be practical for use in such a small radio, and for this reason a trimmer was modified somewhat so that a knob could be attached. This was done by drilling a hole through a piece of quarter-inch brass shaft. The shaft was affixed to the screw extending from the trimmer. The quarter-inch shaft should be brass, since

brass is soft enough that the trimmer screw will "tap" into it if the hole is made slightly smaller than the trimmer screw. A compact regenerative coil was provided by removing the terminal strip and dowel from a standard oscillator coil.

All wiring should be done with a pencil type soldering iron for ease of construction. The three flat hearing-aid type tubes are held in place

should serve admirably. Time did not permit further work with the receiver, so it is given "as is" for what help it may be to other experimenters with compact apparatus.

(This receiver, tried out in a New York apartment, brought in stations WHN, WNEW, WOV and WBNX with good volume and quality. These stations

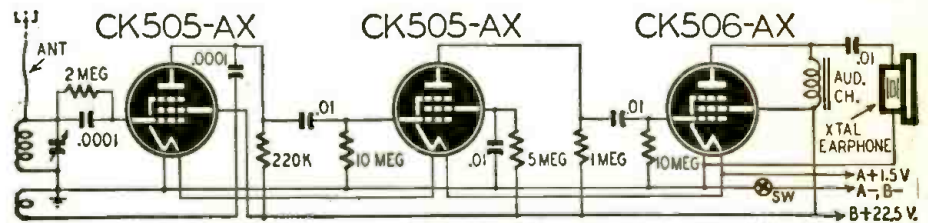

PARTS LIST

- 1—14034 Meissner Coil
- 2—CK505AX tubes, Raytheon
- 1—CK506AX tube, Raytheon
- 1—22½-volt battery, Eveready

- 1—Audio Choke, Stancor OC-32
- 4—.01-mf Condensers, Good-All S-7
- All resistors BT½ s I.R.C.
- 1—370-mmf padder, 2—.0001 mica condensers

with speaker cement. These tubes are provided with long leads which should be cut short. Flexible No. 22 d.c.c. wire was used for wiring in place of the comparatively rigid tube leads.

Although some sort of antenna is necessary, it need not be more than a foot long in a favorable location. The constructor will probably notice that the volume will increase when the radio is brought near any metal object, especially electrical appliances; in fact the electrical wiring in the walls may be followed by noting signal strength variations.

Mention should be made of the set's rather narrow tuning range which is from 1600 to 1100 kc with the coil-condenser combination specified. To cover lower frequencies, a coil with a higher inductance such as an iron-cored antenna coil with suitable alterations

range from 1050 [WHN] to 1380 [WBNX]. It would appear that the first problem is to increase the tuning range to cover the entire broadcast band, instead of the fraction which can now be received, if the set is to be practical. This might be done with a specially-built condenser, or even better, permeability-tuned coils. Regeneration is another problem by no means solved. The three-foot antenna wire, when brought near a radiator or telephone, would load the circuit sufficiently to prevent oscillation. Moving the aerial away would first increase signal strength, then as the coupling decreased, the set would burst into oscillation, ruining the program. Possibly a hearing-aid type of control could be combined with the off-on switch. The set contains a number of good ideas, and is an excellent starting point for anyone who wishes to construct a miniature receiver.—*Editor*)

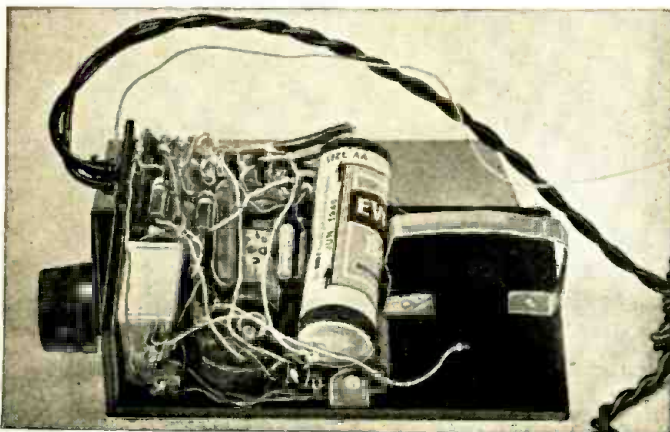

Inside the set. Special tuning condenser is in foreground, left.

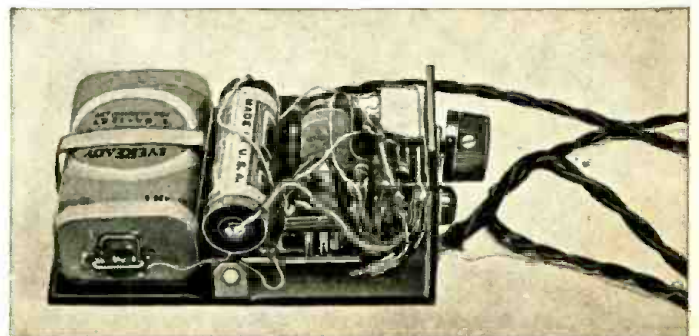

Other side of receiver with batteries in place. Cord is for phones.

NOW YOU can BUILD a TELEVISION

To stimulate its radio and television training program, the New York Technical Institute of New Jersey is offering men interested in television this unusual opportunity.



Instructor demonstrating rare Schmitt Optical System, used in big picture, projection type, television receivers. This famous television school's location in the heart of the television industry, helps it to get such scarce scientific equipment. At N.Y.T.I. of N.J. all types of television receivers are available for student study.

IF you are unable to leave home to go to a resident school, N.Y.T.I. of N.J. can supply you with parts to build a television chassis in your own home. You will be supplied with the same instructions and directions with which the school's resident students are equipped, when they reach the stage in their training that calls for television set construction. If you already have a sound radio background, with experience in building radio receivers, you will be surprised to find how much you can learn about television by building this set.

N.Y.T.I. of N.J. is one of America's leading resident schools for men seeking dependable, thorough, up-to-the-minute training in the various fields of radio and electronics.

A School Particularly Suited to War Veterans

The schooling offered by N.Y.T.I. of N.J. is particularly useful to War Veterans who recognize the high-earning possibilities of technical training in radio and television and are willing to tackle the class and laboratory work offered, regardless of their previous education.

No high-school diplomas are needed for entrance. But N.Y.T.I. of N.J. requires that a student be earnest, sincere and radio-minded. Students without proper mathematical backgrounds are taught the radio and television mathematics they need. Several students with only grammar school educations have successfully completed advanced technical television courses.

Many veteran students are now attending N.Y.T.I. of N.J. under the generous provisions of the G.I. Bill of Rights, which allows any approved school of the veteran's choice to charge the Veterans Administration up to \$500 a school year against the educational expenses of qualified veteran students. Full-time students, with depen-

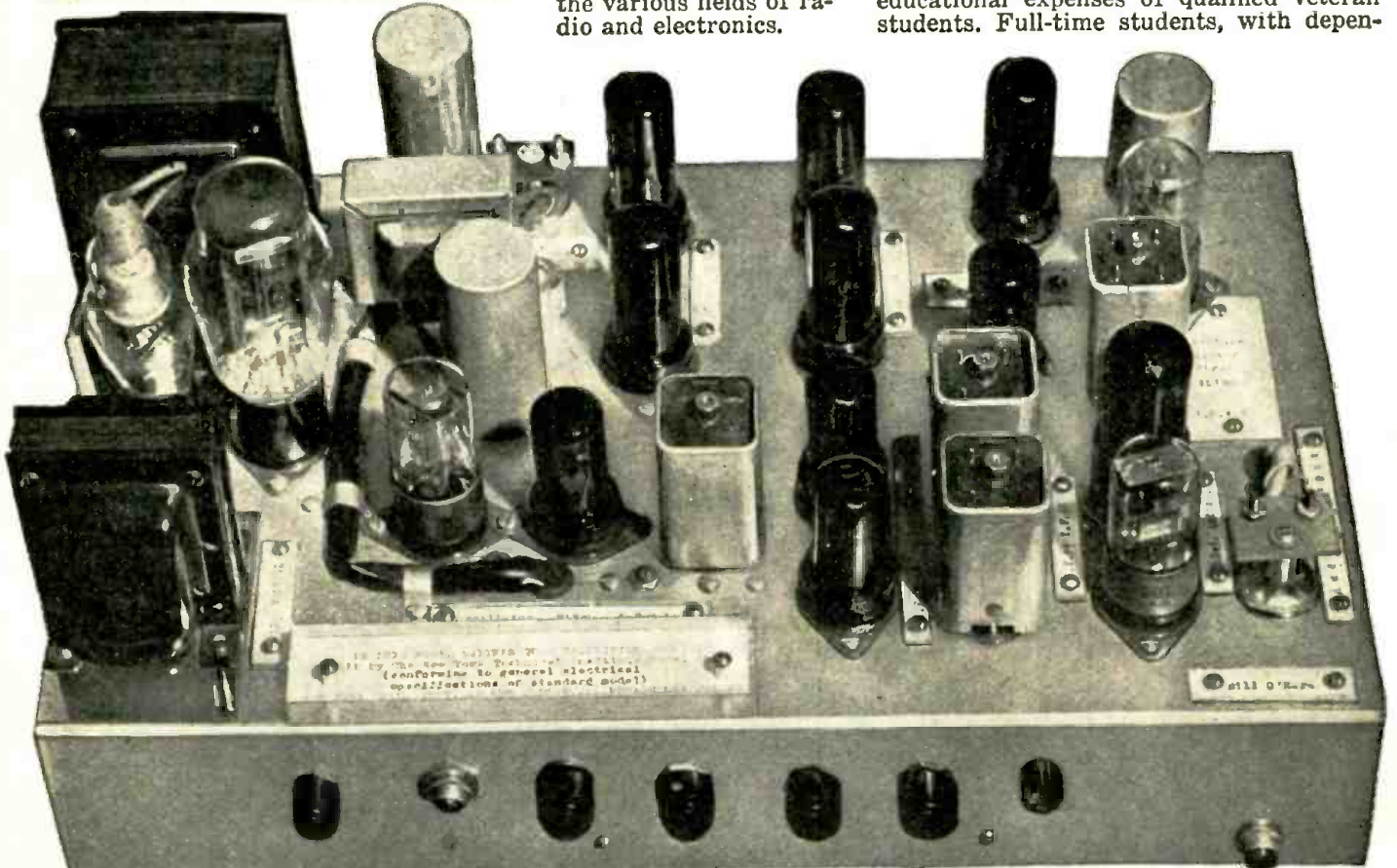

You can build a direct viewing television chassis similar to the one pictured above, either in your own home or in the magnificently equipped shops and laboratories of this famous television

school, located square in the HEART of America's television manufacturing and broadcasting industry. Mail the coupon at the right to get full details.

SET RIGHT in YOUR OWN HOME!

dents, are also paid a subsistence allowance of \$90 monthly by the VA, and those without dependents, \$65. Many students hold part-time jobs, thus augmenting their monthly subsistence payments. However, you do not have to be a veteran to be accepted as a student.

A considerable number of out-of-state students attend the school because of its excellent, practical type of radio and television courses, so difficult to get anywhere else in the world today. Living quarters are obtainable by single students.

You Put Into Practice Everything You Learn

Students at N.Y.T.I. of N.J. particularly like the way the school puts into practice what it teaches. You may actually build a 17-tube television chassis. You also help build as many as 7 radio receivers of different types, a total of 75 electronic educational devices. Class study and laboratory study, in the proper combination, increase interest—and your hands get as smart as your head. With only average ability you should learn radio servicing in 8 months. In only 4 more months, you can know television receiver servicing. You can take even more advanced engineering-type courses if you wish. And throughout all your laboratory work you are using the finest and latest equipment available.

A 17-tube, commercial-type, television chassis may be built by all resident students of television, and may be kept as their own property, if they choose.

Located in the Heart of the Electronic Industry

The New York Technical Institute of New Jersey is in Newark, N. J., just across the river from New York City (only 20 minutes from Broadway by subway or train). The school is located in the heart of America's great radio and electronics industry. Such leading television, radio and electronics manufacturers as R.C.A., Western Electric, Du Mont, Federal and Edison are nearby. Newark also is near Radio Stations WJZ, WEAJ, WABC and WOR; each a leader in broadcasts going on networks all over the country. This means that the school offers numerous advantages, as it is in touch with the most recent developments in radio and television.

Highly qualified television and radio instructors are here in abundance. Equipment is easier to get. Television students are offered exceptional advantages in this great electronic center.

Send For Special Bulletin 412—FREE

The school issues a special Bulletin, Numbered 412, which illustrates and describes its truly exceptional facilities and equipment. Bulletin 412, also describes classes that may be attended, housing conditions, costs, hours, etc. If you are interested in Television—you will want to read this bulletin. You can have it free, merely by mailing the coupon at right.

The school will also be happy to send you complete information about the television kits and directions which are now available to you if you desire to build your own television chassis at home.

To get information about building a television chassis in your own home or to get Bulletin 412, describing our famous resident school in Newark—just fill out the coupon at right and mail it NOW to: *New York Technical Institute of New Jersey, 158 Market Street, Newark, N. J.*



Instructor demonstrating theory of light in connection with study of optical systems used in projection type television receivers. This is just another one of the pieces of equipment which the New York Technical Institute of N.J. has available for resident student instruction.



Big picture television (16" x 21 1/4") in the flesh at N.Y.T.I. of N.J. When it comes to television receivers, N.Y.T.I. of N.J. has it! All types of television receivers are available for student use and instruction at the school.

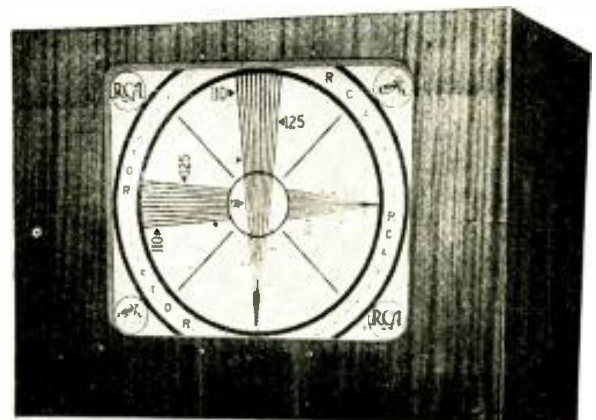

Standard laboratory type test pattern used for determining picture perfection in all types of television transmitters and receivers. (You can see it at N.Y.T.I. of N.J.)

New York Technical Institute of New Jersey
158 Market Street, Newark, New Jersey

Check here if you wish to receive Bulletin 412 describing the resident school of the New York Technical Institute of New Jersey located in Newark, N. J.—including its facilities, equipment, courses offered, costs, hours, etc.

Check here if you wish information about building a television chassis in your own home.

Check here if you are a War Veteran.

Name Age.....

Address.....

City..... Zone No. (if any)..... State.....

HARRISON HAS IT!— RECHARGABLE POWER PACK

- COMPACT!**—only 1 1/2" x 3 3/4" x 4" high (6 1/2" high with battery).
- LIGHTWEIGHT!**—3lb., 10 oz. Complete!
- POWERFUL!**—Delivers:
- 135 volts at 20 ma in continuous Military service or 30 ma, or more, in intermittent amateur service.
 - 67 1/2 volts at 5 to 8 ma.
 - 1.5 filament or 6.3 heater, bias, and microphone voltages.

For little more than the cost of one set of regular dry batteries, you can obtain a new, modern, rechargeable power pack that will save you space, weight, and money! Ruggedly made for Navy radio equipment, this pack gives excellent service under the roughest field conditions.

The vibrator pack has such desirable design features as neon voltage regulator, complete filtering, remote load start relay.



Brand-new, Navy-inspected in original carton with fully charged battery, diagram and instructions. Complete—ready to go. **\$5.50**

GOOD-BYE TO BATTERY EXPENSE!!

for

- Portable Receivers
- Transmitters
- Walkie Talkies
- Remote Controls
- Test Equipment

Smooth, dependable power comes from a 6-volt storage battery which clips into bottom of pack and which can be recharged over and over again for only a penny or two. Unbreakable plastic NON-SPILL (even if turned upside-down) CASE. Can give over 6 solid hours of continuous operation at full rated load before requiring simple recharge by any half amp. trickle charger or our special inexpensive charger.

BATTERY CHARGER

Noiseless, Selenium rectifier type, to trickle charge these or any other small batteries. 110 Volt AC. **\$2.97**

COAXIAL CABLE

RG-8/U, 52 Ohm impedance, FB for feeding beams, etc. Handles a KW with high efficiency. New, perfect cables.

110-foot length with two PL-259 coaxial plugs | 65-foot length with one plug. List **\$3.45**
Total list price **\$4.98** | \$22.59. HSS

Cut to size in one piece within -0% to +20% of length ordered. Full measure!

Type	Impedance	O.D.	1-100'	100' and up
RG-8/U	52 Ohms	.405"	9c	6c
RG-11/U	75 Ohms	.405"	10c	7c
RG-13/U	74 Ohms	.420"	14c	10c

RG-58/U, 55 ohms, an efficient, light-weight transmission line (.195" O.D.) for FM, television, and Amateur antennae. Also use as high quality, inexpensive crystal mike or pickup cable. List..... \$18.50
HSS Special—100 feet for \$3.95

CRYSTAL CALIBRATOR AND MONITOR

A very handy piece of new Navy equipment! Use it for tuning ECO or receiver to spot frequencies, monitoring, alignment, checking crystals, etc. 3A4 tube EC Pierce oscillator covers all crystal frequencies. Sockets for 10 crystals, with ceramic selector switch, Phone Jack. Aluminum cabinet 2 1/2" x 4 1/2" x 8" also holds No. 2 cell and a 5540 battery. Complete, with instructions, diagrams, and kit of spare tube and parts, less only batteries **\$4.95** and crystals.....
(With batteries \$5.95)

★ ALL STANDARD LINES

We are Factory Authorized Distributors for the top quality manufacturers and we now have in stock lots more new, latest improved production item gear! Visit our stores today, for everything you need. We promise you fresh clean material—quicker—at the lowest current prices—and above all, our sincere desire to be of friendly, helpful service.

As one of the world's largest distributors of Communications Equipment, we are delivering plenty of

RECEIVERS AND TRANSMITTERS

right now! ALL MAKES—practically all models. If you want your new set, test equipment, amplifiers, parts, etc., in the quickest possible time send your order to HARRISON!

RCA 1 KW Modulation Transformers
500 Watt Audio. // Impedance Ratio 40 Lbs. **\$24.75**

MAIL ORDERS? Certainly! Just list everything you want (items in this ad, or any ad, magazine, or catalog) and include remittance.

Vy 73 de
Bil Harrison, W2AVA

SERVICEMEN—WAKE UP!

(Continued from page 13)

words, you must know the dollars and cents end of the radio business. Then, as Mr. Charleston puts it so well, you must know how to sell yourself. That's what counts.

There is room for a good deal of improvement in most small service shops. A goodly percentage of servicemen still use archaic methods, still think, because there is a considerable amount of business today, that they can abuse every principle of economics. Rest assured that business will not remain good forever—the day will come when customers with long memories will no longer be around certain servicing shops.

Now, while we still have prosperity, is the time to build for the future. Tomorrow may be too late.

A considerable minority of servicemen still have not seen fit to "play ball" with their customers. TO THEM THESE LINES ARE ADDRESSED. It is these shortsighted men who constantly endanger the entire servicing trade and make it difficult for those who give honest and efficient service.

We are noting more and more newspaper clippings, exposing shoddy servicing and downright gypping, from many parts of the country. This is a healthy sign, because it shows that the press of the country is alive to the danger. In many cases we note that the name and address of the offending shop is given. Such publicity has a salutary effect—no shady shop can stand it. In several cities, newspapers who run regular columns on servicing abuse—not necessarily on radio servicing alone—invite readers to send in their complaints, particularly those of a flagrant nature. As happens in all such cases, the majority of complaints usually are directed against certain shops known for their questionable methods. It is these that the newspapers seek out, after they have investigated a number of complaints. Only the guilty shops fear such publicity, the reliable ones welcome it, because it helps to clear the situation.

Fortunately these crooked shops are in the great minority. Few men are downright dishonest—adversity and lack of business makes them so. But this all goes back to the start: if the owner was up on his toes, alert and hard working, there would have been no adversity nor lack of business. In short: no one is successful in the long run unless he works for it.

To those servicemen who find the going tough, these simple rules may be of help toward a successful career:

1. Work for less—let the volume govern your profit.
2. Astonish and delight your customers by not charging anything at all for small, trifling repairs (such as changing tubes around, cleaning a connection,

(Continued on page 58)

HAM HEADQUARTERS
Since 1925!

HARRISON RADIO CORPORATION
9 WEST BROADWAY • NEW YORK CITY 7
PHONE—SArday 7-9634 • EXPORT DEPT.—CARE—'HARRISONRAD'
[JAMAICA BRANCH—177-31 Hillside Ave.—REpublic 9-4102]

• RADIO CABINETS •

complete line of
SPEAKER BAFFLES
5"-6"-8"-10"-12"
BLANK REPLACEMENT CABINETS and RECORD PLAYERS

Exact duplicate cabinets for Emerson, Crosley, Philco, R.C.A., Motorola, and Fada.
IMMEDIATE DELIVERY
Send for free circular and price list.
SELLING TO WHOLESALE & JOBBERS ONLY
Radio Furniture Distributors, Inc.
1947 Broadway, DEPT. RC, New York 23, N. Y.

PREPARED ASSORTMENTS
GUARANTEED FIRST QUALITY

100	1/3 Watt Resistors All Insulated.....	\$2.98
100	1/2 Watt Resistors All Insulated.....	3.98
100	1 Watt Resistors All Insulated.....	4.45
50	2 Watt Resistors All Insulated.....	3.98
50	200 Volt Paper Condensers.....	2.48
50	Mica Condensers.....	2.98
20	Dry Electrolytic Filter Condensers.....	6.75
10	25 ft. Rolls Hookup Wire—Ass't'd colors	1.98
10	Volume and Tone Controls—No Switches	1.98
100	ft. Spaggetti and Vinylite.....	.98
10	Coils I.P., R.P. Ant. and Oac.....	3.98
20	Wafer and Ceramic Band Switches.....	2.98
20	Auto Suppressors.....	2.98
50	Electrical Wiring Devices, Plugs, Taps, Bases, Elements, Fuses, etc.....	5.00

SEND FOR TRUTONE COMPLETE RADIO AND ELECTRICAL LIST
Terms: 25% deposit required with order. Balance C.O.D.
TRUTONE PRODUCTS CO.
303 W. 42nd St. Dept. C New York 18, N. Y.

Next month RADIO-CRAFT has a special double-sized de Forest Audion issue. Watch for it!

A CARRIER TRANSMITTER

This carrier-current transmitter employs a 6V6 as an oscillator and a 6F6 as a modulator. L1 is a standard 125 ma, 2.5 mh receiving-type r.f. choke. This is tapped one-quarter of the way up from the grounded end. The tuning condensers are the mica dielectric type. L2 consists of 185 turns of No. 28 enameled magnet wire, close-wound on a half-inch form. It resonates sufficiently close to the frequency of the grid circuit when shunted by the high-voltage mica condenser to insure oscillation. Variable tuning in the plate circuit is unnecessary. L3 consists of 20 turns of No. 28 enameled magnet wire close-wound on a half-inch form loosely coupled to L2. T1 is a universal-type modulation transformer. A 200-ohm audio choke may be substituted if the modulation transform-

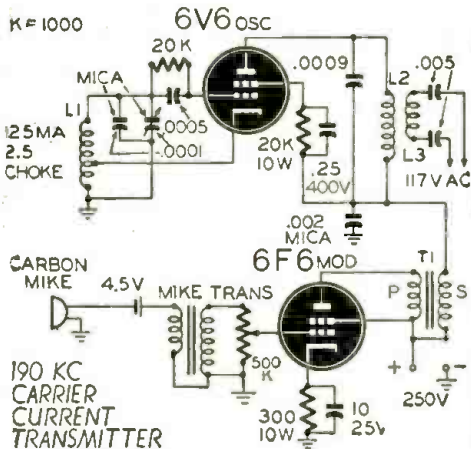

The circuit. Coil is a 2.5-millihenry choke. er is not available, with equally good results.

Interference with nearby radio receivers is minimized by thoroughly shielding the entire transmitter, tuning it to a frequency of about 190 kc or one that is not normally used in superheterodyne i.f. amplifiers, and coupling the r.f. output to the a.c. line as loosely as possible for satisfactory reception at the receiver end. The entire unit can be made quite compact, depending on the skill of the builder.

A license is not required to operate the transmitter. However three restrictions should be observed: FCC regulations (Sec. 2.102) which limits the field strength radiation at 190 kc to 826.3 feet; a restriction imposed in certain regions by military authority; (These zones are designated by notices posted at your local post office. Where such a military restriction is still in effect, operation is specifically prohibited.) The third is imposed by the electric and power companies, who often use carrier for communication and control. A carrier-current transmitter must not interfere with these companies.

A new phonograph holds records up on edge to play them. The instrument has two tone arms, and turns in one direction to play one side, then reverses to play the other. The machine is the invention of two New Jersey men, and has been assigned patent No. 2,406,355.

RADIO PARTS ELECTRONIC EQUIPMENT MONEY SAVING VALUES

Concord has them! Radio & Electronic Parts, Supplies and Equipment of every kind, for every need... long-awaited, hard-to-get items... new merchandise, just received... Hundreds of bargains... in stock NOW for immediate shipment from CHICAGO or ATLANTA. Listed below are just a few of Concord's Money-Making Values in Top-Quality, Standard-Make Parts and Equipment. CHECK these offerings now - or write us your needs.

IMMEDIATE SHIPMENT



ALNICO V 5" P.M. SPEAKER

New Alnico V magnet provides maximum performance with minimum weight. Normal wattage 3, peak wattage 4 1/2. V.C. impedance 3.2 ohms, depth 2 1/16". **\$1.98**

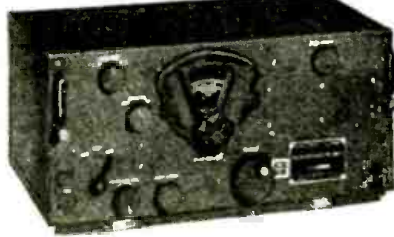

WELLS-GARDNER BC-348-N Communications Receiver. 6 Bands—200-500 KC. and 115 MC. to 18 MC. in 5 Bands. 2 stages RF, 3 stages IF, Beat Frequency Oscillator, Crystal IF, Filter, Manual or Automatic A.V.C. Complete with tubes and 24 V. 12 C. input dynamotor power supply, but supplied with complete instructions and diagrams for converting to 110 V. A.C. 60 cycle operation. **BC-348-N . . . \$53.95**

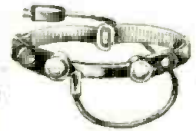

CARBON THROAT MICROPHONE

Will work into any 200 ohm impedance input circuit. Has adjustable strap to fit any neck. Ideal for ultra high frequency mobile work for hams. Supplied with strap, 10' cord and 49¢ plug. **SB7060 . . . 49¢**



3 Mfd. 4.00 Volt Hi-Voltage Condenser

Large 3 mfd., 4000 v. D.C. condenser, hermetically sealed in an aluminum can. Size 4 1/4 x 3 11/16 x 7 3/4" high. **\$4.95**



Supreme Model 543B 1000 O.P.V. A Sensitive Meter

Has pin jack terminals, and includes the following ranges: 0/6/60/600 D.C. M.A., 0/15/150/600/3000 V. A.C. and D.C., 0/2000/200,000 ohms. This meter is convenient to carry. Weighs 28 ozs. Uses full size 3" meter with a rugged, accurate I.M.A. movement. All resistance ranges are operated by batteries furnished with the unit. Bakelite case. Size: 6 7/8" x 2 1/16" x 2 1/8". Shpg. wt. 2 lbs. **\$18.57**



D.C. MILLIAMMETERS

2 1/2" flange mounting type. Black dull finish bakelite case. Mtg. lldwe. included—Large, clearly legible dial calibrations. Either **5B4122—0.20 M.A.D.C. or 5B4116—0.300 M.A.D.C. \$3.23** Special . . .

SAVE ON VALUES LIKE THESE

A POPULAR HAM TUBE AT A REAL LOW PRICE

VHF Midget Super Control Rf Pentode Tube. Type 9003. SPECIAL **95¢**

HEAVY DUTY LINE FILTER

Solar Eilm.-O-Stat. Completely shielded. Type EN106. **5B3218 Each \$1.79**

NEUTRALIZING TOOL KIT

12 tools Telescope into 5 units Composed of alligator side wrench—6" insulated driver—metal nib, 5/16" and 3/4" nut wrench, 3/4" square nut wrench, 3/4" hex metal side wrench, 2 1/2" ins. driver with metal nib, 3/4" hex slotted insulated wrench driver, 5/16" hex ins. nut wrench, 5" and 6" ins. **\$2.49** driver. **5B6547**

WIRE STRIPPER

Strips wire instantly! Fastens to bench or other support. Wire stripped to any length. Strips wire up to 12MM diam. Each **98¢** **C15268**

AERIAL WIRE

Contains 7 strands—4 copper—3 of monel. 100 foot coils. **29¢** **5B5133** . . . Each

CRESCENT AUTOMATIC RECORD CHANGER

Simple, single control, plays ten 12" or twelve 10" records automatically. Rejects any record desired, or permits optional playing of records manually. Only three moving parts while changing. Fast... changes records in 6 seconds. Has self-starting. 78 R.P.M., 110 volt 60 cycle A.C., heavy duty motor. Finished in two-tone brown with attractive plastic trim. Requires only 5 1/2" head room and fits any cabinet with 12 1/2" x 16 1/2" changer area. **\$19.95** **C22503 SPECIAL**

TUNER UNIT TU-10-B. Continuous frequency range from 10 MC. to 12.5 MC. VFO oscillator for tuning section, buffer, coupling, capacitors and choke, and buffer output matching tapped coil and condenser. Size 16 1/4" lg. x 7 1/2" h. x 6 1/2" deep. **AS4132. SPECIAL \$2.95**

T-17-B 200 Ohm Carbon Mike. Light weight, with press-to-talk button. Built-in filter to suppress carbon hiss. 5' rubber covered cable and **\$2.49**

PL-68 3-circuit plug supplied. 5B7062
Midget Volume Control—1 Meg. ohm Standard 3/4" Bushing, 1/2" dia. Shaft, 3/4" long, with split spline for push-on knob. C8154 . . . 35¢

STANCOR Universal Output Transformer Type A3856. Primary for all single or push-pull plates. Secondary adjustable from 1 to 30 ohms. Two-inch mounting centers. 4 watts at 35 mills. **\$1.32** **C1675. SPECIAL**

Mail the Coupon Below Now!

for New Concord Bulletin of Radio Parts and Electronic Equipment. See 8 giant-size pages packed with Radio Needs—Condensers, Meters, Controls, Transformers, Switches, Relays, Tools, Amplifiers, Records, Players and Changers—new and scarce items—scores of bargains. MAIL COUPON NOW!

CONCORD

RADIO CORPORATION
LAFAYETTE RADIO CORPORATION

CHICAGO 7 901 W. Jackson Blvd. ATLANTA 3 265 Peachtree Street

Concord Radio Corporation
901 W. Jackson Boulevard, Dept. RC-128
Chicago 7, Illinois

Please rush my FREE COPY of the new Concord Bulletin of Radio Parts.

Name _____
Address _____
City _____ State _____

TRY THIS ONE

LOOP AERIALS

Loop aerials on portable and some home receivers can be a constant source of erratic noises. The aerial leads are usually constructed of poorly insulated wire. Vibration may cause the leads to make intermittent contact which will cause annoying static.

Trouble from this source may be prevented by spacing the leads and holding them in place with tacks or Scotch tape.

H. LEEPER,
Canton, Ohio



WIRE STRIPPER

A piece of broken hacksaw blade may be made into a handy tool for stripping insulation from wire. The jagged broken edge is filed smooth. The toothed edge is used to scrape enamel insulation from wire. The back of the blade is sharpened to a knife-like edge and used for cutting rubber insulation.

NEIL S. HIGGINS,
Lincoln Park, Ill.

ADDING HEADPHONES

Here is a circuit that I have found useful when connecting headphones to a radio.

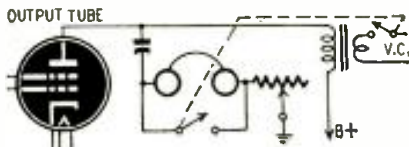

The headphones are connected in the tone control circuit. The phone jack or binding posts are inserted between the bypass condenser and the variable resistor. A d.p.s.t. is wired into the circuit so that the speaker may be silenced when the phones are used. When speaker operation is desired, the voice coil circuit is closed and the phones are

shunted out of the circuit, permitting normal operation of the tone control.

DON BECKERLEG,
Wolf Point, Montana

GUITAR AMPLIFIER

Here is a circuit of a 3-tube guitar amplifier that will give ample volume for many applications.

The circuit uses a cascade-coupled 6SC7 feeding a 6F6. The volume control is located in the grid circuit of the second stage of the 6SC7.

The amplifier is free from feedback and motorboating if ample care is used in placement of parts. All wiring and parts are grouped about the tube sockets. Shielding is required on the grid leads of the 6SC7. The amplifier may be constructed on a chassis less than eight inches square. An additional jack may be wired in parallel with the pickup jack to permit use of a high impedance mike.

KENNETH BALLARD,
Mason City, Ill.

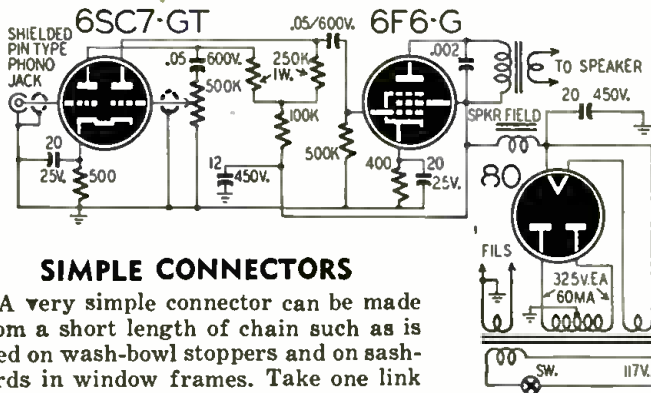

SIMPLE CONNECTORS

A very simple connector can be made from a short length of chain such as is used on wash-bowl stoppers and on sash-cords in window frames. Take one link off and straighten it out. Then bend one half of it into a U-shape. Now put the wire into the hole formed by the U-shape and clinch it tightly. The other end is opened by cutting off the top bar of the closed portion. The open end can now be used as a spade lug and can be connected to binding posts or to screws with a minimum of effort.

EDWARD W. HUTCHINSON
New York City

SUB-PANEL SOCKETS

Sockets for receiving tubes and transmitting tubes like the 802 or 807 may be mounted beneath the surface of the chassis without resorting to hollow-tube spacers. An Amphenol "ACS" above-surface socket is used. The socket is removed from the shell, by removing the retaining ring, remounted in the reverse position. The assembly is turned over and mounted under the socket hole in the chassis.

E. R. MATTHEWS,
Kaslo, B. C., Canada

METER MULTIPLIERS

An accurate multi-range voltmeter may be constructed without using range switches. A potentiometer is calibrated for the multiplier ranges required. With

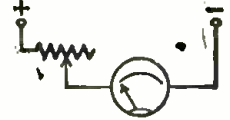

a 1/2-megohm potentiometer, it is possible to calibrate a 1-ma meter to read up to 500 volts.

When the correct values of the multipliers have been determined, the accuracy of the voltmeter will be equal to the accuracy of the potentiometer calibration.

ERNEST TURFFS,
Melrose Park, Ill.

CURING OSCILLATION

Audio oscillation in radio receivers may be caused by poorly soldered contacts. This is particularly true of plate and screen by-pass condensers. To cure the trouble, go over all soldered connections with a hot iron.

H. LEEPER,
Canton, Ohio

(Note: Care should be used when resoldering the connections because it is easy to ruin a well-soldered joint by applying a little too much heat — Editor)

PLUG-IN RECORD PLAYER

I wanted to add a record player to my radio so that it could be connected readily without unsightly wires connecting the two units.

The motor and pickup were mounted on an 8x10x3-inch chassis. The bottom plate was drilled for four banana plugs. Corresponding holes were drilled in the top of the radio cabinet and fitted with banana jacks.

One pair of jacks and plugs were used to connect the motor to the a.c. line and the other pair connected the pickup to the audio system of the radio. The bottom plate was then fastened to the bottom of the chassis.

Plugging the player into the top of the radio completes the necessary connections so that the player may be used. The four inconspicuous banana-plug jacks on top of the radio cabinet not only make electrical connection to the record player but hold it securely in place as well.

C. L. HOLMAN,
Lexington, Ky.

FOLDED DIPOLE ANTENNA

The new "Twin-Lead" 300-ohm line makes it possible for one to construct a folded dipole antenna that can be rolled up and weighs approximately 10 ounces depending, of course, on the length of feeders.

The impedance of the folded dipole antenna is approximately 300 ohms and forms an almost perfect match to the 300-ohm feeders, no matter what length the feeders are. The feeders are extremely efficient and may even be used on the very high frequencies without appreciable losses.

It is possible to make the antenna out of the same transmission line that is used in making the feeders, for the spacing is correct for frequencies of 29 mc and higher. As the spacing is the same for antenna and feeders, and since the antenna wire spacing cannot vary

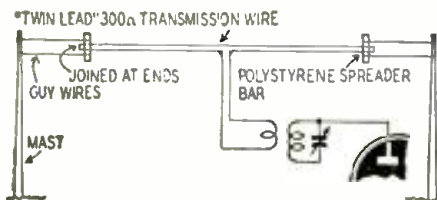

How the transmission-line antenna is erected.

when using this transmission line, the entire system is symmetrical throughout.

In constructing an antenna for 10-meter operation, it is first necessary to cut off 16 feet, 4 inches of transmission line, which is used for the antenna itself.

The insulators used at each end of the antenna are made from a 6-inch plastic spreader bar. The spreader bar is first cut in half with a hacksaw and two holes are drilled into the center. The spacing between the holes is equal to the width of the transmission line. An additional hole is drilled into each end of the spreader bar for the guy wires. The two leads of the antenna are then passed through the center holes of the insulator and soldered together.

In connecting the transmission line to the antenna, the bottom wire of the antenna is cut exactly in the center and each wire pulled aside approximately 3/8 inch. The feeder wire is then pulled apart at the end to about 1/2 inch and connected to the two bottom antenna wires. The remaining piece of plastic material on the end of the feeder is joined to the antenna material by pressing a red hot nail over the joint while holding the connection firmly. A strong weld takes place between the two plastic materials.—Leon S. Wecker

The Canadian Broadcasting Corp. plans to spend between one and two million dollars on expansion, the CBC chairman reported last month. Plans would include new 50-kw stations to cover the vast reaches of the Prairie Provinces, and power increases for many existing stations.

Low Cost **FEILER** TS-1 Signal Tracer

Saves Time, Money, Guesswork on Radio Repairs!

GETS TO THE HEART OF
RADIO TROUBLE IN A FLASH!

Locates Causes of:

- Noisy Sets
- Parts Failure
- Mistracking
- Low Sensitivity
- Distorted Tone
- Intermittent Sets



MODEL TS-1
ONLY

\$ **9⁸⁵**

Complete with vacuum tube (less batteries)

Easy to Use! Pays for Itself!

Servicemen! Experimenters! Here's an absolutely dependable Signal Tracing Analyzer at the lowest price ever quoted for such an instrument! Enables you to test any radio or amplifier just by touching the Analyzer probe to any portion of the circuit—the signal you hear in the phones permits you to isolate and locate the trouble in just minutes. Easy to use—no special skill needed. Works with any magnetic headset, 1000 ohms or higher. Requires only one 22½ v. battery and one No. 2 flashlight cell. Self-contained in compact (6¾ x 4¾ x 3¼") brown metal case; with snap-lock cover and battery compartment. Compact bakelite probe houses miniature vacuum tube and circuit components; has 3 ft. cable. Excellent instructions included. An invaluable instrument that pays for itself quickly!

IMMEDIATE DELIVERY

Place your order for the TS-1 Signal Tracing Analyzer with your regular parts jobber. If he cannot supply you, write for name of nearest jobber stocking this instrument—or send your order directly to us.



FEILER ENGINEERING CO.

803E MILWAUKEE AVE., CHICAGO 22, ILLINOIS

A LABORATORY QUALITY OSCILLOSCOPE For the Service Man . . .

Portable, sturdy, compact—the CRO-5A is an ideal unit for rapid, accurate, high quality service work. Check the utility and features which you have always wanted in the instrument on your bench.

- For better laboratory and production testing . . .
- For routine Service work . . .
- For studying any variable which may be translated into electrical potentials by means of associated apparatus . . .
- Designed with tubes for maximum amplification with minimum noise . . .
- Exceptionally stable trace even under adverse power line variations . . .
- Frequency response—essentially flat from 20 cycles to 350 KC . . .
- Completely self-contained . . .

Write to General Electric Company, Electronics Department SRC-6407, Syracuse 1, New York.



CRO-5A

GENERAL ELECTRIC

177-EE

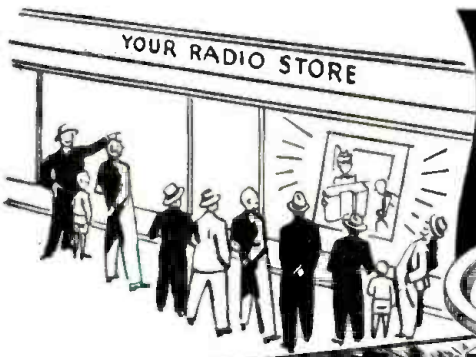

COMIC POSTER FREE



TO DISPLAY IN YOUR WINDOW!

A crowd-pulling cartoon, size 17"x17", drawn especially for OLSON RADIO WAREHOUSE to give you. It's yours for the asking, absolutely FREE and postpaid. Display it in your window or Service Dept. for laughs — and sales!

Why do we make this offer? Because we want you to become acquainted with Olson Bargains. We will send you a Free Catalog with the poster; this Catalog lists nationally famous Radio Parts at prices that will save you plenty!

Paste this coupon on a postcard
and MAIL TODAY

OLSON RADIO WAREHOUSE

73 E. MILL ST., DEPT. 58, AKRON, OHIO

Yes sir! Send me the Comic Poster free.

NAME

ADDRESS

CITY STATE



famous for GREAT VALUES

OUTSTANDING OFFERINGS OF NEW KITS

H-101 Five Tube Superheterodyne Kit

Small Bakelite cabinet approximate size 9"x5"x6", complete parts except wire and solder for the construction of a standard superheterodyne receiver using 50L6, 35Z5, 12SA7, 12SQ7, and 12SK7. A simplified circuit diagram included in this kit enables any one with a slight knowledge of radio to construct a highly efficient receiver. **\$10.75**
Price not including tubes

H-105 Automatic Record Changer Kit

Consists of 1 Automatic Record changer, single post; 1 Portable leatherette cabinet for above; 1 Crystal pick up; 1 5" P.M. and output transformer; 1 complete kit of parts including tubes but excluding wire and solder, to construct a 3-tube amplifier using 1-50L6, 1-35Z5, and 1-12SQ7. Price complete **\$36.95**

All prices are F.O.B. New York City.

Write for our new catalogue showing new test equipment, tubes and a large variety of new replacement parts. We ship anywhere in the U.S.A.—promptly.

RADIO DEALERS SUPPLY COMPANY

135 LIBERTY ST., NEW YORK 6, N.Y.

RADAR WAVES HARMLESS

Radar waves produce no harmful physical effects, the Aero Medical Laboratory at Wright Field reports.

Use of high-power, high-frequency radio equipment first came into extensive use in wartime military equipment. Their biological effects unknown, rumors arose that long exposure to the waves might cause baldness or even sterility. The rumors may have been due to confusion with X-rays or ultraviolet light, both of which are thousands of times shorter, on the other side of the visible light spectrum.

At the Wright Field laboratory Dr. Follis exposed 13 male guinea pigs to ten centimeter radiation three hours daily for from 51 to 53 days. At the end of this time they were killed and every vital organ studied. Absolutely no deviations from the normal were found. There was no loss of hair, and no evidence of sterility. It also was determined that no X-radiation, which might have been harmful, was mixed with the radio waves.

Early in the war clinical studies were made of Navy volunteers exposed for long periods to high frequency radio waves, although not in measured amounts such as were used in the guinea pig experiments. No pathological effects were found. Some of the subjects had complained of headaches after several hours of exposure, but these disappeared shortly after exposure ended.

Free Radionic Catalog



RADIONIC EQUIPMENT CO.
170 Nassau St., Dept. 1012, New York 7, N. Y.

Please send me a FREE copy of your 1947 Catalog. I understand it has thousands of items illustrated, described and priced and will be a great help to me in my search for "hard-to-find" radio equipment.

Name

Address

City State

METROPOLITAN

Guarantees Delivery From Stock!

B-45 SIGNAL GENERATOR

for
Servicing
AM
FM
Television
Receivers

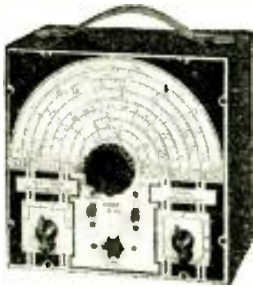

Self-modulated Signal Generator, providing a highly stable signal. Generates R.F. frequencies from 150 Kilocycles to 50 Megacycles (150 Kc. to 12.5 Mc. on Fundamentals and from 11 Mc. to 50 Mc. on Harmonics). R.F. is obtainable separately or modulated by the Audio Frequency.

Television and F.M. as well as A.M. receivers can now be speedily aligned. Modulation in the B-45 is accomplished by Grid-blocking action which has proven to be equally effective for alignment of amplitude and frequency modulation as well as for television receivers.

The R.F. Signal Frequency is kept completely constant at all output levels. This is accomplished by use of a special grid loaded circuit which provides a constant load on the oscillatory circuit. A grounded plate oscillator is used for additional frequency stability. The Model B-45 is truly portable—no external source of current required. Operates on self-contained batteries.

Direct reading—all calibrations are etched on the front panel. Complete with shielded test lead, self-contained batteries and instructions.

\$27.75



New Model 670 SUPERIOR SUPER-METER

A Combination Volt-Ohm milliammeter plus capacity reactance inductance and decibel measurements.

NET **\$28.40**



New Model 450 SUPERIOR TUBE TESTER

"Speedy Operation" assured by newly designed rotary selector switch which replaces the usual snap toggle or lever action switches.

NET **\$39.50**

McMurdo Silver 905 "Sparx" Signal Tracer	\$39.90
McMurdo Silver 904 Capacitance Resistance Bridge	\$49.90
McMurdo Silver "Vomax"	\$59.85
Supreme 543 Multi Tester	\$18.95
Supreme 565 Vacuum-Tube-Voltmeter	\$63.50
Supreme 576 Signal Generator	\$68.95
Superior CA-11 Signal Tracer	\$18.75
Superior 650 Signal Generator	\$48.75
Superior 400 Electronic Multi-Meter	\$52.50
Superior 600 Comb. Tube & Set Tester	\$62.99
R.C.P. 664 Electronic Voltmeter	\$45.00
R.C.P. 705 Signal Generator	\$49.50
R.C.P. 802N Comb. Tube & Set Tester	\$59.50
Monitor Crystalline Signal Generator	\$57.50
Waterman "Pocket Size" Oscilloscope	\$55.00
Dumont Five-inch Oscilloscope	\$99.50

Write for FREE New 1947 Catalog!

**METROPOLITAN
ELECTRONIC & INSTRUMENT CO.**

6 MURRAY ST. NEW YORK 7, N. Y.

NEW RADIO-ELECTRONIC PATENTS

By I. QUEEN

EXPANDED SAWTOOTH WAVE

Frederick J. Altman, U. S. Army
Patent No. 2,402,270

Some investigations require a more detailed study of a waveform than can be obtained with the usual oscilloscope sweep. Greater detail can be obtained by using a portion of a greatly expanded sawtooth sweep.

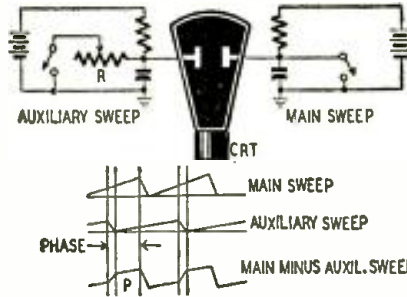

This invention utilizes two separate voltages on the deflection plates. The resultant is the difference between the two. Therefore a more gradual control can be exerted on the actual electron beam deflection. Instead of two separate inputs, only one oscillator is used. The voltage along one path passes through a phase shifter, and both paths contain a square wave generator and a pulse shaper. Therefore the outputs are sawtooth waves of the same frequency but have variable phase difference. Each is applied to one set of deflecting plates, one voltage having an amplitude control R.

The difference between two sawtooth waves is another wave, one portion of which is also a sawtooth. By controlling phase and amplitude the latter shape may be adjusted as desired, so that its expanded portion P coincides with the section of the wave which requires study.

AIRPLANE ANTENNA

Wendell L. Carlson, Haddonfield, N. J.
Patent No. 2,403,500

The problems which attend the design of an airplane antenna are complex. When a plane banks or changes its direction of travel, there are times when the antenna is completely shielded from the contacting station. In addition, a vertical antenna becomes horizontal during a sharp bank, and therefore becomes unsuitable for reception of vertically-polarized waves.

This invention contemplates a system of receiving and transmitting antennas which eliminates these problems. Two V-shaped dipoles are mounted on each plane wing so that energy may be intercepted from both above and below the plane itself. The output of each dipole pair is applied to individual converters and is heterodyned by a single oscillator. The two outputs are alternately keyed or modulated by a 20-ke oscillator. This applies bias to each modulator so that first one channel conducts and then the

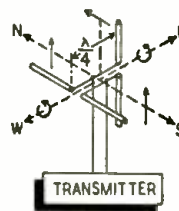

other. This prevents possible phase changes in the antenna outputs from interfering with each other. The alternate outputs are then amplified by a conventional i.f. amplifier and detected. With this system at least one of the antenna dipoles is effective in producing output.

It is also contemplated that the transmitter use a system of antennas which will radiate several types of polarized waves. In a typical installation, for example, two dipoles are erected at right-angles to each other, and spaced by a quarter wave-length. Then, as shown by the corresponding arrows, circularly-polarized waves would be transmitted east and west, vertically-polarized waves would be transmitted north and south, and in the upward direction the waves would be horizontally-polarized. Therefore, no matter what the position of the plane, one of its antennas would intercept energy from the transmitter.

DUAL CONTROL

Amedeo D. Zappacosta, Philadelphia
Patent No. 2,388,590

This circuit provides means for simultaneous variation of volume and selectivity. When strong signals are received, broad tuning is desirable for best fidelity. With weak signals, sharp tuning results in less noise and interference.

A 6H6 is used across the input circuit as a damping control. Its bias is developed across a 150-ohm resistor. A low bias permits the 6H6 to conduct, thereby damping the amplifier circuit and giving broad tuning.

For reception of strong signals, the volume control adjustment is moved to the right. This gives minimum gain and low 6SJ7 cathode current. The 6H6 bias is held to a low value, resulting in low gain, broad tuning. For a weak signal, the control is moved to the left, increasing both 6SJ7 current and 6H6 bias.

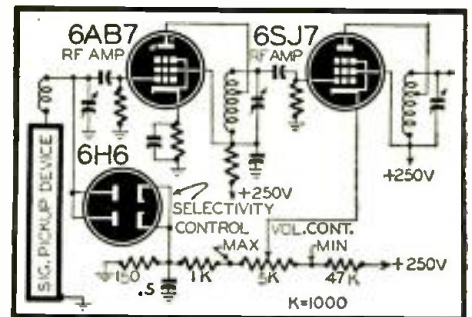

Q-CONTROLLED INSULATION

Robert L. Harvey, Princeton, N. J.
Patent No. 2,403,657

The low power factor (high Q) of polystyrene is well-known and accounts for its wide use as a microwave insulator. Like other material, however, there is an inevitable reduction of Q with increased frequency. There are many applications where it would be desirable to have a constant Q or even a rising Q as the frequency increased. This would compensate for the usual higher loss of radio components in the upper microwave region.

It has been discovered that the addition of 10 percent of copper particles to the polystyrene results in a moldable non-conductive substance whose Q is practically constant from 5 to 400 mc. Greater percentages of metal give a rising Q apparently well into the kilomegacycle range, which means that the efficiency of apparatus may be maintained constant over a desired range. Another result of adding the metal is that the polystyrene can be used at temperatures as high as 90 degrees Centigrade. Ordinarily the limit is 75 degrees Centigrade.

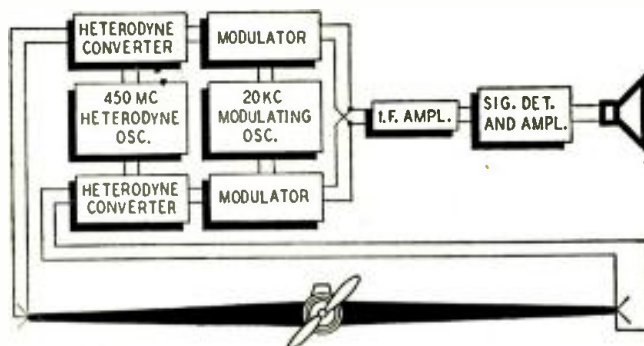

**a Sensational
TERMINAL Value!**

**ALL NEW!
JAN APPROVED!**

STANDARD BRANDS ONLY!

9001	}	YOUR COST	85^c EACH
9002			
9003			
954	}	YOUR COST	65^c EACH
955			
956			
6AK5		1.50	
813		9.95	
814		5.95	
829-B		4.95	
24G		1.95	

Send remittance in full. No C.O.D.'s.
We pay postage anywhere in U.S.A.

TERMINAL
Radio Corporation
85 CORTLANDT ST. N. Y. 7, N. Y.
WOrth 2-4415

TRANSATLANTIC NEWS

(Continued from page 31)

the arrival of its own channel pulses and remains closed while others are coming in.

The way in which the channel pulses are width-modulated is exceedingly neat. It is illustrated in the accompanying drawing. An oscillator applies saw-toothed positive pulses, A, to the grid of the modulator tube, the a.f. modulation, B, being fed to the cathode of the tube in the form of a varying positive bias. The tube can conduct only when the voltage between grid and cathode is less than that required to cut off the anode current. Hence the time during which the tube is open, and therefore the width of the negative voltage pulse, C, produced at its anode, is controlled by the modulating voltage on the grid. Negative peaks on the grid give rise to pulses of maximum width; positive peaks on the grid produce minimum pulse width.

CORRECTION

An error appeared in the Hi-Fi Tuner diagram on the bottom of page 558, May 1946. The bypass condenser connected between the cathode and ground of the 6C5 detector (indicated value of .01 μ f) should be .00025 μ f. We are grateful to Mr. A. R. Killman, of Philadelphia, Pa. for calling this to our attention.

**RADIO PARTS
SOUND SYSTEMS
ELECTRONIC
APPARATUS**

**Depend on
RADOLEK**

Radolek's big Free Profit Guide Catalog and Profit Bulletin supplements keep you abreast of the rapidly changing radio situation. Buying from Radolek means greater values, better service and more profits. Make Radolek your buying headquarters.



RADIO PARTS



SOUND SYSTEMS

**FREE
CATALOG**

**Large Stocks
Fast Service**

SEND TODAY!

RADOLEK CO., Dept. C-112
601 W. Randolph St., Chicago 6, Ill.
Please send your FREE Profit Guide Catalog.

Name

Address

SAVE AT RADOLEK

FIX ANY RADIO

Amazing New Invention



Find radio faults with a new simplified method. Repair all radios in minutes instead of hours. Revolutionary, different *Comparison* technique permits you to do expert work almost immediately. Most repairs can be made without test equipment. Simplified point-to-point, cross-reference, circuit suggestions locate faults quickly and easily.

CHARTS, BLUE-PRINTS, TESTS, PICTURES, HINTS, JOB-SHEETS

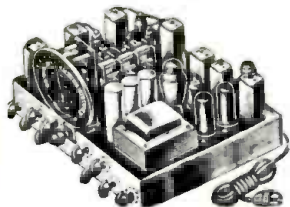

Learn time-saving trouble-shooting short-cuts; find any radio fault with ease. Follow the tests shown on 24 large circuit blue-prints. Over 1,000 practical repair hints. For all types of radios. Hundreds of simplified tests using a 5c resistor and any filter condenser. Introductory material for beginners and to serve as review for experienced radio men. Several chapters on test equipment. Complete plan in manual form. 64 job sheets, data on all tubes, large size: 8 1/2 x 11 inches. Schematics, pictures, charts. Sold on no-risk trial. Use coupon to order.



**NO TESTERS NEEDED
REPAIR ANY RADIO IN MINUTES**

This newly developed method tells you how to locate the source of trouble in any radio set without equipment. Make needed tests, measure voltage, trace the signal, by using only a 5c resistor, small condenser, and a crystal detector. Inject signals without any signal generator. Test parts by the new *Comparison* method. Test tubes without equipment. Repair any radio expertly following simplified picture plans. Improve your radio servicing ability. Data on all sets, portables. AC-DC, FM, recorders, intercoms, P.A. Examine and apply the plan for 10 days without obligation or risk. Send trial coupon today →

NO RISK TRIAL ORDER COUPON

SUPREME PUBLICATIONS

9 S. Kedzie Ave., Chicago 12, Illinois

Ship postpaid the new complete Simplified Radio Servicing by Comparison Method manual for 10 days' examination. I am enclosing \$1.50, full price. I must be entirely satisfied or you will refund my total remittance.

NAME:

ADDRESS:

Variety . . .

VALUES!



Superior Signal Generator
Model 650

110-120 Volts 50 to 60 Cycles A.C. R.F. Frequencies from 100 Kc to 35 Mega-cycles. Harmonics from 25 to 100 Mc/cycles. Audio Modulating Frequency 100 Cycles

Pure Sine Wave. Distortion less than 2%. Uses a Hartley Excited Oscillator with a Buffer Amplifier.
Complete with coaxial cable, test leads and instructions **\$48.75**

SUPERIOR Model 670 Super-Meter
A Combination

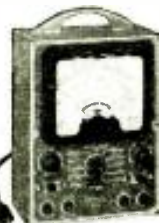

VOLT - OHM MILLIAMMETER plus CAPACITY REACTANCE INDUCTANCE AND DECIBEL MEASUREMENTS.

Complete with test leads and instructions **\$28.40**

1 TUBE RADIO KIT by "EASY-BUILT"



Battery operated, easy tuning, attractive wood finish cabinet. Complete with Tube, Coil, Battery, Headphone, Hardware and Base.

List Price \$4.98
Special **\$3.33**

PHONO MOTOR with TURNTABLE

60 Cycles, 115 Volts
\$3.95



Suitable for every phonograph instrument where low cost and dependable performance are required.

Federal Teleco Selenium Rectifier replaces Rectifier Tube **99c each**

- Tremendous Saving on By Pass Condensers! By Pass Condensers and Kit contains 100 Popular assorted types. Normal Cost \$10.95 **Special \$6.75**
- Filter Condenser Kits—23 assorted types—Value \$13.00 **Special \$8.75**
- Permeability Tuner **\$2.35**
- Dial Face Assortment 10 for **\$1.49**
- Universal Replacement Loops **59c each**
- 10 Watt Amplifier complete with tubes **\$22.75**
- Neon Testers with Instructions List Price 50c ea. **Special 29c**
- Dial Cord 25 ft. **29c**
- Dumont 5" Scope **\$99.50**
- HY-Q 75 Kit unassembled **\$9.95** assembled **\$11.95**
- Test Leads Superflex Pencil Type with Insulated Tip **75c** **\$1.00**
- High Voltage Heavy Duty 10 or more sets of any assortment deduct 10%. **\$1.95**
- 1 cell Bantam Handy Flashlite. Precision tooled, solid bar aluminum, small, powerful and durable. List Price 89c **Dealer's Price 54c**
- Fluorescent Desk Lamps. List Price \$11.95 **Dealer's Price \$6.95**

Write Dept. C12 for our FLYER
20% Deposit with order required.

Variety ELECTRIC CO., Inc.
601 Broad St., Newark 2, N. J.

A MODERN CRYSTAL SET

By W. J. E. SPAIN

THE "Postwar Crystal Receiver" using a Sylvania 1N23 fixed crystal is both selective and a distance getter. In Toronto, Canada, six local stations ranging in power from 1,000 to 50,000 watts, including one police radiophone, are received with no interference between stations and with good volume on phones. Four local stations are strong enough to operate a horn type speaker with a seventy-five-foot antenna. The output of these stations can actually be read on a microampere meter, 2,100-ohm internal resistance, hooked directly across the phone terminals.

WLW, Cincinnati, and WENR, Chicago, come in like strong locals at night. WGR and WBEN, Buffalo, are heard regularly at night.

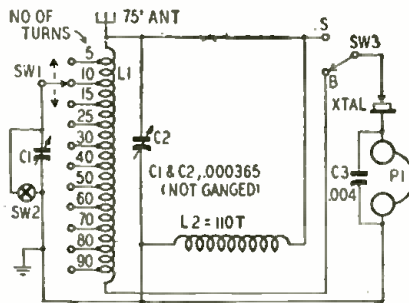

The Sylvania 1N23 crystal used in this set has proven to be an excellent DX xtal, rivalling in sensitivity and volume the results obtained from the most sensitively adjusted steel galena in an adjustable stand, a quality found in a fixed crystal. In addition, the 1N23 tunes two to three times as sharply as galena, making it by far one of the best all-around crystals yet produced.

Selectivity is controlled by switch Sw3. When in position "B," the set tunes broadly; in position "S" it tunes very sharply. When searching for an elusive station, turn Sw3 to "B." When station is located, turn Sw3 to "S" to clear out any interference. Frequency range is controlled by switch Sw1.

Stations are tuned with switch Sw2 open, using tuning condenser C1 and switch Sw1 to locate stations. The stronger stations are brought in best with switch Sw2 closed. Keep Sw3 on "S" position and tune with tuning condenser C2 and switch Sw1.

Tuning condenser C2 acts as a fine control on tuning condenser C1. Moving one scale division on a 0-100 dial on tuning condenser C2 is approximately equal to moving tuning condenser C1 1/20 of one division on a 0-100 dial.

The coils are mounted at right angles to each other and spaced well away from all metal.

Coil L1 consists of 90 turns of No. 22 d.c.c. magnet wire close-wound on a two-inch form. Begin by winding five

turns on the form and slipping a narrow strip of paper under this turn. Continuing, the strip is slipped under each turn that is to be tapped. When the winding is completed, the turns to be tapped are readily scraped and taps soldered. The strip protects the remaining turns from injury. L2 consists of 110 turns No. 34 d.c.c. wire on a two-inch form.

The specifications of the coils must be followed closely for best results. Standard single gang broadcast tuning condensers are used for tuning purposes. The filter condenser across the headphones may be any value between .001 and .006 μ f.

HARD-TO-GET PARTS

POWERFUL ALL-PURPOSE INDUCTION MOTOR



IDEAL FOR EXPERIMENTERS—101 USES

Sturdily constructed to precision standards, this self-starting shaded pole A.C. induction motor is powerful enough for a number of uses. Some of these are: Automatic Timing Devices, Current Interrupters, Electric Fans, Electric Chimes, Window Displays, Photocell Control Devices, Electric Vibrators, Small Grinders, Buffers and Polishers, Miniature Pumps, Mechanical Models, Sirens, and other applications.

Consumes about 15 watts of power and has a speed of 3,000 r.p.m. When geared down, this sturdy unit will constantly operate an 18-inch turntable loaded with 200 lbs. dead weight—THAT'S POWER! Dimensions: high by wide by deep: has a convenient mounting stud; shaft is 3/16" long by 3/16" diameter, and runs in self-aligning oil-retaining bearings. Designed for 110-220 volts, 50-60 cycles, A.C. only. Shp. Wt. 2 lbs.

ITEM NO. 147
YOUR PRICE **\$2.95**

ULTRA MAGNET

LIFTS MORE THAN 20 TIMES ITS OWN WEIGHT
LITTLE GIANT MAGNET

Lifts 5 lbs. easily. Weighs 4 oz. Made of ALNICO new high-magnetic steel. Complete with keeper. World's most powerful magnet ever made. The experimenter and hobbyist will find hundreds of excellent uses for this high quality permanent magnet. Measures 1 3/4" x 1 1/2" Shp. Wt. 1 1/2 lbs.

ITEM NO. 159
YOUR PRICE **\$1.50**



AMAZING BLACK LIGHT!!

Powerful 250 Watt Ultra-Violet Source



The best and most practical source of ultra-violet light for general experimental and entertainment use. Makes all fluorescent substances brilliantly luminescent. No transformers of any kind needed. Fits any standard lamp socket. Brings out beautiful opalescent hues in various types of materials. Swell for amateur parties, plays, etc.; to obtain unique lighting effects. Bulb only. Shp. Wt. 2 lbs.

ITEM NO. 87
YOUR PRICE **\$1.95**

WATTHOUR METER

Completely overhauled and ready for immediate service. Designed for regular 110-volt, 60 cycle 2-wire A.C. circuit. Simple to install; 2 wires from the line and 2 wires to the load. Sturdily constructed in heavy metal case, 4 1/2" high, 6 1/2" wide, 5" deep. Westinghouse, G. E. Ft. Wayne, Sangam or other available make Shp. Wt. 14 lbs.



ITEM NO. 33
YOUR PRICE **\$5.95**

HUDSON SPECIALTIES CO.
40 West Broadway, Dept. RC-12-46, New York 7, N. Y.

I have circled below the numbers of the items I'm ordering. My full remittance of \$..... (include shipping charges) is enclosed (NO C.O.D. ORDERS UNLESS ACCOMPANIED WITH A DEPOSIT.) OR my deposit of \$..... is enclosed (20% required); ship order C.O.D. for balance. NO C.O.D. ORDER FOR LESS THAN \$5.00. BE SURE TO INCLUDE SHIPPING CHARGES.

Circle item No. wanted:

147 159 158 87 152 33

Name

Address Please Print Clearly

City State

WAVE AND PULSE COUNTER

(Continued from page 25)

V2 is the extinction voltage (minimum voltage of C).

(Note: V1 and V2 are functions of frequency; hence the formula cannot be used for an exact determination of F.)

A simple way to determine V1-V2 is to put this sawtooth wave on an oscilloscope, and read its amplitude by previously calibrating the scope with some known alternating voltage.

This pulse repetition frequency counter will work for frequencies up to one

million needle deflection, by proper adjustment of the third 3000-ohm potentiometer.

Condenser C3 is a very large electrolytic, about 500 microfarads, of low d.c. voltage rating. Its purpose is to prevent needle fluctuations at the very low pulse repetition frequencies.

The meter used is a one milliamper d.c. milliammeter.

In pulse work, the frequency generally will never exceed about 10,000 cycles.

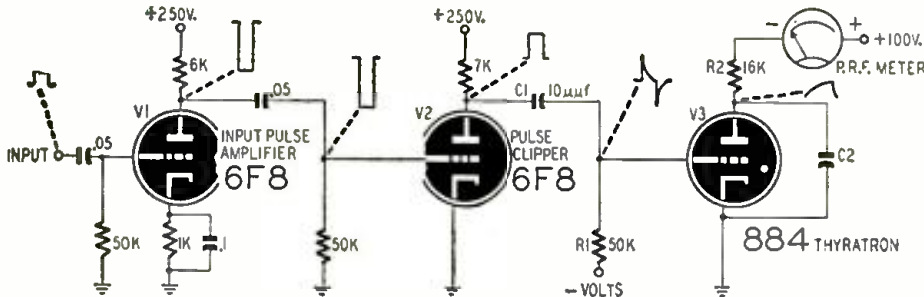

Fig. 3—Circuit of the pulse repetition frequency counter. Thyatron detail shown below.

whose period is not less than the charging time of condenser C2.

Fig. 4 is a detailed diagram of the thyatron tube circuit. If the entire frequency range were to be read directly on the meter it would result in crowding together of figures, and a good reading would be difficult to obtain.

The meter is calibrated from 0 to 100 cycles, and by switch Sw1, the range is extended ten times to 1000 cycles, and also 100 times to 10,000 cycles. As shown in Figure 4, the switch Sw1A can connect in parallel with the thyatron any one of three condensers C2a, C2b or C2c.

In the position shown, C2a, a 0.1 microfarad condenser, is connected across the tube. This is the largest of the three condensers, and therefore its time constant will be greatest. Hence, this is the 0 to 100 cycles circuit. By switching a much smaller condenser across the tube, the frequency range is increased. C2b is 1/10 of C2a, and the frequency range is increased ten times to 0 to 1000 cycles. By finally switching in the smallest condenser C2c, which is 1/10 the size of C2b, the frequency range will be again increased ten times to 0 to 10,000 cycles.

For each condenser, a 3000-ohm potentiometer is placed in parallel with the meter by means of switch Sw1B, which is ganged to Sw1A. These variable resistors are each adjusted for their respective ranges, so that when calibrating the meter, a repetition rate of 100 cycles will cause a maximum deflection of the meter needle on the lowest range. On the "times 10" range, the center potentiometer would be adjusted so that for a frequency of 1000 cycles, the needle is again at maximum deflection. Likewise, on the highest frequency, "times 100," a frequency of 10,000 cycles can again be made to give maxi-

However, if necessary, the frequency range of the counter may be increased

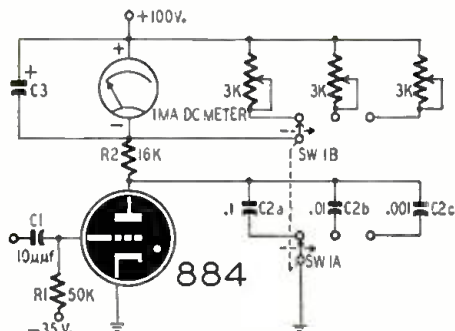

Fig. 4—Meter is switched for three ranges.

still further by simply making C2 smaller than shown.

The same general circuit may be adapted with a larger thyatron and a relay—to operate a recording counter.

NEW ELECTRODE MATERIAL

Tube electrodes made of a nickel substitute developed by the Germans have been found cheaper and to have more desirable qualities for some applications, a Department of Commerce release announced recently.

The metal substitute for nickel consists of an oxygen-containing iron sheet, plated on both sides with silicon-containing aluminum layers approximately .010 millimeters thick. The material has been used for several years, particularly in small radio tubes, some of which have been produced in large quantities.

The notable feature of the metal is that its surface changes from aluminum brightness to a dark gray color when vacuum heated to 600 degrees Centigrade. The manufacturers claim that this makes an excellent black body radiator, comparable to a soot-blackened surface.

MILO

Your "Q" for Quality

FAMOUS NAMES

HAMMARLUND

SP400-X SUPER PRO

This is the new model which covers a continuous range in 5 steps from .51 to 30 mc. **\$347.25**
Complete with Speaker

HAMMARLUND HQ129-X

Frequencies cover .51 to 31 mc. in 6 steps. Complete with Speaker. **\$173.25**

NATIONAL RECEIVERS

HRB 5TA, complete with Power Supply, Speaker and Coils (1.7-4.0; 3.5-7.3; 7.0-14.4; 11.0-30MC) Additional coils available **\$306.70**

NC 2-40D Complete with Speaker **\$241.44**

NC 46 Complete with Speaker **\$107.40**

Federal Selenium Rectifiers

6 or 49 **99¢** Ea.

1 to 5 **\$1.09** Ea.



Quotations on larger quantities gladly furnished.

for: *CONSOLE RADIOS
*AC-DC PORTABLES
*VIBRATOR POWER SUPPLIES
*INTERCOM POWER SUPPLIES
*REPLACES 29 TYPES RECT. TUBES

FEATURES

REPLACE TUBE and SOCKET; REQUIRE LESS SPACE; FACILITATE SMALLER CABINET DESIGN; PROLONG LIFE OF SET; GIVE IMMEDIATE RECTIFICATION

Schematic Application with every order.

TALK-A-PHONE

LP-110 SUPER SELECTIVE SYSTEMS

The LP-110 System is made up exclusively of Master Stations. With this system any station can call any other station in the system and in addition a number of two-way conversations can be carried on at one time. You can begin with 2 Masters and add up to a total of 10 in the LP-110 System.

Each Master **\$26.50**

Milo has complete stocks of nationally known IRC, AEROVOX, B & W, NEWCOMB, THOR-DARSON, MEISSNER, TUNGSOIL, WESTON, SUPREME, NATIONAL, SNC TRANSFORMERS, etc.

If not rated, 20% with order, balance C.O.D.

Dept. C

MILO

Radio and Electronics Corp.

200 Greenwich St., N. Y. 7, N. Y.

BEekman 3-2980-1

Cable Address: "Milelectro, New York"

FREE! Send for it Now!

**ALLIED'S Catalog
of Everything in
RADIO**



**LARGEST STOCKS
QUICK DELIVERY**

Send for your **FREE** copy of the handiest, most complete Buying Guide for Everything in Radio! Features thousands of radio and electronic parts, latest home radios, sound systems, amateur and builders' gear, servicemen's equipment, tools, books—world's largest and most complete quality stocks—at lowest prices! Fastest service; expert help!

OVER 10,000 ITEMS.....



Complete lines of all leading makes. Largest stocks of hard-to-get parts. Money-saving prices. Get everything you need from one dependable supply source.

AMATEUR GEAR.....



Earliest delivery on latest communications receivers. Time payment plan; trade-ins accepted. Headquarters for all ham and experimenter's needs.

HOME RADIOS.....



Large selection of exceptional home radios and phono radios. Handsome new styles. Wonderful performance. Today's leading set values.

(PUBLIC ADDRESS.....



Famous Ready-to-Use Sound Systems for every P.A. requirement. Everything in amplifiers, speakers, microphones, intercom and recording.

HANDY RADIO BOOKS.....



Radio Formulas and Data
Dictionary of Radio Terms
Radio Circuit Handbook
Radio Builder's Handbook
Simplified Radio Servicing
Radio Data Handbook

ALL SIX BOOKS No. 37-799...75c
Parallel Resistance and Series Capacitance Calculator, No. 37-960 25c
R-F Resonance and Coil Winding Calculator, No. 37-955 25c

ALLIED RADIO

ALLIED RADIO CORP.
833 W. Jackson Blvd., Dept. 2-MM-6, Chicago 7, Ill.

- Send FREE Radio Catalog
 - Send 6 Books No. 37-799
 - Send Calculator No. 37-960
 - Send Calculator No. 37-955
- } enclosed

Name.....

Address.....

City.....Zone.....State.....

Available Radio-Electronic Literature

Manufacturers' bulletins, catalogs and periodicals.

A SERVICE FOR RADIO-CRAFT READERS: In order to save your time, postage and incidental work in writing a number of letters to different manufacturers to secure the various bulletins offered, proceed as follows:

On your letterhead (do not use postcards) ask us to send you the literature which you designate. *It is only necessary to give us the numbers.* We will then send your request directly to the manufacturers, who in turn will send their bulletins or other literature directly to you.

256—WIRING DEVICES

A 49-page catalog issued by Eagle Electric Mfg. Co. This catalog lists and illustrates hundreds of electrical appliances and repair parts used in the home or office.—*Gratis.*

257—RELAY CATALOG

Published by Advance Electric and Relay Co. It lists a complete line of relays of interest to the engineer, technician, amateur radio operator and experimenter. Each type of relay is illustrated with photographs and mechanical drawings.—*Gratis.*

258—RADIO PRODUCTS

A new 19-page catalog of radio products issued by National Co., Inc. It covers the complete line of receiving and transmitting variable condensers as well as dials, coil forms and assorted radio hardware. It is well illustrated and gives specifications of all items.—*Gratis.*

259—SWITCHES

A 7-page catalog and handbook of foot-operated switches published by General Control Co. These switches are available in several models which are illustrated with photographs and drawings.—*Gratis.*

260—PANEL INSTRUMENTS

A 12-page catalog of panel instruments is issued by Triplett Electrical Instrument Co. It covers a complete line of a.c. and d.c. current and volt meters. Complete electrical and mechanical specifications are given on each type of meter. Triplett also issues a similar catalog on radio test equipment.—*Gratis.*

261—VARIABLE CAPACITORS

Capacitor catalog No. 46, issued by The Allen D. Cardwell Mfg. Corp. It covers a complete line of variable air capacitors from midget receiving to heavy-duty transmitting types. Two pages are devoted to insulated couplings, dials and mounting brackets that may be used with the capacitors. All items in the catalog are illustrated with photographs and working drawings.—*Gratis.*

262—RECEIVING TUBE GUIDE

Published by General Electric Co. A 40-page book giving complete data on all types of receiving tubes. Two pages are devoted to definitions of tube ratings and technical data. This guide will be of particular interest to experimenters, servicemen and amateur radio operators.—*Gratis.*

263—INSTRUMENT CATALOG

Published by Marion Electrical Instrument Co. This 27-page illustrated catalog covers a complete line of panel type meters. Construction data, working drawings and specifications are given on each meter described in the catalog.—*Gratis.*

264—CENTRALAB CATALOG

The new catalog, No. 25, covers the complete post-war line of resistors, condensers and switches manufactured by Centralab. Complete specifications are given on each item listed.—*Gratis.*

SAVE MONEY!

by getting our big "Surplus"
BARGAIN BULLETIN

Just completed with latest list of surplus items at lowest prices ever offered

- Plate Transformers and Chokes
- Filter Conds., By-Pass Conds., Variable Conds.
- Tubes: Transmitting, Receiving
- Coax Cables, Fittings, Wire, etc.
- Coils, RF Chokes
- Receivers, Signal-Shifters, Test Equipment, Transmitters

We also carry standard lines. Such as—Cardwell, Shure, B&W, Westline, Conant, S/C Labs, Atlas, Telegraph Apparatus, etc.

NIAGARA RADIO SUPPLY CORP.,
160 Greenwich St., New York 6, N. Y.

Please send me copy of your latest bulletin listing hundreds of "hard-to-get" radio supplies, and place my name on file for future mailings.

Name

Address

City Zone State

Exportable address:
MICROWAVE—New York

NIAGARA RADIO SUPPLY
160 Greenwich St., New York 6, N. Y.
Bowling Green 9-7993

SLIDE RULE SHORT CUTS

with Positive Location of the Decimal Point.
EASIER—AC and DC calculations—QUICKER
Second Edition—12-pt. type; 6 by 9 inches
in size; decorative cover—\$1.50 postpaid.

W. P. MILLER

536 "F" Street San Diego 1, California

For the Man Who Takes Pride in His Work

**FM and Television Band Coverage on Strong Harmonics.
Strong Fundamental to 50 mc.**

Another member of the Triplett Square Line of matched units this signal generator embodies features normally found only in "custom priced" laboratory models.

FREQUENCY COVERAGE—Continuous and overlapping 75 KC to 50 MC. Six bands. All fundamentals. **TURRETTYPE COIL ASSEMBLY**—Six-position turret type coil switching with complete shielding. Coil rotates inside a copper-plated steel shield. **ATTENUATION**—Individually shielded and adjustable, by fine and coarse controls, to zero for all practical purposes. **STABILITY**—Greatly increased by use of air trimmer capacitors, electron coupled oscillator circuit and permeability adjusted coils. **INTERNAL MODULATION**—Approximately 30% at 400 cycles. **POWER SUPPLY**—115 volts, 50-60 cycles A.C. Voltage regulated for increased oscillator stability.

CASE—Heavy metal with tan and brown hammered enamel finish.

There are many other features in this beautiful model of equal interest to the man who takes pride in his work.

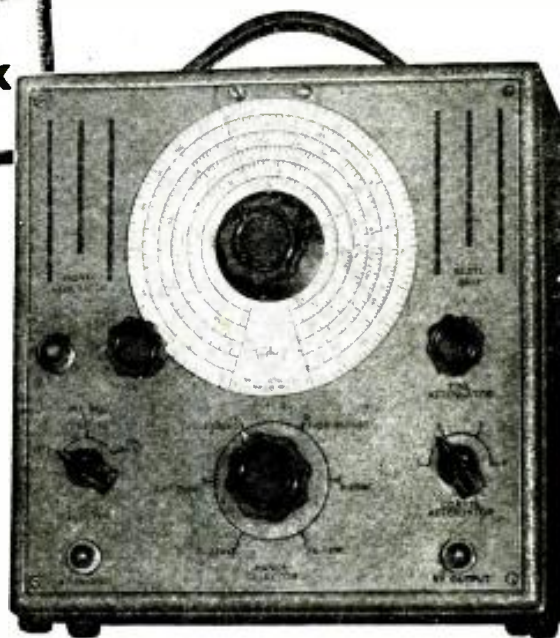

MODEL 2432
SIGNAL GENERATOR



*Precision first
...to last*

Triplett

ELECTRICAL INSTRUMENT CO. BLUFFTON, OHIO

WAR SURPLUS SALES

RADIO - ELECTRICAL - ELECTRONIC EQUIPMENT - PARTS - SUPPLIES

General Radio 1 amp Variacs \$9.95

SUPERIOR 2 KVA Power Stats; Input 115 volt AC, 50-60 cycle single phase. Output voltage range 0-135 volt maximum rated output current 15 amp available over entire range of output voltage; weight approx 20 lbs. 29.50

SUPERIOR 2 KVA 3 1/2 KW power stats. 2 in tandem, each 115 volt AC single phase. Same as the above but twice the input and output voltage 54.50

WESTERN ELECTRIC or SYLVANIA 1-N-21; 1-N-23 Crystals, 35c each 1.00

ZENITH-BENDIX or RAWLINS Frequency Meters BC 221 with original crystals; complete with spare tubes and calibration book, each one tested, guaranteed 54.50

Parallel No. 18 Zip wire; 10 feet lengths, with lugs on each end15

Phantom antennas, each50

Crystals 5000 KC complete in holders 1.95

Standard rack cabinets heavy gauge steel, gray crackle finish; panel opening 19" wide, 27" high 12.95

Many other interesting items

Prompt Delivery

25% deposit required on each order;

Shipped F.O.B. New York—Minimum Order \$2.00

MICHAEL STAHL, INC.

39 VESEY ST.,

Tel. COrtlandt 7-5890 New York 7, N. Y.

RADIO AND RACETRACKS

Race-track trickery with the aid of radio transmitters has often been tried. A new angle on this old game was brought to light in the prosecution of two Chicago bookies.

These operators scorned the complicated systems of former crooks who operated miniature phone transmitters and receivers to rush news of race finishes to betting spots before the regular news arrived. They used a simple "hash" transmitter. This was turned on to jam and prevent reception of broadcast signals in the pool hall, bar or ice cream parlor at which the pair planned to lay their bet. While one partner was operating the transmitter, the other would dash in and place a last-minute bet while the bookie to be victimized was still waiting for the results "over the radio."

One of the partners was sentenced to six months in jail on charges of sending interstate radio signals and operating a radio transmitter without a license. The other, who had not been involved in actual radio operation, was acquitted.

Adaptations of airborne television and remote control apparatus may soon eliminate test pilots on experimental aircraft. The television system could transmit to the ground continuous pictures of the plane's instruments as well as a clear view of the surroundings.

The Quality

RADIO KIT

available at a Record Breaking Low Price

sensationally reduced below O.P.A. ceiling price

MODEL S-5P



Improved superheterodyne circuit, built-in loop antenna, PM Alnico speaker, streamlined airplane dial, wide tuning range, 550Kc-1600 kc, 5 tubes (including rectifier 115V-AC-DC 12SK7 1F) 12SA7 converter, 12SQ7 Det. and 1st audio 50L6GT output and 35Z5GT rectifier, brown bakelite cabinet.

Complete Kit less tubes \$10.95

Tubes available (prices on request)

Also Available Phono Kits Model RP-3 19.95

Radio Phono Kit Model RP-S5 34.95

Portable Radio Phono Kit Model RP-S5P 31.95

Portable Battery Kit Model PB-4 15.95

Record Changer Kit Model RC-3 39.95

(ALL KITS SUPPLIED LESS WIRE & SOLDER)

Write for Descriptive Catalog M

RADIO KITS COMPANY

120 CEDAR STREET
NEW YORK, N. Y.

REPAIR ANY KIND OF RADIO EQUIPMENT!

SEE SPECIAL CHRISTMAS OFFER IN COUPON!

THE BOOK THAT HELPS YOU FIX TWO RADIOS IN THE TIME NORMALLY REQUIRED FOR ONE

You don't have to be an expert! You don't always have to use a lot of costly test equipment to repair 4 out of 5 troubles in radio sets! You only need the few ordinary tools of the trade—AND a copy of Ghirardi's big, 744-page RADIO TROUBLESHOOTER'S HANDBOOK!

Every receiver model has its "weak" spots that usually give trouble first. Through many years of painstaking work, Ghirardi has compiled the "Case Histories" of these common troubles into this one big volume. When you want to repair a set, simply look up its make and model number in the HANDBOOK! Four times out of five, it explains exactly WHAT the trouble is likely to be—then tells you exactly HOW to fix it. No needless tedious testing! No lost time or motion! You fix two sets in the time normally required for one and make a lot more money accordingly. It's a service short cut that really works. It's one that honestly pays for itself in time saved the first time you use it whether you are in the business or only tinker with radios once in a while. Smart servicemen use it on every job.

A. A. GHIRARDI
Radio's foremost servicing authority and most widely read magazine and book author.



Just about every home radio, auto radio and record changer in common use is covered in detail—over 4800 models by 202 different manufacturers! Everything is carefully indexed so you can find just what you are looking for. It isn't a "study" book. You just look up the radio you want to repair—then follow the complete, easy instructions that are given. It's as EASY as that.

BE A Professional RADIO-ELECTRONIC SERVICE EXPERT

Ghirardi's famous 1300-page MODERN RADIO SERVICING is a complete, 1 vol. course in professional service methods of the type that open doors to big money opportunities that only scientifically-trained men can grasp—including profitable industrial electronic work. It shows you how to eliminate guesswork by analyzing circuits scientifically by professional methods. It explains how all types of radio test instruments work and how, when, why and where to use them; how to troubleshoot components; how to make repairs and replacements; even how to start and operate a successful radio servicing business of your own!

In short, it shows how to handle every phase of radio service work in approved modern ways as compared to screw driver and plier technique. Invaluable as a "refresher course" for men already in the business. Worth its weight in gold to service beginners. Everything is written and explained clearly so it can easily be understood at home without an instructor. 706 illustrations and 720 specially prepared self-test review questions further simplify instruction. Only \$5—on our 5-DAY MONEY-BACK GUARANTEE.

Let Ghirardi's RADIO TROUBLESHOOTER'S HANDBOOK save you time and money on the common, every-day jobs. Let his MODERN RADIO SERVICING train you for the big opportunities in professional service work of all kinds! Buy BOTH on our special Money-Saving Christmas Combination Offer explained in coupon.

5-DAY MONEY-BACK GUARANTEE

MURRAY-HILL BOOKS, INC., Dept. RC-126
232 Madison Ave., New York 16, N. Y.

Enclosed find \$..... for books checked (send postpaid); or send C.O.D. (in U.S.A. only) for this amount plus postage. If I am not fully satisfied, I may return the books within 5 days and receive my money back.

- MONEY-SAVING COMBINATION CHRISTMAS OFFER—Both of the above big books for only \$9.50 for the two (\$10.50 foreign).
- Ghirardi's RADIO TROUBLESHOOTER'S HANDBOOK, \$5 (\$5.50 foreign)
 - Ghirardi's MODERN RADIO SERVICING \$5 (\$5.50 foreign)

Name

Address

City & Dist. No. State

CHRISTMAS GIFT TIP de luxe!



Give Ghirardi's Radio-Electronic books to friends this Christmas—ASK FRIENDS AND RELATIVES TO GIVE THEM TO YOU! Why not suggest using the attached coupon today. They'll appreciate the hint—and you'll appreciate the books every day of your life!

The books that tell you **WHAT** to do **HOW** to do it

WORLD-WIDE STATION LIST

(Continued from page 33)

- 9.535 BERNE, SWITZERLAND; to North America at 8:30 to 10 pm.
- 9.540 VLG2 MELBOURNE, AUSTRALIA; Asiatic beam, 7 to 9 am.
- 9.540 VLG5 SHEPPARTON, AUSTRALIA; North American beam, 7 to 7:45 am; 8:45 to 9:45 pm.
- 9.540 PARIS, FRANCE; midnight to 12:15 am; 12:30 to 12:45 am; 1 to 1:15 am.
- 9.540 XERQ MEXICO CITY, MEXICO; evenings.
- 9.540 LKJ OSLO, NORWAY; 2 to 2:30 am; 4:45 to 7 am.
- 9.540 CJCA EDMONTON, CANADA; 9:30 am to 11 pm.
- 9.548 SINGAPORE, MALAYA; 8 to 9:30 am.
- 9.550 GWB LONDON, ENGLAND.
- 9.550 OLR3A PRAGUE, CZECHOSLOVAKIA; 3 to 6 pm.
- 9.550 KGEI SAN FRANCISCO, CALIF.; East Indies beam, 4 to 10:45 am; Alaska beam, 11 am to 12:45 pm.
- 9.555 XETT MEXICO CITY, MEXICO.
- 9.565 KOMSOMOLSK, U.S.S.R.; 9 pm to midnight; 2 to 9 am; 11 am to 2 pm; 4 to 6 pm.
- 9.570 KWID SAN FRANCISCO, CALIF.; Oriental beam, 11:15 am to 1 pm; South American beam, 7:45 to 11:15 pm; Alaska beam, 11:30 pm to 1:45 am.
- 9.570 WRUA BOSTON, MASS.; European beam, 4:30 to 6 pm.
- 9.570 KWIX SAN FRANCISCO, CALIF.; Oriental beam, 2 to 11 am.
- 9.580 GSC LONDON, ENGLAND; Central American beam, 6 to 10:15 pm; India beam, 8 to 9:15 pm.
- 9.580 VLG MELBOURNE, AUSTRALIA; 9 to 10 am; 10:15 to 10:45 am; 11 am to noon.
- 9.590 WLW0 CINCINNATI, OHIO; European beam, 3 to 4:45 pm; South American beam, 6 pm to 12:15 am.
- 9.590 VUD4 DELHI, INDIA; 8 to 10:30 pm; 1 to 4 am; 5:30 to 7 am; 7:30 am to 3:45 pm.
- 9.590 PCJ HUIZEN, NETHERLANDS; 8 to 9:45 pm.
- 9.595 ATHLONE, IRELAND; 4:30 to 4:30 pm.
- 9.600 KEYU MEXICO CITY, MEXICO; heard late afternoons and evenings.
- 9.600 GRY LONDON, ENGLAND; South African beam, noon to 1 pm; Near East beam, 3 to 4 pm; Far East beam, 11 pm to 2:30 am; Northwest Pacific beam, 11 pm to 1:45 am.
- 9.608 ZRL CAPETOWN, SOUTH AFRICA; 3 to 7 am; 9 am to 4 pm.
- 9.610 ZYC8 RIO DE JANEIRO, BRAZIL; evenings 11 to midnight.
- 9.610 MCH LUXEMBOURG; heard irregularly at 4:30 pm calling New York.
- 9.615 VLG6 SHEPPARTON, AUSTRALIA; 5:15 to 5:30 am; 8:30 to 9:50 am; 11 am to noon.
- 9.615 TIPG SAN JOSE, COSTA RICA; 9 pm to 12:30 am.
- 9.623 CXA6 MONTEVIDEO, URUGUAY; 3:30 to 8 pm.
- 9.625 XGCA SOMEWHERE IN CHINA; 6 to 7:45 am.
- 9.625 GWO LONDON, ENGLAND; West African beam, 11:30 pm to 1:45 am; 4:15 to 5:45 pm; Mediterranean beam, 12:30 to 1:45 am.
- 9.630 CKL0 MONTREAL, CANADA; European beam, 3:15 to 7 pm.
- 9.640 GVZ LONDON, ENGLAND; North American beam, 7 to 11 pm; New Zealand beam, 1 to 5 am.
- 9.646 XGOY CHUNGKING, CHINA; news at 6 am.
- 9.660 GWP LONDON, ENGLAND; Far East beam, 8:45 to 10:15 am.
- 9.680 HVJ VATICAN CITY; 8:30 to 9:20 am.
- 9.660 HHBM PORT AU PRINCE, HAITI; 5 to 8:30 am; 11 am to 2 pm; 5 to 9 pm.
- 9.650 MOSCOW, U.S.S.R.; 4:30 to 9:15 pm.
- 9.670 WRCA NEW YORK CITY; Brazilian beam, 7 to 9 pm.
- 9.670 VUD4 DELHI, INDIA; 6:30 to 11 am.
- 9.675 JW2 TOKYO, JAPAN; 2 to 5 am; 5:30 to 7:15 am; 7:30 to 9:40 am; 9:55 am to 11:40 am; 12 to 1:40 pm; 4:30 to 6:45 pm.
- 9.680 XEQQ MEXICO CITY, MEXICO; evenings.
- 9.680 VLG2 SHEPPARTON, AUSTRALIA; 10 to 11 am.
- 9.680 EQC TEHERAN, IRAN; 1 to 3:30 pm.
- 9.683 LRA1 BUENOS AIRES, ARGENTINA; 6 to 8:30 pm.
- 9.685 TGWA GUATEMALA CITY, GUATEMALA; Sundays at 6:55 pm.
- 9.700 WRUS BOSTON, MASS.; Central American beam, 6:30 pm to 1 am.
- 9.700 KCBF SAN FRANCISCO, CALIF.; Oriental beam, 1 to 4:45 pm.
- 9.700 KCBR LOS ANGELES, CALIF.; Oriental beam, 2 to 4:45 am; 5 to 11 am.
- 9.705 FORT DE FRANCE, MARTINIQUE; heard at 5:30 pm.
- 9.710 CR7BE LOURENCO MARQUES, MOZAMBIQUE; 2 to 3:30 pm.
- 9.715 MOSCOW, U.S.S.R.; 6:30 to 7:30 am.
- 9.720 PRL7 RIO DE JANEIRO, BRAZIL; 3 to 9:30 pm.
- 9.730 XG0A CHUNGKING, CHINA; 12:30 to 1:45 am; 5:30 to 10:15 am.
- 9.735 CSW7 LISBON, PORTUGAL; 7 to 8 pm.
- 9.735 CXA15 MONTEVIDEO, URUGUAY.
- 9.745 OTC LEOPOLDVILLE, BELGIAN CONGO; 5 to 9:45 pm.
- 9.750 WLWRI CINCINNATI, OHIO; North African beam, 3:15 to 6 pm.
- 9.750 KCBF LOS ANGELES, CALIF.; South American beam, 11 pm to 1 am; East Indies beam, 4 to 9:45 am.
- 9.750 WNRA NEW YORK CITY; European beam, 4:45 to 6 pm.
- 9.763 OTC LEOPOLDVILLE, BELGIAN CONGO; relay BHC at 9:30 pm to 12:45 am.
- 9.785 OAX5C INCA, PERU; evenings.

9.800 HNF BAGDAD, IRAQ; 9 am to 4 pm.
 9.823 VIENNA, AUSTRIA; midnight to 2 am; 6 to 8 am; 10 am to 4:30 pm.
 9.825 GRH LONDON, ENGLAND; North American beam, 5 to 11 pm; Central and South African beam, 11 pm to 1:45 am; North African beam, 11 pm to 1:45 am.
 9.833 COBL HAVANA, CUBA; 7:15 am to 12:45 am.
 9.855 KWID SAN FRANCISCO, CALIF.; South Pacific beam, 2:30 to 6:30 am.
 9.860 MOSCOW, U.S.S.R.; 8 to 9:30 pm; 10 pm to 2 am; 3:30 to 9:30 am; 10 am to noon.
 9.897 WBOS BOSTON, MASS.; European beam, midnight to 3:15 am; 1 to 5:15 pm.
 9.900 ZTJ JOHANNESBURG, SOUTH AFRICA; 7:15 to 7:45 am.
 9.915 GRU LONDON, ENGLAND; North African beam, 12:15 to 4 pm; South African beam, 12:15 to 4 pm.
 9.930 SVM ATHENS, GREECE; heard 1 to 6 pm.
 9.958 HCJB QUITO, ECUADOR; afternoons and evenings.
 10.000 WWV WASHINGTON, D. C.; U. S. Bureau of Standards; frequency, time and musical pitch; broadcasts continuously by day and night.
 10.000 XGOL FOCHOW, CHINA; 5 to 9 am; 11:30 pm to 1 am.
 10.220 PSH RIO DE JANEIRO, BRAZIL; evenings.
 10.400 YPSA SAN SALVADOR, EL SALVADOR; heard evenings.
 10.420 VLN SYDNEY, AUSTRALIA; around 12:15 am.
 10.450 MOSCOW, U.S.S.R.; midnight to 2 am; 9:30 to 10 am.
 10.510 KUIG GUAM; heard calling NBC around 5:30 pm.
 10.730 VQ7LO NAIROBI, KENYA; 9 am.
 10.780 SDB2 STOCKHOLM, SWEDEN; 3:15 to 5 pm.
 11.040 CSW6 LISBON, PORTUGAL; Brazilian beam, 12:30 to 3 pm; 4 to 6 pm.
 11.090 PONTA DEL GADA, AZORES; 3 to 4 pm.
 11.115 MCH LUXEMBOURG; heard with Army Hour for New York.
 11.145 WCBN NEW YORK CITY; European beam, 1 to 5:45 pm.
 11.595 VRR4 JAMAICA, BRITISH WEST INDIES; heard at 10 am.
 11.616 COK HAVANA, CUBA; 11 am to 11 pm.
 11.640 PY2 MANILA, PHILIPPINES; 6:30 to 7:15 am; evenings.
 11.645 BRUSSELS, BELGIUM; evenings about 7:30 pm.
 11.650 XTPA CANTON, CHINA; 7 to 9:15 am.
 11.680 XMCY HAVANA, CUBA; afternoons and evenings.
 11.680 GRG LONDON, ENGLAND; Far East beam, 7 to 9 am; Northwest Pacific beam, 7 to 9:30 am.
 11.690 XGRS SHANGHAI, CHINA; 10:15 am to 11:30 am.
 11.696 HP5A PANAMA CITY, PANAMA; 7 am to 11 pm.
 11.700 GVW LONDON, ENGLAND; Southwest Pacific beam, 1 to 5 am; Indian beam, 11 pm to 1 am; South African beam, 10:30 am to 4 pm; Near East beam, 1 to 4 pm.
 11.705 SBP STOCKHOLM, SWEDEN; 8 to 9 pm; 1:45 to 2:15 am; 6 to 7 am.
 11.705 CXA19 MONTEVIDEO, URUGUAY; 8 to 9 pm.
 11.705 CBFY VERCHERES, CANADA; 10 am to 11 am.
 11.710 WLWS2 CINCINNATI, OHIO; 4:45 pm to 1 am.
 11.710 WLWK CINCINNATI, OHIO; European beam, 7:30 am to 4:30 pm.
 11.710 VLG3 MELBOURNE, AUSTRALIA; 1 to 4:45 am.
 11.715 HE15 BERNE, SWITZERLAND; 6:30 to 8 pm except Saturdays.
 11.718 CR7BH MARQUIS, MOZAMBIQUE.
 11.720 PRL8 RIO DE JANEIRO, BRAZIL; heard at 5 am.
 11.720 CKRX WINNIPEG, CANADA.
 11.720 OTC LEOPOLDVILLE, BELGIAN CONGO; 5:30 to 7:30 am.
 11.725 JYW3 TOKYO, JAPAN; heard at 1 pm.
 11.730 KGEI SAN FRANCISCO, CALIF.; Southwest Pacific beam, 1 to 4:45 pm.
 11.730 WRUW BOSTON, MASS.; European beam, 1 to 5 pm; Caribbean beam, 5:15 to 5:45 pm.
 11.730 KGEX SAN FRANCISCO, CALIF.; 2 to 4:45 am; 5 to 11 am.
 11.730 WRUL BOSTON, MASS.; 5:30 to 6 pm; 6:30 pm to 1 am.
 11.730 GVV LONDON, ENGLAND; Far East beam, 12 to 4:45 am.
 11.740 COCY HAVANA, CUBA; afternoons.
 11.740 CEI174 SANTIAGO, CHILE; 7 am to 11:30 pm.
 11.740 HVJ VATICAN CITY; noon to 1 pm.
 11.750 GSD LONDON, ENGLAND; South African beam, 12:30 to 3 am; 10:30 am to 1 pm; West African beam, 1 to 3 am; South American beam, 4:15 to 10:15 pm; Central American beam, 4:15 to 9 pm; Mediterranean beam, 1 to 4 am; 6 to 10 am; 10:30 am to 2:30 pm; North African beam, 2 to 4 am; 6 to 10 am; 10:30 am to 1 pm.
 11.760 VLG10 MELBOURNE, AUSTRALIA; 2:30 to 5 am; 5:30 to 8 am; 8:30 to 9 am.
 11.765 ALGERS; 6 am to noon.
 11.770 KCBA SAN FRANCISCO, CALIF.; South American beam, 11 pm to 1 am; 5 to 10:15 pm; Oriental beam, 1 to 4:45 pm.
 11.770 VLA4 MELBOURNE, AUSTRALIA; 2 to 3:15 am.
 11.780 HP5G PANAMA CITY, PANAMA; daytime and evenings.
 11.780 OIX3 MOSCOW, U.S.S.R.; 9 to 10 am.
 11.780 LAHTI, FINLAND; 2:30 to 3 am; 6 to 7 am; 8:15 to 8:45 am; 1 to 5 pm; 5:45 to 6:15 pm; 8:15 to 8:30 pm.
 11.785 BRUSSELS, BELGIUM; 5:30 to 6 pm; 8 to 8:15 pm.
 11.790 WRUL BOSTON, MASS.; 11 am to 5 pm.
 11.790 KNBA SAN FRANCISCO, CALIF.; Philippine beam, midnight to 3:45 am; South American beam, 5 to 11:45 pm.

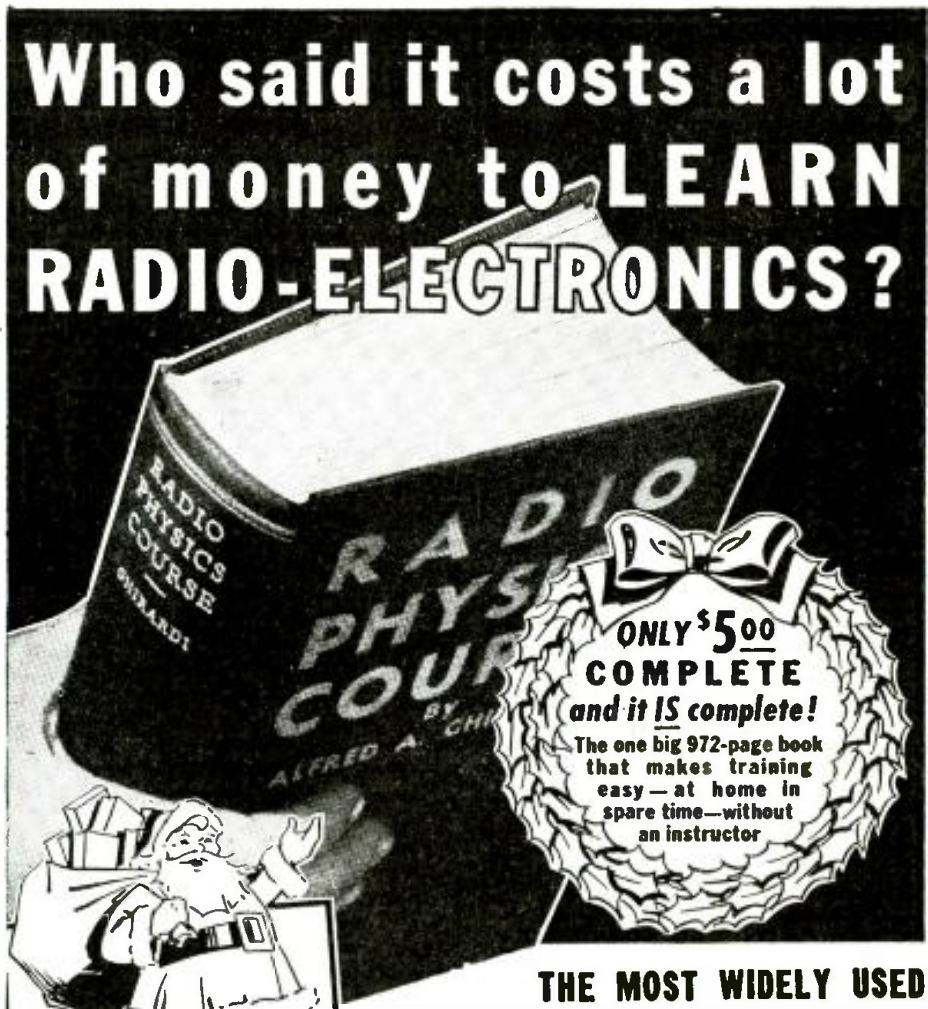

Get it for CHRISTMAS!
Give it for CHRISTMAS!

What finer Christmas gift could you ever hope to receive—or give to a radio inclined friend—than this 3 1/2 lb. book that can pave the way for big pay or a self-owned business in the most fascinating, fastest growing industry of all?

Friends or relatives are wondering what to give YOU this Christmas. Why not drop a hint that you'd like A. A. Ghirardi's RADIO PHYSICS COURSE and give them the attached coupon to mail?

YOUR MONEY BACK!

Send coupon today! Compare Ghirardi's RADIO PHYSICS COURSE with any other Radio book or course AT ANY PRICE. Use it for 5 days. Then, if you are not more than satisfied that it will teach you basic Radio Electronics—EASIER, FASTER, and at LESS COST—return it. We will refund your money WITHOUT QUESTION!

36 COURSES IN ONE!

Actually, RADIO PHYSICS COURSE gives you the scope of 36 complete courses in one big book. If it were broken into sections and sold as a series of lessons, you'd regard it as a bargain at \$50 or more. It's yours, however, in this handy 1-vol. form for only \$5 COMPLETE (\$5.50 foreign)—and you don't even take the slightest chance on that amount.

Who said it costs a lot of money to LEARN RADIO-ELECTRONICS?

ONLY \$5.00 COMPLETE and it IS complete!

The one big 972-page book that makes training easy—at home in spare time—without an instructor

THE MOST WIDELY USED RADIO-ELECTRONIC TRAINING BOOK IN THE WORLD

Let Alfred A. Ghirardi PROVE to you that Radio-Electronic Training doesn't have to cost a lot of money to be GOOD! Let him prove that his famous RADIO PHYSICS COURSE book can teach you faster, easier and AT FAR LESS COST than any other book or course! Let him prove that you'll be pleasantly surprised how easily this one big 972-page illustrated book AT ONLY \$5 complete makes it easy for you to understand subjects that other training makes seem too difficult for beginners!

EVERY CENT of your money will be cheerfully refunded if you're not more than satisfied after a 5-day trial. No questions will be asked!

LEARN AS FAST AS YOU CAN READ!

No matter what phase of Radio or Electronic work you plan to specialize in, you'll need the basic training RADIO PHYSICS COURSE gives you first. It is a matter of record that this book is more widely used for home study and was selected for more Signal Corps and Navy radio training programs during the war than any other book of its kind. On an actual survey among hundreds of practical radio men themselves, 9 out of 10 endorsed it as the finest, easiest-to-understand Radio-Electronic Course on the market!

COMPLETE — EASY TO UNDERSTAND

Nothing is omitted or condensed. Starting with a thorough foundation in Basic Electricity, Ghirardi's world-famous RADIO PHYSICS COURSE leads you through the entire field. Everything is made crystal clear by both text and 508 helpful illustrations. 858 Self-Test Review Questions make learning and self-check doubly easy. No lessons to wait for. You get the Complete Course all at once in convenient bound book form—and you get it for only \$5. Many who never even studied a circuit diagram before have completed it in a few weeks—and an amazingly high percentage of them are now successful Radio experts. You can do the same!

MAIL THIS COUPON NOW!

MURRAY-HILL BOOKS, Inc.
 Dept. RC-126, 232 Madison Ave., New York 16, N. Y.

Enclosed find \$5 (\$5.50 foreign) for A. A. Ghirardi's 972-page RADIO PHYSICS COURSE book; or send C.O.D. (in U.S.A. only) for this amount plus Postage. In either event, it is understood that I may return the book in 5 days for refund if not satisfactory.

Name

Address

City and Dist. No. State

Learn at home — EASIER, BETTER, FASTER

SPECIAL OFFER

**Surplus
New
Guaranteed**

METERS

COMBINATION SET A

A.C. VOLTMETER W.H., 2 1/2", Aircraft type, 4 hole mtg., 0-150 volt A.C., Black scale, luminous markings, suitable for use from 25 to 125 cycles.

D.C. MICROAMMETER Triplett Gruen, 2 1/2", round bakelite case, 0-100 microamperes D.C., black scale divided into 0-100 microamp and 5 to 6 DIBM.

D.C. MILLIAMMETER W.H., 2 1/2", NX-33, round bakelite case, 0-1 MA movement, Black scale marked C.W. PA Plate, PA Grid & Battery.

D.C. MILLIAMMETER G.E., 1 3/4" square, miniature, 0-1 M.A. 100 ohms internal resistance, 10 division Black Scale.

R.F. AMMETER G.E., DW-14, 2 1/2", round bakelite case, 0-6 Amps Radio Frequency, Black scale luminous markings, Internal thermocouple.

R.F. MILLIAMMETER Weston 507, 2 1/2", round metal case, 0-750 MA Radio Freq. with external thermocouple, Black scale marked 0-10 Antenna Current Indicator.

D.C. VOLTMETER G.E., DW-11, 2 1/2", round bakelite case, 0-15 volts D.C., Black scale, luminous markings.

D.C. AMMETER G.E., 2 1/2", round, stamped metal case, 0-15 A. D.C. moving iron vane type.

Total List Price of these EIGHT METERS is over \$100 Dollars. NOW ALL THESE NEW METERS can be had Post Paid any place in the U.S. and Canada

FOR ONLY \$13.50

COMBINATION SET B

A.C. VOLTMETER Westinghouse, 2 1/2", Aircraft Type 0-150 Volts, Black scale, luminous markings, Suitable for use from 25 to 125 cycles.

D.C. VOLTMETER General Electric, 2 1/2", Aircraft Type, 0-30 Volts, Bl. sc., lum. mks., 5 M.A. movement.

D.C. MILLIAMMETERS General Electric, 2 1/2", Aircraft Type, black scale, lum. mks., 1-0-1 milliamperes movement.

D.C. MILLIAMMETER General Electric 1 3/4" square miniature meter, special black scale 1.37 M.A. movement full scale.

Total List Price of these FOUR METERS is Approximately \$60.00. NOW ALL THESE NEW METERS can be had Post Paid any place in the U. S. and Canada

FOR ONLY \$5.25.

Maritime Switchboard

336 CANAL ST. N. Y. 13, N. Y.
Worth 4-8217

TELEVISION FOR TODAY

(Continued from page 29)

will then limit the load resistor to a value between 7,500 and 10,000 ohms for the full 4.0 mc response. A series peaking coil, as shown in the illustration, will ensure that the higher video frequencies are maintained at the level of the lower frequencies.

It is well to remember that the size of the final image will have a considerable influence on the care required in the design of the video circuits. If high definition is required, then the full 4.0 mc must be passed by all the receiver circuits. On the other hand, if the final image is to be small, then some loss of definition will hardly be noticeable and 3.0-mc, or even 2.5-mc, band-pass characteristics will suffice. In this instance we can raise the gain of the stages if we maintain the bandpass at this decreased value instead of the full 4.0 mc. It is important for the radio serviceman to realize these limitations, especially when replacing resistors or condensers with other units having other values. In the detector circuits being analyzed right now, higher load resistor (with subsequent increased output) is possible if we desire only a restricted range of frequencies up to 2.5 mc.

INFLUENCE ON POLARITY

It has been mentioned previously that the standard method of transmission in the United States is the negative-polarity system. It is well known, too, that at the control grid of the cathode-ray tube, the video signal must have positive polarity. So long as the video voltages remain attached to the carrier (which is true until the second detector) the polarity is negative and no simple method exists of reversing it. At the second detector, however, we divorce the video voltages from the carrier and now strict observance must be given to the phase of the picture signal if it is to be in proper phase at the cathode-ray tube.

The polarity of the signal across the load resistor will depend upon the manner in which the diode detector is wired in the circuit. In Fig. 1, for example, the diode will conduct only when the plate is positive, which means that maximum current will be obtained for the synchronizing and blanking pulses. The polarity of the resulting voltage across the load resistor will reach its greatest maximum value at these same instants. Hence the output of this detector is of the negative phase. The

synchronizing peaks still possess the most positive voltage in the video signal, as shown by the form of the voltage to the right of the detector.

It is possible to achieve positive picture polarity by either shifting the ground terminal on the above circuit

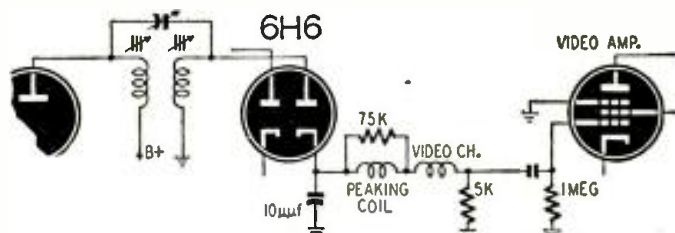

Fig. 4—A peaking coil is used to extend frequency response.

(as shown in Fig. 6-a) or else reverse tube connections, as shown in Fig. 6-b. In the latter two circuits, the ungrounded end of the load resistor decreases to its most negative voltage upon the application of the synchronizing pulses. As a result, the video voltage values contained in the incoming carrier are reversed, producing positive polarity.

The voltage, as obtained from the detector, is insufficient to drive the cathode-ray tube and additional amplification must be furnished by one or more

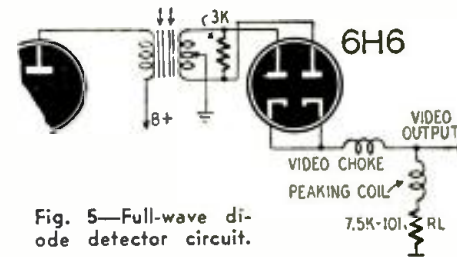

Fig. 5—Full-wave diode detector circuit.

video amplifiers. Since each tube in a resistance-coupled amplifier introduces a 180-degree phase shift, we have in essence a reversal of polarity whenever a signal passes through the tube. Thus, if the output of a video detector is of the positive picture phase, two or any even number of stages are required between the detector and the control grid

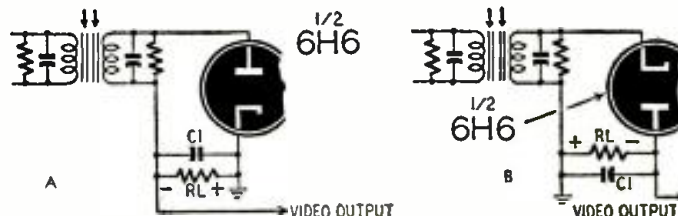

Fig. 6—Detector adjustments to insure positive picture polarity.

of the cathode-ray tube. But if a negative picture phase is obtained from the detector, then one or three or any odd number of amplifiers are required. It is interesting to note that if a receiver customarily designed for an odd number of video stages is altered to include an even number, the image as seen

(Continued on page 61)

Electricity

Capacity range: 350 to 35,000 watts; 115 to 660 volts A.C.; 50 to 800 cycles; 6 to 800 volts D.C.; combination A.C.—D.C. types.

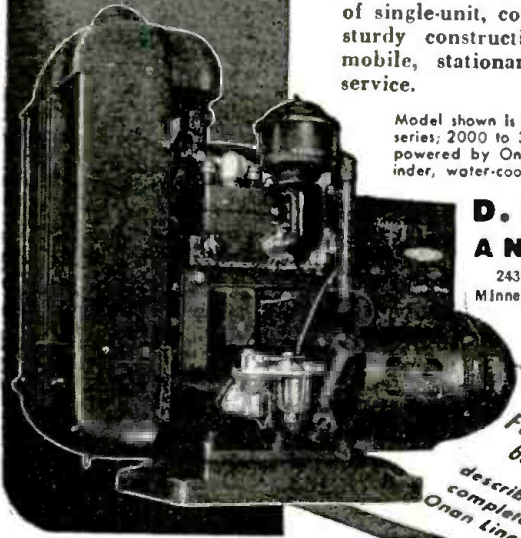

FOR RADIO AND ELECTRONIC APPLICATIONS

ONAN ELECTRIC GENERATING PLANTS supply reliable, economical electrical service for electronics and television applications as well as for scores of general uses. Driven by Onan-built, 4-cycle gasoline engines, these power units are of single-unit, compact design and sturdy construction. Suitable for mobile, stationary or emergency service.

Model shown is from W35 series; 2000 to 3500 watts; powered by Onan two-cylinder, water-cooled engine.

D. W. ONAN AND SONS

2435 Royalston Avenue
Minneapolis 5, Minn.

Write For Folder 690 describing complete Onan Line

TWIN-CHANNEL AMP

I was asked to construct two small amplifiers of good tone and medium volume for our record and sales department. These were to be used to demonstrate records on two separate record players.

As the amplifier is being used eight hours a day and parts are very scarce here, I decided to use only a minimum number of components to make it as reliable as possible, leaving the quality of tone to the proper selection of the tube, output transformer and speaker.

The tone of this circuit is good as is, and I found no necessity for tone controls, which may be added at the discretion of the constructor. The output is about five watts at a total harmonic distortion of 5 percent per channel. The two record players work independently at the same time, without interfering with each other. The use of filter chokes or the field of speaker depends on the type of speaker used—W. Buscher

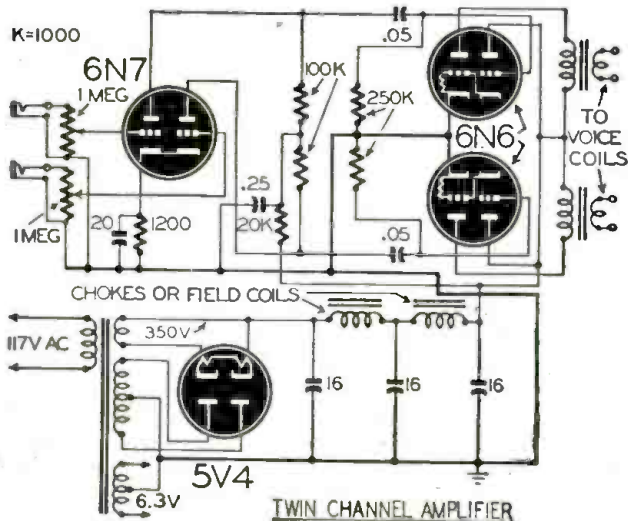

TWIN CHANNEL AMPLIFIER

Good news for FM and TELEVISION set owners

KINGS

tunable dipole antenna

Now... KINGS ELECTRONICS brings you the answer to low signal interception... a TUNABLE dipole antenna. Weak stations can be brought in clearly and powerfully by a simple adjustment of the calibrated arms. Truly a tremendous advantage over antennae of conventional design. And note the range! The Kings Dipole covers all bands from 62 mc. to 840 mc. for reception of black-and-white, color and experimental television, as well as FM and amateur communication.

The Kings Dipole is a well-constructed, sturdy, corrosion-resistant antenna that will please your customers and build good-will and sales for yourself. Don't delay... write today for further information about this unique, powerful TUNABLE dipole.

Model A1100—List price

\$22.50

(Antenna only)

TRANSMISSION LINES AVAILABLE WITH KINGS DIPOLE ANTENNA

Cat. No. 500. Special weather-proofed line having the correct surge impedance to match the Kings antenna and the standard television receiver.

Cat. No. 500-50. 50 feet..... \$ 8.75 List Price

Cat. No. 500-75. 75 feet..... \$10.70 List Price

Cat. No. 500-100. 100 feet..... \$12.60 List Price

Cat. No. 501. Ultra low-loss Transmission line of the co-axial type. Especially recommended for minimum loss of power from antenna to set. Has highest efficiency of any line for this purpose.

Cat. No. 501-50. 50 feet..... \$17.50 List Price

Cat. No. 501-75. 75 feet..... \$23.75 List Price

Cat. No. 501-100. 100 feet..... \$30.00 List Price

Cat. No. 501-150. 150 feet..... \$42.30 List Price

Cat. No. 501-200. 200 feet..... \$55.00 List Price

Price includes 2 Co-axial Connectors PL-259, 1-50-239.

KINGS ELECTRONICS

372 CLASSON AVENUE, BROOKLYN 5, N. Y.

manufacturers of
MICROPHONE PLUGS AND JACKS • CO-AXIAL CONNECTORS
TELEVISION ANTENNA • VARIABLE CONDENSERS • WAVE GUIDES
WAVE TRAPS • RADAR ASSEMBLIES AND SPECIAL EQUIPMENT

SERVICE-MEN'S LEOTONÉ SPECIALS

BARGAIN ASSORTMENT KITS

- #1-Ten assorted antenna, R.F. and oscillator coils \$.98
- #2-Speaker Cones—12 assd. 4" to 12" moulded & free-voice (magnetic incl) Less voice coil 2.00



- #3-BAKELITE MICA CONDENSERS—50 assd. .00001 to .2 mid. 400-800 WV. Capacitors clearly marked 2.95
- #4-TUBULAR BY-PASS CONDENSERS—50 assd. .0005 to .25 mid. 200-600 WV. Standard brands 2.49
- #5-Electrolytics—10 assd. including multisection, paper & can types 1.25
- #6-Dial Scales—25 assd. airplane & slide rule (acetal & glass included) 2.98
- #7-Escutcheon Plates—25 assd. airplane, slide-rule & full-vision types 2.95
- #8-Knobs—25 assd. wood & bakelite (screw & push-on types) 1.00
- #9-Wafer Sockets—12 assd. 4 to 7 prongs25
- #10-Bakelite Coil Forms—18 assd. sizes up to 3" diameter 1.00
- #11-Shield Cans—15 assorted sizes for coils, tubes, transformers, etc. 1.00
- #12-Mica Trimmers—15 assd. including multiple & ceramic base types69

RADIOMEN'S HARDWARE TREASURE. Approx. 1000 assd. screws, nuts, washers, etc. PLUS handy 36 compartment kit box with cover. All for \$.59

TUBES: Perfect condition, but not in sealed cartons. Guaranteed for 30 days. 28, 27, 4E, 56, or 6F8-29c; 21, 42, 77, 6A7, 6CG, 6DE, 6HF, 6J5, 6K6, 6K7 or 6Q739

20 mid 200V tubular electrolytics—5 for 1.00

5 Tube Punched Chassis, cadmium plated steel, 11"x4"x1 1/2" Mid. on 8 1/2"x11" steel panel.59

EXPERIMENTAL TUBES. 20 assd. sizes & base types for testing, research, etc. Fil. tested. 1.00

SURPLUS VALUES

- 4 TUBE AMPLIFIER (2-7C5, 7F7, 7Y4) Used as electronic amplifier control. 110V, 400 cycle. Contains: 1 power transformer, 7 condensers (mica & oil), 7 resistors, 4 local sockets plus other components worth many times the price. Black crackle case & fitted slide-in chassis. 8 1/2"x4 1/2"x3 1/2". Less tubes 1.49
- 110V. PANEL LIGHT ASSEMBLY. 1" amber jewel. D.C. bay. Base. Gun metal finish. 580P. Neon Glow Lamps 2/watt. 110V. clear. D.C. bay base49
- Frequency Meter, Tech. Manual (Navy), Theory & operation. 39 tubes & shutrams. 580P.15
- EARPHONE HEADBANDS (Army HS-23) Leather covered frame, adj. forks. With PL-51 & double cord39
- PL-54 plug & 13" lined double phone cord19
- PL-26 ext. jack for PL-54. Bakelite shell23
- PL-55 two way phone plug. Bakelite shell25
- Earphone Cushion, sponge rubber10

16" N.R.C. RECORDINGS. Each contains 2 complete 15 min. "Voice of the Army" dramatic programs with music. Over 50 different titles, such as: Combat Dog, I'll Never Forget, Casualty, etc. 33 1/3 RPM **29^c EA.**

- POWER RHEOSTATS.** 15 ohm-50 watt. Suitable control for small motors, electric trains, filaments, etc. Porcelain insul. cast alum. shell.98
- 5 TUBE AMPLIFIER (Hexidex). 2-6H6, 3-6SN7. Originally used with remote indicator. 27V. DC or 110V. 400 cycle. Black crackle shock-mid. case & fitted chassis. 7 3/4"x5 1/2"x4 1/2". Shpr. wt. 7 lbs. Less tubes 2.49
- SELSYN SYNCHRO-TRANSMITTERS: 115V. 60 cycle. Used in pairs as transmitter & follower. 3 1/2"x5 1/2" per pair 5.95
- SELSYN GENERATORS (#211F3) Used in pairs as above, but on 45V. 60 cycles. 2 1/2"x4 1/2" per pair 3.95

ALNICO MAGNETS

- #1-Bar in shorter lengths, per inch12
- #2-Face 1 1/4"x1 3/4"x3/8" high98
- #3-Heavy duty bar, 2 1/2"x1 3/4"x5/16" thick98
- #4-Face 3/4"x3/4"x3/8" high39
- #5-Polished, 3/4"x5/16"x3/8" high35
- #6-Polished bar, 9/16"x1/2"x1/4" 20 for 1.00
- #7-Face 1 1/2"x1 1/2"x3/8" high10
- #8-Horseshoe, ea. pole 3/8" sq.; 1 1/2" high89
- #9-Horseshoe, ea. pole 9/16" sq.; 1 1/2" high 1.29

Prompt Service on All Speaker and Phone Pickup Repairs
Minimum Order \$2.00—20% Deposit Required on all orders
Please Add Sufficient Postage
Write Dept. 12

LEOTONÉ RADIO CO.
MAKERS OF CONES AND FIELD COILS
65-67 DEY STREET, NEW YORK 7, N.Y.
WORTH 2-0284-5
12,000 SQ. FT. OF RADIO PARTS

SERVICING MOVIE SOUND

(Continued from page 30)

frequency units, using the same technique as for PA or radio speakers, however if trouble occurs in the high-frequency unit it is best to replace it with a new one or ship it to the factory for repairs, as these units cannot be repaired successfully in the average radio shop.

The circuit of a typical cross-over network is shown in Fig. 5. Cross-over occurs at about 400 cycles.

EMERGENCY SERVICING

The most important point in servicing theatre sound in an emergency is to start the show running again as quickly as possible, using any means available. A permanent repair can be made when the day's run is finished.

Since all parts of the sound system are not invariably necessary for emergency operation, it is often possible to bridge the inoperative unit or effect a substitution that will be satisfactory for emergency operation.

The fact that there are two sound heads and usually two voltage amplifiers helps locate the unit in which trouble has occurred because one can be compared with the other. Component parts of sound heads and amplifiers such as photocells, tubes, exciter lamps, etc., may be quickly swapped from one head or amplifier to the other for comparison.

The first test should be made on the a.c. power supply. A test lamp is handy for this purpose. If power is being supplied to the system we proceed to check the amplifiers.

Turn the main volume control up high and tap the first tube in the voltage amplifier. This should produce a thump in the monitor speaker. If it does not, trouble exists in the voltage or power amplifiers and they should be checked.

If the amplifiers are operative, each sound head can be quickly checked by interrupting the light beam rapidly with a pencil. This should produce a loud plopping sound in the speakers each time the beam is interrupted. If it does not, trouble exists in the photocell or coupling circuits, on either or both sound heads. Probably no polarizing voltage is reaching the cells and this should be checked first. If trouble exists in the polarizing voltage supply, B batteries may be used to supply the proper voltage until a permanent repair can be made.

Trouble in the stage speakers or cross-over network will generally re-

sult in normal reproduction from the monitor speaker and no sound from the stage speakers. Failure of the high-

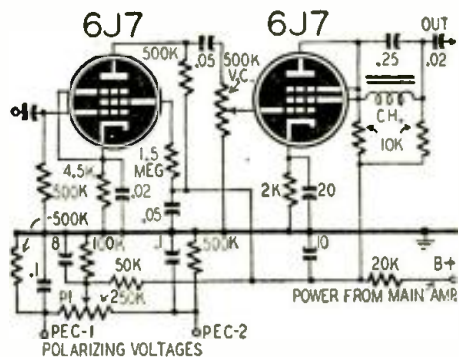

Fig. 3—Voltage amplifier for two soundheads.

frequency unit or units will result in heavy unintelligible sound in the auditorium. It is a simple matter to quickly

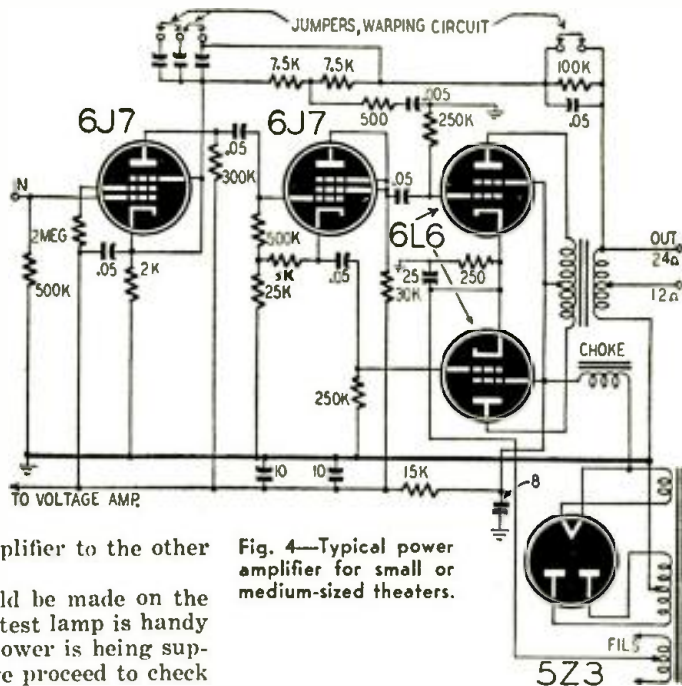

Fig. 4—Typical power amplifier for small or medium-sized theaters.

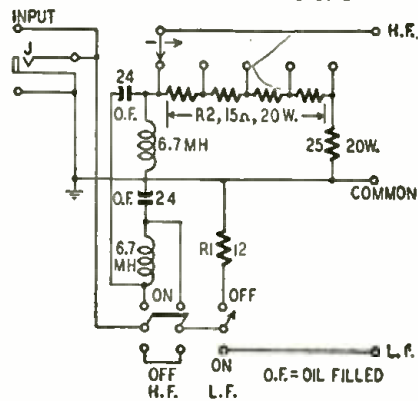

Fig. 5—A simple cross-over network.

disconnect the cross-over network and feed the amplifier output directly to the low-frequency units, using them as full-range speakers until the high-frequency unit may be repaired or replaced. The

(Continued on page 60)

PRIVATE AIRCRAFT RADIO

(Continued from page 22)

high voltage so that loud-speaker operation may be had. Adequate sidetone still exists in the headphones for pilot's operation.

In the upper left-hand corner is located the manual control of the transmit-receive relay. The function is made available in case the remote push-button electrical control is not desired.

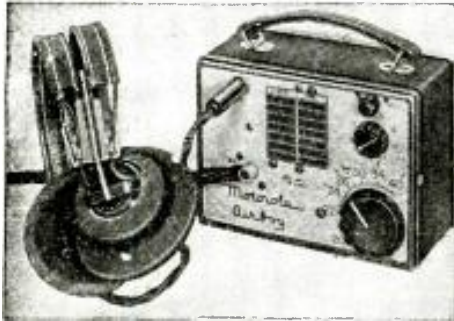

Photo B—Airboy, little larger than phones.

The accessories are illustrated in Fig. 1. The automatic reeling antenna is positioned in the fuselage as shown at 2. The guide rail device mounts inside the fuselage exposing a short length of antenna wire between the cabin and the vertical fin. The antenna is reeled out or in automatically during take-off or landing. At cruising speed, the wind sock extends the antenna wire to its proper length and automatically retracts and retunes it when the plane reaches minimum gliding speed. All necessary springs and pulleys are mounted on the guide rail. Transmitter adjustments for maximum and minimum antenna lengths is made by pre-

adjustment of the antenna loading coil.

At 3, we find the marker receiver complete with antenna.

The teardrop loop is illustrated at 4. It is statically shielded and rotated by a 15-foot flexible shaft which is connected to the loop control knob through a 12 to 1 gear ratio.

The light-weight headphone and microphone unit is shown at 5. These units are of the latest military types operating on the dynamic principle. The lip microphone is connected to the headband with a flexible supporting tube. This leaves the hands free for airplane operation as the push-to-talk button may be mounted on the stick or wheel.

The antenna loading coil is mounted behind the upholstery with the resonance indicator bulb exposed to view. It is pictured at 6.

The marker antenna is shown as it is mounted on the fuselage with the lead wires in place.

All cables and accessories necessary for installation are shown at 7.

In conjunction with the presentation of the "Navigator," the Galvin Mfg. Corp. also announced the introduction of the Motorola "Airboy," a portable receiver weighing only 4 pounds with battery. It is designed for the typical aircraft antenna and receives beacon, weather and tower signals.

The Airboy is pictured in Photo B. This four-tube receiver may be used in or out of the plane with equal ease. It has a sensitivity of 7 microvolts and a range of 100 miles. A handy station log is included for reference to beams, frequencies and call letters.



WHOLESALE RADIO-ELECTRONICS PARTS DISTRIBUTOR

ALMO OFFERS OVER 100,000 RADIO TUBES

AT O. P. A. DEALER PRICES

Tube Types	Your Cost Each
5Y3G/GT — 27 — 80	44c
5Y4G — 26 — 56	49c
75	52c
6J5 — 24A	59c

1H4G — 5U4G — 6C6 — 6K6GT 6SA7 — 6SK7 — 6SQ7 — 6SS7 6U7G — 12SA7 — 12SK7 — 12SQ7 — 39/44	65c
---	-----

1A5GT — 6C5 — 6F6 — 6H6 — 6SJ7 — 6SK7 — 6SQ7 — 6SR7 — 6V6GT — 12H6 — 12SJ7 — 38	73c
---	-----

1C6 — 1C7G — 6C4 — 6SC7 1N5GT — 6SN7GT — 7Y4 — — 7Z4 — 12SA7GT — 7A7 — 12SC7 — 12SF7 — 12SG7 — 12SH7 — 12SN7GT — 12SR7 — — 33 — 34 — 82 — 83	86c
---	-----

OY4 — 1G6GT — 1L4 — 1P5GT — 1R5 — 1S4 — 1S5 — 1T4 — 1SB6GT — 5V4G — 6BA6 — 6BE6 — 6F7 — 6N7GT — 6R7 — 6SL7GT — 6SV7 — 6Y6G — 7F7 — 12AT6 — 12BA6 — 12BE6 — 12SL7GT — 117Z3	\$1.08
--	--------

1D8GT — 5T4 — 6B4G — 6B8 — 6L6GA — 12A6 — 12C8 — 14A7/12B7 — 14N7	\$1.32
---	--------

1LN5 — 2A4G — 6AC7/1852 50B5	\$1.58
---------------------------------	--------

6AK5 — 10	\$1.93
-----------	--------

MAIL ORDERS FILLED PROMPTLY



509 ARCH STREET
PHILADELPHIA 6, PA.
LOmbard 3-0513

SPEED UP REPAIRS WITH THESE G-C AIDS!



Two Popular
New Additions
to the Famous
G-C Line!

G-C De Luxe "SPEEDEX" Wire Stripper Kit

Handiest tool in the shop—the famous Speedex Wire Stripper complete with 7 interchangeable blades for stripping any size wire from No. 8 to No. 30. Put up in attractive permanent steel box. Available with Automatic or Regular Strippers.

No. 733-K Regular List Price \$15.00
No. 744-K Automatic List Price 17.00

Send For
Latest G-C
Catalog No. 147

G-C PHONO TURNTABLE SERVICE STAND

This quickly adjustable phono service stand supports turntable at any convenient angle. Top or bottom mechanism can be worked on with ease. Definitely saves time and prevents damage to parts. Rugged—all steel—low cost.

No. 5205 List Price \$6.65

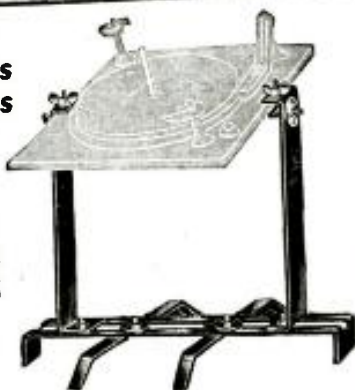

GENERAL CEMENT MFG. CO.
ROCKFORD, ILLINOIS

MIDWEST RADIOS

at Greater-Than-Ever VALUES

BIG, POWERFUL
WORLD-RANGING CHASSIS
with FM
(Frequency Modulation)
5 WAVE BANDS
SEPARATE CHASSIS or COMPLETE CONSOLES AVAILABLE



SERIES 16

30 DAYS TRIAL



The SYMPHONY GRAND A M - FM RADIO-PHONOGRAPH CONSOLE

A magnificent radio and musical instrument that is completely new—from the ground up. Big, powerful Series 16 Chassis brings in long wave, short wave and FM reception... an automatic record-changing phonograph... and scores of NEW Post-war features. **EASY TERMS**

SEND FOR **FREE CATALOG**

BUY DIRECT FROM FACTORY and SAVE!

FILL IN COUPON AND MAIL TODAY OR JUST SEND YOUR NAME AND ADDRESS ON 3 POSTCARDS

MIDWEST RADIO CORPORATION
Dept. 38-A, Cincinnati 2, Ohio

Gentlemen: Please send me your new FREE Catalog and details of Your Liberal 30 Days' Trial!

NAME _____
STREET _____
CITY _____ ZONE _____ STATE _____

Make MONEY

SERVICING THREE-WAY PORTABLES



\$2⁹⁵

POST PAID!

Radio Service Engineer Lyle C. Treakle tells you how to repair 3-way portables **quickly AT A PROFIT!** No more burned-out tubes. This new book makes 3-way portable servicing your biggest money-maker! Includes handy reference list of all 3-way portable radios.

ORDER TODAY!

DALE'S OF DENVER
510 15th Street,
Denver 2, Colorado

YES! Send me my copy of the big new book "Servicing 3-way Portables," by Lyle C. Treakle!

Name

Address

City State

Check enclosed Send C.O.D., plus post.

Money Order

SERVICEMEN — WAKE UP!

(Continued from page 40)

soldering or connecting an odd wire, etc.). These things make a big hit, particularly *today*, when the public is being pushed around. It will be long remembered.

3. Keep your shop **NEAT, CLEAN, and ORDERLY**. Few junk-shops are successful. They may look successful, but their owners seldom are. Reason: You can't take inventory when there is only confusion, consequently you never know if you make or lose.

4. Pay close attention to your window dressing. *The public judges you by it.* Dusty, sloppy store windows have been the ruin of most unsuccessful shops. (We know a radio store that did a big business during the war—it changed from retail to wholesale. During this time its former attractive windows became a mass of junk. Now the store has few of its old customers. It had to retrench to keep going.)

5. Be neat yourself. Few customers respect a sloppy-appearing man. A successful man rarely goes about unshaved, in overalls — his customers judge his work by his appearance.

6. *Keep your promises.* Nothing is more irritating to customers than uncertain service—it always loses trade. It is far better to lengthen your promise and deliver on that date (or earlier) than make a rash promise and disappoint your customer.

7. **TIME-test** all radio sets you take into your shop. No set should ever be delivered unless you have had it playing for at least three hours. Many sets work well when first repaired, only to fail on a time-test.

These rules are simple and elementary, yet some of them are constantly violated. Observe them all and you will be sure to prosper.

A submarine trap is described in a recent patent (No. 2,406,111). It consists of an automatic radio sending set that gives out a weak signal, to lure the enemy submarine to a supposed victim. Surrounding this floating robot Lorelei is a circle of submerged magnets, connected to a radio alarm transmitter. When the U-boat enters the fatal circle of attraction, the magnets cling to its steel hull, while the alarm calls in air or surface sub-killers to finish the job. The inventor, Berthold Sheffield of Rocky Point, N. Y., has assigned rights in the patent to the Radio Corporation of America. Whether the device was actually used during the last war has not been revealed.



CANNON-BALL

Circular R-12 covers complete line of sensitive, clear-tone, dependable Headsets. Get it. Choose the super-quality Headset you like best. Twenty years headset specialization insures satisfaction.

Scientifically Heavy bar magnets greatly increase their efficiency.

Write **C. F. CANNON COMPANY**
SPRINGWATER, N. Y.

Headset Headquarters

EASY TO LEARN CODE

It is easy to learn or increase speed with an Instructograph Code Teacher. Affords the quickest and most practical method yet developed. For beginners or advanced students. Available tapes from beginner's alphabet to typical messages on all subjects. Speed range 5 to 40 WPM. Always ready—no QRM.



ENDORSED BY THOUSANDS!

The Instructograph Code Teacher literally takes the place of an operator-instructor and enables anyone to learn and master code without further assistance. Thousands of successful operators have "acquired the code" with the Instructograph System. Write today for convenient rental and purchase plans.

INSTRUCTOGRAPH COMPANY

4701 Sheridan Rd., Dept. RC, Chicago 40, Ill.

Do you need BINDING POSTS?



The XL **PUSH POST** with its Spring Action assures Constant Contact and quick connection.

Manufactured in All Aluminum Type M at 12c each.

Aluminum Body, Bakelite Top Type B1 at 13c each.

Type CP or NP. ALL BRASS—STAINLESS STEEL SPRING & PIN PROVEN BY 240 HR. SALT SPRAY TEST as NON-CORROSIVE at 28c each.

Manufacturers and Dealers Liberal Discounts

X. L. RADIO LABORATORIES

420 West Chicago Ave., Chicago 10, Ill.

ELECTRONIC VOLT-OHMMETER

\$11⁸⁵

110 VOLTS AC 20 RANGES

0/5/10/50/100/500/1000/5000 volts DC and AC. 0—1,000,000,000 ohms in six overlapping ranges. Sensitivity: over **MILLION OHMS per VOLT** on 5 volt range.

Complete kit includes all component parts, tubes, punched and drilled chassis and beautifully enameled panel. Easily assembled and wired.

Special slideback circuit developed during war by scientist at the California Institute of Technology gives amazing sensitivity and flexibility while completely eliminating necessity of batteries and expensive meter. Each instrument is individually calibrated. Dial scale over nine inches long!

In addition to performing the usual volt-ohm functions, this instrument easily measures these voltages: **SUPPHERET OSCILLATOR, AVC, AFC, TRUE GRID BIAS AT THE GRID, BIAS CELLS** without affecting the circuit. Measures the exact leakage resistance of **INSULATION, TUBES, CONDENSERS**. It can be used with a signal generator for **SIGNAL TRACING**.

STERLING ELECTRONIC COMPANY

166 N. Sierra Bonita Ave., Dept. 2, Pasadena 4, Calif.

The Army lists 244,319 pairs of telephone headsets among surplus property now being disposed of.

DE FOREST 40TH ANNIVERSARY NUMBER

Reserve your copy of January, **RADIO.CRAFT**, now. It will have twice the number of pages and will be of historical import. January marks the 40th Anniversary of the birth of the vacuum tube.

ELECTRONIC MATHEMATICIANS

(Continued from page 27)

and L will give any particular time constant that may be desired; however, practical considerations place some limits on the choice that can be made. The R-C differentiation circuit is often used in the grid circuit of a vacuum tube, and the resistance in such a circuit is limited in many cases to less than 0.5 megohm. On the other hand, the resistance value should not be so low (and the capacitance so high) that it would load the driving circuit excessively and cause distortion. In the inductive circuit, the value of inductance is limited by practical considerations of physical size and resistance of coil windings. Too much winding resistance deteriorates the action of the circuit.

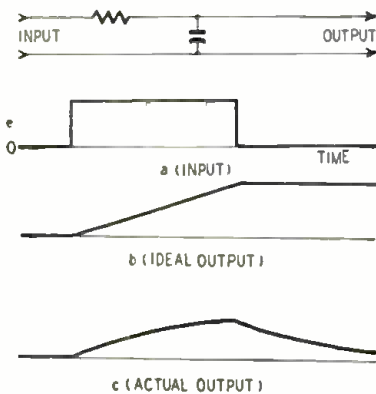

Fig. 10—Integration circuit and waveforms.

Time constant problems are also present in integration circuits, but here it is necessary to go after a long time constant rather than a short one. Fig. 10-a shows a step voltage, similar to that of Fig. 9, applied to an integration circuit. The ideal integrated output, shown in figure 10-b, is a straight line, sloping upward during the time the voltage is applied and then continuing at a constant value after the step voltage is removed. To confirm this, observe that the step voltage (a) expresses the rate of change of the integrated voltage (b).

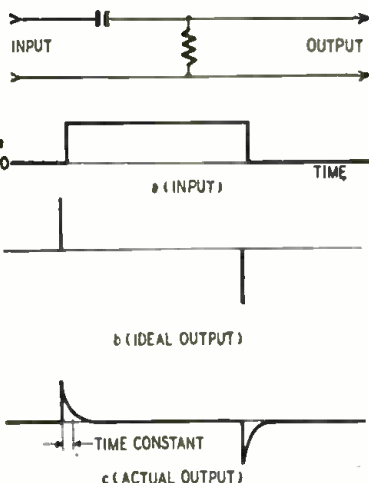

Fig. 9—Action of a differentiator circuit.

The actual output voltage from a typical integration circuit, shown in Fig.

10-c, departs from the ideal because the time constant is not infinite in length and because the charge across the capacitor leaks off due to imperfections in the capacitor itself. With an infinite time constant, the charge on the capacitor in Fig. 7 (or the flow of current through the inductor of Fig. 8) could last indefinitely with zero applied voltage. In the practical case of finite time constant, the charge (or flow of current through the inductor) will eventually decrease and become zero. The nearest approach to perfect integration is made by making the time constant just as great as is consistent with practical capacitance and inductance values. If some departure from perfect integration can be tolerated, the time constant can be reduced and more output voltage obtained. A fair compromise that is usually employed is to make the time constant of the integration circuit from 2 to 5 times greater than the fundamental period of the wave to be integrated.

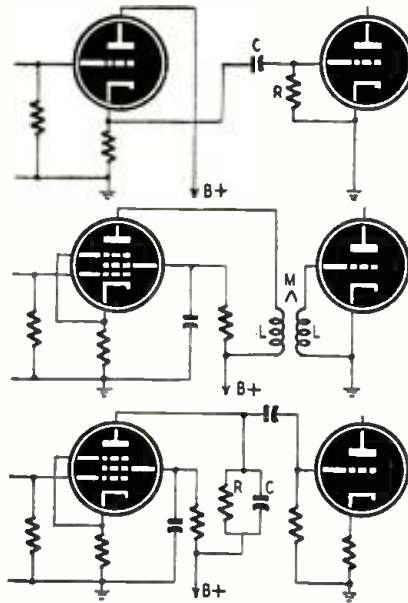
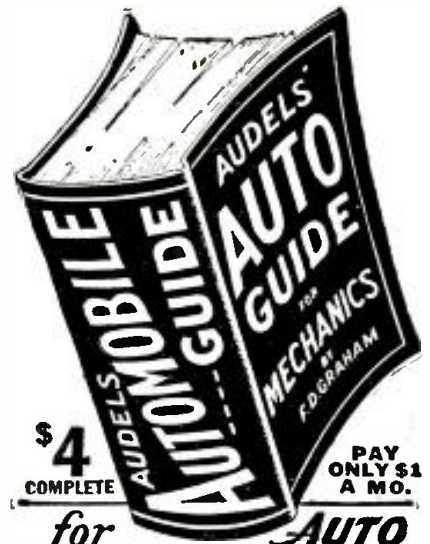

Fig. 11—Some practical vacuum-tube circuits.

As already implied, integration and differentiation circuits are used almost exclusively in conjunction with vacuum-tube amplifiers. In such applications, the internal impedance of the driving stage must be taken into account. The high plate resistance of a pentode tube is often used to advantage in replacing the series resistors of Figs. 6 and 7, while a low resistance triode (or cathode follower) is used to feed circuits of Figs. 5 and 8 in order to minimize unwanted series resistance. Fig. 11 shows some practical differentiation and integration circuits involving vacuum tubes. Note that what appears to be a simple coupling circuit as it is drawn on the diagram can turn out to be an integrating or differentiating circuit when waveform and time constants are considered.

USEFUL XMAS GIFTS



for **AUTO MECHANICS**

AUDELS AUTO GUIDE explains in detail with illustrations and diagrams for better service the whole subject of auto mechanics: Basic principles—Construction—Operation—Service—Repair. Handy Size, Easily understood. NEW FLUID DRIVE, HYDRAULIC SHIFT AND DIESEL ENGINES FULLY COVERED. Over 1700 pages—1540 illustrations showing inside views of modern cars, trucks and buses with instructions for service jobs. This standard book saves time, money and worry for operators and mechanics. Step up your own skill with the facts and figures of your trade. Audels Mechanics Guides contain Practical Inside Trade Information in a handy form, Fully Illustrated and Easy to Understand. Highly Endorsed. Check the book you want for 7 days' Free Examination. Send No Money. Nothing to pay postman.

CUT HERE
MAIL ORDER

AUDELS, Publishers, 49 W. 23 St., NEW YORK 10, N. Y.

Please send me postpaid for FREE EXAMINATION books marked (x) below. If I decide to keep them I agree to mail \$1 in 7 days on each book ordered and further mail \$1 monthly on each book until I have paid price. Otherwise, I will return them.

- AUTOMOBILE GUIDE, 1700 Pages . . . \$4.
- REFRIGERATION & Air Conditioning, 1280 Pgs. 4.
- OIL BURNER GUIDE, 384 Pages . . . 1.
- POWER PLANT ENGINEERS Guide, 1500 Pages. 4.
- PUMPS, Hydraulics & Air Compressors, 1658 Pgs. 4.
- WELTERS GUIDE, 400 Pages . . . 1.
- BLUE PRINT READING, 416 Pages . . . 2.
- SHEET METAL WORKERS Handy Book, 388 Pgs. 1.
- SHEET METAL PATTERN LAYOUTS, 1100 Pgs. 4.
- AIRCRAFT WORKER, 240 Pages . . . 1.
- MATHEMATICS & CALCULATIONS, 700 Pgs. 2.
- MACHINISTS Handy Book, 1600 Pages . . . 4.
- MECHANICAL Dictionary, 968 Pages . . . 4.
- DIESEL ENGINE MANUAL, 400 Pages . . . 2.
- MARINE ENGINEERS Handy Book, 1280 Pages 4.
- SHIPFITTERS Handy Book, 272 Pages . . . 1.
- MECHANICAL DRAWING COURSE, 160 Pages 1.
- MECHANICAL DRAWING & DESIGN, 480 Pgs. 2.
- MILLWRIGHTS & Mechanics Guide, 1200 Pgs. 4.
- CARPENTERS & Builders Guides (4 vols.) . . . 6.
- PLUMBERS & Steamfitters Guides (4 vols.) . . . 6.
- MASONS & Builders Guides (4 vols.) . . . 6.
- MASTER PAINTER & DECORATOR, 320 Pgs. 2.
- GARDENERS & GROWERS GUIDES (4 vols.) 6.
- ENGINEERS and Mechanics Guides Nos. 1, 2, 3, 4, 5, 6, 7 and 8 complete . . . 12.
- Answers on Practical ENGINEERING . . . 1.
- ENGINEERS & FIREMANS EXAMINATIONS . . . 1.
- ELECTRICIANS EXAMINATIONS, 250 Pages . . . 1.
- WIRING DIAGRAMS, 210 Pages . . . 1.
- ELECTRICAL DICTIONARY, 8000 Terms . . . 2.
- ELECTRICAL POWER CALCULATIONS, 425 Pgs. 2.
- HANDY BOOK OF ELECTRICITY, 1340 Pages 4.
- RADIOMANS GUIDE, 914 Pages . . . 4.
- ELECTRONIC DEVICES, 216 Pages . . . 2.
- ELECTRIC LIBRARY, 12 vol., 7000 Pgs., \$1.50 vol.

Name _____
Address _____
Occupation _____
Employed by _____ R.C.F.

HERSHEL'S LOW PRICED SPECIALS



Transmitter and receiver Navy BNI-1FF. The famous boat anchor test released from the Government for surplus. The set has been widely used on the 144 MC band. It can now be used as a transmitter and receiver. Shpg. wt. 100 lbs. Your price **\$14.95** less tubes and power transformer.

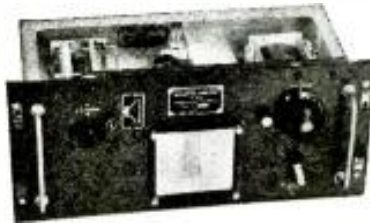

Tuning unit B. C. 375. Each unit has three double spaced tuning cond. Approximately 65 MMFD. Coils SW chokes national velvet diols and assorted Mica cond. 2500 WVDC **\$4.95** over \$50.00 in parts.



Dyna Motor power supply—Input 6 or 12 V., output 500 VDC at 160 MA mounted on box with circuit breakers, relays, interference filter and two 10 ft. cables. Army surplus. **\$9.95** Shpg. wt. 84 lbs.

TUBES	
832.....	\$4.95
955-9004.....	.65
Sockets for Acorn Tubes.....	.24
VR 150 Voltage Regulators.....	.49
CONDENSERS—FILTER	
6J6.....	1.50
6J4.....	.95
8 M.F.D.—600 W.V.D.C. Oil Paper Round Can.....	1.95
4 M.F.D.—600 W.V.D.C. Oil Paper Round Can.....	.95
1 M.F.D.—1000 W.V.D.C. Oil Paper Square Can.....	.89
1 M.F.D.—3000 W.V.D.C. Oil Paper Round Can.....	.95
8-8 M.F.D.—350 V.—20 M.F.D. at 150 V.—Can.....	.69
8-8 M.F.D.—475 W.V.D.C. Micamold ..	.69
20 M.F.D.—250 V. Non Polarized.....	.49
BLEEDERS	
75 M. OHM—200 Watt.....	.49
2500 OHM—100 Watt Adj.....	.49
TRANSFORMERS	
6.3 V.—6 Amps. 110 V.A.C.—60 Cycle..	\$1.49
6.3—4 Amps.—750 C.T. at 150 Ma.....	3.95
6.3—3 Amps.—600 C.T. at 100 Ma.....	1.95
Coaxial Cable—Rg. 54 A/U—58 Ohm per Ft.....	.06
Amphenol Coax Fittings—Male—35c—Female.....	.25

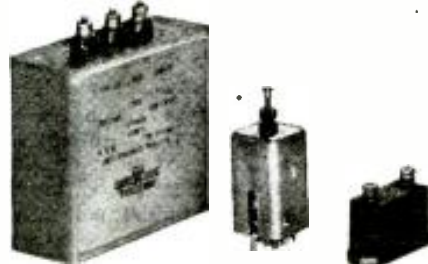

Condenser oil filled, hermetically sealed, 8.5-8.5 M.F.D., 1000 V.D.C., convertible to 4.25 M.F.D., 2000 V.D.C., 5 1/4" long, 2" wide, 5" high.. **\$3.95**

A wonderful coil which can be used on high frequency Aluminum can. 30 MC, I.F. trans. silver slug tuned..... **\$.29**

Mica capacitor .002 M.F.D., 3000 V.D.C., 2.5 Amps., 300 K.C..... **\$.89**

(20 per cent deposit on all C.O.D. orders.)

HERSHEL RADIO COMPANY
5249 Grand River, Detroit 8, Michigan.

CONDENSERS	
100 M.M.F.D. Variable A.P.C.—Type—Silver Plated.....	.59
30 M.M.F.D. Variable A.P.C.—Type—Silver Plated.....	.25
12 M.M.F.D. Variable 1/4" Shaft.....	.30
Neutralizing Condenser for (250 Th.) Johnson.....	.95
12 M.M.F.D. Vacuum Condenser—20,000 V.D.C.....	3.95
3/8" and 1/2" Powdered—Iron Slugs—6-32 Screw Shaft.....	.10
Hallcrafters Tuning Knobs—S X 28.....	.29
Hallcrafters Volume Knobs—S X 28.....	.15
25 Watt—210 Johnson 4 Prong Porcelain Socket.....	.39
Pots.—Screw Driver Shaft—2 Meg.—1 Meg.—150 M.—50 M.—25 M.—5 M.—2 M.—200 Ohm—Ea.....	.29
BC 610 HT4—Tuning Units—ECO or XTAL IN STOCK—2 to 2.5 MC.—2.5 to 3.2 MC 5 to 6.34 MC.....	1.95
8 to 12 MC.—Diagrams Furnished.....	.25
SOCKETS TO MATCH.....	.25
0-50 Micro. Amp. Meters 0-1.2 Scale—Amsco. DeJur 312.....	9.50
Flexible Coupling—15,000 V. Insulation—1/4" to 1/2" Shaft.....	.49
144—MC. Radar OSC. uses 15 E or HY 75 Tube. Enclosed Silver Plated Tank and Variable Couplink. Complete—Less Tube.....	3.95
Setsyn—Motors—2 for.....	3.95

Order from LAKE! You'll Make No Mistake! RADIO Cabinets & Parts



NOW Available
Postwar
2 Post
RECORD-CHANGER

With Luxurious brown leatherette portable case 15" L x 15" W x 10" D. Latest electronic developments make this modern record-changer the finest on the market today!
Changer—**\$18.50** Cabinet for same—**\$8.95**

Also blank table cabinets of walnut veneer in the following sizes, with speaker opening on left front side. (Note: #7 has center speaker grill.)

#1 — 8 1/4" L x 5 1/2" H x 4" D	\$1.95
#2 — 10 1/4" L x 6 3/4" H x 5" D	\$2.75
#3 — 13 1/2" L x 7 5/8" H x 6 1/4" D	\$3.25
#7 — 10 3/4" L x 7" H x 5 1/2" D	\$2.50

*Speaker Opening in center of front side.

All types of radio cabinets and parts are available at Lake's lower prices. A large stock is listed in our catalog. **SERVICEMEN—RETAILERS** Join our customer list today.

Write today for our new 16-page illustrated catalog NR-116. It's free. Get on our mailing list.
Dept. C



LAKE RADIO SALES CO.
615 W. Randolph Street, Chicago 6, Ill.

SERVICING MOVIE SOUND

(Continued from page 56)

amplifier output should never be connected directly to the high-frequency units as the powerful signals below 400 cycles would probably damage the delicate voice coils.

Most d.c. exciter lamp power supplies are provided with a stand-by switch for supplying a.c. to the lamps in an emergency. However if trouble has occurred so that no current can be drawn from the unit, the exciter lamps can be operated from storage batteries until a repair can be made.

If trouble occurs in one voltage amplifier or photocell coupling circuit, photocell circuits may be quickly paralleled with a length of shielded wire, using the good amplifier for both sound heads until the inoperative one can be repaired.

If the power amplifier is at fault it is usually possible to substitute the monitor speaker amplifier and continue the show, possibly at reduced volume.

If trouble exists in the speaker field power supply, the field leads can be connected to the arc-lamp generator or rectifier, provided the fields have the usual 100-volt rating. Additional filtering may be needed to eliminate ripple.

Whatever the trouble may be, there is usually a way to quickly bridge or substitute the inoperative unit temporarily, the method and time involved depending on the ingenuity of the serviceman.

TUNER



Completely wired SUPER-HET tuner. Makes your amplifier or record player into a modern radio. Ideal for PA systems. Uses 12SA7-12SQ7-12SK7 tubes. Mounts in 7" x 3 1/4" space.
less tubes **\$7.95**

AMPLIFIER



Completely wired amplifier using 12SQ7 - 50L6 - 35Z5 tubes. Just the thing for Record Player or small paging set. Requires 6 1/2" x 3" space.
less tubes **\$2.95**

COMBINATION OFFER

SINGER Tuner and Amplifier described above, with instructions both for **\$9.45**

IMMEDIATE DELIVERY

Write for quantity prices. 25% deposit required on COD orders.

N. J. INDUSTRIAL CO.

11 Hill St. Dept. T Newark 2, N. J.

TELEVISER CORRECTION

An error in Fig. 1 of "Rebuilding a Televiser," on page 833 of the September issue shows, in section "L," a direct connection between the input side of the 300-ohm filter choke and ground. This connection short circuits the power supply. Input connection to this choke is made from the junction of the 200-ohm choke and speaker field.

We are grateful to Mr. George Augusto, Paterson, N. J., for this correction.

CRABREE'S
WHOLESALE RADIO
2608 Ross Ave.
DALLAS 1 TEXAS

STATEMENT OF THE OWNERSHIP, MANAGEMENT, CIRCULATION, ETC., REQUIRED BY THE ACT OF CONGRESS OF AUGUST 24, 1912, AND MARCH 3, 1933.

Of Radio-Craft and Popular Electronics, Published monthly at Springfield, Mass., for October 1, 1946.

County of New York }
State of New York }

Before me, a Notary Public in and for the State and county aforesaid, personally appeared Hugo Gernsback, who, having been duly sworn according to law, deposes and says that he is the editor of Radio-Craft and Popular Electronics, and that the following is, to the best of his knowledge and belief, a true statement of the ownership, management (and if a daily paper, the circulation), etc., of the aforesaid publication for the date shown in the above caption, required by the Act of August 24, 1912, as amended by the Act of March 3, 1933, embodied in section 537, Postal Laws and Regulations, printed on the reverse of this form, to wit:

1. That the names and addresses of the publisher, editor, managing editor, and business managers are: Publisher, Radercraft Publications, Inc., 25 West Broadway, New York 7, N. Y.; Editor, H. Gernsback, 25 West Broadway, New York 7, N. Y.; Managing Editor, Fred Shunaman; Business Managers, none.

2. That the owner is: (If owned by a corporation, its name and address must be stated and also immediately thereunder the names and addresses of stockholders owning or holding one per cent or more of total amount of stock. If not owned by a corporation, the names and addresses of the individual owners must be given. If owned by a firm, company, or other unincorporated concern, its name and address, as well as those of each individual member must be given.) Radercraft Publications, Inc., 25 West Broadway, New York 7, N. Y.; H. Gernsback, 25 West Broadway, New York 7, N. Y.

3. That the known bondholders, mortgagees, and other security holders owning or holding 1 per cent or more of total amount of bonds, mortgages, or other securities are: (If there are none, so state.) None.

4. That the two paragraphs next above, giving the names of the owners, stockholders, and security holders, if any, contain not only the list of stockholders and security holders as they appear upon the books of the company but also, in cases where the stockholder or security holder appears upon the books of the company as trustee or in any other fiduciary relation, the name of the person or corporation for whom such trustee is acting, is given; also that the said two paragraphs contain statements embracing affiant's full knowledge and belief as to the circumstances and conditions under which stockholders and security holders who do not appear upon the books of the company as trustees, hold stock and securities in a capacity other than that of a bona fide owner; and this affiant has no reason to believe that any other person, association, or corporation has any interest, direct or indirect, in the said stock, bonds, or other securities than as so stated by him.

5. That the average number of copies of each issue of this publication sold or distributed, through the mails or otherwise, to paid subscribers during the twelve months preceding the date shown above is (This information is required from daily publications only.)

(Signature of Publisher)

H. GERNSBACK.

Sworn to and subscribed before me this 30th day of September, 1946.

MAURICE COYNE, Notary Public
(Commission expires March 30, 1948)

The BUY of a LIFETIME

U. S. SIGNAL CORPS 5 Meter SHORT WAVE XMTRS. (72.2 Mc)

XMTR and Tube Only Less mike, Batteries and Antenna

One 1 1/2 volt dry cell and 67 1/2 volts of B operates it. Just attach di-pole, key or mike, connect the batteries and it's ready to use. Signal Corps spec wired with silvered wire, mica condensers, and precision resistors. Highly stable circuit with Lo-Loss silvered inductance. (Adjustable paddler.) Schematic supplied. Converts easily to walkie-talkie and Ham bands. Weighs less than a pound. Shipped by express only. No C.O.D.'s, No Parcel Post. A sacrifice at only \$3.49. Postal or express money order or certified check.

NEWARK SURPLUS MATERIALS CO.
324 Plane St., Dept. C, Newark 2, N.J.
SEND STAMP FOR GIANT CATALOG!

TELEVISION FOR TODAY
(Continued from page 54)

on the screen will appear somewhat as a photographic negative in that all of the light values will be reversed.

In other words, whenever the grid of a tube is driven positive, the additional current flow produces a greater voltage drop across the plate load resistor. Since the power supply voltage is fixed, any increases in load voltage must result in a decrease in the voltage at the plate of the tube itself. At this instant the voltage coupled to the grid of the following stage decreases.

For the opposite set of conditions, with the grid of the first tube driven in a negative direction, we know that the circuit current will decrease. As a con-

Prepare NOW for a Better Job in RADIO ENGINEERING



Don't Delay - Write Today!

ADD TECHNICAL TRAINING TO YOUR PRACTICAL EXPERIENCE

CLEVELAND INSTITUTE COURSES OFFER COMPLETE TECHNICAL TRAINING RANGING FROM LOW-LEVEL TO COLLEGE-LEVEL.

- A. Master Course in Radio Communication.**
Covers fundamentals of Radio and includes complete preparation for FCC Commercial License Examinations.
- B. Advanced Course in Radio Communication Engineering.**
A college-level Radio Engineering Course.
- C. Specialized Television Engineering.**
Including post-war Television Techniques.

All Courses Include

The Remarkable Workbooks of Instructional Aids, prepared by the instructing staff of Cleveland Institute.

Choose the course best suited to your needs—Start with the section you are qualified to enter—Use the economical CIRE "Pay-As-You-Go Plan."

You may enroll for individual sections for highly specialized training. Study any one or more of the following sections if you do not require a complete course—

- 1. Mathematics of Radio
- 2. Fundamentals of DC and AC Theory.
- 3. Essentials of Radio Communication.
- 4. Communication networks.
- 5. Advanced Radio Telephony for the Broadcast Operator.
- 6. Audio and Radio Components and Systems (Design of Receiver and Transmitter Equipment).

Write for descriptive folder • No obligation

CLEVELAND INSTITUTE OF RADIO ELECTRONICS

CONTRACTORS TO THE CANADIAN BROADCASTING CORPORATION

Successors to

NILSON RADIO SCHOOL
Founded 1939

SMITH PRACTICAL RADIO INSTITUTE
Founded 1934

RC-12 TERMINAL TOWER, CLEVELAND 13, OHIO

Approved for Veteran Training Under "G-1 Bill of Rights"

(MAIL THIS COUPON)

Cleveland Institute of Radio Electronics, RC-12, Terminal Tower, Cleveland 13, Ohio.
Gentlemen: Please send information about your home study courses in Radio Electronics.

NAME

ADDRESS

CITY

ZONE STATE

I desire training in

I have had experience in broadcasting servicing

operating mfg. CAA Army-Navy

amateur other

I am a High School Grad. College Degree

Check here for Veteran Enrollment Information.

THE YEAR'S BIGGEST OFFER

10 lb. Radio Parts Assortment

A "find" for the radio serviceman. Hundreds of valuable radio parts, including coils, resistors, trimmer condensers, lugs, transformers, switches, hardware, etc.

Only \$2.95

Write for radio parts circular

RANDOLPH RADIO STORES
609 W. Randolph St. Chicago 6, Ill.

ORDER NOW

Signal Corps 1-222A Signal Generator 8 to 15, 150 to 230 MC. \$69.95

300 Ohm Amphenol Twin Lead, per 100 ft. 2.90

75 Ohm Amphenol Twin Lead, per 100 ft. 2.00

P23 Army Head Set, 8000 Ohm with 5 ft. Cord and plug 2.49

3 Gang 410 MMFD, 1'er Sect. Cond. Excellent Quality 2.95

BC312 Army Receiver 59.95

(Write for Prices converted to AC)

Type 400 Advance-1 Kw. Antenna Relay 5.40

National ACN Dials 3.00

Signal Corps Telegraph Key J540

Complete line of RCA, TAYLOR, GE, and EIMAC Tubes. Write Us Your Needs in Any Ham Equipment.

DOW RADIO

1759 E. Colorado Pasadena 4, Calif.
Pasadena Phone—SYcamore 3-1196
Los Angeles Phone—RYAN 16683

sequence, the voltage at the load is reduced, permitting a positive rise of plate voltage which will be transmitted

to the following grid. Thus it is evident that between grids a complete reversal has taken place.

FREE!



MAIL
COUPON
TODAY

25th
ANNIVERSARY

LAFAYETTE'S BIG NEW CATALOG

RADIO & ELECTRONIC EQUIPMENT

SEND NOW for your free copy of this giant-size, 144-page catalog which offers you America's latest, largest line of top-quality ham gear, parts, communication equipment, tubes, tools, test equipment, amateur kits and accessories. Page after page of post war radio developments—plus a special bargain section that lists surplus and standard-make radio and television parts at famous Lafayette economy.

SUPER HAM BARGAIN

STOCK NO. HR 99

Heavy-duty filament transformer plus two brand new 872A tubes complete with sockets. Transformer primary 115 volts, 50/60 cycles. Secondary has two 5 volt, 6.75-amp windings, one 5 volt, 13.5 amp. 3500 volt test. Size: 3" x 5" x 6" H. Shpg. Wt. 15 lbs. Units would cost much more if bought separately. Special price while supply lasts. . . . Items shipped day order is received.

895

LAFAYETTE RADIO

RADIO WIRE TELEVISION, INC.

NEW YORK 13, 100 Sixth Ave.
BOSTON 10, 110 Federal St.
NEWARK 2, 24 Central Ave.

RUSH
COUPON
TODAY

LAFAYETTE RADIO, Dept. JLB
100 Sixth Ave., New York

Rush my free copy of your big new catalog.
Please enter my order for your big bargain offer No. HR99. Check enclosed
Money order Send C.O.D.

Name
Address
City Zone State

PASTE COUPON
ON PENNY POSTCARD

POLICE RADIO MAINTENANCE

(Continued from page 28)

partment has been standardized so that all units are interchangeable. All items used in repairs are given a thorough bench-test and are then studied in the field under actual operating conditions. In this way, inherent weaknesses are detected before the part is purchased in large quantities. If the part is found to be consistently weak in one of its electrical or physical characteristics, the manufacturer is notified and corrective measures are taken.

Complete records are kept on all tests and repairs that are made and a case history is available on each item of equipment. From these records it is possible to determine the relative merit of the various components. These records have proved that the genemotor is the most efficient type of power supply for police work. Magmotors are less popular with the servicemen because the permanent magnets soon lose their efficiency and have to be remagnetized. Synchronous vibrator packs are favored over the non-synchronous type because vehicular polarity does not have to be observed.

The service department has found that interference problems in mobile radio vary with each vehicle in use. Some cars may require the installation of distributor and spark plug suppressors for static-free reception while others may require generator and ammeter suppressors, wheel static suppressors and, occasionally, a condenser across the gas gauge.

The 2450-kc receiving equipment consists of three units, receiver, power supply and speaker. The antenna is a tapered steel rod fixed to the side of the car with a universal mounting.

The receiver uses a sensitive five-tube superheterodyne circuit that has a high degree of selectivity. A.v.c. and manual squeleh control are used on the set. The receiver oscillator is crystal controlled and all variable adjustments are fitted with locks to prevent circuit changes that might be caused by shock or vibration.

Three interchangeable types of receiver power supplies are used, genemotor, magnotor and vibrapack. These units operate at six volts input and supply 250 volts at 50 ma. Built-in filters remove all traces of commutator ripple and vibrator "hash." Identical housings are used on all types of supplies so that either type may be installed in a vehicle without having to change mounting brackets.

A standard six-inch PM speaker is used with the receiver.

All equipment is mounted on special quick-release mounting brackets that are made in the repair shop.

BUY FROM **RESCO** AND SAVE

140 PARTITION METAL CABINET

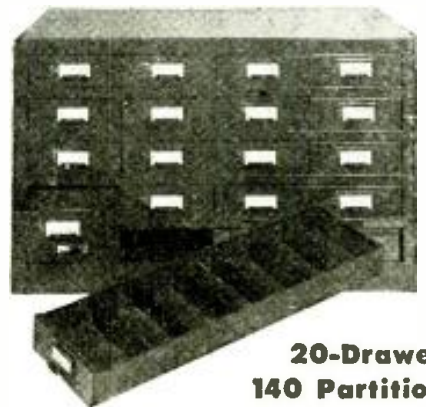

20-Drawer
140 Partition
Heavy Gauge Metal

Durable battleship construction. Save time by finding what you want immediately. Save money by avoiding loss of valuable parts. Special price!

26⁵⁰



6-Drawer Wood
CABINET

Sturdily constructed.
Large, roomy drawers.

A Real Value! **325**

Jefferson Travis MARINE PORTABLE RECEIVER



MODEL MR-28. Standard and marine bands. Built-in loop antenna. Good on any size boat or in the home. Finished with solid brass panel to prevent corrosion.

51⁶⁰

With Batteries

ANTENEX INDOOR AERIAL

No outdoor aerial needed. Perfect reception. **60^c**



WRITE FOR NEW
FREE BULLETIN

Standard size chassis in stock. Our Metal Dept. will make up special sizes. Give us specs, and we'll quote prices, quick delivery.

Radio Electric
SERVICE CO. OF PENNA., INC.

7TH AND ARCH STREETS, PHILA. 6, PENNA.
Branches: 5133 Market St. and 3145 N. Broad St. in Phila.
Also in Wilmington, Del., Easton, Pa., Allentown, Pa., Camden, N. J.

NAMES FOR WAVEBANDS

By E. AISBERG

In every branch of human relations, be it politics, scientific or technical matters, disputes arise because of lack of precision in the language and insufficient clarity of the terms employed.

Such disputes may lead to catastrophe in the political world, but when disputes arise between scientists and technicians the consequences are less vexatious. Nevertheless everything must be done to define technical terms as precisely as possible. By so improving our essential tools, we may make an efficient contribution to the advancement of science and technology.

The method of naming radio wavelength or frequency ranges is a striking example of this lack of precision. We hear of *long waves*, *medium waves* (broadcast waves), *short-waves*, *very short waves* and *ultra-short waves*, and many who use these expressions do not always agree as to their meaning. We questioned a number of engineers in France and England as to the boundaries of short waves, very short waves and ultra-short waves (and their equivalents high frequency, very high frequency and ultra-high frequency). The replies were depressing in their variety. There was even confusion as to whether the very short or the ultra-short waves were the shorter!

You can easily repeat this edifying test with your friends!

A quasi-official classification of wavelengths still exists. It is the one recommended by the Consulting Committee of Radio-Electricity at their meeting in The Hague in 1929. The following are the recommended denominations:

NAME	WAVELENGTH (meters)	FREQUENCY (kilocycles)
Long waves	Longer than 3,000	Less than 100
Medium waves	3,000 to 200	100 to 1,500
Intermediate waves	200 to 50	1,500 to 6,000
Short waves	50 to 10	6,000 to 30,000
Very short waves	Less than 10	More than 30,000

It must be admitted that no technician follows the above definitions today. It must also be recognized that they do not satisfactorily take the laws of logic into account.

Another system was adopted in 1937 by the International Radio-Electric Communications Conference on the motion of Dr. Smith-Rose, president of the radio section of the British Institute of Electrical Engineers. This method of classification satisfies the laws of logic as well as those of mnemonics (because of the ease of remembering it). In addition, it divides fairly conveniently the classes of frequencies differing in their physical properties.

The new method is based on the METRIC SYSTEM, whose beneficial effects in all domains of scientific thought cannot be overestimated. Its decimal system of numbering and its prefixes adopted by the whole world permit the following classification:

(Continued on page 72)

HOW TO PASS Commercial Radio Operators' FCC LICENSE EXAMINATIONS...

How To Pass
FCC
LICENSE
EXAMINATIONS

CLEVELAND INSTITUTE
OF
RADIO ELECTRONICS
Terminal Tower - Cleveland, Ohio

Don't Delay -
Write Today!

FREE BOOKLET

Tells you the Government requirements for all classes of commercial operator licenses.

Tells where to apply for and take the examinations, examining offices, scope of knowledge required, extracts from FCC Rules and Regulations, extracts from FCC Study Guide and Reference Material, approved way to prepare for FCC examinations, positive method of checking your knowledge before taking the examinations.

Edition Limited—Mail Coupon Before Supply Is Exhausted

CLEVELAND INSTITUTE OF RADIO ELECTRONICS

CONTRACTORS TO THE CANADIAN BROADCASTING CORPORATION

Successors to

NILSON RADIO SCHOOL, Founded 1939

SMITH PRACTICAL RADIO INSTITUTE, Founded 1934

RC-12 TERMINAL TOWER

CLEVELAND 13, OHIO

APPROVED FOR VETERAN TRAINING UNDER G. I. BILL OF RIGHTS

MAIL THIS COUPON

CLEVELAND INSTITUTE OF RADIO ELECTRONICS

RC-12 TERMINAL TOWER, Cleveland 13, Ohio

Gentlemen: Please send your FREE Booklet, "How To Pass FCC License Examinations."
(Note: This Booklet does not cover examinations for Amateur License)

NAME

I have had experience in broadcast-

ADDRESS

ing servicing operating

CITY STATE

mfg. CAA Army-Navy

Check license desired:

Radiotelephone 1st. Class 2nd Class

amateur other

Radiotelegraph 1st Class 2nd Class

I am a High School Grad. College

I now hold these licenses

Grad. with degree

If a War Veteran, check here

SCHEMATIC DIAGRAM

For best results—Get our Schematic Diagram for Radio Receivers BC-348-J; BC-348-N; BC-348-Q with complete instructions for converting.

Your cost \$1.00

Send money order or cash
RYAN ENGINEERING ASSOCIATES
1834 Lamont St., N.W. Washington, D.C.

New Photo Electric Unit

For numerous control applications such as burglar alarms, industrial safety controls, automatic counters, or in conjunction with a chime or bell to announce entrance of persons in stores and offices. For AC. Complete with all tubes and built in SPDT relay

\$11.95

ADSON RADIO CO.

221 FULTON ST., NEW YORK 7, N. Y.



Write to Dept. 9C

a GOLD MINE of

SURPLUS PARTS

for RADIO REPAIRMEN
AMATEURS AND EXPERIMENTERS

12 lbs. of RADIO PARTS only \$2.00

Relays — Condensers — Resistors
Transformers — Coils — Hardware
Wire, etc., etc.

Offered subject to prior sale. First come, first served. Write for Radio Parts Catalog. (Dept. C)

ELECTRONIC PARTS, Inc.

622 W. Randolph St.

Chicago 6, Ill.

Buy U.S. Savings Bonds

Look at Our Specials at Lower Prices!

Aircraft Receivers

6 tubes: 3—12SK7, 1—12SR7, 1—12A6, 1—12K8; Range 190-550 Kc. (Specify freq. desired) 1.5-3mc; 3 Gmc; 6-9.1mc; power 28VDC, mfd. by Western Elec., etc. Ship. wt. 19 lbs. Original cost \$90.23.
YOUR COST..... \$12.95
 (Complete with tubes)

Army Aircraft Receivers BC-946-B

Broadcast band from 520 to 1500 Kc, tube complement: 3—12SK7, 1—12SR7, 1—12A6, 1—12K8; can be used with 24 V dynamotor supplying A & B power; can be converted to AC or DC or 32 volt sets; 3 stages of IF used; Uses 3 gang condenser.
Each \$12.95
 Complete with tubes and schematic.

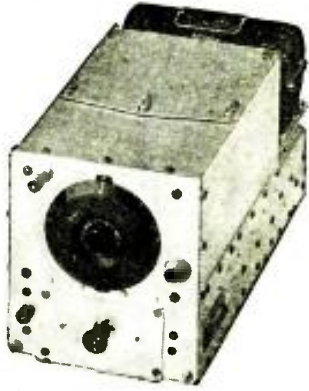

Dynamotor DM-32A

To match receiver; input 28VDC; output 250 V; original cost \$33.95. Ship. wt. 5 lbs
Your Cost ea. \$4.95
 Lots of 10 ea. **3.95**



Signal Corps Radio Receiver

BC-341-B 2 tube set—1—12SQ7; 1—12C8; original price \$18.75; ship. wt. 5 lbs. **Your COST (less tubes) .. \$3.95**

3 1/2" G. E. AUTOMATIC TIME METER
 60 cycle 110 volts. This time meter consists of a cyclometer driven by a telechron synchronous motor. Connect to an electric circuit; it will measure and indicate the number of hours, tenths of hours or minutes that the circuit is in use. Ship. wt. 6 lbs. list \$17.00.
YOUR COST \$4.95

SUPREME FOUNDATION METER

40 Micro Amps. 20,000 ohms per volt. 4 1/2" square. Manufactured by Supreme Instruments Corp.
Each \$8.95

plus shipping charges
 DEPT. D

→ ARROW SALES, INC. ←

59 W. HUBBARD ST., CHICAGO 10, ILL.
 Telephone: Superior 5575

ANTENNA PRINCIPLES

(Continued from page 24)

ly thin wire hung at an infinite distance above earth would be exactly a half-wave long.)

A single wire can also be used as a feeder. Such a line is attached at a point on the antenna where the impedance is about 500 ohms. This system is simpler but has the disadvantage of appreciable radiation because there are no longer two feeder fields which cancel.

A more convenient feeder is the low-impedance non-resonant type which can

Curve No.	1	2	3	4	5
TYPE NO.	RG-8/U	RG-19/U	83	737	88
INSULATION	Solid	Solid	Air	Air	Air
DIA. INCHES	.405	1.120	.375	.875	2.125
MAX. POWER, W.	2,000	2,000	250	2,000	10,000
IMP. OHMS	52	52	70	64	69

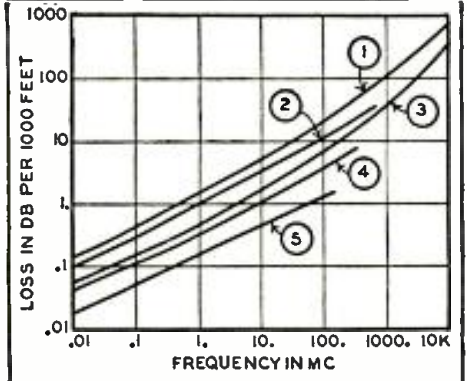

Fig. 7—Characteristics of co-axial cables.

connect directly to the antenna center (72 ohms) without fanning, but due to the lower impedance the conductors are more closely spaced and therefore have higher loss. Three types of the well-known twin-lead feeder are listed in Table 2. They are insulated by polyethylene between wires. Twisted pair conductors are also low-impedance but their loss (attenuation) is much higher. The lowest loss is provided by a coaxial cable, radiation being eliminated because the outer cable shields the inner one.

Co-axial cable is available in either solid or air dielectric. Two popular types are shown in Fig. 6. Polyethylene is generally used as the solid dielectric, since it is a very low-loss material and withstands all reasonable weather conditions. The illustrated RG-8/U coaxial is now extensively used in amateur installations as well as FM and television receiving systems. It is effective well beyond 250 mc, the attenuation of signals being only .027 db per foot at 100 mc and .25 db per foot at 3000 mc. It can withstand a voltage up to 4000.

The air-dielectric co-ax is a lower loss type but is more expensive, and cannot be handled as conveniently, especially where it must be bent to follow structures. In damp locations it is often required that the cables be filled with dry nitrogen or air in order to repel moisture which, in high-power installations, may short-circuit the line. Fig. 7 compares important characteristics of the air and solid co-ax types.

HAM SPECIALS

From Ham Headquarters

Order	Net Price
— Panoramic Adapter (PCA2)	\$99.75 Ea.
— Cabinet: 24 1/2" Wide, 29 1/2" Deep, 7 1/2" High, Gray Crackle Finish. Ideal for Transmitter	90.00 Ea.
— Choke: 300 MA Swing 9-19 Henry, Smooth 11-Henry	7.50 Pr. .19 Ea.
— Choke: 2 1/2 M.H. R.F.C.	.19 Ea.
— Code Oscillator: (Complete with Speaker, Telegraph Operated, MS-700)	9.95 Ea.
— Coil Assembly: R.F. from Army Receiver BC-224M	.75 Ea.
— Condenser: .1x.1x.1 Mfd., 600-Volt Tube Metal Case, Bath Tub	.49 Ea.
— Condenser: .5 and .2 Mfd., 600-Volt Bath Tub	.19 Ea.
— Condenser: 2 Mfd., 600-Volt Solar DC Aluminum Can, Oil Filled	.89 Ea.
— Condenser: 100 MMF. Midret Variable	.50 Ea.
— Condenser: 2 Mfd., 1000-Volt, Oil Filled, Round Can, C.D.	1.50 Ea.
— Condenser: 10 Mfd., 1400-Volt, Oil Filled, Rectangular Type	6.75 Ea.
— Condenser: 10 Mfd., 1000-Volt, Oil Filled, Rectangular Type	6.75 Ea.
— Condenser: 3 Mfd., 2000-Volt, Oil Filled, Rectangular Type	3.25 Ea.
— Condenser: 50 MMF Air Trimmer	.50 Ea.
— Condenser: 8 Mfd., 600-Volt C.D. Oil Filled	2.75 Ea.
— Condenser: .001 Mfd., 5000-Volt Mica	2.40 Ea.
— Condenser: 6 Mfd., 600-Volt Oil Filled	.75 Ea.
— Condenser: 3x3 Mfd., 600-Volt Oil Filled, Rectangular Type	.99 Ea.
— Condenser: 4 Mfd., 600-Volt C.D. Aluminum Can, Oil Filled	1.50 Ea.
— Converter: Gonset 4-tube supplied for either 10 or 6-Meter band	39.95 Ea.
— Crystal: IN27 Sylvania Diode	.50 Ea.
— Handy Talkie: Complete with Batteries, 3885 K.C. Frequency	49.50 Ea.
— Chassis: for Handy Talkie BC-611F	10.00 Ea.
— Insulator: 3" Feed Through	1.00 Ea.
— Meter: Westinghouse 2" D.C. MA.-0-10-25-50-100-150-200-250-300-400-500	3.50 Ea.
— Meter: Burlington, 2" A.C. 0-150 2" Round	2.25 Ea.
— Meter: Time Hour 110-Volt 60-Cycle	3.50 Ea.

MANY OTHER METERS UPON REQUEST

Order	Net Price
— Mike: Brenst Mike	1.95 Ea.
— Mike: T17B Carbon Hand Mike	2.50 Ea.
— Plug: PL-55 Army Type Plug (100-Lots -\$.25 Ea.)	.35 Ea.
— Receiver: BC-342 Frequency 200 to 500 KC.—1500 KC.—20 MC as Is	60.00 Ea.
— Relay: D.P.D.T. 6-Volt D.C. Coil, Leach 1/4" Silver Contact	1.75 Ea.
— Shield: GC4 Tube Shield	.12 Ea.
— Transformer: 5.3 M.C. I.F. Iron Core Intermix	.49 Ea.
— Transformer: 5.3 M.C. I.F. Iron Core Diode	.49 Ea.
— Transformer: G.E. Modulation—200 Watts for 811s to 813	6.00 Ea.
— Transformer: 2.88 M.C. I.P.	.29 Ea.
— Transformer: Filament, 6.3 Volt at 1 3/5 Amps Small Round	1.20 Ea.
— Transmitter and Receiver: BC-1335 F.M. Ideal for 10 Meter Mobile Operation 6 or 12-Volt Input 2 1/2 Watts Output, Dimensions 12 1/2" Long, 1 3/8" Deep, 6 1/4" High. Ready to go with Telephone Headset and (3) Crystals for 10-Meter Band	53.00 Ea.
— Trimmer: Air, 15 Mfd.	.25 Ea.
— Trimmer: 3-30	.15 Ea.
— Wire: Bronze Stranded Wire (250 Ft. Rolls) Heavy	3.50 /Rl.

Mail Orders Promptly Filled
 Amateurs to Serve You

(20% Must Accompany All C.O.D. Orders)
 Write Dept. RC

W6SCQ—W6UXN—W6NAT—
 W6VHZ—W6UIW

WRITE FOR FREE BULLETIN 29

Radio Products Sales Company

238 WEST 15TH STREET

LOS ANGELES 15, CALIFORNIA

PRospect 7471

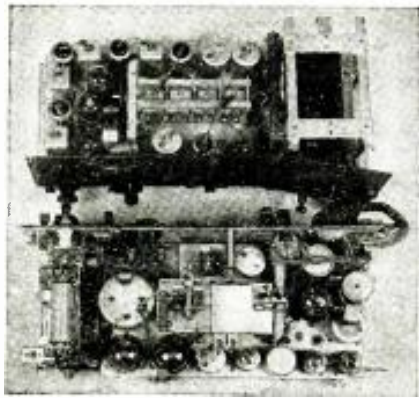

Here is a set adaptable for all amateur, experimental, marine, aircraft, police, and mobile applications. A 7-tube receiver featuring an RF stage, four double-tuned 455 KC iron-core IF transformers, 2 audio stages, and a beat frequency oscillator for 4W reception. The transmitter employs a calibrated crystal oscillator, a buffer amplifier, and a pair of RK-75 tubes in the final amplifier stage. The transmitter plates are supplied by a 500V 160MA dynamotor which operates from a 6 or 12 Volt automobile battery. The frequency range is 3760-5825 KC. Circuit diagrams are furnished. These units are priced at \$29.95, complete with set of 13 tubes and crystal. The dynamotor which must be used, if it is not desired to use 110V AC, is \$15.00 additional.

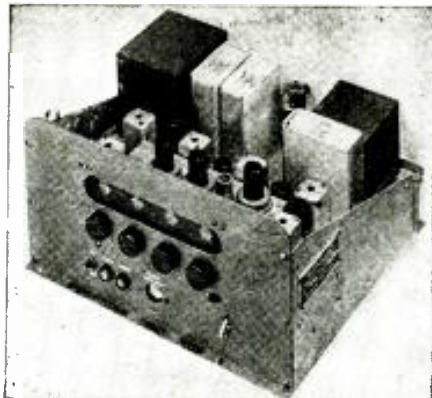

The above 14-tube beautifully built Signal Corps Receiver is one of the most sensitive sets ever manufactured. It operates directly from 110V 60 Cycles. Has two tuned RF stages, tuned converter and oscillator, five IF stages, using iron core IF's, a diode detector, tuning eye, and a two-stage amplifier that will drive a speaker or phones. Easily converted from its 155 to 212 Mc. band to any desired frequency. This 15-tube receiver cost the government about \$700, but is priced to sell now for only \$39.95.

GENERAL ELECTRIC RT-1248

General Electric RT-1248 15 tube transmitter-receiver with TERRIFIC POWER (20 Watts) on any 2 instantly selected, easily pre-adjusted frequencies from 435 to 500 Megacycles. Transmitter uses 5 tubes including a Western Electric 316 A as final. Receiver uses 10 tubes including 955's as first detector and oscillator, and 3-7H7's as IF's, with 4 slug-tuned 40 MC. IF transformers, plus a 7H7, 7E6's, and 7F7's. In addition unit contains 8 relays designed to operate any sort of external equipment when actuated by a received signal from a similar set elsewhere. Originally designed for 12 Volt operation, power supply is not included, as it is a cinch for any amateur to connect this unit for 110V AC, using any supply capable of 400V DC at 135 MA. The ideal unit for telephone use as in a taxicab, or for any kind of remote control applications as with drone airplanes. Instructions and diagrams supplied for running the 1248 transmitter on either code or voice, and for using the receiver as either an AM or FM set. As an FM set, the receiver section of the 1248 is capable of better results than almost any of the commercial FM sets on the market, largely as a result of the superb engineering and meticulous workmanship employed in constructing the converter, oscillator and IF sections. Supplied in original factory packing with 15 tubes. Your cost \$29.95—10% less if ordered in lots of 2 or more.

BENDIX SCR-522—Very High Frequency Voice Transmitter-Receiver—100 to 156 MC.—THIS JOB WAS GOOD ENOUGH FOR THE JOINT COMMAND TO MAKE IT STANDARD EQUIPMENT IN EVERYTHING THAT FLEW, EVEN THOUGH EACH SET COST THE GOV'T. \$2500.00.—Crystal Controlled and Amplitude Modulated—High Transmitter Output and 3 Microvolt Receiver Sensitivity gave good communication up to 180 miles at high altitudes. Receiver has 10 tubes and transmitter 7 tubes, including 2-832's. Furnished complete with 17 tubes and power supply for 12 or 24 volts, also remote control boxes, cable connectors and antenna. We include complete diagrams and instructions for the simple conversion of the 522 to full 110 Volt 60 Cycle operation. Your cost—\$75.00.

BUFFALO RADIO SUPPLY • 219-221 GENESEE STREET • DEPT. C-12 • BUFFALO, 3, N. Y.

OSCILLOSCOPE FOUNDATION KIT 5 INCH

Consisting of Case, Chassis, two shelves (right & left), tube shield and bracket, front panel, screen window frame, handle, plastic window socket, with 5CP1 Cathode Ray tube—Special

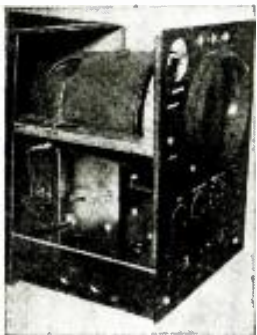

\$18.95

2x2 Tube \$1.00
Socket for 2x2 Tube25
H.V. Condenser .5 Mfd 2000 V 1.95
KIT, without Cathode Ray tube 11.95
5CP1 Cathode Ray tube only 7.40
Tube shield and bracket only 1.98

**Highbridge Radio-Television
and Appliance Co.**

340 CANAL STREET NEW YORK 13, N. Y.

Radio Thirty-Five Years Ago In Gernsback Publications

HUGO GERNSBACK

Founder

Modern Electrics1908
Electrical Experimenter1913
Radio News1919
Science & Invention1920
Radio-Craft1929
Short-Wave Craft1930
Wireless Association of America1908

Some of the larger libraries in the country still have copies of MODERN ELECTRICS on file for interested readers.

From the December, 1911, issue of MODERN ELECTRICS:

- The "Comet" Portable Mast.
- The Fessenden Interference Preventer, by *Eberhardt Rechin*.
- New System of Wireless Telephony, by *Charles Proner*.
- Using Telephone Receivers Without Detectors.
- The Marconi Cavalry Pack Set.
- A Variable Mercury Condenser.
- An Improved Transmitter for Wireless Telephony.
- An Inductance or Loading Coil, by *R. S. Crawford*.
- A Simple Miniature Lamp Socket, by *F. Blechinger*.
- Data on the Magnetic Detector.
- The Law and Wireless Amateurs.
- Selenium and Its Extraordinary Characteristics, by *Charles Proner*.
- A New Marconi Record.

War Surplus Bargains

TRANSMITTING TUBES

304TL\$7.00	826\$3.50
250TL or R\$7.00	832\$4.00
450 TH\$10.00	6C21\$10.00
807\$1.00	VT-127 A\$2.25

CATHODE RAY TUBES

3API\$3.50	3GP1\$3.50
5BP1\$4.95	5BP4\$4.95
12DP7\$12.00	\$12.00

AND OTHERS

TRANSFORMERS

High Voltage, Kenyon, Type S-13336, for Scope, 8.3V-6A, 2.5V-1.75A 2500V, -015A \$ 5.00
FILAMENT: 115V, 60 cyc. sec. (3, 4) 6.1V. at 1 Amp; 8.1 W. Weeco #ESXX-683609; P/O

Beclio type 1.30
FILAMENT: Kenyon, type S-13377, 115V, Pri 3V. CT at 60 amp. sec 6.00

GENERAL PURPOSE: Power Transformer, Gen Trans. Corp., type 6284, Pri. 115V 60 cyc. 3 sec. 300-0-300V; 100MA; 6.8V at 5 Amp. 5V. at 3 Amp 3.00

We Have Large Inventory of Power, Plate, Filament, Audio and Other

SEND FOR SPECIAL TRANSFORMER FLYER

NAVAL AIRCRAFT RECEIVER, ARCS. SUPERHET. TUBES—Included—3-12SK7, 1-12K8, 1-12SK7, 1-12AG7 14.95

NAVAL AIRCRAFT TRANSMITTER, ARCS, 25 Watt CW; 15 Watts Phone. Tubes included: 2-1625, 1-1629, 1-1626, 1-6200KC Crystal Range LEES-Dynamotor; Operates on 28V. Power Supply 17.95

METERS: WESTON MODEL 506 2 inch. 0 to 150 DC MA 3.00

RELAYS, IXBM-COIL 115V 60 Cyc. Will carry 2 Amp 1.75
SOCKETS, STEATITE, 4 Prong..... Dozen 1.60

SPECIAL GRAB BAG OFFER

Over \$100. Cost of Miscellaneous Radio Parts, etc. Including Pilot Bulbs, Condensers, Resistors, Sockets, Insulators, Fuse Holders, Terminal Strips, Transformer, Volume Controls, and Many Other Articles—A REAL VALUE

FOR ONLY — \$10.00

Add Postage to Above Prices

THE ABELL DISTRIBUTING COMPANY

7 E. Biddle Street Baltimore 2, Maryland
SEND FOR OUR FLYER—
NAME ITEMS INTERESTED IN

The inaudible songs of small insects have considerable strength, according to Professor Pielemeier of the Pennsylvania State College. With a supersonic intensity meter he registered 70 decibels at one foot from a small meadow grasshopper. Frequency was 40,000 cycles.

Automatic Combinations—NOW!

The New Arnold Shure Automatic Wired Record Player Ready For Immediate Delivery!

The Shure automatic record player connects easily to any radio. Its feather-weight crystal pickup and quiet, smooth changer action assure high quality playing of ten 12" records or twelve 10" records. Every one of your customers can now own a fine automatic combination at a remarkably low cost.



Shure players are shipped complete with A.C. cord and shielded cable—only 2 wires to connect and it's ready to play.

Your price only **\$21.92 net**
F.O.B. CHICAGO, ILLINOIS

OPA Retail Price \$31.30 Zone 1
OPA Retail Price 33.87 Zone 2

Orders are now being accepted for immediate delivery—no waiting. Terms: 2% check with order. Or 25% deposit, balance express C.O.D.

PHONO AMPLIFIERS

1-Tube Phono. Amplifier.....\$2.35 ea.
3-Tube Phono. Amplifier.....4.50 ea.

PM SPEAKERS

4" Alnico (5) PM Speaker.....\$1.39 ea.
5" Alnico (5) PM Speaker.....1.49 ea.
6" Alnico (5) PM Speaker.....1.89 ea.

TUBULAR ELECTROLYTICS

100-MFD-25 V.....\$.22 ea.	10-MFD-450 V.....\$.29 ea.
10-MFD-50 V......22 ea.	16-MFD-450 V......39 ea.
20-MFD-150 V......22 ea.	10-10-MFD-450 V......59 ea.
30-MFD-150 V......29 ea.	20-20-MFD-150 V......29 ea.
40-MFD-150 V......39 ea.	30-20-MFD-150 V......39 ea.
50-MFD-150 V......45 ea.	40-30-MFD-150 V......45 ea.
8-MFD-150 V......25 ea.	60-30-MFD-150 V......59 ea.

THE CINEMATIC ANALYZER

(Continued from page 19)

fact, in the analyzer itself, in the frequency-modulated 877-kc generator. An output jack, I.F. (Fig. 2) is provided to take off a signal from it. It is connected to the antenna post of the receiver under study, which is then tuned to 877 kc. For the rest, the signal is tapped out at the detector or some point after it, and applied to the vertical deflection plates of the cathode-ray tube (A.F., Fig. 2). Under these conditions the receiver's i.f. resonance curve may be seen traced out on the screen, thus permitting correction of any imperfections.

GAIN MEASUREMENTS

A calibrated potentiometer permits regulation of the analyzer gain. By applying to the deflection plates the signal at the input of an r.f. or i.f. stage, then at the output of the same stage, and bringing the height of the image to the same level in the two cases, the stage gain may be determined by comparing the corresponding indications of the potentiometer.

STUDY OF AUDIO STAGES

A modulated r.f. signal is fed into the receiver. The a.f. post of the analyzer is connected to the successive stages from the detector to the loudspeaker, and the modulated signal viewed on the screen. In this manner any defect—including non-linear frequency distortion—in the audio-frequency stages may be localized.

This brief description falls far short of exhausting the various applications of the cinematic analyzer, which can well be called a universal instrument for receiver trouble-shooting, diagnosis and alignment or adjustment.

A second article, in an early issue, will show how the technician can construct his own cinematic analyzer, a priceless instrument.

FM Broadcasting can cover nearly ninety percent of the country's population, said Frank Stanton, president of Columbia Broadcasting System, recently. Arguing against any fundamental revision of AM frequencies, he stated that we are now "on the verge of a new and superior service, and now is not the time to look backward into AM and patch together temporary remedies."

Plans and charts presented by the CBS president indicated that nearly 90 percent of the population and about half the land area of the United States could be covered by a proposed 200-station FM network, with outlets placed to serve largest centers of population.

Night-time sky-wave service could be provided for the population not provided for in the FM network by supplementary AM stations, Dr. Stanton said, adding that the quality of sky-wave service thus made available would be substantially better than now provided by AM stations.

HOLLANDER RADIO SUPPLY CO.

549 West Randolph Street Chicago 6, Illinois

A KIT FOR A Battery Charger or Auto Radio Checker or As a Supply for Dynamotor in Surplus Equipment, Consists of
115 Volt Primary—6 or 12 Volt Secondary at 5 Amp. Xformer
Selenium Stack—6 Volt @ 4 Amp. or 12 Volt at 3 Amp.
Smoothing Capacitor 1000 Mfd.
Chassis Black Crackle
Binding Posts. Instructions Furnished.

COMPLETE AND GUARANTEED—\$10.00

SPECIAL AMPLIFIER. No data supplied for this unit.

Consists of 4 Transformers. Relay. Pot. Condensers. Resistors. Sockets, housed in a Black Crackle Finish Cabinet 7"x8"x4". Brand New.

COMPLETE WITH 2 TUBES \$3.00

Brand New RCA Boxed Jan Accepted Vacuum Tubes

6HG—55c; 954, 956, 6V6—65c ea.; 6AC7—90c; 2X2/879—1.00; VR150—85c

CATHODE RAY TUBE—

5BP1 and Socket7.75
3BP1 and Socket6.00

THESE TUBES PACKED IN ORIGINAL NAVY CARTONS AND STAMPED.

Greenwich Sales Co.

59 Cortlandt Street New York 7, N. Y.

The
HOUSE OF A MILLION RADIO PARTS

Service Men
Sound Men
Amateurs

Write for the latest Lifetime BARGAIN BULLETIN just off the press. Thousands of money-savers in parts, supplies, equipment.

Lifetime
SOUND EQUIP. CO., Dept. 24
911-913 JEFFERSON AVE., TOLEDO 2, OHIO

SURPLUS SPECIALS

2 by 1.15 Amp. Chokes.....\$3.50
.35 mfd. 5000 v. G.E. condensers.....\$1.50
.003 mfd. 7000 v. Sagamo. 15 amps @ 1000 kcs.....\$2.25
Hytron 2C26A Tubes.....50c
RCA 1619 Tubes.....55c

TIRET ELECTRIC CO.

47-46 Vernon Boulevard, Long Island City 1, N. Y.

IRON CORE TUNERS

For Broadcast Band Superhets

Replaces 2-gang condenser and oscillator. One compact tracked unit. Includes hookup diagrams and instructions.

ONLY \$4 POSTPAID

Send for FREE price list of standard radio coils.

MAGNA-METAL PRODUCTS CO.

Grand Central Terminal Bldg., New York 17, N. Y.

Increase in receiver license fees for Canadian listeners was advocated at hearings of the Parliamentary Radio Committee at Ottawa, Canada, early in the fall.

The present annual fee is \$2.50. The

proposal is that that charge should be increased to \$3.00 to permit the government-controlled Canadian Broadcasting Co. to carry on sustaining educational programs without the necessity of commercialization.

"TAB"

That's a Buy

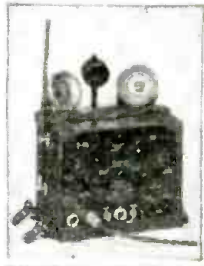

TRANSCIEVER TBY NAVY 28 to 80 mc's PORTABLE
Complete all tubes & NEW Navy vibrator pack & horn spill Willard 30amp/117/4.2V storage battery chargeable from 6V S'Bat. Voice & CW, self contained xtal spot calibrated pis. Continuous 200mc's adaptable 112mc's. Complete incl. adj. whid. Ant. phones, mike, shoulder carrying case, tubes 2-20. 3-959A, 959, 2-1E7G, CK1005 excellent for marine, police, forestry, utility, broadcast & Amateur use. Complete with manuals. "TAB" SPECIAL \$30.95 ea. 2 for \$72 New TBY Vibrator pack & S' Battery \$9.95

WE 115V/60cps PPL 640VCT or 1300/1650V no CT 300ma. Hmctically cased \$4.95 ea. 2 for	7.00
Condor all AVX 1-10 0.5mf/1500WVDC: 2 for	1.15
Condor 10mf/1500WVDC 2 for	2.50
Molded .01mf/600WVDC 100 for \$7.50: 1000	30.00
Condor WE oil 16mf/400WVDC: 2 for	2.35
Condor 0.5mf/600WVDC 1000: 5 for	1.00
Condor 10mf/600WVDC 2 2.5mf/3mf/2 for	2.50
Condor 20mf/600WVDC (1-2-4-5-8mf): 2 for	2.50
Condor GE 3mf/200VAC/1000WVDC: 2 for	2.50
Condor 2mf/200WVDC W&C: 2 for	4.25
Condor 3mf/300WVDC: 2 for	2.50
Condor 10mf/600VAC 2000WVDC GE (S22):	2.70
Condor 15mf/660VAC 2000WVDC GE (S29):	3.90
Condor 2mf/1250WVDC Westlake (S210):	25.00
Condor 1mf/2500WVDC Westlake (S303):	75.00
Condor 6mf/1500WVDC oil insulators: 2 for	4.00
Condor 25mf/1000WVDC wkt new: 3 for	1.75
GE oil 0.1mf/1500WVDC: 45: 0.1mf/3000	1.25
GE 0.1mf/1500WVDC \$4.50: 0.25mf/3000	2.95
.01mf/1500WVDC M Tubular oil: 10 for	1.50
.02mf/600WVDC M Tubular oil: 10 for	1.10
Condor mica .01mf/2000V Test (S140) 2 for	1.00
Condor mica .001mf/0.002mf/8000V (S32):	3.90
Condor mica .005mf/3000WVDC (S12)	2 for
Condor 4mf/600WVDC CD-TLA	1.25
Condor 500mf/200WVDC AVX 102 (S810)	.99
GE COP-ON Rect. FW 5V, 5amp 25-60cv output	3.95
Westlake-Rectox. FW 12V 1.25amp 25-60cv	3.40
Cased line to 6-lead transformer S.C. specs	1.20

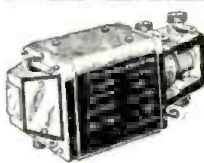

NEW NAVY DYNAMOTORS
FICOR DC G'd Overseas packed, AN inst. Hi-eff. Cont. duty input 12V/RA or 24V/4A. Output 500V/50ma. Input same, output 275V/110ma & 12V/3A.

EITHER UNIT \$1.95 or both units (2) & filter, \$3.49. Wgt. 9 lbs; 7 1/2" L x 2 1/4" H x 1 1/4" W. Adaptable to 6V operation.

WE 200 microamps 31A* Rtl lkl case	4.95
Simpson one ma 31A* Rtl lkl case	3.00
Westhco AN Landing Ind Dual 200 micro-ammeter	4.50
Weston GE-10 GDB 500-600 ohm line	3.95
Weston 176 84 3" I-Case 15VAC G'd (\$10)	4.25
Weston 506 Id 2 1/2" I-Case 250 ma (\$8.50)	3.00
GE-10E microammeter 100 microamps 31A* I-Case	8.98
Socket Amphion SMTN Octal HF: 25 for	1.50
Socket Hammarlund Acorn LHS 900: 4 for	1.00
Punched chassis, 2 sizes "TAB" Harkins, 2 for	1.00
Russ & Little funds 3AG 250 ma, 48 for	1.00
GE Variac 100Q 2KW I.N. G'd	25.00
WE 250 Watt Trussard & Drivers	125.00
WE Dynamic microhds D-17344A	9.95
National XI-5 Ceramic 5" socket, 4 for	1.00
National mixed G&P R1ps 3 1/2" & 1 1/2" No. 8-	1.00
No. 24: 3 for	1.00
Heavy duty ext. Sl. cord set M & F plugs 10 ft.	1.50
Resistor R.T. 100HT 1/2W: 50 to 2 mck.	2.00
Control Kit gray Silver: 50 for	2.50
Condor Kit Type Al-4: 50 to 1 mck: 10 for	2.50



ELECTRONIC VOLT-OHMMETER 11 meg SENS NEW S.C. 1-107-F PRECISION UNIT "TAB" special \$21.60 additional V.T.V.M. Loctal tube 1LE3/SP SigC \$1.15.

V	OHMS
0-3	1000
0-10	10000
0-30	100 M
0-100	1 Meg
0-300	10 Meg

GE transformers 115V/60cps/High V inst
0.5V/10A: 6.5V/6A: 5V/3A: 5V/3A 3.95
750VCT/320ma \$3.25: 800VCT/270ma 3.95
1340VCT/170ma \$4.95: 6.3V/8A 1.65
1011V/100ma/200ohm 95: 1011V/250ma/100ohm 1.65
Thord II-FI 196L6 output 3800ohm, Tapped Sec. 3.00
Kenyon 5V/60amp 7.95
Collins Choke cased 611/1.2amp/12500wkg 16.00
Thermador S.C. Rated 3800VCT/6KW 2.7amps 45.00
Primary 240-210-220-240-240 80-60w cased
Collins Transformer Mfgd CHT. PRI 145-50-60cv 45.00
Sec 1100VCT 212ma 2-1011V/100ohm/250ma 7.95
Some combination Pri Invt 115V/230V/50 60w
Raytheon cased 850VCT/110ma 500VCT 21ma 8.95
3V/3A, 5V/3A, 6.3V/1A, 6.3V/3A, 11V/1A (S28) 2.50
Two for \$4.50: Five for \$10: 25 for 45.00
Same with 2-1011V/110ma cased Chokes: 3.95
Chokes Hmctically cased 1011V/110ma 88: 2 for 1.75
Chokes Hmctically cased 1011V/30ma 85: 50ma 4.50
Chokes Cased GE Dual 151V 85ma 1.65

RCA 808 JAN-CRC New G'd. Fil 7.5V/4amp. plate 1300V/200 Watts Rated 140 watts output each "UHIF" (List \$7.75) "TAB" price \$2.75 ea. 2 for \$5.00.

GEAWat 807JAN (\$2.75) \$1.35 ea. 2 for \$ 2.50
829B/3E29 JAN Boxed G'd & socket 4.50
GEARBY 855JAN (\$2.85) .85 ea. 2 for 1.25
RCA956 JAN (LPS5) & socket 1.25
805/905 JAN & socket \$8. 11.00
Two for 11.00
GEN45 new G'd & socket, \$7.50 ea. 2 for 14.00

GE 446A/2C40 Lighthouse tube (S11) 6.95
NU 2V3G JAN H.V. Rect. 16500V (\$3.40) 7.25
RCA 6A7 JAN boxed new 4 for 3.00



WE 307A RF Pentode (LPS13) 5.95
WE 308A RF Pentode (LPS24) 6.95
WE 308As tube UUIH 20Watt 1700mc's new 7.95
WE 703A tube UUIH 20 Watt 1000mc's new 5.95
WE 717A Door Knob, tube new (\$7.50) 1.95
657 or 958A Acorn tube JAN & socket 1.25
2C26 JAN new UUIH (LPS5) boxed 1.95
BX215 Raytheon new FW 500V/15amp (LPS24) 7.95
GE 1041 RK60 new FW 11.5V Rect. (\$2.75) 1.95
GE 806A & Johnson 224 socket: 2 for 2.90
872A JAN & socket: 2 for 5.75
1925 JAN new beam (S'807) 78cm: 2 for 1.50
RCA-VR150 JAN new (LPS8) 75cm: 2 for 1.30
RCA 30 JAN (LPS1.20) .85 ea. 2 for 1.20
RCA 1F7G JAN (LPS2.80) \$1.50 ea. 2 for 2.50
RCA 6J4 JAN UUIH (LPS8.10) 2.49
805/905 Ray tubes (LPS1.55): 2 for 1.00
3A4 Tungosol JAN new (LPS2) 1.65
6AG5 JAN new (LPS2.80) 75cm: 2 for 1.30
6AK5 JAN new boxed (\$4) \$1.25 ea. 2 for 2.00
GE Vacuum Condor 50mf/16000V 3.99
5CP1 JAN & socket \$7.50: 8B11JAN & socket 3.95
5BP1 or 5BP4 New G'd JAN boxed 9.95
58N7 JAN new (\$1.50) 80cm: 2 for 1.45
6X5 JAN new boxed (\$1.10) 55cm: 2 for 1.98
9006 JAN new boxed (\$1.25) 70cm: 2 for 1.25
9002 JAN new boxed (\$2.00) 90cm: 2 for 1.90



Raytheon 8 6 G A filament transformer 115V 60CY PRL 2.5VCT 11A sec and Two New GE 866A tubes \$5.90 with Millen caps & 24 sockets \$ 7.00 Raytheon Trans. former only 3.25 (combination 872A Rectifiers, Transformer & Sockets new \$12.00

"TAB", Dept. RC12, 6A Church St., N.Y. 6, N.Y., U.S.A.

18 YEARS IN RADIO



GET THIS New CATALOG By This Old Firm

Latest developments in radio and electronic parts and devices, newest ham gear, gadgets for experimenters, bargains in war surplus items.

FREE TO YOU

Mail the coupon below and get this new catalog FREE.

BURSTEIN-APPLEBEE CO., 1012 McGee, Kansas City 6, Mo.
Send me FREE catalog advertised in Radio Craft

I AM _____ STATE CONNECTION IN INDUSTRY

NAME _____

ADDRESS _____

TOWN _____ STATE _____

YOUR ELECTRIC DRILL Has 100 Other Uses

when used with K-Jax attachments
METAL SAWING SHEARING
RIVETING ATTACHMENTS
Dept. R. Write for illustrated circular
K-JAX, 2600 Canton St., Dallas, Texas

SUPERSONIC APPLICATIONS

(Continued from page 17)

A diagram for such a system is shown in Fig. 4. A super-sonic signal is passed through the metal being tested. As it travels to the opposite side, any flaws, such as a crack or an air pocket, shows up on the cathode ray oscilloscope as a mark between the two shown in the illustration; those two marks representing the two edges of the object under test. It is possible with this scheme to not only discover the flaw, but to locate it by calibrating the screen of the oscilloscope in inches. A somewhat similar idea is a supersonic thickness gage, which measures the thickness of sheet metal from one side, the sound being echoed back from the opposite boundary.

Super-sonic signals are now being used in projection television equipment, in the agitation and mixing of liquid solutions, and also in locating oil deposits. Research will no doubt find more ways in which the phenomena of supersonics can serve man.

¹ H. PENDER, *Electrical Engineers Handbook*, Vol II, p. 9-02, John Wiley and Sons, 1936. New York.
² H. PENDER, *Electrical Engineers Handbook*, Vol II, p. 9-02, John Wiley and Sons, 1936. New York.
³ J. F. RIDER, *Oscillators at Work*, p. 65, J. F. Rider, 1940. New York.
⁴ E. HAUSMAN, *Physics*, p. 526, D. Van Nostrand, 1939. New York.
⁵ H. J. REICH, *Theory and Application of Electron Tubes*, p. 488, McGraw-Hill-Book Company, 1939. New York.
⁶ B. N. ANDREWS, "Supersonic Inspection Methods," *Electronics*, May, 1944, p. 122. New York.

TRY TO MATCH THESE VALUES!

IMMEDIATE DELIVERY

- SPEAKERS:**
5" P.M., ALNICO 5 Magnet Ea. \$1.39
6" P.M., ALNICO 5 Magnet Ea. 1.98
- VOLUME CONTROL with SWITCH,**
500,000 Ohms, Long Shaft Ea. .69
- WIRE:** Approx. 400 ft. in 2 to 4 ft. lengths assorted colors and gauges, solid & stranded in packages Per Pkg. .99
- COILS: 456 KC., I.F. Ea. .45**
- Kit of 20 wirewound resistors, 5, 10, 20 & 25 Watts Per Kit 1.98
- 7-8 tube power transformer, 6.3V. winding 70 Ma. Ea. 2.95
- Headphones, Official Signal Corps. 200 Ohms Ea. 1.95
- Kit of 100 insulated Resistors, assorted 1/4, 1/2, 1 & 2 Watts, all in popular values Per Kit 1.95
- 50L6 output Transformer Ea. .59
- Kit of 10 assorted Volume & Tone Controls, no switches (all with shafts) Per Kit 1.98

Write for catalog. Hundreds of usable parts — lowest prices — Immediate delivery anywhere.

20% Deposit with Order—Balance C.O.D.
ELECTRONIC PARTS, Inc., Dept. C
622 W. Randolph St. Chicago 6, Ill.

COMMUNICATIONS

**MORE SMASH BUYS at
National Radio Distributors**

IMMEDIATE DELIVERY
In Plenty of Time for Christmas Trade

The Famous National Radio Kits



ALL PARTS MOUNTED.
Ready for easy wiring.
5-tube A.C./D.C. Superhet.
includes a beautiful plastic
cabinet, built-in loop antenna
& new Alnico speaker. Uses
12SA7, 12SK7, 12SQ7, 50L6,
& 35Z5 tubes. Price (complete
with cabinet)\$11.95

Kit of 5 matched tubes for above 4.75
5-tube A.C.-D.C. Superhet, 2 band. Frequency range
550-1600 kc. and 5.5 to 18 megacycles. Price com-
plete with cabinet 13.95
Kit of 5 matched tubes 4.75

THE WORLD'S SMALLEST RECORD PLAYER

Actual Size 12 1/2" x 10" x 5 1/2"

- Featherweight Crystal Pick-up
 - Absolutely New & Different
 - Features New FTII Miracle Rectifier
 - New Alnico 5" P.M. Speaker
 - Plays 10" and 12" Records
 - Output 1 1/2 Watt-Beam Power
 - Leatherette covered pastel shades of Green, Blue & Red
- Incl. Fed. Tax
List \$29.65 (subject to O.P.A. approval) Dealer's Net
\$19.95 (Packed 3 to master carton)

COMBINATION PORTABLE RADIO & RECORD PLAYERS

MODEL N.R. 14

- Beautiful Leatherette Covered Carrying Case
 - Built-in Powerful 5 Tube Superheterodyne Radio
 - Neat, Compact, Light-weight, Fool-proof
- List (incl. Fed. Tax)\$59.90
NET 1-5 \$37.50, 6 or more\$36.65

RECORD PLAYERS

Easily attached to any radio.

MODEL R.P. 340

- Self-Starting Heavy duty Photo-Motor with 9" Turn-Table.
 - Light-weight Crystal Pick-up Arm
 - High Polish Walnut Veneer Cabinet
- NET 1-5 \$10.95,
6 or more \$10.50

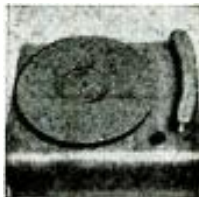

FLUORESCENT DESK LAMPS

(15 Watt A.C. only)
MODEL F134

- Brown Baked Crackle Finish
 - U.L. Approved & Guaranteed
 - Toggle Switch On-Off
 - Packed in Individual Cartons, 6 to Master Carton.
- NET 1-5 \$5.95, 6 or more\$5.50



O.P.A. List (incl. Fed. Tax) \$8.98 (less bulb)
NET 1-5 \$5.95, 6 or more\$5.50

PHONO MOTORS

MODEL M418

- Heavy Duty, Self-Starting, Rim Drive
 - Unconditionally Factory Guaranteed
- NET PRICE \$4.25 each
Master Carton of 20\$3.95 each

Terms: At least 10% with order. Balance C.O.D. For Prompt Delivery. Place Your Order NOW! and avoid disappointment.

Write NOW for New Free Catalog

National Radio Distributors

1029 E. 163 St., New York 59, N.Y.

METER BUYS



RANGES:

- 0-15 Ma. D.C.
- 0-100 Ma. D.C.
- 0-300 Ma. D.C.
- 0-5 Amp. R.F.
- 0-9 Amp. R.F.

**Your
Choice
\$3.95**

A really swell buy in Westinghouse 2 1/2" flange type meters, brand new, black face, white letters. Reg. net from \$7.00—\$14.00. Ask for surplus list No. RC-1.

ALFRED C. DENSON

38 Park Place

Rockville, Conn.

LIKES SOME NON-SERVICING MATERIAL

Dear Editor:

In reply to John Zandler's plea for more service material in the magazine, I should like to suggest that the title of this publication is RADIO-CRAFT, not "The Handy Serviceman's Guide" or "Seven Steps to Simple Service." The title itself designates that the publication deals with all phases in the "Craft" of radio, not just servicing.

Thus far, you have run some very informative articles about servicing, but no doubt space is limited, and other

things must be included.

RADIO-CRAFT has been doing a wonderful job during the war with paper shortage to combat, and its informative articles of current nature are more than timely.

To me, it seems that Mr. Zandler's indignant objections are for the most part unfounded. You have been doing a wonderful job, so keep up the good work!

BEN SHAVER, JR.,
Durant, Oklahoma

TWO OPINIONS CONCERNING ONE EDITOR

Dear Editor:

I have been a somewhat inconsistent Gernsback fan for over twenty years. I used to think he was "cracked," but have certainly changed my opinion of him in recent years. Most of his flights of fancy have become common-place practice, especially since the discovery of the atomic bomb, radar, radio-controlled television planes and other recent inventions predicted by him many years ago.

I am a firm believer now. More power to him!

DON TIFFANY,
Vallejo, Calif.

Dear Editor:

The sensational covers and articles by Hugo Gernsback do not appeal to me now any more than they did when he was publishing *Modern Electrics*. At that time (1908) I first went on the air with a two-way amateur station, which I have operated continuously since then—only interrupted for a short time by the first and second world wars. I am the original licensee of Amateur Radio Station W2EY.

I have a suggestion to make. If you wish to interest radio amateurs, print articles on reactivating amateur stations.

FRED J. MCKINNEY,
Bloomfield, N. J.

MORE IMPROVEMENTS FOR SONICATOR?

Dear Editor:

The *Sonicator* is one of the most interesting articles I've seen for several months in any semi-technical radio magazine. Mr. Gould probably got the idea from Navy depth sounders, but he has a very ingenious and simplified version. He undoubtedly could get extremely accurate results by using a simple automatic temperature and atmospheric

compensator circuit (electrical or mechanical) which would make up for the difference in the speed of sound with changes in temperature, humidity and pressure. I dare say that he could easily get the accuracy to within a few inches, instead of five feet. Give us more on radar and micro-wave technique.

PAUL E. BRASSARD,
Brunswick, Maine

BROAD-BAND ANTENNA INQUIRIES ANSWERED

Dear Editor:

So much interest was evidenced by readers of RADIO-CRAFT in the July issue article covering new types of rotary beam antennas on page 681, that some of the questions submitted are answered below. Lengthy explanation is precluded by lack of space.

The rotary beam antenna shown in Fig. 1 on page 681 cannot be fed directly by 72-ohm line, but if a quantity of this line is available it may be pressed into service by placing a quarter-wavelength of 60-ohm transmission line between the antenna and available 72-ohm cable. This provides a geometric-mean transformer between the antenna and available cable, and hence a satisfactory match.

When using the stacked array of one three-element antenna over the other,

a half-wave spacing between upper and lower tiers gives the greatest low-angle gain (page 732, Fig. 2-a). Reducing this spacing to 3/4 wavelength reduces gain by approximately 2 db at the horizon, and is not advisable except for medium frequency use, or perhaps on 14 mc where high poles are difficult to obtain. When a 50-foot telephone pole, sunk 6 feet in the ground, is used to support stacked arrays for 14 mc, the bottom antenna falls only 12 feet from the ground. This is undesirable due to increased ground losses and increased vertical angle of fire, but none the less the use of the two arrays is far and away superior to a single antenna for 10,000-mile communication. Better method is to affix a 20-foot topmast (a 4 x 4) to the 50-foot phone pole, using through-bolts—standard pole line equipment.

This raises the lower array to a half-wavelength above ground and greatly increases antenna effectiveness, particularly for overseas circuits. This writer used two such poles, with topmasts, for a 16-element stacked array on 14-mc phone, prior to the war. Its performance, due largely to stacked tiers, very closely approached the performance of a two-acre rhombic antenna for New York-to-London radiotelephone. Topmasts, then, are the answer to height problems for the 14-mc work. They are relatively inexpensive, far less so than additional phone-pole height.

The rotary three-element antennas described on pages 681 and 732 should use at least 1/2-inch tubing. The use of adequately supported wire changes the antenna characteristics considerably and calls for re-matching of the antenna and transmission line.

All credit for the original research on the broad-band three-element close-spaced antenna goes to Mr. A. Kampinsky who first visualized its possibilities, and brought it to its present state of perfection.

H. B. CHURCHILL
Bradley Beach, N. J.

TOO DARNED TECHNICAL

Dear Editor:

Regarding the letter "More Simple Servicing" by William J. Morgan, which appeared on page 605 of the June issue, it expresses my sentiments exactly.

YOU ARE GETTING TOO DARNED TECHNICAL.

Let's get down to earth, so us common folks can understand you.

C. L. ROBESON,
Tampa, Florida

OPPORTUNITY AD-LETS

Advertisements in this section cost 20 cents a word for each insertion. Name, address and initials must be included at the above rate. Cash should accompany all classified advertisements unless placed by an accredited advertising agency. No advertisement for less than ten words accepted. Ten percent discount six issues, twenty percent for twelve issues. Objectionable or misleading advertisements not accepted. Advertisements for January, 1947. Issue must reach us not later than November 21, 1946. Radio-Craft • 25 W. B'way • New York 7, N. Y.

BUILD YOUR OWN RADIO 5 TUBE SUPER NET KIT complete with tubes and walnut cabinet using 50L6-33Z5-12SA7-12SK7-12SQ7. Easy to wire. Your cost \$16.95. McGee Radio Co., 1330 Broadway, Denver, Colo.

MAGAZINES (BACK DATED)—FOREIGN, DOMESTIC, arts, books, subscriptions, pin-ups, etc. Catalog 10c (refunded). Cicerone's, 863 First Ave., New York 17, N. Y.

AMATEUR RADIO LICENSES. COMPLETE CODE and theory preparation for passing amateur radio examinations. Home study and resident courses. American Radio Institute, 101 West 63rd Street, New York City. See our ad on page 72.

CORRESPONDENCE COURSES AND SELF-INSTRUCTION books, slightly used. Sold, Rented, Exchanged. All subjects. Satisfaction guaranteed. Cash paid for used courses. Complete information and 92-page illustrated bargain catalog free. Write—NELSON COMPANY, Dept. 2-39, Chicago 4.

REPUTABLE AND LONG ESTABLISHED IMPORTER and wholesaler of radio components in Holland wishes to contact first class United States manufacturers of all kinds of radio components. Tubular, mica, variable and electrolytic condensers, loudspeakers, resistances, volume controls, switches, coils, padders, trimmers, measuring instruments, etc. Box D-11.

WE REPAIR ALL TYPES OF ELECTRICAL INSTRUMENTS, tube checkers and analyzers. Hazelton Instrument Co. (Electric Meter Laboratory) 140 Liberty Street, New York, N. Y. Telephone—Barclay 7-4239.

WIRELESS PHONO OSCILLATOR—NO LICENSE REQUIRED

Transmits recordings from phono pickup or voice from mike to radio without use of wires up to 500 ft. Neatly designed.
Complete kit, less tubes\$3.49
Above kit assembled and tested 4.49
Tubes for above kit (12SA7, 35Z5) 2.49
IMMEDIATE DELIVERY
CONSTANT ELECTRIC, Dept. C
112 Cornelia Street Brooklyn 21, N. Y.

THE SECRET'S OUT!
The New and Spectacular
ACA-100DC AMPLIFIER
Is Ready For Delivery!
DESIGNED BY A. C. SHANEY



A revolutionary development in amplifiers cleverly designed to defy obsolescence and amazing in its performance. New circuits, new materials and new processes are actually combined in this one amplifier to produce the most satisfying musical amplifier the world has ever known. If you are one of those discriminating persons for whom nothing less than the best is a disappointment, you are one for whom the ACA-100DC was designed. Send for technical literature.

AMPLIFIER CORP. of AMERICA
398 Broadway, New York 13, N. Y.
A. C. Shaney's FM-AM AMPLIFIER MANUAL is still available at 25c



NEW! *faster, easler* servicing by "listening in" with **PRECISION ELECTRONICS SIGNAL TRACER**

Real versatility! The "number one" instrument in any Service Man's equipment. Probe with Polystyrene tip (operates on frequencies up to 300MC), top quality parts throughout and exclusive engineering features. Outstanding "on-the-job" superiority!

\$29.95
COMPLETE
115 VOLTS
50-60 CYCLES

Checks signal stage by stage in R.F., I.F., and Audio sections. Speeds location of intermittents, opens, shorts, hums and noisy circuits with set hot or cold—coils condensers, transformers, resistors, speakers, tubes! See your Jobber or write for descriptive literature. (Please address Dept. C).

PRECISION ELECTRONICS, Inc.
641-643 MILWAUKEE AVENUE
CHICAGO, 22 ILLINOIS



MINE DETECTORS

YOU CAN NOW BECOME A PROSPECTOR—HERE IS ONE OF THE WAR'S TOP SECRETS:
ARMY MINE DETECTORS

NEW, in original cases; portable. Will detect METALLIC and NON-METALLIC objects. Very sensitive; using 955 tube in detecting head. Two-tube amplifier using two 1N5GT; headset; or microphone; also 150 micro meter. Power supply—3 45v, 1 6v or 2 3v batteries. Complete with instructions. See "How Mine Detectors Work" in July, 1946, Radio-Craft. Shipping weight 108 pounds. F.O.B. N.Y. Special, less batteries.....

\$17.50

SEND ORDER TO
**HIGHBRIDGE RADIO-TELEVISION AND
APPLIANCE CO.**

340 Canal Street New York 13, N. Y.

RESISTORS IS OUR BUSINESS

Which means that your orders for
**1/2—1—2 Watt
CARBON & WIRE-WOUND
RESISTORS**

Will be filled from stock
The same day we receive them
That's a fact!

LEGRI S COMPANY
846 Amsterdam Ave., New York 25, N. Y.
Phone: ACademy 2-0018

Come to the famous

COYNE TRAINING SHOPS

where you learn by doing



TRAIN FOR RADIO-ELECTRONICS IN A FEW WEEKS

Prepare For A Good Job Now With A Lifetime Future!

Trained Radio-Electronics men needed now. They will be needed too in the years to come. Don't be caught napping. Get a Radio training now and be ready. Learn by Doing. Free employment service for life after graduation. Many earn while learning. If you are short of money, ask about my Student Finance Plan. Now added Training in Electric Refrigeration. We are also equipped to train those who qualify under G. I. Bill. We also have facilities for men with physical disabilities whether due to war or other causes. Fill in and mail coupon for details.

SEND COUPON FOR FULL DETAILS

B. W. COOKE, Dir., Radio-Electronics Div.
COYNE ELECTRICAL SCHOOL
500 S. Paulina St., Dept. 96-8E, Chicago 12, Ill.
Send Big Free Book; also details about Coyne Part-Time Employment and Student Finance Plan.
 Send G. I. Bulletin Physical Disability

NAME AGE

ADDRESS

CITY STATE

ATTENTION Radio Servicemen!

IMMEDIATE DELIVERIES ON

- V. T. V. M.
- Triplett-Hickok Volt-Ohm-Milliammeter
- Triplett Tube Checkers—Radio City Products
- A. T. R. Battery Eliminators
- Turner Microphones
- Rider Manuals VI — VII — VIII — IX X — XI
- Write us for hard to get tubes

The **POCKETSCOPE**—A pocket-size complete cathode ray oscilloscope. Weighs only 5¼ lbs. \$55.00 less 2%.

RADIO ELECTRIC PRODUCTS, INC.

677 Michigan Ave., CL. 6457, Buffalo 3, N. Y.



NEW MINIPOCKETSIZED RADIO!

Slips in your pocket or purse! WT. ONLY 1¼ lb. Complete READY TO PLAY as shown with self contained phone for personal use. Beautiful black silver plastic case. Has patented fixed CRYSTAL-SLIDE TUNING DIAL! NO TUBES, BATTERIES OR ELECTRIC PLUG. IN REQUIRED. USUALLY RECEIVES LOCAL BROADCASTS without outside aerial wires.

GUARANTEED TO WORK when connected and used according to instructions. Can be used in homes, offices, hotels, cabins, in bed after hours, etc. (cash, money order, check) and pay postman \$2.99 plus delivery fees on arrival or send \$3.99 for postpaid delivery. IDEAL GIFT FOR CHILDREN OR ADULTS ALIKE! Get your PA-KETTE RADIO NOW for real enjoyment. (Foreign orders \$5.00 U.S. Cash.)
Pa-Kette Electric Co., Dept. RC-12, Kearney, Nebraska

PEN-OSCIL-LITE

Extremely convenient test oscillator for all radio servicing; alignment • Small as a pen • Self powered • Range from 700 cycles audio to over 600 megacycles u.h.f. • Output from zero to 125 v. • Low in cost • Used by Signal Corps • Write for information.

GENERAL TEST EQUIPMENT

38 Argyle Ave. Buffalo 9, N. Y.

INDEX TO ADVERTISERS

Abell Distributing Co.	65	N. J. Industrial Co.	60
Adson Radio Co.	63	Wm. N. Scheer Advertising Agency	
Bass & Weber Co., Inc.	50	N. Y. Technical Inst. of N. J.	38, 39
Allied Radio Corp.	50	Schwab & Beatty, Inc.	68
George Brodsky		National Radio Distributors	
Almo Radio Co.	57	Burke & Wayburne Advertising Agency	1
E. L. Brown Co.	69	National Radio Institute	7
Amplifier Corp. of America		Van Sant, Dugdale & Co.	7
Sternfield-Godley, Inc.	64	National Schools	2
Arrow Sales, Inc.	59	The Mayers Co.	61
Sander Rodkin Adv. Agency		Newark Electric Co., Inc.	61
Audel Publishers		The Charles Brunelle Co.	50
Grant & Wadsworth		Newark Surplus Materials Co.	50
Bell Telephone Labs.	Back Cover	Wm. N. Scheer Advertising Agency	
N. W. Ayer & Son		Niagara Radio Supply	
Buffalo Radio Supply		Burke and Wayburne Advertising Co.	
International Advertising Ag.		Olson Radio Warehouse	
Burstein-Applebee Co.	67	Jessop Advertising Co.	55
Frank E. Whalen Adv. Co.	58	Onan & Sons, D. W.	69
C. F. Cannon Co.	9	Graves and Associates	
M. J. Werner Adv.		Opportunity Adlets	
Capitol Radio Engineering Institute		Pa-Kette Radio Co.	70
Henry J. Kaufman & Associates		Arrow Advertising Agency	
Cleveland Institute of Radio Electronics	61, 63	Precision Electronics, Inc.	69
Kenneth Kolpein		Campbell & Reynolds	
Communications Equipment Co.		Radio Dealers Supply Co.	45
Borough Advertising Co.		H. J. Gold Co.	70
Concord Radio Corp.	41	Radio-Electric Products, Inc.	
E. H. Brown Advertising Ag.		Roizen Adv. Agency, Inc.	
Constant Electric		Radio Electric Service Co.	62
Coyne Electric School		David Zibman Adv.	
Phil Gordon Agency		Radio Furniture Dist., Inc.	40
Coyne Electrical School		Radio Kits Co.	51
McJunkin Advertising Agency		Hamburger Agency	
Crabtree Wholesale Radio			
Dale's of Denver			
Bill Bonsib Adv. Ag.			
DeForest's Training Institute	5		
MacDonald Cook Co.			
Denson, Alfred C.	68		
Dow Radio			
Editors & Engineers, Ltd.	71		
Electronic Parts, Inc.	63, 67		
Campbell & Reynolds			
Feiler Engineering Co.	43		
George Brodsky Adv.			
General Cement Mfg. Co.	57		
Turner Advertising Agency			
General Electric Co.	43		
Maxon, Inc.			
General Test Equipment Co.	70		
Suzanne Hayman			
Greenwich Sales Co.	66		
Bass & Weber Co., Inc.			
Harrison Radio Co.	40		
Altomari Advertising Agency			
Hershel Radio Co.	60		
Hugh Allen Advertising			
Highbridge Radio-Television & Appliance Co.	65, 69		
Burke and Wayburne Advertising Agency			
Hollander Radio Supply Co.			
Turner Advertising Agency			
Hudson Specialties			
Instructograph Company			
Turner Adv. Agency			
K-Jax			
Kings Electronics Co.	67		
Sternfield-Godley, Inc.			
Lafayette Radio Co.	62		
Reiss Advertising Agency			
Lake Radio Sales Co.	60		
Sander Rodkin Adv. Agency			
Legri S Company			
Cromwell Advertising Agency			
Leotone Radio Corp.	56		
Altomari Advertising Agency, Inc.			
Lifetime Sound Equipment Co.			
The Miller Agency Co.			
McMurdo Silver Co.	12		
Edward Owen & Co.			
Magna-Metal Products Co.	66		
Equity Adv. Agency			
Maritime Switchboard			
Metropolitan Electronic & Inst. Co.			
Bass & Weber Co., Inc.			
Midwest Radio Co.	58		
Savage & Talley			
Miller, W. P.	50		
Milo Radio & Elec. Corp.			
Burke & Wayburne Advertising Agency			
Modern Technical Book Co.	71		
Murray Hill Books, Inc.	52, 53		
Harry P. Bridge Co.			

RADIO SCHOOL DIRECTORY

See Page 72

American Radio Institute	
Sternfield-Godley, Inc.	
Baltimore Technical Institute	
Candler System Co.	
Rand-Ries Adv., Inc.	
Commercial Radio Institute	
Electronics Institute, Inc.	
Chester Miller	
Lincoln Engineering School	
Buchanan-Thomas Adv.	
Melville Radio Institute	
Seidel Adv.	
RCA Institutes	
Tri-State College	
Clem J. Steigmeyer Adv.	
United Radio Television Institute	
Radio Shack	11
The Schram Adv. Co.	
Radio Products Sales Co.	64
Barton A. Stebbins, Adv.	
Radioic Equipment Co.	45
Bass & Weber Co., Inc.	
Radolek Company	47
Turner Advertising Agency	
Randolph Radio Stores	61
Ryan Engineering Associates	63
Sprague Products Co.	Inside Front Cover
Harry P. Bridge Co.	
Sprayberry Academy of Radio	3
Harry P. Bridge Co.	
Stahl, Michael, Inc.	51
Bass & Weber Co., Inc.	
Sterling Electronic Co.	58
Superior Instruments Co.	Inside Back Cover
Bass & Weber Co., Inc.	
Supreme Publications	47
Henry T. Teplitz Adv.	
"TAB" Technical Apparatus Bldrs.	67
Bass & Weber Co., Inc.	
Terminal Radio Co.	47
Regent Adv. Agency	
Tiret Electric Co.	66
Triplett Electrical Instrument Co.	51
Western Adv. Ag.	
Trutone Products Co.	40
Terrill Belknap Marsh Associates	
Variety Electric Co.	48
Bass & Weber Advertising Agency	
Weston Electrical Inst. Co.	4
G. M. Basford Co.	
X. L. Radio Laboratories	58

RESERVE YOUR

BIG ANNIVERSARY NUMBER

Watch for the double-size January de Forest 40th anniversary issue. In addition to many important and historic articles on the birth of the vacuum tube and the inventions of Dr. Lee de Forest, there will be a collection of the articles readers have been waiting for. Constructing an electronic organ will be one of these. Another will be on the building of a sound-on-light-beam transmitter and receiver. First of the series "Building a Televiser" and "Sound-Recording Laboratory" will appear in this issue, and a number of other vital and important stories.

BOOK REVIEWS

INDUCTANCE CALCULATIONS, Working Formulas and Tables, by Frederick W. Grover, Ph.D. (Professor of Electrical Engineering, Union College; formerly consulting physicist, National Bureau of Standards.) Published by D. Van Nostrand Co. Stiff cloth covers, 6 1/4 x 9 1/4 inches, 286 pages. Price \$5.75.

This work brings together a collection of usable inductance formulas for all types of coils and for inductors not including circular elements. It is in the latter subject that it differs most from many books which deal with inductance formulas. Part I of the book, consisting of five chapters, is devoted entirely to circuits with straight elements, including transmission lines, polygons of straight wires, single-wire lines, mutual inductance of wires at an angle to each other, and single-layer coils on rectangular forms.

Coils and other circuits composed of circular elements are dealt with in 13 chapters. All types of air-core inductors likely to be met with in the most extended practice are covered.

While the aim is to present the engineer with the simplest formula covering the given case, accuracy is never sacrificed for simplicity. According to the preface, an accuracy of one part in one thousand is the general aim, but greater precision is often possible.

COYNE ELECTRICAL, RADIO, ELECTRONICS DICTIONARY and DATA BOOK, by the Technical Staff, Coyne Electrical School. Published by Coyne Electrical School. Flexible leatherette covers, 3 x 6 inches, 304 pages. Price \$1.50.

This book is vest-pocket size. It is a dictionary of 3350 words, terms and expressions used in the fields of electricity, radio and electronics. Listed under the terms "atomic energy" and "radar" are all words and phrases common in those fields.

The data section of the book includes a number of charts, diagrams, tables, equations and formulae that may prove helpful to many students, engineers and experimenters.—R.F.S.

UNDERSTANDING MICROWAVES, by Victor J. Young (Senior Project Engineer, Sperry Gyroscope Co.). Published by John F. Rider. Stiff cloth covers, size 6 x 8 1/2 inches, 385 pages. Price \$6.00.

Cutting loose from traditions of older texts, even the introductory chapters of this book deal with electrostatics and magnetostatics in terms of electrostatic and electromagnetic fields. Other standard subjects of a radio text are handled in the same fashion. Even a direct current circuit is calculated on a basis of fields, and the student finds it possible to compute the wattage dissipated in a circuit consisting of a 6-volt battery, two large flat conductors and a 3-ohm resistor without any of the familiar formulas.

Poynting's Vector and Maxwell's equations are explained as far as possible, and while such explanation is necessarily incomplete, it is extremely helpful, as well as being unique in an elementary text.

Waveguides, transmission lines, and resonant cavities are covered very thoroughly, with the aid of concepts built up earlier in the book. The chapter on antennas is much shorter than might have been expected.

All subjects are treated non-mathematically in the text, but footnotes at the end of each chapter contain mathematical material for the interested student.

INVENTING FOR PROFIT, by Louis Chayka. Published by Bruce Humphries, Inc. Stiff cloth covers, 5 1/2 x 8 inches, 205 pages plus two-page index. Price \$2.50.

A popularly-written text for the would-be inventor. Describes "for the average man" the process of conceiving an invention, how to find out if it has been invented before, and how to secure patent protection for it.

The style is interesting, and the book is interspersed with anecdotes. It is written for the beginner in invention, and most of its contents are already known to the person who has had even slight experience in that field.

RADIO TERM ILLUSTRATED

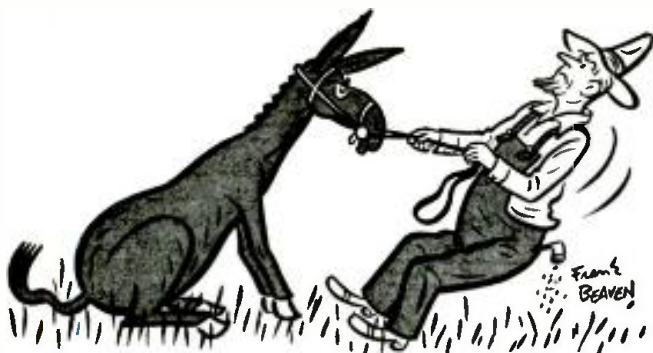

"A Good Resistor"

Suggested by:
Joe W. Baker.
Ollie, M o n -
tana

RADIO - ELECTRONICS

LEARN AT HOME

A complete, easy to understand, reference-instruction book.



"Cyclopedia of Radio and Electronics"

1946 EDITION

Standard radio, high-frequency and UHF, public address and sound, television, phototubes, industrial electronic tubes, and applications. Acoustics; Automatic Tuning; Beam Power Tubes; Biasing; Broadcast Transmitters; Contact Rectifiers; Cold-cathode Tubes; Electrolytic Condensers; Electrostatic Heating; Foaming; Frequency Modulation Receivers; Gas-filled Tubes; Ignitrons; Induction Heating; Klystron Tubes; Load Lines; Microphones; Oscillators of all types; Oscilloscopes and Uses; Phase-shift Control; Rectifiers; Relaxation Circuits; Resonators; Saturable Reactor; Signal Generator; Superheterodynes; Thyretrons; Time Constants; Transit Time; Tuning Indicators; Velocity Modulation, etc. 764 PAGES, 1400 headings, 900 illustrations, tables, and graphs. ONLY \$6.00 POST-PAID if C.O.D. plus postage fee

MONEY BACK GUARANTEE.

JOIN OUR NEW TECHNICAL BOOK CLUB — FREE

Members receive current literature, guidance on all book problems, premiums. No obligation. ALL BOOKS: Technology, Chemistry, Physics, Mechanics, REFRIGERATION, AIR CONDITIONING, Building, Construction, ELECTRICITY, RADIO, TELEVISION, ELECTRONICS, Automobiles, Mathematics, Woodworking, Homecraft, Business Language, Farming, Sports, Photography, etc.—WRITE FOR FREE LITERATURE, please specify subject.

MODERN TECHNICAL BOOK CO.

Dept. M R C, 55 West 42nd St., New York 18, N. Y.

Please send me copies CYCLOPEDIA OF RADIO AND ELECTRONICS. Enclosed find \$ check cash money order. Please send C.O.D. (plus postage). If I am not fully satisfied I may return the book within five days for refund.

NAME

ADDRESS

CITY ZONE STATE

Carry 3000 RADIO FACTS IN YOUR POCKET!



RADIOMAN'S HANDBOOK

Helps You On the Job!

The handiest radio reference book on the market... a library of 3,000 facts, wiring diagrams, formulas, charts, tables, rules—condensed into one pocket-size 4 1/2" x 7" volume. Take it with you on the job—have the answers to daily problems always on hand. Saves time—helps you earn more. Flexible leatherette cover withstands hard usage. Get this book on free trial now!

350 PAGES
Circuits
Reactances and Energy Losses
Coils & Coil Windings
Meters and Measurements
Resonance and Coupling
... and thousands of other facts!

SEE IT FREE

GET THIS BOOK FREE! . . . TRY IT ON THE JOB—see how often you refer to it—how much time it saves you. Then, if you are not satisfied, return it to us. If you keep the book, AFTER 7 days, you pay only \$3.25.

Educational Book Publishing Division
COYNE ELECTRICAL SCHOOL
500 S. Pauline Street, Dept. 96-T1, Chicago 12, Ill.

*FREE TRIAL COUPON

Educational Book Publishing Division

COYNE ELECTRICAL SCHOOL, Dept. 96-T1,

500 S. Pauline Street, Chicago 12, Ill.

Please send Radioman's Handbook on 7 days FREE TRIAL. If satisfied after 7 days, I will pay you \$3.25—if not, I will return book to you.

Name Age

Address

City Zone State

CHECK here if you want to pay Postman \$3.25 on delivery. Same 7 days' trial arrangement and money-back guarantee.

RADIO BOOKS BY MAIL

OVER 125 TITLES IN STOCK

SAME-DAY SHIPMENT ON 98% OF ALL MAIL ORDERS. Books of value all radio publishers. If you don't know price, send deposit and we'll ship C.O.D.

SEND STAMP FOR CATALOG TO **EDITORS AND ENGINEERS, Ltd.**
1305 Kenwood Road • Santa Barbara, California

RADIO SCHOOL DIRECTORY

PREPARE NOW FOR SKILLED JOBS IN RADIO AND ELECTRONICS

CAREERS in RADIO

INTENSIVE COURSES—Thorough, technical education for progressive men and women.

1. **RADIO TECHNICIAN**—The MRI General Course. Includes F.M. & Television. Prepares for FCC Broadcast Licenses.
2. **RADIO & TELEVISION SERVICING**—Prepares for employment as Repairman on Standard Broadcast, F.M. & Television Receivers.
3. **RADIO COMMUNICATIONS**—Prepares for FCC Operators' License. Leads to position as Merchant Marine or Flight Radio Officer; Commercial Operator.
4. **FUNDAMENTAL RADIO MATHEMATICS**—The MRI Preparatory Course. Required pre-training for students lacking a basic mathematical background.

MELVILLE RADIO INSTITUTE
45 W. 45th St., N. Y. 19, BR 9-5980

"The Radio School Managed By Radio Men"

Licensed by the State of New York

MELVILLE RADIO INSTITUTE

45 West 45th St., New York 19, N. Y.

GENTLEMEN: RC

Send me **FREE** information about your school.

Name.....

Address.....

MAIL THIS COUPON NOW!

NAMES FOR WAVEBANDS

(Continued from page 63)

NAME	WAVE-LENGTH (meters)	FREQUENCY (megacycles)	AB-BRE-VIA-TION
Kilometer waves	above 1,000	0.03 to 0.3 mc	km
Hectometer waves	1,000 to 100	0.3 to 3.0 mc	hm
Dekameter waves	100 to 10	3.0 to 30 mc	dam
Meter waves	10 to 1	30 to 300 mc	m
Decimeter waves	1 to 0.1	300 to 3,000 mc	dm
Centimeter waves	0.1 to 0.01	3,000 to 30,000 mc	cm
Millimeter waves	0.01 to 0.001	30,000 to 300,000 mc	mm

The advantages of the proposed classification are numerous and for the most part evident:

1. Some classifications have been accepted spontaneously because they are so characteristic. (We speak regularly of centimeter and decimeter waves.)

2. The kilometric and hectometric waves correspond rather closely to those we have been in the habit of calling long and medium waves.

3. The physical properties—and particularly those of propagation—of the various ranges change approximately at their limits. Kilometric waves are very little affected by fading and present only slight daylight and seasonal variations. Hectometric waves present almost the opposite characteristics. Dekametric waves are characterized by their great range and irregularities in propagation. Metric and shorter waves obey laws which approach closer and closer those of optics.

4. The intervals, when measured logarithmically, are equal to each other, in wavelengths as well as frequencies.

5. No effort is required to remember the system, for it is identified with the familiar metric scale.

Let us add, to cut short all objections, that there is no intention whatever to attempt to substitute this system for that of expressing the exact values of radio waves in frequencies. That is the most practical method and the one best adapted to all forms of calculation. But since the habit of expressing the various ranges in wavelengths does exist (particularly in Europe—Editor) the proposed metric system brings to it all the clarity required.

Further, at hyperfrequencies, terms in frequency lose a little of their force. A "3-centimeter wave" is more expressive than a "frequency of 10,000,000 kc," or even "10,000 mc." And, at these frequencies, the physical existence of wavelength is manifested by the dimensions of apparatus, such as wave-guides, horns, antennas, reflectors, etc., which depend closely on the wavelength of the signals handled.

By agreement with our fellow-publishers, this suggestion will be published simultaneously in France, England, the United States and Argentina. We should be glad to know what the radiotechnicians of these countries think of it.

In the interests of full discussion, permission is granted for reproduction of all or part of this article. Please credit E. Aisberg of Paris, France.

RADIO COURSES

Servicing, Broadcast Engineering, Commercial Operating, Television

Individual Laboratory Work!
Learn by Doing!

Day and Evening Classes

Approved by the Maryland State Department of Education and the Veterans' Administration.

Free to Vets—Textbooks, Tools, Test Set.

Write for Bulletin

Baltimore Technical Institute

1425 EUTAW PLACE — DEPT. C.
BALTIMORE 17, MARYLAND

RADIO ENGINEERING!

VETERANS can complete work here in shortest possible time. Courses also in Civil, Electrical, Mechanical, Chemical, Aeronautical Engineering; Business Administration, Accounting, Secretarial Science. 63rd year. Enter Jan., Mar., June, Sept. School now filled to capacity. No applications can be accepted until further notice.

TRI-STATE COLLEGE 24126 College Ave. ANGOLA INDIANA

COMMERCIAL RADIO INSTITUTE

A radio training center for twenty-six years.

RESIDENT COURSES ONLY

Broadcast, Service, Aeronautical, Television and Marine telegraphy classes now forming. Literature upon request. Veteran training. Classes now forming for mid-year term, Feb. 1st. Entrance exam. Jan. 13. Dept. C, 38 West Biddle St., Baltimore 1, Md.

RADIO

RADIO Technician and Radio Communications courses. Register now for new classes starting first MONDAY of each month. Day and Evening Classes.

AMERICAN RADIO INSTITUTE

101 West 63rd St., New York 23, N. Y.
APPROVED UNDER GI BILL OF RIGHTS.

 **RCA INSTITUTES, Inc.**
Offer thorough training courses in all technical phases of **Radio and Television**
DAYS—EVENINGS WEEKLY RATES
VETERANS: RCA Institutes is approved under G. I. Bill of Rights
For Free Catalog Write Dept. RC-46
RCA INSTITUTES, Inc.
A Radio Corporation of America Service
75 VARICK STREET NEW YORK 13, N. Y.

CODE SENDING SPEED
RECEIVING SPEED

Be a "key" man. Learn how to send and receive messages in code by telegraph and radio. Commerce needs thousands of men for jobs. Good pay, adventure, interesting work. Learn at home quickly through famous Candler System. Write for **FREE BOOK**.
CANDLER SYSTEM CO.
Dept. 3-0, Box 928, Denver 1, Colo., U.S.A.

LES Correspondence Courses in **RADIO and ELECTRICAL ENGINEERING**

ELECTRICAL ENGINEERING Get good grasp of wide electrical field. Prepare yourself, at Low Cost, for secure future. Modern, simplified, you can understand quickly.
RADIO ENGINEERING Extra fine course in radio, multiplies your income. Lic. address. photo-electric work. Trains you to be super-service man, real vacuum tube technician. Servicemen needed badly. Diploma on completion. Tuition \$25, either course. Deferred payment plan. Get copies of school catalogs, student magazines, complete details. **SEND NOW!**
FREE
LINCOLN ENGINEERING SCHOOL Box 931C-94 Lincoln, Nebr.

LEARN
RADIO—TELEVISION—FM
Complete courses in all phases given in both day and evening classes.
Veterans accepted under G.I. bill
United Radio Television Institute
225 Halsey Street Newark 2, N. J.

ELECTRONICS

Electronic Technician Training Course. Qualify for Radio Communication (Commercial Government License); Radio Repair Service; or be an Industrial Electronic Technician. Register now for new classes starting every four weeks. Approved under G. I. Bill of Rights. Residence day and evening school. Write to **ELECTRONICS INSTITUTE, INC.**
21 HENRY, DETROIT 1, MICH.

DE FOREST 40TH ANNIVERSARY NUMBER

Don't miss the January issue of RADIO-CRAFT. It will have twice the number of pages and will be of historical import. January marks the 40th Anniversary of the birth of the vacuum tube.

NOW AVAILABLE FOR IMMEDIATE SHIPMENT!

Please place your order with your regular radio parts jobber. If your local jobber cannot supply you, kindly write for a list of jobbers in your state who do distribute our instruments or send your order directly to us.



The New Model CA-11
SIGNAL TRACER
 Simple to operate . . . because signal intensity readings are indicated directly on the meter!

Essentially "Signal Tracing" means following the signal in a radio receiver and using the signal itself as a basis of measurement and as a means of locating the cause of trouble. In the CA-11 the Detector Probe is used to follow the signal from the antenna to the speaker — with relative signal intensity readings available on the scale of the meter which is calibrated to permit constant comparison of signal intensity as the probe is moved to follow the signal through the various stages.

Features:

- ★ SIMPLE TO OPERATE — only 1 connecting cable — NO TUNING CONTROLS.
- ★ HIGHLY SENSITIVE — uses an improved Vacuum Tube Voltmeter circuit.
- ★ Tube and resistor-capacity network are built into the Detector Probe.
- ★ COMPLETELY PORTABLE — weighs 5 lbs. and measures 5" x 6" x 7".
- ★ Comparative Signal Intensity readings are indicated directly on the meter as the Detector Probe is moved to follow the Signal from Antenna to Speaker.
- ★ Provision is made for insertion of phones.

The Model CA-11 comes housed in a beautiful hand-rubbed wooden cabinet. Complete with Probe, test leads and instructions.....Net price

\$18⁷⁵

The New Model 450
TUBE TESTER

Specifications:

- Tests all tubes up to 117 Volts including 4, 5, 6, 7, 7L, Octals, Loctals, Bantam Junior, Peanut, Television, Magic Eye, Hearing Aid, Thyratrons, Single Ended, Floating Filament, Mercury Vapor Rectifiers, etc. Also Pilot Lights.
- Tests by the well-established emission method for tube quality, directly read on the scale of the meter.
- Tests shorts and leakages up to 3 Megohms in all tubes.
- Tests individual sections such as diodes, triodes, pentodes, etc., in multi-purpose tubes.
- New type line voltage adjuster.
- NOISE TEST: Tip jacks on front panel for plugging in either phones or external amplifier will detect microphonic tubes or noise due to faulty elements and loose internal connections.
- Works on 90 to 125 Volts 60 Cycles A.C.



SPEEDY OPERATION assured by newly designed rotary selector switch which replaces the usual snap, toggle, or lever action switches.

The model 450 comes complete with all operating instructions. Size 13"x12"x6". Net weight 8 lbs. **\$39⁵⁰** Our Net Price.....

The New Model 670P
SUPER-METER

A Combination Volt-Ohm Milliammeter plus Capacity Reactance Inductance and Decibel Measurements.



Specifications:
 D.C. VOLTS: 0 to 7.5/15/75/150/750/1,500/7,500 Volts.
 A.C. VOLTS: 0 to 15 30/150/300/1,500/3,000 Volts.
 OUTPUT VOLTS: 0 to 15/30/150/300/1,500/3,000 Volts.
 D.C. CURRENT: 0 to 1.5/15/150 Ma. 0 to 1.5 Amperes.
 RESISTANCE: 0 to 500/100,000 ohms; 0 to 10 Megohms.
 CAPACITY: .001 to .2 Mfd., .1 to 4 Mfd. (Quality test for electrolytics).
 REACTANCE: 700 to 27,000 Ohms, 13,000 Ohms to 3 Megohms.
 INDUCTANCE: 1.75 to 70 Henries; 35 to 8,000 Henries.
 +30 to +58.
 DECIBELS: -10 to +18; +10 to +38;

Added Feature:

The Model 670P includes a special GOOD-BAD scale for checking the quality of electrolytic condensers at a test potential of 150 volts.

The Model 670P is housed in a hand-rubbed, portable oak cabinet complete with cover, test leads, and all operating instructions.

\$35⁷⁵ Net



SUPERIOR INSTRUMENTS CO.
 Dept. RC 227 FULTON ST., NEW YORK 7, N. Y.

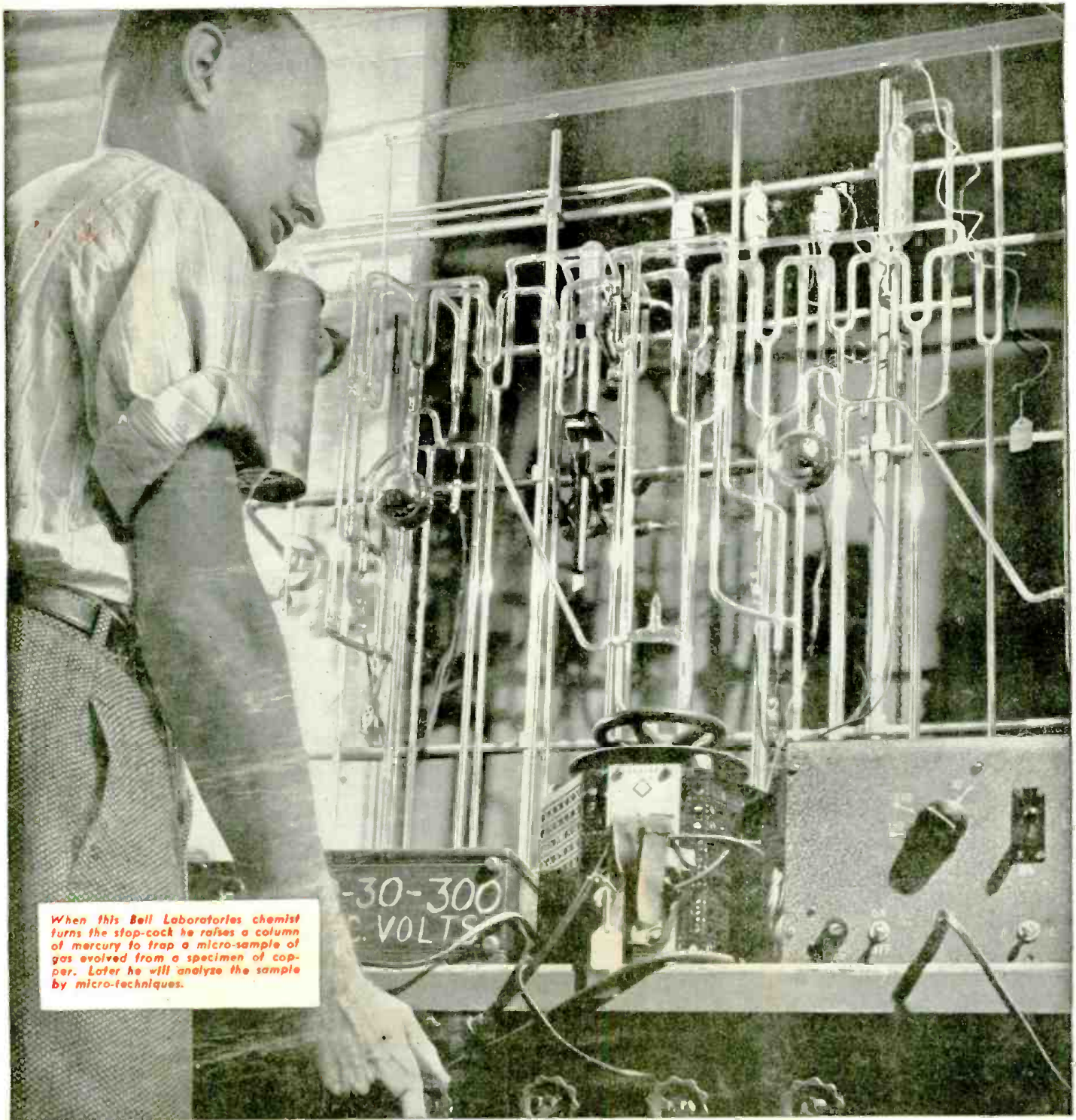

When this Bell Laboratories chemist turns the stop-cock he raises a column of mercury to trap a micro-sample of gas evolved from a specimen of copper. Later he will analyze the sample by micro-techniques.

Trapping poisons by micro-chemistry

Touch of a finger-tip—or even the dust in apparently clean air—can carry enough contamination to ruin an electron tube. Bell System scientists found this out through micro-gas analysis using new and original techniques.

They determined what could destroy the tube cathode's power to give off electrons, and how much—to the millionth of a gram. Then, with Western Electric, they developed a manufacturing technique to keep these destroyers out of

the tubes. . . . Bell Telephone Laboratories scientists established the world's first industrial micro-chemical laboratory more than 16 years ago for the Bell System.

Today micro-chemistry is constantly at work, helping to raise still higher the standards of telephone service and performance.

BELL TELEPHONE LABORATORIES



EXPLORING, INVENTING, DEVISING AND PERFECTING FOR CONTINUED IMPROVEMENTS AND ECONOMIES IN TELEPHONE SERVICE