

RADIO CRAFT

In this issue—

Bridged-T Circuits

Electronic Transients

Magnetron Tubes

PULSE POSITION
MODULATION

SEE PAGE 814

FEB

1946

25¢

CANADA 30¢

RADIO-ELECTRONICS IN ALL ITS PHASES

You can't put the *squeeze* on "Sealdtite" Capacitors

Take a genuine "Sealdtite" capacitor and try to squeeze it. No "soft spots."
Why? Because this Solar capacitor has its high purity paper-and-foil-winding ingeniously molded into a cylinder of solid wax.

No atmospheric moisture can penetrate this protective housing to attack the capacitor element. In genuine wax-molded "Sealdtite" capacitors, there just is no possibility of those twin omens of trouble — soggy cardboard tubes and moisture-filled hollows.

For real reliability, specify Solar "Sealdtites" on your next order.

P.S. If you haven't a copy of our Catalog SC-1, get one from your Solar distributor, or drop us a penny postcard today.



SOLAR CAPACITOR SALES CORP.
285 Madison Avenue • New York 17, N. Y.

©1949





Building this
A. M. SIGNAL GENERATOR
gives you valuable experience. Provides amplitude-modulated signals for test and experiment purposes.

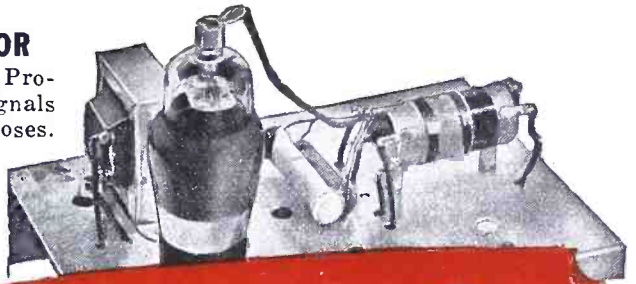

RADIO SERVICING
pays many good money for full time work. Many others make \$5, \$10 a week EXTRA fixing Radios in spare time.

Learn RADIO by PRACTICING in Spare Time

with 6 Big Kits of Radio Parts I Send You

Let me send you facts about rich opportunities in Radio. See how knowing Radio can give you security, a prosperous future. Send the coupon for FREE 64-page book, "Win Rich Rewards in Radio." Read how N. R. I. trains you at home. Read how you practice building, testing, repairing Radios with SIX BIG KITS of Radio parts I send you.

Future for Trained Men Is Bright in Radio, Television, Electronics

The Radio Repair business is booming NOW. There is good money fixing Radios in your spare time or own full time business. Trained Radio Technicians also find wide-open opportunities in Police, Aviation, Marine Radio, in Broadcasting, Radio Manufacturing, Public Address work, etc. Think of the boom coming now that new Radios can be made! Think of even greater opportunities when Television and Electronics are available to the public!

Many Beginners Soon Make \$5, \$10 a Week EXTRA in Spare Time

The day you enroll I start sending EXTRA MONEY JOB SHEETS to help you make EXTRA money fixing Radios in spare time while learning. You LEARN Radio principles from my easy-to-grasp Lessons—PRACTICE what you learn by building real Radio Circuits with Radio parts I send—USE your knowledge to make EXTRA money in spare time.

Mail Coupon for Free Copy of Lesson and 64-page Illustrated Book

I will send you FREE a sample lesson, "Getting Acquainted with Receiver Servicing," to show you how practical it is to train for Radio in spare time. With it I'll send my 64-page, illustrated book, "Win Rich Rewards in Radio." Just mail coupon in an envelope or paste it on a penny postal. J. E. Smith, President, Dept. 6BX, National Radio Institute, Pioneer Home Study Radio School, Washington 9, D. C.

My Course Includes Training in
TELEVISION--ELECTRONICS



You build this
MEASURING INSTRUMENT
yourself early in the course—use it for practical Radio work on neighborhood Radios to pick up EXTRA spare time money!

You build this
SUPERHETERODYNE CIRCUIT
That brings in local and distant stations. You get practical experience putting this set through fascinating tests.

BE A SUCCESS in RADIO
I Will Train You at Home

Sample Lesson FREE



Gives hints on Receiver Servicing, Locating Defects, Repair of Loudspeakers, I.F. Transformer, Gang Tuner, Condenser, etc., 31 illustrations. Study it—keep it—use it—without obligation! Mail coupon NOW for your copy!



GET BOTH 64 PAGE BOOK SAMPLE LESSON FREE

MR. J. E. SMITH, President, Dept. 6BX
NATIONAL RADIO INSTITUTE, Washington 9, D. C.
Mail me FREE, without obligation, Sample Lesson and 64-page book, about how to win success in Radio and Television—Electronics. (No Salesman will call. Please write plainly.)

Age

Name

Address

City Zone State 4FR



SYLVANIA NEWS

RADIO SERVICE EDITION

JAN.

Published by SYLVANIA ELECTRIC PRODUCTS INC., Emporium, Pa.

1946

RADIO SERVICEMEN KNOW THEIR BUSINESS; HAVE COUNTRY'S COMPLETE CONFIDENCE, SURVEY SHOWS

National Research Bureau Reports Findings to Sylvania

A recent nationwide, independent survey—conducted by one of America's leading market research organizations—reveals that not only do 93% of the thousands of set owners interviewed firmly believe that the radio serviceman does a good

job, but also that 89% say he charges a fair price for his work!

That's a flattering record—since the ground covered was scientifically selected, both from the geographical distribution standpoint and income group.

WHAT THIS MEANS TO YOU

To radio servicemen this means they are virtually assured of the continuance of this public trust in the busy years ahead. For, if this confidence was main-

tained throughout the past difficult period, it certainly may be expected to continue—and grow—in the following years, when the millions of radio tubes and parts needed will be available.

All of this spells opportunity for the radio serviceman. Knowing that he has the public confidence, he can combine the other ingredients of quality components and high class equipment, backed by aggressive promotion, to form an unbeatable recipe for success.

**SYLVANIA
SERVICEMAN
SERVICE**

by
FRANK FAX

Now that the war's over, radio tube production is rapidly getting into its stride. All the pre-war tubes should be available gradually—and along with them will come the newly developed tubes, or improvements and modifications of some of the older ones.

So to keep you in step with the latest tube characteristics and base diagrams, we at Sylvania are having prepared a brand new Radio Tube Characteristics Sheet as well as an up-to-date Base Chart.

You can get both your copies—free—from your Sylvania Jobber or send your request direct to me at Emporium, Pa.

**YOU SAY
WE DO GOOD WORK**

A NATIONWIDE SURVEY
CONDUCTED FOR US
AMONG THOUSANDS OF
RADIO SET OWNERS REVEALS...

93% SAY
REPAIRS MADE ON THEIR
RADIOS WERE SATISFACTORY

89% SAY
THE CHARGES FOR THE
SERVICE WERE REASONABLE

**LET US SERVICE YOUR RADIO
EXPERT WORK AT REASONABLE COST
WE USE SYLVANIA RADIO TUBES**

This is the
special poster—in color—
mailed to radio servicemen with Sylvania News

SYLVANIA ELECTRIC

Emporium, Pa.

MAKERS OF RADIO TUBES; CATHODE RAY TUBES; ELECTRONIC DEVICES; FLUORESCENT LAMPS, FIXTURES, WIRING DEVICES; ELECTRIC LIGHT BULBS



Announcing
THE NEW
SPERRY Microline*

As a reading glass aids visual search, so MICROLINE test and measurement equipment provides means for making all measurements at microwave frequencies.

Sperry announces a comprehensive line of microwave test and measurement equipment for labora-

tory and field use. The new line... the MICROLINE... is the outgrowth of years of research and experience in modern microwave techniques beginning with the development of the Klystron.

Write our Special Electronics Department for further information.

- Available now:**
- WAVEMETERS • WATTMETERS
 - BARRETTOR ELEMENTS AND MOUNTS
 - DIRECTIONAL COUPLERS
 - KLYSTRON SIGNAL SOURCES
 - STANDING WAVE DETECTORS
 - ATTENUATORS
 - IMPEDANCE MATCHING EQUIPMENT
 - WAVEGUIDE AND COAXIAL COMPONENTS

*TRADE MARK

SPERRY GYROSCOPE COMPANY, INC. GREAT NECK, N. Y.



Division of the Sperry Corporation

★
 LOS ANGELES • SAN FRANCISCO • SEATTLE • NEW ORLEANS
 CLEVELAND • BROOKLYN • HONOLULU

GYROSCOPICS • ELECTRONICS • RADAR • AUTOMATIC COMPUTATION • SERVO-MECHANISMS



IMMEDIATE DELIVERY for all radio service replacements

Now it's N. U. Panel Lamps, as month by month the N. U. line of quality tubes and parts grows broader . . . opens up more avenues for profitable business for service engineers. And now, you can pick up extra sales of panel lamps *by the box*. That smart looking new vest-pocket N. U. package of 10 lamps does it! Countless numbers of replacements are needed, for radios, cars, flashlights, and other uses. *Order now from your N. U. Distributor.*



NATIONAL UNION RADIO CORPORATION, NEWARK 2, N. J.



Vest-pocket box of 10 lamps—easy to sell that way—and profitable!



Complete line of types for all radio dials, panel boards, tuning meters, instruments, auto radios, flashlights, parking lights, coin machines.



The right bulb for every job—engineered to initial equipment standards—builds your reputation for accuracy and good work.



Torsion-tested filament wires . . . torque tested basing cement . . . shock and vibration tested bulbs . . . all combine to assure better service—*longer*.

NATIONAL UNION RADIO TUBES AND PARTS

Transmitting, Cathode Ray, Receiving, Special Purpose Tubes • Condensers • Volume Controls • Photo Electric Cells • Panel Lamps • Flashlight Bulbs

I'LL SHOW YOU HOW TO SUCCEED IN RADIO

Here's the right training for Big Post-War Pay!



F. L. Sprayberry, one of the country's foremost Radio Teachers.

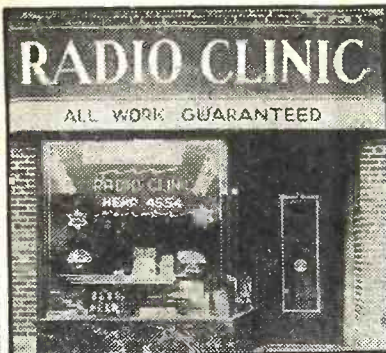

A RADIO SERVICE BUSINESS OF YOUR OWN

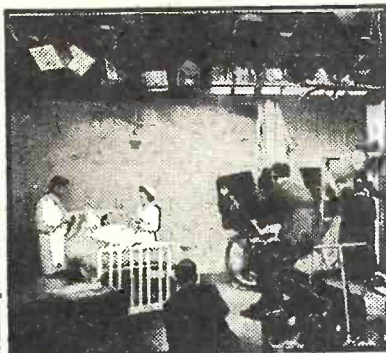

A GOOD JOB IN RADIO & TELEVISION BROADCASTING

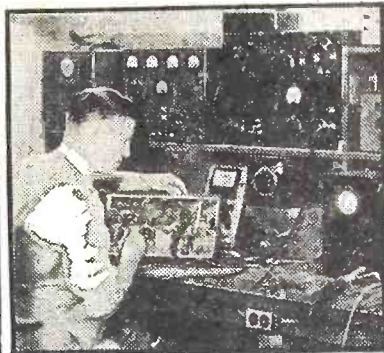

RADIO-ELECTRONIC SERVICE ENGINEER

BE A RADIO ELECTRONICIAN



I SUPPLY A FULL RADIO SET for practical easy LEARNING

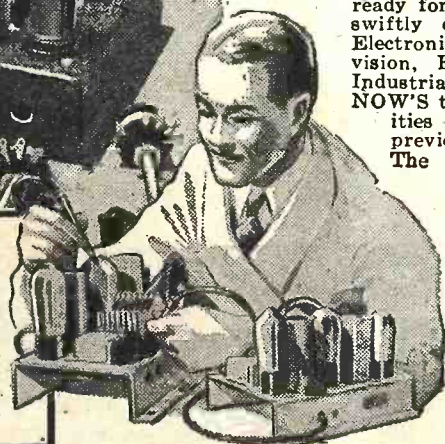

NOW! YOU CAN PREPARE AT HOME IN YOUR SPARE TIME FOR THE AMAZING OPPORTUNITIES AHEAD IN RADIO — ELECTRONICS — TELEVISION

The offer I make you here is the opportunity of a lifetime. It's your big chance to get ready for a wonderful future in the swiftly expanding field of Radio-Electronics INCLUDING Radio, Television, Frequency Modulation and Industrial Electronics. Be wise! NOW'S the time to start. Opportunities ahead are tremendous! No previous experience is necessary. The Sprayberry Course starts right at the beginning of Radio. You can't get lost. It gets the various subjects across in such a clear, simple way that you understand and remember. And, you can master my entire course

in your spare time. It will not interfere in any way with your present duties. Along with your Training, you will receive my famous BUSINESS BUILDERS which will show you how to make some nice profits while learning.

Prepares You for a Business of Your Own or Good Radio Job

My training will give you the broad, fundamental principles so necessary as a background, no matter which branch of Radio you wish to specialize in. I make it easy for you to learn Radio Set Repair and Installation Work. I teach you how to install and repair Electronic Equipment. In fact, you'll be a fully qualified RADIO-ELECTRONICIAN, equipped with the skill and knowledge to perform efficiently and to make a wonderful success of yourself.

Just Out! FREE!

"How to Read Radio Diagrams & Symbols" . . . a valuable new book which explains in simple English how to read and understand any Radio Set Diagram. Provides the quick key to analyzing any Radio circuit. Includes translations of all Radio symbols. Send for this FREE book now, and along with it I will send you another big FREE book describing my Radio-Electronic training.

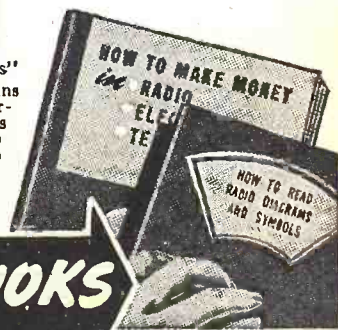

GET FREE BOOKS

SPRAYBERRY ACADEMY OF RADIO

F. L. Sprayberry, Pres.
Room 2026
Pueblo, Colorado

Please, rush my FREE copies of "HOW TO MAKE MONEY IN RADIO, ELECTRONICS and TELEVISION," and "HOW TO READ RADIO DIAGRAMS and SYMBOLS."

Name Age

Address

City State

Tear off this coupon, mail in envelope or paste on penny postcard.

SPRAYBERRY TRAINING GIVES YOU BOTH TECHNICAL KNOWLEDGE • SKILLED HANDS

There's only one right way to learn Radio Electronics. You must get it through simplified lesson study combined with actual "shop" practice under the personal guidance of a qualified Radio Teacher. It's exactly this way that Sprayberry trains you . . . supplying real Radio parts for learn-by-doing experience right at home. Thus, you learn faster, your understanding is clear-cut, you acquire the practical "know how" essential to a good-paying Radio job or a Radio business of your own.

I'll Show You a New, Fast Way to Test Radio Sets Without Mfg. Equipment

The very same Radio Parts I supply with your Course for gaining pre-experience in Radio Repair work may be adapted through an exclusive Sprayberry wiring procedure to serve for complete, fast, accurate Radio Receiver troubleshooting. Thus, under Sprayberry meth-

ods, you do not have one cent of outlay for manufactured Test Equipment which is not only expensive but scarce.

DON'T PUT IT OFF!

Get the facts about my training—now! Take the first important step toward the money-making future of your dreams. All features are fully explained in my big, illustrated FREE Catalog which comes to you along with another valuable FREE book you'll be glad to own. Mail Coupon AT ONCE!

ATTENTION, VETERANS!

The Sprayberry Radio-Electronics Home Study Course has been fully approved for Veterans' Training under the G.I. Bill of Rights. This is important to you! It's your opportunity to get our complete Radio Training through Government grant. Find out about your eligibility AT ONCE!

RADIO CRAFT

AND POPULAR ELECTRONICS

Incorporating
SHORT WAVE CRAFT TELEVISION NEWS
RADIO & TELEVISION



HUGO GERNSBACK, *Editor-in-Chief*
FRED SHUNAMAN, *Managing Editor*
M. HARVEY GERNSBACK, *Consulting Editor*

I. QUEEN, *Editorial Associate*
ELMER FULLER, *Shortwave Editor*
E. A. WITTEN, *Technical Editor*
A. PASCALE, *Production Manager*
G. ALIQUO, *Circulation Manager*
JOHN J. LAMSON, *Advertising Director*
ALFRED STERN, *Promotion Manager*

IN THE NEXT ISSUE

Sensitive Signal Tracer
Simple Capacity Bridge
Tuner-P.A. Amplifier
V. H. F. Transceiver
Limiting Circuits

Published by Radcraft Publications, Inc.
Publication Office: 29 Worthington Street, Springfield 3, Mass.
Editorial and Advertising Offices: 25 West Broadway, Tel. RE 2-9690, New York 7, N. Y.
Chicago Advertising Office: Radio-Craft, 308 W. Washington Street, Suite 1413, Chicago 6, Ill. Tel. Randolph 7363.
Cleveland Advertising Office: 405 Erie Bldg., Cleveland, Ohio. Burdette Phillips, Manager. Tel. Main 9645.
Los Angeles Advertising Office: 606 South Hill Street, Los Angeles 14, Calif. Ralph W. Harker, Manager.
San Francisco Advertising Office: 582 Market St., San Francisco 4, Calif. Ralph W. Harker, Manager. Tel. Garfield 2481.
Michigan Advertising Office: 70 Highland Ave., Highland Park 3, Michigan. Harry R. Lipson, Manager.
RADIO-CRAFT is published monthly on the 25th of the month preceding that of date. Subscription rates: United States and possessions, Mexico, Central and South American countries, \$2.50 a year, \$4.00 for two years, \$6.00 for three years. Canada, \$3.00 a year, \$5.00 for two years, \$7.50 for three years. All other foreign countries, \$3.25 a year, \$5.50 for two years, \$8.25 for three years. Special rates for members of the Armed Forces in U. S., or those addressed by A.P.O. or F.P.O. mail, \$2.00. Entered at the post office at Springfield as second-class matter under the Act of March 3, 1879. All communications about subscriptions should be addressed to: Circulation Manager, Radio-Craft, 29 Worthington St., Springfield 3, Mass.

Notice of CHANGE of ADDRESS should reach us at least one month in advance. When ordering a change, please furnish an address stencil impression from a recent wrapper if you can. Address changes cannot be made without the old address as well as the new.

Foreign Agents

London—Atlas Publishing and Distributing Co., Ltd., 18 Bride Lane, Fleet St., London, E.C. 4.
Melbourne—McGill's Agency, 179 Elizabeth St., Australia.

Text and illustrations of this magazine are copyright and must not be reproduced without permission of the copyright owners. Copyright, 1946, Radcraft Publications, Inc.

Contents February, 1946 Volume XVII, No. 5

Editorial: Television Recording	by Hugo Gernsback	305
Radio-Electronics Monthly Review		306
Swiss Radio Rental		312
Laws of the Atoms	Compiled by Helen M. Davis	346

ELECTRONICS

Magnetron Tubes		308
Anti-Radar Devices		309
Electronic Transients	by Jordan McQuay	310
PPM—New Technique	by Fred Shunaman	314
Elements of Radar, Part III	by Jordan McQuay	317
I.F.F.—Identification, Friend or Foe		332

SERVICING

Hum Elimination	by J. C. Hoadley	313
Decibel Problems	by John B. Ledbetter	320
Blind Servicemen	by D. W. Uhl	321
Some FM Factors	by Jack King	324

CONSTRUCTION

Bridged-T Circuit	by Robert B. Essex	316
144-MC Transmitter	by I. Queen	319

TEST INSTRUMENTS

A "Portable Shop"	by Wesley Neelands	311
Revamped Tester	by Hyman Herman	322

DEPARTMENTS

World-Wide Station List	by Elmer R. Fuller	326
Radio Electronic Circuits		328
New Radio-Electronic Devices		338
Try This One!		340
The Question Box		342
Technotes		358
Communications		364
Book Reviews		367



ON THE COVER

The cover picture this month is from a photograph of three parabolic antennas atop the New York Telephone Building. One of each pair is a transmitting, the other is a receiving antenna. Engineers are shown making circuit adjustments.

Chromatone Cover by Alex Schomburg

hallicrafters *new Model S-40*

New beauty and perfect ventilation in the perforated steel top

Separate electrical bandspread with inertia flywheel tuning.

Tuning range from 540 kc to 42 Mc continuous in four bands

Self-contained, shock mounted, permanent magnet dynamic speaker

All controls logically grouped for easiest operation. Normal position for broadcast reception marked in red, making possible general use by whole family.

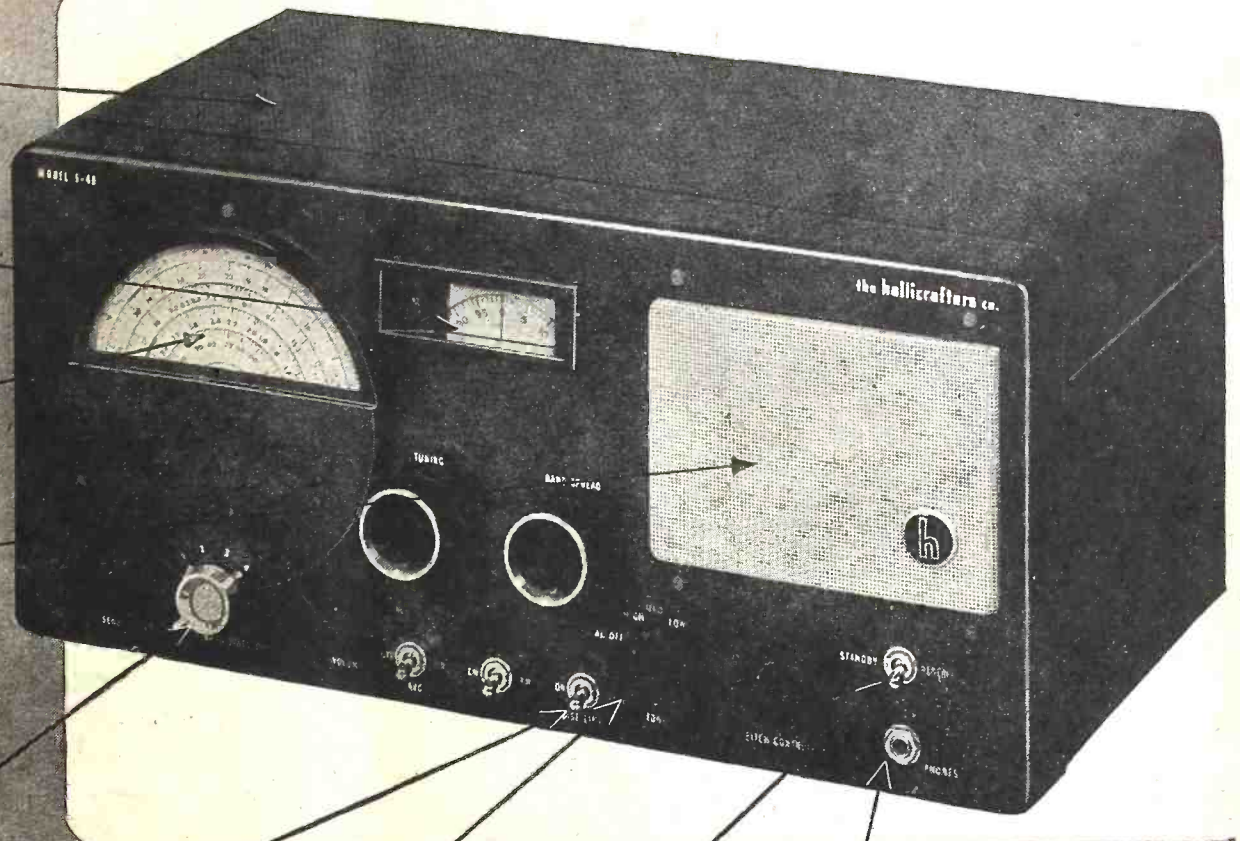

Automatic noise limiter

3-position tone control

Standby receive switch

Phone jack

New design, new utility in a great \$79⁵⁰ (APPROXIMATELY)
new communications receiver . . .

Here is Hallicrafters new Model S-40. With this great communications receiver, handsomely designed, expertly engineered, Hallicrafters points the way to exciting new developments in amateur radio. Read those specifications . . . it's tailor-made for hams. Look at the sheer beauty of the S-40 . . . nothing like it to be seen in the communications field. Listen to the amazing performance . . . excels anything in its price class. See your local distributor about when you can get an S-40.

INSIDE STUFF: Beneath the sleek exterior of the S-40 is a beautifully engineered chassis. One stage of tuned radio frequency amplification, the S-40 uses a type 6SA7 tube as converter mixer for best signal to noise ratio. RF coils are of the permeability adjusted "micro-set" type identical with those used in the most expensive Hallicrafters receivers. The high frequency oscillator is temperature compensated for maximum stability.

From every angle the S-40 is an ideal receiver for all high frequency applications.

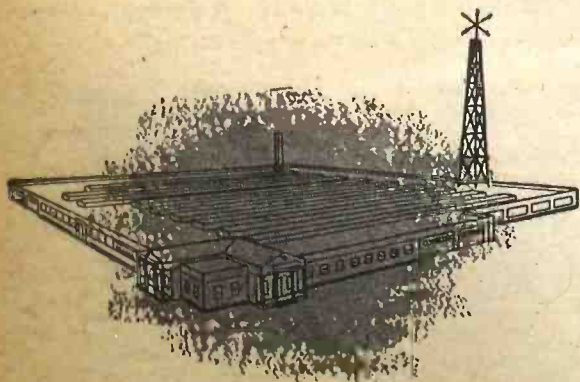

COPYRIGHT 1946 THE HALLICRAFTERS CO.

hallicrafters RADIO

THE HALLICRAFTERS CO., MANUFACTURERS OF RADIO AND ELECTRONIC EQUIPMENT, CHICAGO 16, U. S. A.

Sole Hallicrafters Representatives in Canada: Rogers Majestic Limited, Toronto - Montreal





HOW WE "ADVERTISED" in JAPAN

Shown here are only 333 of the 9,675 Capacitor and *Koolohm Resistor types engineered by Sprague and produced in 1944—most of them for war requirements of the most exacting sort.

FROM RADAR TO THE ATOM BOMB AND VT FUZE



SPRAGUE

How good are Sprague Capacitors and *Koolohm Resistors? Ask the Germans! Ask the Japs! From radar to the atom bomb and VT (radio-controlled) fuze, those nations got the most convincing evidence of electronic component quality the world has ever seen. And were they convinced!

Today with Sprague Capacitors and *Koolohm Resistors coming back on the civilian market in goodly quantities you'll also be convinced—but in a much more pleasant way. Every Sprague unit you now buy brings you full benefit of a wartime engineering record unsurpassed in the entire component field. Sprague Capacitors and *Koolohm Resistors are "tops"—because an unparalleled program of engineering makes them that way.

*Trademark Reg. U. S. Pat. Off.

SPRAGUE PRODUCTS COMPANY, North Adams, Mass.

(Jobbing Distributing Organization for Products of the Sprague Electric Co.)



CAPACITORS FOR EVERY SERVICE, AMATEUR AND EXPERIMENTAL NEED

Now You can Use.



ALL OF THESE RADIO PARTS

to help You learn

RADIO

FASTER-EASIER AT HOME

YOU CAN BUILD **133** FASCINATING EXPERIMENTS

At home—in your spare time—you get real Radio experience from these many *interchangeable* Radio parts and sub-assemblies. DeForest's handy "Block System" eliminates unnecessary mechanical work; the convenient spring clip connections save a great deal of time. You quickly build Radio circuits that work. You experiment with Photo-Electric Cell "Magic" .. a 5 tube Superheterodyne Receiver .. a Radio Telephone, and scores of other fascinating projects. Little wonder learning Radio at home is so practical .. effective and real fun—with DeForest's modern "Home Laboratory."

YOU USE "LEARN-BY-SEEING" MOVIES!

Think of the pleasure, as well as help you get from the use of this DeVRY Motion Picture Projector and exciting "movie" TRAINING FILMS. You will be surprised how much faster .. easier .. Home Movies help you understand Radio-Electronic fundamentals. Here's a preferred training method of tomorrow—yours today. See the principles of what you're learning—in motion .. ANIMATED! See circuit actions otherwise hidden from the eye. You get this big Radio home training advantage—exclusively with DeFOREST'S. So act now! Mail coupon for complete details.]

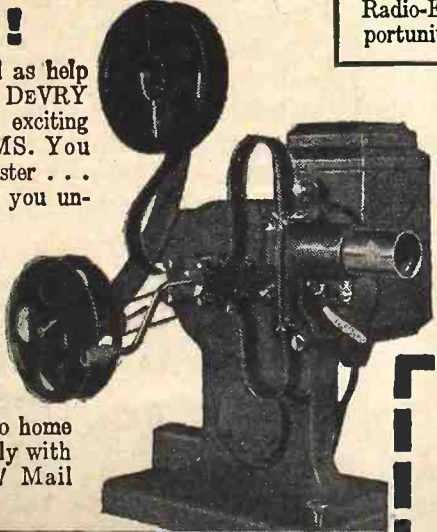

VETERANS!

Big things are happening at DeForest's for veterans! See how we can prepare you WITHOUT COST for a GOOD JOB or a BUSINESS OF YOUR OWN in the vast Radio-Electronic opportunity field.

See how DeForest's fascinating SHOP METHOD Radio Training at home can help you toward a good start in the Billion Dollar Radio-Electronic Field. Write for DeForest's BIG FREE book, "VICTORY FOR YOU!" that has helped many to good pay jobs. You'll be surprised at the opportunities ahead in F.M. Radio, Aviation Radio, Broadcast Radio, a Profitable Business of Your Own, Motion Picture Sound Equipment, Electronics—plus the exciting future possibilities ahead of Television, Radar, etc.

YOU Get "ALL THREE" With DeFOREST'S

Where else can you get such a combination of PROVED MAJOR training features as—(A) modern loose-leaf lessons prepared under the supervision of Dr. Lee DeForest, often called the "Father of Radio;" (B) the use of "Learn by Seeing" home movie films and a genuine 16 mm. DeVRY

MOVIE PROJECTOR—and (C) eight big kits of "Home Laboratory" Radio parts to give you valuable practical Radio experience—at home.

You Also Get EFFECTIVE EMPLOYMENT SERVICE ... to help you get started toward a Radio-Electronic job or a business of your own. Residential training in our Chicago laboratories also available! DeFOREST'S TRAINING INCLUDES INSTRUCTION IN MOTION PICTURE SOUND EQUIPMENT, FM RADIO AND TELEVISION ...



DeFOREST'S TRAINING, INC., Dept. RC-C2
2535-41 N. Ashland Ave., Chicago 14, Illinois, U.S.A.

Send—FREE and WITHOUT OBLIGATION—illustrated book, "VICTORY FOR YOU" and KIT SUPPLEMENT, showing how Home Movies and Home Laboratory can speed my preparation for a place in the Radio-Electronics industry.

Name _____ Age _____
Address _____
City _____ Zone _____ State _____
 If under 16, check here for special information.
 If a discharged veteran of World War II, check here.

DeFOREST'S

TRAINING, INC.

CHICAGO, ILLINOIS



Get Ready for POSTWAR RADIO ELECTRONICS AND TELEVISION *NOW!*

Great strides of progress have been made during the war. New equipment, methods, uses have been developed. Keep in the lead yourself with modern

SHOP METHOD HOME TRAINING BY A GREAT ESTABLISHED RESIDENT SCHOOL



NATIONAL SCHOOLS HAS BEEN BRINGING OPPORTUNITY TO AMBITIOUS MEN FOR MORE THAN A THIRD OF A CENTURY. Above and to the right are two departments in this great school where modern developments are analyzed to provide National students with first-hand knowledge of short cuts and trade secrets. For full details fill out the coupon.

Take your place in the forefront of Radio, Television and Electronic progress. Get your share of the NEW business. War inventions and improvements—walkie-talkies, radar, aircraft control and communications—will quickly be adapted to civilian use. F.M. is winning almost universal acceptance and use.

Everywhere you turn new and important changes in the field of Radio are being put into operation every day. Television is rapidly being perfected. Electronics is being applied to industry and better living. The successful technician **MUST KEEP UP WITH PROGRESS** if he is going to be sure of his job—**GET AHEAD IN BUSINESS.**



National Schools presents a Radio and Electronic training system geared to the rapid advancement of the industry itself. Here is an exclusive home training system based on the shop methods as practiced in one of the World's foremost vocational education centers—the actual shops and experimental laboratories of this National institution. Send the coupon on the next page for complete details. Only National can bring you this type of training for only National has the shops, equipment and experimental laboratories for the development and extension of the system.



The very essence of National Shop Method Home Training is **EXPERIENCE**. You get to know Radio and Television circuits by building them yourself. You get

Use This Modern Electronic Laboratory

first-hand knowledge of how instruments work by a sound analysis and construction system.

You build a beautifully toned, high fidelity, long distance modern super-

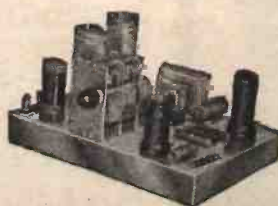

heterodyne receiver from the parts furnished with your course. In this way you have a thorough understanding of the superheterodyne principle. You learn modulation,

beat frequency and signal generation by building yourself a small, operating radio transmitter with National parts. You get to know and

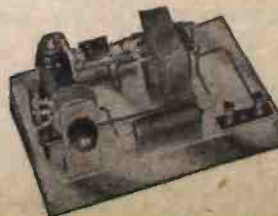

understand the process of creating audible signals by electronic means by conducting experiments with a National Audio Oscillator.

You conduct cathode ray experiments to gain a first hand knowledge of the operation, repair and maintenance of Television equipment. Hundreds of experiments may be performed to gain first hand experience with your National laboratory equipment.



New Fields

Electronics is already a most important factor in industry. Many manufacturing processes depend on electronic controls—employ electronic processes. In medicine and agriculture, too, electronics is being used extensively. Are you ready to cash in on this development in a field that is so close to radio?

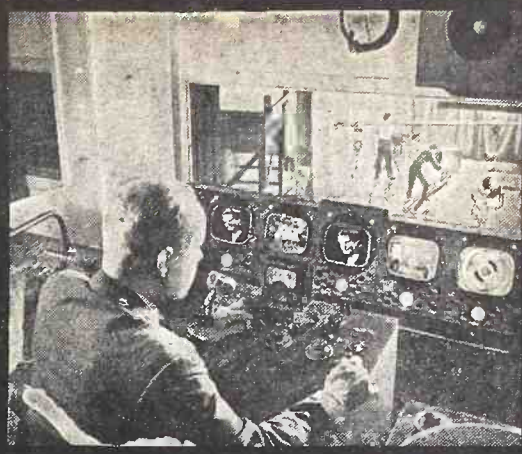

New Equipment

Every day you learn of new types of radios and improved television—new electronic devices. Fac-simile, F.M., Radar, Sonor—all present new problems of manufacture, operation and maintenance that demand training and experience. Consider your advantages if you have the necessary preparation to tackle this work.

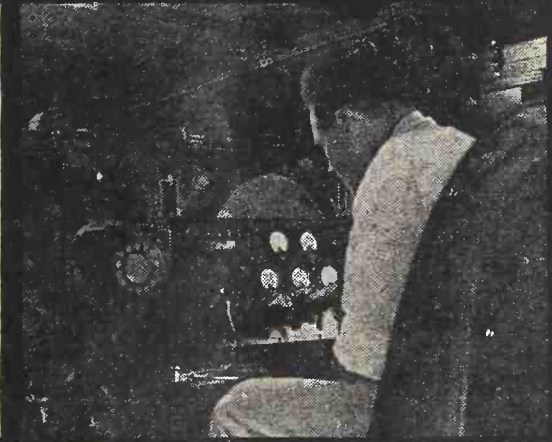

New Hook-Ups

The relatively simple wiring of the radio receiver of a few years ago is as out-of-date today as one of the first automobiles. The new Radio and Television sets, and Electronic devices demand a thorough knowledge of new principles. National brings its students the results of *continuous research* and improved methods.

NEW OPPORTUNITIES

Think what all this great progress in Radio, Electronic power and control and Television means to YOU PERSONALLY—you who are already in Radio or have a natural inclination toward it. The greatest opportunity of a lifetime is right within your grasp.

Compare the job you now have or expect to get when you are out of service or your present war job with the great future presented you by the broad field of Electronics.

Literally tens-of-thousands of technicians are needed in Radio and Television stations and communications companies all over the country—to operate, maintain and repair equipment. The man who knows modern methods and equipment is welcome almost at his own price.

Latest figures show that Radio represents a 5-billion dollar industry and, in the opinion of experts, it is a secure, well-established, basic type of business offering steady employment. Television, according to authorities, offers half a million openings right at the start.

The man trained in modern Electronics CAN CHOOSE THE KIND OF INDUSTRY HE WANTS—THE PART OF THE COUNTRY HE PREFERS AND THE KIND OF POSITION MOST SUITABLE.

YOU WANT ACTION

With this amazing speed-up training you can progress just as quickly as you wish—start taking advantage of your new found knowledge and experience in a very short time. Send the coupon below and learn the facts about this great educational development. Try out the FREE SAMPLE LESSON and see for yourself what you can accomplish so quickly and easily with the remarkable SHOP METHOD HOME TRAINING.

In a few months—perhaps only weeks—you may start making good money; maybe accept a BIG PAY JOB in industry—GET INTO A PROFITABLE, LIFE-TIME BUSINESS OF YOUR OWN, with little or no capital investment.

Take the first step now. Fill out and mail the coupon below.

FREE LESSON



Get this BOOK

Here is an interesting forecast of the future of Radio and the opportunities present for you in this, and allied fields right now. It is profusely illustrated and describes the jobs waiting for trained men everywhere. Send the coupon below for your copy.



Here Are Some Samples of Success in Radio by National Graduates

National Shop Method Home Training wins good jobs, independence and security quickly. Take the word of National men who have established records in their favorite Radio, Television, or other branches of Electronics:



Joseph Grumich, Lake Hiawatha, New Jersey writes: "My latest offer was \$5,800.00 as Radio Photo Engineer

but I'm doing well where I am now engaged. I am deeply indebted to National."

Here's a statement from R. R. Wright, Blackfoot, Idaho: "Due to my training at National I was selected to instruct in the laboratory work of Navy and Marines."



From O. K. Ivey, Washington, D. C., comes this endorsement: "I believe National offers the best course to be had ... Keep up the good work."

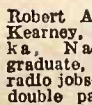

Robert Adamsen, Kearney, Nebraska, National graduate, has two radio jobs—makes double pay as a radio instructor and as engineer at Station KGFV. He writes: "I am proud of My National training and appreciate the cooperative spirit."

Read what hundreds of other enthusiastic students have written about National Training. Send in your coupon today.

NATIONAL SCHOOLS

LOS ANGELES 37, CALIFORNIA EST. 1905



MAIL OPPORTUNITY COUPON FOR QUICK ACTION

National Schools, Dept. RC-2
4000 South Figueroa Street, Los Angeles 37, California

(Mail in envelope or paste on penny post card)

Mail me FREE the two books mentioned in your ad including a sample lesson of your course. I understand no salesman will call on me.

NAME AGE

ADDRESS

CITY STATE

Include your zone number

Men! You Need "All-Around" Training for Tomorrow's Better Jobs in



RADIO - ELECTRONICS and TELEVISION

"Learn by Doing"

— 12 FASCINATING WEEKS of STREAMLINED TRAINING

You like Radio work. But if you're really serious about making it your lifetime career, **GET PRACTICAL TRAINING NOW.** Don't be satisfied to putter along in a "one-operation" no-future job. Prepare for better pay and advancement with Coyne all-around training in Radio-Electronics-Television.

Many Branches Included

Here in the great shops of Coyne in Chicago, you're trained in everything from basic principles and Radio construction, to F. M. (frequency modulation), electronic controls, public address systems, television and radio-phonographs. You can even get valuable extra training in Industrial Electronics and Electric Refrigeration at no extra cost, for still more opportunities in the years ahead. Coyne gives "all-around" training!

Work on Real Equipment

You work on real actual equipment and expert instructors give you necessary theory in blackboard lectures and demonstrations. In 12 WEEKS OR SO—you're ready for a real future!

Starting Your Own Radio Shop

Want to be your own boss, with a fine-paying radio shop of your own? We show you how to set one up and operate it successfully. Hundreds of Coyne graduates are doing it. You can, too. Send now for details.

Get the Facts — FREE!

My new giant Radio Opportunity Book has dozens of shop pictures, facts about Radio and Television jobs, my plans to help you. Rush coupon today. No obligation; no salesman will call. You alone will decide. But don't delay. Act NOW.



H. C. Lewis

Send for Details on My STUDENT FINANCE PLAN

If you don't have much cash, I'll arrange to finance most of your tuition and you can pay it back in easy monthly installments after you graduate. We'll even help you get a part-time job if you wish, so you can **EARN WHILE LEARNING.** My **LIFETIME EMPLOYMENT SERVICE** is free to Coyne Graduates. Coyne Training is the finest investment you can make.

MEN WITH PHYSICAL DISABILITIES

Also facilities for men with physical disabilities, whether due to war or other causes. Check coupon for special information.

THE HOME OF
COYNE



VETERANS!

Coyne is also equipped to train those who qualify for training under the G. I. Bill of Rights. Check the coupon for special G. I. Bulletin.

H. C. LEWIS, Pres.

Founded 1899

COYNE ELECTRICAL SCHOOL
RADIO-ELECTRONICS DIV.

500 So. Paulina Street, Dept. 26-8H, CHICAGO 12, ILLINOIS

H. C. Lewis Pres., Radio-Electronics Div.,
COYNE ELECTRICAL SCHOOL,
500 S. Paulina St., Dept. 26-8H
Chicago 12 Ill.

I want to build a **REAL FUTURE** for myself. Send your big **FREE BOOK** on Radio-Electronics, also details of your Student Finance Plan. Check if you are interested in information on the following:

- Send special G. I. Bulletin
- Send details on Physical Disability

NAME.....

ADDRESS.....

CITY..... STATE.....

TELEVISION RECORDING

Video recording paralleling that of sound is urgently needed

WHEN radio broadcasting was young (in the early Twenties), it became necessary for the radio industry to record radio programs for many different purposes. It did not take long to solve the problem because the phonograph had pointed the way. Inasmuch as all recording was on relatively low frequencies, the solution was comparatively simple. Soon programs could be recorded on disks, on films, and magnetically. Today, these methods are standardized and most of the engineering problems have been solved.

In television there exists a parallel need for recording video programs, but so far the problem has not been solved satisfactorily. That there is a distinct necessity for video recording is apparent to all interested.

To begin with, television broadcasters—for many reasons—wish to keep an actual log of some of their important broadcasts so they can be recorded for historical, as well as commercial, purposes. In the near future, television sponsors will also wish a permanent record of their television broadcasts. Commercial television (advertising) broadcasts, where the same program is to be put on the air in different cities, by different stations,—will also require recorded video for that purpose.

At the present time the only way in which this can be accomplished is by means of a photographic film whereby a picture record is made of the broadcast. This film can then be preserved for any length of time and can be "played back" at a later date. This is cumbersome because film must be developed, then dried, etc. The film can either be exposed photographically, by filming the action in the studio direct, by attaching a motion picture camera to the television camera, or the motion picture camera is trained on a cathode-ray tube so that the actual television sequence is photographed.

These two methods are roundabout ways as they are purely optical in nature and are not true, direct, video recordings. What is wanted is a radio-electronic record rather than optical-film recording. The trouble with video recording is that the frequencies now used in television run above three million cycles a second, which is much too high to allow satisfactory recording (for instance), on a wax record. The ordinary phonographic method no longer works at these high frequencies for the simple reason that so far no means is known whereby a phono-

graph needle could vibrate at such high speeds.

There are, however, other methods whereby it will be possible to solve the problem, which now becomes one of engineering. One of the obvious methods is, a disk-film similar to a phonograph record. A sensitive circular film could conceivably be exposed whereby a light beam could be modulated electrically and a record made on the film in this manner. To "play back" such a film-record would merely mean to reverse the process by having a light beam follow the recorded spiral by shining through it. Then a very sensitive photo-electric, or similar cell, would record the light variations which then would be fed into an amplifier, thence into a television receiver. In this manner the complete record could be "played back" exactly as is a phonograph record in the audio band now. For a short program such a system would be satisfactory no doubt, but for programs running an hour or more it would necessitate too many film disks. This is also a cumbersome method, because the film-disk must be developed, dried, etc. For these reasons something better is required.

The first alternative that comes to mind is a magnetic recorder. The trouble with this is that so far it has not been possible to make a recording anywhere near three million cycles a second. There is a "lag" in magnetic recording and it also takes a certain amount of time for a magnetic "impregnation" to be impressed on iron wire.

It is believed, however, that in time this difficulty may be overcome, and it would seem that there is a possibility that magnetic recordings—even at a frequency of three million cycles—should not be thought impossible. Much experimental work remains to be done in this field, but in time this problem will also be solved.

That it is possible to do recording at very high speeds is best shown by the fact that it has been done in another way for several billion years. By this we mean that the animal eye has, and is doing it successfully. It is known that we see by electro-chemical means. There would, for instance, be no persistence of vision if it were not for the visual purple on the retina of the eye. This too constitutes a type of recording, similar to optical-film recording, except that the time-consuming developing and drying is done away with.

We now come to the second (Continued on page 368)

Radio Thirty-Five Years Ago

In Gernsback Publications

HUGO GERNSBACK

Founder

Modern Electrics	1908
Electrical Experimenter	1913
Radio News	1919
Science & Invention	1920
Radio-Craft	1929
Short-Wave Craft	1930
Wireless Association of America	1908

Some of the larger libraries in the country still have copies of Modern Electrics on file for interested readers.

FROM the February, 1911, issue of MODERN ELECTRICS:

Non-Heating Spark Gap, by *D. E. McKisson.*

An Eighty-Foot Wireless Mast, by *R. C. Bodie.*

A Hot Wire Meter, by *P. W. Wormser.*

A Rotary Tuner, by *E. J. Sortore.*

New Marconi Circuit.

An Efficient Aerial Lead-In, by *Howard Tucker.*

To Receive Long and Short Waves, by *H. H. Anderson.*

A Novel Practicing Set.

A Simple Detector Stand, by *J. N. Davis.*

New Electrolytic Detector.

Compact Tuning Device, by *J. E. Crockford.*

Electrolytic Detector, by *A. P. Gompf.*

PRESIDENT of the Institute of Radio Engineers for the year 1946 is Dr. Frederick B. Llewellyn of Summit, New Jersey. He succeeds Dr. William L. Everitt. Dr. Llewellyn, a consulting engineer on the staff of Bell Telephone Laboratories, is an international authority on the design of vacuum tubes used for communication and electronic control purposes. His theoretical study of the subject resulted in his invention of the ultra-high-frequency oscillator tube which is fundamental to the development carried on during the war in radar and other communication devices. He is also known for his work on stabilized oscillating circuits used in radio and telephony. A graduate of Stevens Institute of Technology, his early work was in connection with the transatlantic telephone, and he was also one of the engineers who installed radio telephones aboard the steamship Leviathan, the first installation to be used in public service between ship and shore. In 1936 he received the Morris Liebman Memorial prize for his analysis of reactions within the vacuum tube.

FM OUTLETS are being grabbed up by existing radio groups, standard broadcasters and newspapers, *Advertising Age* declared last month. Newspapers and standard broadcast stations were responsible for more than eighty per cent of the applications for FM stations pending before the Federal Communications Commission.

Digging resolutely into its backlog of applications, FCC has demonstrated in its actions so far that no anti-newspaper theories are guiding the allotment of FM grants. Of 65 licenses awarded on one recent weekend, fully a third went to newspapers.

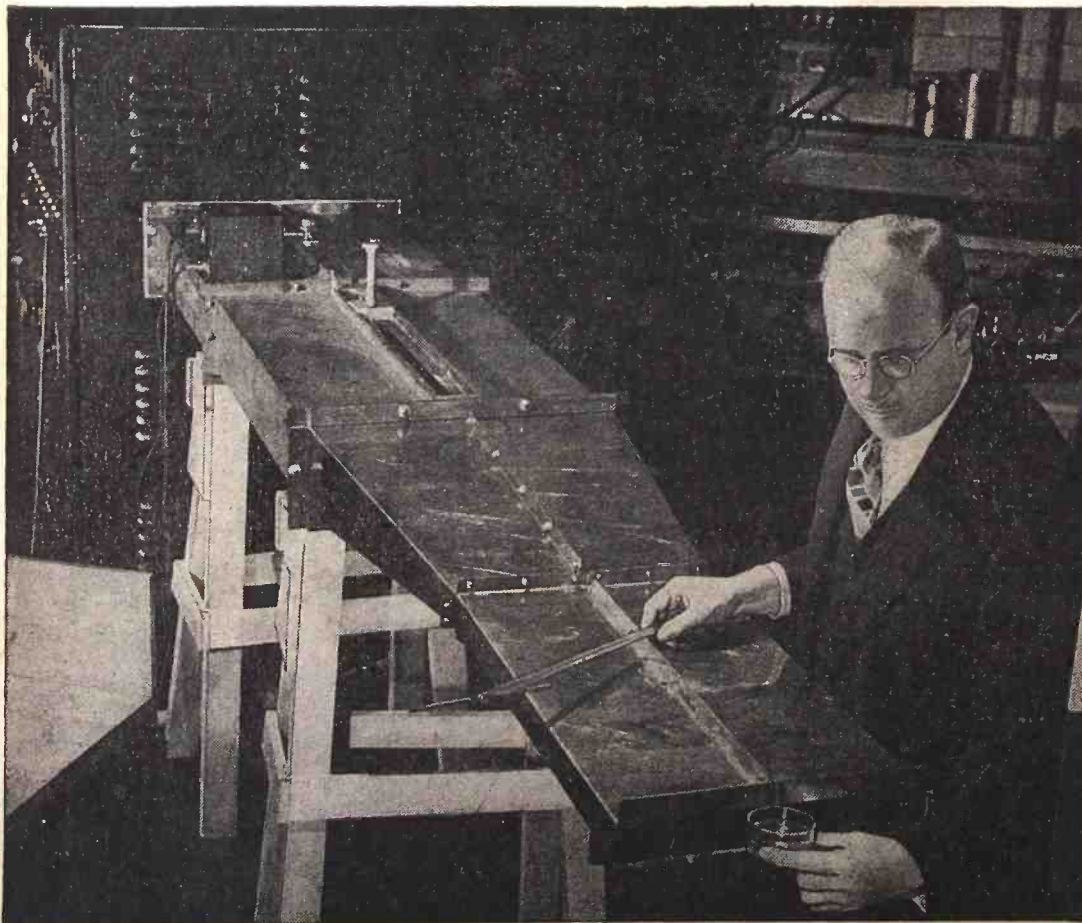

Dr. J. A. Hutcheson demonstrates the new "blow-torch" at the Westinghouse laboratories.

RADIO-ELECTRONICS

Items Interesting

Impartiality of the procedure is illustrated by the fact that 107 of the 129 new licenses processed during the past month are going to applicants who are already operating standard stations, says *Advertising Age*. Of the 22 newcomers, 14 are newspapers.

PHASITRON a new FM modulator tube, will make possible savings up to 10% in the cost of low-power postwar FM transmitters, General Electric officials reported last month.

The tube is so constructed that the electron stream is in the shape of a disc, directed against an inner cylindrical plate which has two rows of staggered holes cut in it, one just below and one just above the plane of the disc. The excitation voltage from the crystal-controlled oscillator of the transmitter is transformed into three phases and applied to a 36-wire grid in such a way that the edges of the disc of electrons are alternately bent up and down, giving it a scalloped effect, with the edge of the disc tracing out a line on the inner anode like that of the conventional representation of a sine wave. On each deviation from the horizontal, electrons escape to the outer plate through the two rows of holes in the inner one. The rotating three-phase field causes the irregular edge of the disc to appear to rotate—all these effects resulting in a



The G-E Phasitron, frequency modulation tube.

sinusoidally-varying output current.

Audio voltage from the speech amplifier is applied to a coil around the Phasitron's glass envelope. Increase and decrease of the magnetic field surrounding the coil speeds up or slows down the rotating disc of electrons, dependent on the modulation voltage, thus causing a sound-controlled phase modulation of the Phasitron's output current.

From an engineer's standpoint, the purpose of the new modulator tube is to make possible the introduction of comparatively wide phase excursions at audio rates in a crystal-controlled radio frequency carrier voltage.

AN ELECTRONIC "blow-torch" may revolutionize industrial high-frequency heating methods, stated Gwilym A. Price, executive vice-president of Westinghouse, at a demonstration last month. The electronic blow-torch, a dielectric heating unit which hurls ultra-short radar waves at an object to be polymerized, cured or bonded, was displayed by Dr. J. A. Hutcheson, associate director of the Westinghouse Research laboratories.

The device projects electronic waves on the material to be heated, wherever it may be, whereas previous dielectric heaters require that the object be placed in an electrical field created between two stationary metal plates or electrodes.

The advantage of this unit is that it is possible to bring heat direct to the object or joint to be heated. It can be used in restricted areas and effectively on irregularly-shaped pieces of material. Formerly, when a non-symmetrical piece

MONTHLY REVIEW

to the Technician

was placed between the electrodes, the areas nearest the electrodes were in danger of being scorched or burned before the entire piece was uniformly heated throughout.

Odd-shaped plywood forms and T-joints formed by struts or spars can be easily cured or bonded with this new super-high-frequency unit, which is still in the research stage and not available commercially.

OVER-OPTIMISM about the new Citizens Radio service was deprecated last month by Daniel E. Noble, general manager of the Communications and Electronics division of Galvin Manufacturing Corporation. Speaking over Radio WGNB, Mr. Noble pointed out that there is not room for an unlimited number of radio telephone conversations on the air, and that other services which have received much wider frequency bands are likely to be pinched at times.

"The FCC did set up a Citizens Radio Band of ten megacycles" stated Mr. Noble, "but not more than 100 party lines can be established in the band. One of the reasons for establishing the band at 460 megacycles was that this is not a very satisfactory region for radio telephone mobile and portable communications at the present time and there was no great commercial demand for such frequencies."

TELEVISION images of heretofore unachievable detail, brilliance and contrast were demonstrated to press representatives last month at the RCA Laboratories, Princeton, N. J. The new black-and-white images were made possible by receivers containing new and greatly improved Kinescopes, or picture tubes. These television pictures were bright enough to be seen in a fully lighted room.

The tubes used in the new receivers were far more efficient than any publicly demonstrated previously. In the new tubes the fluorescent screen on which the image appears in black-and-white is backed up with a very thin coating of aluminum which permits the use of higher voltages than formerly. The aluminum film acts as a mirror preventing loss of light inside the tube thereby greatly improving picture brilliance and contrast.

Stereoscopic pictures in color were also shown. The perspective of the pictures was emphasized when girl models held out flowers as if offering them to the audience. A cane pointed toward the audience protruded with amazing realism. Special polarized filters in the camera and receiver, and polaroid glasses worn by the spectators produced the

three-dimensional effect.

Although the pictures reproduced by the mechanical color system show promise, RCA engineers pointed out that color television is still distinctly in the laboratory stage of development, with obvious shortcomings. There is much technical development, they said, that needs to be completed before a practical color television system will be ready for the home service to the public. They estimated that this will require about five years.

On the other hand, demonstration of the black-and-white all-electronic television system clearly showed that it is now ready for the home.

A PREVIEW of what the future may bring in the way of radio masts was given to inhabitants of New York City with the erection last month of a new kind of antenna for facsimile broadcasting. Guesses as to the function of the new apparatus ranged from atom-bomb developments to equipment for a trip to the moon.

The new antenna is built to carry both FM sound and the amplitude-modulated facsimile carrier, which is practically equivalent to that used in television. Designed by Captain W. G. H. Finch, USNR, well-known pioneer in facsimile, it is expected to concentrate the "beam" in a horizontal disc-like pattern which will result in stronger signals to receivers near the extreme range of the transmitter, which operates on line-of-vision frequencies.

According to Dr. Andrew Alford, who designed the antenna:

"The high frequency of the new FM band together with the horizontal polarization have made it possible to achieve something new in broadcasting: a single unit antenna which has gain over a half wave. This gain is obtained by using



Close-up view of the new facsimile antenna.

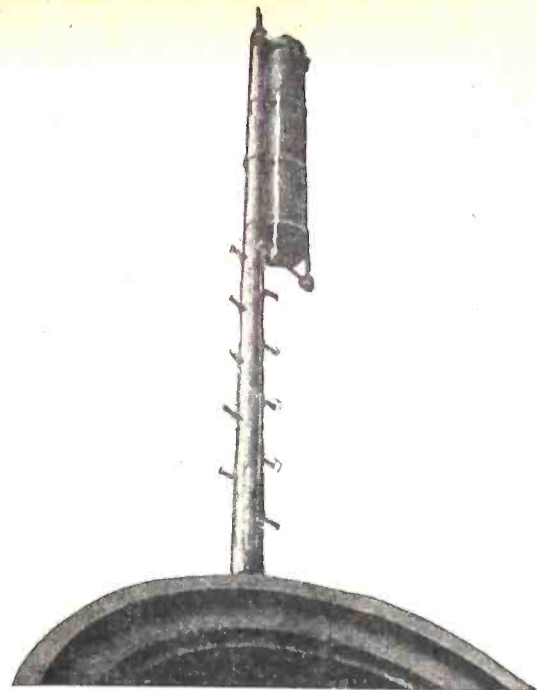

The disc-beam facsimile antenna on its mast.

a bent metal sheet along which the wave length is longer than the wave length in space so that the radiation comes from a long vertical column. This results in a concentration of radiation toward the horizon—where it is desired—with less power being sent to the sky and into the area immediately adjacent to the station where the signal is always more than sufficient. WGHF's antenna radiates nearly equally in all directions of the compass. The input impedance of the antenna is relatively low so that the insulation is not subjected to high voltages. Only one seal insulator which is protected from the weather is used."

MAGNETIC RECORDINGS of an improved type are made by a German tape machine, specimens of which — sent home by the Army in Germany—were on display at the Department of Commerce last month. Feature of the instrument is that it uses a plastic tape with an almost microscopically thin film of magnetic material on its surface.

The equipment, which operates on alternating current, is designed primarily for connection to a radio receiver for recording, and to head-phones for playback. The signal from the receiver passes through an amplifier to the recording head, which magnetizes the coating on the tape. The exact composition of the tape is not known, but it appears to be a plastic composition coated with highly magnetic material.

The tape is very thin but fairly strong, and can be demagnetized and reused many times without signs of wear or deterioration. Each tape is about a half-mile in length on a single reel, and provides a recording time of about 45 minutes at average ribbon speed.

One of the interesting features of this machine is a pitch-restoring head. This device, used when the tape is played back at speeds other than the recording speed, permits restoration of the original speed.

MAGNETRON TUBES

Supply at microwave frequencies the tremendous power required by radar and anti-radar devices

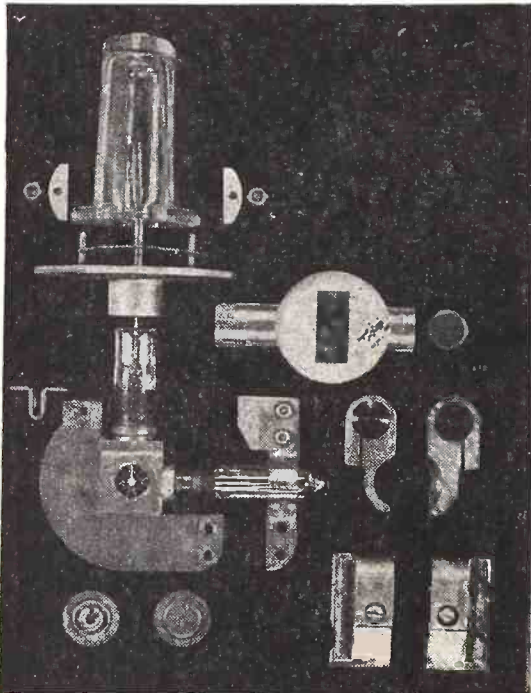

Cavities surrounding the central anode are easily seen in this 10-centimeter magnetron.

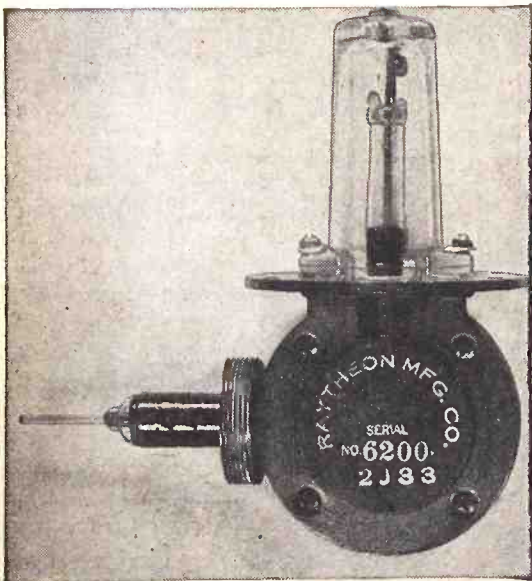

300-kw, 10-centimeter magnetron oscillator.

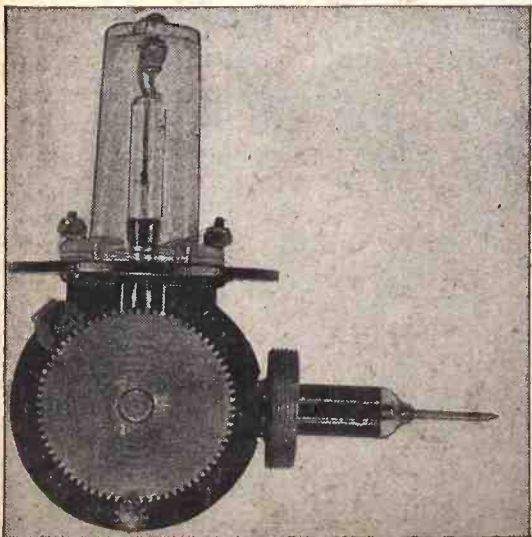

Tunable oscillator delivering 50-kw pulses.

OUR use of frequencies higher than any attainable by the enemy was one of the chief causes of the spectacular success of Allied radar equipment. Output of large quantities of power on wave lengths a few centimeters—even a few millimeters—long, was achieved of the *cavity magnetron*, one of the most important as well as most secret of our war weapons.

The magnetron itself is neither new or secret. Invented in 1920 by A. W. Hull of General Electric, it was described in technical magazines of that period as a possible means of producing ultra-short-wave oscillations. Existing tubes were efficient on all frequencies used at that time and for years thereafter, so the magnetron remained in comparative obscurity. Even when interest in waves a meter or two in length began to develop, velocity-modulated tubes or special types of standard triodes were generally used. Only the necessity of generating centimeter-length waves, needed for greater definition in radar apparatus, brought investigators back to the almost forgotten magnetron.

Basically, the magnetron is one of the simplest tubes in existence. It consists of a straight cathode surrounded by a cylindrical anode. The anode may be divided into segments, making an array of two or several plates around the cathode. The tube is operated in a strong magnetic field, with the access of magnetizing forces parallel to the cathode (N and S poles at end of tube).

When no magnetic field is applied, the magnetron acts like an ordinary diode. Electrons leaving the filament are drawn directly to the positively-charged plate. Upon application of a magnetic field, the electron is acted on by two forces—the electrostatic force attracting it to the plate and the magnetic force urging it in a direction at right angles to its path from cathode to anode. Therefore the electron moves in a curved path (Fig. 1), the curvature of which increases with the magnetic field strength, until a point is reached where the plate is missed altogether, and the electron—carried on by its own momentum—curves back toward the filament.

By properly adjusting plate voltage and magnetic field strength, an oscillation somewhat similar to the Barkhausen-Kurz type described in a recent number of *Radio-Craft* (Microwaves, August, 1945), may be produced. There are a number of other ways in which oscillation may be obtained in a magnetron.

One type of oscillation uses a split-anode magnetron. Electrostatic and

magnetic forces are so adjusted that the tube acts as a negative resistance. The magnetic field force is increased to a point which prevents practically all electrons from reaching the anodes. If, however, one of the split sections is at a higher voltage than the other, the electrostatic field in the vicinity of the slot between sectors will be distorted as shown in Fig. 2. Any electron whose circular path causes it to move paral-

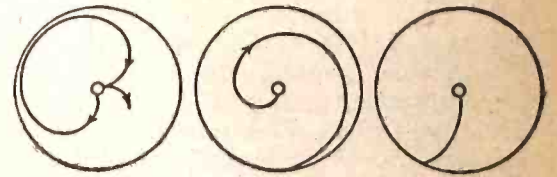

Fig. 1. The electron paths in a magnetron.

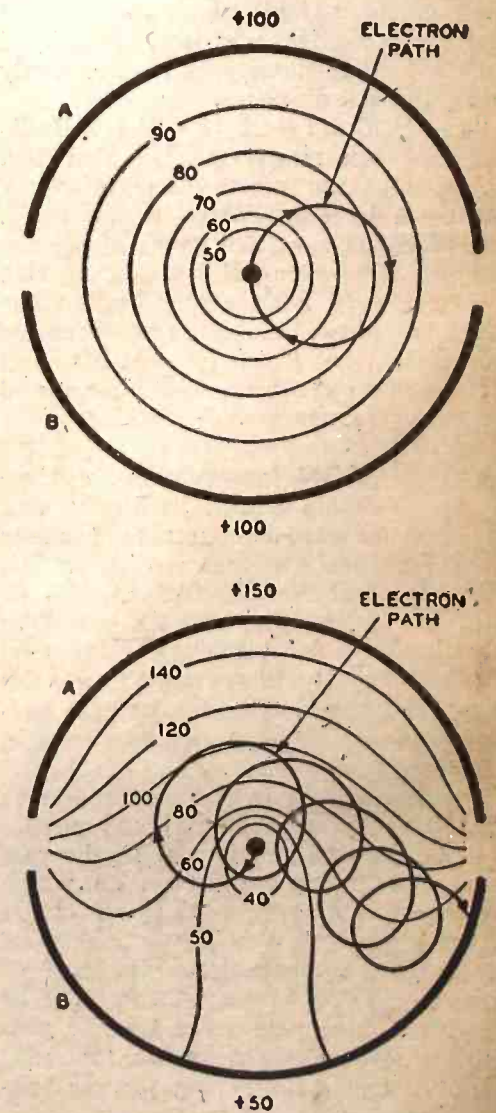

Fig. 2, top—Anode voltages equal. Electron never reaches either. Bottom—Voltages unequal. Electron reaches lower-voltage anode.

lel with the plate and in the direction of the one with lower voltage is retarded by the opposing field and no longer has momentum enough to carry it clear of the plates and back to the

(Continued on page 327)

ANTI-RADAR DEVICES

Anti-radar devices are jamming systems of various kinds which interfere with the radar echo. Since radars were the indispensable "eyes" of all armies, navies and air forces in World War II, the Allied jamming system, first sprung on the Germans in 1943, threw the Axis' defenses into utter confusion. It reduced the effectiveness of German anti-air-craft guns by 75 per cent. On D-Day, a carefully planned Allied anti-radar

blitz thoroughly bewildered the Germans and feinted much of their strength out of position. By the late stages of the war, the Allied scientists' devices had made such a boomerang of Axis radar that the Germans and Japanese often gave up using radar lest it betray them. Photograph 1 shows a horn antenna used with the most powerful radar jammer ever made. It was known as "Tuba" and was used to jam German radars and

prevent them from tracing RAF planes returning from raids on the Continent.

Photo 2 is the oscillator of a high-power jammer developed by Harvard University's Radio Re-

search Laboratory. Capable of sending out tremendous quantities of power over an extremely wide frequency range (200-2500 megacycles) it rendered useless all radar installations on which its ether-shaking waves were beamed.

Photo 3—called a tinsmith's nightmare—is actually an ingenious antenna for radar jammers, sending out a circularly polarized signal to jam enemy gun-control radars.

Photo 4 is another "Tuba" antenna, designed to give a beam very sharp in

(Continued on page 359)

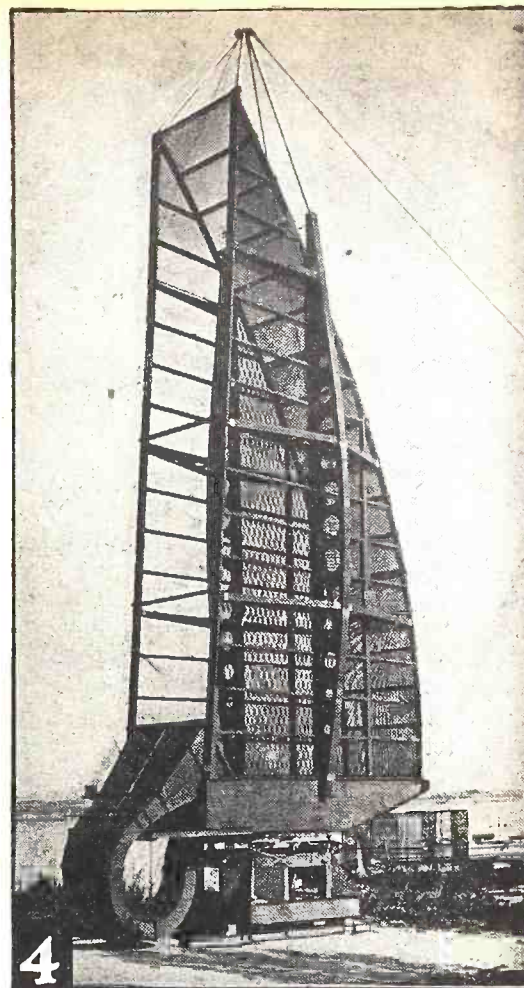
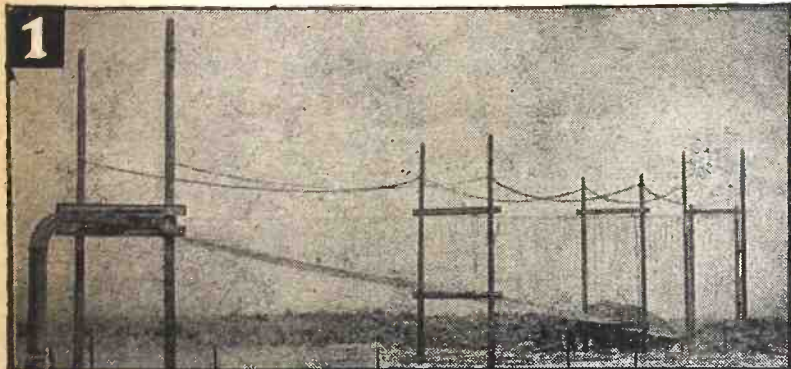

ELECTRONIC TRANSIENTS

The Future Belongs to These Odd-Shaped Waves

PERIODIC waves of electrical energy may have many different shapes. Simplest of these is the pure sine wave. More complex waves may have a large number of harmonic frequencies—voice, music, or random noise. In most audio and radio work the exact shape of these waveforms is unimportant—provided the output of the operating device or equipment is not *too* distorted. Even so-called high fidelity allows for considerable distortion inaudible to the human ear.

In electronic applications—radar, television, and electronic timing, delay, and control circuits—the shape of these waves is very important. They control microsecond action of other circuits and components of the equipment, where accurate timing and measurement often depends entirely upon the wave shape.

Despite their apparent simplicity when viewed on a test oscilloscope, such control waves are usually extremely complex in composition. Simple-appearing waves—such as the saw-tooth, square, and peaked waves, rectangular pulses, and others (Figure 1)—are complex combinations of many waveforms.

Although not sinusoidal, such electronic waves *are* periodic. That is, they repeat themselves at regular time intervals, permitting examination with a synchronized test oscilloscope.

The composition of these periodic, nonsinusoidal waves is important to an understanding of the operation of all electronic circuits. Because these waves, under the guidance and control of the

special types of electronic circuits, perform the many functions of timing, modulation, measurement, and delay in radar, television, and general electronics work.

USE OF HARMONICS

All complex, periodic waves have their basis in the pure sine wave, the recurrent sine wave having the same frequency as the complex wave. This is called the fundamental or first harmonic.

Component waves of multiple frequency are known as second, third, fourth, fifth, etc. harmonics. And the waves are designated according to ratio of their recurrence frequency to the fundamental. That is, a frequency three times that of the fundamental is known as the third harmonic, a frequency six times the fundamental as the sixth harmonic, and so on.

By skillfully combining certain harmonics (of different amplitudes) with the fundamental, basic sine wave, a complex wave having almost any given shape can be created by electronic circuits.

The *saw-tooth wave*—familiar as a time base control in test oscilloscopes and certain radar applications—consists of the fundamental wave to which are added harmonics of lower amplitude. When only the second and third harmonics are combined with the basic sine wave, the resultant wave [Figure 2 (4)] begins to assume a saw-tooth form. But the positive and negative peaks are not sharp and the slope is irregular. To obtain an acceptable saw tooth wave [Figure 2 (5)] a great many other harmonics—often as many as eight or nine—must be combined with the fundamental.

A *perfect* saw tooth wave—with sharp edges and a perfectly flat slope—would have to consist of an infinite number of added harmonics. For most radar and electronic purposes, however, saw tooth waves with harmonics up to the eighth or ninth are acceptable.

A *square wave* consists of a fundamental and a number of *odd* harmonics only. When the fundamental is combined with a third harmonic of lower amplitude [Figure 2 (6)], the general "square wave effect" is illustrated. Addition of more *odd* harmonics—the fifth, seventh, ninth, and sometimes the 11th—results in a wave shape more nearly approaching a perfect square. However, a *perfect* square wave is impossible to obtain since it would have

(Continued on page 350)

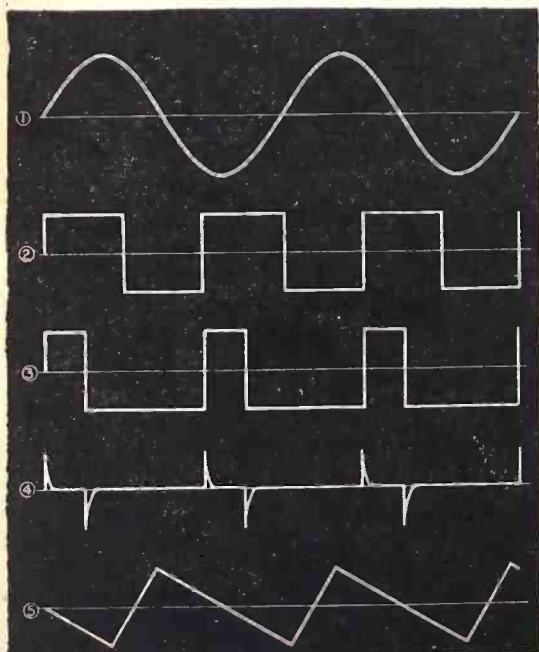

Fig. 1—Types of periodic waves. 1—Sine wave. 2—Square wave. 3—Rectangular wave. 4—Peaked wave-forms. 5—Saw-toothed wave.

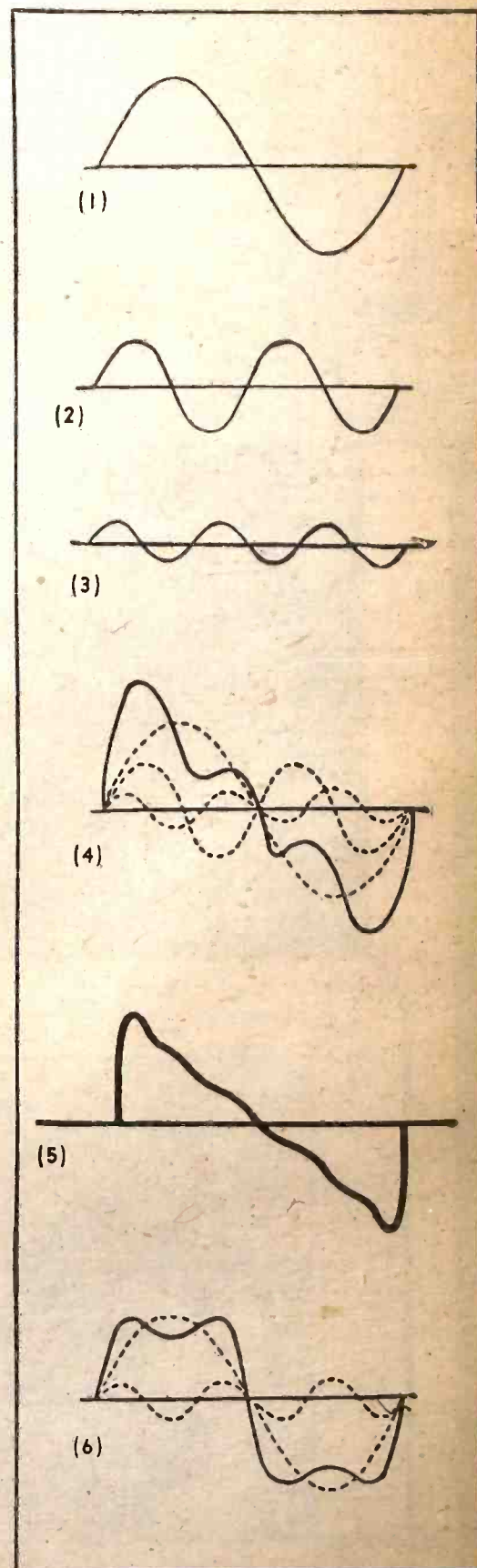

Fig. 2—Composition of complex wave forms: 1—Fundamental sine wave. 2—Second harmonic. 3—Third harmonic. 4—Fundamental and 2nd and 3rd harmonics. 5—Fundamental with 2nd, 3rd, 4th, 5th, 6th, 7th and 8th harmonics. 6—Fundamental with third harmonic.

A "PORTABLE SHOP"

The Radioman Goes to Live in an Apartment

THE housing shortage is no respecter of persons. My radio hobby and I had grown up together with space unlimited. There was a large room to tinker in, a big work table, home made instruments and apparatus, built with no regard for compactness. Then came a better job in a crowded city . . . and a four-room apartment. Also came a baby into our apartment, who in spite of her pint size occupied at least one-half the space. There just wasn't room for so much as a variable condenser to open out. My "junk" was packed and stored in an old unheated shed. But friends kept saying, "Wish you'd take a look at my radio." Besides, I was getting mighty lonely for the feel of a soldering iron. I began making trips to the shed. The photo shows the result.

The whole thing tucks away into a closet when not in use but comes right out into the living room in the evening and perches on a kitchen chair in front of the Chesterfield. There's room in the bottom for tools. The shelves at the right hold test prods, plug-in coils and a pocket volt-ohm-milliammeter. This meter is my one piece of "boughten" apparatus. In the lower left corner is a 110-volt outlet (Fig. 1) controlled by the switch just above it. There's a pilot light shunted across the outlet (so you won't forget and leave the soldering iron on). Above the switch is another 110 outlet and there's another one behind the panel. The test instruments plug into it. This completes the first section. The apparatus is built in sections on masonite backed with metal shields. Different sections can be removed separately. Above the outlets is a four-inch dynamic speaker. The audio channel is located in the lower central section, with the off-on switch at the left. Below the electron-eye is a neon bulb. To the left of the attenuator knob (below) is a single-pole double-throw switch. This is shown in the diagram and explained later. The three pin jacks at the left are: Common, B-plus, and 6.3 volts A.C. The two at the right are Input and Ground. The upper section was built directly on the back of the panel with no chassis but is carefully shielded. The large dial above is for tuning. The pin jacks at the right are for R.F. input (or aerial) and output. To the left is the regeneration control and two Diode Voltmeter pin jacks. The upper is an A.C. input and the lower is plus D.C. output. The plug-in coil can be seen protruding slightly from behind the panel at the right.

THE AUDIO CHANNEL

The circuit diagram is given at Fig. 2. The unit consists of the loud-speaker, 6V6 output tube, 6SQ7 voltage amplifier, 6E5 electron-ray voltage indicator, 2-meg. attenuator and a switching arrangement. The switching arrangement allows one to listen to any audio signal or its effects may be noted on the electron-ray indicator. The electron-ray indicator is especially useful in making voltage gain tests and in balancing phase-inverter circuits. It is sensitive

to frequencies above and below the limits of the loud-speaker. The 6V6 is much superior to the more common 6F6 because of its greater sensitivity, which is very valuable when listening to weak signals. Voltage variations of low frequency—hum, etc., cause the edge of the indicator-shadow to waver, flicker or blur. Frequencies above the audible range to 50,000 cycles or more close the eye smoothly but no signal is heard from the loud-speaker. It should be noted that when the speaker is in the circuit the diode rectifier is inoperative. If it were left in the circuit it would cause distortion. The 2-megohm attenuator causes little loading in any circuit and allows a range of from 1 volt to 500 to be measured.

With good building and careful calibration this unit will give accurate A.C. measurements which compare favorably with those of a good electronic voltmeter. Strong I.F. signals are rectified by this instrument and close the eye smoothly. Even R.F. signals from a strong local station have been picked up by a test probe and have found their way to

the grid of the 6V6 and appeared as an untuned and unwanted program.

The Neon Tester—shown in the Audio Circuit diagram—needs no explanation. As a condenser tester it is the most used apparatus on the panel.

R.F., I.F. AND SIGNAL GENERATOR

This, as can be seen from Fig. 3, is a simple one-tube regenerative circuit of the Hartley oscillator type. This is the simplest and most satisfactory circuit for this purpose. It has good stability with respect to load, because the only coupling between the oscillating circuit and the load is the elec-

(Continued on page 357)

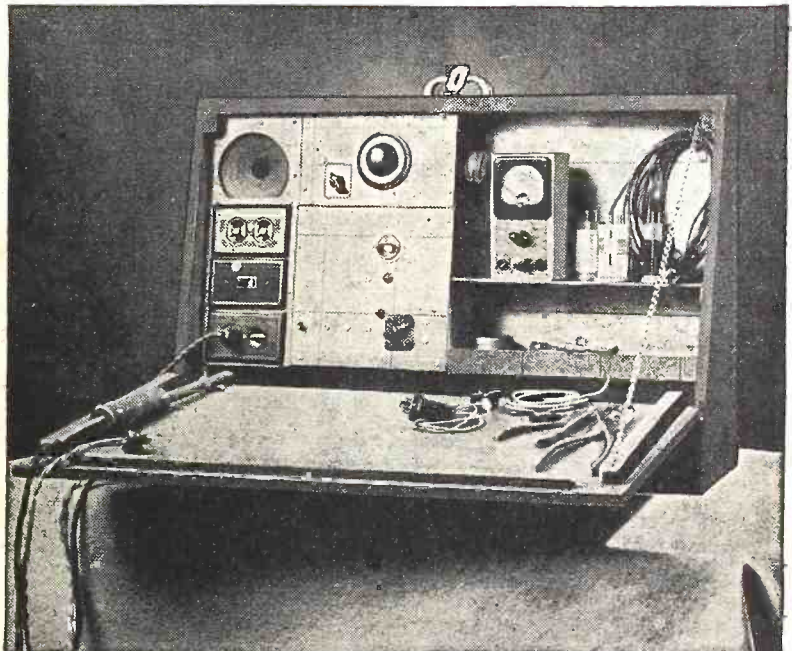

Right—Photo of the "portable radio shop." Below—the four circuits, an oscillator, signal tracer, VTVM and amplifier.

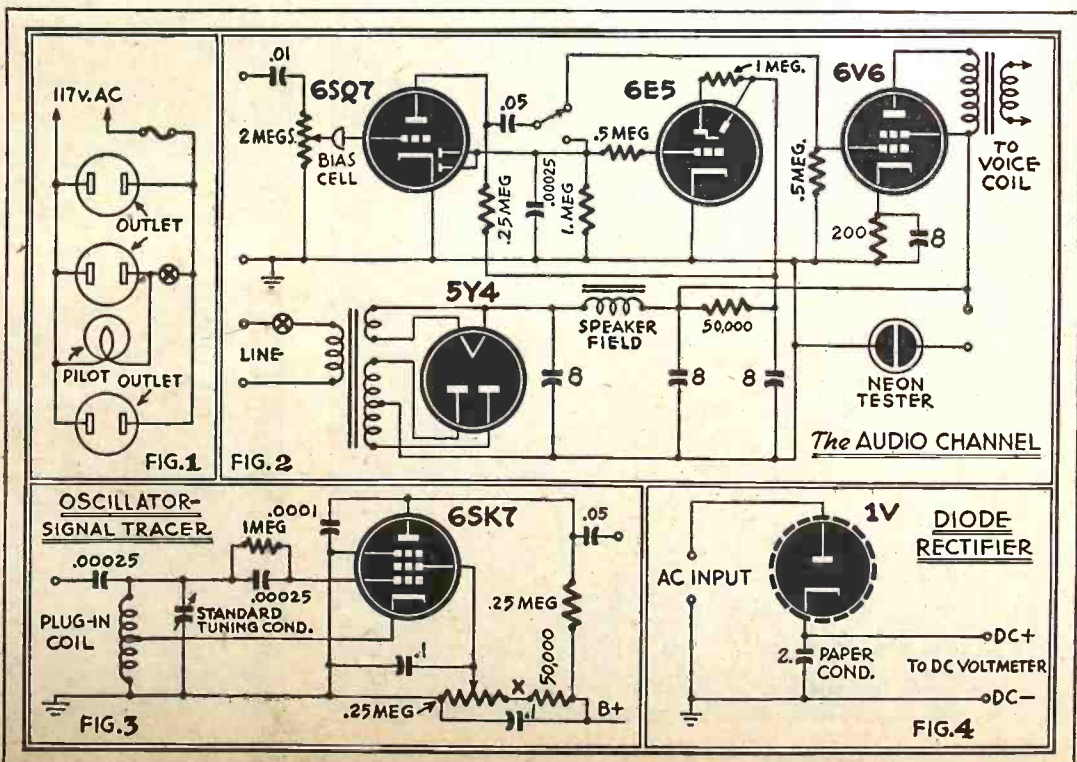

SWISS RADIO RENTAL

RADIO receiver rental plans have never been popular in the United States, although many small-scale attempts have been made to sell such plans to the public. In Switzerland the case has been different. One firm, Radio Steiner, has built up over the last 18 years, a large business based on what it calls a *subscription lease plan*.

The firm has 225,000 subscribers, and employs over 400 people, including 90 fully-equipped independent servicemen. Comparing the Swiss figure of 819,000 radio listeners with that of 30,000,000 radio families in the United States, that would be 7,650,000 subscribers for a comparable U. S. enterprise.

Radio Steiner offers different subscriber plans: for those who own no radio at present, for those who wish to trade in an old set, and for those who have a radio receiver but wish to subscribe for repair service only.

This is how the plan works. Suppose Mr. Jones decides that he wants a radio for the first time. He is offered a selection of sets ranging from about \$23 to \$230. In each price range, however, only one set is available.

Suppose Jones picks out a \$48 set. He signs a contract by which he agrees to pay a rental fee of \$1 a month (1/48 of set price per month). During the first

three months he agrees to pay a rental charge of \$3 a month instead of the regular \$1 fee. In addition Jones will pay an additional monthly insurance fee ranging from 80 cents to \$1.40. This fee also covers cost of any necessary repairs. From the fourth month on Jones can break the contract by giving one month's notice, or (if he wishes) he can purchase the set outright at its normal new sale price. In this case the rental he has already paid (less the insurance) is deducted from his purchase price. If Jones decides to continue on a subscriber basis he will own the set after 42 months. When a set becomes the property of a subscriber, the insurance and repair benefits are discontinued.

By the terms of the contracts, Steiner is guaranteed at least 10 months' rental fee in each case. This fee covers the expense of those cases where the subscriber breaks the contract after the initial three-month period and does not purchase the set.

If Mr. Jones turns in an old set at the time he subscribes for new-set service, he is allowed ten to fifteen percent of the price of the new set, thus



Steiner puts out its own radio publication, reducing his rental fee. The old sets are overhauled and used in two ways. They may be used in subscribers' homes while the regular set is removed for re-
(Continued on page 366)



Just a few of the types of radios leased to subscribers. These are mostly trade-ins which are overhauled and refinished before renting out.



Each of these three mobile radio workshops have crew of ten men. Right—Excellent music attracts crowds to the travelling shops.



Overhauling trade-in radios in preparation for renting out.

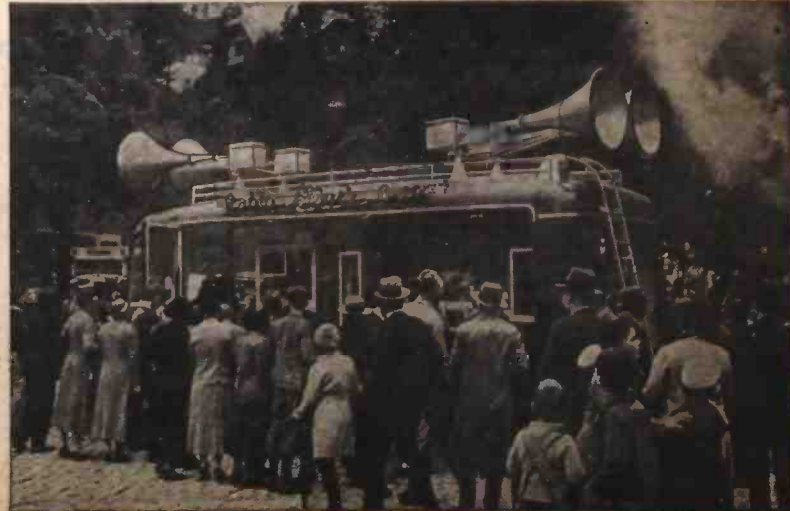

HUM ELIMINATION

Some New Ideas on an Old and Important Subject

HUM, that bane of every engineer's existence, the spoiler of recorded and transcribed music, can be eliminated. It merely requires careful analysis and a large dose of common sense. There is a myriad of ways that this insidious nuisance can creep into an otherwise well-designed piece of equipment, either through faulty design or from aging or faulty components.

First, hum may be eliminated through proper design. One of the most violent sources of hum is lack of filtering. Proper filter components are arrived at by designing the power supply—for the unit under consideration—to have a certain percentage ripple when loaded with the load the unit will draw. This is not always enough. It is sometimes necessary to utilize a voltage-regulated power supply to reduce the ripple to the desired amount. This may take the form of the well-known RCA circuit which uses a sharp cut-off pentode to receive the variations in the D.C. output voltage and with a resistor in its plate circuit to influence the grids of several power tubes such as 6B4G or 2A3's, connected in series with the power supply. Their resistance is increased or decreased, and, thereby, the voltage held constant and the ripple wiped out. For smaller loads, a gaseous regulator of the VR-150 type may be employed.

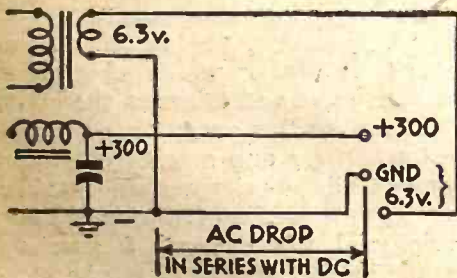

Fig. 1—Piping A.C. hum into a D.C. circuit.

In the former case, the regulator may function well with a resistive load, but when coupled to the circuit it is intended to power, ripple develops. This may be caused by several things. First and foremost is the shielding of the grid circuit of the pentode which controls the regulator tubes. If 60 cycles is introduced at this point, the tube will amplify the 60 cycles and swing the D.C. voltage at this frequency. Secondly, *this type of power supply cannot be overloaded*. It must be designed to handle the maximum current to be delivered. The regulation and ripple increase very rapidly after its maximum output has been reached.

If a VR tube is used as a regulator, its current range cannot be exceeded. This tube must be supplied with a minimum of 5 milliamperes, else it will not remain in a conducting condition. It must be remembered that the line voltage may change, so a low line voltage condition should be used to figure the minimum current value and the highest line voltage for the maximum

current value. This current should not exceed the current rating for the tube.

These tubes under certain conditions will oscillate. This condition may be cured in some cases by inserting a series resistance of about twenty ohms between the VR tube and ground. It is interesting to note that VR tubes have an effective resistance in the order of 40 ohms.

MAGNETIC FIELD COUPLINGS

The power supply should be laid out with the fields generated by the power transformer and chokes properly oriented. The chokes and power transformers should be magnetically shielded and placed so their cores are at right angles to each other, as there is no point in building a good low-ripple power supply and then inducing a volt or so of 60 cycle from the power transformer into the chokes. This hum source will cause even more trouble if audio transformers are involved, as there is usually a considerable amount of amplification following these items and the induced hum is amplified accordingly.

Audio transformers should of course be kept away from power transformers and chokes and should be oriented properly as well. If these components are mounted on a common iron or steel chassis, their cores should be kept away from the chassis by mounting them on aluminum or brass bushings, as the magnetic chassis becomes a common lamination in the core of each transformer and comprises a convenient path for the transference of magnetic fields.

In general, the smaller an audio transformer is, the fewer external magnetic lines will cut it and, consequently, the less it will be bothered by external fields.

Remember that the field around a conductor is proportional to the current that conductor is carrying, so be very careful with leads such as supply lines for the power and filament transformers, and filament wiring which supplies a large number of tubes. Grounding one side of the heater winding on the filament transformers *in one place* is helpful, but keep the filament wiring to itself. This, of course, applies also to high voltage wiring to the rectifier tubes. Don't forget to shield all mercury-vapor rectifiers.

"GROUND" CIRCUIT COUPLINGS

Where the power supply and the unit to be powered are separated, do NOT run the negative B voltage and the grounded side of the filament through a common wire, because (as a look at Fig. 1 will show you) you will effectively connect an A.C. voltage in series with the D.C. supply which you consider hum-free. Although this voltage is small, being due to the filament current, it may be amplified many times by several tubes and assume much greater proportions in the output of your device.

It is somewhat risky to ground the filaments of high-gain amplifiers in several places or depend on the chassis to carry

one side of the filament current. This is quite all right from the current standpoint, but if a previous plate is by-passed at Point A in Fig. 2 and a subsequent grid

J. Carlisle Hoadley was born in Washington, D. C., November 22, 1916. Began his radio career at the age of ten, and was president of his High School radio club (McKinley Tech) a few years later.

After ten years in the servicing and sound apparatus business, sometimes with repair organizations and sometimes on his own, Mr. Hoadley went to the Naval Research Laboratories at Anacostia, D.C., as a radio engineer. Was engaged on pre-Pearl Harbor radar research, later studied captured enemy equipment and ran tests on Navy gear.



Went to the Bryant Chucking Co. of Springfield, Vermont, as Electronics Engineer, in 1943. At completion of the project on which he was engaged, he accepted a position with the Raytheon Manufacturing Co. of Waltham, Mass., as engineer on design and development of radar apparatus.

Started radio writing while at Springfield, Vt. Still spends most of his waking hours in his radio laboratory. Engaged at present in high-fidelity reproduction of music.

is returned to point B, then a hum voltage may be placed in series with the grid of the second tube. Even though this voltage is in the order of .01 volts or smaller, if that tube is a pentode with an amplification of several hundred followed by several more amplifier stages, as in a micro-

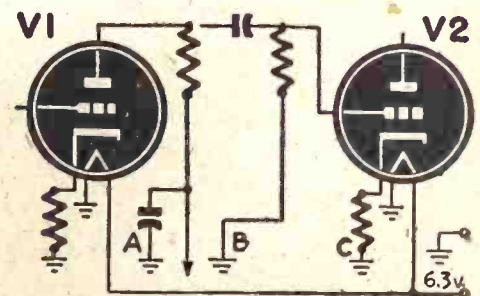

Fig. 2—Effect of voltage drops on a chassis.

phone amplifier, then this hum voltage can be very appreciable.

In high-gain stages, incidentally, hum
(Continued on page 355)

PPM-NEW TECHNIQUE

Pulse Position Modulation—Radio of the Future

A COMPLETELY new radio signaling system—Pulse Position Modulation—opens up new vistas in both voice and telegraph communication. Differing from AM and FM, it permits multiplexing on a single beam; up to eight channels are being handled simultaneously by one transmitter.

Pulse position modulation, it was revealed recently by Bell Telephone Laboratories who developed the system, was the principle underlying the famous AN/TRC-6 relay radio communications system, used with telling success in the last months of the European war. (An earlier Army radio relay set-up, the AN/TRC-4, which was a frequency-modulated job, was described as far as security restrictions would permit in the May, 1945 issue of *Radio-Craft*.)

A different pulse-position multiplex communications system was described in the December issue. That method requires special cathode-ray tubes to perform the intricate switching operations. The Bell system—constructed for combat service—uses standard cheap receiver-type tubes for all but the final U.H.F. transmitter and receiver converter tubes. These two are velocity-modulated types, similar to the Kly-

strons already described in more than one article.

Pulse-position modulation cannot be classed with either AM or FM, though it resembles the latter type of modulation more closely. Abandoning the carrier wave entirely, PPM carries intelligence on a series of short, sharp, radar-like pulses. In the AN/TRC-6, these are, first a "marker" 4 microseconds in length, followed by eight 1-microsecond pulses. The sequence is repeated 8,000 times a second, making each series, or "frame" occupy a time period of 125 microseconds, as shown in Fig. 1. Thus each of the 1-microsecond pulses is in the center of a 15-microsecond period, or "channel."

Modulation causes the pulse to occur earlier or later than the middle of the time period allotted to it. If a positive voltage at voice frequency is applied, the pulse will be delayed slightly. If the signal is negative, the pulse will occur before the middle of its time period. The degree of delay or acceleration depends on the amplitude of the voice (or other) signal. Limiting circuits prevent the pulse signal from swinging over more than 12 microseconds of its 15-microsecond space, thus preventing interference with the next channel.

At the receiver end, circuits timed by the "marker" measure the time difference between the start of a modulated pulse and the time it would start if it were unmodulated. Translating

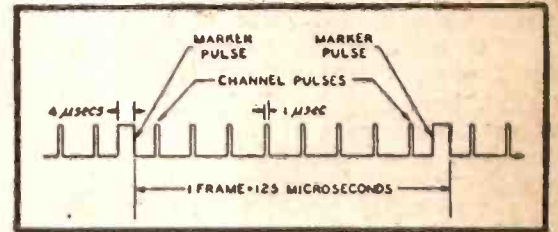

Fig. 1—Frame of PPM time-division signals. that time difference back into signal amplitude, the original voice frequencies are reconstructed.

All eight pulses could be used to handle one transmission, but experience has shown that it is not necessary. A "sampling" of the signal eight thousand times per second by the pulses of one channel is sufficient to transmit voice signals clearly and with excellent telephone quality. Each of the other seven pulses per frame can carry its own transmission.

SIMPLIFIED OUTLINE

A simplified block diagram is shown in Fig. 2. Heart of the circuit is the 8-kilocycle oscillator which originates the marker pulse and triggers the eight channel circuits. Its output goes to the marker generator and marker amplifier to produce the 4-microsecond marker pulse. Meanwhile the oscillator clipper has triggered the channel 8 position modulator, action of which will be considered later. Phone signals from the voice frequency amplifier vary the pulse's position according to the amplitude of the voice signal. It is then passed through a clipper, which ensures that all pulses shall be of the same amplitude, and then is introduced into the main line. There it is further amplified, with the marker pulse (and the seven other channel pulses) through two more video amplifier stages before being introduced to the transmitter unit, mounted behind the parabolic reflectors of the antenna.

The signal is amplified through two more stages in the transmitter unit, then introduced to the modulator. This tube supplies heavy pulses of power to the velocity-modulated oscillator, which oscillates only when these pulses are applied to it. Since the pulses take up a very small part of the total time (about 12 out of the 125 microseconds in each frame) exceptionally heavy sig-



Rear view of three parabolic antennas on roof of the Telephone Building, New York City.

nals can be put out with low average power, as in radar transmitters.

The position modulator is the unit which actually converts speech-actuated voltages to changes in pulse position. It consists of a multivibrator and a pulse generator. The multivibrator consists of the two halves of a 6SL7-GT (V 52 A and B), so biased that free oscillation without outside excitation is impossible. It thus tends to act as an electronic switch. The two cathodes are connected together and grounded through R286 (Fig. 3). Grid of the second section is connected to 300 volts through resistors R284 and R278, and the plate direct to the 300-volt lead. (Resistor and condenser numbers are from the Bell Laboratories blueprints.) Because of the positive grid, this section of the tube draws a heavy current, biasing the cathodes about 50 volts positive because of the heavy current through R286 to ground. Grid of the tube's first section is biased about 35 volts positive with respect to ground by the voltage divider system R270, 378 and 288. It is therefore 15 volts more negative than its own cathode, a bias beyond cut-off for this tube.

Application of the excitation pulse from the oscillator clipper drives the first-section grid far enough positive to permit the tube to pass current. The resulting increased voltage drop across R266 and P8 now causes the plate voltage to drop rapidly, applying a negative voltage to the second section's grid through coupling condenser C120. Plate current of the second section is accordingly reduced and the voltage drop across the cathode resistor R286 falls, reducing negative bias on the first section of the tube, thus permitting it to carry current even after the initiating pulse has ceased.

Current continues to flow in the first section of the multivibrator tube until the second section grid becomes sufficiently positive to bring the voltage across the cathode up to a point which cuts off the first section. When the first section cuts off, the tube goes back to its original condition with the characteristic suddenness of a multivibrator.

The second section's grid is connected directly to the grid of another 6SL7-GT section, V53B, the pulse generator. During "normal" condition of the multivibrator, this tube draws a small current through the 2.2-megohm resistor (R280) in its plate circuit, due to its positive grid voltage. When the second section of the multivibrator is triggered by the initiating pulse from the oscillator clipper, current flow in the pulse generator tube is cut off and rising plate voltage charges the plate blocking condenser (C126). When multivibrator conditions reverse, the plate voltage drops suddenly as a surge of current passes through the tube. A pulse appears in the output circuit, the exact instant of which depends on the instant of the multivibrator's reversal to "normal." The inductance L₁, which is common to four channels, together with tube and wiring capacity, fixes the pulse length at about one microsecond.

The instant at which the reversal

takes place is dependent on a number of factors, most important of which is the potential applied to the grid circuit of the second section through resistors

R278 and R284. Since R278 is also in the voice amplifier plate circuit, instantaneous voltage at the junction of R278 and (Continued on page 348)

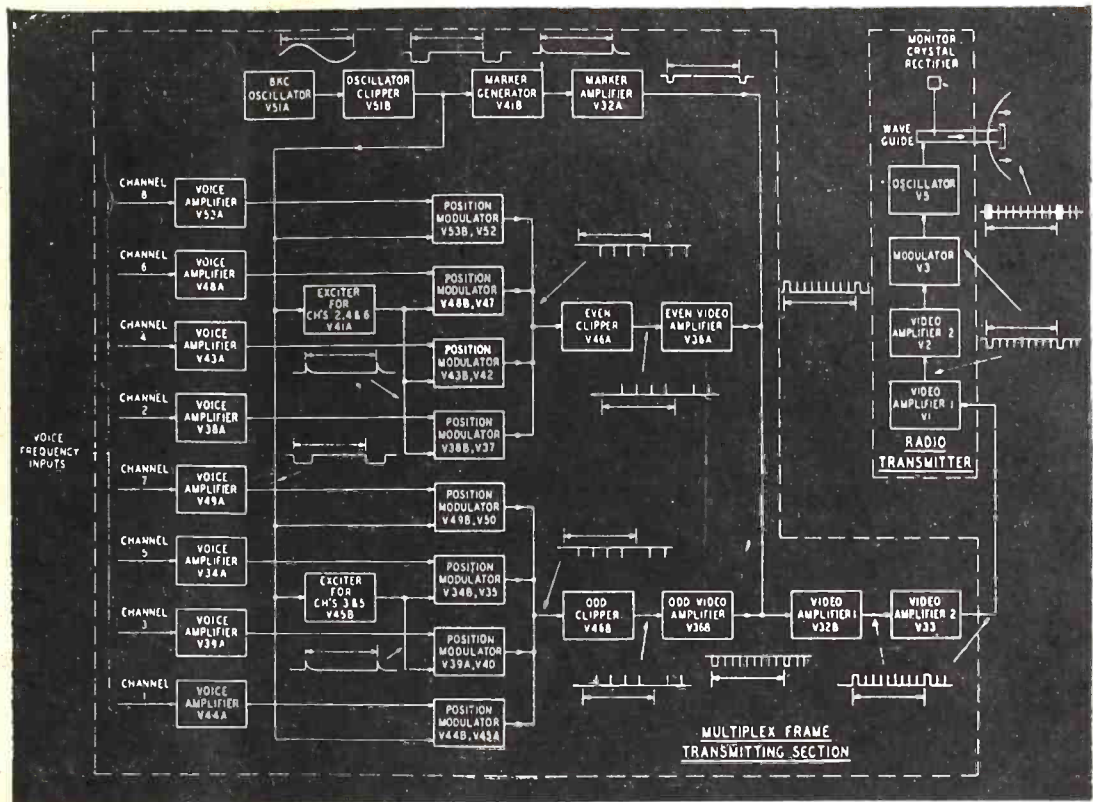

Fig. 2—Complete block diagram of the transmitter circuits, from voice input to antenna.

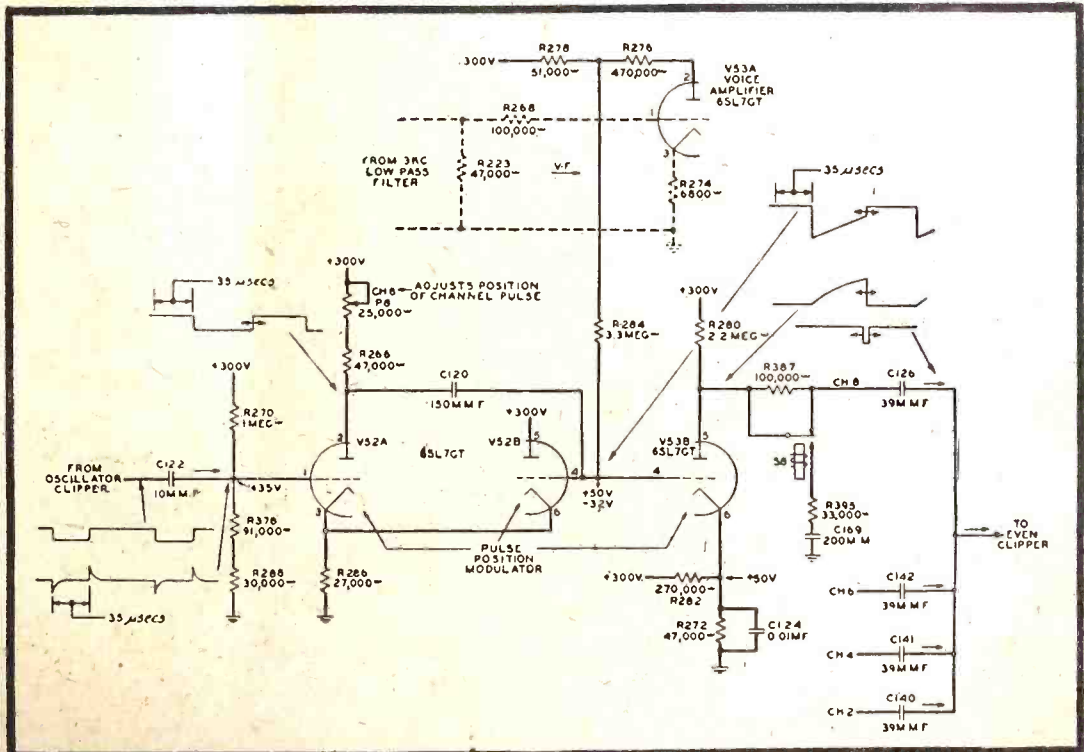

Fig. 3—The eight position modulators change voice variations to changes in pulse position.

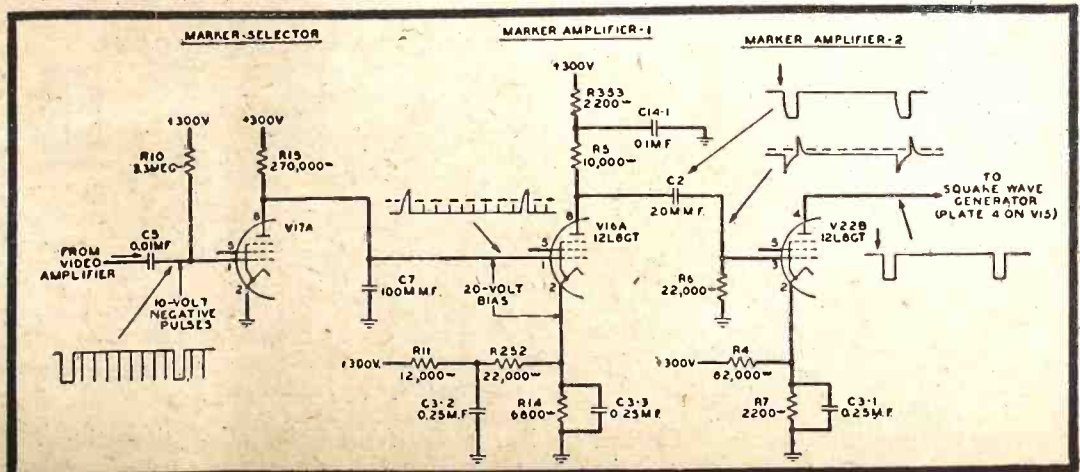

Fig. 4—Marker selector and amplifier which triggers the receiver circuits into action.

BRIDGED-T CIRCUIT

Pointing Out Possibilities of This Useful Circuit and Describing a Self-Powered Two-Tube Unit

THE Bridged-T circuit has been placed upon a shelf and almost entirely cast aside by the home experimenter, Ham, serviceman and design engineer, because of its seeming complexity. In reality, this circuit is very easy to handle, and may be applied with little difficulty by anyone with a little radio knowledge.

The Bridged-T is actually an R-C filter network, and when employed as shown in Fig. 1, will attenuate or suppress only one frequency. In other words, if we knew that several widely separated frequencies were present in the plate circuit V_1 Fig. 1, we could by choosing the proper values of the Bridged-T following V_1 , suppress any one of those frequencies. All other frequencies would appear at the output of the Bridged-T (grid circuit of V_2 Fig. 1). The circuit as shown in Fig. 1 is applicable as a scratch filter in high- or low-fidelity phonographs, and as a "whistle

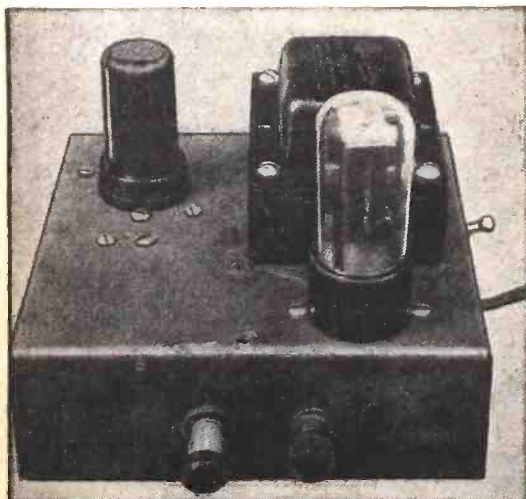

Bridged-T filter with self-contained power supply, as constructed for the author's use.

eliminator" in high-fidelity, wide-band broadcast receivers. The whistle or heterodyne phenomenon is caused by two stations in adjacent channels beating with each other and giving rise to a high frequency audio note. The scratch noises and whistles are subdued by choosing the components of the Bridged-T to suppress 10,000 cycles. Frequencies much above 10,000 cycles are generally not reproduced by even good phonographs or broadcast receivers, and therefore noise in this portion of the spectrum is not our concern. The values of R and C for some very common frequencies are shown at the end of this article; also the mechanics of computation for a 2,000-cycle filter. For frequencies other than indicated, component values may be chosen and substituted in the formula for computation of the 2,000 cycle filter.

The great advantage in using an R-C network of this type is that no bulky and expensive iron-core inductances are necessary as in many of the more common

frequency-discriminating circuits and filters.

When the Bridged-T is applied as shown in Fig. 2 an interesting phenomenon takes place. The tube V_2 will amplify only one frequency. In other words the circuit becomes a selective amplifier and rejects all but that one frequency. The constants and frequencies shown in the table below may be substituted for R and C in Fig. 2

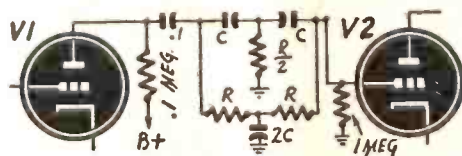

Fig. 1—A standard bridged-T filter circuit.

and the desired amplifier characteristics obtained. Thus, if a selective amplifier is required in a CW receiver for code reception to cut down static, noise and interfering signals, a Bridged-T may be employed. Most CW signals sound best to the ear when heterodyned to give a 1,000-cycle beat-note. A selective amplifier operating at 1,000 cycles will permit only one signal to pass through and suppress any other signal producing heterodyne notes of a higher or lower frequency than 1,000 cycles. Naturally, static and noise are also considerably reduced, as this type of interference is generally high-frequency audio and much above 1,000 cycles.

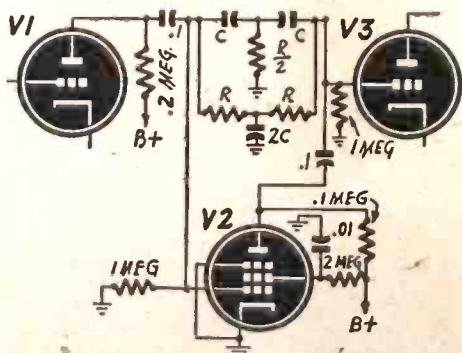

Fig. 2—This circuit passes one frequency.

R AND C FOR COMMON FREQUENCIES				
Cycles	C-mfd	R-ohms	2C-mfd	R/2-ohms
60	.005	530,000	.01	265,000
120	.005	265,000	.01	133,000
400	.001	398,000	.002	199,000
1,000	.0005	318,000	.001	159,000
5,000	.00025	127,000	.0005	635,000
10,000	.0001	159,000	.0002	79,500

All tolerances should be held within 5%.

The basic formula is:

- (1) $f = \frac{1}{2\pi RC}$;
- or solving for R:
- (2) $R = \frac{1}{2\pi fC}$;
- F = frequency in cycles
- R = resistance in ohms
- C = capacity in farads
- $2\pi = 6.28$

For audio frequencies other than those shown in the table and falling between 60 and 10,000 cycles, "C" is chosen as the

value corresponding to the next highest frequency. This value of "C" is substituted in formula (2) and "R" obtained.

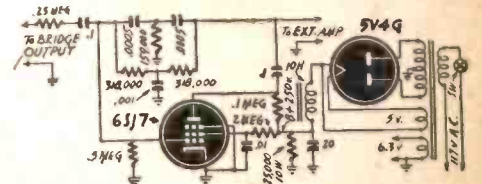

Schematic of equipment shown in photograph.

Let us suppose that it is necessary to have the filter operate at 2000 cycles. The next highest frequency above 2000 is 5000 cycles. The value of "C" corresponding to 5000 cycles is .00025 MFD., and is substituted as shown below:

$$R = \frac{1}{(6.28)(2000)(.00025 [10]^{-6})}$$

Therefore

$$\begin{aligned} R &= 318K\Omega \text{ approx} \\ C &= .00025 \\ R/2 &= 159K\Omega \\ 2C &= .0005 \text{ MFD.} \end{aligned}$$

The foregoing represent only a few of the many uses of the Bridged-T. The author constructed the Bridged-T selective amplifier shown in the photograph.

Excellent results were obtained when it was used in conjunction with a capacity and inductance bridge, to suppress the harmonics of the internal 1,000 cycle mechanical vibrator.

Other applications would call for changes in the R and C constants of the circuit to meet the special conditions of the given job. Used for phonograph scratch filter, as suggested earlier in the article, these constants might be adjusted to 5000 cycles or slightly higher. At 10,000 cycles, as stated previously, the circuit might be used to cut out 10-Kc. beat notes between adjacent broadcast stations. An item on a bridged-T circuit as a simple 10-Kc. filter appeared in the June, 1945, issue of *Radio-Craft* on page 585. This circuit, a coil-condenser-resistor combination without a tube, is not as adaptable as those described here, as the tube's amplification compensates for the insertion loss otherwise experienced when a filter is placed in any circuit.

The writer has not attempted to work with a bridged-T circuit having a variable resistor, though the idea immediately suggests itself in connection with many kinds of experimental work. A unit could also be constructed which could be switched from a "rejector" to an "acceptor" circuit, thus making it more versatile for use in the home laboratory or shop.

It is hoped that this article will direct the attention of the technician to the many possibilities of the Bridged-T circuit, as well as to the ease of designing and constructing it.

ELEMENTS OF RADAR

Part III—Radar Receivers and Indicators

ECHO signals from distant objects or surfaces are characteristically weak, because targets reflect or reradiate echoes in all directions. Only a relatively few succeed in returning to the radar set. For this reason the radar receiver must be extremely sensitive, providing considerable amplification. The superheterodyne is admirably suited for radar.

At lower u-h-f carriers, the superhet circuit resembles any typical u-h-f communications receiver (Fig. 1) with the important addition of a large number of I.F. amplifier stages and a video or wide-band amplifier in the output stage.

Referring to the upper block diagram (Fig. 1), the incoming signal from the antenna system is amplified by one or two stages before being mixed with a locally generated signal. Intermediate frequencies on the order of 30 megacycles are used, and the I.F. stages designed to pass a band of frequencies about two to three megacycles in width. Since reception is of the double-sideband variety, passage of video frequencies up to about one megacycle is permitted. Combined stages of I.F. amplification supply a maximum gain of 100 to 150 db. The video amplifier will also pass an equally wide—or sometimes wider—band of frequencies to preserve the shape of the radar echo. The cathode follower is merely an impedance-matching device for coupling to the radar indicator.

As the u-h-f operating frequency is increased, however, the superhet circuit undergoes considerable change. (Fig. 1).

Direct amplification of the received echo is impossible when operating in the microwave region, and R.F. amplifier stages must be omitted. The signal is fed directly to a sensitive mixer stage. There the echo signal is combined with

a locally generated signal, mixed in the cavity of a resonant chamber, and an intermediate frequency (the difference frequency) extracted through a crystal.

A Klystron tube (Sperry) is the best type of local oscillator. With a suitable cavity resonator, this velocity-modulated tube can generate any desired frequency. The output power of the Klystron is very low, however, precluding its use as an R.F. oscillator in the radar transmitter. As a local oscillator, the Klystron is unexcelled.

The use of a crystal and resonant cavity as a mixer is required because of its fairly high efficiency when compared with any other type of mixer. For microwave operation, it surpasses even the diode.

After several stages of I.F. amplification, radar receivers may reconvert to a second, lower intermediate frequency by means of a second mixer stage. Such a mixer is of the more conventional diode type. Further amplification of the new intermediate frequency follows. Finally the signal is detected, and the video impulses amplified by one or two stages of wide-band amplification.

Microwave receivers require other special considerations. Chief among these are: shortness of leads, and careful shielding of every stage of the receiver.

SUPERREGENERATORS

Radar sets of small size, designed for extreme mobility, may use a much simpler circuit: the superregenerative receiver (Fig. 2).

This is a variant of the familiar regenerative receiver, with a means provided to throw the detector in and out of oscillation. Frequency of this quench voltage is usually between 50,000 and 250,000 times per second, and permits a considerable increase in the sensitivity of the detector.

When no signal is being received, the usual hiss of regeneration is greatly amplified. Hissing then diminishes in proportion to the strength of the received signal, strong signals eliminating the regenerative hiss completely.

The frequency of oscillator interruption causes a voltage variation on the plate of the detector. Receivers of this type require adequate shielding to prevent radiation into other components of the radar set and consequent harmonic distortion of both radar pulse and received echo.

VIDEO AMPLIFICATION

Energizing voltages of from 50 to 250 volts (peak) with a band-width of from two to three megacycles are required by the indicator of a radar set.

It is the responsibility of the video amplifier of the receiver to supply such a signal.

(Continued on following page)

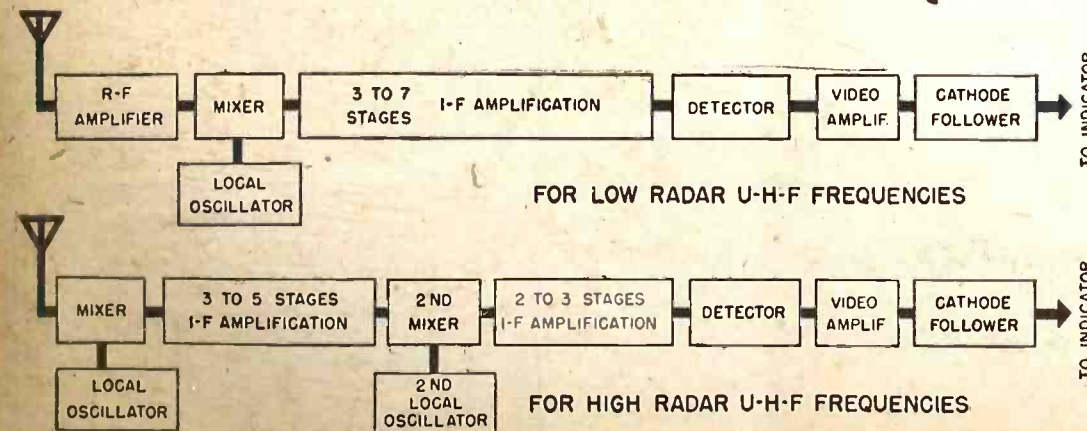
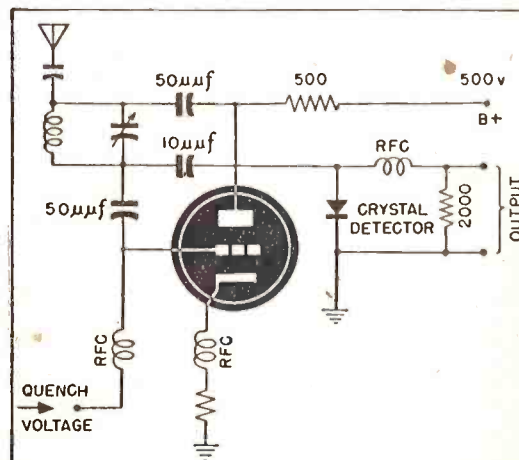
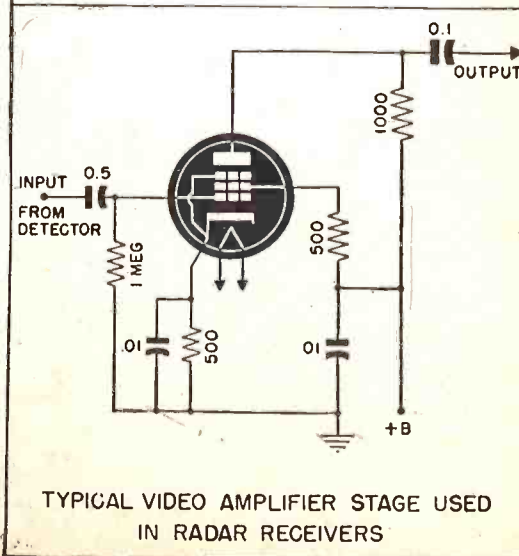

Fig. 1—Block diagram of two typical receivers, for "low" and "high" radar frequencies.



TYPICAL SUPERREGENERATIVE RECEIVER FOR RADAR ECHOES



TYPICAL VIDEO AMPLIFIER STAGE USED IN RADAR RECEIVERS

Fig. 2, Top—The Superregenerative receiver. Fig. 3, Bottom—Typical video amplifier stage.

One or two stages of video amplification can be used, each stage having an almost-flat gain response over the entire range of frequency operation. Gain of each stage is from 30 to 50 db.

Unlike audio-frequency amplifiers, the video amplifier must be free from phase distortion. This would result in a distorted pulse detail, rendering the echo unuseful.

A typical video amplifier circuit is shown in Fig. 3. The circuit operates as a distortionless Class A voltage amplifier, using resistance coupling. Each stage uses a high-gain pentode—such as the 6SH7, 6AC7, or 6SJ7 types. The video output is usually coupled to a cathode follower stage.

Some video circuits require filters or other compensating devices to insure a uniformly flat frequency response.

Plate and grid leads of pentodes must be kept short as possible. Grid coupling condensers should have a very small capacitance to ground.

The output signal from the radar receiver may be either a positive- or negative-going impulse. The type of cathode ray oscilloscope used in a radar set normally does not influence the shape of the video output from the receiver.

Although the T/R switch protects the radar receiver from the violent power surges of the transmitter, a very small signal—known as the “transmitter pulse”—is allowed to filter through the receiver circuits each time the radar transmitter functions. This signal is allowed to reach the indicator and registers at the start of the base line on the oscilloscope, providing a reference point from which to measure distance along the linear time base.

To prevent serious overloading of the receiver circuits by this “transmitter pulse,” a blocking or *gating* signal is sometimes applied to the I.F. stages of the receiver during the time the transmitter is pulsing. This blocking signal de-sensitizes these stages. But when it is removed, the I.F. stages operate in the normal manner.

Echo information collected by the radar receiver is displayed visually by the indicator—final link in the radar echo-detection system.

The cathode ray oscilloscope is ideal for the presentation of radar data, because it not only shows a variation of a single quantity such as voltage, but also gives an indication of the relative values of two or more synchronized variations.

There are two general kinds of radar

oscilloscopes: (1) the deflection type, and (2) the intensity-modulated type.

DEFLECTION-TYPE INDICATOR

Simplest radar indicator—the deflection type—uses a cathode ray tube with electrostatic plates (Fig. 4). The tube is employed much in the manner of a conventional low-frequency test oscilloscope. Most of the controls are somewhat similar.

A saw-tooth voltage (Fig. 5) applied to the horizontal deflecting plates establishes a linear, horizontal base line. This permits a rectilinear calibration of the screen of the cathode ray tube. The total length of the time base on the screen bears no direct relationship to the time scale.

Periodicity of the saw-tooth wave is determined by the pulse recurrence frequency or p-r-f of the synchronizer. The base line is retraced each time a radar pulse is radiated into space by the radar transmitter.

Video signals from the receiver are applied to the vertical deflecting plates of the oscilloscope, and cause actual deflections or interruptions of the base line proportional to the strength of the received echo. The scope screen can be calibrated according to any given range. Sets used for long-range reporting have scales as high as 100, 150, or 250 miles. Short-range radar sets can measure targets only up to a few thousand yards. The slope of the saw-tooth wave (Fig. 5) determines the rate of speed of the sweep and therefore the range.

There are many variations of the straight-line time base (Fig. 6). For greater accuracy, a circular time base may be used—with range measurements computed from a given starting point on the circular sweep.

A vertical base line requires only the complete turning of the cathode ray tube through 90 degrees.

There are other variations. But all depend upon a *deflection* of the electron beam to cause a deflection or interruption of the time base.

INTENSITY-MODULATION

Another type of indicator causes the appearance of echo signals by an entirely different electronic means.

An electromagnetic type of cathode ray tube is generally used for this kind of radar indicator. In such tubes, the deflection plates of the electrostatic tube (Fig. 4) are replaced by one or two pairs of coils, wound around the neck of the tube.

Currents passing through the coils establish a measuring pattern on the scope of the screen, much like a television raster. A saw-tooth wave of *current* applied to one pair of coils causes a linear movement of the electron beam in one plane. And a synchronizing current applied to the second pair of coils causes movement of the beam in a second plane.

Echo signals from the radar receiver are applied to this measuring screen by means of intensity modulation. If the video signals are negative-going, they are applied to the grid of the tube—resulting in an intensification of the beam: a brilliant spot of light on the screen of the tube. If the video signals are positive-going, they are applied to the cathode of the tube—with identical results.

Use of intensity-modulated indicators permits measurement of more than just one quantity on a single cathode ray tube.

For instance, such a tube could measure range *and* azimuth—since the latter direction could be indicated by currents flowing through one of the two pairs of magnetic coils.

One such type of tube is known as the PPI—or plan position indicator. The time base actually begins at the center of the scope screen and moves outward radially in a direction corresponding to the position of the radar antenna. Time base and antenna are synchronized, thus giving immediate direction in azimuth. Returning echoes intensity-modulate the electron beam, and appear on the

(Continued on page 337)

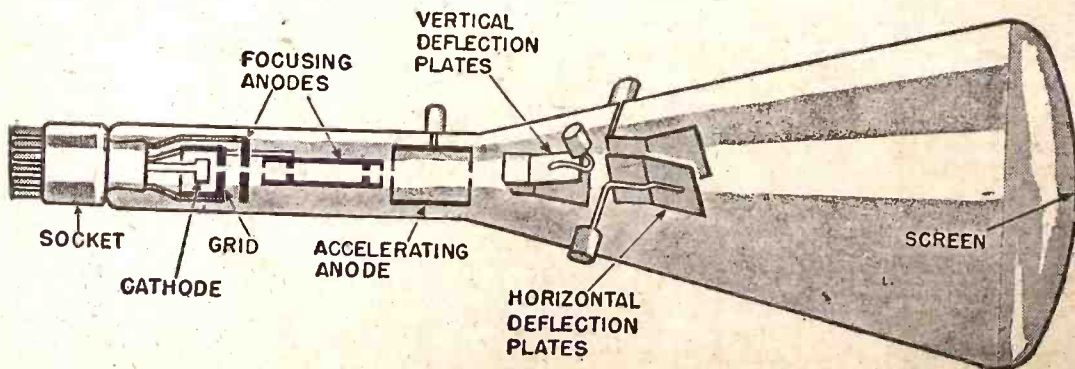

Fig. 4, above—Typical electrostatic cathode-ray tube such as is used for radar indicators.

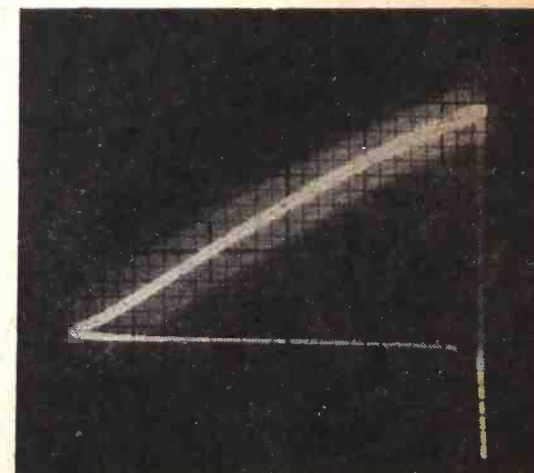

Fig. 5—Sawtooth sweep voltage on C-R screen.

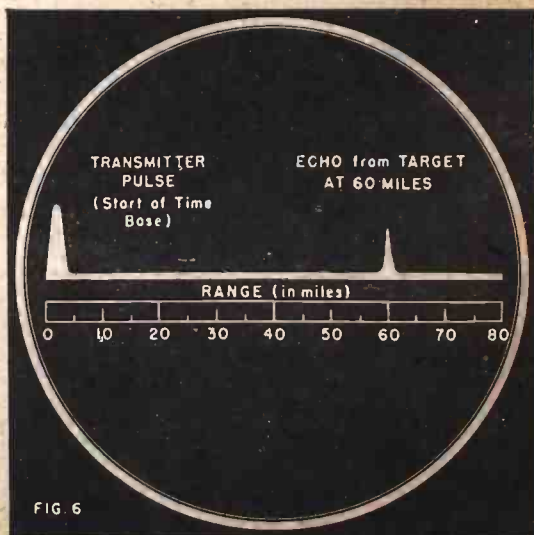

FIG. 6

Echo on straight time base of radar screen.

144-MC TRANSMITTER

This Low-Power Unit Gives Excellent Results

THE former 112 mc. and the present 146 mc. bands are unique, at least in the widely divergent opinions expressed about them.

On 2½ meters we met many fellows who were wondering why they ever invested time and money on a band which they claimed produced far inferior results to those obtainable on a local telephone call. On the other hand, others were obtaining very satisfactory and even (relatively) spectacular results with apparatus similar to that used by

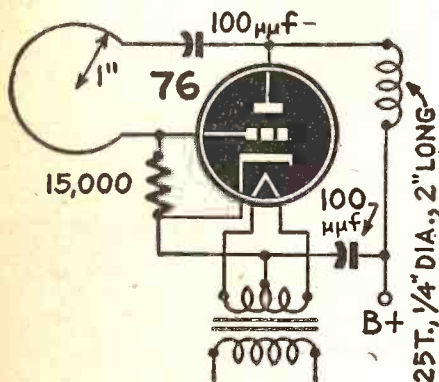

Fig. 1—A simple circuit with 76-type tube. the disgruntled hams. We found that in many cases the last named had at least average VHF locations (good height, radiator space, etc.).

Now that the 2-meter band has been open for a little while, the same difference of opinion exists. We hear (both over the air and through personal QSO) that the new band is far more effective with regard to distance than the former one. Others who worked the band for some weeks have moved to other bands, many vowing never to return!

In our opinion, the 2-meter band is definitely more limited than 2½ was, at least at W1HCO/2. Many stations contacted on 112 just do not have the same

pep now and others cannot be heard at all. Theoretically, of course, the higher frequencies should have a shorter range. Note that the record for 1¼ meters is far less than half that of 2½!

In our opinion, height, which was important before, becomes even more so now. The importance of height over power output was well demonstrated last month when W4IFW, operating portable-airborne near Philadelphia, was heard R9 in the New York-New Jersey area. Using eight watts above 6000 feet, his clear signals easily out-classed many higher power local stations. Needless to say, the appearance of his signals created as much commotion as would the sudden appearance of a full-grown whale among a group of sardine fishermen.

VHF TRANSMITTERS

Not many tubes oscillate efficiently below 5 meters. This does not mean that ordinary receiving type tubes cannot be used. Many QSO's have been completed here with a rig using two 6V6G's in push-pull with 325 volts on plates and screens. With 18 watts input on 2½ the output was approximately 4 watts (and slightly less on 2 meters). Metal types and GT tubes are more efficient since they possess smaller capacitance and shorter leads.

Postwar tubes may be more adaptable to v.h.f. than any obtainable at present.

Experiments carried on here show that a triode of the 76 or similar type generates almost 1.5 watts of power with little

coaxing. We apply 300 volts to the plate, obtaining about 20 Ma. plate current when the load is applied, at 146 mc. The tubes seem to take it well. See Fig. 1.

Lower power (with greater efficiency) is possible with a 955 type tube. With a plate voltage of 180 and a current of about 7 Ma., the output is approximately one-half watt.

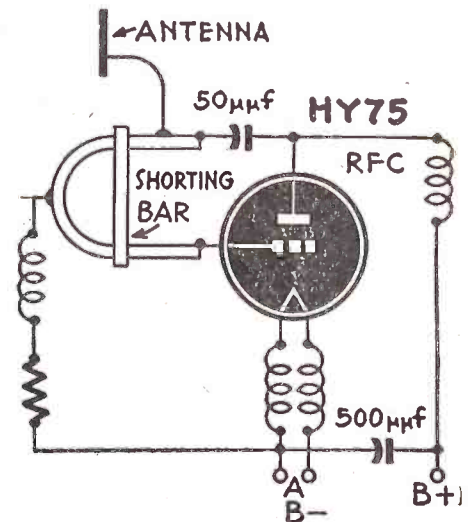
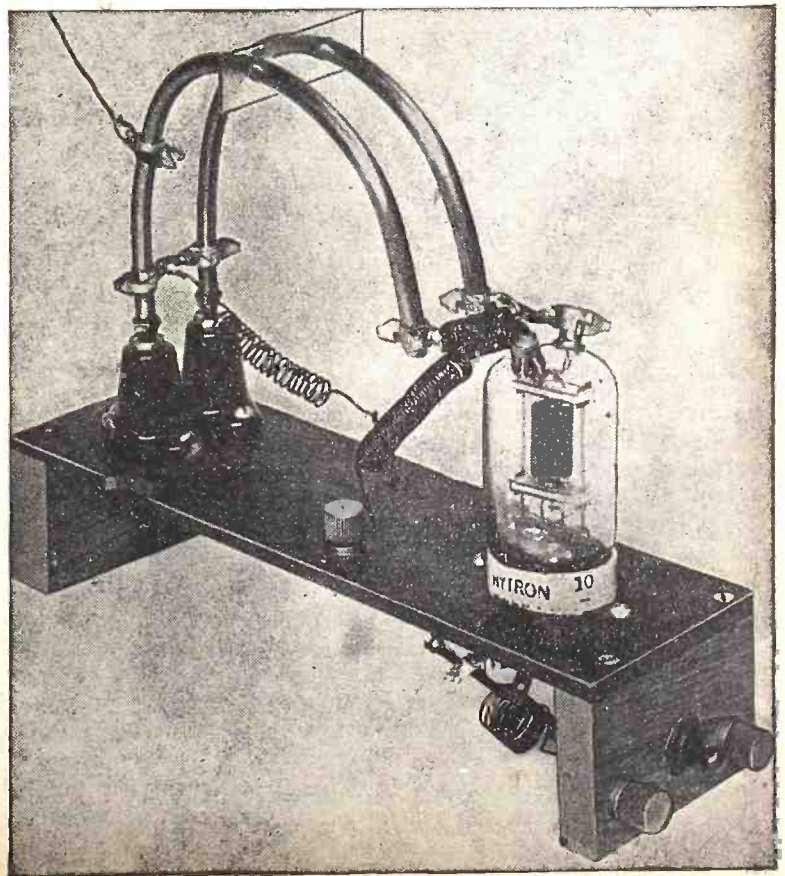

Fig. 2—An efficient long-lines transmitter.

An efficient rig using an HY75 is shown in Fig. 2. This rig is used at W1HCO/2 for low-power work and is operating satisfactorily. This tube pro-

(Continued on page 362)

Right—The tuned-line 144-mc. transmitter. Below W1HCO/2. The unit at rear contains speech and audio amplifiers as well as power supply.



DECIBEL PROBLEMS

Explanation of a subject which often puzzles

UNDERSTANDING the various uses of the decibel is not at all difficult, even though the beginner is often nonplussed at the extremely complicated formulae generally used in expressing ratios of sound. These same formulae may be expressed in simple everyday terms so that even the non-technical reader may grasp a working knowledge of them.

First, we all know what sound is. From the moment of birth we were conscious of sound and its pleasant effects upon us. Later, in school we learned that tone is the difference between music and noise; pitch is the difference between various keys in the musical scale; and an octave is a *multiple* or *sub-multiple* of a certain pitch.

Pitch	-2	-1	0	1	2	3	4
Octaves							
Freq. (cps)	64	128	256	512	1024	2048	4096

Add one octave to double frequency

Fig. 1—Octaves express pitch in logarithms.

This means that in order to go an octave *above* any pitch, the frequency of the original pitch must be *doubled*; to *drop* the pitch one octave, the frequency must be *divided* by two. Thus 4000 cycles (per second) is one octave *above* 2000 cycles, and 400 cycles is one octave *below* 800 cycles.

The pitch scale is shown in Fig. 1. In this diagram, figures above the vertical lines represent octaves of the physical pitch of C, and the figures below are the corresponding frequencies.

THE DECIBEL SCALE

With the advent of the telephone, and later radio and its numerous applications, came the necessity of measuring accurately the levels and various power ratios of sound energy. Since the human ear is much more sensitive to changes in sound at *low* than at *high* levels, all means of expressing sound changes and ratios electrically must be made in the same manner. A standard unit called the Bel was introduced by sound transmission engineers for these measurements. The Bel, however, proved to be rather unwieldy for small ratios of sound and so a more suitable unit, the *Decibel* (one-tenth Bel) was adopted. Since one Bel (10 Db) indicates an amplification by 10, two Bels (20 Db) mean an amplification by 100 and three Bels (30 Db) mean amplification by 1000.

The decibel scale shown in Fig. 2 is similar to the pitch scale except that its major steps represent changes by a fac-

tor of 10 instead of 2 and its basis is power in watts instead of frequency in cycles. To go up the scale by 10 Db, the power must be multiplied by 10; to go 10 Db further, the power is again multiplied by 10. We now have gone up the scale 20 Db and the power is 10 x 10 or 100 times what we started with. To go down 10 Db the power is divided by 10.

Another convenient step found on the Db scale is 3 Db. To go up 3 Db means to *double* the power; to go down 3 Db the power is divided by 2.

The clue to the rest of the scale is found in the definition: The Bel is equal to an amplification by 10. One Db, then, is a step which, taken 10 times, will multiply the original power by 10. This requirement sets the value of 1 Db as a power ratio of 1.26. In other words, the addition of 1 Db multiplies the original power by 1.26. This ratio can be proved as follows: Start with 1 watt, for example, and increase this power by 1 Db or $1 \times 1.26 = 1.26$ watts. Increasing again by 1 Db, $1.26 \times 1.26 = 1.588$ watts. Increasing the third time by 1 Db, $1.26 \times 1.588 = 2.0$ watts. (Note that we have made 3 one-Db steps and have doubled the power). Increase by three more one-Db steps, a total of 6 Db, and we have $2 \times 2 = 4$ watts. Again increase by 3 Db, a total of 9 Db, and we have $2 \times 4 = 8$ watts. Now increase by 1 Db to make the total increase 10 Db and we have $1.26 \times 8 = 10$ watts, or 10 times the original power.

There we have the decibel unit, and that's about all there is to it. The Db is a unit for expressing a change in *power*. This it does on a *relative* basis

Decibels	-10	0	3	7	10	20	30
Watts	.0006	.006	.012	.03	.06	0.6	6.0

Add 10 Db and power is multiplied by 10

Fig. 2—Watts versus decibels. Not to scale.

so that a 1 Db change is always a change of approximately 26% regardless of the power we start with. A tenth of a watt is a big change if we had only .1 watt to start with, but .1 watt added to 25 watts would be hardly worth bothering with. A change of 1 Db, however, is the same *relative* size change for any value of power, 26% for .1 watt or 26% for 25 watts.

If you have been interested only in knowing what the decibel is, stop here! For a review of the uses and rules for applying this unit, the following should serve for the practical man. For the mathematician who likes these things

served up rich in complicated formulae, study of some of the classical treatises on the subject is suggested, such treatment being beyond the purposes of this paper.

IMPORTANCE OF RATIOS

The ratio of one number to another is the *first* number divided by the *second* number, as, for example, the ratio of 10 to 5 is $10/5 = 2$. The ratio of 5 to 10 is $5/10 = .5$, and the ratio of W_2 to W_1 is W_2/W_1 .

The ratio of the output voltage of an amplifier to the input voltage is constant. For instance, in a certain ampli-

John B. Ledbetter was born at Hugo, Oklahoma, June 4, 1917. Started in radio service and obtained amateur license (W5FFI) in 1934.

Later specialized in public address and sound equipment and maintenance of U.H.F. communications equipment.

Obtained Radiotelephone First Class License in 1941 and joined WRK, Dallas as transmitter and maintenance engineer. Later joined KFJZ, Ft. Worth, as transmitter-studio engineer and in 1942 assumed present duties of studio-field-recording engineer with WKRC, Cincinnati.

Hobbies—Amateur radio, crossword puzzles, writing. Associate member I. R. E., member ARRL. Present ambition is to stop spare-time work on aircraft radio and B. C. receivers long enough to build a .5-Kw 10-6-2-meter portable-mobile rig.



fier an input of one volt becomes 5.6 volts at the output. Two volts input would result in 11.2 volts output, and 10 volts in would appear as 56 volts out. These ratios of output to input are $5.6/1 = 11.2/2 = 56/10$. The output of an amplifier bears a *constant* ratio to the input.

Let us say that another amplifier has a voltage ratio of 1.6. Then the combination of this amplifier with the one mentioned above would result in a ratio of 1.6×5.6 , or the *ratio* of an amplification system is the *product* of the *ratios* of its components.

The ratio is encountered in every phase of our work—even after the sound has emerged from the speakers and we listen to it. If we start with 1 microwatt (one-millionth watt) at the ear and increase it to 2 microwatts, we notice a small increase in loudness. Increase from 2 to 4, from 4 to 8, 8 to 16, etc., and the steps of loudness will be approximately the same. In these cases

(Continued on page 339)



By D. W. UHL

BLIND SERVICEMEN

THE blinded veteran and his future is one of the major problems of the Veterans Administration. Full of hopes and plans for the future, the handicapped GI is unwilling to settle down to rug making or basket weaving. He spurns these and other "traditional" occupations that are often forced on the blind. Like most of us, he wants what many think he can't have. He longs desperately to make his living in one of the normal professions of his sighted brethren.

That is why the Veterans Administration is enthusiastically welcoming the brain child of blind LaVon Peterson of Omaha, Nebraska—a radio engineering school for the blind. It is the only one in the world and was dubbed "impossible" before Mr. Peterson proved it could be done.

Mr. Peterson's Radio Engineering Institute teaches blinded veterans as well as other blind men to become independent radio servicemen; and even to become in many cases better servicemen than the average sighted shop owner.

The lineup of courses taught at the institute sounds like a college curriculum. It goes far beyond the usual instruction in ailing tubes and receivers. All the latest developments in radio and related fields are included. Training is given in both theory and operation of frequency modulation equipment, for instance. Even industrial electronics is taught.

The blind graduate will be able to build as well as service record players, record changers, home recorders, public address systems and push button sets.

The institute also offers a number of courses aimed at making the blind man an efficient shop keeper and business man. He gets a touch of elementary psychology in the course on "Selling Your Repair Work." Proper business methods are covered in bookkeeping, typewriting, keeping an inventory, and good business ethics. A special type of Braille, comparable to business English, teaches him to write down the complicated terms of his profession.

A BRAILLE MULTITESTER

The most important thing in the school, however, is a machine—a special multitester which makes a blind radio man the equal of his sighted colleagues. Like the multitester of the seeing radio service man, it measures voltages, traces current, etc. But Mr. Peterson's Braille Multitester goes

further. When attached to a conventional tube tester, it will record the relative strength of the tube tested.

Because its patent is still pending, Mr. Peterson is reluctant to reveal details of his invention. But here is the principle:

Inside and out of sight is the conventional dial of a multitester. A photoelectric cell reads this dial for the blind radio man. The operator swings a pointer on the face of the machine until he hears an audible signal. The sightless man then "reads" with his sensitive fingers the outside Braille dial.

The Braille Multitester is believed to be the only one in the world. It was developed and used successfully by Mr. Peterson in his own radio service shop. Each student will build his own before leaving the school.

The school at present is set up in the Omaha Y.M.C.A. in rented offices and laboratories. There is a side agreement for housing the institute's blind students at the Y. Thus it is made easier for them to get to classes. They also eat most of their meals in the Y dining room.

Students are from all sections of the country. For, in addition to the Veterans Administration, state rehabilitation agencies have expressed great interest in the school.

The idea for the Institute was planted in Mr. Peterson's mind eight years ago when he hung out his shingle as a radio service man. He refused to listen to teachers who said "It can't be done!" He had already gone too far by then to give up his passion for radio.

The earnest, red-haired young man with the determined chin and the eyes that had been blind since birth had got hold of the Braille Radio Amateur's Handbook. The book was well worn and dog-eared before young Peterson would give up trying to gain more information from it. He found a few more books, translated into Braille, which gave him a little more meager knowledge of radio.

Then he was stopped. He could find no more books on radio which he could read with his sensitive fingers. He went to teachers at the Idaho School for the Blind and told them his dream of becoming a radio serviceman. He asked for help.

They were kind. But they answered: "It is impossible." They told him sight was an absolute necessity for recognizing types of tubes, for reading dials, for handling the intricate apparatus of a repair man, for

1—Mr. Peterson's Braille Multitester in use.
2—Blinded servicemen use power machinery.
3—Some of the students working at the bench.
4—The soldering iron tip is located by "feel."

using a hot soldering iron. He listened but he was not convinced. There was no one who could teach him what he wanted to know. He determined to learn for himself. And he did.

He got some parts and began to learn them by touch. He pattered with old radios until he knew them inside out. Then he began his toughest job—soldering. "You'll burn yourself if you try to solder," his teachers had told him. They were right! He burned his hands repeatedly. But he finally learned a method of handling the hot iron. He gently fingers the spot to be soldered, bringing the iron ever closer. Then suddenly his fingers draw back and the iron comes down on the critical spot. Today he solders as efficiently as any sighted man. Professional radio men who can see are amazed at the smooth and workmanlike job he does.

Last came his idea for the Braille Multitester. That did it. He could do anything

(Continued on page 360)

REVAMPED TESTER

An Old High-Quality Instrument Is Put to Work

THE pre-war Model 90 Supreme Analyzer was and is a very fine instrument. It used an analyzer plug, (with various adapters) which was inserted into the receiver, the tube being placed in a socket in the analyzer, while the various readings were taken with the use of buttons.

It was also used as a multimeter tester. The meter has a very sensitive, 350 microampere movement, with a built-in rectifier.

The present day V-O-M does not use these plugs, some radio sets being so small as to make it impossible to replace the tube with the analyzer plug.

This revamped instrument is much smaller, because the sockets, buttons and analyzer plug have been eliminated.

All the original wire-wound resistors and shunts have been retained. The only new addition necessary was a four-gang eleven-position switch.

In the original instrument, the resistors and shunts, which were on individual spools, were mounted on a circular bakelite disc, which was secured to the meter, with additional holes provided to make connections to the meter terminals.

In the revamped instrument, these spools were mounted on a rectangular piece of bakelite, making the terminals of the meter more accessible.

Due to the peculiar arrangement of the connections within the meter, all readings are taken through the rectifier.

This arrangement, together with the 2000-ohm series resistor and the tapped shunt, acts as a protector of the sensitive movement, should the range switch be set in a wrong position.

There is no polarity on either of the probes. Both A.C. and D.C. readings can be taken with the same range switch and without the use of any special A.C.-D.C. switch.

There is a 3150-ohm resistor, incorporated in the meter, controlled by an A.C.-D.C. switch, but this is used only to make the A.C. readings linear with the scale. The difference in the reading, by using this switch is unimportant for servicing purposes. A.C. readings may be taken with the switch in the D.C. position as well as taking D.C. readings with the switch in the A.C. position.

For all voltage and current ranges, a tapped shunt is used across the meter, increasing the full scale current to 0-1 milliampere, resulting in a 1000 ohm-per-volt meter, on both A.C. and D.C. This tapped shunt is disconnected for all resistance measurements and the 350-microampere movement is taken advantage of, resulting in a 0-500,000 ohm reading with a self-contained 4½ volt battery.

This range can be easily increased to 0-5,000,000 ohms by the addition of a small 45-volt battery in series with a 150,000-ohm resistor.

As the current for a full-scale deflection is only one-third of a mil-

liampere both the 4½- and the 45-volt batteries should last a long time.

As the zero adjustor—used in resistance measurements—is a variable resistor across the movement, it should be in the OFF position when taking voltage and current readings. This is necessary because the original volt-resistance switch has been eliminated.

The low-ohm scale is a closed circuit in the 0-5000-ohm range. Resistance as small as a fraction of an ohm can easily be read.

A small chart can be glued to the cover of the instrument or the new values inked on the original scale, which is easily accessible.

As bakelite was difficult to obtain, I used the ½-inch pressed board, which was very easy to drill.

There was sufficient room in the instrument to use the larger flash-light batteries, which with normal use, should last at least a year. All the leads to the battery were soldered directly to the battery carbon and the zinc casing. The three cells were soldered in series.

The markings on the panel were easily made with white gummed paper. After the positions of the range switch was marked out, the words and figures were typed in, before pasting it into position on the panel.

Output readings can be taken without any changes of the switches, the ranges being the same as A.C. voltages. This

(Continued on page 345)

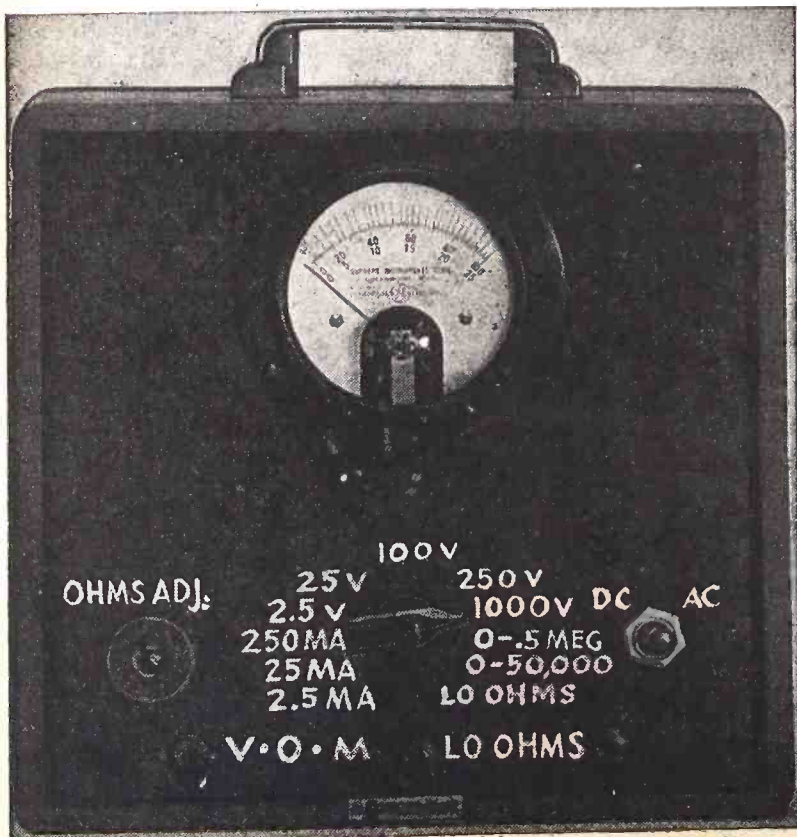

Left—The multitester in a compact case. It will be noted that only three terminals and one switch—for A.C. and D.C.—other than the gang are needed for a large number of checks. Below—Schematic of the reconstructed tester showing parts values, also switch positions.

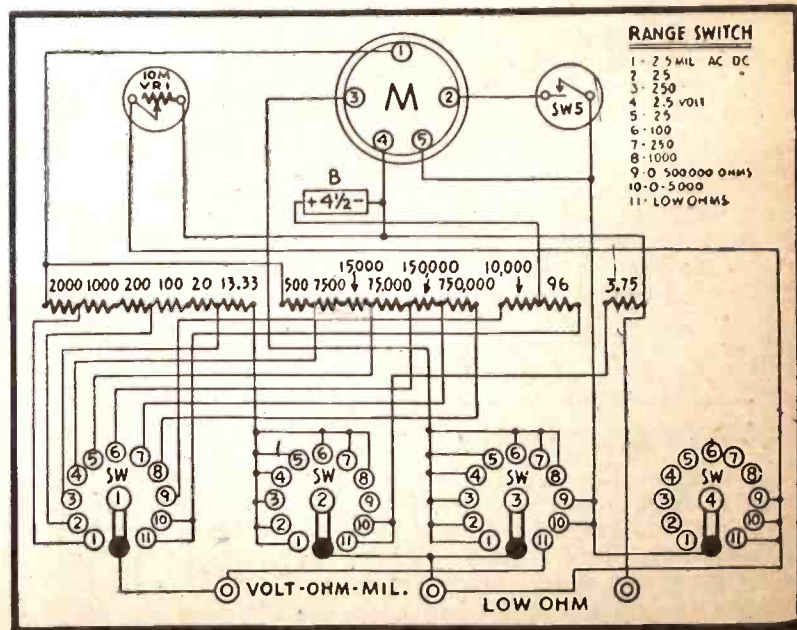

SCREWDRIVER

or *SLIDE RULE*

... which will **YOU** be using 2 years from now?



What's Ahead for You? Add CREI

Home Study Training to Your Present

Experience — Then Get That **BETTER** Radio Job You Want?

Face the facts! Thousands of new men entered the radio-electronics industry during the war. Now, many more thousands are returning as they are being discharged from the Services.

Where will you fit into this picture? What are your chances of holding down a good-paying job—of advancing to a better one?

No matter what your past radio-electronics experience has been—no matter what your training—you must start anew to add to your store of radio-electronics knowledge—to improve your ability by keeping pace with the rapid developments that have been taking place in the industry.

You must keep pace with such new developments as U.H.F. Circuits, Cavity Resonators, Wave Guides,

Klystrons, Magnetrons and other tubes. All these largely revolve around U.H.F. applications, and

here is where CREI technical training can help you—by providing you with the know-how and ability to keep pace with these new developments and to keep ahead of competition for the good jobs.

In our proved method of instruction you learn not only how—but why! Easy-to-read-and-understand lessons are provided well in advance, and each student has his personal instructor who corrects, criticizes and offers suggestions on each lesson examination. This is the basis of the CREI method of training for which more than 10,000 professional radiomen have enrolled since 1927.

It's up to you to decide if you will be a "screwdriver" mechanic or a real technician in a responsible engineering position. Let CREI train you now to trade that "screwdriver" for a sliderule. Our proved program of home study training should increase your technical ability and equip you to advance to the better-paying jobs that offer security and opportunity.

The facts are in the free booklet. Send for it today.

● **WRITE TODAY FOR**

**FREE
BOOKLET**

"Your Opportunity
in the New World
of Electronics"

If you have had professional or amateur experience—let us prove to you that we have something you need to qualify for a better radio job. To help us to intelligently answer your inquiry—PLEASE STATE BRIEFLY YOUR BACKGROUND OF EXPERIENCE, EDUCATION AND PRESENT POSITION.

CAPITOL RADIO Engineering Institute

HOME STUDY COURSES IN PRACTICAL RADIO-ELECTRONICS
ENGINEERING FOR PROFESSIONAL SELF-IMPROVEMENT

Dept. RC-2, 3224—16th Street, N. W., Washington 10, D.C.

Contractors to U. S. Navy—U. S. Coast Guard—Canadian Broadcasting Corp.
Producers of Well-trained Technical Radiomen for Industry.

Member: NATIONAL COUNCIL OF TECHNICAL SCHOOLS

SOME FM FACTORS

Underlying Principles of Frequency Modulation

VARIATION of the frequency of the signal rather than its amplitude is the feature of frequency modulation. In Fig. 1, a simple R.F. oscillator is shown. Frequency of the oscillator is governed primarily by the values of effective inductance and capacitance in the tuned circuit, being equal to:

$$f = \frac{1}{2\pi\sqrt{LC}} \quad (1)$$

where f = cycles per second, frequency
 L = inductance in henrys
 C = capacitance in farads

The above is the basic formula from which other formulas may be derived. The following one is convenient to use in making calculations:

$$f_{kc} = \frac{159,160}{\sqrt{L\mu_h C\mu_{mf}}} \quad (2)$$

Assuming that a 10 microhenry coil and 100 mmfd. condenser are used,

$$f_{kc} = \frac{159,160}{\sqrt{10 \times 100}} = \frac{159,160}{31.61} = 5035.11 \text{ kc.}$$

These figures are more accurate than those given by a slide rule and were worked out by hand. Six- or seven-place log tables could be used. Assuming that the frequency is swung higher on the positive modulation peak and that the change in capacitance value is 10% of 100 mmfd. or 10 mmfd., the new value will be 100—10 or 90 mmfd. Then,

$$f_{kc} = \frac{159,160}{\sqrt{10 \times 90}} = \frac{159,160}{30} = 5305.33 \text{ kc.}$$

Since the capacitance value is reduced, the shift is toward a higher operating frequency. The 10% shift in capacitance has caused a change of 729.78 kilocycles. Now assume that the capacitance value is shifted from 100 mmfd. to 100 mmfd. plus 10 mmfd., a 10% increase in C value. The new capacitance is 110 mmfd. and the frequency is:

$$f_{kc} = \frac{159,160}{\sqrt{10 \times 110}} = \frac{159,160}{33.16} = 4799.75 \text{ kc.}$$

The difference between this new frequency and the original resting frequency is 235.36 kc., obtained by subtracting 4799.75 kc. from 5035.11 kc.

From this, it is seen that an equal capacitance change in opposite directions from the resting capacitance value does not produce an equal frequency shift in each direction. Therefore, the system must be arranged so that a smaller change in capacitance results on positive than on negative modulation peaks, assuming that the tuned circuit capacity is decreased on positive and increased on

negative modulation peaks, or some other means of securing linearity of modulation would need to be employed.

We have assumed a 10% change in the C value and have observed the effect. Now, for this circuit, of Fig. 1 and the assumed 10 microhenry coil and 100 mmfd. condenser use a 10% change in inductance and observe the results. We swing from 10 microhenries to 9 microhenries on positive modulation peaks (assuming the modulation on positive peaks causes a rise in frequency) and to 11 microhenrys on negative modulation peaks. For the 9 microhenry value:

$$f_{kc} = \frac{159,160}{\sqrt{9 \times 100}} = \frac{159,160}{30} = 5305.33 \text{ kc.}$$

Note that the 10% change in inductance gives us the same frequency shift

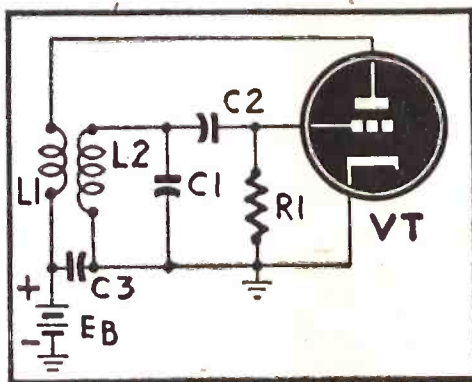

Fig. 1— L and C values determine frequency. as the 10% change in capacity from 100 mmfd. to 90 mmfd. For a 10% increase in inductance (11 microhenries) the LC product is 1100 as in a previous example, so that:

$$f_{kc} = \frac{159,160}{\sqrt{11 \times 100}} = \frac{159,160}{33.16} = 4799.75 \text{ kc.}$$

Therefore, equal changes in either L or C will produce equal frequency shifts, the 10% shift in C producing the same effect as the 10% shift in L , since both affect the LC product in the basic formula (1).

EFFECT OF SMALLER SHIFT

Let us now see what happens when the frequency shift is made smaller. Assuming that a 1% shift in C is used and the shift on positive modulation peaks, going higher in frequency, would be from 100 mmfd. to 99 mmfd., while on negative modulation peaks, going lower in frequency, the shift would be from 100 mmfd. to 101 mmfd. The first frequency would be:

$$f_{kc} = \frac{159,160}{\sqrt{10 \times 99}} = \frac{159,160}{31.46} = 5059.12 \text{ kc.}$$

The second frequency is:

$$f_{kc} = \frac{159,160}{\sqrt{10 \times 101}} = \frac{159,160}{31.78} = 5008.11 \text{ kc.}$$

The difference in the frequency limits of 5059.12 and the resting or unmodulated frequency of 5035.11 is, for a 1% shift of capacitance, from 100 mmfd. to 99 mmfd., equal to 24.01 kilocycles. The negative modulation peak swings the frequency lower, to 5008.11 kc. The difference between the 5035.11 kc resting frequency and the lower limit of 5008.11 kc is 27.00 kc. Note that as L or C are varied by a smaller percentage of their normal values, better modulation linearity is obtained. In the above example, there is a difference in the shifts of 27.00 minus 24.01 kc or only 2.99 kc.

FREQUENCY DOUBLING CIRCUITS

The frequency change, or bandwidth, extends over a range of 27 plus 24.01 or 51.01 kilocycles in this example, from 5059.12 to 5008.11 kilocycles. Suppose, now, we feed the signal frequencies into an amplifier which is tuned to twice the frequency of the unmodulated FM oscillator, twice the resting value or twice 5035.11 equals 10,070.22 kilocycles. The oscillator fundamental frequencies of 5008.11 kc. and 5059.12 kc. will have second harmonics of 10,016.22 kc. and 10,118.24 kc. and the new bandwidth will extend between these second harmonic frequencies,

$$f_a = f_1 - f_2 = 5059.12 - 5008.11 = 51.01$$

$$f_b = 2f_1 - 2f_2 = 2(5059.12) - 2(5008.11) = 10,118.24 - 10,016.22 = 102.02$$

$$= 2f_a = 2(51.01) = 102.02 \text{ kc.}$$

A small percentage shift in L or C results in linearity of modulation, while the use of a double stage permits increasing the bandwidth as well as raising the frequency of operation. The bandwidth is doubled. If the new carrier frequency of twice the original, equal to 10,070.22 Kc. is now fed into another doubler, a third frequency of 20,140.44 Kc is obtained. That is, 5035.11 (fundamental carrier) now becomes 4 x 5035.11 or 20,140.44 Kc and the output of the second doubler stage is four times the frequency of the fundamental FM oscillator. The output of this doubler may be fed into a third doubler stage to obtain twice 20,140.44 Kc or 40,280.88 Kc as the FM carrier. Using a fourth doubler stage in the transmitter, we obtain twice 40,280.88 or 80,561.76 Kc as the final FM carrier. The ratio of 80,561.76 to the original carrier frequency of the FM oscillator is 16 to 1, so

(Continued on page 354)

PLEASE PLACE YOUR ORDER WITH YOUR REGULAR RADIO PARTS JOBBER. IF YOUR LOCAL JOBBER CANNOT SUPPLY YOU, KINDLY WRITE FOR A LIST OF JOBBERS IN YOUR STATE WHO DO DISTRIBUTE OUR INSTRUMENTS OR SEND YOUR ORDER DIRECTLY TO US.

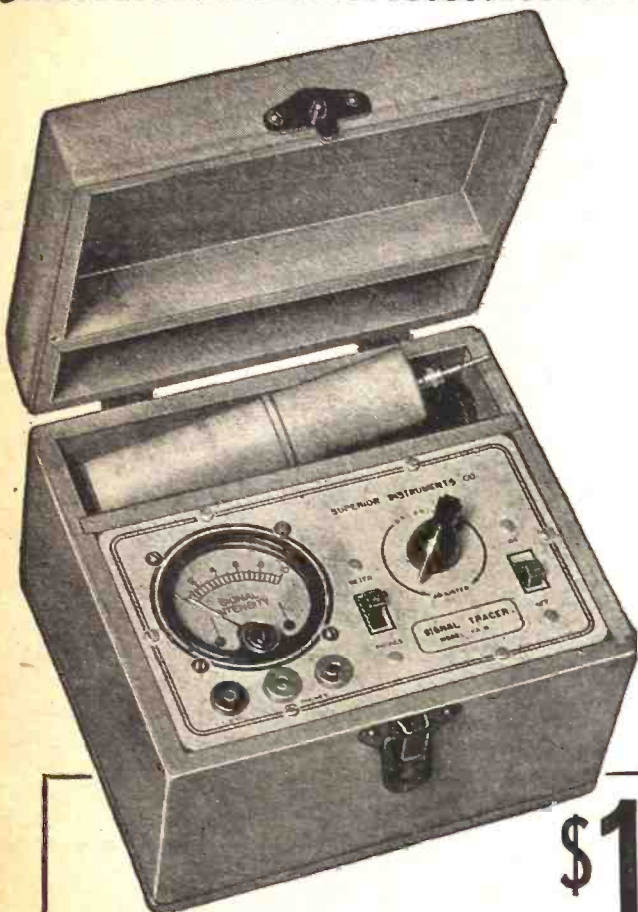

The New Model CA-11 SIGNAL TRACER

Simple to operate . . . because signal intensity readings are indicated directly on the meter!

Essentially "Signal Tracing" means following the signal in a radio receiver and using the signal itself as a basis of measurement and as a means of locating the cause of trouble. In the CA-11 the Detector Probe is used to follow the signal from the antenna to the speaker — with relative signal intensity readings available on the scale of the meter which is calibrated to permit constant comparison of signal intensity as the probe is moved to follow the signal through the various stages.

Features:

- ★ SIMPLE TO OPERATE — only 1 connecting cable — NO TUNING CONTROLS.
- ★ HIGHLY SENSITIVE — uses an improved Vacuum Tube Voltmeter circuit.
- ★ Tube and resistor-capacity network are built into the Detector Probe.
- ★ COMPLETELY PORTABLE — weighs 5 lbs. and measures 5" x 6" x 7".
- ★ Comparative Signal Intensity readings are indicated directly on the meter as the Detector Probe is moved to follow the Signal from Antenna to Speaker.
- ★ Provision is made for insertion of phones.

\$18⁷⁵

The Model CA-11 comes housed in a beautiful hand-rubbed wooden cabinet. Complete with Probe, test leads and instructions.....Net price

The New Model 450 TUBE TESTER

Specifications:

- Tests all tubes up to 117 Volts including 4, 5, 6, 7, 7L, Octals, Loctals, Bantam Junior, Peanut, Television, Magic Eye, Hearing Aid, Thyratrons, Single Ended, Floating Filament, Mercury Vapor Rectifiers, etc. Also Pilot Lights.
- Tests by the well-established emission method for tube quality, directly read on the scale of the meter.
- Tests shorts and leakages up to 3 Megohms in all tubes.
- Tests individual sections such as diodes, triodes, pentodes, etc., in multi-purpose tubes.
- New type line voltage adjuster.
- NOISE TEST: Tip jacks on front panel for plugging in either phones or external amplifier will detect microphonic tubes or noise due to faulty elements and loose internal connections.
- Works on 90 to 125 Volts 60 Cycles A.C.



SPEEDY OPERATION assured by newly designed rotary selector switch which replaces the usual snap, toggle, or lever action switches.

The model 450 comes complete with all operating instructions. Size 13" x 12" x 6".
Net weight 8 lbs. **\$39⁵⁰**
Our Net Price.....

The Model PB-210 MULTI-METER

Features:

- ★ SPEEDY!
- ★ PUSH-BUTTON OPERATION!

Measures:

- ★ A.C. Volts
- ★ D.C. Volts
- ★ D.C. Current
- ★ Low Resistance
- ★ High Resistance
- ★ Low Capacity
- ★ High Capacity
- ★ Decibels

Specifications:

5. A.C. VOLTAGE RANGES: 0 to 10/50/250/500/1000 Volts
5 D.C. VOLTAGE RANGES: 0 to 10/50/250/500/1000 Volts
5 OUTPUT METER RANGES: 0 to 10/50/250/500/1000 Volts
4 D.C. CURRENT RANGES: 0 to 1/10/100 Ma. 0 to 1 Amp.
2 CAPACITY RANGES: .0005 Mfd. to .3 Mfd. .25 Mfd. to 100 Mfd.
3 DECIBEL RANGES: —10 to +15; +10 to +35; +30 to +55
4 RESISTANCE RANGES:
0 to 2,000/20,000/200,000 Ohms. 0 to 20 Megohms

Model PB-210 comes housed in hand-rubbed oak portable cabinet, complete with cover, self-contained battery, test leads and instructions. Net Price.....

\$35⁷⁵



SUPERIOR INSTRUMENTS CO.

Dept. R 227 FULTON ST., NEW YORK 7, N. Y.

WORLD-WIDE STATION LIST

CONDITIONS on the ten-meter ham band have been constantly improving, and lately some very fine business results have been obtained during the daylight hours. A few times, this band has been open until seven-thirty or eight in the evening, but it usually closes down about five-thirty or six during this season of the year. A few reports have been received on this band, and we would like more as well as reports on the other ham bands as soon as they are put back into use.

A letter was received from a friend in France a short time ago. He stated that it would probably be six months to a year before the French amateurs would be able to get back on the air. At the present time, equipment there is available only for industrial uses. Most of the formerly used transmitters were confiscated by the invaders. We were very glad to hear from this friend, as he was one of our observers before France went to war, and nothing was heard from him for about four years. His last letter was mailed just a few days before France fell. We wrote to him twice during the

war, but the letters were never received. A third letter written in October of this year got through to him, and he had wanted to write to us, but had lost all of his possessions, and did not know my address. His letter stated that as soon as he can get a receiver together, he will send us reports on what he hears over there. With his brother, who could not speak English, he owned and operated amateur station F8UE, and hopes to have it on the air sometime this year.

The other day we received a most welcome card from Commander H. J. Scott of Oakland, California. It was a short note criticizing our graph "An evening on the short wave band," but it was certainly constructive. Personally, I have never been farther west than New York State, hi, and so did not realize, even though I should have, that by twelve midnight our evening is over, but in California on the west coast, it is only nine o'clock, and their evening is only about half over. Because of this, next month we will print an addition to our graph, showing the most important sta-

tions on the air from 9 pm to 12 m Pacific time. Cards and letters of this type are surely appreciated; and will be of great aid in getting the type of material you want into this publication.

This month we have added a few stations to our list which have been skipped over in the past. It is hoped to keep this log as complete as possible, but stations are coming, going and moving around the dial every day; as well as changing skeds until it is almost impossible to keep track of them. Every report received is a help in doing this.

New Listening Post Certificates have been mailed to all active observers; and we have quite a supply of them waiting for new observers, particularly overseas. So let's keep up the work that you have been doing such a fine job at, and see what new sigs we can pull in.

Got a postwar receiver here a few days ago, and it sure has it all over the old one. Hard to take out time enough to sleep and work, hi!

All schedules U. S. Eastern Standard Time.

Location	Station	Frequency and Schedule	Location	Station	Frequency and Schedule	Location	Station	Frequency and Schedule
SOUTH AFRICA			Johannesburg	ZRH	6.007 11 pm to 2 am; except Saturdays	Madrid	EA2	9.970 2 to 3 am; 7 to 9 am; 10 am to 5 pm; 6:30 to 9 pm
Capetown	ZRK	5.863 11:45 pm to 1:30 am; 10 am to 4 pm	Johannesburg	ZRG	9.520 3 to 7 am	SPANISH MOROCCO		
Johannesburg	ZRH	6.028 11:45 pm to 1:30 am	Johannesburg	ZTJ	9.900 7:15 to 7:45 am	Tetuan		6.065 5 to 6:15 pm
Capetown	ZRL	9.608 3 to 7 am; 9 am to 4 pm	SPAIN			SURINAM		
			Alicante		7.950 off at 5 pm	Paramaribo	PZX3	5.750 6 to 8:45 pm
						Paramaribo	PZX5	15.405 11:30 am to noon
						SWEDEN		
						Stockholm	SBU	9.535 1:30 to 5 pm; 8 to 9 pm; Sundays only, 5 to 9 am
						Stockholm	SDB2	10.780 3:15 to 5 pm
						Stockholm	SBP	11.705 11 pm to 1:30 am; 3 to 8 am; 10 to 11 am
						Stockholm	SBT	15.155 6 to 7 am; 10 am to 1:15 pm; Sundays, 2:45 to 1:15 pm
						SWITZERLAND		
						Berne	HER3	6.165 1 to 3 pm
						Berne	HEI2	6.345 12:30 to 1:45 am; 2:45 to 7 am; 1 to 5:15 pm; 8:30 to 10 pm
						Berne	HET3	7.360 6:30 to 8 pm
						Berne	HEK3	7.380 10 am to 12:30 pm; 3:15 to 3:30 pm; 8:30 to 10 pm
						Berne	HEF4	9.185 North American beam, 7:15 to 7:45 am; 4:20 to 5:20 pm; 6:30 to 8 pm; 8:30 to 10 pm
						Geneva	HBL	9.345 1 to 3 pm
						Berne	HEJ5	11.715 Tuesday and Saturday, 10 am to noon
						Berne	HEK4	11.960 Tuesday and Saturday, midnight to 1:30 am
						Berne	HEO4	15.875 2:15 to 2:50 pm
						SYRIA		
						Damascus		8.000 11 pm to midnight
						TAHITI		
						Papeete	FO8AA	6.980 Fridays and Saturdays, 11 pm to midnight
						TURKEY		
						Ankara	TAP	9.465 11 am to 4:45 pm
						Ankara	TAP	9.510 1 to 2 pm
						Ankara	TAQ	15.195 4:15 to 8 am

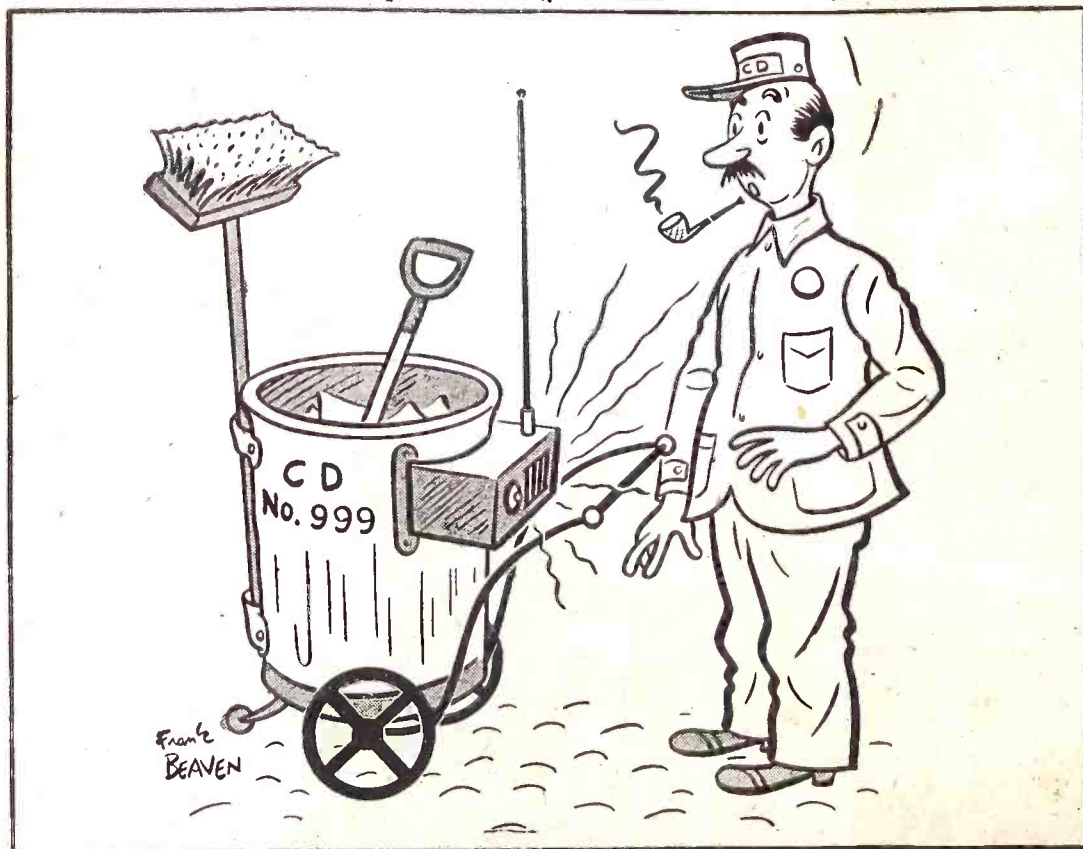

Suggested by: F. J. Dunnett, Vancouver, B. C., Canada
 "Calling cleaner No. 999! Proceed at once to 42nd St. and Vine—the circus parade is over! That is all!"

(Continued on page 344)

cathode. Consequently, it comes to rest on the lower-voltage anode.

This is a true case of negative resistance. A lowering of voltage results in an increase of current, and vice versa. In a circuit like that of Fig. 3, which has a number of resemblances to a triode Hartley, if the voltage on one of the anode sectors is increased the current to it drops and that to the lower-voltage sector increases. Due to voltage drop through the inductance, this further decreases the voltage on the low-voltage sector. The action continues to a limit set by the circuit factors, including plate voltage and magnetic field strength. When this limit is reached,

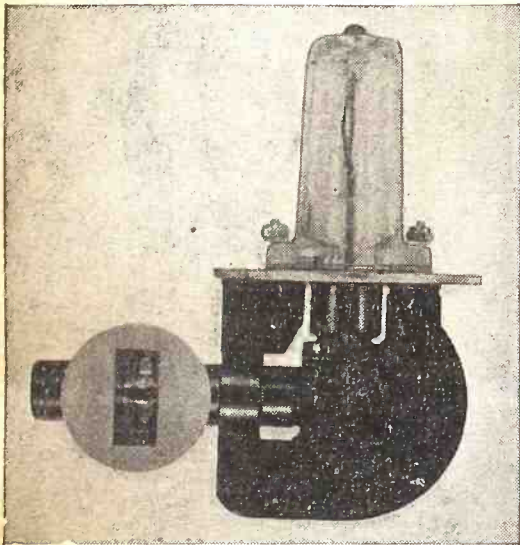

12-cavity magnetron for fire control systems.

the plates start to return to a condition of equal voltage, discharging circuit capacities and building up an inductance field around the coil in the ordinary fashion of a coil-condenser combination. When the plates reach a condition of voltage equilibrium, current flow continues as the magnetic field around the inductance collapses, reducing the voltage on the former high-voltage anode and increasing it on the other. The action continues in the opposite direction, resulting in steady oscillation at a frequency determined by the inductance and capacity in the circuit.

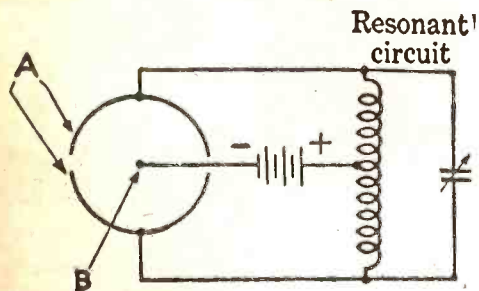

Fig. 3—Circuit for magnetron oscillations.

As is the case with oscillating circuits which use ordinary tubes, it is not necessary to make any special provision for supplying the plates with an initial unequal voltage. Random effects, variations in supply voltage—all the causes to which oscillation in triodes are ascribed—suffice to start oscillations in a circuit similar to that of Fig. 3.

The ability of magnetrons to reach

MAGNETRON TUBES

(Continued from page 308)

higher frequencies is increased by reducing the external coil-condenser combination to a pair of Lecher wires. The total capacity in circuit is supplied by the plates and distributed capacity of the wires. The two-sector anode, in other cases, is further split into four or more sectors, each with its Lecher-wire oscillating system.

The next step in the evolution of the tube was the cavity magnetron, with the whole Lecher-wire system converted into resonant cavities and enclosed in the tube itself. Descriptions of cavity magnetrons are still somewhat limited by war security restrictions. Raytheon, who released the photographs shown in connection with this article, explains their product in the following simplified form:

"Basically, the cavity magnetron is made up of a heavy cylinder of copper around whose inner diameter a series of identical key holes have been cut with the narrow slot opening into the center hole. Each of the key holes represents a transmitter circuit. In the center of the body is placed an emitting cylinder, usually a nickel sleeve coated with an active material which upon heating produces a copious flow of electrons. If each hole and slot is identical to its adjacent member, and if the configuration is correct, the tube, upon application of proper voltages and magnetic field can be made to produce thousands of watts of pulsed microwave energy. This energy is taken out of the tube by coupling into one of its key-hole cavities and conducting the energy to an external lead. This may be achieved either by use of a coupling loop, or by a wave-guide.

The electrical operation of the cavity magnetron can best be understood by remembering that the oscillators are placed cylindrically around the axis of the cathode and a means of exciting these cavities must be provided. A magnetic field is applied axially to this diode which causes the electrons emitted from

the cathode to perform circular paths about the cathode. The electron motion can be considered as an air stream passing a slot, which, when it acquires the correct velocity, causes the cavity to resonate. This is a simple analogy; however, the complete problem of the growth of oscillations is too complex to be dealt with completely at the present time. The critical speed of the electron stream is obtained when the velocity is such that one cavity represents a negative portion of the output wave while the next cavity is positive."

Microwaves, as generated by the magnetron, have been of decisive value in wartime applications. Immediate benefits to be felt in peace time will be that large commercial airlines which

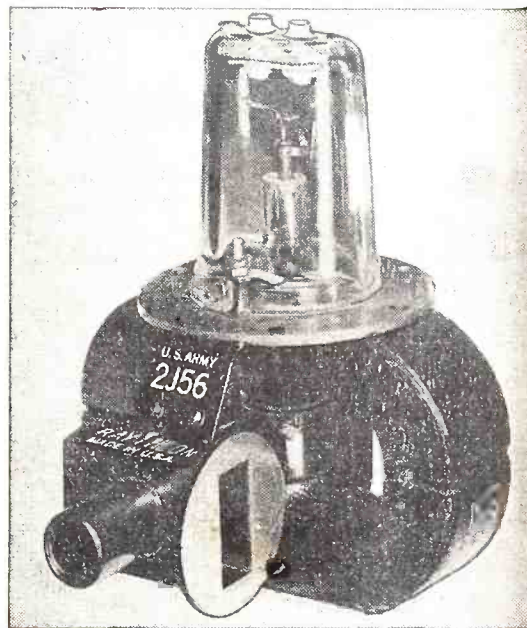

Another magnetron used for fire control work.

have been badly restricted in operation by weather conditions will soon be able to fly and land on schedule regardless of weather. Ships will no longer have to wait the lifting of fog to get into harbors. However, the magnetron and other microwave types offer many other possibilities which to date have not been pursued. With peace, newer applications and uses for these tubes will be brought forth in ever increasing number.

PEACETIME USES FOR ATOMIC POWER

AMERICAN industry and science can begin reaping the benefits of large-scale atom-splitting right now, without having to wait for the development of atomic power, A. L. Baker, general manager of the Kellogg Corporation of Oak Ridge, Tenn., declared recently at a press conference in New York. These benefits will flow from the new engineering principles, new equipment and new methods which had to be used under the forced draft of war to produce the atomic bomb in time for use as a weapon.

Some of the beneficial by-products of the work on large-scale atom-splitting enumerated by Mr. Baker are: Cheaper, more abundant sources of radioactivity for the treatment of cancer.

Improved methods for combating industrial hazards due to presence of poisonous substances.

High-vacuum, low-temperature dehydration of foods.

Improvements in vacuum distillation for the production of vitamins.

Better heat exchangers, new methods of separating gasoline fractions and more efficient mass-spectrum analysis for the petroleum industry.

New electronic techniques in high vacuum for the electrical industry.

More efficient gas pumps; some of these, developed for this project, can deliver a stream of gas at a velocity greater than that of sound.

All told, about 5,000 new and improved products and procedures are now available to American industry, awaiting only governmental release for volume production, Mr. Baker stated. He especially emphasized the improvements that have been made in pumps, and declared that in 20 years the benefits accruing from this one source alone would probably be worth the outlay of \$2,000,000,000 made by the government for the whole atomic bomb project.

RADIO-ELECTRONIC CIRCUITS

CAR TALKIE

The diagram shows an outfit which, when plugged into your car radio, makes a transceiver. This car talkie transceiver derives all of its power from your car radio itself through an Amphenol connector plugged into a special socket on the radio. The necessary connections are brought to this socket from the various parts within the radio itself.

The connection marked "B-plus" is run directly to the plate terminal of the receiver's power output tube. The two terminals marked "F" are connected to the filaments of one of the receiving tubes in the car radio. The one marked "Gnd" is run to the chassis of the radio. The connection marked "Grid" is run to the grid of the first audio tube in the receiver where the volume control is usually connected. The terminals marked "C" are any type of microphone connectors which the builder may have on hand. The mike can be a small PM speaker. The oscillator coils are all wound on a 3-inch form. (A salt box makes a good one.) The coil wire size is No. 22, silk or cotton covered, single-layer wound 1/4-inch space between each coil.

To operate as a transmitter, plug the oscillator terminal plug into the radio receiver receptacle and turn the

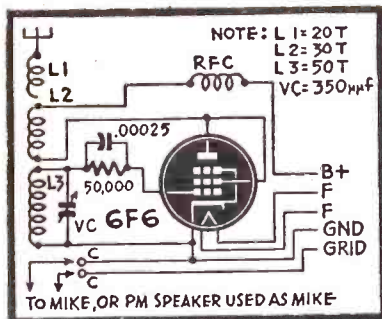

volume control of the receiver to the off position. You are then ready to transmit. The audio amplifier section of the radio acts as the modulator for the transmitter. To receive, just turn up the volume of the receiver and tune for stations. With two cars equipped this way, a two-way conversation may be carried on between cars, each oscillator having a different operating frequency.

This can also be used in the home, if desired, as long as FCC regulations in regard to licenses and operation of transmitters, is observed. In either case, home or auto, a

license is required before transmitting, with heavy penalties for operation without a license.

HOWARD L. CULBERTSON,
Zanesville, Ohio

Radio-Craft welcomes new and original radio or electronic circuits. Hook-ups which show no advance on or advantages over previously published circuits are not interesting to us. Send in your latest hook-ups—Radio-Craft will extend a one-year subscription for each one accepted. Pencil diagrams—with short descriptions of the circuit—will be acceptable, but must be clearly drawn on a good-sized sheet of paper.

PHONO OSCILLATOR

This is a circuit of a phono oscillator that I have been using for quite some time. The tone is just about the best I have heard from any phono oscillator, and I have tried a good many other types of circuits.

The average constructor should find no difficulty in building this unit. The scratch-filter resistor and condenser may be varied for

best results. Coils are standard broadcast type.

T. BJORN,
Chicago, Ill.

(A word of caution is again in order. Make sure that this does not radiate more than 157,000/f[Kc] feet, in accordance with FCC regulations. More than this amount on the broadcast band is likely to interfere with the neighbor's reception.—Editor.)

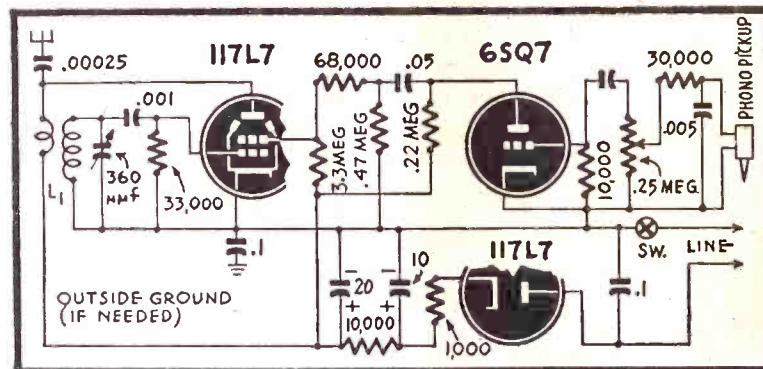

TWO-TUBE REGENERATOR

Here is a diagram for a 2-tube regenerative long and short wave receiver which gives excellent performance with good volume and selectivity. It uses two pentode output tubes in cascade as A.F. amplifier. Real volume was obtained with little or no distortion. A 1D8GT was used for the first stage of audio and the detector; a

1C5GT for the output. The R.F. choke and impedance coupling between the first A.F. and the detector were both necessary for good regeneration. Ordinary plug-in coils were used in this hookup but fixed wired-in coils can be used if desired.

L. CLARE FOWLER,
Aldersyde, Alberta

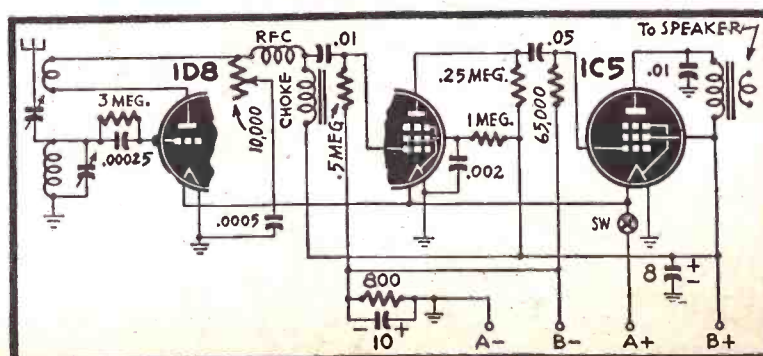

TEST RESISTOR

I have had radio sets brought in for repair that had one or more carbon resistors so badly burned out from overheating that it was nearly impossible to determine what resistance they used to be. I therefore devised a gadget that makes repair jobs on these sets very easy. I use a 500,000-ohm variable resistor which is connected to the two test leads with alligator clips on one end.

The defective resistor is cut out of the circuit and the two alligator leads are connected in its place. The radio is then turned on and the resistor is adjusted to the point where best performance is noted. The variable resistor is then disconnected and checked for resistance with an ohmmeter. A carbon resistor of that particular resistance is selected, installed, and the job is done.

Several of these units can be made for covering a wider range.

C. G. PETERSON,
Rosepine, La.

DIVIDING NETWORK

This is an idea for a tone control which I am using at present and which gives excellent results. A small speaker with little baffling is used for the high frequencies and a 12-inch speaker in a bass reflex cabinet for the lows. The .05 condenser is used as a high-frequency bypass. Any change in condenser will serve to vary the tone slightly. The 13,000-ohm variable resistor is used as the tone control, properly apportioning the

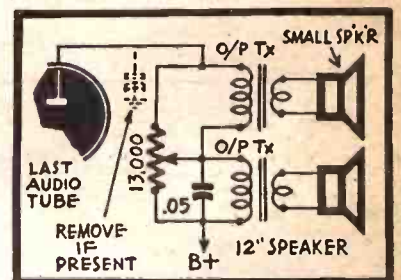

amount of signal given to each speaker. The difference in volume between that reproduced by the "high" speaker and the "low" speaker gives the listener an "apparent" tone control. The resistor should be a wirewound type capable of handling double the plate current of the last audio stage.

CAPT. VAUGHN G. LAYMAN,
Wendover Field, Utah

AC RADIO SERVICE

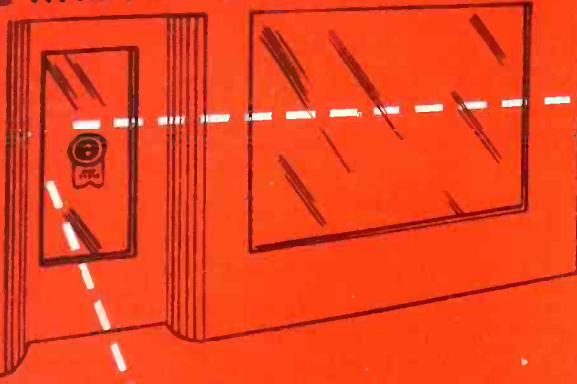

Here's
where
your
profits
start!



RAYTHEON
Bonded
**ELECTRONIC
TECHNICIANS**



Right on your door, every visitor will see this smart, modern decal — and know your shop is operated by Bonded Electronic Technicians. Here, where your profits start, your doorway becomes a sales-aid. And this is only the beginning. Wall banners, displays, job record cards—the Raytheon Bonded Electronic Technician will have plenty of these to help build a substantial, money-making radio service business. See your Raytheon distributor today. Find out how you can qualify to become a Bonded Electronic Technician. Join the practical, responsible business men known to their communities as Bonded Electronic Technicians.

Another reason why it pays to qualify as a Raytheon Bonded Electronic Technician.

Excellence in Electronics
RADIO RECEIVING TUBE DIVISION
NEWTON, MASS. • NEW YORK • CHICAGO

Two Ghirardi books THAT TEACH YOU TO DO ANY REPAIR JOB ON ANY RADIO EVER MADE!



Meet Alfred A. Ghirardi—the man who makes Radio easy to learn!



HOW TO TEST A RADIO IN 2 MINUTES or less!

Want to repair your own radios—without months of specialized service training? Want to repair sets for friends for fun or profit? Or, if you are already a radio serviceman, do you want to learn how to diagnose radio troubles in two minutes or less and fix sets TWICE AS FAST and TWICE AS PROFITABLY—without a lot of unnecessary testing? Then order Ghirardi's RADIO TROUBLE-SHOOTER'S HANDBOOK today. 5-Day Money-Back Guarantee!

START A SERVICE BUSINESS GET A BETTER PAYING JOB!

There's a real future for you in servicing—and Ghirardi's MODERN RADIO SERVICING is just the book to start you on it without delay. And remember: Radio is just the beginning! What this big book teaches you about Radio Servicing, Test Instruments, and modern technical procedure is exactly the training you need to fit you to "grow up" with the fast-expanding Electronics profession in all of its servicing phases! It gives you real PROFESSIONAL Training ... for only \$5 COMPLETE!

MODERN RADIO SERVICING

THE BOOK THAT GIVES COMPLETE Professional SERVICE TRAINING

Once in a blue moon a technical book is written that is so important, so complete and so easy to understand that it is used and recommended universally by members of a profession. Ghirardi's MODERN RADIO SERVICING is exactly that kind of a book as leading radio men everywhere will quickly tell you!

TEST INSTRUMENTS, TROUBLE-SHOOTING, REPAIR

Actually, MODERN RADIO SERVICING is the only single, inexpensive book giving a complete, easy-to-understand course in modern Radio repair work in all of its branches—branches that lead right through to all types of Electronic equipment. Written so simply you can understand it without an instructor! Read

from the beginning, it takes you step by step through all phases of the work. Used as a reference book by busy servicemen, it serves as a beautifully cross-indexed volume for "brushing up" on any type of work. Included is a thorough explanation of all Test Instruments, telling exactly how they should be used and why (it even gives complete data for making your own Test Equipment if you prefer!); Receiver Troubleshooting Procedure and Circuit Analysis; Testing & Repair of Components; Installations; Adjustments, etc., etc.—also, How to Start a Successful Radio-Electronic Service Business. 1300 pages, 720 self-testing review questions, 706 helpful illustrations and diagrams. Only \$5 complete (\$5.50 foreign).

RADIO TROUBLE-SHOOTER'S HANDBOOK

MAKE MONEY REPAIRING RADIOS

This 4 lb. Handbook Shows Exactly How to Diagnose and Repair Common Troubles in Practically Every Radio in Use

Speed up radio repair work! Eliminate needless, tedious testing! Handle common radio troubles fast and profitably. Make spare time money repairing sets for friends and neighbors—without a lot of costly equipment or experience.

of five, the HANDBOOK will show you step by step just what to do—in a fraction of the usual time. Ideal for either busy service shops or service beginners. Pays for itself in time saved on the very first job.

Save Time on Every Job!

Ghirardi's famous 744-page, manual-size RADIO TROUBLE-SHOOTER'S HANDBOOK shows what to do—exactly how to do it. Over 400 pages given common trouble symptoms, their causes and remedies for over 4800 receiver, auto radios and record changers of 202 different manufacturers. Just look up the Make, Model and Trouble Symptom of the radio to be repaired. Four times out

Hundreds of Service Hints

Over 300 additional pages include service hints; i-f alignment peaks for over 20,000 superhets; transformer trouble data; the finest tube information you've ever seen; color codes; and hundreds of graphs, diagrams, charts, etc.—all carefully indexed so you can find what you need in a hurry. Price only \$5—on 5-DAY MONEY-BACK GUARANTEE BASIS. Send coupon now!

YOUR MONEY BACK IN FIVE DAYS!

Murray Hill Books, Inc., Dept. RC-26, 232 Madison Ave., New York 16, N. Y.

Enclosed find \$..... for books checked; or send C.O.D. (in U.S.A. only) for this amount plus postage. If not fully satisfied, I may return the books within 5 days and receive my money back.

3rd Edition RADIO TROUBLESHOOTER'S HANDBOOK \$5 (\$5.50 foreign)

Ghirardi's MODERN RADIO SERVICING \$5 (\$5.50 foreign)

Special MONEY-SAVING COMBINATION: MODERN RADIO SERVICING and RADIO TROUBLESHOOTER'S HANDBOOK (both books) \$9.50 (\$10.50 foreign).

Name

Address

City & Dist. No. State

Special MONEY-SAVING OFFER

Get both of these big books at our special Money-Saving price—a complete servicing library of over 2040 pages for only \$9.50. (\$10.50 foreign.)

724 OUT OF 817!

Recently, a group of 817 radio instructors, students, repair men, radio men in the armed forces, in broadcast stations, big manufacturing plants, etc., were asked what they think of the various books and courses for the study of basic Radio-Electronics. 724 of these men—NINE OUT OF TEN—said that, in their opinion, GHIRARDI'S RADIO PHYSICS Course was their first choice—far better than any other AT ANY PRICE!

"IT'S THE BEST OUT OF 20" SAYS CHIEF ENGINEER

From F. S. Bailey, Chief Engineer, Radio Operator's School, Brownsville, Texas, comes this sweeping endorsement of Radio-Electronic's greatest basic training book: "We find Ghirardi's RADIO PHYSICS COURSE the best book out of 20 or more that we have tried—both as a complete course in Radio Physics, and for all other branches. It is best for beginners as well as those who already know something about Radio . . . It is giving our students the very best for their money!"

Who said it costs a lot of money to LEARN RADIO-ELECTRONICS?

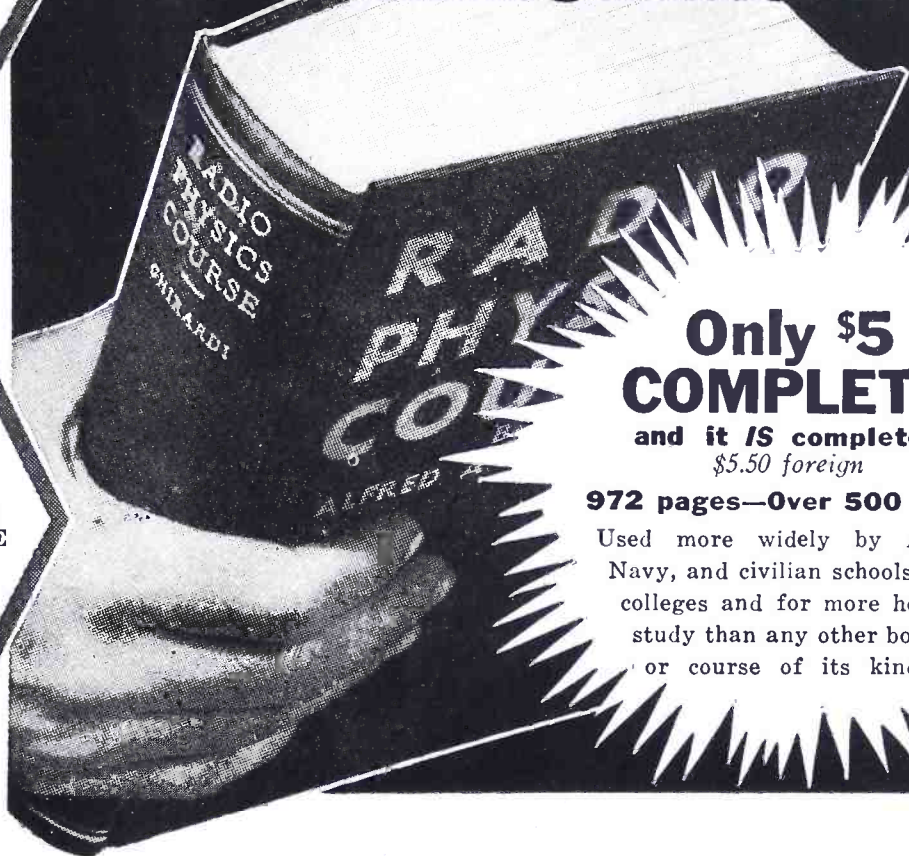

Only \$5 COMPLETE
and it IS complete!
\$5.50 foreign

972 pages—Over 500 illus,
Used more widely by Army, Navy, and civilian schools and colleges and for more home study than any other book or course of its kind.

THE BOOK THAT MAKES IT EASY FOR BEGINNERS TO LEARN AT HOME . . . without an instructor



Send the coupon today! Examine Ghirardi's RADIO PHYSICS COURSE in your own home! See for yourself how this giant book at ONLY \$5 can give you complete

basic training that can pave your way to a good-paying job or a business of your own in Television, Frequency Modulation, Facsimile, Broadcasting, Communications, Radio Servicing, Industrial Electronics and so on down a long list of glittering opportunities.

This one big 972-page, profusely illustrated book gives just the training you need—ALL YOU NEED—easier, better, faster

and at FAR LESS COST. It backs up theory with actual practice. No previous training necessary. It starts right in at the beginning. Every step is made crystal clear in both text and over 500 illustrations. Many beginners who never even saw a circuit diagram before have completed it in a few weeks. Thousands of Ghirardi-trained men now hold important Radio-Electronic positions. No training AT ANY PRICE is more widely endorsed by the experts themselves!

AS SIMPLE AS A-B-C

Ghirardi's RADIO PHYSICS COURSE makes Radio-Electronics-Television amazingly easy to learn. Everything is explained carefully and thoroughly in a clear, easy style. No involved mathematics! No lessons to wait for. You get

your training QUICKLY while the big money-making opportunities still beckon on every side. You'll be amazed and pleasantly surprised to find how soon RADIO PHYSICS COURSE has you understanding every phase of this fascinating subject—how it enables you to grasp subjects that other books and courses make seem highly complicated. Best of all, you buy it on an UNRESERVED 5-DAY MONEY-BACK GUARANTEE BASIS. Every cent of your money will be cheerfully refunded if you are not more than satisfied. You cannot lose! Send coupon today!

YOUR MONEY BACK IN 5 DAYS

if Ghirardi's RADIO PHYSICS COURSE doesn't teach you Radio-Electronic-Television fundamentals EASIER, FASTER and at LESS COST than any other book or course. You be the judge!

ALL THE FACTS ON A LITTLE-KNOWN SUBJECT . . . Now Available



Don't buy, specify, use or replace Capacitors blindfolded! Save time, save money, and increase your service efficiency by really knowing all about this vital subject! No Radio-Electronic component is more important or less understood than the Electrolytic Capacitor and many new and improved types are now fast coming into general use. This new book, THE ELECTROLYTIC CAPACITOR, by Alexander M. Georgiev at last explains the entire subject. It tells what types to use and where and how to use them properly. Explains the advantages and disadvantages of each—how to make emergency repairs and includes a wealth of other invaluable data. Over 200 pages. 80 illustrations. Only \$3 (\$3.25 foreign).

Murray Hill Books, Inc.

Dept. RC-26, 232 Madison Ave., New York 16, N. Y.

Enclosed please find \$5 (\$5.50 foreign) for which rush me a copy of A. A. Ghirardi's big, 972-page RADIO PHYSICS COURSE BOOK or

Send C.O.D. for \$5 (no foreign C.O.D.'s) plus postage. In either case, it is understood I may return the book within 5 days of its receipt and have my money refunded.

Send a copy of THE ELECTROLYTIC CAPACITOR, \$3 (\$3.25 foreign), \$..... enclosed, or send C.O.D. (U.S.A. only) for this amount plus postage.

Name

Address

City & Dist. No. State

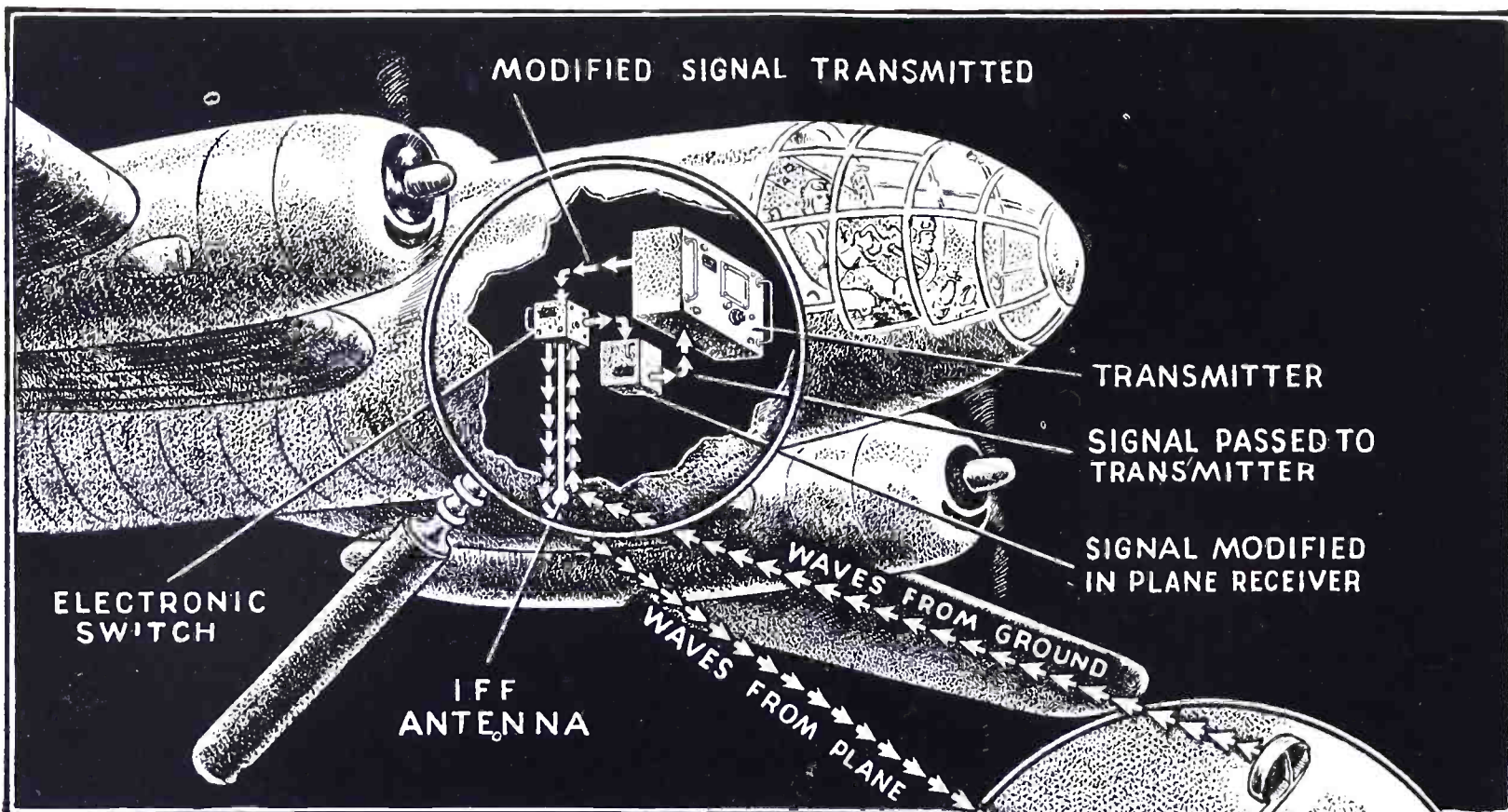

Route of IFF signals from ground station to plane and back to identifying indicator.

I. F. F.

IDENTIFICATION, FRIEND OR FOE

THE device known as IFF (Identification, Friend or Foe) in military circles has been surrounded by such great secrecy that it has not yet been given a name more appropriate for peacetime purposes. The necessity for such a device was determined as soon as radar was adopted for military uses because all types of airplanes give exactly the same response to the radar beam. While radar served to warn of the approach of enemy aircraft when it was known definitely that none of our planes were in the air, it lost its effectiveness in areas where there was continuing air activity by both sides in warfare.

Early in the war, the British devised several means of identifying aircraft by modifying the type of reflection of the radar impulse. Although none of these systems was completely satisfactory, the experimental work indicated the elements which were necessary. These experiments also showed the necessity of a standard system to be used by all the Allied nations.

American work on the device—co-ordinated with that of other United Nations and working to common specifications—was handled by the Belmont Radio Corporation, with the assistance of engineers from Wells-Gardner Co. and Admiral Corp. After six months of intensive endeavor, an IFF system was perfected which gives positive identification and is now used with all radar equipment by the armed forces. IFF is essentially a form of radar, but it also requires a separate ground unit with a directional antenna, as well as a special receiver and transmitter in the airplane.

Here is how the IFF system works:

The radar picks up an approaching plane and indicates its position and range. From this information, the directional antenna on the IFF ground unit is adjusted to point directly to that position. Secondly, the range circuit is adjusted so that the response, in the event it is a friendly flyer, will come

only from the plane previously detected by the radar.

Then the IFF ground unit sends out a pulse of radio frequency energy. If the plane is friendly, it is equipped with a receiver for this impulse. This receiver, when it receives radar signals, sets an FM transmitter which also contains an automatic keying circuit, into action. The signals sent out by the plane are picked up by a special receiver which forms part of the radar equipment and after detection are applied to the vertical deflecting plates of the cathode-ray tube indicator, setting up the special traces below those caused by echoes from the aircraft.

From the nature of the code signal received, the IFF ground unit operator can immediately determine whether the plane under observation is friend or foe.

By means of the I.F.F., the image which appears on the fluorescent radar screen is not the same when it comes from an enemy plane as when it is caused by a friend. In the former case, the reflected waves produce a line above the horizontal sweep line. But when a friendly plane finds itself in the beam sent out by the radar transmitter, there is in addition to the upright vertical line, another vertical line below the sweep base. This second "pip" is intermittent, modulated in the form of Morse signals. These vary daily according to a pre-established code.

The equipment in the airplane is turned on when the ship leaves the ground and its operation is completely automatic. *No attention from the pilot is required.*

IFF was adopted for a new and important use at the time of the Normandy invasion. The ground units were planted at points inland by Allied secret service agents and the electronic beams served to guide planes and gliders so that paratroopers could be dropped at the most strategic points. Never before in warfare

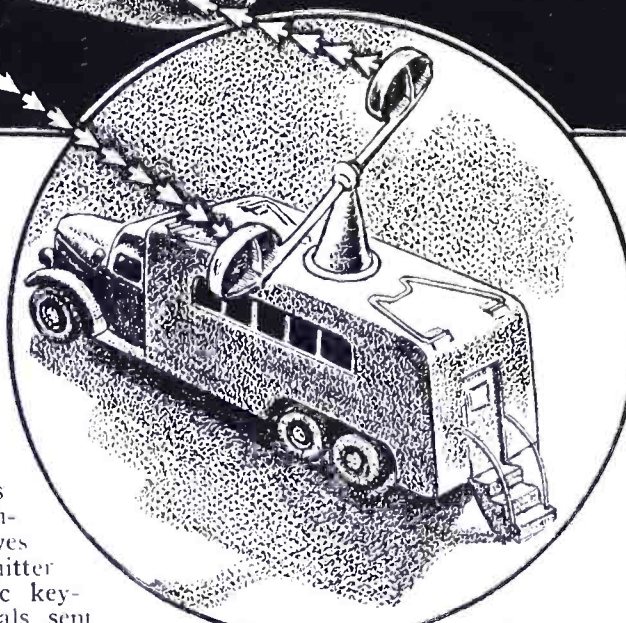

had parachute troops and gliders been landed so accurately and the means by which it was done remained a mystery to the enemy.

IFF devices were among the topmost secret apparatus of the war; according to some sources being so secret as to prevent full realization of their value. Each of them was said to have been so booby-trapped that any attempt of the enemy to open a captured one would result in an explosion which would—at the least—destroy the apparatus beyond possibility of discovering its purpose.

According to experts in the field of electronics, IFF equipment has a definite application to peacetime aviation. Any plane carrying a small IFF unit can be located almost instantly by its home airport or the airport to which it is flying. If a pilot flew off his course, he could, using regular radio communication, ask the nearest airport to determine his exact location by stating his IFF code. In this case, the IFF operator at the airport would search with his antenna until he received a signal with this code and, from readings on position and range, could advise the pilot of his exact location.

The advantage of IFF is that it does not have the defects of the radio compass because it operates on higher frequencies. At the present time the radio compass is not infrequently affected by climatic conditions which render it subject to considerable error.

**MOST -
OFTEN -
NEEDED**

RADIO DIAGRAMS

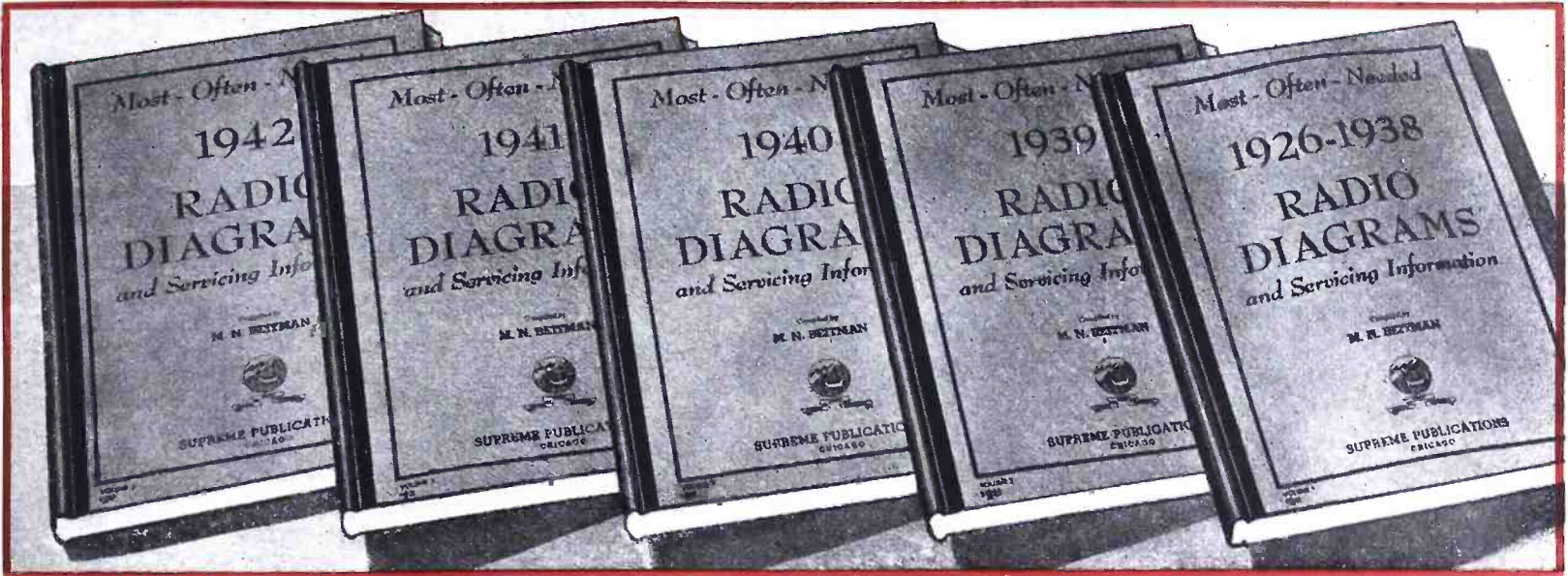

1942 4 Out of 5 Diagrams You Will Ever Need

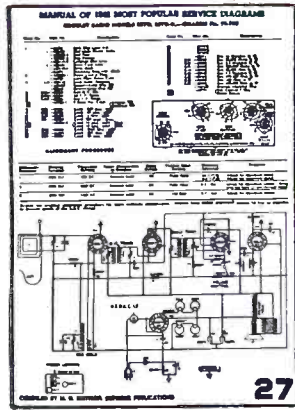

Find radio faults quickly. Make the needed repairs in any radio. Save time on every job. This large, new and inexpensive diagram manual has the circuit for every popular 1942 radio set. 4 out of 5 diagrams you will ever need are included.

WITH ALIGNMENT DATA

Clearly printed circuits, alignment data, parts lists, service hints are the facts you need to speed up all radio servicing. Repair radios quickly and properly—follow the factory instructions given in these manuals. 351 models of 40 largest manufacturers. 192 fact packed pages. Large size, 8½ x 11 in. Manual style binding. Well printed. Price postpaid, only **\$2.00**

NEW, POPULAR, LOW-PRICED MANUALS

1941

These easy-to-apply, inexpensive manuals will help you repair radios faster. This volume covers 1941 models, with alignment data, I.F. peaks, and replacement parts lists. Compiled by M. N. Beitman, radio serviceman for many years, author, and teacher. Be an expert in radio servicing; simplify your work. 192 pages 8½ x 11 inches. Only **\$2.00**

1940

Let this important manual give you over 80% of all 1940 circuits you will ever need, acquaint you with new developments, train you to service quickly and efficiently millions of sets. Data on F.M., portables, recording, etc. 417 models of 43 manufacturers. 208 pages. Net price.. **\$2.00**



1939

Another handy manual of the most popular diagrams you need. Circuit data, hints and information are time-savers and money-makers for you. Let these diagram manuals guide you to easier service work. Why try to get along without helpful diagrams? Use this volume with 192 pages of diagrams of 39 makes. Only **\$2.00**

Most Popular Models Made by:

Philco Radio, RCA, Zenith, Sears, GE, Emerson, Belmont, Detrola Radio, Fada, United Motors, Westinghouse, Arvin, Majestic, Stewart-Warner, Admiral, Delco, Stromberg-Carlson, Western Auto, Sparton, Motorola, Wards, Gamble, and many others.

Other Practical Radio Manuals

RADIO SERVICING COURSE



Let this 22-lesson course help you fix and adjust any radio set. Easy-to-understand explanations; hundreds of simplified diagrams, pictures, practical hints. Quickly learn how to make needed tests, locate faults, complete the repair. Learn new speed-tricks of radio fault finding, case histories of common troubles, servicing short cuts, extra profit ideas. Many active servicemen used this reduced price radio training for brush-up and study of new service methods. Large size: 8½ x 11 inches, 22 lessons, 224 pages. Hundreds of diagrams, illustrations, charts. **\$2.50**

★ STEWART-WARNER MANUAL 50c

★ ARVIN DIAGRAM MANUAL 50c

★ GENERAL-ELECTRIC MANUAL 50c
64 pages of popular circuits. Size: 5½ x 8½ inches

PRACTICAL RADIO MATHEMATICS

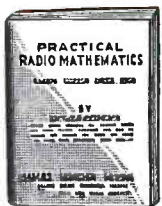

Introduces and explains the use of arithmetic and elementary algebra in connection with units, color code, meter scales, Ohm's Law, alternating currents, ohmmeter testing, wattage rating, circuits series and parallel connections, capacity, inductance, mixed circuits, vacuum tubes, curves, the decibel, etc., etc., and has numerous examples. Net. **25c**

See Your Radio Jobber or Send Coupon →

Supreme Publications

PUBLISHERS OF RADIO BOOKS, MANUALS, AND DIAGRAMS

1926-1938

The most popular volume of the series. Will pay for itself with the time saved during the first day of use. Includes all the popular old timers. Save hours on every job. 427 diagrams of the most serviced radios of this period, with parts lists and alignment information. 240 pages, 8½ x 11 inches. Sold with a money back guarantee. Price, postpaid, **\$2.50**



Compiled by M. N. Beitman, radio engineer, teacher, author & serviceman.

SAVE HOURS ON EVERY JOB

Be ready to make repairs in minutes instead of hours. You will be called upon to fix hundreds of models listed in these easy-to-use manuals. Tackle each job with the needed help found on every page in these handy service manuals. Greatest bargain in diagram books. Send your order today. Use these manuals this week.

NO RISK TRIAL ORDER COUPON

SUPREME PUBLICATIONS, 9 S. Kedzie Ave., Chicago 12, ILL.

Ship the following manuals: (Money back guaranteed)

- 1942 1941 1940 1939 1926-1938
 Radio Servicing Course Stewart-Warner Arvin
 General-Electric Manual Radio Mathematics

I am enclosing \$..... send postpaid.

Send C.O.D. I am enclosing \$..... deposit.

Name:

Address:

(Use Coupon or Send Order in a Letter)

3 STAR NOW TEAMED

THORDARSON

MEISSNER

RADIART

IMPORTANT!

For Faster, Better and More Complete
Service to All Customers,

Maguire Industries, Inc.,

formed its new

Electronic Distributor

and

Industrial Sales Department

This New Department Will Assume All
Merchandising, Sales & Customer Relation

Duties and Responsibilities Essential in
Marketing the Combined Products of the
Thordarson, Meissner & Radiart Divisions



**ELECTRONIC DISTRIBUTOR AND
INDUSTRIAL SALES DEPARTMENT**

PERFORMERS... TOGETHER!

ONE SALES SOURCE...ONE MARKETING RESPONSIBILITY
YOUR GUARANTEE OF BETTER SERVICE!



MEISSNER

COMPONENTS AND KITS

Meissner precision built components include Antenna, R.F. and Oscillator Coils; plastic, standard and Ferrocart Transformers; Cartwheel and replacement Windings; Coils, Chokes and Accessories.

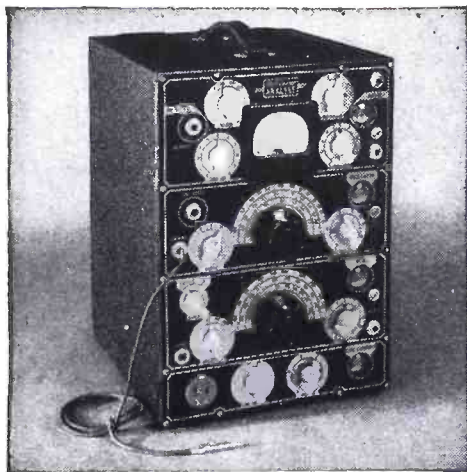

MEISSNER ANALYST

SERVICE INSTRUMENTS

Meissner Analyst operates by the "signal tracing" method, fastest and most reliable. Furnished complete, ready to go to work. Portable Signal Calibrator designed for accurate checking and adjusting of radio equipment.



RADIART

RUST-PROOF AERIALS



RADIART RUST-PROOF AERIAL

A complete line of newly designed aerials to fit all cars; cowl, fender and under hood types. Featuring water-proofed leads, "static muffler" magic ring and permanent all metal anti-rattler.



VIBRATORS

Radiart Correct Replacement Vibrators are individually engineered to meet exactly the physical as well as the electrical requirements of each application.



THORDARSON

TRANSFORMERS

Quality built and precision-engineered for all requirements; replacement, communications, sound amplifier, industrial, experimental and amateur. Tropex-impregnated for protection against moisture, salt air and humidity.

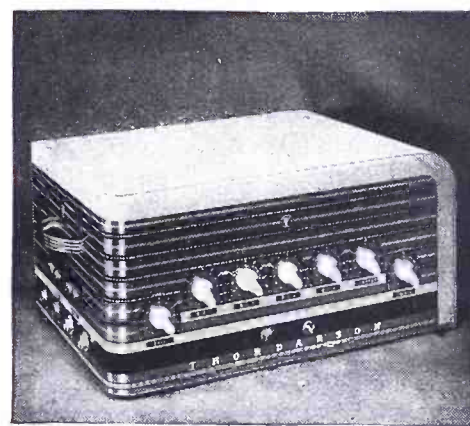

THORDARSON TRU-FIDELITY AMPLIFIER

TRU-FIDELITY AMPLIFIERS

True-Fidelity Amplifiers, in new modern designs, feature advanced tone compensation, conservative ratings, ample ventilation for continuous operation, low hum level, multiple input channels, and maximum flexibility of controls.

MAGUIRE INDUSTRIES, INC.

936 NORTH MICHIGAN AVENUE, CHICAGO 11, ILLINOIS

AUDELS REFRIGERATION & AIR CONDITIONING GUIDE \$4

New from Cover to Cover—1280 Pages, Fully Illus. Covering basic principles, servicing, operation & repair of household, commercial & industrial refrigeration & air conditioning. A gold mine of essential important facts for engineers, servicemen, shopmen & users.

AUDELS SHEETMETAL PATTERN LAYOUTS \$4

Developed by Experts for Sheet Metal Workers, Layout Men & Mechanics. A Practical Encyclopedia in 10 Sections, size 7 x 10 x 2—1125 Pages—350 Layouts—1600 Illustrations. 1001 Key Facts. Fully indexed for ready reference in answering your layout problems. Covers all phases of sheet metal work including Pattern Cutting, Pattern Development & Shop Procedure.

AUDELS SHEETMETAL WORKERS HANDY BOOK \$1

Practical inside information. Fundamentals of Sheet Metal Work. 388 pages. Fully illustrated. 11 sections. Clearly written. Essential & important facts, figures, pointers in everyday language. Ready Reference Index.

AUDELS WELDERS GUIDE \$1

A concise, practical text on operation and maintenance of all welding machines for all mechanics. Over 400 pages, fully illustrated. Covers all methods of electric and acetylene welding including airplane work.

AUDELS ANSWERS ON BLUE PRINT READING \$2

For Mechanics & Builders. Covers all types of blue print reading including ship & airplane. 376 pages, fully illustrated. New, complete.

AUDELS NEW MACHINIST & TOOLMAKERS HANDY BOOK \$4

Covers modern machine shop practice in all its branches. 5 practical books in 1. New from cover to cover. Tells how to set up & operate lathes, screw and milling machines, shapers, drill presses and all other machine tools. 1600 pages, fully illustrated, 5 x 6 1/2 x 2. Indexed. 5 sections. 1—Modern Machine Shop Practice. 2—Blue Print Reading & How to Draw. 3—Calculations & Mathematics for Machinists. 4—Shop Physics. 5—How to Use the Slide Rule. 60 chapters. Easy to read and understand. A shop companion that answers your questions.

AUDELS MATHEMATICS & CALCULATIONS FOR MECHANICS . \$2

Mathematics for home study or reference. 700 pages, 550 illustrations. Practical mathematics from beginning. How to figure correctly. New, easy, correct methods covering a complete review. Illustrated & indexed.

AUDELS AUTOMOBILE GUIDE \$4

A practical quick ready reference book for auto mechanics, service men, operators & owners. Explains theory, construction and servicing of modern motor cars, trucks, buses & auto type Diesel engines. 1540 pages, fully illustrated. 55 chapters. Indexed. A standard book for mechanics.

AUDELS DIESEL ENGINE MANUAL . . . \$2

A practical, concise treatise with questions and answers on the theory, operation and maintenance of modern diesel engines including General Motors 2 cycle Diesel. 384 pages, fully illustrated, flexible binding, pocket size. All details plainly brought out, this book is of extreme value to engineers, operators & students.

AUDELS SHIPFITTERS HANDY BOOK . \$1

288 pages of information, instruction, pictures & reference charts, together with many short cuts & trouble savers for shipfitters in their work.

AUDELS RADIOMANS GUIDE \$4

A key to the practical understanding of radio including Frequency Modulation, Television, etc., Aircraft & Marine Radio. For radio engineers, servicemen, amateurs. 772 pages. 400 Illustrations & Diagrams. Photos. Review Questions & Answers, Reference Index. Authentic, clear, concise.

AUDELS MECHANICAL DICTIONARY . \$4

950 pages. Over 17,000 new and standard mechanical terms, words, phrases, tables, formulas, helps, hints, short-cuts and practical suggestions. The right word when needed most.

AUDELS HANDY BOOK OF PRACTICAL ELECTRICITY \$4

For maintenance engineers, electricians & all electrical workers. 1440 Pages, 2600 Illustrations. Covers important electrical information in handy form—including Marine Wiring, Radio Principles, Welding. Fully indexed. The key to a practical understanding of electricity.

AUDELS CARPENTERS & BUILDERS GUIDES—4 Vols. \$6

A practical illustrated trade assistant on modern construction for carpenters, joiners, builders, mechanics and all woodworkers. 4 vols., 1600 pages, 3700 illustrations, flexible covers. Each volume pocket size. Sold separately \$1.50 a vol.

AUDELS PLUMBERS & STEAMFITTERS GUIDES—4 Vols. \$6

A Practical Trade Assistant & Ready Reference. Explaining in plain language & by clear illustrations, diagrams, charts, graphs, pictures the principles of modern plumbing practice including Marine Pipe Fitting and Air Conditioning. 4 Vols.—1670 Pages—3642 Diagrams. Each Vol. Pocket Size. Sold Separately \$1.50 a Vol.

AUDELS WIRING DIAGRAMS \$1

210 Pages. Illustrated. Gives practical facts on wiring of electrical apparatus. It explains clearly in simple language how to wire apparatus for practically all fields of electricity. Each diagram is complete & self-explanatory. A Highly Endorsed Pocket Companion.

AUDELS ELECTRIC DICTIONARY . . . \$2

For Every Worker Who Has To Do With Electricity. Enables you to understand and explain electrical problems. Defines more than 9000 words, terms & phrases in plain, unmistakable language, compiled with accuracy & thoroughness. Alphabetically arranged, reference index.

AUDELS MILLWRIGHTS GUIDE \$4

Practical up-to-date information on Plant Installation, Operation and Maintenance. 1200 pages completely illustrated, fully indexed. 1000 facts at your fingertips in 6 convenient sections with ready reference.

GUETHS MECHANICAL DRAWING . . \$1

A Concise Drawing Course. 150 pages, 50 plates. A complete instructor & reference work. Gives many helpful hints & suggestions on How to Draw.

AUDELS ELECTRONIC DEVICES \$2

Tells What You Want to Know About Electric Eye. Easily Understood. Covering photo-electric cells & their applications. Amplifiers, illumination, frequencies, voltage, photocell, tubes, Ohm's Law, wiring diagrams, etc.

AUDEL, PUBLISHERS, 49 W. 23 St., N.Y.



Information in a Handy Form! AN AUDEL GUIDE IS A GOOD FRIEND!

Use the brains and experience of others in these Guides of the Trades. Save time and money with right methods, short cuts, labor-saving ideas—"Learn more to earn more." Use our generous 7-day free examination privilege and our dollar a month payment plan. Become a Master in your Trade, and understand the Trades that tie into yours. How to obtain these Guides for examination. Mark X on the order blank the Guides desired. Every Audel Guide is complete, up-to-date, easily understood with Questions and Answers, fully illustrated and indexed. They speak for themselves. Send for yours today at our risk and expense. Ask to see them.

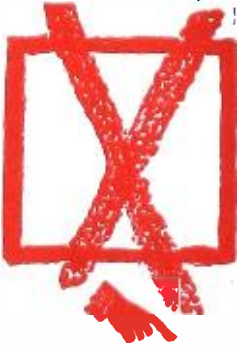

Check NOW!

You Can Look Over Any Guide In Your Own Home

Start the Easy Payments If Satisfied

MAIL THIS TODAY

CUT HERE MAIL ORDER

THEO. AUDEL & CO., 49 W. 23 St., New York 10, N.Y.

Please mail me for 7 days' free examination the books marked (X) below. I agree to mail \$1 in 7 days on each book or set ordered, and to further mail \$1 a month on each book or set ordered until I have paid purchase price.

If I am not satisfied with Guides I will return them.

- Audels REFRIGERATION & Air Conditioning Guide . \$4.
- Audels POWER PLANT ENGINEERS GUIDE . 4.
- Audels PUMPS, HYDRAULICS & AIR COMPRESSORS . 4.
- Audels WELDERS GUIDE . 1.
- Audels BLUE PRINT READING 2.
- Audels SHEET METAL WORKERS Handy Book 1.
- Audels SHEET METAL PATTERN LAYOUTS 4.
- Audels AIRCRAFT WORKER 1.
- Audels MATHEMATICS and CALCULATIONS 2.
- Audels MACHINISTS & TOOLMAKERS Handy Book . 4.
- Audels MECHANICAL Dictionary 4.
- Audels AUTOMOBILE GUIDE 4.
- Audels DIESEL ENGINE MANUAL 2.
- Audels MARINE ENGINEERS Handy Book 4.
- Audels SHIPFITTERS Handy Book 1.
- Gueths MECHANICAL DRAWING COURSE 1.
- Rogers DRAWING and DESIGN 2.
- Audels MILLWRIGHTS and Mechanics Guide 4.
- Audels CARPENTERS and Builders Guides (4 vols.) . 6.
- Audels PLUMBERS and Steamfitters Guides (4 vols.) . 6.
- Audels MASONS and Builders Guides (4 vols.) . . 6.
- Master PAINTER and DECORATOR 2.
- Audels GARDENERS & GROWERS GUIDES (4 vols.) . 6.
- Audels ENGINEERS and Mechanics Guides Nos. 1, 2, 3, 4, 5, 6, 7 and 8 complete 12.
- Audels Answers on Practical ENGINEERING 1.
- Hawkins Aids to ENGINEERS EXAMINATION 2.
- Audels ELECTRICIANS EXAMINATIONS 1.
- Audels WIRING DIAGRAMS 1.
- Audels Handy Book of PRACTICAL ELECTRICITY . . 4.
- Audels ELECTRICAL POWER CALCULATIONS 2.
- Hawkins ELECTRICAL Guides at \$1. each 10.
- Audels ELECTRONIC DEVICES 2.
- Audels ELECTRIC Dictionary 2.
- Audels RADIOMANS GUIDE 4.
- Audels NEW ELECTRIC LIBRARY at \$1.50 a Volume Vols. I, II, III, IV, V, VI, VII, VIII, IX, X, XI, XII.

Name _____
 Address _____
 Occupation _____
 Employed by _____ ROF

RADIO-CRAFT for FEBRUARY, 1946

ELEMENTS OF RADAR

(Continued from page 318)

scope screen as brilliant dots of light. Reflections from land, ships at sea, tall buildings, and other obstructions also appear on the indicator screen. Thus the PPI tube virtually draws a "map" of the area surrounding the radar set (Fig. 7). A high degree of screen phosphorescence permits examination of the "map" long after the antenna and base line have passed target echoes.

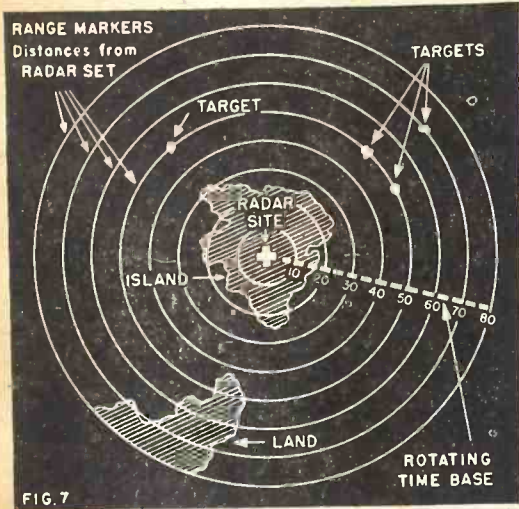

Fig. 7—PPI indicator shows surrounding area.

Radar indicators often have several oscilloscopes; one for measuring range, one for azimuth, one for elevation of aircraft. For obtaining precise data, some radar sets may have as many as five or six oscilloscopes. But their function is primarily the same: to present in detail information gathered by the remainder of the radar equipment.

In succeeding articles Mr. McQuay will explain in detail a number of the electronic phenomena and circuits used in radar transmitters. The first of these "Electronic Transients" will appear in our next issue.

TESTS ON NEW RADIOS

Postwar receivers should be purchased with caution, *Consumer Reports* stated last month. Tests on three of the earliest sets put on the market—all of them carrying unknown brand names—indicated shock hazard, over-pricing and other shortcomings.

Set No. 1, a large midget, priced at \$32.95, had fairly good tone, sensitivity, and volume, some hum and telegraph interference. Workmanship was poor, and set had a loose connection which crackled when cabinet was jarred. Set 2, a small table model, priced at \$39.95, had poor, boomy tone, not remediable by adjustment of the "tone control." Set 3, priced at \$44.05, was the poorest of the three, combining poor calibration with poor sensitivity at the low-frequency end of the dial, which exhibited excessive backlash. Tone quality was fair, construction poor. Higher price was apparently due to the standard short wave band incorporated in the set.

All three sets were A.C.-D.C., and had "live" parts such as screw heads projecting through the bottom, creating shock hazard. All were overpriced by pre-war standards, none of them comparing with a standard 1942 model which sold for \$28.95.

No standard brand radios manufactured by any of the leading manufacturers were available for testing at the time these radios were put on the market.

Sensitive to a Pin Drop Yet Tough as a Bull

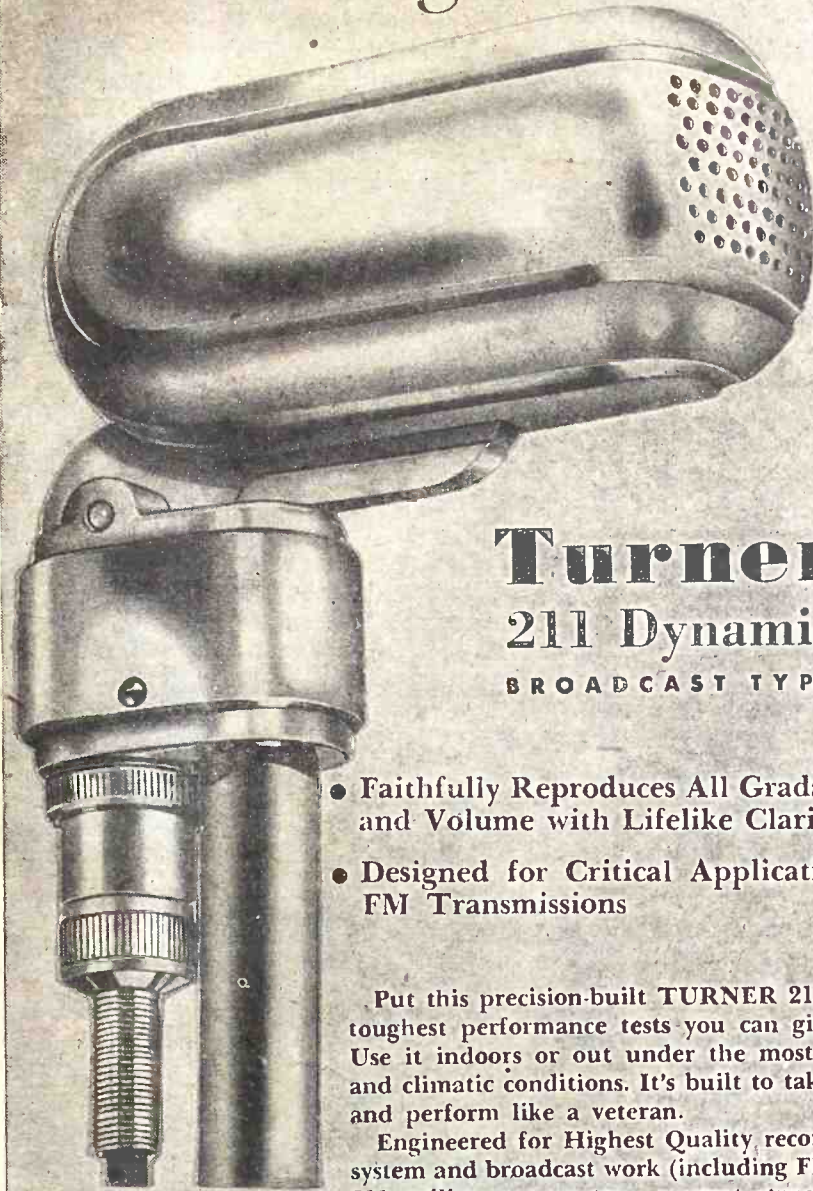

Turner 211 Dynamic BROADCAST TYPE

- Faithfully Reproduces All Gradations of Tone and Volume with Lifelike Clarity
- Designed for Critical Applications including FM Transmissions

Put this precision-built TURNER 211 Dynamic to the toughest performance tests you can give a microphone. Use it indoors or out under the most difficult acoustic and climatic conditions. It's built to take rough handling and perform like a veteran.

Engineered for Highest Quality recording, P.A., sound system and broadcast work (including FM), the TURNER 211 utilizes a new type magnet structure and acoustic network. The high frequency range is extended and the extreme lows raised 2 to 4 decibels. A unique diaphragm structure design results in extremely low harmonic and phase distortion without sacrifice of high output level. It has a range of 30-10,000 cycles with a very smooth response. Finished in rich chrome, the TURNER 211 Dynamic is equipped with tilting head for semi- or non-directional operation, balanced line output connection, and 20-ft. removable cable set.

Ask Your Distributor or Write



FREE Catalog

Write for complete catalog describing dependable, precision-built TURNER Microphones for all communications purposes.

The TURNER Co.

902 17th Street, N.E., Cedar Rapids, Iowa

Pioneers in the Communications Field



TURNER Microphones

CERTIFIED PERFORMANCE

Crystals Licensed Under Patents of the Brush Development Co.

NEW RADIO-ELECTRONIC DEVICES

AIRCRAFT RADIO

Airadio, Inc.
Stamford, Conn.

THIS two-way communication system is compact, highly sensitive, and ruggedly constructed. The two-band aircraft receiver and transmitter give highest performance and dependability under all flight conditions. The set offers standard plane-to-ground communication, radio range, weather broadcast, and standard broadcast reception, as well as interphone between pilot and passengers.

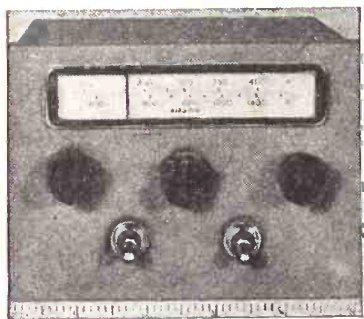

A space the size of a post-card is all that is necessary on the aircraft instrument panel for mounting the receiver. The edge-lighted slide rule dial is accurately calibrated and greatly simplifies tuning. The transmitter does not have to be accessible in flight and may be installed in a remote location.—*Radio-Craft*

SOLDERING IRON

Sound Equipment Corp of Calif.
Glendale, Calif.

THE Kwikheat Thermostatic Soldering Iron has a thermostat self-contained—maintaining constant heat at all times and preventing overheating.

The iron has an unusually long life expectancy because it eliminates the excessively high temperature acquired by the conventional electric soldering iron when in "idle" condition... the major contributing factor in soldering iron deterioration. Tips, too, last longer because they are never overheated and consequently need less re-tinning in this modern tool.

It heats up ready-to-use only 90 seconds after plugging in. This is made possible by a spe-

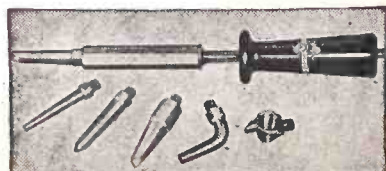

cial powerful 225-watt quick-heating element—held in check by the thermostat.

Six different tip styles can be easily interchanged. The tips are made of corrosion-resistant copper alloy. They screw into the iron for good contact and are tapered for efficient heat conductivity. One tip is an aluminum alloy melting pot for tinning, etc.—*Radio-Craft*

MIDGET VIBRATOR

Radiart Corporation
Cleveland, Ohio

THIS is the smallest vibrator made. It measures 2 1/8 inches high by 1 1/8 inches in diameter. One of the new radio developments of the war, it is designed for operation from a small 6-volt storage battery, furnishing power to replace dry-battery power in certain communications equipment. The entire power supply including the storage battery had to be made for a space 6 1/2 x 3 1/2 x 1 3/4 inches.

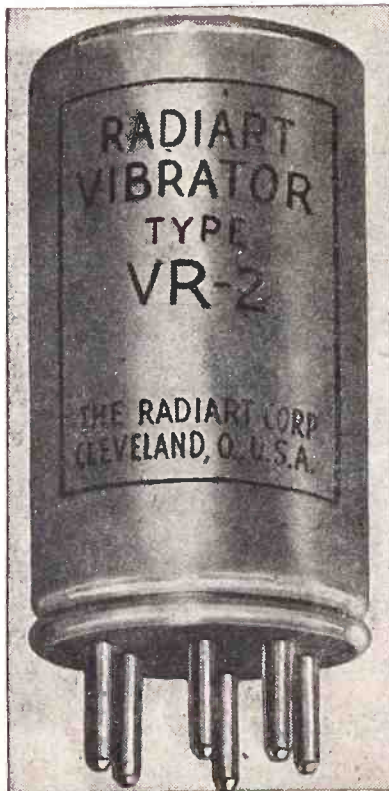

Naturally the vibrator had to be as small as possible.

Specifications of the VR-2 follow:

Vibrator frequency, 185 CPS ± 10%; input voltage nominal, 6.0v; input voltage range, 4.5v to 7.5v; input current, 1.5 amps max. at 6.0v; output voltage, 200v D.C. maximum; potential difference between primary reed and secondary reed, 25v maximum.—*Radio-Craft*

TUBE TESTER

Simpson Electric Co.
Chicago, Illinois

FEATURING a method of testing tubes in terms of percentage of rated dynamic mutual conductance, the new tester is believed by its creators to be so revolutionary that it will start a new trend in tube testing methods. A tube under test by the instrument is compared with the standard rated micromho value for that tube. Colored zones on the dial coincide with the micromho rating or

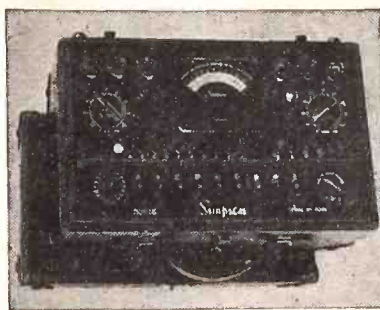

percentage of mutual conductance, indicating that the tube is good, fair, doubtful or definitely bad.

Ten push-button switches and nine rotating switches of six positions each provide a multitude of combinations in tube element and circuit selection. Very complicated tubes require only a few settings. A tube chart is provided for identifying the tube and setting the controls.

An automatic reset button returns all switches to normal when the test is completed, rendering the tester instantly ready for a new test.—*Radio-Craft*

CONNECTORS, ETC.

E. F. Johnson Co.
Waseca, Minnesota

CABLE connectors, pilot and dial light assemblies, tip plugs and tip jacks, formerly Mallory-Yaxley products, have been added to the Johnson line of radio parts

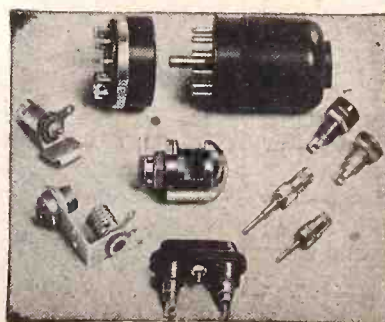

and in the future will be manufactured and sold solely by Johnson. The seven- and 12-wire cable connectors are polarized and contacts are clearly marked for convenience.

Tip plugs are of the solderless type and supplied in a long and short length. Tip jacks are available with either metal or bakelite type heads and both are available with round and hexagon heads. Pilot lights can be supplied with a variety of jewel colors and jewels may be purchased separately for replacement. Dial lights are supplied as shell assemblies and with slip-on brackets to facilitate speed and ease in installation and bulb replacement.—*Radio-Craft*

V-O-MA METER

Triplett Electrical Instrument Co.
Bluffton, Ohio

MODEL 2405 ranges are:
DC volts: 0-10-50-250-500-1000, at 25,000 ohms per volt; AC volts: 0-10-50-250-500-1000, at 1000 ohms per volt; DC amperes: 0-10; AC amperes: 0-0.5-1-10; DC mil-

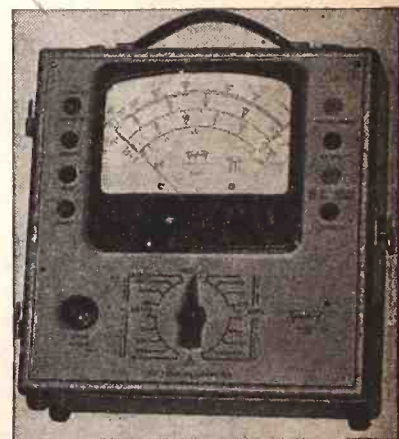

liamperes: 0-1-10-150-250; DC microamperes: 0-50; ohm-megohms; 0-4000-40,000 ohms—4-40 megohms. Output: Condenser in series with AC volts.

The large 6-inch model 626 Microammeter is adjusted to 40 microamperes. Scale is 5.6 inches long.

"SQUARE LINE" metal case, 10x10x5 3/4 inches, detachable, hinged cover, compartment for instructions and accessories. Leather strap handle for portable use. Batteries self-contained. Leads furnished. Weight approximately 11 pounds.—*Radio-Craft*

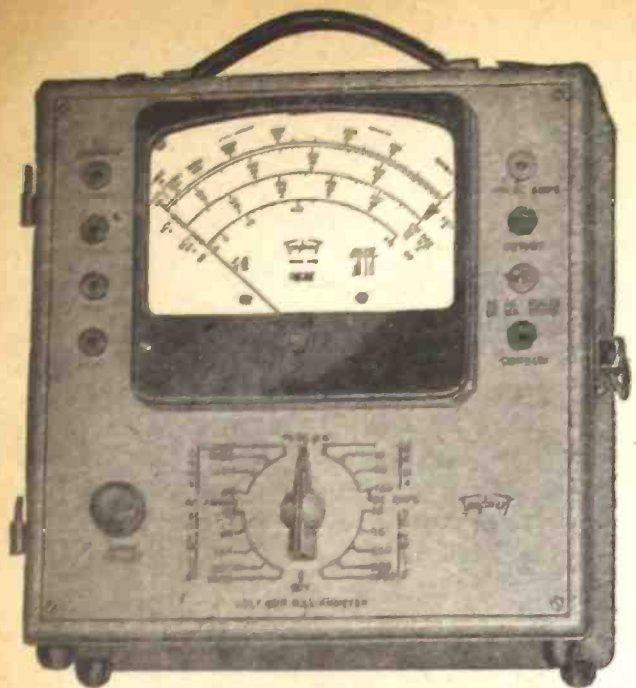

MODEL 2405

Volt-Ohm-Milliammeter

25,000 OHMS PER VOLT D.C.



SPECIFICATIONS

NEW "SQUARE LINE" metal case, attractive tan "hammered" baked-on enamel, brown trim.

- PLUG-IN RECTIFIER—replacement in case of overloading is as simple as changing radio tube.
- READABILITY—the most readable of all Volt-Ohm-Milliammeter scales—5.6 inches long at top arc.
- RED-DOT LIFETIME GUARANTEE on 6" instrument protects against defects in workmanship and material.

NEW ENGINEERING • NEW DESIGN • NEW RANGES 30 RANGES

- Voltage: 5 D.C. 0-10-50-250-500-1000 at 25000 ohms per volt.
- 5 A.C. 0-10-50-250-500-1000 at 1000 ohms per volt.
- Current: 4 A.C. 0-.5-1-5-10 amp.
- 6 D.C. 0-50 microamperes—0-1-10-50-250 milliamperes—0-10 amperes.
- 4 Resistance 0-4000-40,000 ohms—4-40 megohms.
- 6 Decibel -10 to +15, +29, +43, +49, +55
- Output Condenser in series with A.C. volt ranges.

Model 2400 is similar but has D.C. volts Ranges at 5000 ohms per volt.

Write for complete description

Triplet

ELECTRICAL INSTRUMENT CO.

BLUFFTON, OHIO.

DECIBEL PROBLEMS

(Continued from page 320)

Power Ratio	W_2/W_1	Logarithms	Bels	Decibels
10	10^1	1	1	10
1	10^0	0	0	0
.1	10^{-1}	-1	-1	-10
.01	10^{-2}	-2	-2	-20
.001	10^{-3}	-3	-3	-30
.0001	10^{-4}	-4	-4	-40
.00001	10^{-5}	-5	-5	-50

First the power ratio is re-written as 10 raised to some exponent, the exponent being the number of zeros to the right of the 1 and preceding the decimal point (for numbers less than 1 the zeros are to the left, so the exponents are negative). This exponent of 10 is called the *logarithm* of the ratio.

We already have enough to define the common logarithm; the log of a number is the *power* (exponent) to which 10 must be raised to equal the number. In other words, if 10^n equals a certain number, then "n" is the log of the number. *That's all there is to the logarithm.*

Bels are logs provided we start, not with just any number, but with a ratio of two values of power (watts) since Bels, to avoid confusion, apply only to power ratios. Decibels, as the prefix Deci- implies, are 10 x the number of Bels or 10 x the log of a power ratio. In other words, Db power change = 10 x the logarithm of the final power divided by the original power. This formula may be stated:

$$\text{Db power change} = 10 \log W^2/W^1, \text{ or } \text{Db} = 10 \log P^2/P^1$$

We have taken easy cases in the above tables—exact powers of 10. Finding the logs of other numbers requires the use of log tables since it is not so easy to find the exponent to which 10 must be raised to produce, say, 5.

LOG AND DECIBEL RULES

(Refer to logarithm tables)

When the ratio is more than 1, the log and Db value will be positive. If less than 1, they are negative. When the ratio is exactly 1 they are zero.

For a ratio between 1 and 10, the log is somewhere between 0 and 1 (a fraction or decimal) and the Db value is between 0 and 10. For a ratio between 10 and 100, the log is between 1 and 2 and the Db value is between 10 and 20, etc.

When ratios are to be multiplied together, their logs or Db equivalents must be added together. This may be illustrated by the example— $100 \times 1000 = 100,000$. Expressing this in exponential form, $10^2 \times 10^3 = 10^{(2+3)} = 10^5$. The log of 100 is 2, the log of 1000 is 3, and the log of 100,000 is 5, since $2+3 = 5$. The preceding operation may be written: $\log 100 + \log 1000 = \log 100,000$. By decibels, a power ratio of 100 is 20 Db, of 1000 is 30 Db, and of 100,000 is 50 Db. Hence $20 \text{ Db} + 30 \text{ Db} = 50 \text{ Db}$ is another way of writing $100 \times 1000 = 100,000$.

A second article on this subject will appear in an early issue. In it, Mr. Ledbetter will discuss voltage and power levels, and describe how decibel tables are made.

the ratio of change is 2 to 1. So, it may be said that the successive increase of acoustic power by a constant ratio results in increases of loudness by approximately constant steps.

From the foregoing it is evident that the word "Ratio" is all-important. It is the business of the decibel to express such ratios in a convenient form which tremendously simplifies calculations and the interpretation of the results.

DECIBELS AND LOGARITHMS

The subject of decibels could easily be handled without once using the word "logarithm." This has been seriously contemplated, since many seem to be afraid of the word. But it is so great a help that it just isn't fair to pass it up. We could walk twenty miles on foot, but we prefer to drive a very complicated automobile. "Logs" have certain complicated aspects (which do not enter into Db work), but we need only to know what logarithms are and how to use them—a very simple matter. Now, if necessary, forget all you know about logs and study the relation between the columns in the following tabulations.

Power Ratio	W_2/W_1	Logarithms	Bels	Decibels
10	10^1	1	1	10
100	10^2	2	2	20
1000	10^3	3	3	30
10000	10^4	4	4	40

Proceeding downward from 10 we have zero and negative exponents, as may be seen in the next table. Note that a power ratio of 1:1 is expressed by 10^0 , a rather strange-looking expression, but one justified by its position in the scale.

SILVER



"VOMAX"

SEE FEBRUARY, 1946,
RADIO NEWS FOR
COMPLETE DESCRIPTION

Leaving far behind the limitations of conventional testers and electronic voltmeters, "VOMAX" blazes new trails to make the serious service technician the master . . . no longer the victim . . . of service and design problems. With "VOMAX" you can measure every voltage found in radio receivers.

What this means in time saved . . . work better done . . . increased profits . . . is conclusively proved by overwhelming acceptance of "VOMAX". Since V-J Day the military, university research groups, atomic bomb laboratories, service technicians by the thousands have forced production up . . . and again up.

Read the briefed specifications at right, and you will realize why "VOMAX" is the primary "must" for every service technician. Built to rigid specifications . . . using finest of parts . . . no wonder OPA ceiling is much the higher than \$59.85.

Your favorite jobber can supply "VOMAX" . . . make you master of your trade, for only \$59.85 if you order now.

OVER 34 YEARS OF RADIO ENGINEERING ACHIEVEMENT

McMurdo Silver Company
1240 MAIN STREET, HARTFORD 3, CONNECTICUT

RADIO-CRAFT for FEBRUARY, 1946

Measures EVERY Voltage

1. Brand new post-war design . . . positively not a "warmed-over" pre-war model.
2. More than an "electronic" voltmeter, VOMAX is a true vacuum tube voltmeter in every voltage resistance db. function.
3. Complete visual signal tracing from 20 cycles through over 100 megacycles by withdrawable r.f. diode probe.
4. 3 through 1200 volts d.c. full scale in 6 ranges at 51 and in 6 added ranges to 3000 volts at 126 megohms input resistance. Plus-minus polarity reversing switch.
5. 3 through 1200 volts a.c. full scale in 6 ranges at honest effective circuit loading of 6.6 megohms and 8 mmfd.
6. 0.2 through 2000 megohms in six easily read ranges.
7. -10 through +50 db. (0 db. = 1 mw. in 600 ohms) in 3 ranges.
8. 1.2 ma through 12 amperes full scale in 6 d.c. ranges.
9. Absolutely stable—one zero adjustment sets all ranges. No probe shorting to set a meaningless zero which shifts as soon as probes are separated. Grid current errors completely eliminated.
10. Honest factual accuracy: $\pm 3\%$ on d.c.; $\pm 5\%$ on a.c.; 20 Ω through 100 megacycles; $\pm 2\%$ of full scale, $\pm 1\%$ of indicated resistance value.
11. Only five color-differentiated scales on 4" D'Arsonval meter for 51 ranges (including d.c. volts polarity reversal) eliminate confusion.
12. Meter 100% protected against overload burnout on volts ohms db.
13. Substantial leather carrying handle. Size only 12" x 7 3/8" x 5 7/8".

Send postcard for free catalog of measurement and communication equipment.

300-MC TRANSCEIVER

? I would like a diagram of a portable one-meter transceiver, using battery tubes. The range should be about three miles. I would like the set to be as small as possible.—J. M., Barnesville, Ohio.

A. Radio transmission is prohibited to the general public without a license. The possession of an amateur radio license permits transmission in certain bands, but 300 mc is not included at the present time. The set shown will operate on 2½ meters. See Fig. 1.

In the diagram the HY114 is used both as super-regenerative receiver and transmitting oscillator. The antenna coil is one turn of No. 14 wire and the secondary has two turns, both with a diameter of ¼". The spacing of the secondary must be determined by experiment, as with Lecher wires, for example.

More than three miles can be covered from a suitably high location with a good antenna. The latter should be about 9 inches long, using the system shown. If a dipole is desired, each half should be 9 inches long and the center goes to a twisted pair or coaxial cable.

A carbon microphone is used, and operated from the "C" battery.

A diagram of a transmitter for working on these short waves appears on page 319. The use of Lecher wires are also explained in the same article.

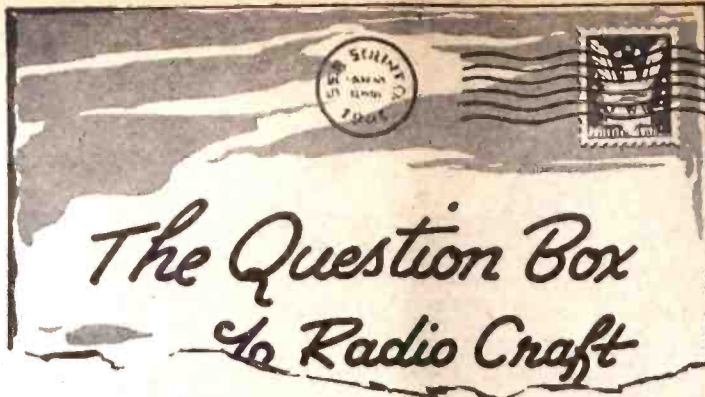

The Question Box is again undertaking to answer a limited number of questions. Queries will be answered by mail and those of general interest will be printed in the magazine. A fee of 50c will be charged for simple questions requiring no schematics. Write for estimates on such questions as require diagrams or research.

6-TUBE AMPLIFIER

? I would like to build an amplifier using the following tubes: 56, 53, 2A5's in push-pull, and an 80. The input side of the amplifier should be equipped to handle a phono pickup and a mike.—B.S.N., Stratford, Conn.

A. The diagram shows an amplifier using the tubes requested. However, there would be insufficient gain for a microphone, so an additional 57 high-gain stage has been added. With reasonable care, there should be no difficulty in construction and operation. The usual problems in shielding can be solved in the ordinary manner. Leads should be kept close to the chassis and as short as possible. (See Fig. 2.)

quate power for a portable phono. W.F., Blairstown, N. J.

A. The amplifier shown is designed to give you the most power with a minimum of parts and reasonably high

fidelity. The values of all parts are given on the diagram. (Fig. 3.) Choke should be one of about 200-ohms resistance. A phono pickup with an output of about one volt should drive the amplifier to

A.C. AMPLIFIER

? Please print a diagram of a small A.C.-operated amplifier that uses as few parts as possible yet will give ade-

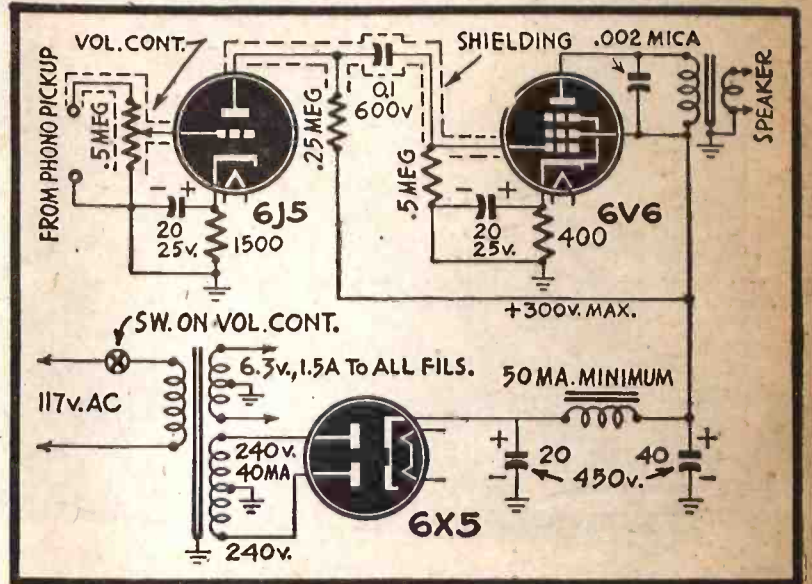

Fig. 3—A two-tube amplifier for A.C. use.

full power output. Very little shielding should be necessary if the input leads and the 6J5 are kept away from the power and output transformers.

ALIGNMENT TROUBLES

? I have built the two-tube radio shown in the Radio-Electronic Circuits last September. This set is very weak at one end of the dial only. Can this be remedied?—S. F. L., Indianapolis, Ind.

A. This, or any other TRF set using a two-gang condenser, may be aligned easily. You need a dial calibrated in kilocycles and an extra variable condenser of about the same capacity as one section of your gang.

Disconnect one of the gang sections from its coil, tuning the coil with the temporary variable. Tune in several stations, using both condensers. Check their positions on the dial, and add or remove turns from the coil still connected to the gang section till they come in at the correct points. This will align one coil, which is then connected to the temporary condenser, while the other coil is attached to its gang section and similarly aligned.

In other words, you simply adjust each circuit with the help of the calibrated dial, using the temporary condenser to tune the other circuit while doing so.

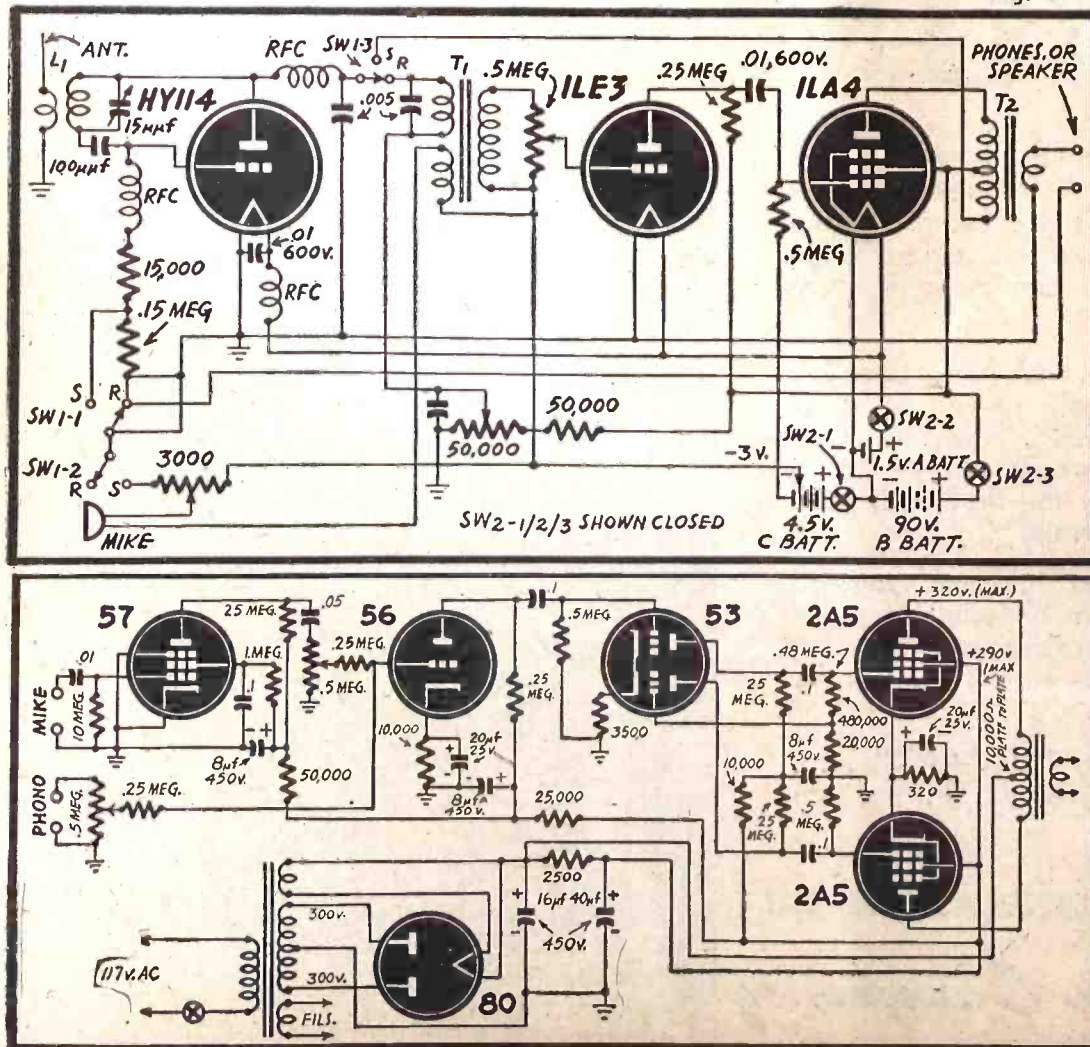
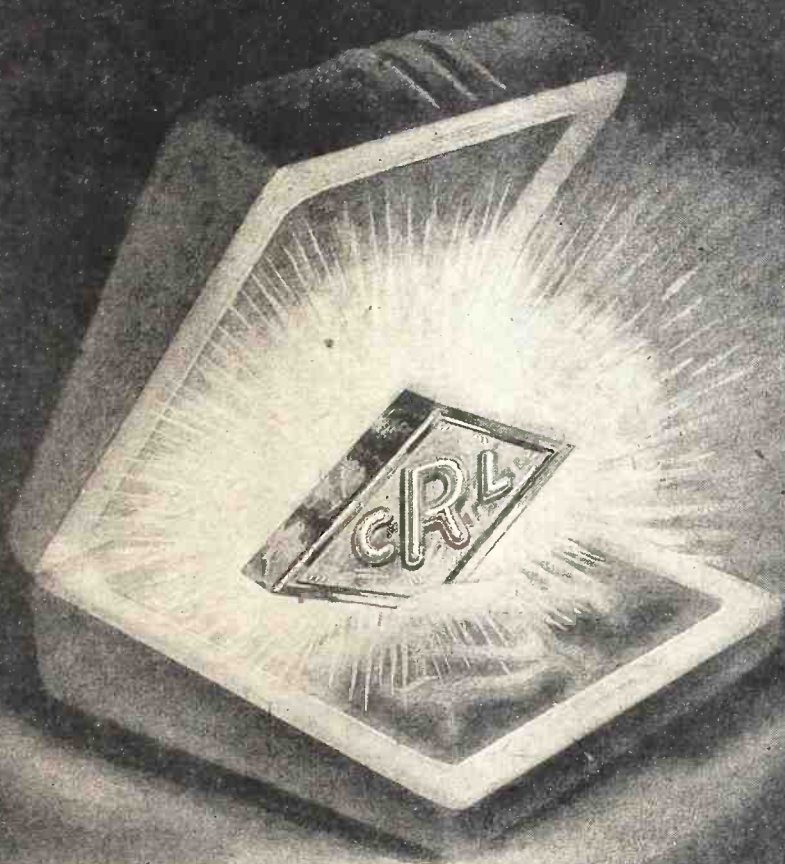

Fig. 1, above—Transceiver for 2 meters. Fig. 2, below—Amplifier for 2½-volt tubes.

The Mark of Quality



The initials "CRL" in the Diamond stand for Centralab

They are an integral part of the Centralab name, and for more than a quarter of a century have represented the utmost in engineering skill and precision . . . the height of manufacturing perfection.

Both in original equipment and in replacements, the symbol "CRL" is the Mark of Quality.

. . . Always specify Centralab.

Ceramic High Voltage Capacitors
Bulletin 814

Centralab

Division of GLOBE-UNION INC., Milwaukee

PRODUCERS OF

Ceramic High Voltage Capacitors
Bulletin 814



Variable Resistors
Bulletin 697

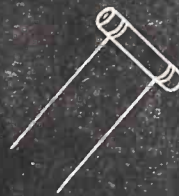

Tubular Ceramic Capacitors
Bulletins 630 and 586



Selector Switches
Bulletin 722



Ceramic Trimmers
Bulletin 695

33 well overlapped ranges . . .

plus long-life dependability!

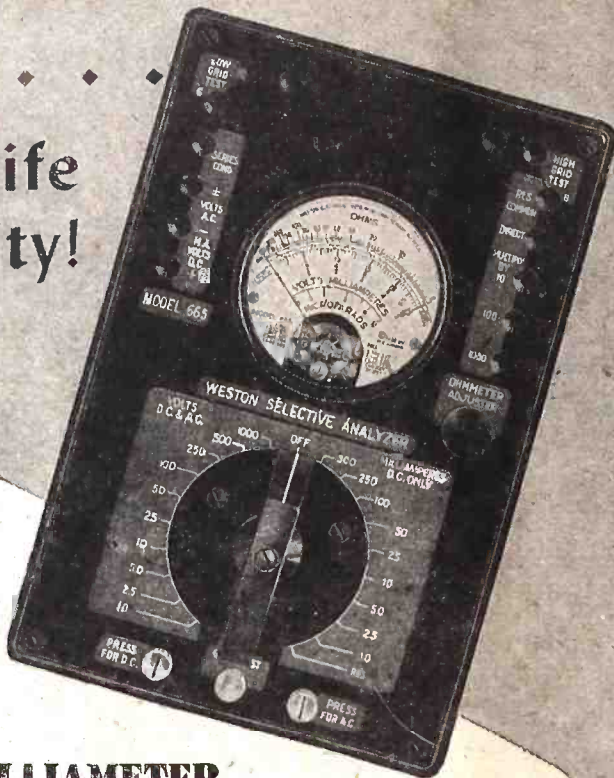

WESTON

(Model 665 Type 1)

VOLT-OHM-MILLIAMETER

Its compactness, versatility and rugged dependability make Model 665 the ideal instrument for use in the field, or in the shop . . . whether servicing communications equipment, testing electrical components in production, or research or maintenance work. Provides 33 AC and DC voltage, DC current, and resistance ranges . . . with simplified switching arrangement for rapid operation. Built to WESTON standards to assure dependable measurement accuracy throughout the years. Full details on request. Weston Electrical Instrument Corporation, 599 Frelinghuysen Avenue, Newark 5, N. J.

WESTON Instruments

WORLD-WIDE STATION LIST

(Continued from page 326)

UNITED STATES

Boston, Mass.	WRUW	6.040	Central American beam, 8:30 pm to 1 am
Boston, Mass.	WRUA	9.570	European beam, 4:30 to 6 pm
Boston, Mass.	WRUS	9.700	Central American beam, 6:30 pm to 1 am
Boston, Mass.	WBOS	9.897	European beam, midnight to 3:15 am; 1 to 5:45 pm
Boston, Mass.	WRUL	11.730	North African beam, 6 to 8:45 am; Mexican beam, 6:30 pm to 1 am
Boston, Mass.	WRUW	11.730	European beam, 1 to 5 pm; Caribbean beam, 5:15 to 5:45 pm

Boston, Mass.	WRUS	11.790	European beam, 6 am to 4:15 pm; 4:30 to 6 pm
Boston, Mass.	WRUW	15.180	European beam, 6 to 8:45 am
Boston, Mass.	WBOS	15.210	European beam, 6 am to 12:45 pm
Boston, Mass.	WRUL	15.290	North African beam, 9 am to 5 pm; Caribbean beam, 5:15 to 5:45 pm
Boston, Mass.	WRUA	15.350	European beam, 6 am to 4:15 pm
Boston, Mass.	WRUW	17.750	Central American beam, 6:30 to 8:15 pm; European beam, 9 am to 12:45 pm
Cincinnati, Ohio	WLWK	6.080	South American beam, 7:30 pm to 12.15 am

Cincinnati, Ohio	WLWO	9.590	European beam, 8 to 4:45 pm; South American beam, 6 pm to 12:15 am
Cincinnati, Ohio	WLWRI	9.750	North African beam, 3:15 to 6 pm
Cincinnati, Ohio	WLWK	11.710	European beam, 7:30 am to 4:30 pm
Cincinnati, Ohio	WLWS2	11.710	South American beam, 5 to 7:15 pm; 7:30 to 9:30 pm
Cincinnati, Ohio	WLWLI	11.810	European beam, 6 to 7:45 am; 1 to 5:45 pm
Cincinnati, Ohio	WLWSI	15.200	South American beam, 5 to 7:15 pm
Cincinnati, Ohio	WLWL2	15.230	North African beam, 6 to 7:45 am; 8 am to 12:45 pm; 1 to 5:45 pm
Cincinnati, Ohio	WLWK	15.250	South American beam, 5 to 7:15 pm
Cincinnati, Ohio	WLWRI	15.250	North African beam, 7:30 am to 3 pm
Cincinnati, Ohio	WLWO	17.800	South American beam, 5 to 5:45 pm; European beam, 7:30 am to 2:30 pm
Cincinnati, Ohio	WLWLI	17.955	European beam, 8 am to 12:45 pm
Los Angeles, Calif.	KCBR	9.700	Oriental beam, 2 to 4:45 am; 5 to 11 am
Los Angeles, Calif.	KCBF	9.750	South American beam, 11 pm to 1 am; East Indies beam, 4 to 9:45 am
Los Angeles, Calif.	KCBR	15.270	Oriental beam, 4 to 10 pm; 10:15 pm to 1 am
Los Angeles, Calif.	KCBF	17.850	South American beam, 5 to 10:45 pm
New York City	WCBN	6.060	Mexican beam, 6:30 pm to 1 am
N. Y. City	WOOW	6.120	European beam, midnight to 3:15 am
New York City	WNRE	7.565	European beam, midnight to 3:15 am; 4:30 to 6 pm
New York City	WOOC	7.805	European beam, midnight to 3:15 am; 3:30 to 5:45 pm
New York City	WCBX	9.490	Brazilian beam, 4 to 10:30 pm
New York City	WRCA	9.670	Brazilian beam, 7 to 10:30 pm
New York City	WNRA	9.750	European beam, 1:45 to 6 pm
New York City	WCBN	11.145	European beam, 1 to 5:45 pm
New York City	WCRC	11.826	European beam, 6 to 10:30 am
New York City	WCRC	11.830	European beam, 10:45 am to 4:30 pm; South American beam, 5 to 11 pm
New York City	WNBI	11.870	South American beam, 6:30 to 11 pm
New York C.	WOOW	11.870	European beam, 6 am to 5:45 pm
New York City	WNBI	11.893	European beam, 1:15 to 4:45 pm
New York City	WNRI	13.050	European beam, 6 am to 6 pm
New York City	WNRX	14.560	European beam, 6 am to 3:45 pm
New York City	WRCA	15.150	European beam, 7:30 am to 3:30 pm; Brazilian beam, 4 to 6:45 pm
New York City	WOOC	15.200	European beam, 6 am to 3:15 pm
New York City	WCBX	15.270	European beam, 6 am to 3:45 pm
New York City	WNRE	15.280	European beam, 7:30 am to 4:15 pm
New York City	WNBI	17.780	South American beam, 5 to 6:15 pm; European beam, 7:30 am to 1 pm
New York City	WCBN	17.880	European beam, 6 am to 12:45 pm
New York City	WNRA	18.160	European beam, 6 am to 1:30 pm
San Francisco, Calif.	KWID	7.230	Oriental beam, 6:45 to 11 am
San Francisco, Calif.	KGEX	7.250	Philippine beam, 5 am to noon
San Francisco, Calif.	KNBA	7.565	Oriental beam, 4 to 9:45 am
San Francisco, Calif.	KCBA	7.575	East Indies beam, 4 to 9:45 am

(Continued on page 365)

REVAMPED TESTER

(Continued from page 322)

is possible because of the full-wave rectification of the meter.

If polarity indications are necessary, connections can be made to terminals Nos. 1 and 5 on the meter, in series with a suitable resistor, for any range needed, using 1000 ohms per volt.

The master switch offers the following ranges:

Pos.				
1	0-2½	miliampere, D.C. and A.C.		
2	0-25	"	"	"
3	0-250	"	"	"
4	0-2½	volts	"	"
5	0-25	"	"	"
6	0-100	"	"	"
7	0-250	"	"	"
8	0-1000	"	"	"
9	0-500,000	ohms		
10	0-5,000	ohms.		
11	Low	ohms.		

The parts used are:

- M—350 microampere meter.
- R—Built-in rectifier
- B—Self-contained battery.
- Y—3150 ohm resistor, for compensating of the A.C. readings.
- X—2000 ohm resistor, in series with meter.
- VR1—10,000 ohm resistor, across the meter used for zero set.
- SW1, 2, 3, 4—Gang switch, with eleven positions.
- SW5—S.P.S.T. switch, to compensate for the A.C. readings.
- Resistors—2K, 1K, 200, 100, 20, 13½ ohms, form the tapped shunt.
- Resistors—500, 7,500, 15,000, 75,000, 150,000, 750,000 ohms, are the series resistors for the voltage readings.
- Resistors—10,000, 96 ohms are the series resistors used for the resistance measurements.
- Resistor—3.75 ohms is the shunt to increase meter current for low-ohm scale.

BINAURAL HEARING AID

A new British hearing aid employs two microphones and two earpieces to give the stereophonic effect of normal hearing. The average person's ability to distinguish direction from which a sound comes is upset by an ordinary hearing aid.

For frequencies below about 1,000 cycles per second, this directional effect is attributed to the time interval between "reception" of the sound in the ear nearer the source and in the one farther away, while for higher frequencies it is considered to be due to a difference in intensity because of the acoustic shadow cast by the head. The "cross-over" frequency at which the effects merge varies with different individuals, but both demand that each ear be used at approximately the same sensitivity.

The stereophonic hearing aid has two separate amplifying channels, each with its own tone and volume controls. In addition, there is an overall volume control. The individual controls are pre-set by an expert for the individual user, who then adjusts volume with the master control.

For best binaural results the microphones should be placed on the sides of the body, in a position corresponding to that of the ears.

RADIO PARTS

ELECTRONIC EQUIPMENT



Mail Coupon NOW for

CONCORD

**Victory Clearance
Flyer . . . FREE!**

● Ready now! 32 Bargain-packed pages listing thousands of standard-make, top-quality radio parts and electronic supplies—now available without priority at low VICTORY CLEARANCE prices. The values listed at the left are typical of the important savings offered in Meters, Condensers, Transformers, Resistors, Controls, Switches, Relays, Test Equipment, Generators, Microphones, Tools, and hundreds of Repair, Replacement, and Accessory Parts. On special requirements, Concord experts are ready to help you in expediting and speeding action on essential needs.

**Order Today for Shipment
Tomorrow from
CHICAGO OR ATLANTA**

Huge stocks in TWO convenient warehouses—one in CHICAGO and one in ATLANTA—are ready to supply you quickly with needed parts of dependable, nationally-known quality—and at VICTORY CLEARANCE prices that mean real savings. Mail the coupon below NOW for your FREE copy of CONCORD'S VICTORY CLEARANCE Flyer.

Check These Typical CONCORD VALUES



D. C. Milliammeters
2½" flange mtg. type.
Metal case dull black
finish. G. E. 0-200
M. A. C10650.
Specially
Priced \$4.95

Output Transformer

Hermetically sealed. Six studs. 1, 2, and 3 are pri. 4, 5, and 6 the sec. Pri. ind. at 5 V. 1000 cy.; .20 H. Ratio sec. to p.i. 3.02:1. size: 3¼ x 2 41/64" 5B5045.
Your cost \$1.95



Dry Electrolytic Condenser

Hermetically sealed. Size, 1½" x 3". Can negative. Cap.: 40 mfd. at 475 volts; 15 mfd. at 350 volts; 15 mfd. at 150 volts; 20 mfd. at 25 volts. 5B3161
Each 59c

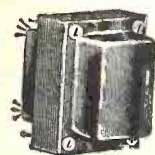
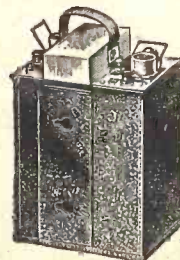

Plate Power Transformer

Pri. tapped at 115, 117 and 120 V.A.C. Sec. output 850 V., at 200 ma. c. t. 4¼" L x 3¼" W x 3¼" H. 5B5035.
Your cost \$4.29



Mobile High Voltage Power Unit

Input 12 V. at 10 amps. Output consists of two voltage ranges: (1) 275 at 110 ma. (2) 500 at 50 ma. 5B9518
Your cost \$39.50



300 Watt Rheostat

Wire wound. Vitreous enameled. Cast aluminum base. 6" dia. 2½" deep. 1400 ohms. 5B9517
Your cost \$3.95

CONCORD RADIO CORP.

LAFAYETTE RADIO CORPORATION

CHICAGO 7, ILL.
901 W. Jackson Blvd.

ATLANTA 3, GA.
265 Peachtree Street

CONCORD RADIO CORPORATION
901 W. Jackson Blvd.
Dept. RC-26
Chicago 7, Ill.



Please RUSH FREE copy of CONCORD'S new 32-page VICTORY CLEARANCE Flyer.

Name
Address
City State

OHMITE RESISTORS

+
Your Guide to

**DEPENDABLE
RESISTANCE
CONTROL**

+

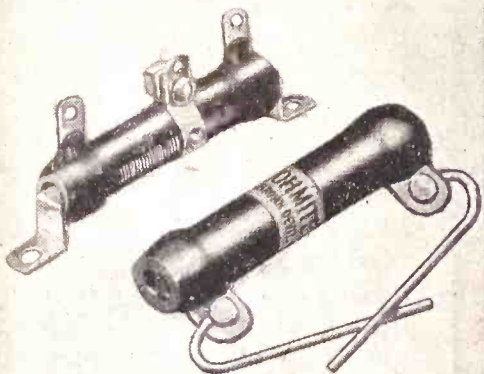

The service record of Ohmite Brown Devil and Dividohm Resistors before and during the war . . . is your best guide to resistance-control now. Ohmite construction insures long, trouble-free performance . . . makes these units favorites for the best in resistor replacement.

Write for Stock Unit
Catalog No. 18

Authorized Distributors Everywhere



OHM'S LAW CALCULATOR

Figures ohms, watts, volts, amperes...easily. Solves any Ohm's Law problem with one setting of the slide. Send only 10c in coin.

OHMITE MANUFACTURING CO.
4894 FLOURNOY ST. • CHICAGO 44, U. S. A.

Be Right with **OHMITE**
RHEOSTATS • RESISTORS • TAP SWITCHES

LAWS OF THE ATOMS

Compiled by HELEN M. DAVIS*

1. A single ATOM is the tiniest particle of any chemical element that can exist by itself and retain the qualities that mark it as that element.

2. All material things in the universe known to our senses are composed of one or more CHEMICAL ELEMENTS.

3. Substances composed of more than one element are known as COMPOUNDS. Atoms of elements are held together in compounds by electrical forces in the outer parts of their structure.

4. The smallest unit of a compound, usually composed of two or more atoms, is known as a MOLECULE.

5. There used to be 92 chemical elements, from hydrogen (${}^1\text{H}^1$) the lightest, to uranium (${}^{92}\text{U}^{238}$), the heaviest. There are now two new elements, NEPTUNIUM (${}^{93}\text{Np}^{239}$) and PLUTONIUM (${}^{94}\text{Pu}^{239}$).

6. When elements are represented, as above, by their chemical SYMBOLS, the subscript number is the atomic number. This is different for each element. The superscript number represents the atomic weight.

7. One of the qualities characteristic of matter is weight or mass. ATOMIC WEIGHT is expressed on a relative scale, as compared with the weight of hydrogen which is taken as one.

8. ATOMIC NUMBER is the measure of the electric charge on the nucleus of the atom. Atomic weight is the measure of the atom's mass.

9. Different samples of the same element, when tested by chemists, are sometimes found to have different atomic weights. Lead which occurs with radium, for example, has a different atomic weight from ordinary lead.

10. In all other ways the two kinds of lead are chemical twins, exactly alike except for weight. Elements which differ in weight only are called ISOTOPES.

11. Uranium has several isotopes. The usual kind, whose atomic weight is 238, was used to produce the two new elements. U-235 was used to make the ATOMIC BOMB.

12. Each of the new elements, neptunium and plutonium, has two isotopes whose atomic weights are 238 and 239.

13. Different elements, quite distinct in chemical behavior, may have the same atomic weight. We have ${}^{92}\text{U}$ -238, ${}^{93}\text{Np}$ -238 and ${}^{94}\text{Pu}$ -238, all with different properties. Such elements are now called ISOBARS.

14. All atoms are composed of standard interchangeable parts. These are PROTONS, NEUTRONS and ELECTRONS.

15. Protons and neutrons make up the NUCLEUS of the atom. The structure of the atom is much like that of the solar system. The nucleus corresponds to the sun at the center. The planets are electrons revolving in their orbits.

16. The proton and the neutron each have a mass about equal to that of a hydrogen atom, which is 1 on the chemist's scale. Each is about 1800 times heavier than the electron.

17. The ELECTRONS, light in weight and some distance away from the heart or nucleus of the atom, revolve around the nucleus much as planets revolve around the sun. They are held in their courses by electric attraction.

18. The proton has a POSITIVE charge of electricity, the electron has a NEGATIVE charge equal and opposite to the positive charge of the proton. The neutron has no charge at all.

19. The difference in chemical properties of the elements is caused by difference in the number of protons in the nucleus. This is the ATOMIC NUMBER.

20. Atomic weight is the SUM of the weights of the protons and neutrons in the nucleus.

21. It is the NEUTRON which figures in the

transmutations which give atomic power. Neptunium and plutonium were formed by bombarding uranium 238 with neutrons.

22. Neutrons can PENETRATE to the nucleus of heavy atoms when charged particles would be repelled by charges in the atom.

23. The HYDROGEN atom is believed to have just one proton as its nucleus, with one electron circling around it. Hydrogen's atomic weight and atomic number are each one.

24. Hydrogen has one isotope which is just like ordinary hydrogen except that it is twice as heavy. It is known as "heavy hydrogen" and sometimes as DEUTERIUM. Its compound with oxygen is called "heavy water."

25. The nucleus of HEAVY HYDROGEN contains one proton and one neutron. The atomic number of heavy hydrogen is one, corresponding to one proton. The atomic weight is two, corresponding to the two heavy particles, proton and neutron.

26. HELIUM has two protons and two neutrons in its nucleus. The two protons correspond to helium's atomic number two. The combined weights of protons and neutrons in the nucleus give helium its atomic weight 4. Two electrons, held in their orbits by the two protons, revolve around the nucleus.

27. The VOLUME of an atom is determined by the orbits of its outermost revolving electrons. Only a small fraction of the size of an atom is actually occupied by the protons, neutrons and electrons, just as the space occupied by the sun, the earth and other planets is only a small part of our solar system.

28. In spite of all the unoccupied SPACE, an atom is quite IMPENETRABLE to other atoms and to larger bodies. The electrons revolve millions of times a second, and keep everything out of the space within quite as effectively as though they were everywhere at once.

29. The only things that can get inside an atom are smaller things, FRAGMENTS of other atoms, protons, neutrons or electrons. They must be shot with just the right speed. These fragments of atoms are observed as radiations given off by radio-active elements which are breaking up spontaneously.

30. RADIATION is wave motion, known to us as the electro-magnetic waves used for radio transmission, heat, light, X-rays and cosmic rays. Large numbers of extremely tiny particles in motion together act like waves.

31. Three types of radiation are given off by radio-active substances. ALPHA particles are high-speed nuclei of helium atoms. BETA particles are high-speed electrons. GAMMA rays are electro-magnetic radiations similar to X-rays and light.

32. Of these, only the gamma rays are properly called radiations, and even these act very much like particles because of their short wave-length. Such a "particle" or quantum of gamma radiation is called a PHOTON.

33. In general, the gamma rays are very penetrating, the alpha and beta rays less so. Even though the alpha and beta rays are not very penetrating, they have enormous SPEED.

34. The speed with which atom particles travel is the source of atomic energy. ENERGY is capacity to do work. It is work stored up for future use.

35. If you raise a weight to a height above the ground and suspend it there by some device, the WORK you put into raising it can be stored there indefinitely as POTENTIAL ENERGY. It will be there, ready, whenever you decide to release it.

36. The energy which a moving body has because it is in motion is called KINETIC ENERGY. The kinetic energy of any particle depends upon its mass and the square of its velocity. Energy is conserved by the moving

*SCIENCE NEWS, Washington.

particle until it strikes an object, then work is done.

37. All ENERGY is either potential or kinetic. Either one can be converted into the other. These two conversions are continually occurring.

38. Particles of atomic size have kinetic energy arising from several different kinds of MOTION. All atoms are constantly in motion.

39. If the atoms are so dispersed that the material constituting them is a GAS, that gas will exert pressure on all sides of the container that holds it. If the container is a balloon bag, the imprisoned gas can do work by lifting heavy weights into the air, as in the case of a dirigible.

40. Atoms which compose an element that will combine readily with another element, as hydrogen or carbon will combine with oxygen, have unsymmetrical arrangements of the outer electrons in their systems. These unsymmetrical arrangements tend to set up a sort of strain, which causes CHEMICAL COMBINATION to take place when elements with suitable combining powers are brought together.

41. These unsymmetrical arrangements give rise to FORCES which result in kinetic energy. This energy appears, for example, when carbon and oxygen burn to carbon dioxide, giving off heat, or hydrogen and oxygen explode to form water, again giving off heat.

42. Chemicals combining to form stable compounds give off energy in the process. These are known as EXOTHERMIC REACTIONS. Combinations which absorb energy, forming unstable compounds, are known as ENDOTHERMIC REACTIONS. Explosives, for example, which are highly unstable, are formed by endothermic reactions.

43. Chemical forces, electricity and heat are all forms of energy. Potential and kinetic energy may be distinguished in each case.

44. These energies all arise from motion of the atom as a whole, or motion resulting from attractions and repulsions between the outer PLANETARY ELECTRONS of the atoms' structure.

45. Energy resulting from motion of particles deep within the structure of the atom was unknown until the discovery of RADIOACTIVITY.

46. Radioactive elements undergo SPONTANEOUS breaking up of their atoms, giving off alpha and beta particles and gamma rays. Loss of these particles causes the radio-active elements to change into other elements.

47. The energies shown in these TRANSFORMATIONS are thousands of times greater than the kinetic energies which the molecules of a gas have by reason of their motion when heated. They are thousands of times greater than the energy changes per atom in chemical reactions.

48. The property of matter that connects it with motion is INERTIA. Inertia is opposition to change of motion.

49. One conclusion that appeared early in the development of the theory of RELATIVITY was that the mass due to inertia of a moving body increases as its speed is increased.

50. This increase implied an equivalence between an increase in energy of motion of a body (kinetic energy) and an increase in its MASS.

51. It was for this reason that Einstein suggested that studies of radioactivity might show the EQUIVALENCE of mass and energy.

52. Einstein's statement is that the amount of energy, E, equivalent to a mass, m, is given by the equation $E=mc^2$ where c is the VELOCITY OF LIGHT.

53. From this equation, one kilogram (2.2 pounds) of matter, if converted ENTIRELY into energy, would give 25 billion kilowatt hours of energy. This is equal to the energy that would be generated by the total electric power industry in the United States (as of 1939) running for approximately two months.

54. Compare this fantastic figure with the 8.5 kilowatt hours of heat energy which may be produced by BURNING an equal amount of coal.

55. Until the atomic power research program, no instance was known of matter being converted into energy without more energy being used to produce the transformation than was released by it.

DON'T SETTLE FOR LESS THAN:

the Best

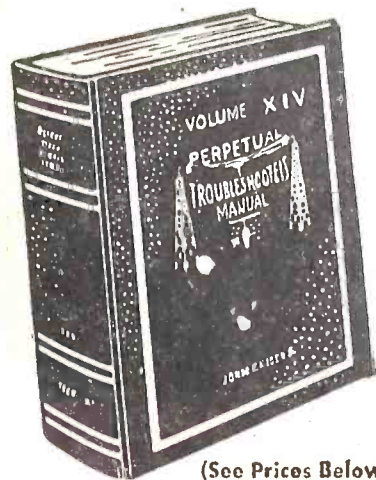

(See Prices Below)

When you must service any and all models of radio sets, only Rider Manuals can fill the need.

For sixteen years Rider Manuals have been furnishing complete and authentic servicing data on American radio receivers. Today they represent the only single source upon which you can depend for all the information you need on such vital material as receiver schematics, voltage data, alignment data, resistance values, chassis layouts and wiring, trimmer connections—in fact all the things that lead to quick diagnosis of troubles in ailing receivers.

—And they're complete! Since the publication of Volume I over 42,000 models have been covered—only Rider Manuals contain wiring diagrams on Scott receivers. (These diagrams were received officially from the E. H. Scott Radio Labs., Inc.)

There are good reasons why better servicing shops have waited during the war until they could get their Rider Manuals. There are better reasons today why you should not settle for less than "The Best." For, the flow of Rider Manuals is again approaching normal.

See your jobber and place your order today to guarantee fastest possible delivery.

Get on the Mailing List for "Successful Servicing"

A monthly paper, dedicated to the financial and technical advancement of the electronic and radio maintenance man. Free distribution—Just

MAIL COUPON

JOHN F. RIDER PUBLISHER, INC.
404 (e) FOURTH AVE., NEW YORK, N. Y.

NAME _____
ADDRESS _____
CITY _____
STATE _____

YOU MUST STUDY TO KEEP UP TO DATE

Just Out "INSIDE THE VACUUM TUBE"...424 Pages, \$4.50

RIDER MANUALS (14 VOLUMES)

Volumes XIV to VII . . .	\$12.50 each volume
Volumes VI to III . . .	9.50 each volume
Abridged Manuals I to V (1 Vol.) . . .	\$15.00
Record Changers and Recorders . . .	7.50
The Cathode Ray Tube at Work . . .	4.00
Frequency Modulation . . .	2.00
Servicing by Signal Tracing . . .	4.00
The Meter at Work . . .	2.00

The Oscillator at Work	\$2.50
Vacuum Tube Voltmeters	2.50
Automatic Frequency Control Systems	1.75
A-C Calculation Charts	7.50
Hour-A-Day-with-Rider Series—	
On "Alternating Currents in Radio Receivers"	
On "Resonance & Alignment"	
On "Automatic Volume Control"	
On "D-C Voltage Distribution"	1.25 each

JOHN F. RIDER PUBLISHER, INC. 404 Fourth Avenue, New York 16, N. Y.
Export Division: Rocke-International Electric Corp. 13 E. 40th Street New York City Cable: ARLAB

RIDER MANUALS *are complete* IN 14 VOLUMES

56. Two axioms of physics stated: (1) MATTER can be neither created nor destroyed; (2) ENERGY can be neither created nor destroyed. For all practical purposes they were true and separate principles until about 1940.

57. It is now known that they are, in fact, two phases of a single principle, for we have discovered that energy may sometimes be CONVERTED into matter and matter into energy.

58. Such conversion is observed in the phenomenon of nuclear FISSION of uranium, a process in which atomic nuclei split into fragments with the release of an enormous amount of energy.

59. The extreme size of the CONVERSION FACTOR explains why the equivalence of mass and energy is never observed in ordinary chemical combustion.

60. We now believe that the heat given off in such COMBUSTION has mass associated with it, but this mass is so small that it cannot be detected by the most sensitive balances available.

61. Transformation of matter into energy is an entirely different sort of phenomenon than the usual chemical transformations, where the matter is changed into a different form but its MASS persists.

62. From the standpoint of the Laws of the Conservation of Matter and of Energy alone, transformation of matter into energy results in the DESTRUCTION of matter and CREATION of energy.

63. The OPPOSITE transformation, which astronomers believe may be going on in some of the stars, amounts to the destruction of energy and the simultaneous creation of matter.

64. It is difficult for us to imagine the reconciliation of two such different concepts as matter, with its characteristic mass or weight, and energy, which does not have this quality. We shall, perhaps, be forced to think of the stuff of the universe as some such combination of matter and energy as would be symbolized by the coined word "MATTERGY."

**YOU NAME IT,
WE'LL SUPPLY IT**



**EVERYTHING IN RADIO
AND ELECTRONICS**

R. W. T., world's oldest and largest Radio Supply House is ready again with tremendous stocks of sets, parts and equipment. You can depend on our quarter-century reputation for quality, sound values and super-speed service. Orders shipped out same day received. All standard lines already here or on the way, including: National, Hammarlund, R. C. A., Hallicrafters, Bud, Cardwell, Bliley and all the others you know so well.

Originators and Marketers of the Famous

Lafayette Radio

**Radio Wire
Television Inc.**



100 Avenue of the Americas
(Formerly 6th Ave) New York 13
Boston, Mass. • Newark, N. J.

R. W. T. DEPT. JB6, 100 AVENUE OF THE AMERICAS, NEW YORK 13, N. Y.

I want your big new post-war Catalogue.

NAME _____

ADDRESS _____

HAM? (CALL LETTERS) _____

ENGINEER? SERVICE MAN? STUDENT?

PPM—NEW TECHNIQUE

(Continued from page 315)

R284 depends on the amount of current flowing through the voice amplifier tube. If a positive signal is applied to the grid of that tube, current increases and so does voltage drop across R278, reducing the voltage available for application to the multivibrator grid. Hence the multivibrator's snap back to normal will be delayed. If a negative signal is being applied to the voice amplifier grid when the multivibrator is excited, plate current is reduced, voltage is higher and the snap-back and consequent pulse formation takes place at an earlier point than would otherwise be the case.

Variable resistor P8 sets conditions in the multivibrator so that with no modulation the pulse occurs exactly in the middle of its proper channel.

Thus simply is the apparently difficult feat of pulse position modulation performed. Between the pulse generator and the velocity-modulated oscillator which launches it on the ether, the pulse passes (with pulses 2, 4 and 6) through a clipper and a stage of video amplification. The odd pulses are similarly generated and pass through a similar clipper-amplifier. Then the common two-stage video amplifier further builds them up and passes them on to the transmitter unit up on the antenna mast, directly behind one of the parabolic reflectors.

Undergoing two more stages of amplification (through a 6AK5 and a 6V6-GT/G) the signals are applied to the grids of the modulator tube, a 3E29. This is a double beam-tube with both sections connected in parallel, which operates at a plate voltage of 1500. The plates of this tube are connected to the cathode of the U.H.F. velocity-modulated oscillator, driving it into oscillation during the period of each pulse. The U.H.F. signals (at frequencies between 4300 and 4800 megacycles) travel through a hollow waveguide to a plain reflector at the focal point of the transmitting parabolic reflector, from which they are reflected back against the face of the parabola and sent out in parallel rays to the receiving station, which may be from 30 to 50 miles away, depending on the terrain between the two towers.

PULSE RECEIVING SYSTEM

Arriving at the receiving parabola, the pulses are converged by it on the reflecting plate at the end of the receiving waveguide and sent down the guide. A frequency 60 Mc. lower than the transmission frequency is mixed with the incoming waves in a crystal detector, producing a modulated 60-Mc. beat-frequency signal, which is further amplified in a multi-stage I.F. amplifier, and detected. From here there is a video signal similar to that in the video stages of the transmitter. This signal is amplified and clipped to eliminate amplitude variations, again passing

through a number of stages, and applied to a *marker selector*.

THE MARKER PULSE

The function of the selector stage is to select the marker pulse from the rest of the incoming signals and use it to operate a series of square-wave generators which supply "gate" pulses in the proper sequence to each of the *pulse converter* circuits, which convert the position-modulated pulses back to voice frequency.

The method of selecting the marker pulse is simple. The pulses, which at this point have an amplitude of about 10 volts (negative) are applied to the grid of the marker selector tube, V17A in Fig. 4. Its grid, normally held positive by the 3.3-megohm resistor R10 connecting it to the 300-volt line, is brought below cut-off potential and plate current stops flowing. Plate voltage starts to rise, charging C7 through the 270,000-ohm plate resistor, R15. Since the combination's charging time is relatively long, voltage rise is proportional to the length of the pulses, those of one microsecond producing a rise of about ten volts, while the four-microsecond marker pulse causes a rise of about 40 volts in the plate circuit.

These output pulses are applied to the grid of the *marker amplifier* tube, which is biased to a point 20 volts below cut-off. Because of this bias, the 10-volt signals from the one-microsecond channel pulses have no effect, while the 40-volt impact of the marker pulse is sufficient to cause plate current to flow and to send amplified pulses on to the *square-wave generator*. This is a 12L8-GT hooked up as a freely-oscillat-

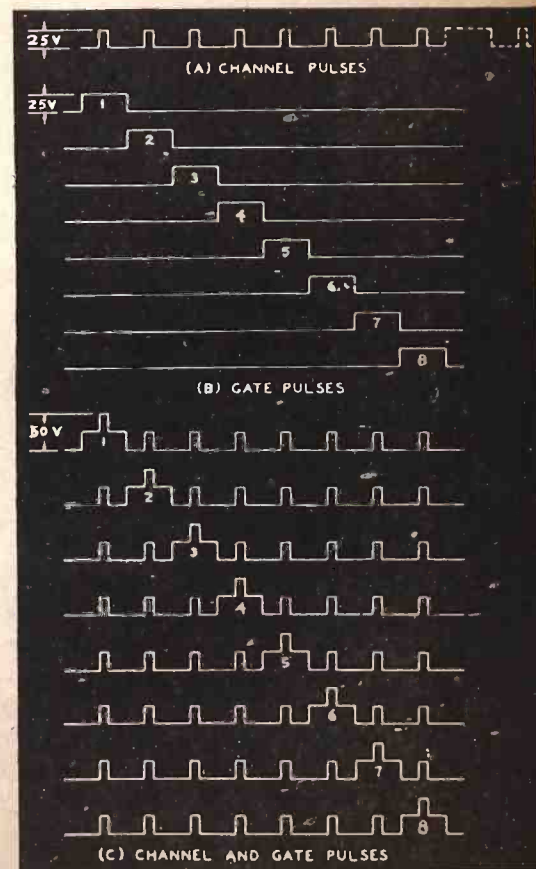

Fig. 5—Channel plus gate pulse waveforms.

ing multivibrator. The amplified marker pulses lock the multivibrator in precise synchronism. Its two plate circuits are connected directly—in the case of two of the eight channels—or through delaying circuits, to the eight *gate generators*. These produce pulses (called *gate pulses*) of about 25 volts, 13 microseconds long, so spaced that each one occupies the space allotted to a channel. (See Fig. 5).

THE PULSE CONVERTER

The gate pulses are applied to the eight *pulse converters* in the order shown in the figure. At the same time, all the channel pulses are applied to all the pulse converters in parallel. The pulse converters are multivibrators, hooked up somewhat like the pulse position modulators, whose work they are to reverse. The grid of the first tube V13A (Fig. 6), is connected directly to the plate of its gate generator, as well as to the output of the final pulse amplifier. Its cathode resistor is common to the second section of the tube, whose plate is connected to 300 volts through a 56,000-ohm resistor. The grid of this second section is also brought to the 300-volt positive lead through a 3.3-megohm resistor. The second section therefore conducts heavily, biasing the first section well below cut-off. Channel pulses from the final pulse amplifier are insufficient to overcome this bias. When the gate pulse is applied, the channel pulse added to it is sufficient to drive the first section's grid far enough posi-

tive to make the section conduct. Once the first section starts conducting, it continues to do so till the end of the gate pulse.

Thus the output of the pulse converter is a series of pulses of varying length, the rear edge of each pulse occurring at a fixed period, but the leading edge varying at the voice frequency. Thus we have a length-modulated pulse.

be in the case of an unmodulated signal, as the pulses begin before or after the channel's mid-point.

The output of the pulse converter contains, besides the voice-frequency signal, a strong 8,000-cycle component and its harmonics, together with voice-frequency sidebands of the 8,000-cycle component and its harmonics. It is therefore passed through a low-pass

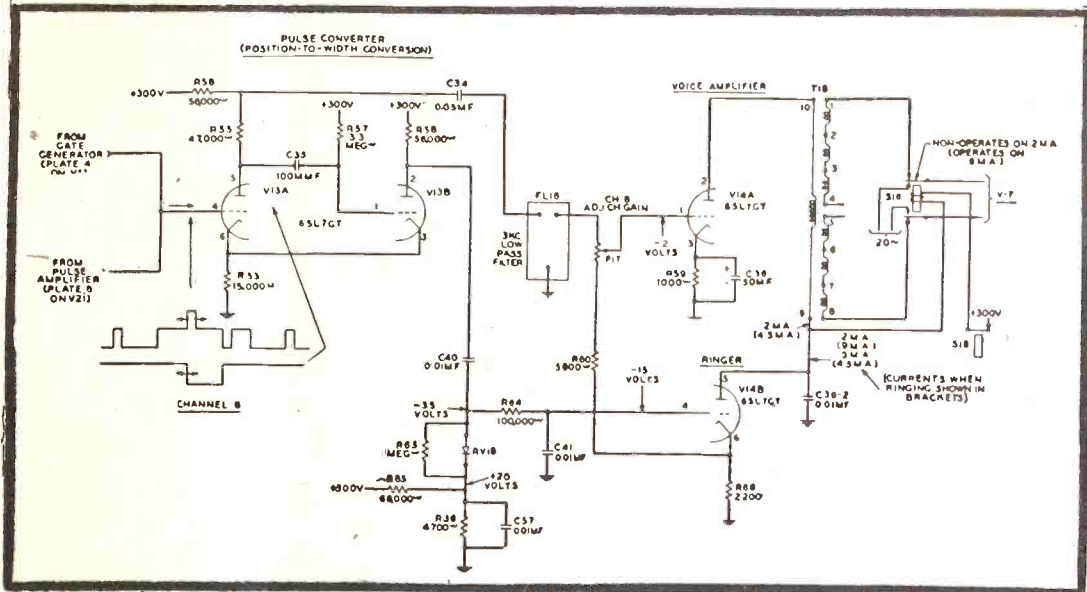

Fig. 6—Simplified schematic diagram of the pulse converter and voice frequency amplifier. Since the voltage drop through the 56,000-ohm resistor, R56, and consequently the charge on C34, the output pulse, is dependent on the length of the pulses, it is easy to see that the voltage across C34 varies with the voice signals, rising above and falling below what it would be in the case of an unmodulated signal, as the pulses begin before or after the channel's mid-point. The voice frequencies are then applied to the voice or audio amplifier, from which they go to the

(Continued on page 359)

FIX ANY RADIO

Amazing New Invention

Find radio faults with a new simplified method. Repair all radios in minutes instead of hours. New, revolutionary different **Comparison** technique permits you to do expert work almost immediately. Most repairs can be made without test equipment. Simple point-to-point, cross-reference, circuit suggestions locate faults quickly and easily.

CHARTS, BLUE-PRINTS, TESTS, PICTURES, HINTS, JOB-SHEETS

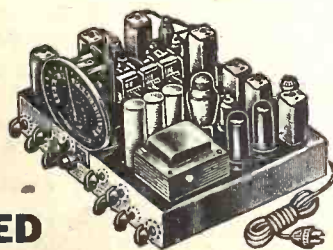

Learn time-saving trouble-shooting short-cuts; find any radio fault with ease. Follow the tests shown on 24 large circuit blue-prints. Over 1,000 practical repair hints. Hundreds of simplified tests using a 5c resistor and any filter condenser. Introductory material for beginners and to serve as review for experienced radio men. Several chapters on test equipment. Complete plan in manual form, 64 job sheets, data on all tubes, large size: 8½x11 inches. Schematics, pictures, charts. Sold on no-risk trial. Use coupon to order.



NO TESTERS NEEDED

REPAIR ANY RADIO IN MINUTES

This newly developed method tells you how to locate the source of trouble in any radio set without equipment. Make needed tests, measure voltage, trace the signal, by using only a 5c resistor, small condenser, and a crystal detector. Inject signals without any signal generator. Test parts by the new **Comparison** method. Test tubes without equipment. Repair any radio expertly following simplified picture plans. Improve your radio servicing ability. Data on all sets, portables, AC-DC, FM, recorders, intercoms, P.A. Examine and apply the plan for 10 days without obligation or risk. Send trial coupon today. →

NO RISK TRIAL ORDER COUPON
SUPREME PUBLICATIONS
 9 S. Kedzie Ave., Chicago 12, Illinois

Ship postpaid the new complete Simplified Radio Servicing by Comparison Method manual for 10 days' examination. I am enclosing \$1.50, full price. I must be entirely satisfied or you will refund my total remittance.

NAME:RCF
 ADDRESS:

for everything in
ELECTRONICS
 and **EQUIPMENT**
 follow
ARROW!
"VOMAX"



Choice of Electronic Engineers!
NEW POST-WAR V.T. V-O-DB-MA METER
 D.C. volts at 51 and 128 megohms A.C. and r.f. volts at 6.6 megs. Resistance .2 ohms to 2,000 megs. D.C. current 1.2 ma. through 12 amperes. D.B. — through + 50 . . . plus visual dynamic signal tracing. In our critical opinion these features establish "VOMAX" as standard of comparison. Prompt shipment. Your cost only. **\$59.85**

ELECTRON-O "Make-it-Yourself"
ELECTRONIC & ELECTRICAL KITS



Little Giant Amplifier
 Parts and instructions for building the Little Giant Amplifier. Enough power to fill a large sized room. Easy to assemble—can be used in many instructive and entertaining experiments.
 Your net cost complete **\$18.95**

RECORD PLAYER & CONTROL UNIT
 Everything needed to build a real phonograph record player. A real electric turntable motor—a crystal reproducer arm—even parts for building the cabinet. Special switch to change from mike to record player.
 Your net cost complete **\$17.95**

BRUSH TRANSCRIPTION TYPE CRYSTAL PICKUP

Plays 16" records. Wide-range frequency response (flat within plus or minus 2.5 db. from 50 to 6,000 cps.; slight rise to 10,000 cps.). Complete with high impedance equalizer used for commercial "Constant Velocity" recordings.



Your net price **\$26.46**

Write to us for anything in **ELECTRONIC PARTS and EQUIPMENT**. Get our mailing list and keep informed as merchandise becomes available.

ARROW
ELECTRONICS COMPANY
 82 CORTLANDT ST., NEW YORK 7, N. Y.
 COrtlandt 7-2935 — 2998

ELECTRONIC TRANSIENTS

(Continued from page 310)

to consist of an infinite number of odd harmonics.

Omitting certain odd harmonics in the series and changing the amplitudes of others, results in a variant of the square wave—the *rectangular wave*.

Countless other periodic wave shapes are encountered in electronics. But their shape always depends on the harmonics that are present, their relative amplitudes, and their relative phase relations with each other. The steeper the sides of the final wave shape, the more harmonics it contains.

All of the wave shapes shown in Figure 2 have equal alternations. That is, the positive portion of each wave has mirror symmetry with the negative portion. Sometimes waves are encountered that do not have equal alternations but which are periodic. Again, these waves are the result of combining a fundamental and certain harmonics of given amplitude.

Thus, any shape of recurrent wave may be produced by the careful selection and combination of a fundamental and harmonics of the basic frequency. And, in like manner, any existing wave may be broken down into a fundamental and certain harmonics.

DISTORTION

This represents distortion of the original, fundamental wave. But it is desirable distortion. The large number of harmonics present in the wave generally is necessary to obtain specifically shaped waves, without which certain types of electronic circuits—such as timing relays, delay and control devices, or others—could not function.

Steep-front waves are widely used in practically all phases of radar, television, and electronics. As such, they represent a highly distorted wave consisting of a great number of harmonics.

For this reason it is impossible to pass such a wave through an ordinary audio or radio circuit. To do so would introduce *unwanted* distortion and loss of shape.

When amplification of such a complex wave is required, the fundamental and *all* harmonics must be amplified equally. In radar and television this led to the development of wide-band or *video* amplifiers, capable of equal amplification of all frequencies from a few cycles to several megacycles. Most coupling stages, also, are required to pass complex waves without discrimination as to frequency, phase, or amplitude of the component harmonics.

In some electronic applications, however, just the opposite is true. Circuits are designed to introduce the intentional distortion. Particularly in radar, this *controlled* distortion is necessary for shaping control waves prior to their application to the final stage of some other component. A typical example of this is the very steep-front, narrow, rectangular pulse required to modulate a

radar transmitter during each "pulsing period" of the set's operation.

The behavior of these distortion circuits can best be understood as transient phenomena—or "transients." A measure of the introduced distortion is sometimes known as the *time constant*.

TIME CONSTANT

Ohm's law states that the voltage across a resistance is equal to the current through it times the value of the resistance. In other words, a voltage is developed across a resistor only when current flows through it. By controlling this flow of current the shape of the voltage wave (across the resistor) can be controlled.

Simplest method of current control is to utilize the charging and discharging properties of a condenser. In a simple

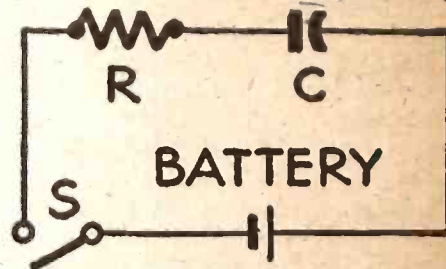

Fig. 3—The simplest wave-forming circuit.

R-C circuit [Figure 3], when the switch S is closed the rate of the condenser charge is limited by the amount of resistance R in the circuit. The charging of the condenser is not instantaneous, but of an exponential nature. It takes place within a measurable time, determined by the amount of resistance R and capacitance C.

The product of R and C is a measure of the time (in seconds) required for the condenser charge to reach 63 percent of its final or fully charged value. This product (RC) is known as the *time constant* where R is in ohms and C is in farads.

When the condenser [Figure 3] is discharged through the same resistance R, the discharge current will be limited by the resistance. The current decrease will again be exponential, the slope at any time depending upon the values of R and C. The time constant is again a measure of the time required to discharge the condenser.

When the time constant for a given

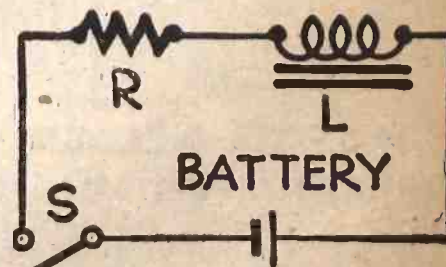

Fig. 4—An inductor changes the wave shape. circuit equals 1 (or RC seconds), the charge on the condenser is considered to have reached 63 percent of its final value. When the time constant equals 5 (or 5RC seconds), the condenser is

considered, for all practical purposes, to be fully charged.

Conversely, in discharging, when the time constant equals 1 (RC seconds), the amount of charge on the condenser is considered to be 37 percent of its final voltage. And when the time constant equals 5 (or 5RC seconds), the condenser is considered to be fully discharged.

Current flow through a resistance can also be controlled by means of inductance-retarding effects. In a simple R-L circuit [Figure 4], when the switch S is closed the battery forces a current through the inductance L. The reactance of the coil retards any change in the flow of current, and the current increases exponentially—the rate depending upon the values of R and L.

The quotient L/R is a measure of the time required for the current to rise to 63 percent of its full value. And this quotient is known as the time constant (in seconds), where R is in ohms and L is in henrys. There is a similar exponential fall of current when the circuit [Figure 4] is discharged through the resistance R, the time constant again being a measure of the time required for current decay.

By utilizing transient current effects of either R-C or R-L circuits, it is possible to influence the distortion and formation of voltage waves—to any desired shape. For instance, the common saw-tooth wave used for the time base of most types of cathode ray tubes is but the charge-discharge wave taken from across a condenser.

Resistance-inductance circuits are occasionally used in electronic delay, timing and counting circuits. But the resistance-capacitance or R-C circuit has wider general use in radar, television, and electronics.

TRANSIENT EFFECTS

In a given R-C circuit [such as Fig. 3], if the value of either resistance or capacitance is increased, or if both are increased, the circuit will have a longer time constant because the condenser will take longer to charge.

Thus, the value of either R or C, or both, can be varied to obtain any desired value of charging time.

The terms *long* time constant and *short* time constant are purely relative evaluations.

A *long* time constant means that the time (expressed in RC seconds) is long compared with the time necessary for the impressed or signal voltage to complete half a cycle. If the product of R and C is large enough there will be little or no introduced distortion.

A *short* time constant means that the time (expressed in RC seconds) is short in comparison with the frequency of the impressed or signal voltage. A circuit possessing a short time constant introduces a particularly desirable form of distortion known as *peaking*.

The input wave applied to either R-C or R-L circuits may be of any shape. But the greatest amount of distortion can be obtained in the output when the

(Continued on following page)

HAM HEADQUARTERS FOR Equipment and Information

15 YEARS of Service

to HAMS throughout the
U.S. and Canada.

Complete Line

of nationally famous
Radio and Electronic
Parts and Equipment.

Thousands of Items

in stock right now . . .
comprising every well
known brand of Component
Parts and Equipment.

FREE

Write today for our current bulletins about extraordinary values in surplus Radio and Electronic Component Parts and Equipment.

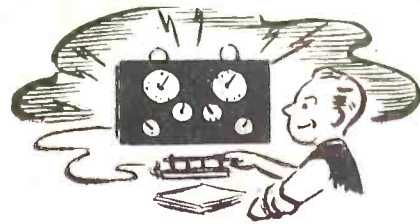

Get Started on Your
"DREAM SET"
TODAY!

We have all the component parts and equipment and our HAM department, which is staffed by Engineers, will gladly help you with your problems. Write, 'phone, or visit us today.

Radio Product Sales Company

238 WEST 15TH STREET

LOS ANGELES 15, CALIFORNIA

PRospect 7471



UNIMETER

This unit fulfills an extremely important need for general utility portable service equipment. It has wide range coverage for both a-c and d-c measurements of voltage, current measurements on d-c and the popular ranges on resistance.

The UM-3 is designed to clearly indicate all the functions which aid in the prevention of application of high voltages when preparing for current or resistance measurements.

Other G-E units for better servicing include: Tube Checker TC-3, Unimeter UM-4, and Oscilloscope CRO-3A.

For details write: *Electronics Dept., Specialty Division, General Electric Company, Syracuse, New York.*

Electronic Measuring Instruments

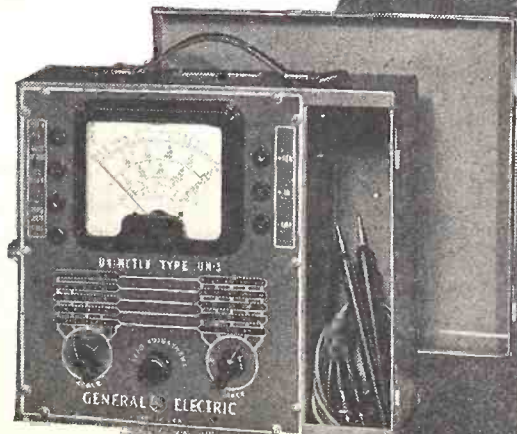

GENERAL ELECTRIC

177-E1

UM-3

FOR EVERYTHING IN RADIO

WRITE

Leo, W9GFQ

For Fast Delivery!



Get Leo's own personal, sudden service on your radio and electronic needs. Quick delivery, lowest terms, liberal trade-in allowances.

SERVICE DEALER NEEDS



WRL MULTITESTER

Steel case with 30-60% angle. Cat. No. 16-491 Less Leads .. **\$1875**

Handles AC DC Voltmeter, DO Milliammeter, high and low range Ohmmeter. 3" meter with sturdy D'Aronsva movement. Size 5 1/2 x 8 x 3 1/4.

A complete stock of tools, replacement parts, test equipment, intercom and public address systems . . . everything for the progressive service dealer.

FOR EXPERIMENTERS

PHONO AMPLIFIER KITS



Complete with tubes, speaker, stamped chassis, and all resistors and condensers.

Cat. No. 7-271. \$9.50 ea. Lots of 3, ea. **\$915**

Crystal sets, Antenna Kits, Code Oscillator Kits, Transmitter Kits, and many other items for the experimenter and radio enthusiast.

HAM NEEDS



Transmitting tubes, condensers, mikes everything for the Ham. One of the country's largest stocks of Ham equipment. Write Leo, W9GFQ, today, and be first with the latest. We invite inquiries for special equipment of all kinds.

TRANSMITTERS

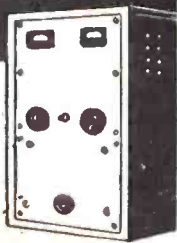

For peak performance and more dollar for dollar value, get a WRL Transmitter Kit . . . designed in Leo's own laboratories . . . tested and proven. Available in 15, 35, 70, and 150 watt kits as well as kits custom built to your own specs. Write Leo today for complete details, prices and terms.

RECEIVERS



Here are just a few of the many well-known receivers offered by Leo:

Hallcrafters SX-25	\$ 94.50
Hallcrafters S-20R	\$ 60.00
Hallcrafters SX-28A	\$223.00
Echophone EC-1A	\$ 29.50
Hammarlund HQ-120X	\$129.00
National NC-2-40C	\$225.00

Write for details of our trade-in plan and easy terms

Free!

NEW POST WAR 52 PAGE FLYER

52 pages packed with real buys in radio, electronic, and general merchandise. Write for your free copy today.

- Send for these exclusive items:
- Tube and Circuit Book 10c
 - Giant Radio Reference Map (size 3 1/2 x 4 1/2) 15c
 - Handy Tube-Base Calculator 25c

Address Dept. RC-2
Council Bluffs, Iowa

Wholesale RADIO LABORATORIES

ELECTRONIC TRANSIENTS

(Continued from previous page)

input wave consists of abrupt changes, that is, when the input wave has very steep sides. Most ideal type of input wave is the *asymmetrical square wave*.

Figure 5 illustrates such a signal voltage applied to two kinds of R-C circuits. By earlier definition, the upper circuit has a short time constant ($RC=0.001$ seconds), the lower circuit has a long time constant ($RC=0.1$ seconds), both with respect to the frequency of the applied square-wave voltage.

When the voltage E is applied to the short time-constant circuit [upper Figure 5], the condenser is charged to E volts according to the rate of charge permitted by the values of R and C . Polarity of the condenser charge is determined by the polarity of the applied square wave.

As the input voltage changes, the voltage across the condenser, e_c , follows the rate of charge and discharge. This wave form is known as the *integrated portion* of the original impressed square wave. Should such a sloping wave, e_c , be desired to operate or control an electronic circuit, the voltage wave could be tapped off from across the condenser and fed to other stages or components. This circuit is referred to as an *integrator circuit*.

Of more practical use, however, is the *peaked wave* appearing across the resistance, e_r . Such a circuit is referred to as a *differentiator circuit*.

Peaking is an important form of distortion, finding wide use as a trigger impulse. The output voltage, e_r , is often applied to limiting or other types of pulse-forming circuits to obtain extremely narrow and precise rectangular impulses.

Thus there are two principal types of distortion in the R-C circuit: integration and differentiation.

Distortion of the input square wave by a short time constant R-C circuit is due to the poor low frequency response of the stage. The square wave has steep sides, and therefore a large number of odd harmonics. The highest frequency harmonics cause the impressed wave to be even further removed from the shape of the fundamental sine wave. Reactance of the condenser is greatest for low frequency harmonics, causing an exaggeration of the high frequency harmonics in the resistor output wave, e_r .

Although both waveforms, e_r and e_c , are available for use, either but only one of the two are ever utilized because of loading effects on the stage. And of the two types of output waves, the voltage, e_r , is more generally used.

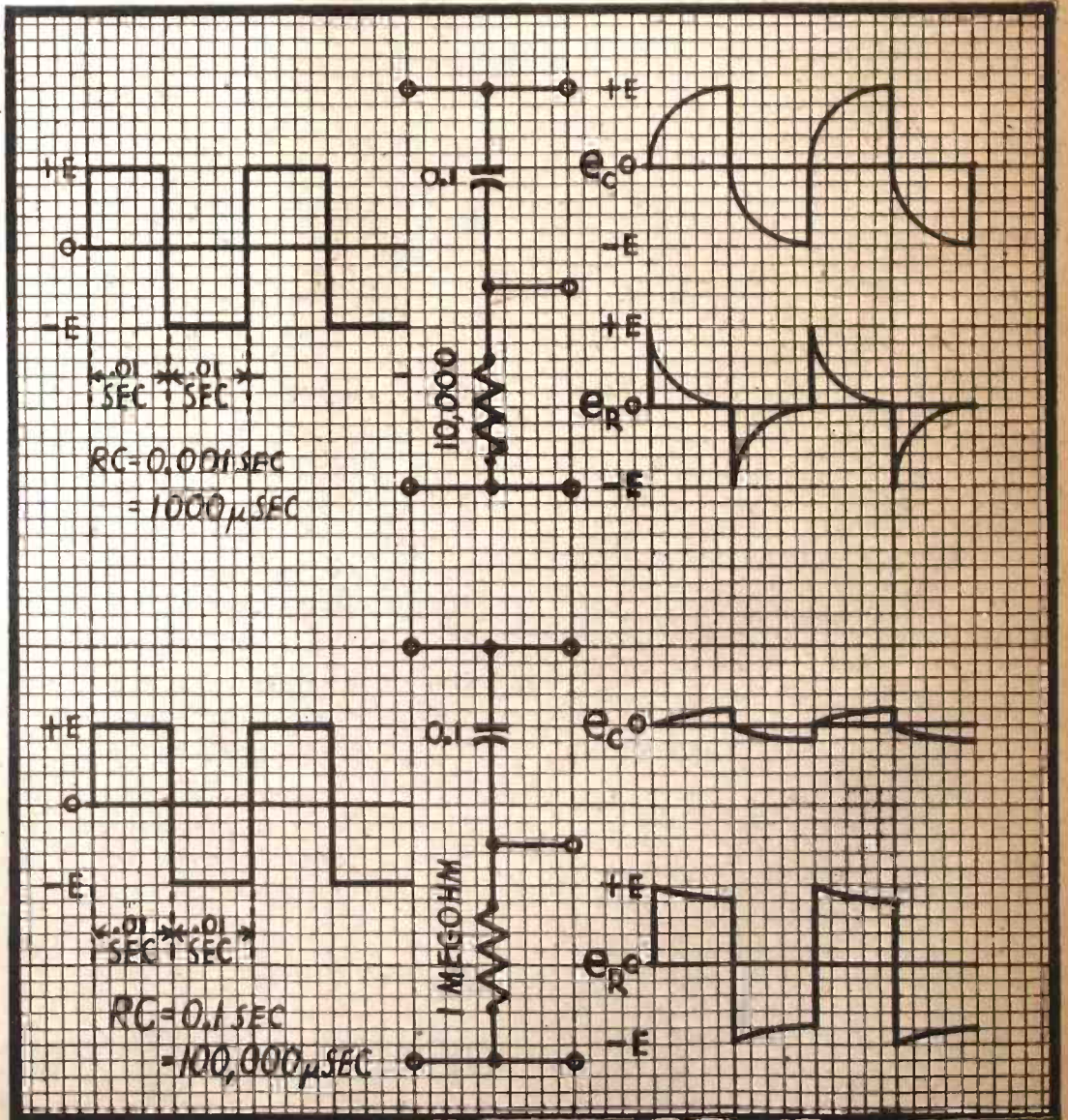

Fig. 5—Distorting circuits for shaping waves and the forms that may be produced by them.

A long time-constant circuit [lower Fig. 5] also provides two waveforms, but of somewhat different nature. In this circuit the time constant is ten times the required time for a half cycle of the impressed square-wave voltage. When this voltage E is applied to the circuit, the condenser does not charge to its full value during an alternation. Before it has time to charge fully, the polarity of the impressed voltage is reversed.

The wave across the condenser, e_c , is of little use because of its diminished amplitude.

The integrated voltage across the resistance, e_r , is almost a duplicate of the impressed square wave. If the time constant for this particular circuit were 40 or 50 times that of the signal frequency, the voltage across the resistor would be almost identical with the input voltage. And the condenser voltage, e_c , would have no perceptible change.

Since practically the entire voltage drop of the R-C circuit [lower Fig. 5] is across the resistance, this explains the wide use of long time-constant circuits as coupling devices between stages of resistance-coupled amplifiers. Careful selection of R and C values is necessary, since improper selection might result in a short time-constant circuit introducing unwanted distortion.

Wave shapes other than square waves may be applied to either long or short time-constant circuits, resulting in various wave forms in the differentiated or integrated output. For instance, a rectangular wave may be integrated to obtain a saw-tooth voltage wave.

However, a pure sine wave suffers no distortion when passing through either a long or short time-constant circuit, since one of the important mathematical properties of a sine wave is that it may be differentiated any number of times without changing its shape.

Besides the important distortion effects of R-C and R-L circuits, the time constant of such simple circuits is the basis for all electronic delay and timing circuits. The delay action depends upon the R-C or R-L values, and the time required for a current to build up or decrease. The retarding action of these circuits can be utilized to achieve either postponed control actions or to measure required time intervals.

These circuits permit delayed action of both electrical and mechanical devices, control of circuits during pre-scheduled intervals of time, and other electronic functions.

In radar and television applications, selected impulses containing very high-order harmonics are used to synchronize the operating of many components.

CORRECTION

An error occurred in the article "Elements of Radar" on page 169 of the December issue. In the 24th line, second column, the time for a pulse to travel 3270 yards should have been 10, not 50 microseconds. The time for the full circuit would of course be 20 microseconds instead of 100 as stated.

SERVICEMEN'S HEADQUARTERS FOR QUICK DELIVERY!

We carry a complete line of Standard

Test Equipment
Amplifiers
Recording Devices
Phono-pickups
Microphones

and the hard-to-get equipment you have waited so long to obtain. Please send us your order or write us what you need. We will show our appreciation by rendering any helpful service to you.

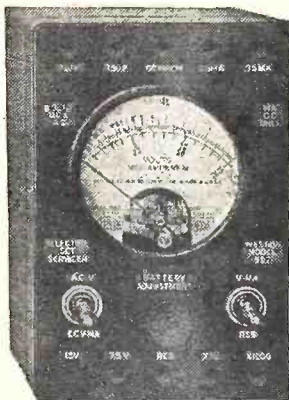

Weston Tube Checker Model 777

Consult us on your many sound problems and requirements. Estimates and help cheerfully given. We have many standard systems now available, for immediate delivery. Priced from \$100.00 up, complete with tubes.

JACK GREENE

BE 3-9374

79 CORTLANDT ST. NEW YORK, N. Y.

This month's specials are on Weston!

VOLT-OHM MILLIAMMETER

Model 697
Illustrated

24⁰⁰ NET

Weston Analyzer Model 772 type 6
\$49.50 net

\$49.50 net

ORDER NOW!



NEW

ECHOPHONE EC-1A RADIO RECEIVER

Be one of the first to own this popular set for short-wave and regular broadcast reception. Order now for earliest delivery. Many new features! Covers entire tuning range from 550 Kc. to 30 Mc. (550 to 9.85 meters) in 3 bands. For 110-125 volts AC-DC. Automatic noise limiter. Built-in PM speaker. Complete with tubes. Net **\$2950**

Other well-known receivers such as:

Hollicrafters S-20R.....\$60.00

Hollicrafters SX-25.....\$94.50

Hammarlund HQ-129X.....\$129.50

Net, F.O.B. Chicago (All prices subject to change)

ALLIED RADIO CORP.

833 W. Jackson Blvd., Dept. 2-B-6, Chicago 7

Ship ECHOPHONE EC-1A

Enclosed \$..... Full Payment

Part Payment, Balance C.O.D.

Send additional information on Echophone EC-1A.

Send information on other Communications Receivers and Time Payment Plan, without obligation.

Name.....

Address.....

City.....Zone.....State.....

SPEED UP REPAIRS WITH THESE G-C AIDS!



FREE STEEL CABINET

G-C Dial Belt Kits

Every Serviceman needs a G-C Dial Belt Kit. Save money—be ready for that repair job. Finest woven fabric replacements. Easy to install—no stretch—no adjustments. Supplied in kits of 25, 50, 100, 200 or 300 Belts in sturdy metal box with slide-in drawer. Free Belt Guide and measuring device.



G-C Dial Drive Cables

G-C has a complete line of Dial Drive replacement cables. Available by the spool for prompt servicing of all sets. Every Serviceman should have a complete assortment. Best quality—extra strength. Preferred by Radio Men everywhere.



G-C Radio Service Cement

The best Cement for Speaker and Radio Work. Especially suitable for cementing replacement cones and repairing rattling and torn cones. Also used on glass to seal adjustments, hold wires in place, etc. Dependable, vibration proof, water-proof and fast drying.

Write for New G-C Catalog No. 146 and G-C Dial Belt and Service Book

Immediate Delivery on all G-C Products

Order From Your Radio Parts Jobber
ALWAYS ASK FOR G-C PRODUCTS



GENERAL CEMENT MFG. CO.

ROCKFORD, ILLINOIS

RADIO SERVICEMEN:

RADIO PARTS—TUBES

BARGAIN PRICES—NO PRIORITIES

TUBES—12SK7, 12SQ7, 25L6, 50L6, 6V6GT...\$0.65

TREBOR 450 OHM SPEAKERS, 4 or 5 inch...1.69

FILTER COND., 20-20 Mfd., 150 V... .39

BY PASS COND., .01, .02, .05, 1-800 V... .07

LOOP ANTENNA (High Gain)... .59

ANT. & OSCIL. or ANT. and RF coil SETS... .69

RESISTOR KIT—50 Ass'd., 1/3 to 1 Watt... .99

Write Today for Bargain Bulletin

RADIO DISTRIBUTING CO., Pasadena 18, Calif.

Order Your New Communications Receivers Now From RESCO—

For Earliest Delivery!



ECHOPHONE EC - IA

Popular low-cost communications-type short-wave and broadcast receiver, with many new features. Covers entire tuning range from 550 kc. to 30 Mc. in 3 bands. For 115-125 volts AC-DC Electrical bandspread on all bands with separate tuning control and dial. Dial calibrated in megacycles. Beat frequency oscillator for CW reception. Automatic noise limiter. Built-in PM dynamic speaker. Headphones or speaker selected by panel switch. Housed in metal cabinet with gray wrinkle baked-on finish.

\$29.50
Net

OTHER WELL-KNOWN RECEIVERS SUCH AS:

- Hallicrafters SX-25 \$94.50
- Hallicrafters S-20R 60.00
- Hallicrafters S-22R 74.50
- Hallicrafters S-39 110.00
- National HRO 197.70
- PM23 Speaker 15.00

RADIO ELECTRIC SERVICE COMPANY

Everything in Radio and Electronics
N. W. Cor. 7th and Arch Sts.,
PHILADELPHIA 6, PA.

Radio Elec. Serv. Co. Date

701 Arch St., Phila. 6, Pa.

Please enter Order for:

..... MODEL

.... Enclosed \$..... MONEY ORDER CHECK

.... Please send full information on Communications Receivers.

NAME

ADDRESS

CITY ZONE ... STATE

SOME FM FACTORS (Continued from page 324)

that using four doubler stages permits a frequency change of 4 squared or 4 x 4 equals 16.

The limit frequencies of 5059.12 and 5008.11 will also be stepped up to:

$$f_1 = 16 (5059.12) = 80,945.92 \text{ Kc}$$

$$f_2 = 16 (5008.11) = 80,129.76 \text{ Kc}$$

The bandwidth at the higher range is 80,945.92 Kc minus 80,129.76 Kc or 816.16 Kc.

IMPROVING THE LINEARITY

Since a bandspread of 816.16 Kc is far too wide for our purpose, decreasing this final bandwidth will result in decreasing the oscillator frequency shift and improve linearity. If a bandwidth of 150 Kc is used, the oscillator frequency shift should be (with four doublers) equal to 150 Kc./16 or 9.375 Kc.

Thus, the frequency shift for both positive and negative modulation peaks, at the oscillator, may be made very nearly the same to secure linear modulation conditions. In this example, an FM oscillator shift of only 9.375/2 or 4.6875 Kc above and below the resting value of 5035.11 Kc gives us a high-frequency final doubler output range of 16 times 9.375 or 150 Kc. The 150 Kc figure may be used on the basis of selecting a deviation ratio of 5 times the highest modulating frequency, which we may assume to be—in this example—equal to 15,000 cycles per second.

As the carrier frequency is shifted from 5035.11 to 5059.12, numerous sideband FM frequencies are produced. The bandwidth is 5059.12 minus 5035.11 or 24.01 Kc. Let us split this up into 100 parts. Then,

$$f_a = f_c + \left(\frac{f_b}{100} \right)$$

where f_a = the first sideband frequency in a positive direction (going higher in frequency)

f_c = the original carrier frequency (of 5035.11 in this example)

f_b = the bandwidth, equal to 24.01 kc in this case. Note this is for 1/2 the total band and is the upper frequency half of the complete band.

In this case, 24.01 divided by 100 gives 0.2401 and the first sideband frequency would be,

$$f_a = 5035.11 + 0.2401 = 5035.3501 \text{ Kc.}$$

The interval that we have selected is 0.2401 and the tenth sideband frequency would be, simply,

$$f_{10} = 10 \left(\frac{f_b}{100} \right) + f_c = 10 \times 0.2401 + 5035.11 = 5037.511$$

Other sideband frequencies could be calculated for analysis purposes. Actually an infinite number of such frequencies are produced both above and below the unmodulated FM carrier frequency. As the oscillator deviation is increased, the side frequencies, which are developed by the carrier shifting through a frequency range, are increased in number. Us-

ing a lower carrier frequency, and small shift, the sideband frequencies are reduced in comparison with the number of frequencies produced at a higher FM carrier frequency level.

The carrier frequency in this case is 5035.11 Kc, which means that 5035.11 x 1,000 complete waves are produced per second. Since t equals $1/f$, a 1,000 Kc wave equal to 1,000,000 complete vibrations per second would have a time duration of 1/106 or 0.000,001 second. 5035.11 x 1000 equals 5,035,110 cycles per second. Thus for one complete wave of R.F. there would be required a time duration of 1/5,035,110 second or 0.000,000,1787 second, equal to 0.17 microseconds.

AUDIO COMPENSATION NEEDED

When a 40-cycle audio signal modulates the transmitter, the high frequency carrier is moved from 5035.11 Kc to 5059.12 Kc, back to 5035.11, then to 5008.11 Kc and back to 5035.11 Kc, the starting point. This change is made at the rate of 40 cycles per second. The time required for the modulating signal to go through one cycle is 40 divided into 1 or 0.025 second. This is the time of one complete 40 cycle wave, and during the positive half of that wave, assuming positive peaks cause a rise in the carrier frequency, the carrier is shifted from 5035.11 to 5059.12.

Let's start from zero for the modulating signal and assume that we are rising from zero to the maximum positive value or peak. The time required to reach the peak will be 1/2 that of the 40-cycle duration time or 0.125 second. For a time duration of 0.125 second, assuming no modulation of the carrier, 0.025/0.000,000,1787 waves of R.F. would be produced each 1/2 cycle of 40 cycle modulating signal. This would be 139,898 waves per second. (It must be remembered that the above example is given for simplicity's sake.)

When the modulating frequency is 15,000 cycles per second, the time duration of the modulating signal is equal to 15,000 divided into 1 or 0.000,066 second. This is equal to 66 microseconds. The positive and negative half of the wave each require 33 microseconds for completion. As the time is now much shorter than it was for the 40-cycle signal, during a given half of the high audio frequency cycle a fewer number of R.F. waves will be transmitted. That is, 33 microseconds divided by 0.17 microseconds gives 194.11 R.F. waves during the positive half of a single cycle of the 15,000-cycle audio signal. The duration of the 5035.11 Kc carrier is 0.17 microseconds.

We may expect a greater output at the lower audio modulating frequencies than at the higher audio modulating frequencies, and can compensate for the effect by increasing equalization in the audio modulator of the transmitter, so that the higher frequency sounds produce greater deviations.

HUM ELIMINATION

(Continued from page 313)

may be caused by emission from the heater to the cathode, or emission from the cathode to the heater. This condition may be reduced or eliminated, in the first instance by applying a positive voltage on the heater, sufficient to make it as positive as the cathode. In the second instance, the application of a negative voltage on the heater sufficient to make the heater-cathode voltage difference small is the remedy.

It must be remembered that although a tube is supposedly cut off by the application of bias to the cathode, the cathode does not always cover the heater completely, and that emission can occur from the heater to the plate. If this emission takes place from one exposed heater wire, said emission will not be from an equipotential surface and will vary as the heater supply frequency.

It is best, in audio amplifier design, not to rely on multiple grounds to the chassis. It is better to carry the ground circuit from point to point with a heavy copper wire, and this ground, insulated from the chassis, should be grounded in one spot only. This spot will have to be found by trial and error. This is particularly effective in high-gain amplifiers. A spot will be found at which the hum will drop appreciably and even reduce to the vanishing point.

RESISTANCE-CAPACITY FILTERS

It sometimes becomes impractical from an economic standpoint to use brute force methods, such as complicated filters and regulators, to effectively filter the entire power supply, when the addition of an RC network, in one or more circuits, will accomplish the desired result. This may be either keeping the supply ripple from this stage, or isolating the plate excursions of this stage from the power supply RC filter networks are usually figured on the basis of $T = RC$ (see Fig. 3) where T is the time in seconds, R is the resistance in ohms and C is the capacity in farads.

It might be pointed out that a lot of time can be saved and time-constant problems can be worked in the head, if you remember that microseconds equals ohms times microfarads or that microseconds equals megohms times micro-microfarads. One of these formulas puts the parameter you want in the terms that you want it and eliminates converting farads, for instance, to microfarads or micro-microfarads, or ohms to megohms. This will also eliminate the possibility of error in adding and subtracting negative and positive exponents.

This formula states the time, T, it takes the voltage across the Condenser, C, to charge to 2/3 of its full value or to discharge to 1/3 of its original value. These fractions are approximate, as the exact amount that the value C charges to is

equal to $1 - \frac{1}{e}$ and the value it discharges to is $\frac{1}{e}$.

The condenser charges or discharges according to an exponential function so that it takes a much longer time to change even a much smaller additional amount in the direction we are considering. (See Fig. 4.) It is interesting to note that C may charge to 95% of its maximum in 3RC (seconds) or it will discharge to 5% of its total

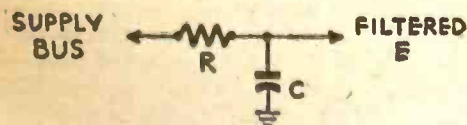

Fig. 3—Charging time is set by R and C.

value in the same time, as the case may be. This figure is accurate to about three decimal places.

If we compute our RC value on the basis of $T = RC$ in an isolation filter, we will still have 1/3 of the original amount of ripple left, which in most cases is not reducing it to a sufficiently low value. We could compute the necessary RC to reduce the ripple to any premeditated value but

(Continued on following page)

Electricity

Models range from 350 to 35,000 watts, A. C. types from 115 to 660 volts, 50, 60, 180 cycles, single or three-phase and 400, 500 and 800 cycles, single phase. D. C. types from 6 to 4000 volts. Also available in dual voltage and special frequency types.

ONAN ELECTRIC PLANTS

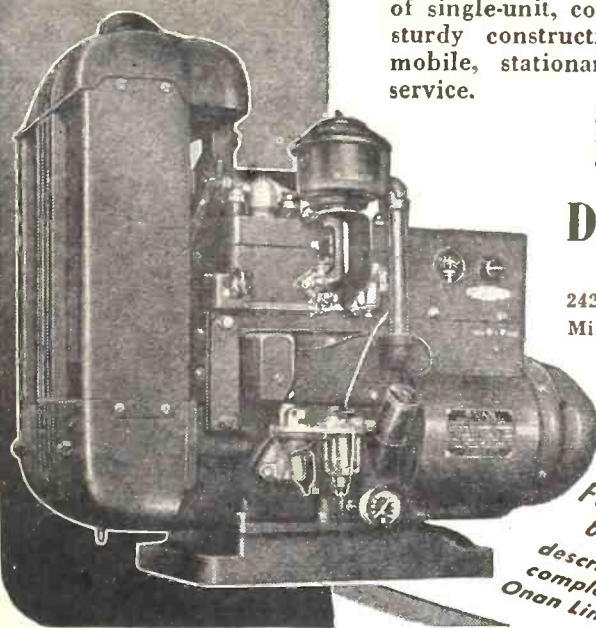

FOR RADIO AND ELECTRONIC APPLICATIONS

ONAN ELECTRIC GENERATING PLANTS supply reliable, economical electrical service for electronics and television applications as well as for scores of general uses. Driven by Onan-built, 4-cycle gasoline engines, these power units are of single-unit, compact design and sturdy construction. Suitable for mobile, stationary or emergency service.

Model shown is from W2C series; 2000 to 3500 watts; powered by Onan-built, two-cylinder, water-cooled engine.

D. W. ONAN

AND SONS

2424 Royalston Avenue
Minneapolis 5 Minn.

Write For Folder 690-A describing complete Onan Line

FREE TO RADIO MEN

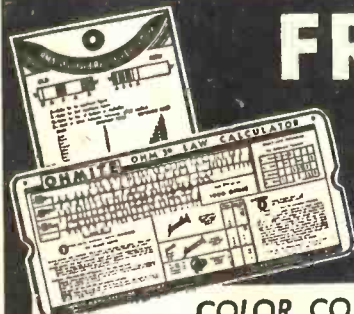

COLOR CODE and OHMS LAW CALCULATOR

Burstein-Applebee of Kansas City offers you this great convenience FREE. Easy to work. Solves many problems in a jiffy. FREE to radio men, electronic engineers and others in the business. Attach coupon to your letterhead.

MAIL COUPON NOW

BURSTEIN-APPLEBEE CO.
1012 MCGEE, KANSAS CITY 6, MO.
Send me FREE Color Code and Ohms Law Calculator along with latest catalog.

I am _____ STATE CONNECTION IN INDUSTRY

NAME _____

ADDRESS _____

TOWN _____

STATE _____

Get Started in Radio



10 "HOW-TO-DO-IT" BOOKS

Get a solid foundation in radio by means of these 10c timely text books. Each clearly written, profusely illustrated, contains over 15,000 words. You'll be amazed at the wealth of information packed into these handy books. Excellent for reference—ideal for technical library. Your money back if not satisfied.

5 BOOKS for 50c
10 BOOKS for \$1.00

Sent to You Postpaid

- | | |
|--|-------------------------------------|
| No. 1—How To Make Four Doerle Short Wave Sets | No. 6—How To Have Fun With Radio |
| No. 2—How To Make The Most Popular All-Wave 1 and 2 Tube Receivers | No. 7—How To Read Radio Diagrams |
| No. 3—Alternating Current for Beginners | No. 8—Radio for Beginners |
| No. 4—All About Aerials | No. 9—Simple Electrical Experiments |
| No. 5—Beginners' Radio Dictionary (Leading Terms) | No. 10—Television |

Remit by check or money order—register letter if you send cash or stamps.
RADIO PUBLICATIONS, 25F West B'way, New York (7)

French Firm, selling radio articles in France and North Africa, is looking for representation of an American make of radio, accessories, receivers, tubes, etc. Please write to: Le Materiel-Radiophonique, Service Commercial, 7, Boulevard de Brou, Bourg (Ain), France.

FOR SALE 250, five-tube chassis, with 4 octal sockets. I.F. and power transformer, variable condenser. Antenna and Oscillator coils, by-pass Condensers and Resistors, phone jack, and tie-strip—\$3.50 each; lots of 10 or more, \$3.00 each. Also 600 Chassis blanks with sockets only and assorted parts.

LEE DE FOREST LABORATORIES

5106 Wilshire Boulevard
Los Angeles, California

Spell radar backward and you get confusion, says Frederick C. Othman, newspaper columnist. He refers to the confusion surrounding both the early censorship of the subject and the subsequent "revelation," which was not entirely revealing.

Possibly to illustrate the confusion, the distinguished columnist goes on to declare: "My professor says that radar some day

will become television, without scanning discs, synchronous motors and all the other complicated innards now in use."

The ghost of Nipkow will be pleased to hear that in this day of cathode-ray tube television, the scanning disc is still referred to, even if the reference is due to confusion caused by publicity on radar.

Attention! HAMS

... FINISH YOUR OWN CRYSTALS



NEW Complete Crystal Finishing Kit

Meet F.C.C. regulations for frequency control with Quartz Crystals. Finish your own crystals to meet your individual requirements. It's fun—it's easy—it's economical. Kit contains four AT

or BT low drift Quartz Crystals cut to U.S. Signal Corps wartime specification. Complete accessories including a holder with stainless steel hand lapped electrodes and special device for making limited frequency adjustments—flat glass grinding plates—coarse and fine special grinding abrasives—cleaning brush and syntex beads and complete instructions. Be sure to specify frequency desired so we can send blanks within easy grinding range.

ALL AT AMAZING LOW COST—
Send money order, check or cash for your kit today.

COMMERCIAL EQUIPMENT CO.
Dept. B
1416 McGee Street
Kansas City 6, Missouri

FREE INSTRUCTION

I Guarantee this Book will Earn You 5 TIMES ITS COST!

Or It's Yours FREE!
Here's a book that will make money for you. Let me prove it with one of the greatest satisfaction guarantees in technical book history. **COYNE TROUBLE SHOOTING MANUAL** is 4 great books in 1. 610 large pages packed with over 600 valuable wiring diagrams, plans, etc. Shows you new methods for shooting trouble on motors, appliances, refrigerators, automotive devices, air conditioning and diesel equipment.

SEND NO MONEY

Here's my sensational offer—Fill in and mail the coupon below. Send no money. Look the book over 7 full days FREE—then decide if you want to keep the book. If you keep the book you can pay \$8.00 cash or send \$3.00 after 7 days and \$3.00 a month until \$8.95 is paid. And further I GUARANTEE that the book must earn 5 times its cost in one year or I'll refund every cent you paid and you keep the book FREE. You can't possibly lose on an offer like that—the book must pay its cost 5 times over or your money is refunded. Offer Limited—Act Now! Send 7-day trial coupon today!

H. C. LEWIS, Pres., COYNE ELECTRICAL SCHOOL, Dept. 26-T1
500 S. PAULINA STREET, CHICAGO 12, ILLINOIS

Send me the COYNE TROUBLE SHOOTING MANUAL for 7 days FREE examination. After 7 days I'll either return the book and owe nothing or send \$3.00 and \$3.00 per month until \$8.95 is paid or I'll pay cash price of \$8.00. You agree to refund my entire payment if this book does not earn 5 times its cost in one year.

NAME _____ Age _____
ADDRESS _____
TOWN _____ Zone _____ STATE _____
 IF YOU WANT BOOK sent C.O.D. (you pay postman \$8.00) check here. Same satisfaction guarantee or your money back.

Make your own Talkies 8m/m • 16m/m
WITH PAT'D. **FILMGRAPH** RECORDER
and Instantaneous Permanent **PLAYBACK UNIT.** Lengthy Recordings; Clear, Powerful; Eliminates Titles.
CIRCULAR FREE
MILES REPRODUCER CO., INC. 812 BROADWAY, N.Y.3 RC-2

HUM ELIMINATION

(Continued from page 355)

for a reasonably close estimate we may use the formula $T = \frac{RC}{25D}$ where D is the duty cycle expressed in a fraction of one.

This will yield an RC filter which will reduce the ripple to approximately 1% of its unfiltered value. The duty cycle is the ratio of time of duration of a wave form to the period of successive wave forms. In the case of a sine wave these values are equal, so D will equal .5.

Remember when using RC filters that the choice of R is limited to the largest value that will give the required filtering but which will not drop the average DC potential on the tube plate to a value lower than the value which was used in designing the components for that stage.

The importance of this factor "D" will be more evident when a non-sinusoidal circuit is to be decoupled. For instance, a multivibrator which produces a square wave ten microseconds wide and then rests for ten thousand microseconds will draw current for 10 μsec., whereas one which produces a square wave three thousand μsec. wide and rests for seven thousand μsec. will draw current for 3000 μsec. and will, therefore, discharge our C to a much lower voltage, indicating the necessity for a bigger C or a larger R.

In any event, when unequal wave forms are considered, it is more convenient to consider time constants rather than impedances and reactances.

MISCELLANEOUS METHODS

Decoupling is necessary where several stages are to be cascaded, as oscillation can result. It is conventional, therefore, to isolate several or all the stages, not only in the interest of hum reduction, but to eliminate the unwanted regeneration introduced by common coupling in the power supply.

Hum which cannot be eliminated in any other manner can be reduced by the application of degeneration which will reduce the hum, within the loop, proportional to the amount of feedback. In several cases, this feedback loop could be resonant at the hum frequency only, so that a maximum of degeneration is introduced at the hum frequency.

In cases where the low-frequency response is not important, it is feasible to reduce the coupling time constants by reducing the coupling condensers and grid resistors, reducing the gain at the hum frequencies. When all other means fail or when economy dictates, hum may be balanced out by applying to the circuit in question a hum voltage of proper amplitude and 180° out of phase. This voltage may be applied to any of the tube elements in a number of ways.

Remember that the field of a dynamic speaker, when used as choke in the power supply, has a very strong hum field surrounding it and an input transformer should not be located close thereto. A velocity microphone will pick up a strong hum voltage when located as far as 8 or 9 feet from such a speaker field. Microphone orientation will reduce this pickup to a minimum.

When connecting a self-powered tuner to an amplifier, remember to reverse the line connections if undue hum results. If both units have by-pass condensers from one side of the line to ground, it is possible to plug the units into the supply mains in such a way as to place some, or all, of the

110 V A.C. 60 cycle power source in series with the common ground between the units.

Consider, when using a cathode follower, that the cathode is swinging with the signal, and, at some parts of the cycle, it may well be a hundred volts above the filament, which may give rise to cathode-filament emission, or capacitive hum coupling.

Electrolytic condensers are a potential hum source. Their capacity reduces with age and their impedance increases, which can also give rise to oscillation. They should not be depended upon for R.F. bypassing and, in such instances, should be paralleled with a good paper or mica condenser.

Don't forget to by-pass to ground all the cathodes in which degeneration is not desired. The value of the condenser should be large so that its impedance at 60 cycles will be much lower than that of the cathode resistor, so that any hum developed between the heater and the

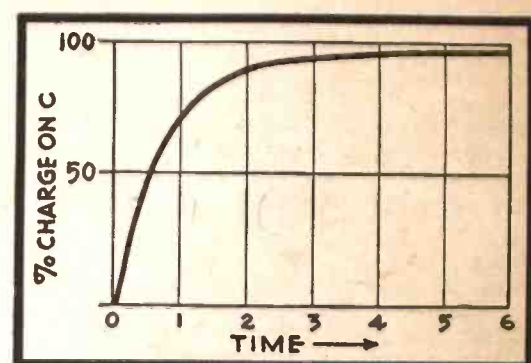

Fig. 4—Graph of condenser charging time.

cathode will be by-passed to ground. It is important that this condenser be grounded to the same place as the grid and cathode resistors, so that an AC circulating current in the chassis is not connected in series with the cathode by-pass condenser. (See Fig. 2.) Electrolytics used for by-passing sometimes give rise to tunable hums in radio tuners. Tunable hums have also been known to be caused by unwanted 60 cycles introduced into the oscillator of a superheterodyne receiver, due either to faulty by-passing or a faulty tube.

Hum can be caused by induction from a phonograph motor to a magnetic pickup. This can be reduced by magnetically shielding the pick-up and using an iron turntable. Of course, the leads from the pick-up should be run through shielded wire and, in low-level pickups or microphones, the shield braid should not be relied upon for the ground return. Rather, use double wire shielded cable, connecting shield braid to the amplifier chassis and the ground wire to the amplifier ground. In this instance, do NOT connect the braid to the ground at the microphone or pickup but only to its frame. In connection with phonographs, it may be noted that what appears to be a hum only when records are played, may be turntable rumble. This may be reduced by replacing the rubber drive wheel on the rim drive models or by reducing the low frequency response of the amplifier.

Last, but not least, mechanical vibration can be responsible for hum. In such cases mechanical isolation is indicated. Mounting on rubber or removal of the source is the answer.

There are very few cases where the annoying hums cannot be eliminated or reduced to the point where they are no longer objectionable and the full capabilities of the unit under consideration can be realized.

A "PORTABLE SHOP"

(Continued from page 311)

tron stream flowing through the other elements to the plate. The plate is electrostatically shielded from the oscillating portion by the screen, which is at R.F. ground potential. It is also stable in respect to voltage variations. Any variable condenser which was or could be used to cover the broadcast band with standard coils may be used here. Standard 4-prong plug-in coil forms are used. The coil is wound continuously but is tapped for the cathode connection. Complete information on coil data is given in the table. The 6SK7 is a perfect tube for the job; being single ended wiring is easy, and one can be assured of complete shielding. Grid condenser and grid leak should be of the smallest physical size procurable and should be fitted with a metal shield. The value of the resistor supplying voltage to the potentiometer is given as 50,000. Actually it should be determined after the voltage from the power-pack is known. For the 6SK7 the voltage at X should be 100 volts, which is the screen voltage given in the tube manual. B-plus and filament voltages are supplied from the power-pack below by two wires plugging into male receptacle situated at the back of the panel.

As an R.F. and I.F. signal-tracing unit the tester compares not unfavorably with elaborate 3-stage TRF analysts. For signal tracing the output jack is connected to the input of the audio channel by a short connection. Signals can then be picked up with a shielded test probe.

A word of warning is needed for anyone who thinks that all that is necessary is to pick out the right sized condensers and stick them together. There is a world of difference between an ordinary regenerative set and one that is carefully designed. When used as a service tool one wants no worries as to whether that birdie, whistle, hum or howl is coming from the defective radio or from one's test instrument. Here are a few pointers. 1.—Plate and grid wires must be very short, yet parts must not be crowded. 2.—Half the battle is in constructing strong, neat shields. 3.—Build rigidly and solder carefully. 4.—Three factors influence the smoothness of going into and out of oscillation; the amount of feedback, grid leak, and antenna coupling. The final setting of the cathode tap on a coil should be such that the detector breaks into oscillation at the recommended screen grid value as given in the tube manual. If it oscillates only at a higher voltage too little feedback is present and the cathode tap should be moved higher on the coil. A low enough value of feedback should be used to ensure smooth regeneration from an almost noiseless condition to slight hiss, loud hiss, whistle (when passing station). If it comes into oscillation with a plop and is not stable (starts squealing if you shake your fist in its face) adjustment of the grid-leak or antenna coupling is indicated. If, however, smooth regeneration cannot be obtained with at least a one-megohm leak, the antenna coupling should be loosened; that is, use a smaller condenser. A tiny trimmer condenser works well in this position.

5.—Another disease from which regenerative sets suffer is fringe howl, noticed when tuning through a station. This is more than a matter of too much regeneration. It means that R.F. signal is getting through into the audio section. The remedy lies in better R.F. filtering.

6.—A good regenerative set should have little or no hum. Methods of elimination are: 1.—More careful shielding, not just of wires but of parts and sections. 2.—

Grounding of chassis. 3.—Better power supply. 4.—Ground one side of heaters and by-pass other side through an .01 mfd condenser.

To obtain an audio signal for test purposes, plug in broadcast coil, attach antenna to input jack (a small built-in antenna in the top of the cabinet brings in all local stations). Connect output jack to input of audio channel. Tune in a station.

MODULATED R.F. OR I.F. SIGNAL

As anyone who was ever bothered by interference from a neighbor's radio in the old days knows, a regenerative set can be made to give out a self-modulated R.F. signal. This is done by turning up the regeneration control until the tube breaks into audio oscillation. If the tube merely oscillates smoothly the result is an unmodulated signal. If the regeneration is increased still more the grid becomes more negative until the plate current has been reduced to so low a level that the tube stops oscillating. The grid then becomes less negative and oscillations can again begin, so an audio cycle is repeated and is superimposed upon the fundamental R.F. wave.

It is unnecessary to tell how one uses an R.F. or I.F. signal in locating a fault in a radio. Nor is it necessary to outline the alternative method of signal tracing. Many good articles have appeared in *Radio-Craft* on both of these methods. It hardly needs to be mentioned that when the test instrument is used for signal tracing the apparatus is not used in an oscillating condition. The regeneration control is merely advanced to a position where the apparatus is sufficiently sensitive to pick up a signal, detect and amplify it and pass it on to be registered by the audio channel. Always use a shielded test probe when picking up an R.F. or I.F. signal from a radio.

DIODE VACUUM-TUBE VOLTMETER

To use, the D.C. pocket voltmeter, seen at the right in the photo, is connected to the Diode. Refer to the circuit diagram for connections and note that the two ground terminals on the lower part of the panel are used along with the two pin jacks in the upper left corner. This circuit reads peak A.C. volts and while it is not as sensitive as more complicated V.T.V.M.'s it is a distinct improvement over ordinary A.C. voltmeters. The RMS value of the A.C. voltage under measurement can be determined by multiplying the peak value as read on the meter by 0.71. Most common measurements are peak voltages across filter condensers; to check turns ratios of transformers, and as an audio-frequency output meter across the voice coil of a speaker. The condenser must be a high quality paper 2.0 mfd. It should be noted that this circuit has certain limitations. It is no more sensitive than the meter with which it is used and loads the circuit. As here constructed it has too high losses to measure R.F. frequencies.

Many possible uses occur to one who has an idle evening with the apparatus. The audio-amplifier becomes a record player, a music booster, or a miniature P.A. system. The broadcast band may be covered, and short-wave coils can easily be wound for foreign reception.

You can also try modulating the suppressor-grid of the 6SK7 with a strong audio signal from a record player or a carbon microphone. The broadcast can be picked up by the kitchen radio. (But not by the neighbor's radio or the federal authorities won't like it.)

Radiomen's Headquarters

BUFFALO RADIO SUPPLY

219-221 Genesee St., Dept. C

Buffalo 3, N. Y.

ALMOST ALL KINDS OF RADIO TUBES
IN STOCK AT BEST WHOLESALE PRICES

Mail in your orders for all types needed,
not just the critical numbers, and we'll try
to fill them completely!!!

BALLAST TUBES—Nationally known quality, any type—\$.39 ea.

CONDENSERS—Guaranteed 1 year. Prices in lots of ten, either 1 type or assorted. 100 Mfd. 25V—.35; 50 Mfd. 150V—.45; 20-30 Mfd. 150V—.40; 20-20 Mfd. 150V—.30; 25 Mfd. 25V—.20; 10-10 Mfd. 450V—.45; 20 Mfd. 150V—.20; 16 Mfd. 450V—.40; 12 Mfd. 150V—.15; 10 Mfd. 450V—.27; 10 Mfd. 50V—.15; 8 Mfd. 450V—.23. Following paper condensers in 600V size: .25 Mfd.—.18; .1-10; .05 Mfd.—.09; .02 Mfd.—.08; .01 Mfd.—.08; .008 Mfd.—.05; .005 Mfd. and smaller capacities—.07 ea. 100 ass't new but outdated condensers, average over 15 lbs., no guarantee—\$.90.

Highest Grade standard style car antennas with lossless leads: 66"—1.50; 96"—2.50. Volume controls in any standard resistance—.58. with switch—.87.

Speaker Specials: Per. Magnet 2½"—1.45; 4"—1.45; 5"—1.25; 6"—1.75; 8"—3.95; 10"—5.95; 12"—(21 oz. magnet)—7.95. Electro-dynamics: 4", 5" or 6"—450—1.50.

115V. 60 CYCLE, HALF SHELL POWER TRANSFORMERS. At prices that can't be beat.

For 4 or 5 Tube sets: 40 MA. HV., 5V Fil and either 6.3 or 2.5V Fil\$1.40

For 5 or 6 Tube sets: 45 MA. HV., 5V Fil and either 6.3 or 2.5V Fil 1.55

For 6 or 7 Tube sets: 50 MA. HV., 5V Fil and either 6.3 or 2.5V Fil 1.70

For 7 or 8 Tube sets: 70 MA. HV., 5V Fil and either 6.3 or 2.5V Fil 2.05

For 9 to 11 Tube sets: 100 MA HV., 5V Fil and either 6.3 or 2.5 Fil 2.75

Filter Chokes, Cadmium Plated Straps, 2" Mounting; 200, 300, 400 or 500 ohms—\$.49. Universal Audio Output Transformers, tapped for various impedances—\$.79. Single or double-button mike transformers—\$.69.

Gold-Plated Single-Button Midget Carbon Microphone with stretched duraluminum diaphragm. Works in any position. Made for Signal Corps. Perfect for lapel mike or concealed or secret pickups. Waterproof-Super-Special \$.95 ea. Bullet Crystal Mikes—\$.45. Bullet Dynamic Mikes—\$.75.

BARGAINS IN WIRE: No. 18 POSJ 2 conductor approved parallel Zipcord, 250' spool, \$.425; No. 18 FF (fixture wire), 1000' or 2000' spools, \$.695 per M; No. 18SV round rubber-covered double wire for electric drills, wash machines, etc., 250' for \$.95; No. 18 PO brown rayon covered parallel lampcord, 250' spool, \$.450. Hook-up wire, per 100 ft.—\$.60. Radio and appliance plugs—Bakelite, 100 for \$2.00; Heavy Rubber, 100 for \$4.50.

Operate any 1½ Volt portable or farm radio on 110V AC, with the new GTC Portable Power Unit. Complete for \$8.95.

Our latest price list is just off the press.
Send for your free copy now.

**LOWEST PRICES • COMPLETE STOCKS
FAST SERVICE
STANDARD MERCHANDISE!**

BUILD YOUR OWN! FAST FREEZER PLANS \$1.00

It's easy to build this household appliance and profitable to use. Save up to 75%. Operates on 110 or 32 volts. Plans show 5 sizes and are easy to follow. ENJOY MAKING ONE OF these freezers from new or used parts. No expert knowledge needed. Mail \$1.00 bill or check for complete plans and catalog. **LEJAY MFG. CO.,** 456 Lejay Bldg., Minneapolis 8, Minn.



• Ted McElroy
World's Largest Manufacturer of
Wireless Telegraphic Apparatus
COMPLETE CENTRAL OFFICE EQUIPMENT
McElroy Manufacturing Corp.
82 Brookline Avenue • Boston, Massachusetts

TECHNOTES



University

ELECTRO-ACOUSTIC REPRODUCERS

An all-inclusive line of permanent magnetic electro-acoustic reproducers designed for specific applications—directional and radial, for indoor and outdoor mounting. Exclusive design features assure high efficiency and dependable functioning.

UNIVERSITY LABORATORIES
225 VARICK STREET
NEW YORK 14, N. Y.

LAKE'S RADIO Cabinets & Parts

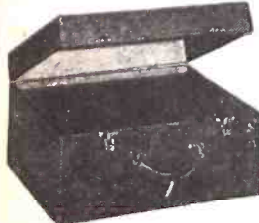

Portable Phonograph case, of sturdy durable plywood, in handsome brown leatherette finish. Inside dimensions 16½" long, 14" wide, 9½" high. Has blank motor board. As illustrated above specially priced at \$6.95

NOW AVAILABLE! Postwar 2 Post RECORD-CHANGER

In luxurious brown leatherette portable case, 13" L x 15" W x 10" D. Latest electronic developments make this modern record-changer the finest one on the market today! List price... \$49.95 Dealers' Net... \$29.97

Also blank table cabinets of walnut veneer in the following sizes, with speaker opening on left front side: (Note: 7" has center speaker grill.)

#1	8¼"	L x 5½"	H x 4"	D	\$1.95
#2	10¼"	L x 6¾"	H x 5"	D	\$2.75
#3	13½"	L x 7¾"	H x 6¼"	D	\$3.25
#7	10¾"	L x 7"	H x 5½"	D	\$2.50
#8	17"	L x 9"	H x 9¾"	D	\$4.50
#9	21"	L x 9¼"	H x 10½"	D	\$5.50

*Speaker Opening in center of front side. Cabinets available in Ivory color and Swedish Modern. Write for prices.

All types of radio cabinets and parts are available at Lake's lower prices. A large stock is listed in our catalog.

See VICIEN-RETAILERS Join our customer list today. Write for our NEW, 12 page, illustrated, elaborate catalog! Order from Lake! You'll make no mistake!

Dept. C

LAKE RADIO SALES CO.

615 W. Randolph Street, Chicago 6, Ill.

BUILD YOUR OWN RADIO

It's Easy . . . We Show You How!

4 tube T.R.F. Kit complete with tubes \$10.95

2 tube Superheterodyne Kit complete with tubes \$17.95

We manufacture complete radio kits. Tubes and parts at special prices. Send for details.

RADIO KITS COMPANY

Dept. M 120 Cedar St. New York 6, N. Y.

ATTENTION, SERVICEMEN!

Do you have any servicing notes available which you would like to bring to the attention of the readers of *Radio-Craft*? If so, send them along. If they are publishable a six-month subscription to *Radio-Craft* will be awarded you. If your notes are illustrated you will be given a one-year subscription.

BROADCAST TECHNOTES

Here are a few tips regarding console equipment for use in broadcast studios:

1—Use of soldering lugs can result in erratic performance. To eliminate, skin back the shielded portion of the shielded conductor, then scrape off the insulation near the wire ends and clean the wire. Make loops in the ends and sweat solder around them. These "lugs" make perfect contact at all times.

2—Where shielded wire has a tendency to short, due to shielding braid touching terminals, push the braid back and wrap Scotch tape around the exposed portions of the shielding.

3—In servicing the potentiometers used for level controls, first clean with carbon tetrachloride, then apply a thin layer of graphite grease and a relatively thick layer of vaseline.

4—Put a little graphite grease on the ends of cord tips and push in and out of each tip jack several times. The graphite grease creates a better electrical bond.

5—Preamps should be mounted on sponge rubber if any microphonic noise is present.

6—When making connections to lug-type terminals on the patch panel, twist as much exposed wire through the eyelets as possible, to make area of soldering surface between the wire and terminals.

7—Put a little graphite grease on microphone connectors to prevent corrosion of contact surfaces.

BURR JAMISON,
Chief Engineer, WROX

SUPREME GENERATOR 571

I was continually having trouble with the output plug on this model signal generator. Solved the problem by replacing the existing jack with a four-circuit Amphenol mike connector, using terminals 2-3 as the internal generator ground connection. Terminals 1-4 were used as the output feed jacks.

This gives excellent results; it is easier to connect and disconnect the plug for transporting, and is the perfect plug connection after the plug ring is screwed into the jack. A shielded mike cable was used as the output leads.

JACK BORITZ,
Bronx, N. Y.

TUBE SUBSTITUTE

With some older types of tubes still short and liable to be so for the next few months, this idea may prove useful. I needed a 1V tube for a Silvertone radio, and not having one, I substituted an OZ4 gas-filled tube. I made an adapter out of an old 1V base and an octal socket.

CASELLA RADIO SERVICE,
New Orleans, La.

GRUNOW 1101

The owner complained that he had practically no control over the volume of the set. I found that he disconnected the aerial at the window strip in an attempt to lower the volume to comfortable listening standards. The set used a 2-megohm volume control.

After considerable testing, I found leakage between the volume control wire and another wire in the remote control cable. I ran another wire to the volume control as a temporary repair until a new cable could be obtained, and all was O. K.

CLAUDE M. PREW,
New London, N. H.

PILOT LIGHT

Some transformers have several taps on the primary side. If the line voltage is 115 volts and a tap at 120 volts is provided, a pilot light can be connected

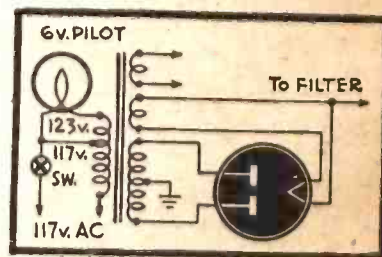

across this 5-volt potential. The leads from the pilot light to the transformer should be twisted to prevent tunable hum.

This is particularly useful on certain old-time receivers, where there are primary taps and the filaments run at lower voltages than the ordinary pilot lamps. Of course it is also possible to connect up a 2.5-volt lamp across any filament circuit which includes a type 27 or 56 tube.

NORMAN H. KENT,
Moose Jaw, Sask.

WESTINGHOUSE 42X5

Three sets of this particular model came in with a shorted by-pass condenser on the plate of the 6K6. Only one of these by-pass condensers shorts out, but since the third set came in, I made it a routine part of my job to remove the bypass on both 6K6 plates, and replace them. The original condensers were .0035 mfd., and I use an .002 mfd. in replacing them.

F. A. CLIFFORD,
Shamokin, Pa.

PPM—NEW TECHNIQUE

(Continued from page 349)

common frame of the system, where they may be put on telephone lines or otherwise routed as desired.

OTHER RECEIVER ELEMENTS

The actual receiver circuit is not as simple as has been described. A number of necessary circuits have not been mentioned. One of these is the automatic frequency control circuit, which is hooked in after the eighth I.F. stage. This applies to the high-frequency oscillator a voltage which keeps it exactly 60 Mc. below the received signal, correcting for slight frequency variations in either transmitter or local oscillator. Operation is along standard a.f.c. lines. When no signal is being received, a searcher circuit is activated, causing the local oscillator to travel over the tuning range till a signal is found, when it locks in on the signal frequency.

An a.v.c. circuit is also provided after the first video amplifier, control voltages being applied to the I.F. stages. Two clipper stages also assure uniformity of received pulses.

The gating circuits are also more complex than appears in the simplified discussion. While two gate generators work directly off the square-wave generator, each of the other six channels requires its own sweep generator and gate starter to properly delay gate action so that the eight-gate circuits operate in turn, each occupying its proper portion of the 125-microsecond period.

(All photos and drawings courtesy Bell Telephone Laboratories.)

ANTI-RADAR DEVICES

(Continued from page 309)

the vertical, and broad in the horizontal, plane. The superstructure is a reflector excited by the horn at bottom.

Photo 5 is a portrayal of the feelings which German radar operators might have been expected to feel when their apparatus was rendered useless by "window." It was posed with a captured German radar at Foggia, Italy.

Radio defense against the atom bomb is unlikely to be of great value, in the opinion of many of the scientists who helped develop it. Many different methods can be used to detonate the bomb; just how many is probably not yet known. Because of the possibility of employing many different detonating mechanisms, the defense against the atomic bomb is complicated. Radio might detonate it, but to do so one would have to know the type of detonating mechanism used in the bomb. Just as there is no defense against conventional explosive, per se, so there is no defense against atomic-energy explosive.

Atomic explosives would without doubt be launched against an enemy country in an atom-powered rocket, atomic power itself rendering other means obsolete for war use. Thus any other than radio means would be too slow to detonate the destructive charge at a safe distance from its objective.

THERE'S PROFIT in ELECTRICITY... LEARN from PRACTICAL ELECTRICS, \$1.00



Whether you want to enter the electrical field as a profession — or whether you want to know more about fixing electrical gadgets around the house, you will find Practical Electrics a profitable investment. You can find the right answers quickly. It gives you the fundamentals of electricity, electrical circuits, motors, transformers, electrical symbols, trouble shooting, etc. — all in plain, simple, understandable language. Send \$1.00 today for a copy of Practical Electrics, the ready reference book of electricity.

AUTOPOWER, Inc.

2118 PINE STREET • ST. LOUIS 3, MISSOURI



Civilian RADIO JOBS Wanted

FREE WANT-AD SERVICE

LABORATORY TECHNICIAN: 23 yrs. 4 years experience in audio, and research Labs. Seeking position with Electrical or Electronic Laboratory. David M. Lisbin, 77 Rodney St., Brooklyn 11, N. Y. EVergreen 8-8354.

RADIO MECHANIC—Operator 3½ years Army experience; desires position with radio company; ambitious, conscientious; interested servicing, television, electronics. Solomon Posner, 654 Williams Ave., Bklyn 7; CL7-2072.

RADIO TECHNICIAN: 4½ years Maint. Inst. and Repair. 1 yr. Radio eng. night. Electronic Lab assistant or trouble shooter. Future Primary. Salary secondary. I. Weinberg, 1563 Hoe Ave., Bx. 60. FUTURE IN RADIO, electrical, selling, any field desired; 24, married; 4½ years AAF radio mechanic, operator. Restricted radio telephone license. Ritzer, 2020 76th St., Brooklyn 14, N. Y.

RADIO OPERATOR—2nd phone, res. tel. licenses; eager and quick to learn, married, 24, will accept most anything in the operating field; New York only. Michael O'Connor, 55 Mt. Hope Place, Bronx 53.

RADIO TECHNICIAN: 9 yrs. exp. Army Signal Corps A.M.—P.M. Repair. Good selling ability. Salary secondary providing there is advancement. S. Jacobowitz, 299 Atkins Ave., Brooklyn 8, N. Y. AP7-6864.

VETERAN—Former D/F Station Chief with 4 years of Comm. experience desires a job of FM or VHF Install. and maint. Prefers work in middle-west. Will furnish references. Age 25. Write P. O. Box 14, Springfield, Mo.

RADIO TECHNICIAN, 25, married. Graduate of Air Force radio and radar schools. Two years of practical experience in a Signal Corps Depot and with the Air Transport Command. Familiar with all test instruments. Vicinity of New York City. Moderate salary to start. Morris Landsberg, 937 E. 181st St., Bronx 60, N. Y.

RADIO TECHNICIAN, 3 years exp. on low and medium power HF and VHF transmitters and receivers. Radiotelephone 1st class license. Desire position with good opportunity with broadcast station anywhere in U.S.A. Robert A. Boyle, 31-33 80th St., Jackson Heights, N. Y.

YOUNG MAN 29, married. 3 years experience AAF Radar. Maintenance, installation, and operating. Desires position in above. Anthony Urban, 412 W. 57th St., New York City (19). CI7-2539.

RADIO INSTRUCTOR, Air Force trouble shooting, maintenance, 3 yrs.; 15 yrs. commercial exp., service, sales; broadcast and "ham" licenses. Brody, 1057 Bryant Ave., Bronx 57.

RADIO REPAIRMAN; semi-skilled, 2½ yrs. army; 1 yr. civilian, experience in pulling sets, giving estimates; desires work in store. Sam Brounstein, 1248 St. Marks Ave., Brooklyn 13; PR 4-5345.

RADIO AND RADAR TECHNICIAN: 3 yrs. exp. aircraft communications and navigation equipment. Azuz, 415 Claremont Pkwy., Bronx 57.

PREVIOUS 4 yrs. electrical exp., indoor and outdoor work; also thorough radio, radar trouble shooter and tester. E. Rothenberg, 2939 Brighton 5 St., B'klyn 24; DE 2-4075.

YOUNG MAN: 23; radio tech., 3 yrs. army exp., desires pos. with future; willing to sell—mod sal. Harry Garten, 2233 81st St., Brooklyn 14.

RADAR MECHANIC—3 yrs. Army exp. installations, repairs, will take any position with future; salary within reason. Sid Edelstein, 1059 53d St., Brooklyn 19.

AAA for alertness, ambition and ability; 23; some college; radio and sales office exp., speak French; will go anywhere. Ephraim Schwartz, 186 Clymer St., Brooklyn 11.

RADIO—2d class telegraph and amtr.; License M.O.S. 766; oper. mfg. operator; transmitter maintenance; 24, single. Nemoyten, 446 Georgia Ave., Brooklyn 7.

MAN: 27, married; ambitious, experienced business administration radio and sound equipment field. Elliot Schwartzman, 141 E. 19th St., Brooklyn 26; BU 4-2672.

AMBITIOUS: 23; 1 year army radio; radar repair training; seeks future in radio field; willing to learn; 1 year college. Stanley Klein, 9205 Flatlands Ave., Brooklyn, N. Y.

EXTREMELY MECHANICALLY INCLINED. Licensed amateur; 3 yrs. army operating and maintenance. Code speed 30. Prefer Radio or Mechanical Work with future. Joseph Tartas, 320 Sterling St., Brooklyn 25, N. Y.

RADIO TECHNICIAN: 3 years exp. installation, testing, modification and repair aircraft, radio. Exp. also repair and conversion commercial receivers. Familiar all test equipment. Can type, drive; seeks servicing or laboratory position with future. Single, age 33, Murray Cohen, 132 Penn St., Brooklyn 11, N. Y.

TECHNICIAN RADIO, Electrical 10 years Civilian. Army exp. Maintenance, Construction. Installations including Amplifiers, Intercommunication, FM, Radio. Possess complete test equip. N. A. Zuloft, 303 So. 1st St., Brooklyn 11, N. Y.

RADIO REPAIRMAN, 23; 4 yrs. Army, civ. exp.; full or part time; interested in position with oppor. for advancement; willing worker. Anthony Palumbo, 93 Adam St., Hoboken, N. J.

RADIO TECHNICIAN, Navy chief, married, exp. radio, radar, electronic tester, radio telephone, 1st class license. Edward Chesnik, 61-03 Maspeth Ave., Maspeth, L. I., HA 8-0642.

COMMUNICATIONS; inter-office telephone, automatic or common battery; 5 yrs. wire chief; willing, living wage. Bernard Levine, 1000 E 173d St., Bronx 60.

RADIO ENGINEER: int. broadcasting, 18 mos. exp. upstate station as transmitter engineer, hold 1st class commercial. Milton Meinwald, 7207 18th Ave., Brooklyn 4; BE 2-8044.

YOUNG: 21; ambitious; mechanically inclined; 3 yrs. radar work; seeks any pos. with future; willing to learn. Paul Rubin, 1068 Ward Ave., Bronx 59.

RADIO-OPERATOR, MECHANIC: 3 yrs. Army exp.; seek pos. with radio company; interested television, electronics; married. Paul Pushinsky, 579 Saratoga Ave., Brooklyn 12; DI 2-0797.

RADIO TECHNICIAN, 23, married; mathematics, radio design background; exp. radio, radar, control eqts.; construction, lab., research. S. Granat, 1717 Carroll St., Brooklyn 13; PR 4-3405.

RADIO, Loran, UHF Technician: 8 yrs. exp. in radio repair and design; repaired and designed all type electronic equipment; 23. Jerome Kass, 1124 43d St., Brooklyn 19.

RADIO OPERATOR—4 years Army experience, ambitious, quick to learn, 28, married, good at selling, accept position with future. Jack H. Glusky, 1150 Vyse Ave., Bronx 59.

TECHNICIAN; desires day job, tester or lab. asst.; 8 yrs. exp.; married; willing take test; prefer New York. Wm. Pendergrass, 104 Central Ave., Jersey City, N. J.

TELETYPEPIST, 23, 2½ years army experience operation news transmission; preferably news bureau or communication work; worked staff P.R.D. of S.H.A.E.F., scribe, Paris; some radio-teletype work; steady position. Isidoro Heiss, 40 Bristol St., Brooklyn, N. Y.

RADIO TECHNICIAN, 3 years Army, 9 yrs. civ. exp. seeks pos. as lab. techn., engr. aid. Coll. drifting bekyrd. Frank Platt, 19 West 82 St., N.Y.C. 24.

EX-JASCO CAPTAIN: 29, civilian investigator, intelligence officer, staff communication air liaison, administrative executive ability, knowledge communications, radar, vaudeville, operations, production. Married, child; salary and future. A. Silverstadt, 410 Eastern Parkway, Brooklyn 25, N. Y. NEVINS 8-9825.

VETERAN 27, ambitious, easily adaptable. Attending Radio school evenings. Modest salary as radio apprentice. Harry Rothenberg, 3325 Park Ave., Bronx 67, N. Y.

RADIO MECHANIC; desires pos. with mfr. firm of electronic equipment; 3 yrs. army maintenance exp.; 24, married. Sol Katz, 1680 Vyse Ave., Bronx 60.

SOUND VALUES at TERMINAL RADIO

VERTROD V-103 VERTICAL ANTENNA

Especially designed for communication receivers. Noise-free reception, efficient coverage from 600 to 10 meters. Can be mounted anywhere—a screwdriver is the only tool you'll need. V-103 kit includes 3 section 9 foot rod, base antenna transformer, 75' weatherproof transmission line, receiver coupler, all mounting hardware and full illustrated instructions.

Special
\$6.95

Replacement POWER TRANSFORMER

Fully shielded, upright mounting. Delivers 375-0-375 volts @ 70 ma., 6.3 volts CT @ 2.5 A. and 5 volts @ 3 A.

Special
\$2.69



G.E. 3 1/2" SQUARE

0-150 D.O. Milliameters. Very accurate, fully guaranteed.

Special **\$4.95**

• 25% deposit requested with mail orders. • Please include sufficient postage; excess will be refunded.

TERMINAL Radio Corp.

85 CORTLANDT STREET • NEW YORK 7, N. Y.
Phone: WOrth 2-4415

Immediate Delivery! SIGNAL CORPS TELEGRAPH KEY



Genuine U. S. Signal Corps key with switch to close contacts, polished durable enameled metal base mounted on a bakelite base, key lever is nickel-plated brass-silver contacts; packed in new, original boxes. Shipping weight, 1 lb. **\$1.29**
10 for \$11.00

Army-Navy Type Headphones

Save up to 70% on genuine U.S. Signal Corps headphones. These are the better \$10.00 headphones for only \$2.95. Leather-covered headband, detachable rubber cushions, lightweight construction, impedance 8000 ohms. Each plus shipping charges..... **\$2.95** ea.



Order from your jobber or write direct. Write for our illustrated literature featuring all types of radio parts.

ARROW RADIO CO.

2205 W. Division St., Dept. D, Chicago 22, Ill.

speco

PLASTIC PLIERS

- Weighs 1 1/2 ounces!
- Absolutely shock-proof non-magnetic!
- 6,000 volt breakdown!
- Heat resistance 240 to 300 degrees!
- Tensile strength of material, 5000 lbs. per square inch!
- Pick up nuts, screws and washers without danger of shorting!
- Relocate wiring without disturbing magnetic fields while equipment is operating!



\$1.00

DEPT. C-2

ROBERTS ASSOCIATES, P. O. BOX 622, G. C. ANNEX, N. Y. 17

BLIND SERVICEMEN

(Continued from page 321)

in a radio shop that a man with sight could do. In 1937, he opened his shop doors to customers. He was a success. He sold new radios as well as repaired old ones. In general, he carried on his business as any sighted person could have done.

When he had proved to himself that a blind man could do radio work successfully, he began to dream of passing his knowledge on to other blind men. He knew from experience that independence is the thing the blind man desires above almost anything else. He knew that if he could teach them to be radio experts, they could be independent.

But problems beset him. Where would the money come from for such a school? Where would he get students? Who would pay for their training and the equipment they would have to have?

Then, one day in 1942, while he was still dreaming his dream, a telephone call came from the Army Signal Corps and Marine Materiel School in Omaha. A story about him in *Radio-Craft* had caught the eye of the school's owner. Could he come and teach servicemen to repair wounded radios in the dark?

He could and he did. He taught soldiers and Marines to repair and service their equipment in total darkness under the conditions they would find on a battlefield. So successful was he that in the 30 days allotted for each class, he not only taught them to service their equipment but to build simple radio circuits in a darkened room.

His wartime experiences further proved to him that his dream of teaching other blind men could be a reality. If persons with sight, naturally clumsy in the dark, could be taught this work, he knew that the average blind man could learn it far more easily. For the blind learn great manual dexterity, and their sense of hearing is developed beyond that of their sighted fellow men. And, after all, radio is concerned with the science of sound.

First he went to a few friends for financial backing. Then he got in touch with agencies for the blind all over the country. When he told them of his plan, some were skeptical. Many were enthusiastic.

But the blind themselves seized upon the plan. Inquiries about the proposed institute flooded in from all corners of the nation. They came from broom makers, piano tuners, rug weavers, men with popcorn stands. They came from men in all sorts of occupations, but they had one thing in common. Each of the letters was from a man with a burning desire to do radio work, to become an economically independent business man.

Now came the job of convincing the rehabilitation agencies of the states that radio work is suited to the blind man and that he can make a financial success of it. And be convinced they must, for almost all blind persons are forced to rely upon the agencies for their educations.

There was proof ready and waiting for them in Mr. Peterson. After successfully operating his shop in Preston, Idaho, and after his tenure as teacher for the Army and Marine Corps, he had opened his own shop in Omaha.

In little more than a year he had built his business to the point where he had one of the largest, if not the largest, in the area.

A traveling representative was appointed to explain the institute to the rehabilitation agencies, which are continually on the lookout for new opportunities for the blind. The representative already has covered some 20 states in the east, northeast and north. Convinced, agencies are now sending students.

The states pay for a student's training with the help of the Federal government. After his graduation, each blind person may have up to \$250 to set himself up in business. It is not a great deal to equip a radio repair shop. But radio men agree that "it's more than the usual shoestring" on which radio men often start.

The training takes a year—a little more or a little less as the student needs it. The first half of the course is spent in learning theory, practicing on models, and attending classes. The last half is devoted to actual work on radios and similar equipment.

In other words, the blind student will have a chance to serve his apprenticeship under the direction of the school with all the help he needs available.

An unusual feature of this last half



FRANK
BEAVEN

Suggested by:
J. F. Dunnnett,
Vancouver,
B. C., Canada

"Yeah! Well if you're not here in a couple of minutes, it's all off!"

year's work is that the student works on actual radios in need of repairs, not just laboratory models deliberately thrown "out of gear."

And so the blind are learning to recognize tubes and parts, not through endless trial-and-error methods; but quickly and surely under methods developed by Mr. Peterson. Using his technique, they are learning to solder without burning themselves. "I have enough burns for all of them," comments Mr. Peterson.

The project is so strikingly successful that Mr. Peterson is already faced with the

problem of finding new quarters for the school because of its rapid growth. The letters, cards and telegrams which pour in daily from blind men are eloquent testimony to their desire for independence. Letters have been received from as far as England.

They are learning all about radio. In short, they are learning to become useful, important members of their communities. They are learning to be independent.

Radio-Craft will print in an early issue an article showing how to construct a Braille-type multimeter. This instrument was designed and constructed by a blind radio amateur in New York.

ELECTRONIC STETHOSCOPE

THE value of electronic instruments in medical work has long been recognized. Among the most important of these is the electro-cardiograph. Now we have an instrument for study of the heart which combines the advantages of electronic amplification obtained in the electro-cardiograph with almost the lightness and portability of the ordinary stethoscope.

The new instrument, produced by Maico, leading manufacturer of electronic medical apparatus, is called the Stethetron. It consists of a microphone, a 3-stage amplifier, a special transducer and regular stethoscope earpieces.

One of the difficulties in the use of electronic amplifying apparatus for listening to the heart has been that louder low-frequency sounds masked the high-frequency sounds which are most important from a diagnostic point of view. The normal thump of the heart prevented hearing faint, high-pitched heart murmurs. By use of a special tone-emphasizing circuit, which Maico calls "Inverted Tonal Emphasis" it is possible to subdue the normal, low-pitched heart sounds at will and listen to those which might indicate abnormal conditions.

Because the normal heart-beat is composed largely of low-frequency notes, the tonal emphasis modifier can also be adjusted to increase these at the expense of

the higher portion of the spectrum, in the fashion of a radio's "tone control." The special transducer is also built to respond to low-pitched sounds. The microphone is a special unit, a contact type being necessary to pick up sounds from the patient's body without being affected by extraneous, airborne sounds.

A certain type of heart murmur is inaudible to a physician with normal hearing, using an acoustic stethoscope, unless the patient is rolled on his side. In actual experiments, the Stethetron has revealed this murmur instantly while the patient was flat on his back.

The 3-stage amplifier provides electrical amplification up to 100 decibels. Acoustical amplification is very difficult to measure accurately because of the peculiar nature of the body as a source of sound, but subjective tests indicate acoustical amplification in the Stethetron of up to 60 decibels for the important higher pitched sounds.

The new electronic stethoscope is housed in a plastic case, measuring only eight and three-eighths inches by three and seven-eighths in length and width and being but one and three-fourth inches deep. The whole instrument can be slipped into an overcoat pocket. Instead of requiring a heavy extra case, it can be carried easily in the case with a physician's other instruments where it may be conveniently on hand on private calls.

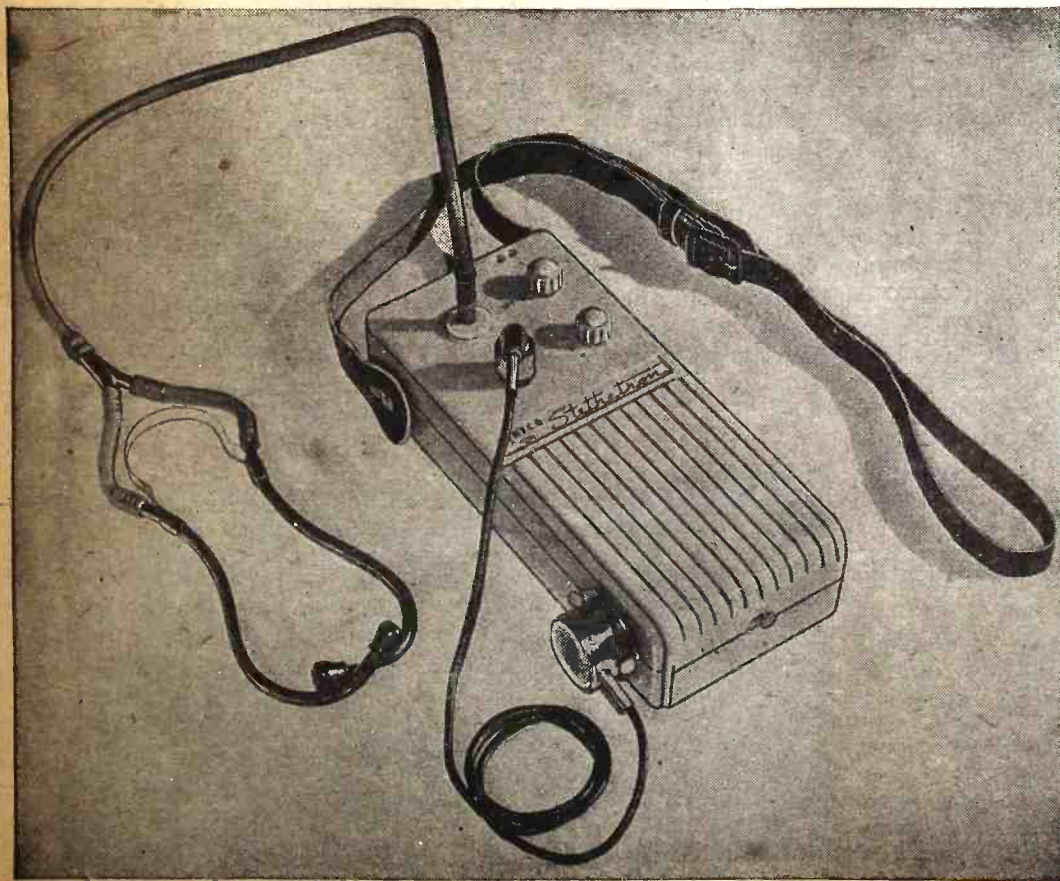

RADIO AND ELECTRONIC ACCESSORIES SEEKING INSTALLATION!

Let Radionic's experienced personnel help you with your radio and electronic requirements.

At your call are large and varied stocks at lowest possible prices—prompt personal service, with all merchandise guaranteed!

For a quarter-century, Radionic's management has specialized in serving Amateurs, Repair Dealers, Equipment Builders, Laboratories, etc.

So, send today for your free copy of our catalog of Radio and Electronic Parts—a valuable buying guide for amateurs and dealers.

Radionic Equipment Co., Dept. V2
170 Nassau St.
New York 7, N. Y.

Gentlemen:
Please send me, without charge, your new catalog.

Name

Address

City State ...

Nature of Business

RADIONIC EQUIPMENT CO.
"Chancellor Radio"
170 NASSAU ST., N. Y. 7, N. Y.

Cable Address:
"CHANSLOR"



CANNON-BALL

is unusually sensitive. For clarity of tone, dependable performance, quality at a fair price, choose the Cannon-Ball Guaranteed Headset like you like best. Folder R-2 illustrates complete Cannon-Ball line of efficient Headsets. Write

Scientifically Built
Heavy bar magnets greatly increase their efficiency.

C. F. CANNON COMPANY
SPRINGWATER, N. Y.

Headset Headquarters

In the Rocky Mountain Region
it's

RADIO & TELEVISION SUPPLY CO.
806 EUCLID AVE., PUEBLO, COLO.

"If we don't have it, we'll get it—
or it can't be had! Phone 5729"

TEST EQUIPMENT

—SHIPPED FROM STOCK!—

SUPERIOR 400—electronic multimeter.....\$52.50
SIMPSON 260—volt-ohm-milliammeter..... 33.25
RADIO CITY 805—tube and set tester..... 89.50
TRIPLETT 666-H—volt-ohm-milliammeter..... 16.00

25% deposit with order, balance C.O.D.
Also, many other types available.

SCENIC RADIO & ELECTRONICS CO.
53 Park Place New York City 7

A leading British radar expert proposes that radar be used for mapping the moon.

HARD-TO-GET PARTS

POWERFUL ALL-PURPOSE INDUCTION MOTOR

IDEAL FOR EXPERIMENTERS—101 USES



Sturdily constructed to precision standards, this self-starting shaded pole A.C. induction motor is powerful enough for a number of uses. Some of these are: Automatic Timing Devices, Current Interrupters, Electric Fans, Electric Chimes, Window Displays, Photocell Control Devices, Electric Vibrators, Small Grinders, Buffers and Polishers, Miniature Pumps, Mechanical Models, Sirens, and other applications.

Consumes about 15 watts of power and has a speed of 3,000 r.p.m. When geared down, this sturdy unit will constantly operate an 18-inch variable loaded with 200 lbs. dead weight—THAT'S POWER!

Dimensions 3" high by 2" wide by 1 3/4" deep; has 2 convenient mounting studs; shaft is 7/8" long by 3/16" diameter, and runs in self-aligning oil-retaining bearings. Designed for 110-20 volts, 50-60 cycles. A.C. only. Shp. Wt. 2 lbs.

ITEM NO. 147
YOUR PRICE \$2.95

ULTRA MAGNET

LIFTS MORE THAN 20 TIMES ITS OWN WEIGHT

LITTLE GIANT MAGNET

Lifts 5 lbs. easily. Weighs 4 oz. Made of ALNICO new high-magnetic steel. Complete with keeper. World's most powerful magnet ever made. The experimenter and hobbyist will find hundreds of excellent uses for this high quality permanent magnet. Measures 1 3/4" x 1 1/2" Shp. Wt. 5/8 lbs.



ITEM NO. 159
YOUR PRICE \$1.50

GENUINE MICROPHONE TRANSMITTERS

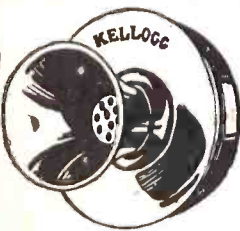

Regular telephone transmitters taken from a large telephone supply company's overstock. Work perfectly on 2 dry cells. Can be used on P.A. systems, call systems, intercommunications sets, short-line telephone circuits, house-to-house or farm-to-farm phone lines, also to talk through your own radio or as concealed dictaphone pick-up. Useful replacements on battery-operated rural telephone lines.

THESE ARE GENUINE TRANSMITTERS, MADE BY KELLOGG, WESTERN ELECTRIC AND STROMBERG-CARLSON, excellent in appearance and operation. A remarkable value, and one seldom offered in these times. Shp. Wt. 1 lb.

ITEM NO. 160
YOUR PRICE \$1.50

AMAZING BLACK LIGHT!!

Powerful 250-Watt Ultra-Violet Source



The best and most practical source of ultra-violet light for general experimental and entertainment use. Makes all fluorescent substances brilliantly luminescent. No transformers of any kind needed. Fits any standard lamp socket. Brings out beautiful opalescent hues in various types of materials. Swell for amateur parties, plays, etc. to obtain unique lighting effects. Bulb only. Shp. Wt. 2 lbs.

ITEM NO. 87
YOUR PRICE \$1.95

WESTERN ELECTRIC BREAST MIKE

This is a fine light-weight aircraft carbon microphone. It weighs only 1 lb. Mike comes with breastplate mounting and has 2-way swiveling adjustment so that it can be adjusted to any desired position. There are 2 woven straps; one goes around neck, the other around chest. Straps can be snapped on and off quickly by an ingenious arrangement.

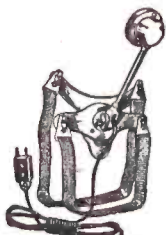

This excellent mike can be adapted for home broadcasting or private communication systems. By dismantling breastplate, it can be used as desk mike. Comes complete with 6-foot cord and hard rubber plug. Finished in sherdarized plate, non-rustable. Shipping weight, 2 lbs.

ITEM NO. 152
YOUR PRICE \$2.55

WATT HOUR METER

Completely overhauled and ready for immediate service. Designed for regular 110-volt, 60 cycle 2-wire A.C. circuit. Simple to install; 2 wires from the line and 2 wires to the load. Sturdily constructed in heavy metal case. 8 1/2" high, 6 1/4" wide, 5" deep. Westinghouse, G. E., Ft. Wayne, Sangamo or other available make. Shp. Wt. 14 lbs.



ITEM NO. 33
YOUR PRICE \$4.95

HUDSON SPECIALTIES CO.

40 West Broadway, Dept. RC-2-46, New York 7, N. Y.

I have circled below the numbers of the items I'm ordering. My full remittance of \$..... (include shipping charges) is enclosed (C.O.D. ORDERS UNLESS ACCOMPANIED WITH A DEPOSIT.) OR my deposit of \$..... is enclosed (20% required), ship order C.O.D. for balance. NO C.O.D. ORDER FOR LESS THAN \$5.00. BE SURE TO INCLUDE SHIPPING CHARGES.

Circle item No. wanted:
147 159 160 87 152 33

Name

Address

Please Print Clearly

City State

144-MC TRANSMITTER

(Continued from page 319)

vides a maximum of 14 watts output for an input of about 27 watts at 2 meters. We use long-lines (1/4-inch copper tubing) in a shunt-fed ultra-audion circuit. This design keeps high voltage off the lines and was adopted after a number of accidental contacts with the copper tubing while using other circuits. The shape of the tubing saves much space.

The length of each line is 8 3/4 inches and their separation is 1 inch (center-to-center). One line connects to the tube plate cap through a 50 mmf. mica condenser. The other connects to the grid cap through a short length of twisted pair No. 18 wires (for rigidity). Connections to both tube caps and copper tubing are made by means of National grid caps (No. 8). The other ends of the lines terminate in banana plugs which fit into stand-off insulators. The plug-in feature is used because it provides good line rigidity and good electrical connection. A piece of lucite, drilled to accommodate the tubing, aids in keeping them in proper position.

We use a plate voltage of 380 on the HY75. The current with no load is 38 Ma. This rises to 56 Ma. when the antenna or a dummy load is added. The input is then approximately 22 watts. If the circuit has low efficiency, such as is caused by poor VHF chokes or insulation, it will be found that the no-load current will be higher and the tube may be overloaded. The plate should show no bright color even after the longest "rag chews." Since the filament is of the instantaneous heating type, it can be turned off between transmissions. (This is a good feature for mobile work.)

The photograph shows the transmitter adjusted for 146 mc. Frequency is controlled by changing the position of the shorting bar which consists of a twisted pair of No. 18 wires terminated in grid caps. A displacement of less than an inch is sufficient to tune from one end the band to the other. It is well to check frequency whenever a major change is made in the circuit.

Four home-made chokes are used. The grid return is made of 20 turns, 1-inch diameter, 1 1/2-inch length. The plate return uses 25 turns, 1/4-inch diameter, 2 1/4-inch length. No. 24 enameled wire is used for both. The filament chokes use 8 turns of No. 18 wire, 1/2-inch in diameter, 1/2-inch length.

When using plate modulation it is a good idea to keep an eye on the modulating equipment necessary for good results.

One end of Lecher-wire wavemeter, showing slider and turn-buckles to tighten wires.

For an R.F. input of approximately 25 watts, a single 6L6 with 350 and 250 volts on the plate and screen, respectively, is sufficient. Such a convenient set-up eliminates expensive and complicated apparatus at the modulating end of the transmitter.

Most amateurs use a relatively high-gain mike of the crystal or carbon variety for very-high-frequency operation, since very good fidelity is seldom necessary. However, we are equipped with a very low-level velocity mike at W1HCO/2. This requires a high-gain amplifier to bring up the voice.

The amplifier uses a 6J7, 6SJ7 and a 6L6 in that order. The audio stages are conventional except for the addition of a .4 megohm resistor directly between the plates of the last two stages. This degenerative circuit permits higher output with less distortion

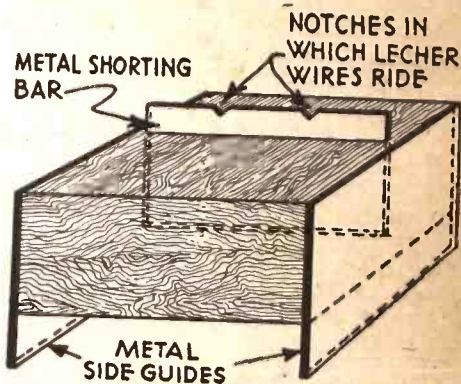
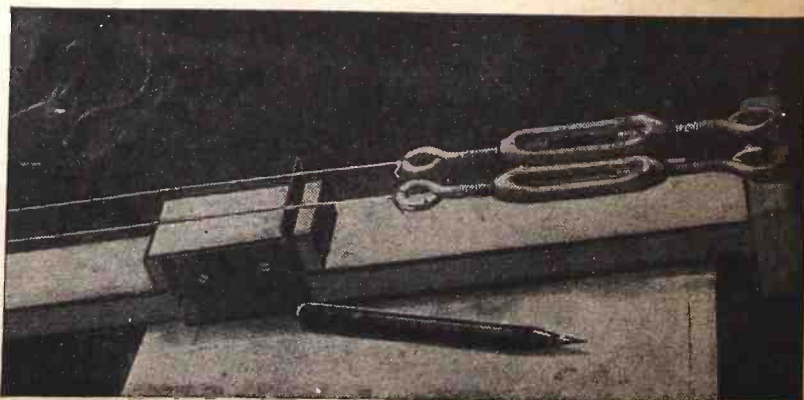

Fig. 3—Sliding block to short Lecher wires. because it minimizes grid current. The 6L6 can provide approximately 11 watts with relatively low distortion with such a connection.

The modulation transformer here is a UTC universal type. Primary and secondary connections are so made as to present an impedance of 4200 ohms at the primary and 6900 ohms at the secondary, thus matching impedances properly.

THE ANTENNA

Our location is not the best for 2-meter work. The roof is not easily accessible for readjustments and the feeder is approximately 4 wavelengths long. Height—so important at these frequencies—is very disappointing here. Use of a long coaxial cable is not recommended because it introduces excessive losses at VHF. Because of the difficulty of constructing a good two-



feeder system of great length we have used a single wire system, which has worked well.

The radiator is a half-wave dipole 40 inches long, made of 1/4-inch brass tubing. It is held at its center by a block of lucite to minimize loss, although this point is a voltage node and special precautions are not required. The feeder connects to a point 12 inches from an end. The other end of the feeder is soldered to a National No. 8 grid cap which slides along the plate line.

To determine the exact point where the feeder connects, it is moved along the copper tubing, starting from the shorting bar end. As it advances, the plate milliammeter will rise from the unloaded value. It should not be moved beyond the point at which the meter indicates maximum plate input. We find that in our rig a point about 2 inches from the shorted end is correct.

POWER MEASUREMENT

A simple and effective means of measuring power output is the use of an ordinary 120-volt incandescent bulb.

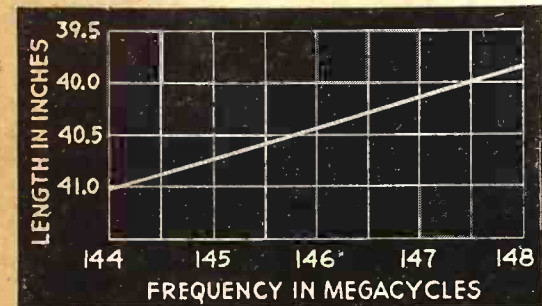

Fig. 4—Frequency may be determined by distance between nodes on the Lecher-wire system.

A 15-watt bulb has an impedance of about 900 ohms at full brilliance, a value not too far from that of usual single or double feeder systems.

To measure power output from the transmitter, disconnect the antenna. Hold the glass bulb so that one base connection is in contact with each line. As the lamp is moved away from the shorted end, it becomes brighter and reaches maximum intensity about three inches away. Its intensity can be compared with that obtained when it is screwed into a line socket. We estimate that 11 or 12 watts are obtained with our set-up.

As the bulb is moved toward the high impedance end of the lines, the plate current will increase. The meter should

be watched and should not be permitted to exceed maximum tube rating. It is even possible to light the bulb by holding it so that only one contact is made, for example, on the plate cap or the grid cap. The return circuit, of course, is made through capacitance.

A small pilot bulb connected in series with the feeders can be used to indicate relative power output while adjustments are made.

It is advisable to use a plate current meter at all times. This allows a continuous check on power input and shows if unusual conditions occur, such as upward or downward modulation, sudden circuit changes, or improper loading.

FREQUENCY DETERMINATION

Exact frequency measurement is essential for any radio transmission service. Fortunately this is simplicity itself at very short wavelengths. We use a Lecher wire system constructed on a 7-foot length of 1x2-inch white pine. Bare wires, one-inch apart, are stretched the length of the baseboard.

At one end the wires are insulated by stand-offs and at the other end small turnbuckles (the ten-cent variety) are used to maintain tension. No insulation is needed at the latter end. A loop of wire made up of a total length of about 18 inches is connected to the insulated end for coupling to the transmitter.

First it is necessary to couple to the transmitter lines or tank a small loop of wire in series with a pilot bulb so that the bulb lights to reasonable brilliancy. Now the Lecher wires are coupled to the transmitter through the 18-inch loop.

A runner made of 1x2-inch wood with a metal shorting strip slides along the base board. As this portable shorting bar is moved along the wires a resonant point is reached where the pilot lamp becomes very dim and possibly goes out. This point is noted. The shorting bar is now moved out to the next resonant point. The distance between these two points determines the operating frequency (Fig. 4).

For convenience we have marked off the wooden base in foot lengths. Then it is only necessary to measure from a resonant point to the nearest mark and subtract or add as called for. The Lecher wire board may be screwed down to a table at each end while it is being used.

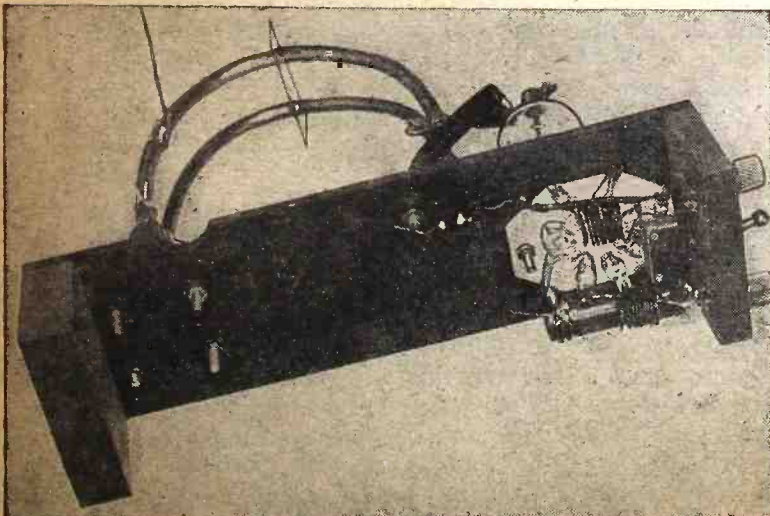

A bottom view of the transmitter unit. The chokes in the filament circuit may be seen at right, under the socket. Grid leak is just below.

RADOLEK

Radio-Electronic Service Parts

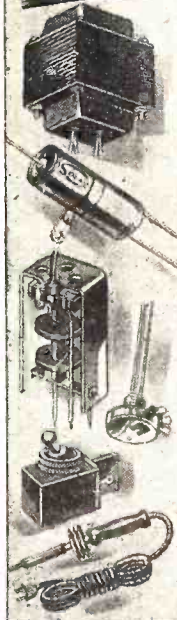

Large stocks assure the finest and most complete selections of all available items at lowest prevailing prices. Thousands of active buyers depend on us for their entire Radio repair and replacement requirements. Because we understand service problems, every order is expedited for delivery in double quick time. Everything we do is planned for convenience and satisfaction to our customers. You will find it profitable to make Radolek your buying headquarters.

FREE BUYING GUIDES

Because of existing conditions we keep our customers right up to the minute on available merchandise by releasing supplements frequently instead of sending our regular Big Profit Guide once a year. Send the coupon now to get these Free Buying Guide Supplements as they are issued.

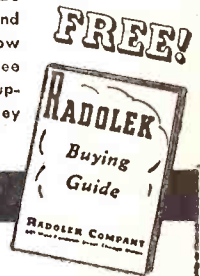

FAST SERVICE!

RADOLEK CO., Dept. C-111
601 W. Randolph St., Chicago 6, Ill.

Please send FREE Buying Guide Supplements

NAME _____
ADDRESS _____

ORDER FROM RADOLEK

Do you need

BINDING POSTS?



The XL PUSH POST with its Spring Action assures Constant Contact and quick connection.
Manufactured in All Aluminum Type M at 12c each.
Aluminum Body, Bakelite Top Type B1 at 15c each.
Types CP or NP, ALL BRASS—STAIN-LESS STEEL SPRING & PIN. PROVEN by 240 HR. SALT SPRAY TEST as NON-CORROSIVE at 28c each.
Manufacturers and Dealers Liberal Discounts

X. L. RADIO LABORATORIES
420 West Chicago Ave., Chicago 10, Ill.

GRABTREE'S WHOLESALE RADIO

2608 Ross Ave.
DALLAS 1 TEXAS

**FILTER CONDENSER BARGAINS!
BIG NEW CATALOG! WRITE FOR LIST!**

CHICAGO
Newark ELECTRIC Company

115-117 W. 45th St. NEW YORK 19 323 W. Madison St. CHICAGO 6

True space ships travelling 3,000 miles per hour are all but practicable today, according to General H. H. Arnold, commander of the Army Air Forces. He believes that "research will unquestionably bring them into being within the foreseeable future."

ROEHR DISTRIBUTING COMPANY

St. Louis' Radio
Mail Order House

- ANTENNAS (Auto and Home)
- CONDENSERS
- RESISTORS
- MICROPHONES
- TUBES
- PHONO MOTORS
- BATTERIES
(All Types
AB Packs)
- PHONO NEEDLES
- TRANSFORMERS (All Types)
- VOLUME CONTROLS
(Complete Stock Carbon
and wire wound)
- ALL R. M. S. CABINETS IN
STOCK

Write for our list of tubes catalog package, and information on how to secure a Speedex Tube Base Chart free of charge.

ST. LOUIS 3, MISSOURI

500 FORMULAS TO SUCCESS

MANY million dollar firms started with a single formula, for which they paid a big price. Here you have 500—no less—tried and tested formulas, recipes and processes for making things . . . all at the ridiculously low price of 25c. Here is your opportunity to start a business with but a few dollars' capital and with undreamed of profits in prospect. You can also use these formulas in your own home to cut household expenses to the bone. Or you can put them to use in your workshop to cut costs as much as 100%. Quit paying out many dollars in profits to manufacturers, wholesalers, and dealers, when you can make the same thing yourself for a few cents. It's so easy when you follow our simple instructions.

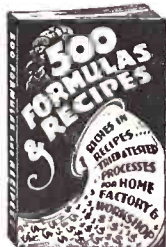

66 PAGES, 3200 WORDS IN TEXT
Send for "500 FORMULAS AND RECIPES" today. Enclose 25c, that's all! You won't be asked for another cent now or later. Sold on a money-back guarantee.

NATIONAL PLANS COMPANY
P. O. BOX 26 R. STATION N. New York 23, N. Y.

BUILD YOUR OWN RADIO SETS

All instructions including simple, easy-to-follow schematic diagrams. All kits complete with tubes.

- 4-tube T.R.F. \$10.75
- 5-tube Superhet \$17.95

Also available in quantities at special discounts. Write for our complete catalog of hard-to-get parts.

NATIONAL RADIO DISTRIBUTORS

Dept. C, 140 West 42nd Street, New York 18, N. Y.

Sixty per cent of all radios manufactured for the postwar market should include FM, it was revealed last month by Frank Mansfield, director of sales research for Sylvania Electric Products. Basing his figures on a survey just completed by his staff, he stated that out of a potential market of 17,400,000 receivers, 10,700,000 prospective owners wanted FM.

Prospects were willing to pay enough above the cost of an AM unit to assure their getting a true high-fidelity type of FM set. Of those queried, 56% stated they would pay \$100 to \$150 extra for a good FM receiver; 27% would add \$30 to \$50; and 13% were undetermined.

COMMUNICATIONS

WE CAN LEARN A LITTLE FROM THE PAST

Dear Editor:

In the minds of the general public, the words radio, television, and to some extent FM, and the ideas they convey, are more or less fixed and clear. How many of these people, though, have ever heard of a crystal set? How many of those who have heard of a crystal receiver, know what it will do or what its limitations are?

Often, in the course of my daily rounds, I take along a little crystal unit complete with an eight-inch magnetic speaker. I ask the householders if they ever saw a crystal set, and most of them reply: "A crystal set? What's that?"

Then, after I demonstrate the set to them, using their antenna, they all marvel and express amazement that such a simple thing, without tubes, without batteries, without current, can do so

much. The usual response is:

"Amazing!" or "It's unbelievable" or "When was this invented, and how soon will I be able to get one of these gadgets?"

It is hard to believe that people who have been using radios for twenty years, do not know what a crystal set is, but that's been my experience. It brings to mind the thought that while people are being educated to the many good NEW things, it might be a good idea to educate or "re-educate" them to some of the many good OLD things that have gone by the board. This is an age of "new gadgets" and I have never succeeded in evoking much interest in crystal sets until I have set up my little pip-squeak radio and shown them what the results were.

JOSEPH D. AMOROSE
Richmond, Va.

ERROR IN 10-TUBE TEST PANEL DRAWING

Dear Editor:

Regarding my article "A Combination 10 Test Panel" printed in the October issue of *Radio-Craft*. I would like to advise you of an error that I made in the drawing of the blueprint pertaining to units No. 8 and 9. I would appreciate it very much if you could spare a little space in your valuable magazine to print this correction.

CHARLES H. McELROY,
Los Angeles, Calif.

The correction is shown in the drawing which appears in the right-hand column opposite.—Editor

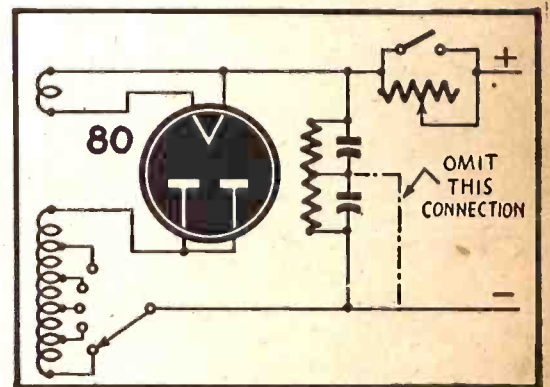

THIS READER JUST DOESN'T BELIEVE US!

Dear Editor:

I have just found time to read your editorial in the November issue of *Radio-Craft*. I am a disabled veteran of World War II and back in the radio business. In your editorial, you seem to think that all a veteran needs will be fulfilled by a neat letterhead. I am afraid you do not grasp our problems at all. First, the printers take care of their old customers first and take as long as a month to print our material. Second, a typewriter has been almost impossible to get. Third, ALL the distributors and manufacturers give us the runaround. They are catering to their old big customers. They don't give a damn if we are veterans and did not have a chance to build up our business during the war to double and triple pre-war levels.

The veterans are the poor slob that went out to win the war while all the draft dodgers stayed home and built up a big business. Now that we are back and have to start from scratch, we get promises of everything, but when you go to see a distributor, they are either out or they frankly tell you that they have already signed up all the dealers they intend to. How the hell will a let-

terhead cure the selfishness of these people?

Let's see you put this in an editorial (without finding excuses for your advertisers).

ROBERT RUBANE
Rubane Radio Service
Baltimore, Maryland

(Radio-Craft has made it a point, since 1929, never to excuse anyone, whether reader or advertiser if the truth was at stake. The above letter is printed to point out that frequently men fail because they do not put enough effort behind their work. World War II could not have been won if the generals, officers, and GI's had not had sufficient resourcefulness to overcome all obstacles.

While some printers take care only of their old customers, we visited at random two printing shops in busy New York, which we had never seen before. Our identity unknown, we had little trouble to get a quotation. Delivery of letterheads was promised in one week, if we wanted them. *Typewriters can be obtained.* Second-hand machines, reconditioned ones, are available in most cities, or can be rented if necessary. It

is true that distributors and manufacturers frequently do give runarounds. This is a country-wide condition, much of which will be rectified by the time this letter appears in print.

If veterans present their case in a business-like manner, they are more likely to be taken care of if there is merchandise to be had. It is no doubt true that some manufacturers have

signed up all the dealers they need—we doubt that all of them have done so. The very real difficulties pointed out in the letter above are all the more reason why the serviceman must make a business-like approach. These difficulties can and must be surmounted—there is no reason why you should add further handicaps to those that already exist.—*Editor*)

THIS RADIOMAN WANTS 'EM HARD TO FIX

Dear Editor:

Having come across a copy of *Radio-Craft*, August issue, I was struck by the childish attitude some "service engineers" adopt towards their chosen profession. According to them, coils, resistors, and condensers, etc., ought to have indicators to show whether they are faulty or not; then the engineer checking such a set just looks at a dial, remove the faulty component, and plugs in a new one. Do you call this repairing a radio?

Why do these people call themselves engineers, if all they have to do is read a dial and remove a plug in a new part? What are analyzers, oscillators, etc., for? If they don't know how to use

these instruments, let them chuck the radio trade and do something where brains aren't needed. If these people want to earn money, they'll have to use their heads, and they should remember that "there's nowt for nowt in this world."

O. NEUMANN

London, England

(Strangely enough, industrial electricity and commercial communications do just what our correspondent objects to. There is a growing trend toward fuses that indicate when they are blown out, and components that are "repaired" by simply removing the whole unit and installing a new one.—*Editor*)

WORLD-WIDE STATION LIST

(Continued from page 344)

San Francisco Calif.	KNBX	7.805	Oriental beam, 5 to 11 am
San Francisco Calif.	KNBX	9.490	Oriental beam, 11:15 am to 3:30 pm
San Francisco Calif.	KNBI	9.490	Oriental beam, midnight to 3:45 am; Hawaiian beam, 4 to 9:45 am
San Francisco Calif.	KGEI	9.550	East Indies beam, 4 to 10:45 am; Alaska beam, 11 am to 12:45 pm
San Francisco Calif.	KWID	9.570	Oriental beam, 11:15 am to 1 pm; South American beam, 7:45 to 11:15 pm; Alaska beam, 11:30 pm to 1:45 am
San Francisco Calif.	KWIX	9.570	Oriental beam, 2 to 11 am
San Francisco Calif.	KCBF	9.700	Oriental beam, 1 to 4:45 pm
San Francisco Calif.	KWID	9.855	South Pacific beam, 2:30 to 6:30 am
San Francisco Calif.	KGEX	11.730	Southwest Pacific beam, 2 to 4:45 am
San Francisco Calif.	KGEI	11.730	Southwest Pacific beam, 1 to 4:45 pm
San Francisco Calif.	KCBA	11.770	South American beam, 11 pm to 1 am; 5 to 10:45 pm; Oriental beam, 1 to 4:45 pm
San Francisco Calif.	KNBA	11.790	Philippine beam, midnight to 3:45 am; South American beam, 5 to 11:45 pm
San Francisco Calif.	KWIX	11.890	Hawaiian beam, 4 pm to midnight; 12:15 to 1:45 am
San Francisco Calif.	KCBR	13.050	Oriental beam, 10:15 pm to 1 am
San Francisco Calif.	KGEI	15.130	Alaska - Oriental beam, 5 to 7:45 pm; Southwest Pacific beam, 8 pm to midnight
San Francisco Calif.	KNBX	15.150	Oriental beam, 9 to 11:45 pm
San Francisco Calif.	KGEX	15.210	Philippine beam, 4 pm to 1:45 am
San Francisco Calif.	KNBX	15.240	Oriental beam, 3:45 to 8:45 pm
San Francisco Calif.	KNBI	15.340	South American beam, 5 to 11:45 pm; Oriental beam, 2 to 4:45 pm
San Francisco Calif.	KWID	17.760	South American beam, 5 to 7:30 pm

San Francisco Calif.	KNBA	17.780	South Pacific beam, 2 to 4:45 pm
Schenectady New York	WGEO	9.530	South American beam, 5 to 11 pm
Schenectady New York	WGEO	11.847	European beam, 6 am to 3:45 pm; Brazilian beam, 4 to 10:30 pm
Schenectady New York	WGEQ	15.330	European beam, 6 am to 4:30 pm
Washington D.C.	WWV	2.500	U.S. Bureau of Standards; 6 pm to 8 am
Washington D.C.	WWV	5.000	U.S. Bureau of Standards; frequency, time and musical pitch; continuous day and night
Washington D.C.	WWV	10.000	U.S. Bureau of Standards; frequency, time and musical pitch; continuous day and night
Washington D.C.	WWV	15.000	U.S. Bureau of Standards; frequency, time and musical pitch; continuous day and night
U.S.S.R.			
Moscow		5.440	8 am to 6 pm
Moscow		5.815	11 am to 6 pm
Moscow		5.960	11 am to 6 pm
Moscow		6.028	5:45 to 9:30 pm
Moscow		6.230	noon to 6:25 pm; 7 to 9:45 pm
Moscow		6.230	noon to 6:25 pm; 7 to 9:45 pm
Moscow		6.980	5:45 to 6:25 pm; 7 to 9 pm; 11:15 to 11:45 pm
Moscow		7.300	noon to 5 pm; 6:15 to 11:30 pm
Moscow		9.480	6 to 8 am; 11 to 11:30 am; midnight to 1 am
Moscow		9.650	4:30 to 9:15 pm
Moscow		9.715	6:30 to 7:30 am
Moscow		10.450	midnight to 2 am; 9:30 to 10 am
Moscow		11.780	9 to 10 am
Moscow		11.830	10 pm to 2 am; 6 to 8 am; 11 to 11:30 am; 6 to 7 pm
Moscow		11.885	6:45 to 8 am; 6:30 to 7:30 pm
Moscow		12.080	8 to 11 am
Moscow		12.175	6:45 to 7:45 am; 8:30 to 10:30 am; noon to 1 pm; 7 pm to 1 am



Learn modern watch and clock repairing

At home, spare time. Good field now... security and contentment in future. Start part-time business and earn while you learn. Horology is precision instrument work... a great and growing field, potential opportunities. Busy self-instruction course. Low price. Money-back guarantee. Write now for Free Success-Catalog.

NELSON CO., 1139 S. Wabash Ave. Dept. 2839, Chicago 5, Ill.

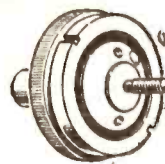

"WONDER" ELECTRIC BUTTON

Most interesting electrical apparatus ever discovered. Make your own Telephone Amplifier. Detectophone. Transmit your voice or music to distant rooms. Perform hundreds of fascinating experiments. So tiny it can be concealed in dozens of places. Send \$1 now for button and free 5,000 word instruction booklet with 50 illustrated experiments. SPECIAL OFFER 6 buttons and booklets sent postpaid for \$5. Write now to

BUCK MFG. COMPANY North Aurora, Illinois



MAGIC CUTTER

Cuts up to 4" hole in plastics, wood and metal. Wonder tool for amateurs and professionals developed by famous lab for own use. Send \$1 to: Dept. C-2

ROBERTS ASSOCIATES P.O. Box 622, G.C. ANNEX, N.Y. 17

HAZELTON INSTRUMENT CO.

Electric Meter Laboratory

Electrical instruments, Tube Checkers, and Analyzers repaired.

140 Liberty St., New York, N.Y.

Tel. BARclay 7-4239

Moscow		12.265	4 to 5:30 pm; 8 to 9:30 pm; 10 pm to 6 am; 7 am to 1 pm
Moscow		15.320	5 to 11:30 am
Moscow		15.340	5:30 to 9:30 am
Moscow		15.230	5:45 to 6:25 pm; 6:45 to 8:15 am; 3 to 3:45 pm
URUGUAY			
Montevideo	CXA6	9.623	3:30 to 8 pm
Montevideo	CXA15	9.735	
Montevideo	CXA19	11.705	7 to 8 pm
Montevideo	CXA19	11.835	6 am to 10 pm
Montevideo	CXA10	11.900	3:30 to 9 pm
VATICAN CITY			
	HVJ	5.968	11 am to noon; 1 to 3 pm
	HVJ	9.660	noon to 1:30 pm; 1:45 to 2:30 pm
	HVJ	11.740	noon to 1 pm
	HVJ	15.120	Wednesdays, midnight to 12:30 am
	HVJ	17.445	Wednesdays and Saturdays, 8:45 to 9:15 am
VENEZUELA			
Trujillo	YVIRO	3.310	5 to 9:30 pm
Maracaibo	YVIRT	3.370	5:30 to 10:30 pm
Caracas	YV5RY	3.380	9:30 am to 10:30 pm
Maracay	YV4RK	3.390	6 to 10:30 pm
Merida	YV2RC	3.420	6 to 9:30 pm
Maracaibo	YVIRV	3.440	7 to 9:30 pm
Barquisimeto	YV3RS	3.490	4:30 to 9:30 pm
Barquisimeto	YV6RC	3.510	6 to 9:30 pm
Caracas	YV5RS	3.530	5:30 am to 10:30 pm
Maracaibo	YVIRV	4.750	6 to 9:30 pm
La Guaira	YV5RV	4.760	5 to 9:30 pm
Coro	YVIRY	4.770	4 to 10 pm
Valencia	YV4RO	4.780	4:30 to 9:30 pm
Maracaibo	YVIRL	4.810	6:30 am to 11 pm
Volera	YVIRZ	4.840	4:30 to 9:45 pm
Barquisimeto	YV3RN	4.990	6:30 am to 10:30 pm
Ciudad Bolivar	YV6RD	6.200	5 to 9:30 pm
Caracas	YV5RW	3.400	5:30 am to 10:30 pm
Caracas	YV5RX	3.500	6:30 am to 10:30 pm
Caracas	YV5RM	4.890	5:30 to 10:30 pm
Caracas	YV5RN	4.920	6 am to 10:30 pm
Puerto Caballo	YV4RQ	3.480	5 to 9:30 pm
San Christobal	YV2RN	4.830	11 am to 9 pm
Valencia	YV4RP	3.460	8 to 9:30 pm
YUGOSLOVIA			
Belgrade		6.150	1 to 6 pm
Cetinje		9.360	1:30 to 3 pm
Belgrade		9.420	midnight to 2 am; 10 to 10:45 am

VELOCITY P.G. DYNAMIC

AMPERITE

FOR PUBLIC ADDRESS & RECORDING

MICROPHONES THAT SURPASS THE HIGHEST REQUIREMENTS OF BROADCASTING, PUBLIC ADDRESS, AND RECORDING

KONTAK MIKES

Write for Catalog

AMPERITE COMPANY
561 BROADWAY NEW YORK, N. Y.

DEALERS YOU CAN MAKE A DOUBLE PROFIT THROUGH HANDLING BOOKS

1. BOOKS BRING YOU BETTER CUSTOMERS
They stimulate the interest and knowledge that make steady buyers. The more your customers know about radio the more they will buy from you.

2. BOOKS ARE A PROFITABLE STOCK ITEM
Our trade discounts allow you a good profit on each sale. Our wide promotion insures their sale without effort on your part.

We can supply copy and cuts for your catalog and circulars with your imprint. Write us today for full information on our new radio books, our dealers' discounts and free promotional aids.

The Macmillan Co., 60 Fifth Ave., New York 11
Tech. Bk. Dept.

Latest claimant for the title of "America's oldest broadcast station (until now in dispute between KDKA and WWJ) is KQW, San Jose, California. According to evidence submitted by the present station manager, KQW, established in 1909 by Dr. Charles D. Herrold, began broadcasting on a regular schedule in 1912.

The pioneer station has been consistently on the air since then, with the exception of the time it was compelled to remain closed during the first World War.

INDEX TO ADVERTISERS

Allied Radio Corp.	353	Ohmite Manufacturing Co.	346
Amperite Co.	356	Onan & Sons, D. W.	355
Arrow Electronics Co.	350	Opportunity Adlets.	367
Arrow Radio Co.	360	RADIO SCHOOL DIRECTORY	
Audel & Co., Theo.	336	(See Page 368)	
Autopower, Inc.	359	American Radio Institute	
Bell Telephone Labs. Ins. Back Cover		Candler System	
Buck Manufacturing Co.	365	Commercial Radio Institute	
Buffalo Radio Supply Co.	357	Lincoln Engineering School	
Burstein-Applebee Co.	355	Melville Radio School	
Cannon Co., C. F.	361	RCA Institutes, Inc.	
Capitol Radio Eng. Institute.	323	Western Radio Institute	
Centralab Co.	343	YMCA	
Commercial Equipment Co.	356	Radio-Craft	367
Concord Radio Corporation.	345	Radio Distributing Co.	353
Coyne Electrical School ..	304, 356	Radio Electric Service.	354
Crabtree Wholesale Radio.	363	Radio Kits Co.	358
DeForest Laboratories, Lee.	355	Radio Product Sales Co.	351
DeForest's Training, Inc.	301	Radio Publications	355
Free Want Ad Service.	359	Radio & Television Supply Co.	361
General Cement Mfg. Co.	353	Radio Wire Television, Inc.	348
General Electric Co.	351	Radionic Equipment Co.	361
Greene, Jack.	353	Radolek Co.	363
Hallicrafters, Co., Inc.	299	Raytheon Manufacturing Co.	329
Hazleton Instrument Co.	365	Rider, John F.	347
Hudson Specialties Co.	362	Roehr Manufacturing Co.	364
Kluge Electronics Corp. Back Cover		Roberts Associates	360, 365
Lake Radio Sales Co.	358	Scenic Radio & Electronic Co. ...	361
LeJay Mfg. Co.	357	Solar Mfg. Co. Inside Front Cover	
Le Matériel Radiophonique	355	Sperry Gyroscope Co.	295
McElroy, T. R.	357	Sprague Products Co.	300
McMurdo Silver Corp.	341	Sprayberry Academy of Radio ...	297
Macmillan Co., The	366	Superior Instrument Co.	325
Maquire Industries.	334, 335	Supreme Publications.	333, 349
Miles Reproducer Co.	356	Sylvania Electric Prods. Co.	294
Murray Hill Books.	330, 331	Terminal Radio.	360
National Plans Institute.	364	Triplett Elec. Instrument Co. ...	339
National Radio Distributors.	364	Turner Co.	337
National Radio Institute.	293	University Laboratories	358
National Schools.	302, 303	Weston Instrument Co.	344
National Union Radio Corp.	296	Wholesale Radio Laboratories ...	352
Nelson Co.	335	X. L. Radio Labs.	363
Newark Electric Co., Inc.	363		

SWISS RADIO RENTAL

(Continued from page 312)

pairs. However, the majority are leased to subscribers desiring a low-cost lease service.

The used-set subscriber makes a down payment of about \$5.75. His total monthly rental fee is about \$1.40. There is no insurance and repair fee. If the subscriber breaks the contract on one month's notice he is given a credit note for rent paid minus \$11.50 which he can use toward the purchase of a new set from Steiner. This plan is attractive to a customer and at the same time guarantees the firm at least \$17.75 to cover the cost of the exchange, in addition to the profit on the sale of a new set.

Another service is offered by the firm for those who already own a receiver and don't wish to trade it in. This is called a *Tube and Repair Subscription* service. The subscriber signs a 20-month contract and pays about \$1.40 a month. In return Steiner keeps his set in repair and replaces necessary parts

and tubes at no extra cost. The unusual feature of the plan is this: Over a 20-month period the customer will have paid a total of about \$27.60. Against this is charged \$11.50 for repairs made during the period. The remaining \$16 paid in is given back to the subscriber in the form of a credit which can be applied to the purchase of a new set from the firm. The customer participates in a savings plan and the firm is assured a new set sale. Over 20,000 subscribers participate in this plan.

Before the war all repair work in outlying regions was done by a small fleet of well-equipped mobile repair shops. Each of these glass-panelled repair trucks carried a crew of three repairmen and seven salesmen.

Radio Steiner is now going ahead with its postwar plans which include the introduction of television to Swiss audiences. The company plans to purchase a television transmitter and 50 receivers for demonstration purposes. The transmitter will be installed in one of the mobile repair trucks. The other repair trucks will be converted to a television demonstration caravan.

BOOK REVIEWS

ELECTRICAL MEASURING INSTRUMENTS, Measurement and Surveys, by E. S. Lincoln, Consulting Engineer, Fellow A.I.E.E. Published by Essential Books. Stiff cloth covers, 5½ x 8½ inches, 284 pages. Price \$3.00.

This book deals with electric systems and electrical surveys as well as with electrical measuring instruments. Since the whole electric field is covered, only one chapter is of direct interest to the radioman—that on portable instruments.

All types of industrial measuring instruments are covered, including power factor meters, wattmeters and various types of recording meters. Useful information on connections to various types of meters, on accuracy, damping, scales, etc., is also included.

THE ELECTROLYTIC CAPACITOR, by Alexander M. Georgiev. Published by Murray-Hill Books, Inc. Stiff cloth covers, 6 x 9½ inches, 191 pages. Price \$3.00.

A thoroughly modern book on the subject. The author's approach is from the industrial point of view, and much of his space is devoted to discussion of electrolytic capacitor design and manufacturing processes.

Four chapters discuss electrodes and electrolyte from both the theoretical and practical viewpoints. Discussion of the dielectric film is divided into two chapters—one theoretical and one practical. Such subjects as spacers, impregnation of dry and liquid capacitors, the container and its vent, measurements, routine and special tests and the causes and detection of troubles in electrolytic capacitors, are discussed.

Advantages and disadvantages of electrolytic in comparison with non-electrolytic capacitors, and of dry versus wet capacitors, are given a chapter each. Another is devoted to semi-electrolytic capacitors (types with a dry electrolyte which permits greatly increased working voltages at the expense of very high internal resistance).

Design also receives a chapter, and the one following it, "Trends in the Development of Electrolytic Capacitors," indicates possible future improvements.

TRANSMISSION LINES, ANTENNAS AND WAVE GUIDES, by Alexander H. Wing, Lecturer on Electronics, Harvard University; Ronold W. P. King and Harry Rowe Mimno, Associate Professors of Physics and Communication Engineering, Harvard University. Published by McGraw-Hill Book Co. Stiff cloth covers, 6 x 9 inches, 347 pages. Price \$3.50.

The section on transmission lines, which occupies seventy pages, is possibly the most interesting part of the book. A combination of mathematical treatment and physical application is

used, equations and schematic drawings often appearing together in the text. Such items as standing-wave ratios, impedance matching by various methods, measurements, efficiency and harmonic suppression are covered with great thoroughness in a mathematical manner.

The section on antennas also combines the physical and mathematical approach. Electromagnetic theory is considered from the viewpoint of retarded action and special divisions are made for the "near zone" (where action may be considered instantaneous) and "far-zone" in which the antenna is considered as being coupled to the universe as a whole.

Wave guides are dealt with in the section headed, "Ultra-High-Frequency Circuits," and are treated in standard fashion. A further section covers wave propagation, treatment of this subject also being standard.

A number of problems based on the work of the first three chapters appears at the back of the book.

SCIENCE YEAR BOOK OF 1945, edited and with an introduction by John D. Ratcliff. Published by Doubleday, Doran & Company, Inc. Stiff cloth covers, 5½ x 8 inches, 224 pages. Price \$2.50.

This fourth annual edition is a compilation of the twenty-eight best science articles published during the past year. The articles are culled from national magazines and were chosen for their readability and reliability as well as for their interest to the greatest number of people. The entire volume is divided into four parts, covering the most beneficial discoveries and developments in the fields of medicine, physics, chemistry, aviation, electronics and other fields of science.

One article of particular interest to radiomen and radio technicians is "Electrons in Medicine," which describes such electro-medicinal aids as the pygmy phototube earring worn by pilots as an automatic oxygen control, and which measures the change in capacity in the ear lobe, turning on and shutting off the oxygen supply automatically; an electronic surgical knife which, while it cuts, sterilizes and coagulates the blood and seals the capillaries to prevent bleeding; a new type of metal detector for locating steel splinters in a person's eye; a balloon-equipped device that is lowered into the stomach to determine the presence and position of ulcers; and cyclotron treatments by which simple salts are activated to give them the properties of radium.

The chapter, "The Electron in Industry," is from an article by Waldemar Kaempfert in *The New York Times Magazine*, "Electrons in Medicine" from one by A. G. Mererik in *Hygeia*.

WORLD'S FIRST RADIO MAGAZINE

APRIL, 1908
(Miniature Size)

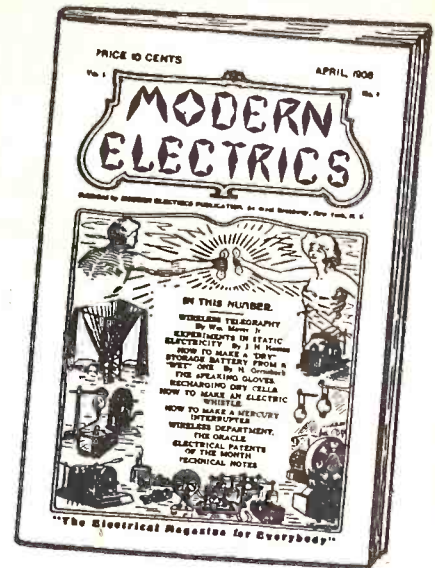

This souvenir booklet reduced to 3¼" x 5" is a copy of the first edition of *Modern Electrics* originally issued April 1908. It was recently distributed at the Annual Meeting of the Institute of Radio Engineers. You will find it fascinating reading. Look back with the pioneers to the early wireless days, and you will appreciate more fully the extraordinary development of radio since that period. Enclose 15c for your copy.

RADIO-CRAFT
25 West Broadway New York 7, N. Y.

OPPORTUNITY AD-LETS

Advertisements in this section cost 20 cents a word for each insertion. Name, address and initials must be included at the above rate. Cash should accompany all classified advertisements unless placed by an accredited advertising agency. No advertisement for less than ten words accepted. Ten percent discount six issues, twenty percent for twelve issues. Objectionable or misleading advertisements not accepted. Advertisements for March, 1946, issue must reach us not later than January 28th, 1946.
Radio-Craft • 25 W. B'way • New York 7, N. Y.

USED CORRESPONDENCE COURSES, EDUCATIONAL and Technical Books Bought, Sold, Rented, Catalog Free. Educational Exchange, Henager, Ala.

MAGAZINES (BACK DATED)—FOREIGN, DOMESTIC, arts, Books, booklets, subscriptions, pin-ups, etc. Catalog 10c (refunded). Cicerone's, 863 First Ave., New York 17, N. Y.

AMATEUR RADIO LICENSES, COMPLETE CODE and theory preparation for passing amateur radio examinations. Home study and resident courses. American Radio Institute, 101 West 63rd Street, New York City. See our ad page 368.

CORRESPONDENCE COURSES AND SELF-INSTRUCTION books, slightly used. Sold, Rented, Exchanged. All subjects. Satisfaction guaranteed. Cash paid for used courses. Complete information and 92-page illustrated bargain catalog Free. Write—NELSON COMPANY, Dept. 2-39, Chicago 4.

RESISTORS—WIRE WOUND—5 WATT ADJUSTABLE up to 3500 ohms. Five for \$1.00. RADIOCO, 1110 Marshall Bldg., Cleveland, Ohio.

SURPLUS RADIO AND ELECTRONIC PARTS AND equipment. New and used. Write for free list. Highbridge, 812 Canal St., New York City 13.

J. R. Poppele, chief engineer of WOR, New York, was re-elected president of Television Broadcasters Association at their annual meeting of the Board of Directors in New York.

All the other officers of the organization were also re-elected, as follows: Vice-President, F. J. Bingley, Philco Radio & Television Corp.; Secretary-Treasurer, Will Baltin, Assistant Secretary-Treasurer, O. B. Hanson, NBC. Ernest H. Vogel, Farnsworth Television & Radio Corp., was elected a director of TBA to succeed Lewis Allen Weiss, Don Lee Broadcasting System. Mr. Poppele and G. Emerson Markham, General Electric Co., were re-elected as directors.

RADIO SCHOOL DIRECTORY

PREPARE NOW FOR SKILLED JOBS IN RADIO AND ELECTRONICS
MAKE a place for yourself in a new world of radio and electronics—a world in which revolutionary electronic developments will require highly specialized technical knowledge. Take a good course now to fit yourself for a good paying job. The training you need can be supplied by one of the schools advertised in this publication.

CODE SENDING
RECEIVING SPEED

Be a "key" man. Learn how to send and receive messages in code by telegraph and radio. Commerce needs thousands of men for jobs. Good pay, adventure, interesting work. Learn at home quickly through famous Candler System. Write for FREE BOOK.

CANDLER SYSTEM CO.
 Dept. 3-B, Box 928, Denver 1, Colo., U. S. A.

RCA INSTITUTES, Inc.
 Offer thorough training courses in all technical phases of
Radio and Television
 DAYS—EVENINGS WEEKLY RATES

VETERANS: RCA Institutes is approved under G. I. Bill of Rights
 For Free Catalog Write Dept. RC-46

RCA INSTITUTES, Inc.
 A Radio Corporation of America Service
 75 VARICK STREET NEW YORK 13, N. Y.

RADIO

Train with professionals. Complete, intensified courses; Repair & Maintenance, Communications, High-speed telegraphy, Slip transcription, FCC exams, etc.
 High School Students accepted for training as Merchant Marine Radio Officers. Gov't sponsorship available to veterans.

"A Radio School managed by radio men."
 45 W. 45th St., Dept. RC, New York 19, N. Y.

MELVILLE RADIO INSTITUTE

COMMERCIAL RADIO INSTITUTE
 A radio training center for twenty-four years.

RESIDENT COURSES ONLY

Broadcast, Service, Aeronautical, Television and Marine telegraphy classes now forming. Literature upon request. Veteran training. Classes now forming for mid-year term February 1st.

Dept. C, 38 West Biddle St., Baltimore 1, Md.

RADIO

RADIO Technician and Radio Communications courses. Register now for new classes starting first MONDAY of each month. Day and Evening Classes.

AMERICAN RADIO INSTITUTE
 101 West 63rd St., New York 23, N. Y.
 APPROVED UNDER GI BILL OF RIGHTS.

RADIO COURSES

- RADIO OPERATING
- RADIO SERVICING — ELECTRONICS
- CODE
- REFRIGERATION SERVICING

Personal Counseling Services for Veterans
 Write for Latest Trade & Technical Catalog

Y.M.C.A. TRADE & TECHNICAL SCHOOLS
 4 W. 64th Street New York City

LEARN RAPID RADIO SERVICING

Send for Free Information: "3 Ways to Learn Radio." Approved for Training Veterans.

WESTERN RADIO INSTITUTE
 1457 Glenarm, Denver 2, Colo.

LES Correspondence Courses in
RADIO and ELECTRICAL ENGINEERING

ELECTRICAL ENGINEERING Get good grasp of wide electrical field. Prepare yourself, at Low Cost, for secure future. Modern, simplified, you can understand quickly.

RADIO ENGINEERING Extra fine course in radio, public address, photo-electric work. Trains you to be super-service man, real vacuum tube technician. Servicemen needed badly. Diploma on completion. Tuition \$25 either course. Deferred payment plan. Get copies of school catalogs, student magazines, complete details. SEND NOW!

FREE

LINCOLN ENGINEERING SCHOOL Box 931C-84 Lincoln, Neb.

TELEVISION RECORDING

(Continued from page 305)

consideration: when we speak of television recording we not only refer to video impulses alone, but to audio impulses as well.

Today, nearly all television broadcasts are made on a single channel. For instance, one station in New York City uses a video channel from 60-65.7: the audio band is 65.7-66. If a broadcast using such a channel is to be recorded it can be seen that the problem becomes more complex due to the great differences of frequencies between the audio and the video parts. Besides *both* must be recorded simultaneously.

Nevertheless, it can be accomplished if we use the circular film-disk, as mentioned above, or if recording can be done by magnetic means, say on a thin, narrow band of iron, then simultaneous video and audio recording becomes possible. (The Germans before the war had an interesting plastic film, impregnated with an exceedingly thin deposit of pure iron, for recording purposes.) If some

electro-chemical means of recording can be developed, that also becomes a future possibility.

Some interesting possibilities of television recording become possible once the problem has been solved. We give but one example.

At the present time there is already on the market a machine now used in hospitals. This appliance is placed on the floor, or on a table; book pages are projected on the ceiling, enabling the patient to read a book without moving a hand, or moving a muscle. Once we have television recording it then becomes feasible to record the pages of an entire book and project them on your home television screen. As the pages are turned at the rate of 1¼ to 1½ minutes per page, you can then sit in front of your television receiver and read a book from your easy chair without the necessity of holding the volume and turning the pages. There is a real demand for appliances of this type.

RARER RADIO TROUBLES

THE Philco 19 chassis often develops two troubles, especially when put in use after long disuse because of the radio shortage due to the war. These are a leakage in the 75-42 coupling condenser and decreased gain in the R.F. coil. The coupling condenser trouble can be easily overlooked since the grid may still be negative despite the leakage. This is a result of the fixed bias circuit which grounds the 42 cathode. The check must be made across the grid leak only, especially since bias increases with grid voltage, though not fast enough to prevent distortion. (As a result of this leakage the 42 usually becomes very weak and should of course be replaced also.) The 75 bias also increases, which causes added distortion (75 is also fixed-biased). The coupling condenser between volume control and 75 should be checked *after* the 75-42 coupling condenser is replaced.

The RF coil sometimes is open, sometimes still passes a little current, causing plate voltage to be low by 100 or more volts. Gain is then negligible, and the 1st stage actually attenuates even with 150 volts nominal plate supply.

On the Montgomery Ward 93WG603 I often find a hum of the sort caused by a shorted tube, but very elusive indeed. The trouble is caused by the pilot light socket developing leakage to chassis, which is off ground potential for A.C. It is originally mounted on a bakelite bracket, which breaks off, so that the metal frame is used directly as support. One may cure the trouble by replacing bracket or socket.

Also, on this set, the volume control is mounted "aloft," with a rubber twisted pair extending from switch. The rubber soon deteriorates and a short occurs from wire to wire, or wire to chassis, so that the owner is no longer Lord and Master of the "offs and ons" of his set. Customers remark on the quaint habit these sets develop of coming on during the night, with high volume since the volume contact is often back on the high volume side of the resistance when the switch is off, a situation of little consequence in the normal set.

Here is a trouble I find occasionally on any model set with push-pull output. Distortion increases with volume, and disappears when either output tube is removed. The trouble is that the replacement output transformer is incorrectly connected, as shown in the figure.

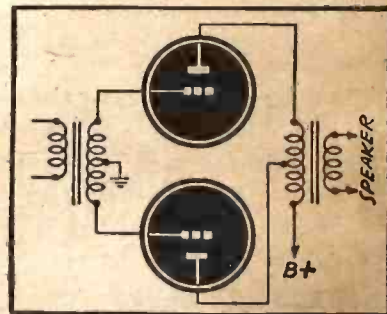

The trouble could be traced no doubt to unusually coded outputs and faded coding on long cables from chassis to speaker. Also parts with unlabeled lugs may have been used with this slip resulting.

You can usually sell a couple of new tubes with the job, since only mismatched (usually from age) tubes sound at all good in the wrong connection.

RCA T-10-1 and similar sets have a metal cased coupling condenser which often shorts, diode-biasing the 6F5 to cutoff on strong signals on high volume settings. Due to high grid leak, this is almost impossible to check without a VTVM.

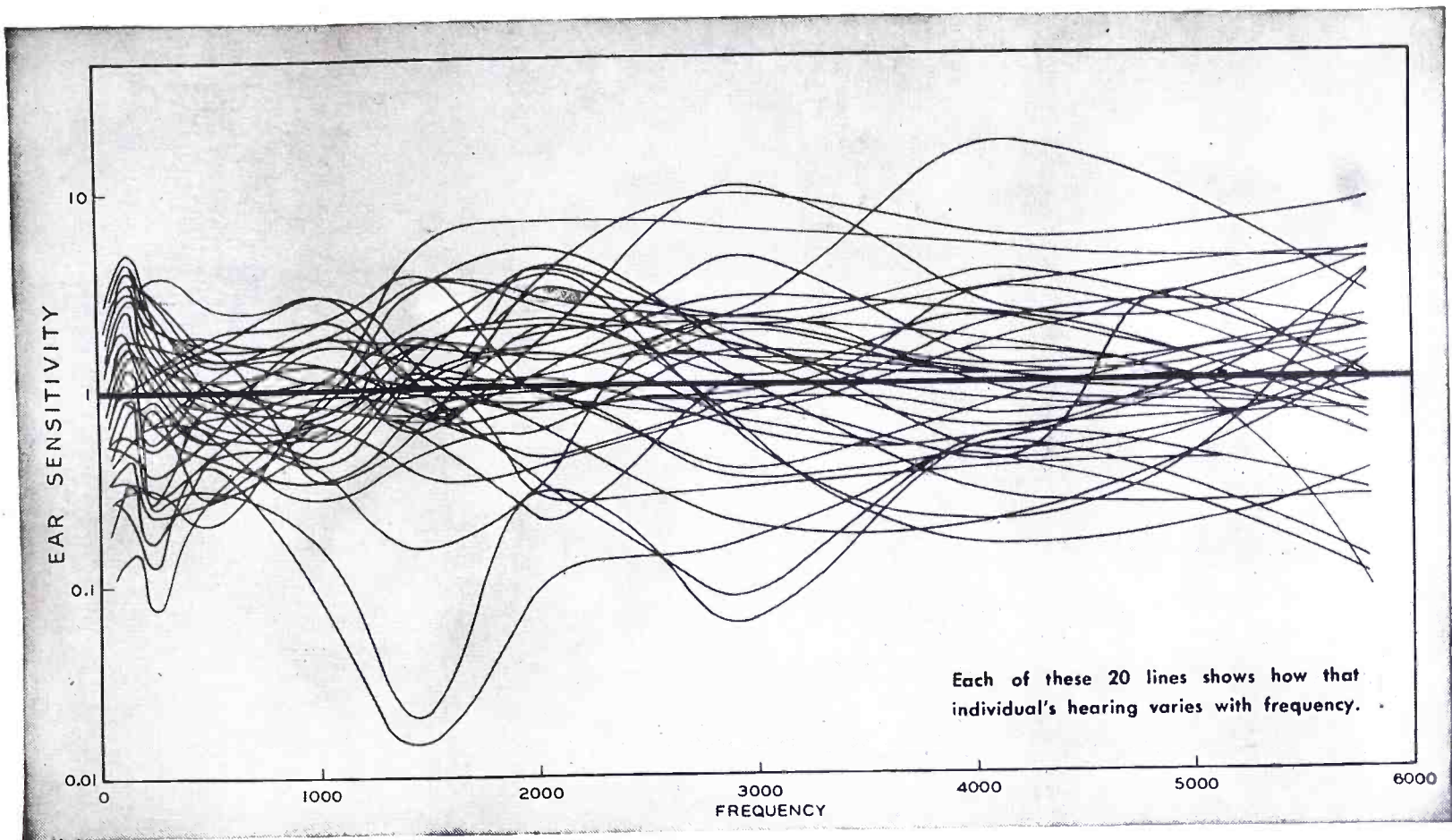

To measure is to know

Twenty-five years ago, one standard of sound power was the ticking of a watch, another was the clicking of two coins; and the measure was how far away the tick or the click could be heard. That test was made in measuring people's hearing, a field of interest to the Bell System scientists because the ear is the end-point of every talking circuit.

Accustomed to exact measurements, Bell scientists proceeded to develop a method of measuring hearing-sensitivity in terms which could be precisely

defined and reproduced. After plotting hundreds of runs like those above, they decided on a particular sound intensity, representing an average "threshold of hearing," as a starting point.

The sounds delivered by a telephone line had previously been evaluated by listeners who compared their loudness with that of a standard source. There were wide variations in ears, as the chart shows, so the engineers replaced them by electrical instruments. When later their associates developed the

Western Electric radio and public address systems, the necessary measuring circuits were promptly forthcoming. Addition of a standard microphone made a noise meter, widely used in quieting airplanes and automobiles.

"Through measurement to knowledge," said a famous Netherlands scientist. The principle finds wide application in Bell Laboratories, whether the quest be for a way to measure sound, a new kind of insulation, or more economical telephone service.



Hearing was first measured reliably by engineers in the Bell Telephone Laboratories



For good reception, program loudness must stay within certain limits. Volume-meters help to hold it there

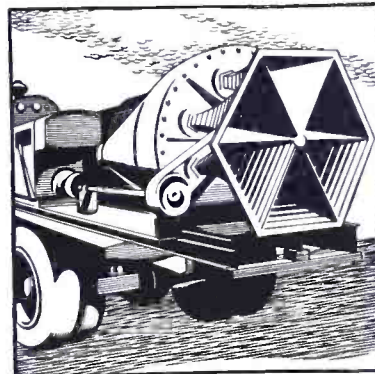

From the throat of this mighty air-raid siren comes the loudest sustained sound ever produced



Visible Speech, result of telephone research, turns sound into "pictures" that the deaf can read

BELL TELEPHONE LABORATORIES



Exploring and inventing, devising and perfecting for continued improvements and economies in telephone service

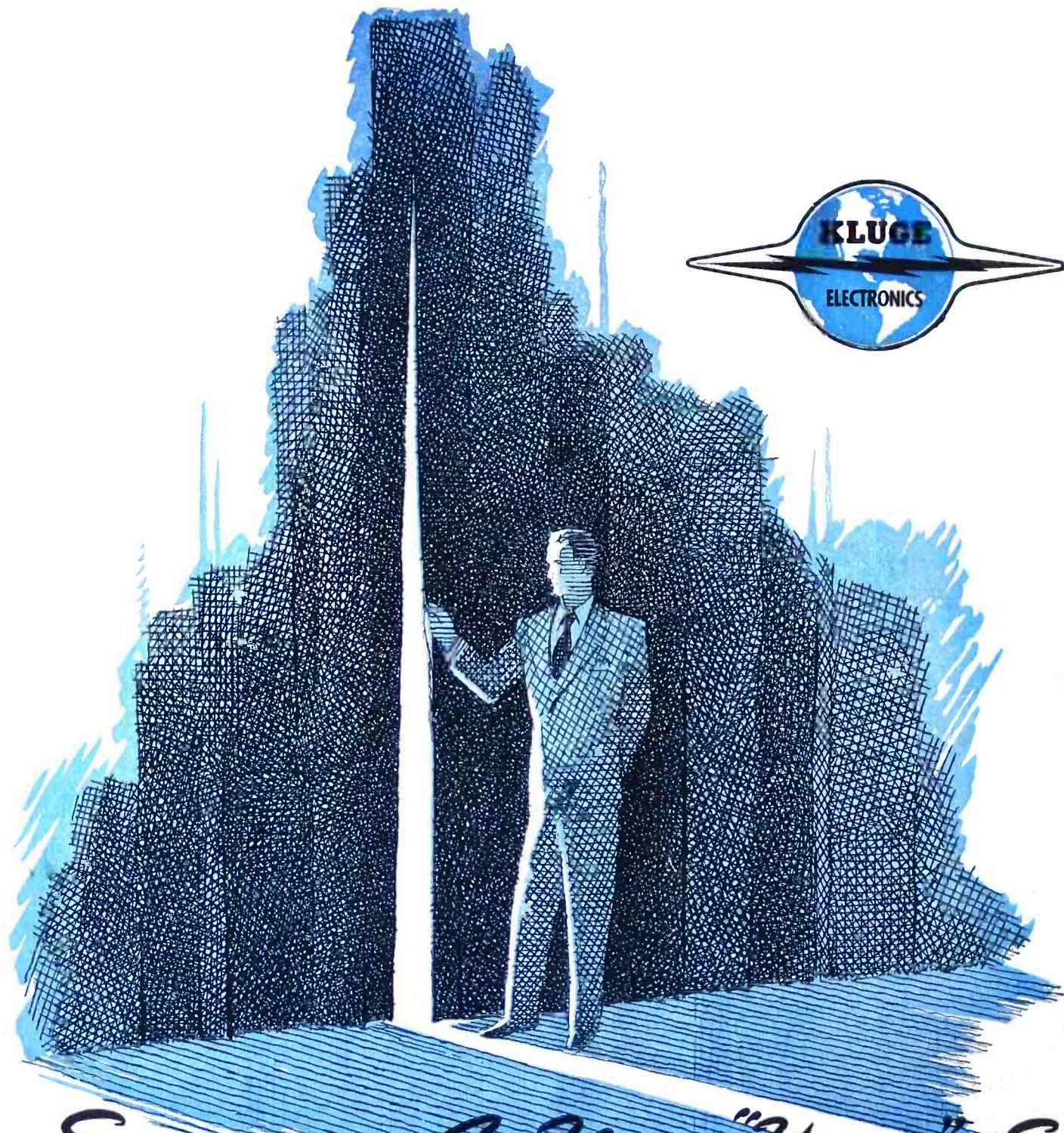

Soon... A New "Ham" Era

The curtain is rising on a remarkable "new era" development for the "hams" and *potential* hams of the world! It's so logical... so ingenious, in its use of advanced electronics and ultra-modern principles of design that we have kept the secret for showings in *all parts of the country*, at the same time. Dealers will be ready soon. Don't miss their KLUGE "Premieres" ... It won't be long!

KLUGE
ELECTRONICS
C O M P A N Y

1031 NORTH ALVARADO STREET • LOS ANGELES 26, CALIFORNIA